

RADIO & TELEVISION NEWS

MAY
1950

RADIO-ELECTRONIC
ENGINEERING
EDITION

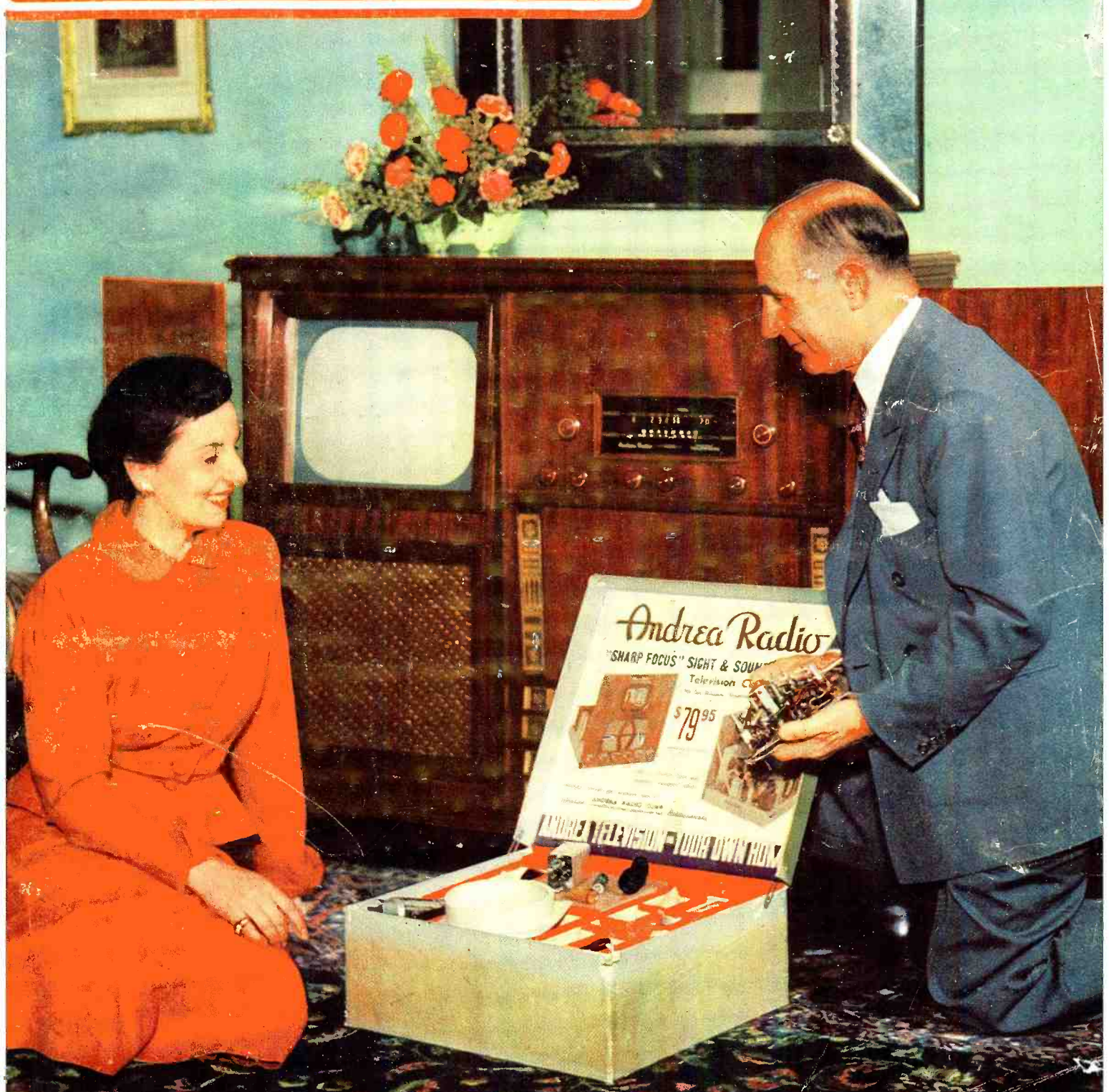

30 YEARS OF RADIO-TELEVISION PIONEERING

PAGE 40

THE QUALITY OF RCA TUBES IS UNQUESTIONED

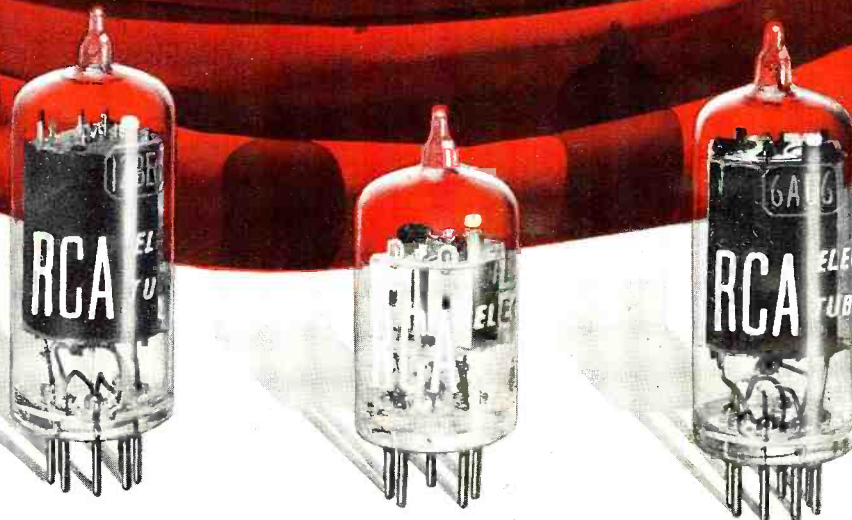

Higher Quality Standards

for TV, FM and AM

THE *QUALITY LEVEL* of RCA miniatures has been continually advanced in step with circuit progress. Improved design . . . more rigid control over manufacture and inspection . . . and more exacting tests, including rigid re-test before shipment, are the reasons why RCA miniatures have unusually uniform characteristics, so important to tubes for television receivers in particular, and also for FM and AM receivers. Their dependability in criti-

cal circuits cuts down costly service call-backs.

And now . . . this *extra* quality of RCA miniatures is "packed in so it can't be shaken out." A new type "snug-fit" carton protects tubes against damage by holding them securely in place during transit.

RCA's engineering leadership adds *value beyond price* to the RCA tubes you sell. Your customers know about this advantage too.

Always keep in touch with your RCA Tube Distributor



RADIO CORPORATION of AMERICA
ELECTRON TUBES

HARRISON, N. J.

Editor
OLIVER READ, Lit.D., W9ETI

Managing Editor
WM. A. STOCKLIN, B.S.

Technical Editor
H. S. RENNE, M.S.

Associate Editor
RAY FRANK, W9JU

Contributing Editor
R. HERTZBERG, W2DJJ

Television Consultant
MILTON S. KIVER

Short-Wave Editor
KENNETH R. BOORD

Editorial Assistants
I. M. CARROLL
E. V. HITZEL
P. B. HOFFER

Staff Artist
R. S. KUPJACK

Advertising Manager
L. L. OSTEN

Midwest Adv. Manager
JOHN A. RONAN, JR.

Art Director
HERMAN R. BOLLIN

RAD O & TELEVISION NEWS

First in
radio-television-electronics

Average Paid Circulation over 200,000

Radio News Trademark Reg. U.S. Pat. Office No. 378427 • Television News Trademark Reg. U.S. Pat. Office No. 517468
 Radio & Television News Trademark Reg. U.S. Pat. Office No. 517025

CONTENTS

MAY, 1950

Radio Parts Show Program of Events.....	24
Simplified Ham TV Station.....	<i>J. R. Popkin-Curman, W2LNP</i> 35
Something New in Transceivers.....	<i>Kenneth M. Kortge, W8AHT</i> 39
Frank Andrea—Radio and Television Pioneer.....	<i>Arthur Pine</i> 40
Use Test Pattern to Align Your TV Set.....	<i>Jack H. Kubanoff</i> 42
A Simple Electronic Metronome.....	<i>Guy Dexter</i> 45
Extra Income for the Service Shop.....	<i>John B. Ledbetter</i> 46
The Variable Permeability Sweep Generator.....	<i>M. E. Clark</i> 48
A Supermodulated Phone Transmitter.....	<i>Rufus P. Turner, K6AI and John W. Graves, W6MYR</i> 51
A High Efficiency Triode Amplifier.....	<i>Melvin C. Sprinkle</i> 55
Sterling—First "Ham" on FCC.....	<i>Jack Terry</i> 58
Built-in TV Antenna.....	<i>Robert B. Albright</i> 59
The Genescope—A TV Test Instrument.....	<i>Milton S. Kiver</i> 60
NBFM and Frequency Shift Keying Unit for Self-Excited Oscillator.....	<i>R. W. Jones, W6EDG</i> 63
Experimental Magnetic-Type D.C.-A.C. Signal Inverter.....	<i>James Kauke</i> 64
Development of Fan Type TV Antenna.....	<i>Harry Greenberg and Harold Harris</i> 66
Mac's Radio Service Shop.....	<i>John T. Frye</i> 68
Design Considerations for High-Quality Reproducing Systems (Part 2).....	<i>Herb Matthews</i> 69
Multi-TV Receiver Operation from Single Antenna.....	<i>Daniel Lerner</i> 79
Fixed Bias vs. Self Bias.....	<i>Charles P. Boegli</i> 88



COVER PHOTO: Frank A. D. Andrea and his daughter inspect one of his early "Neutrodyne" kits in front of a present-day Andrea television set. (Kodachrome by Nick Desmond)

Chairman of the Board and Publisher
WILLIAM B. ZIFF

President
B. G. DAVIS

Secretary-Treasurer
ARTHUR T. PULLEN

Vice-Presidents
MICHAEL H. FRÖELICH
Dir. Eastern Div.

H. J. MORGANROTH
Production Director

H. G. STRONG
Circulation Director

BRANCH OFFICES

NEW YORK (1)
 Empire State Bldg., WJ 7-0400

LOS ANGELES (14)
 815 S. Hill St., Tucker 9213
 Manager, WILLIAM L. PINNEY

DEPARTMENTS

For the Record.....	<i>The Editor</i> 8	MARS.....	100
Spot Radio News.....	16	What's New in Radio.....	117
Within the Industry.....	30	AFCA News.....	138
Short-Wave.....	<i>K. R. Boord</i> 54	New TV Products.....	146
Technical Books.....	84	Manufacturers' Literature.....	156
Letters from Our Readers.....	172		



COPYRIGHT 1950
 ZIFF-DAVIS PUBLISHING COMPANY
 185 North Wabash Ave., Chicago 1, Ill.
 VOLUME 43 • NUMBER 5



Member
 Audit Bureau of
 Circulations

RADIO & TELEVISION NEWS is published monthly by the Ziff-Davis Publishing Company, 185 N. Wabash Ave., Chicago 1, Ill. Subscription Rates: In the United States \$4.00 (12 issues), single copies 35c; in Canada \$4.00 (12 issues), single copies 40c; in Mexico, South and Central America, and U. S. Possessions, \$4.00 (12 issues); in British Empire, \$5.00 (12 issues)—all other foreign countries \$5.00 (12 issues). Subscribers should allow at least 2 weeks for change of address. All communications about subscriptions should be addressed to: Director of Circulation, 185 N. Wabash Ave., Chicago 1, Ill. Entered as second class matter July 21, 1948, at the Post Office, Chicago, Illinois, under the Act of March 3, 1879. Entered as second class matter at the Post Office Dept., Ottawa, Canada. Contributors should retain a copy of contributions and include return postage. Contributions will be handled with reasonable care but this magazine assumes no responsibility for their safety. Accepted material is subject to whatever revisions and byline changes that are necessary. Payment made at our current rates, covers all authors', contributors' or contestants' rights, title and interest in and to accepted material, including photographs and drawings.

RADIO & TELEVISION NEWS



BE A SUCCESS AS A RADIO-TELEVISION TECHNICIAN

TWO FREE BOOKS SHOW HOW MAIL COUPON

America's Fast Growing Industry Offers You All Three

I TRAINED THESE MEN AT HOME



OWNS SUCCESSFUL BUSINESS
"Today I am considered an expert Radio-Television Technician. I have four employees working in my shop. Repair business has doubled."—PAUL MILLER, Toledo, Ohio.



RADIO ENGINEER ABC NETWORK
"4 years ago, I was a bookkeeper with a hand-to-mouth salary. Now I am a Radio Engineer with key station of the ABC network."—NORMAN H. WARD, Ridgefield Park, New Jersey.



\$5 TO \$10 WEEK IN SPARE TIME
"While learning, made \$5 to \$10 a week in spare time. Now have a spare time shop in my home and earn as high as \$25 a week."—LEANDER ARNOLD, Pontiac, Michigan.



SERVICING BUSINESS PROFITABLE
"For the past two years, I have been operating my own Servicing business. Net profit, \$6,850. N.R.T. training made it possible."—PHILIP G. BROGAN, Louisville, Kentucky.



GETS FIRST JOB THROUGH N.R.T.
"My first job, with KDLR, was obtained for me by your Graduate Service Dept. Am now Chief Engineer, Police Radio Station WQOX."—T. S. NORTON, Hamilton, Ohio.



SEES PROFIT IN RADIO-TELEVISION
"I am operating my own Radio Sales and Service business. With FM and Television, we are looking forward to a very profitable future."—ALBERT PATRICK, Tampa, Florida.



SPARE TIME SERVICE PAYS WELL
"Work only in spare time at Radio and average about \$40 a month. Knew nothing about Radio before enrolling with N.R.T."—SAMUEL T. DEWALD, St. Clair, Pennsylvania.

1. EXTRA MONEY IN SPARE TIME

As part of my servicing course, I send you SPECIAL BOOKLETS starting the day you enroll that show how you can make \$5, \$10 or more a week EXTRA fixing neighbors' Radios in spare time while learning. Tester you build with parts I send helps.

2. GOOD PAY JOB

Your next step is a good job installing and servicing Radio-Television sets, or becoming boss of your own Radio-Television Sales and Service Shop, or getting a good job in a Broadcasting Station. In 1945, there were 943 Radio Stations. Today, about 2,700 are on the air! Result—thousands of qualified men stepped into good jobs. Then add developments in FM, Two-Way Radio, Police, Aviation, Marine, Micro-wave Relay Radio. Think what this means! New jobs, more jobs, good pay for qualified men.

3. BRIGHT FUTURE

And think of the opportunities in Television. Only 19 Stations were on the air in 1947. Today, more than fifty. And the experts say there will be over 1,000 within three years. Manufacturers are producing over 100,000 Television sets a month. Be a successful Radio-Television Operator or Technician . . . get in line for success and a bright future in America's fastest-growing industry!

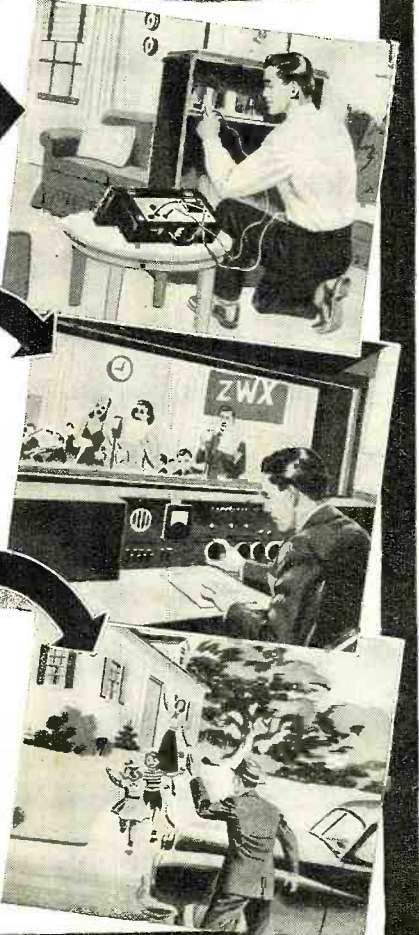

I Will Train You at Home You Practice Servicing or Communications with MANY KITS

I've trained hundreds of men with no previous experience to be successful TECHNICIANS. I will train you, too. Or now you can enroll for my NEW practical course in Radio-Television Communications. Train for your FCC operator's or technician's license. You learn Radio-Television theory from clear, illustrated lessons in my tested home study courses.

As part of both my Servicing and Communications course, I send you MANY KITS of modern equipment that "bring to life" theory you learn.

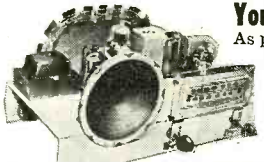

You Build This MODERN RADIO
As part of my Servicing course, I send you speaker, tubes, chassis, loop antenna, transformer. EVERYTHING you need to build this modern Radio. Use it to conduct many valuable tests and practice servicing. It's yours to keep.

You Build This TRANSMITTER
As part of my New Communications course, I send parts to build this low-power broadcasting Transmitter that shows how to put a station "on the air." Perform procedures demanded of Broadcast Station operators, conduct many tests, experiments. It's yours to keep.

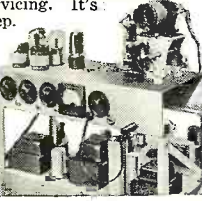

Building circuits, conducting experiments with them, introducing and repairing defects, gives you valuable, practical experience. (Some of the equipment you get is shown below.) Everything I send is yours to keep.

Mail Coupon for Books FREE

Coupon entitles you to ACTUAL LESSON on Radio Servicing with many pictures and diagrams plus my 64-page book, "HOW TO BE A SUCCESS IN RADIO-TELEVISION" . . . both FREE. See what my graduates are doing and earning. Send coupon today. J. E. SMITH, President, Dept. OER, National Radio Institute, Pioneer Home Study Radio School, Washington 9, D. C.

VETERANS

GET THIS TRAINING UNDER G. I. BILL. MAIL COUPON NOW.

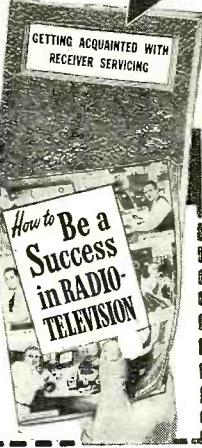

Good for Both - FREE

MR. J. E. SMITH, President, Dept. OER National Radio Institute, Washington 9, D. C.

Mail me Sample Lesson and 64-page Book about How to Win Success in Radio-Television—both FREE. (No salesman will call. Please write plainly.)

Name.....Age.....
Address.....
City.....Zone.....State.....
 Check if Veteran Approved Under G. I. Bill

Six Months from Today

Which will YOU hold?

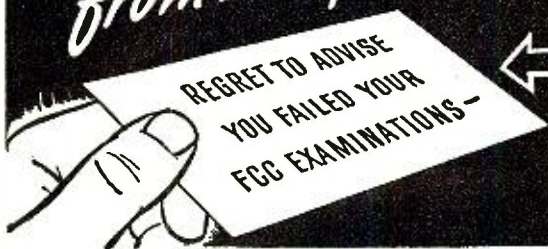

← THIS
OR THIS →



WANT YOUR FCC COMMERCIAL LICENSE IN A HURRY?

Add Technical Training to Your Practical Experience and Get Your "Ticket" in a FEW SHORT WEEKS It's EASY When You Use CIRE Simplified Training and Coaching AT HOME in SPARE TIME

Thousands of new jobs are opening up—FM, Television, Mobile Communication Systems. These are only a few of the radio fields which require licensed radio technicians and operators. Get your license without delay. Let Cleveland Institute prepare you to pass

FCC license examinations, and hold the jobs which a license entitles you to, with CIRE streamlined, post-war methods of coaching and training.

Your FCC Ticket Is Always Recognized in ALL Radio Fields as Proof of Your Technical Ability

More than ever before an FCC Commercial Operator License is a sure passport to many of the better paying jobs in this New World of Electronics. Employers always give preference to the license

holder, even though a license is not required for the job. Hold an FCC "ticket" and the job is yours!

CIRE Job-Finding Service Brings Amazing Offers of Jobs!

"Have found and accepted a position at KWAD in Wadena, Minn. I am indebted to CIRE for I secured this position through the help of the CIRE Job Finding Service. I had six other offers from stations receiving my employment application and CIRE reference. I am sincerely under obligation to you."
Fred Kincaid, Wadena, Minn.

"I am working at WRJM as transmitter engineer, and I received this position in response to one of the employment applications sent me upon completion of my course and the receiving of my Diploma. I received my 1st class Radiotelephone License on March 2, 1949."
"I want to express my sincere appreciation to the staff of CIRE."
George Hugo, New Haven, Conn.

"Thanks for the Application for Employment you recently prepared for me. I found satisfactory employment. I submitted 57 letters, enclosing the resume you supplied. I received 17 letters indicating my application was filed for future reference; 3 telephone calls, and one letter requesting personal interviews.
"As a result, I am employed in a development engineering capacity."
Kenneth Forsberg, Cambridge, Mass.

"I have secured a position as combination engineer-announcer at WBSC, Bennettsville, S. C. I mailed 140 of the Job-Finding applications and I started here January 29th. I wish to thank you again for your very good course and your help in getting me this job."
Russell Caldwell, Bennettsville, S. C.

Look at the Job Opportunities You Will Have When You Get Your FCC Ticket!

- | | | |
|----------------------------|------------------------|-----------------|
| Forestry and conservation | Bus and truck fleets | Street railways |
| Ambulances and hospitals | Police and fire depts. | Taxicab fleets |
| Gas and electric utilities | Telephone companies | Railroads |
| Gas and oil pipe lines | Merchant marine | Airlines |
| Private automobiles | Highway Patrol | |

LOOK AT THESE AVERAGE PAY SCHEDULES FOR BROADCAST JOBS (Reported by FCC Nationwide Survey)

Position	Big Stations	Little Stations
Transmitter Engineer	\$4800	\$3000
Studio Engineer	5000	3650
Chief Engineer	7700	4300

Other jobs requiring FCC commercial licenses pay similar salaries.

Ours is the *Only Home Study Course of Coaching and Training Primarily Planned to Lead Directly to an FCC Commercial License.*

Get this AMAZING NEW BOOKLET

1. Tells of Thousands of Brand-New Better Paying Radio Jobs Now Open to FCC License Holders.
2. Tells How We Guarantee to Train and Coach You Until You Get Your FCC license.
3. Tells How Our Amazing Job-FINDING Service Helps You Get the Better Paying Radio Job Our Training Prepares You to Hold.



Mail Coupon At Once GET ALL 3 FREE

Approved for Veteran Training under

"G. I. Bill of Rights"

CLEVELAND INSTITUTE OF RADIO ELECTRONICS (Address to Desk No. to avoid delay)
Desk RN-17, 4900 Euclid Bldg., Cleveland 3, Ohio

I want to know how I can get my FCC ticket in a few short weeks by training at home in spare time. Send me your amazing new FREE booklet "Money Making FCC License Information," as well as a FREE sample FCC-type exam and FREE booklet "How to Pass FCC License Examinations" (does not cover exams for amateur license).

Name

Address

City..... Zone..... State.....

Veterans check for enrollment information under G. I. Bill

**YOU BUILD 'EM
IN ONE EVENING
BUT...**

THEY LAST A LIFETIME!

SAVE 50% WITH

**LABORATORY
PRECISION**



**INSTRUMENTS
& KITS**

SENSATIONAL NEW

**EICO Model 360-K TV-FM SWEEP
SIGNAL GENERATOR**

• Crystal marker oscillator with variable amplitude. • Covers all TV and FM alignment frequencies between 500 kc. and 228 mc. • Sweep-width variable from 0-30 mc, with mechanical inductive sweep. • Extremely wide sweepwidth allows gain comparison of adjacent RF TV Channels. • Provides for injection of external signal generator marker. • Phasing control included. • Large, easy-to-read dial is directly calibrated in frequencies. Vernier tuning condenser. Comes complete with all tubes (including new, high-frequency miniature types): 6X5GT, 12AU7, two 6C4's. Crystal not included. 10"x8"x6 3/4". 5 Mc. Crystals available for above, each \$3.95.

\$29.95



FACTORY-WIRED AND TESTED Model 360. Ready to use Sweep Signal Generator. \$39.95
See it at your local jobber!

**ANYONE
CAN BUILD
THEM!**



\$19.95

**NEW! MODEL 320-K
SIGNAL GENERATOR**

For FM, AM alignment and to provide TV marker frequencies. Highly stable Hartley oscillator has range of 150 kc. to 102 mc. with fundamentals to 34 mc. Colpitts audio oscillator supplies pure 400 cycle sine wave voltage for modulation. Vernier tuning condenser. Use audio oscillator voltage to test distortion in audio equipment, bridge measurements, etc.

FACTORY-WIRED AND TESTED Model 320. Ready to use. . . . \$29.95

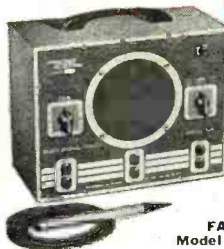

\$18.95

**VERSATILE MULTI-
SIGNAL TRACER**

Model 145-K. High gain—high frequency. Self-contained test speaker permits audible signal tracing of RF, IF, FM, audio and video circuits. Provision for visual tracing with VTVM. Response is well over 200 mc. 3-color hammettone panel. 110-125 V. AC. Size: 10"x8"x4 3/4". Comes complete with tubes and diode probe in kit form.

FACTORY-WIRED AND TESTED Model 145. Ready to operate. . . . \$28.95

**NEW PUSH-PULL
5" TV
OSCILLOSCOPE
Model 425-K Kit**

ALL-NEW laboratory precision scope has Push-Pull deflection and .05 to .1 volts per inch sensitivity. Wide range, flat from 5 cps to 500 kc. with full gain setting, useful to 2 1/2 mc. Wide-range, multi-vibrator, sweep circuit from 15 cps to 75,000 cps. Direct connection to plates of CRT available at rear of cabinet. Z axis intensity modulation feature included. Size: 8 1/2"x17"x13" high. Complete with 3-6SN7s, 2-6J5s, 2-5Y3s, and 5BP1 CRT.

FACTORY-BUILT OSCILLOSCOPE Model 425. Fully wired and tested \$69.95

\$39.95



**HIGH PRECISION
VACUUM TUBE
VOLTMETER
Model 221-K**

\$23.95

Tops in workbench versatility—15 different ranges! AC and DC ranges: 0/5/10/100/500/1000 volts. Electronic ohmmeter ranges from .2 ohms to 1000 megohms in 5 steps. New features include Zero Center for TV discriminator alignment. 26 Meg. DC input impedance. Accurate, 4 1/2" meter cannot burn out. Double triode balanced bridge circuit assures guaranteed performance. Sturdy portable steel base with etched rubproof panel. Will measure up to 30,000 V. and 200 MC. when used with our HVP-1 or P-75 probes. 110-130 V. AC 50-60 cycle. Size: 9 7/16"x6"x5".

FACTORY-WIRED AND TESTED Model 221. Same, but completely wired, calibrated, and tested. . . . \$49.95



**DELUXE SIGNAL
GENERATOR
MODEL 315**

Completely wired, ready-to-use Signal Generator with 1% accuracy! A wonderful instrument with dozens of expensive features. Frequency range: 75 kc to 150 mc. Has microcycle band-spread vernier tuning for FM, AM, and TV. Voltage regulator. Write for \$59.95 full details.

Model 511-K. A "Must" for every serviceman! Small, handy instrument used a thousand times a day. Large 3" meter, beautifully etched panel. A perfect kit for beginners. Simple to assemble. Ranges: DC-0/5/50/250/500/2500 volts. AC-0/10/100/500/1000 volts. Output-0/10/100/500/1000 v. DC Ma-0/1/10. DC A m p s. -0/1/10. Ohm meter -0/500/100,000 ohms/0/1 meg. DB meter -8 to +55 Db. \$14.95

ASSEMBLED-READY TO USE Model 511 - Completely wired, tested, and assembled at the factory. Rugged, built for heavy duty. . . . \$17.95

**VOLT-OHM
MILLIAMMETER
Complete Pocket Kit**



\$14.95



HIGH VOLTAGE PROBE

Complete top-quality Voltage Test Probe Measures up to 30,000 Volts. Special Helical-Wound Ceramic HV Multiplier Resistor adaptable to most VTVM's and all 20,000 ohms per volt meters with 1000 or 5000 volt scales. Lucite head, plywood bakelite handle, large flashguards for additional safety. Specify your instrument. Complete, ready to use. . . \$6.95

**ASK YOUR
LOCAL JOBBER**

About EICO's new Tube Tester Kit Model 625K—"The most 'versatile' Tube Tester ever designed!"

**Write For New Catalog "R"
Prices Higher on West Coast**

**Model
HVP-1**

HIGH FREQUENCY RF PROBE

Model P-75K germanium crystal probe for visual RF signal tracing and measurements to over 200 megacycles. Can be used with models 221 or 113A Eico instrument (state which when ordering). 6 1/2" long, 1/2" O.D., with wire, plugs, and all components.

IN KIT FORM \$3.75
Model P76K same as above, but for oscilloscopes; in kit form. \$3.75
Models P75 or P76 similar to above but factory wired, ready to operate. Each. . . \$7.50

EASY-TO-FOLLOW SCHEMATIC & PICTORIAL DIAGRAMS

Come complete with every EICO Instrument Kit. Each kit fully guaranteed to operate perfectly when assembled according to our simple instructions! **EXCLUSIVE LIFE-TIME REPAIR SERVICE:** For a nominal charge, we will repair and service your EICO instrument, regardless of its age!



**ELECTRONIC INSTRUMENT CO., INC.
276 Newport Street, Brooklyn 12, N. Y.**

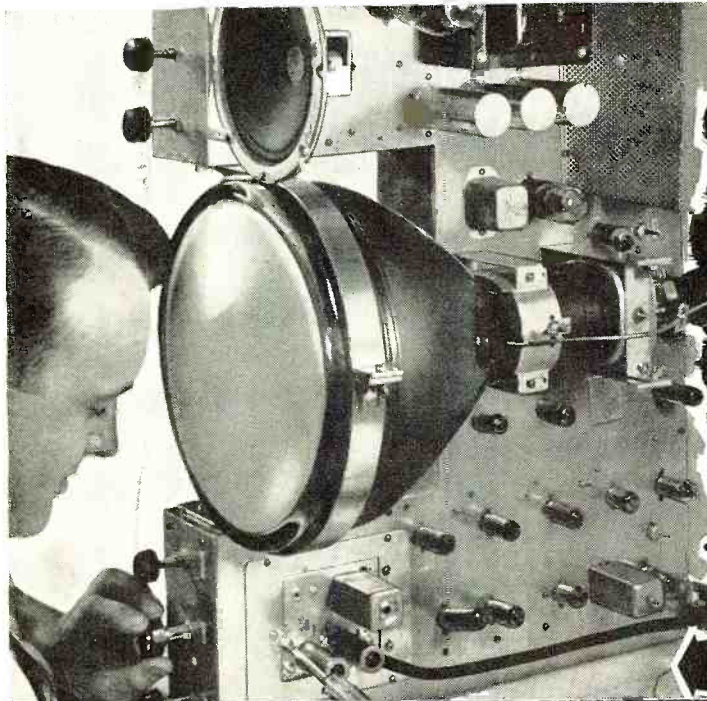

Only D.T.I.
offers you the
"BIG 5"
TELEVISION
RADIO-ELECTRONICS
Laboratory Type
HOME TRAINING

1 **OPTIONAL FEATURE**

Build and Keep 10, 12½ or 16 inch Picture Tube Quality TELEVISION RECEIVER as you prepare for a Profitable Future



You Learn-By-Doing from D.T.I.'s HOME LABORATORY

2

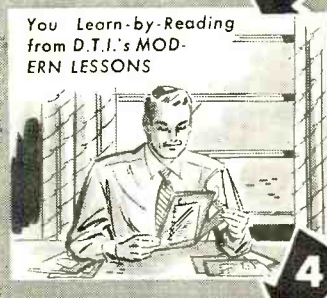

You Learn-by-Reading from D.T.I.'s MODERN LESSONS

4



You Learn-by-Seeing from D.T.I.'s HOME MOVIES

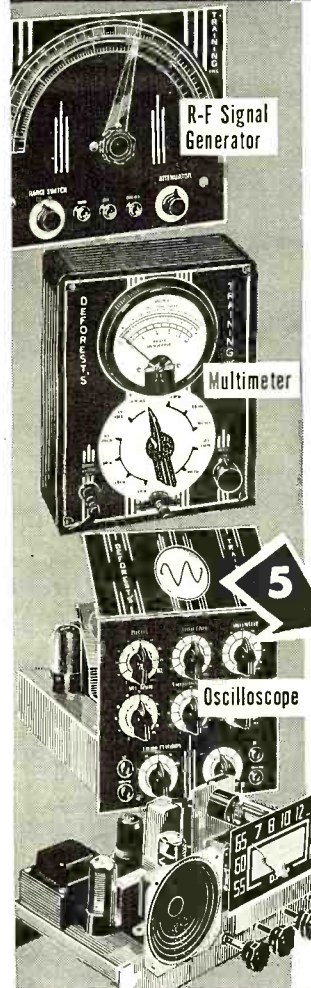
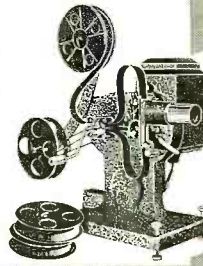

R-F Signal Generator

Multimeter

Oscilloscope

6 Tube Radio Receiver

Here is everything you need to prepare you at home for FASCINATING WORK, GOOD MONEY and a THRILLING FUTURE in one of America's most promising fields.

This includes the opportunity to build and keep the top quality Television Receiver shown above—with choice of a 10, 12½ or 16 inch picture tube that gives big, bright, sharp, steady pictures. Get the complete facts. This is an optional feature — available when you complete your training described below. See how D.T.I.'s wonderfully practical "BIG 5" method meets industry's needs. No previous experience needed. Mail coupon today!

16 Big Shipments of Parts — Plus Lessons

Work over 300 electronic experiments and projects from 16 big shipments of parts. This includes building and keeping all test equipment and radio set shown at left side of page. Modern easy-to-read lessons with handy fold-out diagrams simplifies your entire training.

You Also Use Home Movies

D.T.I., alone, includes the modern, visual training aid . . . MOVIES to help you learn faster, easier at home. See electrons on the march and other fascinating "hidden action"—a remarkable home training advantage that speeds your progress.

EMPLOYMENT SERVICE

When you complete your training, our effective Employment Service helps you get started toward a real future in Television-Radio-Electronics.

Modern Laboratories

If you prefer, you can get ALL your preparation in our new, Chicago training laboratories . . . one of the finest of its kind. Ample instructors . . . modern equipment. Write for details!

DeFOREST'S TRAINING, INC.
Chicago 14, Illinois
A DeVry Institution

MAIL THIS COUPON TODAY!

DeFOREST'S TRAINING, INC.
2533 North Ashland Avenue, Dept. RN-G-5
Chicago 14, Illinois.

Without obligation, give me complete facts showing how I may make my start in Television-Radio-Electronics.

Name _____ Age _____
Street _____ Apt. _____
City _____ Zone _____ State _____

POWER- PACKED

FOR HEAVY DUTY



SOLDERLITE

STREAMLINED



5-SECOND
HEATING

RIGID-TIP

LONGER REACH

DUAL HEAT

—single heat
200 watts,
dual heat
200/250 watts;
115 volts,
60 cycles

New WELLER 250-watt Soldering Gun

Heavy jobs and light jobs—the new 250-watt Weller Soldering Gun speeds them all. Chisel-shaped RIGID-TIP provides more soldering area for faster heat transfer. New “over-and-under” terminal design gives bracing action to tip. Your Weller Gun does delicate or heavy soldering with equal efficiency; compact and lightweight, it gets into the tightest spots.

Weller Guns actually pay for themselves in a few months. Fast 5 second heating means no time lost. Trigger-switch control means no current wasted—no need to unplug gun between jobs. Prefocused spotlight and longer length let you see the job and reach the job with ease. No other soldering tool offers so many time-and-money-saving features. Order your new 250-watt Weller Gun from your distributor today, or write for bulletin direct.

SOLDERING GUIDE

Get your copy of “SOLDERING TIPS”—new fully illustrated 20 page booklet of practical soldering suggestions. Price 10c at your distributor's or order direct.

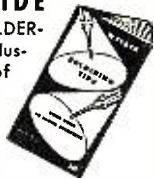

WELLER

MANUFACTURING COMPANY

810 Packer Street, Easton, Pa.

For the RECORD.

BY THE EDITOR

RADIO-TELEVISION SHOPS NEED SHOWMANSHIP

THE past few weeks have been spent by this editor on an extensive field trip in order to gather ideas from radio and television dealers and technicians and to discuss problems of sales and maintenance. We have had the opportunity to “spot check” cities and towns, both large and small.

Eleven states were included in order to make visits in both TV and non-TV areas. We wanted to find out what radio and television dealers were doing to increase sales, what promotion they used, what test equipment was doing to speed the repair of sets, and what we, as publishers, could do to help make their businesses more profitable.

It didn't take many stops to discover that, in comparison to other merchandisers, radio and television shops were far behind in the matter of display of sets and components and that the average service shop presented an unsightly mess to its customers.

The trend in automobile dealer service departments has been toward neatness, cleanliness, and “showmanship.” It was only a short time back that such service to automobiles was rendered in space cluttered with old parts, with greasy floors, inadequate lighting, and without specialized equipment.

Today the aggressive auto dealer takes great pride in the appearance and efficiency of his repair department. He knows, from experience, that customers—especially women—won't hesitate to bring in their cars to a well-equipped shop where cleanliness, efficiency, and courtesy prevail.

And so it is in the case of radio or television service shops. We technicians can learn much of specific value by observing methods and techniques employed successfully by other businessmen that cater to the same public.

We can, and economically, tidy up our service benches and rearrange our test equipment to be both workable and presentable. We can clean up the messy (and dangerous) wiring of the line supply on the bench. We can do a bit of painting and arrange our parts cartons to good display advantage. These things come under the heading of “showmanship.”

The wearing of a neat shop coat does much to impress the customers. They cost but little and can pay real dividends to the technician.

Many of the dealers we visited actually featured and pointed with pride to their service departments. These, in most instances, were situated at the front of the store by the window for all to see. We were impressed by this

method of “showmanship” and can readily see its advantages.

In other establishments, however, the service bench was back in a dark corner and was cluttered with old chassis and dust laden cabinets from as far back as 1930. Visible to customers, these shops certainly couldn't expect to make a good impression with those who had occasion to bring their sets in for repair.

It is particularly important that service technicians who own and use modern, up-to-date service equipment bring it out into the open and give their customers a true appreciation of the “professional” character of the work involved in servicing radio and television receivers.

Good commercial test equipment represents a large investment on the part of the shop owner. Failure to exploit its “showmanship” value is simply missing a good and no-investment possibility.

Conversely, if the test equipment being used is of the type casually thrown together by the service technician, cabinetless, or hopelessly outdated, the shop owner would do well to bury this equipment on the service bench in some remote part of the store. This type of equipment lends no prestige and often might shake the customer's confidence in the service technician to whom he had planned to entrust his radio or video set.

Don't misunderstand us—the amount of beautifully-matched test equipment on a service bench is no infallible criterion of the work capable of being performed in that particular repair shop, but often the customer is far more impressed with such a display of equipment than conditions warrant. It seems to be human nature to seek the external trappings of a successful business and then assume from the visual evidence that here indeed is an A-1 establishment.

There are many service technicians who can perform miracles with a v.t. v.m. and those good little grey cells and more power to him! The point we are trying to make is that if you have invested large sums in modern test equipment don't relegate it to the bench located in the recesses of the shop but have it visible where it can do its bit in promoting “showmanship.”

Yes—we radio and TV technicians can learn much by visiting other shops which use “showmanship” and use it to good advantage. Let's give it a try.

O. R.

RADIO & TELEVISION NEWS

THERE'S ONLY ONE COMPLETE CATALOG FOR EVERYTHING IN RADIO AND TV!

T'S YOUR **FREE**
ALLIED 196-PAGE
VALUE-PACKED CATALOG!

SEND FOR IT TODAY



Here's the only *complete* Buying Guide to everything in TV, Radio and Electronics—packed with the world's largest selections of quality equipment at lowest money-saving prices! See the latest in TV, AM and FM receivers; radio-phonos; new Sound Systems and P.A. equipment; high-fidelity custom sound components; recorders and accessories; full selections of newest Amateur receivers and station gear; test instruments; builders' kits; huge listings of parts, tubes, tools, books, diagrams—all in stock for immediate shipment.

ALLIED gives you every buying advantage: speedy delivery, expert personal help, lowest prices, assured satisfaction—plus the most liberal Time Payment plan in radio. Get the 1950 ALLIED Catalog—it will save you time and money. Send today for your FREE copy!

WORLD'S LARGEST STOCKS

*Radio Parts Unlimited
 Test Instruments—All Makes
 Television & Home Radios
 P. A. and Hi-Fi Equipment
 Amateur Station Gear
 Experimenters' Supplies*

QUICK, EXPERT SERVICE



ALLIED IS YOUR TELEVISION HEADQUARTERS



You keep up with TV when you depend on ALLIED! Count on us for the latest releases and largest stocks of picture tubes, component parts, antennas and accessories—plus the latest in TV receivers, tuners and kits. If it's anything in TV—we have it in stock! So remember—for TV—it's ALLIED First!

Send for Radio's Leading Buying Guide

ALLIED RADIO

THE WORLD'S LARGEST RADIO SUPPLY HOUSE

Everything in Radio, TV and Electronics

ALLIED RADIO CORP.
 833 W. Jackson Blvd., Dept. 1-E-O
 Chicago 7, Illinois

Send FREE 196-page 1950 ALLIED Catalog.

Name

Address

City Zone State



Jensen

Model H-510

COAXIAL 2-WAY SPEAKER

For thrilling life-like reproduction . . . For truly satisfying listening pleasure . . . For a host of history-making features that mean higher performance . . . new flexibility and convenience—be sure to hear and see the Jensen H-510. You'll know why wise listeners tell us it's the best at any price!

*The Genuine Jensen Wide-Range Series includes a distinguished group of new coaxial and single-unit speakers—a complete range of sizes, ratings and prices. Ask for Data Sheet 152.

"—best—at any Price!"

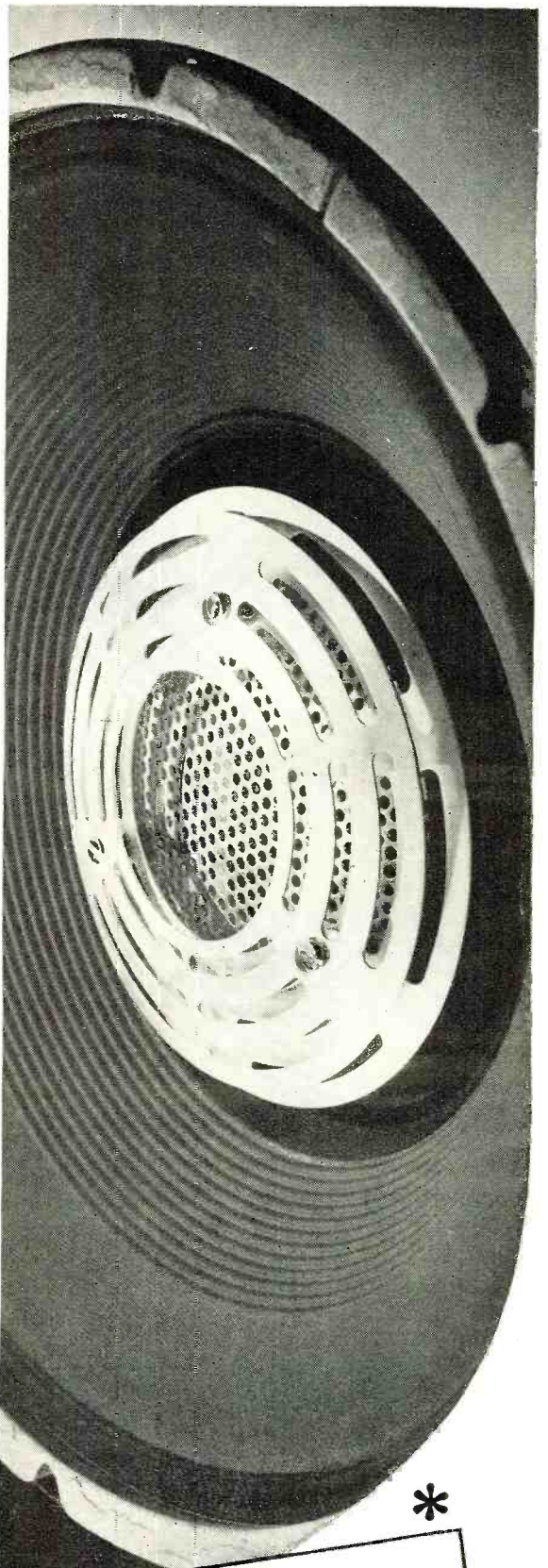
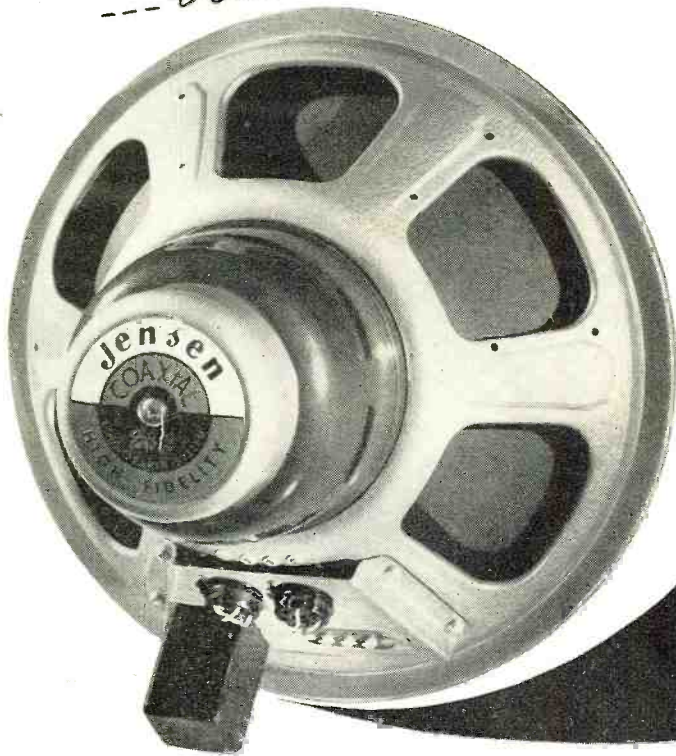

JENSEN MANUFACTURING COMPANY DIVISION OF THE MUTER COMPANY
 6617 South Laramie Avenue, Chicago 38, Illinois • In Canada: Copper Wire Products, Ltd., 351 Carlaw, Toronto
 10 **RADIO & TELEVISION NEWS**



Get
Into

TELEVISION, RADIO ELECTRONICS

Master ALL Phases

Get Complete Training. You Receive and Keep All Tubes, Equipment, Parts and Lessons. No Extra Charges.

**GOOD PAY
and Unlimited Opportunities
in JOBS LIKE THESE:**

Business of Your Own. Radio Manufacturing, Sales, Service. Broadcasting. Telecasting. Television Manufacturing, Sales, Service. Laboratories: Installation, Maintenance of Electronic Equipment, Electrolysis, Call Systems. Garages: Auto Radio Sales, Service. Sound Systems and Telephone Companies; Oil Well and Drilling Companies; Engineering Firms. Theatre Sound Systems. Police Radio.

And scores of other good jobs
in many related fields

**YOU CONDUCT MANY
EXPERIMENTS LIKE THESE!**

Checking action of condensers
Experiments with AF and RF amplifiers
Experiments with resonance
Producing beat frequencies
Calibrating oscillators
Experiments with diode, grid-bias, grid-leak and infinite impedance detectors
Practical experience in receiver trouble shooting
Application of visual tester in checking parts and circuits
Experiments with audio oscillators
Advanced trouble-shooting
... and many, many others.

Complete Training by Practical Resident Trade School, Est. 1905

The same highly trained faculty, instruction materials and methods used here in our large, modern resident school, are adapted to your training in *your own home*. Shop Method Home Training has been proved by hundreds of successful graduates.

**Both Resident and Home Study
Courses Offered**

YOU LEARN BY DOING

You receive special laboratory experiment lessons to show you how to build with your own hands various experimental units such as those shown at left, and how to conduct many tests.



YOU RECEIVE THIS
PROFESSIONAL MULTITESTER
YOU BUILD ALL THESE AND
MANY OTHER UNITS WITH
PARTS WE SEND YOU!

Signal Generator

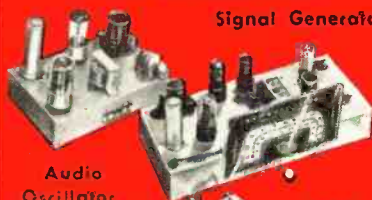

Audio
Oscillator

T.R.F.
Receiver

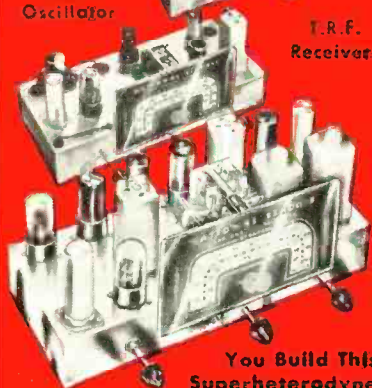

You Build This
Super-heterodyne

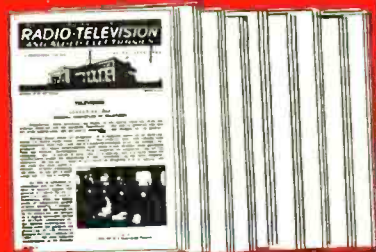

You Receive a Special Series
of Modern Lessons in TELE-
VISION, all a part of your
course: you master all phases

You will find all lessons easy to understand because they are illustrated throughout with clear diagrams and step-by-step examples that you work out yourself. Every piece of the equipment and complete lesson material we send you is yours to keep and enjoy, including the multitester, experimental equipment, all parts of the Superheterodyne, tube manual, radio dictionary, and complete, modern Television texts. All parts are standard equipment.

Shop Method Home Training ... Earn While You Learn

With our practical resident Shop Method Home Training, you study in your spare time. You receive Spare Time Work Lessons, which show you how to earn while you learn. Service neighbors' radios and TV receivers, appliances, etc., for extra money and experience. Many National students pay all or part of their training with spare time earnings!

DON'T DELAY! The Radio-Television Industry needs trained men NOW!

**APPROVED
FOR
VETERANS!**
Check coupon below!

For quick action,
mail coupon
today and we'll
rush you full in-
formation.

Free!

**NEW, ILLUSTRATED
OPPORTUNITY
BOOK AND SAMPLE
LESSON SHOW YOU
HOW WE TRAIN
YOU ... SEND FOR
THEM TODAY! NO
COST. NO
OBLIGATION.**



NATIONAL SCHOOLS

LOS ANGELES 37, CALIF. • EST. 1905



FIND OUT NOW ... MAIL COUPON TODAY

National Schools, Dept. RN-5
4000 South Figueroa Street
Los Angeles 37, California

Mail in envelope
or paste on
penny postal.

Send me your FREE book "Your Future in Radio" and the sample lesson of your course. I understand no salesman will call on me.

NAME..... AGE.....

ADDRESS.....

CITY..... ZONE..... STATE.....

Check here if Veteran of World War II

NOW! Convert 10" 12½"

Quickly, Profitably, Easily with

NEW! NORELCO DUO-VUE
world's first dual-purpose TV offers
3' x 4' picture — \$199.50 list*

NEW! PROTELGRAM "CONVERSION PACKAGE"
makes possible huge 234 sq. in.
picture for trade-in buyers



This 2½" 3NP4 is smallest projection tube on market, is lowest in cost (\$19.50 retail), produces largest home picture (3' x 4').



PROTELGRAM

North American Philips has really BIG PROFIT NEWS for you—and BIGGER, BETTER PROTELGRAM TV pictures for your customers, up to 3' x 4' in the sensational NORELCO DUO-VUE now making its world premiere at \$199.50 — more television picture for less money than ever before offered!

What is there in it for you? PROFITS from PROTELGRAM's Four-Way Plan described on the right.

Philips makes it easy and profitable for you to—

1. Sell PROTELGRAM to set builders interested in bigger pictures — 13½" x 18".

2. Sell PROTELGRAM for custom-built, large-screen installation, up to 3' x 4' for homes, clubs, bars, hotels, etc.

3. Sell NORELCO DUO-VUE, television's newest, finest and biggest picture used with the customer's direct-view table set to produce 3' x 4' pictures on a home-movie screen. A flip of a switch selects either picture, and you can connect DUO-VUE to almost any table-model receiver in less than an hour.

4. Sell PROTELGRAM in a conversion cabinet to customers wanting to convert their 10 or 12½" direct-view receivers to a picture larger than a 20" tube gives. And you can make the conversion in less than one hour following the simple, straightforward instructions provided.

Right now is the time to make extra profits with PROTELGRAM. Read every word of this ad. Then get in touch with your distributor or send the coupon now for all the facts.

**Prices slightly higher west of Rockies. Connection charges extra.*

NORTH AMERICAN PHILIPS COMPANY, INC.

100 E. 42nd Street, New York 17, N. Y.

6" Sets to BIG PICTURE TV

PROTELGRAM

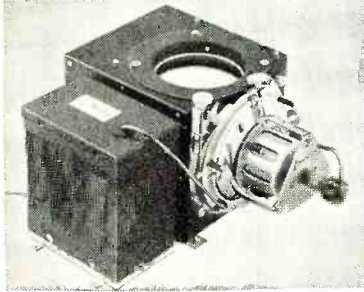

PROTELGRAM UNIT

Projection box measures only 8½" x 9" x 13", contains optical system and alignment assembly, is designed for quick easy service and adjustment. The 2½" 3NP4 projection tube is long-lived, extremely low in cost. Compact 25KV high-voltage unit is only 8½" x 4½" x 7".

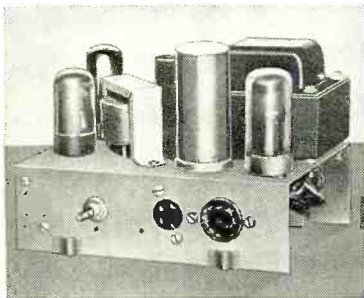

AUXILIARY CHASSIS

New auxiliary chassis fills additional electrical requirements essential to adaption of TV chassis to PROTELGRAM; makes change-over quick and easy. Measures only 8" x 12" x 4".



CONVERSION CABINET

Console cabinet measuring 22" x 27¾" x 46½" provides space for installation of customer's 630 Type TV chassis, comes equipped with complete PROTELGRAM system, auxiliary chassis, cabinet mirror and viewing screen.

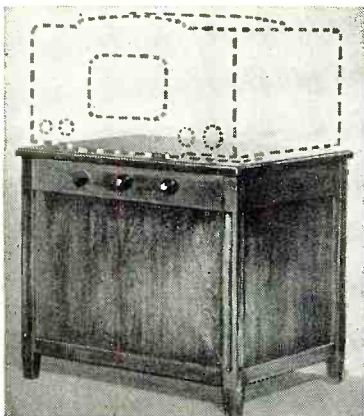

NORELCO DUO-VUE

Beautiful cabinet contains PROTELGRAM unit. Only 23½" high. 20" x 26" top holds most any 10" or larger direct-view table model. Concealed ball-bearing casters make it easy to pull out from wall for 3' x 4' viewing on external screen. Offers customers choice of two picture sizes for small and large group viewing.

FOUR-WAY Profit Plan

Sell PROTELGRAM to the man who builds his own!

Thousands of TV kits have been sold to the man who likes to build his own equipment. These handymen are ripe for PROTELGRAM, because they can combine it with a TV chassis, get life-size TV at a reasonable cost.

Sell PROTELGRAM to custom set buyers

Clients who want built-in installations in walls or cabinets are perfect prospects for PROTELGRAM. Huge picture size, plus compactness and flexibility, makes it the answer for this type of user.

Sell PROTELGRAM to trade-in customers

PROTELGRAM sells itself to customers who want bigger pictures, but are reluctant to take a trade-in loss. You can now use their present TV chassis, connect it with PROTELGRAM in a cabinet such as shown at (3) left. They get a 234 square-inch picture, 13½" x 18".

Sell NORELCO DUO-VUE for largest home-TV pictures

Only with NORELCO DUO-VUE can you offer both direct-view and 3' x 4' movie-size TV . . . and at a reasonable price. This is the newest thing in television for your customers who want the best. Lots of sales opportunities in bars, clubs, institutions and hospitals, too.

CONTACT YOUR DISTRIBUTOR OR SEND COUPON TODAY

NORTH AMERICAN PHILIPS COMPANY, INC.
Dept. PG-4, 100 East 42nd Street, New York 17, N. Y.

Gentlemen: Please send full information as checked

- PROTELGRAM SYSTEM NORELCO DUO-VUE unit
 PROTELGRAM SYSTEM PROTELGRAM SYSTEM
with auxiliary chassis for conversion console

NAME..... POSITION.....

FIRM NAME.....

ADDRESS.....

CITY..... STATE.....

- Check here for Dealer Information on
 Norelco Electric Shaver Lady Norelco Electric Razor

CHANNEL MASTER'S

Super-Fan!

• STRENGTH • RIGIDITY • SENSITIVITY

SUPERSEDES
THE BM 312
FAN FLECTOR
SERIES

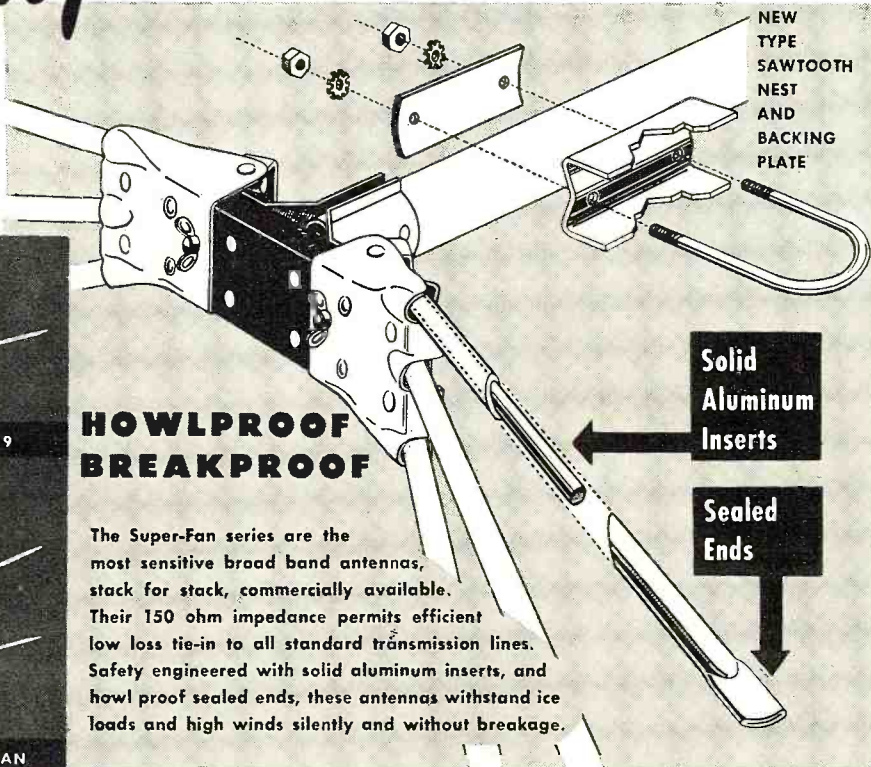

NEW
TYPE
SAWTOOTH
NEST
AND
BACKING
PLATE

- LOWER PRICES
- SMALLER BOX
- SUPERIOR PREASSEMBLY

HOWLPROOF BREAKPROOF

The Super-Fan series are the most sensitive broad band antennas, stack for stack, commercially available. Their 150 ohm impedance permits efficient low loss tie-in to all standard transmission lines. Safety engineered with solid aluminum inserts, and howl proof sealed ends, these antennas withstand ice loads and high winds silently and without breakage.

Solid
Aluminum
Inserts

Sealed
Ends

These models also feature *Swing-Lock-Action*, the patented preassembled feature of all Channel Master antennas. Just swing out elements and lock them in place — as easy as that.

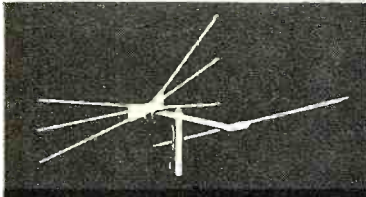

BM 313 SUPER-FAN LIST 12.19

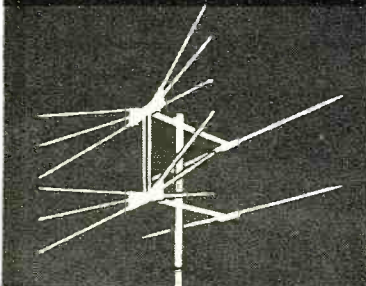

BM 313X2 STACKED SUPER-FAN
LIST 26.25

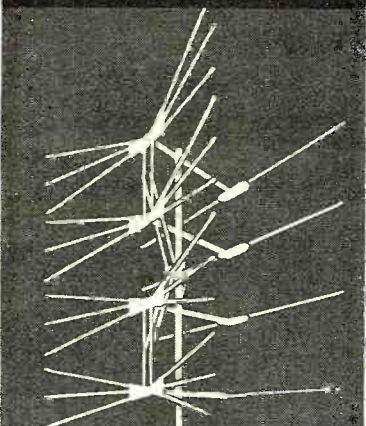

BM 313X4 DOUBLE STACKED SUPER-FAN
LIST 57.10

A TELEVISION SET IS NO BETTER THAN ITS ANTENNA
THERE IS NO BETTER ANTENNA THAN THE SUPER-FAN

Send for FREE Technical Literature

GAIN OF THE SUPER-FAN SERIES

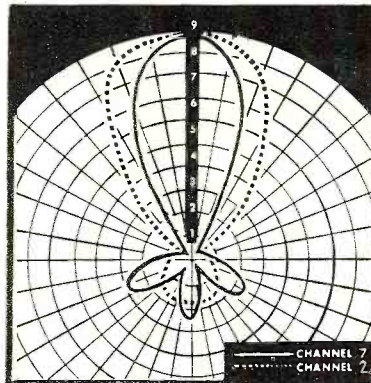

HORIZONTAL POLAR DIAGRAMS

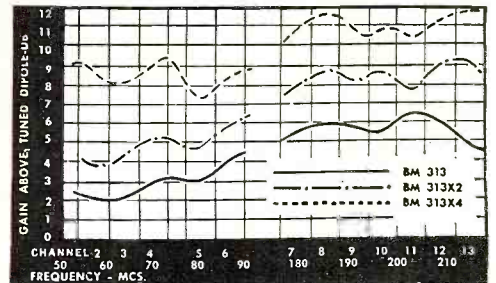

GAIN CURVES

CHANNEL	2	3	4	5	6	7	8	9	10	11	12	13
313	2.1	2.2	3.0	3.0	4.0	5.5	5.8	5.8	5.7	6.5	6.0	4.7
313X2	4.8	5.0	6.1	5.7	6.8	9.0	9.7	9.3	9.4	8.8	9.8	10.0
313X4	9.0	8.2	9.0	7.5	8.5	11.0	11.4	10.8	10.8	10.3	11.3	11.9

GAIN IN DB. ABOVE TUNED DIPOLE



FIRST IN PREASSEMBLED ANTENNAS

ELLENVILLE, N. Y.

"Leave it to Sylvania!"



SYLVANIA ANNOUNCES...

"Another Sylvania advance!"



Two Outstanding New

"That's great news for TV Service men!"



V Test Instruments!

Sylvania's early pioneering in radio testing devices naturally places this company in a position to step ahead in the field of television testing equipment.

So again Sylvania comes through! This time for service dealers everywhere, with a splendid new line of TV Test Equipment. Here are the first two instruments in this line. A new TV Marker Generator will be announced soon. Mail coupon for prices and latest specification sheets.



Sylvania TV Oscilloscope

Here's an entirely new high gain, wide band oscilloscope especially designed for television. Accurately displays any TV pulse, wave-shape or signal on a large 7-inch screen. Has excellent tilt, rise-time, and overshoot characteristics. Features include: 3-position frequency-compensated attenuator; vernier gain control; low internal hum level. Mail coupon for full details.

Type 400

Sylvania TV Sweep Signal Generator

This compact instrument is equipped with electronically controlled sweep circuits to eliminate the complexities inherent in mechanical type sweeps.

The smooth attenuator gives continuous control of the output from 300 microvolts to the maximum of .1 volt. Voltage-regulated power supply insures good frequency stability. Double shielded to prevent unwanted signal leakage.



Type 500



RADIO TUBES; TELEVISION PICTURE TUBES; ELECTRONIC PRODUCTS; ELECTRONIC TEST EQUIPMENT; FLUORESCENT LAMPS, FIXTURES, SIGN TUBING, WIRING DEVICES; LIGHT BULBS; PHOTOLAMPS; TELEVISION SETS

SYLVANIA ELECTRIC

Sylvania Electric Products Inc.
Advertising Dept. R-1205
Emporium, Pa.

Please send me full details about Sylvania's new TV Test Equipment.

Name _____

Street _____

City _____ Zone _____ State _____



Every

**SPRAGUE
TV**

dry electrolytic
is processed

FOR **185°F** (85°C.)

OPERATION!

Sprague leads again with the largest, most complete line of replacement electrolytic capacitors for television receivers. Each type is engineered especially for tough video applications and will stand up under the high temperatures, high ripple currents and high voltage surges encountered in TV equipment. Every Sprague TV capacitor rated at 450 d-c working voltage or less has been processed for 185°F. (85°C.) operation. Send postcard for special TV Bulletin.

SPRAGUE PRODUCTS CO.
51 Marshall Street
NORTH ADAMS • MASS.

Spot Radio News

* Presenting latest information on the Radio Industry.

By RADIO & TELEVISION NEWS'
WASHINGTON EDITOR

TV COLOR activity zoomed on famed Constitution Avenue, in the electronic labs of the Commission at Laurel, Maryland, and in the labs at Princeton, New Jersey, Madison Avenue, New York City, and San Francisco, California, as the furiously-paced renewed hearing and test sessions began in the nation's capital in the early days of spring.

The second comparative-test session roared in as the curtain raiser for the three-colored event, with both the audience and performers, throbbing with first-night jitters. With a room about twenty-five by thirty feet as the theater, twenty-one receivers as the equipment, and about 125 persons looking, listening, and adjusting, the scene was quite a hectic one. There were miles of overhead cables, crowded folding chairs and swaying viewing heads to add to the confusion and audio bursts from different programs which caused many a flushed face. Reaction to the tests ran from very good to completely inconclusive. From the data that was collected, it did appear, however, as if the technical group was able to gather information that would be very helpful in evaluating the systems demonstrated.

Receivers in the room and also installed in a balcony, included ten-inch, twelve-inch, sixteen-inch and fifteen-by-twenty and eleven-by-fourteen inch projection models, all of which were operated simultaneously from antenna setups installed by the color proponents. Signals came from WNBW, operating on Channel 4, for the RCA sets; from WOIC, telecasting on Channel 9, for the CBS receivers; and from WMAL, using Channel 7, for the CTI models. Program material included wedge test patterns, moving horizontally and vertically to simulate camera movements, rotating paddles of various colors moving at varying speeds, keyboard color and black and white patterns, and fixed and live copy. In the fixed setups were cereal boxes, toweling, canned good containers, while the live portions featured dancers, models, and singers attired in bright costumes.

Laboratory signals were also aired to enable the specialists to study such problems as fringing, interference, and ghost reception.

That the test period was a momentous one became strikingly obvious when the audience was surveyed. For among those in the lab room were David Sarnoff, Dr. C. B. Jolliffe and D. F. Schmit of RCA; Dr. Frank Stanton and Dr. Peter C. Goldmark of CBS; Dr. Allen B. Du Mont and Dr. Thomas T. Goldsmith, Jr., of *Du Mont Labs*; Kenneth Norton of the Bureau of Standards; Raymond C. Cosgrove, RMA prexy, and Jack Poppele, prexy of TBA. Canada was also represented with C. W. Browne and W. A. Caton, controller of radio and chief inspector of radio, respectively, of the Department of Transport, as well as W. B. Smith, engineer in charge of the department's broadcast division and W. Hayes of the *Canadian Broadcasting Company*.

During informal interviews, it was learned that some of the FCC representatives were quite impressed with the demonstrations. Madame Commissioner Frieda Henneck indicated that she felt that the RCA system had displayed significant improvement over the setup shown during the first series of comparisons.

AN OFFICIAL VERSION of what the Commission, as a whole perhaps, thought of the tests appeared in quite a frank talk by FCC Headman Wayne Coy, at a conference at the University of Oklahoma. Commenting on the CBS system, for instance, Coy said: "The system proposed by CBS has been in development longer than any of the other two systems and has progressed farther than any of the other two systems. The system has worked well and produces pleasing color pictures of good quality and good color fidelity. At the present stage of development the system must necessarily use a mechanical rotating filter as the means of producing color. Since the mechanical filter must be more than twice the size of the tube, it is obvious that direct view tubes under this system, as a practical matter, can be no larger than ten to twelve inches . . . the larger sixteen to twenty-inch tubes cannot be used with the color wheel. . . . In addition, the CBS system involves a change of transmission standards in two important respects. First, the number of

RADIO & TELEVISION NEWS

"Centre-Kooled"[®]

PAT. APPLIED FOR

SELENIUM RECTIFIERS

With All The Features You Have Been Asking For:

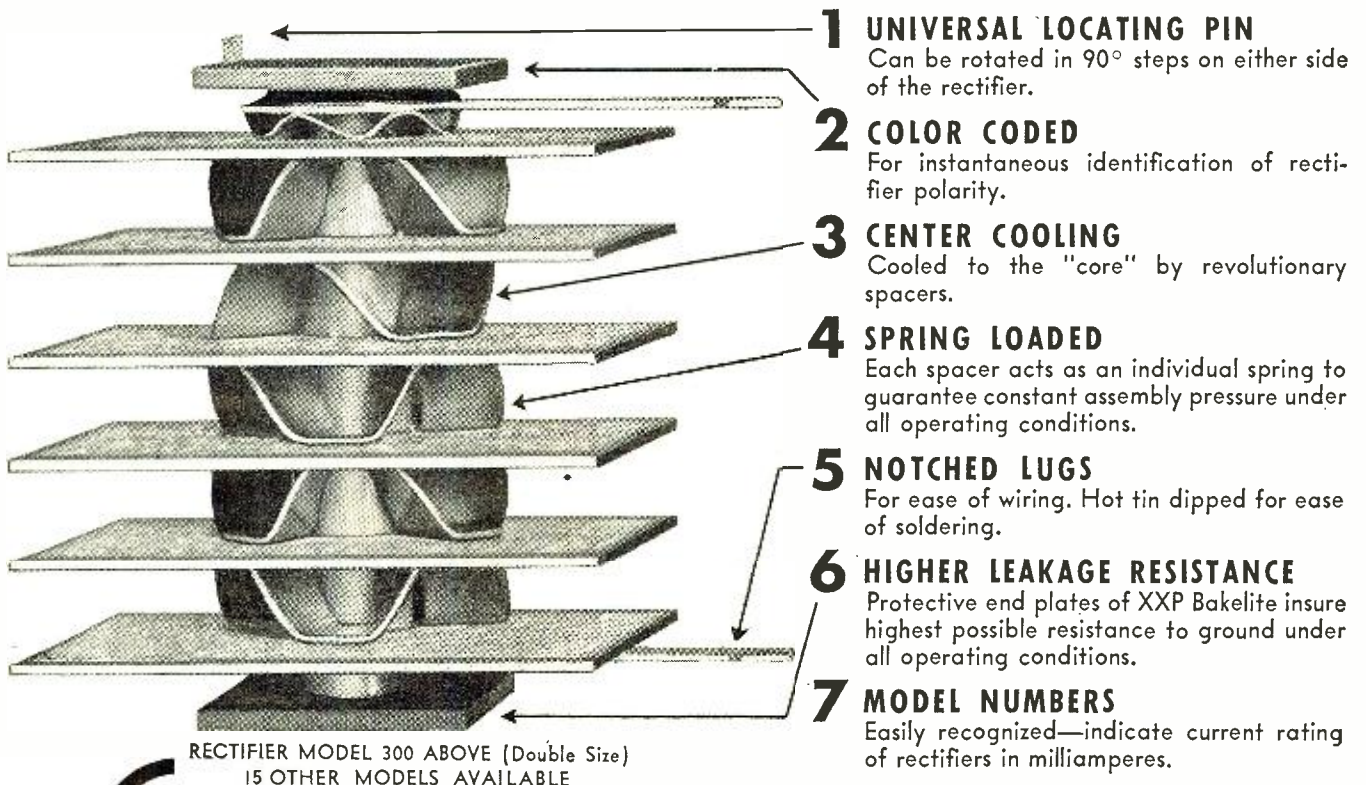

RECTIFIER MODEL 300 ABOVE (Double Size)
15 OTHER MODELS AVAILABLE

- 1 UNIVERSAL LOCATING PIN**
Can be rotated in 90° steps on either side of the rectifier.
- 2 COLOR CODED**
For instantaneous identification of rectifier polarity.
- 3 CENTER COOLING**
Cooled to the "core" by revolutionary spacers.
- 4 SPRING LOADED**
Each spacer acts as an individual spring to guarantee constant assembly pressure under all operating conditions.
- 5 NOTCHED LUGS**
For ease of wiring. Hot tin dipped for ease of soldering.
- 6 HIGHER LEAKAGE RESISTANCE**
Protective end plates of XXP Bakelite insure highest possible resistance to ground under all operating conditions.
- 7 MODEL NUMBERS**
Easily recognized—indicate current rating of rectifiers in milliamperes.

"Centre-Kooled" SELENIUM RECTIFIERS

- Give:
- **Longer Life**
 - **Lower Temperature**
 - **Ease of Installation**

For Further Information or Engineering Service, Write Dept. RN,



PACKAGED FOR DISTRIBUTORS

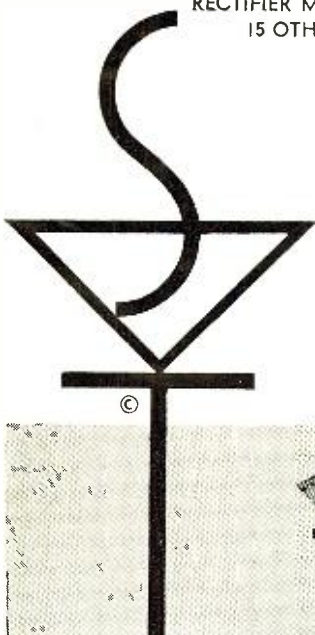

**Sarkes
Tarzian**

RECTIFIER DIVISION

INC. 415 North College Avenue, Bloomington, Indiana

"UA" SERIES CONNECTORS FOR AUDIO CIRCUITS

MANY NEW FEATURES
TO RMA SPECIFICATIONS
AND STANDARDS



UA-3-32 Receptacle



UA-3-11 Plug

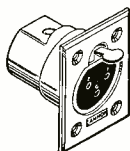

UA-3-31 Receptacle



UA-3-12 Plug

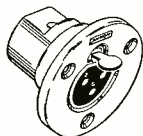

UA-3-13 Receptacle



UA-3-14 Receptacle



UA-3-42 Receptacle

First in the Field with the Latest and the Best!

This achievement of Cannon Electric applies to this new series of audio connectors for the radio industry as well as to other developments such as steel firewall connectors and guided missile plugs, etc.

The UA Series has all of the superior features of the Type P and XL Series and in addition the following: (1) Gold plated contacts for long life; (2) double-protection rubber relief collar and bushing; (3) stronger and better latchlock; (4) flat-top polarization for finger-touch action; (5) steel plug shell and steel insert barrel.

Three 15-amp. contacts; 1500 volts min. flashover; 1/2" cable entry.

Sold through Cannon Electric Franchised Jobbers. Ask for UA-1 Bulletin.

Address Cannon Electric Development Company, Division of Cannon Manufacturing Corporation, 3209 Humboldt Street, Los Angeles 31, California. Canadian offices and plant: Toronto, Ontario. World Export: Frazer & Hansen, San Francisco.



lines is reduced from 525 to 405. Secondly, the number of fields is changed from the 60 of black and white television, to 144 for color. CBS urges that the additional intelligence which results from color more than compensates for the loss in geometric resolution which results. However, when a station is broadcasting color programs, in accordance with CBS standards, an ordinary black and white receiver will not be able to receive the program in black and white, unless either a manual or automatic adapter is incorporated into the black and white sets. *But that is not color television.*"

Then the FCC spokesman went on to describe the RCA system, which he recalled was very unsatisfactory in the early demonstrations, but displayed improvement as the recent tests revealed.

"However," he added, "at the present time, the system relies on three tubes to produce the color image. This is costly and a cumbersome procedure, and involves fundamental problems of registration. If the system works out, present black and white receivers will be able to receive color broadcasts in black and white, with no change in the receiver."

"But," he emphasized, "that is not color television either. . . . Getting black and white reception on present receivers from color broadcasts deals only with an economic aspect of the problem; namely, obsolescence of present-day receivers or lack of obsolescence or the cost of preventing such obsolescence as occurs when television programs, which one wants to see, are broadcast in color. . . . One additional fact about the RCA system is that at the present time a color signal will not pass through the coax presently available. The cable width used at present is about 2.7 megacycles and the RCA system requires about 4 megacycles. An RCA signal passing through the 2.7 megacycle coax emerges as a black and white signal."

In commenting on the third system, the CTI, the Commissioner noted that during two attempts demonstrations before the Commission were not successful and that a third was in prospect.

Reviewing the advantages of the six megacycle systems, unveiled during the hearings and recent comparison tests, Coy said that . . . "Certainly a system that would allow black and white reception on present-day receivers would be most desirable. . . . At the present time we do not have such a fully developed system. On the other hand, we do have a workable color system with good picture quality, but it is handicapped by limitations on tube size and the fact that it cannot be received by present black and white receivers without a change."

The answers to these puzzling problems involve many factors, Coy emphasized. He pointed out that the Commission must decide whether it's wise to choose an undeveloped system because its color transmission can be

received in black and white on existing receivers, or choose a workable system whose color transmissions cannot be received on existing receivers in black and white, or permit all of the systems to have more time for experimentation and development.

Then Coy added: "If more time were to be allowed for experimentation and development of all color systems, could the freeze be lifted and permit black and white television to go ahead? Or should the freeze be kept on until it is possible to write engineering standards for color television?"

The FCC chairman then posed several more key questions. He asked: "If there were to be time for further experimental and developmental work, is there any action, which, taken now, would protect the public presently buying television receivers in a manner which would reduce the obsolescence factor, in the event the Commission decision favored a color system incompatible with present black and white standards? . . . Given the assumptions I have just stated, could it be expected that the industry would immediately build manual or automatic adapters in all receivers? Would the relative small cost for such an addition to a set be worth it, in terms of giving the widest possible latitude for decision, after further experimentation extending perhaps a year or more? . . . Or must we write multiple standards and let the public decide in the market place which is the better system? And is there any way to assure the future use of all color sets if such a proposal is followed?"

The Commissioner then placed these questions before the audience: "Is it a proposal (the multiple-standard proposal) in which the public will willingly accept the risks and costs involved? Or must we reject all of the systems and say that we will proceed immediately with black and white television in both bands and let color wait until another generation or two, and in another, and now unexplored, portion of the spectrum?"

"These are the very difficult questions which the Commission has to face and resolve before it can decide the color television issue," Coy declared. "And," he added, "I am not prepared to answer these questions now."

Commenting on queries as to the hearing's end, in which everyone is so interested, Coy said: "I make no prediction when the hearings will end, or when a decision will be made. I wish the decision could be made tomorrow, but it won't be."

He said that he hoped, but would not predict, that the Commission would be able to resume the processing of applications before the year is out.

CTI, the wallflower contestant in the color race, came to life a few weeks after the official tests, with its own

(Continued on page 112)

MAY, 1950

**RADIO &
TELEVISION
NEWS**

RADIO-ELECTRONIC

Engineering

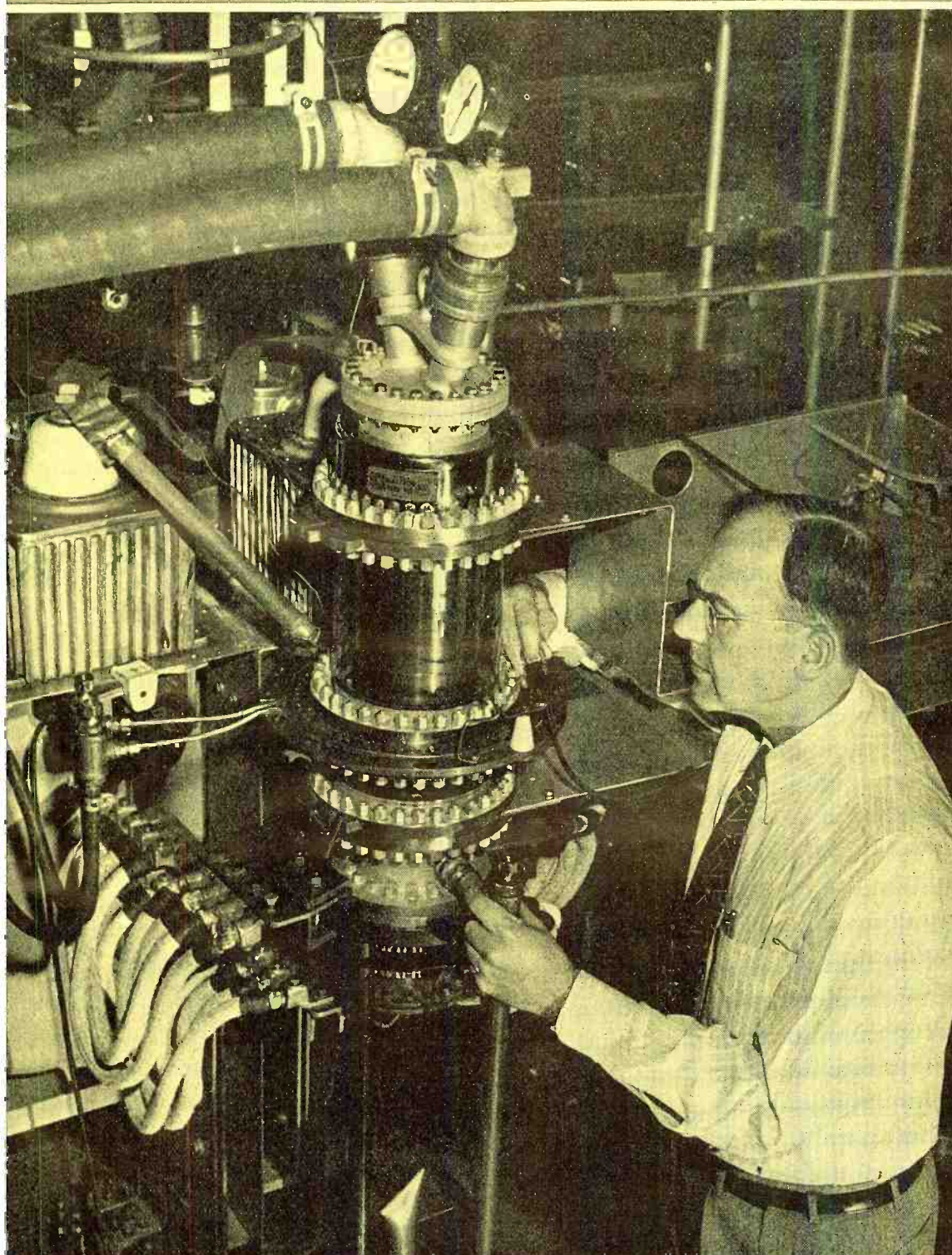

TELEVISION

RADAR

ELECTRONICS

RESEARCH

COMMUNICATIONS

MAINTENANCE

RADIO-ELECTRONIC

Engineering

ELECTRONICS • COMMUNICATIONS • TELEVISION • RESEARCH • MAINTENANCE

MAY, 1950

CUSTOM SOUND INSTALLATION..... Arthur Shapiro 3

MICROWAVE TRANSMITTERS..... J. Racker 6

SURFACE WAVE TRANSMISSION LINE..... Georg Goubau 10

A NEW R-C OSCILLATOR CIRCUIT..... Milton H. Crothers 12

VIDEO AMPLIFIER DESIGN..... Robert C. Moses 15

DEPARTMENTS

NEW PRODUCTS	20	PERSONALS	24
NEWS BRIEFS	22	NEW TUBES	26
TECHNICAL BOOKS	28		



RADIO-ELECTRONIC ENGINEERING is published each month as a special edition in a limited number of copies of RADIO & TELEVISION NEWS, by the Ziff-Davis Publishing Company, 185 N. Wabash Avenue, Chicago 1, Illinois.

VOLUME 14, NUMBER 5, Copyright, 1950, Ziff-Davis Publishing Company

COVER PHOTO—Courtesy of RCA

RCA's new "Super-Power Beam Triode" 5831, mounted for testing, is examined by Dr. L. P. Garner, head of the Advance Development Lab of the RCA Lancaster tube plant. The new tube, which can be operated with maximum rated plate voltage and plate input at frequencies up through the "Standard Broadcast Band" and much higher, is being tested at 1,000,000 watts input.



CUSTOM SOUND INSTALLATION

By **ARTHUR SHAPIRO**

Consulting Engineer, Chicago

Fig. 1. "Wheels-A-Rolling" stage from south end of grandstand. The pylons containing the speakers are at the extreme right and left of the stage.



Design of sound equipment used in the pageant "Wheels-A-Rolling" at Chicago's Railroad Fair.

IN designing the sound installation for the great pageant, "Wheels-A-Rolling," presented at the Chicago Railroad Fair of 1948-49, many unusual conditions had to be met. The tremendous scope of this show can be realized by the great numbers of people and equipment placed on the stage during the one hour and eight minutes of pageantry that told the complete story of transportation in America from early Indian times to the present day. To present this show required a cast of over one hundred actors, 40 engineers, 25 stagehands, stablehands, orchestra, singers and production staff—a total of 250 people who, together with the 94 horses, 35 locomotives and their trains, 32 old automobiles and 100 pieces of horse-drawn equipment, were all controlled from a central point by means of sound, intercommunication, buzzer, light and railroad signal equipment which had to be designed especially for this show.

The audience of 6200 that witnessed this spectacle four times daily was housed in a grandstand that measured 318 feet from stage right to left and 80 feet deep starting at ground level at the stage and rising to 30 feet at the rear of the stands. The grandstand had a metal roof extending from end to end and covered approximately two-thirds of the seats. The stage proper was over two hundred feet wide and 100 feet deep with its wings extending

either end to make a total play area 500 feet long.

The pageant was historical in tenor with variety and comedy that made for a complete and enjoyable show. Music, especially arranged by Isaac VanGrove, was played throughout the show by an orchestra housed in a special band shell at the south end of the grandstand. The offstage singers were also in the orchestra shell as was the control keyboard for the *Deagan Celesta-Chime*, an electronically amplified chime which will be noted later.

Two narrators, located in a booth at the top of the grandstand, told the story of transportation and gave descriptions and comments of the events as they were enacted on stage. Actors' speaking parts and group singing were picked up on stage by means of concealed microphones which were plugged in under cover of stage action.

The pageant was scheduled for presentation four times daily for the one-hundred days from June 25 to October

2nd with performances at 2, 4, 7, and 9 P.M. From this schedule it can be seen that the equipment would be in almost constant service from early afternoon through ten at night. Before the actual show started, there was recorded music to fill the time while the audience found their places. This music was presented for one hour before the 2 and 7 o'clock performances and one-half hour before the other shows. In case of power failure on the grounds, there was a gasoline powered generator as a stand-by to operate the sound system only, so that the show could be presented during the day and to keep the sound operating to avoid panic in the event of power failure during the night shows.

Heavy-duty and trouble-free equipment was a definite requirement. Such items as weatherproof "Twist-Lock" microphone connectors, instant metering of circuits, duplicate wiring and stand-by units were all provided to obviate the possibility of breakdown of the equipment. Since the stage was located on the lake front, the weatherproofing of the equipment was a definite factor to be considered. The high humidity made it necessary to take special care that no space was imperfectly sealed in the equipment that would allow the formation of condensation. On open equipment, sufficient ventilation was required to prevent condensation even when the humidity hovered

Fig. 2. Cross-section of the baffles, showing orientation of the speakers.

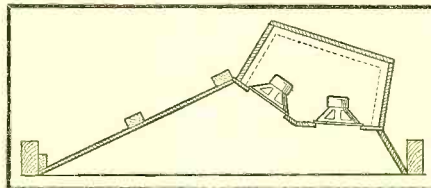

around 98 per-cent. As an indication of the severe humidity, it was not unusual to pick up a tool that had been perfect the night before and find it covered with rust the next morning.

As can be seen from the accompanying drawing, Fig. 7, eleven microphone receptacles were installed, four in the orchestra, one in the room below the orchestra (used for the Celesta-Chime), four on stage and two in the narrators' booth. These receptacles were of the heavy-duty, three wire "Twist Lock" type mounted in weatherproof conduits with spring loaded lift covers. Shure Model 556 Super-Cardioid microphones, set at 250 ohms, were used in all locations except at stage right where a lapel microphone was used in front of the speakers by the actor portraying Abraham Lincoln. This microphone, a high-impedance crystal, required a transformer at the point where it was plugged in to feed the 250 ohm balanced input line.

All microphone lines in the stage area were run underground in steel conduit to a junction box set in the center of the stage apron and then through a two inch conduit under the railroad tracks at the front of the stage to the front of the grandstand where they joined the lines from the orchestra pit. The eleven microphone lines were then brought up to the operating position near the top of the grandstand to a 24 jack patch panel. This panel terminated all the micro-

phone lines and normalled them through to the ten console inputs. The patch panel was installed to permit the instantaneous substitution of an unused console preamp in case of failure of one in use. Inserting a patch cord in the top, or microphone, row of the panel automatically disconnected both sides of the line and transferred the incoming signal to the plug which could then be inserted into the bottom, or console in-

put, row. The eleventh microphone line terminated in a fixed "H" pad. This line was used for the electronically amplified Celesta-Chime. The chime preamplifier fed the signal to the line at 500 ohms and zero level. The front side of the pad fed the signal at 500 ohms direct to either of the loudspeaker systems described below, and the back side of the pad fed through a patch cord to one of the console inputs at 250 ohms

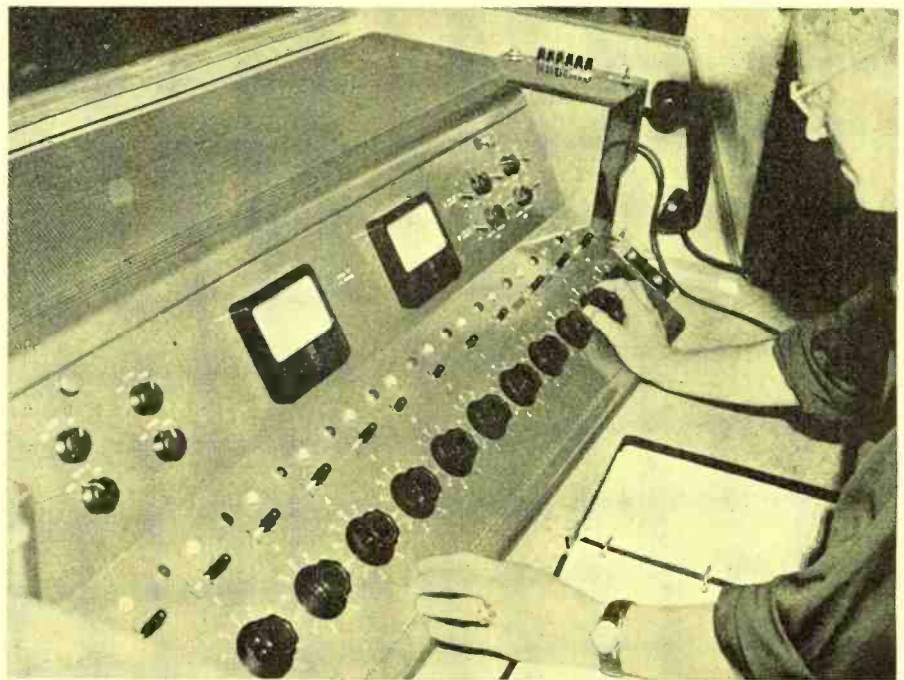
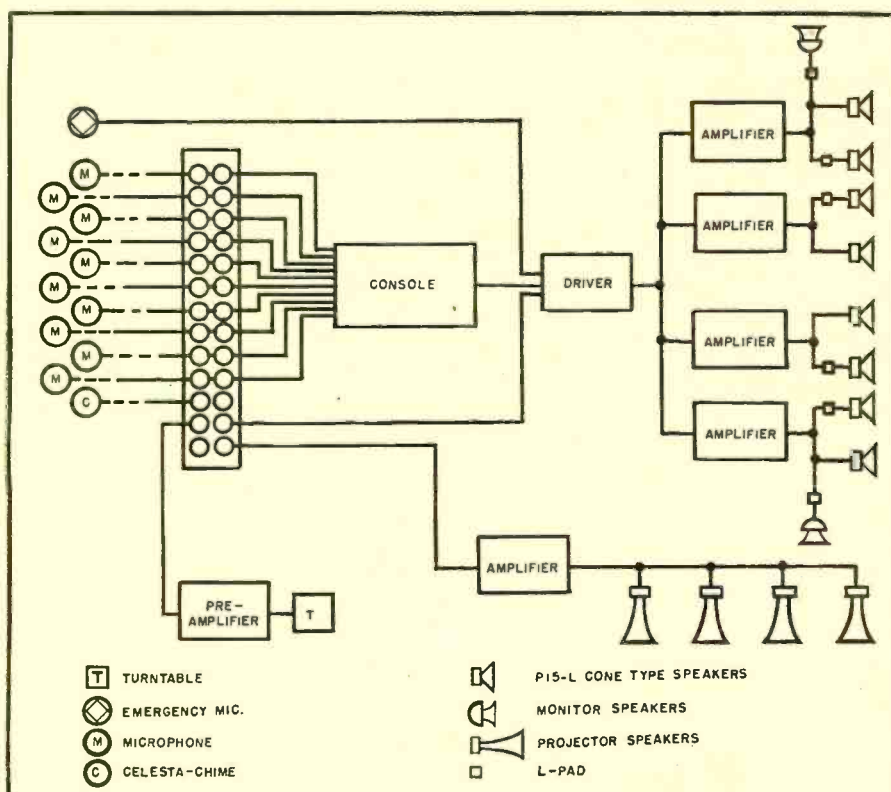

Fig. 3. Ten position, dual channel custom-built control panel in operation. One of the telephone-type intercom masters is visible at the extreme right.

Fig. 4. Block diagram showing essential components of the complete system.



and -55 db. Normally the patch panel operated with only one cord in use as all other circuits were normalled through.

The custom-built console, Fig. 3, contained ten independent preamplifiers feeding through a fader and switch to either of two outgoing channels. Each channel featured independent VU meters, UTC tone equalizers and amplifiers, master faders and output switches. Each preamp position had red and white indicator lights to show which channel was being fed. In operation, the "Red" channel was used for music and the "White" channel was used for speech. This enabled the operator to control the fading of several microphones with a single control. In all there were 37 tubes in the console, three in each preamp and the balance in the equalizer and output section. To eliminate any possibility of hum pickup, all filaments and also all indicator lights were operated on 12 volts d.c. The power supply, mounted within the special weatherproof cabinet, consisted of a heavy duty selenium rectifier for the low voltage and a 5U4G for the plate voltage rectifier. The output of the console was fed through the patch panel

to the line amplifier-driver located in the main amplifier racks in the director's booth. This driver amplifier had provisions for additional high-impedance microphone inputs as well as the 500 ohm low level input. One of these high-impedance inputs was utilized for the director's break-in microphone for use in case of serious accident or emergency on stage. This microphone could break into the system regardless of the status of any other microphones.

The output of the driver amplifier fed four 80 watt booster amplifiers which were limited to approximately 50 watts output each. These boosters were mounted in one rack and were plug connected so that, in case of a failure, a spare could be quickly interchanged. The need for instant change-over was not deemed necessary as each amplifier fed only one-half of the right or left side of the stage, and failure meant only a slight reduction of volume and would not interrupt the show.

The loudspeakers, by far the most important pieces of equipment in the installation, consisted of eight Jensen P15-L cone type speakers specially weatherproofed and treated. These speakers were mounted in special baffles, Fig. 6, and connected two to an amplifier. There are several unique features in the design of these baffles and a study of Fig. 2 will show how each individual motor was oriented to a specific coverage area relative to the grandstand. The pylons in which these units were mounted were not equally spaced and were different distances from the grandstand. This required that the speaker coverage areas be accurately plotted.

Due to the comparatively small difference in angle of each pair of speakers, it was decided that two speakers would be mounted in a common horn and rear enclosure. The loudspeakers had a downward tilt of approximately 10 degrees and the "floor" of the baffles sloped 15 degrees. This angle placed the aural center of the unit at the middle row of the grandstand. These horns were made of three-quarter inch marine grade plywood and finished with flat black paint on the inside so that the speakers were not visible from the audience. The tops of the pylons which supported these large baffles were built with an opening sixteen feet long and four feet high faced with one-quarter inch square mesh screening and treated architecturally with horizontal two by six planks as shown in Fig. 1.

It was evident that with the great variation of distance that the sound had to travel to reach various parts of the grandstand, some control was necessary to drop the level of those speakers operating with the shortest "throw". This was accomplished by inserting a heavy

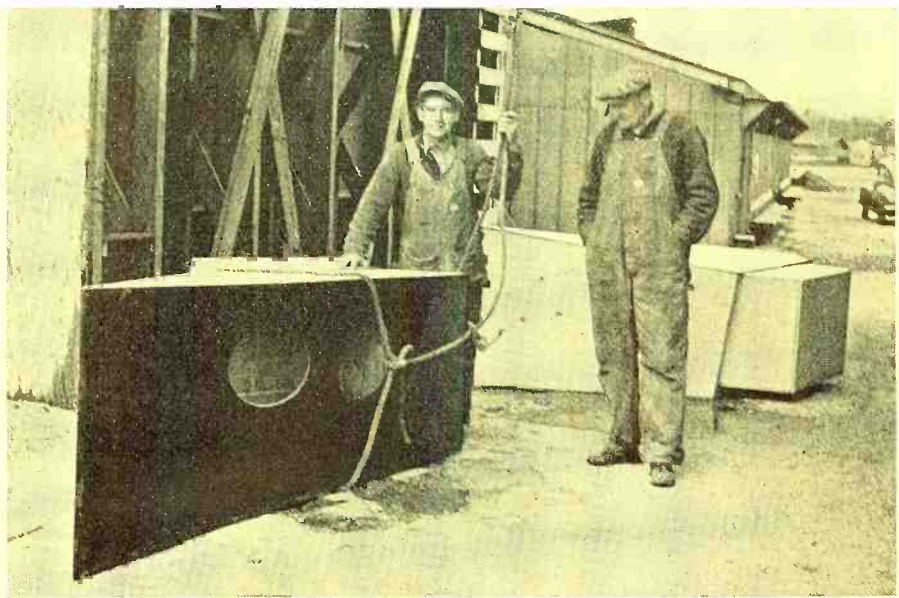

Fig. 5. Two of the special dual loudspeaker housings before being hoisted into place. Flare of horn and mounting of speaker enclosure can be noted on rear horn.

25 watt "L" pad in the line of each of the two inside speakers of each pylon. In the case of the north pylon, where there was a ladder and platform, these controls were mounted on the speaker enclosures. In the south pylon where the speakers were inaccessible, these controls had to be mounted in a weatherproof box remote from the speakers. Once these controls were set by experimentation and measurement after the installation was completed, they were not changed for the rest of the season. Referring to the block diagram, Fig. 4, it can be seen how these controls were installed. The entire grandstand was covered with a variation of not more than 6 db. This was accomplished by sound pressure measurement and setting each booster amplifier separately and then setting the "L" pads on the individual speakers.

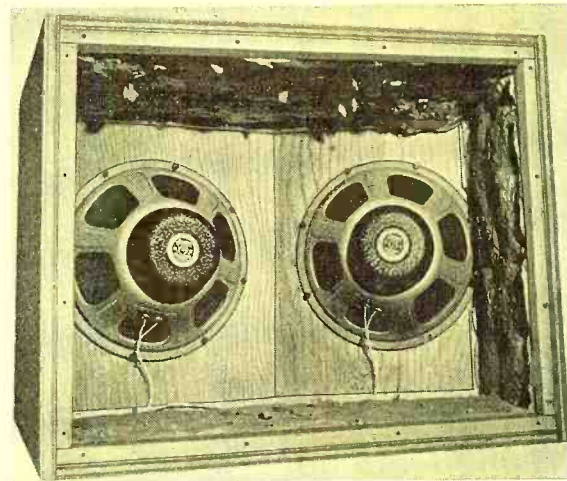
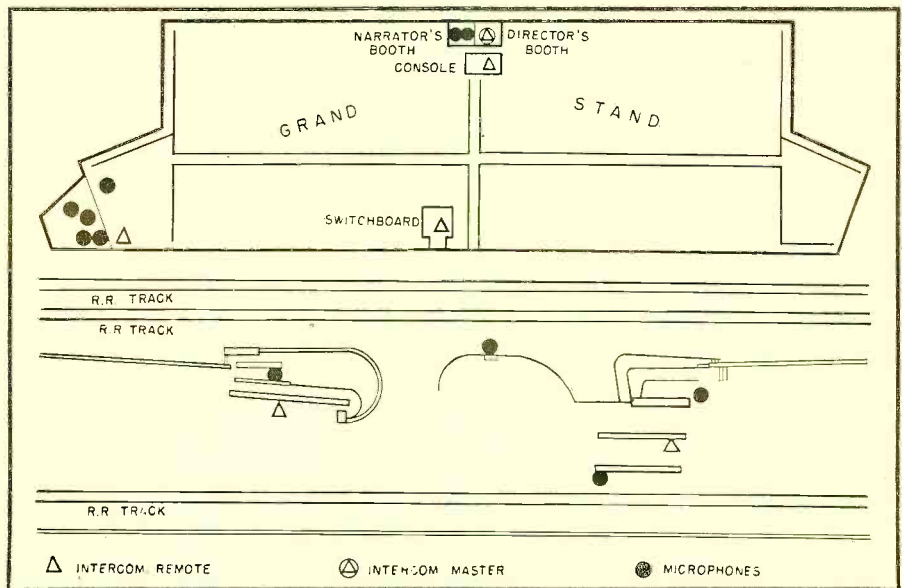

Fig. 6. Dual speaker enclosure showing speakers mounted on individual sections. Note lining of sound absorbent material.

This may seem to be adjusting rather
(Continued on page 31)

Fig. 7. Drawing showing the location of various components of the system.



MICROWAVE TRANSMITTERS

By J. RACKER

Federal Telecommunication Labs.

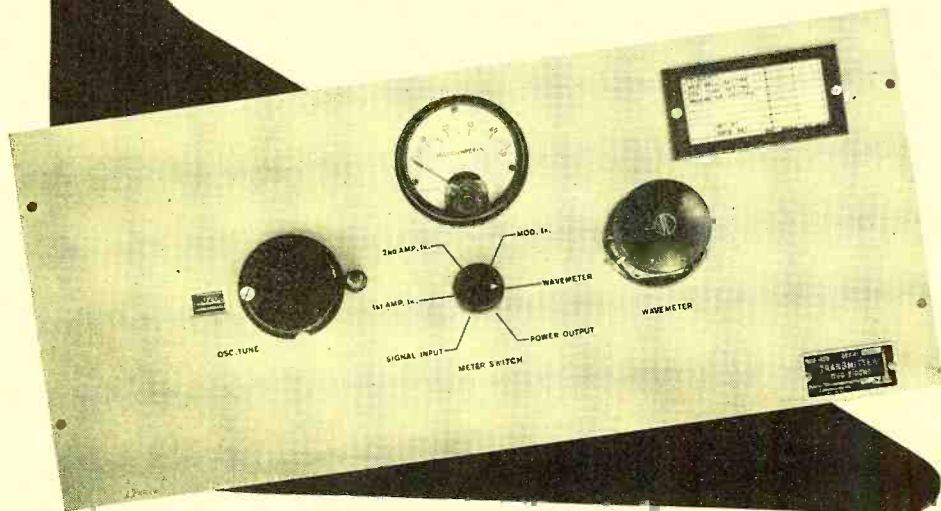

Typical microwave transmitter using a lighthouse oscillator.

First of two articles discussing the generation, modulation, and frequency control of microwaves.

THE compactness and simplicity of microwave transmitters is of great interest to all engineers, particularly so to most "low frequency" engineers accustomed to regarding point-to-point transmitters in terms of large size. The main reason for the reduction in size—for equivalent service—is the large power gain obtained by microwave antennas. It is generally true that the higher the frequency, the more expensive and inefficient the generation of power but, due to the increase in antenna gain, less transmitter power is required. It is therefore possible to operate at higher frequencies—all other factors remaining equal—without too much loss in over-all system efficiency, provided directional point-to-point transmission is desired.

Since it is more expensive to operate at microwave frequencies (for a given power output), virtually all transmitters operating in this band employ high level modulation, i.e. one r.f. stage is used with the modulating voltage amplified to a sufficient degree to modulate the final at the desired power output level. Thus in considering the design of a microwave transmitter, we are primarily interested in the final stage—all other stages employing conventional techniques.

Microwaves can be generated in a number of ways. The most important of these are the lighthouse triode oscillators, klystrons, magnetrons, and traveling wave tubes. With the excep-

tion of the lighthouse triodes, the tubes used at these frequencies are as different in concept and design from conventional tubes as amplitude modulation differs from frequency modulation. The important characteristics of these four methods of microwave generators are:

1. *Lighthouse Triodes.* Operating range: up to about 3300 mc.; peak power of the order of kilowatts depending upon frequency and duty cycle; average power of the order of watts. This tube requires an external cavity designed by an engineer. This cavity

is permanent and only the tube must be replaced when it burns out (in contrast to other tubes as will be noted), therefore from a long term viewpoint it is the most economical method. Requires relatively elaborate automatic frequency control systems when a high degree of stability is required, can be pulsed, operated c.w. or amplitude modulated. Difficult to frequency modulate.

2. *Klystrons.* Frequency range: 900 to 21,000 mc.; power (peak and average) of the order of 5 watts depending upon frequency; efficiency is poor—less than 10%. Cavity is built right into tube and therefore no special cavity design is necessary unless other design problems are involved. Entire assembly must be replaced if tube goes bad. Can readily be frequency modulated, electronically tuned and frequency controlled (a.f.c.). Requires multiple, well regulated power supplies which are relatively expensive and bulky. Cannot readily be amplitude modulated.

3. *Magnetrons.* Frequency range: 900 to 30,000 mc.; peak power of the order of megawatts depending upon frequency and duty cycle; average power of the order of kilowatts depending on frequency; efficiency is very good—better than 50% depending on frequency. Cavity built right in and entire assembly must be replaced if tube goes bad. Good frequency stability—depends only on expansion of copper. Not easy to

Fig. 1. (A) and (B) Two types of double coaxial resonator circuits. (C) Re-entrant cavity circuit. (D) Quarter-wave choke used as r.f. shorting plug.

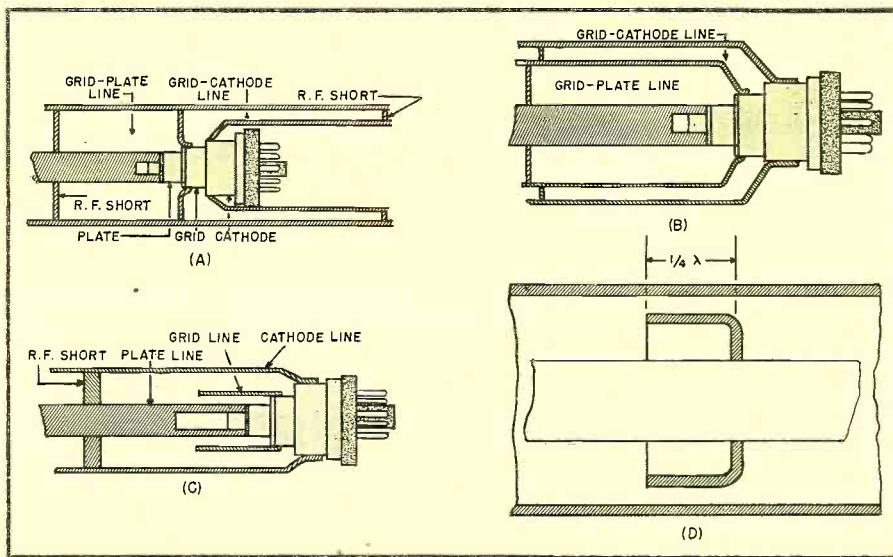

a.f.c., amplitude or frequency modulate. Usually used for c.w. or pulsed applications.

4. *Traveling Wave Tubes.* Frequency range: 500 to 10,000 mc. (and higher); power, c.w., is of the order of hundred watts depending upon frequency; efficiency may be as high as 60%. These tubes are particularly noted for their broad bandwidth. At the present time they are largely experimental and show great promise for the future.

This brief summary of the characteristics of the four major methods of generating microwaves indicates the primary considerations confronting the engineer in designing the transmitter. When the power output, carrier frequency, and method of modulation are specified, the choice of the optimum method of generation is usually apparent though other system characteristics such as bandwidth, frequency stability, and equipment size should also be evaluated before the final selection is made.

Transit Time Effect

It is known that a finite period of time is required for an electron to travel from the cathode to the plate of a tube. This period of time is called the transit time and at low frequency ranges it is negligible compared to time required to evolve one cycle. However, starting at about 500 mc., the time required for one cycle of operation is less than 0.002 microseconds which is comparable to the transit time in most conventional tubes.

This fact invalidates many of the characteristics and design principles governing these tubes since the assumption had been made that the electron stream flowing from cathode to grid traveled under essentially static conditions, i.e., transit time small compared to time variation of tube potentials. However, when the transit time becomes comparable to the period time, then the tube conductance is increased and tube efficiency and output decreased.

This can be best understood by considering the action in a triode with an alternating current applied to its grid. When the grid is at zero (a.c.) potential, the electrons travel from cathode to plate at the quiescent velocity. With the grid at a positive a.c. potential, the electrons are accelerated and pick up energy from the grid in the cathode-to-grid path and are retarded and lose energy in the grid-to-plate path. The reverse occurs when the grid is at a negative a.c. potential so that there is no net energy transfer from the a.c. grid potential source to the electrons.

At frequencies where the period is comparable to the transit time, it is possible for the a.c. grid potential to

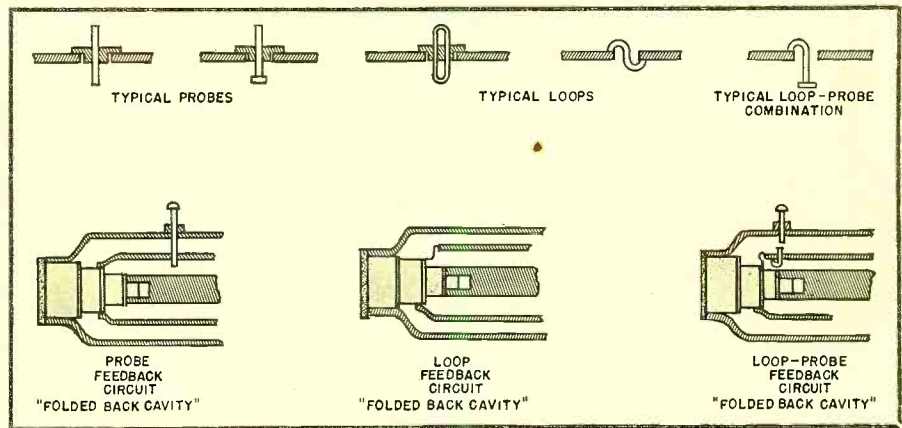

Fig. 2. Typical loops, probes, feedback circuits, and combinations.

reverse its phase before the electrons reach the plate so that, in the positive grid case, the electrons are accelerated and gain energy in both the cathode-to-grid and grid-to-plate regions. Under these conditions, there is a net energy transfer from a.c. grid potential to electrons, resulting in an increase in input conductance. In a similar manner it can be shown that energy can be transferred from the source of a.c. plate potential to the electrons during a portion of the cycle resulting in a decrease in power output and efficiency.

Another factor influencing the operation of tubes at microwave frequencies is the lead inductance of the tube elements (plate and cathode) and the tube interelectrode capacitance. In many cases the resonant frequency of these L-C networks falls below or within the range of operation. Hence, microwave tubes must be designed with a minimum of lead inductance and interelectrode capacitance.

The requirements of reducing transit-

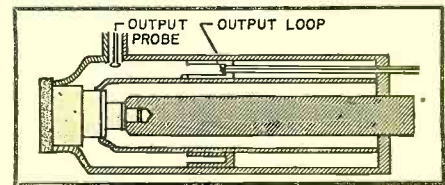

Fig. 3. Alternate methods of output coupling—probe or loop circuit.

time and interelectrode capacitance are conflicting, necessitating design compromises. Interelectrode capacitance may be reduced by decreasing the physical size of electrodes and increasing the spacing.

However, increasing the spacing increases the transit time, while reducing element size decreases maximum safe power dissipation. Transit time may be reduced by increasing the plate potential, but increased plate potential means greater power dissipation.

It is therefore readily seen that special tubes must be used for microwave frequencies which overcome the limita-

Breakdown of a typical lighthouse tube oscillator.

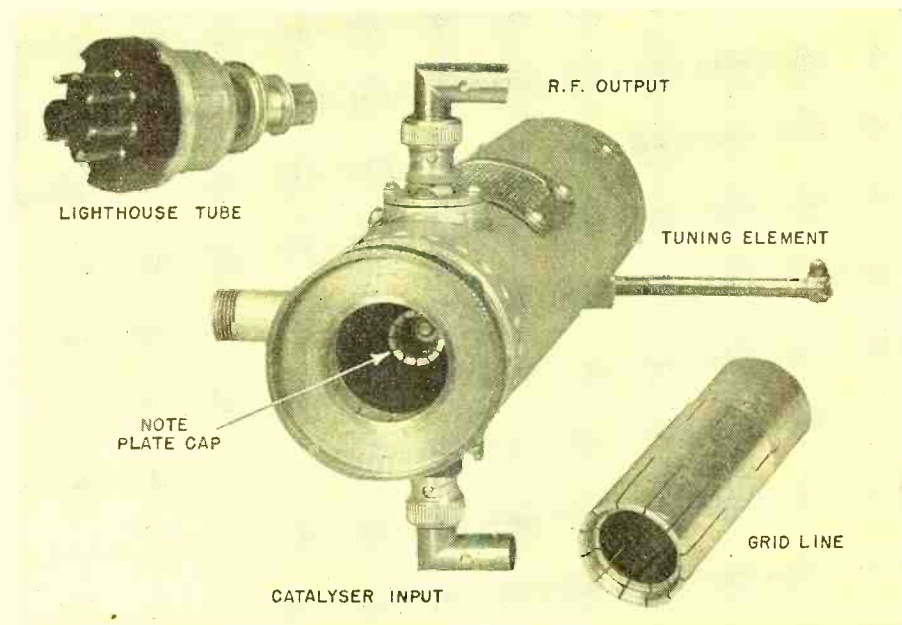

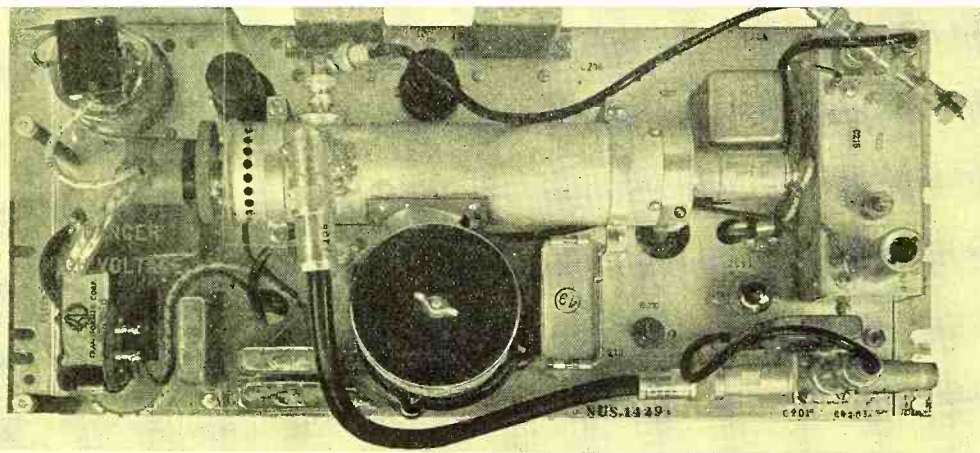

Microwave transmitter—rear view—showing lighthouse oscillator.

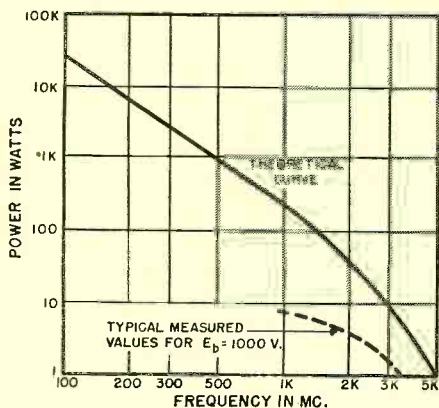

Fig. 4. Theoretical and typical power output versus frequency for a simple triode oscillator.

tion of transit time and capacitance noted above or employ entirely different techniques than conventional tubes. Lighthouse tubes fall in the former category, while klystrons, magnetrons, and traveling wave tubes are examples of the latter category.

Lighthouse tubes are designed for

operation in the frequency range of 200 to 3370 megacycles in which coaxial line resonators and elements are used. A typical lighthouse tube is shown on page 7 and as indicated in this picture it has the over-all appearance of a lighthouse—hence its name. These tubes are constructed in this way to permit the use of coaxial elements which fit right over the cathode, grid and plate leads.

This tube has effected reduction in lead inductances by use of disk seals, and employs a parallel plane structure which permits the use of relatively small electrode areas; thereby making possible low interelectrode capacitances while reducing the spacing between electrodes to the point where the transit time is small in comparison with the period at the frequencies indicated.

Design of Lighthouse Oscillators

There are two types of resonator circuits used in conjunction with the lighthouse tube, one is known as the double coaxial resonator, shown in Figs. 1-A

and B, and the other a re-entrant cavity, shown in Fig. 1-C. As indicated in Figs. 1-A and B, there are two variations of the double coaxial resonator. In one case, the grid to cathode line is completely independent from the grid to plate line. In the second case, in order to conserve space, the grid to cathode line is folded back over the grid to plate line. This does not alter the fundamental principles of the two resonant circuits inasmuch as the inner surface of the grid cylinder acts as the grid side of the grid-anode line while the outer surface forms the grid side of the grid-cathode line. There is no coupling between these two lines through the common conductor since, as indicated in a previous article¹, the depth of penetration of the electromagnetic field at these frequencies is much less than the thickness of the metal.

The shorting plugs, shown in Figs. 1-A, B, and C, are actually r.f. shorts and not d.c. shorts. This is done by using a quarter-wave "choke" shown in Fig. 1-D. Since this element is a quarter wave long and open circuited, it presents a short circuit to the r.f. energy. The spacing between the choke and the wall of the tube is determined by the amount of d.c. voltage applied to the plate of the tube. The smaller the spacing the more effective the "choking" or "shorting" action, since Z_0 will be small.

In the double coax circuits shown in Figs. 1-A and B, both grid-cathode and plate-grid lines have shorting plugs which can be varied to tune over the desired frequency range. The re-entrant cavity circuit, shown in Fig. 1-C, is similar to the "folded back" grid-cathode line. However, this circuit is not tuned in the same manner that is used in the double coax resonator. Instead of terminating the tuned circuits in "shorting plugs," the grid line is made one half wavelength long and mounted directly on the flange of the tube. The length of the grid line is fixed for any given setup, and thus becomes the frequency determining factor in the circuit.

The shorting plug in the re-entrant cavity, which is mounted on the plate line, does not affect the resonant frequency of the circuit, but functions primarily to optimize conditions for oscillation with a given grid cylinder rather than to change the frequency.

The double coax and re-entrant cavity circuits are basically degenerative and the amount of feedback provided by the interelectrode capacity is insufficient for oscillation, if care is used in shielding the resonant lines from one another. Probably the most frequent cause of insufficient shielding is poor grid contact design. These lines should be slotted to permit a spring contact. Similarly

Fig. 5. Typical automatic frequency control circuit for a microwave oscillator.

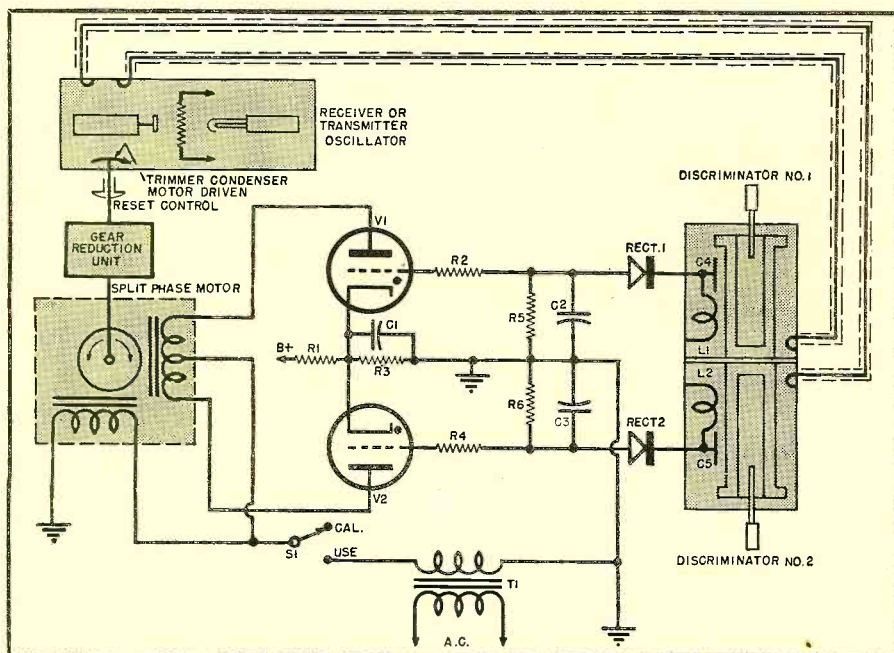

the plate line should be machined and slotted so that it grips the plate cap of the lighthouse tube firmly.

There are a number of feedback loop or probe arrangements that can be used to sustain oscillations. Some of these are shown in Fig. 2. A loop is usually placed at a voltage minimum and a probe at a voltage maximum. When broad tuning is desired, a combination of probe and loop feedback elements may be used to cover the entire frequency range.

It will be found that the frequency and efficiency of the oscillator will depend to some degree upon the position (determining phase of feedback) and size (determining the amplitude of feedback) of the probe or loop. A trial and error procedure is used to determine the optimum feedback circuit that provides maximum output and efficiency.

The output of the oscillator is picked up by either a probe or loop as shown in Fig. 3. The exact position of the probe or loop will depend upon the impedance of the load. Again the best procedure is to vary the position until maximum output is obtained across the load. This effect is similar to tapping the coil of a tank circuit to match a given impedance.

The diameters of the lines are determined by the requirements of the oscillator. Using standard theory, the desired Q of the tank circuit is determined considering both the effects of the tube and the load. The Q of a resonant length of coaxial line was given³ in a previous article as:

$$Q = \frac{2\pi f_0 \sqrt{LC}}{2\alpha_T} \dots \dots \dots (1)$$

This equation can be simplified by assuming that the attenuation due to the dielectric, α_d , is negligible, in which case $\alpha_T = R_f/2Z_0$, and Eq. (1) becomes:

$$Q = \frac{2\pi f_0 Z_0}{R_f V_T} \dots \dots \dots (2)$$

since $V_T = 1/\sqrt{LC} = 3 \times 10^{10}$ cm./sec. for air. Further simplification of this equation can be obtained³ by writing Z_0 in terms of D/d and the r.f. resistance² in terms of D , d , and f . Doing this we obtain:

$$Q = 8.39\sqrt{f} DHR_1 \times 10^{-2} \dots \dots \dots (3)$$

where D is in cm., f in mc., R_1 is the ratio of the d.c. resistance of the conductor used to the d.c. resistance of copper, and H is defined as:

$$H = 3.6 \left(\frac{D+d}{d} \right) \log_e \frac{D}{d} \dots \dots \dots (4)$$

Eq. (4) is plotted in Fig. 7. With the help of this figure and Eq. (3), the Q of a coaxial line for a given D/d ratio can readily be determined.

For the purpose of mechanical simplicity, the plate line diameter is usually made so that it will just slip over the plate cap. The diameters of the grid and cathode rods are then calculated based on this parameter and the Q required. Of course it is desirable to use rods that are of the same diameters as the caps provided or slightly larger.

Earlier in this article it was noted that there is a definite relationship between interelectrode capacitance, electron transit time, and maximum plate dissipation in a tube design, i.e., reducing interelectrode capacitance and transit time also causes a reduction in maximum plate dissipation. Due to the various mechanical factors involved, there is a maximum theoretical (at least at the present time) continuous power output than can be obtained from a single triode employed in the conventional manner. This maximum value has been plotted in Fig. 4 as a function of frequency.

The continuous power output obtained from commercially available tubes is less than this theoretical value. Fig. 4 plots a typical power output versus frequency curve of a 2C43 lighthouse tube operating in a re-entrant cavity. The outputs obtained from other tubes operating with different potentials can be obtained from the tube manufacturers.

At microwaves, where considerable spectrum is available, it is frequently convenient to use greater r.f. bandwidth for greater efficiency and power. This can be done by using one of the

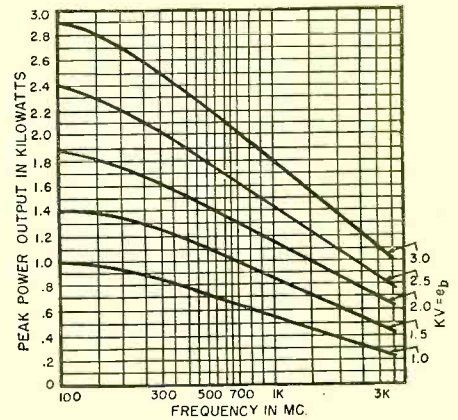

Fig. 6. Plate-pulsed oscillator performance, power output vs. frequency. Pulse rate, 1000 per second; duration, 1 microsecond.

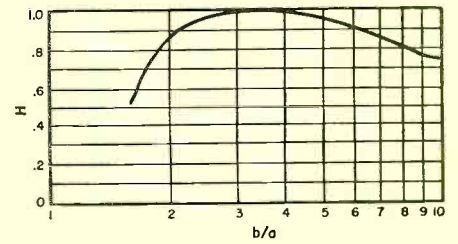

Fig. 7. Variation of H with b/a.

several pulse modulation techniques available such as pulse time modulation (PTM), pulse amplitude modulation (PAM), or pulse frequency modulation (PFM)⁴. When the transmitter is pulsed, a much higher peak power can be emitted for a given maximum average power.

It is known that the average value of a pulse series is equal to⁵:

(Continued on page 30)

Fig. 8. Another type of microwave automatic frequency control circuit.

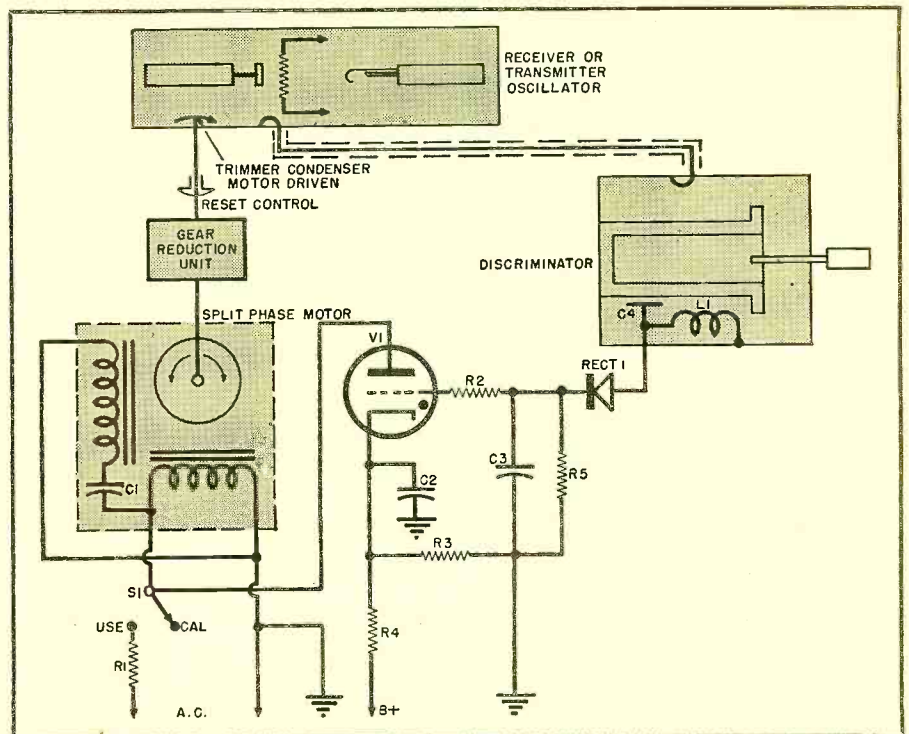

Dr. Goubau at the Signal Corps Engineering Laboratories with a model of the simplified "G-String" transmission line which he invented.

SURFACE WAVE TRANSMISSION LINE

By **GEORG GOUBAU**
Signal Corps Engineering Labs.

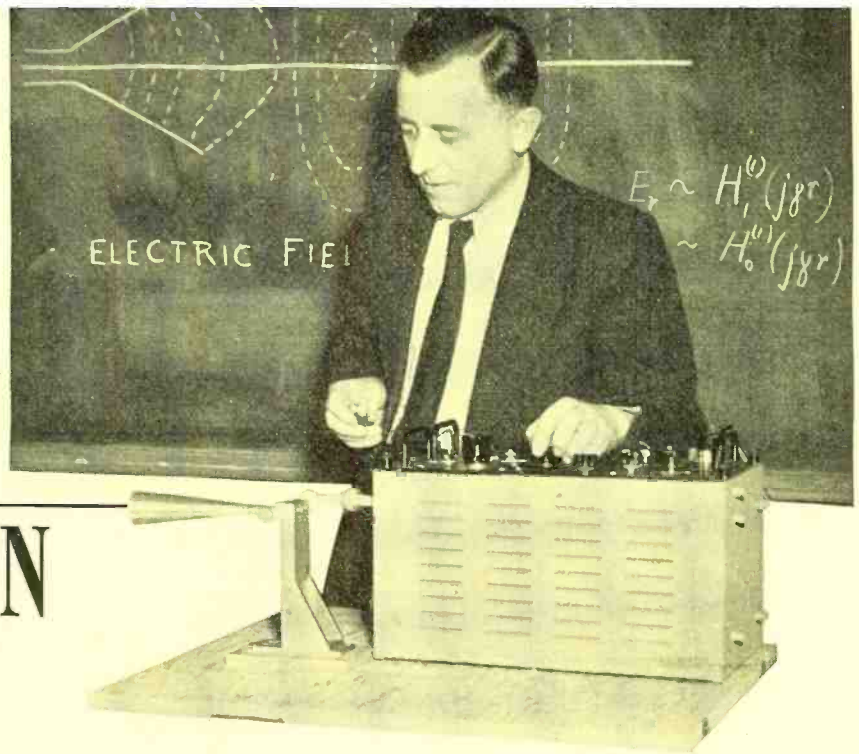

A single insulated wire with special funnel-shaped terminals provides very efficient h.f. transmission.

A PAPER published by Sommerfeld in the year 1899 describes a surface wave guided by a cylindrical conductor of finite conductivity. This wave differs from the wave mode usually excited on long wire antennas in two respects: first, it suffers no radiation loss along its path and second, the field distribution depends to a high degree upon the conductivity of the wire material; and the wave would not exist at all if the conductivity were infinite. Though there is a solution of Maxwell's equations in that case, the solution lacks physical reality since the power transmitted by the wave is infinite if the current in the wire is finite.

Sommerfeld's paper has seen little consideration in the modern literature and there are only a few books in which it is quoted. One of these books is Stratton's well-known "Electromagnetic Theory". It may have been doubtful to many a physicist whether this surface wave can be excited, because not every special solution of Maxwell's equations is realizable. Sommerfeld's wave is a plane wave and therefore the wave could be part of an asymptotic solution, which is valid at a large distance from the power source. In that case, only an infinitesimally small amount of the total power would be converted into the surface wave. To our knowledge nobody has proven as yet that Sommerfeld's surface wave can be excited with finite amplitude. Though we are convinced that this can be done, there are two facts which will make it difficult to obtain good efficiency. The field extends

very far from the wire and has a rather complicated shape. An effective launching device would have to be very large, otherwise the radiating wave mode would become predominant.

The reason we were interested in Sommerfeld's wave for a long time is the theoretically low attenuation of this wave. Transmission lines using this wave mode should have less insertion loss than coaxial cables and—provided the diameter of the wire is sufficiently large—even smaller loss than rigid wave guides. This fact made us think about the possibility of concentrating the field closer to the wire; thus, the excitation of the wave would become simpler and besides, the clearance around the wire required for an un-

disturbed propagation could be kept smaller. A study of cylindrical surface waves showed that the extension of the field of a surface wave depends upon the phase velocity. The more the wave is urged to travel with lower speed, the more the diameter of the field shrinks. A reduction in phase velocity of less than one per-cent is in general sufficient for obtaining reasonable dimensions of the field. Such a reduction can be achieved by a dielectric coat on the wire or by other modifications of the conductor surface like the application of a thread on the wire. The wave mode guided by a conductor, the surface of which is modified as mentioned, differs from Sommerfeld's wave not only in the extension but also in the structure of the field. Both wave modes are mathematically described by Hankel functions; however, in the case of the plain wire, the argument of these functions is complex, while it is purely imaginary in the other case, at least if the losses are disregarded. And here we have an important difference: the finite conductivity is no longer an essential provision for the existence of the non-radiating wave mode.

Last summer we started experiments with this wave mode on dielectric coated and threaded wires. From the very beginning we observed that this wave mode can be easily excited with an efficiency up to 90%. Furthermore, the experiments showed that the wave mode is very stable with regard to a sag of the wire or to small bends. The meas-

Fig. 1. Distribution of magnetic field for various reductions in phase velocity $\lambda/(\text{wire radius}) \alpha$ is 100.

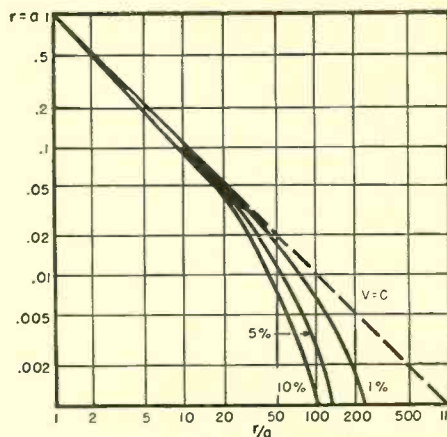

ured loss of transmission lines based on this wave mode was in very good agreement with the theoretical expectations.

Before discussing the setup and the results we would like to say a little bit more about the wave mode. The wave mode is a radially symmetrical transverse magnetic mode with a small longitudinal electric component. Fig. 2 shows the electric field lines for a case in which the wavelength is 100 times the wire radius and the phase velocity is reduced by 10%. In general a much smaller reduction of phase velocity is used. We assumed here a large reduction in order to get more field lines on the drawing. All electric field lines start on the wire and return to the wire. The magnetic field lines are circles around the wire.

Fig. 1 shows how the field decreases with the distance from the wire. The ratio of the magnetic field strength at a distance from the wire to the magnetic field strength at the surface of the wire is plotted versus the distance, measured in multiples of the wire radius. Both scales are logarithmic. The broken line indicates a $1/r$ decrease as it would be present in the case of a plain wire with infinite conductivity. In this case the phase velocity would be equal to the velocity of light, and as mentioned before the power would be infinite if the field strength were finite. The unbroken curves show how the field decreases if the phase velocity is reduced by 1, 2, 5 and 10%. The curves follow first the $1/r$ decrease and approach at larger distances an exponential decrease. The smaller the phase velocity is, the earlier the exponential decrease begins.

Fig. 3 is a schematic sketch of a surface wave transmission line. The launching device used in the experimental work consisted of a metal horn connected to the outside conductor of the coaxial feed lines. The inner conductor of that line is connected to the surface wave guide consisting in most of the experiments of a normal enameled wire. The transmitting and receiving ends of the line are alike. The dimensions given in Fig. 3 refer to the curves of Figs. 5 and 6.

The loss of such a surface wave transmission line consists of three parts: the conductivity loss in the wire, the loss in the dielectric coat and the loss, effected by the launching device, due to a partial excitation of the radiating mode. The first two parts, conductivity loss and dielectric loss, can be calculated from the field distribution of the wave. They are proportional to the length. The launching loss is independent of the length of the line and can be determined with fair accuracy by the following consideration. At the receiv-

ing end that portion of the wave energy will be received which travels within the area of the aperture of the horn. The wave energy outside this area will be lost. The ratio between received energy and the total energy determines the efficiency of the receiving horn. Because of the reciprocity theorem the efficiency of the transmitting horn must be the same as the efficiency of the receiving horn.

The loss of the transmission line shown in Fig. 3 was calculated for various frequencies and Fig. 5 is a plot of the results. The length of the line is 120 ft., the diameter of the wire 0.2 cm., and the thickness of the enamel layer 5.0×10^{-3} cm. The dielectric constant is assumed to be 3 and the power factor 8×10^{-3} . The opening of the horns is 13". The conductivity loss L_c and the dielectric loss L_i increase with frequency while the launching loss L_h decreases. The total loss L_{tot} , which is the sum of the three components L_c , L_i and L_h has a flat minimum of about 2 db. The loss was measured for three frequencies. For 1600 mc. it measured 2.2 db.; for 3300 mc., 2.3 db.; and for 4700 mc., 4.5 db. While the deviation between theory and measurement for the lower frequency is comparatively small, it is pretty large for the high frequency. The main reason for this deviation lies in the fact that the angle of the horns was too large for the high frequency and thus the efficiency of the horns was much smaller than expected. For comparison, the approximate loss of 120 ft. of RG-8/U cable is 13 db. for 1600 mc., 22 db. for 3300 mc. and 30 db. for 4700 mc. Though these data refer to a very good cable the losses are about 6 to 10 times as high as the losses of the surface wave transmission line.

The effect of the thickness of the dielectric coat on the efficiency of such a transmission line is demonstrated by curves shown in Fig. 6. Length of the line, diameter of the wire and dimensions of the horns are the same. Only the thickness of the dielectric coat is assumed to vary. The curves refer to a frequency of 3000 mc. For a very thin

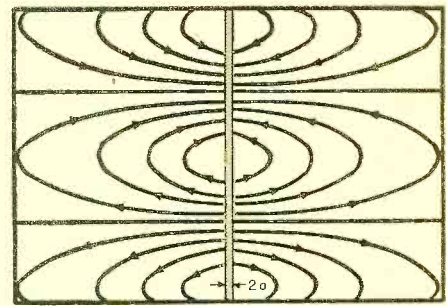

Fig. 2. Electric field lines where $\lambda = 100 \alpha$ and $v/c = 0.9$

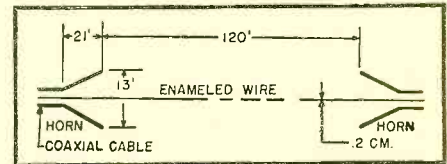

Fig. 3. Schematic sketch of a surface wave transmission line.

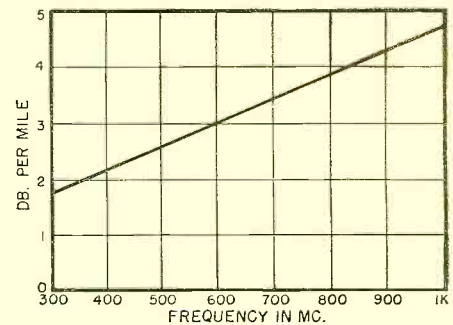

Fig. 4. Calculated attenuation for 2 cm. wire with $\frac{1}{2}$ mm. polystyrene coating.

dielectric coat the insertion loss is large because of the low efficiency of the horns. There is an optimum thickness for which the loss is a minimum. For larger thickness of the dielectric coat the loss rises slowly because of the increasing conductivity and dielectric losses. A curve like this has been verified. The same horns and the same wire length (120'), but a wire of 0.26 cm. thickness were used (this was the only available bare copper wire). The measurements were made at a frequency of 2600 mc. The wire was outdoors for
(Continued on page 29)

Fig. 5. Losses for the transmission line of Fig. 3 as a function of frequency.

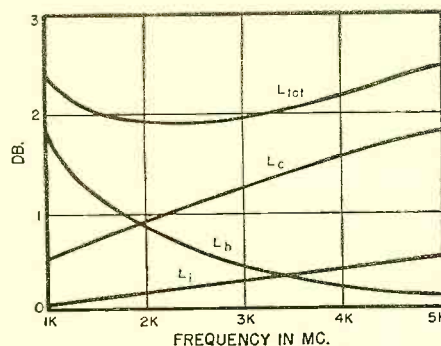
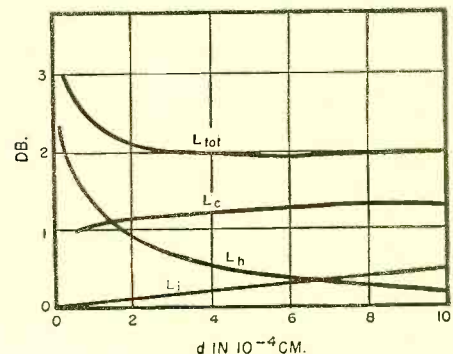

Fig. 6. Losses for the line of Fig. 3 for varying thicknesses of dielectric coating.



A NEW R-C OSCILLATOR CIRCUIT

By **MILTON H. CROTHERS**
Electrical Engineering Dept., U. of Illinois*

Oscillator using a 12AU7 and operating near 9 kc. Note compactness of unit.

Development of an R-C oscillator having greater stability and fewer parts than conventional units.

VACUUM tube oscillators are truly fundamental to the art of modern communications. Vacuum tube oscillators may be grouped in two general classes depending upon the class of operation of the amplifier stage, that is, linear or nonlinear. The first vacuum tube oscillators depended upon non-linear operation of the vacuum tube to locate and determine the steady state amplitude of oscillation. Nonlinear operation of the amplifier tube must introduce distortion components of the fundamental signal frequency. These distortion components are attenuated by a highly selective tuned circuit.

Resistance-capacitance oscillators have become very popular within the last decade. This paper will introduce a novel form of this oscillator, making use of the standard R-C network and a new amplifier, and having several marked advantages over circuits which have been used to date.

Need for Nonlinearity in an Oscillator

Let the general oscillator be described as an amplifier section and a feedback section. The gain of the amplifier will be represented by the symbol K and the transmission of the feedback section will be represented by the symbol β . Either one or both of these sections will include some form of a selective circuit so the gain through the sections will be a maximum at only one frequency, as indicated in Fig. 1.

* From the thesis submitted in partial fulfillment of the requirements for the degree of Master of Science in Electrical Engineering to the Graduate College of the University of Illinois 1949. 'A Study of Nonlinear Circuit Elements'.

When the input signal (E_1) and the output signal (E_3) are identical the loop may be closed to form an oscillator. If the net gain around this loop is greater than unity the oscillations will build up in amplitude with each succeeding cycle. The gain around the loop must be self adjusting in order that the oscillator maintains some particular value of oscillation amplitude. The steady state amplitude in an oscillator is defined as that signal level which just makes the loop gain unity. An amplifier operating in a nonlinear region varies its effective gain somewhat inversely with signal amplitude and thereby controls the oscillation amplitude.

Nonlinearity and Circuit Selectivity

An oscillator using any nonlinear element which is instantaneous in nature generates distortion components. The

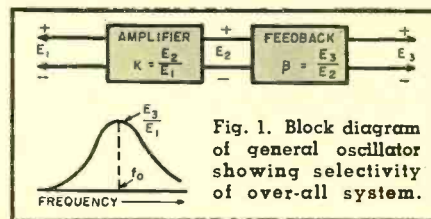
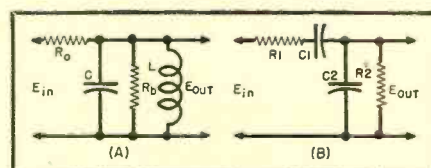

Fig. 2. (A) Tuned L-C circuit. (B) Tuned R-C network.



relative distortion depends upon the degree of nonlinearity over the operating range. Attenuation of these distortion components depends upon the selectivity of the circuit. Highly selective circuits permit highly nonlinear operating regions in the amplifier.

The resistance-capacitance network shown in Fig. 2 may be used as a selective network. The Q of the R-C network is only $\frac{1}{2}$ when equal values of resistance and capacitance are used. A highly selective tuned circuit is compared with the R-C network in Figs. 3 and 4.

Very little attenuation is offered to distortion components by the poorer selectivity of the R-C network. For this reason there must be control of the loop gain by a method which is not an instantaneous nonlinear element.

Nonlinear Elements Which Are Not Instantaneous

Most of the resistance-capacitance oscillator circuits use thermally responsive nonlinear devices. Generally these elements are low current 115 volt tungsten lamps. Low current fuses are also suitable for higher frequency signals. These devices have a positive temperature-resistance coefficient. Typical characteristics of a number of common nonlinear elements are given in Figs. 5 and 6.

The lamps show linear operation within each cycle for frequencies as low as ten cycles per second. They will not introduce distortion components when operated over the audio range. The small fuses show some instantaneous nonlinearity at frequencies below 100 cycles and therefore are not suitable for use at frequencies lower than 1000 cycles.

A fundamental and useful oscillator circuit using class 'A₁' amplifiers with an R-C feedback network is shown in

Fig. 7A. Pentodes are normally used but triodes are shown to illustrate the basic circuit.

A great amount of inverse feedback is included to stabilize the circuit. The inverse feedback circuit includes a non-linear element R_x which controls the gain inversely as the signal amplitude varies. The gain of this amplifier is indicated in Fig. 13.

The condition required for steady state oscillation is that the loop gain is unity, that is, E_1 and E_3 are identical. This will lead to two general expressions:

$$K = 1 + \frac{R_1}{R_2} + \frac{C_2}{C_1} \dots \dots \dots (1)$$

$$\text{Freq.} = \frac{1}{2\pi\sqrt{R_1 C_1 R_2 C_2}} \dots \dots \dots (2)$$

Adjustment and selection of circuit elements and tube coefficients should be made so the action of R_x limits the oscillation amplitude to class A₁ operation. The nature of control obtained from R_x depends upon the heating by the a.c. signal current. It is to be noted that d.c. quiescent current must also pass through R_x and thus hinders the control action. Oscillator circuits of this general type have been used with great success in a large number of applications over frequency ranges of 1 to 200,000 cycles. The distortion in most cases is of the order of 2 per-cent or less.

These are the general characteristics desired of the amplifier section selected for this oscillator circuit:

- 1—Gain is stable and constant as a function of supply voltages, component values (in general) and tube changes.
- 2—Wideband frequency response and minimum phase shift over the working frequency range.
- 3—Low output impedance compared to values of elements used in the feedback network.
- 4—Nonlinear element controlling the gain inversely with signal amplitude. This element must not introduce distortion and the signal level must be within the class A₁ region.

The New Amplifier Circuit

The circuit devised by the author and shown in Fig. 7B complies in general with the specifications listed above and offers a number of advantages. A fewer number of circuit components are required with this new "π coupled" amplifier circuit. There is also one fundamental advantage in the manner in which the nonlinear element operates and responds to the signal level. These items will be discussed in detail.

The "π coupled" amplifier is that part of the circuit within the dotted lines and uses one dual triode tube, three resistors and one nonlinear element. This is a total of four circuit elements

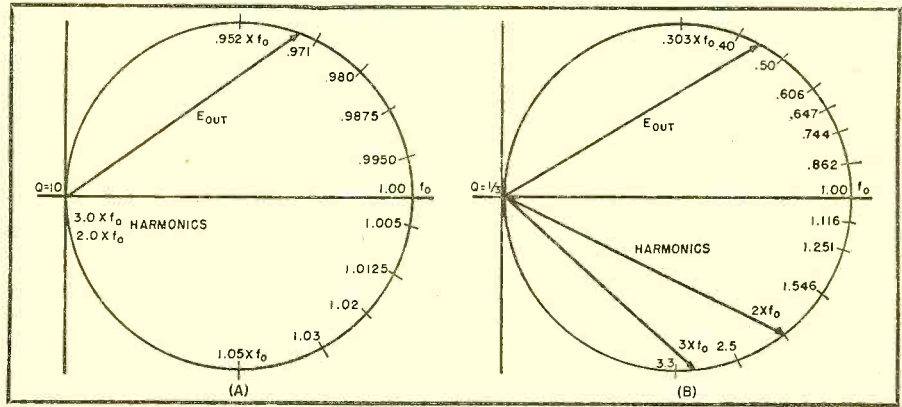

Fig. 3. Frequency response of networks for a Q of 1/3 and a Q of 10.

as compared to the nine components required by the amplifier in Fig. 7A. This smaller number of elements offers decided advantages where cost, space, and weight are to be considered. This is the major reason for advancing this new circuit.

The second advantage results because the nonlinear element R_x does not carry quiescent current in this new circuit. The element can respond more readily to the a.c. signal component in the circuit and offers a greater sensitivity to signal amplitude. This greater sensitivity offers some compensation for the less stable amplifier characteristics. It is true that any of these circuits could be arranged to impress only the a.c. signal across the element R_x but this new circuit provides such isolation within the basic form. A total of three variations will be given for this circuit. These variations differ only in the manner of balancing out d.c. from the nonlinear element.

The amplifier shown in Fig. 7A has low output impedance because the inverse voltage feedback reduces the output impedance below the value of the amplifier without this inverse feedback. The output impedance of the new amplifier is higher because there is no inverse feedback applied. A value of 5-10 k. ohms is typical of this output imped-

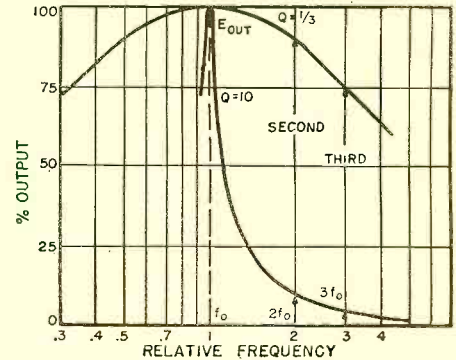

Fig. 4. Selectivity of a network for a Q of 1/3 and a Q of 10.

ance. The value of R_1 in the feedback section might be corrected to allow for this impedance.

Examination of the circuit for the "π coupled" amplifier reveals that the first stage is operating as a grounded plate amplifier and the gain is therefore less than unity:

$$K_1 = \frac{\mu_1 R_{k1}}{R_{p1} + R_{k1} + \mu R_{k1}} \dots \dots \dots (3)$$

The gain of this stage is reasonably constant with respect to changes in supply voltages.

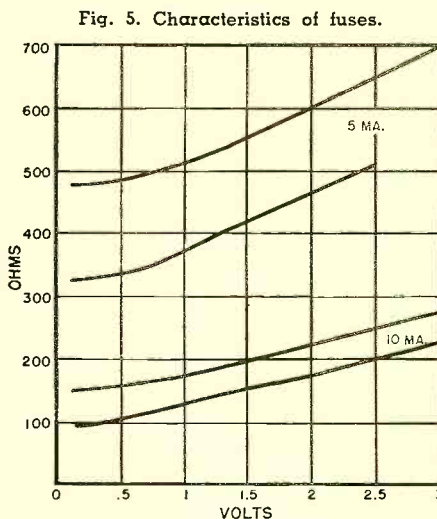

Fig. 5. Characteristics of fuses.

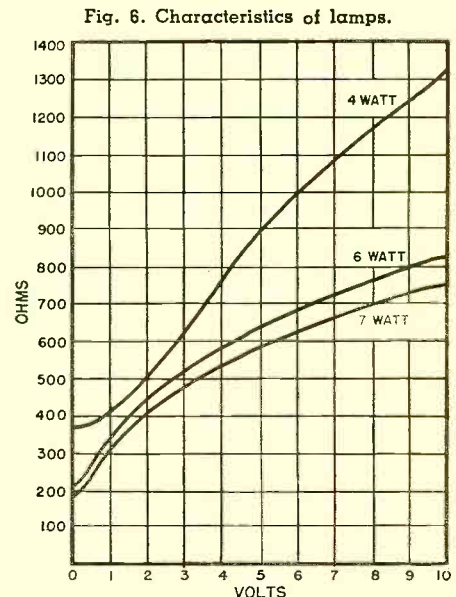

Fig. 6. Characteristics of lamps.

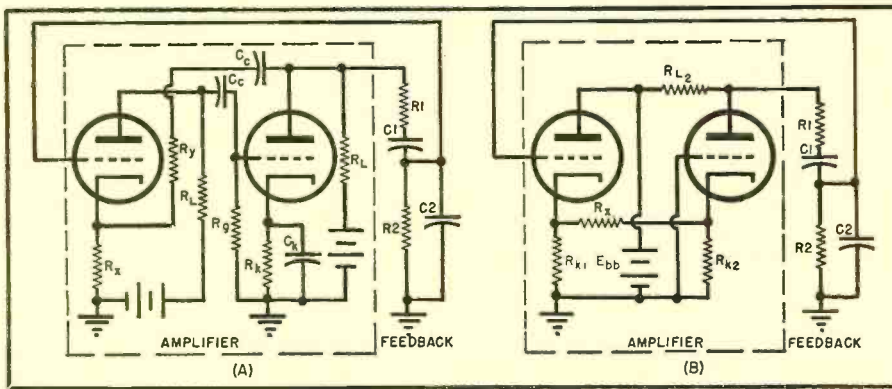

Fig. 7. (A) Fundamental circuit using class A₁ amplifiers with an R-C feedback network. (B) New "\$\pi\$ coupled" circuit has advantages over (A).

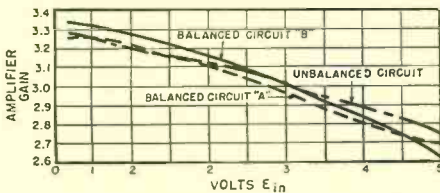

Fig. 8. Variation in amplifier gain with respect to signal level.

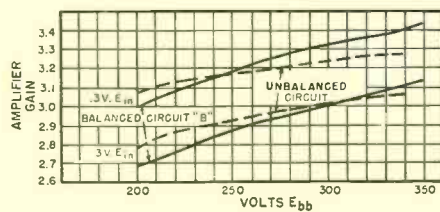

Fig. 9. Variation in amplifier gain with respect to plate voltage.

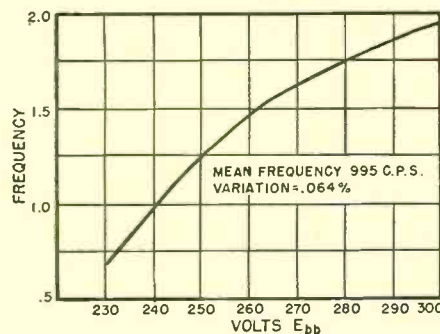
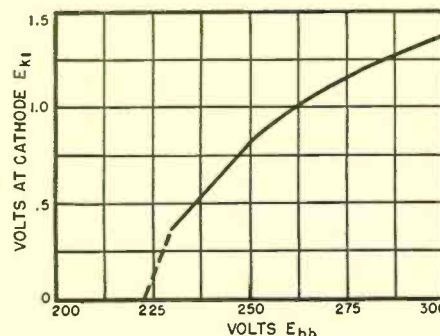

Fig. 10. Frequency stability of typical oscillator plotted against variations in plate voltage.

Fig. 11. Amplitude stability vs. plate voltage using a 115 volt, 4 w. tungsten lamp as \$R_x\$. Frequency is 400 c.p.s.



This first stage is coupled to the second stage by means of the \$\pi\$ type network between the cathodes. For this reason the name of "\$\pi\$ coupled" amplifier has been coined for the circuit. The second stage operates as a grounded grid amplifier, the gain of which is given as:

$$K_2 = \frac{(\mu_2 + 1) R_{L2}}{r_{p2} + R_{L2}} \quad (4)$$

Interaction between these stages through the \$\pi\$ coupling network gives a net gain different than that of the product of \$K_1\$ and \$K_2\$ above. The net over-all gain has been calculated and is given in this form:

$$K = \frac{A}{B + CR_x} \quad (5)$$

where \$A\$, \$B\$ and \$C\$ are:

$$A = \mu_1 (\mu_2 + 1) R_{L2} R_{k1} R_{k2} \quad (6)$$

$$B = (R_L + r_p) [r_p R_{k1} + r_p R_{k2} + (\mu + 1) R_{k1} R_{k2}] + r_p R_{k1} R_{k2} (\mu_2 + 1) \quad (7)$$

$$C = [r_p + R_{k1} (\mu_1 + 1)] \times [r_p + R_L + R_{k2} (\mu_2 + 1)] \quad (8)$$

Loading of the amplifier by the feedback network has not been considered in

Fig. 12. Distortion in 400 cycle 6SN7 R-C oscillator with (A) \$R_x\$ a 4 w. lamp and \$E_{bb} = 200\$ v., (B) \$R_x\$ a 5 ma. fuse and \$E_{bb} = 250\$ v.

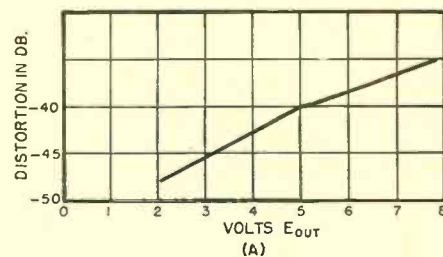

Fig. 12. Distortion in 400 cycle 6SN7 R-C oscillator with (A) \$R_x\$ a 4 w. lamp and \$E_{bb} = 200\$ v., (B) \$R_x\$ a 5 ma. fuse and \$E_{bb} = 250\$ v.

the calculation of amplifier gain. It is assumed that this may be neglected in most cases by proper selection of the elements in the feedback network.

Typical Operation

Most of these oscillator circuits are used with equal values for the resistances in the feedback network. The gain which is required is then found to be three. The dual section triodes 6SN7 and 12AU7 may be used with these approximate circuit values:

$$R_{k1} = R_{k2} = 2,000 \text{ ohms.}$$

$$R_{L2} = 10,000 \text{ to } 15,000 \text{ ohms selected for oscillation level.}$$

$$R_x = \text{one } 115 \text{ volt, } 6 \text{ or } 7 \text{ watt tungsten lamp.}$$

The feedback network values are selected for the frequency desired with these general limits suggested:

$$R_1 = R_2 = \text{values ranging from } 50k \text{ ohms to } 10 \text{ megohms.}$$

$$C_1 = C_2 = \text{minimum values of } 100 \mu\text{fd.}$$

These feedback network values will permit operation over and slightly beyond the audio frequency range.

A number of oscillators have been constructed using the basic circuit with fixed elements in the feedback network. These oscillators have been built within the general circuit of some projects to provide various signals at one frequency. Another oscillator has been constructed using a pair of switches to select any one of a number of fixed frequencies. Continuously variable oscillators have also been constructed using either variable resistors or variable condensers in the feedback circuit.

From a number of these different oscillators the curves given in Figs. 10, 11 and 12 have been recorded to illustrate the general operation of this circuit.

Long time measurements are not indicated for frequency stability for this oscillator does not seem to fit in this general class. The variation in frequency with respect to supply voltage is favorable on a short time test. The frequency will be sufficiently constant for most applications in mind for the circuit.

Measurements on a number of different oscillators indicated that an output voltage with 1 per-cent or less total distortion can be obtained operating near the oscillation threshold. Additional measurements indicate that lower distortion was obtained, for any given output voltage level, when the plate supply voltage is increased and the amplifier gain readjusted for the same output level. In making the observation the gain was adjusted by varying the value of \$R_{k2}\$. In other circuits the

(Continued on page 24)

VIDEO AMPLIFIER DESIGN

By **ROBERT C. MOSES**
Sylvania Electric Products Inc.

Various types of compensation may be used to give an amplifier with essentially flat amplitude and phase characteristics over the entire video band.

HIGH definition television systems are required to convey information transmitted at rates up to 8,700,000 picture elements per second. The ultimate resolution obtainable in the reproduced image is determined by the ability of the equipment as a whole to respond to the maximum rate of transmission. The latter, in turn, is directly proportional to the bandwidth of the circuits through which the video signal must pass. With the present 525 line, 30 frame transmission standards, it can be shown that adequate response up to a maximum frequency of 4.35 megacycles is necessary for faithful reproduction of the finest detail in the picture. On the other hand, satisfactory rendition of backgrounds and of very large objects requires that the system be capable of reproducing one picture element having dimensions approaching those of the entire scanned area. Proper response of the system down to d.c. is therefore indicated. Since transmission of d.c. in the system is a subject beyond the scope of this article, the following discussion will be limited to amplifiers responding to frequencies down to about 30 cycles.

The necessity for handling such a wide spread in rates of transmission imposes severe requirements upon the video amplifier channel. Not only must the amplifier be capable of passing the entire frequency range from 30 cycles to over 4.0 megacycles with a minimum of amplitude discrimination, but also

the transmission time through the system must be as nearly constant as possible for all frequency components within these limits. The latter requires that the curve of amplifier phase shift versus frequency be essentially linear up to the maximum frequency present in the video signal.

The usual resistance-coupled audio amplifier falls far short of these requirements, since both the amplitude and phase characteristics deteriorate rapidly above about 10,000 cycles and below 70 cycles. Some form of compensation for both amplitude response and phase shift is obviously necessary. There are several methods by which such compensation may be accomplished, and for purposes of discussion, the low and

high frequency considerations will be treated separately.

Even if the amplitude response of the conventional pentode resistance coupled amplifier were satisfactory at low frequencies, the phase characteristics below 60 cycles would be troublesome. Excessive phase shifts at low frequencies may be attributed to three sources:

1. The time constant of the grid coupling network
2. The screen circuit time constant
3. The cathode biasing network

These factors are indicated in the equivalent circuit of Fig. 2A. The plate supply terminals and d.c. connections are omitted for clarity.

The reactance of the coupling capacitor C_c at low frequencies introduces a leading phase shift and a drop in amplitude in the component E_o of output voltage across the grid resistor of the following stage. These effects become serious below the frequency at which the reactance of C_c exceeds about $\frac{1}{5}$ the resistance of R_g , and may be sufficiently great to prevent proper reproduction of square waves of 60 cycles base frequency unless large values of C_c and R_g are used. The magnitude of the phase angle is given by:

$$\varphi = -\tan^{-1} \frac{1}{2\pi f C_c R_g}$$

and the relative amplitude characteristic by:

$$\frac{E_o}{E_i} = \cos \varphi$$

where E_o and E_i are the output and input voltage respectively.

While it is theoretically possible to obtain values of C_c and R_g which will keep the frequency of negligible phase shift below 30 cycles, large values of coupling capacitors introduce additional stray capacitances which may affect the high frequency characteristics of the amplifier. At the same time, the maximum value of the grid resistor R_g is usually limited by gas and grid current considerations in the following tube. It is therefore customary to assign reasonable values to C_c and R_g , and

Fig. 1. Low frequency phase and amplitude characteristics of a typical two-stage video amplifier with compensation.

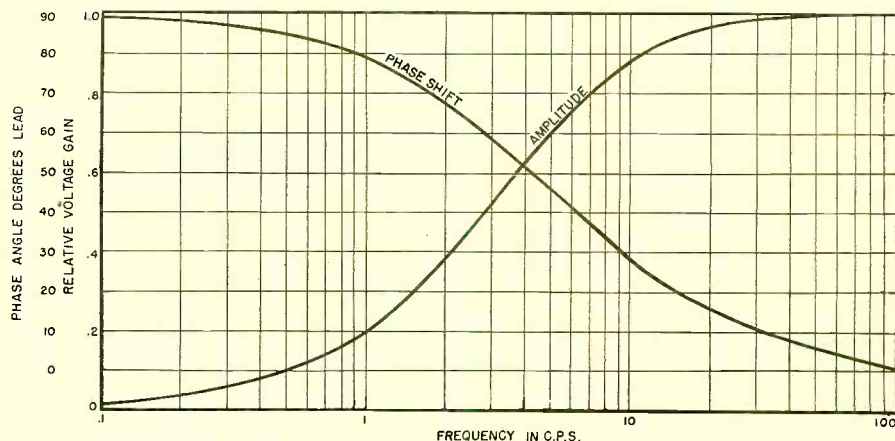

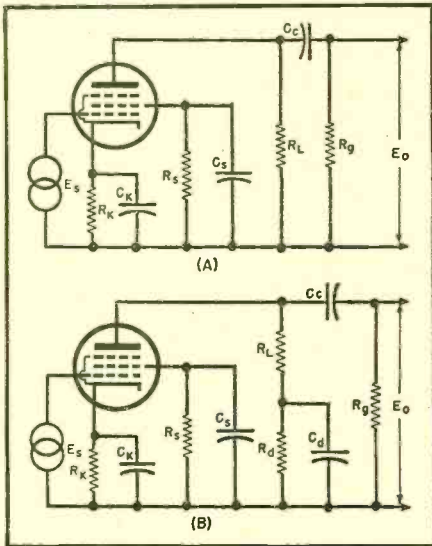

Fig. 2. (A) Low frequency equivalent circuit. (B) Equivalent circuit with low frequency compensation.

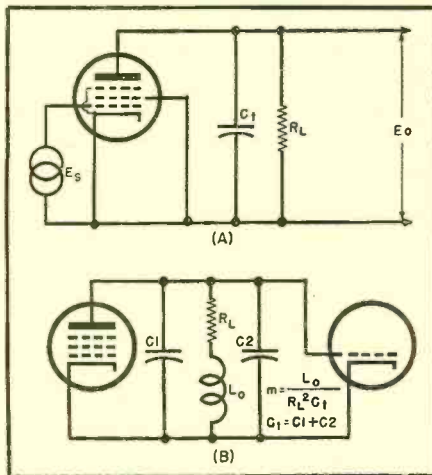

Fig. 3. (A) High frequency equivalent circuit. (B) Shunt peaking network.

provide compensation for the resulting phase shift at some point in the system.

The finite time constant of the screen resistor-capacitor combination \$R_s C_s\$ causes a shift in phase and a drop in amplitude at low frequencies in exactly the same way as the grid coupling network, and the extent of these deficien-

cies may be specified in the same manner. However, the phase angle and departure from flat amplitude response introduced by \$R_s C_s\$ can be kept small with practical component values, and their effect need not be compensated if:

$$R_s C_s \geq 0.077$$

where \$R_s\$ is in megohms and \$C_s\$ is in microfarads, a condition readily achieved in most cases. If the above holds, the phase angle due to \$R_s C_s\$ will not exceed \$4^\circ\$ at 30 cycles.

The impedance of the cathode bias network \$C_k R_k\$ results in degenerative effects and excessive phase shifts at frequencies below that at which the reactance of \$C_k\$ exceeds about 1/10 the resistance of \$R_k\$. In many cases, prohibitively large values of \$C_k\$ are required if the frequency of near-zero phase shift is to be comparable with the frame repetition frequency. Compensation for low-frequency discrepancies due to \$C_k R_k\$ can be provided in much the same manner as for the grid coupling network; however, the design constants for cathode-bias impedance compensation are different.

Despite the fact that there are several arrangements for compensating the effects of the grid coupling and cathode biasing networks, one simple form of correction circuit has been widely used. This consists of a parallel resistor and capacitor in the plate circuit of the stage to be compensated, as shown in Fig. 2B.

In this circuit, the additional components \$C_d R_d\$ in series with the plate load of the tube introduces a compensating phase shift which causes the output voltage \$E_o\$ to lag in phase by the same amount as the leading phase angle produced by either \$C_c R_g\$ or \$C_k R_k\$. At the same time, the reactance of \$C_d\$ causes a rise at low frequencies in the effective load impedance presented to the tube. The resulting increase in gain counteracts deficiencies in amplitude response. It is usually not possible to satisfy the conditions for correction of both grid coupling and cathode biasing network effects in one such correction circuit.

An entirely satisfactory degree of compensation for either can, however, be achieved through a suitable choice of correction parameters.

Compensation for Grid Coupling Network

For a satisfactory degree of compensation for phase shifts produced by the grid coupling network, the following relations must hold:

1. The time constant of the plate load resistor and compensating capacitor must equal the time constant of the grid coupling network.

$$C_d R_d = C_c R_g$$

2. The resistance of the decoupling resistor must be at least ten times the reactance of the compensating capacitor at the lowest frequency for which correction is required.

$$R_d \geq 10/\omega C_d$$

It should be noted that this type of compensation for deficiencies in the grid coupling network will not give perfect correction to very low frequencies or to d.c. except in the theoretical and practically unattainable condition of infinite decoupling resistance \$R_d\$. For a fixed value of \$C_d\$, the lowest frequency for which compensation is exact is inversely proportional to the value of \$R_d\$.

The usual procedure in compensating a stage for the effects of the grid coupling network is to select a suitable value for \$C_d\$, say 10 microfarads. This, in combination with the plate load resistor as determined from high frequency considerations, gives the time constant to be obtained in the following grid circuit. The decoupling resistor \$R_d\$ is then made as large as possible consistent with obtaining the required plate voltage at the tube.

Compensation for Cathode Bias Network

Correction for phase shifts and amplitude discrimination due to the cathode biasing network can be effected in a similar manner to the above, except in this case, exact compensation can be achieved down to d.c. with practical circuit values. Perfect correction will be obtained if:

1. The time constant of the compensating network is made equal to that of the cathode bias network.

$$C_d R_d = C_k R_k$$

2. The decoupling resistor is made equal to the product of the midband stage gain and the value of the biasing resistor.

$$R_d = \bar{A} R_k = G_m R_L R_k$$

where \$G_m\$ is the tube transconductance.

Compensation for All Low-Frequency Effects

It will not usually be possible to obtain values for the correction circuit, such that the requirements for phase

Fig. 4. Amplitude characteristic of the two shunt peaking networks (Fig. 3B).

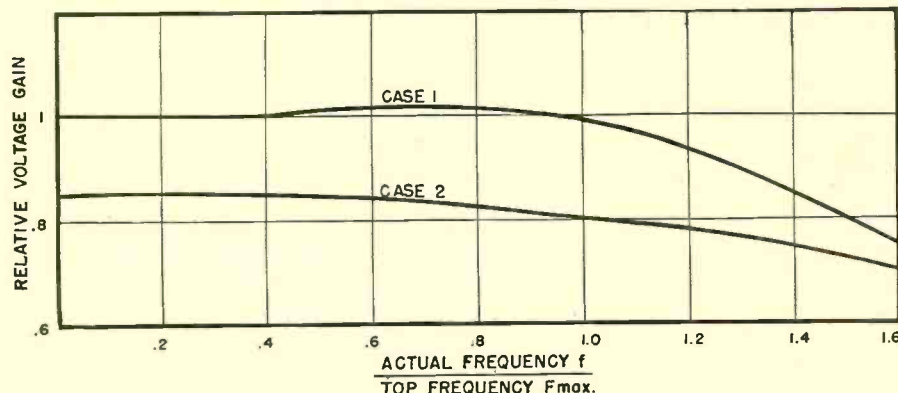

and amplitude compensation of both grid coupling and cathode bias networks are simultaneously satisfied. For correction of all low-frequency effects in a multistage amplifier, the preferred procedure is to make the grid circuit time constants as large as possible in stages having a cathode bias network, and compensate the latter in each plate circuit. Then, for every two or three such stages, a stage having no cathode bias network is provided, and the combined phase shifts of all grid couplings compensated in the plate circuit of this stage. This arrangement operates quite satisfactorily provided the total phase shift to be corrected is smaller than about 20° at 60 cycles. This figure is readily achieved if the time constants of the uncompensated grid coupling networks are from 8 to 15 times greater than the period of the lowest frequency to be passed.

For adequate vertical resolution of a 525 line picture, the maximum delay time $\left(\frac{1}{\text{phase shift} \times \text{frequency}}\right)$ variation tolerable at the low end of the video band is on the order of 850 microseconds. With two video stages involved, a phase shift of 4 or 5 degrees per stage at 30 cycles can be considered allowable for design purposes. The amplitude response should be flat within a few tenths of a decibel to well below 30 cycles if the above requirement is to be met. Low frequency phase and amplitude characteristics of a typical two-stage video amplifier with compensation are shown in Fig. 1.

Tube interelectrode capacitances and stray capacitances associated with circuit components and wiring have a shunting effect which produces excessive phase shifts and departure from linear amplitude characteristics at the higher video frequencies. For a fixed value of plate load resistance, the absolute magnitude of these capacitances becomes the limiting factor on the top frequency f_o , at which satisfactory performance can be obtained. Referring to the high-frequency equivalent circuit of Fig. 3A, it can be shown that a phase shift of 45° together with an amplitude drop of 3 decibels will occur when:

$$f_o = \frac{1}{2\pi C_t R_L}$$

where C_t is the total shunting capacitance, and R_L is the plate load resistance (Fig. 3A). For half-power (3 db.) response to 4.5 megacycles, and a total shunt capacitance of 25 $\mu\mu\text{fd.}$, (a reasonable figure for a two-terminal interstage) the above equation indicates that the load resistor must be 1400 ohms. The stage gain is given by:

$$\bar{A} = G_m R_L$$

For a tube with a transconductance of 9000 ohms the stage gain will be 12.6.

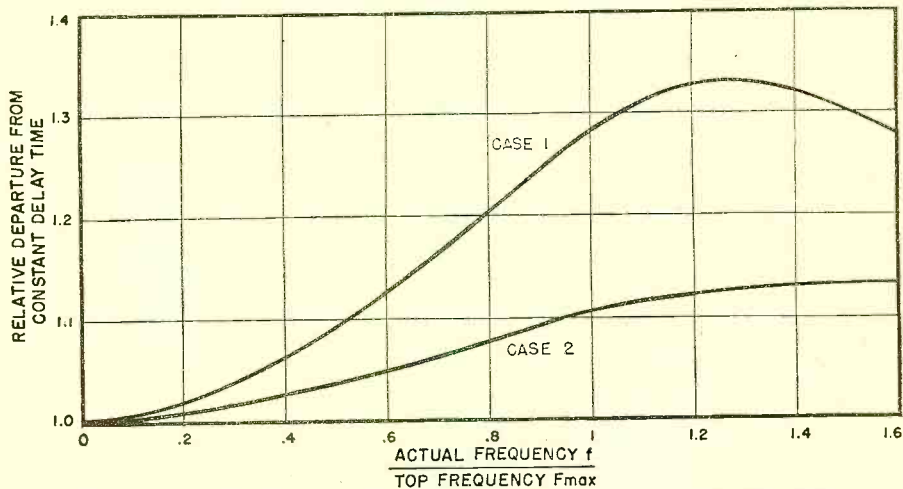

Fig. 5. Time delay characteristics of the two shunt peaking networks (Fig. 3B).

The above considerations lead to a "gain bandwidth" (hereafter abbreviated G.B.) rating for video amplifier tubes, in which the input and output capacitances are compared with the transconductance. For tubes of the same type, coupled by a two terminal network, the input and output capacitances add directly, and the G.B. factor F'' is:

$$F'' = \frac{G_m}{2\pi (C_1 + C_2)}$$

where C_1 and C_2 are input and output capacitances respectively.

With four terminal and certain filter couplings, the input and output capacitances are isolated from each other. The G.B. factor F''' in this case is:

$$F''' = \frac{G_m}{2\pi \sqrt{C_1 C_2}}$$

Gain-bandwidth factors for several common tube types are given in Table I.

The G.B. factor has the dimensions of frequency, and denotes the bandwidth at which the voltage gain of an ideal stage becomes unity. Thus, a type 6AC7 with a two-terminal interstage coupling would have a gain of 1 at a half-power bandwidth of 90 megacycles; conversely, with a 1 megacycle bandwidth, the stage gain would be 90 times. These figures take into account the tube capacitances only, and do not include the unavoidable strays.

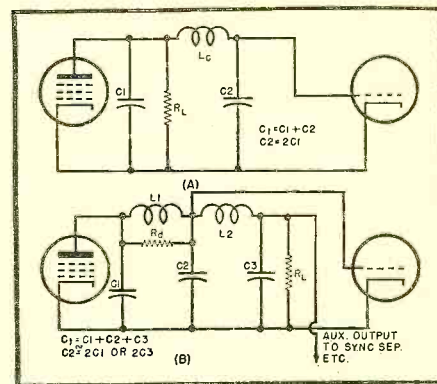
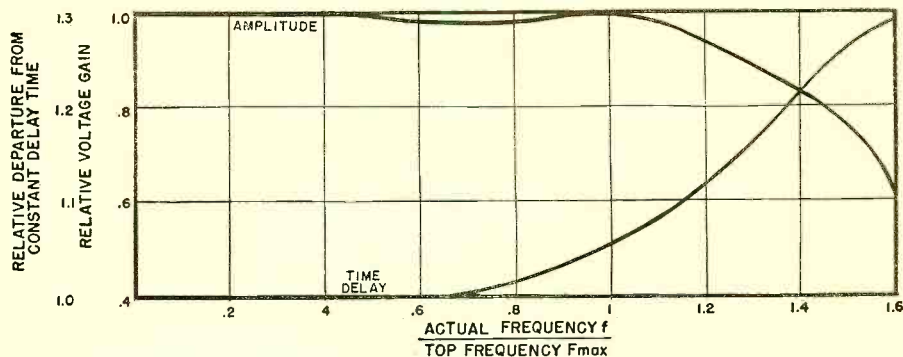

Fig. 6. (A) Series peaking network. (B) Two section filter coupling.

From the above discussion, it is apparent that a tube having high G_m and low interelectrode capacitances (largest G.B. factor) is the most desirable for video amplification. At the same time, the figures given represent the ultimate performance of which the tube is capable, and will not be realized in practice because of the presence of external circuit capacitances which tend to restrict the bandwidth. Furthermore, the G.B. factor is based on half-power bandwidths, and for television video applications, which may involve several amplifier stages, a much more linear phase and amplitude characteristic in each stage is necessary. The G.B. factor does, however, serve to indicate the rel-

Fig. 7. Amplitude and time delay characteristics of the series peaking network (Fig. 6A).



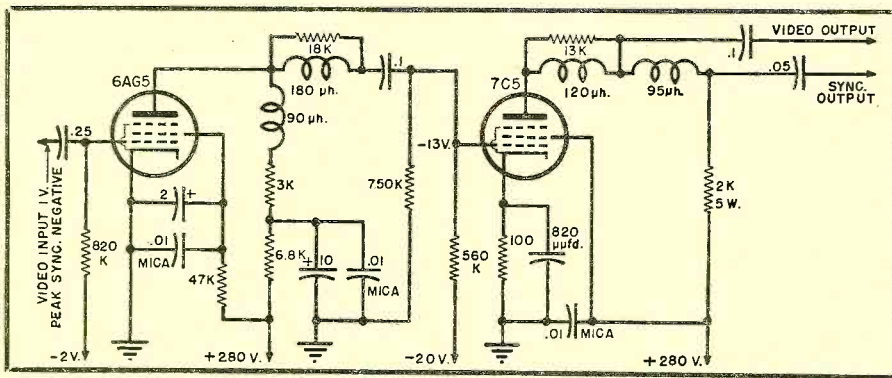

Fig. 8 Typical two-stage video amplifier incorporating high and low frequency compensation. Over-all gain is 90, and bandwidth is 4.35 mc.

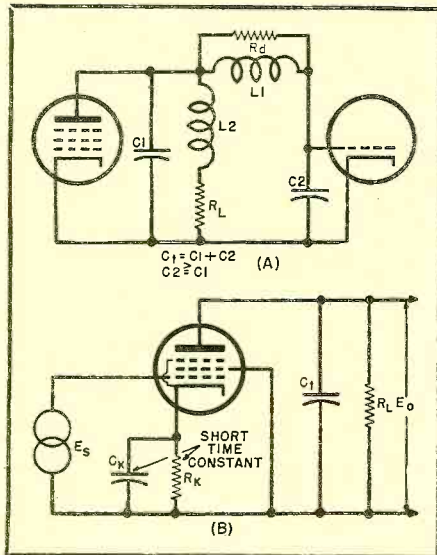

Fig. 9. (A) Modified shunt-series peaking. (B) Cathode peaking.

ative merit of the various tube types in wide-band amplifier applications.

High Frequency Compensation

It is possible to approach more nearly the theoretical performance indicated by the G.B. factor for any tube type through the use of one of a number of two or four terminal interstage coupling networks. Such networks may provide nearly complete phase and am-

plitude compensation up to a top frequency F_{max} which equals or exceeds

$$\frac{1}{2\pi C_i R_L}$$

This is to be contrasted with the uncompensated case where the departure from ideal phase and amplitude characteristics at the top frequency is very much greater than can be tolerated. In the following discussion of several such coupling networks, the basic circuit parameter for design purposes is the reactance of the total shunting capacitance C_i at the top frequency F_{max} . The figures of merit given in each case apply to the network itself, and indicate its midband voltage gain in relation to the uncompensated case.

Two Terminal Networks

Shunt Peaking, case 1 (Fig. 3B):

$$m = 0.50$$

$$C_i = C_1 + C_2$$

$$R_L = \frac{1}{2\pi F_{max} C_i}$$

$$L_o = 0.5 R_L^2 C_i$$

Figure of merit 1.0

Shunt Peaking, case 2

$$m = 0.41$$

$$C_i = C_1 + C_2$$

$$R_L = \frac{.85}{2\pi F_{max} C_i}$$

$$L_o = 0.41 R_L^2 C_i$$

Figure of merit 0.85

The shunt peaking circuit of Fig. 3B

is the simplest type as it involves only one inductance. It has the lowest figure of merit of any coupling network, but has the advantage of permitting relatively wide tolerances in circuit values with little change in performance. The design coefficient m relates the reactance of the peaking inductor L_o to that of the total shunt capacitance C_i at the frequency of correction, and determines the linearity of the phase characteristic up to the top frequency F_{max} . In case 2, improved phase response is obtained at the expense of gain factor. Figs. 4 and 5 show amplitude and time delay characteristics of the two shunt peaking networks, as a function of the ratio of actual to top frequency.

Four Terminal Networks

Four terminal networks give improved figures of merit, since the tube input and output capacitances are effectively isolated from each other. On the other hand, four terminal networks are more difficult to adjust, and frequently require certain specified ratios between the capacitances at each end. In general, both the figure of merit and the linearity of phase and amplitude response will be determined by the manner in which the capacitances are distributed; this is particularly true of the more complicated structures.

Case 1 Series Peaking (Fig. 6A).

$$C_i = C_1 + C_2$$

$$C_2 = 2C_1$$

$$R_L = \frac{1.5}{2\pi F_{max} C_i}$$

$$L_o = 0.67 R_L^2 C_i$$

Figure of merit 1.5

The series peaking network of Fig. 6A provides a gain of 1.5 over the uncompensated case, at the same time permitting a moderate tolerance with respect to capacitance distribution and circuit values. It is sometimes possible to achieve a slightly greater figure of merit than the above figure would indicate by using higher values of inductance and load resistance, but this procedure may require resistive damping of L_o in order to obtain sufficiently uniform response.

It might be noted that the positions of the source and load may be interchanged so that R_L is at the output end, with no change in network characteristics. This may be found necessary in certain cases where the terminating capacitance C_2 is less than the input capacitance C_1 . In any case, the load resistor R_L should be on the low capacitance side of the peaking inductor L_o .

Capacitance ratios other than 2 to 1 or 0.5 to 1 may be accommodated at the expense of uniformity of phase and amplitude response. If, in Fig. 6A, the

(Continued on page 27)

Fig. 10. Time delay and amplitude characteristics of amplifier of Fig. 8.

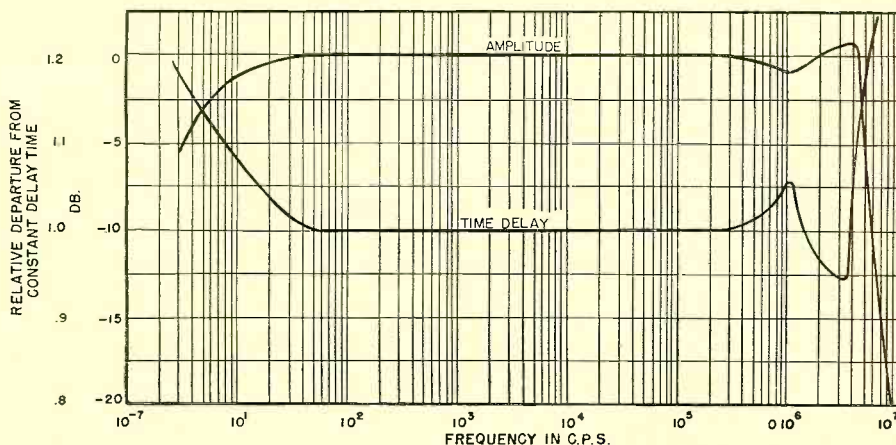



Q. Why have
SYLVANIA
Picture Tubes
grown so famous?

A. Their performance is
rooted in experience

Step by step, from the early days of radio . . . up through the development of multi-element tubes, and on to electronics and television . . . Sylvania has progressed to a position of leadership in today's TV picture tube industry. During the war period, Sylvania's production of precision radar equipment and cathode-ray tubes added much to the skills and know-how of Sylvania engineers.

Still further contributions to Sylvania's high standing in the picture tube field have come from this company's half-century experience in lighting . . . and in perfecting new phosphors for the finest in fluorescent lamps.

Born AND Made—It's important to remember that Sylvania is a picture tube *manufacturer* . . . not merely an assembler!

Every Sylvania part is quality controlled by Sylvania craftsmen. Even the micro-fine tungsten filaments are drawn and tested in Sylvania plants. That's why we say Sylvania picture tubes are born *and* made to serve better . . . last longer. For full information, write: Sylvania Electric Products Inc., Dept. R-2305, 1740 Broadway, New York 19, N. Y.

Five reasons why Sylvania
Picture Tubes are the finest

Research . . . specialized radio, television, and electronics laboratories constantly exploring and testing every approach to future improvement.

Background and Experience . . . 25 years a recognized leader in highest quality radio and electronic tubes. Developed new fluorescent lighting phosphors and techniques applicable to TV picture tube production.

Engineering Development . . . alert engineering procedures assure efficiency and speed production of all Sylvania products.

Quality Control . . . a continuing program of checking and rechecking every step of every process to assure, beyond question, the perfect performance of Sylvania Picture Tubes.

Enlarged Plant Facilities . . . 2 great plants, devoted exclusively to TV picture tube production, assure quick delivery to your factory anywhere.

SYLVANIA  **ELECTRIC**

RADIO TUBES; TELEVISION PICTURE TUBES; ELECTRONIC PRODUCTS; ELECTRONIC TEST EQUIPMENT; FLUORESCENT LAMPS, FIXTURES, SIGN TUBING, WIRING DEVICES; LIGHT BULBS; PHOTOLAMPS; TELEVISION SETS

NEW PRODUCTS

INFRARED SPECTROPHOTOMETER

A double beam infrared spectrophotometer which will meet the demands of the structural chemist for high resolu-

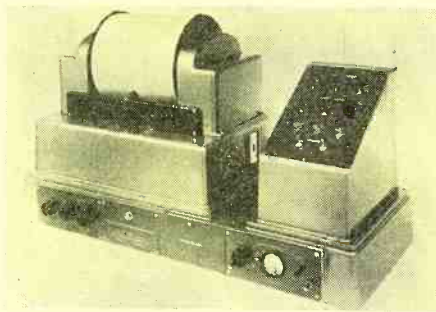

tion and sensitivity, and the analytical chemist for speed and accuracy, is now in production at the plant of the *Perkin-Elmer Corporation*, Glenbrook, Conn.

Designated Model 21, the instrument records directly in percent transmission against a linear wavelength scale on large, easily read charts. The instrument's resolution is up to the limitations imposed by the Raleigh criterion and Johnson noise. Its speed of scanning ranges from 3 minutes to 100 hours for the rock salt region, and the wavelength drive speed can be suppressed automatically when desired. The over-all range of the instrument is from less than 2 microns to 15 microns in the rock salt region.

Chart scales of the *Perkin-Elmer* Model 21 are uniform from 1 to 50 inches per micron by integral factors. The amplifiers and power supplies are external.

PICTURE TUBE COMPONENTS

The Tube Department of *RCA*, Harrison, N. J., recently offered to equipment manufacturers five new components for the *RCA* 16GP4 deflection sys-

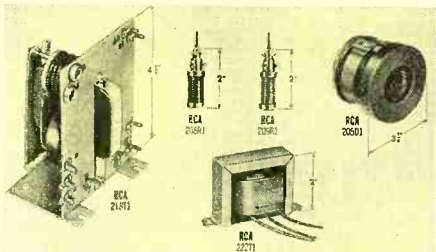

tems designed to use the horizontal-deflection amplifier tube 6CD6-G and

the vertical-deflection amplifier tube 6S4.

These new components are as follows: Deflecting Yoke, Type 206D1; Width Control, Type 208R1; Horizontal-Linearity Control, Type 209R1; Horizontal-Deflection-Output and High-Voltage Transformer, Type 218T1; and Vertical-Deflection-Output Transformer, Type 222T1.

PARABOLIC ANTENNAS

Five new parabolic antennas to cover the 5929-7125 mc. frequency band are now available from the *Workshop Associates, Inc.*, 66 Needham St., Newton Highlands 62, Mass.

Each parabola is available in two, four, six, and eight foot diameters, and

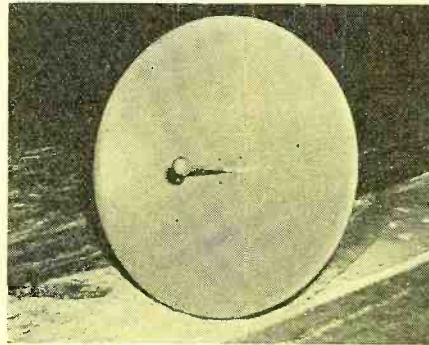

mounts are available for all types of installations. The antennas have gains up to 44.9 db., and can be supplied with complete de-icing equipment and junction boxes.

A free booklet giving complete descriptions of these antennas may be obtained upon request.

TEST EQUIPMENT

A new instrument which indicates on the screen of an oscilloscope instantaneous speed vs. time is announced by *Kay Electric Co.*, Maple Avenue, Pine Brook, New Jersey. The Rotalyzer uses a properly magnetized disc and a pick-up to provide a signal whose frequency is proportional to instantaneous speed. An accurate determination of this frequency is made and indicated on the cathode-ray oscilloscope screen. Average speed is read on a panel meter.

This instrument may be used in the study of torsional vibrations in rotating shafts, in the study of "wow" in phonograph equipment, and in the measure-

ment of shaft rotational changes in computer systems. The r.p.m. range of 900 to 7200 r.p.m. may be extended down to 33-1/3 r.p.m. and upward to 50,000 r.p.m. Speed variation is up to 200 c.p.s.

ELECTRONIC TILE SORTER

An electronic tile sorter designed primarily to detect flaws in 4 1/4" x 4 1/4"



x 1/4" double-fired tile when it is in the bisque state has been announced by *Electronic Associates Incorporated*, Long Branch, N. J.

The Model 203 Tile Sorter is adjustable to meet any possible conditions of mixture or firing. Adjustment to any level desired by the tile manufacturer is dependent on the following ratios: 1) When set to reject 100% of the tiles with objectionable air pockets, it will also reject 100% of the cracked tile and will reject all tiles under 200 lbs. on the 3-point break test; 2) When set to reject 95% of the tiles with objectionable air pockets, it will reject 87% of the cracked tiles and will reduce the break test to 110 lbs; and 3) When set to reject 90% of the air pocket tiles, it will reject 80% of the cracked tiles and the break test is reduced to 80 lbs.

This sorter is capable of sorting tiles at any rate up to 10 tiles per second, which is much faster than the tiles can be brought to the machine using present conveyor methods.

HIGH SPEED RELAY

The Autocall Company, Shelby, Ohio, has released for general use their ultra high-speed "HHA" relays which were originally designed and built as a basic component of the Harvard University's

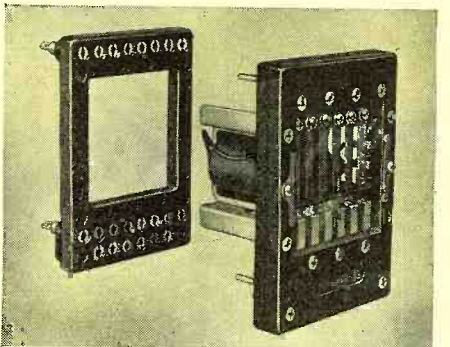

Mark II Calculator for the Navy Department.

These relays, according to the manufacturer, are built for long life with 100 million operations, minimum, at high speed of 6 to 8 milliseconds and incorporate many features including six single-pole double-throw contacts arranged side-by-side to provide 28 different contact combinations; individual contacts and prongs are of one-piece construction, and each contact provides its own prong for jack-connecting to the circuit.

Coils can be furnished for 24 to 150 volts, d.c., with no increase in price for the various voltages.

SOLDERING UNIT

A soldering unit, operating on the conduction principle, and suitable for all types of soldering operations including silver soldering and brazing, is now



available from *Wasserlein Mfg. Co., Inc.*, 7400 3rd Ave., No., St. Petersburg 6, Florida.

The Wassco Glo-Melt has a 24 heat selector to handle lightest up to heaviest work. With capacity equal to a 450 watt heavy electric iron, Glo-Melt soldering is done with a light handpiece weighing only 5 oz., which is said to be as easily and accurately handled as a pencil. According to the manufacturer, this unit is faster and more accurate, consumes less power, and uses solder and flux.

Glo-Melt literature and a use-manual are available from the manufacturer.

TIME INDICATOR

Electronic Systems Co., 555 East Tremont Avenue, New York 57, N. Y., has announced its Model 632-B Pulse Rise Time Indicator for the accurate plotting of the rise time of rapidly rising positive voltage pulses. The device employs a specially designed delay line of variable length and a vacuum tube voltmeter.

The 632-B features a radical change in the method of analyzing the build-up time of a pulse. However, the most important factor is the range available:

.005 to .1 microseconds in 20 steps. Other ranges are available upon request.

PILOT TUNNEL KILN

Harper Electric Furnace Corporation, Niagara Falls, N. Y., has announced a small tunnel kiln for speeding up pro-

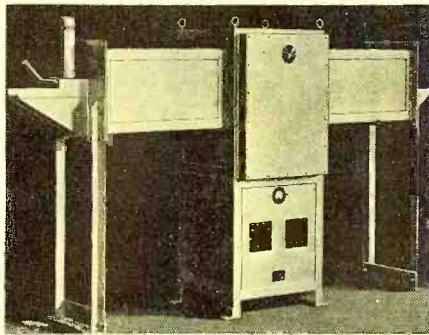

duction test runs. Its versatile design permits variations in firing cycles to allow duplication of most firing schedules.

These units are being used in test firing of ceramic powders, steatite, electrical porcelain, insulators, resistors, spark plugs, grinding wheels, newly developed electronic components, and other ceramic products.

Further information may be obtained by writing the company direct.

FM SIGNAL GENERATOR

Boonton Radio Corporation, Boonton, N. J., has announced the Type 202-D frequency modulated signal generator designed for use with telemetering receiver equipment and in other associated applications.

This instrument covers the frequency range from 175 to 250 megacycles and is provided with three continuously adjustable deviation ranges: 0-24 kc., 0-80 kc., and 0-240 kc. In addition, amplitude modulation up to 50% may be obtained using the internal audio oscillator and

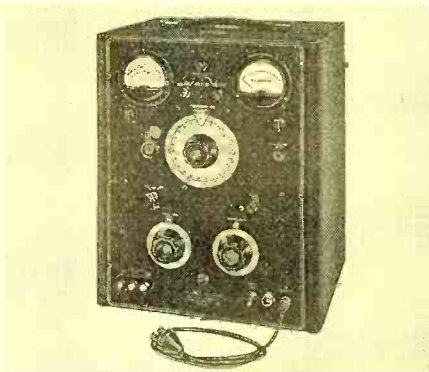

modulation to 100% using an external audio oscillator.

The deviation sensitivity of the frequency modulation system is within ± 0.5 db. from d.c. to 200 kc. The ampli-
(Continued on page 29)

When the situation
calls for **BETTER**
COILS.



PRECISION
paper tubes
provide the BASE!

Precision Paper Tubes assure better coils by providing a superior coil base of finest dielectric Fish Paper, Cellulose

Acetate, or combination, that improves insulation, has lower moisture absorption.

Spirally-wound and heat-treated for greatest strength, they're lighter;

afford greater heat dissipation. Whether your coils be round, oval, square, rectangular or other shape—regardless of their length, ID or OD—we can supply a Precision Coil Form made exactly to your specifications. Write or wire today for new Mandrel List of over 1,000 sizes. Ask about new Precision Di-Formed Paper Tubes that allow making more compact coils at no extra cost.

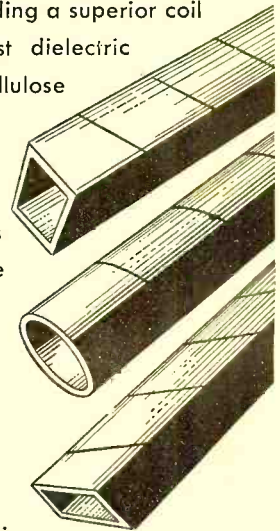

PRECISION PAPER TUBE CO.

Also makers of Precision Coil Bobbins
2063 W. Charleston St., Chicago 47, Ill.
Plant #2, 79 Chapel St., Hartford, Conn.

NEWS BRIEFS

DR. LANGMUIR RETIRES

Dr. Irving Langmuir, regarded as one of the greatest scientists of modern



times, has retired as associate director of *General Electric Company's* Research Laboratory. Dr. Langmuir will continue work in the laboratory in a consulting capacity, but will engage primarily in activities of Project Cirrus, joint weather research program of the U. S. Army Signal Corps and the Office of Naval Research in consultation with *General Electric*.

Dr. Langmuir, who has received the world's top-ranking scientific awards, including the Nobel Prize in chemistry in 1932, was responsible for the development of the gas-filled incandescent lamp, the high-vacuum power tube, atomic hydrogen welding, screening-smoke generator for the military, and methods for artificial production of snow and rain from clouds.

MICROWAVE REPEATER IN PRODUCTION

The *Philco* feedback-type microwave repeater announced at the recent annual session of the Communications Section of the Association of American Railroads is now being manufactured on a production basis.

Capable of handling up to 32 two-way voice channels or combinations of voice and coded intelligence, the *Philco* CLR-5 microwave repeater is designed for operation in the 6575-6875 megacycle band, which is available to railroads. This feedback repeater circuit permits multiple chain repeats with very little distortion and makes possible the use

of only one microwave oscillator tube for both transmitting and receiving functions of a single-direction repeater.

The Industrial Division of *Philco Corporation*, Philadelphia 34, Pa., will give further information and detailed technical specifications upon request.

ELECTRIC FIELD

A shadow technique, developed by Dr. L. L. Marton and associates of the National Bureau of Standards, now makes it possible to photograph and study quantitatively electrostatic and magnetic fields of extremely small dimensions.

The striking pattern shown is the result of an electric field about a charged crystal of barium titanate when studied by the electron-optical shadow

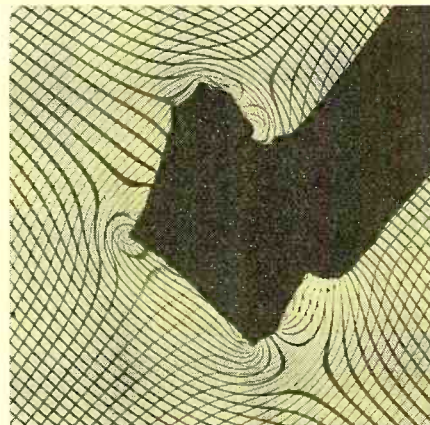

method. This method offers a powerful tool for exploring fields that have not been susceptible to other methods of investigations.

An electron lens system is used to produce a shadow image of a fine wire mesh placed in the path of an electron beam. From the distortion in the shadow network caused by deflection of the electrons as they pass through the field under study, accurate values of field strength are computed. In the photograph, the distorted shadow image of the wire mesh is superposed on the image of the crystal (center) and its 0.010-inch tungsten-wire support.

NEW SITE FOR NBS LABORATORY

Approval has been given for the development of a site at Boulder, Colorado, for additional Bureau laboratory

facilities. To be used initially by the Bureau's Central Radio Propagation Laboratory, the site consists of about 210 acres directly south of the city.

Laboratory facilities at Boulder for research in radio propagation at a cost of about \$4,500,000 have been authorized by Public Law 366 of the 81st Congress. Actual construction is expected to start in the summer of 1951 and when completed will maintain a research staff of about 300 people.

NBS TO USE MEMORY UNITS

The first of three *Technitrol* memory units has been obtained by the National Bureau of Standards for use in the latest type of large scale electronic computer developed jointly by funds of the Air Comptroller Department of the Army and NBS.

The memory unit, based on the principle of the mercury delay line originally conceived at the University of Pennsylvania and manufactured by the *Technitrol Engineering Co.*, is an automatic brain which will remember for later recall any sequence of facts or figures once placed on it. It has reached its latest development in the computer to be known as the NBS Interim Computer.

In addition to contemplated work in processing the 1950 census figures, the Interim Computer will be studied in an effort to develop new and better computers for Government and commercial use. It will also be utilized for solving many of the scientific problems that arise in the normal work of the Bureau.

ULTRASONIC GENERATOR

One of the many electronic developments described in "Electrical and Allied Developments of 1949" published in the *General Electric Review* was an ultrasonic generator having a quartz



transducer on top of the power supply and operating in an oil-filled well.

Power at 300, 500, 750, or 1000 kc. is supplied by the equipment. Applications of this ultrasonic generator include as-

sistance to chemical reactions, bacteria control, and the mixing of immiscible liquids such as mercury into water.

IMPROVED MULTIPLIER PHOTOTUBE

Important advances in nuclear research, astronomy, photoelectric spectrometry, and other fields involving work with light at extremely low levels



is expected with the announcement of a greatly improved 1P21 multiplier phototube by RCA's Tube Department. Heart of the cyclotron used in radiation research at the University of Rochester is an RCA 1P21 multiplier phototube shown partially disassembled. The "equivalent noise input" of the improved 1P21 has been reduced to 5×10^{-13} lumen at room temperature. This value represents a six-fold reduction in operational noise and permits a corresponding reduction in the lower limit of measurable light intensities.

This extension in the range of the 1P21 makes it an even more valuable aid for astronomers studying light from distant stars, for nuclear scientists studying atomic radiation, and for other laboratory research work requiring measurement of light of extremely low intensity.

INSTRUMENT TO RECORD BRAIN AND HEART ACTION

Equipment for making radar-like pictures of the heart and brain in action was described by Dr. Stanford Goldman, professor of electrical en-

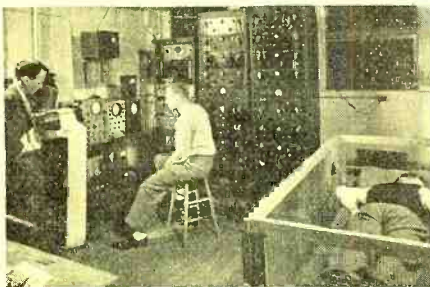

gineering at Syracuse University and former research associate in the M.I.T. Research Laboratory of Electronics, at the recent IRE Convention. Results already obtained indicate that the pictures will be useful for the diagnosis

of disease in the heart and brain and in studying the physiology of these vital organs.

The equipment, first conceived and developed at M.I.T., picks up tiny electrical impulses which flow through nerves in the body. These impulses are then converted into a constantly moving map-like picture similar to those made by World War II radar sets.

Equipment shown in the center of the photograph amplifies signals from electrical pick-ups on the patient at the right. Dr. Goldman at the left is shown examining a printed record of these signals while William F. Bantelmann, Jr., M.I.T. Research Assistant in electrical engineering, watches the visual pattern.

NEW LITERATURE

Handling of Radioactive Isotopes

The National Committee on Radiation Protection, established by the National Bureau of Standards, has prepared a handbook giving recommendations for the safe handling of artificially-produced radioactive isotopes in the typical laboratory or small industrial operation.

Handbook H42, *Safe Handling of Radioactive Isotopes*, gives general safety recommendations which may be modified to suit the control requirements

of different types of operations. Specific problems discussed are those of personnel, laboratory design and equipment, hazard instrumentation, hazard monitoring, and transportation of isotopes. The increasing use of radioactive isotopes by industry, the medical profession and research laboratories has made it essential that certain minimal precautions be taken.

This handbook is priced at 15 cents a copy and is available from the Superintendent of Documents, U. S. Government Printing Office, Washington 25, D. C.

Paper Laminates

A report prepared by the Plastics Laboratory of Princeton University under joint sponsorship of the National Defense agencies describes the development of a low-loss, arc-resistant paper laminate for high frequency applications.

The report, released to the public by the Office of Technical Services of the U. S. Department of Commerce, deals with modifying standard melamine-formaldehyde impregnating resin with varying amounts of hexamethylenediamine to produce a laminated material with high dielectric strength,

(Continued on page 25)

The Shape and Size YOU need!

PARAMOUNT

SPIRAL WOUND PAPER TUBES



All Sizes in

Square and Rectangular Tubes

Leading manufacturers rely on the quality and exactness of PARAMOUNT paper tubes for coil forms and other uses. Here you have the advantage of long, specialized experience in producing the exact shapes and sizes for a great many applications. *Hi-Dielectric, Hi-Strength.* Kraft, Fish Paper, Red Rope, or any combination. Wound on automatic machines. Tolerances plus or minus .002". Made to your specifications or engineered for YOU.

Write on company letterhead for Arbor List

PARAMOUNT PAPER TUBE CORP.

613 LAFAYETTE ST., FORT WAYNE 2, IND.

Manufacturers of Paper Tubing for the Electrical Industry

SEND FOR ARBOR LIST OF OVER 1000 SIZES

Inside Perimeters from .592" to 19.0"

Convenient. Helpful. Lists great variety of stock arbors and tube sizes. Includes many odd sizes. Write for Arbor List today.

Personals

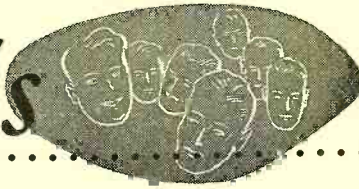

DR. MERLE M. ANDREW has joined the staff of the machine development section of the National Bureau of Standards applied mathematics laboratories. Before coming to the Bureau, Dr. Andrew was engaged in operational research with the Naval Operations Evaluation Group and prior to that time conducted radar research at the Radiation Laboratory of MIT. He is a member of the American Mathematical Society and the American Physical Society.



ARTHUR L. CHAPMAN has been named general manager of the *Colonial Radio and Television Division* of *Sylvania Electric Products Inc.* With headquarters in Buffalo, N. Y., Mr. Chapman will be responsible for production and sales of the division in addition to his duties as general manager of *Sylvania's* newly formed Parts, Wire and Plastics Division at Warren, Pa. Mr. Chapman has been associated with *Sylvania* since 1933.



CURTIS R. HAMMOND has been appointed equipment sales manager of the Receiving Tube Division of *Raytheon Manufacturing Company*. He will be responsible for the sale of radio receiving tubes and cathode-ray picture tubes and will direct activities from *Raytheon's* Chicago warehouse. Mr. Hammond joined *Raytheon* five years ago after many years in sales and sales engineering work with *Ken-Rad Tube and Lamp Corporation*.



DELMAN E. ROWE has been appointed senior test director in the guided missiles research laboratory of the National Bureau of Standards. Mr. Rowe, who received the Naval Ordnance Development Award with Certificate by the Naval Bureau of Ordnance in 1945, is a member of the Institute of Radio Engineers, is the inventor of a microwave switch and attenuator, and has published several technical papers in the electronics field.



ROBERT A. STAREK has been appointed field engineer for the Radio Tube Division of *Sylvania Electric Products* at Emporium, Pa. Formerly commercial engineer, Mr. Starek joined the Engineering staff of *Sylvania* immediately after receiving his B.S. degree in electrical engineering from Iowa State College. He is a member of the American Institute of Electrical Engineers and the IRE and will make his headquarters in the Cincinnati office.



JEROME R. STEEN, director of quality control for *Sylvania Electric Products, Inc.*, New York, has been elected to grade of Fellow by the board of directors of the Institute of Radio Engineers. Mr. Steen joined the engineering staff of the Radio Division of *Sylvania* at Emporium, Pa., in 1931 and since that time has been active in the application of quality control and standardization methods in radio tube manufacture.

New R-C Osc.

(Continued from page 14)

plate load resistor R_{L2} or the alternate cathode resistor R_{k1} may be varied for manual adjustment of amplifier gain. The higher supply voltages give a more linear operating region for the amplifier tubes.

Oscillators of this type have been adjusted to operate with various supply voltages ranging from 100 to 350 volts. When distortion is considered important the circuit should be supplied with higher voltages and adjusted to as near the oscillation threshold as is deemed advisable. The supply should be regulated if possible but satisfactory results can be obtained over quite a range of voltages.

The amplitude of oscillation is a marked function of these supply voltages; therefore, the relative distortion will also vary. Some compensation is possible by using one of the circuit variations.

Circuit Variations

There will be some quiescent current flowing in the nonlinear element if two equal resistors are used in the cathodes. These tubes are not balanced because the load resistor appears only in the plate circuit of stage two. This condition will be known as the unbalanced circuit.

If the cathode resistor R_{k2} is increased in value the d.c. voltages on the cathodes may be made equal and the nonlinear element will not carry d.c. current. This will be known as balanced circuit A and does not require any additional circuit components.

When the circuit is made symmetrical by using a dummy load resistor in the plate circuit of the first stage the quiescent current may be removed from the nonlinear element. This will be known as balanced circuit B. If this dummy load is bypassed for a.c. signals the gain is given by the first expression. If the dummy load is not bypassed the element R_{L1} must be included in calculation of the net amplifier gain in this manner:

$$K' = \frac{A}{B + CR_z} \dots \dots \dots (9)$$

where the constant A is the same as Eq. (6), and B and C are given by:

$$B = (r_p + R_{L2}) [r_p (R_{k1} + R_{k2}) + (\mu + 1) R_{k1} R_{k2}] + r_p R_{k1} R_{k2} (\mu + 1) + R_{L1} \{ R_{k2} (r_p + R_{L2}) + R_{k1} [r_p + R_{L2} + (\mu + 1) R_{k2}] \} \dots \dots \dots (10)$$

$$C = [r_p + (\mu + 1) R_{k1}] [r_p + R_{L2} + (\mu + 1) R_{k2}] + R_{L1} [r_p + R_{L2} + (\mu + 1) R_{k2}] \dots \dots \dots (11)$$

The basic unbalanced circuit causes the attenuation in the "π coupling" network to increase with increasing supply voltages. This tends to counteract

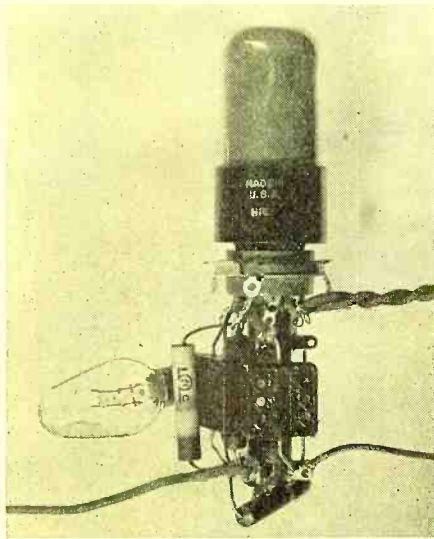

A 6SN7 oscillator of the unbalanced circuit form operating at 995 to 997 c.p.s.

the increase in tube amplification at higher supply voltages in much the same manner as the circuit of Fig. 7A. This unbalanced circuit offers this inherent compensation; however, where the greatest a.c. sensitivity is desired the amplifier should be balanced for equal d.c. voltages on the cathodes.

The variation of amplifier gain with respect to signal level has been examined for the unbalanced and two balanced circuit variations. Typical results are indicated in Fig. 8.

The basic unbalanced circuit is shown to be less responsive to supply voltage variations in the results given in Fig. 9.

The circuit presented is well suited to fixed frequency oscillators. The values required may first be calculated and then trimmed on a trial and error basis. A great deal of care is required to locate the frequency to less than 1 per-cent using fixed elements. These rules may prove helpful:

1—To raise the frequency pad additional resistance across R_1 or R_2 in the feedback circuit.

2—To lower the frequency pad additional capacitance across C_1 or C_2 in the feedback circuit.

3—The choice between the two resistors (or the two condensers) is made considering the present level of oscillation. When additional resistance is placed across R_1 or additional capacitance is placed across C_1 the signal level of steady oscillation will increase. If some adjustment of amplifier gain is provided this need not be considered.

A number of fixed frequencies may be obtained by suitable switching of fixed components in the feedback network. Both the resistance and the capacitance elements may be switched for frequency ranges greater than one decade. There is a relationship between the values selected; these general rules may help in adjusting these values.

1—Begin with the larger values of resistance and capacitance first.

2—Complete the selection of the set of elements (R 's or C 's) which are greater in number. Attempt to maintain nearly constant output signal amplitude for these values.

3—Complete the selection of the remaining set of elements. This set will generally be used as multipliers of the frequencies given by the first set.

A very useful audio oscillator may be constructed using two sets of element values for the feedback network. An example of the different frequencies which might be obtained is as follows:

The resistor elements are selected with a two pole, nine point switch to give these base frequencies: 10, 15, 20, 25, 30, 40, 50, 60 and 80 cycles per second. The condenser elements are selected with a two pole, three point switch to give these multiplier factors: Times 1, Times 10 and Times 100.

Continuously variable frequency oscillators may use ganged resistance or capacitance pairs with the alternate elements switched for different multiplier factors times the basic frequency range. Ganged resistors may be used in series with fixed resistors to minimize tracking errors—a frequency range of 3:1 may be suggested here. Variable resistor elements will cause the loading of the feedback network upon the amplifier to vary as the oscillator is tuned to different frequencies. Ganged condensers may be used for a range of 10:1 as tracking is much easier and the loading upon the amplifier is constant. If the minimum capacitance is to be 100 $\mu\text{mfd.}$ the condenser pair would require a maximum of 1000 $\mu\text{mfd.}$ per section for a decade of frequency variation. With care a smaller minimum capacitance might be used.

Advantages of this new oscillator are primarily in design and economics,



Fig. 13. Gain characteristics of the amplifier shown in Fig. 7A.

where cost, weight and space are important. Fixed frequency applications include bridge test sets, intermodulation test sets, modulation signals for signal generators, telemetering systems, tone generators, and simple musical instruments.

Semi-variable and continuously variable frequency oscillator applications are many and varied. This oscillator will best serve in those applications where it has not been possible to use other circuits because of the cost, space and weight factors.

News Briefs

(Continued from page 23)

very low dielectric loss and good punching characteristics.

PB 99220, Low-loss Arc-resistant Paper Laminates, sells for 50¢ a copy. Orders should be addressed to the Office of Technical Services, U. S. Department of Commerce, Washington 25, D. C., and should be accompanied by check or money order payable to the Treasurer of the United States.

Welding Control Equipment

Westinghouse Electric Corporation now has a booklet describing in detail its electronic resistance welding control equipment, both synchronous and non-synchronous.

Basic equipment in the control circuit includes a sequence-weld-timer panel and a means to fire the ignition tubes in the power circuit. Auxiliary control panels can be readily added to meet specific job requirements.

A copy of this booklet, B-4309, may be obtained by writing Westinghouse Electric Corporation, P. O. Box 2099, Pittsburgh 30, Pa.

TV Tube Booklet

The Radio Tube Division of Sylvania Electric Products Inc., Emporium, Pa., is offering a new 20-page booklet providing television picture tube and general purpose cathode ray tube characteristics; replacement tube data; base diagrams; suggestions for tube handling; and a concise description of cathode-ray oscilloscope use in television servicing.

Information contained covers 165 tube types with faces ranging from two to twenty inches maximum dimension utilizing electrostatic or magnetic deflection systems. A nomenclature chart explains the meaning of type number letters and figures and applications for different types of tube screens.

The booklet is available through Authorized Sylvania Distributors.

Geiger-Muller Counter

The nature, construction, and use of the Geiger-Muller Counter is presented in a new booklet just published by the National Bureau of Standards.

In addition to the treatment of the counter itself, the booklet discusses methods of detecting counter pulses, applications of counters to quantitative measurements, proportional counters, and the preparation and filling of Geiger-Muller Counters.

Circular 490, The Geiger-Muller Counter, may be obtained from the Superintendent of Documents, U. S. Government Printing Office, Washington 25, D. C., 20¢ a copy.

NEW TUBES

SYLVANIA TUBES

Subminiature Tubes

Two additional *Sylvania* subminiature tube types, a medium-mu triode

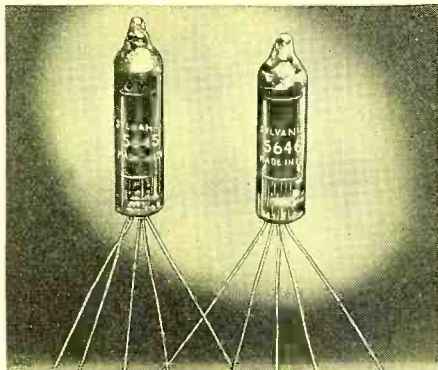

and a high-mu triode, are now available. Type 5645 medium-mu triode is a T-2 suitable for Class A amplifier applications. Under typical operating conditions the tube will have a transconductance of 2700 micromhos and an amplification factor of 20. Maximum rated plate dissipation is 1 watt and plate resistance is 7400 ohms.

Type 5646 high-mu triode is a T-2 suitable for Class A amplifier or resistance coupled amplifier applications. Under typical operating conditions the tube will have a transconductance of 2400 micromhos, an amplification factor of 70, and a plate resistance of 29,000 ohms. Maximum rated plate dissipation is 0.3 watt.

Both subminiature types have 6.3 volt, 150 milliamperer heaters, and flexible leads for direct wiring to circuit.

Beam Power Amplifier

A high-perveance beam power amplifier designed for use as a horizontal



deflection amplifier in high efficiency deflection circuits for television receivers

is another of the many new tubes announced by *Sylvania*.

Features of type 6AU5GT include: low-mu, high plate current at low plate voltage and high operating ratio of plate current to number 2 grid current. The tube has a 6.3 volt, 1.25 ampere heater. Under typical operating conditions, it will have trans-conductance of approximately 6000 micromhos; mu approximately 5.9. The maximum plate dissipation is 8 watts; peak positive pulse plate voltage is 4500 volts; and maximum d.c. plate voltage is 450 volts.

Picture Tubes

An 8½-inch, all-glass, direct-view television tube with electrostatic focus and deflection for use in television sets designed for 7-inch viewing tubes is now available through authorized *Sylvania* distributors.

The tube, type 8BP4, is interchangeable with type 7JP4 and offers the advantages of 50% increase in useful area. Deflection sensitivity is provided for full scan in circuits designed for full scan



with 7-inch tube types. Operating voltages include: 6000 on number two anode; 1620 to 2400 on number one anode; and zero to -72 to -168 volts on number one grid.

Type 16LP4 is a 16-inch, all-glass, direct-view television tube supplied with an external conductive coating which acts as a filter capacitance when grounded. The tube is supplied with neutral or clear face plates and employs an ion trap gun for use with external magnet.

Typical 16LP4 picture tube operating conditions include: maximum usable face diameter, 15⅞ inches; heater volts, 6.3; heater current, 0.6 amperes; focus coil current, 110 milliamperes; ion trap magnet current, 120 milliamperes; number 1 grid volts (for cut-off) -33 to -77; number 2 grid volts, 300; and anode volts, 12,000.

Miniature Portable Radio Tubes

A new line of miniature radio tubes for portable radio receivers, said to be the first announced in this country in

more than ten years in which filament current has been reduced below 40 milliamperes per tube, is now being offered by *Sylvania*.

The new tubes require only 25 milliamperes per tube which means that "A"

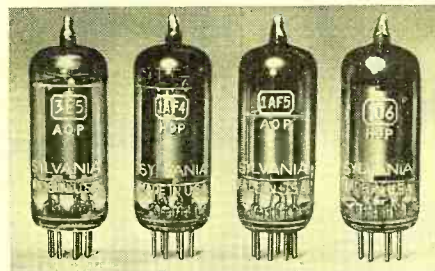

batteries used in portable receivers will last approximately three times as long as with previous tubes. All are supplied with 7-pin miniature button bases.

Types included are: 1U6, a heptode converter with oscillator anode as a separate element; type 1AF5, a diode pentode; type 1AF4, a sharp cutoff r.f. pentode; and type 3E5, a beam power output tube. Power required for a complement of the new tubes in a typical battery-operated superheterodyne is only 2.1 watts. They will also operate satisfactorily over a range of 1.4 volts to 1.1 volts.

Miniature Rectifier Tubes

The Radio Tube Division, *Sylvania Electric Products Inc.*, 500 Fifth Ave., New York 18, N. Y., has announced a miniature high voltage half wave rectifier designed for television receiver pulse rectifying systems and voltage doubler circuits for magnetically deflected 10 and 12-inch viewing tubes.

The tube, type 1V2, has a peak inverse plate voltage of 7500, a peak plate current of 10 milliamperes, and an av-



erage plate current of .5 milliamperes.

Type 1X2 is a double ended miniature high voltage rectifier tube designed for use with r.f., fly-back, and 60-cycle types of power supply for television picture tube anodes. This type is for use in power supplies where voltages up to

15,000 volts d.c. are required. The 1X2 is mounted in a T-6½ bulb and has an over-all height of 2¼ inches.

RECEIVING TUBES

Three new receiving tubes designed mainly for television receivers have been added to *General Electric's* tube production lines.

The 6AS5 is a beam-power amplifier of miniature construction intended for use as the audio power-output tube in television receivers and small radio receivers. When operating Class A1, with

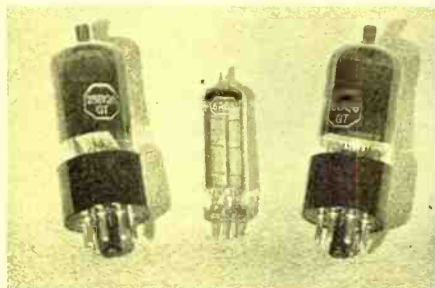

a plate voltage of 150 volts and an input signal of 8.5 volts peak, 2.2 watts of output power can be realized with 10 per cent distortion.

The 6BA6-GT and 25BQ6-GT are beam-power amplifier tubes designed to withstand high-surge plate voltages for short periods of time. These tubes are intended for use as horizontal-deflection amplifiers in television receivers. Maximum ratings of the tubes include a plate dissipation of 10.9 watts, a plate current of 100 milliamperes, and a peak positive surge plate voltage of 5000 volts.

Further information may be obtained from the Tube Divisions, Schenectady, New York.

RCA TUBES

Deflection Amplifier Tubes

Two new deflection amplifier tubes designed particularly for use with the



new 16-inch "metal" picture tube 16GP4 have been announced by the Tube Department of RCA, Harrison, N. J.

The 6CD6-G shown is a high-perve-
(Continued on page 29)

Video Amp. Design

(Continued from page 18)

ratio C_2/C_1 is designated by M , the values of R_L and L_c will be modified by:

$$R_L' = \sqrt{MR_L/2}; L_c' = ML_c/2$$

where R_L' and L_c' are the new values of load resistance and peaking inductance respectively. The curves of Fig. 7 show amplitude and time delay characteristics of the series peaking network, for the case where $C_2 = 2C_1$.

Two Section Filter Coupling

It is frequently possible to secure uniform response and an improved figure of merit with a four terminal coupling network designed on the basis of a low-pass filter. Although such a network requires rather carefully controlled distribution of capacitances for best results, it does provide a gain factor approaching 2 over the uncompensated case, and has the further advantage that two output terminals are available (Fig. 6B).

The filter structure consists of a T type constant K full section, with mid-shunt terminated half-sections at each end. The full T section is composed of C_2 and the two series impedances $L_1/2$ and $L_2/2$. The load resistance and the cut-off frequency of the filter as a whole is determined by the capacitance C_2 . The cut-off frequencies of the end half-sections are determined by capacitances C_1 and C_3 . In order to prevent an unwanted rise in the image impedance of the input half-section, it is usually necessary to add resistive damping across L_1 . The value of the damping resistor R_d is best determined by experiment, and will generally lie in the vicinity of 5 to 6 times the load resistance.

Due to the larger number of reactive elements, this type of coupling network shows a somewhat greater deterioration of phase characteristics about the top frequency. In order, therefore, to obtain sufficiently uniform response, it is sometimes necessary to design for a higher top frequency than would otherwise be the case. For optimum results, the terminating capacitances C_1 and C_3 should be nearly equal to one half the center capacitance C_2 .

$$C_1 = C_1 + C_2 + C_3; C_2 \approx 2C_1 \text{ or } 2C_3$$

$$R_1 = 1/\pi F_{max} C_1$$

$$L_1 = \left(\frac{1}{2} + \frac{C_1}{C_2} \right) \left(\frac{R_1}{2\pi F_{max}} \right)$$

$$L_2 = \left(\frac{1}{2} + \frac{C_3}{C_2} \right) \left(\frac{R_1}{2\pi F_{max}} \right)$$

Figure of merit ≈ 2.0

Case 3. Modified Shunt-Series Peaking

This type of coupling network provides a large figure of merit and at the same time quite uniform phase and amplitude characteristics. It is similar to

the two section filter coupling described above, except that the terminating half-section is of the mid-series type. C_3 of Fig. 10 is therefore missing. The shunt-series network may afford a slightly better gain factor than the network of Fig. 6B, and the deterioration of phase response about the top frequency is not so great (Fig. 9A).

The accompanying Table II, taken from a report by O. H. Schade of RCA Laboratories gives the information necessary to design a shunt-series peaking network for capacitance ratios of 0.3, 0.5, and 1.0. Since the characteristics of the network are comparatively insensitive to this ratio, it is possible to interpolate between the values given with a fair assurance of success.

Unequaled

- GREAT RADIO SHOWS "STANDARD OF THE GREAT"
- instantaneous start and stop
 - ease of operation and editing
 - WOW-proof performance
 - true-to-life fidelity
 - installation assistance
 - for scientific research
 - mechanical ruggedness
 - critical user satisfaction

AMPEX

magnetic tape recorder

Models to \$3800
Shown model 300-C \$1575
(control panel \$105 extra)

AMPEX ELECTRIC CORP., San Carlos, California
Without obligation please send 16-page illustrated booklet containing technical specifications of Ampex Magnetic Tape Recorders.

NAME _____

ADDRESS _____

CITY _____

STATE _____

Our need is for:

- | | |
|--|--|
| <input type="checkbox"/> Laboratory Research | <input type="checkbox"/> Telemetering |
| <input type="checkbox"/> Multi-Channel Recording | <input type="checkbox"/> Industrial Recording |
| <input type="checkbox"/> Recording-Broadcasting | <input type="checkbox"/> Aerophysical Research |

Distributed by . . .

BING CROSBY ENTERPRISES (Hollywood)
AUDIO & VIDEO PRODUCTS CORP. (New York City)
GRAYBAR ELECTRIC COMPANY (Everywhere)
EXPORT: WESTREX (New York City)

AS-3

HAVE YOU A JOB FOR A TRAINED TECHNICIAN?

We have a number of alert young men who have completed intensive training in Radio and Television Repairing. They learned their trades thoroughly by working on actual equipment under personal, expert supervision.

If you need a trained man, we invite you to write for an outline of our course, and for a prospectus of the graduate. No fees, of course. Address:

Placement Manager, Dept. P-106-5
COMMERCIAL TRADES INSTITUTE
1400 Greenleaf Chicago 26

Of the six circuit values in the network, only two need be determined in order to completely design the interstage for a given bandwidth or gain. As the capacitances C_1 and C_2 are presumed fixed and reduced to their practical minimums, either the bandwidth or the gain may be used as a design parameter. Once the capacitances have been evaluated, the remaining parameters may be determined as a function of the chosen parameter directly from the table. The necessary design equations are:

$$C_1 = C_1 + C_2; R_0 = 1/\pi F_c C_1$$

$$L_1 = R_1^2 C_1; L_2 = 0.5 L_1$$

where F_c is the cutoff frequency of the network and R_0 is the load resistance design constant.

The general procedure in designing a network of this type is to determine first the capacitances C_1 and C_2 , the capacitance ratio C_1/C_2 and the total capacitance C_1 . The ratio of the network cut-off frequency F_c to the top frequency of correction F_{max} for the existing capacitance ratio is determined from Table II (col. 4). The resulting value of F_c is then used to calculate the load resistance design constant R_0 . The actual load resistance R_L can then be obtained from column 3 and the values of L_1 , L_2 , and R_L determined.

Where the video amplifier provides a fairly large gain reserve, it is sometimes possible to make use of selective degenerative feedback to compensate for discrepancies in the over-all high frequency characteristic. One simple method of accomplishing this is shown in Fig. 9B.

The resistance-capacitance network in the cathode circuit of the tube has a short time constant, and provides selective degeneration. C_k is a small mica capacitor, seldom larger than 1000 μmfd .

The voltage gain of the stage at low and medium frequencies where C_k is not effective is given by:

$$\bar{A}_L = \frac{G_m R_L}{1 + G_m R_k}$$

and is, of course, always smaller than the stage gain were R_k omitted. The gain reduction due to R_k is:

$$20 \log (1 + G_m R_k) \text{ decibels}$$

This equation indicates the maximum degree of amplitude compensation ob-

Table II. Table for determining the ratio of the network cut-off frequency to the top frequency of correction for the existing capacitance ratio.

1	2	3	4	5
$\frac{C_1}{C_2}$	$\frac{R_1}{R_0}$	$\frac{R_1}{R_0}$	$\frac{F_{max}}{F_c}$	Figure of merit
0.3	5.66	1.088	0.96	2.1
0.5	5.66	1.075	0.85	1.8
1.0	18.90	1.00	0.76	1.5

Tube Type	G_m	F'	F''
6AG5	5000	98	232
6AH6	9000	117	238
6AK5	5100	119	242
6AU6	5200	79	157
6AC7	9000	90	184
6AG7	11000	85	177
7B5 (6K6GT)	2300	24	47
7C5 (6V6GT)	4100	35	71
6L6G	6000	40	84

Table I. The gain-bandwidth factor for some of the more common tubes.

tainable with cathode peaking for a fixed value of R_k .

At the high frequency end of the video band, the shunting reactance of C_k causes a decrease in the effective cathode circuit impedance, and results in an increased voltage gain. At the same time, the a.c. plate-cathode voltage is shifted in phase in a direction such as to partially counteract the phase shift produced by the plate circuit time constant $C_1 R_L$. The gain at high frequencies is given by:

$$A_h = \frac{G_m R_L}{1 + (G_m R_k / y)}$$

where $y = [(2\pi f C_k R_k)^2 + 1]^{1/2}$ and the added phase shift by:

$$-\tan^{-1} \left(\frac{1}{2\pi f C_k R_k} \right)$$

It is possible to effect nearly complete high frequency phase and amplitude correction with cathode peaking by making the plate circuit and cathode circuit time constants equal, that is:

$$R_L C_1 = R_k C_k$$

The figure of merit of a stage using cathode peaking only is generally not nearly so good as will be obtained with the two and four terminal networks described. Cathode peaking is, however, useful in small and controlled amounts to supplement compensation obtained by other means.

The high frequency characteristics of a well designed television video amplifier should be such that the maximum variation in over-all delay time at 4.0 megacycles will not exceed about 0.08 microseconds. This requires that the total phase deviation up to the highest frequency of importance be not greater than 57° per stage in a two stage amplifier. The over-all amplitude characteristic should be flat to within ± 1 decibel or so up to the top frequency of correction.

The schematic diagram of Fig. 8 shows a typical two stage television video channel incorporating high and low frequency compensation, while Fig. 10 indicates its time delay and amplitude characteristics.

TECHNICAL BOOKS

"ACOUSTICAL DESIGNING IN ARCHITECTURE" by Vern O. Knudsen and Cyril M. Harris. Published by John Wiley & Sons, Inc., 440 Fourth Ave., New York 16, N. Y. 457 pages. \$7.50.

Architects, builders, acoustical engineers, teachers and students of architectural acoustics will find this book extremely valuable as it covers the entire field of acoustical design in architecture. Practical applications are emphasized and includes design of auditoriums, theaters, school buildings, homes, churches, radio, television and sound-recording studios.

The contents is divided into two sections: (1) a consideration of the general principles and procedures which form a basis for all acoustical designing, and (2) a description of specific applications of these principles and procedures.

Complicated mathematical formulas are translated into physical explanations, and charts and nomographs are given for many formulas. Comprehensive tables give pertinent data on sound-absorptive materials and sound-insulative structures.

This volume will serve as a practical guide to good acoustical designing as well as a handbook in the solution of problems encountered.

"ADVANCES IN ELECTRONICS"

Volume II, Edited by L. Marton, National Bureau of Standards. Published by Academic Press Inc., 125 East 23rd St., New York, N. Y. 378 pages. \$7.60.

Because of the favorable reception given the first volume of "Advances in Electronics," it was decided that a year-book of this kind would receive wide acclaim. This second volume covering the latest advances in the field of engineering electronics includes a large contribution from European authors, whereas the first volume was written in its entirety by American authors.

Contributors to this second volume are: Donald K. Coles, *Westinghouse Research Labs*; H. Fröhlich, University of Liverpool, G. F. J. Garlick, University of Paris, France; Gunnar Hok, University of Michigan; G. Liebmann, *Associated Electrical Industries, Ltd.*, Berkshire, England; Hilary Moss, *Electronic Tubes Ltd.*, Reading, England; George T. Rado, Naval Research Laboratory; and J. H. Simpson, National Research Council of Canada.

The editors and publishers have expressed a hope that this text will be a definite contribution to the free and international exchange of ideas among scientists.

New Products

(Continued from page 21)

tude modulation system is substantially flat from 30 cycles to well above 100 kc. A monitoring meter is used to standardize the output level of the signal generator in order to make the mutual inductance r.f. attenuator direct reading over the range from 0.1 microvolts to 0.2 volts.

The instrument is self-contained, with power supply, and is designed for use on 115 volts, 60 cycles. Complete details may be obtained on request.

COIL WINDER

A manually-operated coil winding machine designed for the production of paper-insulated coils in multiple or "stick" form is announced by *Universal Winding Company*, Providence, Rhode Island.

The No. 108 Winder was designed to supplement the automatic type of machine with a low-cost machine suitable for the predominantly "job shop" type of market characteristic of the ever-changing electrical and electronic parts industries. The machine can be adjusted quickly to accommodate changing requirements of wire size, coil length and diameter.

Power is supplied by a ½ h.p. a.c. constant speed motor driving through an adjustable-sheave speed controller to a multiple-disc friction clutch attached directly to the spindle. Speed range is 400 to 2200 r.p.m.

VOLTMETER

A new model of the Mini-Volt Voltmeter manufactured by *Industrial Devices, Inc.*, Edgewater, N. J., which features an expanded scale centered on the common 110 and 220 line voltages, is announced.

The new adaptation of this voltmeter is known as Model 410A and is accurate to within 2 volts at 110 volts a.c. Practically burnout proof operation is assured by the glow-lamp indicator which is guaranteed for 25,000 hours' operation minimum. 12" flexible test leads are tipped with heavily insulated test prods assuring user maximum safety.

The Mini-Volt can check voltage, a.c. or d.c.; check for continuity; check blown fuses; locate grounded components; warn of live wires and scores of other possible troublesome occurrences known to electricians, refrigeration servicemen, maintenance men, and anyone who works with electrical circuits.

PRECISION POTENTIOMETERS

Technology Instrument Corporation, 1058 Main St., Waltham, Mass., is now

manufacturing an improved version of their Type RV3 precision potentiometers. Available in two types, the Type RV3-8 (8 watts) and the Type RV3-12 (12 watts), these potentiometers have been redesigned to include bronze bushings for the rotor shaft, tapped mounting inserts, rotor take-off slip ring, dustproof construction with Bakelite cover fastened with screws, and molded parts of low-loss mica-filled Bakelite.

The Type RV3 potentiometers can be supplied with a wide variety of non-standard features to meet special requirements, and the manufacturer has published an established price scale covering such non-standard features. Complete information may be obtained by writing the company direct.



New Tubes

(Continued from page 27)

ance, beam power amplifier featuring low mu-factor, high plate current at low plate voltage, and a high operating ratio of plate current to grid No. 2 current. In suitable horizontal-deflecting circuits, only one 6CD6-G is required to deflect fully any directly viewed kinescope having a deflection angle up to 70° and operating at an anode voltage up to 14 kilovolts.

The 6S4 is a high-perveance, medium-mu triode of the 9-pin miniature type. In suitable vertical-deflecting circuits, the 6S4 will deflect fully a 16GP4 or any other similar kinescope having a deflection angle up to 70° and operating at an anode voltage up to 14 kilovolts.

Sharp-Cutoff Pentode

The 6AS6 announced by *RCA* is a sharp-cutoff pentode of the 7-pin miniature type. Designed so that grid No. 1



and grid No. 3 can each be used as independent control electrodes, the 6AS6 is especially useful in gated amplifier circuits, delay circuits, gain-controlled amplifiers, and mixer circuits.

This tube is also suitable for use as an r.f. amplifier at frequencies up to about 400 megacycles per second. —⊕—

Surface Wave

(Continued from page 11)

several months and had a rather thick corrosion layer. In this state the measured loss was 3 db. Most of the corrosion was then removed by sandpaper. The result was an increase of the loss to about 3.6 db. The expected loss for a wire with perfectly clean surface is much higher. Then we applied several coats of polystyrene solution by means of a brush. The loss went down more and more till a minimum of 1.7 db. was reached. Further increase of the dielectric layer gave a slight increase of the loss by about 0.2 db. The thickness of the dielectric coat varied more than 1:10 along the wire, thus it was not possible to measure the average thickness. This test indicated that the wave is not sensitive to inhomogeneities of the guide.

Finally, a test was conducted with a 600 ft. line which showed that the support of the wire is not a serious problem. The horns used were the same as in the other experiments (opening of 13"). The wire was an enameled wire of 3.2 mm. thickness. The enamel coat was 25/100 mm. thick and the frequency was 1600 mc. The line was stretched along the slope of a hill with the distance from the ground varying between 4 and 8 feet. The wire was supported at intervals of about 80 feet by waxed strings. The calculated loss was 4.5 db. and the measured loss 5 db. For comparison, an RG-8/U cable of the same length has an attenuation of 70 db. The supports and the bends in the wire produced by the supports had no measurable effect in the attenuation.

Fig. 4 shows the calculated attenuation in db. per mile for a line with 2 cm. diameter and a polystyrene coat of ½ mm. in the frequency range from 300 to 1000 mc. In addition to this loss which is proportional to the length we get the loss of the launching devices, which could be kept below 2 db. Considering the wide frequency band which could be transmitted by such a line, the loss is very small.

The question of the effect of weather conditions can be answered only partially and only as far as rain is concerned. An increase of the attenuation was observed only if the wire was covered with rows of big raindrops. The maximum increase measured so far for 1600 mc. was less than 1.5 db. A water film did not increase attenuation. It enlarges the thickness of the dielectric layer and behaves like a good dielectric because the ratio of the power factor to ($\epsilon-1$) which determines the losses is very small. The effect of snow and ice will certainly be more serious and it may be necessary to prevent the settling

down of snow by shaking the wire or by electric heating.

It is a pleasure to acknowledge the close cooperation in Coles Signal Laboratory which made it possible to obtain the present results in a relatively short time. Thanks are due to Mr. J. Hessel and R. Lacy, Chief and Assistant Chief, Radio Communication Branch, to Mr. J. Egli, Chief, Radio Relay & Microwave Section, and especially to the group who cooperated in the measurements, Mr. C. Sharp and L. Battersby and particularly Mr. A. Meyerhoff, who checked all calculations and improved the English of the paper which otherwise would have been much worse.

Microwave Trans.

(Continued from page 9)

$$A_{av} = \frac{1}{T} \int f(t) dt \quad (5)$$

where T is the time required for one period (shown in Fig. 9).

The integral is merely equal to the pulse area. For the rectangular pulse shown in Fig. 9, this area is equal to the amplitude times the pulse width. The relation between average power and peak power for a rectangular pulse is therefore equal to:

$$P_{av} = \frac{1}{T} P_p t_a \quad (6)$$

Thus it is seen that if the period is equal to 1000 microseconds, and the pulse width equal to 1 microsecond, the peak power is equal to 1000 times the average power.

In a lighthouse tube the maximum power rating, for a given frequency, is primarily limited by the maximum allowable plate temperature or the average power dissipated. As a result, a peak power thousands of times greater than the maximum average power rating of the tube can be effected. Fig. 6 is a series of typical power output versus frequency curves for different plate voltages for a 2C43 tube modulated by the pulse series shown in Fig. 9.

In pulse modulating systems where the timing of the pulse carries the intelligence an effect known as "jitter" may be introduced into the microwave oscillator. The r.f. oscillator is normally keyed "on" at some time during the rise time of the applied pulse—the exact instant of keying depends upon the tube characteristics, circuit constants, and random noise fluctuations. If all of these conditions remained the same, the r.f. oscillation would start at the same relative instant for each succeeding pulse. However, the random fluctuations of the noise signal may cause the tube to fire either slightly before or after the normal repetition rate. Since the timing of the pulse carries the intelligence, this shift in pulse position

appears as noise or "jitter" in the demodulator of the system.

This effect can be minimized through the use of a "catalyzer".^{6,7} A "catalyzer", as many readers may remember from their chemistry courses, is an element which aids a reaction but does not react itself. In this case the catalyzer consists of a small oscillator which injects a signal of approximately the same frequency as that of the r.f. oscillator into the microwave cavity. The catalyzer oscillator can be a conventional push-pull oscillator operating in the 300 to 500 megacycle band with a crystal multiplier used to obtain the fifth or sixth harmonic of this signal. The output of the crystal multiplier is then fed to the cavity through a probe or loop. It has been found that the use of a catalyzer appreciably improves the signal to noise ratio of the microwave oscillator. The reason for this effect is probably that the "catalyzer" signal is sufficiently large to "overpower" the noise. Thus random changes in noise have little effect on the oscillator.

There are a number of parameters that affect the frequency of a lighthouse oscillator. Among these effects are the change in cavity length due to a variation in temperature (as a result of expansion and contraction of conductors), change in plate or filament voltage (affecting electron transit time), and cathode to grid interelectrode capacitance (feedback effects). In a typical commercial transmitter, it has been found that the cumulation of all these effects (using "self compensated" temperature conductors in the coaxial lines) results in a frequency stability of about 0.05 per-cent at 2000 mc. In this latter unit no attempt had been made to compensate for the voltage variations through the use of a regulated plate supply.

Where a higher degree of frequency stability is required, some method of automatic frequency control (a.f.c.) must be employed. Heretofore it has been found that the best method of frequency control is an electromechanical system in which a variation in frequency from the desired value is detected by a discriminator, whose output actuates a motor which drives a tuning device until the desired frequency is

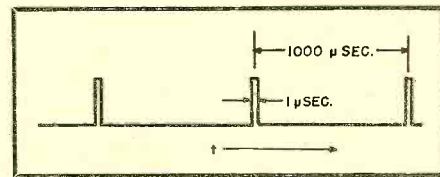

Fig. 9. Typical pulse series.

obtained. Completely electronic systems of control are difficult and expensive to design since the easiest and surest method of tuning involves adjustment of the resonant line length, rather than variation of plate voltage or interelectrode capacitance, which is essentially a mechanical operation.

Two typical a.f.c. circuits are shown in Figs. 5 and 8. The a.f.c. circuit shown in Fig. 5 uses two reference cavities, one resonant at f_1 and the other at f_2 . The desired resonant frequency of the triode line, f_0 , is equal to $(f_1 + f_2)/2$. These relations are plotted in Fig. 10.

A small amount of energy from the triode line is picked up by loops shown in Fig. 5 and injected into the two reference cavities. When the frequency of this energy is exactly equal to f_0 , the outputs of the two cavities are equal and no discriminator voltage is developed across the grids of V_1 and V_2 . V_1 and V_2 are thyratrons which are normally cut off. If the energy obtained from the triode line is not equal to f_0 , a discriminator voltage will be developed across the grid of V_1 or V_2 (depending upon whether frequency is above or below f_0) causing one to conduct and operate the split phase motor. This motor will operate the reset control in the direction that will correct for the "off frequency" variation. An a.c. voltage is applied to the plates of the thyratrons, so that they will be extinguished when the discriminator voltage reduces to zero. The cavities used can be made highly reliable by using temperature compensated metals such as Invar or using a temperature controlled oven.

The a.f.c. circuit shown in Fig. 8 is a simplified version of the previous circuit. In this case a single cavity and thyatron are used in conjunction with a motor driven trimmer condenser. The effect of a condenser at the end of a line was discussed in the article, "Microwave Components". The action of this circuit is as follows: The existence of a frequency other than the desired value in the cavity provides a discriminator voltage which fires the thyatron. This operates the motor which drives the condenser rotor. The plate of the condenser turns very slowly, first increasing and then decreasing resonant line frequency. The plate will turn until the discriminator voltage drops to zero. The motor speed is made sufficiently low compared to the time required for the discriminator to extinguish the thya-

Fig. 10. Frequency response of two reference cavities and desired resonant frequency of triode resonant line.

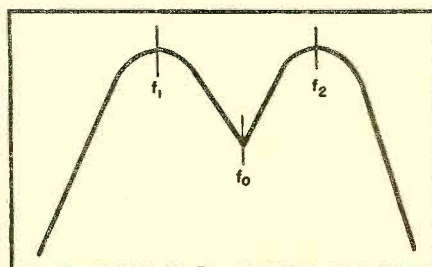

tron, that the condenser will not "over-shoot" the desired frequency.

Acknowledgement is hereby gratefully made to Mr. Harris Gallay of Federal Telecommunication Laboratories for automatic frequency control circuits described in this article.

BIBLIOGRAPHY

1. Racker, J., "Microwave Techniques", RADIO-ELECTRONIC ENGINEERING, p. 3, February, 1950.
2. Racker, J., "Microwave Transmission Lines", RADIO-ELECTRONIC ENGINEERING, March, 1950.
3. Racker, J., "Microwave Components", RADIO-ELECTRONIC ENGINEERING, April, 1950.
4. Moskowitz and Racker, "Pulse Communication Systems", RADIO-ELECTRONIC ENGINEERING, September, 1948.
5. Moskowitz and Racker, "Pulse Techniques", RADIO-ELECTRONIC ENGINEERING, January, 1948.
6. Young, N. H., U. S. Patent 2,416,367.
7. Hoffman, R. B., U. S. Patent 2,418,121.



Custom Sound

(Continued from page 5)

finely, but it must be remembered that at certain times there were high levels of noise to overcome on stage due to the locomotives, western style gunplay, and old one-lung autos. If the system were not adjusted so carefully, much of the dialogue and music would be lost in some areas while in other areas the level of the sound would be so high as to be objectionable.

An interesting note is the fact that these speakers and baffles were so efficient in projecting the sound to the grandstand that additional monitor speakers had to be installed backstage in the wings to allow the stage managers and cast to follow the continuity. These were Jensen eight inch heavy-duty loudspeakers mounted in weatherproof metal projectors. Each of these monitors had an adjustable "L" pad control to allow the stage managers to set the level to suit their surrounding noise level.

For use before show time and for fill-in in case of rain or accident, a record turntable and its preamplifier was incorporated in the console control cabinet. This unit could be plugged into the patch panel at the output terminal of the console and automatically replace the console program with the recorded program.

In addition to the stage sound system, a second independent amplifier and set of four 24" re-entrant drive unit loudspeakers were installed atop the grandstand roof to cover the outside plaza in front of the grandstand entrances. This system could be fed from the console, the turntable, the Celesta-Chime or from a microphone position located in one of the grandstand entrances. The primary purpose of this system was to advertise the pageant and also to furnish music to the plaza between shows.

The Deagan 25 note Celesta-Chime was chosen for this installation because it was found to be the only electronically

amplified chime that could be played in tune with an orchestra. The chime rods are tuned harmonically which eliminates the "wow" and "out of tune" effect that is usually associated with chimes and bells. In some instances where the Celesta-Chime was played solo, full chords were used. No other instrument was found that was suitable for such usage. A special low "G" chime was built by Deagan to furnish the deep tolling bell effect that was desired for the Lincoln Funeral Train scene. As explained above, these chimes were reproduced through the control console and entire system and could be controlled the same as any microphone.

Since all the sound and control equipment had to be integrated with the entire operation of the show, the design and installation of the intercommunication, buzzer, cue and railroad signal systems was undertaken along with the sound system. The intercommunication system was in two stages; the first stage consisted of an electronically amplified 20 station master unit located in the director's booth connecting with remote stations back stage, ticket booths in the plaza, the orchestra pit, the equipment tents north and south of the stage, the electricians' switchboard room and the sound man. The importance of this intercom system can be realized when it is understood that it was the only two-way communication that the director had with the show from his remote position. It was used to check on equipment, cue in some of the vehicles, instruct the orchestra conductor and deliver the light cues, of which there were 62, to the electricians under the stands. As a supplementary system, there was a battery operated telephone type intercom system with three master stations. One was in the director's booth, one at the sound control console (visible at the extreme end of the control console, Fig. 3), and one in the orchestra pit. This system was used mainly between the orchestra conductor and the sound man.

The buzzers, music cue lights and the railroad signals were all controlled from a small custom-built console located in the director's booth. Buzzers were located in all dressing rooms backstage, in the wings and at the extreme ends of the stage extension wings. Each buzzer could be controlled independently or all could be sounded at the same time. The music cue lights were located on the orchestra conductor's stand and con-

sisted of one flashing white warning light and a second steady amber "go" light. The railroad signals were located at the ends of the stage wings and were used to cue the locomotives on stage. These signals had to be visible to engineers on any of the four switch tracks in either the north or south yards both in daylight and dark. The operation of the controls for these buzzers, lights and signals had to be simple and foolproof as a mis-cue during the show could cause a serious accident. Some of the trains that crossed the stage traveled 30 to 40 miles per hour, so it is easy to see that an accident would be hard to prevent in case of a mis-cue.

During the rehearsals before the show opened, a temporary talk-back system was installed in the grandstand to enable the directors to speak to the people on stage and in the equipment and railroad yards. This system utilized the two re-entrant projectors that were on either end of the grandstand roof and additional projectors that were placed in the stands and aimed toward the stage.

Much of the success of the entire installation was due to the intelligent discussion of the entire staging problem by Helen Geraghty, the director of the pageant. By talking over the entire show, and not just the sound system, a clear picture of the entire operation was established before the designing was even undertaken. It must be emphasized here that too many times a sound system of this type will be installed as just a P.A. job and will fail to do the job because "new and unusual" conditions pop up that had not been thought out. One of the reasons that this installation was so successful was that, not only was it a good sound reinforcing system, but a live part of the show. The two operators, who alternated at handling the mixing, worked from a complete technical script that listed all the dialogue, the music cues and the mixing cues. In all they had 260 separate sound cues to handle in one hour and eight minutes.

A good sound installation is noticed and appreciated by those who have to listen to it. Many compliments were received this past summer from musicians, directors and members of the industry who attended the show, and many favorable comments were voiced by members of the audience who had never before paid any attention to the sound systems that they had heard. In every large outdoor amphitheater, stadium or fairgrounds attention should be paid to all the details that contribute to or detract from the coverage and quality of the sound system installation so that high-quality sound systems can become the rule instead of the exception.



PHOTO CREDITS

6, 7, 8. Federal Telecommunication Laboratories

10. Official Department of Defense

QUARTER-WAVE MATCHING SECTION

This chart is used to obtain the surge impedance of a $\frac{1}{4} \lambda$ matching section used as an impedance transformer from one real impedance to another.

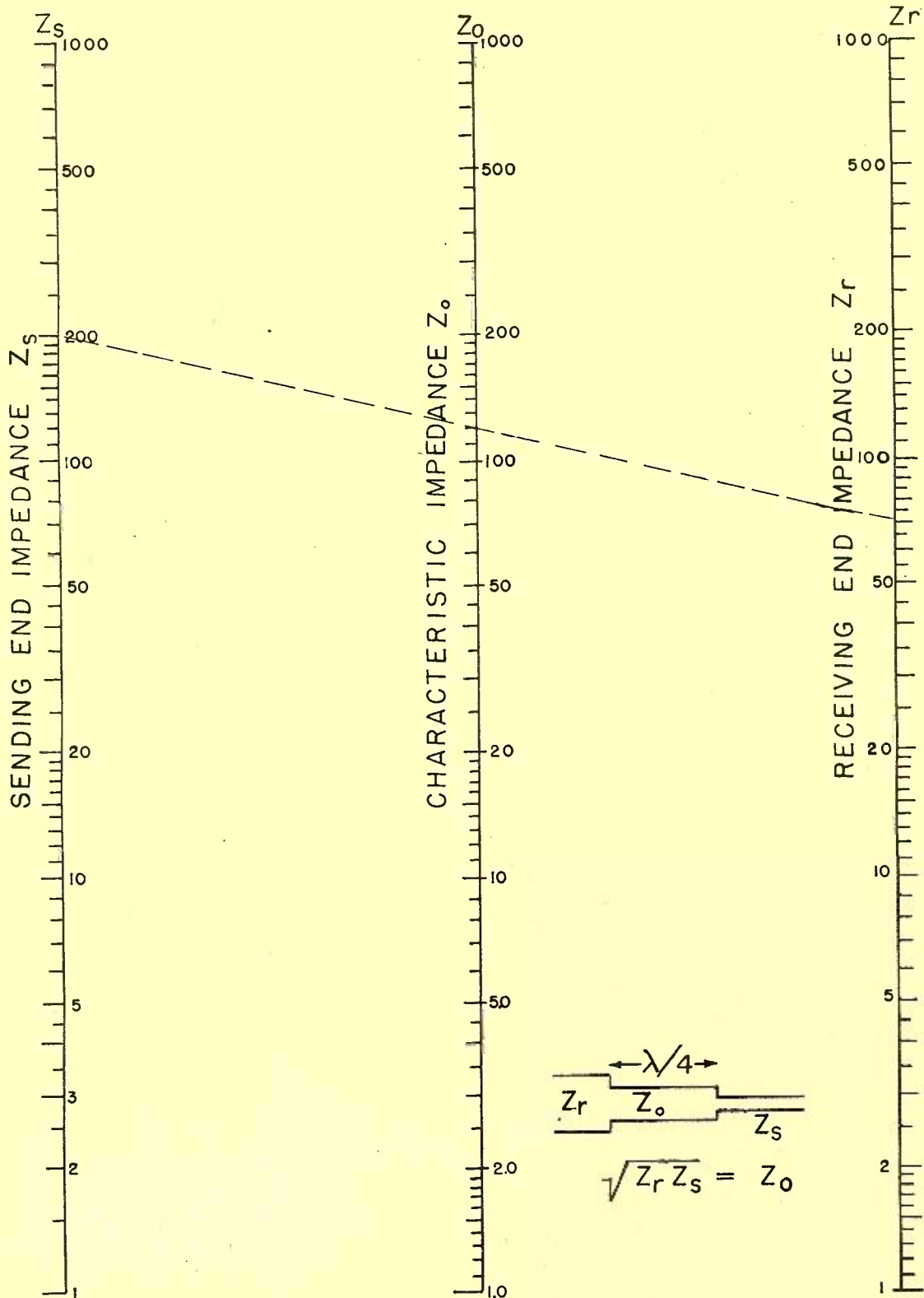

Courtesy of Federal Telephone and Radio Corporation



HERE IS THE LONG SOUGHT ANSWER IN TELEVISION TRAINING FOR THE MAN ALREADY IN RADIO! TRAIN AT HOME—FULL PROGRAM—4 TO 8 WEEKS!

Low Cost—Monthly Payments. Everything You Need to Learn...
TELEVISION

I Send You NOT JUST an Ordinary TV Kit—But a Complete Training System Including TV Test Equipment

Here is the NEW Combination Sprayberry Television Training System

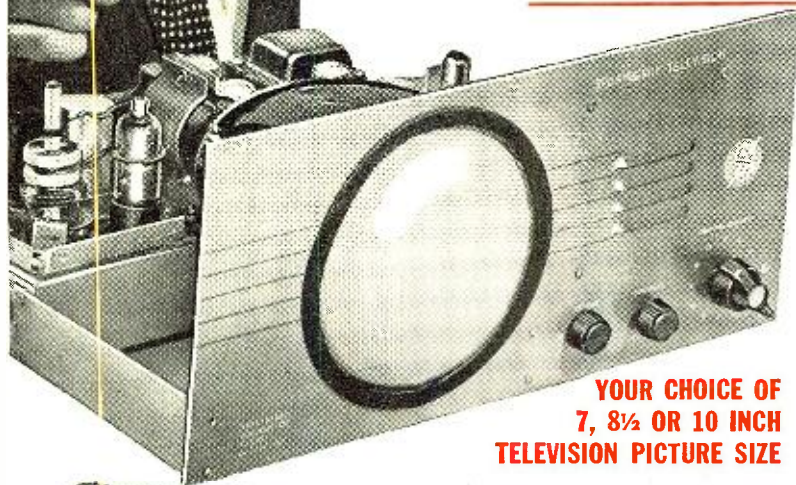

YOUR CHOICE OF 7, 8½ OR 10 INCH TELEVISION PICTURE SIZE

Out of my laboratory has come an entirely new Television Training...cutting months off the time required in old methods. I give all the knowledge and experience you need in weeks instead of months. I start where your present radio experience ends. The same day you enroll with me, I rush the first of many big Television kits that I will send during your training. From the first hour you are experimenting and testing practical TV circuits...and you keep right on from one fascinating experiment to another. You build the remarkable new Television Receiver-Tester illustrated at the left and useful TV Test Equipment. I give you theory, too, but it's 100% practical stuff that will make money for you in Television.



Exclusive THREE-UNIT Construction

You build my Television Receiver-Tester in three separate units—one unit at a time...each complete and self contained within itself. With each unit you perform dozens of important experiments—and each unit may be used in actual Television receiver servicing. In this way my training may save you many dollars by eliminating the need for costly TV Test Equipment. With these three units you can locate most TV Receiver troubles quickly and easily.

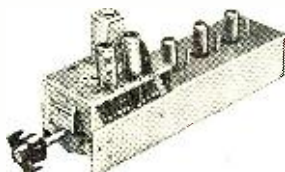

TV Tuner—I.F. Unit

Contains the RF amplified local oscillator, mixer and three stages of broad band IF amplification and the video second detector. The output constitutes the video signal and audio IF signal. For training, it is used to build and test video second detector, and stagger tuned IF amplifier obtaining 4.5 mc band pass. For TV servicing, it becomes a TV calibrator for IF alignment, substitute tuner, IF signal injector and second detector.

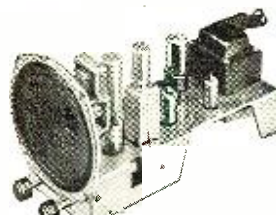

Video-Audio Amplifier Unit

Provides 4.5 mc IF ratio detector, low voltage power supply. For TV, it becomes the audio output, including speaker, video output and low voltage power supply for RF and IF stages. For training, it is used to build and test transformer type power supplies, audio, video, IF amplification and FM detection. For TV servicing, it is an audio signal tracer, IF signal tracer, video signal tracer and low voltage power supply.

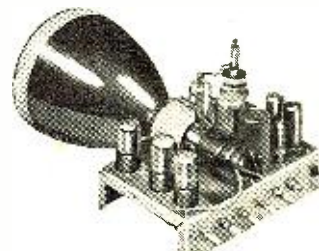

Video Tube "Scope" Unit

Scope unit contains low and high voltage (6000 V.) power supply for independent operation. For television, it becomes the sync, vertical and horizontal sweep circuits and their power supplies. For training, it is used to build and test most TV power supply, deflection, sweep, oscillator, and sync circuits. For TV servicing, it is a video signal tracer and sweep signal analyzer as well as substitute high and low voltage power supplies.

BE READY FOR TOP PAYING TELEVISION JOBS

If you are a radio-serviceman, experimenter, amateur or advanced student... **YOUR FUTURE IS IN TELEVISION.** Depending upon where you live, Television is either in your town now... or will be there shortly. This is a vast new industry that needs qualified trained men by the thousand to install and service TV sets. There's really big money in Television, but you **MUST** know what you are doing to "cash-in" on it. I will train you in a few short weeks if you have had previous radio training or experience.

IMPORTANT—FOR MEN JUST STARTING OUT IN RADIO-TELEVISION

If you have no previous experience in Radio work, be sure to mark that fact on the coupon below. I will send you complete information about my Radio-Television training that starts with basic fundamentals and carries you right through my new Radio and Television Training. I will send you my two big Radio-Television books, including an actual lesson selected from my course. I want you to know exactly what this great industry has in store for you. There is no obligation, of course, and **NO SALESMAN WILL CALL.**

VETERANS—Radio portion of training available under G. I. Bill



FILL OUT AND MAIL COUPON
Get these Valuable Books FREE!

Every Radio Serviceman today realizes his future is in Television. He knows he **MUST** have training—the right kind of practical training such as I am now offering—to protect his job, his business for the future. This is equally important for the man just starting out. And so I urge you to get the facts I offer you **FREE** and without obligation. Learn how quickly and easily you can get into Television. Fill out and mail the coupon **TODAY.**

SPRAYBERRY ACADEMY OF RADIO, Dept. 25-J
 111 North Canal St., Chicago 6, Ill.

Please rush to me all information on your Radio-Television Training plan. I understand this does not obligate me and that no salesman will call upon me.

Name..... Age.....

Address.....

City..... State.....

Please Check Below About Your Experience

Are You Experienced? No Experience

SPRAYBERRY ACADEMY OF RADIO, 111 N. Canal, Dept. 25-J, Chicago 6, Ill.

NEW



- 1/2%
RESISTORS
- COMPENSATED
OHMMETER
CIRCUIT**
- LONG
HAND-DRAWN
MIRRORED
SCALES**

ACCURACY

Designed for the engineer and technician who wants laboratory accuracy. Achieved in Model 630-A by more accurate components and hand-drawn scales that compensate for the average individual characteristic of each instrument. Also includes knife-edge pointer and mirror scale to eliminate parallax.

Model
630-A

ONLY \$47.50 AT YOUR DISTRIBUTOR



CONFIDENCE STARTS HERE!



DO YOU HAVE THESE G-E SALES BUILDERS?

- NEW 4-way plan for more business
- NEW electric window sign
- NEW outdoor metal sign
- NEW luminescent window card
- NEW decalcomania
- NEW tube storage-display cabinet
- NEW newspaper ad mats
- NEW postcard promotion mailers
- Convenient G-E pocket office
- Handy G-E tube puller
- Techni-talk Magazine
- TV service course
- Distinctive shop garments
- Wall plaque
- Giant tube cartons
- Imprinted stationery and business cards
- Repair and tube-test stickers
- Job-tickets and shipping labels

"It's the 'G-E' on my store window that brings in customers. And 'G-E' on the tube cartons on my shelves leads them to buy!" Radio-TV servicemen unite in this statement, for their sales have proved the *pull* of the General Electric trademark.

Also . . . more business comes to G-E tube dealers because *all* their needs are met with a complete line of TV-picture, metal, glass, and miniature types, as well as germanium diodes and selenium rectifiers. Profits are bigger by reason of General Electric's sensational group of plus-powered promotion helps (the list at the left shows how many *new* items there are to give your 1950 sales a jet take-off).

Phone or write your G-E tube distributor . . . today. He'll show you how to make real money from an active local market you can dominate with G-E tubes to install and sell, G-E promotions to help you sell! *Electronics Department, General Electric Company, Schenectady 5, N. Y.*

You can put your confidence in—

GENERA  ELECTRIC

181-JA4

SERVICE TECHNICIANS ACCLAIM SENSATIONAL IRC control development

Concentrikit

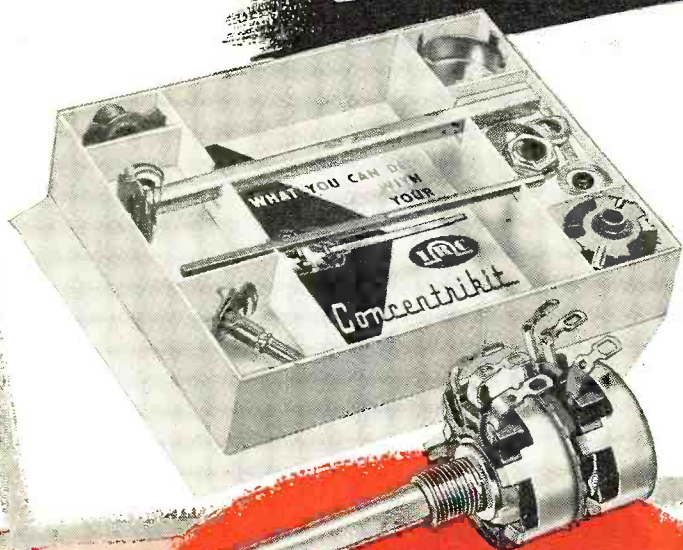

Amazing new IRC Concentrikit is the practical answer to your concentric dual replacement problems. With this set of specially designed parts you can assemble over 90% of all concentric dual types . . . no more long searches and waits for exact duplicates. You save time, worry *and* inventory investment.

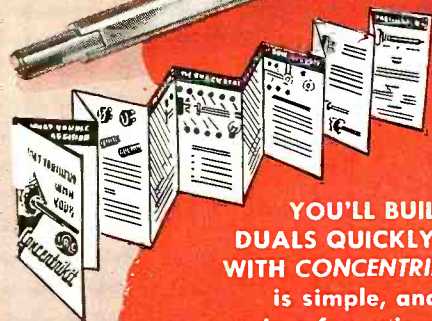

**YOU'LL BUILD CONCENTRIC
DUALS QUICKLY AND EASILY
WITH CONCENTRIKIT.** Assembly
is simple, and can be completed
in a few minutes. Step-by-step
instructions are furnished with every kit.

REPLACEMENT MANUAL AVAILABLE
Full replacement data on concentrics
for all applications, from the earliest
home and auto radios to television,
are contained in a new IRC CON-
CENTRIC DUAL REPLACEMENT
MANUAL. Be sure to get a copy
from your IRC Distributor.





STOCK ASSORTMENT

Television has greatly increased your concentric dual requirements . . . be ready with this CONCENTRIKIT Stock Assortment on your bench. Handsome metal cabinet contains all you need to assemble quickly any of 144 different concentric duals. It covers over 500 models . . . RCA, Admiral, Air King, Belmont, Emerson, General Electric, Motorola, Philco, Westinghouse, Zenith and many others. Order from your IRC Distributor now, or send coupon for more information. International Resistance Company, 401 N. Broad St., Philadelphia 8, Pa.

HERE'S WHAT YOU GET

In Concentrikit Stock Assortment #13

	Quantity		Quantity
Complete Concentrikits	4	B19-133X	1
Base Elements		B11-137	3
B11-108	1	B13-137	2
B11-114	1	B13-137X	1
B11-115	1	B18-137XX	1
B11-116	1	B19-137X	1
B17-116	1	B11-139	2
B11-119	1	B13-139	1
B11-120	1	B13-139X	1
B11-121	1	Inner Shaft Ends	
B11-123	2	E-187	3
B11-128	2	E-190	1
B11-130	1	E-202	2
B13-130	2	Sleeve Bushings	
B13-130X	1	S-4	1
B18-130X	1	S-5	1
B18-132X	1	Resilient Retainer Rings	10
B11-133	2	Switches	
B13-133	2	76-1	3
B13-133X	1		
B18-133X	1		

Concentrikit Stock Assortment comes in a sturdy all-metal cabinet. Four drawers and individual compartments assure efficient stocking . . . and cabinets may be stacked with IRC Resist-O-Cabinets to make a convenient and good-looking shop arrangement. METAL CABINET IS SUPPLIED AT NO EXTRA CHARGE, you pay only the regular price of the parts.

and
the
price
is—

ONLY
\$ 24.78
dealer net cost

ORDER YOURS TODAY!



**INTERNATIONAL
RESISTANCE COMPANY**

Wherever the Circuit Says

In Canada: International Resistance Co., Ltd., Toronto, Licensee

INTERNATIONAL RESISTANCE COMPANY
415 N. Broad Street, Phila. 8, Pa.

- I'm interested. Send Catalogs DC1A and DC2S with details on CONCENTRIKIT and Dealer Stock Assortment.
- Enclosed find 25c in stamps or coin for my copy of IRC Concentric Dual Replacement Manual.

Name.....
Company.....
Address.....

“I can't understand why your picture is so much better than ours! It's the same make of set, you know!”

“Well, according to the TV service man, the picture quality of any TV set is only as good as the antenna on the roof. We have an Amphenol **INLINE** Antenna and that accounts for the better picture quality.”

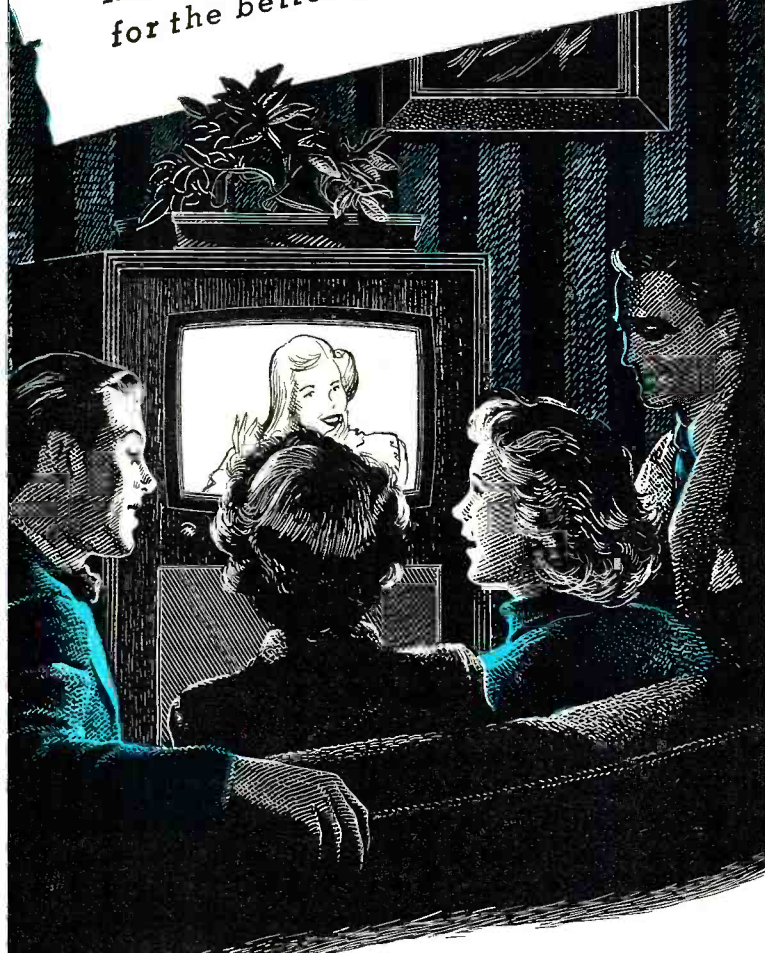

AMPHENOL SINGLE BAY
INLINE ANTENNA
MODEL 114-005

AMPHENOL

—INLINE*

TV ANTENNAS

*U. S. Patent No. 2,474,480

AMERICAN PHENOLIC CORPORATION

1830 SO. 54TH AVENUE • CHICAGO 50, ILLINOIS

Remember... **the 1950** May is Market Month!



"The only all-industry sponsored Conference and Show in Electronics"

PARTS DISTRIBUTORS CONFERENCE AND SHOW

MAY 22-25 1950 • STEVENS HOTEL • CHICAGO

PROGRAM OF EVENTS

SUNDAY, MAY 21

- 9:00 a.m. Exhibition Hall and Display Room Area open for erection of displays
- 10:00 a.m. Registration Desk Opens—Exhibition Hall Lobby
- 6:00 p.m. Radio's Old Timers—Cocktail Party for Members—South Ballroom, Stevens Hotel

MONDAY, May 22 "ASSOCIATIONS' MEETING DAY"

- 9:00 a.m. Erection of Displays
- 10:00 a.m. Registration Desk Opens—Exhibition Hall Lobby
- 10:30 a.m. General Meeting—"The Representatives" of Radio Parts Manufacturers, Inc.—Upper Tower Room, Stevens Hotel
- 12:30 p.m. Luncheon Meeting for General Members—"The Representatives" of Radio Parts Manufacturers, Inc.—Lower Tower Room, Stevens Hotel
- 2:00 p.m. Joint Meeting of Sales Managers Club, Eastern Division; Association of Electronic Parts & Equipment Manufacturers; and West Coast Electronic Manufacturers' Association—South Ballroom, Stevens Hotel
- 2:30 p.m. Delegates' Meeting—"The Representatives" of Radio Parts Manufacturers, Inc.—Upper Tower Room, Stevens Hotel
- 3:30 p.m. Annual Meeting of Member-Exhibitors and General Members of Radio Parts & Electronic Equipment Shows, Inc.—South Ballroom, Stevens Hotel
- 6:00 p.m. Registration Desk Closes
- 7:00 p.m. **INDUSTRY KEYNOTE DINNER**—Grand Ballroom, Stevens Hotel

TUESDAY, May 23

- 10:00 a.m. Registration Desk Opens—Exhibition Hall Lobby
- Exhibition Hall Opens—Attendance confined to exhibitors, their booth attendants, sales representatives, and all distributors
- 1:00 p.m. Display Room Area Opens
- 2:00 p.m. Distributors' Educational Session on "Sales and Merchandising"—North Ballroom, Stevens Hotel
- 6:00 p.m. Registration Desk Closes
- Exhibition Hall Closes

WEDNESDAY, May 24

- 10:00 a.m. Registration Desk Opens—Exhibition Hall Lobby
- Exhibition Hall Opens—Attendance confined to exhibitors, their booth attendants, sales representatives and all distributors
- 1:00 p.m. Display Room Area Opens
- 2:00 p.m. Distributors' Educational Session on "Inventory Control"—North Ballroom, Stevens Hotel
- 6:00 p.m. Registration Desk Closes
- Exhibition Hall Closes

THURSDAY, May 25

- 10:00 a.m. Registration Desk Opens—Exhibition Hall Lobby
- Exhibition Hall Opens—Attendance confined to exhibitors, their booth attendants, sales representatives, and all distributors
- 1:00 p.m. Display Room Area Opens
- 2:00 p.m. Distributors' Educational Session on "Financial Management"—North Ballroom, Stevens Hotel
- 6:00 p.m. Registration Desk Closes
- Exhibition Hall Closes

1950 Parts Distributors Conference & Show ends.



HOW TO REDUCE TV INTERFERENCE

Use Wave Traps Made With **OHMITE** "Frequency-Rated" **CHOKES**

There are many cases where the front end of a TV receiver lacks the selectivity required to eliminate very strong 14 or 28 Mc signals. These fundamental frequencies jam through the receiver front end and create many kinds of cross-modulation products which affect the viewed picture (not to mention the set-owner's temper). The only solution: each receiver affected must be treated separately, to prevent such fundamental frequencies from getting in and affecting the TV signal.

Tuned wave traps—either series, parallel, or combination types—are most commonly used to eliminate this trouble. They can be made effectively with Ohmite high-Q Chokes, in combination with suitable trimmer capacitors. (See diagrams at the right.)

Since most receivers have 300-ohm input, that type has been treated here. These designs, however, can be adapted to 72-ohm input as well. Series-tuned traps are connected from the receiver terminals to ground. In some cases, however, two parallel-tuned traps may prove equally satisfactory. The chokes and trimmers can be mounted on a small terminal board with binding posts or clips for easy installation.

WRITE FOR BULLETIN 133
AND CATALOGUE 21

OHMITE MANUFACTURING COMPANY
4885 W. Flournoy St., Chicago 44, Ill.

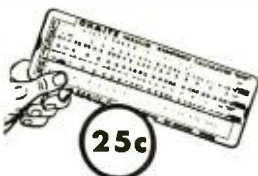

NEW OHM'S LAW CALCULATOR

Quickly solves all Ohm's Law problems—including parallel resistance. Also has standard slide rule.

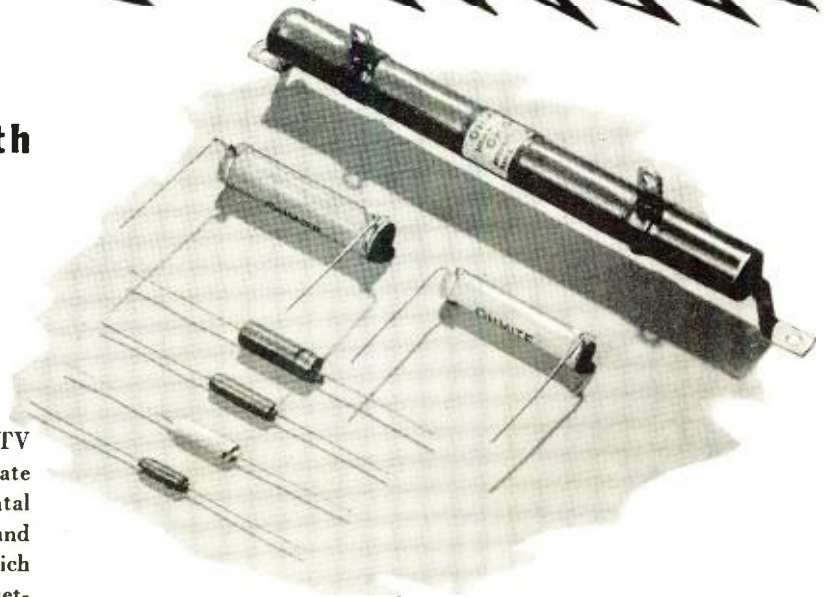

OHMITE CHOKES have accurately predetermined frequency characteristics. High "Q" single-layer wound on low power-factor plastic or steatite cores; insulated and protected by moisture-proof coating. Z-14 and Z-28 rated 600 ma; others 1000 ma. Seven sizes—covering range 3 to 520 megacycles.

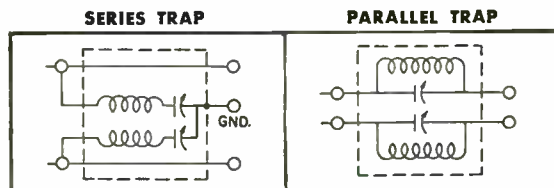

Table below shows approximate capacity necessary to resonate OHMITE Frequency-Rated Chokes at various frequencies:

OHMITE CHOKE	mmf at 3.5 Mc	mmf at 7 Mc	mmf at 14 Mc	mmf at 21 Mc	mmf at 28 Mc	mmf at 50 Mc	mmf at 56 Mc
Z-28	98	25	6.2				
Z-50		74	19	8.2	4.6		
Z-144			72	32	18	5.7	4.5
Z-235				6.9	39	12	9.7
Z-460						51	40

Be Right with **OHMITE**
Reg. U.S. Pat. Off.

RHEOSTATS • RESISTORS • TAP SWITCHES

The Service
Managers of
Admiral
ZENITH
Hallicrafters
Motorola
all recommend the

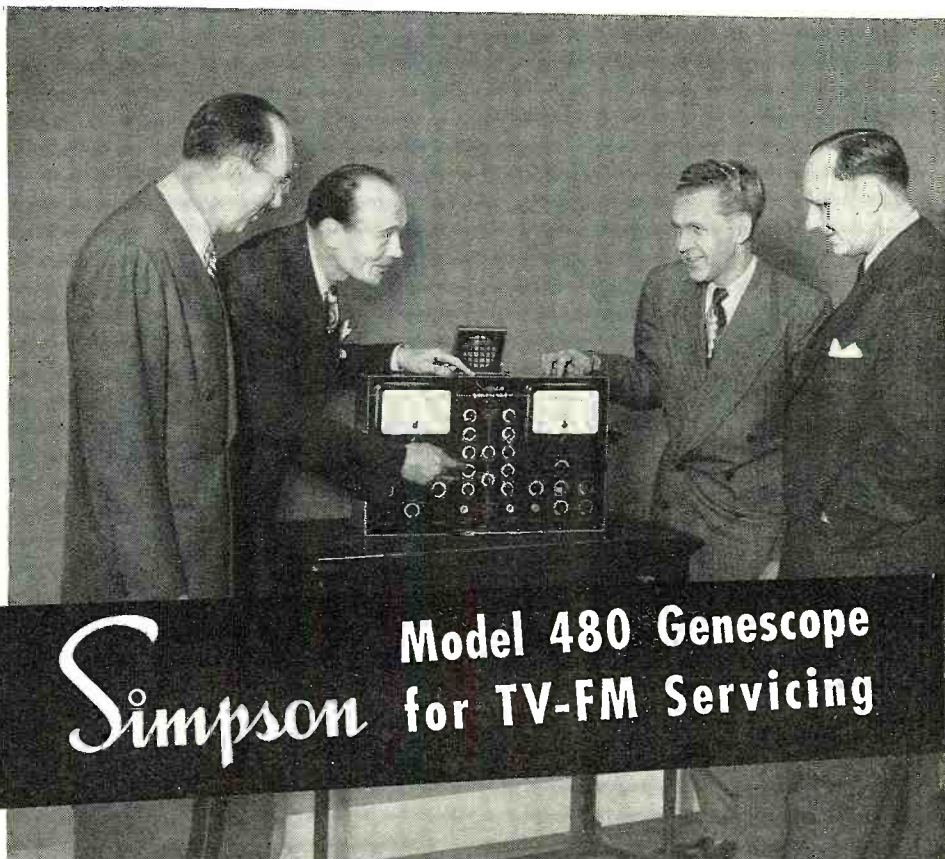

Max Schinke—ADMIRAL Frank Smolek—ZENITH Ed Croxen—HALLICRAFTERS Tim Alexander—MOTOROLA

Simpson Model 480 Genescope for TV-FM Servicing

• These four well known general service managers prefer the Simpson Model 480 Genescope for their FM and TV servicing.

For proper testing, servicing, and alignment of all TV and FM receivers, the Simpson Model 480 Genescope is the ideal instrument, leading general service managers agree.

These service managers know that modern FM and TV development and servicing demands test equipment made to the most exacting standards. They prefer the Simpson Model 480 Genescope because it is the most accurate, flexible, and convenient instrument available.

The Genescope is ruggedly built to give many years of trouble-free, accurate service.

In addition to providing all necessary signal sources, the new Simpson Genescope includes a high sensitivity oscilloscope of unique advanced design, complete in every detail. Equipped with a high frequency crystal probe for signal tracing, AM and FM oscillator sections provided with large, easy to read dials with 20:1 vernier control and 1000 division logging scales. *Revolutionary, ingenious, exclusive* output termination provides for various receiver impedances, either direct or through an isolating condenser. Step attenuator for control of output. Size 22" x 14" x 7½". Weight 45 lbs. Shipping Weight 54 lbs.

DEALER'S NET PRICE complete with Test Leads and Operator's Manual \$375.00

THESE RANGES SHOW HOW MUCH THE SIMPSON GENESCOPE CAN DO FOR YOU	
FREQUENCY MODULATED OSCILLATOR	AMPLITUDE MODULATED OSCILLATOR
Band A: 2-120 megacycles	Band A: 3.3-15.6 megacycles
Band B: 140-260 megacycles	Band B: 15-75 megacycles
Sweep width variable from zero to 15 megacycles	Band C: 75-250 megacycles
Sweep rate 60 cycles per second	30% modulation at 400 cycles or unmodulated
Specially designed frequency sweep motor	Continuously variable attenuator
Continuously variable attenuator	Visual method of beat frequency indication
Crystal calibrator: 5 megacycles ± .05%	OSCILLOSCOPE
Audio Oscillator 400 cycles	Vertical sensitivity: 35 mv per inch
Output Impedance 75 ohms	Horizontal sensitivity: 70 mv per inch
Step attenuator for control of output	Linear sweep frequency: 3 cycles to 60 kilocycles
	60 cycle sine sweep
	Frequency essentially flat to 200 KC. usable to over 3 megacycles

THE SIMPSON MODEL 479 TV-FM SIGNAL GENERATOR

Exactly the same circuits, ranges and functions as the Model 480, described above, with the exception of the oscilloscope. Size 17" x 14" x 7½". Weight 34 lbs. Shipping Weight 40 lbs.

DEALER'S NET PRICE with Test Leads and Operator's Manual . . . \$245.00

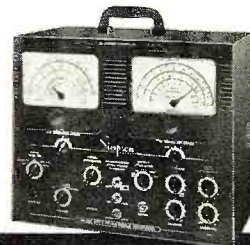

SIMPSON ELECTRIC COMPANY
5200 WEST KINZIE STREET • CHICAGO 44, ILLINOIS
In Canada: Bach-Simpson, Ltd., London, Ont.
Phone: COLUMBUS 1-1221



The Redskin of course...

SANGAMO'S NEW MOLDED PAPER TUBULAR CAN HELP SOLVE YOUR CAPACITOR PROBLEMS!

The Sangamo Redskin has the "How" it takes to lick paper tubular troubles. The strong, tough plastic casing stands rough handling and the especially designed, flexible leads are troublefree . . . they resist breakage and they can't pull out. It is used extensively by television manufacturers because it gives dependable *long life* operation at 85° C. The thermo-setting plastic case is molded under low pressure—assuring elements undamaged in fabrication, longer life, greater dependability, and the absence of "hot spots."

A trial of these *better* molded tubulars will convince you. See your Jobber for the Redskin and the other capacitors in the Sangamo Tribe.

NEVER FLINCHES IN THE PINCHES!



WATER TEST

Far surpasses any existing specification requirement.



HEAT TEST

Excellent operation under high temperature conditions.



PULL TEST

Leads resist breaking or pulling out. Takes rough handling.



LIFE TEST

Long life even under most severe operating conditions.



SANGAMO ELECTRIC COMPANY SPRINGFIELD, ILLINOIS

In Canada: Sangamo Electric Company Limited, Leaside, Ont.



Centralab Components

**CENTRALAB
CAPACITORS**

*... More Than Meet Your
Replacement Needs*



HI-VO-KAPS
for TV Power Supplies.



KOLORDISKS
for by-pass and coupling in AF,
RF, VHF, UHF, TV, FM and AM
circuits.



BC HI-KAPS
for by-pass and coupling in RF,
HF, VHF, UHF, TV, FM and AM
circuits.

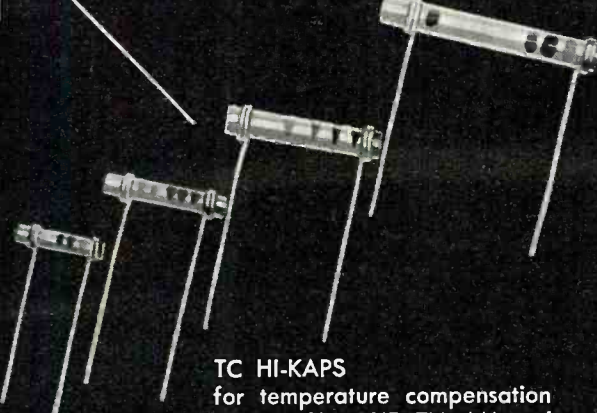

TC HI-KAPS
for temperature compensation
in AF, VHF, UHF, TV, AM and
FM circuits.

CRL CAPACITORS MEAN PROFITS FOR YOU!

WHEN YOU use high quality Centralab replacement capacitors in repairing radio sets, television receivers and other electronic equipment, you can be sure of customer satisfaction. You can be sure of new business. What's more, Centralab capacitors — *Hi-Vo-Kaps*,

Kolordisks, *TC* and *BC Hi-Kaps* — make your job easier, save you time. Here's why. They're simple to install . . . easy to stock. Get all the facts on profit-making CRL replacement capacitors from your nearby Centralab distributor.

Saves for Servicing

Successful servicemen, like successful engineers don't guess — they know! Here are Four important standards they run their business by: "1) Do the replacement parts I use give my customers trouble-free service? 2) Are these parts designed to help me do a good job quickly? 3) Are they packaged to save shelf space . . . to make accurate selection easy? 4) Am I getting the kind of service I want from my distributor?" If you can answer "Yes" to all these questions, it's very likely you use quality Centralab parts, too. If you can't, we're confident you will find it profitable to ask your nearest Centralab distributor for all the facts. Call him today!

Centralab
CRL
Division of GLOBE-UNION INC. • Milwaukee

Ask Your Distributor for These CRL Parts

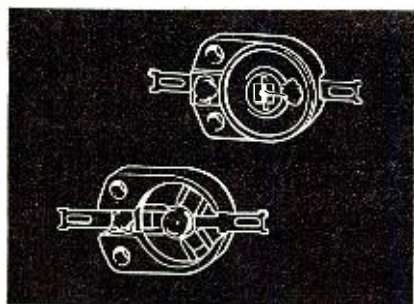

TRIMMERS

CERAMIC TRIMMERS for padder application in RF and HF circuits. These trimmers are noted for their great mechanical strength and electrical stability; low power factor. Hold circuit drift to a minimum. Truly an indispensable "must." Ideal for amateur, experimental and industrial use.

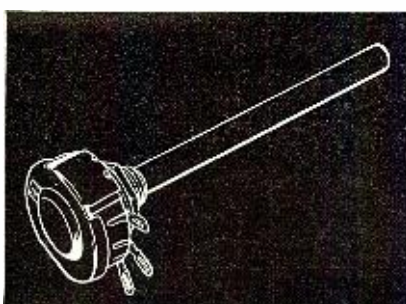

CONTROLS

MODEL "M" for voltage-divider, antenna shunt and "C" bias control, tone control, AF grid control. **MODEL "1"** for all miniature applications; rated at 1/10 watt, actually smaller than a dime. **MODEL "R"**, wire wound, for voltage divider, antenna shunt, "C" bias, AF grid or tone control circuits.

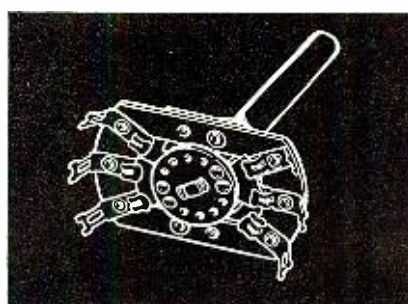

SWITCHES

ROTARY for band change, meter, intercom circuits; made in ceramic and phenolic models. **ROTARY SPRING RETURN** for meter selection, intercom, phono-radio applications. **MEDIUM DUTY** for band changing in low power exciter-transmitters and receivers. **LEVER ACTION** for intercom, speaker, microphone and other applications.

the New
PYRAMID
"Humidi-Seal"

(TUBULAR PAPER CAPACITOR)



Repels Moisture!

Ruggedly built to withstand undue vibration and rough handling

Outer tube plastic impregnated to prevent moisture-absorption

Light outer coat of high-temp wax provides double protection

Each end plastic sealed against moisture

Leads anchored securely in solid plastic end

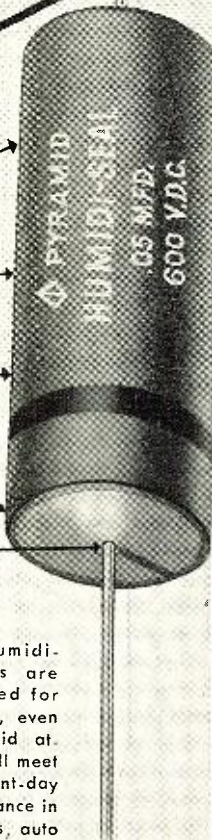

Type 85TOC "Humidi-Seal" capacitors are specially designed for 85° C. operation, even in the most humid atmospheres, and will meet the severe present-day demands of endurance in television receivers, auto radios, etc.

WRITE FOR COMPLETE LITERATURE

Representatives and Distributors throughout the U.S.A. and Canada



PYRAMID

PYRAMID ELECTRIC COMPANY

155 Oxford Street
Paterson, N. J., U.S.A.

TELEGRAMS: WUX Paterson, N. J.
CABLE ADDRESS: Pyramidusa

Within the
INDUSTRY

JACK HARRISON has been named to the post of general manager in charge of the custom-built cabinet division of *Mars Television, Inc.* of Corona, Long Island.



Mr. Harrison comes to his new post from *W. & J. Sloane* where he served as manager of the radio and television department for the Fifth Avenue department store. Prior to his association with *Sloanes* he was, for many years, the sales engineer for *Scott Radio*.

His new duties will include the creation of individually styled cabinets in addition to handling the sales and distribution of the company's custom line.

* * *

SIMPSON ELECTRIC COMPANY has recently merged with *The American Gage & Machine Company* and will be known as the *Simpson Electric Division*.

Ray Simpson, veteran of 38 years in the industry, will remain as chairman of the new division. Herbert Bernreuter has been elected to the post of vice-president of the parent company and will act as operating head of the *Simpson Division*, with which he has been associated since its inception.

Personnel, operating and sales policies will remain unchanged.

* * *

HAROLD J. NEWTON, vice-president and general sales manager of *National Electric Products Corp.* of Pittsburgh, resigned his post recently because of ill health.



The resignation of Mr. Newton brings to a close a 38-year continuous sales effort for the company. He was first associated with the organization in 1912 and transferred to Pittsburgh in 1929 as eastern district sales manager. He later served as western sales manager and sales manager of the corporation.

He has been vice-president and a director of the firm since June, 1948.

* * *

AUSTIN LESCARBOURA, a well-known figure in the radio industry, has been awarded the French Legion of Honor for technical assistance rendered over many years and more recently to industrial missions sent to the United States in conjunction with the rehabilitation of postwar France.

This is the third French decoration

awarded to Mr. Lescarboursa. He previously received the Officier d'Academie decoration in 1919, followed by his promotion to Officier de l'Instruction Publique in 1947.

* * *

CONCORD RADIO CORPORATION and *Radio Wire Television, Inc.*, have announced a severance of the joint ownership of stock in the two firms.

Samuel J. Novick has acquired all the stock and is now the sole stockholder of *Concord Radio Corporation* which operates stores in Chicago and Atlanta, Georgia.

Abraham Pletman has acquired all the stock and is now the sole stockholder of *Radio Wire Television, Inc.*, which operates stores in New York City, Newark, New Jersey, and Boston, Mass. Heretofore, the stock in each corporation was owned jointly by the two men. The stores will continue to operate under the same names as before.

* * *

CHARLES L. DAVIS has been named manager of distributor sales to head the new distributor sales setup at *American Transformer Company* of Newark, New Jersey.



Mr. Davis was formerly associated with *Jones Motorola Company* of Stamford as vice-president in charge of sales, service, and advertising. Prior to that association he was assistant to the vice-president of *Central National Bank* of New Rochelle, New York and assistant to the treasurer of the *Delaware, Lackawanna and Western Coal Company* of New York City.

Under the new program headed by Mr. Davis, distributors will be appointed in key locations throughout the country to handle the sale of *AmerTran* transformers.

* * *

INSTRUMENT ASSOCIATES has moved its office and warehouse to 37 East Bayview Avenue, Great Neck, New York . . . **HERMAN H. SMITH, INC.**, manufacturer of radio hardware, electrical components, and TV accessories, has moved to new and larger quarters at 436 18th Street, Brooklyn 15 . . . **POLARAD ELECTRONICS CORPORATION** has increased the size of its manufacturing facilities by moving to 100 Metropolitan Avenue in Brooklyn . . . **W. H. BRADY COMPANY** recently moved to 204 West Washington Street in Milwaukee . . . The increase in television production has forced **HAYDU BROTHERS**, manufacturers of electron

RADIO & TELEVISION NEWS

THESE LEADING SET MAKERS

Emerson

hallicrafters
air-king

Admiral

Spartan

Sentinel

BENDIX RADIO
REG. U.S. PAT. OFF.

PHILCO

TRAV-LER

STROMBERG-CARLSON

GAROD

Westinghouse

CROSLLEY

Majestic

SETCHELL-CARLSON, INC.

Seen these Hytron firsts in popular new TV sets? The prominent TV set makers shown are using them. And the list is growing.

DuMont, for example, now uses the 1X2 and 6BQ6GT. You'll see many more of these famous tubes. And many more new Hytron types designed for low-cost TV for the mass market. When you buy these Hytron firsts, follow the leading set manufacturers. Buy the original. Buy Hytron!

choose one or more of
THESE HYTRON TV FIRSTS

HYTRON TV FIRST

1X2 compact, high-voltage TV rectifier.



HYTRON TV FIRST

6U4GT high-perveance damping diode.



HYTRON TV FIRST

16RP4 original rectangular TV picture tube.

HYTRON TV FIRST

6BQ6GT, 25BQ6GT extra-performance deflection amplifiers.



HYTRON TV FIRST

12BH7 twin-triode sweep amplifier with superior efficiency.

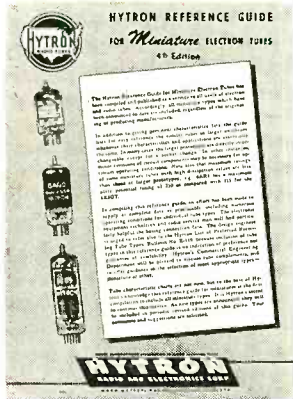

NEW 4th EDITION Hytron Reference Guide for Miniature Electron Tubes

Miniature types are multiplying fast. You need this Hytron Reference Guide. Originated by Hytron, it is unique. Lists all miniatures to date, regardless of make. Six pages of pertinent data. 132 miniatures — 41 of them new. 70 basing diagrams. Lists similar larger prototypes. Free from your Hytron jobber. Get your copy of this old friend brought up to date — today.

OLDEST MANUFACTURER OF RECEIVING TUBES
HYTRON
RADIO AND ELECTRONICS CORP.



MAIN OFFICE: SALEM, MASSACHUSETTS

DUAL RESPONSE

*Instantly Gives You High Fidelity
or Rising Characteristic . . . as you want it!*

IT'S IN THE

Cardax

**.. the Only High Level Cardioid Crystal
Microphone with All these Features!**

★ **EXCLUSIVE E-V DUAL FREQUENCY RESPONSE**
Convenient screw control provides:

1. *Smooth, Wide Range Response for High Fidelity Sound Pick-up.*
2. *Wide Range with Rising Characteristic for extra crispness of speech or emphasis of high frequencies.*

★ **HIGH OUTPUT LEVEL**

★ **E V MECHANOPHASE* CARDIOID**

Overcomes background noise, reverberation, feedback. Extends front pick-up range. Solves troublesome problems.

★ **ENCLOSED METAL-SEAL CRYSTAL**

Greater Protection against Moisture

★ **BUILT-IN "ON-OFF" SWITCH**

★ **HIGHEST PURITY PRESSURE CAST CASE**

★ **DURABLE SATIN CHROMIUM FINISH**

★ **TILTABLE HEAD. 3/8"-27 THREAD**

★ **BUILT-IN CABLE CONNECTOR**

Favorite of thousands for its quality, its performance, its value!

CARDAX Model 950. List Price. . \$39.50

CARDAX Model 950A. Made to match Collins 32V-1. Built-in control switch. MC-3 connector on free end of cable. List Price. \$42.50

Send for Full Facts Today

NO FINER CHOICE THAN

Electro-Voice

ELECTRO-VOICE, INC., BUCHANAN, MICH.

EXPORT: 13 East 40th St., New York 16, U. S. A.

Cables: Arlab

E-V Pat. Pend. Licensed under Brush Patents.



guns for television tubes, to acquire a plant in Mount Bethel, New Jersey, with a 10,000 square foot addition being erected at the present time . . . **SIGHTMASTER CORP.** has moved to 111 Cedar Street in New Rochelle, N. Y. The new plant will enable the company to quadruple production of its television receivers . . . **ACCURATE MANUFACTURING COMPANY**, manufacturers of friction and rubber tapes, has recently completed a new plant in Garfield, New Jersey, which will increase the facilities of its existing factory building in that city . . . Construction has begun on a new 15,000 square foot area building in Cuba, New York, which will house additional production facilities for **ACME ELECTRIC'S** line of television transformers . . . **CORNING GLASS WORKS** is building a new plant in Albion, Michigan, for the manufacture of glass bulbs for television picture tubes . . . **HOFFMAN RADIO CORP.** has added 20,000 square feet of floor space to its plants in Los Angeles . . . **GLOBE-UNION, INC.**, has acquired a new plant in Denville, New Jersey, which will be devoted to the production of a full line of ceramic capacitors manufactured by the *Centralab Division* of the company . . . The new television tube plant of the **RADIO CORPORATION OF AMERICA** was recently dedicated at Marion, Indiana, with local and state dignitaries in attendance.

* * *

GEORGE R. SOMMERS has been appointed assistant general sales manager of the Radio Tube Division of *Sylvania Electric Products Inc.*



Mr. Sommers joined the company as a lighting fixture specialist in 1940 and early in 1943 was transferred to the Washington, D.C. territory where he instituted a decentralized sales policy which was later adopted for the company's district sales offices. He was appointed director of Pacific Coast sales for *Sylvania* in 1945 and in 1949 was transferred to the New York office to assist the general sales manager of the Radio Tube Division.

* * *

WALTER F. GREENWOOD has been named manager of industrial sales for *Telechron, Inc.*, of Ashland, Mass. . . .

PINCKNEY B. REED is the new manager of the Industrial Equipment Section of the RCA Engineering Products Department . . . *Associated Merchandising Corporation* has named **GEORGE W. SMITH** to the post of merchandise representative for radios, television, and records . . . **D. Y. ROBINSON** will represent *Webster Electric Company's* sound division in the New York area . . .

R. C. DOVE and **H. V. SOMERVILLE** have been named operating assistant to the vice-president and technical assistant to the vice-president respectively with the distribution division
(Continued on page 120)

For Clear Sharp Pictures and
Powerful Trouble-Free Performance

THE  SKY HAWK

TELE-ROTOR

 CHECK THESE FEATURES

- Will Handle 7/8" to 2" diameter Upper and Lower Masts
- Heavy-Duty Motor — Reverses Instantly
- Mast, Tower or Platform Mounting
- Four Heavy-Duty Guy-Wire Lugs
- Completely Weather-Sealed ... Factory Lubricated For Life
- Handles Heavier Loads With Ease ... As Much As 150 Pounds
- Streamlined Weather-proof Design ... Durable Sturdy Construction
- 12 Heavy-Duty Ball Bearings in two 6 1/2" diameter Ball Bearing Races
- Heavily Reinforced Die-Cast Housing
- Heavy-Duty Precision Gears
- Positive Stop at End of Rotation

C-D SKY HAWK
TELE-ROTOR
CONTROL

... with the PERFECT PATTERN dial... fingertip control with instant indication of antenna position shown on the illuminated two-tone face.

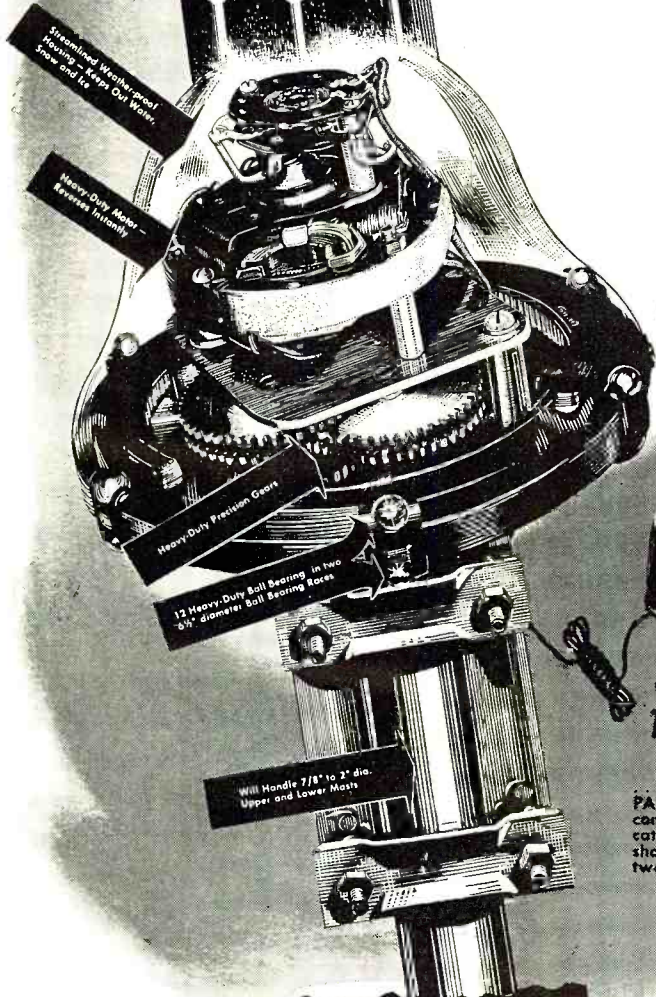

Available in the Following Models:

- TR-1 ... rotator with control box ... \$37.45
- TR-2 ... compass control rotator with "Perfect Pattern" dial ... \$44.95

A Combination You Can't Beat ...
It's a C-D Sky Hawk Antenna with a
C-D Sky Hawk Tele-Rotor

The television industry has been looking for something like this ... and it took CORNELL-DUBILIER to produce it! THIS is the last word in ROTATORS ... the finest! ... BECAUSE IT HAS EVERYTHING! It wasn't developed overnight but is the result of fourteen solid months of research and development! BUT ... it has been worth it! ... BECAUSE IT MEASURES UP TO CORNELL-DUBILIER STANDARDS

CONSISTENTLY DEPENDABLE

CORNELL-DUBILIER

SOUTH PLAINFIELD, NEW JERSEY



- CAPACITORS
- ANTENNAS
- ROTATORS
- VIBRATORS
- CONVERTERS



hallicrafters

1950 Version of the famous World War II (and pre-war) Transmitter!

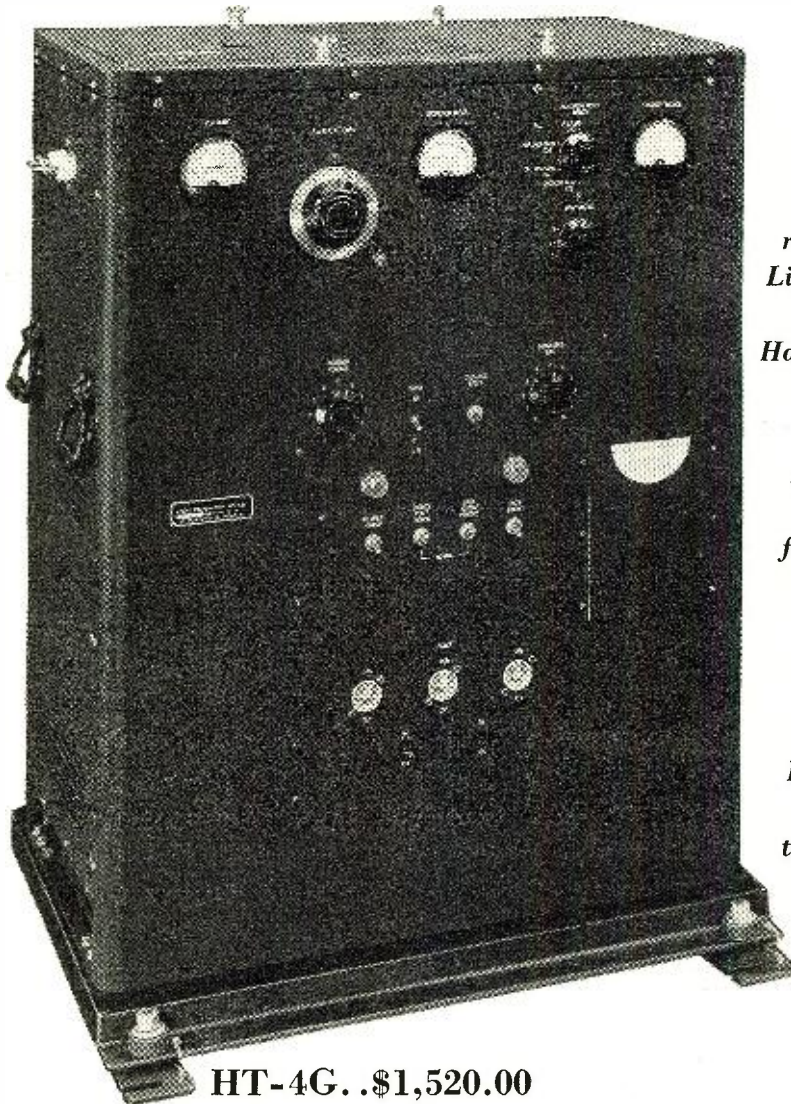

HT-4G..\$1,520.00

The communications "work-horse" of World War II has returned to its peacetime role! Limited quantities of this most respected member of Hallicrafters transmitter family are now being built for the civilian market.

All transformers hermetically sealed. Shock mounted for mobile use. Complete with tuning units and output coil sets for 2 to 18 Mc (coils for 28-30 Mc available separately). 450 Watts CW, 300 AM phone. Ask wherever Hallicrafters communications equipment is sold or write to the factory for a spec sheet.



Speech Amplifier
HT-5G...\$217.00



CHICAGO 24, ILLINOIS

"The Radio Man's Radio"

See and Examine the Latest Hallicrafters Equipment at the Radio Parts Show—Chicago—May 22nd to 25th.

Simplified HAM TV STATION

By J. R. POPKIN-CLURMAN, W2LNP
Hazeltine Electronics Corporation



Fig. 1. To simplify construction and testing, system is built in separate units.

FROM time to time there have been amateur television systems described in the various radio publications. While these have been of good design in most cases, all lacked the definition and quality that people have been led to expect since the advent of popular television. The system to be described is capable of the full resolution and detail associated with the present day television standards.

By the ingenious use of scanning pulses taken from any standard television broadcast station by means of a standard TV receiver, much of the complication of a commercial transmitter is avoided.

The expensive image orthicons and iconoscopes are replaced by standard cathode-ray tubes which may be of the surplus variety.

Reception of the signal is accomplished by any TV receiver equipped with a simple converter. If desired it is possible to use the same receiver to pick up both the scanning pulses

from the transmitter, and for reception of the transmitter picture from another amateur TV station.

Operation is on the 420-450 mc. band, permitting the use of small high gain antennas and readily available tubes.

While the equipment may appear complicated, it has been broken into several component parts to simplify the construction. This enables the advanced amateur to construct and test

the units individually and avoid many of the pitfalls associated with a combined unit.

It should be pointed out that the equipment is operating on an amateur band and only licensed amateurs may

will have many of the parts needed and be able to hold the completed cost to a low figure. In any event the cost will be far below that of any comparable system.

This television system uses relatively common components and is capable of being built by the average experimenter experienced in the radio art. It provides a means of making a standard-definition broadcast picture of 525 lines, 60 fields, 30 frames interlaced two-to-one, having a video bandwidth up to 4.5 megacycles. In this system, for simplicity, a single transmitter sends the sound simultaneously with the video by means of frequency modulation

of a 4.5 megacycle sub-carrier. The complete signal is transmitted on an amateur carrier frequency, such as 432 megacycles. Reception can, therefore, be accomplished on a standard television receiver preceded by a simple frequency converter.

The basic "picture maker" or camera used in this inexpensive system is derived from an old device used in early television experiments with ro-

Part 1. Complete description of a ham TV station that can be built from available parts at relatively low cost. Succeeding articles will present details on constructing entire station.

BOTH SOUND AND VIDEO ARE INCORPORATED IN SINGLE TRANSMITTER
STANDARD DEFINITION, 525 LINES, 60 FIELDS, 4.5 MC. BANDWIDTH IS PROVIDED
NO EXPENSIVE ICONOSCOPES OR IMAGE ORTHICONS REQUIRED
STATION COVERED OPERATES ON 420 MC. BAND. HIGHER FREQUENCY AMATEUR BANDS CAN BE USED
SYSTEM DESCRIBED IS FOR TRANSMISSION OF STILLS. ALTERNATE METHOD FOR SCANNING MOVING OBJECTS IS DISCUSSED
IMPROVED SYSTEM, ALSO DESCRIBED, EMPLOYS STANDARD TV RECEIVER TO PROVIDE SYNC AND SCANNING PULSES. SAME RECEIVER CAN ALSO BE USED TO RECEIVE PICTURE AND SOUND FROM ANOTHER AMATEUR STATION
TO REDUCE COST, ANY STABLE 420 MC. TRANSMITTER, EITHER SURPLUS OR HOME-BUILT CAN BE USED
OPERATOR OF EQUIPMENT MUST BE A LICENSED AMATEUR. TO BUILD COMPLETE STATION CONSTRUCTOR SHOULD BE FAMILIAR WITH RADIO DESIGN AND THEORY

operate this television equipment.

This first article will outline the system used and show different ways of accomplishing the final result. Succeeding articles in this series will give details of the various component parts which go to make up the complete station.

Many of the components used are taken from surplus equipment to reduce the over-all cost. Most amateurs

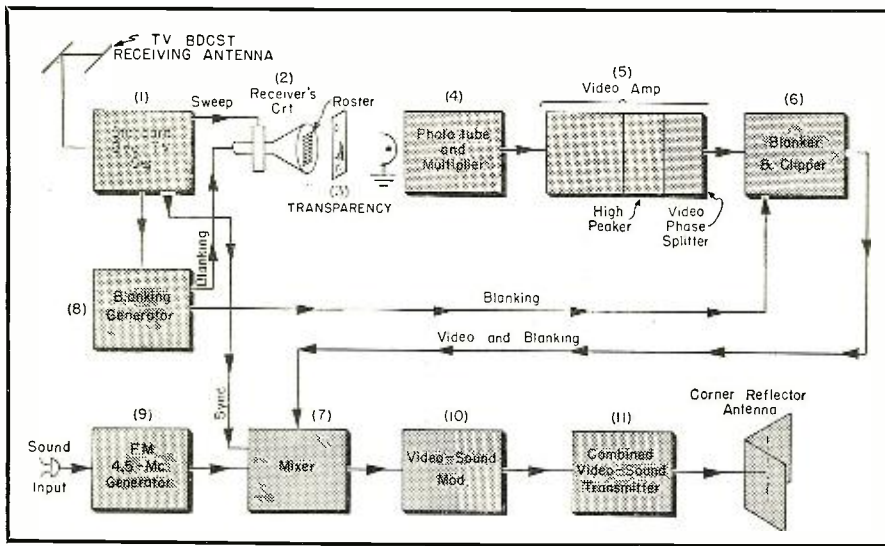

Fig. 2. Block diagram of transmission system showing functions of the units.

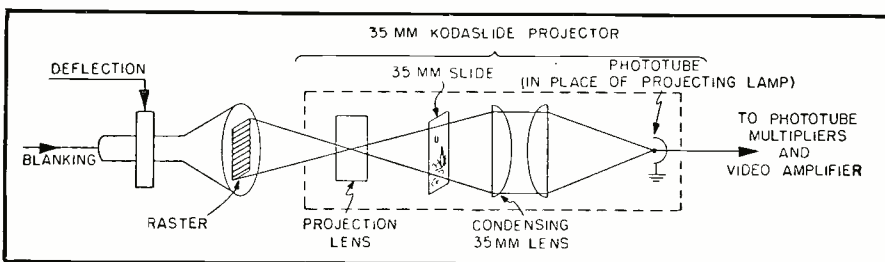

Fig. 3. Method for using cathode-ray tube as light source for 35mm transparencies.

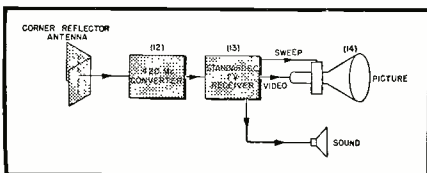
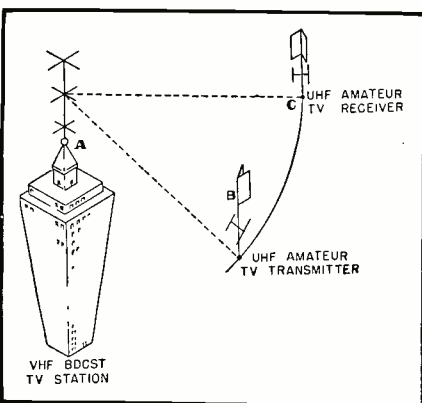

Fig. 4. A 420 mc. converter is used with a standard television set for reception.

tating discs and known as the *flying spot scanner*.

Suppose that a spot of light such as is generated by an arc lamp is fed through a rotating disc with small holes in it arranged spirally so that they progressively become nearer to the center of the disc. This means that if a scene is illuminated by this light,

Fig. 5. Diagram showing direct reception of scanning signals from a TV station.



there will be one small flying spot after another traversing the scene, each illuminating a line of the scene, and each line successively displaced, so that at the end of one revolution of the disc the entire scene has been covered. As the spot of light covers each small portion of the scene, a phototube picks up the light derived from this particular portion of the scene. The phototube current is then a video signal suitable for transmission. (At the receiver the corresponding signal is amplified and drives a source of light which can be modulated in intensity. This light is then viewed through a similar receiving disc rotating in synchronism with the transmitting disc, allowing the original scene to be observed.) This old principle is applied electronically in the modern flying-spot scanner. Instead of using the rotating disc with holes, a raster is generated on the screen of the cathode-ray tube shown as unit (2) in Fig. 2. Since the raster is produced by the motion of one dot behind the transparency, the variations of light value from point to point of the transparency are picked up by the phototube.

In the present system the transmitter uses an ordinary TV receiver altered so as to separate the sync from the received television signal from any local TV station. This sync is then used to generate the interlaced standard RMA sweeps. A block diagram of the sending end of the system is given in Fig. 2. Unit (1) is the broadcast TV set, which is standard and whose

sweeps and sync-separating circuits are as normally found. It is tuned to any local TV broadcasting station. In the event that it is not possible to receive a standard TV signal, then it is merely necessary to derive the sync and blanking from the TV set's own sweep circuits. In this case the picture will often have only 262 lines non-interlaced, since the horizontal oscillator is running free. The picture retains the same horizontal resolution but the vertical resolution is reduced by a possible factor of two. For this type of operation it is desirable to sync the vertical to the 60-cycle power supply so that hum effects will be reduced.

The lead to the video amplifier from the grid of the television set's cathode-ray tube (2) is disconnected in the set and is instead connected to the blanking generator (8). (For this source of the flying-spot illumination, practically any CRT can be used, including surplus P7-phosphor radar types.) In addition, the sync derived from (1) is to be used later for transmission purposes in mixer (7). The light from the raster of (2) is then passed through a transparency (3) (which is the picture being transmitted). This can be held in a slide projector holder or put directly on the face of the cathode-ray tube (2). If a slide projector is used the phototube is substituted for the slide projector light source, as shown in Fig. 3. Returning to Fig. 2, the light passing through the transparency is picked up by a phototube (4), amplified by a video amplifier (5), passed through a video clipper and blanking inserter (6), and then passed through a sync and sound sub-carrier mixer (7). The output of the mixer is fed to a combined video-sound modulator (10), which modulates a transmitter (11), and this feeds an antenna radiating the picture and sound signals simultaneously.

The receiver block diagram is given in Fig. 4. The combined picture and sound carrier is picked up by a converter (12), which includes a "cascode" (grounded-cathode triode followed by a grounded-grid triode) i.e. amplifier as its output section; it delivers an output corresponding to an unused channel of a regular standard broadcast TV set (13), where the picture and sound are separated by the normal processes.

Other possibilities lend themselves suitably to this system. In Fig. 5 the TV station A supplies picture and sync for the amateur television transmitting station located at B. If the receiving station is located along a circumference of radius AB, say at C, it becomes possible for the receiver C to use the sync directly derived from station A without having to receive sync from transmitter B. This means that all that is necessary to receive B's transmission is to disconnect the video from the picture-tube grid of C's receiver and use instead the video received from B over the u.h.f. link. The broadcast TV receiver at C is tuned

to station A and is, therefore, scanned in synchronism.

Under these conditions reception of B's picture at C will be accompanied by a horizontal shift or displacement of the picture proportional to the delay with which B's picture arrives at C with reference to the sync received from A. For short distances this shift is small. For greater shifts recentering of the picture at C or adjustment of the horizontal sync phasing control becomes necessary.

This system is not limited to transparencies. It is possible to send pictures of live subjects or of fixed objects as shown in Fig. 7. The raster from the CRT is projected by a projection lens on the object, and the reflected light from the object is collected by a condensing-lens system for delivery to the phototube. The remaining operations are then just the same as with a transparency. Considerably greater light is needed than for the transparencies, and a 5TP4 or 5WP15 projection-type CRT with associated high voltage is suitable.

For sending motion pictures the setup is essentially the same as for still transparencies. A film projector has its light source removed and the phototube put in its place. A 60-cycle synchronous motor is used to drive the film sprocket and the film is run through the projector at 30 frames per second instead of 24. This speeds up the motion on the film somewhat. It is also necessary to blank the raster during the film pulldown time. More elaborate means are needed to show the film at 24 frames per second.

Since the transmitter (unit (11) in Fig. 2) sends out the picture double-sideband, a total bandwidth of nine megacycles at the transmitter is desirable. This presents no problem on 420 megacycles. However, in order to use a standard receiver advantageously it is preferable to follow the vestigial-sideband method as in broadcast practice. One TV sideband with the vestigial other sideband is obtained by the selectivity of the receiver's i.f. amplifier, resulting in reception and reproduction of standard RMA pictures. See Fig. 8. The shaded portion represents the sideband eliminated by the selectivity of the receiver. Of course in tuning up the transmitter it is also possible to adjust the tuning in such a way that one sideband is amplified more than the other—naturally the sideband to be used in the receiver should be favored.

Since the sound is transmitted as a sub-carrier, it becomes impossible to use full modulation on the transmitter for pictures as this would not allow the sub-carrier of 4.5 megacycles to be continuously transmitted. Generally fifty per-cent modulation is used for the sideband carrying the FM sub-carrier and the other fifty per-cent devoted to video signal. Changing these proportions of modulation in favor of more picture modulation will result in undesirable buzz in the sound portion of the transmission. Of course, if it is

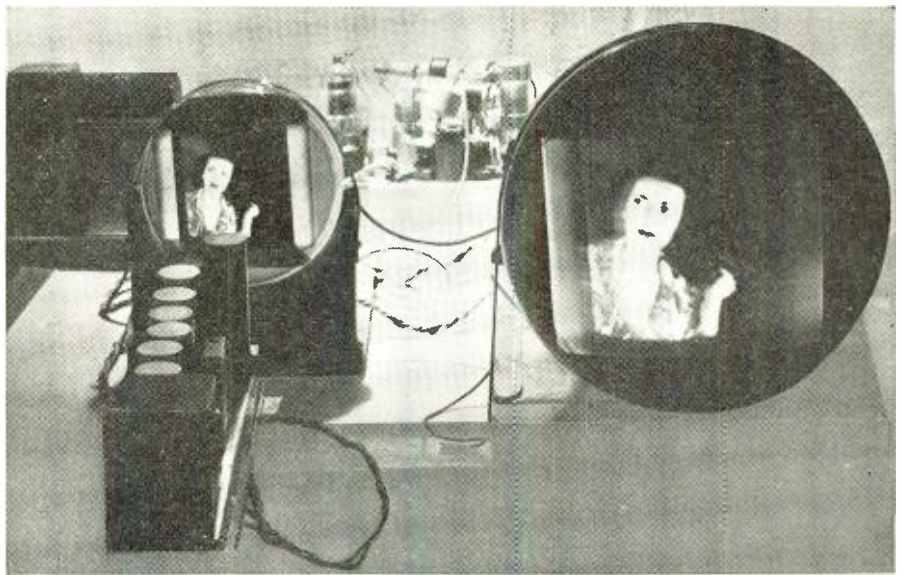

Fig. 6. The original transparency (left) compared to the reproduced image (right).

desired, a separate sound transmitter spaced 4.5 mc. can be used, or other sound not necessarily associated with a picture can be used.

The phototube used is a standard surplus 931A multiplier type. These were used in most of the radar countermeasure noise generators for radar jamming (AN/APT-5). In the noise-generator application, use is made of the extreme amplification capabilities of the tube. However, it is not desirable, in the present case, to employ enough gain to reach the noise-level capabilities of the tube, as this results in "snow" in the television picture. For convenience in handling the total of 550 volts supply potential, a positive and negative source of voltage is used. The gain control of the whole video system is obtained by adjusting the value of the negative supply voltage.

The output of the phototube is fed to a series of video amplifiers, including one stage, known as the high-frequency peaker. This peaker is necessary to equalize or compensate for the time it takes a spot of light to build up and decay, as the phosphor of the cathode-ray tube (2) does not light up or die down instantly. This corresponds to a pulse of voltage in the phototube which is exponential in rise and decay time. This is the same as saying that the pulse derived from the spot of light is deficient in high frequencies, which are then equalized by the additional high-frequency response of this stage. The desired rise and fall time of the pulse is shown in Fig. 9 by the dotted line. The actual pulse without the high-frequency peaker is shown by the heavy lines. If the peaker is used, the higher video frequencies are favored so that the dotted wave shape is obtained. This effect is produced by an RC network. As the condenser C is adjusted, the "blurs" and smears in the video picture will disappear causing the picture to sharpen up and display the detail expected.

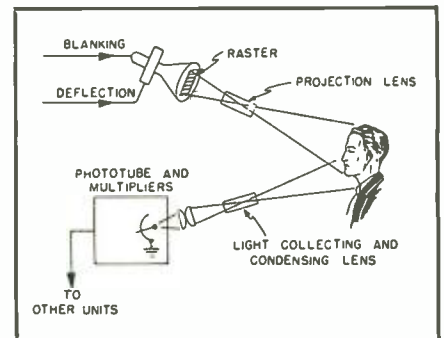

Fig. 7. Method of using cathode-ray tube as a light source for scanning live subjects.

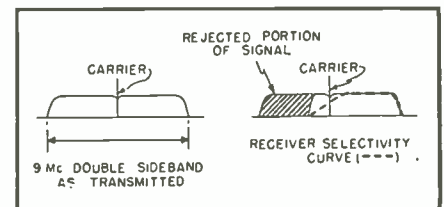
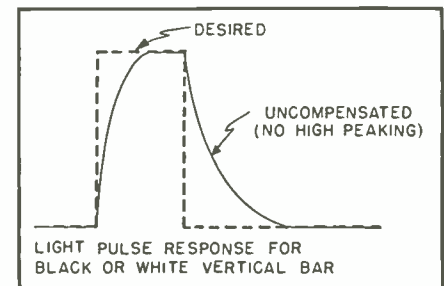

Fig. 8. The carrier as transmitted and the vestigial sideband obtained (right).

It is necessary to provide for picture reversal in order to transmit from either a negative or positive picture transparency. The received picture will then always be positive.

The blanking portion in the RMA signal cannot generally be used be-

Fig. 9. Compensation in the video stage.



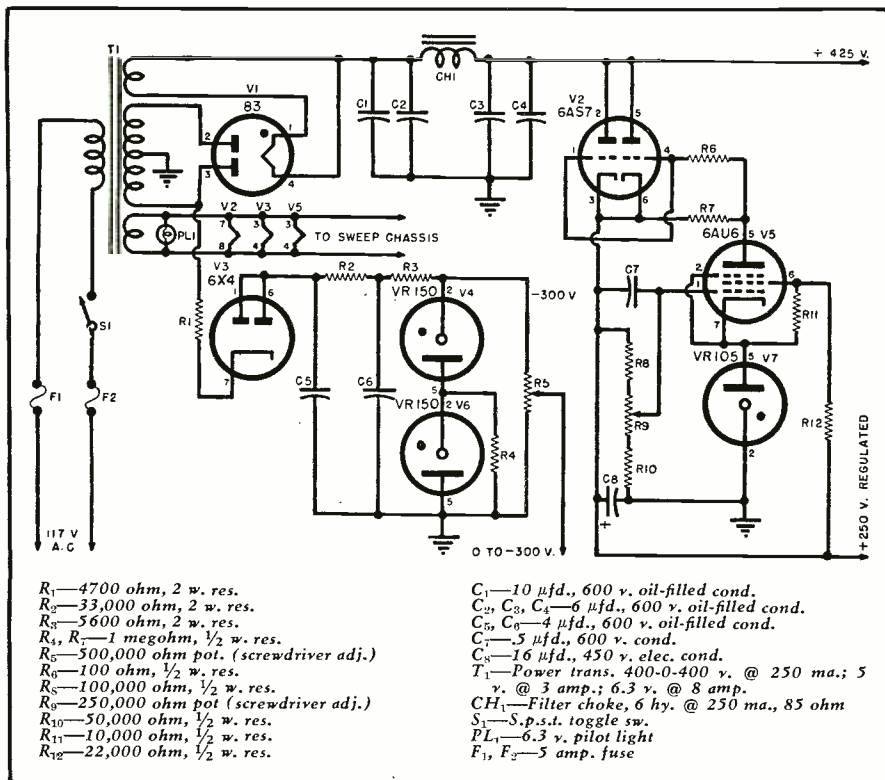

Fig. 10. The regulated supply used to power all units except the r.f. section.

cause the black portions of broadcast pictures are sometimes so close to the blacker-than-black region of the composite signal that the flying-spot raster might have some unwanted black portions. However it is possible to use the horizontal sync pulses as H blanking pulses. A better way is to use the flyback period of the H and V oscillators in the receiver for deriving blanking signals. It is usually possible to find some place in the sweep circuits which already has a good pulse of the proper polarity. For example, the vertical pulse present at the output of the vertical integrating network. The horizontal blanking is easily obtained from the output of the sync separator or by

taking a portion of the flyback pulse present in the horizontal deflection coils. These signals are then fed to the blanking generator where they are clipped and then fed to the flying-spot CRT grid and the video blanking inserter.

So far in our discussion, the video has been allowed to go through the video amplifier without thought of what should be done with the blanking and the sync. Actually the video is limited by superimposing on it a pulse which will shut off the picture-tube grid when the time comes for the re-traces of the lines to take place. This is accomplished by adding together in

plified by (5) and a pulse derived from the blanking generator (8). The extremity of the blanking pulse with its video superimposed is then chopped off in the same unit.

Beyond the clipped portion, the sync signals derived from the TV broadcast (or locally generated) are superimposed in mixer (7). The result is a standard RMA experimental signal capable of being received on a standard receiver without any difficulty.

The FM sub-carrier unit (9) consists of a 4.5-megacycle oscillator modulated by a reactance tube. A portion of the 4.5-megacycle output is mixed with the video and handled then in the same manner as if it were a video component.

The video modulator is a straightforward amplifier similar to the power video stage of an ordinary television set. However, it has to swing over a much wider voltage range than is required in a normal television set. The output of a 6AQ5 feeds a 6AS7G power-handling cathode follower which is used directly to modulate the transmitter. The use of the cathode-follower modulator, with its low source impedance, is especially desirable because of the high bypass and stray capacitances generally associated with the transmitter.

It is desirable to use a regulated power supply for most of the circuits, associated with the video, scanning, blanking, and related circuits. For those anxious to get started, a satisfactory supply is illustrated in Fig. 11 with the schematic diagram shown in Fig. 10. Many amateurs will have a supply available which will meet these requirements.

Succeeding articles will deal with the construction of the various units and cover the tuning and adjustment. The experienced amateur will be able to make many changes in the basic design to accommodate equipment on hand.

For those who desire more power, a transmitter of the SCR-522 type will serve as a driver for a tripler furnishing an output of ten to twelve watts on the 420 mc. band.

There are several pieces of surplus equipment which operate on the 420 mc. band and if some of this equipment is on hand, many of the components may be used. Usually the receiver portion of this surplus equipment is of the superhet type with a broad i.f. system, and by substituting a front end capable of tuning to a TV station, the necessary signal for scanning may be obtained. In many cases there will be unused tubes which may be adapted to serve as the vertical and horizontal oscillators, or the video section included in the receiver may be used.

Of course operation is not limited to the 420 mc. band and the system may be used on any of the amateur bands above this frequency. The 420 mc. band was chosen as it permits the use of familiar techniques without resorting to waveguides and plumbing.

(To be continued)

Fig. 11. Photograph of the power supply of Fig. 10. Three outputs are available.

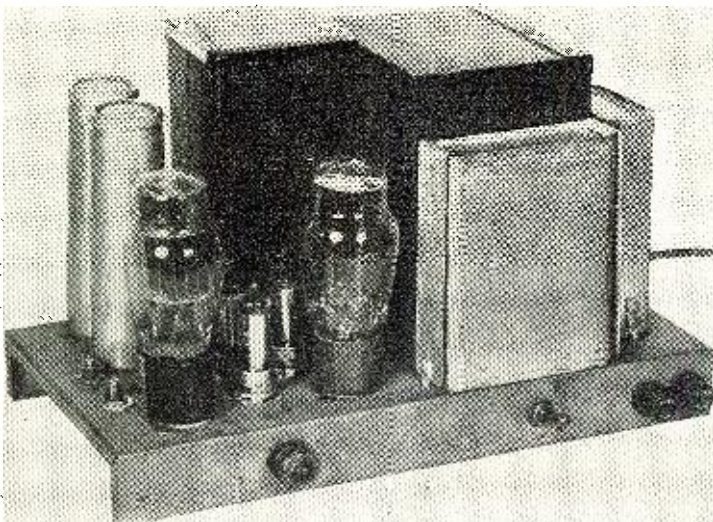

Something NEW in TRANSCEIVERS

By KENNETH M. KORTGE, W8AHT



Fig. 1. Battery and audio unit with assembled handset. The r.f. section and antenna are mounted on earphone end of handset. A slot was cut in the shield can to clear projecting antenna socket. Cover is held in place by sheet metal screws.

Details for building a handy two meter transceiver from a readily-available surplus TS-13 field phone.

WITH conditions becoming crowded in the larger cities and with more and more surplus crystal-controlled transmitters being put in use, the modulated oscillator is rapidly becoming a thing of the past on the two meter band and rightly so. But for super-portable, short-range operation the "handie-talkie" version of the standard transceiver is still holding its own.

The common method of constructing the handie-talkie is to assemble microphone, headphone, batteries, antenna and all the parts in a single unit. This necessitates handling a fairly bulky package and struggling to manipulate switches as well as supporting the weight of the batteries, which, though relatively light, can tire the operator's arm if used for any length of time. The author decided to make an attempt at eliminating these two evils. The end result is the apparatus shown in the photographs.

To facilitate handling, a surplus TS-13 field telephone handset was used as the basic unit. This unit has a 200 ohm microphone, and a high impedance headphone. Many similar units are available. In order to keep the antenna as high as possible during operation it was decided to mount the r.f. portion, along with the antenna, on the earphone end of the handset. To house this part an aluminum shield can about two inches square and three inches tall was salvaged from the junk box. A base was cut

from one-eighth inch aluminum and shaped so that the shield can would fit snugly over it. A flat was filed on the earphone end of the handset in such a way as to lie vertically when the phone is in operating position. The base was then fastened to this flat with machine screws after drill-

ing and tapping two holes, $\frac{3}{4}$ " apart, in the filed portion. A third hole was drilled between the two tapped ones through the base and the bakelite into the chamber occupied by the headphone to accommodate the leads from the r.f. section. Bringing these leads into the switch opening in the handle presented a problem since a hole could not be drilled directly from one opening to the other. The solution was to drill from each chamber toward the next at as close an angle as possible so that the two holes met. A stiff wire was pushed through the resulting "V" shaped path and the small conductors from the r.f. section pulled through with this wire. The same procedure was used to pass several wires from the switch chamber into the microphone opening. (There were conductors moulded in the plastic of the handset but most of them were severed during drilling operations so it was necessary to install replacement wires.)

The switch was found to be a double-pole, single-throw one of the leaf variety and, since a ganged d.p.s.t. and s.p.d.t. is used in the circuit, a

(Continued on page 106)

Fig. 2. Circuit diagram and parts list covering the two meter transceiver unit.

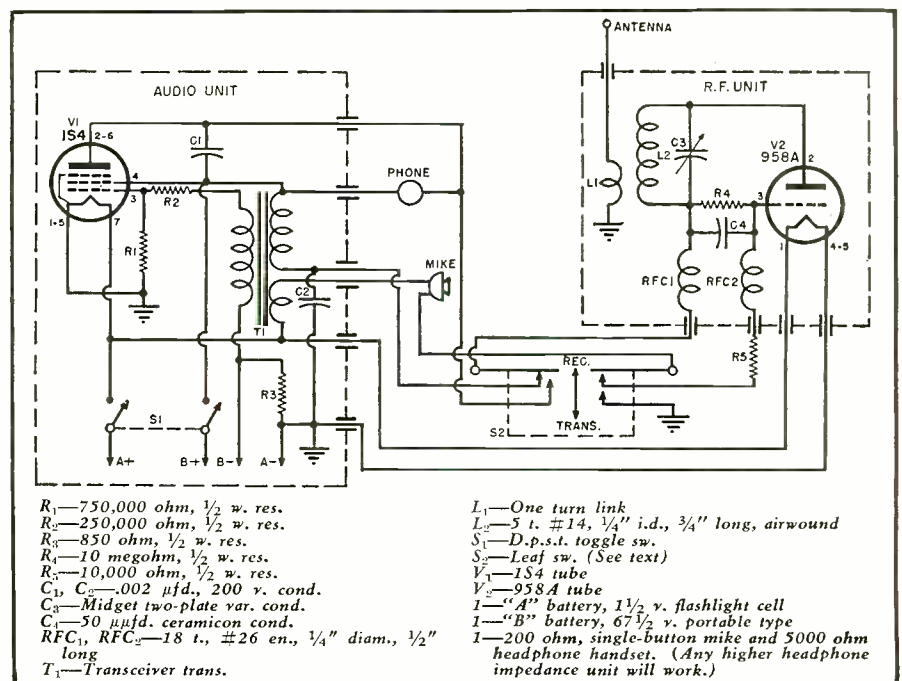

Frank Andrea— RADIO and TELEVISION PIONEER



**Thirty years of progress in the radio industry
is typified by the life and work of this pioneer.**

By
ARTHUR PINE

NO HISTORY of the radio or television industry would be complete without the saga of Frank A. D. Andrea, for during the 60 years of his life, this pioneer has added much to the advancement of electronics.

Today, as president of the *Andrea Radio Corporation* of Long Island City, New York, he is still busy each day with experimental work directed toward perfecting television to the point where it is flawless.

1950 is a landmark in his career for it marks his 30th year in radio and television, and places him, along with Lee DeForest and others of that caliber, as one of the pioneers in the industry. Few men still active in radio and television today were in this field back in 1920 when he organized *Frank A. D. Andrea, Inc.* in a small room on Jerome Avenue at 176th Street in the Bronx.

At that time, the entire organization consisted of Frank Andrea and two helpers. Their first efforts were concentrated on producing such items as rheostats, crystal detectors, and sockets for the pioneer set builders of that time.

His interest in radio was stimulated by two of the pioneers in the communications field—Guglielmo Marconi, the "Father of Wireless" and Lee DeForest, one of radio's early "masterminds."

In 1917 he went to work for Lee DeForest. Then in July of 1920, *Frank A. D. Andrea, Inc.*, came into existence. Broadcasting soon came into its own and the company started to expand. By 1922, the organization had begun to prosper, a large percentage of the business being in "Neutrodyne" kits which were sold to amateur set builders for home construction. These were the first radio kits to be offered to the amateur, according to Mr. Andrea.

In 1923 the company produced the first commercial "Neutrodyne" receiver, based on designs by Professor L. A. Hazeltine of Stevens Institute of Technology. By March of that year the new receivers were being turned out in quantity and shipments were on their way to jobbers throughout the country. This receiver captured the pub-

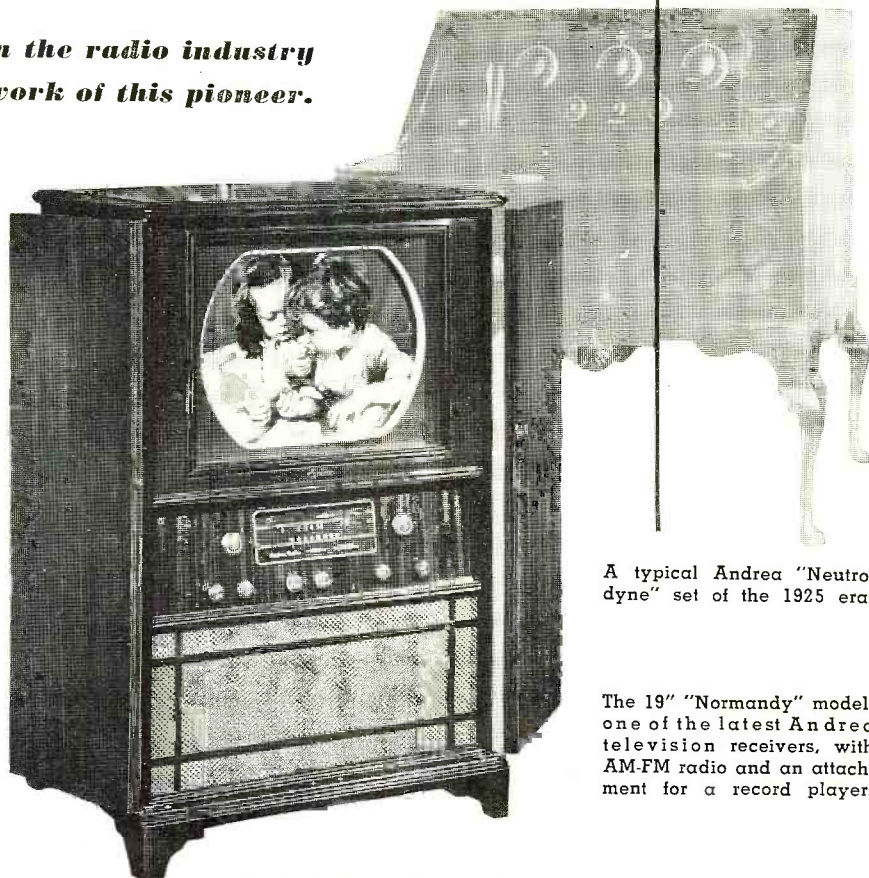

A typical Andrea "Neutrodyne" set of the 1925 era.

The 19" "Normandy" model, one of the latest Andrea television receivers, with AM-FM radio and an attachment for a record player.

Frank Andrea with one of his engineers, Louis Clement (now Director of Research and Engineering for Crosley Div. of AVCO Mfg. Co.) working on their first cone speaker in the year 1925.

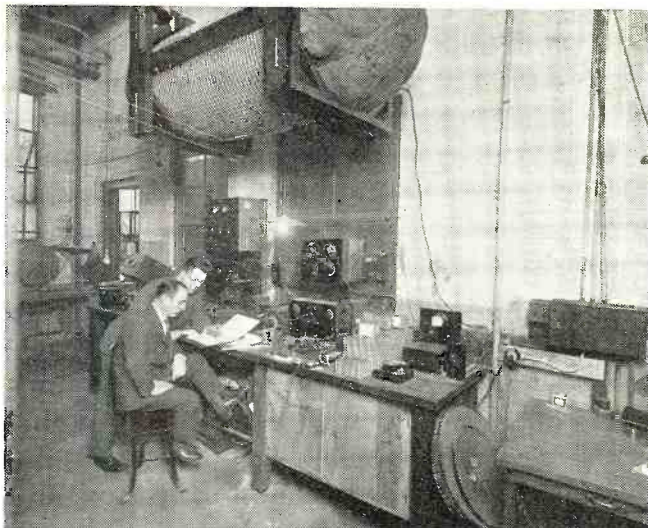



The present-day Andrea cabinet assembly line where the completed chassis are installed into the television cabinets.



The television assembly line at the Andrea plant. Here table model video receivers are being produced in quantity.

lic's fancy and over 30,000 were put on the market before the year was out—an undreamed of output for that era.

By the end of 1925 the company was well on its way to success. Throughout this period and until 1932, Mr. Andrea was interested in the development of television and spent a great deal of time and money developing the scanning method of television. This system used a revolving disc to obtain a picture. In 1931, the *National Broadcasting Company* was telecasting experimentally with the picture being received on television sets via the scanning method.

In 1932, Mr. Andrea was bitten by the "retirement bug," and he relinquished control of the company. It took only two years, however, for him to realize that his interests were too closely allied with radio and electronics to retire, so in 1934 he organized the *Andrea Radio Corporation*.

After much experimentation the first *Andrea* television kit was offered to the public in 1938, and, like the original "Neutrodyne" kit, was sold to those people who wanted to "assemble their own." Over 5000 of these kits were sold in the first year they were offered.

Today Mr. Andrea and his staff of engineers are busily engaged in the problems involved in color television. Like others in the industry, Mr. Andrea believes that the ultimate in television will be color and a third-dimension picture.

-50-



The original Andrea "Knockdown Neutrodyne Receiver Kit."

(Left) Scene at the original Andrea factory in the Bronx shows engineers testing one of the first Neutrodyne sets in 1923. (Right) Frank A. D. Andrea demonstrating one of his early Neutrodyne chassis to a group of Canadian engineers.



USE TEST PATTERN To Align Your TV Set

By
JACK H. KUBANOFF

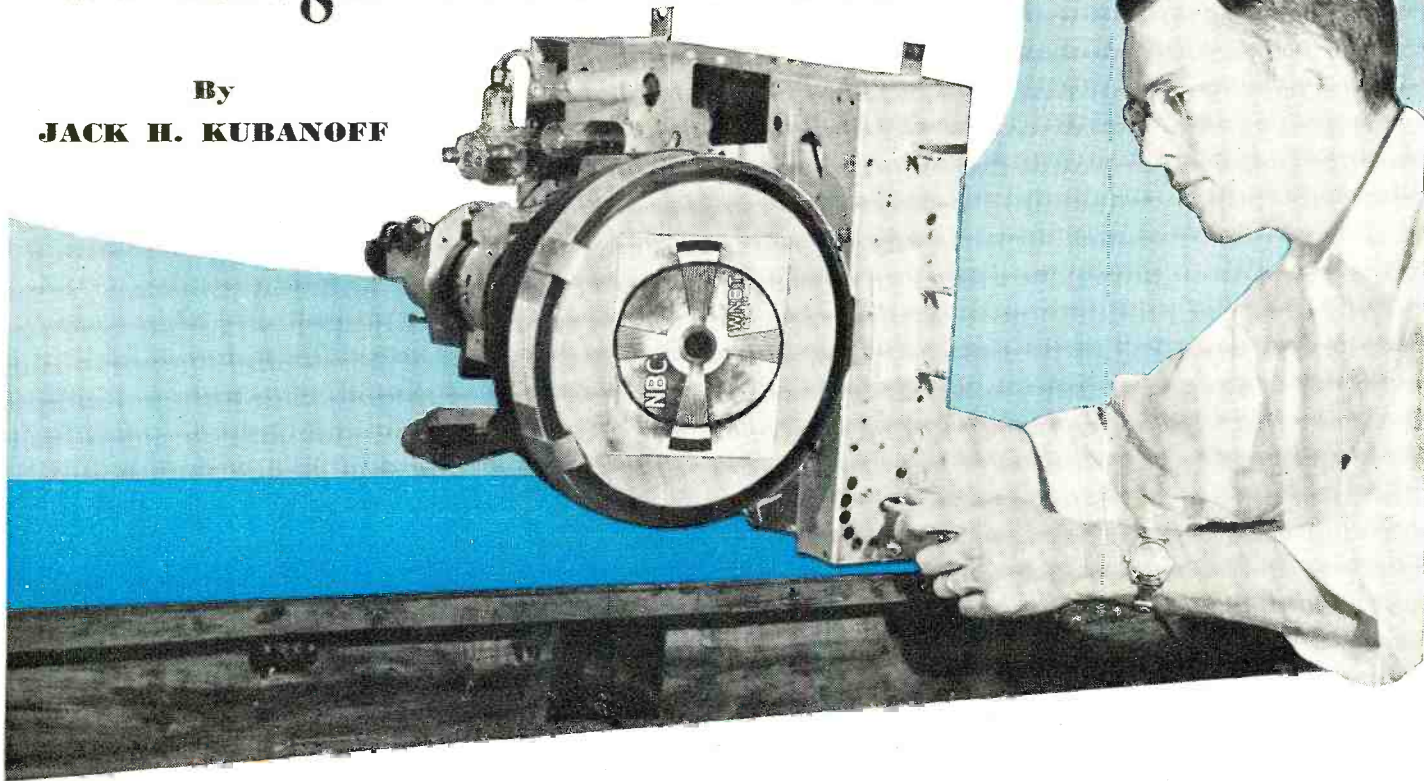

***A simple method for aligning video receivers
without the use of tools or test instruments.***

UNDOUBTEDLY the most accurate method of aligning television receivers is with an oscilloscope, sweep signal generator, and marker generator. The procedure is, however, rather involved and time-consuming. There is also the possibility of error caused by loading of the circuit with the signal generator. In addition, many service technicians find the cost of test instruments a decided handicap. Furthermore this type of alignment procedure is not adaptable to servicing in the field, in homes, or away from the test bench thus entailing the time and trouble in removing the receiver to the shop.

Over a period of years the author has been developing and using a method of television alignment which has proven to be practical, inexpensive, rapid, and accurate within the tolerable limits of visual capabilities. This system has the added advantage of permitting the simultaneous adjustment of the linearity, aspect ratio, focus, and bandpass. No further adjustment of the picture position, size, definition, aspect ratio, focus, or linearity is required after aligning by the method outlined. With the control of the picture present, the technician is assured of the greatest gain, best available frequency response, and the most pleasing picture possible.

Television alignment without the use of instruments is entirely possible providing the service technician understands basic television circuits and uses his knowledge wisely.

Test Pattern

The test pattern, an integral part of every station's programming, is the basis of the alignment procedure outlined. The test pattern should not be treated as just another picture because it is, in reality, the "last word" in what a properly aligned television receiver should be able to reproduce. In fact, in the final analysis, a good alignment job is one that produces greatest clarity and the finest detail in the test pattern.

In Figs. 2 and 4 are shown typical resolution charts. The more nearly the receiver reproduces these charts

the more perfect is the receiver performance. In order to better understand these resolution charts, a brief review of their characteristics is in order. Notice that the chart of Fig. 2 consists of two circles. These circles are used to obtain the proper aspect ratio, *i.e.*, height to width ratio. When the circles are perfectly formed and fill the tube face while remaining circular, the largest possible picture is obtained, compatible with the proper height and width. An improper setting here may cause distorted letters and figures. The linearity and aspect ratio must be set correctly before adjustments are made to obtain the proper bandpass.

Next notice that part of the chart which is in the form of a Maltese Cross. The cross is made up of a number of converging lines. Each line is wide at the periphery of the circle and narrows as it approaches the center circle. At the periphery the left-hand and lower wedges represent about 150 line resolution. This means that approximately 150 lines of that thickness, with equal spaces of the same thickness between lines, will fill the horizontal or vertical space completely and be of the definition visible on the screen of the set. Now the

Fig. 1. Heterodyne principle (see text).

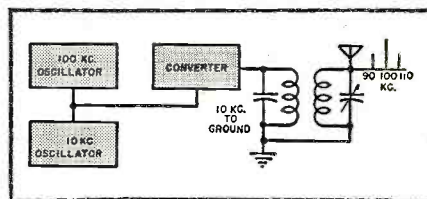

lines become narrower as they approach the center of the test pattern and the spaces between the lines also become narrower, occupying the same space between lines as the line width at each point on the pattern. At the center circle the lines represent 350-450 lines, varying with the pattern. This indicates that the receiver is capable of reproducing 350-450 lines and spaces, vertically and horizontally. Naturally the more lines and spaces a receiver can distinguish, the finer the detail it will be capable of reproducing. Fine detail is the result of optimum amplification of the full 6 mc. television bandwidth and particularly that part of the bandwidth associated with the video (5.25 mc.).

Notice, too, that the pattern contains wedges of varying degrees of shading in addition to the Indian head. These are used in adjusting the contrast and brightness controls to provide a full range of contrasting black to grey to light grey to white. The proper setting of the brightness control almost always requires a slight compensation in the contrast control. If the four distinct shades of the pattern are not visible in the wedges it is an indication of nonlinear distortion in the video amplifier. This is usually caused by an improperly biased or gassy tube. The signal from a second transmitter should be checked to insure that this trouble is not in the transmitter.

Focusing of the test pattern is very important and since present-day cathode-ray tubes do not focus evenly over the entire face of the tube a median setting must be obtained so that the most satisfactory over-all focus is achieved. This can be set tentatively as the point at which the lines of the raster are distinguishable and are of the minimum possible width.

Alongside of the wedges (Fig. 2) are a series of numbers from 20 to 45 (indicating 200 to 450 lines). These numbers are indicative of the number of lines represented by that particular line and space thickness. It is of great advantage not only to know the number of lines a receiver is capable of producing (as indicated on the test pattern) but also the frequency represented by that number of lines in order to check the definition as well as the lowest and highest frequencies capable of being received clearly. Table 1 is a handy chart which lists the number of vertical lines and the equivalent frequency in megacycles. The chart may be used in judging the bandpass of the resultant adjustments to the receiver.

The diagonal lines for interlace check enable the user to test for improper interlace. A television picture is scanned with alternate lines and the lines must interlace perfectly. An irregular saw-tooth effect on the diagonal lines indicates poor interlace caused by an improperly functioning vertical sweep system.

The horizontal lines of varying

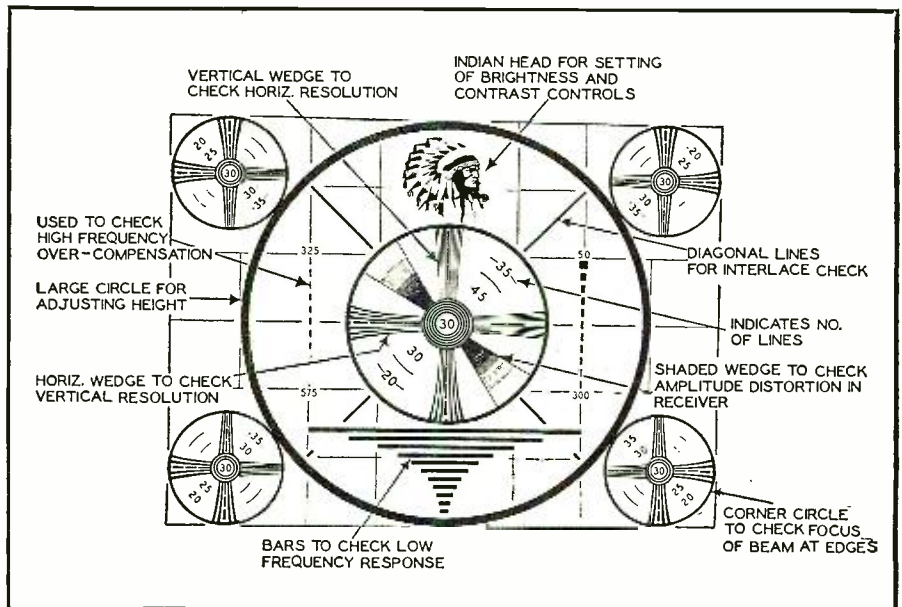

Fig. 2. The familiar Indian head test pattern used by many television stations.

length at the bottom of the circle are for the purpose of checking low frequency response. They should be sharply defined and without variation in intensity. Any variation in the intensity of these lines will indicate poor low frequency response.

The group of vertical rectangular areas located on either side of the inner circle are used to check "ringing" caused by overcompensation at the high frequencies. If the video output stages are overcompensated, these rectangles are followed by multiple images similar to ghosts but spaced equally from each other.

Heterodyne

Few people realize the dramatic changes which take place in a super-heterodyne receiver during the heterodyne process. Prior to the advent of television little attention was paid to the high or low frequencies since in broadcast work most of the channels are so narrow that they can be easily tuned and the complete band of frequencies is always transmitted. Although many persons have a fairly

VERTICAL LINES	FREQ. (mc.)
100	1.25
150	1.56
200	2.50
250	3.12
300	3.75
350	4.37
400	5.00

Table 1. Chart for determining the frequency from number of lines on pattern.

sensitive ear for alignment, often a broadcast set receives only a portion of the transmitted signal. Tuning in a broadcast signal emphasizes the lows or increases the hisses and other high frequencies on the sides of the carrier. This same principle can be used not only in the alignment of the video section but in the proper adjustment of the sound portion of the television receiver.

Whenever two signals are mixed together in a nonlinear device two new signals are generated, i.e., the original two signals are still in evidence but the presence of two new

Fig. 3. (A) Spectrum of Channel 3, (B) Comparison of the r.f. and i.f. bands in TV.

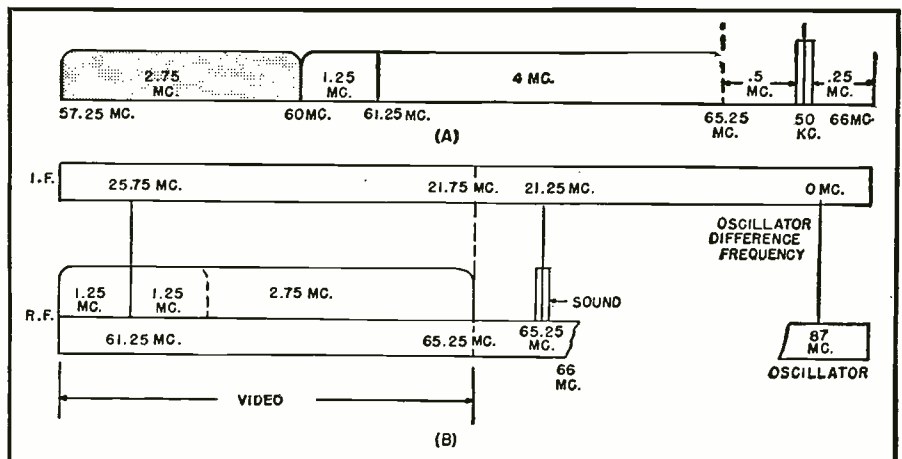

signals is always apparent. These signals are the sum and difference between the two original frequencies. Therefore, if a 100 kc. and a 10 kc. signal are mixed in an amplifier, the r.f. output stage will contain signals of 100 kc., 10 kc., 110 kc. and 90 kc. If an r.f. stage follows (as in the final stage of the video transmitter) the only signal present on the antenna will be 100 kc., 110 kc., and 90 kc. The original low frequency signal is attenuated due to the limited bandwidth of the r.f. stage. Fig. 1 demonstrates this principle.

Thus it may be said that a 10 kc. signal represents a full bandwidth of 20 kc. (from 90 kc. to 110 kc. in this example) and in order to produce this 10 kc. signal properly *all* of the bandwidth should be received and amplified. In television an attempt is made to approach this ideal. Fig. 3A shows the ideal television signal for Channel 3 (60 to 66 mc.).

However, for the present, our concern will be with the video. Since the highest signal produced will be in the region of 4 mc. it is reasonable to assume a bandwidth of 8 mc. But experiment has shown that a great deal of space may be saved by transmitting only a portion of the difference frequencies (that portion below the carrier frequency is referred to as the *difference frequency* while that above the carrier is known as the *sum frequency*). The portion transmitted is only 1.25 mc. of the original 4 mc. difference frequency. This signal can, however, produce an intelligible video picture and yet maintain a minimum of bandwidth. This principle is known as vestigial sideband transmission. This is the reason that the video carrier appears as it does in Fig. 3A.

A careful study of Fig. 3A reveals that the center of the video carrier is 61.25 mc. Low frequencies are gath-

ered close to this point while the high video frequencies are farther away (both higher and lower than 61.25 mc.). Referring again to the test chart and frequency table it may be seen that a few kilocycles on either side of 61.25 mc. corresponds to definition in the horizontal wedges whereas high frequency video or vertical wedge detail is located at points well over 1 mc. and as high as 4 mc. on either side of the 61.25 mc. carrier. However, for video frequencies greater than 1.25 mc. the picture information is located in the *sum frequency* region of the video. Now add an oscillator signal, *i.e.*, mix with this r.f. carrier from the station a local oscillator of fixed frequency as is the case in the superheterodyne process.

In the superheterodyne process an oscillator of fixed frequency is used and mixed with the incoming r.f. signal thus taking the difference frequency as the signal we call i.f. or intermediate frequency. Fig. 3B represents the video signal with the oscillator.

Notice that for Channel 3 the oscillator is tuned to 87 mc. Thus the center of the audio band is 21.25 mc. below and the center of the video band is 25.75 mc. below the oscillator. This is the reason for the two i.f. frequencies, 21.25 mc. and 25.75 mc. This choice of i.f. frequencies varies from receiver to receiver but in all cases the video and audio i.f.'s are separated by 4.5 mc.

Up to this point the processes do not materially differ from broadcast methods. Reviewing the r.f. video spectrum again and comparing the i.f. as is diagrammed in Fig. 3, the low frequency or horizontal wedge information is located at 61.25 mc. and extends a few kc. on either side. The i.f. low frequency horizontal wedge information is located a few kc. on

either side of 25.75. Note too that the frequencies up to 1.25 mc. are gathered about the center carriers as before. This frequency will produce about 100 lines of vertical wedge information. We are striving, however, toward 400 line vertical wedge information which lies in the r.f. frequency range of 62.5 mc. to 65.25 mc. and in the i.f. range of 21.75 mc. and 24.5 mc.

This is very important and may be stated in various ways. The high frequency r.f. video is, when heterodyned, transformed to low frequency i.f. video. Note that the high frequency r.f. is the low frequency i.f. and that the low frequency r.f. is high frequency i.f. and that the higher the desired definition, *i.e.*, the finer the vertical wedge definition required, the *lower* the i.f. frequency must be. In short, to tune for low frequency video, 100-200 lines, iron slugs are pulled out of the coil forms. For high frequency video the slugs are turned into the center of the coil to increase the inductance and lower the i.f. frequency.

Remember that as more and more vertical wedge is required, the inductance and capacitance of the i.f. amplifiers must be increased. Also in order to produce greater clarity in the horizontal wedge, inductance and capacitance must be decreased.

Presetting the I.F.'s

Presetting the i.f.'s is necessary only when the receiver is completely misaligned. Set all the slugs in the video i.f. coils so that they are in the center of their respective coils. Then set all of the audio i.f. slugs so that they are in the center of their respective coils.

Stagger Tuning

Stagger tuning is used to broaden the frequency response of the video i.f. It is not too difficult to accomplish without the use of a sweep generator if care is taken and every movement of the i.f. slug and the resultant effect upon the test pattern is noted.

First observe where or from what i.f. the audio is obtained. This will be the lowest video i.f. The slug will be set approximately in the center of the coil form. The last i.f. should be set for high frequency video information or at low i.f. frequency, *i.e.*, the slug here will also be set at approximately the center of the coil form. It is therefore advisable to leave the last video i.f. and the video i.f. from which the audio is taken strictly alone. Between these stages the slugs in the video i.f. are set in gradual steps to cover the full coil length. If the audio is taken from any stage but the first video the stages remaining from the converter to this point are staggered in gradual steps from the high i.f. (slug out of coil) to the low i.f. (slug in center of coil), that stage immediately following the converter being set to high i.f. setting.

Now the set may be turned on and
(Continued on page 168)

Fig. 4. The television resolution chart adopted as a standard in 1946 by the RMA.

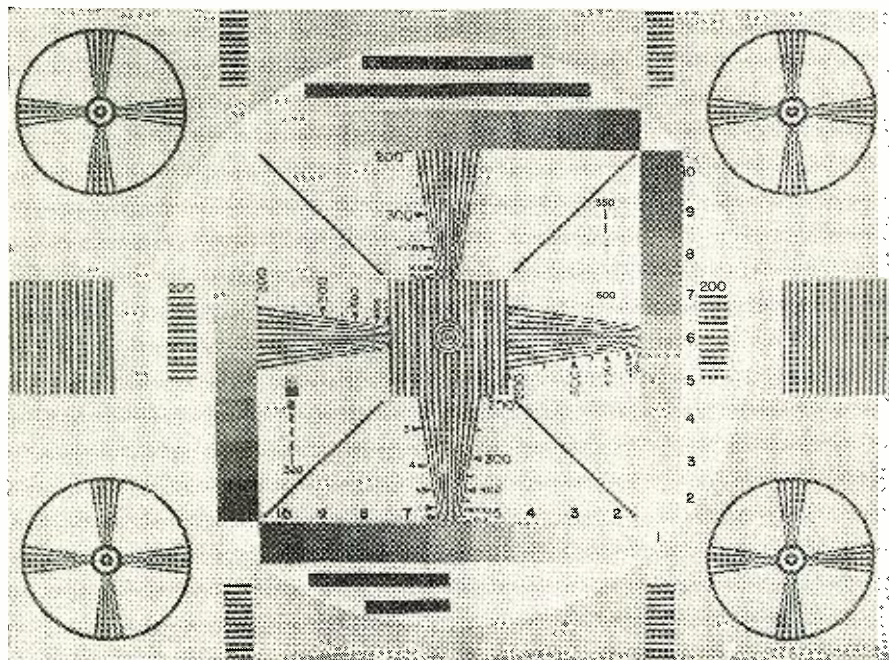

A SIMPLE ELECTRONIC METRONOME

By
GUY DEXTER

THE metronome is a device well known to music students. In its long-used mechanical form, it consists essentially of a small adjustable pendulum driven by clockwork, which audibly beats time. Aside from setting rhythm accurately for musicians and dancers, the metronome has found use in totally unrelated fields. Some applications include the beating of seconds in completely darkened photographic laboratories, timing of mechanisms when the eye cannot be transferred to a stop watch, timing of successive steps observed in chemical or biological processes when the sight is totally occupied with watching the process, marking time in physical training exercises, etc. An electronic metronome has the advantage of freedom from moving parts. It requires no winding and does not run down. Its volume may be adjusted to suit room conditions.

The heart of any electronic metronome is a low-frequency oscillator or recurrent discharge circuit of some kind. The frequency of this oscillator is continuously variable over a small range. For simplicity, compactness, and good service, the circuit must be simple.

The author tested several circuits while developing the instrument described in this article. These included a multivibrator with two-stage audio amplifier, blocking oscillator and amplifier, gas-triode saw-tooth oscillator with amplifier, low-frequency resistance-tuned high-output oscillator, and neon-bulb oscillator with amplifier.

Results obtained with the neon-bulb oscillator driving a single-stage loud-speaker amplifier were good enough to justify turning away from the more complicated schemes. There has been a great deal of opposition to using neon-type relaxation oscillators in timing operations because of the instability of these units. However, the frequency of the neon circuit can be made sufficiently stable for metronome use by regulating the applied voltage and by using good-grade condensers in the circuit.

The final circuit (see Fig. 2) delivers readily-controlled beats ranging in rate from slightly less than 1 per second to 5 per second. This corresponds to a little under 60 to 300 per minute. The beats are delivered by a small loudspeaker and are "plops" which are not harsh to the ear. This metronome is small enough to be

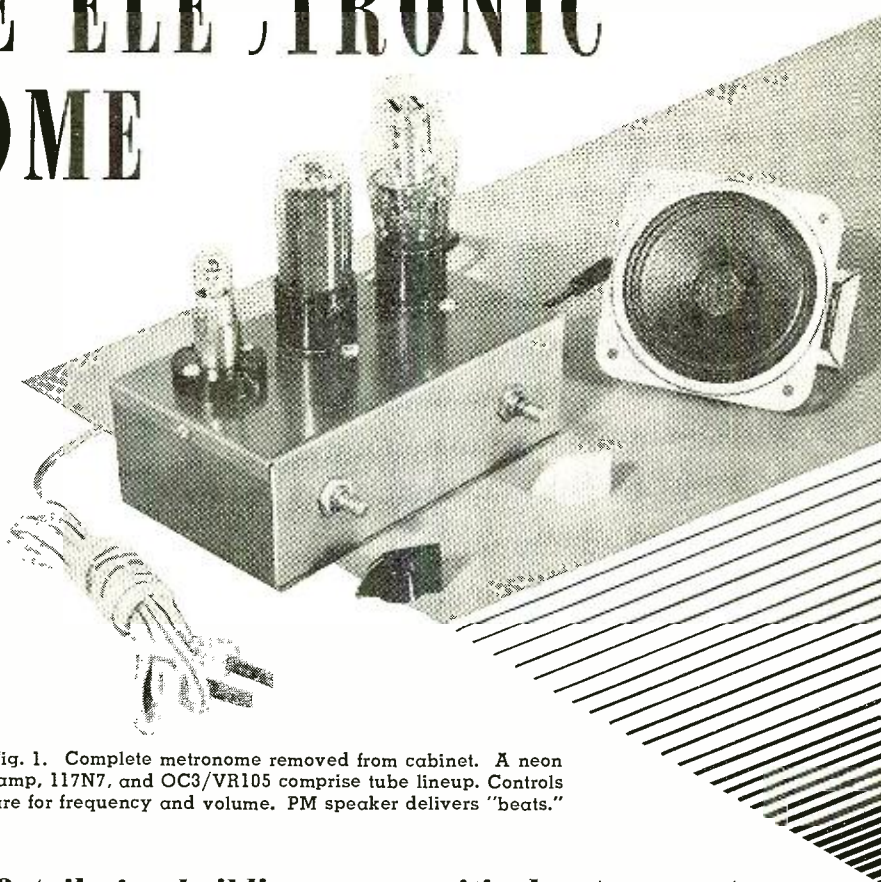

Fig. 1. Complete metronome removed from cabinet. A neon lamp, 117N7, and OC3/VR105 comprise tube lineup. Controls are for frequency and volume. PM speaker delivers "beats."

Details for building a non-critical yet accurate marker for various laboratory and service jobs.

mounted in a midget radio or intercom cabinet and is inexpensive to build and operate. It is an ac-d.c. device.

Circuit Features

The relaxation oscillator consists of resistors R_1 and R_2 , condenser C_2 , and neon lamp N_1 . Rheostat R_3 is the speed control. The highest beat rate is obtained at the minimum-resistance setting of R_3 . Resistor R_2 sets the high-frequency limit of oscillation by raising the lowest resistance value to which R_3 may be set. Condenser C_2 couples the oscillator output into the volume control, R_4 , and thence into the grid circuit of the amplifier. Adjustment of the volume control has no

effect upon the frequency (speed). High-grade oil-impregnated, oil-filled .1 μ fd. condensers are used for C_2 and C_3 . For high stability of frequency, ordinary wax condensers must not be used.

The 117N7-GT tube supplies both the pentode amplifier and half-wave power supply rectifier. The cathode resistor (R_1) of the pentode is left unbypassed to obtain a small amount of degeneration. This serves to make the sound of the beats more agreeable to the ear. The pentode drives a 3-inch PM dynamic speaker which was found to deliver enough volume for an average size room. If louder beats are required, as for use in a large classroom

(Continued on page 143)

Fig. 2. Complete schematic diagram and parts list for the electronic metronome.

- R_1 —100 ohm, 1 w. res.
- R_2 —600 ohm, 5 w. wirewound res.
- R_3 —1 megohm pot.
- R_4 —5 megohm pot.
- R_5 —2.2 megohm, 1/2 w. res.
- R_6 —1500 ohm, 2 w. res.
- C_1 —40 μ fd., 150 v. elec. cond.
- C_2 , C_3 —1 μ fd., 400 v. oil-filled cond.
- C_4 , C_5 —40/40 μ fd., 150/150 v. elec. cond.
- N_1 —1/4 watt neon lamp (G. E. Type NE-48)
- S_1 —S.p.s.t. sw. (on R_3)
- T_1 —Speaker matching trans. (single 3000 ohm plate-to-v.c.)
- Sprk.—3 or 5 in PM dynamic speaker
- V_1 —117N7 tube
- V_2 —VR105 tube

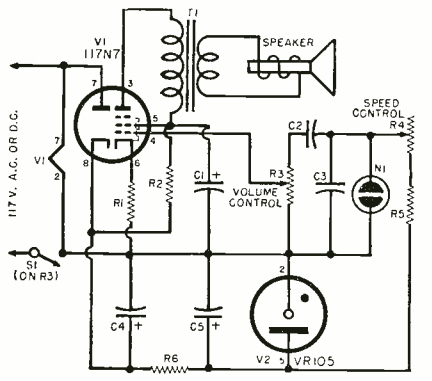

Extra Income



for the SERVICE SHOP

By **JOHN B. LEDBETTER**

Eng., WKRC-TV

Profitable sidelines help stabilize a service business and provide a good economic cushion.

IN THESE days of servicing complicated receivers and electronic equipment, it is almost heresy to mention "sidelines" as a means of increasing shop income. The average service technician usually has his hands full keeping up with radio service alone. However, those little "odds and ends" often are welcome fill-ins and can often be built up to a point where employment of extra or full-time radio or appliance service technicians is justified. At the same time, these sidelines often attract new customers who might otherwise have taken their sets elsewhere for repairs.

There are many things which may be done to expand shop income. Here are a few: (1) sales and rental service of small p.a. systems, (2) installation of sound systems and intercom units in offices, large homes, schools, farms, and plants, (3) modernizing old-model a.c. receivers, p.a. ampli-

fiers, intercoms, etc., (4) replacing electrodynamic speakers with new, more efficient PM units, (5) improving the performance of a.c.-d.c. receivers, (6) electrifying battery sets, (7) servicing small home appliances, (8) custom-building radio and television installations, (9) sales of records, record-players, and other attachments, and (10) operating a small recording studio in the shop.

Appliance Servicing

Small appliance servicing is probably one of the most effective ways of increasing shop repair work. Although not too profitable in itself, it *does* pave the way for more profitable work on radios, washers, refrigerators and other large household appliances. Each repair job on a small item provides an opportunity to suggest a replacement, a check on other appliances, an examination of radio sets in the home, or

the sale or repair of large appliances.

Service can be expanded to include electric irons, toasters, waffle irons, hot-plates, heaters, lamps, fans, mixers, washing machines, vacuum cleaners, and even electric ranges, without requiring an expensive outlay of tools or replacement parts. Test instruments needed for most repairs need only include a volt-ohm-milliammeter with a 150 volt scale, an a.c. ammeter (0-20 amps.), and a simple a.c. test lamp. Anyone with any knowledge at all of simple a.c. circuits can repair small appliances; for washing machines, ranges, etc., where repair or replacement of motors, thermostats, etc., is necessary, a little more knowledge and preparation will be helpful.

Trouble in small appliances usually is limited to faulty connections in the plug or line cord, or breaks in the elements or wiring due to long use or rough handling. Permanent wave machines, hair dryers, ultraviolet lamps, etc., are subject to the above troubles; very seldom will trouble be found in their timing units.

Electric irons will perhaps need service more often than other small appliances. The usual difficulty is a faulty line cord or plug, or open or corroded elements or contacts. In automatic irons, the thermostat may be defective.

In *electric mixers, fans, etc.*, motor trouble can be caused by dirty, worn brushes, lack of tension in the brush springs, or a dirty armature. Sometimes high mica between the armature segments prevents proper contact with the brushes. See that the motor is clean and properly lubricated. (Clean by disassembling and dipping each part in gasoline, or use a gasoline-saturated brush. Don't use carbon tetrachloride; it is corrosive). Worn take-up and thrust washers may be replaced, but for worn or "frozen" bearings, open arm-

ature, field coil, etc., the motor should be sent to a local automotive or electrical repair shop, returned to the factory, or replaced.

Vacuum cleaners have the same motor troubles just mentioned. In addition, the brush holders, fan, shaft, and intake tubes may be clogged with dirt, strings, wool nap, and other foreign matter picked up in cleaning. Usually the belt needs replacing. Check the switch, cord and plug as a safety measure.

Electric lamps (wall, desk, floor, etc.) are easy to service. Troubles include a defective switch, cord or plug, occasionally a bad socket. In fluorescent lamps, a bad lamp tube or faulty starter is usually encountered.

Electric ranges and washing machines are not difficult to repair. Defective heating elements in ranges can be replaced with exact factory replacements or universal elements; washing machine motors can be repaired at a local electric shop, returned to the factory, or replaced with a new unit. Wringer rollers, gears, and other worn parts can usually be obtained from the factory or from a local distributor. If the unit is so old that replacement parts are no longer available, the customer is a prospect for a new machine.

Another source of income is the *installation* of new electric ranges. Right now, you probably know several customers who are definite prospects for an electric range. You can do your "good deed" by recommending a particular dealer to the customer, and notifying the dealer of the customer's needs.

You may wonder how the radio service technician can profit by this. Here's how—many dealers do not employ regular installation men but call in outside help, and in many cases will be glad to pass this business along to you or your electrician associates. A good installation inevitably leads to future contacts with the customer and provides the opportunity to inquire about the condition of radios and other appliances in his home and in the homes of his neighbors. Don't overlook any of these opportunities. (A number of small, well-equipped service shops have carried the idea of sales, service, and installation a bit further by having an extra man (or men) specialize solely in work of this kind. Some have added refrigeration servicing as a profitable sideline). The *Norwood Radio Service* (see photograph on page 46) is a practical example of how sidelines may be added. This shop is not elaborate, neither does it let the grass grow in its show window. Note the sidelines offered: vacation and picnic portables, electric roasters, fans, irons, toasters (and for summer comfort, insect repellent lamps). Included are vacuum cleaners, washing machines, and, in the background, several console radios and an auto radio demonstrator—everything but the kitchen sink. Well, look again—the kitchen sink is there too! You may not want

to go this far with sidelines, but you'll have to admit it's a good way to get customers into the shop, and it has paid off for this one.

Small P.A. Rentals

Many small amateur dance bands, schools, clubs, and other organizations need a low-power p.a. system occasionally but cannot afford the usual high-fidelity, high-power system. For these occasions, however, they are able to pay a nominal fee for a small 5- or 10-watt system. Old-model p.a. amplifiers can often be bought quite reasonably from large sound equipment companies and modernized, or if you prefer, you can build your own in spare time. A number of such rental systems in constant circulation will help pay for quite a few "incidental" around the shop and, what is more important, will be valuable in promoting good-will and keeping your name before the public. (Along these lines, be sure your business name, address, and phone number are neatly painted or decalcoed on speakers, amplifiers and microphones). It is also good publicity to donate a p.a. system, receiver, record-player, etc., to civic organizations, business clubs, etc. It does not take long for cooperation of this sort to bring its rewards in increased sales, service, and business contacts. Many customers are connected with or own business concerns which could use intercom systems, paging systems, or sound equipment, or have equipment which is in need of repairs. In many cases the equipment is obsolete, or its effectiveness has been outgrown by expanding business. Situations of this sort are ripe for replacement units—make it your business to bring up these points. Sales can be helped along with a simple demonstrator like the one shown in Fig. 1. This set-up permits actual listening and comparison tests of amplifiers, low- and high-frequency speaker units, and record-changers; several different makes can be switched in for comparisons.

Small Recording Studio

A number of progressive service shops regularly make recordings of speeches, group functions, or special



Fig. 1. A simple demonstrator unit for merchandising amplifiers, low and high frequency speaker units, and record-changers. It is a good sales stimulant.

occasions on inexpensive paper discs and pass them out to the participants. These make good "plugs" for the shop and often bring requests for more professional recordings from musicians, singers, and voice students who are interested in keeping permanent records of their progress. Small bands, school orchestras (and parents anxious to record junior's gurgling for posterity) help in making a small recording studio feasible. Many vocalists like to try new arrangements without the presence and attendant costs of a "live" orchestra. Special records and transcriptions (known commercially as "Synchro-discs") are available for this purpose. The vocalist and "canned" orchestra can be mixed very realistically.

Recording equipment, especially at the start, need not be too expensive. You can build your own mixer, pre-amplifiers, and recording amplifier, or you can use a rebuilt 5- or 10-watt p.a. amplifier if its quality is fairly good.

(Continued on page 152)

Fig. 2. A special room for demonstrating the possibilities of custom installations set up by Altec-Lansing but equally adaptable to the smaller radio service shop.



The Variable Permeability Sweep Generator

By M. E. CLARK
General Electric Company

THERE have been many approaches to the problem of wide-band sweep generator design. Most of these have involved mechanically moving parts such as rotating or reciprocating variable condensers or a reciprocating disc moving near enough to a pancake coil to change its inductance as the disc moves. Such mechanically moving parts are subject to the usual problems of mechanical devices. Sliding surfaces wear and grow loose while flexed pieces fatigue and break. They are also subject to irregularities of motion when shocked or jarred as so often happens under ordinary working conditions in the laboratory or the service shop.

The obvious solution would be an electronic sweep such as the reactance tube type so commonly used for FM visual alignment work. In practice it turns out that it is extremely difficult to get sweeps of the width needed for TV work from the reactance tube sweep. The variable permeability sweep solves these problems by providing the needed width of sweep along with a total absence of moving parts.

As in any other design of an oscillator which is to be varied in frequency, it is necessary to vary either the inductance of the coil or the capacity of the condenser in the frequency determining network. Here we achieve the sweep by varying the inductance.

Variable Permeability Unit

As is generally known, the inductance of a choke falls off when the d.c. through it is increased. This is true because as the flux is increased in the iron the permeability of the iron is decreased and its effectiveness in increasing the inductance over that of an air core coil is lessened. Obviously, if this choke were a part of a tuned circuit the resonant frequency of the circuit would go up with saturation. By opening up a wide gap in the choke and putting a small piece of iron in that gap, it becomes possible to saturate the small piece of iron well in advance of the main part of the core because of its limited cross section. By using a piece of high quality radio frequency iron for the small slug and winding the oscillator coil on it we can cause a variation of inductance of the oscillator coil simply by running



Fig. 1. Front view of the generator. The vernier r.f. output attenuator is at left of the coaxial cable.

Complete electronic control of sweep eliminates the many problems inherent in the often-used mechanical type systems.

d.c. through the winding of the original choke. See Fig. 2 for the development of this part which is the heart of the instrument under discussion.

Fig. 5 shows the final form of the variable permeability unit itself. L_1 is the choke or wide gap reactor, and L_2 is the high frequency oscillator coil. The small caps over the end of the laminated core serve merely to reduce losses by keeping r.f. out of the low frequency iron, and do not enter into the creation of the sweep.

When there is no d.c. through the choke coil, the iron slug in the tuned

circuit lowers the frequency of the oscillator by many megacycles over what it would be without the core. Now if the d.c. through the choke is increased the iron slug will gradually saturate and become less and less effective in increasing the coil inductance. Consequently, the oscillator will go up in frequency in much the same way as it would if the slug were withdrawn from the coil (as it is in many common iron-slug tuned circuits such as i.f. transformers).

Characteristics of the Unit

If frequency is plotted as the choke current is varied the resulting graph approximates a straight line as shown in Fig. 4, and the frequency is said to be linear with respect to the current. Note that if the current is reversed, the same frequencies are covered again. In other words, a saturated condition is reached regardless of which way the saturating flux happens to be flowing.

When a sine wave of voltage is applied to an inductance, the resulting current is also of a sine wave form, but shifted in phase. Since the wide gap choke coil (or wide gap reactor as it is often called) is nothing more than an inductance, the current through it will be a sine wave if a sine wave voltage is applied to it. The ra-

Fig. 2. Inductance of oscillator coil is varied by saturating the r.f. iron slug.

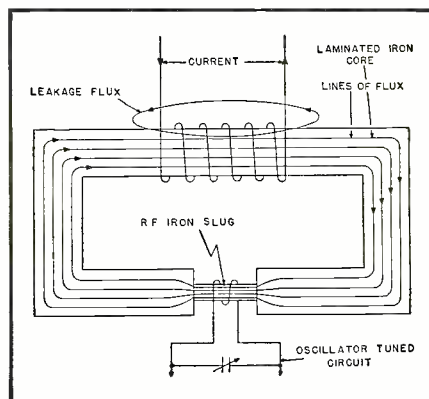

dio frequency will then be varied according to this same sine wave voltage because, as is shown in Fig. 4, the frequency varies the same way the current does. Saturation of the iron circuit would make this statement not strictly true, but saturation of the r.f. iron changes the over-all reluctance so slightly as to cause no trouble.

As also shown in Fig. 4, the frequency will repeat itself if the current is swung the same amount negative as it is positive. Under the condition where a sine wave is applied, this would cause the frequency to repeat four times. For example, going up toward 10 ma., it would pass through 205 mc. and it would pass back through 205 mc. on the way down toward zero. Then it would do the same thing on the negative half of the cycle, thus covering any one frequency (except at the extremities), four times. Two of these can be eliminated very simply by introducing a positive direct current of such a value as to prevent the total current from ever going in a negative direction. This is similar in principle to the negative bias on a class A amplifier which prevents the grid from ever going positive, but in this case the polarity happens to be reversed.

If the oscillator is turned off during the time when the frequency is sweeping back there will then remain only one repetition of any one frequency for each cycle of the sweeping voltage. This is referred to as blanking and is accomplished by biasing the oscillator cease. The source and wave shape of the blanking voltage will be discussed later.

Now if the same voltage that is causing the frequency to sweep is applied to the horizontal amplifier of a scope, the spot will move across the screen at the same rate as the frequency is changing. By introducing a phasing control in the voltage applied to the scope it is possible to cause the spot to move not only at the same rate as the frequency, but to cause it also to be in step with the frequency at all times. We now have the basic unit upon which the variable permeability sweep was built.

A Practical Design

In applying the above principle to a practical design, it was found that a sweep oscillator could readily be made to cover the television channels in the frequency range of 165 to 220 mc. The lower channels and intermediate frequencies were then covered by taking the difference frequency between the swept oscillator and a c.w. oscillator. To effectively take this difference, a mixer was used in which one oscillator was fed to one grid of a dual triode, and the other oscillator to the second grid of the same tube. The plates were connected in parallel and the difference output taken directly from the plates into an attenuator. When the c.w. (or beat oscillator) is turned off the mixer becomes simply an ampli-

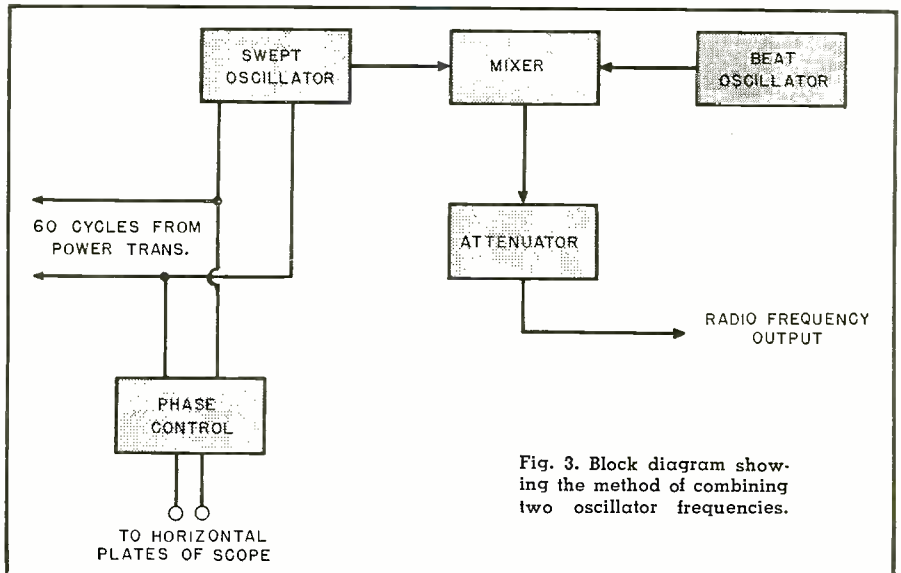

Fig. 3. Block diagram showing the method of combining two oscillator frequencies.

fier using one half of the tube to carry the swept oscillator output to the attenuator. Fig. 3 is a block diagram showing the above arrangement.

The high television band is covered by the direct output of the swept oscillator which covers from 165 to 220 mc. The low television band is covered by leaving the c.w. oscillator fixed at 275 mc., and tuning the swept oscillator over the high band again. A range of 275 minus 220 to 275 minus 165 is then covered. This is 55 to 110 mc., and covers the low television band and the FM band.

Next, the swept oscillator is left tuned to 220 mc. while the c.w. oscillator is varied from 220 to 275, thus yielding 275 minus 220 to 220 minus 220. This is a range of 55 to zero mc. Actually it is impossible to arrive close to zero output frequency because the oscillators lock together and there is then no beat output at all. With no special inter-oscillator shielding the generator works very well down to 4 mc. which allows it to safely cover 4.5

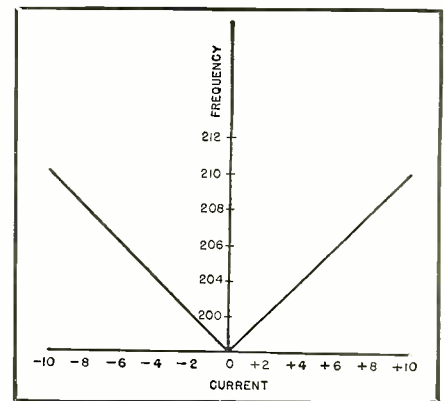
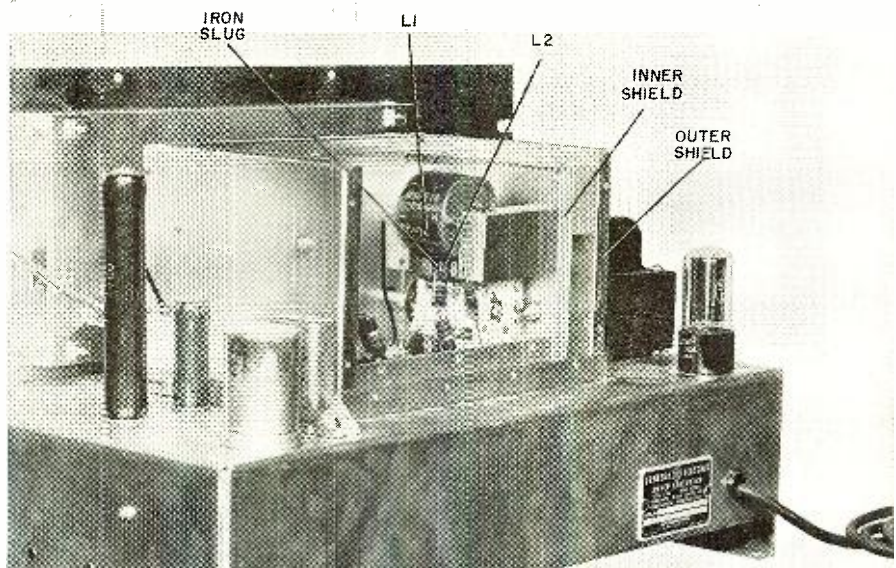

Fig. 4. Variation in oscillator frequency as a result of change in the core flux.

mc. intermediate frequency amplifiers. Differences rather than sums are used in all cases in order to remove the beating oscillators to frequencies above the beat output.

One of the most important characteristics of a good sweep generator is

Fig. 5. Rear view of generator. The frequency sweep unit is shown inside the shield.



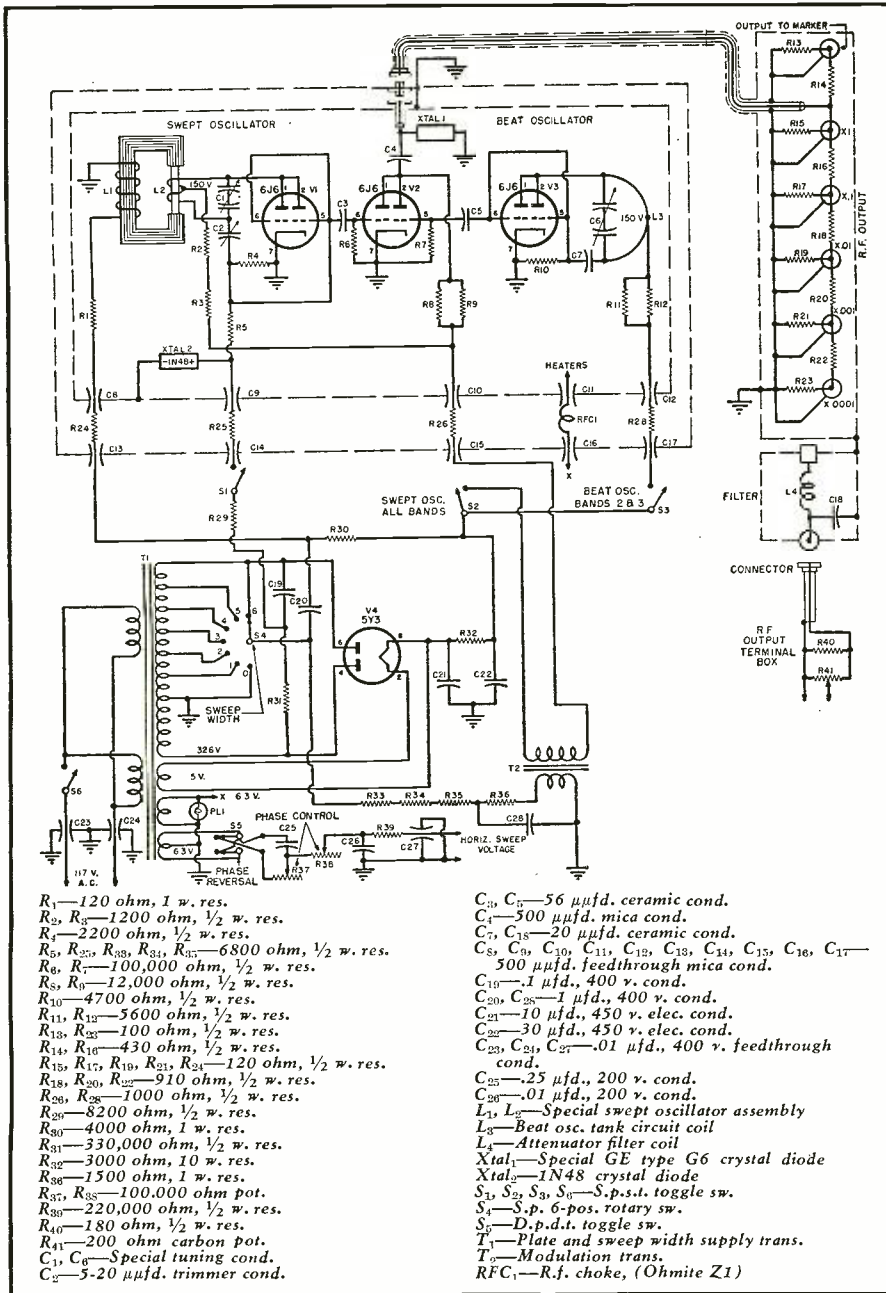
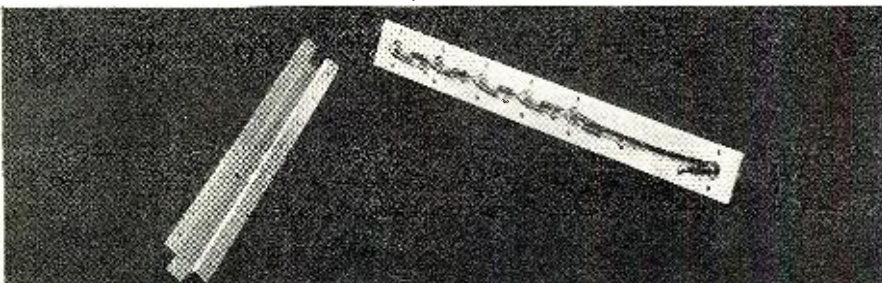

Fig. 6. Schematic diagram of the sweep generator. Complete shielding is incorporated.

that the output remain constant while it is being swept across a band of frequencies. As might well be imagined the "Q" of the oscillator tuned circuit varies as the iron slug is saturated. This results in a variation of output of about 20% which is far too much for a laboratory quality instrument.

Fig. 7. Step attenuator. Capacity coupling, encountered when switches are used, is avoided.



Fortunately, this variation is about as linear with the current through the choke as is the frequency shift. This makes it practical to plate modulate by an approximately equal amount in the opposite direction. This is accomplished by inserting a modulation transformer in the "B plus" lead to

the swept oscillator and modulating it with a little of the same voltage that causes the sweep.

Attenuator

In line with the constant output requirement it becomes absolutely necessary that there be no tuned circuits accidentally built into the unit which might cause resonant rises or take up some of the desired energy and cause the output to fall off for certain frequencies. This was taken into consideration in the design of the step attenuator by making all the leads as short as possible and inclosing the whole unit in a close fitting shield. The resistors were all strung out in a long line in order that capacitive and inductive coupling would be minimized as much as possible. Fig. 7 shows the construction and clearly illustrates the close fitting channel shaped shield. A rotary switch to replace the plug and jack arrangement would be very handy but the problem of decoupling one step from the next is difficult and expensive to solve.

A vernier attenuator was also desired, but whenever a potentiometer was placed anywhere in the circuit between the mixer and the step attenuator it caused the output to vary with frequency. It was found, however, that a low ohmage potentiometer could be placed at the end of the cable without causing any trouble provided that it matched the cable. While the vernier attenuator was put in the output box for a good electrical reason, it has since been found that it is in about the most convenient place possible as well.

Fig. 8 shows the output cable and the vernier attenuator just described along with a filter which will be mentioned later.

Leakage

If a signal generator, whether it be a sweep or not, cannot be cut down in output to match the weakest signal to be received it cannot do an adequate job of alignment. To meet this requirement it was necessary to resort to complete double shielding of the two oscillators, the mixer, and the lead which goes to the attenuator. Fig. 5 shows the double shields with the covers removed. All incoming leads were filtered between the shield cans and again inside the inner can to minimize leakage. Both condensers and one resistor of such a filter are shown in Fig. 9 and will be found on the schematic with the same symbol numbers. The two shields were connected together and grounded at only one point—where the output lead goes through. Fig. 9 illustrates the final solution of this problem: Note the double shielded cable passing over V_1 to the attenuator strip.

Power Supply

The power supply, to meet all requirements of this sweep design, is somewhat more complicated than one
(Continued on page 94)

A Supermodulated PHONE TRANSMITTER

By RUFUS P. TURNER, K6AI

and

JOHN W. GRAVES, W6MYR

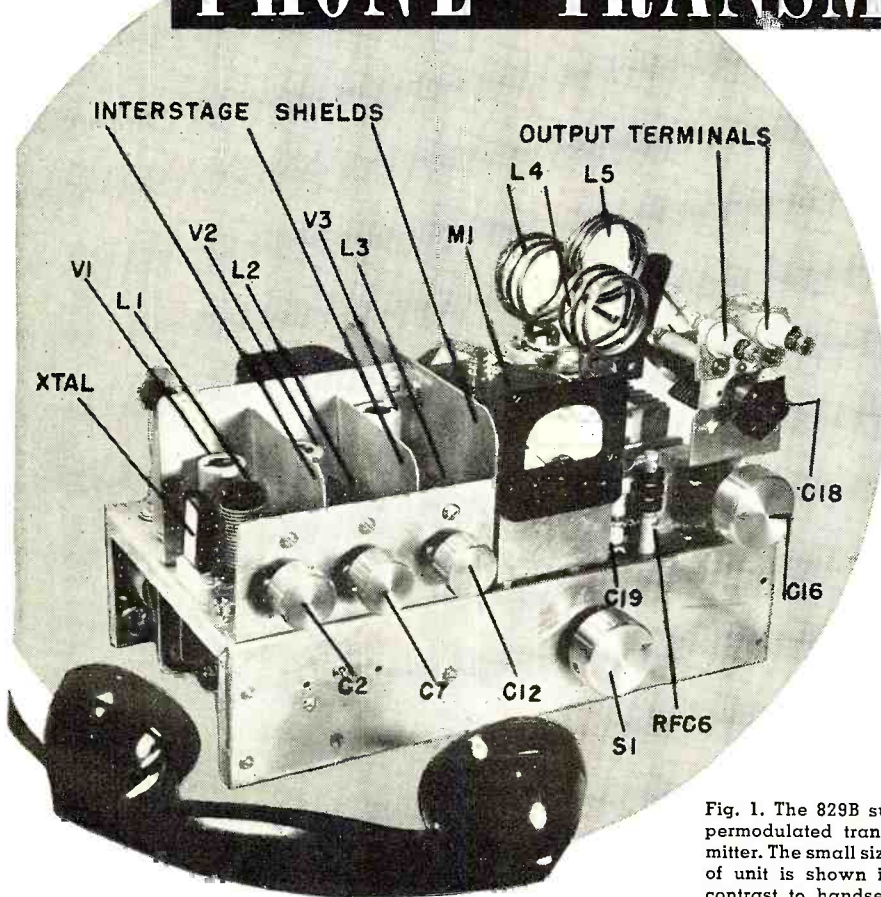

Fig. 1. The 829B supermodulated transmitter. The small size of unit is shown in contrast to handset.

Constructional data on a small transmitter which uses the Taylor modulation system and is capable of handling as high as 90 watts of power input.

THE Taylor system of supermodulation has been a constant attention attractor during the past year. Hams who have supermodulated rigs on the air have been peppered with questions regarding technical details of the circuit and method of adjustment. Receiving operators are intrigued by the characteristic audio punch of the signal, noticed even when the carrier seems weak. Authors of articles on the subject have been kept busy answering letters.

Considerable interest has been expressed in the use of supermodulation in mobile transmitters and especially in the design of a small transmitter which might be used interchangeably as a mobile rig or home unit. This article describes a transmitter which should satisfy the present demand. It is an inexpensive and compact unit.

The transmitter shown here uses an

829B tube in the final amplifier, one half serving as the power amplifier and the other as the positive modulator. All "supporting" stages, down to the speech amplifier and crystal oscillator, are self-contained. With the exception of the 829B, miniature tubes are used throughout. This transmitter has been developed especially for interchangeable mobile and home use and is the prototype of the forthcoming Taylor Model 100A. It is capable of 40 watts input at 500 volts on the 829B plates, and approximately 75 watts input at 750 plate volts. The input power has been increased safely to better than 90 watts.

The stage lineup is: 6AK6 20-meter crystal oscillator, 6AK6 10-meter doubler, 6AQ5 10-meter buffer-driver, 829B combination power amplifier and positive modulator, 6C4 speech amplifier, and 6AQ5 audio driver. A straight-through 10-meter buffer is used, since experimental data has shown that this type of driver gives better supermodulation efficiency and stability than a doubler. The number of stages was minimized by employing a 20-meter oscillator. However, 40-meter crystals can be used if the builder is willing to add a 20-meter doubler to the stage lineup.

The complete circuit schematic is given in Fig. 3. Up to the output of

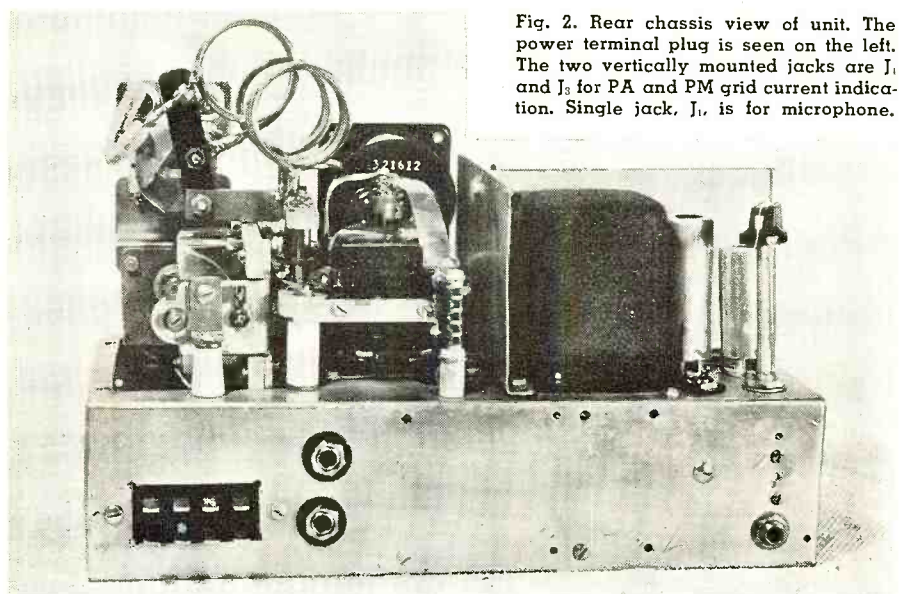

Fig. 2. Rear chassis view of unit. The power terminal plug is seen on the left. The two vertically mounted jacks are J₁ and J₂ for PA and PM grid current indication. Single jack, J₃, is for microphone.

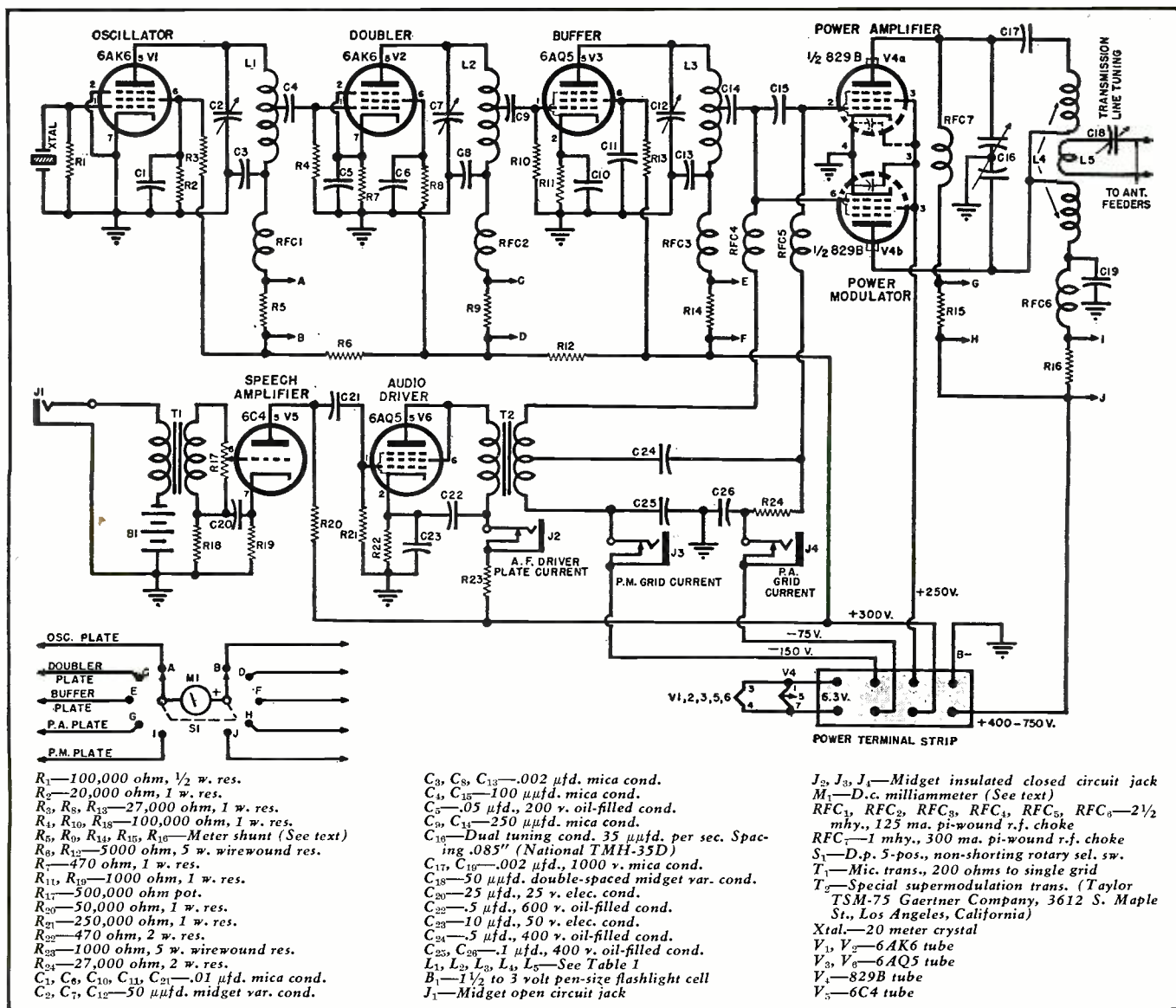

Fig. 3. Complete circuit diagram and parts list covering the 829B supermodulated transmitter.

the buffer stage, this arrangement is an entirely conventional capacitance-coupled exciter with separately-tuned tanks. The r. f. output from the buffer passes through the two coupling condensers, C_{14} and C_{15} , in series, which together form a radio-frequency voltage divider. This divider maintains the proper ratio between r. f. grid voltages presented to the PA and PM sections of the 829B.

Audio voltages are presented to the final amplifier by the secondary winding of the special coupling transformer T_2 , condenser network C_{24} - C_{25} - C_{26} , and resistor R_{24} . Audio voltage at the center tap of the T_2 secondary is equal to one-half the voltage across the entire secondary winding.

The microphone input is intended for a Type F-1 single-button handset-type carbon microphone (See Fig. 1). However, any other single-button unit may be used. Excellent quality reports have been received when the F-1 unit has been employed. The 6C4 speech amplifier is a conventional stage with transformer input and re-

sistance-capacitance output. The 6AQ5 audio driver tube is triode connected (screen tied to plate) to insure good audio output regulation and to provide about 1 watt of audio which is adequate for full modulation.

A swinging link, L_5 , provides variable antenna coupling. This feature plus the antenna tuning condenser, C_{16} , both are essential to peak performance of the supermodulation circuit. C_{18} must be included in the circuit regardless of the impedance of the feeder cable employed.

A self-contained d.c. milliammeter, M_1 , is switched successively across shunt resistors R_5 , R_9 , R_{14} , R_{15} , and R_{16} to read plate currents in the oscillator, doubler, buffer, power amplifier, and power modulator respectively. In addition, jack J_3 is provided for plugging-in a low-range d.c. milliammeter to read PM grid current, and J_4 for PA grid current. Jack J_2 permits occasional checking of audio driver plate current. All three of these jacks may be dispensed with, since none is essential to tune-up operations.

The shunt resistor values must be selected to give the milliammeter a range of 0-100 ma. when reading oscillator, doubler, buffer, and PA plate currents, and 0-200 ma. when reading PM plate current. A 10-milliamper meter was used in the rig shown for the sole reason that it was immediately available. However, most builders will prefer to use the popular 0-1 ma. instrument. For the latter meter (with an internal movement resistance of 105 ohms), the shunts must have the following values: R_5 , R_9 , R_{14} , and R_{15} each 1.06 ohms (1 ohm will be close enough). R_{16} must be 0.527 ohm. The first four shunts may be made by winding the proper length of resistance wire on a 1/4-inch diameter bakelite rod, or on the body of a burned-out carbon resistor. The last one (R_{16}) can consist of a small loop of resistance wire fastened to the two-terminal strip.

A 4-pair rear terminal strip receives the plug and cable from an external power supply. Two values of plate voltage (750 or 500, and 300), one

value of screen voltage (250), two values of grid bias voltage (-75 and -150 for 75 watts input) and (-50 and -75 for 40 watts input), and 6.3 volt tube heater voltage must be supplied, as indicated on the appropriate terminal strip connections in Fig. 3. The plate and screen voltages may be derived from a single high-voltage power supply through a voltage divider. However, some means must be provided for reducing the final amplifier plate voltage during tune-up operations. This is very essential, since it is difficult to adjust the final amplifier properly while employing high plate voltage.

An important point in the transmitter design is the matter of placing the excitation taps on coils L_1 , L_2 , and L_3 . Note from Table 1 that these taps are taken near the *bottom* end of each coil. This is essential to proper impedance matching between one plate and the succeeding grid.

Construction

Mechanical arrangement of the transmitter may be noted from the photographs (Figs. 1, 2, 4, and 5) and from Fig. 1 which identifies the components.

The reader will notice the extensive use of interstage shields both on top of the chassis (See Figs. 1, 2, and 4) and below chassis (See Fig. 5). It is imperative to shield each of the exciter stages separately, as shown, and to shield the audio section from the exciter and final amplifier. Each tube in the exciter and audio sections has its own shield can.

A common ground is a must! Do not merely run the low end of a component to the chassis as a ground point, but make *all* returns in each stage to the *same* single point. Bond all of the separate stage-ground points together with a length of heavy bus wire. This is especially important in the 829B stage where multiple grounds are very apt to rob the transmitter almost completely of efficient super-modulation action.

The transmitter as shown is built on a metal chassis 11 $\frac{1}{4}$ " long, 2 $\frac{3}{4}$ " high, and 6" deep. This makes a compact assembly but the reader may deviate from these dimensions if necessary. To complete the shielding, a metal base is fastened to the bottom of the chassis, and the entire unit may be slipped into a metal case.

Power Supply

The power supply must furnish 500 or 750 volts d. c. at 100 milliamperes full load, 300 volts d. c. at 30 ma., and 250 volts d. c. at 15 ma. The latter two voltages may be obtained from taps on a voltage divider. Additionally, two separate bias voltages (-75 and -150 for 75 watts input and -50 and -75 for 40 watts input), will be required. These may be obtained in the field conveniently from the nearest battery values, but at the home location probably will best be derived from an a.c.-operated bias supply.

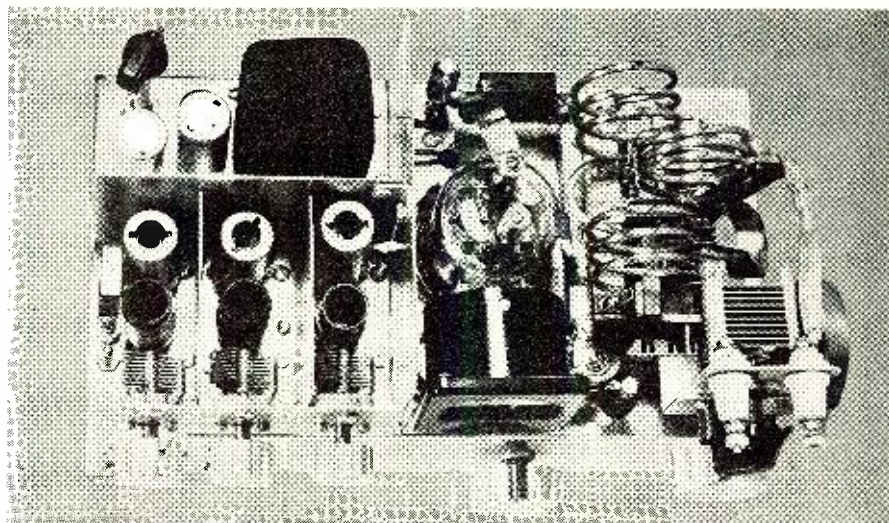

Fig. 4. Top view of the transmitter showing the correct layout of parts. The oscillator, doubler, and buffer stages are shown at the left-front portion of the chassis. The audio section is immediately to the rear. The 829 stage occupies the entire right hand portion of the chassis. Note the adequate interstage shielding employed throughout.

6.3 volts a. c. or d. c. will be required for the tube heaters which draw a total of 3.6 amperes. For complete tube protection, the power supply should be arranged so that the bias voltages are applied automatically as soon as the heater voltage is switched on. The 829B screen voltage must never be applied ahead of the plate voltage.

Tuning Up

For best results, the following tuning operations must be followed closely.

1. Tune-up at a plate voltage not in excess of 500 v. to the 829B.
2. Swing the coupling coil (L_5) completely out of coil L_1 .
3. Unplug the microphone and turn the audio gain control, R_{11} , to its "off" position.
4. (a) Switch the milliammeter, M_1 , to the oscillator stage and tune C_2 for plate current dip. Then, for maximum

(Continued on page 104)

L_1 (Osc.)	16 t. No. 18 en. on $\frac{3}{4}$ " diam. form. Space to winding length of $1\frac{1}{8}$ ". Tap 4th t. from "B-plus" end.
L_2 (Doubler)	7 t. No. 18 en. on $\frac{3}{4}$ " diam. form. Space to winding length of 1". Tap 2nd t. from "B-plus" end.
L_3 (Buffer)	5 t. No. 18 en. on $\frac{3}{4}$ " diam. form. Space to winding length of $\frac{5}{8}$ ". Tap 2nd t. from "B-plus" end.
L_4 (Final)	Each half consists of 3 t. of $\frac{1}{8}$ " copper tubing air-wound $1\frac{1}{2}$ " in diam., each in the same direction. Space each half to winding length of 1". Spacing between halves $1\frac{1}{4}$ ". Junction of inside ends of the two halves forms center tap.
L_5 (Ant. Coup.)	(Swinging Link) 3 t. $\frac{1}{8}$ " copper tubing air-wound $1\frac{1}{2}$ " in diam. and spaced to winding length of $\frac{1}{2}$ ". This coil is hinged so as to be swung between the halves of L_1 for var. antenna coupling.

Table 1. Coil winding data for L_1 through L_5 .

Fig. 5. Under chassis view of the transmitter. Note the use of baffle shields below the chassis as well as on top (Figs. 1 and 4). Rectangular cutout clears tuning condenser, C_{16} .

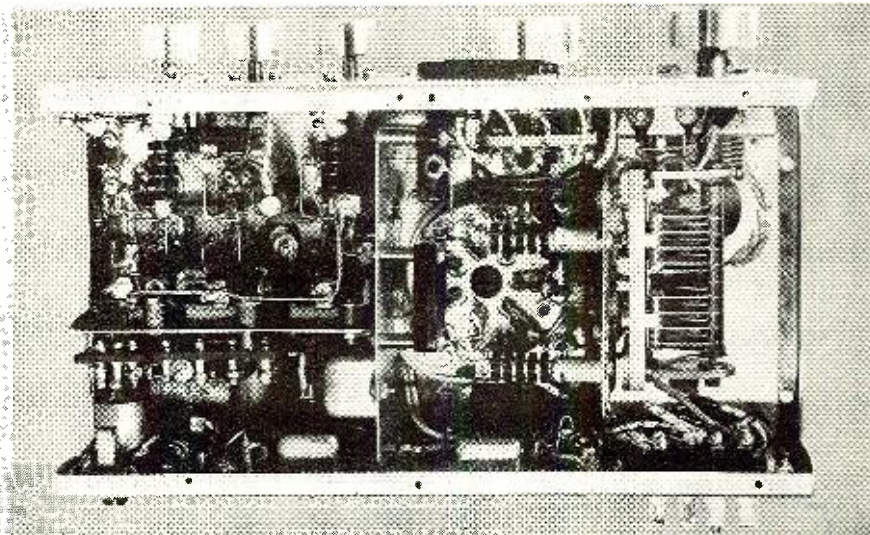



International

SHORT-WAVE

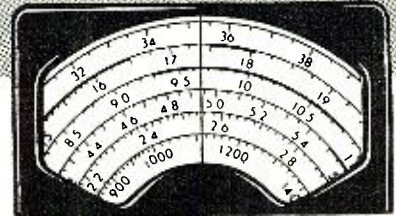

Compiled by **KENNETH R. BOORD**

IT IS a pleasure this month to dedicate the *ISW DEPARTMENT* to s.w. radio outlets in Brazil. The following current data on Brazil stations comes direct from Flavio Serrano, an *ISW DEPARTMENT* monitor in Rio de Janeiro:

The Tropical Band—4.785, ZYM6, Radio Ribamar, Sao Luiz, Maranhao, 0.5 kw.; 4.805, ZYS8, R. Difusora do Amazonas, Manaus, Amazonas, 5 kw.; 4.825, ZYE7, R. Educadora de Parnaiba, Parnaiba, Piaui, 0.5 kw.; 4.845, ZYU8, R. Difusora de Teresina, Teresina, Piaui, 0.5 kw.; 4.865, PRC5, Radio Clube do Para, Belem, Para, 2 kw.; 4.895, PRF6, Radio Bare, Manaus, Amazonas, 2.5 kw.

The 49 Meter Band—6.000, PRK5, R. Inconfidencia, Belo Horizonte, Minas Gerais, 5 kw.; 6.015, PRA8, R. Clube de Pernambuco, Recife, Pernambuco, 25 kw.; 6.085, ZYK2, R. Jornal do Commercio, Recife, Pernambuco, 16 kw.; 6.095, ZYB7, R. Difusora Sao Paulo, Sao Paulo, Sao Paulo, 25 kw.; 6.105, R. Nacional, Rio de Janeiro, Distrito Federal, 50 kw.

The 31 Meter Band—9.500, PRL7, R. Nacional, Rio de Janeiro, Distrito Federal, 50 kw.; 9.505, PRL7, R. Nacional, Rio de Janeiro, Distrito Federal, 50 kw.; 9.565, ZYK3, R. Jornal do Commercio Recife, Pernambuco, 16 kw.; 9.61, ZYC8, R. Tamoio, Rio de Janeiro, Distrito Federal, 25 kw.; 9.77, PRL4, Ministerio da Educacao e Saude, Rio de Janeiro, Distrito Federal, 1 kw.

The 25 Meter Band—11.72, PRL8, R. Nacional, Rio de Janeiro, Distrito Federal, 50 kw.; 11.765, ZYB8, R. Difusora Sao Paulo, Sao Paulo, Sao Paulo, 25 kw.; 11.825, ZYK3, R. Jornal do Commercio, Recife, Pernambuco, 16 kw.; 11.95, PRL5, Ministerio da Educacao e Saude, Rio de Janeiro, Distrito Federal, 1 kw.

The 19 Meter Band—15.145, ZYK2, R. Jornal do Commercio, Recife, Pernambuco, 16 kw.; 15.155, ZYB9, R. Difusora Sao Paulo, Sao Paulo, Sao Paulo, 25 kw.; 15.165, ZYN7, Ceara Radio Clube, Fortaleza, Ceara, 10 kw.; 15.19, PRK9, R. Inconfidencia, Belo Horizonte, Minas Gerais, 5 kw.; 15.37, ZYC9, R. Tamoio, Rio de Janeiro, Distrito Federal, 25 kw.

The 16 Meter Band—17.85, PRL9, R. Nacional, Rio de Janeiro, Distrito Federal, 50 kw.

Construction Permits—For Tropical Band—Radio Poti, Natal, Rio

Grande do Norte; Radio Brasil, Campinas, Sao Paulo, 1 kw. day, and 0.5 kw. night; R. Industrial de Juiz de Fora, Juiz de Fora, Minas Gerais, 0.5 kw.; R. Brasil Central, Goiania, Goias, 1 kw.; R. Quitandinha, Petropolis, Rio de Janeiro; R. A. Voz de Oeste, Cuiaba, Mato Grosso, 0.5 kw.; Government of the Territory of Guapore, Porto Velho, Guapore, 0.5 kw.; R. Relogio Federal, Rio de Janeiro, Distrito Federal. For *Short-Wave Band*—Radio Guaiba, Porto Alegre, Rio Grande do Sul.

Further comments by Mr. Serrano include—ZYE7, 4.825, has m.w. station on 1470 kc., call PRJ4, 500 w.; ZYU8, 4.845, has m.w. station on 1410 kc., call ZYQ3, 1 kw.; PRC5, 4.865, has m.w. station on 1450 kc., call PRC5, also, 500 w.; PRK5, 6.000, has m.w. station on 880 kc., call PRI3, 22 kw., to be increased to 50 kw.; PRA8, 6.015, noted on 6.016, has m.w. station 720 kc., call PRA8 also, 50 kw.; ZYK2, 6.085, effective radiated power is 64 kw., has m.w. outlet on 780 kc., 20 kw. day, and 10 kw. night, also FM stations (4); ZYB7, 6.095, has m.w. outlet on 960 kc., 5 kw., call PRF3, also FM station with call PRF3-FM; ZYN6, 6.105, has m.w. outlet on 1200 kc., 10 kw., call PRE9; PRL9, 6.147, has m.w. outlet on 980 kc., 50 kw., call PRE8, also on FM; PRL7, 9.50, 9.505, 9.72, see PRL9, 6.147; ZYK3, 9.565, see ZYK2, 6.085; ZYC8, 9.61, has m.w. outlet on 900 kc., 5 kw., call PRB7; PRL4, 9.77, has m.w. outlet on 800 kc., 25 kw., call PRA2 (power on m.w. to be increased to 50 kw.; will have new s.w. transmitter of 7.5 kw.

soon), this channel is inactive, station now radiates on 11.95; PRL8, 11.72, see PRL9, 6.147; ZYB8, 11.765, now inactive on this channel, owned by Radio Difusora Sao Paulo, but transmits programs from Radio Tupi, Sao Paulo, which has m.w. outlet on 1040 kc., call PRG2, 50 kw.; ZYK3, 11.825, see ZYK2, 6.085, as this channel is inactive; PRL5, 11.95, see PRL4, 9.77; ZYK2, 15.145, see ZYK2, 6.085; ZYB9, 15.155, noted on 15.156, transmits Radio Difusora Sao Paulo and Radio Tupi programs, also see ZYB7 and ZYB8; PRK9, 15.19, inactive, see PRK5, 6.000; ZYC9, 15.37, is owned by Radio Tamoio but is operated by Radio Tupi, Rio de Janeiro, which has m.w. outlet on 1280 kc., PRG3, 50 kw.; PRL9, 17.85, inactive now, but is expected to be in use again soon see PRL9, 6.147.

PRN9, Distrito Federal Police Dept., 9.29, 5 kw., has daily transmission in Portuguese from 1700; lasts 30 minutes to two hours; programs consist of principal events and news of the Police Department; station maintains correspondence with overseas listeners; QRA is Departamento Federal de Saguranca Publica, Estacao de Radio, Rua da Relacao 55, Rio de Janeiro, Brazil.

Flashes just received from both Mr. Serrano and Hans Leven (of Sao Paulo) state that *Radio Record*, Sao Paulo, has just taken to the short-waves—heard testing around 0600-2100 on 9.590 or 9.595; using m.w. call PRB9, which m.w. outlet, on 1000 kc., is one of the four m.w. stations in Brazil with 50 kw. power; QRA is Radio Record, Rua Quintino Bocaiuva 22, Sao Paulo, Brazil. Mr. Leven reports as *new*, Radio Difusora de Teresina, Teresina, State of Piaui, with call ZYU8, on (announced) 4.845 in parallel with m.w. ZYQ3 on 1370 kc. (m.w. outlet listed 1410 kc. by Mr. Serrano); heard with good signal to sign-off around 2000.

Mr. Leven says PRL5, 11.95, is scheduled weekdays 0400-1000, 1400-2030; Sunday 0700-2030; power 1 kw. (Continued on page 126)

The sound effects department in action during a radio theater transmission at Radio Nacional in Rio de Janeiro, Brazil.



(Note: Unless otherwise indicated, all time is expressed in American EST; add 5 hours for GCT. "News" refers to newscasts in the English language. In order to avoid confusion, the 24 hour clock has been used in designating the times of broadcasts. The hours from midnight until noon are shown as 0000 to 1200 while from 1 p.m. to midnight are shown as 1300 to 2400.) The symbol "V" following a listed frequency indicates "varying." The station may operate either above or below the frequency given.

A HIGH EFFICIENCY TRIODE AMPLIFIER

By
MELVIN C. SPRINKLE

Peerless Electrical Products Div.
Altec Lansing Corporation

Fig. 1. Peerless amplifier which is available in either the kit (10722) or completely assembled form (A-100A).



Design details of a versatile audio amplifier incorporating a preamp and adjustable equalizing network for magnetic pickups.

THE legion of audio enthusiasts who have stuck by their triode amplifiers through thick and thin have been a hardy lot. They have been assailed by the beam power camp and have been deserted by commercial amplifier engineers, but through it all have held the bridge like Horatius. Through all the controversy they have always maintained that "triodes sound better."

The Achilles' heel in their argument, however, has been the inefficiency of triodes. In spite of all the subjective arguments the fact remained that up to the present time triode quality was costly. In order to realize the full benefits of triodes it was necessary to operate with fixed bias—this meant either a higher voltage power supply with higher voltage condensers or a separate bias supply. Furthermore, because of the high bias required, transformer coupling into the final stage was necessary. Resistance coupled amplifier stages just don't put out high quality signals with enough amplitude to drive triodes. Both triode power supplies and/or transformer coupling are expensive.

On the theoretical side, triodes have had at least a strike and a half on them. Assuming proper power supply for both plate and bias, and good transformers, Terman states that the maximum theoretical efficiency of a Class A amplifier is 50%, and that practical amplifiers have efficiencies from 35% down to 20%. This meant that in order to get an output of 10 watts (developed plate-to-plate—not necessarily in the load) it was necessary to put 28.6 watts into a pair of tubes, and if the efficiency was of the order of 20% the input power had to be 50 watts. No wonder that triodes were limited to low output power! As a matter of fact the heads of many designers were scratched in the search for a high plate dissipation triode

without going into the expensive transmitting tubes. The development of Class AB operation was a partial solution as the efficiencies were raised. Terman gives efficiencies of 40% to 50% for this operation, but the tube manual in its typical operation data for 2A3 tubes says that the efficiency is 34.1% when the tubes are operated with fixed bias.

Class AB₁ operation of triodes has become accepted by audio enthusiasts who require high quality, but they have been in general very dubious about Class AB₂. Up to the present time there has been some justification for their doubts. Recently, however, with the general availability of high quality transformers, operation of tubes up to, and possibly into, grid current becomes possible, with no more distortion than strict Class A operation, and with a prodigious increase in efficiency.

Recently the writer has become interested in a circuit which makes possible 18.6 watts output from a pair of 6A5 tubes at a distortion of 5% total harmonics! This represents an efficiency of 49.3%, a truly remarkable achievement. The amazing performance is made possible by two factors: (1) A good output transformer and (2) use of a cathode follower driver.

The output transformer is the heart of an amplifier. Almost invariably the output transformer is the only audio

transformer used, the other stages, with the possible exception of an occasional input transformer, being resistance-capacity coupled. The techniques for building wide range resistance coupled stages are well known and easily put into practice. If the results are not satisfactory, the builder can easily change values until the desired results are obtained. However, when one buys a transformer he must accept whatever the manufacturer puts into the unit. There are a few things that the user can do, but in general these have minor effects on over-all performance. For example, one cannot alter external circuits to improve efficiency—the ratio between primary power and the power delivered to the load.

It behooves the constructor, therefore, to buy the best possible transformer, considering the following points:

(a) Insertion loss. The useful power output of an amplifier is the power delivered to the load, not the power measured plate-to-plate on the primary side.

(b) Power output over frequency extremes. Vast numbers of amplifiers are built by audio enthusiasts who have absolutely no idea of how many watts their amplifiers deliver at 40 cycles and 10,000 cycles. Their conception of performance is based upon frequency response, which is a gain measurement, not a power measure-

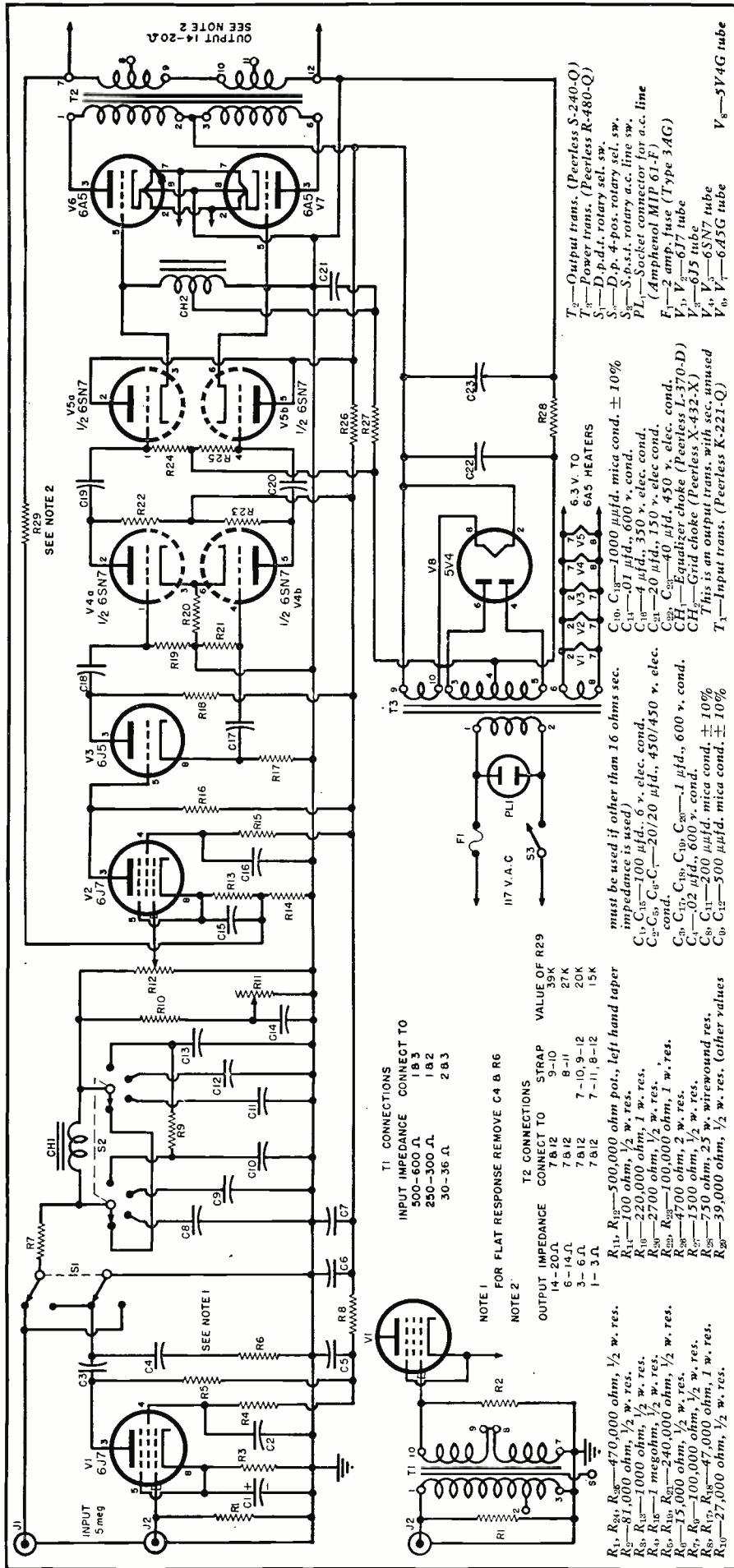

ment. The factors which contribute to power output at frequency extremes are not controllable by the user.

(c) Frequency response. The frequency response of a transformer is a measure of its ability to transmit various frequencies; i.e., it is inherently a gain measurement. As pointed out above, the power output characteristic is often a more important property in output transformers, and it bears no relationship to the frequency response characteristic. On frequency response most manufacturers show response in the audible part of the spectrum, but what is more important is the response at frequencies above and below audibility. This response is of importance because in amplifiers employing inverse feedback, the response must be much broader than the range to be covered if the amplifier is to be stable.

(d) Concomitant with frequency response is phase shift. This is of importance if complex signals are to be transmitted without phase distortion and also if stability with inverse feedback is to be achieved. Phase shift, frequency response, and transient oscillation are most easily checked with square waves.

Most audio enthusiasts are familiar with conventional resistance or transformer coupling to Class A or AB₁ amplifiers. These systems are quite satisfactory within certain limitations, but fail when Class AB₂ operation is approached. The fundamental reason is that when the grid of a tube is driven positive, instantaneously, there is a flow of electrons to the grid, which when they flow through the grid resistor, or even an interstage transformer, produce a voltage which is additive to the tube's bias. The effect is the same as the bias developed in an oscillator's grid leak due to grid current. In the usual Class AB₂ design a special transformer, called a driver transformer, is used, which is a stepdown transformer. In order to supply enough signal with a stepdown turns ratio, and also to supply power to the grids of the final when they draw grid current, it has been necessary to use a power tube as a driver.

Another factor that touches a sore spot in constructors is the cost of a good driver transformer. The cathode follower driver overcomes these limitations. It has been pointed out that a cathode follower is not a voltage amplifier, i.e., the output voltage can approach but not exceed the input signal. However, and this is not as widely known, a cathode follower can be a power amplifier. The power in a resistor is given by the familiar formula $P = E^2/R$. Thus for a constant volt-

Fig. 2. Diagram of the Peerless 10722 amplifier. Circuit includes a preamplifier for magnetic phono pickups. With the addition of a special input transformer (circuit shown in lower left) the amplifier becomes suitable for use with a 30, 250, or 500 ohm microphone or other low-impedance, low level source. The equalizing network can be removed when used with microphone.

age, the power varies inversely as the resistance. Halving the resistance gives a 3 db. power increase for the same voltage. Thus a cathode follower can take in say 25 volts and in its output develop this same voltage (almost) across a much lower load, and thus give a power gain. By simple circuit manipulation a cathode follower driver stage can be direct-coupled to a final amplifier. It is possible to achieve excellent frequency response by the direct coupling and yet supply all the normal d.c. voltages to both stages. A low grid circuit impedance for both a.c. and d.c. is provided and there is sufficient power in the cathode follower to take care of grid current demands should operation in this region occur. The combination of two equally important factors—a good output transformer and a cathode follower driver—produces a high efficiency, high quality circuit that puts the triode on a more equal basis with beam power tubes.

This high efficiency circuit has been incorporated into a general purpose amplifier, specifically designed for high quality music reproduction, called the *Peerless A-100A Amplifier*.

With the development of this amplifier, the problem of low efficiency in triodes has been largely overcome. The unit has a maximum output of 20.3 watts. It uses two type 6A5 tubes in a newly developed high efficiency circuit which makes practical efficiencies of 49.3%. Moreover, and this is the crux of the matter, this power is *useful secondary power*, the implications of which were considered previously.

The frequency response of the amplifier is flat from 20 c.p.s. to 15,000 c.p.s. and is down only ½ db. at 20,000 c.p.s.—an undetectable amount.

The distortion is remarkably low. Using the familiar 5% harmonic content standard, the power output is 18.6 watts at 100 and 400 c.p.s. At 40 c.p.s. the power output is 14.8 watts and at 5000 c.p.s. the power output is 18.3 watts. Using the intermodulation method with test frequencies of 40 and 2000 c.p.s., the power output at 8% intermodulation is 17 watts.

The schematic diagram is shown in Fig. 2, and it will be seen that the amplifier is entirely straightforward in design. The first stage uses a type 6J7 tube as a voltage amplifier. This stage is used as a preamplifier for the magnetic phono pickups so popular in high quality music systems. The plate circuit contains a series resistor-condenser combination, the values of which are adjusted to give the bass boost required for proper equalization of magnetic pickups. A feature of the amplifier is the fact that a chassis cut-out is provided for installation of a *Peerless K-221-Q 20/20* input transformer. With the transformer installed, the amplifier becomes suitable for use with a 30, 250, or 500 ohm microphone or other low impedance low level source, the equalization network being removed when a microphone is used.

Two inputs are provided, one for phono and the other for radio. A switch, S_1 , selects the desired input and grounds the channel not in use to prevent crosstalk. In the phono channel a gain of 107 db. at 1000 cycles is available, which permits full power output from LP records. The radio channel has a gain of 84 db. which is more than adequate for any FM or AM radio tuner.

Following the radio-phono switch, is a four position, pi-type low-pass filter which is intended for record scratch reduction. The filter uses an inductance to give sharp cut-off so that the maximum usable recorded signal can be reproduced, and the higher noise-frequencies eliminated. The circuit must not be confused with resistor-condenser treble roll-off circuits and is quite different in performance. Four positions are provided, the characteristics of which are shown in Fig. 4.

In addition to the low pass filter, there is provided a continuously variable bass boost circuit. A resistor-condenser network is used to provide up to 10 db. of bass boost as shown in Fig. 4. A word of caution might be in order at this time. The bass boost control must be used with discretion, since the transformers provide considerable power at low frequencies.

The second stage uses a type 6J7 tube (V_2), pentode connected to give high gain and very low distortion. A small portion of the cathode resistor is not bypassed as this is used for inverse feedback. The third stage (V_3) is a type 6J5 used in a split load or cathodyne phase inverter circuit. This type of circuit has several advantages among which are almost perfect balance in the output over wide frequency ranges, independence of changes in performance with tube replacement,

(Continued on page 134)

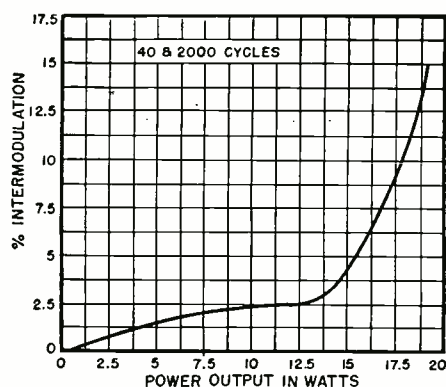

Fig. 3. Power output in watts vs. per-cent intermodulation distortion of amplifier.

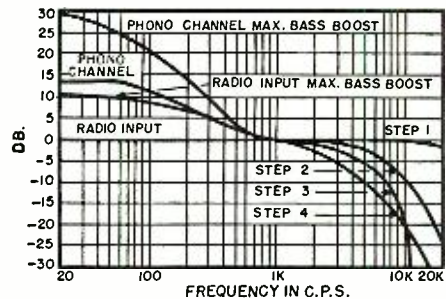

Fig. 4. Amplifier response with low-pass filter and bass-boost circuits operating.

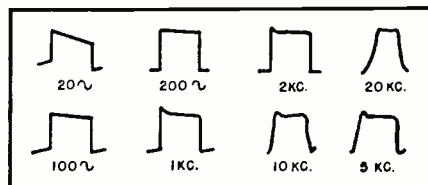
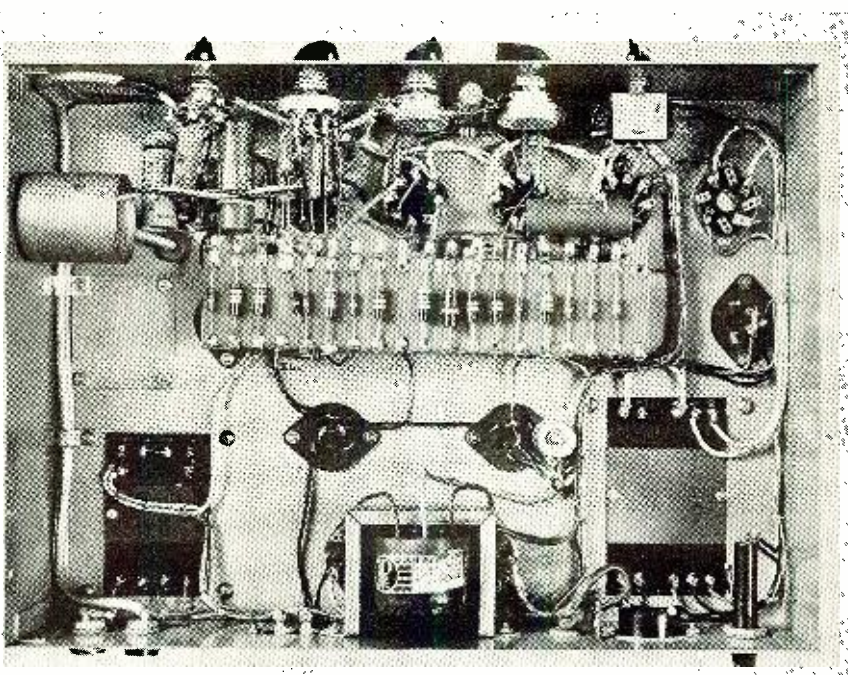

Fig. 5. Square wave patterns at various frequencies throughout amplifier range.

Fig. 6. Under chassis view of the amplifier which may be built from a commercial kit.



Sterling - First "HAM" On FCC



By JACK TERRY

The experience gained in 42 years of radio is now being used to foster all segments of the industry.

WHEN President Truman appointed George Edward Sterling a Commissioner of the Federal Communications Commission, he got not only a top-notch engineer-administrator; he got a radio amateur from Peake's Island, Maine. Sterling is the first and only ham to reach the bench of the FCC.

In 1908, at the age 14, young Sterling became interested in wireless. He talked his chums, Ray Hutchins and Al Ranger, into joining him in this fascinating scientific endeavor. The trio are well remembered by their teachers. One professor recalls, "they were smart as mustard—curious—particularly that George Sterling, but they didn't have the time to study ordinary academic things. Wireless was all that interested them and they would stay up all night combing the air waves with their home-made sets."

One of the trio reported: "We made almost everything we used. We had to buy our headphones though, and had a tough time getting the money. The local druggist, who also operated

the Western Union office, helped us make wet batteries using salvaged carbon poles and zinc from old dry batteries. We made our spark gap out of an old copper lightning rod. That spark gap used to get so hot we were always worried about fire. Our spark transformer was wound by hand."

Reminiscing about those days, Sterling says, "When we started transmitting in 1908 we used the self-assigned call 'GS.' In those days we used a half inch spark coil in the transmitter.

"In 1912 the government licensed me as 1AE. Progress came in the form of a galena detector. And when we finally rigged up a variable coupler, the ultimate was in our grasp. The antenna was a big 4 wire flat-top hung between a couple of 65 foot poles out of the woods.

"The *Titanic* disaster was a first-hand thing to us. Advertised as an unsinkable ship, she rammed an iceberg on her maiden voyage on 1912 with the loss of over 1500 souls. We helped all we could with our wireless. We copied all the traffic—the pitifully

small survivor list was an unforgettable event!"

In 1916 young Sterling went to sea as a pioneer radio operator. This career ended abruptly when the United States declared war on Germany. April, 1917, found his ship returning from South America. On arrival in New York, Sterling found orders to duty with his National Guard unit.

Among the first troops sent to France in the fall of 1917, his special radio talents were quickly recognized. He was transferred from the Infantry to the Signal Corps, commissioned a Second Lieutenant, and assigned as an instructor. It is interesting to note that these few months in the infantry mark his only separation from radio in the 42 years since 1908!

After World War I, the seafaring blood of his Maine ancestry was too strong to resist. It was inevitable that he should return to the merchant marine as a radio operator. For two years he traveled widely, following his profession. During this time he participated in salvage operations following an SOS from the *S.S. Suwide* and was paid \$300 salvage money according to Admiralty Law. He believes with pride that this is the only case on record of a radio operator being paid salvage money.

In 1922 the infant *Radio Corporation of America* invited young Sterling ashore as a Marine Radio Inspector.

A year later he began his long association with the enforcement of radio laws and regulations, joining the Bureau of Navigation, Department of Commerce, as a Radio Inspector.

Questioned as to his ham activities in those days, he replied, "I had a rig on top of the icebox in 1924. It was soon after I was married and space was at a premium in our apartment. That rig used a 5 watter—202—in a Hartley oscillator and its power supply used a chemical rectifier for which I borrowed all my wife's jelly glasses. They were later replaced by *AmRad* S tubes. The receiver was a *Reinartz* tuner. I had a lot of fun. In 1926-27, when I was writing the 'Radio Manual,' that same kitchen and ham setup were used to test out unfamiliar cir-

(Continued on page 122)

Sterling at the controls. Present equipment at W3DF includes an SX-42 and SX-71 double-conversion unit (not shown in photo).



The "ham shack" at W3DF. An HT-18 unit drives either a 600 w. phone or 400 w. c.w. rig. Transmitting gear is home-constructed.



Built-in TV ANTENNA

Complete design characteristics of a tunable built-in antenna used for TV receivers.

By

ROBERT B. ALBRIGHT

Eng. Dept., Philco Corporation

THE increased popularity of the built-in television antenna can be attributed to various causes but the fact remains that most manufacturers have recognized the need for such a unit and are, consequently, equipping their receivers with self-contained antennas.

In most cases the built-in antenna consists of a length of 300 ohm transmission line folded over inside the television receiver cabinet. This antenna may take the shape of an ordinary dipole or the transmission line may be fanned out from the center to form a sort of conical type. In all respects this antenna is essentially an untuned system, but one that can be used in high signal areas to receive a television signal. What are the disadvantages of such a system? The relatively small size of this built-in antenna makes for a very small signal capture area. This may be compared to a fisherman with a net. With a large net he will surely seine more fish than with a small net. Since the antenna is still

Fig. 1. Over-all view of Philco's antenna which is being built into its video sets.

more or less of a dipole, it will be difficult to secure a ghost-free picture in many urban areas. Again, since the antenna is essentially a dipole, its impedance at the feed point, that is, where the transmission line is attached to feed the front end of the receiver, will change radically above and below its resonant frequency.

Some built-in antenna systems use

two antennas, spaced at some angle less than 90 degrees from each other, permitting either antenna to be switched in separately to give some degree of directivity.

The tunable and matched built-in antenna system has several distinct advantages over the previously described types, for by providing a tun-

(Continued on page 144)

Fig. 2. Both series and parallel resonances are used in Philco's built-in antennas.

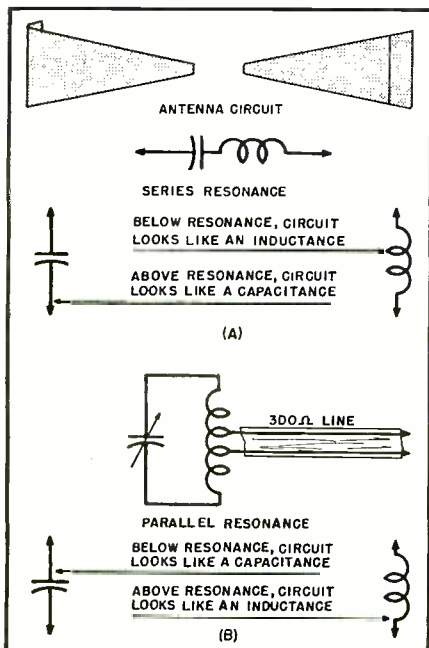
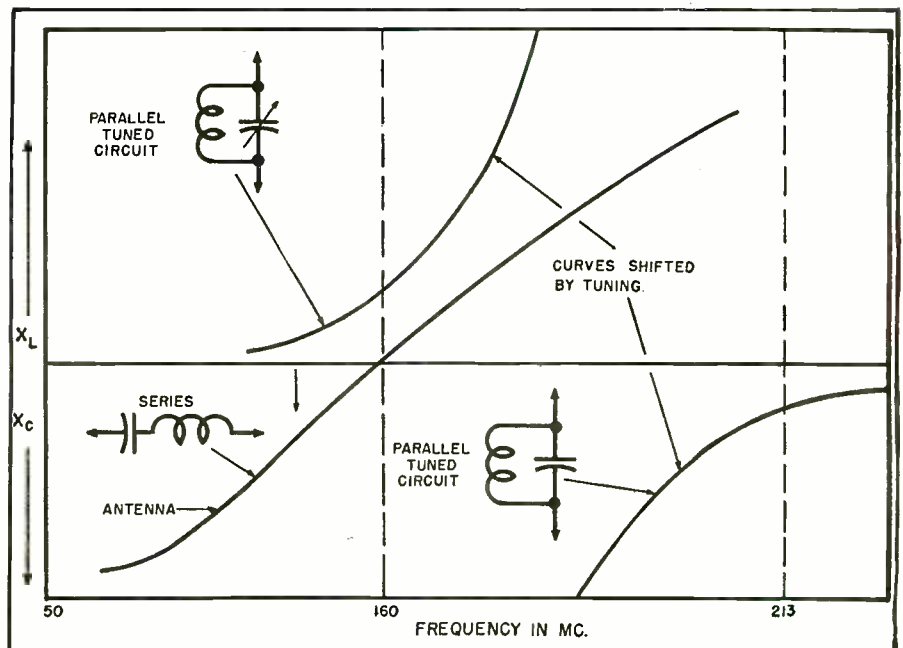

Fig. 3. Graphical representation of the circuit illustrated in Fig. 2, showing how the reactance of the antenna is matched to the load throughout the band.



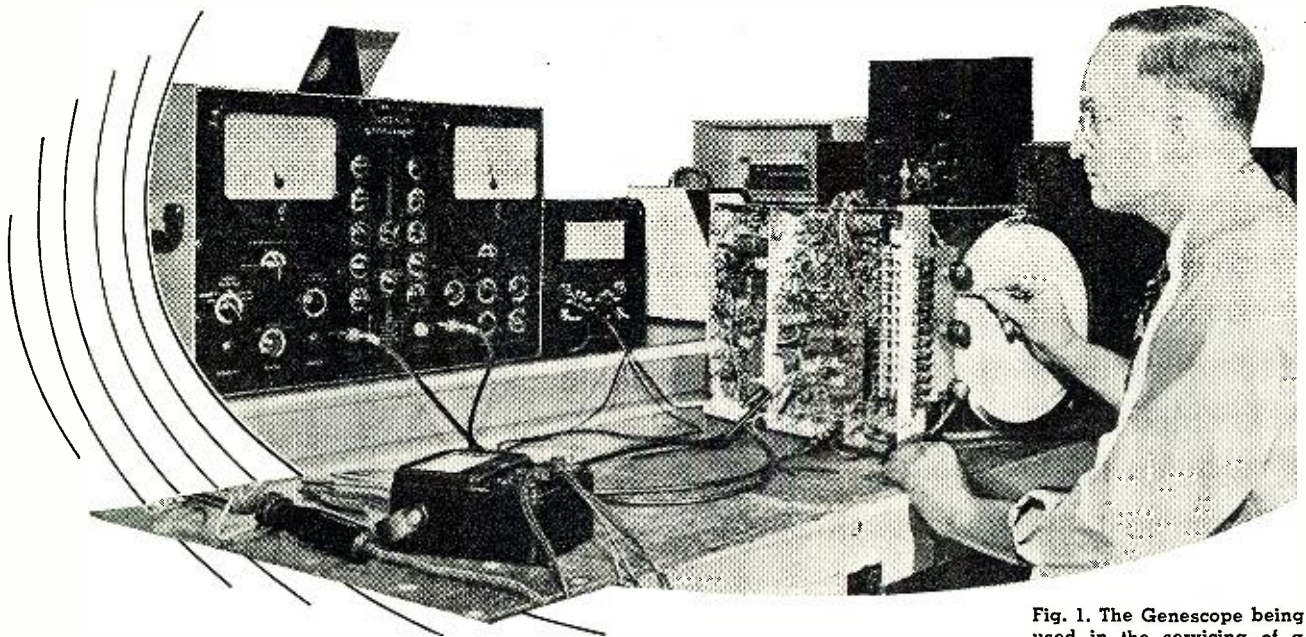

Fig. 1. The Genescope being used in the servicing of a television receiver chassis.

The GENESCOPE—A TV Test Instrument

By MILTON S. KIVER

A marker generator, an oscilloscope, a 400 cycle audio signal, and an FM and TV sweep generator are included in one test unit.

RADIO service technicians, together with radio engineers, long ago demonstrated by their eager acceptance of the multitester, that they prefer test instruments to be as compact and all-inclusive as possible. Thus, the vacuum-tube voltmeter, embracing within itself the functions of an ohmmeter, voltmeter, ammeter, and output meter is today easily the most popular and most important instrument in the service shop or the engineering laboratory. It is accurate, compact, and neat and can be used to perform any of the foregoing functions with a flip of a switch.

Due to this desire for speed and efficiency it was almost inevitable that an instrument like the *Simpson* Genescope should appear. Here, upon one chassis, is available an FM sweep generator, a television sweep generator, a 400-cycle audio signal, a marker generator, and an oscilloscope. In short, everything is provided for the proper alignment, signal tracing, and waveform servicing of FM and television receivers. This instrument, in conjunction with a vacuum-tube voltmeter, represents essentially all of the test and service equipment required by the modern television service shop.

The Genescope, shown in Figs. 1 and 8, is divided into three sections. The left-hand section contains a three-range r.f. generator, a crystal oscillator, and a 400-cycle audio oscillator. Frequencies generated extend from 3.3 mc. to 250 mc., divided into six ranges:

Band A—3.3-7.8 mc. (on fundamentals) and 6.6-15.6 mc. (on second harmonics).

Band B—15-38 mc. (on fundamentals) and 30-76 mc. (on second harmonics).

Band C—75-125 mc. on (fundamentals) and 150-250 mc. (on second harmonics).

The output of the r.f. generator may either be unmodulated or modulated by a 400-cycle note.

The center section of the Genescope contains a 3-inch oscilloscope and all its operating controls. In order to conserve space, the cathode-ray tube is mounted vertically. The pattern on the tube is then made visible to someone standing in front of the instrument by reflection from a tilted mirror mounted at the top of the cabinet. Provision is made for direct connection to the deflecting elements of the CRT by removing a small cover at the lower center of the panel.

The right-hand section of the Genescope contains an FM signal generator, a 140 mc. fixed frequency oscillator, mixer, phasing, and blanking circuits. Frequency-swept signals can be obtained in two ranges extending from 2 to 120 mc. and from 140 to 260 mc. A sweep control permits adjustment of the frequency sweep from zero to over 15 megacycles.

A feature which is unique in this sweep generator is a blanking circuit which injects a negative pulse into the FM oscillator circuit in such a manner that oscillation is stopped during the return trace of the oscilloscope, thereby producing a base line and a single trace response curve on the oscilloscope screen. Thus, as the electron beam sweeps forward, from left to right, the response curve of the circuit under test is traced out. On the return trip, the beam would ordinarily trace back over the response curve produced on the forward sweep. This second tracing is not actually necessary since it provides the same information as the forward trace. Furthermore, there is generally sufficient unbalance existing in the circuit so that the second trace does not coincide at all points with the first trace, thereby producing two curves. See Fig. 3A. In the Genescope, this second trace is removed by stopping the oscillations of the sweep generator during this period. Within the scope, however, the beam is not similarly blanked out, but permitted instead to produce a zero voltage or reference base line. See Fig. 3B. The presence of this base line aids the technician to better orient the various values of the response curve and thereby tends to simplify and hasten the servicing and alignment process. The zero base line proves to be especially valuable for FM discriminator alignment since in this instance the linear portion of

the S-response curve should extend for equal distances above and below this level. See Fig. 3C.

Appropriate connecting cables are furnished with the instrument for making connections between the Genescope and the receiver under test. Also included is a high-frequency probe for signal tracing of high-frequency circuits; this connects to the vertical input jack of the oscilloscope section.

Applications

Any problem in a TV or FM receiver that requires an oscilloscope or an alignment generator can be handled by this instrument. Thus, consider the alignment of a television receiver. The usual order of adjustment is as follows:

1. Video i.f. traps
2. Video i.f. transformers
3. Sound discriminator
4. Sound i.f. transformers
5. The r.f. section

The video i.f. traps require adjustment at certain definite frequencies—each of which can be supplied by the AM generator in the Genescope. As an illustration, consider the typical video i.f. system shown in Fig. 5. The signal output lead from the Genescope would connect to point *F* of Fig. 5, while the ground lead of this cable would be attached to the receiver chassis. The vertical input cable (attached to the vertical amplifier of the oscilloscope) would be placed across the video detector load resistor—point *A* and ground in Fig. 5. The r.f. signal is amplitude modulated by the 400 cycle audio note in order that a varying voltage be developed at point *A*. The visual indication on the oscilloscope will be the 400 cycle sine wave.

Set the r.f. generator for a frequency of 19.75 mc. and adjust the core of L_7 for minimum height of the oscilloscope pattern. If the pattern disappears completely, increase the signal output of the generator until the exact minimum point can be observed on CRT screen. This trap circuit is now properly adjusted. In a similar manner, using the proper frequencies, traps L_5 , L_5 , and L_6 , are adjusted, in each instance making certain that a definite minimum indication is observed on the screen. Particular attention should be given the

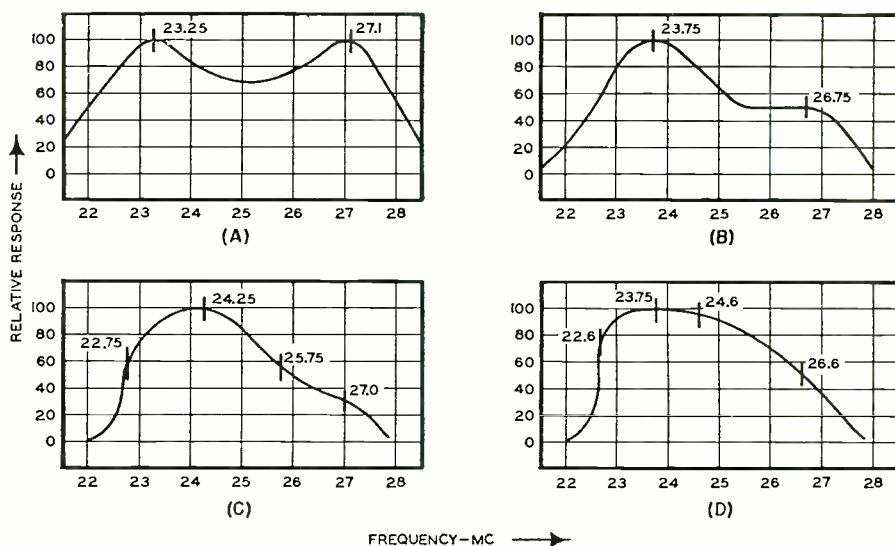

Fig. 2. Response curves for various portions of Philco's video i.f. See text.

21.25 mc. traps since these prevent the sound voltages of the signal being received from reaching the image tube screen.

Coils L_2 , L_{11} , L_6 , L_8 , and L_{11} provide the video response characteristic for this i.f. system and each coil is peaked at its own frequency for maximum indication of the 400 cycle sine-wave pattern on the CRT screen.

Although the accuracy of the AM generator is designed to exceed 1 percent, even greater accuracy is required when adjusting television receivers. For this reason the Genescope is provided with a crystal standard having an accuracy of .05 percent or better. By using this standard and a special scale provided for the AM generator (in addition to its regular scale), frequencies having crystal accuracy may be obtained at any point within the range of the AM generator. This calibrating procedure would be applied to the trap and i.f. peaking frequencies just mentioned, enabling the service technician to adjust these coils to their exact resonant frequency.

After all of the trap and i.f. adjustments have been completed, we are ready to view the over-all response curve of the video i.f. system. Do not molest the connecting cables between the Genescope and the receiver. These remain intact as set for the previous

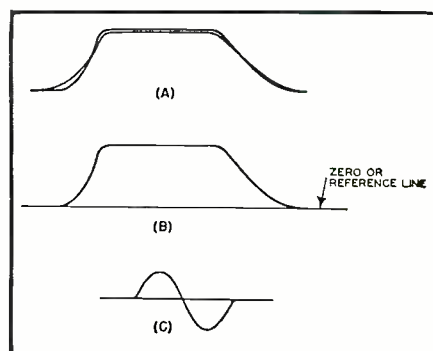

Fig. 3. (A) The response pattern of a video i.f. system as it normally appears. Note the double trace. (B) The same pattern as shown in A with the blanking voltage on. (C) A discriminator response with the special blanking voltage on.



Fig. 4. A video i.f. response curve showing position of marker pip at the point where the video carrier should appear.

adjustments. Merely switch the FM generator to the appropriate range and adjust the sweeping range for a value of 6 to 7 mc. Rotate the phasing control until the two traces visi-

Fig. 5. A condensed and simplified version of the video i.f. system found in many commercially-built television receivers.

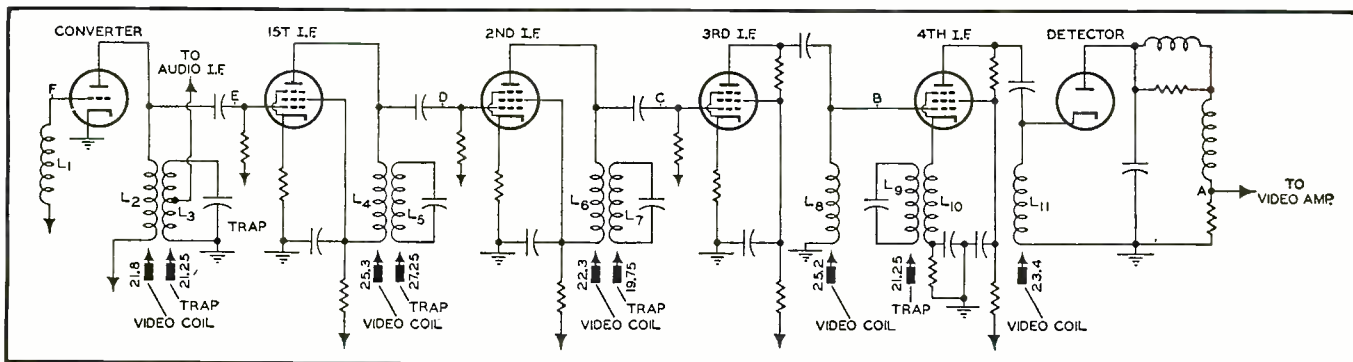

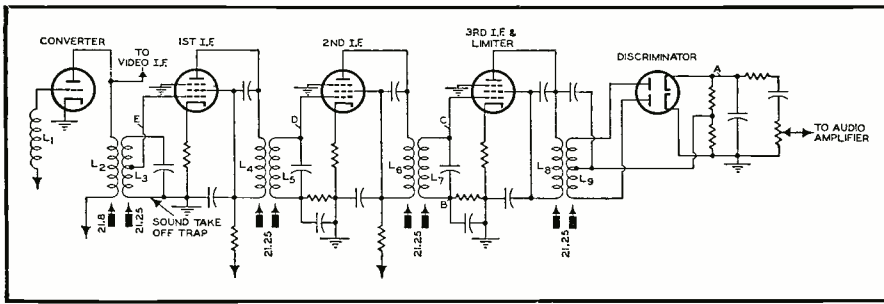

Fig. 6. A conventional sound i.f. system found in many television receivers.

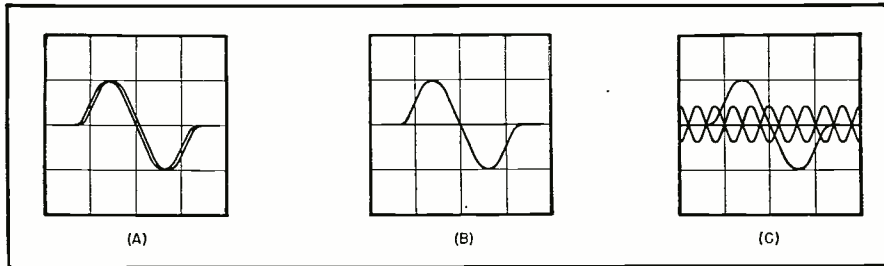

Fig. 7. (A) Discriminator "S" curve before the blanking voltage is applied. (B) The same curve after the blanking voltage is applied. (C) Appearance of the 400 cycle wave, as indicated in text, signifies that discriminator secondary requires some retouching.

ble on the screen blend as closely into each other as possible and then advance the blanking control until only a single trace is seen on the screen accompanied by a straight base line extending across the screen. If the video system has been properly adjusted, the curve shown in Fig. 3B will be obtained.

Since the video response extends for 3 to 4 mc. (depending upon the receiver), it is impossible to judge from a simple viewing of the curve itself whether the carrier and end frequencies are where they should be. Hence, identification markers are required

and these are supplied by the AM generator. This generator is switched to the unmodulated position and set to the i.f. frequency of the video carrier, say 25.75 mc. A pip should appear halfway up the right-hand slope of the response curve. See Fig. 4. To determine the extent of the curve, the frequency of the AM generator is changed until the marker pip appears along the left-hand slope of the response curve. The frequency of the pip can now be read from the scale of the AM generator.

Care should be exercised that the marker pip is kept as low as possible,

otherwise the response curve will be seriously distorted and it will be difficult to establish the exact position of the trace. In this respect a separate attenuator permits the operator to adjust the amplitude of the marker pip independently of the FM sweep signal.

The foregoing alignment considered only a stagger-tuned video i.f. system. Equally good results can be obtained with video i.f. systems using complex coupling. *Du Mont*, *Stromberg-Carlson*, and *Philco* television receivers are good examples of such systems. For these systems, the alignment begins with the last i.f. stage and proceeds back to the mixer. To start, the vertical input cable of the Genescope is connected across the video detector output while the cable from the FM sweep generator is connected between grid and ground of the last video i.f. amplifier. The response curve for the tuned circuit between this last i.f. stage and the video detector will appear on the scope screen. The shape of this curve should be compared with the curve recommended by the manufacturer (in his service manual) for this i.f. stage. If a difference exists, the proper adjustments should be made to bring the response curve into line. Marker frequencies, if desired, can again be supplied by using the AM generator portion of the Genescope.

In *Philco* receivers, the vertical input cable of the oscilloscope is left across the video detector output while the sweep generator output is moved back in turn from the last video i.f. stage (the 3rd video i.f. amplifier) to the 2nd video i.f. stage to the 1st stage and finally to the mixer. In the latter position, the response curve of the entire video i.f. system is obtained on the scope screen. The response patterns for each position of the sweep generator are shown in Fig. 2, together with various identifying frequencies.

In *Du Mont* and other television receivers, the manufacturer recommends that the response pattern of each i.f. stage be considered by itself. To enable the service technician to do this, a high-frequency probe with a self-contained detector is provided. The probe output leads are connected to the vertical input terminals of the Genescope oscilloscope. Now, by connecting the sweep generator leads to the control grid of one i.f. amplifier tube and placing the probe at the control grid of the following i.f. amplifier tube, we will obtain a response curve of the tuned circuit contained between these stages. This procedure can be followed in any tuned circuit in the video i.f. system. In some instances where the stage gain is low, it may be necessary to feed the signal through two stages to produce a usable indication on the scope screen. In this instance, the tuned circuits between both stages would have to be adjusted together.

(Continued on page 108)

Fig. 8. A front panel view of the Genescope, Simpson's new television service instrument.

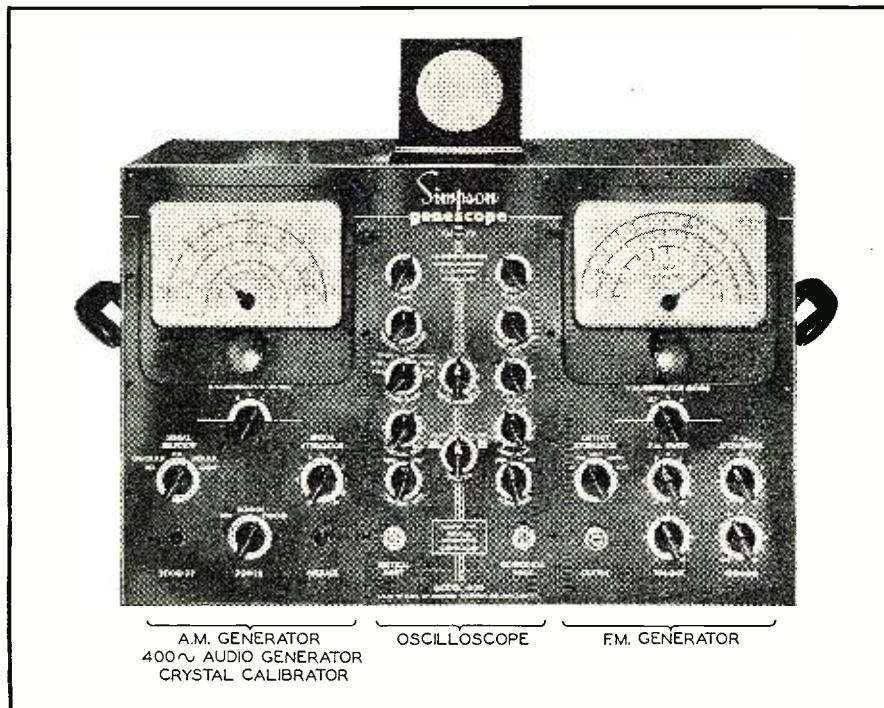

NBFM And Frequency Shift Keying Unit For Self-Excited Oscillator

By **R. W. JONES, WGEDG**
Chief Communications Tech., USN

OF THE many different types of narrow-band frequency modulation circuits none have been described for amateur application using the Miller effect of a vacuum tube. The unit to be described, using the Miller effect of a 6SL7GT, gives good narrow-band frequency modulation with the added feature of frequency shift keying for eleven meter operation.

The input capacity of a vacuum tube depends not only on the actual grid-cathode capacity but will vary with changes in the amplification factor or transconductance of the tube. The change in input capacity with a change in amplification factor is known as the "Miller Effect."

The input capacity of a triode tube with a resistive plate load is calculated from the formula:

$$C_{in} = C_{gk} + C_{gp} (A + 1)$$

Where: C_{in} = input capacity in $\mu\mu\text{fd}$.

C_{gk} = grid cathode capacity in $\mu\mu\text{fd}$.

C_{gp} = grid-plate capacity in $\mu\mu\text{fd}$.

A = gain of triode vacuum tube amplifier.

Note that changing the value of A will change the input capacity of the triode vacuum tube. The amplification of a vacuum tube can be varied by two methods, changing the grid bias or changing the plate voltage. In the application of Miller effect to be described in this article I believe that the plate voltage variation method is the better of the two methods because of better isolation of the audio frequency energy in the oscillator to be frequency modulated.

The complete diagram is given in Fig. 1. The 6SF5 is a conventional audio amplifier stage to amplify the audio voltage from the crystal mike. The heart of the unit is the 6SL7GT, a twin triode with separate cathode connections. Note that the two plates of the triodes are fed plate voltage through a common plate resistor, R_6 .

Any change in plate current to the first section of the 6SL7GT will change the plate voltage on the second section because of the change in voltage drop

The unit, consisting of two tubes as shown, is mounted directly above tuning condenser of author's v.f.o. It is also bolted to the front panel.



Design is based on the "Miller Effect" of a 6SL7GT.
Provides good NBFM and FSK over eleven meter band.

across the plate resistor with changes in plate current. This change in plate voltage in the second section of the 6SL7GT will cause a change in amplification of the second section. Referring again to the formula, a change in the gain A of a triode stage will cause a change in input capacity. The input circuit of the second section of the 6SL7GT is across the grid in-

ductance of the oscillator circuit. Changes in input capacity of the 6SL7GT will cause a change in frequency of the oscillator. The input circuit of the second section of the 6SL7GT is, in reality, then a variable condenser across the grid inductance of the self-excited oscillator. The variable condenser changes capacity with

(Continued on page 98)

Diagram of NBFM and FSK unit. The entire design is based around the 6SL7 tube.

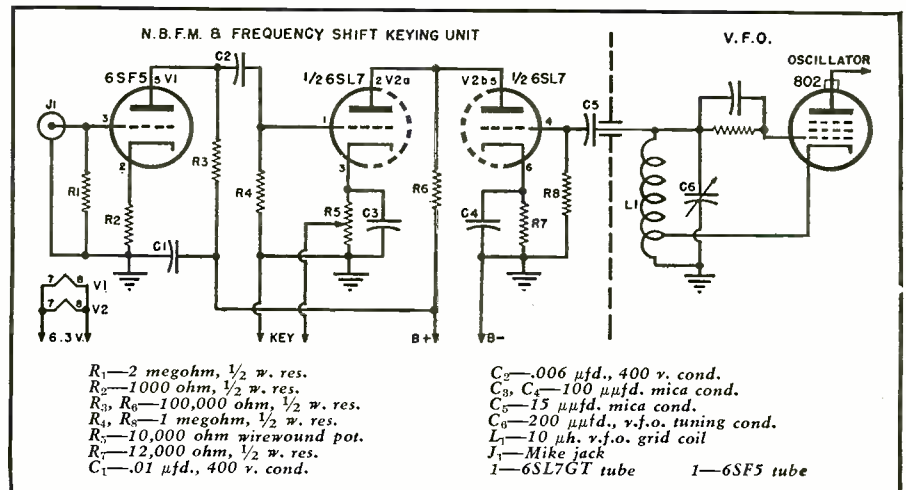

Experimental Magnetic-Type D.C.-A.C. Signal Inverter

By
JAMES KAUKE

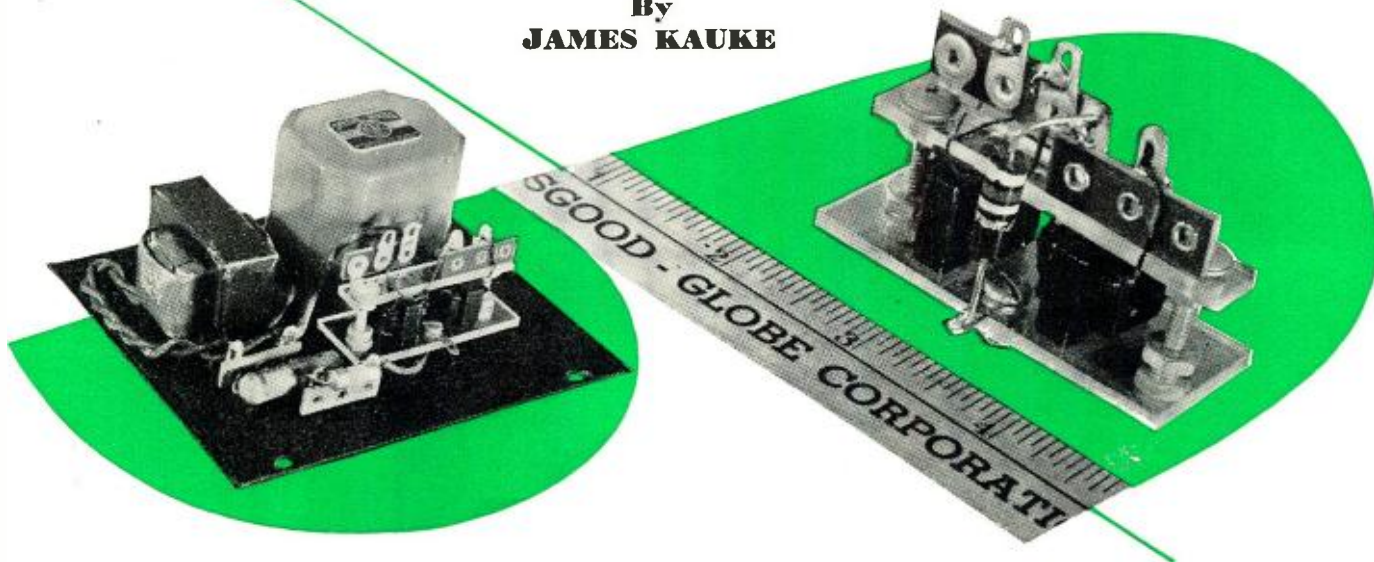

Fig. 1. (Top) A simple, two-transformer type saturable reactor for d.c. to a.c. inversion. This unit was built for installation on audio amplifier chassis to be used for measuring d.c. millivolts. Connections are made to the terminal strip lugs and to load resistor. See Fig. 3A for circuit. The a.c. supply transformer was eliminated as the necessary voltage was obtained from the amplifier filaments.

Fig. 2. (Left) A simple magnetic d.c. amplifier. This unit uses the circuit shown in Fig. 3B. A cable, connected to the terminal strip point, connects with input and output terminals and the power line which is installed in the unit's mounting case.

ELECTROMECHANICAL vibrators or choppers usually are employed as tubeless devices to convert small d.c. voltages to a.c. for measurement or control purposes. A familiar example of the use of such devices is in the amplification of d.c. voltages through a conventional a.c. amplifier. In this application, the small d.c. voltage is turned into a.c. by a vibrator or chopper somewhat similar to an auto radio vibrator. The a.c. is then applied to the input terminals of a regular a.c. amplifier (which can be made much more stable than most d.c. amplifiers). Finally, the output of the amplifier is rectified, and a high d.c. voltage (proportional to the original small voltage) is obtained which may be readily measured or used to actuate a husky d.c. relay.

Electromechanical inverters have proven unsatisfactory to most amateur experimenters because of the presence of moving parts which are subject to sparking, sticking, wearing, noise generation, unsteady output amplitude, and frequency shift. Highly refined vibrators designed for stable instrument use are priced out of the reach of the ordinary experimenter.

By making use of the saturable reactor principle, a simple low-level d.c.-to-a.c. inverter can be constructed without moving parts or tubes. The operating principle of the saturable reactor is quite simple. In its simplest form, this device consists essentially of two coils wound transformer-fashion on a suitable iron core. An alternating current is passed through one winding in series with a load circuit. The d.c. is applied to the other winding. The inductance (and react-

Complete details on a new gadget. This saturable reactor type of tubeless magnetic amplifier can be used for instrumentation and control purposes.

ance) of the a.c. winding changes in accordance with the amount of d.c. flowing through the d.c. winding. As the inductance changes, so does the alternating current flowing through the a.c. coil and load circuit. In this way, d.c. changes are converted readily into a.c. changes. This explanation applies to the most rudimentary type. Most commercial saturable reactors sufficiently sensitive for instrumentation and control are more complicated, but the basic operating principle is the same.

If the core of a saturable reactor has the proper magnetic properties, a relatively large alternating current in one winding can be controlled by a small d.c. in the other winding. This is a type of amplification and is the principle of the *magnetic amplifier*, a device which is assuming increased importance in electronic applications. Saturable reactor devices require only a straight a.c. power supply, an advantage when working for simplicity and compactness.

Like the instrument-type vibrators, commercial high-quality saturable reactors and magnetic amplifier-trans-

formers are priced beyond the budgets of amateur experimenters. This article describes a simple, inexpensive saturable reactor-type d.c.-to-a.c. inverter which can be constructed by the experimenter. Many radio technicians will have the necessary parts already on hand. Aside from the applications listed by the author, the simple inverter can be used for numerous other purposes which will suggest themselves to the ingenious experimenter.

Simple D.C.-A.C. Inverter

A saturable reactor can be made, as shown in Fig. 3A, with two UTC Type S0-2 "Subouncer" transformers, T_1 and T_2 . These are subminiature transformers having cores with high nickel content which enables them to be used much more successfully as saturable reactors than conventional transformers. The secondaries are connected in parallel to handle the a.c. The d.c. signal input voltage is applied to the primary windings which are connected in series *bucking* to eliminate any induced a.c. from the d.c. input terminals. The d.c. input ter-

minals have no particular polarity. The a.c. operating voltage is supplied by a 6.3 volt filament transformer, T_1 . This may be the lowest-current unit available, since the drain is not severe. The a.c. output signal voltage is developed across a 400 ohm load resistor, and may be applied to any high-impedance device, such as an a.c. vacuum tube voltmeter or a.c. amplifier. The signal output voltage will be as steady as the a.c. operating voltage.

A steady value of 0.1 volt a.c. appears across the 400 ohm resistor when no d.c. is applied to the input terminals. This may be reduced to zero by means of an a.c. bucking voltage of the same value applied in series with the resistor, or by means of a bucking voltage applied in series with one of the output leads. If this initial voltage is of no consequence in a particular application, it may be neglected entirely.

The operating curve for this d.c.-a.c. inverter is given in Fig. 5B. It will be observed from this curve that the simple inverter is not an amplifier, the a.c. output voltage being lower than the applied d.c. voltage. However, this is not important, since the chief application of the simple inverter is ahead of a standard high-gain a.c. amplifier, as shown in Fig. 4. In an application of this sort, the small a.c. output voltage of the inverter is applied to the amplifier input terminals. The 6.3 volt operating voltage may be obtained from the filament circuit in the amplifier, and transformer T_1 dispensed with, if desired. The a.c. output of the amplifier is rectified by means of a crystal or selenium rectifier and used to actuate a d.c. milliammeter or husky d.c. relay. A suitable amplifier to use is the familiar 6SJ7-6J5-6V6 (or 6L6) combination. With the inverter-amplifier setup, small d.c. voltages in the millivolt region or less can be measured or used for performing control operations.

It will be noted from the curve, Fig. 5B, that the inverter response is not linear. The shape of the curve is caused by the magnetic properties of the transformer core material. This nonlinearity will occasion little difficulty, however, since a special scale or calibration curve can be drawn for the meter in the amplifier output circuit when the device is to be used for measurements. When the combination is used for control purposes, fixed-point operation ordinarily is desired, and curve shape is of little consequence. Input resistance of the d.c. circuit is 500 ohms. The dotted curve in Fig. 5B shows the d.c. milliamperes drain over the operating voltage range. While the 500 ohm input is a relatively low value, it is considerably higher than the resistance of common d.c. millivoltmeters ordinarily employed.

Fig. 1 shows an assembled simple inverter with transformers T_2 and T_3 and the 400 ohm load resistor. The

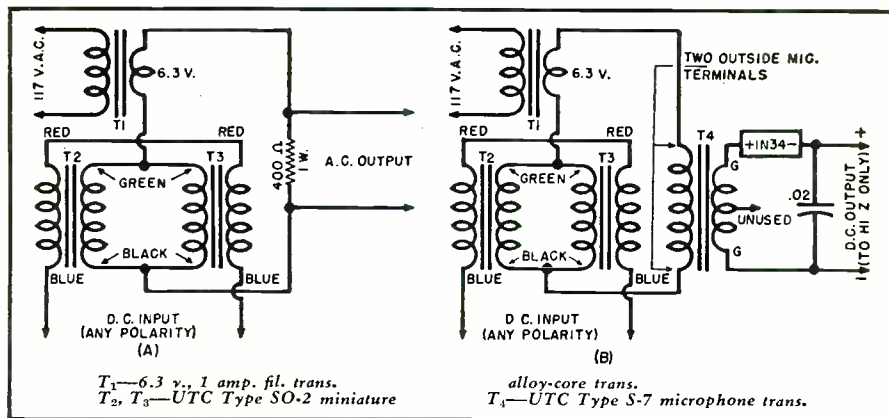

Fig. 3. (A) A simple d.c.-a.c. inverter. (B) Magnetic d.c. amplifier ("d.c. transformer").

6.3 volt transformer was eliminated in this model, since the inverter was built for installation in an amplifier having 6.3 volts available at the tube filament terminals.

Amplifier-Type Inverter

When more voltage output is desired than is supplied by the simple inverter, the 400 ohm output resistor may be replaced by the primary winding of a step-up transformer. This arrangement gives a simple magnetic amplifier, the gain of which is determined by the step-up turns ratio of the output transformer.

Fig. 3B shows such a circuit. Transformer T_1 steps up the output voltage which then is turned back into d.c. by the 1N34 rectifier. The circuit has been referred to frequently as a "d.c. transformer" because it, in effect, steps up a small d.c. input voltage to a higher value through a transformer. If a.c. output is desired, the 1N34 may be omitted and output taken directly from the T_1 secondary.

This circuit permits use of a d.c. vacuum tube voltmeter (connected to the d.c. output terminals of the inverter circuit) to check small d.c. voltages. The curve in Fig. 5A shows operating characteristics of the circuit of Fig. 3B. Note that the voltage gain varies from 5 (for a d.c. input of 0.1 v.) to 11.8 (for a d.c. input of 0.8 v.). The average gain over the d.c. input range of 0.1 to 1.1 v. is 10.4. At d.c. input values lower than 0.1 v., gain falls off rapidly because of the magnetic properties of the T_2 and T_3 cores. This may be improved, along with the gain at all other points, by using a transformer with higher turns ratio than the one specified in Fig. 3B for

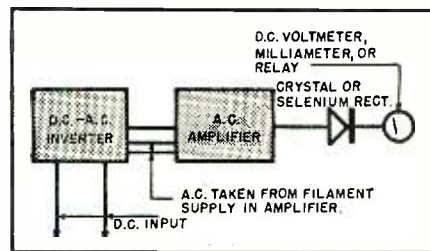

Fig. 4. The d.c. amplifier setup.

T_1 . Inexpensive line-to-grid transformers, for example, are available with turns ratios of 60 to 1 and higher.

A steady d.c. voltage of approximately 1.2 v. appears at the d.c. output terminals when no d.c. is applied to the input terminals. This may be reduced to zero by means of a bucking voltage of the same value applied between the amplifier (inverter) output and the input of the high-impedance load device.

It should be noted that the circuit given in Fig. 3B is strictly a voltage amplifier. It gives neither current nor power gain. For that reason, it must be operated only into a high impedance, such as a d.c. vacuum tube voltmeter or relay-tube grid circuit.

Fig. 2 shows an amplifier type of inverter completely assembled.

Voltage Variation and Impedance

In each of the circuits given, variations of the 6.3 volt a.c. supply voltage will affect the a.c. output voltage value. However, because of the step-down ratio of the 6.3 volt transformer, higher line-voltage excursions can be tolerated than in other circuits. When the inverter is followed by an

Fig. 5. (A) Operating characteristics of the magnetic d.c. amplifier shown in Fig. 3B. (B) Operating characteristics of simple inverter shown schematically in Fig. 3A.

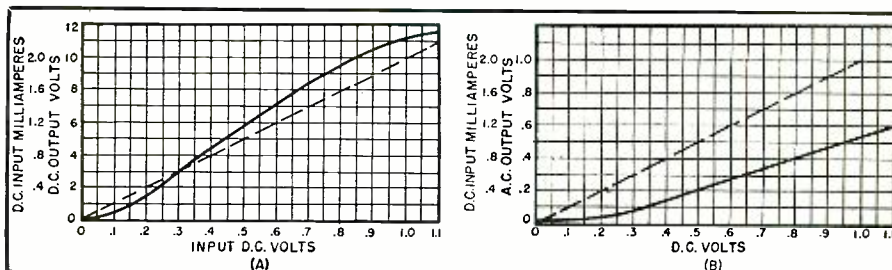

Fig. 1. Commercially-built fan type antenna designed and constructed by Channel Master Corp. engineers.

By
HARRY GREENBERG*
 and
HAROLD HARRIS†
 Channel Master Corporation

DEVELOPMENT of FAN TYPE TV ANTENNA

Design of an antenna which maintains the good broadband performance of conical antennas yet provides better high-band gain characteristics.

THE past year has seen the phenomenal emergence of the conical type as the predominant suburban and fringe area antenna. Its characteristics are superior to the folded or straight dipole type of antenna from the standpoint of gain and of bandwidth. The use of separate high and low sections can be eliminated in most cases. However, this antenna does have several drawbacks. The first is the poor response brought about by its drooping gain characteristic on the

high end of the high band from Channels 10 to 13. (See Fig. 2.) This is accompanied by a splitting of the major lobe into two large side lobes in the horizontal polar pattern. (See Figs. 3A and 3B.) This means that there is both loss in gain on these channels and a high susceptibility to ghosts due to the splitting lobe. The sharp slopes in the gain curve indicate that in a channel having a 6 megacycle bandwidth, there can be differences in gain in an antenna of 2 to 3 db. These sharp slopes

and non-uniform gains introduce distortion to video components of the telecast signal.

About six months ago work was undertaken at the *Channel Master Laboratories* on the design of an antenna which would match or improve the broadband and gain characteristics of the conical antenna without the deterioration of the horizontal polar pattern on the high end of the high band and the resultant drooping gain characteristic.

A brief discussion of field strength standards would help to clarify some of the points which will follow. Field strength contours from transmitters are generally plotted in microvolts-per-meter. Contours are generally shown for 5000 μv ., 1000 μv ., 500 μv . and 100 μv . This means specifically that on the 100 μv . contours, a wire one meter long will intercept that number of microvolts. Fig. 4 shows three contours for a theoretical telecasting setup. For the purpose of this illustration, both Channel 2 and Channel 13 are telecasting from the same point with exactly the same amount of power. A tuned dipole for Channel 2 is roughly two meters long and a tuned dipole for Channel 13 is about half a meter long. This means that at the 100 μv . contour where the one meter wire reference is placed, the Channel 2 dipole will give approximately 200 μv . since it is twice as long as the reference and the Channel 13 dipole will give 50 μv . since it is only half as long as the reference wire. It can be seen that although both tuned dipoles are placed on the same field strength contour, one will give four times as much signal as the other.

Fig. 2. A typical curve showing the gain of a conventional conical antenna.

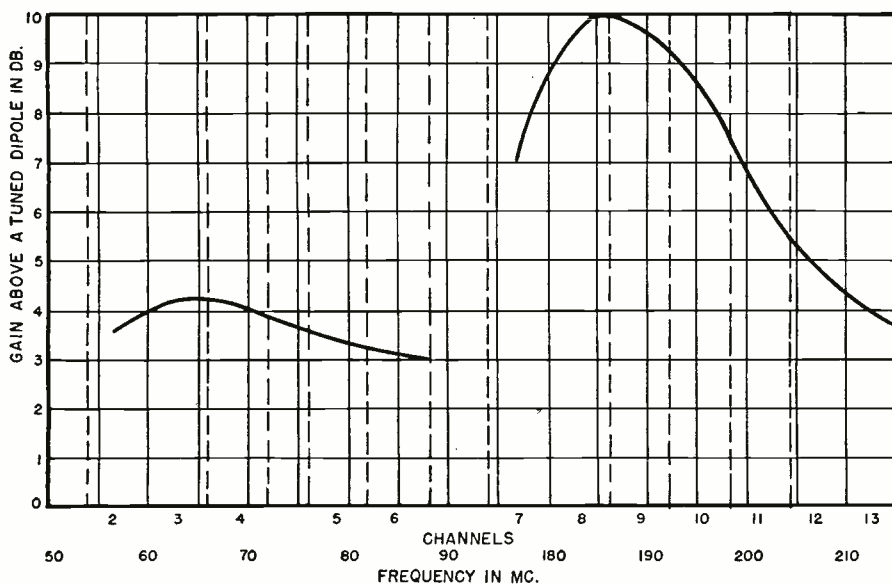

* Chief Electronic Engineer.
 † Sales Manager.

In other words, in areas of equal signal strength, tuned dipoles for low band channels will supply stronger signals to the set than tuned dipoles for high band channels. Moreover, transmission line losses are greater on the high band, and in general, receiver front ends are less efficient on the high band. The chief problem then is to design antennas which can supply more energy on high band channels than the conventional half-wave dipole or dipole and reflector combinations.

Since this is the problem, more energy must be intercepted by the antenna. This means that the high band dipole must be longer than a half-wave. On the average, a half-wave dipole for the low band is three times as long as the half-wave dipole for the high band. This means that three times as much signal would be intercepted on the high band with this dipole. However, since on the high band this low band dipole is three half-waves long, it is operating on the third harmonic at high band frequencies and the resultant lobe pattern is a clover leaf somewhat similar to Fig. 3B. This split lobe means that the antenna is insensitive to "head on" reception and that if one major lobe is pointed toward the station, the other is highly receptive to ghosts and stray pickup. (It is assumed that rear lobes will be reduced by the use of reflectors.) The problem then is to keep the antenna length but to "focus" the energy into one lobe. This is accomplished by arranging the antenna so that it forms a "V" (Fig. 3C). The "V" type antenna gains efficiency as the legs of the "V" become a greater number of wavelengths. The higher the channel, the greater the gain and the narrower the lobe.

However, when this is done, low band efficiency decreases. The reason for this is that veeing forward of the elements reduces the space aperture or area of interception. In addition to this, the nulls at 90 degrees are not complete. (Fig. 3D.)

At this point in the discussion, it is necessary to deviate slightly to consider the evolution and theory of a conical element. What is ultimately accomplished is the incorporation of these two principles, the "V" type element and the conical element into one broadband antenna. The conical element was developed out of the need to create a dipole antenna which would operate efficiently over a wide range of frequencies and also present a relatively uniform impedance over this range of frequencies. A dipole can be considered a special case of the parallel wire transmission line. As is commonly known, the characteristic impedance of such a line depends upon the diameter of the conductors and the spacing between them and is independent of frequency. If such a line is opened and bent so that the two conductors are formed into right angles opposite to each other and each conductor is cut a quarter-wavelength from the bend, a half-wave dipole is obtained. Before the bend, while the

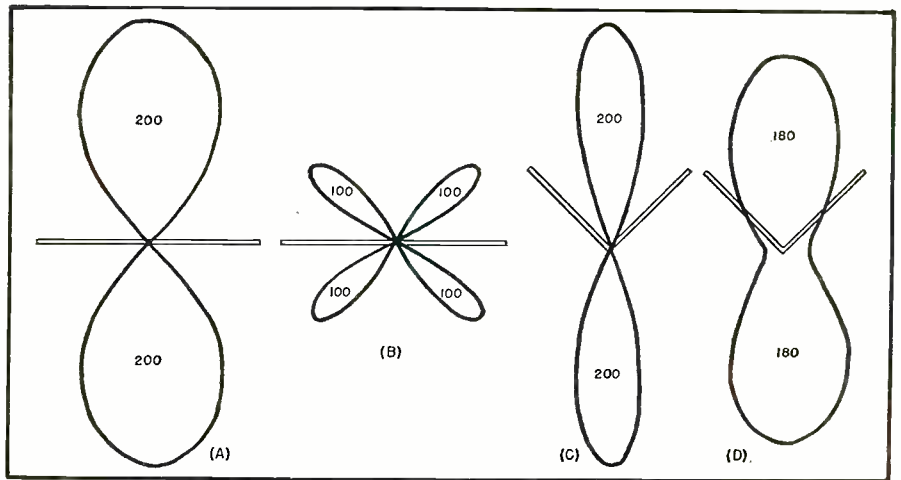

Fig. 3. (A) Horizontal pattern of half-wave dipole cut for Channel 2. (B) Pattern of same antenna when operated on its fourth harmonic or Channel 13. (C) Pattern of antenna shown in B when the elements are bent into the form of a "V". (D) pattern of this same "V" antenna when it is used on Channel 2.

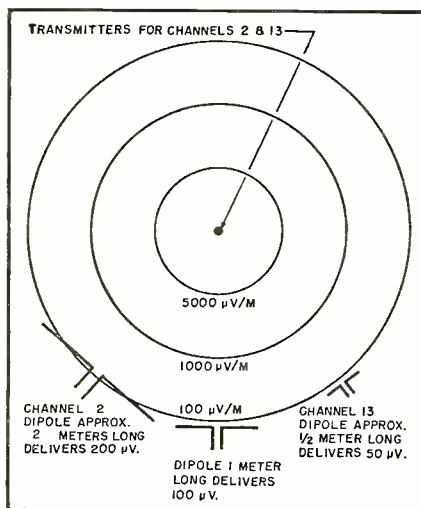

Fig. 4. Reduction in gain of a Channel 13 dipole due to its shorter physical length.

wires are still parallel to each other, voltages and currents in each conductor are equal and opposite as are the fields surrounding these conductors (Continued on page 132)

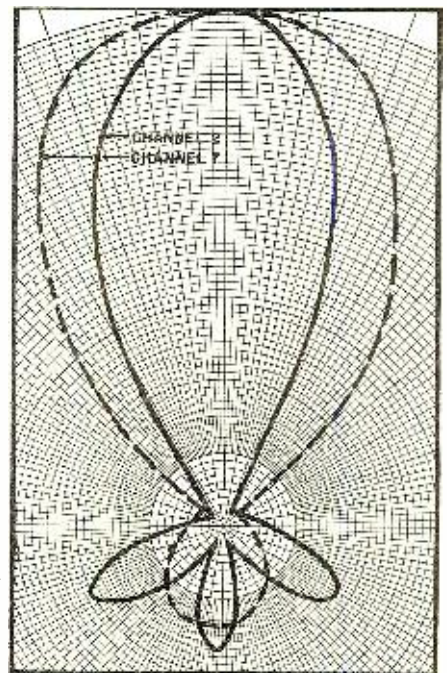
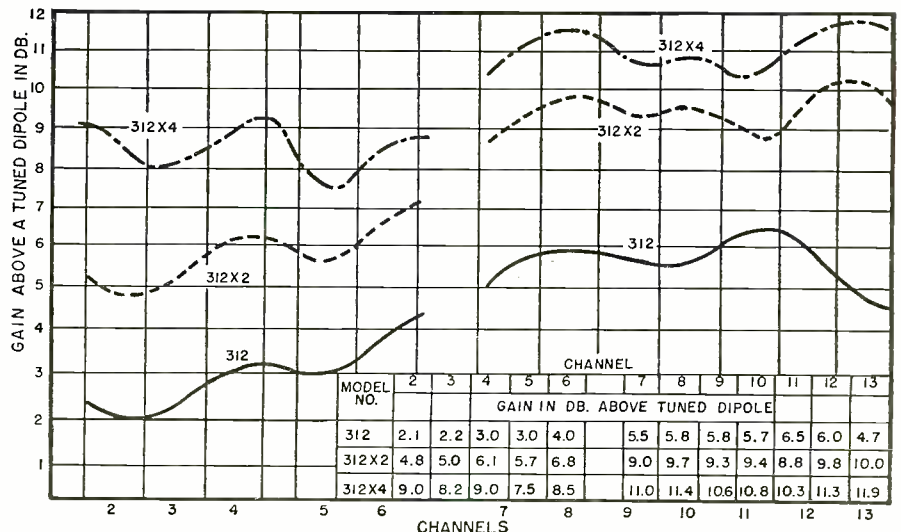

Fig. 5. Polar pattern of fan antenna.

Fig. 6. Gain curves for single, double, and four-bay arrays.



Mac's RADIO SERVICE SHOP

By JOHN T. FRYE



MAC'S "SYSTEM"

IT WAS really too nice an afternoon to work. The whole early May day had been a sneak preview of late June. Outside the open door of Mac's Radio Service Shop the warm sun beat down on the concrete sidewalk that had been washed clean by a shower the night before and sent shimmering heat waves rising through the quiet air. Only the ever-busy, worm-stretching robins seemed to feel industrious.

Inside the service shop that noon hour there certainly was no out-of-tune display of ambition. Mac himself occupied the high stool that was precariously balanced on two legs so that he could lean back against the wall of the service department. Across from him Barney, the apprentice, sat on the service bench with his long legs doubled up and his arms clasped about them so as to form a rest for his chin.

"Hey, Mac," the boy finally drawled.

"Uh huh," Mac acknowledged.

"A guy down at the radio club last night asked me what kind of a system of troubleshooting you use. He looked at me kind of funny when I said I didn't know. What system do you use?"

The stool came down on four legs with a thud as Mac straightened up. "That darned question always makes me mad!" he exploded. "A lot of people can't rest until they get any form of activity boiled down to a neatly-labelled little 'system.' The next time he asks, just tell him we use the looking-and-thinking system."

"Don't you believe in using a regular method in running down trouble?"

"Depends on what you mean by 'regular method.' If you mean working logically from observed symptoms

to likely causes of trouble, I certainly do; but if you mean a religious and exclusive following of the voltage-checking system, the resistance-measurement system, the signal injection system, the signal-tracing system, or the touching-the-grids system—which I now see labelled with the hoity-toity name of 'circuit disturbance method'—the answer is a flat and emphatic No."

"You don't use any of these?"

"I use all of 'em—and a lot of other 'systems' besides. As far as I am concerned, I need everything I can lay my hands and brains on in running down trouble in a receiver. When an intermittent and I go to the mat, it is a fight to the finish with no holds barred. Those devils employ every trick they can hatch up to keep you from finding what ails them, and if you fight fair by following some sort of electronic Marquis of Queensberry rules, they'll tie you up in knots.

"Just look at how dirty they play: a mica condenser, that ought to be like Caesar's wife, above suspicion, will become leaky just often enough to escape an investigation until you have exhausted every other possibility. And then there are those sets that behave like angels on the bench but start cutting out just as soon as you have them all bolted down in the cabinet. When you are dealing with fiendish cases like those, it is no time to be hobbled with a single system. You need every method of diagnosis you can conjure up and a strong dash of inspiration besides."

Barney drew a careful bead on the doorknob with the solder gun as he asked, "You say you need to use everything?"

"That's right. Take the eyes: when I turn on a set, the first thing I do is to look at the rectifier to see if it glows that gorgeous shade that indicates gas or if the plates turn a cherry red because of a shorted filter condenser.

"The nose comes in mighty handy, too. One whiff of the inside of a cabinet in which a power transformer has been too hot is all a service technician needs to tell him that he had better do some checking before he turns that set on."

"And I suppose you use the master's touch to fix them," Barney suggested.

"Modesty forbids my saying Yes," Mac replied with a grin; "but the sense of touch is really a very useful service tool. It will locate a stone-cold metal tube with an open filament or spot a leaky filter condenser that is running a temperature and should be replaced; moreover, a finger probed lightly around the rim of a speaker with a rubbing voice coil will quickly tell you *where* it is rubbing and which way it should be moved to free it.

"I don't think I need to go into any illustrations of the hundred and one things your ears can tell you about a sick set. If you just know how to listen, it will babble all its symptoms to you. I must admit, though," he said musingly, "that I have never been able to figure out a way to use the sense of taste to help fix radios. I wish I could."

"If you forget how the polarity of a bias cell goes, you might try touching a couple of leads from it to your tongue," was Barney's bright suggestion. "I think the positive lead—or maybe it's the negative one—is supposed to taste salty."

"I'll remember that valuable suggestion," Mac promised dryly. "Seriously, though, all of the well-known methods of running down trouble have good qualities, and I want you to be perfectly at home with any of them. Quite likely any one of them, if followed carefully, would eventually spot a trouble; but the service technician can make much better time if he has all of the methods at his finger tips and can change freely from one to the other as he tracks down a receiver fault. Each of the systems should be looked on as a service *tool*. Just as you pick up first one tool and then another when you are working on a mechanical job, so you should be able to switch from one system to another when you are cornering an electronic trouble."

"Let's have a 'ferinstance,'" Barney suggested.

"Well, for instance, suppose you turn on a set and start checking the voltage. You find voltage at the rectifier cathode and the plate of the output tube, but there is none on the i.f. tube plate. It is a good idea to turn the set off at once because of the possibility that there may be a short somewhere that will burn up a resistor—perhaps inside the i.f.—or do

(Continued on page 82)

Design Considerations For High-Quality Reproducing Systems



Fig. 1. Over-all view of audio amplifier built by the author. The unit incorporates many of the design features covered in text. Schematic diagram appears on page 72.

By
HERB MATTHEWS

Part 2. Frequency characteristics of various RC tone control circuits used in high-quality audio amplifiers. The concluding article of the series.

“ONE control” is an ill-used phrase which has been employed to describe a multitude of functions and hide a multitude of sins. Tone controls may range from a simple capacitive roll-off, intended to reduce noise and distortion, to a complex *LCR* network designed to make every music lover his own conductor with complete control over the tonal balance of the orchestra. Neither of these extremes are befitting a high fidelity system. (The term “high fidelity” is used in its pure sense with blatant disregard for its corrupted connotation.)

Tone control, or equalization, may be considered in two distinct classifications: equalization to offset deficiencies (which are generally fixed) in the reproducing system and equalization to offset deficiencies in the original program material. Unless this distinction is recognized it is impossible to design or operate tone controls intelligently.

Deficiencies in the reproducing system may include anything from a phonograph pickup to a human ear. The effect of loudness variations of the ear was covered in Part 1; any other deficiencies in the ear need not affect the audio designer. If a listener has a 10 db. peak in hearing perception in the range of 1000 to 3000 c.p.s., there is no point in trying to change his tonal perspective in the reproducing system because all sounds will be natural to him with the frequency

distortion to which he has become conditioned. If his hearing falls off rapidly above 5000 c.p.s., however, do not expect him to appreciate the full tonal beauty of your wide-range system.

As was illustrated in a preceding article, variations in the loudspeaker system are something which frequently occur and for which compensation may be introduced. Variations in amplifier transformers may also be compensated for by equalization. However, poor frequency response in a transformer is usually indicative of other deficiencies and though the frequency response may be flattened out by means of equalization, other distortions cannot be removed so simply. Where high quality is desired, the best obtainable audio transformers should be used.

The loss of high frequencies in amplifier circuits because of shunt capacities and Miller Effects can readily be compensated by simple treble boost circuits. Low frequency loss is primarily a result of undersized coupling and screen and cathode bypass con-

densers. These components are relatively cheap and you can generally afford to use larger sizes than those specified by many designers with beneficial results. Small losses in various stages of an amplifier can multiply to surprising proportions; when an amplifier is found to have inadequate frequency response it will usually be due to more than one cause.

Deficiencies in input sources such as phonograph pickups, microphones, and radio tuners can usually be made up but not always as readily as those previously discussed. When compensating for high frequency losses it must be remembered that a rising high frequency curve emphasizes distortion. A distorted wave (Fig. 2A) having its high frequency components (harmonic distortion) emphasized would look greatly distorted (Fig. 2B) if observed on an oscilloscope. If, however, a wave of the form of Fig. 2A were passed through a system with high frequency loss (Fig. 6A) and then through a corrective equalizer, its harmonic distortion would remain unchanged. There is, therefore, a limit to the benefit accruing from treble equalization and the best means of achieving real high fidelity is the simple expedient of having every part of the system flat. (This, of course, is a bit more difficult than it may sound.) Corrective equalization is a very useful device, but its proper use must be based on careful consideration of all factors.

The acoustics of the room, then, should also be considered as a property of the reproducing system. A heavily carpeted room with drapery and upholstered furniture will absorb high frequency energy to an abnormal degree. This will not only cause an

Fig. 2

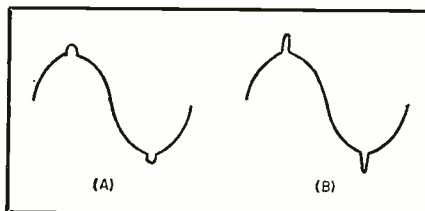

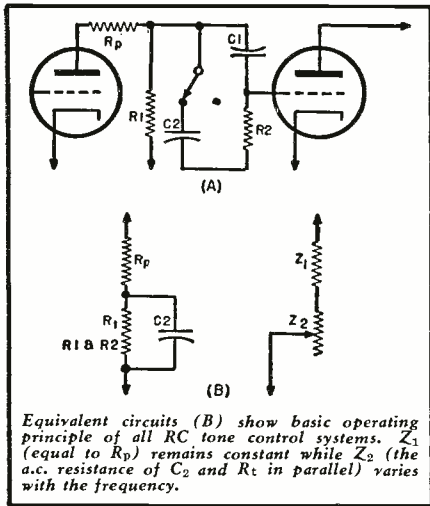

Fig. 3

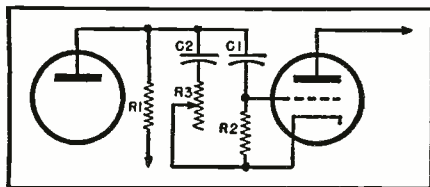

Fig. 4

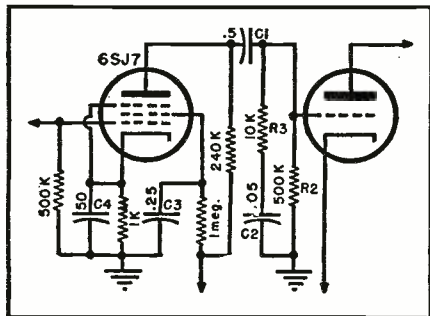

Fig. 5

acoustic attenuation, particularly of the higher frequencies, but will also shorten the reverberation time in the treble region, effecting a marked loss of brilliance. For this reason high frequency boost may be desirable in this type of room; conversely a treble drop may be required in a room with large, smooth-surfaced areas. Other characteristics of the room may affect the response in other portions of the audio spectrum. For example, a long room may act as a resonant air column and produce a peak at certain low frequencies which will result in boominess.

After the reproducing system has been made as flat as possible, the system may still sound unbalanced because nothing has yet been done to equalize variations in the program source. These variations should actually be compensated for in a recording or broadcast studio control room, but unfortunately there are not only differences of opinion as to what correct balance should be, but there are also different recording standards. Low frequency turnover points vary from 250 to 1000 c.p.s. and high frequency pre-emphasis varies considerably among different recording studios. In many broadcast studios it is the practice to place bass instruments abnormally close to the microphone as a means of compensating for poor low frequency response in most home receivers.

These external variations in frequency response may change every time a radio program source changes or a different record is played. For this reason "tone controls" intended to compensate for these changes should have great flexibility and should be convenient to use. The author firmly believes that the only panel variable tone controls provided should be for

compensation of program differences and that the deficiencies peculiar to the reproducing system should be taken care of by fixed pre-set equalizers.

Now that the need for equalization and the philosophy by which it should be applied has been explained, actual tone control circuits may be discussed. The most familiar circuit is the treble cut-off tone control found in most commercial radios. It may be a single condenser switched across the audio section (Figs. 3A and 6A) or a volume control type of rheostat which may be used to connect it into the circuit gradually (Figs. 4 and 6B). In the circuit of Fig. 3A it will be observed that the impedance (a.c. resistance) of C_2 will vary with frequency as follows:

At all low frequencies up to a certain point, P , (Fig. 6A) which shall be called the take-off point, the impedance will be higher than the total impedance across the tube, R_1 . $R_1 = (R_1 + R_2) / R_1 R_2$. Don't be afraid of the algebra. All the formula means is that the resistance R_1 is equal to the total resistance of the two parallel resistors shown in Fig. 3A. It will be necessary to understand the behavior of R_1 in all circuits to be presented in order to apply them properly to any given existing circuit. If you are not yet used to the mathematical form of presentation, now is as good a time as any to familiarize yourself with it. The more you understand about the behavior of radio circuits the more you can do with them.

To continue with the action of a treble cut-off; as the impedance of C_2 approaches that of R_1 , C_2 will begin to absorb power and a voltage dividing network will be operating. From this point on, the amplification will halve as the frequency doubles. This is equivalent to saying that the frequency response of this circuit drops at the rate of 6 db. per octave. The limit which can be accomplished with any single stage of RC tone control of any form is 6 db. per octave. Because of the shunting action of R_1 across C_2 the theoretical maximum of 6 db. per octave is never reached.

When a resistor is connected in series with C_2 (Fig. 4), it limits the maximum effect that the condenser can have and further reduces the slope. As shown in Fig. 6B a variable resistance can make the curve move vertically to any desired degree within the 6 db. per octave limit. Changing the value of C_2 will make the curve move horizontally as desired. Doubling C_2 would move the take-off point one octave (a frequency ratio of 2 to 1) toward the low frequency end of the curve. Using just C_2 it can be seen that the treble range would be seriously affected, but if a limiting resistor is inserted into the circuit the entire frequency spectrum is easily controlled. Fig. 5 shows a practical circuit used in the amplifier illustrated in Fig. 1 to produce bass boost with the response of Fig. 7A. It will be noticed

Fig. 6

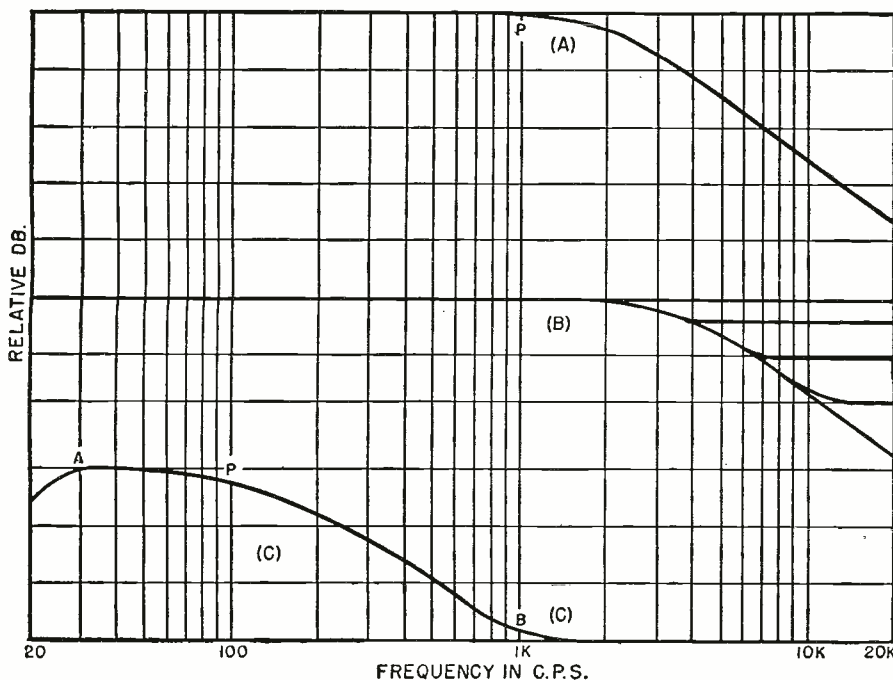

that a pentode tube is specified. The reason for this is that the plate resistance of a triode is so low that the triode operates at constant voltage and the voltage dividing network described above will not operate. With a pentode the plate resistance is quite high and a constant current condition exists. Where a triode is used, the circuit of Fig. 8 will produce approximately the same frequency response; however, the insertion loss of the frequency controlling network will be somewhat greater.

It will be helpful to review the various points of Fig. 6C so that if a different curve were desired by the reader he might readily make changes in the circuit constants to suit his requirements. The point labeled *A* is the point at which the low frequency response falls off. As in any other resistance coupled circuit this point is controlled by the size of the coupling and bypass condensers, C_1 , C_3 , C_4 of Fig. 5. Satisfactory formulas for computing these values for any desired frequency will be found in the "Sylvania Technical Manual" (page 25, 7th edition). The point *P* is the same as previously discussed and is controlled by the size of C_2 . For any given value of C_2 the location of point *B* is determined by the size of limiting resistor R_3 . If point *P* were to be moved down one octave by doubling C_2 , point *B* would also move down one octave. To move point *B* back up one octave halve the resistance of R_3 . This effectively increases the length of the slope *P-B*, and therefore increases the total boost and the insertion loss. See Fig. 7.

It may be seen that any response desired may readily be obtained along a 6 db. per octave slope using simple RC circuits. Obviously a smaller rise than 6 db. per octave might be required and this may readily be accomplished by placing a shunt resistor (R_s , Fig. 10) across C_2 or by making R_3 (Fig. 5) large. By making R_s variable a simple variable bass boost results. By using two stages of bass boost a 12 db. per octave slope may be approached and by using a dual pot to serve as R_s in each stage any desired boost from 0 to nearly 12 db. per octave results. (Fig. 10.) Constants for this circuit are the same as for Fig. 5 with R_s equal to 1 megohm.

It might be required that a complex curve be produced for low frequency equalization. Combinations of various boosts such as those shown in Fig. 7 could be added together by making the constants of the two stages different. The permissible combinations are almost infinite. Another arrangement which permits the take-off point of the curve to be moved about at will by means of a panel control is shown in Fig. 9. For the constants given, rotation of R_2 will produce any of the curves shown in Fig. 11 including intermediate values. The operation of this novel circuit is easily explained. With R_2 set nearest R_1 , both condensers are shorted to ground and no boost will result. With R_2 at the center po-

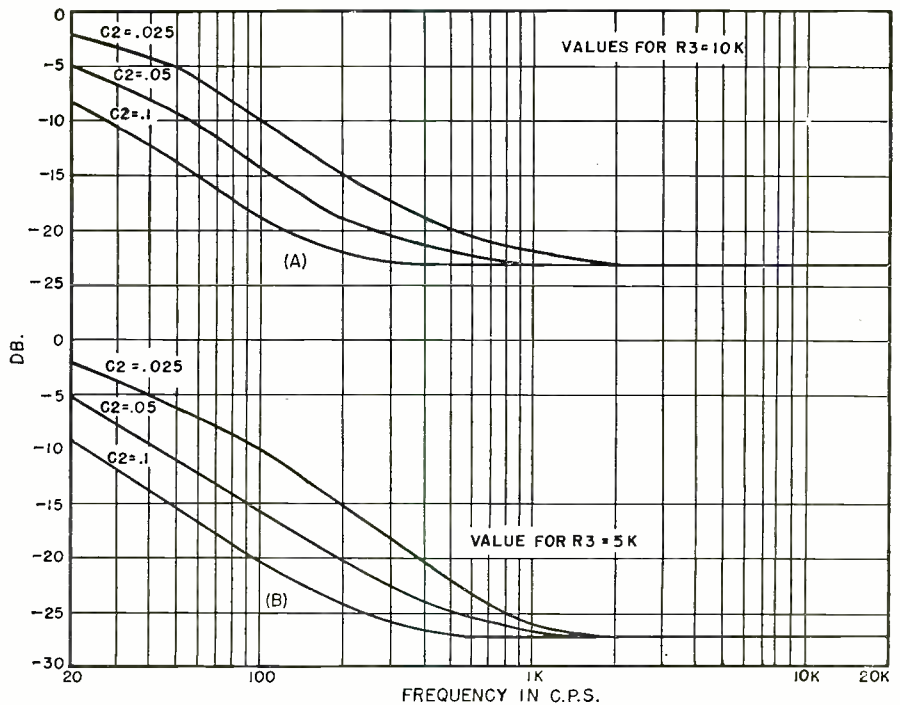

Fig. 7

sition the two condensers are effectively in series and therefore their effective capacity is .008 μ fd., resulting in a 6 db. per octave boost starting at about 2000 c.p.s. This characteristic is ideal for aural compensation at low volume levels. As the control moves toward the other end the effective capacity approaches .05 μ fd., resulting in a 6 db. per octave boost rising from about 300 c.p.s. This control has been found to be very effective.

All of the circuits discussed so far are of the low-pass type. The curves produced all slope downwards and the only factor that determines whether they are low or high frequency controls is the size of C_2 . Let us now turn our attention to circuits whose curves slope in the other direction, the high pass type of equalizer. Fig. 12 illustrates a filter so simple that you may not recognize it, although you may have unwittingly designed it into some of your own equipment.

C_1 is the basic high pass filter. Its characteristic slope is also 6 db. per octave and its low frequency effect may be limited by a shunt resistor across it. Fig. 14 illustrates a simple

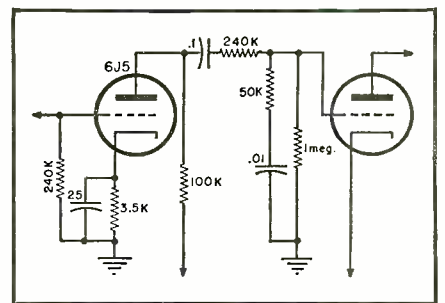

Fig. 8

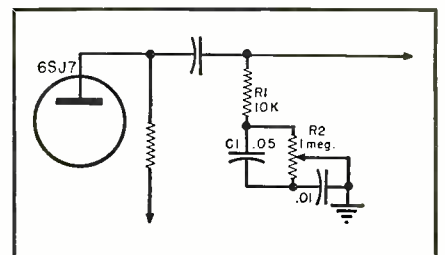
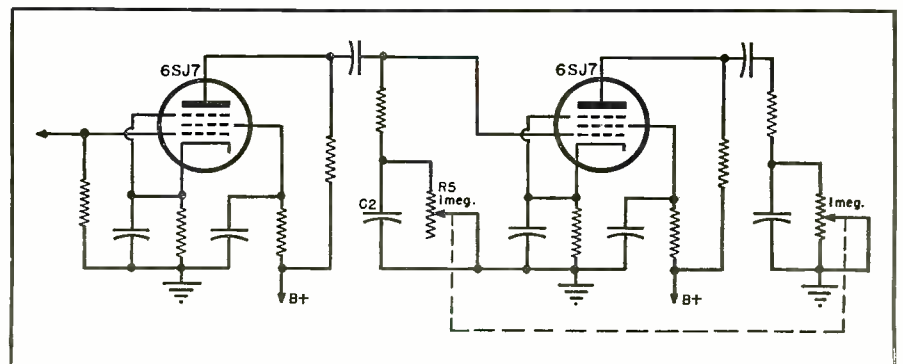

Fig. 9

high pass circuit which will suffice for almost all treble boost circuits. The

Fig. 10



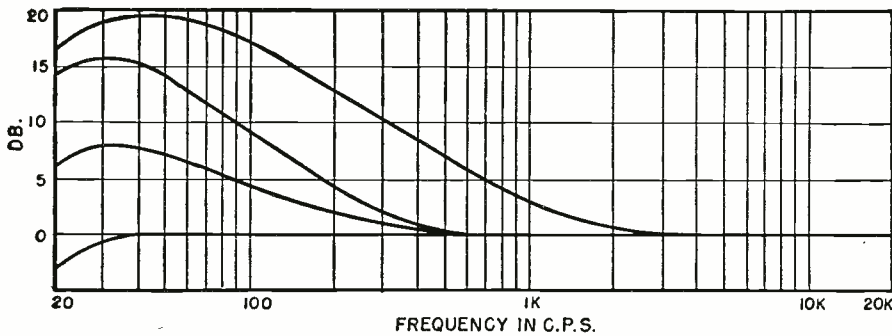

Fig. 11

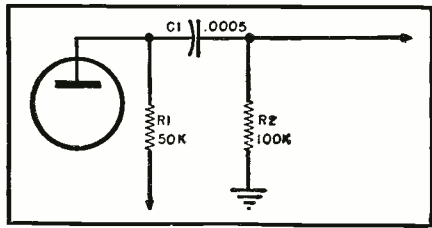

Fig. 12

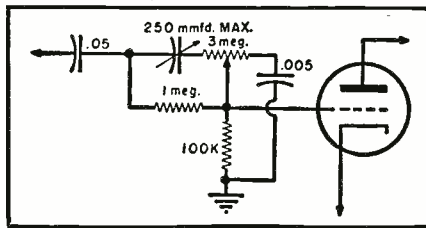

Fig. 13

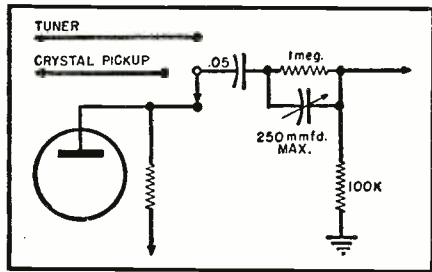

Fig. 14

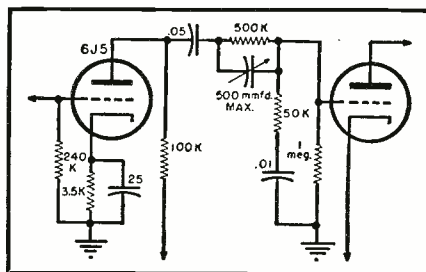
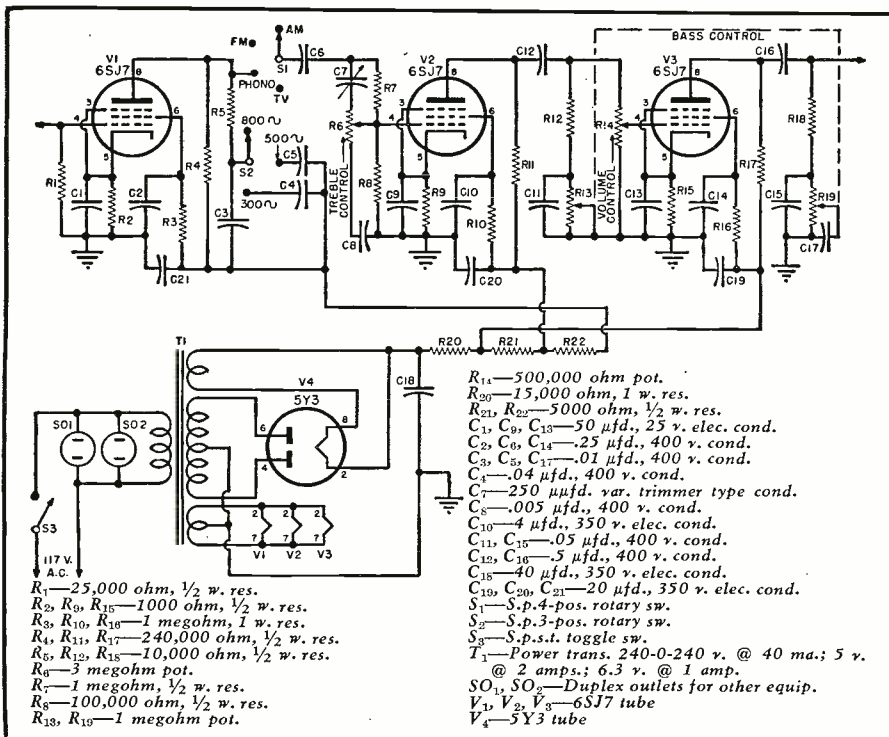

Fig. 15

condenser is made variable in order to move the take-off point horizontally along the frequency spectrum. The

value shown will allow wide flexibility with the rise starting anywhere between 1000 c.p.s. and 6000 c.p.s. The

Fig. 16



selector switch is included only to show that this circuit will work from any source. Fig. 13 is a variation of Fig. 14 which shows a potentiometer connected to permit either treble boost or treble cut. The take-off points for the boost and cut are entirely independent and are controlled by the value of the condensers employed. Many variations of these basic illustrations may present themselves. As an example of the type of thing which can be done Fig. 15 illustrates a combination of Fig. 14 and Fig. 8 which will give a combined high and low boost with a minimum insertion loss.

It is realized that some readers may not wish to take the time and trouble to work out circuits which suit their individual requirements precisely and therefore Fig. 16 has been included to show a completely self-contained pre-amplifier which may be used to feed an existing power amplifier or other equipment which the reader may possess. This unit includes a preamplifier for a magnetic phonograph pickup such as the GE, Pickering, or Clarkstan. The switch included in the phono preamp section is designed to equalize the pickup for various low frequency turnover characteristics as indicated. The treble control incorporated is the same as shown in Fig. 13 and discussed above. The bass control will provide a complex characteristic which will give approximately 24 db. maximum boost at 50 c.p.s. With the controls set at the flat position this unit is capable of uniform frequency response of ± 1 db. over the entire range of 20-20,000 c.p.s.

It is suggested that the power supply section be kept as far from the input section as possible to minimize hum difficulties. The large amount of bass boost called for presents some difficulties in keeping hum out of the circuit and care should be exercised. Grounds have been grouped on the schematic and you are strongly urged to follow the recommended grouping in your wiring. There should be only one place on the chassis where the electrical ground and the chassis are mechanically connected. The best way to stay out of ground loop difficulty (the worst source of hum in home built equipment) is to forget that the chassis can be a conductor and plan all ground returns so that each stage is wired to its own ground point and separate ground points are tied together by a deliberately wired connection. Do not use the chassis as part of the filament circuit. If your power transformer has no center tapped filament winding, connect one side of the filament circuit to ground at one point only.

Prefer to shield hum generating sources rather than the audio wiring. Shielded pair on filament wiring and a metallic shield around the power supply section generally accomplish this satisfactorily. By not shielding audio wiring itself, the circuit capacity is reduced and 20,000 c.p.s. response is readily attained.

There's Real SALES PULL in these Facts about... GENERAL ELECTRIC SPEAKERS!

IT PLAYS UNDER WATER! Submerged in water, the G-E speaker continues to deliver sound reproduction day in and day out. Do you know of any other speaker that will take a similar beating? The answer is in G.E.'s waterproof Voice Coil...the hottest selling feature in any speaker today!



WHEN you're out to corral new business (and what smart dealer or serviceman isn't?) give yourself a head start by selling the line that's booming along today at a dollar volume 40% higher than last-year's record...

General Electric speakers—from the 4" replacement unit to the famous 12" high fidelity champion—are packed with features that assure your customer superb performance and build his confidence in your workmanship. You'll make no mistake when you stock, talk, and sell General Electric speakers!

GREATER MAGNETIC POWER. The stronger the magnet the more sensitive the speaker. Iron filing clusters indicate comparative magnetic strengths... the Alnico 5 alloy used in G-E units is 2½ times as powerful as the standard material previously employed in magnet construction.

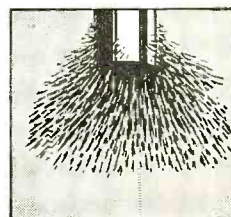
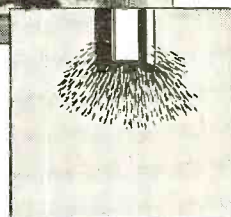

ALL WELD CONSTRUCTION. Rigid enough to support a man's weight, the G-E speaker housing is treated with bright-finish zinc plating...this enables the speaker to resist corrosion long after untreated models have begun to rust.

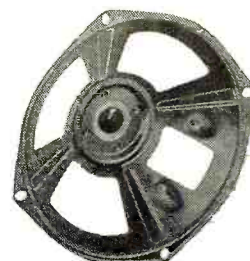

GENERAL ELECTRIC

GET THESE SALES AIDS

Start now to expand your speaker sales. G-E promotion kits help attract new business in home radios, portables, custom installations, drive-in theatres, P.A. systems... Send coupon for full information.



FREE BOOKLET!

General Electric Company, Section 950
Electronics Park, Syracuse, New York

I'm interested in G-E Speakers. Send me new folder illustrated here.

NAME _____
ADDRESS _____
CITY _____ STATE _____

NEW 1950

Heathkits

have all the Features

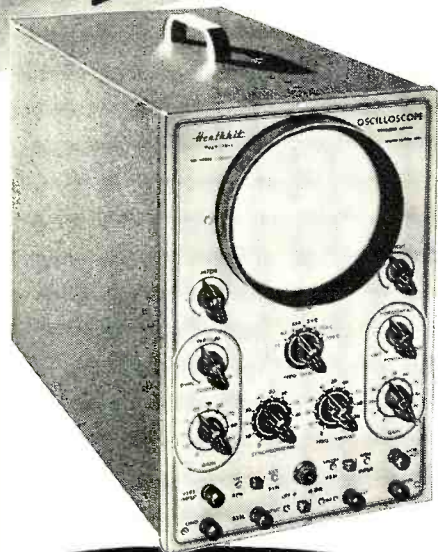

\$39.50

New 1950 Heathkit
**PUSH-PULL EXTENDED RANGE
 5" OSCILLOSCOPE KIT**

Features

- The first truly television oscilloscope.
- Tremendous sensitivity .06 Volt RMS per inch deflection.
- Push-pull vertical and horizontal amplifiers.
- Useful frequency range to 2½ Megacycles.
- Extended sweep range 15 cycles to 70,000 cycles.
- New television type multivibrator sweep generator.
- New magnetic alloy shield included.
- Still the amazing price of \$39.50.

The new 1950 Push-Pull 5" Oscilloscope has features that seem impossible in a \$39.50 oscilloscope. Think of it—push-pull vertical and horizontal amplifiers with tremendous sensitivity only six one hundredths of a volt required for full inch of deflection. The weak impulses of television can be boosted to full size on the five inch screen. Traces you couldn't see before. Amazing frequency range clear useful response at 2½ Megacycles made possible by improved push-pull amplifiers. Only Heathkit Oscilloscopes have the frequency range required for television. New type multi-vibrator sweep generator with more than twice the frequency range. 15 cycles to 70,000 cycles will actually synchronize with 250,000 cycle signal. Dual positioning controls will move trace over any section of the screen for observation of any part. New magnetic alloy CR tube shield protects the instrument from outside fields. All the same high quality parts, cased electrostatically shielded power transformer, aluminum cabinet, all tubes and parts. New instruction manual now has complete step by step pictorials for easiest assembly. Shipping Weight 30 lbs. Order now for this winter's use.

CONVERSION FOR OTHER MODEL HEATHKIT OSCILLOSCOPES

A conversion for all 03 and 04 scopes is available changing them to the new push-pull amplifiers (does not change the sweep generator). Complete kit includes new chassis, tubes and all parts. For a small investment, add the latest improvements to your present oscilloscope (Except C.R. Tube Shield). Shipping weight 10 lbs. Order 05 Conversion Kit No. 315. **\$12.50**

THE NEW *Heathkit*
HANDITESTER KIT

MORE Features THAN EVER BEFORE

- Beautiful streamline Bakelite case.
- AC and DC ranges to 5,000 Volts.
- 1% Precision ceramic resistors.
- Convenient thumb type adjust control.
- 400 Microampere meter movement.
- Quality Bradley AC rectifier.
- Multiplying type ohms ranges.
- All the convenient ranges 10-30-300-1,000-5,000 Volts.
- Large quality 3" built-in meter.

The instrument for all—the ranges you need—beauty you'll enjoy for years and you can assemble it in a matter of minutes—an instrument for everyone. The handiest quality volt-ohm-meter of all. Small enough to put in your pocket yet a full 3" meter. Easy pictorial wiring diagrams eliminate all assembly problems. Uses only 1% precision ceramic divider resistors and wire wound shunts. Twelve different ranges. AC and DC ranges of 10-30-300-1,000-5,000 Volts. Ohms ranges of 0-3,000 ohms and 0-300,000 ohms. Milliampere ranges of 10MA and 100MA. Hearing aid type ohms adjust control fits conveniently under thumb for one hand adjustment. Banana type jacks for positive low resistance connections. Quality test leads included. The high quality Bradley instrument rectifier was especially chosen for linear scales on AC. The modern case was styled by Harrah Engineering for this instrument. The 400 microampere meter movement comes already mounted in the case protected from dust during assembly. An ideal classroom assembly instrument useful for a lifetime. Perfect for radio service calls, electricians, garage mechanics, students, amateurs and beginners in radio. The only quality volt-ohm-meter under \$20.00. An hour of assembly saves you one-half the cost and quality parts give you a better instrument. Order today. Shipping weight 2 lbs.

\$13.50



*Note
 HANDY
 OHMS
 ADJUST.*

EXPORT DEPT.
 13 East 40th St.
 NEW YORK CITY (16)
 CABLE: ARLAB-N.Y.

The **HEATH COMPANY**

... BENTON HARBOR 15, MICHIGAN

MORE QUALITY in

1950 Heathkits

The NEW V-4 Heathkit VACUUM TUBE VOLTMETER KIT

Features

- Meter scale 17% longer than average 4½" meter.
- Modern streamline 200 ua meter.
- New modern streamline styling.
- Burn-out proof meter circuit.
- 24 Complete ranges.
- Isolated probe for dynamic testing.
- Most beautiful VTVM in America.
- Accessory probes (extra) extend ranges to 10,000 Volts and 100 Megacycles.
- Uses 1% precision ceramic divider resistors.
- Modern push-pull electronic voltmeter circuit.
- Electronic AC circuit. No current drawing rectifiers.
- Shatterproof plastic meter face.

The new Heathkit Model V-4 Vacuum Tube Voltmeter has dozens of improvements. A new modern streamlined 200 microampere meter has Alnico V magnet for fast, accurate readings. The new electronic AC voltmeter circuit incorporates an entire new balance control which eliminates contact potential and provides greater accuracy. New simplified switches for quicker assembly. New snap-in battery mounting is on the chassis for easy replacement.

The Heathkit VTVM is the only kit giving all the ranges. Check them — DC and AC full scale linear ranges of 0-3V, 0-10V, 0-30V, 0-100V, 0-300V, 0-1000V and can be extended to 0-3000V and 0-10,000V DC with accessory probe at slight extra cost. Electronic ohmmeter has six ranges measuring resistance accurately from .1 ohm to one billion ohms. Meter pointer can be offset to zero center for FM alignment.

The DC probe is isolated for dynamic measurements. Has db scale for making gain and other audio measurements.

The new instruction manual features pictorial diagrams and step-by-step instructions for easy assembly. The Heathkit VTVM is complete with every part — 110V transformer operated with test leads, tubes, light aluminum cabinet for portability, giant 4½" 200 microamp meter and complete instruction manual.

Order now and enjoy it this entire season. Shipping weight 8 lbs., Model V-4

Accessory: 10,000V high voltage probe, No. 310, \$4.50.
Accessory: RF crystal diode probe kit extends RF range to 100 Mc., No. 309, \$6.50.

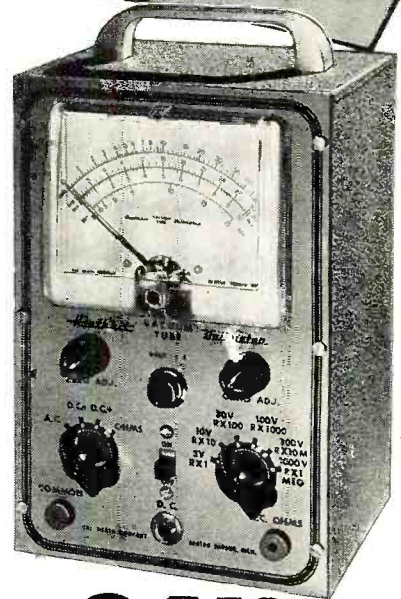

\$24.50

New 1950 VERNIER TUNING R.F. Heathkit SIGNAL GENERATOR KIT

Features

- New 5 to 1 ratio vernier tuning for ease and accuracy.
- New external modulation switch—use it for fidelity testing.
- New precision coils for greater output.
- Cathode follower output for greatest stability.
- 400 cycle audio available for audio testing.
- Most modern type R.F. oscillator.
- Covers 150Kc. to 34Mc. on fundamentals and calibrated strong harmonics to 102 Mc.

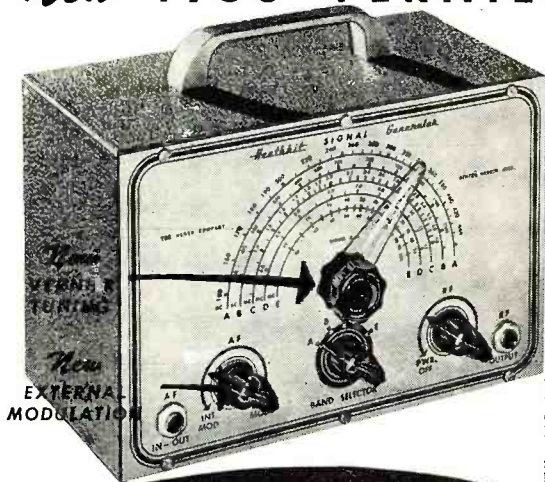

\$19.50

The most popular signal generator kit has been vastly improved—the experience of thousands combined to give you the best. Check the features in this fine generator and consider the low price \$19.50. A best buy for any shop, yet inexpensive enough for hobbyists. Everyone can have an accurate controlled source of R.F. signal voltage.

The new features double the value—think of being able to make fidelity checks on receivers by inserting a variable audio signal. Internal 400 cycle saw-tooth audio oscillator modulates R.F. signal and is available externally for audio testing. The new 5 to 1 ratio vernier drive gives hairline tuning for maximum accuracy in scale settings. The coils are already precision wound and calibrated. Uses turret type coil and switch assembly for base of construction. The generator is 110 V. 60 cycle transformer operated and comes complete in every detail—cabinet—tubes—coils—beautiful two color calibrated panel and all small parts—new step-by-step pictorial diagrams and complete instruction manual make assembly a cinch even for novices. Why try to get along without a signal generator when you can have the best for less than a twenty dollar bill. Better order it now. Shipping weight 7 lbs. \$19.50

CONVERSION KIT FOR G-1 GENERATORS

Conversion kit for G-1 generators for vernier tuning and external modulation includes new high band coil for greater output. Gives all the features of new G-5 listed above. Order G-5 Conversion Kit No. 316. \$4.50

EXPORT DEPT.
13 East 40th St.
NEW YORK CITY (16)
CABLE: ARLAB-N.Y.

The **HEATH COMPANY**

... BENTON HARBOR 15, MICHIGAN

Beauty · Quality · Economy



Only
\$69⁵⁰

Nothing
ELSE TO BUY

New Heathkit

IMPEDANCE BRIDGE KIT

**A LABORATORY INSTRUMENT NOW WITHIN
THE PRICE RANGE OF ALL**

Measures Inductance from 10 microhenries to 100 henries capacitance from .00001 MFD to 1000 MFD. Resistance from .01 ohms to 10 megohms. Dissipation factor from .001 to 1. "Q" from 1 to 1000.

Ideal for schools, laboratories, service shops, serious experimentors.

An impedance bridge for everyone — the most useful instrument of all, which heretofore has been out of the price range of serious experimentors and service shops. Now at the lowest price possible. All highest quality parts. General Radio main calibrated control. General Radio 1000 cycle hummer. Mallory ceramic switches with 60 degree indexing — 200 micro-amp zero center galvanometer — 1/2 of 1% ceramic non-inductive decade resistors. Professional type binding posts with standard 3/4" centers. Beautiful birch cabinet. Directly calibrated "Q" and dissipation factor scales. Ready calibrated capacity and inductance standards of *Silver Mica*, accurate to 1/2 of 1% and with dissipation factors of less than 30 parts in one million. Provisions on panel for external generator and detector. Measure all your unknowns the way laboratories do — with a bridge for accuracy and speed.

Internal 6 volt battery for resistance and hummer operation. Circuit utilizes Wheatstone, Hay and Maxwell circuits for different measurements. Supplied complete with every quality part — all calibrations completed and instruction manual for assembly and use. Deliveries are limited. Shipping weight, approximately 15 lbs.

Heathkit CONDENSER CHECKER KIT

\$19⁵⁰



Features

- Power factor scale
- Measures resistance
- Measures leakage
- Checks paper-mica-electrolytics
- Bridge type circuit
- Magic eye indicator
- 110V. transformer operated
- All scales on panel

Checks all types of condensers, paper-mica-electrolytic-ceramic over a range of .00001 MFD. to 1000 MFD. All on readable scales that are read direct from the panel. **NO CHARTS OR MULTIPLIERS NECESSARY.** A condenser checker anyone can read without a college education. A leakage test and polarizing voltage for 20 to 500 volts provided. Measures power factor of electrolytics between 0% and 50%. 110V. 60 cycle transformer operated complete with rectifier and magic eye tubes, cabinet, calibrated panel, test leads and all other parts. Clear detailed instruction for assembly and use. Why guess at the quality and capacity of a condenser when you can know for less than a twenty dollar bill. Shipping weight, 7 lbs. Model C-2.

New Heathkit

TELEVISION ALIGNMENT GENERATOR KIT



\$39⁵⁰

Nothing **ELSE TO BUY**

Everything you want in a television alignment generator. A wide band sweep generator covering all TV frequencies 0-46 54 to 100 — 174 to 220 Megacycles, a marker indicator covering 19 to 42 Megacycles, AM modulation for RF alignment — variable calibrated sweep width 0-30 Mc. — mechanical driven inductive sweep. Husky 110V. 60 cycle power transformer operated — step type output attenuator with 10,000 to 1 range — high output on all ranges — band switching for each range — vernier driven main calibrated dial with over 45 inches of calibration — vernier driven calibrated indicator marker tuning. Large grey crackle cabinet 16 1/8" x 10 3/8" x 7-3/16". Phase control for single trace adjustment. Uses three high frequency triodes plus 5Y3 rectifier — split stator tuning condensers for greater efficiency and accuracy at high frequencies — this Heathkit is complete and adequate for every alignment need and is supplied with every part — cabinet — calibrated panel — all coils and condensers wound, calibrated and adjusted. Tubes, transformer, test leads — every part with instruction manual for assembly and use. Actually three instruments in one — TV sweep generator — TV AM generator and TV marker indicator.

EXPORT DEPT.
13 East 40th St.
NEW YORK CITY (16)
CABLE: ARLAB-N.Y.

The **HEATH COMPANY**

BENTON HARBOR 15, MICHIGAN

all in HEATHKITS...

Heathkit TUBE CHECKER KIT

Features

- | | |
|--|--|
| 1. Measures each element individually | 5. Checks every tube element |
| 2. Has gear driven roller chart | 6. Uses latest type lever switches |
| 3. Has lever switching for speed | 7. Uses beautiful shatterproof full view meter |
| 4. Complete range of filament voltages | 8. Large size 11" x 14" x 4" complete |
| 9. Checks new 9 pin piniaures | |

Check the features and you will realize that this Heathkit has all the features you want. Speed — beauty — protection against obsolescence. The most modern type of tester — measures each element — beautiful Bad-Good scale, high quality meter — the best of parts — rugged oversize 110V. 60 cycle power transformer — finest of Mallory switches — Centralab controls — quality wood cabinet — complete set of sockets for all type tubes including blank spare for future types — fast action gear driven roller chart uses brass gears to quickly locate and set up any type tube. Simplified switching cuts necessary time to minimum and saves valuable service time. Short and open element check. No matter what arrangement of tube elements, the Heathkit flexible switching arrangement easily handles it. Order your Heathkit Tube Checker today. See for yourself that Heath again saves you $\frac{2}{3}$ and yet retains all the quality — this tube checker will pay for itself in a few weeks — better build it now.

Complete with detail instructions — all parts — cabinet — roller chart — ready to wire up and operate. Shipping Wt., 15 lbs.

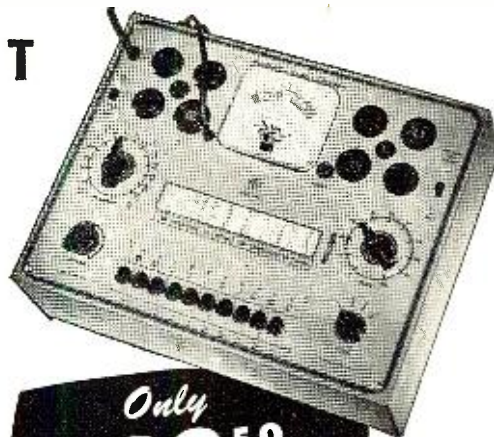

Only
\$29.50

Nothing
ELSE TO BUY

Heathkit SINE AND SQUARE WAVE AUDIO GENERATOR KIT



Nothing
ELSE TO
BUY

\$34.50

Experimenters and servicemen working with a square wave for the first time invariably wonder why it was not introduced before. The characteristics of an amplifier can be determined in seconds compared to several hours of tedious plotting using older methods. Stage by stage, amplifier testing is as easy as signal tracing. The low distortion (less than 1%) and linear output (\pm one db.) make this Heathkit equal or superior to factory built equipment selling for three or four times its price. The circuit is the popular RC tuning circuit using a four gang variable condenser. Three ranges 20-200, 200-2,000, 2,000-20,000 cycles are provided by selector switch. Either sine or square waves instantly available at slide switch. All components are of highest quality, cased 110V. 60 cycle power transformer, Mallory F.P. filter condensers, 5 tubes, calibrated 2 color panel, grey crackle aluminum cabinet. The detailed instructions make assembly an interesting and instructive few hours. Shipping Wt., 15 lbs.

New Heathkit BATTERY ELIMINATOR KIT



Nothing
ELSE
TO BUY

\$22.50

Now a bench 6 Volt power supply kit for all auto radio testing. Supplies 5 - 7 $\frac{1}{2}$ Volts at 10 Amperes continuous or 15 Amperes intermittent. A well filtered rugged power supply uses heavy duty selenium rectifier, choke input filter with 4,000 MFD of electrolytic filter. 0 - 15 Volt meter indicates output. Output variable in eight steps. Excellent for demonstrating auto radios. Ideal for servicing — can be lowered to find sticky vibrators or stepped up to equivalent of generator overload — easily constructed in less than two hours. Complete in every respect. Shipping Wt., 18 lbs.

NEW Heathkit SIGNAL TRACER AND UNIVERSAL TEST SPEAKER KIT



Nothing
ELSE
TO BUY

\$19.50

The popular Heathkit signal tracer has now been combined with a universal test speaker at no increase in price. The same high quality tracer follows signal from antenna to speaker — locates intermittents — defective parts quicker — saves valuable service time — gives greater income per service hour. Works equally well on broadcast — FM or TV receivers. The test speaker has assortment of switching ranges to match push pull or single output impedance. Also test microphones, pickups — PA systems — comes complete — cabinet — 110V. 60 cycle power transformer — tubes, test probe, all parts and detailed instructions for assembly and use. Shipping Wt., 8 lbs.

EXPORT DEPT.
13 East 40th St.
NEW YORK CITY (16)
CABLE: ARLAB-N.Y.

The **HEATH COMPANY**

... BENTON HARBOR 15, MICHIGAN

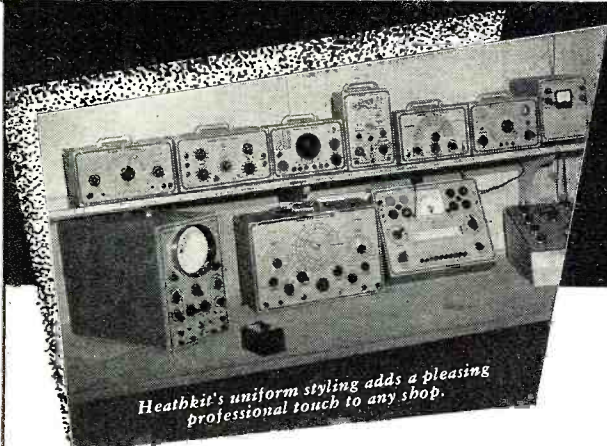

Heathkits PROVIDE PROFESSIONAL LABORATORY APPEARANCE

New Heathkit BROADCAST AND 3 BAND SUPERHETERODYNE RECEIVER KIT

BROADCAST MODEL BR-1
550 to 1600 Kc.

\$19.50

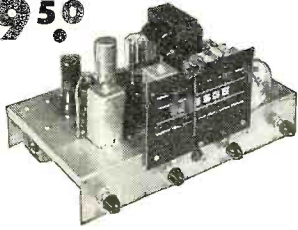

Two new Heathkit Superheterodynes featuring the Best of design and material. Beautiful six inch slide rule dials—110 V. 60 cy. AC power transformer operated—metal cased filters—quality output transformers, dual iron core metal can IF transformers—two gang tuning condenser. The chassis is provided with phono-radio switch—110 V. outlet for changer motor and phono pickup jack. Each kit is complete with all parts and detailed instruction booklet. Pictorial diagrams and step-by-step instructions make assembly quick and easy.

3 BAND MODEL AR-1
550 Kc. to 20 Mc.

\$23.50

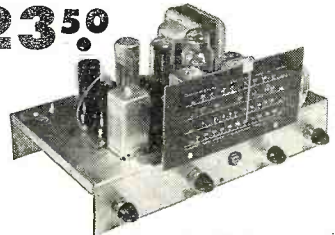

Enjoy the thrill of world wide short wave reception with this fine new AC operated Heathkit 3 band superheterodyne—amazing sensitivity 15 microvolt or better on all bands. Continuous coverage 550 Kc. to over 20 Mc. Easy to build with complete step-by-step instructions and pictorial diagram. Attractive accurately calibrated six inch slide rule dial for easy tuning. Six tubes with one dual purpose tube gives seven tube performance. Beam power output tube gives over 3 watts output.

Ideal AC operated superheterodyne receiver for home use or replacement in console cabinet. Comes complete with attractive metal panel for cabinet mounting. Modern circuit uses 12K8 converter, 12SH7 input IF stage, 12C8 output IF stage and first audio 12A6 beam power output stage, 5Y3 rectifier. Excellent sensitivity for distant reception with selectivity which effectively separates adjacent stations.

The husky 110 V. cased power transformer is conservatively rated for long life.

The illuminated six inch slide rule dial is accurately calibrated for DX reception. Enjoy the pleasure of assembling your own fine home receiver. Has tone, volume, tuning and phono-radio controls. Chassis size 2 1/4" x 7" x 12 1/2". Comes complete with all parts including quality output transformer to 3.4 ohm voice coil, tubes, instruction manual, etc. (less speaker). Shipping Wt., 10 lbs. No. BR-1 Receiver \$19.50.

No. 335 Communications Type Table Model Metal Cabinet..... \$4.50
No. 320 High Quality 5" PM Speaker for above..... 2.75

Separately assembled coil turret with band switch eliminates difficult construction. Conservatively rated 110 V. power transformer supplies full operating voltages to all tubes for maximum reception. Has band switch, tuning, volume, tone and phono-radio controls. Chassis size 2 1/4" x 7" x 12 1/2"—supplied complete—punched chassis—tubes—controls—transformers (quality output to 3.4 ohm voice coil)—all small parts—hardware and instructions (less speaker). Shipping Wt., 10 lbs. No. AR-1 Receiver \$23.50.

No. 335 Communications Type Table Model Metal Cabinet..... \$4.50
No. 320 High Quality 5" PM Speaker for above..... 2.75

Heathkit PUSH-PULL HIGH FIDELITY AMPLIFIER KIT



\$12.50

Build this high fidelity push-pull amplifier and save two-thirds the cost—has two pre-amplifier stages, phase inverter stage and push-pull beam power output stage. Comes complete with six tubes—quality output transformer (to 3-4 ohm voice coil) tone and volume controls—varnish impregnated cased 110V. power transformer and detailed instruction manual and all small parts. Six watt output with output flat within 1 1/2 db between 50 and 15000 cycles.

Build this amplifier now and enjoy it for years.
Shipping Wt. 7 lbs. Model A-4
12" PM Speaker for above..... \$6.95

ORDER BLANK

HEATH CO. BENTON HARBOR MICHIGAN		FROM _____ _____ _____	SHIP VIA <input type="checkbox"/> Parcel Post <input type="checkbox"/> Express <input type="checkbox"/> Freight <input type="checkbox"/> Best Way	
Quan.	DESCRIPTION	Price	Total	

ENCLOSED FIND CHECK . . . MONEY ORDER FOR _____
PLEASE SHIP C.O.D. . . . POSTAGE ENCLOSED FOR _____ POUNDS

EXPORT DEPT.
13 East 40th St.
NEW YORK CITY (16)
CABLE: ARLAB-N.Y.

The HEATH COMPANY

... BENTON HARBOR 15, MICHIGAN

Multi-TV Receive Operation From Single Antenna

One solution to the problem of antenna-laden rooftops is the installation of a "master" unit.

By
DANIEL LERNER
TV Field Service Engr.
Philco Corporation

URING the past few years the number of television receiver owners has increased at an amazing pace. It is predicted that there will be nine million television receiver owners by the end of 1950. With this marked increase comes the problem of providing enough space for outdoor antennas in crowded urban areas. In many locations in New York the larger apartment buildings are beginning to resemble houses with a fringe on top. The probable solution lies in a central antenna system which can be used to feed a large number of receivers.

Many such systems have been tried, but probably one of the most efficient is the recently developed unit called the "Antenaplex." This system is adaptable for apartment houses, hotels, institutions, and for numerous other applications.

Fundamentally, this system includes either a separate antenna for each channel in one particular area, or merely a separate antenna section

for each channel on one mast. Of course the antenna system used depends upon the type of reception in the particular location.

The signals from the individual antenna are fed to a master amplifier

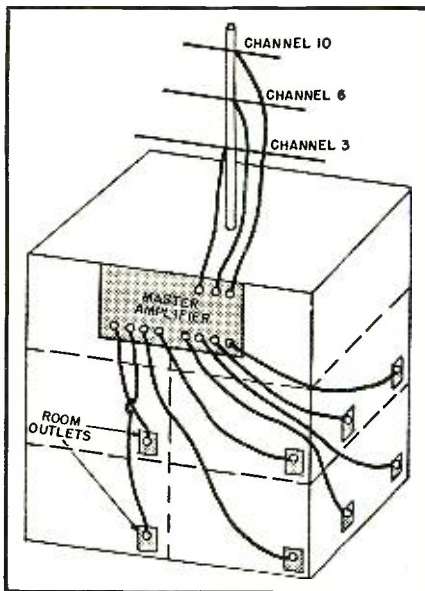
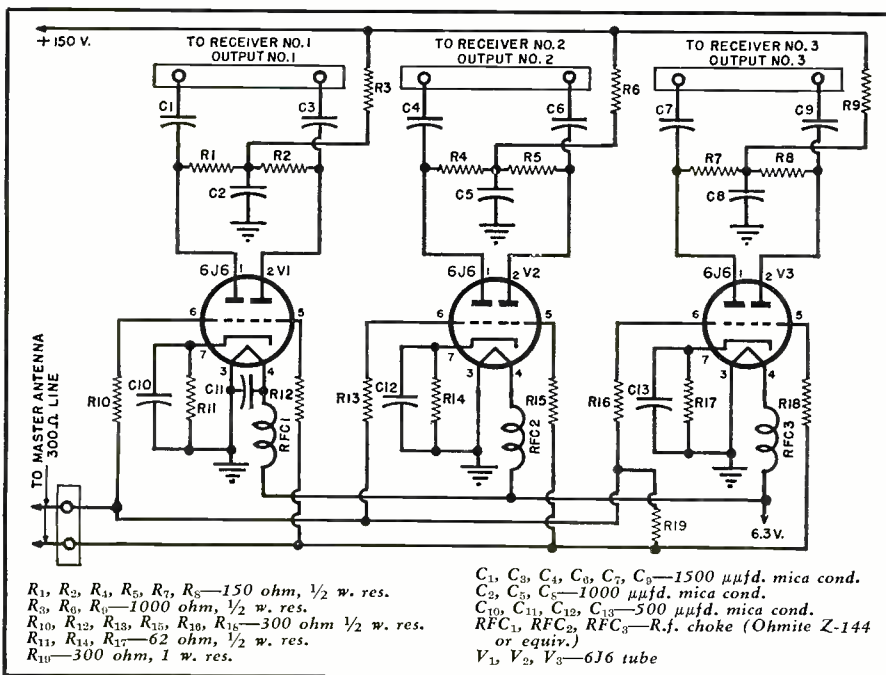

Fig. 1. "Antenaplex" multiple antenna system.

Fig. 2. Multiple antenna system used in department store and dealer installations.



HARVEY HAS THE BARGAINS

AIRCHARGER MODEL 616

6 volt wind charger, with 5 ft. tower and universal mounting brackets. Built-in brake assembly for remote shut-off. Automatic governor. Complete with control panel, battery cut-out and ammeter. Will charge in 5 to 6 mile breeze. Max. Chg. rate 15 amps. at 1100 RPM. Brand New, with full installation instructions. Shpg. Wt. 85 lbs. Very specially priced at... **\$34.95**

SOUND-POWERED FIELD PHONES

Army type EE-108. Any number can be hooked together on any 2-wire or grounded line. Max. range 12 - 15 miles. No batteries needed, simple, few parts. Complete instruction manual. Genuine leather case with strap. Shipping Weight 10 lbs. Each... **\$24.50**



THE NEW SUBRACO MT 15X

The finest in mobile rigs available today. 30 watts power, class B 100% modulation, with push-to-talk and built-in coaxial type antenna relay. Xmtr complete with tubes, coaxial antenna connector, mounting brackets, etc. Shipping weight 15 lbs. **\$87.50**
BRAND NEW—MT15X for 20 meters...\$87.50
 Speech input. Any of the MT15X can be ordered with high-gain speech input for either xtal or dynamic mikes at an additional cost of...\$9.95



SUBRACO DS400

Dynamotor supply. 6 V. DC input, 400 V. at 175 ma. output. Complete with built-in control relays, filter, etc. Shpg. Wt. 10 lbs... **\$59.95**
AC Supply for operation of any of above Subraco xmtrs indoors. Complete with rectifier and built-in control relay...\$39.50

GE FM TUNER

Only a few left of this unusual buy. Covers 88-108 mc range, uses guillotine tuning. Designed for export and tropicalized, has power inputs for 110 to 250 volts 60 cyc. Shpg. Wt. 30 lbs. Harvey Special Price... **\$49.50**



WESTERN ELECTRIC SPEAKERS

Here's another good buy from Harvey's. Genuine WE speakers at a new low price, all brand new in factory cartons.

12" — 728-B.....\$41.90
8" — 755-A.....\$20.60

All prices Net. F.O.B. N.Y.C. Include ample postage with your remittance, any excess will be refunded. Prices subject to change without notice.

Telephone: **728** LUXEMBURG 2-1500

HARVEY RADIO COMPANY INC.
 103 West 43rd St., New York 18, N. Y.

STAHL SEZ!

My Bargain Columns
are always worth reading

Complete GIBSON GIRL The Emergency Radio Transmitter



Sends SOS signals automatically on 500 Kc., 150-mile range. No batteries required. HAS HAND-DRIVEN GENERATOR TUBES COPPER WIRE SIGNAL LAMP 70 SQ. FT. PARACHUTE BALLON COLLAPSIBLE BOX KITE FEEDER PIPE HYDROGEN TANK TECHNICAL MANUAL Packed in knapsack. Weight 35 lbs. The entire caboodle sold complete for only... **\$9.95**

We have available CODE PRACTICE

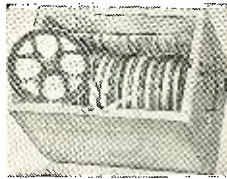

TAPE, which was used for code practice work by the Signal Corps—from slow to fast practice. 15 rolls on 16MM metal reels in heavy wooden slotted case, to be used with McElroy TG10 Keyers. Tone Keyers or any code practice unit using printed tape. Special... **\$9.95**

WATT HOUR METERS

GE 1-16 single phase 60 cycle 115-120V. **\$4.95**
5 Amp.—two wire—glass case.
Westinghouse—metal case—115-120V. 5 Amp. 60 cycle, single phase. **\$3.95**

TRANSMITTER-RECEIVER

Navy Model ABA-1—BC-645
450 MC—15 TUBES, Brand New

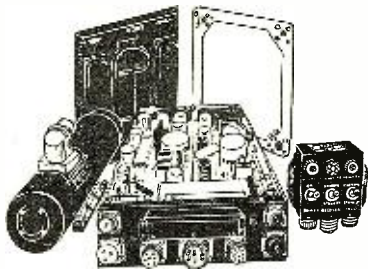

Can be easily converted for phone or CW 2-way communication. Covering the following bands: 420-450MC ham band, 450-460MC for fixed or mobile, 460-470MC for citizens, 470-500MC television experimental. Size 10½x13½x4½. Contains 15 tubes: 4—7F7, 4—7H7, 2—7BE, 2—6F6, 2—955, 1—WE-316A door knob, Dynamotor, Keyer Unit, Remote Control Unit. **COMPLETE \$15.95**
Instruction Book
Complete set of plugs, 2 antennas and rack mountings for control box. Additional **\$9.95**

PORTABLE PUBLIC ADDRESS SYSTEM

Model CS-91-C made by Silman Mfg. Co. for the U. S. Army. Ideal for camps, boat races, ski races, loading platforms, etc., etc. It's a battery operated amplifier with 2 tubes, 1H4—1J6; hand microphone and trigger type switch microphone and loud speaker; 4½ collapsible metal tripod, batteries and carrying case. Brand New. Shipping Weight 25 lbs. While they last...



\$39.95

Prompt Delivery—25% deposit required on C.O.D. order. Shipped F.O.B. New York. Write Dept. RN-5

MICHAEL STAHL, INC.
39 VESEY ST.

WO 4-2882 New York 7, N. Y.

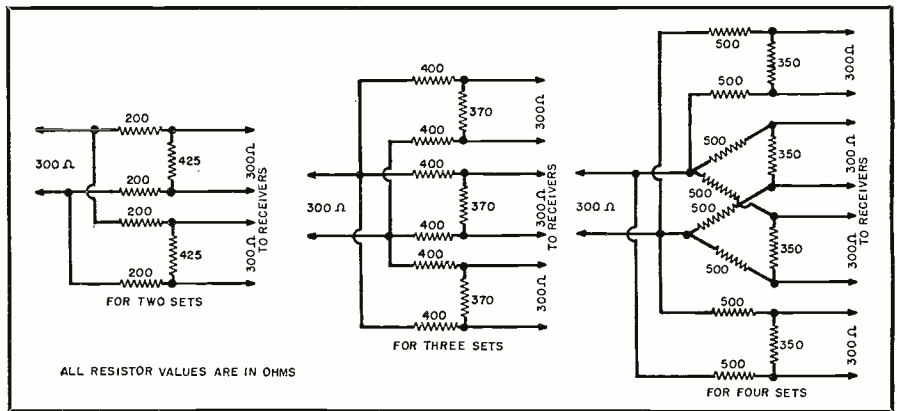

Fig. 3. Simple system for feeding two, three, or four sets by multi-pad arrangement.

which increases the strength of the signal and provides the proper isolation to prevent receiver interaction. The outputs, of a necessarily low impedance to prevent noise and interference pickup, are fed over coaxial cables to room outlets. See Fig. 1.

Another type of system used in some department store, dealer, and school applications is shown in Fig. 2. Here we have a series of 6J6 tubes used as isolation amplifiers. The master antenna is fed to the grids of the 6J6 in parallel, with one triode for each side of the balanced 300 ohm line. It should be noted that a 300 ohm match is maintained at both the grid and plate sides of the triode.

With this type of unit quite a bit of loss, in the order of 60%, should be expected but good isolation is effected nevertheless. Thus receiver local oscillator interaction is kept to a minimum. By using a booster amplifier before the signal is fed to this system, the effects of this loss may be minimized.

A simple system for feeding more than one receiver is a multi-pad arrangement as shown in Fig. 3. With this system a large amount of initial signal is required as the available signal decreases in proportion with the number of receivers fed. In all cases, however, the 300 ohm impedance is kept constant.

SET OWNERSHIP IN FOREIGN COUNTRIES

FROM the Consumers Merchandise Branch of the United States Department of Commerce comes new and additional data on set ownership in various foreign countries, as reported by U. S. legations, embassies, and consulates.

Austria has an estimated 1,280,000 radio receivers in operation, as of November, 1949, of which 64,000 are unlicensed. Approximately 356,000 of the sets are equipped to receive short-wave broadcasts, and an estimated 3 persons listen to each receiver.

An estimated 25,000 radio receivers are in use in Burma of which 7000 were manufactured prior to 1939. Radios of United Kingdom manufacture dominate the Burmese radio market, followed by the United States and the Netherlands. Import controls on radio equipment have been liberalized since September 1949, resulting in increased imports.

Canadian manufacturers sold a total of 460,649 units during the first nine months of 1949 at a total value of \$33,326,189, an increase over the same period in 1948.

Imports during January-September 1949 amounted to 41,416 sets of which 39,974 sets were designated as "sets imported under special conditions". Exports of radio sets in the same period totaled 25,210 units.

Canadian production of radio receiving tubes in the first nine months of 1949 totaled 3,363,410 units, while for the corresponding period in 1948, 3,241,728 tubes were produced. Imports of receiving tubes during the January-September 1949 period aggregated 914,352 units as compared with 759,122 in

the same period of 1948. Imports of radio tube parts during January-September 1949 were valued at \$391,862 as compared with \$216,004 in the like period of 1948.

The report from Finland indicates an estimated 727,000 receivers in use as of December 31, 1949, of which 662,000 were licensed. About 71 per cent are equipped to receive short-wave broadcasts. Approximately 3.6 persons listen to each set.

An estimated 42,000 radio receivers were in use in Iceland as of December 15, 1949. Approximately 65 per cent of the sets in operation were Philips (Netherlands and the United Kingdom), 7 per cent were Marconi (United Kingdom), 4 per cent Telefunken (Germany), 7 per cent other European brands, and 17 per cent United States manufacture.

An estimated 80,000 radio receivers are in use in Iran, most of which were manufactured after 1945. About 60 per cent of the sets are of United States manufacture, 30 per cent British, and the remainder Dutch and Swiss.

Because of the shortage of electric power, particularly in the provinces, an estimated 50 per cent of the radios currently imported are battery operated. The life expectancy of batteries by the time they reach the Iranian market is reported to be as little as two months.

Some European exporters extend three months' credit and are reported to be contemplating extending credit up to six and nine months. It is reported that Iranian importers complain of the continued failure of United States exporters to extend credit.

**"Send in the CREI Graduate,"
says the Television Industry**



Good Paying Jobs are Waiting for Good Men — CREI Training Helps You Cash in on TV Expansion

**Your Present Radio Experience
Plus CREI Home Study Equals a Career Job
in Television at Better Pay!**

THE RADIO-ELECTRONICS-TV field is developing at breath-taking speed. The demands of industry are increasing daily. Never before have so many better-paying jobs beckoned—to **TRAINED MEN ONLY!** If you're an ambitious radio engineer or technician who has the determination to go after—and get—a better job, then CREI has an educational program for you. Whether your interest and activities are in television, broadcasting, servicing, or any other branch of electronics, CREI offers a home study program that can give you the technical ability to keep ahead of competition.

CREI graduates are welcomed by the electronics industry. CREI is an Accredited Technical Institute with more than 23 years of background in home

study and residence school radio-electronics instruction. Its courses take you through introductory principles to advanced work, and on to specialized fields as fast as your capabilities permit. Electronics is such a fast-moving field that you can't say "I don't need more training." You must fortify yourself with the *brain tools* which CREI's practical course offers, no matter what your experience, if you want promotion, more money, and a more secure future. Send for—and study—the **FREE BOOKLET** that explains the CREI self-improvement program. It "costs" only a few moments' time; it may be worth the difference between standing still or going ahead with the Industry to success!

VETERANS: CREI training is available under the G.I. Bill. For most veterans July 25, 1951 is the deadline—so act now!

FREE SAMPLE LESSON

Send for "The Orthicon and Image Orthicon" which describes the development, theory and operation of the orthicon and image orthicon TV camera tubes.

THE THREE BASIC CREI COURSES:

- ★ **PRACTICAL RADIO ENGINEERING**
Fundamental course in all phases of radio-electronics
 - ★ **PRACTICAL TELEVISION ENGINEERING**
Specialized training for professional radiomen
 - ★ **TELEVISION AND FM SERVICING**
Streamlined course for men in "top-third" of field
- ALSO AVAILABLE AS RESIDENCE SCHOOL COURSES

CAPITOL RADIO ENGINEERING INSTITUTE

An Accredited Technical Institute Founded in 1927
Dept. 295-B, 16th & Park Rd., N. W. Washington 10, D. C.
Branch Offices: New York (7) 170 Broadway • San Francisco (2) 760 Market St.

MAIL COUPON FOR FREE BOOKLET

CAPITOL RADIO ENGINEERING INSTITUTE

Dept. 295B, 16th & Park Road, N. W., Washington 10, D. C.

Gentlemen: Send me **FREE SAMPLE LESSON** and booklet, "Your Future in the New World of Electronics," together with details of your home study training, CREI self-improvement program and outline of course. I am attaching a brief resume of my experience, education and present position.

- Check the Field of Greatest Interest:
- Practical Television Engineering.
 - Practical Radio Engineering.
 - TV, FM & Advanced AM Servicing.

- Aeronautical Radio Engineering.
- Broadcast Radio Engineering (AM, FM, TV).
- Radio-Electronics In Industry

NAME _____ AGE _____

ADDRESS _____

CITY _____ ZONE _____ STATE _____

I am entitled to training under G.I. Bill. Send details on Residence School.



Niagara Is INTERFERENCE ELIMINATION HEADQUARTERS!

NIAGARA HI-PASS FILTER

Guaranteed to eliminate R.F. Interference in any standard TV Receiver. Really works!

Stops all Amateur, Industrial, Diathermy TVI. TRY IT



BLEEP BLOOP BLAP
Money Back If It Fails!

Built up—ready to install
Cat. No. N281 **\$2.95**
Kit Form (easy to assemble).
Cat. No. N281K **\$1.95**
Plus 15c packing and mailing in U.S.A.

ATTENTION MOBILE FANS!

Niagara introduces its mobile noise suppression package, designed by W2QDM for guaranteed elimination of noises from generator hash, spark plugs, distrib., wheels, etc. Money back if not delighted. Noise Suppression Kit. Postpaid in U.S.A. Cat. No. N425K **\$3.00**

MORE BARGAINS IN SURPLUS EQUIPMENT

1-2 or 3 of each • Check every line!
(All items on hand May 1st subject to subsequent sale)

- Wiloex CW-3-110V Superhet Rcvr. New... **\$ 75.00**
- Antenna Rotating Motor RL-42A Reel Exc. W.E. XMTR MOD. Comp. w/controls 2.95
- spares New 225.00
- MN 26C Radio Compass—New..... **26.95**
- MN26C Radio Compass—Used..... **26.95**
- 733D Localized Receiver Exc. **6.95**
- AN-APN-1 Altimeter—L.N. **18.95**
- 274N Modulator BC456A w/tubes Exc. **2.65**
- 274N Modulator BC456A Fair less tubes. 1.68
- SCR 522 Receiver BC924 Exc. less tubes. 7.95
- BC 1000A Transceiver New..... **300.00**
- BC 645 Transceiver, Contr. Box. Dyn. In-struction book. New..... **17.95**
- T-17 Handlike 200 Ohm Imp. Exc. 3 for PE 94 24V. D.X.N. for SCR522 Used L.N. Surplus Radio Conv. Manual Vol. 1 or 2. 2.95
- SCR 654 80 Meter XMTR & RCVR w/tubes XTAL L.N. **24.95**
- ASD Parabolic Antenna—Rotable—L.N. 75.00
- BC221 Freq. Mtr. w/XTAL & Calib. Book L.N. **90.00**
- LM Freq. Mtr. w/XTAL, Book, Mod. Exc. TBY, Navy 6 & 10 Mtr. Bat. Transceiver. 34.95
- RM669 RCVR. w/SPKR—Y. GD. **59.00**
- BC-375 Tuning Units New—cased..... **4.95**
- BC-375 Tuning Units Used—cased..... **3.95**
- GE 25 Watt Phone XMTR Model GP1A Pow. Sup. Exc. **29.95**
- ATD 50 Watt XMTR New..... **49.95**
- 10 Navy CV. Port. Audio Ampl. w/VIB. Sup. **9.95**
- Gibson Girl Emergency XMTR. New..... **2.89**
- BC614 Speech Amplifier. For BC610 L.N. W1252 Electronic Wavemeter 22-30 Mcs. Exc. **44.95**
- BC Ant. Tuner for BC610 L.N. **59.90**
- BC 342 Navy Comm. RCVR. Exc. **69.95**
- McMurdo Silver RCVR. Mod. 801 G-80 Mtrs. w/tubes L.N. **29.95**
- Gon-Set 50-54 Mc. Conv. L.N. **24.95**
- Beach 80 Meter VFC New..... **19.95**
- Handy 28.5-29.7 Mc. Comp. New..... **24.95**
- BC-347C interphone Amplif. L.N. **2.95**
- Dynamotor SA 5088 Imp. 18V./Out P. 450V **4.95**
- GP7 Tuning Units—New—cased range A-D. **4.95**
- GP7 Tuning Units—Used—cased range A-D. **3.95**
- GP7 Tuning Units—Used—no case range A-D. **2.95**
- BC 610 Plug-in tuning units TU47 to TU54 Sound Powered Phones. Head and Chest Set—Type O—New..... **4.95**
- Sound Powered Phones. Head and Swing-Away Mike—Type Q—New..... **9.95**
- Low Pass TVI Filter Kit..... **4.95**
- BT Cur. 1000 KC Crystal..... **4.95**
- BC221 Sub-Assy—New..... **6.95**
- Ferris 16C Sig. Gen. Recalib. **1000.00**
- HS-33 Headphones. Brand New..... **2.95**

Niagara Radio Supply Corp. Phone Digby 9, 1132-34
Dept. N-50 160 Greenwich Street, New York 6, N.Y.

Mac's Service Shop
(Continued from page 68)

some other damage. You simply switch over to the ohmmeter and use the resistance-checking method to find out if your trouble is an open i.f. transformer primary, an open plate-isolating resistor, a shorted bypass condenser, or maybe a shorted tube."

"That makes sense," Barney observed judiciously.

"Another fault with being married to one system," Mac went on, "is that it tends to kill a guy's originality. A good service technician ought to be constantly trying to find better ways of doing his work. Just last week I had a convincing demonstration of that. For twenty years I've been trying to cook up a really good way to service those sets that are plagued with a rustling sound. You know what I mean: the kind of sound you get when an i.f. winding is opening up or an output primary is going out or a grid cap solder connection is poor or you have a noisy plate resistor.

"Those rustling sounds are produced by small, instantaneous current fluctuations. They are too quick to show on a meter, and you can't go probing around with an ohmmeter without running the risk of temporarily 'healing' the trouble you are trying to spot by running the ohmmeter current through the coils or resistors. Even a signal tracer cannot be used to advantage unless it is of extremely high gain and very, very quiet.

"The other day, when I had one of these sets, I suddenly got the bright idea of putting the vertical input of the scope across the units I suspected while the sweep was working on a low frequency and drawing out about a three-inch horizontal line. With the input across the output transformer, every little rustle would shoot up a little hair-like filament from the line. These little offshoots kept right on showing up as I moved back through the receiver until I reached the grid of the audio stage. On the plate I saw them; on the grid I didn't. When the tube was yanked, they were still there for a few seconds until the rectifier cathode started to cool—it was an a.c.-d.c. set—so the tube was not at fault. When the mica r.f. bypass was cut loose from the plate, no little spikes were present across the resistor. That

condenser was leaky *only* when a certain critical voltage was across it. It checked OK with the battery voltages ordinarily used with an ohmmeter.

"From now on I intend to use the scope to track down all of these 'rustlers.' If my mind hadn't been burdened with the idea that a scope was only good for aligning, waveform analysis, and distortion-spotting, I might have discovered this much sooner. The less hidebound your service technique is, the more likely you are to discover new and better methods of doing your work.

"Really it all goes back to how you feel about radio servicing. Personally, the thing I like about servicing is that it is a *thinking business* and cannot be easily systemized. The problems you encounter are far too complex and varied and changing to allow you to settle into a dull routine; and, by the same token, they are not to be solved with the greatest efficiency and dispatch by the application of any neat little universal formula or procedure. I am confident that the next set I put on the bench—and incidentally it is high time we started putting some sets on the bench—will be a little different in some detail or other from any I have worked on before—say," he broke off, "what the heck are you trying to do with that solder gun?"

"Just following your advice and working out a new and better method of servicing," Barney explained blandly. "It always gripes me when I want to see if a voice coil is open and I have to unsolder the output transformer secondary from across the coil before I can test it. About half the time I lose the flexible voice coil lead out of the terminal and have a tough time working it back. Now I've got a better way. When you pull the trigger on this gun anyways near the output transformer, you get a strong hum from the speaker if the transformer secondary and the voice coil are both OK. It must be a.c. induction from the gun transformer."

"My boy, I am proud of you!" Mac beamed. "You are really using that old flame-colored noggin. That makes me feel good."

"That's not what makes you feel good," Barney observed.

"What does, then?"

"Getting the 'systems' out of your system," the boy said with a knowing grin as he slid from the bench.

-30-

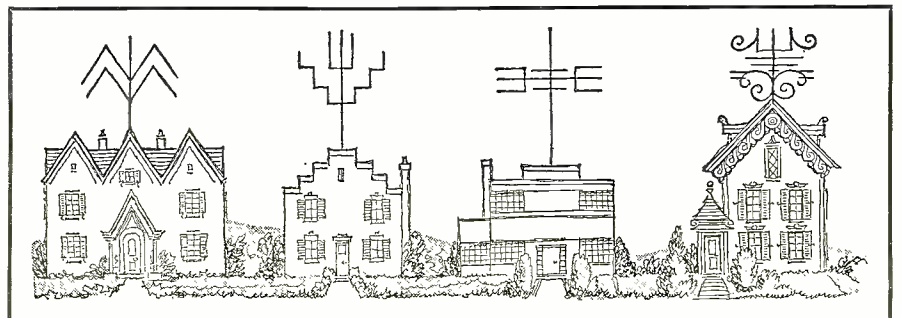

TEN OF THE BEST RADIO TEXTS



RADIO HANDBOOK IN TWO EDITIONS

11TH EDITION: The standard work on practical and theoretical aspects of all radio communication.

12TH EDITION: Detailed constructional information on a wealth of radio communication equipment; all brand-new.

BOTH these top-notch books are a necessity for everyone interested in radio communication. There is little overlap in coverage; each is a perfect companion volume to the other.

\$3.00

FOR EITHER EDITION AT YOUR DEALER — By mail, \$3.25 postpaid. Add tax in Cal. Foreign, \$3.50.



SURPLUS RADIO CONVERSION MANUAL IN TWO VOLUMES

This set of reference data has become standard for the most commonly used items of surplus electronic equipment. All conversions have been proven by testing on several units; each yields a useful item of equipment. For list of items covered, write us.

\$2.50

FOR EITHER VOLUME AT YOUR DEALER — On mail orders from us, \$2.60 postpaid



ANTENNA MANUAL

The most practical, comprehensive book on antennas. 300 pages of down-to-earth help on antenna, feed line, radiation and propagation for all frequencies up to 1000 Mc. including FM and TV. Plain language; no need to brush up on math. A necessity for everyone interested in transmission or reception.

\$3.50

AT YOUR DEALER — On mail orders from us, \$3.60 postpaid. Add tax in Cal. Foreign, \$3.75



"RADIO - TELEVISION Questions and Answers"

A separate book for each element of the study-guide questions pertaining to the various classes of commercial U.S.A. radio operator licenses. You need buy only those elements required for the license you want.

NOW READY:

Element 2: Basic Theory and Practice
Element 3: Radiotelephony
Element 4: Advanced Radiotelephony

85¢ EACH

AT YOUR DEALER—On mail orders from us, \$1 postpaid for one, or 90¢ each for two or more.

NOW AVAILABLE:

Element 1: BASIC LAW, temporary mimeographed edition. (Printed edition awaits pending revision of questions by F.C.C.) 40¢ per copy at your dealer; 45¢ from us postpaid.



RADIO AMATEUR NEWCOMER

Ideal for those just getting started (or interested) in radio. You need no other book to get your license and get on the air. How-to-build simple equipment for a complete station; operating instructions; simple theory; study questions needed to pass license exams; U.S.A. Amateur radio regulations. WRITTEN BY THE EDITORS OF "RADIO HANDBOOK."

\$1.00

AT YOUR DEALER — On mail orders from us, \$1.10 postpaid. Add sales tax in California.



WORLD'S RADIO TUBES (Radio Tube Vade Mecum)

The only book of its kind in the world. 18 languages with more than 15,000 tubes listed. The most complete set of tube data in existence. Many carefully prepared charts. Tube characteristic data of U.S., British, French, Czech, German, Swiss, Australian, Italian, Russian, Japanese, Scandinavian and all other available types... all in one book!

\$3.00

AT YOUR DEALER — On mail orders from us, \$3.20 postpaid. Add tax in Cal. Foreign, \$3.35

OTHER U. S. A. ELECTRONIC BOOKS: You may order from us any such currently advertised book at standard prices; we maintain extensive stocks for prompt shipment. **"SURPLUS" DIAGRAMS:** We can furnish schematics of many surplus electronic items not included in our Conversion Manuals. Send stamp for list.



Technical BOOKS

"THE RADIO AMATEUR'S HANDBOOK" by the ARRL Staff. Published by *The American Radio Relay League*, West Hartford, Conn. 605 pages. Price \$2.00. (27th Edition—1950.)

As indicative of the coming of Spring as the first crocus, the new edition of the "Handbook" has arrived on the amateur horizon.

Long the bible of the ham fraternity, this newest volume enhances its already formidable reputation by the presentation of new and up-to-the-minute information on all phases of ham equipment and operation.

The twenty-five chapters into which the book is divided cover the entire field of ham communications from the basic fundamentals to the latest techniques in single-sideband telephony.

Since few persons in the field need any introduction to the "Handbook" suffice it to say that this edition is the "best ever."

"RADIO TECHNOLOGY" by Ernest J. Vogt. Published by *Pitman Publishing Corporation*, New York. 542 pages. Price \$6.00.

The publishers of this book have dubbed it a "one volume reference library" and they are not far wrong.

Covering telegraphy, telephony, television, transcription, and facsimile in addition to radio, this text packs an amazing amount of basic information into its 500 plus pages.

Designed as an interim handbook which fills the gap between elementary radio texts and books at an engineering level, the author has managed to present his subject matter without resorting to complicated mathematical formulas. What little math is required in the text is fully explained in a chapter devoted to radio mathematics. The first chapter covers basic electrical concepts while additional chapters are devoted to the direct current theory, basic a.c.

theory, motors and generators, inductance, capacitance, advanced a.c. theory, the vacuum tube, the v.t. oscillator, receiving circuit principles, transmitting circuit principles, antennas, sound conversion, radio aids to navigation, measurements in radio, studio and control equipment, and television and facsimile.

Seven tables in the appendix deal with schematic radio symbols, man-tissas of common logarithms, trigonometric functions, db. vs. voltage and power, frequency tolerances, loss constants for attenuation pads, and the international "Q" signal code.

The work is written by and for the practical radio man with the result that all of the material is presented in usable and convenient form. Practical radio technicians, those studying or holding operators' licenses, and practical radio engineers will all find this book valuable in their work.

* * *

"RADIO OPERATING QUESTIONS AND ANSWERS" by J. L. Hornung. Published by *McGraw-Hill Book Company*, New York. 574 pages. Price \$5.00. (Tenth Edition.)

This well-known study text, making its appearance for the tenth time, has been completely revised to provide concise information on radio communication—theory, apparatus, circuits, laws and regulations, FM, television, aircraft radio, radar and loran, grouped into the seven elements which go to make up the FCC commercial radio operator licensing examinations.

The new FCC element, Element 7, which became effective on January 3, 1950 is covered by 266 questions dealing with rules and regulations, radio theory operations, and special air navigation problems.

In addition, this new volume includes 46 special problems covering the more complex questions given in the FCC Guide.

Specifically the book provides 1753 answers to the examination elements. In addition much of the data will prove valuable to those in all branches of electricity, radio broadcasting, and marine radio operation.

-30-

Members of the Federation of Radio Servicemen's Association group around Robert H. Bishop, vice-president in charge of sales, who accepted the Federation's award on behalf of Sylvania Electric Products Inc. The company was awarded the plaque for outstanding promotion and advertising efforts in stimulating public confidence.



You Don't Need a SLIDE RULE to Show **SENCO PRICES** are **EXTRA LOW**

BRAND NEW IMMEDIATE DELIVERY TUBES INDIVIDUALLY CARTONED GUARANTEED

SPECIAL QUANTITY DISCOUNT OFFER. Order 25 or More Assorted Tubes and Deduct 5c from the Price of Each Tube.

15c each	45c each	85c each (cont.)	50c each (cont.)
2C34	1B5	1D5	59
1526	1L4	1D7	71A
1644	1R5	1D8	73
E1148	1S5	1E7	81
19c each	1T5	1F4	89
V99	2A5	1F5	2051
X99	2B7	1G4	
29c each	28-45	1G5	59c each
12A0	3B7	1G6	024
12F0	6AL5	1H4	1C5
36	6B6	1H5	1A5
954	6AU6	1J6	1LA4
955	6C6	1P5	1LA6
956	6D7	1R4	1LB4
957	6P5	3Q4	1LC5
39c each	6J7	3S4	1LC6
1A3	6K5	3V4	1LD5
1U4	6K6	5T4	1LE3
1U5	6L7	5W4	1LN5
1V	6M7	5Y4	1M5
2A6	6SF5	5Z3	6A7
2A7	6SF7	5Z4	6AB5
2X2	6SR7	6A6	6A5
4A6	6SR7	6AE6	6B4
6AB4	6V5	6A8	6BF6
GAT6	6V6	6AC5	6BQ6
6BA6	7B6	6AD7	6J6
6BE6	7E5	6AQ5	6J8
6C4	7K7	6AR5	6J8
6H6	7Y4	6B6	6J8
6I5	12AT6	6B7	6J8
6N4	12AU7	6B8	6SL7
6SA7	12BA6	6B8	6T7
6SH7	12BB6	6BH6	7C7
6SK7	12C6	6C5	7L7
6SO7	12CF7	6C6	7M7
6SQ7	12SF7	6F6	12AT7
6U7	12SJ7	6F8	14A7
6K4	12SN7	6G5	14B7
6K5	12SR7	6S7	14R7
12A8	12Z7	6S7	22
12AV6	14H7	6V6	3Z5
12AV6	25L6	7A5	50L8
12J7	31	7A6	70L7
12K7	34	7A7	82
12K8	35W4	7C5	
12Q7	35Z4	7E7	69c each
12SH7	35Z5	7H7	2A3
10T8	41	7N7	5V4
24A	43	7N7	6A3
25Z6	46	7V7	6AB7
26	50B5	12SA7	6AK5
27	53	12SB5	6E5
32	56	12SC7	6SN7
35/51	58	12SK7	6R6
35B5	60	12SQ7	35A5
35Z6	80	14B6	30A5
39/44	84	23A6	55
57	117Z3	33Y4	117Z6
76		35Z3	
77		42	89c each
78	1A5	45Z5	1B3
85	1B4P	47	1C7
VR53	1C7	49	6B6
		50C5	6L6
		50Y6	19BG6
			83V

MINIMUM ORDER \$2.50. Send 25% deposit for all C.O.D. shipments. Include sufficient postage, excess will be refunded. Orders without postage will be shipped express collect. All prices F.O.B. New York City.

BOTH FREE!
CONDENSER-RESISTOR COLOR CODE CHART
RECEIVING TUBE INTERCHANGEABILITY CHART

Senco's Latest Condenser-Resistor Color Code and Receiving Tube Interchangeability Charts are yours for the asking. This is Senco's way of thanking Old Customers and welcoming New Ones.

NOTHING TO BUY—FILL IN COUPON—MAIL TODAY!

Name

Address

City..... Zone... State.....

Radio Men Who Know **SAVE AT SENCO**

SENCO RADIO, INC., Dept. U
71 West Broadway, New York 17, New York

FIXED BIAS vs. SELF BIAS

Here are some of the advantages of using self bias for audio amplifier power output stages.

By **CHARLES P. BOEGLI**
Cincinnati Research Company

FROM time to time various papers have appeared stressing the advantages of fixed bias over self bias for audio amplifier power output stages. Generally the writers utilize the data printed in tube handbooks to prove the superiority of the former. For example, in the case of push-pull 2A3's with 300 volts on the plates, a fixed bias of -62 volts and a load resistance of 3000 ohms (plate-to-plate) result in a power output of 15 watts at 2.5 per-cent distortion. With the same plate voltage and a load resistance of 5000 ohms the self bias produced by a 780-ohm cathode resistor (-62.5 volts with zero signal) permits only 10 watts output with 5 per-cent distortion.

Such a comparison is, however, unfair; in the highest-fidelity amplifiers self bias is actually equal to fixed bias in performance and much better from the standpoint of convenience. That self-bias arrangements are more convenient than fixed bias, and consequently to be preferred if all other things are equal, is almost self-evident. Self bias eliminates the need for separate power supply systems with their associated rectifiers and filter networks. Furthermore, since a greater d.c. grid impedance is permissible with self bias, there is no need for expensive transformer coupling or cumbersome cathode-follower drive, which introduces two extra tubes that provide no gain.

With the 2A3, for example, there are two reasons for the poor showing of self bias in the tube manuals. First is the fact that the tubes under the specified conditions are in class AB₁ operation. Under these circumstances the plate current increases considerably as the signal becomes greater, after the signal has exceeded a certain value. This is an advantage with fixed bias¹ but quite the opposite for self bias, because here if the bias is correct at zero signal, it will be excessive when a large signal is applied to the grids. The cathode bias resistor thus acts in opposition to the input signal level, resulting in greater distortion for a given output.

The answer to this objection is that in the highest-fidelity amplifiers class AB₁ output stages simply are not used. The *calculated* freedom from even-harmonic distortion would *actually* be obtained only if perfect coupling existed between the halves of the output transformer primary.

This is, of course, never the case. There is no substitute for push-pull Class A output stages when perfect reproduction is demanded. Since with Class A the plate current varies only slightly (because of rectification effects²) with the magnitude of the signal, the bias remains substantially at its predetermined value regardless of the method of supplying it.

In designing a push-pull output stage it must be remembered that the term "plate voltage" on the plate characteristics chart actually refers to the voltage between plate and cathode. When fixed bias is used the "plate voltage" is the same as the "B" supply voltage (neglecting the small drop in the output transformer primary) but with self bias, the bias voltage appears between cathode and ground and the "B" supply voltage must equal the "plate voltage" plus the bias voltage. What this means is that instead of furnishing a negative fixed bias by means of rectifiers and filters, we merely add the amount of the bias to the plate supply voltage. We replace all the power supply components of fixed bias with one or two little bias resistors.

For example, if we want to use push-pull 300A's at 400 plate volts and -87 grid volts (plate current = 60 ma. per tube) we can have a 400-volt "B+" supply and a -87-volt bias supply, or a 487-volt "B+" supply and no bias supply. In either case we get the same power output and the same distortion—provided just one more precaution is taken with self bias.

This precaution eliminates the last cause of self-bias trouble. If a common cathode resistor is left unby-passed the second-harmonic voltages are fed back in phase to both grids and a secondary type of harmonic distortion appears in the output. Consequently, that resistor (or resistors) is bypassed—the bigger the bypass condenser the better.

The power output from push-pull class A output stages is generally limited by the allowable plate dissipation of the tubes, which must not be exceeded with no signal on the grids. For this reason class A doesn't furnish the power that class AB₁ does. From 2A3's or 6B4G's only 10 watts maximum is available with 250 plate volts, and an increase in plate voltage much above 250 results in excessive plate dissipation. This merely means that if more power is

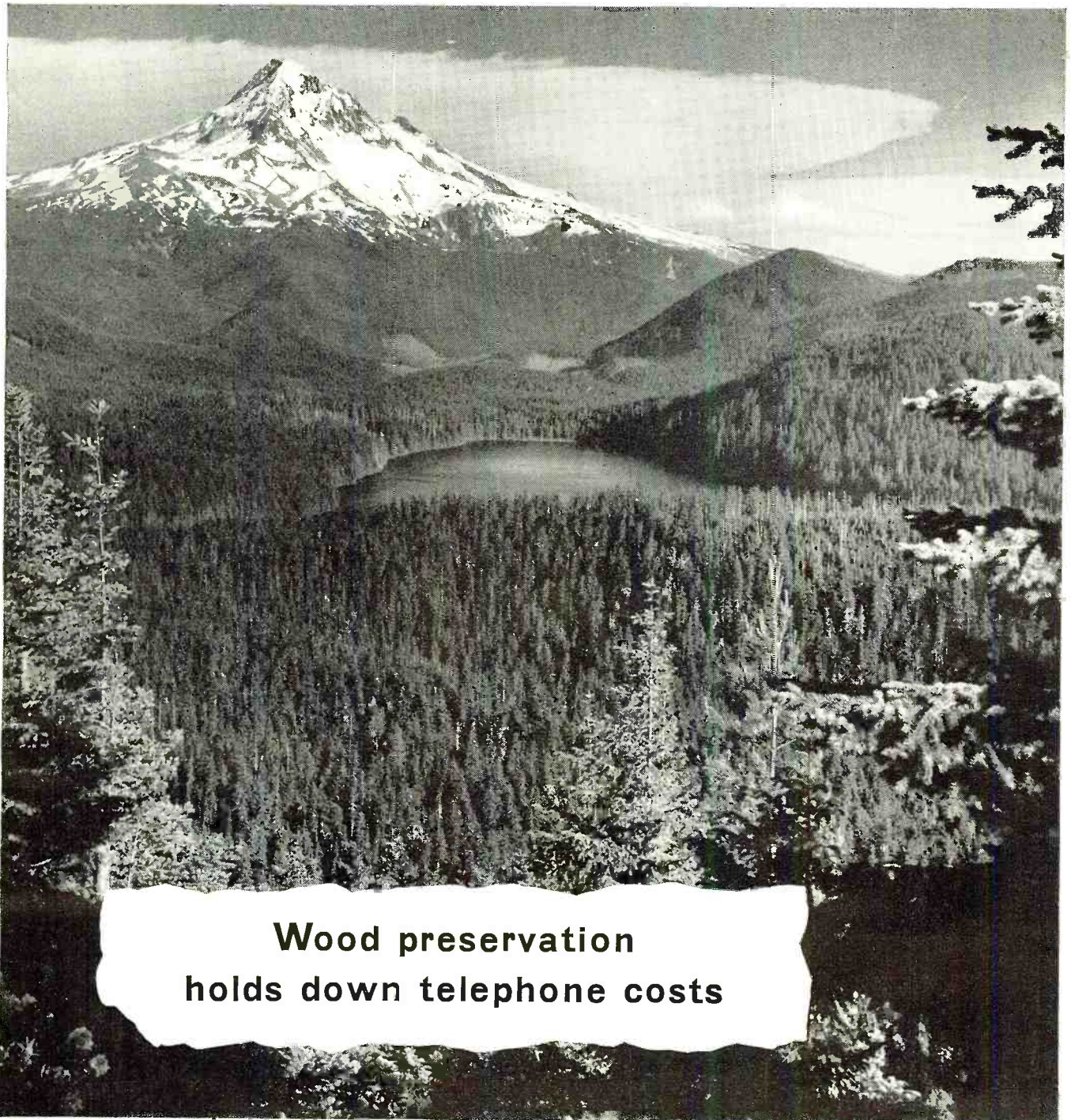

Wood preservation holds down telephone costs

Poles are a substantial part of the plant that serves your telephone; making them last longer keeps down repairs and renewals that are part of telephone costs. So Bell Laboratories have long been active in the attack on wood-destroying fungi, the worst enemies of telephone poles.

Better, cleaner creosotes and other preservatives have been developed in co-operation with the wood-preserving industry. Research is now being carried out on greensalt—a new, clean, odorless

preservative. Even the products of atomic energy research have been pressed into service—radioactive isotopes are used to measure penetration of fluids into wood.

Treated poles last from three to five times as long as untreated poles. This has saved enough timber during the last quarter century to equal a forest of 25,000,000 trees. More than that, wood preservation has enabled the use of cheaper, quickly growing timber instead of the scarcer varieties.

This and other savings in pole-line

costs, such as stronger wires which need fewer poles, are some of the reasons why America's high-quality telephone service can be given at so reasonable a cost. It is one of today's best bargains.

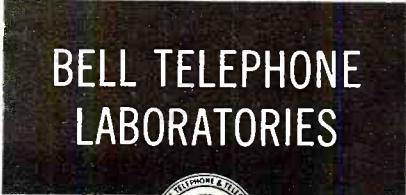

*Exploring and Inventing, Devising and Perfecting, for Continued
Improvements and Economies in Telephone Service.*

???? R89/ARN5-A RECEPTOR ????
HAVE YOU READ MAR/50 "Radio Electronics" about using this set as a FM RECEIVER? You not only get the R89/ARN5-A Receiver but also the companion RCT35D Localizer Receiver. Complete with all tubes, perfect cond. Both units \$9.95



PP4/APQ2 POWER SUPPLY:
 115V 400 cycle. This unit will make a beautiful supply for entire low power transmitter. Puts out Pos. 350, 560, Neg. 960 volts DC. Contains 4-5R4, 6Y tubes, plus wonderful filter system. Change xformers to 60 cycle and you have a fine supply. Complete, excel. cond. \$6.50
R.F. CHOKE: 2.5 mh. 125 ma. Ea. 15c

SCR-522 RECEIVER-TRANSMITTER: 100-156 mcs. One of the hottest 2-meter rigs. Complete with all tubes and push-button control box. Excellent cond. \$24.95

ACCESSORIES FOR 522 RECEIVER-TRANSMITTER
 PE-98 12 V. Power Supply. Used. \$12.95
 PE-94 24 V. Power Supply. Low price. \$2.95
 AN-104-A Antenna. Brand new. \$1.95
 PD-12 110 V. 60 cyc. power supply. Excel. \$37.50
 Set of 7 plugs. New. \$3.95
S.O.S. BALLOONS. New. Ea. \$1.95
12" BRASS ANTENNA. Shuts to 15". Used. \$2.75
OIL CONDENSERS BATHTUB CONDENSERS
 10 mfd., 600V. .99c
 25 @ 400V. .39c
 25 @ 400V. .39c
 2x8 mfd., 600V. .89c
 .1 or 1 mfd. @ 400V. .39c
 4 mfd., 600V. .49c
 .001 @ 600V. paper. New 10 for \$1.25
 2 mfd., 600V. .29c 500V. mica, assorted. New 20 for \$1.00
 .02 @ 2,000V. .79c 40 mfd. 350V. electrolytic. New 3 for \$1.00
 1 mfd., 3,600V. \$1.95 New 3 for \$1.00

TRANSFORMERS 115 V. 60 CY. PRI:
 2.5 V. @ 10 amp. \$4.00
 400-0-400 @ 200 ma. 5V. @ 3 amp. 6.3V. @ 5 amp 3.95
 Choke, 1 henry @ 800 ma. \$3.95

CONICAL TV ANTENNA \$5.95
 274N ANTENNA RELAY BOX
 Contains RF meter plus 50 mmfd H.V. vacuum cond. and relay. New in carton. \$2.25
 SAME but less vacuum cond., used, good cond. .99
EE-8 FIELD TELEPHONE: Uses 2 flashlight batt. Has crank for ringing other phone. Ideal for use in field, mines, camp, house to lab. or garage, etc. Excel. operating condition. Each \$6.75
 ORDER A PAIR FOR ONLY \$12.95
TUBES: 250 TL Tube. \$16.50
 See our ad P. 104 Radio News Feb/50 for more tube buys!
ARC-5 TRANSMITTERS 4-5.3 mcs. Used, excel. cond. \$3.50
COMPLETE 5.3-7 mcs. Used, excel. cond. \$3.50
 2.1-3 mcs. Excel. for ship use. New \$12.95
 3-4 mcs. Used, excel. cond. 7-9.1 mcs. Used, excel. cond. \$9.95
ARC-5 RECEIVERS
 3-6 mcs., excel. cond. \$3.95
 6-9.1 mcs., good cond. 6.95
 190-550 Kes., excel. cond. 9.95

METERS! HOT BUYS! METERS!

2" G.E. or Westinghouse Rd. 2" Weston Rd. \$2.79
 0-1 ma. DC with 3 scales: 0-25 ma. DC \$2.79
 0-140 ma. DC, 0-140 VDC. 0-1.5 amp RF 3.49
 0-500 ma. DC w/3 shunts \$4.50
 0-1 amp R.F. \$3.49
 2" Hickok Rd. 2" Westinghouse Rd. \$2.50
 0-1 ma. with 0-10 scale \$3.29 0-9 amp RF \$2.50
 3" Westinghouse Rd. 3" Simpson Rd. \$2.50
 0-15 ma. DC movement with 0-300 scale \$3.49 0-3 VDC \$2.50
 2" Simpson Sq. 0-50 ma. DC \$2.99
 0-50 ma. \$2.99 0-100 ma DC \$3.49
 2" Triplet Rd. 0-300 ma DC \$3.49
 0-2 amp RF \$2.99 0-1 amp RF \$2.99

APQ-5 POWER SUPPLY: Electronically controlled power. Embraces 2-5U4G, 4-6Y6, 2-VR150, 1-6S17, 1-6X5. Operates from 115 V, 400 cycle. Replacing xformer with 60 cycle. Makes ideal lab or test supply. Excellent cond. Ea. \$4.95

APN-1 ALTIMETER TRANSMITTER
 Operates approx. 420 MC. FM designed to give accurate height above ground. Unit can be revamped for the 420 mcs. ham or foundation for citizens' band. Contains 2-955, 2-9001, 5-12S17, 2-12S17. A dynamic vibrating capacitance for producing FM signal. (Makes excellent unit for FM or TV sweep generators.) Many other useful parts. Excellent cond. With plugs \$4.95
APN-1 DIAGRAM \$1.00
BC 375 TRANSMITTER: 150W. Phone or CW. 2-211 tubes in final. Complete with all tubes but less tuning unit \$10.95
TV IF STRIP: With peaking coils, new. \$7.95
BC 191 TRANSMITTER: Same as BC 375 above but 12V operation. Excel. cond. \$19.95
TCS MARINE RECEIVER & TRANSMITTER: Complete with all tubes and dynamotor, less crystals. 35 watts. 12V. operation. Excel. cond. \$169.50
FISHER MARINE TRANSMITTER & RECEIVER: Complete with 12V. supply. 25 watts, less crystal. Excel. cond. \$139.50

DID U C R AD THIS MONTH IN CO?
COLUMBIA ELECTRONIC SALES
 522 South San Pedro Street
 LOS ANGELES 13, CALIFORNIA

required different tubes must be used, like the 275A (12 watts maximum at 300 plate volts), the 252A (19 watts maximum at 500 plate volts) or the 300A (30 watts maximum at 450 plate volts). Push-pull parallel arrangements can also be used for more power.

In a high-fidelity amplifier with push-pull class A output it thus makes little difference, as far as results are concerned, whether fixed or self bias is used. The only difference is in cost and convenience, where self bias excels. There is no reason for the disrepute that has been attached to self-bias circuits and they deserve every consideration in the design of fine audio amplifiers.

REFERENCES

- ¹ Terman, F. E.; "Radio Engineer's Handbook", First Edition, McGraw-Hill Book Company, New York, 1943, Page 383.
- ² Smith, F. L.; "The Radiotron Designer's Handbook", Third Edition, The Wireless Press, Sydney, 1942, Page 285.

MUTING CIRCUITS

By ROBERT HERTZBERG

The amazing ability of an unshielded receiver to pick up signals from extremely distant stations was demonstrated very forcibly recently. While playing with the numerous adjustments of a 630TS type television receiver, just to see what happens (and believe me, plenty does!), it was found that the v.t.v.m. gave peculiar readings, some of them not related at all to the circuit functions. In twisting some of the alignment screws, it was discovered that the meter responded very nicely with the test signal generator turned off! After two hours of just plain exploring, mixed with a little swearing, I tuned the mysterious impulse through the sound section of the receiver and nearly fell over when a veddy British voice announced a BBC program originating in London!

The signal was killed by pulling out the oscillator tube, and then the circuits beginning with the i.f. stages behaved normally. Eventually, I lined the inside of the receiver cabinet with copper screening, grounded thoroughly. This eliminated not only unwanted voice and c.w. signals, but also TV signals being picked up directly by the chassis. These latter signals previously had produced "leading" ghosts. -30-

SHOOTS TROUBLE FASTER!
 MAKES MORE MONEY FOR YOU ON JOB OR AT SERVICE BENCH!

PRICE \$9.95
 at distributor or postpaid, direct. No C.O.D.'s, Please, Ohioans add 3% State Sales Tax

Signalite
MULTI-FREQUENCY GENERATOR
 In radio service work, time means money. Locate trouble faster, handle a much greater volume of work with the SIGNALITE. As a trouble shooting tool, SIGNALITE has no equal. Merely plug in any 110 V. AC-DC line, start at speaker end of circuit and trace back, stage by stage, listening in set's speaker. Generates RF, IF and AUDIO frequencies, 2500 cycles to 20 Megacycles. Also used for Checks on Sensitivity, Gain, Peaking, Shielding. Tube testing. Wt. 13 oz. Fits pocket or tool kit. Satisfaction, or money back! See at your distributor or order direct.

Clippard Instrument Laboratory, Inc.
 DEPT. A, 1125 BANK STREET
 CINCINNATI 14, OHIO
QUALIFIED JOBBERS WRITE, WIRE FOR DETAILS.

STAY ON THE AIR WHEN POWER FAILS...with an ONAN Electric Plant

AUTOMATIC START & STOP

Model 10EL, 10KW A.C.

When storms, floods, or fires interrupt electricity and force you off the air, you lose listeners and income. Guard against loss, assure vital public service during emergencies by installing an Onan Electric Plant. Onan Standby Electric plants serve many network and private stations. Automatic models to 35,000 watts.

PORTABLE ELECTRIC PLANTS FOR MOBILE RADIO USES
 Supply A.C. power for broadcasting at scene of events. Can be carried by hand or in trunk of car. Weigh as little as 80 pounds. A.C. models 350 to 35,000 watts.

Write for FREE Folder
D. W. ONAN & SONS INC.
 4807 Royalston Avenue
 Minneapolis 5, Minnesota

"I can't see why that window TV antenna must be adjusted every night at this time!"

**ZOOMING
AHEAD
IN DEMAND!**

**Feature For Feature
Compare it... You can't beat a
RADIART TELE-ROTOR**

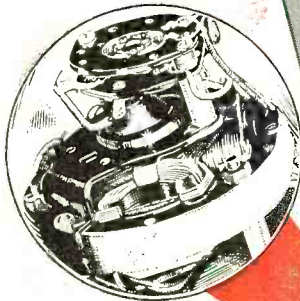

HEAVY DUTY MOTOR... most powerful of all TV rotators



Streamlined Weather-Proof Housing, Keeps Out Water, Snow and Ice

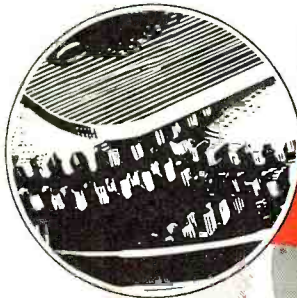

HEAVY DUTY Precision STEEL GEARS



12 Heavy Duty Ball Bearings in 6 1/2" diameter Ball Bearing Races



THE RADIART TELE-ROTOR CONTROL BOX

with the PERFECT PATTERN dial... fingertip control with instant indication of Antenna Position shown on the illuminated two-tone face.

Available in the following models:

- TR-1 ... rotator and Control Unit with end of rotation light (uses 4 wire Cable) **\$37.45**
- TR-2 ... Compass Control Rotator with illuminated "Perfect Pattern" dial (uses 8 wire Cable) **\$44.95**

You Can't Beat a RADIART ANTENNA on a TELE-ROTOR... IT'S TOPS!



IT'S RIGHT WHEN IT'S RADIART

THE RADIART CORPORATION

CLEVELAND 2, OHIO



- VIBRATORS
- AUTO AERIALS
- TV ANTENNAS
- POWER SUPPLIES

VEE-D-X

LOW PRICED

Yagi Arrays

- Transformer ratio of stepped-up driven element provides perfect match to 300 ohm line.
- Lowest standing wave ratio insures maximum transfer of signal.
- High front to back ratio prevents co-channel interference.
- Sharp horizontal pattern helps reject unwanted interference of all types.
- Extra high forward gain makes this the ideal antenna for single channel fringe reception.
- Not designed to replace the famous heavy-duty RLY and EC series.

J SERIES

JA

V. S. W. R. = 1.34
Z = 335 ohms

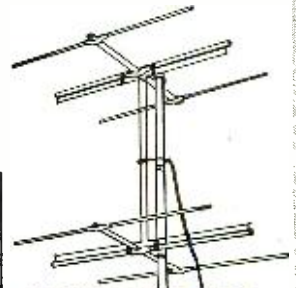
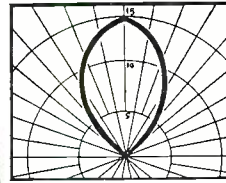

LOW CHANNEL
\$17.35 list
HIGH CHANNEL
12.50 list
For double stack as shown

JB

V. S. W. R. = 1.26
Z = 315 ohms

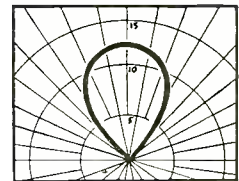

LOW CHANNEL
\$13.20 list
HIGH CHANNEL
6.95 list

JC

V. S. W. R. = 1.28
Z = 317 ohms

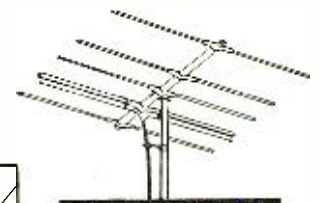
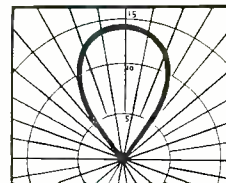

LOW CHANNEL
\$14.60 list
HIGH CHANNEL
7.95 list

PRE-ASSEMBLED FOR FAST, EASY INSTALLATION

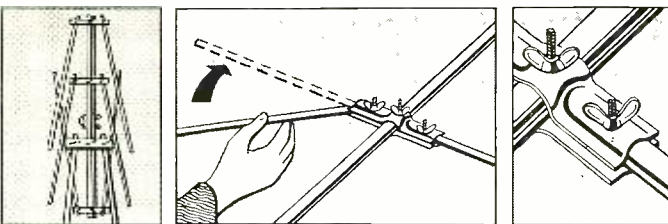

All the parts are in one package ready for assembly. The new clamp type construction makes it easy to swing each element in place and secure it firmly with the wing nut. No bag of hardware to fuss with — no bolts or screws to lose.

THESE ANTENNAS STAY UP

Only the highest quality duraluminum alloys are used.

Yield Strength	36,000 lbs. per sq. inch
Ultimate Strength	41,000 lbs. per sq. inch
Shearing Strength	24,000 lbs. per sq. inch
Endurance Limit	20,500 lbs. per sq. inch

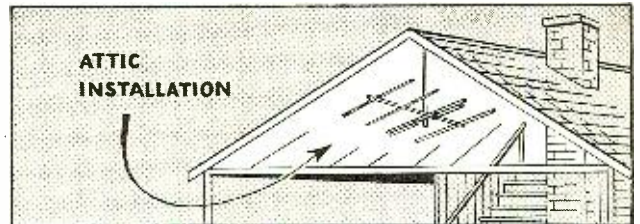

Because of the high gain of this antenna, many people have found that they can obtain excellent results with a single attic installation.

LAPOINTE-PLASCOMOLD CORP., 3
UNIONVILLE, CONNECTICUT

Send me information on the entire line of VEE-D-X antennas and accessories.

NAME

COMPANY

STREET

CITY ZONE..... STATE.....

CHANNEL BUSTER ANTENNA TV and FM ANTENNA

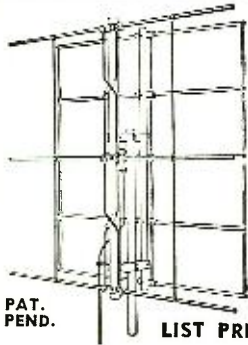

- Will eliminate TV interference from the rear side at a ratio of 30-to-1 on the desired frequency. Other channels vary from 2-to-1—10-to-1 ratio.
- The reflector is tunable to reject any desired frequency from the rear.
- Designed to operate in fringe areas.
- Complete all-channel coverage 2-13.
- One lead-in wire.
- High-gain vertical array.
- Good mechanical construction. *NO VIBRATION.*
- Shipped partially assembled complete with instructions.

PAT.
PEND.

LIST PRICE

\$42.00

BARB CITY UNIVERSAL FOOT MOUNT No. 250



- Rotatable 360°.
- Will fit any size pipe, tube or conduit from 3/4" to 2 1/2".
- Can be swiveled on vertical and horizontal axis.
- Allows raising mast on ridge, valley or slope of any roof.
- Allows clearance in swinging around chimneys, branches, wires, etc.
- Base can be mounted on any shape, angle, slope or ridge.

LIST PRICE

\$3.95

PAT.
PEND.

BARB CITY INDUSTRIES, INC.

1150 SOUTH FOURTH STREET

DE KALB, ILLINOIS

true because in the usual television set the oscillator is on the high side of the signal. This means then that as the sweep generator's frequency goes up, the intermediate frequency produced goes down, thus turning the curve around. The high frequency side may be returned to the right side by simply flipping the phase reversal switch.

In view of the fact that such reasoning becomes extremely confusing, the following rule of thumb is offered. Turn the sweep generator output frequency *higher*. The response curve on the scope will then move toward the *low* frequency side in terms of sweep output frequency.

Spurious Outputs

When working at any other frequencies than those in the range of 165 mc. to 220 mc. a generator such as the one outlined above will have two spurious outputs from the two beating oscillators. The usual practice is to overlook these undesired outputs and depend on the selectivity of the receiver to remove them. Where the most accurate results are desired a filter should be used to attenuate the undesired voltages. Such a filter is shown in the schematic as L_4 and C_{15} . Fig. 8 shows the filter with its cover removed inside the loop of the output cable. Some of the undesirable effects which can be caused by spurious outputs of large amplitude are overloading of early stages, excitation of portions of the circuit not under observation, and causing a "hot" output cable.

Conclusion

This article has been confined to discussion of what we believe to be an excellent laboratory-quality sweep generator, but good equipment alone is not sufficient to yield good results. In the field of visual alignment good technique is more important than in almost any other type of electronic measurements. Reliable results can be expected only after a thorough study of available literature on the subject plus many hours of experience.

-30-

ADSON FOR VALUE!

SAVE \$\$\$ ON TV ACCESSORIES!



ANCHOR TV BOOSTER
Recommended By Famous
Consumer Research Lab.

Boosts signal in fringe areas and trouble locations. Gives 2 1/2 times more gain in signal strength across all channels. Minimizes ghosts. Features exclusive impedance matching of its output to input of set. **\$22.00**



DIETZ ENLARGING LENS
4-Way Adjustable Bracket

Optically perfect picture magnifier gives bigger and better pictures for your TV enjoyment. Compare these prices and order today!

7" \$ 8.95

10" 11.95

12" 15.95

TV WAVE TRAPS

An amazing device for improving TV reception. Connects to lead-in line. Choose one of three to eliminate interference from FM, diathermy, or amateur stations. Each, only \$2.89

SCOOP PURCHASE!

Standard Brand

16" TV BLACK TUBE

only **\$44.95**



You've heard about the sensational new black TV tube featured by all prominent set manufacturers. You know that it gives a picture that is unsurpassed for clarity and detail without eye-strain. Now, modernize your TV receiver with this big, big 16" black tube at a low, low price! Packed in factory sealed cartons ready for immediate installation. Standard RMA guarantee. Limited quantity, first come, first served!

SPECIAL! NEW "STANDARD" TV TUNER. Turret Type, All Channel, High Gain. Our Price **\$26.95**

Satisfaction guaranteed. Send check or money order. 25% deposit with C.O.D. All orders shipped within 24 hours. F.O.B. New York. Please include postage.

ADSON RADIO & ELECTRONICS CO.
221 Fulton Street, New York 7, N.Y.

CUT HOLES 1/2" to 3 1/2" IN RADIO CHASSIS



WITH A GREENLEE
RADIO CHASSIS PUNCH

• Save hours of work . . . no reaming of tedious filing. Punch cuts through chassis quickly . . . makes accurate, clean holes for sockets, plugs, and other receptacles. Just turn with an ordinary wrench. There's a GREENLEE Punch in each of these sizes: 1/2"; 5/8"; 3/4"; 7/8"; 1"; 1 1/16"; 1 1/8"; 1 1/4"; 1 1/2"; 1 3/4"; 1 7/8"; 1 3/4"; 2 1/4". Write for complete facts. Also get information on Knockout Punches and Cutters for conduit and meter holes up to 3 1/2". Greenlee Tool Co. 1885 Columbia Avenue, Rockford, Illinois.

TOOLS FOR CRAFTSMEN

GREENLEE

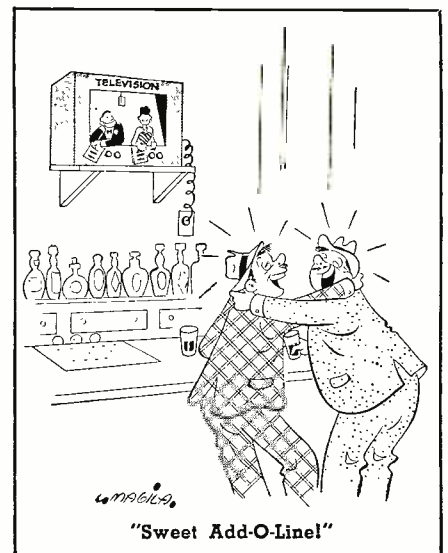

WAGNER

"Sweet Add-O-Line!"

How electronic “paintbrushes” create pictures in our newest art form

There's not a single moving part in a Kinescope —but it gives you pictures in motion

No. 4 in a series outlining high points in television history

Photos from the historical collection of RCA

● Ever watch an artist at work—seen how his brush moves over the canvas to place a dot here, a shadow, a line, a mass, or highlight there, until a picture is formed?

Next time you're asked how television pictures are made, remember the paintbrush comparison. But the “brush” is a stationary electron gun, and the “paint” is a highly refined coating of fluorescent material made light or dark in orderly pattern by electrons.

Developed by Dr. V. K. Zworykin, now of RCA Laboratories, the kinescope picture tube is one of the scientific advances which gave us *all-electronic* television . . . instead of the crude, and now outmoded, mechanical techniques.

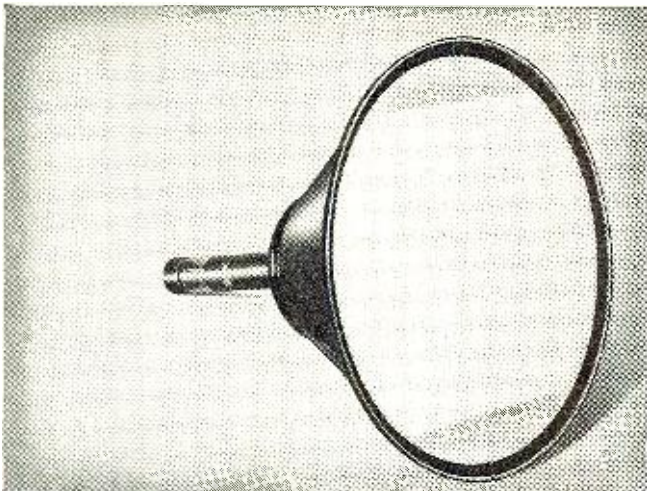

New 16-inch RCA glass-and-metal kinescope picture tube, almost 5 inches shorter than previous types, incorporates a new type of glare-free glass in its faceplate—Filterglass.

(Advertisement.)

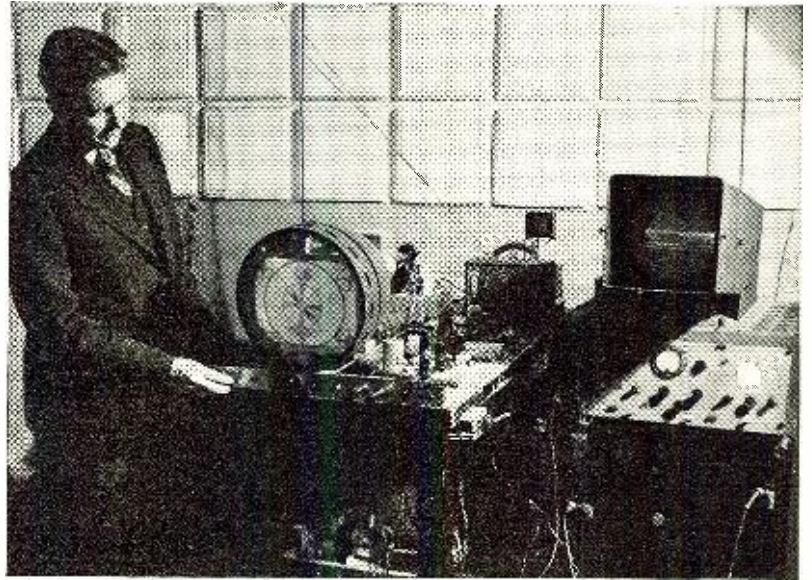

An experimental model of the kinescope—developed by Dr. V. K. Zworykin of RCA Laboratories—is seen undergoing laboratory tests.

Today, through research at RCA Laboratories, these complex kinescope picture tubes are mass-produced at RCA's tube plants in Lancaster, Pa., and Marion, Indiana. Industrial authorities call this operation one of the most breath-taking applications of mass production methods to the job of making a precision instrument.

Thousands of kinescope faceplates must be precisely and evenly coated with a film of absolutely pure fluorescent material . . . the electron gun is perfectly synchronized with the electron beam in the image orthicon tube of RCA television cameras . . . the vacuum produced in each tube must be 10 times more perfect than that in a standard radio tube—or in an electric light bulb!

Once it has been completely assembled, your RCA kinescope picture tube is ready to operate in a home television receiver. In action, an electrically heated surface emits a stream of electrons, and the stream is compressed by finely machined cylinders and pin-holed disks into a pencil-thin beam. Moving back and forth in obedience to a radio signal—faster than the eye can perceive—the beam paints a picture on the face of the kinescope. For each picture, the electron beam must race across the “screen” 525 times. To create the illusion of motion, 30 such pictures are “painted” in every single second.

Yet despite these terrific speeds, there are no moving mechanical parts in an RCA kinescope. You enjoy the newest of our arts because electrons can be made to be obedient.



Radio Corporation of America

WORLD LEADER IN RADIO—FIRST IN TELEVISION

RIDER BOOKS

Get **BETTER** and **BETTER**
and **BETTER!** And these
NEW Books are our

They are in keeping with the
high RIDER standards. They're
"tops" in the field . . . con-
taining more factual information, more prac-
tical data . . . more clearly presented than
anywhere else.

BEST!

NOW AVAILABLE!

RADIO OPERATOR'S LICENSE Q AND A MANUAL by Milton Kaufman

This book is a most complete and comprehensive treatment of the subject and should prove especially valuable as a quick review of essential theory, as well as a refresher for advancement in the field. It lists all the QUESTIONS and ANSWERS for the FCC examinations. However, the outstanding feature of this volume is its thorough FOLLOW-THROUGH . . . a carefully simplified discussion of the answer to the technician's question . . . so essential for a complete and absolute understanding of the answer. Useful appendices, which include Small Vessel Direction Finders and Automatic Alarm, not ordinarily available in a book of this type, provide a valuable "extra." \$6.00

FM TRANSMISSION AND RECEPTION by John F. Rider and Seymour D. Usian UP-TO-DATE • BASIC • COMPLETE

For the student who is grooming himself for activity in the electronic field. This book covers the subject of frequency modulation thoroughly in a down-to-earth treatment of all types of modulated waves. In plain language—radio, amateur radio, railroad, aviation, marine, police, point-to-point and mobile receivers. Basic theory, transmission, reception, circuit design, line servicing are covered, with mathematical steps to an absolute minimum. Almost all presently used, commercial FM transmitters are described in detail. Question section follows each chapter. Confidential instructor's answer booklet. 416 pages, profusely illustrated. \$3.60

INSIDE THE VACUUM TUBE

by John F. Rider

No other book explains so simply and clearly the theory of the vacuum tube and its operation. In plain language—with fascinating pictures and diagrams that really tell a story—you get a solid grounding in theory and a good working knowledge of basic tube types. It's concise, it's accurate. 424 pages, profusely illustrated. \$4.50

UNDERSTANDING VECTORS AND PHASE IN RADIO by John F. Rider and Seymour D. Usian A Shorthand Method to Easier Understanding of Radio Theory

Written for the student and for any man learning, in radio and electronics, who has not had the advantage of previous extensive mathematical education. Step by step, the subject is developed until final practical application to everyday radio problems is demonstrated. 160 pages, amply illustrated, cloth cover. \$1.89 Paper cover99

NEW . . . COMING SOON!

THE THEORY AND PRACTICE OF 30-1000 MC RECEIVING ANTENNAS

by Arnold B. Bailey

This book is a rare combination of theory and practice that: 1.—Clearly explains and teaches. 2.—Can be used as a daily work reference.

An outstanding book, the like of which has never before been written. Author has resolved the mathematics of antenna problems into graphs, charts and tables—it can be put to good use by all. Reflecting worldwide knowledge of the antenna art, it clearly explains the theory behind the performance of every type of 30-1000Mc receiving antenna on the commercial market, leaving the reader with a full understanding of why each behaves as it does. Practical in every sense of the word. 4.50 More than 500 pages, 6 x 9", cloth bound. \$4.50

The New CATHODE-RAY TUBE AT WORK by RIDER, et al.

The greatest and most complete reference book ever written on the cathode-ray tube! It is a practical, down-to-earth encyclopedia about five times the size of the old standard text. Starting with basic theory of cathode-ray tube operation, it proceeds through application in scopes and TV receivers . . . with full and clear explanations for uses in every field and research activity which employs a cathode-ray oscillograph. All scopes produced and sold during the last 10 years, more than 70 different models are described completely—with schematic wiring diagrams. Almost 500,000 words and about 3,000 illustrations are incorporated in more than 900 pages. It is a book which will enjoy years and years of daily use. 22 chapters.

8 1/2 x 11 inches \$9.00 TELEVISION INSTALLATION TECHNIQUES

by Samuel L. Marshall

This book, written by Mr. Marshall, television instructor at the George Westinghouse Vocational High School, is a practical, easy-to-understand treatment of information pertaining to the antennas, transmission lines, receiver adjustments, and above all, the mechanical requirements, whether they be for short mast or chimney attachment or for the installation of a tower, including foundation. Both theoretical and practical aspects of every phase of this activity, from the top-most element of the antenna to the ground connection on the receiver terminal board, are fully discussed.

VACUUM-TUBE VOLTMETERS

by John F. Rider

NEW • REVISED • ENLARGED

Now completely revised, enlarged, and thoroughly up-to-date, this volume explains theory and functions of the different types of vacuum-tube voltmeters. A special section is devoted to d-c and r-f probes and the concluding chapter discusses the latest commercial types of vacuum-tube voltmeters, complete with schematic diagrams.

JOHN F. RIDER PUBLISHER, INC.
480 Canal St., New York 13, N. Y.

NBFM Unit

(Continued from page 63)

changes in plate voltage on the plate of the second section of the 6SL7GT. The v.f.o. in use at W6EDG has the grid circuit of the oscillator on 80 meters with 10 microhenrys inductance and 200 $\mu\text{fd.}$ of capacity. The coupling condenser between the v.f.o. and the grid of the 6SL7GT (C_5 , 15 $\mu\text{fd.}$) was chosen by installing a variable trimmer and adjusting to optimum value and then replacing the trimmer with a fixed condenser of the same value. This unit has been used on 10, 11, and 20 meter phone with good reports of narrow-band FM quality.

Note that in the first section of the 6SL7GT a potentiometer is used in the cathode lead to ground. The entire potentiometer is used as a bias resistor and the tap is used for connecting a hand key or bug for frequency shift keying of the transmitter. When part of the bias resistor is shorted out, the plate voltage changes on the second section of the 6SL7GT, due to a change in plate current in the first section of the 6SL7GT. This change in plate voltage changes the amplification and the input capacity will change. The magnitude of the frequency shift will be dependent on the amount of bias change or the amount of the bias resistors are bypassed for r.f. only. This FSK system has been used by the writer on 11 meters and works very well. The amount of frequency shift on FSK is variable by means of R_3 from 0 to 3200 cycles, on 11 meters, with the circuit constants shown. Receiving FSK is a matter of having a receiver with good enough selectivity to discriminate between the "mark" or key-down signal and the "space" or key-up signal. The transmitter carrier will be on continuously but the frequency will shift from the mark to the space frequency. It is only necessary

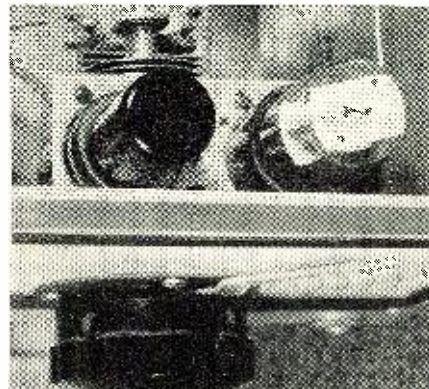

Top view looking down into NBFM and FSK unit bolted in place on front of v.f.o.

for the receiving operator to adjust his receiver so that he receives the mark or key-down signal and the space or key-up signal will then be inaudible. A crystal filter or "Q5-er" will discriminate between the mark and space signal and provide a good signal for copying.

The unit in use in the writer's v.f.o. is built on a small strip salvaged from surplus gear with two conveniently located sockets and tapped holes for mounting. The unit is mounted directly above the tuning condenser of the v.f.o., bolted to the front panel. Filament and plate voltages are taken from the v.f.o. power supply.

The same technique used for communications would also be adaptable for a wireless record player to be used with FM receivers.

It would be desirable to have the oscillator operate on the higher frequency bands, preferably in the FM band of 88-108 mc. As only low power is needed for this type of service, an oscillator such as a 6C4 will be sufficient. With the ordinary crystal pickups it should be practical to feed the pickup directly into the first grid of the 6SL7. The deviation may be adjusted by the cathode potentiometer.

-30-

Front view of v.f.o. Controls under dial are deviation control for FSK in center, microphone input on left under dial, and key jack for FSK on right.

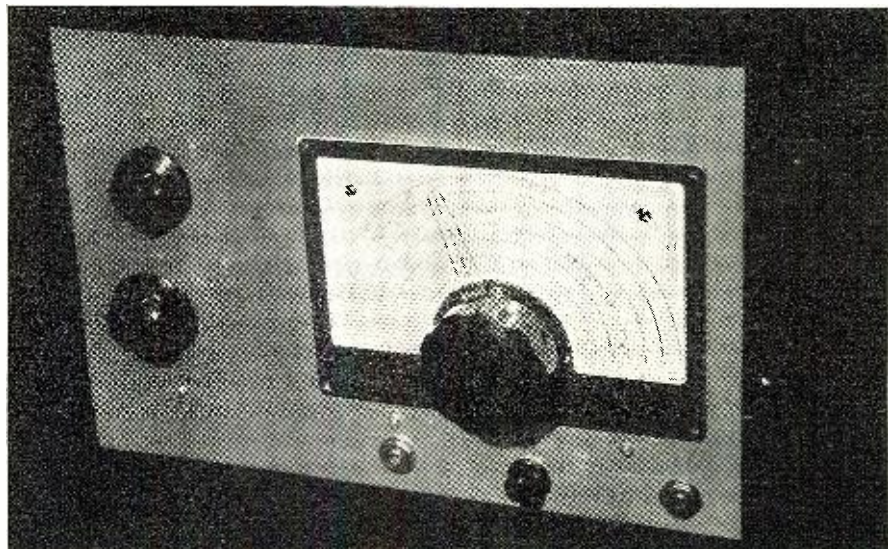



8452

8453

8454

MULTIPLE CONDUCTOR CABLES

Every Type for Every Service

Sold Exclusively Through Recognized Wholesale Distributors

8424

8425

8426

8427

8455

8462

8888

Belden
Radio WIRE

* Design Patented

PARTS at LOWEST PRICES!

FILTER CONDENSERS



Very best
brands
Fresh stock

10 or more
assorted
5% discount

450 Working Volts

8-450 V	ea. 21c
10-450 V	ea. 24c
10-450 V w/	
20-20-25 V	ea. 29c
15-450 V	ea. 29c
20-450 V	ea. 39c
30-450 V	ea. 49c
30-450 V w/	
20-20-25 V	ea. 29c
8-8-450 V	ea. 39c
8-8-450 V	ea. 39c
8-8-450 V	ea. 39c
50-50 V	ea. 39c
8-8-450 V	ea. 39c
50-50 V	ea. 39c
10-10-450 V	ea. 43c
20-20-450 V	ea. 49c
10-10-10-20-	
450 V-150-	
25 V	ea. 49c
25-10-450 V	ea. 49c
30-20-20-450	
V-25 V	ea. 49c
30-30-400 V	ea. 39c
350 V	ea. 39c
30-30-25-400	
V-25 V	ea. 39c
30-10-20-400	
V-25 V	ea. 30c

30-20-150 V	ea. 29c
30-30-150 V	ea. 39c
35-35-150 V	ea. 39c
40-20-150 V	ea. 39c
40-30-150 V	
30-20-25 V	ea. 39c
40-40-150 V	ea. 39c
40-40-150 V	
20-25 V	ea. 39c
50-30-150 V	ea. 39c
50-50-150 V	ea. 39c
60-60-150 V	ea. 39c
20-16-16-350	
V Sprague	
25-25-150 V	ea. 39c
200-10 V	ea. 39c
15-15-40-20-	
150 V-25 V	ea. 29c
20-10-5-10-	
150 V-25 V	ea. 39c
20-20-150 V	ea. 39c
25 V	ea. 39c
20-20-160-40-	
150 V-25 V	ea. 39c
20-10-15-150	
V	ea. 39c
30-5-20-150	
V	ea. 39c
30-30-20-150	
V-25 V	ea. 39c
30-30-15-20-	
150 V-10 V	ea. 39c
30-20-20-150	
V	ea. 39c
30-30-20-20-	
150 V-25 V	ea. 39c
30-30-15-20-	
150 V-25 V	ea. 39c
20-16-16-	
150 V	ea. 39c

Cathode Condensers	
10-25 V	
20-20-25 V	
20-20-20-	
20-25 V	16c ea.
25-25 V	
30-50 V	
100-25 V	24c ea.

150 Working Volts

8-150 V	ea. 19c
8-8-150 V	ea. 19c
10-150 V	ea. 19c
10-10-150 V	ea. 24c
10-10-10-150	
V	ea. 29c
15-150 V	ea. 21c
16-150 V	ea. 23c
20-150 V	ea. 25c
30-150 V	ea. 29c
40-150 V	ea. 29c
15-15-150 V	ea. 29c
20-10-150 V	ea. 24c
20-20-150 V	ea. 29c
20-20-20-150	
V	ea. 39c
20-40-150 V	ea. 39c



HI-LO TV and FM ANTENNA

Model 101
Indoor
Model
101R&W for
roof and
window use

This beautiful antenna is the ultimate in reception, highest signal gain, nothing to adjust. Gleaming walnut plastic and gold anodized aluminum.

List price	\$9.95 ea.
100 or more	\$3.97 ea.
25 to 99	4.47 ea.
13 to 24	4.98 ea.
7 to 12	5.37 ea.
1 to 6	5.97 ea.

Fair trade prices, no deviations.

TV PARTS and ANTENNAS

TV Antennas:	
Conical price leader with 8-ft. mast	\$5.75
World's Best Deluxe Conical with 9-ft. mast and heavy cast fittings	8.95
Hi-Low folded dipole array, 8-ft. mast	6.95
300-ohm line \$1.09 per 100 ft.	\$9.25 per 1000
Ballast Tubes for AC-DC TV Sets	ea. .50
TV Discriminator Transformers	ea. .69
TV Screen Filters with suction cups — best quality IND.	10" \$1.17
	12" 1.95
BOXED for highest re-sale value	16" 2.55

PREMIER RADIO TUBE COMPANY
551 West Randolph St., Chicago 6, Ill.
Phone: Andover 3-1590
"Your Tube Source Since 1926"

MARS Station of the Month

MARS AND NAVY SPONSOR DOUBLE-HEADER PROGRAM MAY 20TH

MARS and the Navy will co-sponsor a double-header program for amateurs on Armed Forces Day, May 20, 1950. The two-fold program will consist of receiving competition, similar to the old Navy-Day Copying Contest, and a QSO and message relay contest which will emphasize the handling of traffic.

The Honorable Louis A. Johnson, Secretary of Defense, will issue a special message to the amateurs. This message will be broadcast on 13 military frequencies at 25 w.p.m. as follows: May 20, 1950 at 2100 EST and at 2300 EST. NSS, Washington, D. C., will transmit on 122 kc., 4390 kc., 9425 kc., 12,630 kc. and 17,000 kc. WAR, Washington, D. C., will transmit on 3497.5 kc., 6997.5 kc., 14,405 kc., 20,994 kc., and 27,994 kc. May 20, 1950 at 2000 PST. NPG, San Francisco, will transmit on 115 kc., 9255 kc., and 12,540 kc.

Anyone who can receive and transcribe the message without error may send his transcribed copy to Headquarters MARS, Room 5 B 519, The Pentagon, Washington 25, D. C., where it will be checked for accuracy. All who submit a perfect copy will receive a special Certificate of Merit attesting to their code copying proficiency.

The QSO and message relay contest will last 12 hours and will have for its main purpose the demonstration on a national scale of the effectiveness of point-to-point or person-to-person communication by amateur radio as a back-up system for normal communications systems which might be knocked out by flood, fire, storm, ice, or sabotage. The contest will begin at 1700 GCT (1200 EST, 1100 CST, 1000 MST, and 0900 PST). Any radio amateur licensed by the FCC or by the Armed Forces of the United States is eligible to compete in the contest. All amateur bands, either fone or c.w. may be used. Single or multi-operator stations will be considered separately for purposes of scoring the contest. Contest log forms (or additional information on the Armed Forces Day program) may be obtained by writing the Headquarters MARS, Room 5 B 519, The Pentagon, Washington 25, D. C.

KING Four Fox Able Charlie, the "MARS" Station of the USAF Special Staff School, Communications-Electronics Division, Gunter Air Force Base, Montgomery, Alabama, has been named the Station of the Month, by Major Rawleigh H. Ralls, Chief MARS, USAF. K4FAC has been "On-the-air" for a year and a half. The station was activated by Lt. Colonel Milburn B. Andrews, Chief, Engineering Section of the school. The original station equipment consisted of a surplus BC-610 transmitter, a "Super-Pro" receiver and a simple di-

pole antenna. The station was later completely "revamped" and equipped with a new *Gordon* 10-20 rotary beam antenna, *Collins* 30-K1 transmitter, *National* HRO receiver, *RME* preselector, converter, "Panadaptor," and other fine "ham" gear.

Each year two different "K4FAC MARS Clubs" are organized, one from each Senior Air Communications-Electronics Staff Officers' Course. The present club has twenty-two members. Although most of the club members have their own ham stations, most of them will be found on-the-air at

Lt. Colonel Milburn B. Andrews (W4TB), K4FAC station director, hands a message to Sgt. H. B. Solomon, station operator. Sgt. Solomon handles most of the regularly scheduled contacts at K4FAC. Most of the student officers who make up the membership of the MARS Club at Gunter Air Force Base operate in late afternoons or in the evening.



LOWEST PRICES TUBES and PARTS

29c ea. 1U4 10 112A 1A4 1D8GT 1H4G
2C26 12A 182B 1A4P 1F4 1H6GT
2C34 39/44 183 1A6 1F5G 1J6G
3A4 47 255 1B5 1F4GT 1619
01A 50 482B 1D5GT 1G4GT
6A3 71A 483 1D7 1G6GT 1626

FREE! \$20.00 List Value
Cornell-Dubilier,
Mallory, Aerovox,
Sprague, Solar Filter Condensers
ten fast moving 150V & 450V filters
free with each 100 tubes.

79c each
1B3GT 6G5
1X2 6L6G
2A3 6SD7GT
2A4 6U5
3Q5 32L7GT
6A7 50A5
6AK5 70L7GT
6BQ6GT 350B
6E5 807

39c ea. 1T4 35Z5GT 25Z6GT 32 35 37
5Y3GT 6C4 6X5GT 33 35Z4GT 38
35W4 6X5GT 31 34 36 46 VT-52 58 89
56 76 HY-615
80

49c ea. 3Q4 6AQ5 6BH6 6K7GT 6SQ7GT 12AU7 12SH7GT 35Z6GT
3S4 6AQ6 6BJ6 6K8GT 6SR7 12BA6 12SR7GT 50B5
3V4 6AR5 6C5 6L5 6U7 12BE6 1629 (eye) 50C5
1C5 5W4GT 6A55 6C8G 6S4 12F5GT 24A 50Y6
1C6 5X4G 6AT6 6D6 6V6GT 12H6 25L6GT 51
1L4 5Y4G 6AU6 6F5GT 6W4 12J5GT 25W4GT 77
1R5 6AB4 6A8GT 6F6GT 6X4 12J7GT 25X6 78
1S5 6AC4 6B6 6G6 6SH7 6Z4 12K7GT 27 77
1U5 6AC5GT 6BA6 6H6GT 12A8GT 12K8GT 35B5 85
2A5 6AG5 6BD6 6J5GT 12AT6 12SF5 35C5 99
2A7 6AL6 6BE6 6J7GT 12AU6 12SF7

89c each
6BG6G 25AC5GT
6B5 25BQ6GT
6BN6 117L7GT
12B9G 117P7GT

59c ea. 1LA4 1LE3 1Q5GT 1T5GT 1V 1C5GT
0Z4 1A7GT 1A5GT 1C7G 5U4G 6AV6 6B4G 6P5GT 6R7 6S8GT 6SF5GT 6SL7GT 6SN7GT
5V4 5Z3 5Z4 6A8 6AC7 6AJ5 6AK6 6AL5 6AV6 6B4G 6BA7 6B8 6C6 6CB6 6D8G 6F8G 6J6 6K5 6K5GT 6R7 6S8GT 6SF5GT 6SL7GT 6SN7GT 6S57 6SU7 6Q7GT 6T7G 6W7G 6Y6G 6Z4 7A6 7A7 7B5 7B6 7B8 7C4 7C6 7E5 7E6 7E7 7F7 7G7 7H7 7J7 7L7 7N7 7Q7 7S7 7T7 7V7 7W7 7Y4 12A7 12AT7 12AV6 12AX7 12BA7 12BF6 12C8 12J5 12Q7GT 12S7GT 12S8GT 12SJ7GT 12SK7GT 12SL7 12SN7GT 12SQ7GT 12Z3 20 35/51 84/6Z4 40 41 42 43 50L6GT 53 75 84/6Z4 117Z3 VR150 9001 XXB

69c ea. 1A3 1AB5 1H5GT 1LA6 1LB4 1LC5 1LD5 1LH4 1LN5 1N5GT 1P5GT 1S4 2V3G 2X2 3LA4 4A6G 6B7 6BF6 6J8G 6S7G 6SU7GT 6T8 7A8 7C5 12A6 12BF6 14A4 14A5 14A7 14A8 14E6 14E7 14H7 14J7 14N7 14Q7 14W7 14X7 14Y4 19T8 25Z5 35Y4 35Z3 45 2050 2051 50C6 81 83 117Z6GT 9001 XXB

Tube prices are for 50 tubes or more—may be assorted. Less than 50 tubes, 5c per tube extra. Individually boxed—Standard factory guarantee

50L6, 35Z5, 12SK7,
12SQ7, 12SA7... 5 tubes for **\$2.19**
1R5, 1S5, 1T4, 3V4 Battery
Tube Special... 4 tubes for **\$1.49**
7JP4... \$9.95 12LP4... \$24.95
10BP4... 17.95 16AP4... 39.50

Miniature tubes 12AT6, 12BA6,
12BE6, 35W4, 50B5... 5 tubes for **\$1.89**
3-Way Portable Tube Kit, 117Z3,
1U5, 3V4, 1R5, 1T4... all for **\$1.99**
3S4, 1T4, 1S5, 1R5
4 tubes for **\$1.49**

1U4, 3S4, 1S5, 1R5
4 tube kit **\$1.49**
3Q4, 1T4, 1R5, 1S5
4 tube kit **\$1.49**
50A5, 35Y4, 14A7, 14B6,
14Q7... 5 tubes for **\$2.95**

Best Quality SPEAKERS Alnico 5 PM
10 or more Each Price Each
5" -95c - \$1.05
2 1/2", 3", 4"—95c-\$1.05
6" \$1.49 \$1.69
8" 2.95 3.25
10" 4.25 4.50
12" 4.95 5.95

VOLUME CONTROLS 10 or more Each Price Each
VERY BEST BRANDS
1/2 meg. or 1 meg. or 1/10 meg. with switch—long shaft... **29c 35c**
2 meg. for battery sets—switch, long shaft... **29c 35c**
1/2 meg., 1 meg., 1/10 meg. or 2 meg., long shaft, less switch... **16c 19c**
1000 ohm... 16c 19c
4 meg... 16c 19c
5000 ohm... 16c 19c
1/2 meg. with 8" shaft... 49c 59c

OUTPUT TRANSFORMERS
For 50L6, 35L6, 50A5, 35A5, 117L7... **39c** ea.
For 6V6, 6F6, 3Q5, 3Q4, 3S4, 3V4, 41, 42, 6K6, 2A3, 45, 6L6... **45c** ea.
UNIVERSAL OUTPUT TRANSFORMER SPECIAL
Up to 12 watts to any speaker (while they last) **98c** ea.

JENSEN 8" SPEAKERS
Jensen 8" Speakers 9 watts output, heavy duty 10 oz. Alnico V magnet Sound Men and JOBBERS, buy them packed 12 to each carton... **\$3.25** ea.
Utah Speaker Baffles—completely enclosed for 8" speakers and smaller... **\$2.00** ea.
Jobbers: write for quantity prices.

NOW! You can buy famous make BATTERIES absolutely FRESH from PREMIER

Battery Type	USA Lite No.	Ray-O-Vac No.	Burgess No.	Eveready No.	RCA No.	Single Lots	Unit Pkg.	Price Each	Std. Pkg.	Price Each
Regular Size D Flashlight Cell and "A" Battery	75		2	950	VS001	.07	48	.06 1/2	288	.05 1/2
6 7/8 Volt Personal Portable "B"	767	4367	XX45	467	VS016	1.74	12	1.58	120	1.36

BY-PASS CONDENSERS
100 Condensers assorted in package... **\$5.95**
.001 5c .0005
.002 5c .00025
.005 5c .0005
.01 600 V. 7c 500 mmf 60c
.02 7c 250 mmf 60c
.05 8c 100 mmf MICA
.1 9c 50 mmf

IF TRANSFORMERS
Standard Replacement Regular size 455 Kc... ea. **29c**
Midget 455 Kc... ea. **39c**

Special on No. 47 Pilot Lights Only—100 Bulbs... \$3.95 Box of 10... 54c
PILOT LIGHTS—100 BULBS \$4.90
Box of 10 bulbs... **54c**
No. 40 6-8 V .15 Amp No. 44 6-8 V .25 Amp
No. 41 2.5 V .50 Amp No. 46 6-8 V .25 Amp
No. 51 6-8 V .20 Amp \$3.79 per 100

400-VOLT BY-PASS CONDENSERS
.05 mfd... ea. 6c
.2 mfd... ea. 6c
.25 mfd... ea. 10c
.5 mfd... ea. 15c
BYPASS SPECIAL—SOLAR
.25 mfd. 600 V... each 12c
in lots of 25 or more... each 9c
BUFFER CONDENSERS
.005 mfd. 1600 WV }
.008 mfd. 1600 WV } ea. 15c
.01 mfd. 1600 WV }
VARIABLE CONDENSERS
Two gang for superhet or TRF... ea. **69c**
Oscillator Coils for any 5 tube AC-DC... **19c**
RF and Antenna Coils Standard Broadcast Band... ea. **29c**

VIBRATORS
Red Hot Vibrator Special. 4-prong, small size Universal, fits 80% of all jobs... ea. **89c**
Jobbers: Write for quantity price.

6-FT. LINE CORDS
Appliance Cord, up to 1,000 watts, 1 rubber plug. 5 for **99c**
Good Rubber with plug. 10 for **\$1.25**
Appliance Cord as Underwriters' Approved, with UL label 5 for **\$1.29**
10 for **\$1.69**

4 PRONG VIBRATORS—VERY BEST BRANDS
Standard Replacement Universal... **\$1.29** ea.
Sensational Value... **\$1.29** ea.
4 Prong PHILCO VIBRATOR... **\$1.29** ea.
RED HOT VIBRATOR SPECIAL!
Standard small size, 2 3/4" in height (the popular small size), bright and shiny... **\$1.29** ea.
Stock up while they last, all 4 prong Universal Vibrators.

SPECIAL—CONDENSER KITS
Kit of 25 BY-PASS CONDENSERS best assorted brands and sizes... **\$1.19**
Kit of 50 BY-PASS CONDENSERS very best, assorted sizes... **1.98**
Kit of 50 MICA CONDENSERS, complete... **1.98**
100 resistors—packed in a box, IRC, etc. Best values only—1/2 watt, 1 watt, 2 watt... **1.98**
SELENIUM RECTIFIERS 79c
Standard 100 mil. Each
PUSH-BACK WIRE 100-ft. rolls... **39c** ea.

Standard replacement crystal cartridge. Each **\$1.39**
NLYON 1J CARTRIDGE... \$2.59

FILTER CONDENSERS
See Preceding Page

PREMIER RADIO TUBE COMPANY
551 West Randolph St., Chicago 6, Ill.
Phone: Andover 3-1590
"Your Tube Source Since 1926"

Rated accounts—10 Days
All others 20% deposit with order, balance COD
50c handling charge for orders less than \$5.00
All shipments FOB Chicago. Prompt attention paid to foreign orders. ORDER TODAY. Our parts and tubes are warranted to be 100% replacements for the prototypes in the listings above. Satisfaction Guaranteed. To speed up delivery, sign your order and your remittance with the same name. Illinois residents add 2% sales tax.
CURRENT ADVERTISED PRICES APPLY.

HIGHEST VALUE

ALL-ALUMINUM CONICALS

At the LOWEST PRICE Anywhere!

JFD "COMMANDAIR" ALL-ALUMINUM TV CONICALS

(less mast)

TOP QUALITY CONSTRUCTION!
Elements made of high-strength, aircraft-type aluminum alloy for greater resistance against vibration and corrosion.

HEAVY DUTY ELEMENT BRACKETS!...
Made with extra-long gripping surface for secure anchoring of elements. No wonder that "Commandair" Conicals will stay put in the face of strong winds, under the strain of ice and snow.

UNIQUE BRACKET FLEXIBILITY!...
An important feature of these amazing Conicals is their unique flexibility, which permits easy conversion from a standard Conical to a 6-element front and 2-element reflector type.

ENGINEERED FOR MAXIMUM GAIN!...
Improved signal-to-noise ratio produces brighter pictures with minimized fading.

NOTE: The "Commandair" Conical is also offered in a separate, lower-priced "Economy" Line of partial steel construction... completely assembled similar to its all-aluminum counterpart in design and performance.

JFD No. C660 — "Commandair" All-Aluminum All-Band Conical. List Price (less mast) \$10.95

JFD No. C661 — Same as No. C660 but 1/4 wave-length stacked for extra gain and directivity. List \$23.00

Write for **FREE** literature completely describing the JFD "Commandair" Line of All-Aluminum TV Conicals.

JFD MANUFACTURING CO., Inc.
6105 16th AVENUE, BROOKLYN 4, N. Y.
FIRST IN TELEVISION ANTENNAS AND ACCESSORIES

K4FAC at some time or another. Non-amateur students are also encouraged to join the club and regular instruction in code, equipment construction, and station operation is conducted for their benefit.

Master Sergeant J. E. "Mat" Mathis as Chief Operator, and Sergeant H. B. "Sol" Solomon hold down the regular station operating shifts and also double as code instructors for the members of the "MARS" Club. Mat is a handy man with tools and is usually the one who builds "that new gadget for the station." Sol is the traffic man and is also gradually getting the "DX" bug.

Lt. Colonel Andrews has been a ham for twenty-four years with such former calls as W5AQ, W6SU, W5BIT, W5GIK, W2MSY. His present call is W4TB and he will usually be found on 10 or 20 fone chasing that very elusive and exclusive "DX." He holds both commercial radiotelephone and radio-telegraph licenses and shakes a speedy bug when he can be talked into doing a little brass pounding on the circuit.

K4FAC is anxious to schedule any of the other MARS Stations and will handle traffic for any area. The station works with the "Alabama Emergency Net," and the "Montgomery Emergency Net." During the hurricane season last year the station was on 24-hour status for several periods. Future plans for the station include auxiliary power supply for the main station and additional portable and mobile gear to prepare the station for any type of emergency operation.

-30-

HAM CONVENTION

THE Detroit Area Amateur Radio Council is sponsoring a ham convention to be held at Detroit's Hotel Statler, May 27, 28, and 29.

This is the first convention held by the Great Lakes Division of the A.R. R.L. since its formation from the old Central Division some four years ago.

Because of the long Memorial Day weekend, the committee in charge of arrangements has been able to plan some unique and interesting events. The program includes all sorts of technical and organizational talks and meetings. There will be a mammoth "Swap 'N Shop" session to which all who attend are invited to bring their swapping material. An YLRL luncheon, a DX stag breakfast, and an AEC get-together have also been planned. Entertainment for XYL's has been provided in addition to events catering to specialized ham interests.

The registration fee for the 3-day meet is \$3.50 with the banquet ducaets costing \$4.25—or both for \$7.50. Tickets can be secured by writing direct to W8AHH, Box 903, Detroit 31, Michigan, or can be purchased through radio clubs and radio parts dealers in the Michigan, Ohio, and Kentucky area.

General chairman of the convention is Ty Kirby, W8TDO. Frank Taylor, W8AW, is secretary, and Fred Chevillot, W8SWI, is treasurer. George Goldstone, W8MGQ, is serving as vice-chairman of the affair.

-30-

WALDOM

Replacement Cone Manual

Catalog No. 50

For Finer Tone a Waldom Cone

Write for your **FREE** Copy of this handy catalog Today!

Waldom's Free 24-Page Replacement Cone Manual is a handy reference that speeds up your repair jobs — which means more profit to you! This reference manual lists excellent replacement data for over 75 different TV, FM, and AM Sets. Write today for your Free copy. Just send your name and address to Dept. RN.

Waldom Replacement Cone Assemblies are manufactured with the highest standards of precision workmanship and technical Waldom Cone Assemblies feature:

- Hawley diaphragms — with the patented thin, tapering edge that assures maximum speaker efficiency and true low frequency response.
- The finest voice coils and spiders made with precision craftsmanship to exacting specifications.
- Unconditionally Guaranteed as to construction and performance.
- The full R.M.A. Warranty.

For Finer Tone a Waldom Cone

WALDOM ELECTRONICS, INC.
911 N. Larrabee St., Chicago 10, Ill.

Nothing Finer!



CHICAGO FEATHERWEIGHT MULTITESTER

CHICAGO FEATHERWEIGHT MULTITESTER

The New Wider Range Model 453

DC Volts: 0-15/30/150/300/1500/3000
AC Volts: 0-15/30/150/300/1500/3000
Ohms Full Scale: 5000/50,000/500,000
DC Milliamperes: 0-150

A compact, pocket-size instrument with laboratory accuracy.
Size: 4" x 2 7/8" x 2". Price \$14.00.

We manufacture a complete line of portable multitesters.

Chicago Send for Circular

INDUSTRIAL INSTRUMENT CO.
536 W. ELM ST. • CHICAGO 10, ILL.

PRICES Slashed

SAVE UP TO
50%
during
**GIGANTIC
CLEARANCE
SALE of
USED TEST and
COMMUNICATION
EQUIPMENT**

**OUR \$50,000 STOCK
OF RECONDITIONED, "GOOD-AS-NEW"
EQUIPMENT MUST GO AT A RECORD-
BREAKING SACRIFICE TO MAKE ROOM
FOR NEW MERCHANDISE!**

Each and every instrument thoroughly checked and guaranteed to be in normal operating condition when shipped to you. While the following is only a partial list of our huge inventory (available at the time this publication goes to press) *bargains like these simply can't last!* So act now and avoid disappointment. Wire, write, phone or use the handy coupon, *today!* When ordering, indicate first, second and third choice. *All merchandise subject to prior sale.*

COMMUNICATION EQUIPMENT

	Original Price	Bargain Price
GONSET		
6 mtr. Converter.....	39.95	27.50
10 mtr. Converter.....	39.95	27.50
HALLICRAFTER		
HT-9 Xmitter with tubes & 1 set of coils.....	360.00	225.00
HT-18 VFO-Exciter.....	110.00	89.50
SX-24 Receiver, less spkr.....	74.50	57.50
SX-25 Receiver, less spkr.....	94.50	69.50
SX-28 Receiver, less spkr.....	223.00	99.50
S-38 Receiver.....	39.95	29.00
S-40 Receiver.....	79.95	49.50
SX-42 Receiver, less spkr.....	275.00	149.50
R-42 Speaker.....	34.50	20.00
SX-43 Receiver & R-44 spkr.....	184.00	119.50
BC-610 Xmitter "and speech amplifier" with tubes and coils for 40 & 80 mtrs.....	695.00	395.00
HAMMARLUND		
HQ-120X & Spkr.....	129.50	89.50
HQ-129X, less spkr.....	177.30	129.00
HQ-129 Spkr.....	11.85	10.00
SP-400X with pwr. supp. & Spkr.....	450.00	199.50
SP-200 Series with pwr. supp. & Spkr.....	250.00	139.50
MECK—T-60-1 with tubes & coils for I band.....	150.00	99.50
MILLEN		
90800 Exciter with tubes & 1 set of coils.....	42.50	24.00
NATIONAL		
HFS VHF Receiver with pwr. supp.....	164.43	110.00
HRO Jr. with B.S. coils & pwr. supp.....		125.00

	Original Price	Bargain Price
HRO Sr. with Spkr., coils, & pwr. supp.....		140.00
HRO-57A1 with Spkr., coils & pwr. supp.....	306.71	175.00
HRO-7 with Spkr., coils & pwr. supp.....	327.00	239.50
NC-57 Receiver.....	89.50	67.50
NC-173 Receiver & Spkr.....	199.50	147.50
NC-183 Receiver & Spkr.....	282.00	210.00
NC-240D Receiver, less Spkr.....	225.00	145.00
NC-240 Spkr.....	16.44	10.00
RME		
HF-10-20 Converter.....	77.00	59.00
DB-20 Pre-selector.....	68.20	24.50
DB-22A Pre-selector.....	71.00	42.50
45 Receiver less Spkr.....	185.20	89.50
45 Spkr.....	13.50	10.00
VHF-152A.....	86.60	59.50
SONAR		
XE-10 NBFM Exciter.....	39.45	14.95
MB-611 Mobile 10 mtr. Xmitter	72.45	29.50
VFX-680 Exciter.....	87.45	49.50
SURPLUS—BC-348 less Spkr. (converted for 115 VAC).....		49.50

TEST EQUIPMENT

TUBE TESTERS		
PRECISION—954 TT & VOM.....	89.28	59.50
RCP—802N TT & VOM.....	58.31	37.50
JACKSON—636 TT.....	55.37	37.50
PRECISION—912 TT.....	50.65	37.50
SUPERIOR—450 TT.....	38.71	22.50
VOMS		
PRECISION—856G (20K ohms per Volt).....	48.23	27.50

	Original Price	Bargain Price
SIMPSON—240 Hammeter.....	24.11	17.50
Case for above.....		2.00
260 (20K ohms per volt).....	38.17	22.50
SUPERIOR—PB-210 VOM & Cond. Tester.....		27.50
TRIPLET		
625N (20K ohms per volt)....	45.00	24.75
666HH.....	21.56	17.50
WESTON—785 (20K ohms per volt).....	122.85	67.50
SIGNAL GENERATORS		
APPROVED ELEC.—A-200.....		17.50
HICKOK—288X (xtal controlled).....	169.20	99.50
RCP—705.....	49.50	27.50
SILVER—909 Sweep Gen.....	48.50	37.35
TEST-RITE—B-45 (Battery operated).....	28.27	14.95
VISION—TSW-50 TV Sweep Gen.....		27.50
SIGNAL TRACERS		
FEILER TS-7 W/Batteries.....	33.45	19.50
MEISSNER—9-1040 Analyst.....	111.57	57.50
RCA—Rider Chandylist.....	162.50	89.50
SILVER—905 Sparx.....	39.90	24.95
SPECO—STAC.....	44.95	22.50
SUPERIOR—CA-11.....	18.37	12.50
OSCILLOSCOPES		
CLOUGH-BREngle—CRA (3")..		37.50
DUMONT—164E (3").....	127.20	64.50
224 (3").....	290.00	155.00
208 (5").....	285.00	145.00
HICKOK—195 (5").....	129.36	99.50
305 (3").....	142.59	89.50
RCA—155 (3").....	115.00	57.50
SUPREME—546 (3").....	87.45	49.50
SYLVANIA—132 (7").....	144.50	95.00

VTVMS

ELECTRONIC INST.		
113A VTVM & Sig Tracer.....		49.50
EICO—221.....	49.95	22.50
RCA—195A VoltOhmyst.....	79.50	44.50
SILVER—900 Vomax.....	59.85	29.95
SYLVANIA—134 Polymeter.....	89.50	49.50
TRIPLET—2450.....	97.51	59.50
CONDENSER CHECKERS		
SOLAR—CE.....	45.00	22.50
CF-160 Exameter.....	78.10	42.50

MISC.

LEEDS-NORTHROP—Type S. Bridge.....		87.50
SHALLCROSS		
630 Wheatstone Bridge.....		55.00
637 Bridge.....		80.00

All prices F. O. B. St. Louis Phone: CHestnut 1125

FREE!

Complete List of Used Test and Communication Equipment . . . also new 164 page catalog. Send for your list and catalog today!

**Walter Ashe
RADIO CO.
1125 PINE ST. • ST. LOUIS 1, MO.**

Walter Ashe Radio Co. R-50-5
1125 Pine St., St. Louis 1, Missouri

Rush my order for Used Equipment as follows:

(1st choice)

(2nd choice)

(3rd choice)

Remittance for \$..... is enclosed.

Send FREE List of Additional Used Equipment Bargains.

Name

Address

City..... Zone..... State.....

AT LAST!

YOU CAN GIVE YOUR TV RECEIVER
OUTSIDE ANTENNA PERFORMANCE
WITH A BUILT-IN ANTENNA
APPEARANCE.

MOSLEY FLUSH SOCKETS

1. Conceals antenna lead-ins and rotator cables within wall.
2. Fits standard metal outlet boxes and wall receptacle plates.
3. Installs as neatly as any electrical outlet.



CAT.
F-1



CAT.
F-14



CAT.
F-15

CAT. F-1 —A Single Outlet for 300-ohm transmission line lead-in.

CAT. F-14—Dual Outlets, one similar to CAT. F-1 and one 4-wire for 4-wire antenna rotator.

CAT. F-15—Dual Outlets similar to CAT. F-14 except one Outlet is for 5-wire rotator.

NOTE: For **MOSLEY PLUGS** to fit **MOSLEY FLUSH SOCKETS**, see below.

MOSLEY PLUGS

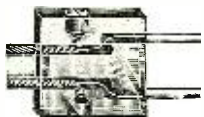

CAT. 300P
Mosley Transmis-
sion Line Plug



CAT. 300-1P
For Federal
Shielded
K-111 Cable

CAT. 301-2P
Special 4-Wire
Mosley Plug



CAT. 301-5P
Special 5-Wire
Mosley Plug

If your nearest dealer does not stock **MOSLEY PRODUCTS** write us for the name of one who does.

FOR SALE AT YOUR JOBBER

MOSLEY ELECTRONIC SPECIALTIES
(W0FQY) 2125 LACKLAND ROAD
OVERLAND (14) MISSOURI.

Phone Transmitter

(Continued from page 53)

stability, detune C_2 slightly to one side of exact dip. (b) Switch the meter to the doubler stage and tune C_7 for lowest plate current dip. (c) Switch the meter to the buffer stage and tune C_{12} for plate current dip. (d) Switch the meter to the PM section of the final amplifier (shunt resistor R_{16}) and retune each of the preceding exciter stages except the oscillator for maximum upswing of the meter. This will be between 15 and 20 ma. (e) Switch the meter to the PA section of the final amplifier (shunt resistor R_{15}) and tune C_{16} for plate current dip. This will be 50 to 60 ma.

5. Connect the antenna. Swing coupling coil L_5 into L_4 to increase coupling (always use the minimum permissible coupling) and tune the antenna circuit, watching for a peak indication of a thermocouple ammeter or lamp connected in the transmission line or feeder cable as C_{18} is adjusted.

6. Plug in the microphone, advance gain control R_{17} , and whistle or hum a sustained constant-volume note into the microphone. Under modulation, the PA plate current will fall to a lower value. The PM plate current at the same time will increase to approximately 4 or 5 times its unmodulated value. The meter or lamp in the transmission line will give an upward indication (an increase of up to 50 per-cent, indicating full modulation). A downward indication of either the lamp or antenna ammeter indicates improper tuning of C_{18} and/or the wrong number of turns in coil L_5 . The number of turns given for L_5 in Table 1 will be satisfactory for low-impedance cables such as RG8/U, but the number must be increased for 300-ohm lines or 600-ohm open lines. If downward modulation is obtained and further adjustment of C_{18} does not correct the condition, coil L_5 must be rewound. Modulation quality may be checked aurally by means of a non-oscillating diode (crystal or tube) detector and headphones. Modulation percentage may be checked visually by means of an oscilloscope, using wave patterns obtained with the aid of the internal sweep oscillator of the scope.

7. After tuning adjustments are completed, apply the full plate voltage to the 829B and recheck tuning throughout. Use the PM plate current as an indicator, retuning to give maximum PM plate current.

8. As a final check, the difference between the "in-resonance" and "out-of-resonance" unmodulated PA plate current under load should be not less than 5 per-cent and not more than 10 per-cent of the PA operating current.

9. While jacks have been provided for checking PA and PM grid current, these checks are not important to the tuning adjustments and were put in

this particular model for laboratory measurements only. They may be omitted if the builder desires.

In the 5 months during which this transmitter has been in use, W6MYR has made approximately 50 contacts for test purposes on 10 meters. Many of these QSO's have been coast to coast and some have been out of the country. Without mentioning beforehand the system of modulation, excellent reports as to carrier strength, talk power, modulation percentage, and speech quality have been received in each instance.

On occasion, W6MYR has operated the supermodulated rig (at 40 watts input) side by side with a standard 40-watt plate-modulated transmitter, switching the antenna from one to the other during a QSO. In these tests, the supermodulated rig has outperformed the standard job, delivering heavier audio at the receiving location even when band conditions were such that the supermodulated carrier seemed weaker momentarily than that of the standard rig. Frequently supermodulation cut through QRM (local at the receiver) when standard plate modulation gave poor account of itself.

In tests at K6AI, 90 watts input to the final amplifier gave excellent supermodulation performance.

Wally Newman, W6FEX, has been operating mobile for the past several months with a duplicate model of this transmitter running about 30 watts input. He reports that excellent results have been obtained and that the transmitter performs very satisfactorily in this type of operation.

While the subject transmitter has been designed specifically for 10-meter operation, the authors can see no reason why the unit should not operate equally well on other bands provided coils are wound for those bands.

-50-

TAPE DISTORTION

By TED POWELL

HERE are a few more notes on the subject of tape recorder head-clogging distortion, originally mentioned by Matthew Mandl in the February issue (page 70).

The clogging is also aggravated by the following conditions. 1. Finger oil and perspiration coating of tape due to handling; 2. Dust, dirt, and fumes coating tape; 3. Plastic adhesive gumming of tape caused by Scotch tape splices; and 4. Tape coating deterioration and "chalking" caused by coarse tape guides.

It is obvious that it is not enough to simply clean the recording, playback, and erase heads. A clean, soft cloth held gently against the tape while running will clean off the dirt and oil coating. When the Scotch tape splices are reached, the tape pulling mechanism should be stopped and the Scotch tape cleaned to remove plastic adhesive from the outside surface. Next all rough tape guides are polished down with very fine sandpaper and erocus cloth. Care should be exercised so that no abrasive gets into the tape pulling mechanism during this operation.

-50-

RADIO & TELEVISION NEWS

Order your **EICO** Test Instrument Kits NOW

SAVE UP TO 50%
 by building your own precision
 laboratory test instruments!
 Easy to build in one evening — They last a lifetime

from
ALLIED

\$19⁹⁵

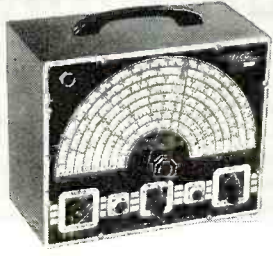

SIGNAL GENERATOR

Model No. 320-K. An invaluable test unit for service, laboratory and school use. Highly stable Hartley oscillator has range of 150 kc to 102 mc with fundamentals to 34 mc. Ideal for quick alignment of FM-AM receivers; provides TV marker frequencies. Also supplies 400-cycle audio output from a Colpitts oscillator. Audio oscillator voltage can be used for testing distortion in audio equipment, bridge measurements, etc. Complete with tubes, portable case, etched panel, all parts, knobs, wire, shielded cable, instructions, diagrams, and operating manual. Size: 10 x 8 x 4 3/4". For 110-120 volts, 60 cycle AC. Shpg. wt., 10 lbs.

83-154. Only **\$19.95**

\$23⁹⁵



VACUUM TUBE VOLTMETER

Model No. 221-K. An easy-to-build, sensitive VTVM for making measurements in high-resistance circuits. 15 different ranges, with DC input resistance of 26 megohms. 4 1/2" meter is protected against burnout. Includes zero center for alignment of FM and TV discriminators. Double-triode balanced bridge circuit assures top stability. Ranges: AC-DC volts, 0-5-10-100-500-1000; resistance, 0-1000 ohms and 0-1-10-100-1000 megohms. With tubes, all parts, portable case, etched panel, wire, instructions, diagrams and operating manual. Size: 6 x 9 1/4 x 5". For 110-120 volts, 60 cycle AC. Shpg. wt., 10 lbs.

83-152. Only **\$23.95**

\$39⁹⁵

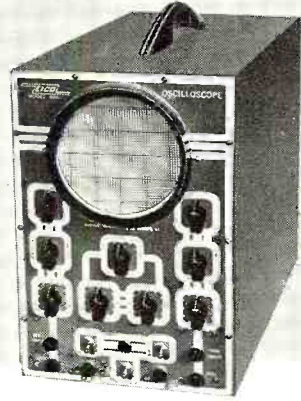

NEW 5-INCH OSCILLOSCOPE

Model No. 425-K. A sensational scope with all new features at amazing low price! With Push-Pull deflection! A precision instrument for TV, FM and AM alignment. Extra sensitive: .05 to .1 volts per inch. Wide range, flat from 5 cps to 500 kc, useful to 2 1/2 mc. Wide range sweep circuit from 15 cps to 75,000 cps. Direct connection to plates of CR tube available at rear of cabinet. Complete with tubes (3-6SN7, 2-6J5, 5BP1, 2-5Y3 rect.), portable case, etched panel, all parts and knobs, wire, instructions, diagrams and operating manual. Size: 8 3/4" x 13 1/2" x 17" deep. For 110-120 volts, 60 cycle AC. Shpg. wt., 30 lbs.

83-155. Only **\$39.95**

\$14⁹⁵

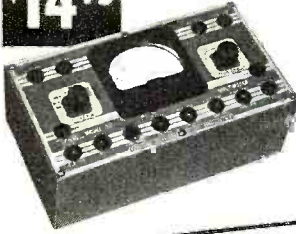

VOLT-OHM-MILLIAMMETER

Model No. 511-K. A pocket-size reliable VOM. 3" meter. Germanium crystal for AC. Ranges: DC v., 0-5-50-250-500-2500; AC and output v., 0-10-100-500-1000; DC current, 0-1-10-100 ma, 0-1-10 amps; res., 0-500-100,000 ohms, 0.1 meg; decibels, -8 to +55. Complete kit, ready to assemble. Shpg. wt., 3 1/2 lbs.

83-153. Only **\$14.95**

SWEEP SIGNAL GENERATOR

Model No. 360-K. For visual alignment at TV and FM frequencies between 500 kc and 228 mc. For use with any scope. Sweep width variable from 0-30 mc. Crystal marker with variable amplitude. Provision for injection of external marker. Phasing control. Vernier dial calibrated in frequencies. Complete with tubes (2-6C4, 1-12AU7, 6X5GT rect.), all parts, shielded cable, portable case, panel, wire, instructions and operating manual. Less crystal. Size: 10 x 8 x 6 3/4". For 110-120 v., 60 cycle AC. Shpg. wt., 12 lbs.

83-159. Only **\$29.95**

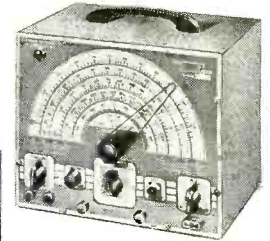

\$29⁹⁵

WE STOCK ALL EICO EQUIPMENT

- Complete with
 Easy-To-Follow
 Diagrams and
 Instructions
- Model 145-K Multi-Signal Tracer. 83-158. Only **\$18.95**
 - Model P-75K High-Frequency Probe Kit. 83-156. Only .. **3.75**
 - Model P-76K H-F Probe Kit. 83-157. Only **3.75**
 - Model HVP-1 High Voltage Probe. 83-160. Only **6.95**
- (All Prices Net F. O. B. Chicago)

FREE SEND FOR YOUR
 196-PAGE 1950
ALLIED CATALOG
 Radio's Leading Buying Guide

Get the only complete Radio Buying Guide in the field—the one book that fills all of your Radio, Television and Electronic supply needs! Get every buying advantage at ALLIED—world's largest stocks of quality equipment at lowest money-saving prices—speedy, expert shipment, personal attention, complete satisfaction on every order. Get your FREE ALLIED Catalog today!



ALLIED RADIO CORP., Dept. 1-EE-0
 833 W. Jackson Blvd., Chicago 7, Illinois

Ship the following EICO equipment:

Enclosed \$..... Full Payment
 Part Payment (Balance C.O.D.)
 Send FREE 196-Page ALLIED Catalog

Name.....
 Address.....
 City..... Zone..... State.....

*this is it—
this is the tuner
you designed!*

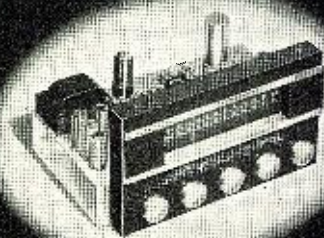

the
CRAFTSMEN RC-10
HIGH FIDELITY
FM-AM TUNER

This new tuner was your idea. It is the precisely engineered answer to hundreds of questions . . . the solution to scores of problems . . . the outgrowth of countless suggestions we've received from you. Developed from your ideas—and a few of ours—the RC-10 retains every feature of the famous RC-8. And it offers a host of innovations.

- Built-in pre-amplifier compensated for reluctance pickups.
- Automatic Frequency Control entirely eliminates drift, simplifies tuning.
- 5 microvolt sensitivity on both FM and AM.
- 10 kc filter on AM eliminates inter-station squeals.
- Base and treble tone controls for boost, cut, or 20—20,000 cycle flat response.

SEE . . . the RC-100A ultra-sensitive, custom TV with built-in booster.

HEAR . . . the RC-2 high fidelity amplifier. All units finished in chrome.

Write for information—or send 50¢ for instructions and schematics.

THE RADIO
craftsmen
INCORPORATED

Dept. F, 1617 S. Michigan Ave., Chicago 16, Ill.

New Transceiver

(Continued from page 39)

slight alteration was necessary. The assembly was dismantled and two additional leaves, patterned after the originals, were cut from sheet brass. One of these was cut about $\frac{3}{16}$ " shorter than the rest and a drop of solder applied for a contact; the contact on the other new leaf was built up to about $\frac{1}{8}$ " thickness. The switch was then reassembled using heavy paper for the leaf spacers in addition to the original plastic ones and replacing the plastic bolt insulators with ordinary spaghetti tubing. For the s.p.d.t. section, the new leaf with the large contact was put in place with the contact facing outward. Next, the short leaf with its contact also facing out and on the outside one of the four original leaves was bolted in place. The latter is the common terminal and is in contact with the short leaf while in normal (receive) position. When the switch is pressed, the inside leaf bends outward, making contact with the outside leaf and, at the same time, moving it away from the middle leaf. For the d.p.s.t. section, the three remaining leaves were simply placed one next to the other in such a way as to be normally separated and all in common contact when the butterfly knob is turned. Details of the switch before and after alteration are shown in Fig. 3.

The r.f. section came next. The sub-midget, two-plate variable condenser was mounted on two aluminum brackets which were held in place by base mounting bolts and the coil was soldered across it. The plate pin of the 958-A was soldered directly to a stator terminal and the plate r.f. choke was connected to the center of the coil. The grid resistor, condenser, and choke were soldered to the grid pin and all other leads kept short. A piece of $\frac{3}{8}$ " polystyrene rod, one end of which was drilled to fit the quarter-wave antenna snugly, was used for the radiator socket. The threaded metal part of a tip jack was heated and

Fig. 3. Conversion details on the handset switch. The unit at the left is the original switch while the one at right shows changes made in conversion process.

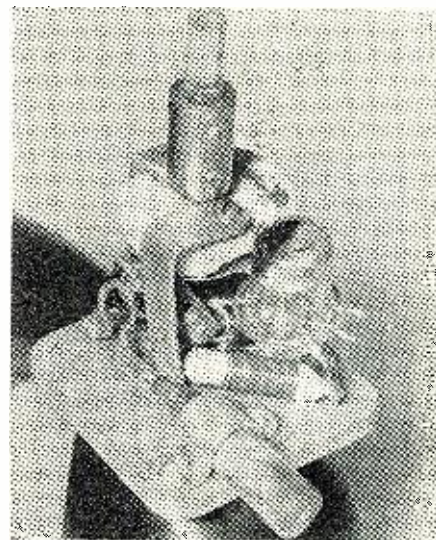
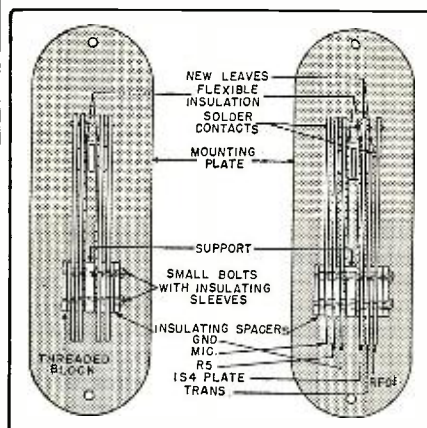

Fig. 4. The r.f. portion of the transceiver. The r.f. grid choke is in the foreground. The grid-leak resistor and feedback condenser can be seen at the left and above the grid choke. The 958-A plate pin (other side of tube) is soldered directly to the stator terminal of the variable condenser. The base was drilled and tapped to accommodate 6-32 machine screws which secure the antenna socket clamp.

turned into the other end after drilling the plastic to accommodate it. A hairpin turn of No. 14 copper wire, connected between the jack and a ground held under a mounting bolt, provided ample pickup. The antenna was cut from the small end of a steel whip but could have been any conductor of equal length and reasonable rigidity. The condenser shaft extension is $\frac{1}{4}$ " polystyrene rod.

A four foot length of six conductor cable was used to connect the hand unit to the battery pack. Four of the six conductors were fastened to lugs in the microphone chamber and the cable terminated at a shielded octal connector which plugs into the battery box. This box, housing batteries and audio components, was constructed of light gauge aluminum and measures 4" x 7 $\frac{1}{2}$ " x 1 $\frac{3}{8}$ ". Its size could have been reduced had smaller batteries and transformer been used. The IS4 provides ample audio for modulation and reception; in fact the gain had to be lessened to prevent excessive frequency modulation of the carrier and to eliminate feedback from headphone to microphone.

Battery current drain is quite low; approximately 15 ma. for the "B" battery and 200 ma. for the "A" battery. The quarter-watt input to the 958-A does surprisingly well. Considerable distances have been covered under most adverse conditions and arm fatigue is a thing of the past. The enjoyment and convenience in operating this little rig has been ample reward for the slight expense and short time required for its construction.

Some adjustment of antenna length may be necessary for optimum results. However, in most cases the rod should be about 19 inches long.

MONEY BACK GUARANTEE—We believe units offered for sale by mail order should be sold only on a "Money-Back-If-Not-Satisfied" basis. We carefully check on the design, calibration and value of all items advertised by us and unhesitatingly offer all merchandise subject to a return for credit or refund. You, the customer, are the sole judge as to value of the item or items you have purchased.

**THE NEW MODEL 247
TUBE TESTER**



Model 247 comes complete with new speed-read chart. Comes housed in handsome hand-rubbed oak cabinet sloped for bench use. A slip-on portable hinged cover is indicated for outside use. Size: 10 3/4" x 8 3/4" x 5 3/4". ONLY..... **\$29.90** NET

Check octals, loctals, bantam jr., peanuts, television miniatures, magic eye, hearing aids, thyratrons, the new type H.F. miniatures, etc.

- Features:**
- ★ Newly designed element selector switch reduces the possibility of obsolescence to an absolute minimum.
 - ★ When checking Diode, Triode and Pentode sections of multi-purpose tubes, sections can be tested individually. A special isolating circuit allows each section to be tested as if it were in a separate envelope.
 - ★ The Model 247 provides a supersensitive method of checking for shorts and leakages up to 5 Megohms between any and all of the terminals.
 - ★ One of the most important improvements, we believe, is the fact that the 4-position fast-action snap switches are all numbered in exact accordance with the standard R.M.A. numbering system. Thus, if the element terminating in pin No. 7 of a tube is under test, button No. 7 is used for that test.

**THE NEW MODEL TV-10
TUBE TESTER**



The Model TV-10 operates on 105-130 Volt 60 cycles A.C. Comes housed in a beautiful hand-rubbed oak cabinet complete with portable cover. **\$39.50** NET

SPECIFICATIONS:

- Tests all tubes including 4, 5, 6, 7, Octal, Lock-in, Peanut Bantam, Hearink-aid, Thyratron, Miniatures, Sub-Miniatures, Novals, etc. Will also test Pilot Lights.
- Tests by the well-established emission method for tube quality, directly read on the scale of the meter.
- Tests for "shorts" and "leakages" up to 5 Megohms.
- Uses the new self-cleaning Lever Action Switches for individual element testing. Because all elements are numbered according to pin-number in the R.M.A. base numbering system, the user can instantly identify which element is under test. Tubes having tapped filaments and tubes with filaments terminating in more than one pin are truly tested with the Model TV-10 as any of the pins may be placed in the neutral position when necessary.
- The Model TV-10 does not use any combination type sockets. Instead individual sockets are used for each type of tube. Thus it is impossible to damage a tube by inserting it in the wrong socket.
- Free-moving built-in roll chart provides complete data for all tubes.
- Newly designed Line Voltage Control compensates for variation of any line voltage between 105 Volts and 130 Volts.

**The New Model 200 AM and FM
SIGNAL GENERATOR**



* **TUBES USED:**—12AU7—One section is used as oscillator and the second is modulated cathode follower. T-2 is used as modulator. 6C4 is used as rectifier.
The Model 200 operates on 110 Volts A.C. Comes complete with output cable and operating instructions. **\$18.85** NET

- ★ **R.F. FREQUENCY RANGES:** 100 Kilocycles to 150 Megacycles.
- ★ **MODULATING FREQUENCY:** 400 Cycles. Also available separately.
- ★ **ATTENUATION:** The constant impedance attenuator is isolated from the oscillating circuit by the buffer tube. Output impedance of this model is only 100 ohms. This low impedance reduces losses in the output cable.
- ★ **OSCILLATORY CIRCUIT:** Hartley oscillator with cathode follower buffer tube. Frequency stability is assured by modulating the buffer tube.
- ★ **ACCURACY:** Use of high-Q permeability tuned coils adjusted against 1/10 of 1% standards assures an accuracy of 1% on all ranges from 100 Kilocycles to 10 Megacycles and an accuracy of 2% on the higher frequencies.

The New Model TV-30 TELEVISION SIGNAL GENERATOR

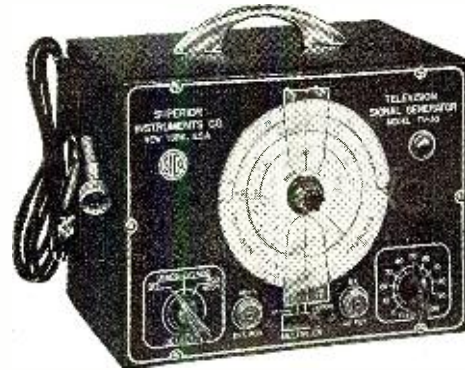

Model TV-30 comes complete with shielded co-axial lead and all operating instructions. **\$29.95** NET

Enables alignment of television I, F, and FRONT ENDS without the use of an oscilloscope.

SPECIFICATIONS

- Frequency Range: 4 Bands—No switching
- 18—32 Mc.
- 35—65 Mc.
- 54—98 Mc.
- 150—250 Mc.
- Audio Modulating Frequency: 400 cycles (Sine Wave)
- Attenuator: 4 position, ladder type with constant impedance control for fine adjustment.

Tubes Used: 6C4 as Cathode follower and modulated buffer. 6C4 as R.F. Oscillator. 6SN7 as Audio Oscillator and power rectifier.

THE NEW MODEL 670

SUPER METER

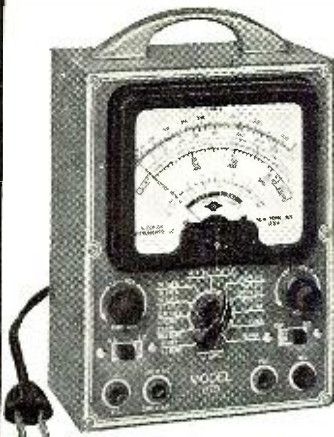

A Combination VOLT-OHM-MILLIAMMETER plus CAPACITY REACTANCE, INDUCTANCE and DECIBEL MEASUREMENTS.

- D.C. VOLTS: 0 to 7.5/15/75/150/750/1500/7500.
- A.C. VOLTS: 0 to 15/30/150/300/1500/3000 Volts.
- 0 to 15/30/150/300/1500/3000 V.P.U.T.
- D.C. CURRENT: 0 to 1.5/15/150 ma.; 0 to 1.5 Amps.
- RESISTANCE: 0 to 500/100,000 ohms. 0 to 10 Megohms.
- CAPACITY: .001 to .2 Mfd., .1 to 4 Mfd. (Quality test for electrolytics.)
- REACTANCE: 500 to 27,000 Ohms; 13,000 Ohms to 3 Megohms.
- INDUCTANCE: 1.75 to 70 Henries; 35 to 8,000 Henries.
- DECIBELS: -10 to +18, +10 to +38, +30 to +58.

The model 670 comes housed in a rugged, crackle-finished steel cabinet complete with test leads and operating instructions. Size 3 1/2" x 7 1/2" x 3". **\$28.40** NET

THE NEW MODEL 770 VOLT-OHM MILLIAMMETER

An Accurate Pocket Size



(Sensitivity: 1000 ohms per volt)

- Features:**
- Compact, measures 3 1/8" x 5 7/8" x 2 1/4".
 - Uses latest design 2% accurate 1 Mil. D'Arsonval type meter. Same zero adjustment holds for both resistance ranges. It is not necessary to readjust when switching from one resistance range to another. This is an important time-saving feature never before included in a V.O.M. in this price range. Housed in round-cornered, molded case. Beautiful black etched panel. Depressed letters filled with permanent white, insures long life even with constant use.

- Specifications: 6 A.C. VOLTAGE RANGES: 0-15/30/150/300/1500/3000 volts.
- 6 D.C. VOLTAGE RANGES: 0-7 1/2/15/75/150/750/1500 volts.
- 4 D.C. CURRENT RANGES: 0-1 1/2/15/150 Ma. 0-1 1/2 Amps.
- 2 RESISTANCE RANGES: 0-500 ohms, 0-1 Megohm.

The Model 770 comes complete with self-contained batteries, test leads and all operating instructions. **\$13.90** NET

20% DEPOSIT REQUIRED ON ALL C. O. D. ORDERS

GENERAL ELECTRONIC DISTRIBUTING CO. DEPT. RN-5, 98 PARK PLACE, NEW YORK 7, N. Y.



HENRY HAS THE NEW hallicrafters MODEL SX-71 NOW!

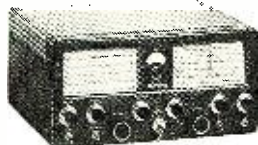

This new type of receiver—the first of its kind on the market—has extra sensitivity, selectivity, and definitely superior image rejection. Continuous AM reception from 538 kc to 35 Mc, and 46 to 56 Mc. One RF, 2 conversion, and 3 IF stages. 105-125 volts AC. 11 tubes plus voltage regulator and rectifier. Only \$179.50.

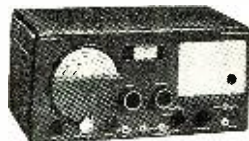

MEDIUM PRICED HALLICRAFTERS MODEL S-40A
540 kc. to 43 Mc. Temperature compensated. One RF, 2 IF, 3-watt output, 4 bands. 115 V. AC. 8 tubes plus rectifier. Internal speaker. Only \$79.95. Other popular Hallicrafters models: S38-A, only \$39.95; S-72, only \$89.95; SX-43, only \$159.50; SX-62, only \$269.50.

I have a complete stock of Hallicrafters receivers and transmitters. I'll make you the best deal on a trade-in for your communications receiver. I give you prompt delivery, and 90-day FREE service. Nobody can beat Bob Henry on a trade-in, and I offer you the world's lowest credit terms. Write, wire, phone, or visit either store today for the best deal.

Bob Henry
W6ARA

Butler 2, Missouri **HENRY RADIO STORES** 11240 Olympic Blvd. LOS ANGELES 26, CALIF.
"WORLD'S LARGEST DISTRIBUTORS OF SHORT WAVE RECEIVERS"

Insuline Challenger TV ANTENNAS

Better 3 ways!

- 1 - precision engineered
- 2 - outstanding performance
- 3 - competitively priced

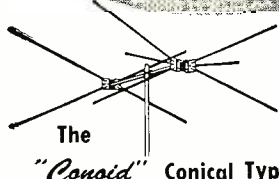

The "Conoid" Conical Type

Precision designed features that add up to flawless television reception on all channels. High forward gain and excellent front-to-back ratio. Perfect matching to transmission line . . . minimizing "ghosts."

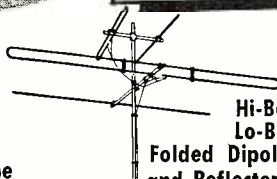

Hi-Band Lo-Band Folded Dipoles and Reflectors

Outstanding reception over entire high band and low band television range. Ideal for "fringe" areas. Antenna sections rotate separately. Easy to install.

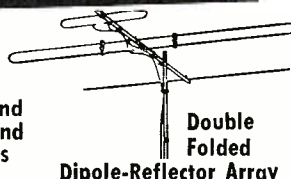

Double Folded Dipole-Reflector Array

Uni-directional broad band system for all-channel, high band-low band reception. High sensitivity for building up weak signals from distant TV transmitters.

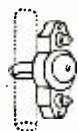

LIGHTNING ARRESTER



DUAL PURPOSE SCREW EYE STAND-OFFS



INSULATED MAST

Conical Window Antenna

Ideal for use where roof-top antenna is impractical. Adjustable base spans 30 to 50 inches to fit any wood or casement window frame. This popular Conical antenna offers horizontal or vertical positioning for maximum response.

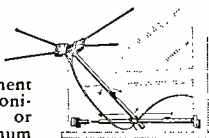

Above are just a representative group of the INSULINE family of TV antennas.

Write Dept. RT-5 for catalog of "Challenger" Antennas and Accessories. Visit our Booth No. 616 at Parts Show.

insuline CORPORATION OF AMERICA
INSULINE BUILDING • 36-02 35th AVENUE • LONG ISLAND CITY, N. Y.
West Coast Branch and Warehouse: 1335 South Flower Street, Los Angeles, Calif.
Exclusive Canadian Sales Agents: CANADIAN MARCONI COMPANY, Montreal

The Genescope (Continued from page 62)

The ability of the Genescope to provide a zero or reference line is most appreciated when the FM sound discriminator is being adjusted. Consider the typical television sound i.f. system shown in Fig. 6. It consists of three i.f. stages and a discriminator. The 3rd i.f. tube serves as a limiter to reduce the effects of amplitude modulation. The output cable of the sweep oscillator is connected to the grid of the 3rd i.f. amplifier tube. The vertical input cable of the oscilloscope is connected between point A and ground. The sweep generator is set to sweep for approximately .5 megacycle above and below the sound i.f. frequency. The vertical gain control on the oscilloscope is now advanced until a response pattern approximately 1 inch high is obtained. The pattern will consist of two separate S-shaped response curves. Rotate the phasing control until the two curves blend as much into each other as possible. The result is shown in Fig. 7A. Now adjust the blanking control until a single curve appears with a base line through it. See Fig. 7B.

Adjust the primary of the discriminator transformer for maximum amplitude and linearity of the S-curve. Reduce the signal generator output as the height of the curve increases. The secondary of the discriminator transformer controls the centering of the S-curve and it is adjusted until there is as much of the curve above the base line as below. Feed in a 21.25 mc. marker signal. If the discriminator is properly adjusted, the pip will appear along the linear portion of the "S" curve. As a further test of the secondary alignment, set the AM signal generator to the sound i.f. value (21.25 mc.) and modulate it with the 400 cycle note. If the discriminator is not in perfect alignment, a 400 cycle modulation pattern should appear along the base line of the S-curve. See Fig. 7C. Adjust the discriminator secondary to the point where the 400 cycle disappears, then reappears if the adjustment is continued in the same direction. When the signal is kept as low as possible, this check is a very sensitive one.

A common difficulty encountered by the service technician when attempting to align the r.f. end of a television receiver is the achievement of a prop-

Fig. 9. Impedance matching output cable.

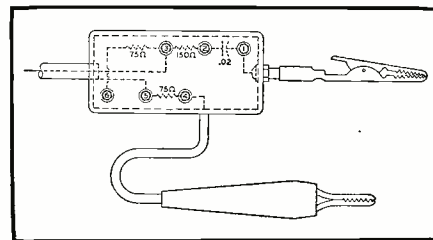

- THE BEST IN ELECTRONIC SURPLUS -

12 V. DC HEAVY BEAM MOTOR



Rated at 1/12 horsepower at 1725 rpm, but actually with built-on reducing gears develops many, many times more power. Worm gear at end of reducer is 43 rpm. As is, can be used for hoisting, electric platforms, portable-electric trucks, conveyors, etc. Operates from 12 volts DC (two 6 volt storage batteries). Additional 7 inch heavy brass worm gear available to reduce rotation to 2 1/2 rpm, for antenna rotator.

NEW, unused surplus.
PRICE, EACH MOTOR \$11.95
 7-inch Brass Worm Gear, for 2 1/2 rpm... \$1.50

HI-QUALITY COMPASS AND ADJ. TRIPOD



For orienting beam antennas, boat owners, hikers and many other useful applications where a real hi-quality compass is required. Compass is deluxe with ball and socket mount adapter, built-in levels, a zero set, a screw for locking needle when not in use, two vertical sights—folding type, 4 inch pointer on 5 inch compass, 0-360 azimuth calibration (counter-clock-wise). Tripod is exceedingly well made, telescoping from 20 inches to 47 inches, and can be adapted for camera work.

PRICE, Complete, as above, NEW, unused surplus.
EACH \$9.95

VARIABLE AUDIO OSCILLATOR

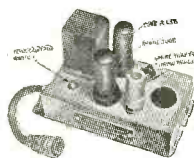

For service test bench, code practice (by keying), tone modulation of ham or commercial transmitters, or with oscilloscope for audio amplifier testing. Has 5-point switch to provide 5 different audio tones. Uses a 12A6 pentode to give plenty of audio power.

Additional 12A6 in spare socket, for spare. No IS4 spare as shown. With diagram.
PRICE, EACH \$5.95

20-40 MC RESONANCE TUNER

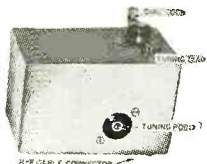

This is a Handy item for hams to have around. Consists of an entirely shielded resonance circuit consisting of 4 turns No. 16 wire tuned by a 75 mmf variable capacitor. A 2 turn rotating link within the above coil, designed for connection to a transmission line or to link coil of plate tank. Use as absorption wavemeter, harmonic or parasitic wavetrapp, or for rotating beams to eliminate slider contacts or wire twisting. Hi-potential contact on polystyrene insulation provides for neon glow lamp tuning. NEW units.

PRICE, EACH \$4.95

2-VOLT VIBRATOR POWER SUPPLY, PE-157

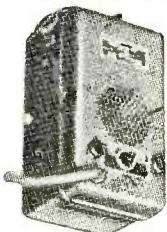

Designed for the "Horsy-Talky" or BC-745 Transmitter-Receiver, this unit can be adapted for supplying power to many other types of battery operated walkie-talkies. Also ideal for converting battery portable receivers to less expensive storage battery operation. Uses self-rectifying vibrator circuit, and self-contained 2-volt plastic storage battery (not supplied). Delivers approx. 125 volts at 80 ma. as well as 1.35 fil. volts, and 13.0 volts bias. Includes vibrator charging circuit, for recharging from another 6-volt (car) battery. Has speaker opening, speaker not included. NEW and Excellent condition units.

PRICE, EACH \$4.95

DECK ENTRANCE INSULATORS, bowl and flange type. 8 7/8" dia. with heavy galvanized metal flange and bell. Top bell 6 1/4" dia. 1 1/2" brass feed-thru rod. Very high voltage insulation. Individually packed in cartons, all NEW.

12 FOR \$18.00
GENERAL ELECTRIC AMPLIDYNE M.G. SET, generator type YV-5875677, motor type #73AB58, Navy #CG-21ABU, 115/230V, 60c., motor rated at 3/4 HP., generator output 250V. DC at 375W. NEW \$60.00
GENERAL ELECTRIC AMPLIDYNE MODEL 5AM78AB47 MOTOR GENERATOR SET, Motor 3HP 440V, 3 phase. Output 250V. DC at 3 amps. anp 60V. DC at 12.5 amps. Excellent Condition... \$85.00

HAM & TELEVISION ANTENNA ARRAY



For the ham, experimenter, or commercial application where directive transmission and reception are desired. This array is designed for 20 to 40 mc coverage. Assembly is simple, and is easily changed to horizontal. Center supporting mast is vertical dipole, contains within an rf transmission line, and at top a phase load box with plug-in inductors. Elements are removable, and design is for both transmission and reception. Sturdy, and ideally adaptable for rotating beam array when used with motor-driven mount below. With instruction and diagram sheet. Shpg. wt. 75 lbs.

NEW, unused surplus.
COMPLETE ARRAY \$14.95

MOTOR-DRIVEN BEAM ANTENNA MOUNT



Weatherproof steel box, 12" x 15 3/4" x 20" high, with 1/12 hp 12V. DC motor installed within that rotates the heaviest possible beam at 2 1/2 rpm. Includes antenna mounting stub, azimuth indicator, clutch for manual or motor rotation, hinged door. Designed to operate with Array shown above. Supplied with cables, instruction and diagram sheet. NEW, unused surplus.

PRICE, EACH \$19.95

580-765 MC SUPERHET RECEIVER, WITH WAVEMETER



Easily modified for Citizen's Band reception, or for experimental use on VHF Television. Uses a 955 Autolyne detector-oscillator into 3-stage resistance-coupled IF amplifier. Output is for headphones. Includes VR-150 voltage regulator tube, 6E5 tuning-eye, and 5Y3 rectifier. For 110 volts, 50/60 cycles AC. Calibrated Wavemeter mounted as separate portion, with variable tuning rod and hand-plotted calibration curve for each, permits checking frequency of incoming signal. NEW unused surplus. With instruction sheets and diagram, plus calibration curve, and tubes.

PRICE, EACH \$75.00

RADAR TRAINING SET—MARK V

For Student, Schools, Labs, or actual radar application. Operates in the 580 to 765 mc region, designed especially to illustrate how radar eqpt. functions, and permits making numerous experiments to put over radar fundamentals. Uses above described receiver; separate transmitter using 8025 triode with 1.5 watts at antenna, with 400 KC internal modulator using two 811 tubes; External modulator, generating audio frequencies of 16,000, 4,000, and 1,000 cycles, and RF at 750, 350, and 175 KC, with selection switch for modulation frequency and wave form control, using 3 tubes, 807, 6N7, and 6J5; set of Antenna Dipole rods. Supplies with full instruction sheets, diagrams, calibration curves, tubes, NEW unused surplus.

PRICE, Per Set \$175.00

Technical Manual (Complete Instruction Book) for the BC-312 & BC-342 Receiver.
 PRICE, Postpaid \$1.50

"SNOOPERSCOPE" TUBE

Intra-Red Image Converter Tube (British) to make "Snooperscopes," "Sniperscopes," and other devices that see in the dark. Has many useful industrial applications. Operates with invisible infra-red rays, without scanning or amplifiers. Supplied with technical data and diagrams. Every tube guaranteed!

WE WILL NOT BE UNDERSOLD.
 EACH \$5.00
 6 for \$25.00
BAUSCH & LOMB Front-End Lens Assembly, for best images. F2.1, 3.5 in. E.F. EACH \$10.00
MOUNTED LENS UNIT, also for front-end, results as good as B & L unit. Speed F1.9 f.l. 91.44 mm, outside dia. at one end 60 mm, length of mount 64 mm. PRICE, EACH \$7.00

All Above Material Subject To Prior Sale. 25% Minimum Deposit With All C.O.D.'s. All prices F. O. B., N. Y. C.

TELEMARINE
COMMUNICATIONS COMPANY
 280 Ninth Avenue
 NEW YORK 1, NEW YORK

20-40 MC FIELD STRENGTH AND WAVEMETER

Uses a 0-100 Micro-ammeter with a 1S4 Pentode, to receive signals in the 20-40 mc range. 1.5 volts battery required. Tuning dial has dial lock, for fixing position, and telescope Antenna permits adjusting for strong or weak signals. Calibration must be self-performed. With instruction sheet and diagram. NEW, unused eqpt. Dim: 6 1/2" x 4 1/4" x 5 1/2" (less antenna).



PRICE, Each \$12.95

VEHICULAR FM TRANSMITTER-RECEIVERS, BC-620 & BC-659

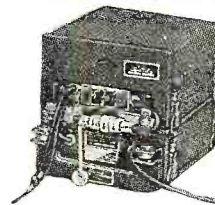

Compact, almost portable, NBFM transmitter-receivers designed for vehicle installation. Provides instantaneous selection of either one of two channels, preset for both Xmitr and revr., crystal controlled. Uses 13 selected Loktal tubes in a highly engineered and efficient unit to give a 10 to 15 mile range with a minimum of power consumption. Operates from batteries, or with PE-120 or 117 or 97—from 6, 12 or 24 volts DC. Includes built-in loudspeaker, meter for checking voltages or various circuits, external handset for talk-receive. BC-620 covers 20.0 to 27.9 mc. BC-659 covers 27.0 to 38.9 mc. Excellent communication eqpt. for industrial or commercial application. With all tubes, handset, less crystals. NEW, unused eqpt.

Either BC-620 or BC-659. EACH \$34.95
VE-97, or 117, or 120, VIBRATOR POWER SUPPLY, for above. Operates from 6, 12 or 24 volts, by changing tap on transformer and vibrator. NEW, unused units. EACH \$16.50

WESTERN ELECTRIC 500 WATT "HLAS" ANNOUNCING SYSTEMS

Gigantic Sound Power amplification for giant political rallies, airports, docks, stadiums, etc. 3-unit eqpt., with 120 db gain; automatic volume control and compression circuits; Speech, Phono, and wire or tape recording inputs, 20 KC erasing oscillator; 12-Speaker bank for handling full output. All in solid, splashproof cases. Operation from 115/3/60 AC.

WRITE FOR FULL DESCRIPTION SHEETS AND PRICES.

PORTABLE 250 WATT W.E. BEACHMASTER SOUND EQPT.

Super-Power 250 Watt Amplifier and Loudspeaker System for stadiums, ball parks, airports, etc. Complete pre-amp and power amplifier in water-tight case with internal blower. 9-Speaker horn assembly in similar case, making complete system portable. Operates from 110/1/60 AC. Complete with cables, tubes, dynamic microphone.

WRITE FOR DESCRIPTIVE SHEET AND PRICES.

— INVITATION —

TO COME AND GET THE BIGGEST BARGAINS IN ELECTRONIC HISTORY!

We invite you to come in and browse around, and see our terrific variety of electronic eqpt., all priced way down for quick sale. Intricate, expensive eqpt. costing hundreds of times our special low prices, just a few of each so that it doesn't warrant advertising or cataloging. You will find, at ridiculously low prices, Tuning Fork Oscillators, Time-Delay Relays, Power Transformers of all sizes for transmitters and receivers, an amazing variety of hi-quality audio components, variable condensers of all types and sizes, insulators for every purpose, test and measurement instruments; Commercial transmitters, from 1/2 watt to 300 watts which will make fine ham rigs, mine detectors, sonobuoy transmitters, radar, underwater sound devices, power supplies, metering panels, amplifiers, and hundreds of other devices and parts.

PLEASE DO NOT WRITE FOR CATALOGUES OR PRICES. All of this material is priced for immediate take away; no shipping or mail order.

Communication Companies and Governmental Agencies!

Do we have you on our mailing list? We have, for immediate delivery, some large hi-powered commercial transmitters, complete ship radar sets, 10 KVA Gas Engine Generator Sets that are NEW and Export Packed, and many other hard-to-get surplus items. Write us your requirements.



keep with it!

Be sure you get that famous ALTEC 21B quality from over-active announcers and recording artists by using the new 155A Chestplate. Because of the microphone's perfect positioning, you may readily obtain the sound separation you desire from vocalists working with an orchestra...without false bass! With this new adaptation of the 21B, sports announcers can always override even the noisiest crowds, for the 21B does not limit at audio peaks. Its smooth frequency response permits use in high-level sound fields which would ordinarily cause acoustic feedback.

The 155A Chestplate is compact, lightweight and contains a matching unit which permits its use up to 400 feet away from associated equipment.

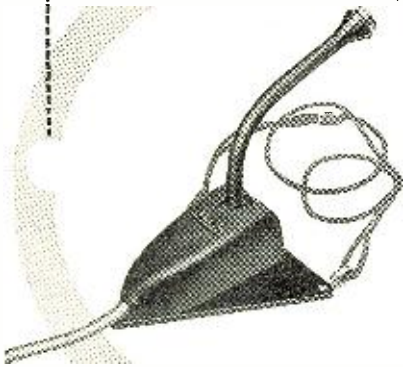

Send for brochure giving technical information on ALTEC 21B Miniature Microphone adaptations.



1161 N. VINE ST., HOLLYWOOD 38, CALIF.
161 SIXTH AVE., NEW YORK 13, NEW YORK

TERMINATION	CONNECTIONS	
300 ohms	Jumper 1-2	Jumper 5-6
150 ohms	Jumper 1-2	50 ohms 2-3
	Jumper 5-6	75 ohms 4-5
75 ohms	Jumper 1-2-3	Jumper 4-5-6
50 ohms	Jumper 1-2	30 ohms 2-3
	Jumper 4-5	50 ohms 1-5
Open Termination	Jumper 1-2-3	Jumper 4-5
Series Condenser .02 μ d. 400 v.	Jumper 2-3	Jumper 4-5

Table 1. Terminal box connections for the impedance matching output cable.

er match between the signal generator and the receiver input terminals. Any appreciable mismatch will act to alter the shape of the response curve, causing adjustments to be made which will not provide the proper response when the signal generator is removed and the regular set antenna is connected. In the Genescope, matching of impedances is specifically provided for by employing the output cable termination shown in Fig. 9. A variable matching network and a series of terminals are available at the end of the generator cable and by connecting the terminals as indicated in Table 1, impedance values of 50, 75, 150, and 300 ohms can be obtained. Information is also provided in the instruction booklet accompanying the instrument for matching to other impedances.

While not specifically outlined above, alignment of FM receivers would proceed in a similar manner.

The stress, thus far, has been directed toward alignment but the Genescope, through its separately contained oscilloscope, is equally valuable for servicing. Waveform checking and testing—which is a common practice for the video amplifiers and the vertical and horizontal sweep systems—can be accomplished by feeding

whatever signal is present to the vertical amplifiers of the scope. Where signal tracing through the i.f. and r.f. circuits is required, recourse can be made to the high-frequency probe. This probe is essentially a high frequency detector and may be used to pick up the signal at any point in the receiver where high-frequencies exist. This applies with equal force to video signals received from a station or an r.f. signal obtained from the AM generator section of the Genescope.

To trace a signal through the sound channel of a TV receiver, connect the output cable of the AM generator section to the antenna terminals of the receiver and set the AM generator to the sound r.f. carrier frequency of the channel being tested. Modulate this signal with the 400 cycle note.

Attach the high frequency probe cable to the vertical input jack and touch the probe to various points along the i.f. system. Starting with the converter grid the signal may be traced through the i.f. system to the discriminator.

The same test may be applied to the video i.f. system by tuning the AM generator to the video carrier frequency and proceeding from the converter tube through the picture i.f. stages to the video detector. Further tracing of the signal beyond the video detector can be done with a pair of conventional leads.

Any single stage may be checked by connecting the h.f. probe across the output of the stage under test and injecting a signal of proper frequency to the input. When a received video (or audio) signal itself is being traced through the various stages, the AM generator is turned off and only the scope section is utilized.

-30-

The Air Materiel Command at Wright-Patterson Air Force Base in Dayton has recently announced the development of a "Tom Thumb" synthetic radio tube, about the size of a match head, which may prove to be the Air Forces' answer to the problem of how to reduce the weight and size of its airborne electronic equipment. Named the "fieldistor", the sub-miniature tube is now in its early stages of development. The new tube is 1/90th the size of the standard radio tube shown at the left while a present-day electronic tube towers over it at the right. Ten of these units could be carried in an ordinary thimble. Another advantage claimed for the new "tube" is that it uses so little current that most batteries can be eliminated, thus reducing equipment size.

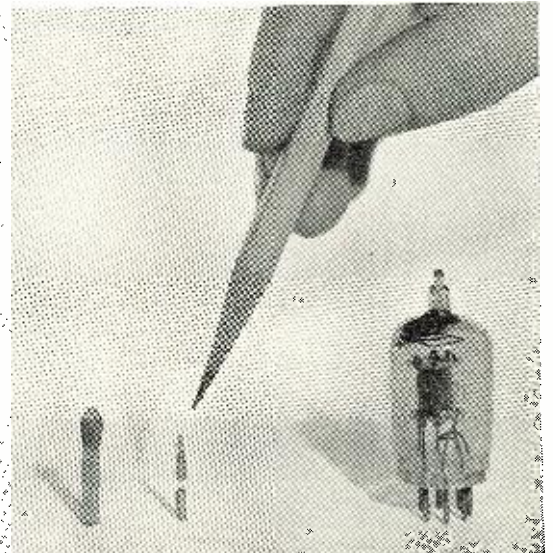
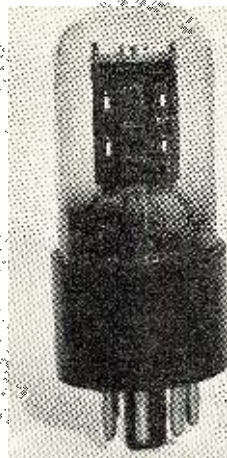



STOP MEASURING "GHOSTS!"



See WHAT YOU Measure

NEW NATIONAL VIDEOMETER ENDS ALL TV INSTALLATION GUESSWORK!

You can't see ghosts or noise on a meter. That's why field strength readings alone are unreliable in making TV installations. Now, the new National Videometer gives you *both* meter readings and a TV picture. You see just what you measure. No more trouble-making initial installations! No more costly call-backs!

Meter Check on Both Field Intensity and Line Voltage

Set the meter switch to A.C. LINE and read the line voltage at the receiver input terminal directly on the 0-150 volt scale. Set the switch to SIG. STR. and read the field intensity on the 0-10 scale. A table is provided to convert directly to microvolts. Reading indicates field intensity at antenna input and is independent of contrast and brightness controls.



METER

A.C. LINE SIG. STR.



\$169.95

(Slightly higher west of the Rockies)



Become an Electrical Engineer

B. S. Degree in 36 Months



Major in Electronics

IMPORTANT advantages are yours at this nonprofit Technical Institute and College. A valuable year is saved by gaining your B. S. degree in 36 months of continuous study. You get both practical, specialized training in well-equipped laboratories—and a solid education in Electrical Engineering and related arts.

The program includes 19 technical specialty courses in Engineering Electronics, along with four courses in Electronic Design—plus Chemistry, Physics, Mathematics, Economics and basic Electrical Engineering subjects.

You Become an ELECTRONIC TECHNICIAN after 12 months study in the Electrical Engineering course. Electronics is of tremendous growing importance in communications, broadcasting, radio-television, power-system control, high frequency heating, printing and other fields.

The Radio-Television Technician's certificate can be yours in 18 months. You are then equipped for specific positions in receiver and transmitter testing, servicing, sales and production. This course will be credited toward your B. S. degree in Electrical Engineering.

Military, Academic or Practical Training is evaluated for advanced credit. Preparatory courses are also available.



Faculty of 85 specialists. 1555 currently enrolled from 48 states and 23 foreign countries. Over 35,000 alumni. Terms open July, Oct., Jan., April.

MILWAUKEE SCHOOL of ENGINEERING

Founded 1903 by Oscar Werwath

Write for free 110-page catalog and 48-page pictorial booklet, "Your Career."



MILWAUKEE SCHOOL OF ENGINEERING
Dept. RN-550
1020 N. Broadway, Milwaukee, Wis.

Without obligation, send me the 110-page catalog and 48-page "Your Career" booklet.

I am interested in.....course.

NAME.....AGE.....

ADDRESS.....

CITY.....ZONE..STATE...

Check if World War II Veteran

Spot Radio News

(Continued from page 18)

private demonstration in the Hotel Statler, before a group of newspaper men and members of Congress, including the chairman of the Senate Interstate and Foreign Commerce Committee, Senator Edwin C. Johnson. The demonstration, which featured a new approach to the problem, involving a vertical shift rather than the horizontal method used previously, was applauded by the Senator, who declared that he was well satisfied with the system now.

THE HEARINGS disclosed that many of the questions which were puzzling the Commission, particularly those raised by Coy during his Oklahoma address, might have effective answers very soon. Dr. E. W. Engstrom provided the clue that solutions were perhaps not too far away, by declaring that RCA had reached the stage where it might be possible to begin probing color standards. Such a step could now be considered, he stated, because of the high-level sampling synchronization and color phasing techniques recently developed and particularly because of the new direct-view, tri-color tube, which would be demonstrated in Washington in the very near future.

Testimony revealed that the direct-view, single tube shows . . . "an attractive picture with good resolution and good color."

Engstrom reported that . . . "Experience in black and white television has shown that in order to realize consistent performance at the limit of system capabilities, it is necessary for the terminal units—pickup tubes and picture tubes—to have resolution ca-

pabilities in excess of those of the system itself. Since this requirement seems equally applicable to a color system, our work on the tri-color tube has as a goal, the attainment of such extra resolution capability. We know of no reason why this goal cannot be attained in the near future. . . . Our investigation of receiver circuits for use in connection with a tri-color tube have, of course, been carried out in parallel with the tube development. We feel that this circuit development is straightforward and will provide for further color-receiver simplification. For example, only one yoke and deflection system are used, just as in ordinary black and white receivers. In turn, the elimination of two of the three deflection systems required in the current three picture-tube assembly also reduces power-supply needs. . . . With a suitable tri-color tube incorporated in the simplified receiver, we may produce in the not-too-distant future a fully-electronic color television receiver, with but ten to fifteen tubes more than for a comparable black and white receiver."

Questioning by Commissioners Jones and Hennoek, as to the use of the tri-color tube for other systems, brought the striking reply that the tube could be used with the CBS system, even though 405 lines were involved, but that performance might not be too satisfactory because of the reduced resolution afforded by the 405-line picture.

When queried about the size of the picture that the tri-color tube would provide, Engstrom declared that a sixteen-inch envelope was being used, with the viewing area masked down to about fourteen inches. The larger envelope had been selected because it simplified construction of the elements required for three-color presentation.

Dr. Peter C. Goldmark, the field-

The "electronic umpire" developed by the General Electric Company and used by the Brooklyn Dodgers during spring training. When a pitched ball passes through the strike zone, the shaded area, its shadow is seen by three electric eyes which look at the sky at the angles shown. If the pitch is a strike the ball is seen by the eyes in 1-2-3 order and electric impulses are created which light a "strike" indicating lamp. An inside or outside ball is not seen at all and a high or low pitch results in the ball being spotted in an improper sequence, and the lamp does not light, thereby indicating a "ball" was pitched. The strikes, as well as the speed of the ball, are registered on the recording machine shown in photo at the left.

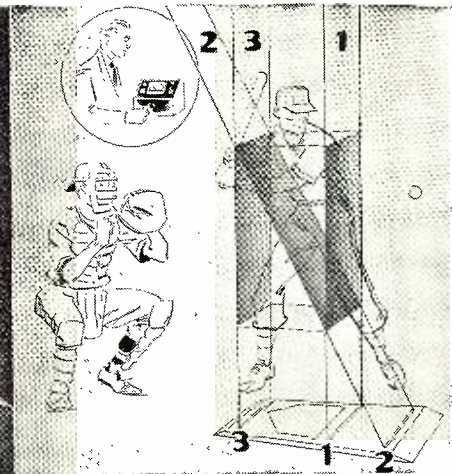

Instant change-over TO EACH ANTENNA

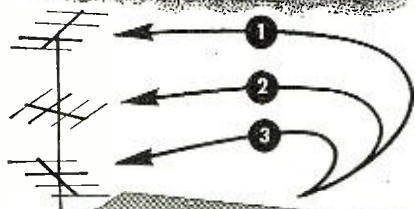

Vee-D-X 3 WAY ANTENNA SWITCH \$4.95 list

Separate lead-ins on multiple antennas are no problem with the new VEE-D-X antenna switch. Just turn the knob, and you can change over instantly from one antenna to another. Eliminates entirely the fuss and bother of changing transmission lines every time a different antenna is used. Very useful for T V Dealers when demonstrating more than one receiver from a single antenna.

Here are the features that make the VEE-D-X Antenna Switch the finest available:

- Specially designed switch prevents leakage.
- Furnished in attractive ivory plastic case with satin finished aluminum face.
- Terminal strip accommodates three separate lead-ins as well as output line to receiver.
- Easy to install.
- Lead-ins attach to rear and are hidden from view.

VEE-D-X

VEE-D-X means video distance

LA POINTE-PLASCOMOLD CORP., 3
Unionville, Conn.

Please send me further information about your
TV antennas and accessories.

Name

Address

City Zone State

sequential color disc exponent, indicated that he was delighted to hear of the tri-color tube, which he felt could be used in the CBS system at a much lower cost and without the addition of other receiver type tubes. He did not agree that the resolution problem was too acute. However, in an appearance before the Commission several weeks later, he described a modified system, using a sampling circuit based on the horizontal interlace principle, which provided a 525-line picture.

As soon as RCA had learned that CBS had outlined a method using sam-

pling and horizontal interlace techniques, similar to what they had prescribed for their picture-dot interlace electronic system, headquarters issued a statement by RCA Lab Chief Dr. C. B. Jolliffe, which declared that: "At last CBS has admitted the weakness of its color television system. Because of lack of resolution in its system, CBS now states that it will now adopt the principles of sampling and horizontal interlace, developed by RCA."

Shortly after the Jolliffe statement was released, CBS issued a biting reply. Prepared by Adrian Murphy,

NEW 500 KW. SUPER-POWER BEAM TRIODE

RADIO Corporation of America has recently announced the development of what is believed to be the world's most powerful electron tube, a high-vacuum "super-power beam triode" capable of 500 kw. continuous output and tested at one million watts input.

The new tube, RCA Type 5831, represents the first commercial attempt to build power output of this magnitude into a single tube. Despite its enormous power input capabilities, the new tube measures only 38¾ inches in length and weighs only 135 pounds.

Applications of the new tube include high-power c.w. applications and international broadcast service. In unmodulated class C service, the 5831 has a maximum plate voltage rating of 16,000 volts, a maximum plate input of 650 kw. and a maximum plate dissipation of 150 kw. To provide 500 kw. output in unmodulated class C service, under typical operating conditions, the tube requires only about 900 watts grid drive. The tube can be operated with maximum rated plate voltage and plate input at frequencies throughout the standard broadcast band and much higher. The limitations for operation of the tube at high frequencies and at higher power have not been determined at present.

The outstanding structural feature of the tube centers around the "electron heart," an array of 48 independent unit electron-optical systems arranged

cylindrically in the tube. Each of these systems consists of a filament in a slot in the beam-forming cylinder, grid rods, and the copper anode. Electrons leaving the emitting surface of the filament are beamed between a pair of grid rods to the anode by the focusing action of the beam-forming cylinder. Even though the grid may be positive, relatively few stray electrons strike it.

The individual filament and grid elements of the unit triodes in the array are tungsten rods 8 inches long, supported at both ends by means of knife-edge V-notch arrangements. Special feature of this design is the "pantographic mounting," consisting of a device with flexible spring-loaded fingers to which the filament rods are hooked. The pantographic device makes each filament strand and grid rod mechanically independent, and allows vertical movement without disturbing the precise alignments and spacings essential to effective electron optics. The filament strands are made of thoriated tungsten for economical operation, as well as for high emission capabilities.

The internal elements of the tube, including the cylindrical beam-forming structure, anode, and filament, are concentrically arranged, adding to the high efficiency of the design, and permitting the use of a simplified internal water-cooling system for the beam-forming cylinder and anode, with simple external hose connections. —30—

RCA's new "Super-Power Beam Triode" which is capable of 500 kw. output and which has been tested at one million watts input, is shown with Dr. L. P. Garner, head of the company's Advance Development Lab at Lancaster, Pa., where the tube was developed.



The BROOK All Triode High Quality AUDIO AMPLIFIERS

Provide the Key to

*Better
Listening*



Model 12A3-10 watts.

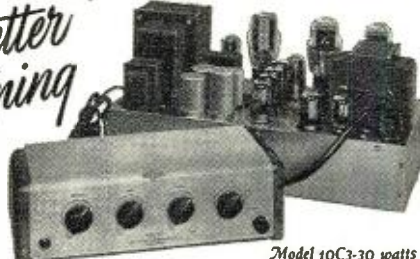

Model 10C3-30 watts

All Low Mu Triodes

Plus

Brook made
Transformers

Plus

Brook's own Circuits

Finest Audio Quality
you ever listened to

Minus

Listening Fatigue

Plus

High Quality at
extremely low volume

Plus

High Quality at the full
loudness of a band or symphony

"You can believe your ears when you listen with a Brook Audio Amplifier."

Write today for FREE Technical Booklet and detailed distortion analysis.

BROOK ELECTRONICS, Inc.

Dept. RE-0 • 34 DeHart Place • Elizabeth, N. J.

CBS vice-prexy, the text indicated that the RCA statement was a . . . "gross distortion of the facts."

To support its view that the pictures provided even by the original Goldmark approach were highly satisfactory, CBS offered the testimony of a parade of experts, one of whom was Dr. Jack W. Dunlap of a research organization in New York City. Reporting on a survey of doctors, who had viewed CBS color TV, he said that over 94 per-cent thought that the "over-all quality" was "excellent." Testimony offered by Oscar Katz, director of research for CBS, showed that only about 1.5 per-cent of close to 10,000 persons interviewed, found fault with the color wheel, a point which was disputed during a questioning period, some experts intimating that large-scale demonstrations do not provide a detailed evaluation of receiver operational features.

A BLANKET PREDICTION that the Commission would lift the freeze next fall was made by former FCC Commissioner E. K. Jett during a talk before a group of furniture dealers in Baltimore.

Jett, who also served as FCC's chief engineer for a long spell, declared that the ultra-high bands would be allocated, around September or October, for black and white service and that color may have to wait. None of the color systems demonstrated thus far, he added, showed promise of immediate adoption. It was his opinion that the Commission would not sanction any color system, unless it could be adapted to existing receivers at a very low cost.

RADIO AND TELEVISION will be used in quite a substantial manner by the Army and Air Force during their recruiting program, with about forty per-cent of the advertising budget set aside for the purpose. The news was revealed during testimony before the House Appropriations subcommittee. It is expected that over \$600,000 will be spent for broadcasts, in an attempt to procure over a quarter of a million volunteer enlistments.

The campaign is expected to begin during the summer.

THE LONG-AWAITED designation of a chief engineer for the FCC has been finally made, with Curtis Plummer chosen to fill the important post. Plummer, who has served as chief of the television broadcast division of the Commission, joined the FCC in 1940 as a radio inspector at Boston. Shortly after that appointment he became an assistant monitoring officer, and in 1941 came to Washington as an associate radio engineer. In '42 he became a radio engineer for the Commission, after which followed service in the nonstandard broadcast section of engineering and then the TV division.

Congratulations, old man. We know that you'll be eminently successful in this key assignment. . . . L. W.

RADIO & TELEVISION NEWS



**INTERLOCKING
SMALL PARTS CABINETS
TO FIT ANY SPACE**

MULTI DRAWERS are the handy small parts steel storage cabinets you and your friends have always wanted! Each 5 x 2 7/8 x 2 1/4 drawer (painted green) interlocks on top, bottom or sides making it possible to fit them around existing fixtures for economy of space. Card holder on front of each MULTI DRAWER. Immediate delivery in sets of 12 at \$3.50 per set. Mail coupon now!

THE CINCINNATI VENTILATING CO., INC.

Third and Madison Sts., Covington, Ky.

Please send ___ sets of MULTI DRAWERS @ \$3.50 per set

C.O.D. Check Money order enclosed. I

agree to pay postage.

I am interested in being a MULTI DRAWER dealer. Send full information.

Name _____

Address _____

City and State _____

NOW AVAILABLE
At your RCA Distributor

**MODEL
515S1**

PRICED RIGHT!
ONLY \$55
Suggested List

**The sensational RCA
15" Duo-Cone Speaker**
... proud offspring of the
famous RCA LC-1A

What's New in Radio

PLAYBACK UNIT

Ampex Electric Corporation of San Carlos, California, has developed a new continuous playback machine utilizing twin-track magnetic tape. It has been designed especially for continuous high-fidelity music or voice reproductions for use in entertainment, educational work, and other services.

Known as the Model 450, the new unit utilizes the special *Ampex* magnetic playback head. The machine uses a synchronous tape drive mechanism in which no part revolves at excessive speed. There are no gears, belts, or rim drives, and all rotating parts run on permanently lubricated, sealed ball-bearings. Operation is entirely automatic and requires no attention other than turning on or off of electric power.

Two separate playback heads are used, one for each of the two recorded tracks on the tape. The machine automatically reverses by means of a special thyatron circuit after playing for approximately one hour and reverses again at the end of the second hour.

BLAST FILTER

Electro-Voice, Inc. of Buchanan, Michigan has developed and is manufacturing a blast filter unit which

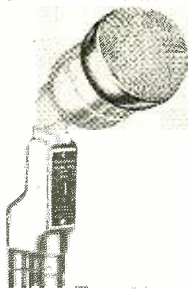

stops wind and breath blasts and prevents pop in dynamic microphones.

The Model 335 blast filter is said to stop breath blasts even when the speaker works extremely close to the microphone. In outdoor pickup it completely eliminates any interference from wind rumble.

The unit is designed to be used with *E-V* Models 640, 635, and 605 moving coil dynamic microphones. The blast filter is small in size and can be easily installed on the microphone without adjustments.

RADIO CODE MACHINE

Ultradyne Electronics of Oswego, Oregon has announced production on a new radio code machine, the Model RCM-2.

Priced to fit the pocketbook of the individual user, this new machine

For additional information on any of the items described herein, readers are asked to write direct to the manufacturer. By mentioning RADIO & TELEVISION NEWS, the page, and the issue number, delay will be avoided.

teaches the code by photoelectrically keyed inked code practice tapes. The tape is pulled through the machine at

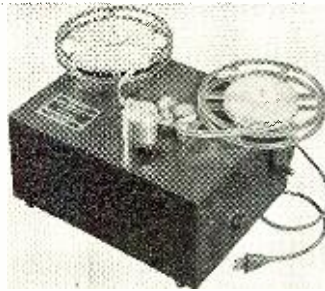

a speed which can be increased a little at a time until the desired code speed is attained.

Sending practice is facilitated by using one of the beginners' tapes that has extra spacing between characters. The operator can then imitate, as closely as possible, using a hand key, the correctly sent character sounded by the machine.

The self-contained unit comprises a tape-puller motor, take-up reel, re-wind and phototube keying circuit and has three controls—keying, speed, and rewind. A complete selection of practice tapes is available for use with the machine.

TUBE TESTER

A mutual conductance tube tester which reads on a calibrated micromho scale as well as on a "Reject-Good" basis has been introduced by *Electronic Measurements Corp.* of 423 Broome Street, New York 13, New York.

The new tester, the Model 201, also checks tubes for gas content and checks all tubes from .75 volt to 117 filament volts as well as all octal, octal, 9-prong miniature and submini-

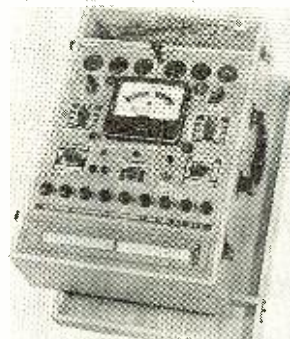

ature tubes. Testing can be done on cold cathode, magic eye, voltage regu-

lator tubes, and ballast resistors. Individual sockets for each type tube base eliminate possible errors.

The unit has a 4½ inch meter and is available in either a sloping counter case style or in a portable model in an oak carrying case.

GOODELL AMPLIFIER

The Minnesota Electronics Corporation of 97 East Fifth Street, St. Paul 1, Minnesota has introduced a new amplifier unit for home installation which will retail in the moderate price class.

Known as the *Goodell "50,"* the new unit features continuously variable bass and treble control, 16 db. bass boost and bass attenuation at 40 c.p.s. and 16 db. treble boost and treble attenuation at 10,000 c.p.s. The amplifier has stabilized degenerative feedback, low internal generator impedance and the automatic switching of feedback resistors on each output tap.

A selector switch provides output impedances of 4, 8, 20, 250, and 500 ohms ganged to simultaneous switch-



ing of feedback resistors for optimum performance on each tap. A four-position switch provides radio, 78 r.p.m. phono, LP phono, and television, with automatic equalization inserted for LP and 45 r.p.m. records. A socket is provided for a plug-in phono preamplifier.

Frequency response is said to be 20 to beyond 20,000 c.p.s. within 1.5 db. Power output is rated at 8 watts. A data sheet listing all of the features is available on the *Goodell "50."*

SOLDERING FLUXES

A line of fluxes, recently developed in England, is now being distributed in this country by *Newage International, Inc.* of 521 Fifth Avenue, New York 17, New York.

These T.S.F. fluxes are self-cleaning, remove oxides and film from ferrous and non-ferrous metals, and are impervious to grease, according to the

FREE Write for Our Monthly Bulletin

SELSYN INDICATOR KIT
FOR 10V, 60 CYCLE OPERATION
 Includes I-82A indicator, Selsyn transmitter, transformer and instructions.
 All items brand new—\$6.15
 I-82A indicator only—NEW.....\$3.95

ASB YAGI ANTENNA
 ADJUSTABLE STUB TUNING
 5 ELEMENT ROTATABLE ARRAY—450 TO 560 MC. \$7.00
 SAME EXCEPT DOUBLE STACKED ELEMENT 450 TO 560 MC. \$12.70
 Same Except Double Stacked 6 Element 370 to 430 MC \$29.40

Suitable for citizens, VHF TV and amateur 420MC bands.
SOUND POWERED PHONES
 FOR TV ANTENNA INSTALLATION CREWS
 ● RCA TS-10 handset \$12.00
 ● RCA S.P. chest set (headset and chest mike)
 EITHER TYPE \$8.92 each—\$17.60 per pair

Build Your Own Geiger Counter
 (See Radio & Television News—July, 1949)
 1B98 Gamma Counter Tubes.....Only \$9.87

COAXIAL CABLE
 RG-8/U—6c ft. \$25.00/500 ft.
 RG-59/U—4½c ft. 20.00/500 ft.
 RG-62/U—6c ft. 20.00/500 ft.

OTHER TYPES IN STOCK
 RCA 913—1" CATHODE RAY TUBE—ORIGINAL CARTONS.....\$4.90
 RCA Sound Power Unit. Use as Mike or Receiver.....Dr. 2.22
 AN/APS-13 Exc. Cond.....14.95
 FILTER CHOKE, 10 Henry 400MA 900 DC res. Hermetically sealed, high voltage insulation... 3.77
 FILTER CHOKE—13H 250MA 120V Full Shield Upright..... 3.22

TUBE SPECIALS
 GUARANTEED BRAND NEW
 STANDARD BRANDS ONLY
 SELECTED FROM OUR COMPLETE LISTING

1B3GT.....\$1.18	6W4GT.....\$0.65	5CP1.....\$2.87
2X2......49	6X4......59	5CP7.....3.76
5V4G......84	6X5GT......59	5HP4.....3.35
5Y4G......46	7C4......19	20S1......49
5Z3......65	10Y......19	24C......44
6AC7......52	12A6......24	304T.....1.25
6AG5......89	12AT6......59	316A......66
6AK6......82	12AT7......99	446A......79
6AL5......69	12AU6......72	807.....1.15
6AQ5......72	12AU7......86	810.....7.25
6AT6......54	12AX7......86	813.....6.95
6AU6......52	12BA6......64	815.....1.72
6BA6......65	12BA7......86	829.....4.91
6BE6......65	12BE6......64	832A.....4.91
6BG6G.....1.72	12SA7GT......59	866A......95
6BH6......72	12SK7......59	1619......19
6B16......72	12SG7GT......59	1624......69
6C4......64	35L6GT......59	1625......19
6J5......49	35W4......45	1629......29
6J6......89	35Z5GT......44	1629......29
6K6GT......52	50B5......69	9001......42
6L6GA......87	50L6GT......57	9002......39
6SL7GT......69	3AP1.....4.63	9003......39
6SN7GT......64	3BP1.....2.59	9004......39
6V6GT......59	5BP1.....2.40	9006......29

COAXIAL CONNECTORS

83-1AC.....\$0.42	83-1SP.....\$0.28	UG-21/U.....\$0.67
83-1AP......09	83-1SPN......28	UG-23/U......63
83-1F.....1.12	83-1T.....1.12	UG-27/U......68
83-1H......10	83-22AP......85	UG-29/U......83
83-1J......80	83-22F......88	UG-58/U......57
83-1R......28	83-22R......48	UG-85/U......62
83-1RTY......45	83-22SP......60	UG-87/U......68

Full Line of Coaxial Connectors in Stock.

SPECIAL
 IN34 CRYSTALS.....69c

MICAMOLD MOLDED BAKELITE OIL-IMPREGNATED PAPER CONDENSERS

Cap.	Volts	Each	Per Wkg.	Cap.	Volts	Each	Per Wkg.
.02	200	\$0.4½	\$3.00	.1	400	\$0.9	\$6.00
.05	200	.04½	3.00	.005	600	.04½	3.00
.1	200	.04½	3.00	.01	600	.07	4.75
.25	200	.06	4.00	.05	600	.08	5.50

HAYDON SYNCHRONOUS MOTOR
 110V., 60 Cye., 3.2 W., 4 RPM. BRAND NEW \$1.79

HAMMARLUND VARIABLE CONDENSER
 Dual 50MMF—.030" spacing—micalex insulation—¼" dia. shaft.....\$1.29

RCA High Fidelity Universal Output Transformer
 15 Watts—Pri. 1,000 to 16,000 CT; Sec. 2/6/15
 \$1.69 each.....In lots of 10, \$1.52 each

LOW VOLTAGE TRANSFORMERS
 Fully shielded. All Pri. 115 V., 60 Cye. Made by G.E. and Jefferson Elec.
 Sec. 6V. @ 8½ A. \$1.24 Sec. 7V. @ 7A. \$1.54
 6V. @ 12½ A. 1.84 7V. @ 11A. 2.34
 6V. @ 16½ A. 2.84 7V. @ 14A. 3.34
 7V. Sec. consist of 2 parallel windings which can be connected to give 14 volts.

G.E. PLATE & FILAMENT TRANSFORMER
 Ideal for SCR-522. 6"x4½"x6" H. Pri. 115 V., 60 Cye. Sec. HV-450-0-450, tapped at 350-0-350; 260 Ma. D.C. Bias. 140 VCT @ 25 Ma. Filis., 6.3 VCT @ 4.5 A.; 6.3 VCT @ 1 A.; 5 V. @ 3 A.....\$7.45 each

Include Postage with Orders
ELECTRONIC RESEARCH LABS.
 1021-R Callowhill St. Phila. 23, Pa.

company. They do not corrode or rust and they do not leave corrosive residues.

The line includes various products for joining different types of metal. A consultant service on special metal joining problems is offered for those with difficult or unusual production requirements.

BOOM BRACKET KIT

Of interest to hams, recording enthusiasts, and commercial broadcasters is the new boom bracket kit recently announced by *Atlas Sound Corporation* of 1449 39th Street, Brooklyn 18, New York.

Designed as an all-purpose support for microphones, the "set screw" assembly makes it possible to cut down any tubular section so that the support bracket can be custom built to meet specific requirements. The microphone cable feeds through the entire support arm as well as the adjustable elbow mechanism. All parts of the bracket are finished in opalescent bronze enamel. The boom is 23" long, maximum.

SELENIUM RECTIFIERS

A new line of selenium rectifiers has been introduced recently by *Sarkes Tarzian Inc.* of Bloomington, Indiana.

Designated the "Centre-Kooled" line, these units have been designed for use in radio, television, or electronic equip-

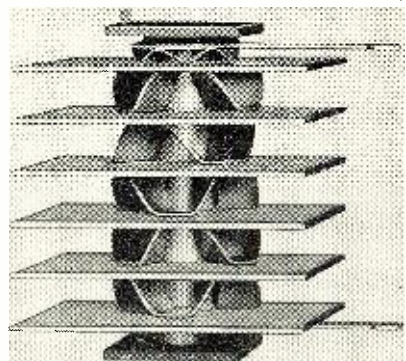

ment. The center-cooling feature is provided by a special spacer between the cells to insure lower over-all operating temperatures by allowing air to reach the portions of the cells in which the current density is the greatest.

Other features include constant assembly pressure under all operating conditions, easily identified color coding, universal locating lug, and constantly high resistance path to ground under all atmospheric conditions.

Sixteen models are currently available and complete data and engineering information on these rectifiers is available from the company.

TUBE CHECKER

Two new tube testers, designed for testing of radio, television, mobile transmitting, and industrial electron tubes, have been introduced by *Sylvania Electric Products Inc.* of 500 Fifth Avenue, New York 18, New York.

Available in either portable or bench

models, the tester features an exclusive ohmmeter-type shorts and leakage test which indicates "Replace" or "Good" directly on the instrument's illuminated meter, direct meter indication for all other tests, an easy-to-



operate gas test, and a combined emission and transconductance test under dynamic operating conditions which takes relative tube life into account.

Twelve sockets provide for testing 4, 5, 6, 7, 8, and 9-pin tubes, octal and lock-in, miniatures, subminiature, acorn and hearing aid types, mobile and ruggedized tubes, and pilot lamps. Facilities for unannounced tube types are also included. Control settings are shown on a smooth, fast-running roller chart which is easily removable from the front panel for adding new tube settings as announced.

The portable unit has been designated the Type 220 while the counter model is Type 219. Both have identical electrical characteristics.

POWER SUPPLIES

A new series of electronically regulated and stabilized power supplies, utilizing a new type of direct-coupled amplifier to control a pair of thyatron rectifier tubes, is now in production at *Amplifier Corp. of America*, 398-2 Broadway, New York 13, N. Y.

Two separate series of 250 watt (output power) supplies are available. The standard series is stabilized against line changes of 90 to 130 volts within ±.5% and load regulated within ±.5% from no load to full load. The super series with a more sensitive

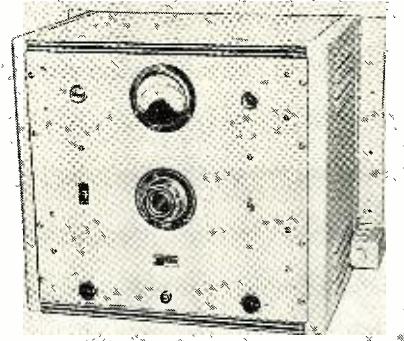

error control circuit is line stabilized and load regulated to well within ±.1%.

Units are available in each series in

GREATEST TELEVISION VALUES

FAMOUS PHILMORE Prices Slashed on these fine TV SETS and KITS

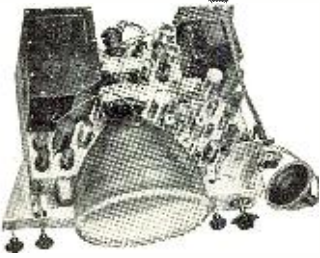

Finest 30-tube Television Receiver Similar to RCA Model 630TS with Automatic Gain Control, "Standard" tuner and many other new features.

BUILD YOUR OWN

Save by building your own TV set in only a few hours. The economical Philmore kits listed below include **ALL TUBES**, except picture tube.

MODEL KP-30D. Deluxe 16" 30-tube kit (including rectifiers, but less CRT). Tuner, video and sound channels completely wired and precisely pre-aligned at the factory, with all major components mounted, voltage doubler built-in. Includes 16" brackets, wood block and **ALL TUBES** except kinescope. NET.....\$149.50

MODEL KP-30. Deluxe 29-tube kit for 10" or 12 1/2" CRT. Same as Model KP-30D but without voltage doubler. With 10" or 12 1/2" brackets (please specify). NET.....\$139.50

MODEL UP-30D. Completely unassembled kit with voltage doubler, 16" brackets, wood block and **ALL TUBES**, except CRT. NET.....\$137.50

WIRED CHASSIS

FOR CUSTOM INSTALLATIONS USE THE BEST

Use Philmore **Factory-wired** chassis, ready to operate. **MODEL CP-30D.** 30-tube chassis for 16" CRT; this is the identical chassis used in the fine Commodore and Belvedere models below. Precision-built to laboratory standards. Design similar to RCA Model 630TS with latest improvements, including automatic gain control. Major components supplied by RCA. Voltage doubler provides 12,000 volts for clear, bright pictures on 16" CRT. Chassis completely wired and factory aligned. Includes 16" mounting bracket, wood block and **ALL TUBES**, except CRT. NET.....\$169.50

MODEL CP-30. 29-tube chassis for 10" or 12 1/2" CRT. Similar to above but less voltage doubler. Includes mounting bracket for 10" or 12 1/2" tube (please specify). Completely factory wired and aligned. With **ALL TUBES**, except picture tube. NET.....\$164.50

BEAUTIFUL 16" CONSOLE \$275.00

More power, longer range, sharper pictures with this powerful 30-tube RCA type TV receiver. Excellent fringe reception, steady, clear pictures. Picture tube is removable—no screws or bolts! These cabinet sets carry Philmore's famous CP-30D 30-tube chassis with AGC and new, improved built-in electronic antenna that really works! All parts and tubes carry standard 90-day warranty.



The **COMMODORE** Console in attractive mahogany. List, \$349.50. **COMPLETE DEALERS' NET**.....\$275.00
The **BELVEDERE** table model, in striking mahogany. List \$309.50. **DEALERS' NET**.....\$249.50

KOENIG "TELE-BEAMER" ROTATOR

With remote direction-indicator. The outstanding rotator for TV antennas and amateur beams up to 10 meters. Points antenna in exact direction for best reception. 1 RPM through 360° in either direction; electromagnetic brake stops antenna at point desired. Weatherproof cast-aluminum housing 3 1/2" x 4" sq., provided with universal clamp for mounting on any mast up to 2" dia. "Oilite" thrust bearings; operates from 115 volts 60 cycles. Shipping weight 10 lbs. NET PRICE, less 5-wire control cable.....\$26.43

5-wire **flat weatherproof plastic control cable**, 500-ft. spool.....\$15.00; per ft. \$0.04

TELESCOPIC TV TOWER built to withstand high winds and heavy ice; easily installed by one man; extends to 40 ft., collapses to 10 ft. Sections cannot pull apart. With heavy cast aluminum swivel base, 3 guy rings. EACH \$27.00.....LOTS OF 6, EACH \$25.50

ELECTRONIC SUPPLIES

May, 1950

RAD-EL-CO—OUTSTANDING VALUE IN TV ANTENNAS

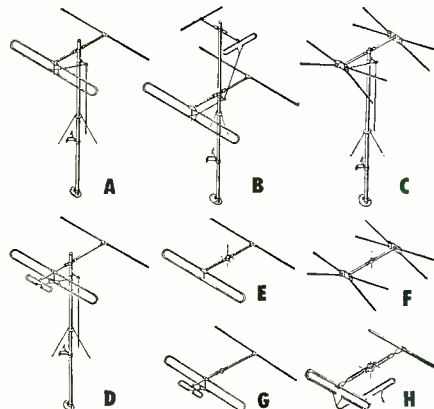

A.—RT-42 LOW BAND DIPOLE & REFLECTOR for channels 2 to 6. Complete with 8-ft. steel mast, guy washer, stand-off insulator and base, less lead-in. EACH.....\$5.26 FIVE EACH.....\$4.85

B.—RT-40 HI-LO DIPOLE REFLECTOR w/ separate bays. Complete w/accessories listed above. EACH.....\$6.44 FIVE EACH.....\$6.13

C.—RT-44 SIMPLEX DIPOLE & REFLECTOR. New conical all-channel suitable for fringe reception. Same accessories as RT-42. EACH.....\$6.73 FIVE EACH.....\$6.32

D.—RT-43 DUAL BAND DIPOLE-REFLECTOR. In-line type with special array to provide higher gain on all channels. Accessories same as RT-42. EACH.....\$6.14 FIVE EACH.....\$5.83

300-ohm lead-in, per 100 ft.....\$1.47

ARRAYS FOR STACKING

E.—RT-52 LOW BAND EACH.....\$3.50 FIVE AT.....\$3.35

F.—RT-54 SIMPLEX X TYPE EACH.....\$4.67 FIVE AT.....\$4.44

G.—RT-53 DUAL BAND EACH.....\$4.38 FIVE AT.....\$4.27

H.—RT-51 HIGH BAND EACH.....\$1.47 FIVE AT.....\$1.40

ME-48.—4-ft. steel mast extension.....\$0.73

"UNIMAC" CHIMNEY MOUNT

Requires use of only one bolt on each of two units to lock-clamp the steel strapping and take up slack. Only one wrench required to assemble; takes mast 3/4" to 1 1/4" dia; complete with 2 preassembled units, two 12-ft. bands and all hardware. Lots of 10.....\$2.20 SET.....\$2.40

JFD LIGHTNING ARRESTOR

For 300-ohm line; protects TV set against lightning; requires no wire stripping; easy to mount. #AT-102 for regular twin lead, #AT-103 for heavy or tubular twin-lead. List \$2.25. EITHER TYPE. PER DOZ.....\$14.70 EACH.....\$1.32

ALL-CHANNEL TV BOOSTERS

MASCO MODEL MTB-13X
Clearer, Sharper Reception... in weak signal areas. Extremely stable, with broad-band amplifier circuit boosting entire 6 mc band width of all TV channels. Broad and fine tuning. Shipping weight 8 lbs. NET.....\$17.64

STANDARD TV BOOSTER

The "Standard" pre-amp. made by mfr. of the famous "Standard" tuner, boosts signal 10 times or more; high signal-to-noise ratio. Printed circuit assures trouble-free operation. Turning off booster automatically turns off TV set. Continuous tuning eliminates switching from hi to lo channels. For 300 or 75 ohm line. NET.....\$17.61

NEW ANCHOR 2-STAGE BOOSTER

Almost twice the gain of single stage.....\$26.43

SAVE \$\$ ON STANDARD REPLACEMENT PARTS

HORIZONTAL DEFLECTION OUTPUT AND FLYPACK 500-volt transformer. Replaces RCA 211T1 or 211T3 for 10" or 12" tubes. NET.....\$2.95
FOCUS COIL, similar to RCA 202D1. SPECIAL. 1.69
DEFLECTION YOKE, RCA type 201D1 for use with tubes up to 16". LOW PRICE.....\$2.39
VERTICAL DEFLECTION OUTPUT, RCA 204T2. 1.95
VERTICAL BLOCKING OSCILLATOR, Potted replacement for RCA 208T2.....\$1.77
HORIZONTAL BLOCKING OSCILLATOR. Potted replacement for RCA 208T1.....\$ 2.16
POWER TRANSFORMER, replacement for RCA 201T6.....14.10

LOW COST GLARE FILTERS

Relieves eye strain, sharpens image, intensifies contrast. Optically correct. Available in either SMOKE or BLUE. (Please specify.)
7" rd. (Hallier's) \$1.49 12".....\$9.99
7" sq. \$1.49 13 1/2" Zenith.....1.15
10".....\$9.13 20".....2.09
10" amber (10" only) \$4.19.....2.19
11".....\$9.20.....3.95

TERMS: Money order or check with order; 25% deposit for C.O.D. Postage extra.

TV TEST EQUIPMENT SAVE 50% WITH EICO KITS AND INSTRUMENTS

New **push-pull** wide range 5" oscilloscope.

MODEL 425—Kit
Complete nothing \$3995
else to buy.....

MODEL 425 factory wired and tested.....\$69.95



SENSATIONAL SWEEP GENERATOR

500 KC to 228 MC: sweep width 0-30 MC, crystal marker.

EICO #360 Kit, less crystal.....\$2995



MODEL 360 factory wired and aligned.....\$39.95

VACUUM TUBE VOLTMETER

26 megohm input resistance AC-DC volts 0-5, 10, 100, 500, 1000; Resistance; 0-1000 ohms & 0-1, 10, 100, 1000 megohms.

EICO #221 Kit.....\$2395



Model 221 Factory wired & calibrated.....\$49.95
Hi-voltage probe #HVP-1 for #221.....6.95

ALL EICO EQUIPMENT IN STOCK For complete description see EICO ad page 6 this issue.

RADIO CITY PRODUCTS

HIGH QUALITY—LOW PRICE

TV-90 'SCOPE WITH BUILT-IN SWEEP GENERATOR ONLY \$12495



Oscilloscope has its own variable linear sweep. Sinusoidal sweep with phasing control for use with internal RF sweep generator when testing band pass characteristics. Synchronization provision for either internal positive, external or line frequency. External jack provided for trace blanking. Requires 10 volts of negative pulse to blank a normal intensity level trace. Independent sweep generator has a center frequency range of 1.5 to 45 megacycles giving a choice of any IF frequency desired. Band width can be varied continuously from 0.5 KC to 7 MC. Attenuation of RF is continuously variable from 10 to 500 millivolts and output is applied through low loss coaxial cable. Traveling detector probe is included for observing signal at any point of the RF circuit under test. 105-130 volts 50-60 cycles. Weight 25 lbs. Size 14x18x12 1/2 inches. Finished in attractive hammettone grey. Supplied complete with tubes, probe, coaxial output cable and operating instructions, ready to operate.....\$124.95



TV-50 MARKER ONLY \$4895

Designed for use in marking television sweep generators. The large planetary driven dial is calibrated to an accuracy of 1%. Uses 4 frequency bands covering frequency of 5 to 130 mc and 96 mc to 260 mc. A self contained crystal oscillator circuit is available for simultaneous marking or may be used alone with the variable frequency marker turned off. Due to the type of oscillator any crystal from 100 KC up, may be used in the crystal socket. An internal mixing arrangement is provided so that the output of a sweep generator may be connected to the TV 50 and the output lead will carry both the sweep frequency and the marker frequency.....\$48.95

Write for **FREE** catalog and flyers
219-R East 1st, TULSA 3, OKLA.

SOLVE your hi-fidelity problems with

University TWEETERS

WIDEST SELECTION • BEST VALUE • HIGHEST QUALITY

SINGLE UNIT TWEETERS

MODELS 4408, 4409—600 CYCLE TWEETERS: Recommended for highest quality reproduction systems requiring a low crossover frequency. Cobra shaped horn results in perfect wide angle distribution. Frequency response 600 to 15,000 cycles. Model 4408 handles 6 watts and 4409 25 watts.



MODEL 4407 ADAPTER MOUNTS 4401 TWEETER IN ANY 12" CONE UNIT: Converts any 12" cone speaker into a wide-range coaxial reproducer in a few minutes. Installation is extremely simple and results in a dual speaker occupying little more space than the original cone speaker. Complete with 4401 tweeter.



MODEL 4401—2000 CYCLE TWEETER: An economical 6 watt unit for converting any good 10-15" cone speaker for extended response to 15,000 cycles. Wide Angle horn. Compact design and low price bring excellent high fidelity well within the popular price range.



DUAL TWEETERS



MODEL 4402, MODEL 4404: Model 4402 reproduces to 15,000 cycles. Crossover at 2000 cps. Horizontal dispersion 100°, Vertical 50°. Handles 12 watts. Compact design mounts in any radio, phono, or speaker cabinet. Model 4404 incorporates 4402 tweeter in handsome walnut cabinet complete with high-pass filter and high frequency volume control. Any one can install.

CROSSOVER NETWORKS



MODEL 4405 HIGH PASS FILTER: An effective and economical unit for preventing lows reaching the tweeter unit. Contains high frequency control to balance highs and lows. Cutoff frequency 2000 cycles.



MODEL 4410, 4420 LC CROSSOVER NETWORK: Genuine LC frequency dividers for segregating highs and lows. Not to be confused with ordinary high-pass filters. Crossover frequencies: Model 4410 600 cycles, Model 4420 2000 cycles. Attenuator controls included and wired.

Write today for illustrated literature — address inquiries to Department A

University

LOUDSPEAKERS • INC

80 SO. KENSICO AV., WHITE PLAINS, N.Y.

the following voltages; 0 to 25 volts up to 10 amps; 0 to 50 volts up to 5 amps; 0 to 125 volts up to 2 amps; 0 to 250 volts at 1 amp; 0 to 500 volts at 500 ma. Each of the ten units has a continuously adjustable and smoothly controlled d.c. output to full voltage and current rating.

Full details are available from the company on request.

SUPERIOR'S TESTER

The Model TV-10 tube tester, which has been designed for checking AM, FM, and television tubes, is being marketed by *Superior Instruments Co.* of 227 Fulton Street, New York 7, New York.



The new unit uses self-cleaning lever action switches for individual element testing. Tubes having tapped filaments and filaments terminating in more than one pin can be tested because any of the pins may be placed in the neutral position when necessary.

Individual sockets are used for each type of tube, thus eliminating the customary practice of combination type sockets. The tester is housed in a hand-rubbed oak cabinet with a portable cover and measures 6" x 11½" x 12".

NEW V.T.V.M.

The *Hickok Electrical Instrument Company* of 10524 Dupont Avenue, Cleveland 8, Ohio has announced the availability of a new volt-ohm-capacity milliammeter, the Model 209-A, which has been designed especially to increase the speed and range in television servicing.

The new instrument measures any resistance, capacitance, voltage, or



current encountered in AM, FM, or TV receiver servicing. The unit features a 9" meter scale for easier readings of greater accuracy. The v.t.v.m. will measure resistance as low as 1/10 ohm and capacitance to 1μfd. It permits peak-to-peak voltage measurements and contains a zero-center d.c. scale for increased accuracy in FM and TV

servicing. The meter has a new a.c. range of 1200 volts and features flat frequency response to 300 mc.

Housed in a portable steel carrying case, the unit comes complete with low capacity, high frequency probes and all necessary test leads.

—30—

Within the Industry

(Continued from page 32)

of *RCA Victor* . . . **HARRY S. GOULD**, formerly merchandising executive for *The Magnavox Company*, has joined *John Meck Industries, Inc.*, as director of merchandising . . . **ERNIE KOHLER** has been added to the engineering-sales staff of the *Oak Mfg. Co.* of Chicago . . . **GERALD C. SCHULTZ** has been appointed chief electronics engineer for *Gibbs Manufacturing & Research Corporation*. He was formerly chief of the radar techniques unit at Air Materiel Command . . . The appointment of **GEORGE P. LOHMAN** as field sales representative of the *RCA Victor Home Instrument Department* in the northern part of the company's East Central Region has been recently announced . . . **CURTIS R. HAMMOND** is the new equipment sales manager of the Receiving Tube Division of *Raytheon Manufacturing Company* in Newton, Massachusetts . . . *Freed Radio Corporation* has named **JOSHUA SIEGER** to the post of vice-president in charge of engineering . . . **JOHN F. HERBST** has taken over the post of western regional manager for the receiver sales division of *Allen B. Du Mont Laboratories, Inc.* . . . **DR. ANTONIO R. RODRIGUEZ** now heads the new ceramic laboratory for *The Electrical Reactance Corporation* . . . **F. P. RICE** has been named executive assistant to the manager of the tube division of *Allen B. Du Mont Laboratories, Inc.*, while **JAY L. FISHER** has been named production control manager for the company's tube division . . . *Sentinel Radio Corp.* has named **DONALD G. HAINES** to the post of chief electrical engineer . . . *Hoffman Radio Corp.* of Los Angeles has named two new vice-presidents, **S. L. SPRAGGINS** to be in charge of plant operations, and **JOHN A. RANKIN** to serve as vice-president in charge of engineering . . . **HARRY SEELEN** is the new manager of the Lancaster Engineering Section of the *RCA Tube Department*. He succeeds Dr. Dayton Ulrey who retired recently.

* * *

MORHAN EXPORTING CORPORATION of 458 Broadway, New York, has been named export sales representative for *Pyramid Instrument Company*. The concern will handle all export work with the exception of Canada . . . **W. B. PRAY** has been appointed sales representative in the six New England states for *Operadio Manufacturing Company* of St. Charles, Ill. . . . **PATTERSON & COMPANY** of Dallas and **MURPHY & COTA** of Atlanta are han-

RADIO & TELEVISION NEWS



LIKE MAGIC! PLATT'S PULLING 'EM OUT OF HIS HAT!

Yes, month after month Platt comes up with the items you want at the prices you want to pay! But everything is moving FAST—so ORDER NOW to be sure you get what you want.
 YOU'RE INVITED TO VISIT PLATT'S NEW STORE AT
489 BROOME STREET, NEW YORK CITY

PLATT'S BARGAIN COUNTER

20 POUNDS OF ASSORTED RADIO PARTS



Transformers, Chokes, Wire, Condensers, Knobs, Sockets, Switches, Dynamotor.
ONLY \$2.39

100 ASSORTED RESISTORS

Non-insulated, various ohmages and wattages.



SPECIAL 97c



KIT OF 15 CONDENSERS

Bathtubs and Electrolytic.

NOW 98c

SELSYN INDICATOR

For use with beam antennas for indicating direction of antennas 1-82-B, 5" type.
NOW \$4.95



OIL FILLED CONDENSERS

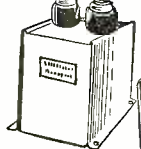

Famous Make TTH 50020, 2 MFD, 5000 VDC.....\$4.25
 Nationally Advertised, 2 MFD, 600 VDC......29
 Famous Makes, 4 MFD, 600 VDC......79
 Highest Quality 23F47, 2 MFD, 4000 VDC..... 3.25
 Highest Quality 25F47, Mu-f, 6000 VDC..... 1.95
 Highest Quality 30 Mu-f, 90 V, 3 phase, 60 cycles..... 1.19
 Mica Capacitor, type G1 ceramic, .01 1000 Volts, 25 amps at 1000 KCS..... 1.29
 Type DT-4W1, CAP. 1 MFD, 400 Volts, Tubular, Box of 25..... 2.98

MICROPHONES

T-24-G, 200 ohms, single button, 8 ft. rubber cord with PL-106 Plug and JK 38 Jack. BRAND NEW. \$1.95
 T-17-B, Hand-held carbon microphone for use in voice communication. Effectively covers the audio frequency range from 300 to 2600 CPS, 200 ohms, with press-to-talk switch, 5 ft. rubber cord and plug. NEW..... \$1.95
 T-30 Microphone suitable for aircraft use. Responds to frequencies in the range of 400 CPS to 2000 CPS. Complete with cord and plug. Original Packing. NEW..... 1.29
 T-36-C Hand Carbon Microphone, 24 ft. cord, 3 contact amphenol plug..... 2.95

TRANSMITTER-RECEIVER

Conversion of BC-645 Bringing Excellent Results.
 Navy Model ABA-1 (CG-43AAG)
 Army Model SCR-515A known as the BC-645
450 MC—15 Tubes
BRAND NEW—ORIGINAL CARTON. Can be easily converted for phone or CW 2-way communication. Covering for the following bands: 420-450 MC ham band, 450-480 MC for fixed or mobile, 480-470 MC for citizens, 470-500 MC television experimental. Size 10 1/2 x 13 1/2 x 4 1/2. Contains 15 tubes: 4-7F7, 4-7117, 2-7E6, 2-6F6, 2-955, 1-WE-316A door knob. Complete as shown above.....only \$17.95



BC-223 TRANSMITTER

30 Watt Transmitter with crystal or MO control on four pre-selected channels, 2000 to 5250 KC. by use of three plug-in coils. Five Tubes: 2-801 & 3-46. With TU-17-18-25 Tuning Units. Tubes and mount included. Specially Priced.
BRAND NEW.
 Only **\$25.95**

SPECIALS-OF-THE-MONTH CATHODE RAY TUBES

3CP1 59c
 801A 39c
 211 39c
 In lots of 10—10% off



TUBES Standard Brands. All New Tubes.

304TL\$1.95 832A\$4.89
 5BP4 2.45 725A 6.95
 872A 1.19 726A 13.95
 10Y39 726A 13.95
 4AP10 2.29 316A39
 7CP1 2.95 162539



RECONDITIONED SCR-522

With New Components Very High Frequency TRANSMITTER-RECEIVER 100-156MC, 4 Channels, Crystal-Controlled, Amplitude Modulated Voice. Electrically Tested.
Complete as shown
Only \$79.50

BEACON RECEIVER BC-1206-C

Manufactured by Satchell-Carlson
 Frequency Range—195 KC to 420 KC. IF Frequency—13.5 KC. Receiver Sensitivity—3 Microvolts for 10 Milliwatts output. Output Impedance—300 Ohms and 4000 Ohms to be selected internally. Power Output—230 Milliwatts. Volume Control—RF Gain Control, Power Supply—24-28 Volts Aeroplane battery. Current—75 Amperes.
BRAND NEW—ONLY \$6.95

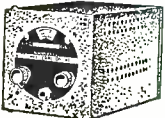

GN-45 HAND GENERATOR

6 Volts. 3 Amps
 500 Volts, 0.14 Amp
 Used with Signal Corps Radio Set SCR-284. Has many applications. Brand New. Original Packing.
ONLY \$12.95



FILTERS

FL5 Lazy Q Radio Filter Unit, high impedance, NEW.....\$0.75
 FL8 Filter. Good Condition..... 1.29

FIELD TELEPHONES

Army surplus, completely reconditioned and electrically tested. LIKE NEW.
 Only **\$8.95**



HEADSETS—Excellent Buys!

HS-33 with cord and plug, used, good condition.....\$1.19
 HS-23—Brand New with ear pads 2.75
 HS-33—Brand New with ear pads, cord and PL54 plug..... 2.75
 TH-37A—1200 ohms with dual plugs..... 2.95
 HS-16A—520 ohms 2.95



Minimum Order \$2.00

Immediate Delivery—Send 25% deposit on C.O.D. orders. All shipments F.O.B., N.Y.C. (N.Y.C. residents add sales tax to your remittance.)

DYNAMOTORS

Dynamotor for DY-12 Power Supply for ART-13 Only \$7.95
 Type DM-33-A, in. 28 V. out. 540 VDC, 250 millia. Brand New 1.95 (Excellent—Used \$1.25)
 Type DM-53-A, 24 V, in. 220 V, 80 MA out. Brand New 3.95
 INVERTER—PE-206, 28 V, in. 80 V at 500 VA, 800 cy. out. Brand New 4.95 (Used Excellent Condition) 3.25
 BD-77 NEW 5.95
 DM-32 USED 75
 PE-94C NEW 5.95
 PE-73C NEW 3.95



BC-348 Receiver—NEW\$165.00
 BC-224 Receiver—Excellent Condition 135.00
 BC-342 Receiver—Excellent Condition 135.00
 BC-221 Frequency Meter—Excellent Condition 79.50
 BC-939 Antenna Tuner for BC-610. NEW... 75.00
 SCR-694 and SCR-284. Complete. New Conditioned. Prices Sent Upon Request.
 MN-26C Compass Receiver. NEW 29.50
 433G Compass Receiver—Excellent Condition 39.50
 ARNT Compass Receiver—Excellent Condition 49.50
 733D Localizer Receiver—NEW 8.95

274-N COMMAND EQUIPMENT

Sensational Buys! BRAND NEW USED \$ 2.75
 BC-442 1.85
 BC-450, 3 Receiver Remote Control .89 1.95
 BC-453 12.95 21.95
 BC-454 4.95 6.95
 BC-455 6.95 2.95
 BC-456 1.95 2.95
 BC-457 5.95 7.95
 BC-458 5.95 24.95
 BC-459 14.95 24.95
 BC-636 14.95 24.95
 3 Receiver Rack 1.50
 2 Transmitter Rack 1.50



TYPE MN-20E ROTATABLE LOOP UNIT

8" diameter, used with MN-26 Compass and RA 10DB. Manufactured by Bendix.
A TERRIFIC BUY! ONLY \$11.95



Multitester Foundation BIAS METER 1-97A

Contains a zero center 3 1/2" round Marlow voltmeter, calibrated 0-100 volts each side. Movement is one mill each side of center. The unit is mounted in a steel box 7" x 5" x 4 1/2" and contains 3 contact push buttons, line cord dual 100 MFD at 200 V DC condenser, a potentiometer 6 1/2 RC 1% wire wound non-inductive resistors; one 400 ohm, two 2500 ohm, one 5000 ohm, one 10,000 ohm, one 15,000 ohm.
 Excellent for building a zero center multitester with ranges of 1, 10, 100, 1000 volt.
COMPLETE BRAND NEW \$3.95



BC-645 ANTENNA.....only 39c

BC-645 TRANSMITTER-RECEIVER ONLY. Brand New. ORIGINAL PACKING. Special **\$12.95**

CORDS AND PLUGS

CD 508A Cord Assembly with SW 14-U Switch and 2 cord attachments with JK 48 Jack and PL 6S Plug. Value—\$5.00. Our Special Low Price, Brand New59c
 CD 307A with PL 55 and JK New59c
 JK 26 Jack with cord, good condition..... 12c
 JK 26 Jack only—Brand New..... 8c
 PL 55 Plug—NEW 35c
 PL 68 Plug—NEW 15c



PLATT ELECTRONICS CORP.

DEPT. A, 489 BROOME ST., NEW YORK 13, N. Y.
 PHONES: RE 2-8177 and WO 4-2915

INTRODUCING the
SUCCESSOR to the
famous S-10-A

POCKETSCOPE®

NEW IMPROVEMENTS
AND FEATURES

Especially Designed For

TELEVISION
SERVICEMEN

MODEL
S-10-B



So Portable!

So Functional! \$69⁰⁰

So Accurate!

So Dependable!

Here's the serviceman's
dream of a pocket-size gen-
eral purpose oscilloscope for
television servicing! Weighs
only 5¾ pounds . . . rugged
. . . compact! Its amazing
performance makes it a must
on every service call . . .

Linear sweep from 10 cycles to 50 kc
. . . Response of vertical and hori-
zontal amplifiers within 0 to -2 dB
from 20 cycles to 150 kc—effective
even higher than 350 kc . . . Intensity
jack provides for modulating beam
so video observations can be made
on screen . . . Self-calibration with
test signal . . . Independent position-
ing and amplification in both vertical
and horizontal channels.

POCKETSCOPE

The Ideal General-Utility Oscilloscope!®

Magnetically shielded cathode ray tube
. . . telescoping light-shield . . . wide angle
vision . . . functional controls and terminals.

WATERMAN PRODUCTS CO., INC.
PHILADELPHIA 25, PA.

MANUFACTURERS OF POCKETSCOPES
RAKSCOPES . . . D.C. AMPLIFIER
RAYONIC TUBES AND OTHER ELEC-
TRONIC TECHNICAL EQUIPMENT

ding the *Alprocco, Inc.*, line of alumi-
num towers in their respective areas
. . . *The Circle "X" Antenna Corpora-
tion* has named **HARRISON-REYNOLDS
COMPANY** of Newton, Massachusetts,
and **ROBERT MILSK** of Detroit to rep-
resent the company in those territories
. . . **BRUNO NEW YORK, INC.**, has been
appointed distributor for *Jerrold Elec-
tronics Corporation's* line of multiple
television antenna systems . . . The
New York City, Long Island and
Northern New Jersey territory will
be covered by **BEN JOSEPH** on behalf
of *La Pointe-Plascomold Corporation's*
"Vee-D-X" antenna line . . . **JACK C.
GARDNER** is the new district merchan-
diser for *Bendix* receivers in the
Maryland and southern Delaware area
. . . **JACK WEBER ASSOCIATES** will
cover the parts jobber accounts in
New York State, New Jersey, Eastern
Pennsylvania, Delaware, Maryland,
and Washington, D. C. for *Odegaard
Manufacturing Company*, producers
of standoff insulators for TV installa-
tions . . . *Starrett Television Corp.*
has appointed **JOEL B. GOODMAN** to
act as its sales representative in West-
chester and Putnam counties, New
York . . . **NICHOLAS J. LAUB** is the
new sales representative for *Oxford
Electric Corporation* in the North and
South Dakota and Minnesota terri-
tories . . . **LEONARD D. ALLEN, INC.**,
will handle the test equipment and
transformer line of *Freed Transform-
er Company, Inc.*, in the New York
State area.

* * *

ROGER BOWEN, formerly associated
with the U.S. Signal Corps, has been
named to head the
engineering depart-
ment of *Cannon
Electric Develop-
ment Company* of
Los Angeles.



During the war
Mr. Bowen special-
ized in radar and
general electronic
equipment, serving for awhile in Eng-
land and later at Red Bank, New Jer-
sey where he was in charge of stand-
ardization of all electro-mechanical
devices. After the end of the war he
joined the Signal Corps at Ft. Mon-
mouth where he headed the electronic
component research and development
division.

D. Frank Jackson who has been act-
ing chief engineer of the company will
continue as chief assistant to Mr.
Bowen.

* * *

FRED ELLINGER, who heads his own
firm in the Chicago area, recently
rounded out a quarter of a century
as a sales representative, handling the
lines of several well-known companies
in the component field.

Mr. Ellinger entered the field in
1925 as an original partner in the *R. F.
Sparrow Company* and later, in 1933,
organized the *Ellinger Sales Company*.
He has been active in "The Representa-
tives" of Radio Parts Manufacturers,
Inc., and has served both as president

and chairman of the organization. He
still serves on the board of governors
of "The Reps."

* * *

"THE REPRESENTATIVES" of Radio Parts
Manufacturers, Inc.'s New England
Chapter recently elected officers for
1950.

Arthur E. Akeroyd was named pres-
ident of the group with Walter T.
Hannigan serving as vice-president.
Robert A. Waters is the new secre-
tary-treasurer.

In addition to the officers, chapter
members named three delegates and
alternates to attend the annual con-
vention of the association to be held
May 22nd in Chicago in conjunction
with the Radio Parts Show. Mr. Ack-
eroyd, Mr. Hannigan and former chap-
ter president Glenn M. Hathaway will
represent the New England Chapter
with Henry Lavin, W. B. Pray, and
Henry P. Segal acting as alternates.

-50-

George Sterling

(Continued from page 58)

cuits scheduled for inclusion. I wanted
to be sure what I wrote was correct
by personal check. My 'Radio Manual'
had to be right!"

One of his first jobs at this time was
to track down unlicensed radio trans-
mitters used by gamblers to flash race
results. Stations were concealed in
buildings close to race tracks and the
gamblers used high-powered glasses to
observe race results which they re-
ported by illegal radio. An automobile
was fitted as a mobile detection and
direction finding station. This and
other measures soon made beating the
races this way a hazardous gamble
and the scientific pony players turned
to personal sets that could be hidden
on the body of a watcher at the track.
Sterling promptly worked out his own
"Dick Tracy" miniature detector
which could be secreted in the hand.
With this he could walk up to a peram-
bulating radio bookie and give him the
legal tap on the shoulder that said,
"Stop violating radio laws!"

In 1935 he was appointed Inspector
in Charge of the 3rd Radio District,
and shortly after was called to the
main FCC office in Washington, D. C.,
where in June, 1937, he was appointed
Assistant Chief of the Field Division,
Engineering Department. With the
need to observe clandestine radio op-
erations becoming of the utmost im-
portance, he was made Chief of the
newly-created National Defense Op-
erations Section, Field Division, on
July 1, 1940, and given a sum of
\$1,500,000 to organize and commence
operations.

Immediately after Pearl Harbor,
wartime protection of our country's
interests started with the location and
suppression of a trans-Atlantic trans-
mitter which commenced operation in
the German Embassy in Washington.
This station was pin-pointed within

RADIO & TELEVISION NEWS



ORDER from ARROW!

TEN TUBE SUPERHET RECEIVER

with crystal controlled local oscillator. Has provisions for six crystal channels between 108 to 112 MCPS complete with tubes and crystals but less dynamotor.

Like New **\$7.95**
Less Tubes and dynamotor but New **\$3.95**

RECEIVER—Easily Converted for Use in Citizens Band
Crystal Controlled Local Oscillator. Broad Band Pass—20.7 MC IF's. Complete with 7-6AJS, 1—12SR7, 2—12SN7, 1—28D7, relays, crystals. Schematic furnished. **NEW \$7.95**

Westinghouse Auxiliary Relay Type MC

Style 423396 C—110 V 60 cycle 4 pole.
Enclosed in glass case. **New \$7.50**

HERMETICALLY SEALED CHOKES

10 H. 100 M.A.59c 3.7 H. 145 M.A.59c
59 H. 100 M.A.95c 10 H. 20 M.A.39c
5x.5x1x1 H—4 winding layer wound.
S H at 3.56 A 140 ohms
I H at 1.56 A 320 ohms. **New \$0.49**

BC-605 Interphone Amplifier

Easily converted to an ideal intercommunication set for office—home—or factory.

Original—New. **\$4.95**

Like **3.95**

New. **3.95**
(With Schematic)



All necessary parts and instructions to convert the above to AC operation with one remote station \$8.25 additional.

BC-604 Transmitter FM 20-28 MC

11 and 15 meters. Can be operated on 10 meters—10 channel push button crystal. With all tubes and meter but less dynamotor. Excellent Condition. **\$12.95**

Crystals. **14.95**

Set of 80.
BC-603—Companion receiver to above with tubes but less dynamotor. **Used \$17.50**

DYNAMOTORS

DM-28—For BC-348 with Mount and Filter. **New \$6.95**
Used **3.95**
DY-12—For ART-13 less filter and base. **New 6.95**
Used **.95**
DM-36. **New 1.95**
Used **.95**
BD-77. **New 5.95**
PE-206. **New 6.95**
Used **2.75**
PE-101. **New 2.75**
PE-73. **New 3.95**
DM-53. **New 3.95**
Used **.95** (3 for **\$2.00**)
DM-32. **New 1.95**
Used **.95** (3 for **\$2.00**)

BEAM INDICATORS

I 82—5". **New \$4.95**
Transmitter Selsyn for above. **2.45**
both for **7.00**
I 81—3". **New 3.45**
Transmitter Selsyn for above. **2.45**
both for **5.25**
I 81. **Used 2.45**

T-85/APTS UHF TRANSMITTER

operating over a frequency range of 300 to 1400 MCPC with a nominal output of from 10 to 30 watts. Unit is equipped with 110 V 60 CPS filament transformer; blower; lecher wire test frequency set, and 8 tubes—1-931A; 2-6AC7; 2-6AG7; 1-6L6G; 2-829B; 1-3C22 (GLS22) (oscillator).

New in original box with Operating Instruction Manual. **\$69.50**

All shipments FOB Chicago. 20% Deposit required on all orders. Minimum order accepted—\$5.00. Illinois residents, please add regular sales tax to your remittance.

TUBES

Drastically Reduced from 10 to 50%
Nationally Advertised Brands

Type	Net Price	Type	Net Price	Type	Net Price	Type	Net Price	Type	Net Price
1A4P.	\$0.24	6FP7.	\$0.95	7C4/1203A	\$0.24	304TL.	\$1.29	837.	\$1.49
1A6.	.19	6J23.	5.95	7E5/1201.	.39	32L7GT.	.39	841.	.29
1B5/25S.	.24	5T4.	.49	10YVT25A.	.19	33.	.24	864.	.29
1B22.	1.49	5W4.	.49	12A6.	.34	34.	.24	872A.	.98
1B26.	2.29	5Z4.	.49	12A6GT.	.34	35/51.	.24	954.	.19
1B29.	.39	6A8T.	.49	12A7.	.34	36.	.24	955.	.34
1B32-632A.	2.29	6AJS.	.89	12A8GT.	.34	37.	.24	957.	.34
1C6.	.19	6B8.	.59	12F5GT.	.29	38.	.24	1625.	.19
1C7G.	.19	6C4.	.29	12H6.	.29	39/44.	.24	1626.	.24
1D5GP.	.24	6D8G.	.59	12J5GT.	.24	49.	.39	1629.	.24
1D7G.	.19	6F6GT.	.39	12J7GT.	.24	50.	.39	1630.	.29
1F4.	.24	6F6G.	.59	12K5GT.	.24	56.	.24	1636.	2.95
1F5G.	.24	6H6.	.29	12Q7GT.	.24	57.	.24	1638.	.59
1H4G.	.24	6J7GT.	.39	12SF5.	.24	76.	.24	1642.	.29
1J6G.	.24	6K6G.	.59	12SF5GT.	.24	77.	.24	2050.	.89
1J6GT.	.24	6L5G.	.39	12SF7.	.24	211/Vt4L.	.29	2051.	.49
1P5GT.	.24	6L7G.	.39	12SH7.	.24	316A.	.34	7193.	.19
1V.	.24	6RT.	.34	12SRT.	.24	371B.	.34	9002.	.34
2A6.	.39	6SFGT.	.39	12T3.	.29	700A.	7.95	9003.	.39
2A7.	.39	6S7G.	.39	12SN7GT.	.89	703A.	1.49	9006.	.29
2C26A.	.19	6S8GT.	.59	12Z3.	.29	705A.	.79	GL4A21.	.29
2V3G.	.49	6SCT.	.59	15R.	.19	714Y.	5.95	Amperite	
2X2/879.	.26	6SF7.	.39	19.	.59	724B.	4.95	10T1.	.29
3FP7.	.98	6SJT.	.69	2J22.	.24	801A.	.39	Jan CRP72.	.98
4AP10.	.98	6T7G.	.39	2B7.	.34	813.	5.95	RE136.	.39
5BP4.	2.95	6U7G.	.39	30SPEEC.		829.	6.95	VR150.	.39
6CP1.	2.95	6Z7G.	.39	(Vt67).	.69	832.	4.95	VR105.	.69
6D21.	9.95	6ZY6G.	.29	30.	.24				

WRITE FOR QUANTITY PRICES

Miscellaneous SPECIALS

	Used	New		Used	New
ID 6/APN 4 Scope, Excellent	\$29.50		A 27 Phantom Antenna		\$0.98
R 7/APS 2 Receiver-Indicator		\$79.50	APS 13 UHF Antenna, Pair		.98
R 78/APS-15 Receiver-Indicator			Manual for BC 312 & 342 J		1.00
BC 1287 A Scope	34.50		Manual for SCR 269 G		2.50
ASE 7 Indicator Scope	75.00		FL 8 Filter	\$2.95	
SCR 522 Transceiver 100 to 150 MC	12.95		I-97 Bias Meter		4.95 3.95
BC 1206 Receiver, 200 to 400 KC	34.95	75.00	RM 25 Remote Telephone Control		7.95 9.95
MN 26 C or V Receiver	3.95	5.95	BC 602 Control Box		.98
RA 10 DA Receiver	17.50	24.95	One Tube Interphone Amplifier—Small compact aluminum case fully enclosed. 2 1/2"x3 3/4"x5 3/4". Less Tube.		.79c
R26/APT2 Transmitter	17.50	24.95	BC 717 Transmitter, New but less Tubes.		\$24.50
RT7/APN1 Transceiver	8.95	9.95	96Q1 Complete Autotune assembly with motor and frame as used in ARC-1 Transmitter.		New \$35.00
APN 1 Complete	5.95	24.50	BC 709 Battery operated lightweight interphone amplifier. Complete with tube and shock mount, but less battery New		\$3.95
BD 71 6 Pos. Switchboard	9.95	12.95	SCR 183 Complete		New \$49.50
EE 8 Field Phones	7.95		Motor—Universal Electric, 24 VDC, will also operate on 24 VAC Diameter 1 1/2"; Length 2 1/2". Shaft 1/4"x3/4".		New \$1.49
BC 347 Interphone Amplifier	2.95		BC 1291—Control box contains motor rheostat control rated 10 ohms at 3.88 amps. Brand new with cord and plug-in ventilated, mounted case.		\$1.95
I-70 Tuning Meter	.89		MC 385A—Headset Adapter		New \$0.49
AM 61 Indicator Amplifier	9.50		Information and Prices on Request		
SCR 625 Mine Detector	39.50		BC 639 Receiver with RA 42 Rectifier		
PE 237 Power Supply	12.95		RTA 1B Transceiver		
BC 461 Veeder Root Counter	.59		TA 2J24 Transmitter and MP 10G Power Pack		
BC 442 Less Condenser	1.49	1.95	SCR 269 Compass Installation		
BC 746—Bantam one watt foundation (See QST Jan. 1948). Contains 2 crystals, coil, tuning condensers, etc. Numbers 1-7-10-11-12-13-76. Each.		\$0.95	R 5/ARN 7 Compass Installation		
			MN 26 Compass Installation		
			I. L. S. Installation (R 89-BC733)		
			SCR 584 Components		
			R-132/TPS 10 Radar Receiver		
			MD-22-URA/T1 Radar Modulator		
			AN APRI Receiver and Tuning Units		
			ASE7 Complete Radar Installation		
			TS-251 Test Set		
			BC 221 Freq. Meter		

SURPRISE PACKAGE

20 lbs.; Ass't radio parts; A \$25.00 value for only **\$1.95**

BC 620

Receiver-Transmitter—2 crystal channels—20 to 27.8 MC FM—13 tubes. Metered. Plate and Filament. **New \$14.95**

Used **9.95**
PE 97 Power Supply for above 6-12 volt vibrator type.

Used—complete. **\$6.95**
Used less tubes, vib. & cond. **2.95**
FT 250 Mount for both BC 620 and PE 97 New **\$1.50**

BC 223

Brand new Transmitter with all three tuning units, two tuning unit cases, spare tube carrying case, shock mount and brace; but less tubes at new low price of **\$19.95**

Set of 5 tubes. **New \$3.95**
Tuning units are available separately at . Ea. **\$2.50**
Cases at . Ea. **.95**

PE 125—12-volt Vibrator Pack. **New \$12.95**
Used **8.95**
Spare parts kit for PE 125 containing 2 tubes; 2 vibrators and 13 fuses in metal container with handle and clasp (BX 41). **New \$2.95**

Send for free 8-page illustrated BULLETIN No. 103 listing many exceptional values

ARROW SALES, Inc.

Dept. N
1712-14 S. Michigan Ave., Chicago 16, Ill.
PHONE: HARRISON 7-9374

COMMAND (SCR 274N) EQUIPMENT

	Used	New
BC-453	\$12.95	
BC-454	4.95	\$6.95
BC-455	7.95	9.95
BC-456	1.95	2.95
BC-457	5.95	
BC-458	5.95	8.95
BC-459 (or T22)	9.95	
BC-698 (or T19)	14.95	24.95
BC-450—3 Receiver Remote Control	.89	1.95
BC-442		2.95
3 Receiver Rack	1.95	
2 Transmitter Rack	1.50	
Complete Command set as removed from aircraft—3 receivers—2 transmitters—Relay unit—control boxes—mounting racks—plugs—modulator and dynamotors—crated. Set		\$34.50

HEADSETS—MIKES

HS-23 Hi Imp Headsets	New \$2.95
HS-33 Lo Imp. Headsets	New 2.95
HS-30 Hi Imp. Headsets	New 1.50
	Used .79
T-17D Carbon Mike	New 2.75
T-24 Hi Imp. Carbon Mike	New 1.19
T-30 Throat Mike	New .98
T-45 (or Navy) Lip Mike	New .98
CD-307 Extension Cord for Headsets	New .59

CODERS

	Each
2 mfd. 4000 VDC. OIL FILLED	\$2.95
	4 for 10.00
1 mfd. 6000 VDC. OIL FILLED	1.98
.25 mfd. 15000 VDC. OIL FILLED	4.95
.00025 mfd. 25000 VDC. OIL FILLED	2.95
.4 mfd. 1500 VDC. OIL FILLED	.29
	10 for 2.49
2 mfd. 600 VDC. OIL FILLED	.39
	3 for 1.00
1 mfd. 600 VDC. OIL FILLED	.24
	5 for 1.00
.1x.1x1—1200 VDC. OIL FILLED	.59
	2 for 1.00
50 mmfd—5KV—5 Amp. Vacuum Cond.	1.19

IN DETROIT IT'S AARON

BC-348 RECEIVER—used but in good condition—less tubes. Will supply tubes at cost.	\$49.95
SCR-522 TRANS/CEIVER—used—less tubes.	29.95
T-26/APT-2 RADAR SET—115V 110 Phase—400-2600 cycle & 26 VDC—680-day-44—contains following tubes:—(2) 5R4 (2) 6AC7 (1) 2X2 (1) 807 (1) 6AC7. New with new motor.	14.95
I-198-A SIGNAL GENERATOR—6-15 MC—New.	19.95
ARK OR BC-966-A IFF RCVR. & XMTR.—with 14 tubes & dynamotor—practically new—never been used.	5.95
(DYNAMOTOR same as 4 speed being advertised for \$5.95—we give you 10 tubes & other useful items for the same price).	
R-1/ARR-1 HOMING RCVR.—Jan. 48 RADIO NEWS tells how to convert this rcvr. to HI-Freq. for use with your present rcvr.—never been used—has 4 acorn tubes—12 or 24 VDC operation.	5.95
MINNEAPOLIS HONEYWELL AMPLIFIER—contains following tubes:—(2)7C5 (1)7F7 (1)7Y4—1—1 MFD 1000 VDC cond.—7 resistors—2 tubes & fuse holders—other parts.	1.95
BC-1141 AMPLIFIER—used with BC-625 Mine-Detector new with following tubes:—(2)1N5 (1)1G5.	5.95
SERVO AMPLIFIER—new—less tubes—contains 18 can cond.—xfrms.—8 sockets—4 neon sockets—8 relays—chokes—other parts.	3.95
REMOTE INDICATOR BC-1153-A—with 5PP7 CR tube.	5.95
BC-741-A Indicator—Contains (2)6AC7 (1)6SN7 (1)6L6 (1)2X2 (1)6R18 (1)97 neon lights—numerous amounts of other misc. parts—have been exposed to weather but can be cleaned up.	19.95
RADAR INDICATOR BC-704-A—from Radar SCR-521 (ASB) with 7 tubes less 9" CR tube & shield—makes a beautiful 30" x 11" x 10" wood chest.	9.95
R-29/APB-2C—37 tubes—including (1) 5PP7 (1) 2AP1 CR tube—with blower motor.	39.95
RADIO MODULATOR BC-188-A—contains Weston 2506 200 MA DC meter—used with BC-187.	4.95
ATB RADIO XMTR. CRV-52233—new in cartons—with dual plug in tuning units for 3.0-9.05 MC—contains following tubes:—(1)6Z5 (1)6X5 (1)6X4 (1)6X3 (1)6X2 (1)6X1 (1)6X0.	29.95
ALTIMETER RT/APN-1-430 MC Rev.—contains 14 tubes—3 1 meg. resistors—4 neon sockets—motor numerous other valuable parts—new.	7.95
BC-645 Trans/ceiver—430-500 MC can be converted to Citizens & Ham bands—new in cartons.	12.95
BC-646 CONTROL BOX for BC-645. New.	1.00
BC-732 LOCALIZER—108-110 MC—8 tubes—10 crystals. New in cartons.	6.95
DM-53-A DYNAMOTOR—used with BC-733.	1.59
AN/CRM-2 VHF RCVR.—contains the following:—(1)6SN7 (1)6J5 (1)6SC7 (3)6SL7—dynamotor—numerous amount of resistors & cond.	5.95
BC-229 RECEIVER—used with tubes.	7.95
BC-40 XMTR.—used with tubes.	7.95
C-439 COIL UNIT for BC-229—(201-398 KC & 2300-4700 KC). New.69
VIBRATOR POWER SUPPLY PE-157-B—Contains (1) 2 V vibrator & (1) 8 V vibrator (2) rectifiers (1) 4" spoke coil for.	7.95
MAINTENANCE KITS FOR BC-348—H-N-O or R Revers. New in original boxes.	1.00
RESISTOR & CONDENSER KITS—contains 43 resistors—various ohmage & wattage values—20 cond. mica, ceramic and oil filled. New.	2.95
VOLUME CONTROL KITS—contains 10 controls—from 2000 to 250,000 ohms—2 W. New.	2.95
COIL SET & CRYSTALS for RX-TX BC-721-B—on freq. of 5500 KC (5500 & 5955 xtals. ant. & lead coils).79
FILTER COND.—30-15-15-40 MFD @ 450-450-350-25 VDC New.59
COIL ASSY BOX—contains variable & fixed cond.—choke—resistors—coils—out of BC-312 Rcvr. New.	1.75
BUTTERFLY COND.—With 1/2" plated loop attached—approx. 1" x 1" x 1". New.38
STANDARD BROADCAST TUNING CONDENSER—365 MMFD RC—270 MMFD Osc.69
5 GANG TUNING COND.—40 MFD for sec. 2 to 1 gear reduction. New.	1.95
CERAMIC COIL FORM & TUNING SLUG—2 1/2" long x 3/8" dia. New 250.	1.00
CERAMIC COIL FORMS—2" dia.—7 1/4" L. 4 1/2" L. or 2 1/2" L.50
30 MC SLUG TUNED IF COIL. New.25
RADIO FILTERS FL-8 or FL-5.97

274-N COMMAND EQUIPMENT

BC-442 with 50 MMFD vacuum conds & O-1 ma Thermocouple R.F. meter.	\$ 2.25
BC-453 Receiver—used but in good cond.	12.95
BC-454 Receiver—used but in good cond.	6.95
BC-456 Modulator. Used \$1.95.	2.50
BC-457 Transmitter. Used	6.95
BC-458 Transmitter. Used	6.95
BC-459 Transmitter. New in cartons.	17.95
BC-696 Transmitter. New in cartons.	24.00
MC-215 Control Cable. 7' long.	1.25
DM-33-A Dynamotor for BC-456.	1.00
BC-450-A Control Box for receivers.	1.50
EXTENSION CORD CD-307—New—with PL-55 & PL-26 plugs. 8 ft.	3/1.00
VT-127 Ceramic Tube sockets.	3/1.00
J-38 BREAK-IN-TELEPHONE KEY—on plastic base—4 3/4" x 3"—has binding post—circuit closing switch—1/16" silver keying contacts etc.39
CX-496-TFS-2 CORD—with AN-3052-10 & AN-3108-20-4P amphenol plugs & connectors. New.50
HONE & WHETSTONE—for shops—fishing—tuning—(handle is cork burnisher) 4" x 1 1/2" x 2 1/2" for 25c.85
24 VDC BELLS—New—use for alarm systems.75
3 SECTION CERAMIC WAFER SWITCH. New—multi-contact—5 position.69
STATIC PRESSURE SELECTOR VALVE SWITCH—Aircraft type. Part #AN5831-1. New.	1.25
DYNAMIC MIKE & HEADSETS—Mark 2-19. New REVERSIBLE MOTOR—Bendix MO-5-B—38 VAC. DC—7000 RPM—approx. 1" dia. x 2 1/2" long.	2.25
ELECTRIC MOTOR CORP.—Type 1—6 VDC with worm gear.	1.95
24 VAC-DC REVERSIBLE MOTOR—40 lbs. torque—1.4 amps. RPM.	6.95
PERMANENT MAGNETIC MOTOR.	3.75
24 VDC SWITCHING MOTOR—simple conversion to 115 VAC-DC—CONVERSION DATA INCLUDED—New.	2.95
DUNMORE SERIES WOUND MOTOR—Intervalometer Type B—4-Gear Rat.	3.95
WE Buy, Sell & Trade any quantity of new or used electronic equipment.	
All items USED, unless otherwise stated. Michigan residents please add 3c tax. 25% with order, balance including postage C.O.D.	

AARON ELECTRONIC SALES
3400 CHEMIE, DETROIT 7, MICHIGAN • LDRAIN 8-9966

hours after its first attempts to contact Germany. It was actually closed down before it had succeeded in establishing the desired contact!

The increasing size and importance of this work resulted in his promotion to Assistant Chief Engineer and Chief, Radio Intelligence Division, on June 1, 1942. On December 19, 1945, he was made Assistant Chief Engineer in Charge of Field and Research Branch; and on May 1, 1947, he was promoted to Chief Engineer of the Commission.

He is probably proudest of his work as organizer and wartime head of RID. Testifying as head of RID before a Congressional Committee in 1944, he said, "I readily admit that this country has been practically free of espionage radio activity and I am extremely proud of that fact. . . . The success of RID, like the success of any police organization, is properly measured, not by the amount of crime which is detected, but rather by the organization's success in preventing illegal conduct and maintaining order." The final score: no enemy spy ever successfully established clandestine radio operations from the U.S.!

George Sterling today is still an active ham operating as W3DF. He has two transmitters, a 600 watt phone rig for 75, 20, and 10 meters and a 400 watt c.w. rig, mostly on 40. Receivers are an SX-42 and an SX-71. Separate dipoles are used on each band, with a three element rotary beam for 10.

The family car includes a ten meter ham rig; it also carries a v.h.f. job on 152.03 mc. used under the "Common Carrier Service."

He also has such things as a 16 inch TV set for family use (FCC Commissioners are not permitted to touch its insides); a 10 inch TV set with a jury-rigged color adaptor; a commercial color receiver on temporary loan for test by the Commissioner and his friends, non-technical as well as technical; a basement workshop which he uses as much as a hurried, crowded official life will permit; and the walls of his ham-shack den are covered with photographs, diplomas, QSL cards and other mementos of a long association with the radio industry.

Commissioner Sterling is the author of the well-known and authoritative "Radio Manual," a text and reference work for radio operators, engineers, and amateurs. First published in 1928, it has been kept up-to-date and the postwar edition has just become available.

Sterling is also a Fellow of the Institute of Radio Engineers and on the Board of Directors of the Veteran Wireless Operator's Association. The Marconi Medal for Public Service was recently awarded by the VWOA. He enjoys attending on-the-air meetings of the Old Old Timer's Club, an amateur organization whose members must have been hams at least forty years ago and must refer to "wireless" instead of "radio" or "electronics" in their sessions. He is an honorary member of the Baltimore Amateur Communications Society; and the Quarter

BARBER-COLMAN CONTROL MOTOR

TYPE AYLC 5091



24 Volts D.C. .7 Amp. 1 R.P.M., Torque 500 in. lbs. Contains two adjustable limit switches with contacts for position indication. Ideal for use as a remote positioner or beam or television antenna rotator. Will operate on 60 Cy. **\$6.50** Ea. Net. Complete with instructions.

GENERAL ELECTRIC SELSYN

Type 2J1G1

Will operate from 110 volts, 60 cycle by using a resistor or a condenser in series. Size is 2 1/4" in diameter x 4 3/8" long. Ideal for beam antenna position indicator.



Price **\$2.75** per pair — removed from new equipment

INSTRUMENT ASSOCIATES
37 EAST BAY VIEW AVE.
GREAT NECK, N. Y.
IMperial 7-1147

Be Sure...
Rely on these
ERIE RESISTOR
components



Watch for
ERIE CERAMICON listings
in Howard W. Sams
Photofact Folders

Electronics Division
ERIE RESISTOR CORP., ERIE, PA.
LONDON, ENGLAND TORONTO, CANADA

Century Wireless Association of New York; the Chicagoland Mobile Club; and the Puerto Rico Amateur Radio Club.

As Chief Engineer of FCC, he participated in preparatory work and assisted at the Atlantic City Telecommunications Conference of 1947. In late 1947, he was Chairman of the Broadcast Engineering Conference under the North American Regional Broadcasting Agreement (NARBA), a most vital safeguard to American broadcasters. Commissioner Sterling was co-chairman of the U.S. delegation at the 1948-49 Mexico City International Short Wave Broadcasting Conference, which worked out the Mexican Plan for high-frequency broadcasting.

Queried as to the future prospects of Amateur Radio in the face of tremendous competition for all available frequencies, he made this statement for RADIO & TELEVISION NEWS' amateur readers:

"There are not enough channels altogether to satisfy more than a small part of the demand. This is particularly true in the high frequency region, which includes the 3.5, 7, 14, and the proposed 21 mc. ham bands. Those who are assigned frequency space must make the fullest possible use of it; and in the public interest. Each of the various services, of which the Amateur Radio Service is one, must justify the precedence and scope of its claim with relation to all others. Naturally, this must be in the terms of the present and the future worth of the service concerned.

"We know that the frequency allocation picture is unsettled and that there are powerful groups who would divert amateur frequencies to other uses. The amateurs should consider how to better justify and support their service—both within this country and in the international field. Under the conditions of today, there is indeed cause of concern. Amateurs must gird their loins for the battle of 1952 scheduled to take place in Buenos Aires, Argentina!"

-30-

PR SMA CHANGES NAME

THE country's oldest service technicians' association, the Philadelphia Radio Service Men's Association, has recently announced that the organization will henceforth be known as the Electronic Technicians' Guild.

The new name was adopted to reflect the new and wider scope of the organization than was implied by the former designation. The Guild membership will now include radio and television dealers, distributors, distributor sales personnel, and independent radio and television service shop owners and their employees.

In addition to renaming the organization the Guild Committee Chairman Karl Vogelsang presented a new plan of operation for the approval of the membership which will increase membership benefits and services.

-30-

May, 1950

TWO Sensational New JACKSON Television Instruments

ONE! NEW TV SWEEP GENERATOR

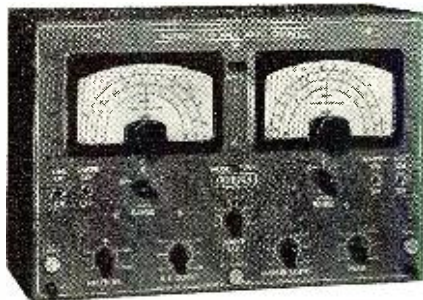

Model TVG-1 Net Price \$220.00

The ONE generator for accurate complete TV servicing. Look at these features:

Built-In Marker Generator. On fundamentals from 4 to 54 Mc. Harmonics readily usable to 216 Mc. Three ranges, accurately calibrated dial.

Crystal Calibrator. Jack provides means for calibrating Marker for any frequency within the range of the instrument.

Complete Sweep Generator. Provides frequencies from 2 Mc. to 216 Mc. in three ranges. Accurately calibrated dial with TV channels and FM band clearly indicated.

Adjustable Sweep width. Easily and quickly adjustable from 100 Kc. to a full 12 Mc. for FM and TV servicing.

400 Cycle Modulation. For use with Marker Generator.

Scope Timing. Provides a phased sinusoidal voltage for the Horizontal timing axis of the oscilloscope. Built-in phasing control assures a single pattern indication on the 'scope screen.

TWO! NEW 5" OSCILLOSCOPE



Model CRO-1 Net Price \$195.00
Demodulation Probe . . . Net 9.95
(For Signal Tracing)

Thanks to an amazing JACKSON discovery, this fine laboratory-type instrument gives you either wide band or high sensitivity. Check these features against any other oscilloscope.

Wide Band Amplifier. Vertical amplifier flat within plus or minus 1.5 db from 20 cycles to 4 1/2 Mc. Readily usable to full 5 Mc! Such band width is essential for accurate picture of TV sync pulses.

High Sensitivity. Vertical sensitivity .018 RMS volts-per-inch. Ideal for proper analysis of low voltage signals. Band width on High Sensitivity ranges is 20 cycles to 100 Kc.

Sweep Oscillator. Saw tooth wave 20 cycles to 50 kilocycles in 5 steps. Provision for external sweep.

Extra Features. Provision for direct connection of AC voltages. Internal and External Intensity Modulation. Synchronizing Input Control. Removable calibration screen. Height same as TVG-1 (above) for compact service-bench installation.

Get all the facts! Mail the coupon today!

JACKSON

"Service-Engineered"
Radio-Television
Test Equipment

Dayton 1, Ohio

Jackson Electrical Instrument Co.
18-20 S. Patterson Blvd.,
Dayton 1, Ohio

Please rush complete information on the following Jackson instruments:

TVG-1 Television Generator Complete line of Jackson Test Equipment CRO-1 5-Inch Oscilloscope

NAME _____

STREET _____

CITY _____ ZONE _____ STATE _____

MY DISTRIBUTOR IS _____

For AC CURRENT ANYWHERE . . .
NO MAGIC just use
ATR
INVERTERS

VISIT
 ATR Booth 420
 Radio Parts Show
 May 22-25
 Stevens Hotel
 CHICAGO



ATR

STANDARD AND HEAVY DUTY INVERTERS



For Inverting D. C. to A. C.
 Specially Designed for operating A. C. Radios, Television Sets, Amplifiers, Address Systems, and Radio Test Equipment from D. C. Voltages in Vehicles, Ships, Trains, Planes and in D. C. Districts.

NEW MODELS NEW DESIGNS
 NEW LITERATURE

"A" Battery Eliminator, DC-AC Inverters
 Auto Radio Vibrators
ATR
 See your jobber or write factory

AMERICAN TELEVISION & RADIO CO.
 Quality Products Since 1931
 SAINT PAUL 1, MINNESOTA-U. S. A.

International Short-Wave
 (Continued from page 54)

Listeners are reminded that Brazilian stations likely will change schedules from around May 1 when that country returns to *Standard Time from Summer Time* and they should adjust the listed programs to conform to the new times which are, or will be in effect very shortly.

Our best wishes go to all radio outlets in our neighboring country to the South—Brazil!

New Allocations

Regarding the possibility of new high frequency allocations, I have received this information, on request, from T. G. Slewie, Secretary of the Federal Communications Commission:

The Mexico City Conference, which adjourned in April 1949, formulated one phase of a plan for high frequency broadcasting for the June season, sunspot number 70. This phase has not been accepted by the United States. It will be subject to modification, along with addition of phases formulated by the Technical Plan Committee at Paris in the fall of 1949, when the work of the Mexico City Conference is resumed in Florence, Italy, this spring. (The Florence meeting was to have begun April 1.—KRB) Those phases of a plan approved at Florence then will become a part of the draft International Frequency List covering all services—except amateur—which have been allocated frequencies below 27,500 kc. in the Atlantic City Radio Regulations. The whole draft List will be considered by the Extraordinary Administrative Radio Conference, scheduled to convene September 1 at Geneva, Switzerland.

The date and the method for implementing any List approved by the Extraordinary Conference have not been determined as yet—but these matters will be considered at that conference.

"It appears at this time that no one service, such as high frequency broadcasting, will be able to implement its portion of the List in advance of the other services because of the inter-related problems of all of the services," Mr. Slewie points out. "It appears doubtful, also, that the Extraordinary Conference can complete its work in time for implementation of the new List to begin during this calendar year."

Portuguese List

Revised call letters for Portuguese stations, from ITU frequency List Supplements, are—Emissora Nacional, Lisbon, 10 kw., CSA38, 6.360; CSA21, 6.374; CSA22, 7.260; CSA23, 9.635; CSA24, 9.670; CSA25, 9.680; CSA26, 9.727; CSA27, 9.740; CSA28, 9.940; CSA29, 11.027; CSA30, 11.040; CSA31, 11.840; CSA32, 11.995; CSA33,

12.749; CSA39, 15.100; CSA35, 15.110; CSA36, 15.120; CSA34, 15.160; CSA37, 15.320. Private Stations—CSB53, 3.960, 10 kw., Lisbon; CSB56, 6.003, 200 w., Lisbon; CSB52, 6.154, 2 kw., Lisbon; CSB54, 6.185, 350 w., Lisbon; CSB55, 9.650, 2 kw., Lisbon; CSB57, 12.130, 2 kw., Lisbon; CSB51, 12.865, 500 w., Parede. Ponta Delgada, Azores, 1 kw., CSA93, 4.845; CSA91, 7.018; CSA92, 11.090. (Legge, N. Y.)

World Listening Guide

O. Lund-Johansen, Copenhagen, Denmark, who compiles *World Radio Handbook*, informs me he is preparing a *World Listening Guide*. He says:

"In order to promote interest in listening to broadcasts from foreign countries—particularly on short-wave—and to give short-wave listeners all over the world a chance to share each other's experiences, *World Radio Handbook* has planned the production of a world listening guide. In this booklet, short-wave listeners the world over will be writing about their experiences, practical handling of the receiver, giving reception reports, technical tips about aerials, and many other matters."

I hope soon to have further information on this project.

Mr. Johansen's QRA is 1, Lindorffsalle, Hellerup, Copenhagen, Denmark.

Club Notes

England—Frank Baldwin is now General Manager for the International Short Wave League, and Mrs. Baldwin operates the club's QSL Bureau.

This Month's Schedules

(NOTE: At this season many short-wave stations will be going on *Summer Time*; in such cases, schedules may be changed to one hour earlier than listed herein.—KRB)

Albania—ZAA, 7.852, Tirana, is now scheduled daily 1230-1600. (Radio Sweden)

Anglo-Egyptian Sudan—Verification and schedules received from Omdurman Broadcasting Station, Khartoum, listed frequencies of 5.000 (temporary), 9.770, and 572.5 kc. Station

Leader, composer, and arranger Radames Gnatalli conducts Radio Nacional's orchestra.



SELENIUM RECTIFIERS

— and —

ELECTRONIC COMPONENTS

THREE PHASE FULL WAVE BRIDGE RECTIFIERS

Input 0-234VAC Type No.	Current	Output 0-250 VDC Price
3B13-1	1 AMP.	\$ 22.00
3B13-2	2 AMP.	32.00
3B13-4	4 AMP.	56.00
3B13-6	6 AMP.	81.50
3B13-10	10 AMP.	105.00
3B13-15	15 AMP.	126.00

CENTER TAPPED RECTIFIERS SINGLE PHASE FULL WAVE

Input 10-0-10VAC Type No.	Current	Output 0-8 VDC Price
CI-10	10 AMP.	\$ 6.95
CI-20	20 AMP.	10.95
CI-30	30 AMP.	14.95
CI-40	40 AMP.	17.95
CI-50	50 AMP.	20.95

RECTIFIER MOUNTING BRACKETS

For Types B1 through B6, and Type C1..... \$.35 per set
For Types 3B..... 1.05 per set

SINGLE PHASE FULL WAVE BRIDGE RECTIFIERS

Input 0-18VAC Type No.	Current	Output 0-12 VDC Price
B1-250	250 MA.	\$0.98
B1-1	1 AMP.	2.49
B1-1X5	1.5 AMP.	2.95
B1-3X5	3.5 AMP.	4.50
B1-5	5 AMP.	5.95
B1-10	10 AMP.	9.95
B1-20	20 AMP.	15.95
B1-30	30 AMP.	24.95
B1-40	40 AMP.	27.95
B1-50	50 AMP.	32.95

Input 0-36VAC Type No.	Current	Output 0-26 VDC Price
B2-150	150 MA.	\$0.98
B2-250	250 MA.	1.25
B2-300	300 MA.	1.50
B2-2	2 AMP.	4.95
B2-3X5	3.5 AMP.	6.95
B2-5	5 AMP.	9.95
B2-10	10 AMP.	15.95
B2-20	20 AMP.	27.95
B2-30	30 AMP.	36.95
B2-40	40 AMP.	44.95

Input 0-115VAC Type No.	Current	Output 0-90 VDC Price
B3-250	250 MA.	\$2.95
B3-600	600 MA.	5.95
B3-750	750 MA.	6.95
B3-1X5	1.5 AMP.	10.95
B3-3X5	3.5 AMP.	18.95
B3-5	5 AMP.	24.95
B3-10	10 AMP.	36.95
B3-15	15 AMP.	54.95

CUSTOM DC POWER SUPPLIES

Built to your specifications.
We will be pleased to quote on your requirements.
Kindly send for our specification form.

RECTIFIER CAPACITORS

Type No.	Value	Voltage	Price
CF-14	3000 MFD	12VDC	\$1.69
CF-15	6000 MFD	12VDC	2.95
CF-1	1000 MFD	15VDC	.98
CF-2	2000 MFD	15VDC	1.69
CF-20	2500 MFD	15VDC	1.95
CF-3	1000 MFD	25VDC	1.25
CF-4	2X3500 MFD	25VDC	0.45
CF-5	1500 MFD	30VDC	2.49
CF-6	4000 MFD	30VDC	3.25
CF-7	3000 MFD	35VDC	8.25
CF-8	100 MFD	50VDC	.98
CF-19	500 MFD	50VDC	1.95
CF-16	2000 MFD	50VDC	8.25
CF-21	1200 MFD	90VDC	3.25
CF-9	200 MFD	150VDC	1.69
CF-10	500 MFD	200VDC	3.25

Mounting clamps for above capacitors .15c ea.

RECTIFIER TRANSFORMERS

All Primaries 115VAC 50/60 Cycles

Type No.	Volts	Amps.	Shpg. Wt.	Price
XF15-12	15	12	7 lbs.	\$ 3.95
TXF36-2	36	2	6 lbs.	3.95
TXF36-5	36	5	8 lbs.	4.95
TXF36-10	36	10	12 lbs.	7.95
TXF36-15	36	15	20 lbs.	11.95
TXF36-20	36	20	30 lbs.	17.95
XFC18-14	18VCT	14	10 lbs.	5.95

All TXF Types are Tapped to Deliver 32, 34, 36 Volts, XFC Type is Tapped to Deliver 16, 17, 18 Volts Center Tapped.

RECTIFIER CHOKES

Type No.	Hy.	Amps.	Dc Res.	Price
HY5	.02	5	.25	\$3.25
HY5A	.028	5	.20	3.95
HY10	.02	10	.30	9.95
HY10A	.014	10	.04	7.95
HY20A	.007	20	.02	12.95

Type "A" low resistance chokes are specially suited to circuits requiring excellent voltage regulation.

ADDITIONAL SELENIUM RECTIFIER TYPES AND GENERAL INFORMATION MAY BE FOUND IN OUR CATALOG No. 719



VACUUM CAPACITORS

Standard Brands
12 Mmfd. 20 Kv \$4.95
50 Mmfd. 32 Kv 5.95
Overall length 6 1/4" diameter 2 3/4"
terminal diameter 3/4", shpg. wt. 2 lbs.

EDISON THERMO TIME DELAY RELAY

Heater voltage 115 V. Norm. open SPST contacts. 15-30 sec. delay. Contact rating 115 V. 3A., 440 V. 2A. Size 3 1/2"x1 1/2" diam. Standard 4-prong tube base. Ea. **98c**



WHILE THEY LAST METER SPECIALS

0-300 VDC, Basic 0-1 ma. 2" rd. Bakelite case. New, in original boxes. Shpg. wt. 2 lbs. Bargain price. **\$2.25**

KLIXON 40 SECOND DELAY SWITCH

Heater operates on 115 VAC or DC. Contacts SPST rated at 30 A., 115 V. or 20 A., 220 V. Auxiliary contacts for lighter loads. Each..... **\$2.49**



DIEHL MOTOR

Fan duty, brushless induction type (no TV interference). For 115 VAC 60 cycles, 46 watt, 1800 R.P.M. Shaft 1/4" diam. 1" long. Noiseless ball-bearings—heavy cast construction. Shpg. wt. 6 lbs. Brand new..... **\$4.50**

D-C PANEL METERS

Attractive, rugged, and reasonably priced. Moving vane solenoid type with accuracy within 5%.
0-6 Amperes D-C Any range \$2.49 each
0-12 Amperes D-C
0-15 Volts D-C

SILVER CERAMIC TRIMMERS

820-Z 5-20 Mmfd. Zero Temp..... 24c
822-N 5-20 Mmfd. Neg. 300..... 24c
822-AZ 4.5-25 Mmfd. Zero Temp..... 24c
823-AN 20-125 Mmfd. Neg. 650..... 33c

ATTENTION!!!

Bulletin No. 713, listing various government and commercial surplus items, is now available upon request.

DC POWER SUPPLY

Limited quantity—Gov't Surplus

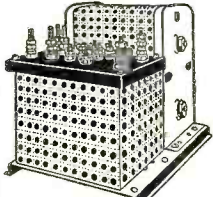

Ready to operate. Full-wave bridge, copper-oxide rectifier, heavy-duty multi-tapped transformer. Input: 85/95/105/115 VAC 50/60 cps. Output: 2.5/24/28/32/36 VDC at 5 amperes, unfiltered.

For wall or bench mounting. Overall dimen. 9"x3 1/2"x8 1/2" high. Shpg. wt. 30 lbs. Like new. Tested and warranted. **\$36.00**
Filter Kit. 2% ripple..... **\$6.65**

POWER SUPPLY KITS 24 to 28 VDC Filtered

Designed for continuous duty ground operation and bench testing of aircraft equipment, these kits provide a reliable means of obtaining a source of low-ripple 24 VDC, from a 115 VAC 60 cycle line. Full-wave bridge Selenium Rectifiers insure instantaneous and efficient operation. Adjustment of the DC output voltage is accomplished by transformer primary taps. Ripple is limited to within 2% of the average DC output by choke-input filters.

Kit No.	Amperes DC	Net Price
242	2.0	\$16.39
245	5.0	22.39
2410	10.0	47.44
2420	20.0	79.44

Write for descriptive Bulletin No. 201.

RECTIFIER KIT No. 612-10 6 and 12 VDC at 10 Amperes

This unit will deliver unfiltered direct current for operation of motors, dynamotors solenoids, relays and similar equipment. Employs full-wave Selenium Rectifier and heavy-duty primary tapped transformer. The two output voltages can be used simultaneously and may be adjusted between 6.7-7.5 VDC and 13-15 VDC under full load. For 115 VAC 60 cycle input. With schematic diagram and instructions. Shpg. wt., 12 lbs. **\$15.95**

Minimum order \$3.00. No C.O.D.'s. Add 10% for Prepaid Parcel Post and Handling. Terms: Net 10 days in the

presence of approved credit.

All prices subject to change without notice.

Prices and delivery F.O.B. our NYC Warehouse.

All merchandise subject to prior sale.

WESTERN ELECTRIC BLOWER

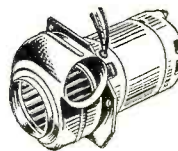

#KS5881—Brand New—Heavy-duty Sirocco type blower, capacitor start, 1/40 H.P., 3400 RPM, 115 VAC, 60 cycles. Displaces 84 CFM. Extremely quiet operation. Opening 2 3/4", overall size 7 1/2" long, 6" diam. Moisture and fungus resistant. With capacitor. Shpg. wt. 15 lbs. Quantity limited..... **\$13.95**

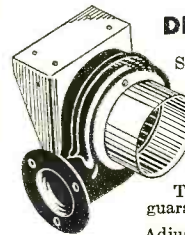

DIEHL BLOWER

Sirocco type, displaces 100 C.F.M., 115 VAC, 60 cps. Moisture and fungus resistant. Flange diameter 4". Overall size 7 1/2"x6 1/2". Removed from original equipment. Shpg. wt. 10 lbs.

Tested and guaranteed. **\$9.95**

Adjustable right angle aluminum extension tube to fit flange..... **98c**

WESTINGHOUSE AIRCRAFT MOTOR

Brand new—24 VDC reversible, 1/50 H.P. Will also reverse and operate on AC. 4800 RPM continuous duty. Length of leads 18". Dimensions 3 1/2"x2 3/4" shaft 1/4" diam. by 3/8" long. **\$2.95**
Reversing switch with "off" position. Each..... **79c**



OPAD-GREEN COMPANY

71-3 Warren St.
New York 7, N. Y.

Phone: BEekman 3-7385-6

The PENN Teletower... NEW 3-WAYS!

- (1) NEW Low Price (2) NEW Ease of Erection
(3) NEW Extended Field of Reception

RETAILERS

Grab at Low Price of
Less Than Dollar per Foot!

Everyone's known for a long time that a tripod-type tower provides the best support for antenna. But until now, "only the rich could afford it." Today, Penn prices the tripod within reach of the solid bulk—not just the thin cream—of television's market.

INSTALLERS

Go For Ease of Erection!

So foolproof—so safe—is the Penn Teletower that just two men zip it up fast without use of rigging hoists. Exclusive pilot hole provides automatic alignment.

HAMS

Enthusiastic About Reception!

Ingenious Teletower sectional construction makes it easy to gain height... rise above interference.

WHOLESALE: Write for details about Penn's profitable line—distributed entirely through jobbers.

PENN Teletower...

Manufactured by PENN BOILER and BURNER MFG. CORP.
Makers of Penn Packaged Heat ESTABLISHED SINCE 1932
LANCASTER, PA.

TOP QUALITY TELEPHONES

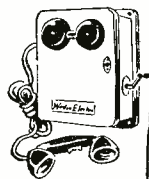

Standard magneto ringer type as used for farms, factories, intercoms, etc. Connect with two wires or single wire and ground. Range 15 miles or more. Ringer box, new, with handset, good. Instructions... **\$8.95**

RCA 6 Inch
Weather Proof
Speaker

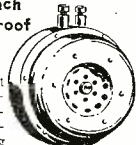

Plastic cone. Made to stand salt water exposure. Ideal for all outdoor installations. Makes fine Hi-Fi tweeter. Includes RCA universal output transformer matching any line or tube impedance from 50 ohms to 10240 ohms. Used, perfect operating condition... **\$4.95**

BC-1068 RECEIVER

110V 60 cycle power supply, 5 stages I.F., 2 stages R.F., 2 stages audio amplifier, separately tuned converter and oscillator, tuning indicator. Frequency range: 150-210 Mcs. Makes good 2 meter or FM broadcast receiver. With 14 tubes, instructions and schematic, in excellent condition... **\$19.95**

HS-33 HEADSETS



With Cord and Plug. Good. Used... **89c**
(\$1.00 Post-paid in U. S.)

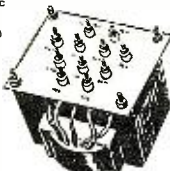

G. E. TRANSFORMERS
110 v. 60 cy. AC
850V CT. 6.3V @ 5A.
6.3V @ 3A, 5V @ 3A.
Conservatively rated @
148 Mil. tested @ 250
mil and will handle more.
A steal at... **\$2.95**

G. E. 12 HENRY CHOKE

Made as companion to above, only... **\$1.95**
F.O.B. Oakland. 25% cash with order. Bal. C.O.D.

EMMONS RADIO SUPPLY

405 - 10th ST. OAKLAND, CALIF.
Phone TWinoaks 3-9103

The ROSE CO. TV SCOOP!

630 Type TV
16" Chassis
A Steal At
\$159.50

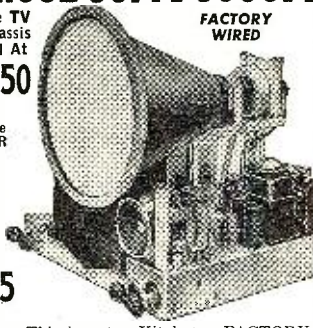

Complete
(Less CR
Tube)
16" Glass
Black
Picture
Tube
(1 yr.
guarantee)

\$39.95

NOTE: This is not a Kit but a FACTORY CUSTOM ENGINEERED, WIRED, TESTED and aligned TV Chassis. Just plug in and it works. Full TV Channel Coverage. Voltage Doubler, complete with 30 tubes.
CHASSIS, as above, but with automatic Gain Control, incl. an additional 6AU6 tube, to eliminate interference.
Your Cost... **\$169.50**

TV ACCESSORIES

RCA Type Antenna: Folded dipole H. & L. adjustable reflectors, complete with hardware and 5 ft. mast... **\$5.45**
FOLDED DIPOLE and Reflector, hi req. antenna... **\$2.75**
TABLE TOP 3 Section antenna... **\$2.75**
300 Ohm Twin Lead... per 100 ft. **\$1.65**
per 1000 ft. **\$10.95**
CHIMNEY MOUNTS complete with straps for masts up to 1 1/2". List \$4.50... per pr. **\$1.59**
WALL MOUNTS—distance from wall to mast is adjustable to 20" clearance from wall.
List \$7.00... per pr. **\$3.15**
HEAVY STEEL wall mounts—clearance of 4" from wall. List \$1.50... **49c**
NEW TYPE STAND OFF insulators for 1 1/2" mast, snaps on the mast (You do not need to screw into wall)... per 100 **\$4.00**
In lots of 10, .65 each

Write Dept. RN-5 for literature on parts and television sets. All Prices F.O.B. New York. 25% Deposit required on all orders. Minimum Order \$5.00.

**THE ROSE COMPANY 98 Park Place
New York 7, N. Y. (Corner Greenwich St.)**

has English on Fridays 1230-1300.

Angola—CR6RL, Radio Clube Angola, Luanda, is testing on a new channel of 5.096 at 1320-1600, according to Stephan, South Africa; is heard better than dual CR6RN on 9.469, Stephan reports. A station heard on 7.590 in Portuguese to closing around 1510 has been identified as Silva Porto, Radio Clube DB, CR6RO; however, according to its QSL card, CR6RO is on 7.582. (Radio Sweden) Reports on the new Nova Lisboa outlet on 11.925 should be sent to P. O. Box 125, Nova Lisboa, Angola, according to Radio Australia. This one has been heard by Stark, Texas, to 1700 when closed with "A Portuguesa." Radio Sweden reports the outlet heard in Portuguese around 1300-1640, identifying as Radio Clube de Huambo, Nova Lisboa.

Argentina—LRM, measured 6.1806, Mendoza, noted 2320 with music. (Treibel, Washington)

Australia—Current Radio Australia transmissions to North America are 2330-0045 to West Coast, VLC9, 17.84, VLA6, 15.20, VLG6, 15.32; 0700-0900 to East Coast, VLC5, 9.54; 0900-1000 to Central and Mountain States, VLC5, 9.54; 1000-1115 to West Coast, VLC5, 9.54, VLA8, 11.81; 1643-1815 to East Coast, VLA6, 15.22.

Austria—Blue Danube Network, Salzburg, logged 0900 on approximately 9.530, apparently is still moving around the 31-m. band. (Pearce, England)

Belgian Congo—OQ2AB, Radio Elisabeth, Elizabethville, operates on 7.150 and 11.900 on Sunday 0800-1000; OQ2AC, Radio College, Elizabethville, operates on 3.390, 4.980, 7.200 daily 1130-1215, Sunday 0200-0300. (Nordh, Sweden, via Radio Sweden)

Brazil—PRL5, 11.95, Rio de Janeiro, good level in Newfoundland from 1630 to after 1730. (Puddle)

British Guiana—Grove, Ill., says ZFY, 5.985, Georgetown, has announced expansion of its service to 0545-1145, 1445-2045.

Cameroons—FIA6, 9.145, is very poor at 1430-1500. (Puddle, Newfoundland)

Canada—Anyone interested in the attractive monthly program booklet issued by CBC's International Service may get on the mailing list by sending his request to CBC International Service, P. O. Box 7000, Montreal, Province of Quebec, Canada. For each of the main areas—Europe and Latin America (including the Caribbean)—CBC publishes a separate booklet each month. Listeners should specify which booklet they want—European or Latin American. Latest schedules are—to Europe, CKNC, 17.82, 0915-1615 (Sunday from 1035); CKCX, 15.19, 0915-1128 (Saturday from 1020); CKCS, 15.32, 1130-1855; CHOL, 11.72, 1630-1855. To Caribbean and Latin America—CKRX, 11.76, CKCX, 15.19, 1910-2200; CKCS, 15.32, 2200-2230. To Australasia (United Nations Service)—Mon.-Fri., 2320-2400, CKLX, 15.09,

SPEAKER SPECIALS

FAMOUS BRANDS

GE—MAGNAVOX—CAPEHART—JENSEN

- Square 4" PM Alnico V 1 oz.
Magnet..... \$1.00 each
- Round 5" PM Alnico V 1 oz.
Magnet..... 1.05 each
- Round 6" PM Alnico V 1.47 oz.
Magnet..... 1.45 each
- Pin Cushion 6" PM Alnico V 3.16 oz.
Magnet..... 1.95 each
- Pin Cushion 8" PM Alnico V 2.16 oz.
Magnet..... 2.45 each
- Round 8" PM Alnico V 3.16 oz.
Magnet..... 2.75 each
- Round 10" PM Alnico V 4.16 oz.
Magnet..... 3.75 each
- Round 12" PM Alnico V 4.16 oz.
Magnet..... 4.25 each
- Round 12" PM Alnico V 6.8 oz.
Magnet..... 4.75 each

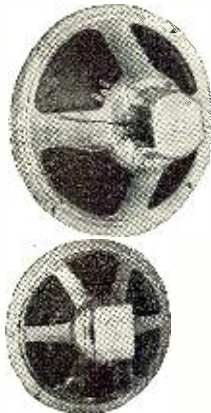

ELECTRO DYNAMIC SPECIALS

- 4" 500 ohm field..... \$1.50 each
- 4"x6" 85 ohm field (TV)..... 1.95 each
- 4"x6" 500-800 ohm field..... 1.95 each
- 5" 450 ohm field..... 1.75 each
- 5" 1000 ohm field..... 1.75 each
- 6" 450 ohm field..... 1.95 each
- 6"x9" 1000 ohm field... 2.25 each
- 8" Speakers Your Choice \$2.25 ea.
60 ohm (TV) 675 ohm 750 ohm
900 ohm 1000 ohm 1300 ohm
1800 ohm fields.
- 10" Speakers Your Choice \$2.95 ea.
1000 ohm 1800 ohm fields.
- 12" Speakers Your Choice
While They Last!... \$3.95
85 ohm 160 ohm 250 ohm
FOR TV
- 425 ohm 600 ohm 650 ohm
1000 ohm 1800 ohm 2700
ohm fields.
- 15" Jensen JAP 60 Coax
Some with networks.....
.....Special \$29.95
- ALL SPEAKERS BRAND
NEW AND GUARANTEED

TRANSFORMERS

GE—STANCOR—PHILCO

—LIMITED QUANTITIES

AT THESE PRICES



POWER

- 50 MA. PRI. 115V. sec. 600 VCT 6.3V 3 Amp. 5V. 2.5 Amp..... \$1.95 each
- 80 MA. PRI. 115V. sec. 700 VCT 6.3V 3 Amp. 5V. 2.5 Amp..... 2.35 each
- 100 MA. PRI. 115V. sec. 600 VCT 6.3V 3 Amp. 5V. 2.5 Amp..... 2.95 each
- 150 MA. PRI. 115V. sec. 700 VCT 6.3V. 4 Amp. 5V. 3 Amp..... 3.95 each
- 150 MA. PRI. 105-120V. sec. 700 VCT 6.3V. 5A.6.33A 5V. 3A..... 4.95 each
- 50 MA. PRI. 110-120V. sec. 600 VCT 6.3V. 3 Amp..... 2.25 each
- 60 MA. PRI. 110-220V. sec. 600 VCT 6.3V. 3 Amp..... 2.75 each
- 50 MA. PRI. 110-260V. with Switch sec. 600VCT 6.3V. 3 Amp..... 3.25 each
- 125 MA. PRI. 110V. sec. 750V. 6.3V. 5 Amp. 5V 3 Amp..... 3.50 each
- 200 MA. PRI. 115V. sec. 750 VCT 6.3V. 5 Amp. 5V. 3 Amp..... 4.50 each

VIBRATOR POWER

- 50 MA. PRI. 6V. Vibrator sec. 600V..... 1.75 each
- 70 MA. PRI. 6V. Vibrator sec. 600V..... 1.95 each

CHOKES

- 80 MA. 300 ohm 10HY.....45c
- 80 MA. 150 ohm 10HY.....75c
- 185 MA. 60 ohm 4HY.....95c
- 50 MA. 100 ohm 20HY AC-DC.....35c
- 20 MA. 2000 ohm 50HY Plate.....35c

SPECIAL PHONO SCRATCH FILTERS 29c

OUTPUT TRANSFORMERS

- 2500 ohms 50L6.....\$0.39
- 5000 ohms 6V6......49
- 8000 ohms 3Q5..... \$0.49
- PP 1000 ohms 6V6..... .69

SPECIAL FILAMENT AND ISOLATION TRANSFORMER

- PRI. 115 Volts sec. 120V. and 6.3V. 3 Amps..... \$1.45 each

Minimum order shipped \$5.00. Remit 20% deposit with all orders. Balance COD FOB New York. Remit in full and save COD charges

AM-FM TUNER

Famous Brand but because of price we agreed not to disclose the name. You will recognize it! With 5 band switch for On-Off-TV-AM-FM-Phono Control. Designed for use with standard TV chassis and any amplifier. Complete with dial-hardware-dual knobs—complete hookup instructions—schematics.

Compact for installation with TV.
Chassis size—8½" w
10L 4½" H.

- 4 tube complement
1 12AT7 converter
2 6BA6 IF Amplifiers
1 6T8 FM Disc.—AM Det.
2 Dual controls for tuning-tone-volume-switching
4 Gang AM-FM Tuning Condenser

PERFORMANCE
AM-535KC-1650 KC.
FM-87.5 Mc-108.5 MC.

FM SENSITIVITY
UV FOR
FREQ. MC 30DB S/N

90	50
98	40
108	40

Image Ratio
13X
10X
9X

Selectivity 2X 170-250 KC
6 IF s 3 for AM 3 for FM
Truly a fine tuner.

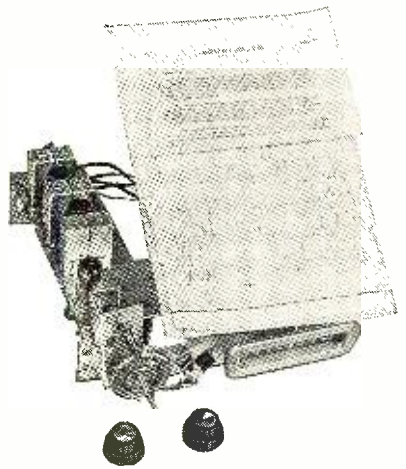

WHILE THEY LAST only..... \$24.95
COMPLETE WITH TUBES—LIMITED QUANTITIES

FAMOUS BRAND ELECTROLYTIC CONDENSERS

Tubulars—Aluminum tubulars—Papers—FP
You will recognize these expensive condensers. Stock up while they are still available.

TUBULARS

- | | |
|--------------------------|--------|
| 15 MFD 150 Volts..... | \$0.19 |
| 20 MFD 150 Volts..... | .19 |
| 30 MFD 150 Volts..... | .25 |
| 40 MFD 150 Volts..... | .30 |
| 20x20 150 Volts..... | .27 |
| 30x30 150 Volts..... | .32 |
| 40x40 150 Volts..... | .35 |
| 50x30 150 Volts..... | .35 |
| 10 MFD 25 Volts..... | .15 |
| 25 MFD 10 Volts..... | .15 |
| 100 MFD 25 Volts..... | .25 |
| 100 MFD 15 Volts..... | .35 |
| 250 MFD 25 Volts..... | .45 |
| 3000 MFD 10 Volts..... | .45 |
| 10 MFD 450 Volts..... | .25 |
| 20 MFD 450 Volts..... | .35 |
| 30 MFD 450 Volts..... | .45 |
| 40 MFD 450 Volts..... | .50 |
| 10x10 MFD 450 Volts..... | .45 |
| 20x20 450 Volts..... | .55 |

Multi-Section FP Aluminum Cans

- | | |
|-----------------------|--------------------------|
| 30x20 MFD 150V | 10x10 MFD 450V |
| 30x20x20 MFD 150V | 20x10 MFD 450V x 25V |
| 20x20x20 MFD 150V | 30x30 MFD 450V |
| 40x40x30 MFD 150V | 20x20x20 450V x 25V |
| 50x50x15x20 150V 25V | 10x10x20 450V x 25V |
| 30x30 MFD 250V | 40x40 MFD 450V |
| 80x10 MFD 350V | 10x10x10 MFD 450V |
| 15x10x20 MFD 400V 25V | 16x16x16 MFD 450V |
| 10x10 MFD 400V | 16x16 MFD 450V |
| 20x20 MFD 400V | 30x20x10 MFD 450V x 150V |
| 25x10 MFD 400V | 40x30x30 MFD 450V |
| 30x10x5 MFD 300V | 60x50 MFD 450V x 50V |
| 30x10x5 MFD 300V | 30x10 MFD 475V |
| | 40x35x10 MFD 475V |

Single FP Aluminum Cans

- | | |
|-------------|-------------|
| 150 Volt | 450 Volt |
| 10 MFD..15c | 8 MFD..25c |
| 20 MFD..20c | 10 MFD..28c |
| 40 MFD..30c | 15 MFD..30c |
| 80 MFD..45c | 20 MFD..35c |
| | 30 MFD..40c |
| | 40 MFD..45c |
| | 80 MFD..50c |

Your Choice 35c each

Your Choice 55c each



AMERICAN RADIO SUPPLY CO.

417 LAFAYETTE ST.

NEW YORK 3, N.Y.

**New Book makes
AUTO RADIO
REPAIR twice
as easy!**

Covers all auto
Radio types from
mid-1930's to
present, includ-
ing mobile FM.



SERVICING THE MODERN CAR RADIO by A. L. Hurlbut

**Second edition, 702 pages,
8 1/2 x 11, 222 illus., over 500
schematic circuit diagrams of
auto radio receivers, \$7.50**

Here—written by a practical auto radio expert of 20 years' standing—is everything to help the beginner or experienced serviceman gain profitable skill in the fast growing field of car radio servicing. A complete guide to the work. Book not only describes installation, testing, and repair methods fully, but also gives needed special facts of car radio circuits, differences between car and home radio servicing problems, shop set-up and business-getting ideas, etc. Particularly valuable for busy servicemen is the array of over 500 diagrams of specific circuit details on a large percentage of sets you may be called upon to repair.

Practical facts and methods on:

- getting into the car radio business
- differences between mobile and home radios
- antennas and input circuits
- power supplies
- circuit features
- auto electrical systems
- setting up shop
- car set installations
- antenna installation
- loudspeaker installation
- remedying interference
- servicing procedure
- vibrator maintenance
- loudspeaker servicing
- car radio alignment
- push-button tuning, etc.

OPPORTUNITY OF A LIFETIME

for alert servicemen, says A. A. Ghirardi,
author of famous radio servicing
books and articles



ALFRED A.
GHIRARDI

"I believe SERVICING THE MODERN CAR RADIO represents an opportunity no wide awake serviceman can afford to miss. There are over 9,000,000 car radios—approximately 16 out of every 100 radio receivers in use today—a wonderful field for increasing servicing business; increasing profits, stepping ahead of competition! Good auto radio men are scarce, and this book gives you a gold mine of information you need to cash in on this profitable, fast-growing business."

10 DAY MONEY-BACK GUARANTEE

Dept. RN-50, MURRAY HILL BOOKS, Inc.,
232 Madison Ave., New York 16, N. Y.

Enclosed find \$7.50 for Hurlbut's SERVICING THE MODERN CAR RADIO; or send C.O.D. and I will pay postman this amount plus postage. In either event, it is understood I may return book after 10 days if unsatisfactory and you guarantee to refund my \$7.50. (Books sent C.O.D. in U.S.A. only. Price outside U.S.A. \$8.00 postpaid, same return privilege.)

Name

Address

City, Zone and State

Occupation

CHOL, 11.72. To Australasia (Sunday only)—0340-0530, CHOL, 11.72, CKLO, 9.63.

Cape Verde Island—CR4AA, 5.92, heard in Pennsylvania 1650 with music, heavy CWQRM. (Slutter)

Ceylon—Radio Colombo, 4.900, noted 1115 following BBC news to give local time as 9:45 p.m.; had music 1130-1200 closedown. (Pearce, England)

Cyprus—ZJM7, 11.72, Limassol, fair 1200-1230 in Newfoundland. (Peddle) ZJM3, 4.06, heard in Stockholm around 1200. (Radio Sweden)

Czechoslovakia—Balbi, Calif., reports OLR3A, 9.55, Prague, from 0000; is QRM'd at 0030 by Paris opening on this channel; also heard in Texas.

OLR4B, 11.76, Prague, noted 0120 with Spanish news at dictation speed. (Treibel, Washington)

Improved signals are widely reported in the 1900-2000 daily beam for North America over OLR4A, 11.84; news at start.

Denmark—OZU, 7.26, noted with relay of Home Service to closing 1730; news in Danish 1300, 1600; QSL card received. (Pearce, England) Copenhagen lists current s.w. schedules as 2100-2230, OZF, 9.52, to Greenland and North America (may be off Sunday); 0500-0600 on Tuesday, Thursday, Saturday, OZH, 15.165, to the East; 1900-

2000 on Monday, Wednesday, Friday on OZH, 15.165, to South America; daily 0040-1730 on OZU, 7.26, with Home Service for Europe; transmitter is listed as located at Herstedvester, with 50 kw. (Klein, N. Y.)

Ecuador—HC2CA, measured 6.8852, Salinas, noted 2130 with Latin American music (Treibel, Washington)

Ethiopia—A letter from ETAA, Addis Ababa, verified reception of the 19-m. outlet; gave *English* program schedule as daily 1020-1100, Sunday 0945-1115; no frequency was listed but said was operating in the 19-, 31-, and 49-m. bands. The 19-m. outlet appears to be on approximately 15.032, although most overseas sources list it around 15.050 to 15.075. *Radio Sweden* says ETA, 9.62, is audible in Sweden around 0600.

Finland—Verie from Helsinki listed OIX1, 6.120; OIX2, 9.555; OIX4, 15.190; OIX5, 17.800. Stated daily program times for 15.190 as 2200-0000, 0700-0800, 1145-1245, 1600-1700; card had photo of the 100 kw. transmitters. (Hankins, Pa.) OIX5, 17.80, noted 0715-0730 with news for North America. (Peddle, Newfoundland)

Formosa—See *Taiwan*.

France—Paris noted signing off on 6.145 recently 2445. (Stark, Texas)

(Continued on page 159)

PRECISION SPONSORS SERVICE MEETINGS

DURING 1950 television technicians throughout the country will have the opportunity of participating in a series of lecture-discussions being sponsored by Precision Apparatus Co., Inc., of Elmhurst, New York.

Designed to assist the television technician solve his servicing problems, this series of practical lecture-discussions has been tailor-made and is being presented under the general title of "Television Circuitry, Video I.F. Alignment Practice, and Troubleshooting." The sessions are being conducted by R. G. Middleton, Senior Engineer of the Precision Design and Application Engineering Section.

Each lecture-discussion is broken

down into two periods. The first half of the session is devoted to a circuit analysis of the television high voltage power supply and how it works, followed by an open floor question and answer period. After a short intermission the second half of the program covers video i.f. alignment procedures including troubleshooting, short cuts, and efficient test equipment applications. An actual TV alignment demonstration follows the lecture with the latest test equipment being featured.

The company's plans now call for lecture-discussions in every primary TV area in the United States during 1950.

—50—

R. G. Middleton addresses his audience of over 300 television technicians who gathered recently at Queens Village, Long Island, for the first of a series of nationwide lecture-discussions sponsored by Precision Apparatus Co. and its distributors.



OUTSTANDING VALUES NOW AVAILABLE

SNYDER TX-A CONICAL ARRAY

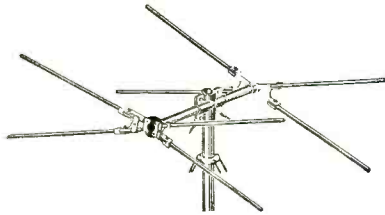

For fine television reception. Array can be used individually or stacked. Will bring in or increase your signal in fringe areas. Has proven successful where other antennae fail.

Features Snyder Quick-Rig truss. Comes to you pre-assembled. **\$5.95** per array.

TX-2—For Ultra-High Receptions.
2-TXA stocked with connecting stubs. **\$11.49** ea.

10-ft. mast section, seamless tubing, rustproof, 1 1/4".....**\$1.69** ea.

Heavy-duty chimney mounts—easy to install.....**\$1.49** ea.

A REAL PORTABLE BUY!



The last word in a handsome, powerful portable. Carries and plays anywhere.

Comes in smart, luggage-type carrying case, with beautiful slide rule dial.

Covers full broadcast band, giving console like tone.

Operates on AC-DC and battery.

Dimensions 12"x6"x9".

Super-efficient built-in loop and large Alnico V magnet speaker. **\$23.50** each, less batteries.

Supplied with RCAVSO19 7 1/2-9-90. **\$3.45** extra.

12" PM Speaker, 32-oz. Alnico Magnet, for 20-watt output. Deep Cone Construction for finest tone quality.

Only \$5.95, each.

Famous CLARK AMPLIFIER KITS

18-Watt Kit

6 tubes: 1—6SQ7, 1—6SC7, 2—6V6, 1—6SN7, 1—5Y3GT. Mike and phono input. Separate Bass and Treble controls, Heavy steel chassis and cover.

Frequency response 50-17,000 CPS & 1DB. Output impedances 4-8-16-500. Hum level 65DB below rated output. Complete, with tubes.....**\$18.95**



25-Watt Kit

6 tubes: 2—6SJ7, 2—6L6, 1—6SC7, 1—5Y3. 2 mike, 1 phono input. Separate bass and treble controls.

Output impedance 2-4-8-16-500 ohms. Frequency response 30-17000 CPS & 1DB.

Attractive heavy steel chassis and cover. Push pull phase inverter driver for hum level. Complete, with tubes.....**\$24.95**

CATHODE RAY TUBE DEAL OF THE YEAR!

Two popular sizes. For testing, servicing and construction work. All come to you pre-tested. All will light.

7JP4—\$5.45 each.

10BP4—\$7.95 each.

We must ship these Railway Express for best handling.

Each kit comes complete with instruction sheet, schematic and parts list.

10 WATT AMPLIFIER



The perfect music amplifier. Fine tone quality up to ten watts. Attractive two-tone Maroon and Gray steel case. Tubes: 6L6, 5Y3, 6SL7. Mike input, phono input. Switching arrangement allows interchanging use of mike or phono inputs.

NEW LOW PRICE \$15.49

SALES ITEMS TO START OFF THE AUTO RADIO SEASON

Vibrators—especially made for us by a top manufacturer—all guaranteed.

Standard 4-prong **\$1.29** ea.....10 for **\$12.50**
Delco Type 4-prong **\$1.39** ea.....10 for **\$13.50**
Buick Type Synchronous **\$2.79** ea.....10 for **\$26.00**

Side Cowl Antenna—Two-Mount

Heavy chrome finish—3 Section 66". Heavy insulators—Shielded Lead. Standard make. **\$1.39** ea.....10 for **\$13.00**
Motorola Type 6V 4-ohm Replacement Speaker, 6" Pin Cushion Type.... **98c**
PM Replacement Speakers—Finest made.
6"x9" Alnico V Magnet.....ea. **\$2.87**
7" Offset Alnico V Magnet.....ea. **\$2.40**

WRITE FOR OUR LATEST CATALOG

Radio Parts Company, 614 RANDOLPH ST., CHICAGO 6, ILL.



L-211



N-91



P-2040

Complete TV and Radio TRANSFORMER SERVICE

• Select your exact requirements from over 300 standard types for replacement, amateur and laboratory work. A wide choice of special outputs, semi-universal and universal outputs . . . impedance matching units . . . powers, vibrators, filaments and chokes. A complete ham line . . . special application units . . . one of the most comprehensive transformer lines available to the service trade today.

TELEVISION

L-211—Power—365-0-365V., 250 M.A. D.C.—5V., 3A.—5V., 2A.—6.3V., 6A.—6.3V., .8A. One of a growing line of dependable Halldorson TV units, available in exact duplicates and for general application.

AUTO VIBRATORS

N-91—6V. to 250V., 50 MA. Available in exact duplicates and for general application.

STEP DOWN

P-2040—230V. to 115V., 1000 Watt. Supplied in capacities from 65 to 1000 Watts.

Sold by Leading Parts-Jobbers, Everywhere. Every Halldorson Unit Is Triple Inspected and Guaranteed Against Mechanical Defect. Write for Free Catalog Today, Dept. 5-A.

The Halldorson Company
4500 N. Ravenswood Ave.
Chicago 40, Illinois



Fan Type Antenna

(Continued from page 67)

and therefore, all radiation is cancelled. However, when the conductors are bent out to form a dipole, the cancellation can no longer take place and the dipole antenna will either radiate or receive.

This dipole has an impedance of approximately 73 ohms. Now if the diameter of the dipole is increased after a right angle bend so that it constantly increases as we get farther from the point of the bend, a three dimensional cone is formed. This cone will still radiate or receive energy. However, its impedance characteristics are different. In this case, as the transmission line has been fanned out, the diameter of the conductors has been increased. The result is that the impedance remains constant over a wide band of frequencies. In other words, by the use of conical elements, a broad-band antenna has been secured. In summarizing the previous two paragraphs, it can be seen that by veeing an antenna forward very narrow horizontal lobes and patterns can be obtained over a relatively wide band of frequencies.

In the case of the conical antenna, by the use of this uniform impedance conical element, it will work over a wide band of frequencies with a low standing wave ratio.

It must be borne in mind that the above description pertains only to driven or receiving elements and does not pertain to reflectors. The requirements of a reflector are such that it must re-radiate energy to the driven element in such a relationship that reinforcement or addition occurs. To fulfill these requirements, a straight reflector is as effective as a conical reflector or a fan shaped reflector provided that it is cut and spaced properly. In the laboratories, the above considerations were given careful thought. It was obviously not feasible to make a three dimensional sheet metal cone or even a wire cage type cone element. Previous conical antennas had simulated this cone by running two dipoles from a common apex producing a cone in two dimensions. It was further observed that in the case of a "V" antenna as the diameter of the legs of the "V" was increased, the antenna would become increasingly uni-directional in the direction of the enclosed part of the "V." It was then reasoned that if the conical element which operated effectively over the entire low band were bent forward so that it formed a "V" on the high band, it would provide an efficient all channel antenna. However, two shortcomings were observed. Veing forward the antenna reduced the amount of energy intercepted on the low band because the distance across the front was decreased and secondly the two element conical antenna did not have an effective diameter large enough to pro-

RADIO & TELEVISION NEWS

The ORIGINAL and Still the BEST LIGHTNING ARRESTER

for all weather conditions will not absorb moisture

completely water proof

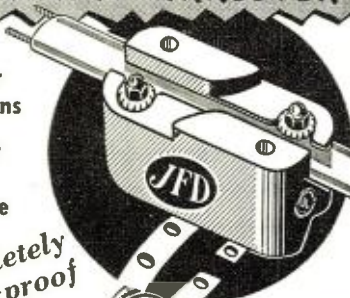

APPROVED for OUTDOOR-Indoor Use!

Protects Television Sets Against Lightning and Static Charges

JFD SAFE TV GUARD

Fits Any Type of Twin Lead

No. AT102 for Regular Twin Lead
No. AT103 for Oval Jumbo Twin Lead
No. AT103 Also for Tubular Twin Lead
BOTH Models Conform With Fire Underwriters and National Electrical Code Requirements for OUTDOOR installations.

SIMPLE TO INSTALL . . . can be mounted directly on mast by strap fastening arrangement . . . or attached to any grounded object, at any position between antenna and set, outdoors or indoors. No stripping, cutting or spreading of wires necessary. Hardware furnished.

Look for the JFD Trademark



MANUFACTURING CO., Inc.
6127 16th Avenue, Brooklyn 4, N. Y.
First in Television Antennas & Accessories

\$2.25 EACH

ACORN

6 GANG TUNING CONDENSER

Silver plated, micaless insulation. Dimensions: 1 1/4" overall, 8 1/2" long, 1 3/4" wide, 2" high; shaft 1/4"

Cap.
1st sec. . . 75 mmfd
2nd sec. . . 50 mmfd
3rd sec. . . 50 mmfd
4th sec. . . 50 mmfd
5th sec. . . 50 mmfd
6th sec. . . 350 mmfd

This is a beauty of a Condenser. Can be used for many purposes such as V.F.O., etc. Sold at a fraction of cost... \$1.98



ATLAS PAGING AND TALK-BACK SPEAKER

Model HU-15V
Alnico V. Magnet. Complete with unbreakable super-efficient driver unit. Power 12 w a t.s. Impedance 8 ohms. Length 1 1/2" diameter 2 1/2", air column 15". List \$29.75. OUR PRICE \$13.95



WESTON METER 508
2 1/2" x 0 to 500 micro-amp basic. Scale 0 to 15 v. and 0 to 600 v.

Reduced to \$3.19
General Electric D.C. VOLT-METER, TYPE DO-41
3 1/2" x 0 to 300 v., 1,000 ohms per volt. Only \$3.89

6V6 OUTPUT TRANSFORMER

8 0 0 0 ohm plate-to-plate 15 w. output. Unloaded voice coil 4, 8, 15, 250 and 500 ohms. Upr. \$1.99 mt. Shielded.



SYNCHRON MOTOR Model 600

1 r.p.m. per minute. 110v. 60 cy. \$2.95



RELAYS

SPDT. Sensitive. Operates on 1 ma., 8,000 ohm coil. New low price

ea. \$1.99

DPDT, 115 v. A.C. Latching type, manual reset. A 11 e c

Only \$1.69



PHONE WORTH 4-3270

TERMS: 20% cash w/order. Bal. C.O.D. Prices F.O.B. our warehouse in N. Y. C. Min. order \$2.50.

ACORN ELECTRONICS CORP.

76 Vesey St., Dept. N-5, New York 7, N. Y.

SAVE 25 TO 52% BY BUILDING YOUR OWN LABORATORY PRECISION TEST INSTRUMENTS!

*"You build 'em in
one evening—
they last a lifetime"*

NEW TV-FM SWEEP SIGNAL GENERATOR KIT

EICO
Model 360-K
\$29⁹⁵



Crystal marker oscillator with variable amplitude. Covers all TV and FM alignment frequencies between 500 kc. and 228 mc. Sweepwidth variable from 0-30 mc., with mechanical inductive sweep. Extremely wide sweepwidth allows gain comparison of adjacent RF TV Channels. Provides for injection of external signal generator marker. Phasing control included. Vernier dial calibrated in frequencies. Complete with tubes (6X5GT, 12AU7, 2-6C4). In sturdy steel case. Less Crystal. Size: 10 x 8 x 6 3/4". 110-125 v., 60 cycle AC. Shpg. wt., 12 lbs. IN KIT FORM.

No. 32P24370: Concord's Price **\$29.95**
No. 32P24371: 5 Mc. Crystal for above **\$3.95**

NEW SIGNAL GENERATOR KIT



EICO
Model 320-K
\$19⁹⁵

For FM, AM alignment and to provide TV marker frequencies. Highly stable Hartley oscillator has range of 150 kc. to 102 mc. with fundamentals to 34 mc. Colpitts audio oscillator supplies pure 400 cycle sine wave voltage for modulation. Use audio oscillator voltage to test distortion in audio equipment, bridge measurements, etc. In sturdy steel case. Size 10 x 8 x 4 3/4". 110-125 v., 60 cycles AC. Shpg. wt., 10 lbs. IN KIT FORM.

No. 32P24562: Concord's Price **\$19.95**

Complete with
STEP BY STEP INSTRUCTIONS
and
EASY-TO-FOLLOW DIAGRAMS

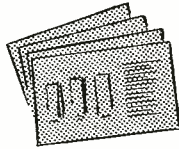

Each EICO kit fully guaranteed to operate perfectly when assembled according to the simple directions.

NEW 5" OSCILLOSCOPE KIT

Push-Pull, Wide-Range, High Sensitivity!

EICO
Model 425-K
\$39⁹⁵



All-new laboratory precision scope has Push-Pull deflection and .05 to .1 volts per inch sensitivity. Wide range, flat from 5 cps to 500 kc. with full gain setting, useful to 2 1/2 mc. Wide-range, multi-vibrator, sweep circuit from 15 cps to 75,000 cps. Direct connection to plates of CRT available at rear of cabinet. Z axis intensity modulation feature included. Size: 8 1/2" x 17" x 13" high. Complete with 3-6SN7, 2-6J5, 2 of 5Y3, 5BP1 CRT. 110-125 v., 60 cycles AC. Shpg. wt., 30 lbs. IN KIT FORM.

No. 32P24552: Concord's Price **\$39.95**

HIGH VOLTAGE PROBE

(Not a Kit)

EICO Model HVP-1 \$6⁹⁵



Measures up to 30,000 volts. Special HV Multiplier Resistor for all 20,000 ohms per volt meters with 1000 or 5000 volt scales and most VTVM's. Lucite head, plywood bakelite handle, large flashguards for additional safety. Assembled, ready to use. Supplied for 221-K VTVM unless other instrument is specified. Shpg. wt., 1 lb.

No. 25P21463: Concord's Price **\$6.95**

order your
EICO
INSTRUMENT
KITS
direct from
**Concord
Radio**

VACUUM TUBE VOLTMETER KIT

EICO Model 221-K
\$23⁹⁵



Tops in workbench versatility—15 different ranges! AC and DC ranges: 0/5/10/100/500/1000 volts. (Use HVP-1 probe to get 30,000 volt range.) Electronic ohmmeter ranges from .2 ohms to 1000 meg in 5 steps. Uses double triode balanced bridge circuit. New features include Zero Center for TV discriminator alignment. 26 Meg. DC input impedance. Accurate 4 1/2" meter cannot burn out. Sturdy portable steel case with etched, rubberproof panel. 110-125 v., AC, 60 cycles. Size: 9 1/2" x 6" x 5". Shpg. wt., 10 lbs. IN KIT FORM.

No. 32P24540: Concord's Price **\$23.95**

HIGH FREQUENCY RF PROBE KIT

EICO Model P-75K \$3⁷⁵



Germanium crystal probe for visual RF signal tracing and measurements to over 200 megacycles. 6 1/2" long, 12" O.D. Shpg. wt., 8 oz. IN KIT FORM.

No. 32P24533: Concord's Price **\$3.75**

CONCORD RADIO

901 W. Jackson Blvd., Chicago 7, Ill.
(Showrooms in Chicago, Ill. and Atlanta, Ga.)

CONCORD RADIO CORPORATION, Dept. RN-50
901 W. Jackson Blvd., Chicago 7, Ill.

Enclosed is \$..... (Include shipping charges. Any excess will be refunded.) Rush me the following EICO equipment:

Send me FREE Concord's 1950 Catalog. (Please do not check if you have already received a copy.)

Name

Address

City..... Zone... State.....

**DO YOU
HAVE
CONCORD'S
1950
CATALOG?**



—The most famous jobber catalog in the field for 29 years!

All well-known makes at the market's lowest prices.

TV and Radio Parts—High Fidelity Equipment—P.A. Systems—Test Equipment—Tools—etc.

NO RADIO MAN CAN AFFORD TO BE WITHOUT THIS VALUABLE 164-PAGE BUYING GUIDE

SEND FOR YOUR FREE COPY TODAY!

THE FINEST 16" TELEVISION SET EVER DESIGNED!

WITH AUTOMATIC GAIN CONTROL (AGC)

Now you can have the finest 1950 model **Voltage Doubler Giant Screen Television Set** ever designed. Custom built and improved with unusually high brilliance—will give you thousands of hours of fine entertainment during day or evening hours. A bright, clear steady picture is assured by the most famous television set ever produced, the RCA designed 630 type chassis. This identical type TV set is used by more Radio & TV Engineers than any other set ever manufactured!

The 30 tube circuit is more sensitive than any of the cheaper sets having less tubes and the new Standard Tuner has a pentode RF stage which acts as a **high-gain built-in Television Booster on all channels**. Also featured is an automatic frequency control system that keeps the picture steady and makes tuning easier.

Factory wired and tested, ready to operate. Shipped complete with tubes, less 16" picture tube **\$149.50**

Extra-Clear 16" glass picture tube—guaranteed for one year—**\$39.50**

SPECIAL!

Super-Giant 19" Television Set. 630 type similar to above, but modified to provide a whopper-sized picture. Factory-wired and tested, ready to operate. Shipped complete with tubes, less 19" picture tube. Price **\$169.50**

Extra-Clear 19" glass picture tube—guaranteed for one year—**\$79.50**

12½" 630 chassis—\$149.50

12½" tube—1 year guarantee—\$24.95

DE LUXE TELEVISION CABINETS

Beautifully designed to match the 630 chassis without any cutting or drilling. Solidly constructed like the finest furniture with a satiny piano finish. Shipped complete with mask and protective glass window.

16" Table Model—Mahogany or Walnut **\$39.95**

19" Table Model—Mahogany or Walnut **\$44.95**

16" Console—with drop panel to conceal knobs when desired. Mahogany or Walnut..... **\$69.50**

Blonde..... **\$79.50**

19" Console—with drop-panel as above—Mahogany or Walnut..... **\$79.50**

Blonde..... **\$89.50**

QUARTZ CRYSTAL CHECKER

Manufactured by Finch Telecommunications. Housed in a hinged steel cabinet with 19" panel. 9" high and 13½" deep. Two meters mounted on panel: 0-1MA and 0-500 cycles diag second. Complete with tubes and power supply. 2—VR105; 2—6J5; 1—6L7G; 1—6SJ7; 1—6F6; 1—5Z4. Crystal sockets mounted on front panel. Sold as is. Instruction book not available. Shpg. wt. approx. 45 lbs. **\$14.95**

TWO STATION INTER-COMMUNICATION SYSTEM

Radiomen—provide yourself with an additional source of income by selling and installing these high quality—low cost intercoms.

Selling Features: • For the nursery (baby sitting) or sickroom • In private homes—room to room—garage to house—basement to attic, etc. • Busy businessmen • Ideal for use in television antenna installation and servicing—instead of unhandy earphones • Simple installation—only 2 wires to connect • Housed in an attractive walnut case, 1 master and 1 slave station, complete with tubes.

Price..... **\$10.95**

Extra for 50 feet twin-lead cable... \$1.00

For complete listings of special buys for experimenters, radio technicians, laboratories, schools and engineers. Write for catalog R5.

EDLIE ELECTRONICS, INC.

154 GREENWICH ST. NEW YORK 6, N. Y.

duce a workable front-to-back ratio on the high band. A third element was added. This element overcame these two shortcomings. On the low band, the third element meant that more energy was being intercepted and therefore the narrowing of the space aperture was overcome. On the high band, the effective diameter of the legs of the "V" was increased so that a high front-to-back ratio was realized. As a matter of fact the same front-to-back ratio was realized on the high band after the inclusion of the third element, with or without reflectors. In addition, to these two improvements, it was found that the third rod made the elements more closely resemble a three dimensional cone and a more uniform impedance was realized. Therefore, a better match was made to the transmission line over the entire range of frequencies. The impedance was found to lie in the neighborhood of 150 ohms so that good matches were available at 72 ohms and at 300 ohms. The finished antenna is shown in Fig. 1. Horizontal polar diagrams at Channels 2 and 7 are shown on Fig. 5. Gain curves for the single, double, and four-bay arrays are shown graphically and tabularly in Fig. 6.

—30—

AN ELECTRICAL LOCK

By WILLIAM K. COOPER

THERE is an easy way to prevent meter movements from being damaged by jars and rough handling when making outside service calls. The tester is often bounced around in the car and accidentally bumped into things when carried on such trips. This can damage the bearings of the movement due to the sudden jars and the needle hitting the "stop" at the low end of the scale. Meters that are lightly damped need the most precautions in handling since they are most susceptible to damage caused by jars.

After having a meter damaged in this way, I found a simple means of preventing this trouble by simply using an "on-off" toggle switch. Drill a hole for it on the panel as near as practicable to the meter. If there is no room on the panel, mount it on the meter case. Before drilling a hole in the panel, the meter must be disconnected and taken out of the tester to prevent damage from vibration. Care should be taken that no circuit components are damaged by the drill. When the switch is mounted, the meter is replaced in the panel.

The switch is wired directly across the terminals of the meter itself and the meter reconnected to its circuit as before. With this switch "on" the moving coil is shorted. Then any motion of this coil as the tester is carried generates a current of such direction that it opposes the coil motion. This is in accordance with Lenz's law, remember? Thus there is dynamic braking of the meter movement. With the switch "on", the needle will barely move no matter how one moves the tester around. When ready to use the tester, turn the switch "off", and proceed as usual.

—30—

Triode Amplifier

(Continued from page 57)

inverse feedback for improving linearity, etc. In addition the circuit lends itself readily to direct coupling from the preceding stage. The positive voltage from the preceding plate circuit is more than offset by the high bias voltage developed across the cathode resistor, so that both tubes operate properly. The direct coupling permits extension of the low-frequency response to d.c. and eliminates coupling networks which can cause phase shift and low frequency attenuation. It will be noted from the schematic of Fig. 2 that in the "radio" channel there are only four coupling condensers in the entire amplifier, two on each side of the push-pull system. As both of these are of generous capacity, and the frequency response of the output transformer specified is no more than ½ db. down at 20 c.p.s., the low frequency response is very good.

The phase inverter is resistance-capacity coupled to a type 6SN7 tube connected in push-pull. A fairly high load resistor is used in order to increase the voltage output and the cathode resistor is not bypassed to take advantage of inverse feedback action in balancing the push-pull system. The stage is resistance-capacity coupled to a type 6SN7 tube used as a cathode follower driver.

The cathode follower is direct coupled to the push-pull power amplifier through an ingenious circuit. Each cathode is directly connected to a power stage grid. The cathode current flows through each side of a center-tapped choke, which has low d.c. resistance so that no d.c. biasing voltages are developed. The choke has sufficient inductance so that its inductive reactance, which is the cathode follower load, is high, even at 20 cycles. The cathode currents from both sections of the cathode follower flow through R_{27} which develops the bias voltage for V_5 . The opposite end of R_{27} connects to the grid return of V_5 and the negative end of R_{28} , which is between the power transformer high-voltage center tap and ground, providing fixed bias for the power stage.

The power amplifier consists of a pair of 6A5 tubes coupled to the loudspeaker (see page 56) through the output transformer, T_2 . As the tubes are operated with fixed bias, the cathodes are grounded. The 6A5 is very similar to the 2A3 and 6B4 in characteristics and application, but is equipped with a cathode which is internally connected to the center point of the heater. The heater-cathode construction results in a considerably reduced hum level over the directly-heated tube types and, in addition, the internal connection provides a center tap ground for the heaters. No balancing arrangement for d.c. plate currents in the output tubes was provided because

Stupendous! Gigantic! Colossal!

BARGAINS in RADIO EQUIPMENT



1/2" ELECTRIC DRILL
 Cannot mention brand name as we are selling below established factory price. Only \$29.95.



Equipped with 1/2" Jacobs Geared Chuck and key. Not an inter mittent duty drill, but a full sized rugged tool. Most convenient type grip handle. Free-swinging pistol-turbine type cooling-switch, extra long pressure bearing slower-extra long pressure bearing under-heaviest ball thrust cause of powerful 110V AC or DC motor and multiple ball thrust bearing. Other bearings lifetime lubricated. Amazing lifetime factory guarantee.

MODEL 592 SPEED TESTER
 By Supreme Instrument Corporation
 Fits most multimeter ranges. Accurate in speed of operation. Accuracy 1% or better. Recovers in 14 seconds and 100 rpm per volt. Senses 1/2 to 1000 rpm. 1/2 0.1 to 2500 1000 rpm. 1/2 0.1 to 2500 1000 rpm. 1/2 0.1 to 2500 1000 rpm. 1/2 0.1 to 2500 1000 rpm. Price (limited time) only \$49.95.



Special Buy AC-DC POCKET TESTER

Sensitive reputation meter in a compact case. AC-DC Model Volt-Ohm-Milliammeter. AC Volts—0-250; DC Volts—0-25; AC Ma.—0-50; DC Ma.—0-50; 8 Ohms Full Scale—100,000; Capacity—0.05 to 15 mfd. Prepaid anywhere in U.S. \$7.00. DC meter lacking AC range. \$5.50.

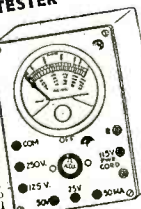

SCR—274N Command Set
 The greatest radio equipment value in history. \$59.95
 A mountain of valuable equipment. Made by Western Electric. 3 receivers covering 190 to 550 KC, 3 to 6 MC, and 6 to 9.1 MC. Receivers use plug-in coils and can be changed to any frequencies desired without conversion. Included are two 40 Watt V.F.O. transmitters, usable in ham bands, 29 tubes, crystals, and all accessories supplied.

RT1463 12 Stage Electronic Brain containing 3-7T7, 1-7Y4, 3-7N7, 4 potentiometers, numerous resistors, filter and bypass condensers, filter chokes, power and audio transformers, and six sensitive plate relays. A military development that provided amazing stepless control proportional to correction required for ailerons, rudder and elevator. In the original application, a control amplifier of the ordinary type would deflect the rudder by some arbitrary amount when the ship was blown off the course to port or starboard. The result would either be that the correction was insufficient and the plane continued off course, or the correction would be too great, sending a series of tankings that would greatly increase fuel consumption and elapsed time in reaching the objective. This phenomenal unit with its 3 amplifiers and six 5,000 ohm relays in bridge circuits, will accurately control any 3 operations, related or unrelated, in minutely adjustable uniquely quantitative variations in either forward or reverse directions. 9"x7"x8" black crackle aluminum case. Brand new in original carton, \$9.95.



Full size folded dipole with reflector and mast. Stand-off insulators included. \$4.75 complete. \$40.00 per dozen. Order No. 6430.
 Connector bars for double stacking either antenna. \$1.00 per pair.

SPECIAL ANNOUNCEMENT!! FCC THORIZES RADIO FOR PRIVATE SERVICE!!!
 (The FCC announced that effective June 1, any American over 18 years of age may be eligible for a 5 year station permit, in the Citizens' band, no code test or technical knowledge are necessary for voice transmissions.)
GENERAL ELECTRIC 15 TUBE TRANSMITTER-RECEIVER SET. This brand new 15 tube transmitter-receiver was designed for mobile storage battery powered service. Properly modified, it will operate on voice in the Citizens Band. It's a cinch for the experimenter to connect this unit for 110-volt a.c. operation by following the instructions and diagrams supplied, which cover numerous applications, including FM and amateur television transmission and reception. For those intending to use on car or boat, a new dynamotor, exactly as originally supplied, costs only \$15.00. Don't fail to write for FREE descriptive bulletin. Order our RT-1248 for only \$29.95, or two for \$53.90.

Latest model fan type conical with reflectors. Better on all channels, but superiority is most terrific on higher channels. A year ago we advertised an antenna that sold for over \$100.00. This antenna is hotter. \$4.75 each in lots of 10—\$40.00. Order No. 6449. \$1.00 per pair.



WINDOW ANTENNA
 For All-channel Television Reception. Precision engineered, featuring ease of installation, maximum adjustable dipole for best all-channel reception; durable aluminum and steel construction, excellent reception. Special adjustable base to fit window frame. Skillfully designed support permits horizontal or vertical positioning for maximum directional response. No. 6450 \$66.95 or 3 for \$20.00.

SINGLE-GANG CERAMIC INSULATED-VARIABLE CONDENSERS
 Ideal for high-frequency applications in receivers and low power transmitter stages. All types.

10 mmf.	10 for \$2.90	100 for \$23.00
15 mmf.	.35	2.90
25 mmf.	.35	2.90
35 mmf.	.40	3.40
50 mmf.	.45	3.70
79 mmf.	.50	4.40
100 mmf.	.55	4.50
80 mmf.	.80	7.40
160 mmf.	1.00	8.50
140-140	1.60	12.50

SPECIAL
 50 MMF. 24 plate variable cond. 22c or 5 for 99c



RT1655
 ONLY \$14.95 with Tubes
 11 tube crystal controlled superhet receiver. Covers the FM band. Ultra modern circuit. Latest type tubes. Diagram included.

NEON RADIO TESTER
 60 to 550 Volt. Selectively indicates AC, DC or RF. Instruction booklet outlining various tests on radio sets, including dead stages, shorts, and making screen grid tests. Attractive display. \$4.00.

SPECIAL
 Universal 4 lead broadcast band oscillator coil can be converted to 3 lead type by addition of jumper. Ten for \$1.00.

COMPRESSED AIR INSTANTLY ANYWHERE

Portable Air Compressor and storage tank. Ruggedly built of best material. Connecting rod ball bearing. Main shaft bearing oil impregnated. Unusual design for ever eliminates valve trouble. The common fault in air compressors. PATENTED unique air intake system increases efficiency. Tremendously over other compressors.

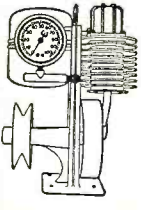

Air output is much greater than that from larger compressors powered by heavier motors. Delivers approximately 2500 cu. inches of air per minute at maintained pressure of 90 lbs., or will inflate a 60 lb. truck tire in less than one minute. Complete with 100 lb. gauge. Finger-tip adjustment allows setting of output pressure at any value, which will automatically be maintained. Works from any 1/4 H.P. motor. Greases, paints or lacquers, insecticides, anneals or brazes with natural gas, inflates tires, etc. \$14.50 postage prepaid anywhere in the U.S. Efficient, completely adjustable syphon type spray gun complete with 12 ft. of 100 lb. tested hose for only \$7.75 with pint container.

3-FOR-1 SALE ALL 3 ITEMS ONLY \$7.00

ALUMINUM GEAR BOX 18X8X7 contains two powerful electric motors and two matched gear trains, 62 gears in all varying in size from 1/2 to 4 inches in diameter. Readily converted to rotate a beam antenna or any other similar use. \$5.00.

SIGNAL CORP INTER-CONNECTOR RELAY BOX 730A

This valuable unit, BC616, made by Bell, is encased in a highly polished aluminum case 6 1/2 x 5 1/2 x 2 1/2, and contains 150 mfd. of condenser capacity, sensitive relays, resistors, and terminal strips. Order several at the giveaway price of only \$1.95.

REMOTE CONTROL UNIT—Aluminum case 4 x 3 x 2 containing 100 mfd. of condenser counter, 2 potentiometers, triple pole switch, 4 knobs, phone jack, and gear mechanism. Including 8 prong JAN connector to fit box—\$4.29.

SIGNAL GENERATOR

Genuine Laboratory-type precision signal generator. Manufactured and sold for \$88.00 each in large quantities during the war by Northeastern Engineering Corp., one of the top manufacturers of electronic equipment for the U.S. Govt. Five fundamental bands starting at 150 KC. Strong harmonics up to 120 MC. Five step ladder type attenuator as well as potentiometer output control. Regular 1000 cycle audio oscillator using vacuum tube, not a cheap neon saw tooth audio oscillator. Audio output separately available externally. Weight without packing material 16 lbs., which should show what a world of difference exists between this signal generator and the ordinary cheap oscillator used by the average serviceman. Complete with fused plug and coaxial output lead. Super Special, \$38.75.



AUDIO AMPLIFIER

Push-Pull stage triode amplifiers having 2 of the valuable and scarce oilcure type audio transformers that sell for over \$10.00 each. Neat aluminum case, fully enclosed. Perfect for intercom system, phone, mike or signal tracer amplifier for testing radio. A \$25.00 bargain at only \$3.40 each.

AC-DC Superhet Radio Kit

Extra high quality standard production line radio in kit form with complete instructions. Features 2 iron core I.F. transformers, 2 gang condensers, and polyethylene insulated edgewise wound antenna loop. Tubes include 12AT6, 12BE6, 60B5 & 35W4. Receives broadcast band from 550 to 1700 KC. Kit form \$8.75 or 2 for \$17.00. Assembled, wired and tested \$12.95 or 2 for \$25.

1000 CYCLE AUDIO FILTERS

Sharp Cut-Off • Compact High Stability • Highest Q! Low Insertion Loss • Hum Proof Navy PD52010 low pass audio filters that are the exact electrical and physical equivalent of commercial audio filters selling for \$35.00 wholesale. Far superior to surplus Radio Range Filters now being offered. Twice as selective as Q-tiver section of 274N, which has previously provided the amateur's highest standard of interference elimination. With diagram, \$2.



Splatter Chokes
 These Tapped "Splatter Chokes" are used between Class C stage and Modulator to eliminate objectionable side band splatter. DC resistance 50 ohms. Our Part No. 8660, \$1.00.

SELL OUT
 26th Edition of Radio Amateur's Handbook. Tells all, shows all, 700 pages of valuable information. \$1.50 each.

SAFETY SWITCHES SAVE LIVES
 G.E. Interlock Safety Switches eliminate fatal shocks. 40c each or 7 for \$1.00.

HURRY
 2 gang midjet superhet tuning condensers with 1/2 shift and trimmers. Reg. \$1.25 each, now 5 for \$2.00.

BUFFALO RADIO SUPPLY, 219-221 Genesee St. Dept. RN-3, BUFFALO 3, N. Y.

Performance Plus!

with the Peerless hi-quality 18 watt TRIODE output amplifier kit. Heart of this kit is the Peerless S-240-Q output transformer, conclusively proved superior to all competition in square wave tests. Amplifier's response is flat from 20 to 20,000 cps for radio input. Phono input is equalized for variable reluctance pickup. Simple modification adapts amplifier for use with microphone. Kit contains all basic components and instructions for assembly.

1161 N. VINE ST., HOLLYWOOD 38, CALIF.
161 SIXTH AVE., NEW YORK 13, NEW YORK



SQUARE WAVE TEST
PROVES PEERLESS BEST

10722
Triode
Amplifier
Kit



PEERLESS Electrical Products Division



RIGHT—for fast assembly!
RIGHT—for real dependability!
RIGHT—for easier installation!

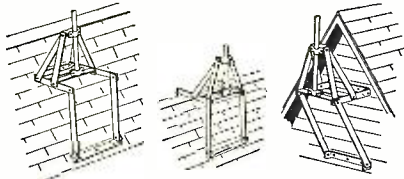

Phoenix UNIVERSAL Speed-Mount PAM-3

Mounts on flat, sloping, peaked roofs and perpendicular walls. Holds any size pole 1" to 1 1/2". Strong, easily installed—all steel construction.

SEE US AT THE SHOW—BOOTH 618

PHOENIX
ELECTRONICS, INC.
Lawrence, Mass.

AT LEADING
JOBBER'S
Write for
folder V of
complete line
of television
accessories.

Leotone FACTORY SPEAKER REPAIRS SINCE 1927

"ALNICO" MAGNETS—New Experimental Kit of powerful Bar, Block, "U," Ring, etc.
Kit of 10 ass'd. \$1.98
CABINET DRAW SLIDES—for CONSOLE CHANGERS, RECORDERS, XMTR RACKS, etc. Smooth ball-bearing action. Shpg. wt. 2 lbs. pair.
9" extension (12" overall) \$1.89 pr.
11" extension (15" overall) 2.19 pr.
12 1/2" extension (16 1/2" overall) 2.89 pr.
Hvy. duty, all-steel, 12 1/2" / 16 1/2" 2.89 pr.
LID SUPPORT (Stay Hinge). Hvy. spring type59
W-110B ARMY FIELD WIRE—Twisted pair, weather-proof. Avail. only in rolls 150-350 ft. ea. Shpg. wt. 4 lbs. per 100 ft. SPECIAL 1/2¢ FT
PERFECT CONDITION

STRETCH THOSE \$\$\$... ORDER TODAY
LEOTONE'S "JUMBO RADIO PARTS KIT"—Your best buy in New & Dismantled Radio & Electronic parts—17 FULL POUNDS of: RESISTORS, CONDENSERS, SPEAKER ACCESSORIES, WIRE, HARDWARE, SOCKETS, COILS, ETC., ETC. All these (shpg. wt. 21 lbs.) and MUCH, MUCH MORE. \$2.95

BRAND NEW METER SPECIALS!!!
0-9V. DC. 2 1/2" sq. 1.29
0-100 DC AMPS. with shunt.98
PORTABLE DC AMMETER—0-15 AMPS. COMPLETE WITH CONVERSION DATA TO MAKE "VOLT-OHM-MILLIAMMETER." 3 1/2" mirror scale, int. shunt. PERFECT AS IS FOR TESTING: Electric Appliances, Batteries, Auto, Industrial & Medical Eqpt. With 36" test leads & hinged lid metal case. Shpg. wt. 6 lbs. AND ONLY. \$3.95
RADIO HARDWARE TREASURE—A FULL POUND OF NUTS, SCREWS, LUGS, WASHERS, ETC. All in handy SELF-SEALING HINGED LID CAN. 49¢
120" WHIP ANTENNA—3 steel screw-in sects. with hvy. duty spring base. Shpg. wt. 4 lbs. \$1.98
POWER RHEOSTATS—50W—50, 300 or 500 ohms. 1/4" shafts, standard makes. \$1.29
BRAND NEW METER SPECIALS!!!
EXPERIMENTAL TUBES—for Servicers, Experimenters, Students. Fil. tested. Kit of 20 ass'd. \$1.00
TUBE CARTON..... Per 100
Miniature (1" sq. x 2 1/2") \$0.98
GT size (1 1/4" sq. x 3 1/4") 1.25
Medium (1 1/2" sq. x 4 1/4") 1.49
Large (2" sq. x 5") 1.79
HIGH FIDELITY CRYSTAL MICROPHONE—Sensitive diaphragm, hi-imped. (1 3/4" OD, 1/4" deep). Rubber Shock Mt. Less housing. 98¢
Aluminum Housing for crystal mike. 15¢
BARGAIN KIT SPECIALS!!!
WIRE-WOUND RESISTORS—5-20 watt. 15 ass'd. \$0.98
WAFER SOCKETS—4 to 8 pin. 12 ass'd.25
KNOBS—Wood, Bakelite. Set-screw, push-on, etc. 25 ass'd.98
Min. order \$2.00. 20% deposit on all COD's. Please add sufficient postage—excess refunded. Full Remittance With Foreign Orders.

LEOTONE RADIO CO.
67 Dey Street,
New York 7, N. Y.

the unique circuit and the latitude possible in the output transformer made it unnecessary.

It will be noted that inverse feedback is included in the amplifier. Inverse feedback is usually thought of as being used with beam power amplifiers, but the circuit is not confined to beam tubes. The benefits of inverse feedback are just as real with triodes. Approximately 7 db. of feedback is used, the feedback loop including five stages and the output transformer. More than this amount of feedback could have been used, but it was found that this amount produced optimum results. It should be pointed out that the value of the feedback resistor, R_{20} , must be changed should the output transformer be strapped for other secondary impedances.

When the output transformer is strapped for a 16 ohm load, the internal impedance, looking back into the winding, is approximately 2 ohms. Thus the damping factor, the ratio of load impedance to internal impedance, is 8 and thus the amplifier will adequately damp a high efficiency loud-speaker.

The power supply is conventional, using two high capacity filter condensers and a resistor to provide hum-free power. The resistor is used in the negative lead to provide, at the same time, grid bias for the power amplifier stage. (See schematic diagram, page 56.) The type 5V4 rectifier tube was used as it has a low internal resistance resulting in an increased d.c. plate supply voltage.

Another effect of primary concern to the user is hum. Assuming that the high voltage winding is properly center-tapped, hum can be produced by the stray magnetic fields from the power transformer. In some shell type designs, utilizing a single coil, the stray magnetic field may extend to audio transformers as far as three or four feet away, producing a hum that all the power supply filtering in the world will not eliminate. While the power transformer used in the A-100A Amplifier is of this shell type construction, it does have interesting features. The core operates normally at a flux density of 10,500 gauss and the cross sectional area of the core is uniform. The exception, of course, is at the joints where only one-half of the core is continuous. It is the concentration of flux at these points which contributes so greatly to the large external field normally encountered in small transformers of this type. Here though, the interleaving of the laminations is in a 2x2 arrangement so that the transverse flux path resistance is increased to the same order as that of the air gap between the single layer E and I pieces.

While this arrangement reduces to some extent the structure permeability and increases the reactive exciting current, it also produces a more uniform flux distribution in the core, particularly at the joints. The reduction of flux "hot spots" reduces the exter-

nal field. It also reduces the in-phase exciting current by an amount greater than the increase in reactive exciting current.

Therefore, two advantages result: (1) The external field is more uniform and less intense and (2) the over-all I^2R losses (in both core and copper) are reduced.

The completed amplifier performs exceptionally well when tested with square waves, the square waves showing at a glance the frequency response, phase distortion, and transient response. Fig. 5 shows traces of square waves passed through the entire amplifier. At 20 cycles the square wave shows some linear tilt which is caused by a slight phase shift. This tilt must not be confused with the exponential decay caused by lack of primary inductance often observed in inferior output transformers. The good high frequency response is confirmed by the fine square waves at fundamental frequencies up to 20,000 cycles. There is no transient oscillation and only a little phase shift up to almost astronomical frequencies, as the square wave covers frequency and phase characteristics up to at least 20 times the fundamental. Square wave testing is becoming increasingly important as the performance of audio equipment is continually improved and has been widely publicized in connection with output transformer performance.

-30-

HAMFEST

THE Starved Rock Radio Club of Utica, Illinois, has planned its annual Hamfest for Sunday, June 4th.

The event will be held at Boy Scout Camp Ki-Shau-Wau like last year's hamfest. The usual arrangements are being made to assure an interesting time for all. Mobile operation will be stressed and those operators who keep a good log of their mobile work enroute to the meet will be rewarded for their trouble.

Registration is \$1.00 in advance or \$1.50 at the gate. Lunch will be available at the camp or those attending can bring their own lunches. Advance registration should be in the mail on or before May 25th to insure return of registration tags.

Registration requests should be sent to George E. Keith, Secretary, The Starved Rock Radio Club, Box 22A, Utica, Illinois.

-30-

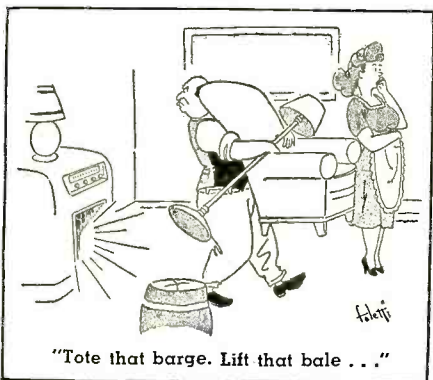

May, 1950

CLEARANCE SALE

DRASTIC PRICE REDUCTIONS ON DOZENS OF SHORT-LOT AND OVERSTOCK ITEMS!

These are real values . . . prices are absolute rock-bottom!

FL-8 FILTER

AND "FILTER FACTS" BOOKLET

BRAND NEW

Both for

98¢

TUBES . . .

316A, (WE)	\$.049 ea., 4 for \$1.80
815	1.15 ea., 4 for 3.95
826	.39 ea., 4 for 1.00
829	1.35 ea., 4 for 5.00
807	4 for 3.95
615, (HY)	.29 ea., 4 for 1.00
114B, (HY)	.29 ea., 4 for 1.00
388A, (WE)	.49 ea., 4 for 1.80
708A, (WE)	.39 ea., 4 for 1.40
8012	.75 ea., 4 for 2.80
532	.39 ea., 4 for 1.40
211	2 for .90
836	2 for 1.10
5MP1	1.25 ea., 4 for 4.40
20-4 Reg. tube.	.15 ea.
3FP7	1.25 ea., 4 for 4.40
3DP1A	2.50 ea.
805	2 for 6.50
2X2	.39 ea.
5U4	.39 ea.
5Z3	.39 ea.
6AC7	.39 ea.
6K7GT	.30 ea.
6SN7GT	.45 ea.
6L6 Metal	.90 ea., 4 for 3.40
6L6G	.79 ea., 4 for 3.00

PHONE PATCH!

Now available, the superior new O-R, #6008 phone patch. Provides you with exactly what you need to patch your phone into transmitter or receiver. Featuring a bi-impedance input suitable for all mike. Both hi and lo impedance outputs to insure proper match to your particular receiver. Unit is complete—'sure-fire' ready to go to work for you. Only \$3.95 ea.

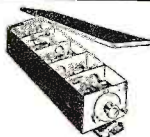

R-1/ARR-1 RECEIVERS

See January "Radio News" for dope on making a fine converter from this receiver. Clearance price! Now, only \$6.95

Push-Button Tuner

P-B tuner assembly from BC-603. Has ten PB with adjustable cams. 50 mmf variable and 10 air trimmers. A precise unit with many uses. Trimmers alone worth far more than the asking price. Brand new, original packing. Only \$1.95 ea.

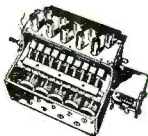

AN-75-D WHIP ANTENNA

A great buy for you mobile men. 7'3" collapsible to 14". Has 9 sections—corrosion-proof brass. Sturdy bakelite mount with jiffy wing-nut fastener. These sold formerly at \$2.50 ea. Now, BRAND NEW, only \$1.25 ea.



ALUMINUM CHASSIS

A beautiful little drawn, .025" aluminum chassis. 5 1/4" long, 3 1/8" wide, 1 3/8" deep. Bright-dipped finish. Use for RF stages, TV filters, amplifiers, etc. Only 49c ea.; 3 for \$1.35

NOISE LIMITER FOR ANY 274-N RECEIVER

Use this effective double-diode circuit between receiver output and phones to clip positive and negative noise peaks! Fully adjustable for wide audio levels. Simple, effective. KIT form, aluminum chassis, tube, all parts, complete instructions.

NL-6R. (6V. 6L1). \$4.20
NL-24R. (24V. 6L1). \$4.58

RECEIVERS:

BC-342, used but in good condition. Regularly \$79.50. Now \$39.00 ea.

CRYSTAL SETS:

A real treat for the kids, old-fashioned crystal sets. Made by Philmore. Large model, reduced to 79c. Small model, reduced to 59c. HS-16 fones, fine for above sets. \$1.35 ea. R89/ARN 5A RECEIVERS. See March Radio-Electronics for converting to FM set. Brand new, orig. boxes. Now only \$10.95 ea.

FREQUENCY METERS:

BC-221. Only a few left. Reg. \$90.00 now \$39.95 ea. Used but good condition. With original book and crystal. UHF Freq. Meter. Model 1030. Mfgd. by Hazeltine. 145 to 235 mc. Self-contained power supply. NEW. Only a few at \$39.50 (reg. \$59.50).

TRANSFORMERS-CHOKES:

2.5V, 10A. Heavy-duty, 15kv insulation. Suitable for 866, 836, etc. Only a few. Reg. \$4.95 reduced to \$2.95 ea. 5H, 400ma chokes. Fully shielded, drawn steel case. Made by Chicago Transf. Reg. \$4.95, reduced to \$2.95 ea. 10H, 50 ma choke. Strap mounting. Handy for dozens of applications. Reg. 98c, reduced to 65c ea.

CAPACITORS:

1 mfd, 6000V, oil. GE Pyranol. . . . only \$2.00 ea.

MICROPHONES:

Aircraft-type, push-to-talk mike. Button on top. NEW. A real buy! Were \$1.15 ea. now reduced to 59c. RCA Hand Mike. Hi-grade, single button. Bronze colored w/cord and plug. NEW. Were \$1.98 now reduced to 98c ea.

CODE PRACTICE EQUIPMENT:

Code practice sets. (See former ads.) NEW, original boxes. Formerly \$49.50, now \$16.95 ea. McElroy Tape Pullers. Variable speed, 115 V motor. Excellent condition, like new. Now only \$5.95 ea.

TELEPHONE EQUIPMENT:

EE89 Repeaters. (See previous ads.) Only a few left. NEW. Regularly \$9.95 ea. . . . now \$6.95 ea. EE8 Field Telephones. Used, good condition. Tested before shipment. Reg. \$18.95 pr. Reduced to \$10.95 per pair. RM-29A Telephones. BRAND NEW. With TS-13 handsets. Formerly sold at \$25.95 pr. . . . now only \$17.50 per pair. Used handsets. Reg. \$2.95 ea. . . . now \$1.85 ea.

RU-16 RECEIVERS

With conversion sheet.

With 3 coils, used, \$ 4.95
good condition. Only

NEW, with 5 coils
and plug. Only \$ 16.95



Just arrived . . . limited quantity SMALL PRECISION LATHE—110-V. AC

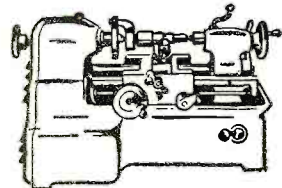

Now with
Larger
Motor
\$44.50

A small lathe for radio shops, jewelers, laboratories, dentists, hobby-crafters, model makers, machine shops, schools, etc. Automatic Feed. Work capacity 3" between centers. Swing over bed 2". Constructed of steel and cast iron. Accurately machined and finished. Fan-Cooled Motor mounted inside the base. Complete with 1 1/4" face plate, 2 lathe centers, tool post and rocker, one lathe dog, one tool-bit and test rod.

COMPLETE ACCESSORY KIT

including 4-Jaw chuck, drill chuck, center counter-sink drill, 2 tool-bits, 2 lathe dogs, 1 face plate with 8 drilled and tapped holes, 4 collets, 1 collet chuck, 1 Allen wrench. . . . \$24.50

MINIMUM ORDER \$2.00. ALL ITEMS SUBJECT TO PRIOR SALE.
ALL PRICES SUBJECT TO CHANGE WITHOUT NOTICE.

★ 4-HOUR MAIL-ORDER SERVICE. WE SHIP ANYWHERE.

20% DEPOSIT MUST ACCOMPANY ALL ORDERS. BALANCE C.O.D.

OFFENBACH & REIMUS CO.

372 ELLIS ST. SAN FRANCISCO CALIF.

PHONE—Ordway 3-8551

Lowest prices!



SYNCHRON MOTOR

Model 600, 1 RPM, 115 Volts, 60 cycles. Brand New.

Special Price \$2.45 each

C-1 AUTOPILOT SERVO UNIT

Use to rotate beam antenna, actuate boat rudder control, etc. Contains 24 V. motor, clutch, relays, etc. Reversible. Size overall approx. 10 1/2" x 8 1/2" x 6 1/2". Ideal for light hoisting. Make your own garage door opener.



PRICE \$8.95

C-1 AUTOPILOT VERTICAL GYROS

May be used to conduct many interesting and amusing experiments. Operates from 24 V. DC or may be operated for short periods on 110 V. AC Gyro will run for approx. 15 minutes after actuating. Size—approx. 8" x 8 1/2" x 8 1/2". Govt. Cost \$1500.00. Special \$4.95



C-1 AUTOPILOT AMPLIFIERS

Three channel servo amplifier consisting of many valuable electronic parts including 6 relays, 7 tubes, etc. Unit removed from new aircraft.



Super Special \$4.95

12 V. DYNAMOTOR

WinCo Type 4156 input 13 Volts DC 13 amps. Total output 250 volts at .060 A and 300 volts .225 A. Ideal for boat or mobile use.

NEW at \$3.95 each

BEAM INDICATOR

I-82F Compass Indicator. 0-360°-5 in. dial. 26 v 400 cy. 8-12 v. 60 cy. Ideal position indicator.



New Price \$2.95 each

SAMPSEL PM MOTOR

Alnico Field 27.5 v. DC. 10,000 rpm. 1/100th hp. Ideal also as tachometer generator.



Price \$3.95 ea.

SERVO AMPLIFIER

Minneapolis-Honeywell G408AC1AC4 115 v. 400 cy. Use with a-c error signal. Price \$6.50 ea. USE WITH M.H. MOTOR G303AY2CA4. Built in gear reduction. 50 in/lb. torque. Special low price \$6.75 ea.



Edison Time Delay Relay—s.p.s.t. nor. closed. 30 v. 7 sec. to open. Sealed. 59c ea. Neon Blown Fuse Indicator—110/220 v. AC or DC 39c ea. Relay—6/12 v. DC. D.P.S.T. Special at 69c ea. Relay—6/12 v. DC. Makes one breaks one. (10 Amps.) 89c ea. Contactor—Cutler Hammer 6041H30B. (50 Amps.) Special \$2.95 ea. Tube Specials—7F7, 7N7, 7Y4 at 49c ea.

TERMS: 20% cash with order—balance C.O.D. Orders accompanied by payment in full must include sufficient postage, otherwise shipment will be made via Railway Express collect. Minimum order \$2.00.

Electro Devices
INCORPORATED
BOX NO. 1941 PATERSON, N.J.

AFCA NEWS



This Association is a patriotic non-profit organization, with chapters in most of the larger cities. dedicated to developing and maintaining efficient personnel, commissioned, enlisted, civilian, for the supply (including design and development), installation, maintenance, and operation of communications and electronic equipment for Army, Navy, and Air Force and their supporting civilian activities. It publishes a magazine "SIGNALS" at its national headquarters in Washington. Every American interested in any way in communications is eligible and invited to join. Dues are \$5.00 per year. Application should be submitted to the secretary at 1624 Eye St., N. W., Washington 6, D. C., who will furnish details upon request.

CHAPTER NOTES

Augusta—Camp Gordon

On March 3rd the chapter celebrated the 87th anniversary of the founding of the Signal Corps with a dinner-dance at the Camp Gordon Officers' Club. In keeping with the occasion the principal address, given by Lt. Col. Royal S. Copeland, was devoted to a review of the history of the Signal Corps and current developments.

Prior to the meeting, members availed themselves of the opportunity to review the exhibits and parade at Camp Gordon which marked the anniversary.

Baltimore

The Baltimore Chapter featured a talk on "Frequency Resources and National Policy" by Federal Communications Commissioner E. M. Webster at its February 23rd meeting. This was Commissioner Webster's second appearance before an AFCA chapter this year, having addressed the New York Chapter in January.

The meeting took place in the auditorium of the Pythian Building and was presided over by Chapter Chairman E. K. Jett of the *Baltimore Sunpapers* Station WMAR. He introduced Col. George P. Dixon, AFCA's new Executive Secretary, who spoke on "AFCA Present and Future."

Chicago

The Chicago Chapter's March meeting was held at the *Motorola Inc.* plant with Robert W. Galvin, executive vice-president of the company acting as host.

In the absence of Oliver Read, the Chapter's 1st vice-president, Dwight

Brown, presided during the meeting.

D. E. Noble's speech on "Motorola's Program for Decentralization of Facilities" was read for him as Mr. Noble was detained in Phoenix. Henry Magnuski spoke on the company's microwave equipment and John Doremus discussed "Recent Developments in Mobile Communications and Selective Signalling." A tour of the *Motorola* plant followed the talks.

Far East

Despite the handicaps of a widely scattered area and a transient membership, the Far East Chapter is carrying out a program which is receiving the enthusiastic support of its entire membership. Activities are conducted by the individual posts and are climaxed by an annual meeting of the entire chapter each spring.

The following is a round-up of post news:

Okinawa Post: New officers were elected at a meeting held at the Ryukus Command Signal Office on November 25th. Col. Joy T. Wrean, commanding officer of the 97th AAA Group, was unanimously elected president. Other officers elected were: 1st vice-president—M/Sgt. Royle E. Morris; 2nd vice-president—Lt. Col. Clarence H. Lewis; Secretary—Capt. J. A. Beauregard; Treasurer—DAC Carl P. Dunkel.

Maj. J. W. Powers, outgoing chapter president, then introduced the Army and Air Force Military Amateur Radio System directors, and Capt. George H. Schmidt, of the 11th Signal Service Battalion, MARS director in Rycom, explained the proposed activities of his organization in the command.

The program closed with the film "The Battle of Okinawa."

On February 14th, members of the Okinawa Post toured the communication center of the Rycom Signal Section. After an explanation of visual screen teletype messages, the group sent and received teletype messages to and from the Tokyo Post of the Far East Chapter, AFCA.

Following this, visits were made to the ship-to-shore radio station, the center's terminal and relay section, the facilities control operations room and the Rycom telephone exchange.

Philippine Post: The Philippine Post was organized at Clark Air Force Base during the fall of 1949. Officers of the post are: Chairman—Maj. Forrest V. Diehl; 1st vice-chairman—Manuel A. Vargas; 2nd vice-chairman—1st Lt. Wyatt L. Law; Secretary—Capt. Bernard R. Grossman; Treasurer—SFC William A. Finney.

TWIN-TRAX TAPE RECORDERS

feature

- WIDER FREQUENCY RESPONSE
- GREATER DYNAMIC RANGE
- LONGER PLAYING TIME
- - - - and lower price!



For the Home \$285



Broadcast Studio \$375



Educational Institution \$335



Wired Music System \$495



Experimenter \$89.50

AMPLIFIER CORP. OF AMERICA

Professional-type specifications that mean professional quality, operating ease, and trouble-free construction that you would normally associate with recorders selling at \$1000 and more. Yet the Twin-Trax Recorder series is available to you direct from the factory at low factory prices, starting at \$285 for complete high-fidelity recorders, and \$89.50 for precision-built basic tape transport mechanisms.

If you are thinking of buying a tape recorder, or if you use recorded sound for any purpose—for personal enjoyment or in your business, there is a Twin-Trax instrument for you. There are more than 30 standard and special Twin-Trax models available, including continuous-playing instruments, two-speed models, 24-hour recorder, etc.

Learn why Twin-Trax is the only professional recorder in the popular-price field. Save many dollars by dealing direct with the factory. Write today for illustrated 16-page catalog, including complete technical data.

*TRADE MARK REG. U.S. PAT. OFF.

398-2 Broadway

New York 13, N. Y.

SAVE

THAT GOOD LOOKING OLD CONSOLE
WITH THE OBSOLETE RADIO!

install a modern

ESPEY AM/FM CHASSIS

and your favorite console is "right-up-to-date"

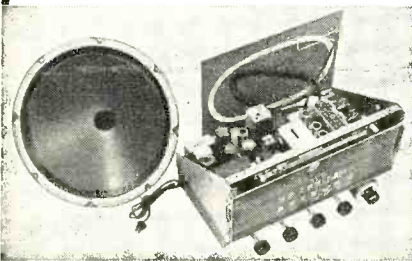

Rated an excellent instrument by America's foremost electronic engineers. Fully licensed under RCA patents. The photo shows the Espey Model 511, supplied ready to play. Equipped with tubes, antenna, speaker and all necessary hardware for mounting.

ATTENTION SERVICEMEN—Did you know there are over 19 million consoles waiting to have a modern AM/FM chassis installed? Here is a gigantic sales market just waiting for you to develop. In fact there are thousands of out-moded radios in your "backyard" just waiting to be replaced.

VISIT OUR BOOTH 406 AT THE PARTS SHOW

Makers of fine radios since 1928.

Write for literature RN for complete specifications on Model 511 and others.

ESPEY

TEL. TRafalgar 9-7000

MANUFACTURING COMPANY, INC.

528 EAST 72nd STREET, NEW YORK 21, N. Y.

May, 1950

LOOK
who's
excited...

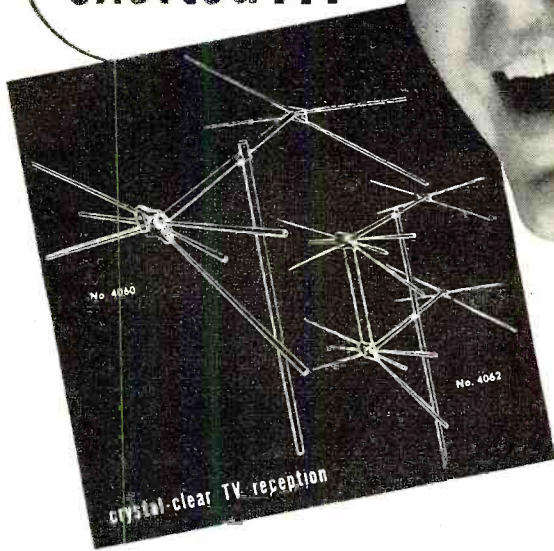

"selling

WALSCO

faster than all others!"

It's no trick to sell WALSCO. Dealers and jobbers from coast to coast report amazing sales volume with WALSCO TV Antennas.

WALSCO offers several exclusive advantages available in no other antenna.

ONLY WALSCO features a silicone-treated styron molded insulator.

ONLY WALSCO uses marine type high tensile chromium aluminum alloy for elements... with a yield point 94% higher than ordinary aluminum.

ONLY WALSCO uses butt-seamed tubing for elements to assure the highest elasticity.

WRITE FOR FREE ILLUSTRATED CATALOG 94-R

WALSCO new TV Alignment Tools are used everywhere. Available at your local jobber.

WALTER L. SCHOTT CO

Beverly Hills, California • Chicago 6, Illinois

139

INVENTORY SALE ALL PRICES CUT TO BONE

25¢ TUBE SALE—#53-2A7-55-27-85-31-
56-57.....6 for \$1.00

12 BRAND NEW 10" PHONO RECORDS—Ass't.
Jazz—Pop—Hilbilly—Polkas.....\$1.79

WOOD MIDGET CAB. 8 1/8x5 7/8x4 1/4"......69c

Slightly used Phono Records, Popular, Jazz, etc.
Ass't.8 for \$1.00

POWER PACK KIT

COMPLETE COMPONENT PARTS for Heavy Duty Power
Pack. Made from Signal Corps Brand New Parts—
Delivers approx. 350 volts—150 mls. 1 Plate Trans.,
1 Filament Trans., 2 Chokes and Schematic Diagram.
U. S. Gov't cost over \$60. Shipping wt. 30 lbs.
SPECIAL PRICE.....\$3.49

JONES 20 TERMINAL BARRIER TYPE STRIP.....25c

Signal Corps Phones—2 M. Ohms (8 M. Ohms
Imp.).....\$1.00

2 Ft. Ext. Cord (and Plug).....40c

OIL FILLED FILTER CONDENSERS

1—MFD—2000 volts.....75c ea.
1—MFD—1000 working volts.....6/99c; 12/\$1.75

FAMOUS BRAND RECORD CUTTING HEAD
Size 1 3/8x2 1/4 ready to fit your cutting arm or
bracket. SPECIAL.....\$2.95

TUBE TUBULAR ELECTROLYTICS

20-20 MFD. 150 V. .25c 30-30 MFD. 150 V. .30c
40-40 MFD. 150 V. .32c

2 1/2 M.H. R.F. CHOKE COIL—27c ea. 5 for \$1.00

3 BAND OVAL DIAL—7 1/2" L x 5 1/2" H......60c

100 RESISTOR ASST. 1/4-1/2-1 WATT......95c

Low-Loss Short Wave

Lock Type Air Trimmer
Variable Condensers

3 Plate—12-15 MMFD......12c
8 Plate—30-35 MMFD......16c
10 Plate—40 MMFD......17c
14 Plate—56 MMFD......24c
20 Plate—80-100 MMFD......28c
27 Plate—100-110 MMFD......35c

3 GANG T.R.F.
VARIABLE COND.
D.E.S.E.R.
.000365 Con. 65c
D.E.D.T. SLIDE
TOGGLE
SWITCH......23c
2 piece 5-pole
Male and Female
Separable Plug.
Each with Flex.
Cord. 4 prs. \$1.00
35c per pr.

4 PR. WAFER SOCKETS—\$1.49 per C. each......3c

PHILCO 4 MF—300 V.—1 1/2" CAN CONDENSER—10c ea.

5-6 PRONG WAFER SOCKETS—4-5-6-7......25.50 per C.

100 ASST. SOCKETS—4-5-6-7......25.50 per C.

1,000 OHM WIRE WOUND POTENTIOMETER......15c

30 HY-FILTER CHOKE SHIELDED......39c

UNSHIELDED......39c

10 WIRE WOUND RES. KIT—5-50 W. ASST......49c

2,000 ohm Wire Wound Rheostat.....\$1 per doz

CARTER WIRE WOUND C.T. VARIABLE 20 OHM
RESISTORS......85c per doz.

RCA 6 OHM POWER RESISTORS......7.39c

PHILCO AUTO SUPPRESSORS—\$8.00 per C......7.39c

GEN. ELEC. WESTINGHOUSE, etc., 60 CYCLE WATT
HOUR METERS, slightly used, perfect condition,
same as used in your home. 110-125 volts.

10 Amps.....\$3.95

PIEZO CRYSTAL HOLDERS with cover......12 for \$1.00

Grind your own crystals—Pure Brazilian Quartz, all
sizes and thicknesses—1/2 lb. package.....\$1.00

RCA Band Switches—
3 gang. 3 pos. 3 band. 30c 6 gang. 5 pos. 4-5 band. 40c

1. C. A. 30 MH RF choke......25c

Trimmer-Padder Asst.—all isolantite—singles, dual;
triples—100 asst. pieces.....\$2.25

5"—450 ohm AC-DC dynamic speaker.....\$1.35

Philco rotary tap tone control......25c

ATTENTION: Prospectors, Explorers for Hidden Treasures!
Construct a U.S. Army Type of Metallic Mine Detector
Amplifier. Amplifier unit only (less tubes and bat-
teries) with cables, headphone cord, and jack. Army
wiring diagram. Type AN/PRS-1.....\$1.95

TUBES—024, 79c; 68C7, 35c; 117P7......95c

6 ASST. WET ELECTROLYTIC CONDENSERS.....59c

RADIO EXPERIMENTER'S SURPRISE PACKAGE—CON-
TAINS BYPASS FILTER CONDENSERS, SHORT
WAVE TUNING UNIT, POWER AND AUDIO TRANS-
FORMERS, SOCKETS, RESISTORS, CHASSIS HARD-
WARE, OVER 20 LBS. OF VALUABLE PARTS.....\$4.95

DRILLED CHASSIS FOR 5-6 tubes 5"x10"x1 1/4"......25c

RCA ADJUSTABLE CODE INTERFERENCE WAVE
TRAP 436-473 K.C......25c

PHONE JACKS—OPEN & CLOSED, Auto......18c

NATIONAL 5-15-450 VOLT CAN FILTER CON-
DENSER......39c

ERY SPEAKER VOL. CONTROL—60 OHMS......15c

SALE—PHONO RECORD ALBUMS—SALE
10"—3 comp.—15c, 4 comp.—20c; 12 comp.—49c
12"—3 comp.—15c

WESTERN ELEC. TRANSMITTING STEP-DOWN
TRANSFORMER—100, 210, 230, 250 V. W.E.
20 AMP RETARD CHOKE TO MATCH. Wt. 125 lbs.
ea. Freight Shipments Only. SPECIAL.....\$5.00 ea.

75 MFD., 25 V. Tubular Cond......15 for \$1.00

Line Noise Elim. R.F. Choke, #14 Wire......10c

4 Wire Shielded Cable, 6 Ft. with Plug...7 for \$1.00

Upright Elec. Cond. Clamps, 1 3/8" Diam..25 for \$1.00

IRC—300 Watt—300,000 OHM Wire Wound
Resistor......95c

6 Pr. Amphenol Sockets.....\$4.00 per C

Majestic 6 V. Auto Vibrator......50c

Tube Ring Holders......75c ea.; 15 for \$1.00

10 MFD., 300 V. Cond.....\$1.00 per doz.

Transmitting Filter Cond. Asst., W.E. Parvult,
RCA, G.E., Etc. Cap. 1 MFD—3 1/2 MFD..6 for \$1.00

MINIMUM ORDER \$2.00—NO C.O.D.
SHIPMENTS—PLEASE INCLUDE POSTAGE

NEWARK
SURPLUS MATERIALS CO.

Dept. MY NEWARK 1, N. J.
324 Plane Street

Tokyo Post: At a meeting of the Tokyo Post on January 10th, the following new officers and directors were unanimously elected: Chairman—Lt. Col. R. H. Mapes; 1st vice-chairman—Lt. Col. Jamie L. Wicker; 2nd vice-chairman—C. B. Allsopp, vice-president of the International Tel & Tel Corp.; Secretary—Miss Nina Jo Culver; Treasurer—Capt. D. V. Mayer.

Approximately 125 members and guests were present at the meeting. Entertainment featured showing of the film, "The Battle of Okinawa," and a social hour afterwards.

Yokohama Post: Grouped around the Headquarters Eighth Army at Yokohama, the Yokohama AFCA Post provides a fine medium for the acquaintance and association of the numerous communications personnel of the Army, Navy and Air Force in that area. Present officers of the post are: President—Lt. Col. Robert B. Tomlinson; 1st vice-president—Mr. Frank Hagen; 2nd vice-president—Capt. David M. Uhler; Secretary—Maj. Edgar DuBois.

Fort Monmouth

Although busy with arrangements for the national AFCA convention to be held there on May 13th, the Fort Monmouth Chapter took time out on February 9th to hold a chapter meeting at the Noncommissioned Officers' Club. In the absence of the president and vice-president on temporary duty, the meeting was conducted by Maj. J. D. Evans, Jr., senior member of the board of directors.

Short talks were given by S/FC Albert Cohen on the "Army Career Plan" and by M/Sgt. Pat Mulcahy on "Benefits of AFCA"

The main speaker was Capt. Henry E. Bernstein, USN, Director of the Armed Services Electro Standards Agency, who gave an interesting talk on the problems in connection with the operation and plans for the future of ASES and the results being accomplished on a joint basis in standardizing the component parts of electronic equipment.

After the meeting, a program of entertainment was presented by the Special Services School of Fort Monmouth.

New York

Admiral Thomas C. Kinkaid, Commander of the Eastern Sea Frontier, was the guest speaker at the February 23rd meeting of the New York Chapter. The gathering was held at the Third Naval District's Officers' Club in the New York Naval Shipyard, Brooklyn, and was attended by 100 members and guests.

Admiral Kinkaid discussed the growth of communications in the Navy from the use of flag and blinker signals to modern radio and radar systems, and told a number of anecdotes about his experiences with Naval communications over a forty-year period. He described a few incidents in the Battle of Leyte Gulf, where he commanded the Pacific 7th Fleet, in which

For finest performance
and longest life...

KOENIG TELE-BEAMER

ROTATOR

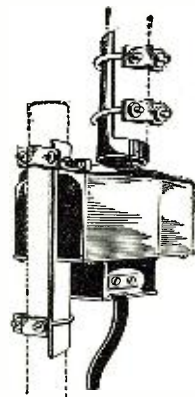

USES **2**
HEAVY DUTY
MOTORS



Koenig TELE-BEAMER Rotator... most dependable made today. Carries any weight antenna with a 3/4- to 2-inch mast; takes winds up to 80 m.p.h. Positive action push button controls; indicator shows exact position every instant. A precision, lightweight instrument; absolutely weatherproof. Electrical stops, machine cut steel and bakelite gears. Investigate TELE-BEAMER before you buy!

See your jobber or
write for folder

H. G. KOENIG

ENGINEERING COMPANY

735 Southwest Blvd. Kansas City 3, Kans.

POWER!

Your ad in the Classified Section of RADIO & TELEVISION NEWS is read by the largest audience in the field—monthly circulation—over 200,000.

TELEVISION RECEIVER—\$1.00

Complete instructions for building your own television receiver. 16 pages—11" x 17" of pictures, pictorial diagrams, clarified schematics, 17" x 22" complete schematic diagram and chassis layout. Also booklet of alignment instructions, voltage and resistance tables and trouble-shooting hints—All for \$1.00.

CERTIFIED TELEVISION LABORATORIES
5507-13th Ave., Brooklyn 19, N. Y.

**THE FACTS YOU WANT
Now at Your Finger Tips
in this Latest, Complete**

TV MANUAL

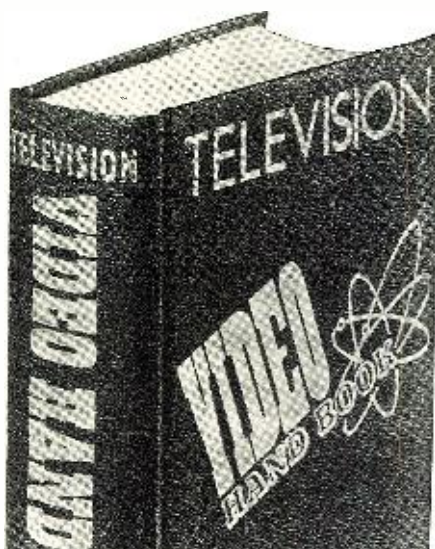

**OVER 900 PAGES—860 ILLUSTRATIONS
REALLY 14 BOOKS IN ONE**—The a-b-c of TV. Complete, authoritative. Covers every phase of television from basic through advanced data and techniques. Gives you the answers and procedures in *quick, easy-to-understand, practical* form. Photographs, charts, diagrams, schematics. *Invaluable daily reference* for engineers, technicians, executives, students, or anyone in television. *Saves you time and work.* Helps you get ahead and increase your earnings. Handsomely bound in DuPont Fabrikoid. Order this best-seller now!
Only **\$5.00**

RADIO DATA BOOK

Over 900 pages—fully illustrated. All data and basic knowledge in radio and electronics digested into 12 sections, in a complete, quick-to-find, easy-to-read handbook!
Only **\$5.00**



COMPLETE RADIO AND TV LIBRARY

SAVE MONEY by ordering both the Radio and Video Handbooks in attractive slip case. Gives you a complete library for only **\$9**

**Get them at Your Dealer or
MAIL ORDER COUPON NOW**

**BOYCE-ROCHE BOOK CO.
MONTCLAIR, NEW JERSEY**

RTV5

Please send the following, postpaid:

- VIDEO HANDBOOK @ \$5.00
- RADIO DATA BOOK @ \$5.00
- RADIO & VIDEO LIBRARY @ \$9.00
- Check or M. O. enclosed for \$.....
- Send C.O.D.

Name.....

Address.....

City..... Zone..... State.....

munications, electronic, and photographic industry.

Washington

Major General Spencer B. Akin, Chief Signal Officer of the Army, was the guest speaker at the Washington Chapter's luncheon meeting on March 7th at Fort Myer, Va., which commemorated the 87th anniversary of the founding of the Signal Corps.

During its 87 years of existence, and particularly during the last war and the postwar period, the Army Signal Corps has accomplished notable progress in communications operations, research and development, and procurement, distribution and training, because it is a member of a "team composed of science, industry and armed services," General Akin declared.

After the luncheon, which was attended by 150 members, the group toured the Signal Corps station WAR, and the mobile communications center at Fort Myer and the Army Communications Center at the Pentagon.

-30-

TRANSMISSION LINE

A revolutionary telephone and television transmission line has been developed by the U. S. Army Signal Corps and dubbed the "G-String" in honor of its inventor, Dr. Georg Goubau.

The line, which is simple, highly efficient, and costs little to make, promises to open up wholly new possibilities in microwaves and home TV. It is a single wire with special insulation and funnel-shaped terminals.

The Signal Corps expects that the new line may eventually replace the more costly coaxial cable for transmission of television programs.

-30-

SIGNAL CORPS PROGRAM

WHAT promises to be the most elaborate communications and electronics program in Signal Corps history will be presented at Fort Monmouth, New Jersey, on Saturday, May 13th under the sponsorship of the Fort Monmouth Chapter, Armed Forces Communications Association and the Signal Corps.

The Fort Monmouth program is scheduled for the day following the annual National AFCA convention at the Commodore Hotel, New York, under the auspices of the New York Chapter.

The scheduled all-day program at Fort Monmouth will be highlighted by the presence of leaders in the communications and electronics fields and high-ranking officers from all branches of the Armed Services.

Convention delegates will be transported from convention headquarters in New York to Fort Monmouth in chartered buses. The program will feature elaborate displays from the Signal Corps Engineering Laboratories, the Armed Services Electro-Standards Agency, and The Signal School of Fort Monmouth; parachute drops by the 82nd Airborne Division; wire laying demonstrations by helicopter and bazooka; and a combat communication problem in which 82nd Airborne troops will figure, weather permitting.

-30-

**Have you ever
really heard FM?**

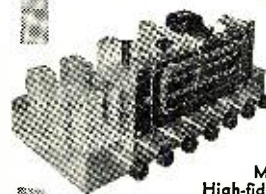

MODEL RJ-20
High-fidelity FM-AM Tuner
incorporating tone controls

To truly enjoy FM . . .

and the unmarred brilliance Armstrong-circuit FM alone makes possible — you need the performance of the RJ-20. The man who knows radio knows nothing less will give equal performance.

Music is flawless, noise-free — every instrument sounds true . . . speech is clear, with astonishing "presence". Tuning is precise and drift-free.

And for better AM . . .

Superior performance with maximum tonal quality. Wide-range tone control to suit your taste; 20 db. treble and bass boost.

Also available: RJ-12A FM-AM tuner with triple tuned IF transformers in AM, RV-10 FM tuner only. All with same Armstrong FM circuit.

Free Bulletin RN-150 gives performance curves and data on these high-fidelity tuners.



BROWNING
LABORATORIES, INC.
WINCHESTER, MASS.
ENGINEERED FOR ENGINEERS

PREMAX

SERIES "B"

Marine Antennas

Here at last! A low-cost Marine Antenna that has practically EVERYTHING any boat owner desires. It's a properly proportioned, slender, flexible center-loaded Antenna which retains all the superior radiating qualities of the large center-loaded models. It's a type "B" coil-loaded whip that will increase effective power five times over that radiated by an equivalent straight whip.

In stainless steel with heavy ceramic base. Write for complete details and special low prices.

Available with Four
Styles of Mountings

PREMAX PRODUCTS

DIVISION CHISHOLM-RYDER CO., INC.

5006 HIGHLAND AVE., NIAGARA FALLS, N. Y.

RADIO & TELEVISION NEWS

TELEVISION SCOPE

SUPERIORITY AT A GLANCE!

The vertical response of this economy TV scope is usable to 5000 kc, not 50 kc. Response is flat to 750 kc, down 3 db at 1000 kc. Amplifier supplies a voltage gain of 20 at 5000 kc.



AR-3

Check this necessary feature before you buy any scope for TV use.

The R.S.E., AR-3 Scope has been built by Ross Armstrong to our rigid specifications. It's a complete unit that embodies standard horizontal amplifier and sweep circuits with normal sensitivity.

The case is 8" high x 5" wide x 14" long, attractively finished in "hammered" opalescent blue enamel. Operates on standard 110 volts—60 cycles—40 watts. Tubes, 3BP1-6AC7-6SJ7-6X5-5Y3-884. Instructions included. Complete specifications upon request. Satisfaction or your money back.

PRICE
\$4995

AVAILABLE TO JOBBERS
IN QUANTITY

F. O. B.
DETROIT

INTERCOM & RADIO

AT A PRICE THAT CAN'T BE BEAT



6 tube superhet—3 tube intercom permits communication between radio-master and up to 4 sub-stations.

Original cost \$64.50

WHILE THEY LAST

\$2995

With 1 sub-station and 50 feet of cable
Extra Sub-stations \$3.95 each

PUSHBACK WIRE



25% BELOW MILL COST!

1st class, Essex or Lenz, ALL SOLID lined copper, double cotton serve, waxed finish.

SIZE	COLORS	100 feet	1000 feet	Production Reel
22	BLACK-BROWN	.39	3.79	3.65M
20	RED-WHITE-BLUE	.49	4.49	3.95M
18	BROWN	.69	5.98	

ORDER INSTRUCTIONS

Minimum order—\$2.00. 25% deposit with order required for all C.O.D. shipments. Be sure to include sufficient postage—excess will be refunded. Orders received without postage will be shipped express collect. All prices F.O.B. Detroit.



Demand This Seal of Quality

Quantity and Export Orders Solicited

RADIO SUPPLY & ENGINEERING CO., Inc.
89 SELDEN AVE. DETROIT 1, MICH.

It is also possible that the calibration might be made with the aid of a variable-speed recorder (wire, tape, or disc). Place the metronome speaker before the recorder microphone and record a full minute of operation at a given speed. Then play back the recording at a slower speed and count the beats per minute (sum total of the recording).

-30-

Built-in Antenna

(Continued from page 59)

able matching device the maximum amount of signal can be transferred into the front end. As can be seen from Fig. 1, the Philco built-in antenna is shaped in a tapered form with the narrowest part in the center. This form allows for a relatively broadband response over both the low and high bands. The antenna itself is made of two sections of aluminum foil 0.005" thick, which are attached to the tunable matching device. The foil is mounted to the underside of the top of the cabinet, and its ends are folded over. This folding has the effect of adding capacity and thus lowering the natural resonant frequency of the dipole. This increases the electrical length of the antenna.

Tuning this system consists simply of tuning a variable condenser connected across the terminals of a hair-pin coil which has two shorter loops attached to it at the antenna end. A long wooden rod is attached to this condenser and projects through the cabinet front so that it can be adjusted.

To understand just how this system is tuned it is necessary to fall back on resonant circuit theory. The dipole may be represented as a series resonant circuit. This is shown simply in Fig. 2. As is known from resonant circuit theory, a series resonant circuit will look inductive below resonance and capacitive above resonance. The tunable matching network may be represented as a parallel resonant circuit. This is also shown in Fig. 2. It can be seen that, above resonance, the circuit is inductive; below resonance, it is capacitive. If we draw a curve for this effect and plot reactance (X_L and X_C), against the frequency, we obtain Fig.

Fig. 4. Position of Philco's built-in antenna tuning knob in relation to the twelve assigned video channels.

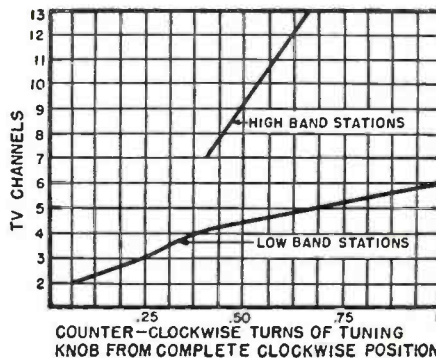

ALMO SPOTLIGHT SPECIAL ELECTROLYTICS!

PART NO.	CAPACITY	VOLTAGE
C-100	4	50
C-101	10	25
C-102	20	25
C-103	25	25
C-112	20-20	25-400
C-114	8-8	300
C-115	200-30-30-50	10-25-100-150
C-116	4	150
C-118	25-10-20	25-300-350
C-121	40	300
C-122	40-40	150
C-123	10-30-30	25-150-150
C-129	10	475
C-130	30	200
C-135	20-20-40	25-150-150
C-136	30-30	200
C-138	10-40-75	250-250-250
C-139	16	400
C-142	1000-250	6-10
C-144	20-16-40	25-150-150
C-149	10	300
C-151	90	10
C-153	50	50
C-155	25	25
C-160	100	6
C-165	12	500
C-166	12	450
C-174	2x30	150
C-177	20-40	150
C-183	30	300
C-188	100	6
C-189	20-30	200-25
C-190	1000	6
C-191	10	150
C-195	200	25
C-196	16	250
C-202	20	250-25
C-203	4	450
C-205	25	25
C-208	16	25
C-211	40	250
C-214	15	450
C-215	4	250
C-217	40-40	150
C-218	16-16	150
C-219	8-8	450
C-220	8-16	450
C-221	8-8-8 (Can)	450
C-222	20-20	350
C-223	12	250
C-224	8-4 (Can)	450
C-225	10-20	150
C-227	16-25-25-25	450-25-25-25
C-231	150	50
C-233	8-16-4-50	450-425-250-50
C-236	75	250
C-239	30	300
C-241	20-20	400-25
C-242	40-30	150

SINGLE SECTIONS.....19c
DUAL-TRIPLE-
QUADRUPLE SECTIONS.....29c

10% CASH WITH ORDERS

ALMO RADIO CO.

509 ARCH STREET • Philadelphia
6205 MARKET STREET • West Phila.
6th & ORANGE STS. • Wilmington
4401 VENTNOR AVE. • Atlantic City

FOR BARGAINS IN

Receivers, Transmitters, Amplifiers, Television Sets, Batteries, Surplus Parts, Phonograph Records, and many more items

Read
RADIO AND TELEVISION NEWS
Classified Columns Every Month

Mass. Radio School

273 Huntington Ave., Boston 15, Mass. Offers Training Courses for Radio Technician (Pre-Television) and Licensed Radio Operator (All Types) including maintenance and operation of General Electronic Equipment. Over 20,000 Alumni and 30 years' radio-training EXPERIENCE. Courses approved for Training for Veterans.

Send for Catalog

Licensed by Commonwealth of Mass.
Department of Education

RADIO & TELEVISION NEWS

FREE!

1000' OF TV TWIN LEAD

WITH EVERY PURCHASE OF 12 TV ANTENNAS AT ONLY \$5.55 EACH! Record-Low-Price

FREE! A giant 1000 ft. reel of .045 web heavy-duty 300-ohm twin lead with every lot of 12 of our famous-make double-folded dipole (with reflectors) duo-orienting TV antennas!

FREE! A giant 1000 ft. reel of .045 web heavy-duty 300-ohm twin lead with every lot of 12 of our famous-make double-folded dipole (with reflectors) duo-orienting TV antennas!

SPECIAL! Antenna Kit worth over \$10. yours for only \$8.50. Includes: \$5.95 outdoor antenna. 4 stand-off insulators, \$1.95 double-strap chimney mount, 75c lightning arrester, and 75 ft. of twin lead worth \$1.15. **ONLY \$8.50**

SAVE \$10 On This 400 VDC @ 200 Mills Power Supply Kit!



YOURS for only \$7.95

Designed for revrs, xmtrs, testers, oscillators, preselectors, monitors, amplifiers and other applications requiring a well filtered supply. Kit includes: power transformer, choke, two 10 mfd at 600 V oil-filled condensers, 5T4 rectifier tube, octal socket, 7x11x2" aluminum chassis, and line cord! Gives a well-filtered supply of 400 VDC at 200 mills with less than 1% ripple. Has secondary voltages of 6.3 V at 4.2 amps; 5 V at 3 amps.

DELCO (G-M) DUAL AC BLOWERS



SALE! NOW ONLY \$14.85 POSTPAID

Brand new! FAR below regular price! Ideal for darkrooms, cooling xmtr tubes, draft boosting, humidifiers, dryers, ventilation, suction, shipboard, etc. Continuous duty, brushless, 115 V 60 cy. Operates at 2900 rpm. 200 cfm free vol. air delivery. 82 watts input. Overall 10 1/2" by 5 1/2" by 6 1/2"



CRYSTAL MIKE \$2.85

Record-Low-Price Lowest price EVER! Exclusive special purchase of a famous-maker's \$6.50-value crystal mike (crystal element alone is exact replacement for his \$10 unit)! Excellent response 100-6000 cycles. Ideal for public address, entertainers, hams, recording, etc. Streamlined metal case, 6 1/2 ft. cable. Sensitive!



DEMAND ONLY \$2.49

Made by Stewart-Warner, No. 748A-RB, worth \$5-10 times our POSTPAID sale price! 20 amp range, thermally operated, 2-wire, for 600 volts or less. Accurately checks transformer loading, load distribution, etc. Metal case 4 1/2 x 3 1/2 x 2 1/2"

FREE 152-PAGE CATALOG

GET THE WHOLE STORY IN THIS FREE CATALOG — Radio Shack bargain mail-order catalog is best in the U.S.A. Profusely illustrated! An encyclopedia of radio-electronic equipment, tools, books, sound systems, plus war surplus and special buys! Rush request today. — Ask for free catalog 50-RM —

The RADIO SHACK Corp.
167 WASHINGTON ST., BOSTON, MASS.

NEW TV PRODUCTS on the Market

19-INCH CONSOLE

Among the television receivers unveiled by *Motorola, Inc.* recently is the

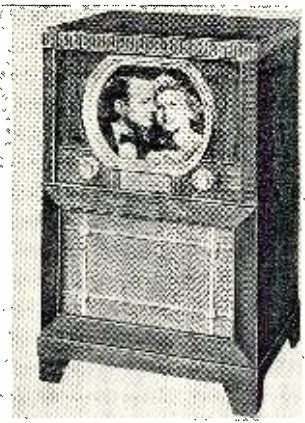

Model 12K2 console which retails in the moderate price class.

Featuring a furniture-styled cabinet and simplified controls, this 22" wide, 36" high, and 18 3/4" deep set is available in either mahogany or limed oak finishes.

The receiver has the new "flywheel" a.f.c. circuit which keeps the picture clear and steady despite noise and changes in signal strength, according to the manufacturer. A built-in antenna and target tuning are also features of this receiver.

The sets are being manufactured at the Company's plant at 4545 Augusta Boulevard in Chicago, and further information may be obtained from this address.

SIGNAL GENERATOR

A miniature TV-FM signal generator for the service technician has been put on the market by *Oak Ridge Products*, 239 East 127th Street, New York 35, N. Y.

The new model "103" is said to pinpoint any signal failure from antenna to cathode-ray tube or speaker in less than two minutes. Incorporating three

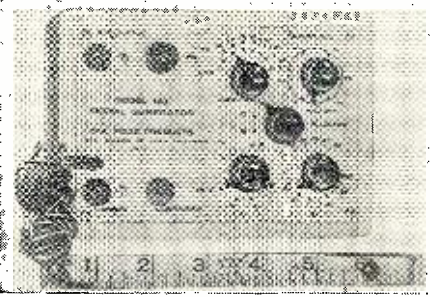

separate tuning bands and modulation output and attenuator for TV and FM, the unit generates a signal to perform as a complete r.f., oscillator, and mixer tester, video i.f. tester, audio i.f. tester,

and as a checker for the video and audio second detector, the video and audio amplifiers, sound traps, adjacent picture traps, and as a marker generator, antenna orientation and sensitivity tester.

TV ACCESSORIES

The *LaPointe Plascomold Corporation* of Unionville, Conn., has added two new items to its line of television accessories.

Production is under way on a lightning arrester for use with the four-wire control cable employed with antenna rotators. Designated the Model RW 204 arrester, the new unit is designed to serve dual purposes in that it may also be used for standard 300 ohm ribbon transmission line. It is supplied in a low-loss polystyrene case which will not absorb moisture nor deteriorate from weather. Pin point contacts eliminate the need for wire stripping.

The second item recently introduced is a three-way antenna switch for multiple antenna installations. The new unit allows the use of a separate transmission line for each antenna in

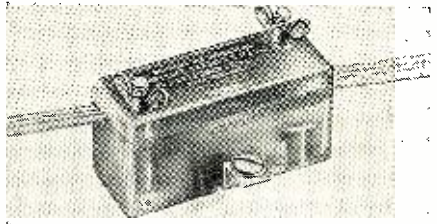

such installations and provides maximum performance from each antenna. By a simple turning of the knob the viewer can change over instantly from one antenna to another. The switch is also suitable for television dealers when demonstrating more than one receiver from a single antenna.

MATCHING TRANSFORMER

To prevent mismatch between a folded dipole antenna and the coaxial lead and to prevent loss of signal, *American Phenolic Corporation* of Chicago 50, Illinois, has recently developed a new matching transformer.

The new unit employs *Amphenol* four-conductor twin-lead specially connected to provide a transformation in impedance from 300 ohms down to 75 ohms. It is particularly useful in matching 300 ohm transmission line to 72 ohm or 75 ohm input television receivers or providing an efficient match between any 300 ohm antenna and a coaxial 75 ohm line such as might be used in an area of high noise level.

The terminals on the transformer are spade type lugs at each end of the

You' Have A he Answers

EVERY MONTH, RADIO & TELEVISION NEWS' alert, authoritative knowledge of today's trends assures you of being fully prepared for tomorrow's big developments. It's a profitable habit to read every issue.

HERE ARE A FEW FEATURES FOR JUNE:



..... Custom-Built Projection TV
is Still Profitable

..... A Portable 40 Meter
C. W. Station

..... Linearity Tests
with an Oscilloscope

..... Mobile Antenna for
75 Meters

..... Many Others

ENJOY ALL THE ADVANTAGES OF EXPERT
RADIO & TELEVISION NEWS GUIDANCE . .
THE CONVENIENCE AND CERTAINTY YOU
WON'T MISS A SINGLE VITAL ISSUE

Subscribe
Today!

USE MONEY-SAVING ORDER CARD FACING THIS PAGE

ZIFF-DAVIS PUBLISHING COMPANY • 185 N. WABASH AVENUE, CHICAGO 1, ILLINOIS

PUBLISHERS ALSO OF RADIO-ELECTRONIC ENGINEERING EDITION OF RADIO & TELEVISION NEWS • POPULAR PHOTOGRAPHY • FLYING • MODERN BRIDE
May, 1950

Here's Your Complete Kit-- PEERLESS High-Efficiency Triode Amplifier

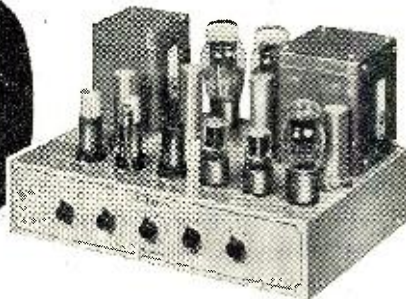

This great amplifier, featuring high efficiency triode design and described in an article by Mr. Melvin C. Sprinkle in the current issue of Radio & Television News is supplied in complete kit form by Sun Radio & Electronics Co., Inc.--since 1922 one of America's favorite parts supply houses, reknown for its friendly, square-dealing service.

PEERLESS KIT: contains 4 Peerless transformers, chassis, bottom plates, RC mounting board, all instructions and diagrams \$46.80

SUN ACCESSORY COMPONENT KIT: contains all additional parts needed--sockets, switches, wire, plastic case capacitors, tubes, knobs, connectors, everything. . . \$28.50

TOTAL COST, both kits complete \$75.30
(Either kit sold separately)

FAST MAIL ORDER SERVICE TO ANY PART OF THE UNITED STATES. Send full amount to speed handling, 25% required with COD's.

We are exclusive distributors in the New York area for Peerless transformers -- not only for this kit but for the complete line of high-fidelity audio, power and other types of transformers and chokes. Write us for the Peerless catalog.

FEATURES

Response: 20-20,000 cps \pm 0.5db. 15W output at 4% Intermodulation Distortion. 7db of feedback around 5 stages & output transformer. Cathodyne phase inverter. Cathode follower driver. Fixed bias. 8 tubes: 2 - 6J7, 1 - 6J5, 2 - 6SN7, 2 - 6A5G, 1 - 5V4G. Equalized for GE, Pickering pickups. Terminal strip for easy construction, servicing. Peerless transformers.



transformer section which should be operated fully open or in a very loose coil. Tight coiling is unnecessary, according to the company.

HIGH-VOLTAGE PROBES

Two new high-voltage probes, designed for use with popular low-current voltmeters to provide safe, convenient and accurate means for measuring high voltages in high-im-

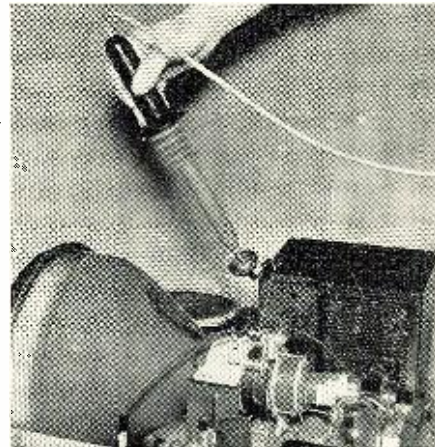

pedance circuits such as those found in television receivers and broadcast transmitters, have been announced by the Tube Department of *Radio Corporation of America*.

The two probes, Types WG-289 and WG-290, are identical except for their connectors. The WG-289 is designed for use with electronic voltmeters and is equipped with a microphone-type connector. The WG-290, for use with non-electronic voltmeters, has phone-type connectors. To adapt the probes to various popularly-used makes of voltmeters, five types of multiplier resistors are available separately.

The probes are being handled by RCA test equipment distributors.

BOOSTER KIT

Tech-Master Products Company, 443-445 Broadway, New York 13, New York, is marketing a television booster kit, the Model 3375.

The unit, which is easily assembled, features fixed grid and variable plate tuning, separate coils for low and high channels, a tunable high channel input coil, pre-stamped chassis for ease in mounting parts, wood cabinet, simplified step-by-step wiring instructions, and adaptability for either 300 or 72 ohm lines.

The booster kit comes complete with the 6AK5 and pre-aligned coils. A data sheet on the kit is available.

ATTIC BEAM

Telrex, Inc. of Neptune Highway, Asbury, Park, N. J., has just introduced a new television receiving antenna expressly designed for indoor installation. Known as the Attic "V" Beam, the new unit may be easily and quickly installed. It requires no masts, towers, or guy wires and is free from all hazards.

The entire assembly folds into a compact package for easy handling

TOP THIS!!!

BUY DIRECT FROM FACTORY AND SAVE. WELL KNOWN BRANDS OF CATHODE RAY TUBES WITH ONE YEAR GUARANTEE.

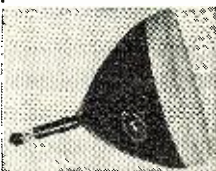

10BP4... \$21.00
12LP4... 22.95
★16DP4... 37.00
16RP4 Rectangular 37.00
★19CP4... 67.00

★Black Velour Available

★ **NEW IMPROVED** de luxe R.C.A. licensed 630 chassis not a kit but completely wired. This chassis has the following features.
★ Extended leads for 16" or 19" operation with ★ Wide angle yoke for latest picture tubes. ★ Full tube complement. ★ A.G.C. ★ Standard Coi. Tuner. ★ Voltage Doubler.

PRICED AT ONLY \$147.50 PLUS \$1.79 FEDERAL EXCISE TAX, less C.R.T.

COMPONENTS for Conversion From 10" to 16" or 19" ★ 70" Wide Angle Yoke \$4.25 ★ 13.5kv Flyback Trans. Using Single 1B3 Rectifier Tube \$3.75.

PROJECTION T.V. COMPONENTS

30 KV-RF Power Supply.....\$99.50
F1.9 Bausch & Lomb Lens..... 59.50
Projection Metal Cabinets for 630 Chassis Finish in Grey Wrinkle—Ideal for Commercial Installations for Pictures up to 7x9 Ft. . . . Rear Projection Screen 2x3—3x4—4 1/2x6—6x8 @ \$3.00 per sq. ft. Chassis Supplied for Custom Built Remote Installations for Projection, etc. Prices on Request.

Terms 25% Deposit With Order Balance COD
FOB Newark, N. J.

CASCADE TELEVISION CO.
179-181 SOUTH STREET, NEWARK 5, N. J.

Need information on

TELEVISION?

you can find what you want in the

ELECTRONIC ENGINEERING MASTER INDEX.....with

over 1100 references on **Television!**

over 1400 references on **Servicing!**

over 3000 references on **Communications!**

over 1350 references on **Microwaves!**

... just a part of the 12,500 entries on electronics and allied engineering in the 1949 edition.

The series to date—from 1925 to the present time—total over 50,000 entries!

A "finger-tip" bibliography of world-wide periodicals, journals, proceedings, government reports, technical house organs, texts and U. S. patents.

Editions to date: 1925-1945. 1935-1945.
1946. 1947-1948. 1949.

Write today for full descriptive literature

Electronics Research Publishing Co., Inc.
Dept. RN-5, 480 Canal St., New York 13, N. Y.

and placement and then opens up completely assembled into a full two-bay Conical "V" Beam array, complete with transmission line. The array is

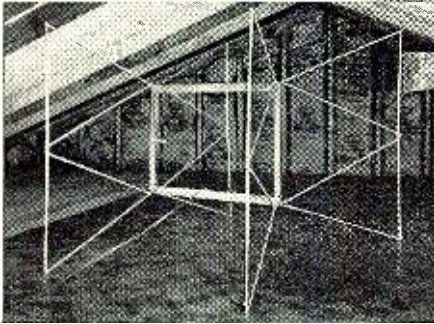

extremely light and entirely self-supporting. It may be suspended or rested on flooring, beams, or rafters.

DISTRIBUTION UNIT

Lynmar Engineers of 1721 Delancey Street, Philadelphia 3, has developed a new distribution system for multiple television receiver operation from a single antenna.

Designed for apartment houses, showrooms, and service shops, the new unit covers both high and low bands without switching. Feedback from one television receiver to another through the equipment is said to be negligible.

The standard unit for feeding six television receivers is composed of three coupling units, each of which feeds two television sets, a power supply, and a mounting cabinet.

More than six receivers may be operated from the same antenna by connecting additional assemblies in series. The equipment has been standardized for 52 ohm antenna input coaxial transmission line. An impedance matching transformer is available for use with installations where a 300 ohm input line is used.

A flyer on the #PD-16 is available on request.

TV-FM AMPLIFIER

Sonic Industries, Inc. of 221 West 17th Street, New York is producing a new "Super Sonic" TV-FM amplifier, the Model IT4.

Designed to provide high gain pre-selection for any television or fre-

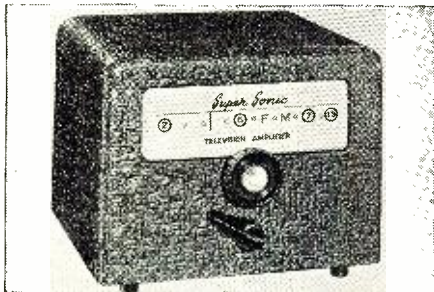

quency modulation receiver with adequate bandwidth to pass all desired modulating elements and provide adequate selectivity to reject unwanted off-carrier signals and noise, the new unit has one continuous tuning control and one off-on switch, without any verniers or Hi-Lo switching.

May, 1950

MICROPHONES

- Pressure
- Velocity
- Cardioid
- Variacoustic
- Hand Sets
- Sound Power
- Telephones
- Stands, Plugs, Cables and Connectors



AMPLIFIERS



- Pre-Amplifiers
- Line Amplifiers
- Voltage Amplifiers
- Power Amplifiers
- Remote Amplifiers

SPEAKERS



- Cone Type
- Horns and Drivers
- High-Fidelity Speakers
- Speaker Accessories

SPEAKER HOUSINGS



- Baffles, All Types
- Console Cabinets

INTERCOM SYSTEMS



- All Master Systems
- Master-Remote Systems
- Combination Systems

CUSTOM-BUILT EQUIPMENT



- Consoles
- Desks
- Turrets
- Cabinets



PORTABLE SOUND SYSTEMS



PROGRAM CONTROL UNITS



- Single Channel
- Dual Channel
- Custom-Built

Why shop around?

It's easy to get the right equipment from RCA's full line of matched sound products

Buy your sound products the easy way. The wide variety of RCA Sound Products simplifies your problem of finding the right equipment for your sound jobs.

Every item in RCA's extensive sound line is electronically engineered with its own special characteristics to give top performance, dependable long-life service with quality appearance. Not only is the

RCA Sound Products line built right, it is also priced right to enable you to build a steady volume of profitable business.

No other manufacturer offers so extensive a line of "matched" sound products from the smallest "bally-hoo" system to the largest systems for industrial, educational, institutional, church, hotel, hospital or commercial users.

See your RCA Sound Products Distributor for catalog and new sound sales manual



SOUND PRODUCTS
RADIO CORPORATION of AMERICA
ENGINEERING PRODUCTS DEPARTMENT, CAMDEN, N.J.

1n Canada: RCA VICTOR Company Limited, Montreal



Patent Pending

- New Model "BJ" Junior filtered power supply utilizes same exclusive application of selenium rectifiers used in the famous Model "B". This application, using conduction cooling, doubles the rectifier power rating, dissipates over 3 times the heat and provides lower cost per ampere

new! **LOW COST DC SOURCE**
ELECTRO "BJ" JUNIOR

SUPPLIES 1 to 12.5 AMPS. 6 VOLTS CONTINUOUS DUTY
3 to 9 Volts at Other Ratings

Operate, Test from AC Lines

Auto Radios • Relays • Telephone Circuits
Instruments • Other Low Voltage Devices
output over other types. Supplies ample power, with a peak instantaneous current rating of 25 amperes (from standard 50/60 cycle 115 volt source). Heavy duty components withstand high over-loads. AC ripple less than 0.4 volts at 6 volts DC 8 amperes.

Pioneer Manufacturers of Battery Eliminators



ELECTRO PRODUCTS LABORATORIES, INC., 4509 N. Ravenswood Ave., Chicago 40, Ill.

2 IMPORTANT NEW PHOTOFACT BOOKS

"TELEVISION TUBE LOCATION GUIDE"

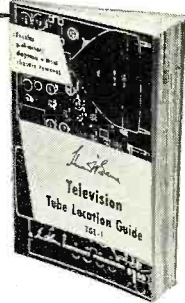

Gives Tube position and function in hundreds of important TV receiver models, made by 56 manufacturers.

FIND THE TROUBLE AND REPLACE TUBES WITHOUT REMOVING CHASSIS

Nothing like it! The only book that shows the position and function of tubes in hundreds of TV receivers. Often an operational check in the customer's home . . . looking at the picture tube and listening to the sound . . . can give you a clue to the trouble. Many times only a tube failure is responsible. TGL-1 makes trouble diagnosis and tube replacement quick and simple, in most cases without removing the chassis! Each model has its own clear, accurate diagram. Book fully indexed for quick reference. Over 200 pages, handy pocket size, 5 1/2 x 8 1/2". Get two copies . . . one for outside calls and one for your bench. Pays for itself on the first job!

ORDER TGL-1 Only..... \$7.50

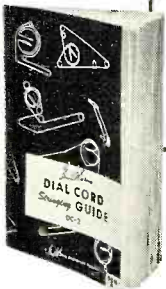

"DIAL CORD STRINGING GUIDE"

NEW!
SECOND VOLUME
Covers models from 1947 to October 1949

Over 45,000 servicemen bought the first volume of this invaluable book! New second volume includes 511 different dial cord stringing diagrams used in almost 1000 receivers produced from 1947 to October, 1949 (all new data continuing from where the first volume left off). There's only one right way to string a dial cord . . . and here's the only book that shows you how. Saves time—saves effort. Handy pocket size. Order copies for your tool kit and work bench today.

ORDER DC-2 Only..... \$7.00

HOWARD W. SAMS & CO., INC.

Order from your Parts Jobber today, or write direct to HOWARD W. SAMS & CO., INC., 2201 East 46th Street, Indianapolis 5, Ind.

My (check) (money order) for \$..... enclosed. Send the following books:

- TGL-1 "TV Tube Location Guide" \$1.50
 DC-2 "Dial Cord Stringing Guide" \$1.00

Name

Address

City..... Zone..... State.....

Balanced input and output circuits provide for minimum noise pickup. Versatility in application has been provided by both 72 ohm and 300 ohm input and output matching impedances. An isolating power transformer is used to keep input and output circuits above the power line circuit.

ROOF BRACKET

A low-priced roof bracket which may be adjusted to hold television antennas on the peak of a roof, on the

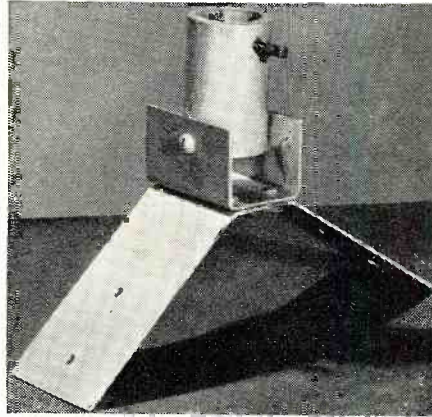

slope, on the flat, or on the side, is currently being offered to the trade by TV Accessory Engineering Co., of 2105 Lagrange St., Toledo 8, Ohio.

The bracket comes prepared for use as a roof saddle but may be bent into any necessary shape to permit its use in other locations.

RAYTHEON'S "ROVER"

As one of the company's "Silver Anniversary" line of television receivers the Belmont Radio Division of Raytheon Manufacturing Company has introduced "The Rover," a compact table model video set.

Housed in a maroon tooled leather-



ette cabinet, "The Rover" (Model M-1106) carries a 12 1/2-inch, glare-free, black picture tube which provides a full 110 inches of viewing surface. The set uses a built-in antenna.

The cabinet measures 19" wide, 18" high, and 19" deep.

TV ISOTAP TRANSFORMER

In an effort to promote safety and efficiency in the testing and servicing of television and radio receivers and other electronic and electrical equipment, the Tube Department of Radio

\$59.50 13 TUBE FM-AM CUSTOM CHASSIS

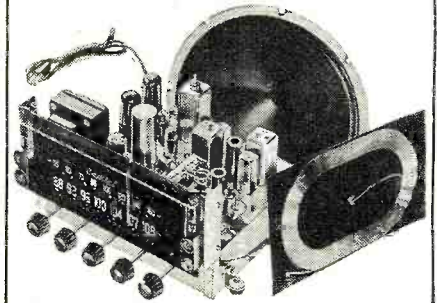

13 Tube, Hi-Fidelity Chassis
11 3/4" wide x 10" deep x 7 1/4" high
Complete with tubes and magnavox 12" FM speaker. Every chassis brand new 1950 production. Used in consoles selling for \$1,000 and more. **SOLD TO YOU ON A 10 DAY MONEY BACK GUARANTEE.** You be the judge of this fine chassis. Includes 2-6V6 PP for power output, driven by a balanced Phase Inverter Circuit using 2-6AT6 Tubes. Includes a Ratio Detector circuit. Freq. Response 50-10,000 CPS (3db down). AM Freq. 540-1700 KC. FM Freq. 88 MC-108, 105-125 Volts A.C. Write for full specifications. **ORDER YOURS TODAY.**

VM 3-SPEED CHANGER
SPECIAL—can be hooked up to Phono input of above chassis. Brand new in original cartons. One tone arm with twist cartridge and precious needles. **\$25.50 ea.**
WHILE THEY LAST.

3-SPEED PHONO
You couldn't buy the parts for this price. Incl. pickup with precious needles, 3-speed alliance motor. Built in amplifier and 5" FM Speaker. 115 Volts A.C.
Only **\$18.95**

All Merchandise Brand New
10 Day Money Back Guarantee
Terms: 20% deposit. Balance C.O.D.
Get on Our Mailing List. Dept. ON

RADIO WAREHOUSE
Wholesale Distributors
373 Broadway, Brooklyn 11, N. Y.

LEARN
**Radio-Television,
OR
Electricity**
IN THE GREAT SHOPS OF **COYNE**

COYNE 51st ANNIVERSARY
TRAIN QUICKLY!
OLDEST, BEST EQUIPPED SCHOOL of ITS KIND in U.S.
2 Opportunity Fields

Come to the Great Shops of COYNE in Chicago during our 51st Anniversary Year! Get quick, practical training in RADIO-TELEVISION or ELECTRICITY. G I Approved. Finance plan for non-veterans. Mail Coupon Today for complete details.

NOT "HOME-STUDY" COURSES!
You learn on real, full-size equipment, not by mail. Finest staff of trained instructors to help you get ready quickly for a better job, a fine future.

FREE BOOKS Clip coupon for big illustrated Coyne book on either ELECTRICITY or RADIO-TELEVISION. Both books sent FREE if you wish. No obligation; no salesman will call. Act NOW!

B. W. COOKE, Pres.
COYNE Electrical & Radio-Television School,
500 S. Paulina St., Chicago 12, Ill. Dept. 50-85H

Send FREE BOOK and full details on:
 RADIO-TELEVISION ELECTRICITY
NAME.....
ADDRESS.....
CITY..... STATE.....

Corporation of America has announced the availability of the "Isotap," a unique test instrument.

Combining in one compact unit an autotransformer and an isolation



transformer, the new television "Isotap" is designed to speed up television receiver service, minimize shock hazards, cut down service returns, and prevent damage to costly shop test equipment.

TV FILTER

Norval H. Copple, of 3701 North Broad Street, Philadelphia 40, Pa., is handling the distribution of a new television filter which has been trademarked "Nutro-Lite."

An optically correct filter, the new unit was developed by Kern-Moss Op-

tical Co. According to the company, the filter rests the eyes while viewing and eliminates all chromatic distortion and reflections to give a clear, sharp, flickerless, and easy-on-the-eyes picture. The filter is said to work equally well on both the conventional and black tubes with no additional brightness being required.

The "Nutro-Lite" filter is available in two types. A single clip-on lens which is placed against the outside of the safety glass and held there by inserting small metal clips between safety and frame and the type whereby the filter lens is incorporated into the laminated safety glass which replaces the plain safety glass supplied by the set manufacturers and is known as a custom-made installation.

MATCHING TRANSFORMER

An impedance matching transformer which can match a 70-95 ohm coax line to a 300 ohm input has been developed by Lynnmar Engineers of 1721 Delancey St., Philadelphia.

The unit may be used to match a 300 ohm antenna to a receiver made for 70-95 ohm coax. In receivers with both coax and 300 ohm twin-lead connections, improvement in reception is possible when the input is connected through this transformer.

-50-

ZENITH TO TEST PHONEVISION IN CHICAGO

HAVING received FCC authorization to conduct a series of Phonevision tests in the Chicago area, Zenith Radio Corporation is currently setting the stage for the 90 day test.

A group of 300 families, representing a cross-section of the community and selected by the National Opinion Research Center of the University of Chicago, have been named and currently television receivers equipped with Phonevision and the necessary telephone facilities are being installed in these homes.

As to the operation of this new type of television, the company explains that in this system the Phonevision-transmission codes, or scrambles, the television picture. The receiver, with the key signal provided over a telephone wire, decodes or unscrambles it. A Phonevision receiver is a standard television receiver with a decoding unit built in or added to the original receiver. It will receive any of the desired "free" programs that are within range in addition to the subscription programs if it is set up to receive the key signal over the telephone wire.

When a television broadcaster wishes to transmit a subscription program and prevent its unauthorized reception he merely throws a switch which connects a special unit into the circuits of his transmitter. From that moment on, the subscription program is broadcast with certain variations which produce a jumpy, uncertain image shifting back and forth across the television screen at a rapid but entirely random rate. In this form the picture has no entertainment value and cannot be watched for more than a few seconds without eyestrain.

To make the program available to those set owners who wish to pay for it,

the transmitter generates a key or decoding signal which passes over the telephone wire to the telephone exchange. From the exchange, this signal can be sent over the regular telephone wire that serves any home and delivered to the television receiver of any subscriber who has asked for the service. In the television set the key signal actuates a decoder which automatically corrects the broadcast signal sent to the television set over the air. The random shifting of the image on the screen is stopped and the picture becomes clear.

If commercial Phonevision is established it will operate as follows. The set owner consults his daily newspaper or program booklet to select the subscription program scheduled for that day. Next he contacts the Phonevision operator to request the key signal for the program of his choice. The operator then makes a record of his telephone number and makes the connections which will send the key signal over his line at program time. Shortly before the scheduled hour the set owner tunes his receiver to the proper channel. When the subscription program begins, it is received in clear form. At the end of the month the set owner is billed for the fees for each picture he has ordered.

According to Zenith, Phonevision will not interfere with the normal use of the telephone. A filter arrangement added to the telephone wire stops the TV signals from getting into the telephone, prevents the key signal from reaching the telephone, and blocks telephone impulses for disturbing the television sets. In cases of party line telephone service, different frequencies will be used for transmitting the key signals to the two different subscribers on the party line.

-50-

SERVICEMEN!

We'll Prove You'll Save Time & Earn More with PHOTOFAC!

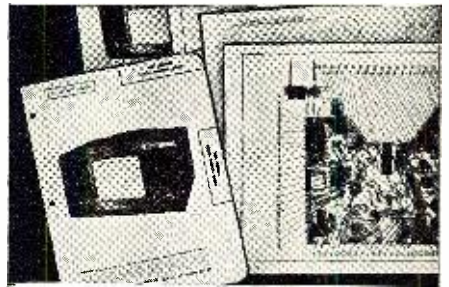

We'll send you absolutely

FREE

any PHOTOFAC Folder listed in the Photofact Cumulative Index

NOW—learn for yourself—at our expense—how PHOTOFAC makes your service work quicker, easier, more profitable! Examine an actual PHOTOFAC Folder. Use it. You'll learn first-hand why this indispensable service data is used daily by over 35,000 successful service technicians. You'll discover quickly that no other service gives you PHOTOFAC's outstanding advantages: *completeness, accuracy, uniformity and ease-of-use* at the lowest cost to you! PHOTOFAC alone is the *only* radio service data prepared from laboratory analysis of the actual equipment. Nothing in the field equals PHOTOFAC. Know the facts—get your FREE Folder now. Examine it—use it—compare it—learn why no modern service shop can afford to be without PHOTOFAC!

NOTE: This FREE offer is limited to Service Technicians. Attach coupon below to your letterhead and mention the name of your jobber. If you have no letterhead, send coupon to your jobber. Experimenters and others may obtain the Photofact Folder by remitting amount shown below.

HOWARD W. SAMS & CO., INC.
2201 E. 46th St., Indianapolis 5, Ind.

- Send FREE Photofact Cumulative Index
- Send Full Easy-Pay Details

I am a Service Technician:

- Send FREE Folder for set model.

I am an Experimenter: Enclosed \$.....

- Send Folder for set model.
- TV—\$1.00; Record Changer or Comm. Receiver—75c; AM/FM—50c

Name.....

Address.....

City.....Zone.....State.....

Look for the QUAM FOCALIZER UNIT



in better television receivers!

The new QUAM FOCALIZER UNIT, utilizing Alnico permanent magnets instead of the more expensive and less stable wire wound construction, not only provides better, sharper focus of the television image, but is unaffected by operating temperature and voltage fluctuations.

With a QUAM Focalizer Unit in the set it is unnecessary to refocus the image because the coil has heated, increasing resistance and weakening the magnetic field. Since there is no wiring, voltage fluctuations have no effect on the operation of the QUAM Focalizer.



Focusing is done upon installation of the set by a simple operation—it is then permanent! You will find the QUAM Focalizing Unit in the better TELEVISION Receivers.

THE QUAM ION TRAP

The improved and simplified construction of the QUAM ION TRAP, also utilizing permanent magnets, makes it preferred equipment for better television receivers.

QUAM-NICHOLS CO. 33rd Place and Cottage Grove
Makers of QUAM Adjust-A-Cone SPEAKERS
CHICAGO, ILLINOIS

RADAR, COMMUNICATIONS AND SONAR TECHNICIANS W-A-N-T-E-D For Overseas Assignments

Technical Qualifications:

1. At least 3 years practical experience in installation and maintenance.
2. Navy veterans ETM 1/c or higher.
3. Army veterans TECH/SGT or higher.

Personal Qualifications:

1. Age, over 22—must pass physical examination.
2. Ability to assume responsibility.
3. Must stand thorough character investigation.
4. Willing to go overseas for 1 year.

Base pay, Bonus, Living Allowance, Vacation add-up to \$7,000.00 per year. Permanent connection with company possible.

Apply by Writing to
D-4, P.O. Box 3575,
Philadelphia 22, Pa.

Men qualified in RADAR, COMMUNICATIONS or SONAR give complete history. Interview will be arranged for successful applicants.

RCA DETENT EXCHANGE

We will exchange your defective RCA TV Tuner Switch Detent Assembly for a factory rebuilt one. ***59c** Prepaid. No C.O.D.

Unconditionally Guaranteed for 3 months *You must mail us your defective detent.

TECHNICAL RADIO PARTS CO.

557 McDonald Ave., Brooklyn 18, N. Y.



EVERY RADIOMAN Can Use These SERVICE HINTS!

Valuable Manual Yours—FREE!

Every page of "How to Simplify Radio Repairs" is packed with on-the-bench, practical ideas. Contains photos, charts, diagrams—no fluff—no vague theory. In plain every-day language it gives you priceless suggestions—new servicing ideas. You'll use and benefit from the experience of experts. Partial list of contents: How to Localize Trouble; How to Service Amplifiers; How to Test for Distortion; How to Test Audio Circuits; How to Test Speakers; How to Find Faults in Oscillators; How to Test Radio Parts—and it's all yours—FREE! No obligation.



SEND COUPON OR PENNY
POSTCARD FOR YOUR
FREE COPY TODAY!

FEILER ENGINEERING CO., Dept. 5H5
1601 S. Federal St., Chicago 16, Illinois
Please RUSH my FREE copy of "How to Simplify Radio Repairs."

Name
Address
City Zone State

Extra Income (Continued from page 47)

The recording turntable, cutter head, and playback table can be inexpensive "mail order" types; occasionally a bargain can be found in the "swap" sections of catalogs and trade magazines. More professional-type equipment can be added later as your recording business grows.

Improving Receivers

Have you ever serviced a receiver, completely aligned all stages, replaced all defective parts, and still were not satisfied with its performance or sensitivity? This is more common in receivers several years old, particularly the a.c.-d.c. type. (In many cases this is a result of poor design and not much can be done.) Sometimes, however, a simple circuit change or part replacement will help. Here are a few things you can try:

(1) If the set is worth the cost, replace the i.f. transformers with iron-core units. (2) The "Q" of the oscillator and r.f. coils may be low, too, due to absorption of moisture, high coil form loss, etc. Replace with improved types recommended by the manufacturer. (3) Decrease the value of the a.v.c. return resistor. (Try paralleling a ½ megohm resistor from the r.f. end of the a.v.c. filter resistor to ground.) This reduces attack time and raises the gain. (Avoid this change if strong local stations tend to overload or distort.) (4) Performance in some sets can be improved by raising plate and screen voltages. (Keep within tube ratings; be sure bias voltages are correct.) (5) In some a.c.-d.c. sets, there is excessive interaction between the chassis and the unshielded loop antenna. Move the antenna farther away if possible or insert a thin sheet of copper between loop and chassis, and ground the sheet to chassis. (This increases the "Q" of the loop.) (6) On receivers having no trimmer on the detector section of the tuning condenser, try adding one. (Use a surplus unit or a trimmer from a discarded i.f. transformer.) (7) In extreme cases, try leaving the tube shield off in the converter or one of the i.f. stages. This amounts to increased interstage coupling and controlled regeneration up to a certain point. If receiver oscillates, detune one of the i.f. stages slightly or discard the idea. (8) Some owners of well-designed receivers prefer hi-fi local reception to sharp DX tuning. Try "flat-topping" the i.f. stages to give a 10 kc. bandwidth; note the improvement in tone quality and reduction in noise. (A scope will be needed for symmetrical ± 5 kc. alignment.)

Battery Set Conversion

Converting battery sets to a.c. operation is a relatively simple operation. The simplest method is to install a power supply or converter

D.C.-A.C. Inverter

(Continued from page 65)

amplifier having considerable voltage gain, it will be desirable to regulate the a.c. supply voltage. A simple way to do this is to connect a ballast unit in one of the supply leads.

For best results, the output load device operated from the inverter should be of high enough impedance to offer negligible loading. Operation of each of the inverter circuits given in this article is not noticeably affected by impedance of the d.c. signal source.

Outlook

We believe that the saturable reactor-type of d.c.-a.c. inverter and the magnetic amplifier merit consideration as useful components in amateur experimental circuits. Many interesting experiments and much practical development work can be carried on with these units. The units shown in this article have utilized readily available transformers having easily saturated cores. However, the power-handling ability of these simple units is not great. Other experimenters may elect to build saturable reactors with high-permeability core materials and thus obtain power amplification in addition to voltage amplification. —30—

SYNC LOCK FREQUENCY CONTROL

By MATTHEW MANDL

TELEVISION technicians often find that they are called to service sets which only require readjustment of rear panel controls because the latter had been tampered with by the set owner. The control which has the most serious effect on the picture is the horizontal sync lock frequency control because a maladjustment of this will result in loss of sync to such an extent that the horizontal hold control is no longer able to bring the picture back into lock. On modern receivers this control is recessed or located in such a position that it is not easily accessible to indiscriminate handling by the set owner. On many of the older sets, however, the frequency control is located on the rear panel of the chassis and can be turned without the necessity for special aligning tools. Typical receivers are the Admiral 30A-1 chassis, the RCA 630TS receiver, and the many kits and modifications of the popular 630-TS.

When servicing such receivers the technician can reduce the danger of tampering by covering this control with several strips of Scotch tape after he had made the proper adjustment. Inasmuch as the inherent stability of the sync lock system is high, this control will not need readjustment again unless a tube or component part of the horizontal sync system is changed. Some technicians use a pair of diagonals to cut off the knurled end of this control so that subsequent adjustment would require the use of a pair of pliers. This procedure will also tend to discourage tampering and help in cutting down on the number of unnecessary calls on the technician's list. —30—



FOR . . .

- RADIO SERVICING
- TELEVISION SERVICING
- AMATEUR RADIO
- HIGH FIDELITY SOUND

Stancor transformers are original components in thousands of radio and television receivers made by the biggest names in the industry—they have to be good to be specified by critical design engineers and value-conscious purchasing men!

Why shop around? Specify Stancor for your replacement work. You will get a dependable, honestly-rated transformer. You'll cut down on expensive call-backs. You will keep your customers.

FREE For complete, accurate specs and prices of the complete Stancor stock line, write for your copies of the literature illustrated above. Just ask us for the Stancor transformer library. Standard Transformer Corporation, 3584 Elston Avenue, Chicago 18, Illinois.

It's Stancor
FOR

TRANSFORMERS

MOST COMPLETE LINE IN THE INDUSTRY



When answering Advertisements please mention
RADIO & TELEVISION NEWS

AUTOMATIC M-90 AUTO RADIO



- Six Tube Superheterodyne • Three Gang Condenser • Powerful, Long-Distance Reception • Fits All Cars, Easy Installation
- Mounting Brackets Included Net \$29.97
- C Tube model M90 \$29.97
- S Tube model X50 \$24.36

MAIL US YOUR ORDERS

All orders filled within 24 hours. Illustrated parts list on request. Sylvania and Cunningham tubes 50% off list

Bill Sutton's Wholesale Electronics
Fifth at Commerce Port Worth, Texas

RADIO ENGINEERING DEGREE IN 27 MONTHS

Radio engineering is a big field. There's room for you in it—if you're good. Get first-class training at Indiana Tech. Intensive specialized course, including strong basis in mathematics and electrical engineering, advanced Radio Theory and Design. Modern laboratory. Low tuition. Also 27-month courses in Aeronautical, Chemical, Civil, Electrical and Mechanical Engineering. Approved for G.I.'s. Enter June, September, December, March. You can earn part of your expenses right here in Fort Wayne while you are studying.

INDIANA TECHNICAL COLLEGE

950 E. Washington Blvd., Fort Wayne 2, Indiana
Please send me free information on B.S. Engineering Degree in 27 months as checked.

- Radio-Television, Aeronautical,
 Civil, Mechanical, Electrical

Name

Address

AGAIN IN 1950

IT'S

ATLAS



Again Atlas leads
the field with its new line of
speakers and projectors.

Again Atlas makes the news in
the Sound System field.

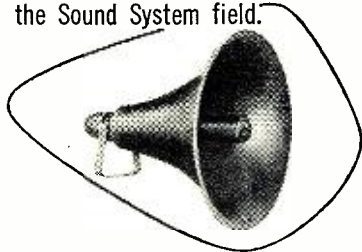

Atlas Reproducer units continue to retain the famous "Atlas V Plus" super-efficient magnetic assembly and in addition many more "Extra Plus" features. A new reversed dome, blast proof diaphragm is now standard in the high power, high fidelity models. Built-in transformers, designed for either constant 70 volt or constant impedance audio circuits are included. Improved appearance—functionally designed for maximum convenience. Double seal weather-proofing. All this and more without any general increase in price.

Atlas projectors have a new micrometrically calculated and controlled rate of expansion. Atlas non-vibrant projectors are rugged and fine in appearance. Sound energy is not dissipated in rattle vibration, distortion or cancellation.

The new improved line of Atlas speakers are really new from the voice coil to the final lock washer. It's really the "modern look" in speakers, a new high in overall performance.

Let Atlas speakers play an important part in your SOUND PROFITS.



Write for our new catalog —
the most complete line of
speakers, microphone stands and
sound accessories.

ATLAS SOUND CORPORATION

1466 39th Street
Brooklyn 18 N. Y.

Manufacturers' Literature

Readers are asked to write directly to the manufacturer for the literature. By mentioning RADIO & TELEVISION NEWS, the issue and page, and enclosing the proper amount, when indicated, delay will be prevented.

WOODEN BEARINGS

A new engineering manual which covers the principles and applications of "oilless" wooden bearings in modern machine design has been released by the *Paramount Oilless Bearing Co.* of Worcester, Massachusetts.

The booklet discusses the application of wood bearings in certain electrical and electronic situations where no other type of bearing can serve as well. Typical applications include their use where the dielectric qualities of the bearing itself are important, where oil drip or spatter from conventional surface-lubricated bearings would injure the efficiency of surrounding circuit components, use in locations of difficult or impossible access, where surrounding high voltages prohibit lubrication maintenance, and where elimination of noise is paramount.

Copies of the manual will be loaned to accredited engineers and machine designers. Application for a copy of the manual should be made, on business letterhead, direct to the company.

ELECTRICAL CONDUITS

An elaborate, 30-page catalogue, the No. 603, covering the various types of electrical conduits manufactured by the company has recently been issued by *National Electric Products Corp.*, Chamber of Commerce Bldg., Pittsburgh 19, Pa.

The first half of the new booklet is devoted to Sherarduct, Xduct, and Economy rigid steel conduits and their accessories. The electrical metallic tubing produced by the company is next listed along with related accessories. A line of flexible steel conduit for branch circuit wiring and the company's non-metallic tubings are also described and illustrated.

AMERTRAN BULLETIN

A bulletin describing a redesigned and improved line of air-cooled transformers has been announced by *American Transformer Co.*, of 285 Emmet Street, Newark 5, New Jersey.

Designated bulletin No. 110-02, the publication contains 8 pages of information and data, including tables which list standard ratings with dimensions, weights, list prices, and wiring diagrams of transformers in capacities up to 200 kva., single phase, and 300 kva., three phase.

TRANSFORMER DATA

An 8-page folder containing 36 photographs and corresponding specifications on auto and insulated transform-

ers has been released by *Nothelfer Winding Laboratories* of Albemarle Avenue, Trenton, N. J.

Illustrated and described are open frame, cased, channel, and end bell cased electrical transformers from .01 to 300 kva., 25 to 400 cycles, in 1, 2, or 3 phases.

In writing for copies, please specify NWL Bulletin No. 150.

POWER SUPPLIES

A new 4-page booklet describing its line of electronically-regulated power supplies has been issued by *Furst Electronics* of 12 S. Jefferson Street, Chicago 6, Illinois.

Various units are pictured and described in tabular form. In addition, details on the Model 910 klystron power supply are given. Copies of this pamphlet are available on request.

PARTS CATALOGUE

Radio Shack Corporation of 167 Washington Street, Boston 8, Massachusetts, has announced its new 152-page parts catalogue for the trade.

Covering the fields of industrial electronics, communications, television, high-fidelity music systems, recording, testing, and research, the new catalogue lists complete equipment, kits, components, hardware, tools, test equipment, and technical books.

Copies of the catalogue are free of charge on request.

TV SERVICE DATA

A series of technical bulletins designed to assist the television technician has been issued by *American Phenolic Corporation* of 1830 South 54th Avenue, Chicago 50, Illinois.

One set of data sheets discusses the television antenna in some detail and provides valuable information on installation and orientation. The second booklet, entitled "Sell a TV Picture" is designed as a guidebook for personnel selling television receivers.

Copies of these helpful publications may be secured from the company on request.

MEISSNER KITS

A 4-page illustrated folder covering five new radio kits recently introduced by the company is now available from *Meissner Mfg. Division, Maguire Industries, Inc.*, Mt. Carmel, Illinois.

The booklet describes the T8CK FM receptor, the T4AK 20-watt amplifier kit, the T2BK 2-tube battery trainer kit, the T3BK a.c.-d.c. trainer kit, and the T6BK 6-tube a.c. superheterodyne kit for instructional purposes.

A copy of the new publication may be secured by writing the company and requesting the "New Radio Kits Folder."

WIRED TELEVISION

A booklet describing the operation and application possibilities of the "Utiliscope" has been issued by *Diamond Power Specialty Corporation* of Lancaster, Ohio.

The photographs and text material point out the varied ways in which wired television may serve industry and trade. The equipment is described as being particularly suitable for locations where the operation to be observed is inaccessible due to dangers involved, poor location, or adverse atmospheric conditions.

A brief description of the equipment required for the closed circuit television setup is given in the folder, copies of which are available on request.

AUDIO EQUIPMENT

The Electronic Workshop, Inc. of 351 Bleeker Street, New York 14, is currently offering two data sheets to persons interested in audio equipment.

One sheet covers the company's amplifier Models S-20 and A-20-5 while the second sheet describes the Series 510-A miniature audio oscillator. Performance features and technical data are provided on both of these units.

"DATALOG"

Electrical Reactance Corporation of Franklinville, New York has recently issued a "Datalog" covering its line of "HI-Q" capacitors, resistors, and choke coils.

Designed for the television and radio manufacturer and the producer of electronic devices, the new publication provides technical data in addition to the usual product information found in catalogues.

The "Datalog" carries 32 pages and is available on request from the company.

EQUIPMENT CATALOGUE

A catalogue covering the company's line of equipment has been issued by *Approved Electronic Instrument Corp.* of 142 Liberty Street, New York 6, New York.

Included are the company's 15" custom built TV receiver chassis, television field strength meter, sweep signal generator for TV and FM, marker generator, a signal generator kit, a sweep generator kit, FM tuner kit and tuner, a TV tuner, a 4 watt amplifier, and a 4 tube miniature broadcast superhet tuner.

"HAM NEWS"

As a service to radio amateurs throughout the country, the *General Electric Company* has announced that "Ham News," a bi-monthly publication currently being distributed to 65,000 amateurs and experimenters through the company's tube distributors, will now be available on subscription to those who find it difficult to obtain copies each month.

Cletron

Rain and Weatherproof OUTDOOR SPEAKERS

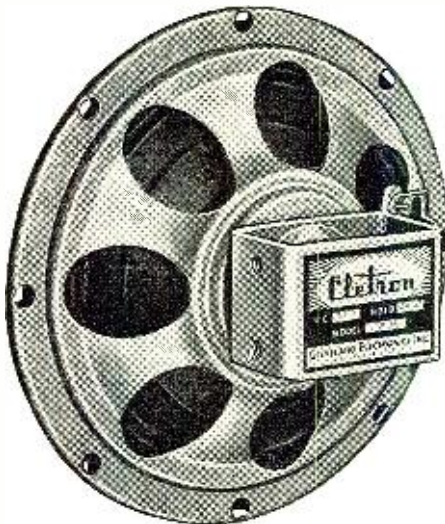

• Let it rain or blow—freeze or thaw—from arctic cold to blistering sandstorms, CLETRON loudspeakers keep functioning properly on P. A. systems and outdoor theatres with full-tone reproduction. CLETRON speakers have passed a 200-hour salt spray test and then another 200 hours on a weatherometer. In fact, these speakers actually operate when fully submerged in water.

A typical user writes: "During the last three years, we have used your speakers exclusively. Our engineering staff has found

the CLETRON speaker to be the only one on the market to meet our severe requirements. Actual field experience from Cape Hatteras to the sands of Texas has proved that our faith in your product is entirely justified." E. B. Brady, Chief Engineer, Drive-In Theatre Equipment Company, Inc., Cleveland.

The complete CLETRON line is distributed through leading jobbers. Whether you need weatherproof outdoor models or better radio and TV replacements, remember that CLETRON speakers are *unexcelled* in construction, performance and endurance.

CLEVELAND ELECTRONICS, INC.

6616 EUCLID AVE. • CLEVELAND 3, O.

EXPORT DIVISION:

Morhan Exporting Corporation
458 Broadway, New York, New York

Cletron
THE CHOICE OF EXPERT RADIO TECHNICIANS

TOP PRICE OFFERED! for BC-312 RECEIVERS

Write—stating whether 1 or more available, condition, and other possible description. Get our CASH offer!
Box 503
% RADIO & TELEVISION NEWS
185 N. Wabash Ave. Chicago 1, Ill.

When answering Ads please mention
RADIO & TELEVISION NEWS

AUDIO (SOUND) ENGINEERING HOME STUDY TRAINING

Practical, easy-to-understand lessons, written by competent Audio Engineers and Educators, prepare you for a better job and a good future in the Television, Radio, Motion Picture, and Recording Industries.
Write today for details—Learn while you earn!
HOLLYWOOD TECHNICAL INSTITUTE
Div. B.N.
4925 Santa Monica Blvd. Hollywood 27, California

STEADY PROFITS

YOUR OWN
BUSINESS WITH
COVIDEO

Coin Operated
Television

Place these specially built television sets that play 30 minutes for 25c in the thousands of available public places, hotel lobbies, restaurants, etc. They yield immediate profits and steady income. Install Covideo, the finest made. Limited capital required. Send for further information. Write today.

COVIDEO Coin Operated Television, Dept. B

212 Broadway, Phone: BEekman 3-0038-9
NEW YORK 7, N. Y.



9.695, noted 2300 with news in French. (Stark, Texas) Heard in Ohio as early as 2230. (Sutton)

Malaya—Radio Malaya, 9.712, noted to closing 1030, good signal in Calif. (Rosenauer) The Blue Network is now heard in dual on 7.200 and 7.250; news 0900. (Dilg, Balbi, Rosenauer, Calif.) While broadcasts are in Malay and Chinese dialects, the stations can be identified when they announce "Radio Malaya." (Radio Australia)

Malta—The Forces Broadcasting Service, Middle East, is being heard well in East from 2330 sign-on on both 4.965, 7.270. Verification card lists frequencies allocated as 7,220, 7,270, 4,965, 11,785, 6,140, all 7.5 kw.; former 4.782 channel is crossed out; hours of broadcast are listed 2330-0200, 0430-1700.

Mauritius — V3USE, approximately 15.050, is being heard erratically in the Eastern U. S. at 2159-2315 (approximately), and in both East and West USA around 0930-1200; has BBC (*English*) news relay 2200, and sometimes carries "*English by Radio*" shortly after the end of the news; most other items are in French; frequency seems to vary.

Mozambique—At the time this was compiled, Lourenco Marques seemed to be experimenting in its *English* language program—was being heard weekdays from 2300 and Sunday from 0000 on 11.764, 9.763, 6.137 (all approximate). August Balbi, Calif., reports this is the first time Lourenco Marques has been noted in the 25-m. band since 1937; widely reported; announces that the 25-m. outlet is for "listeners in the Cape." This outlet has been measured 11.7692 by Treibel, Washington. More recently the 31-m. outlet has been on approximately 9.755, probably having dropped to avoid QRM from TGWA and Leopoldville.

The Portuguese program was noted recently in Pennsylvania coming on the air 2300 on approximately 9.705, 9.660, 9.568; 9.660 was best level. (Hankins, Pa.)

Peddle, Newfoundland, says the best signal from Lourenco Marques is now over CR7BG, 15.196, heard first testing on Thursdays to 1500; later has been heard on other days; some days may run to 1530. Announces as beamed "regularly" to Europe and Portugal and Portuguese Colonies; always gives program preview for the following day. I have heard this one at good level here in West Virginia as early as 1400. Noted in England by Pearce on occasion after 1505 with messages addressed to Lisbon, Angola, and other Portuguese possessions; signed off 1525 with the Portuguese National Anthem, "A Portuguesa"; Pearce says this appears to be the same program as radiated on 4.825 and also sometimes on approximately 9.670.

New Caledonia—Slutter, Pa., is hearing a station on 6.000 signing on 0230 with "La Marseillaise"; probably is Noumea; has music to 0245.

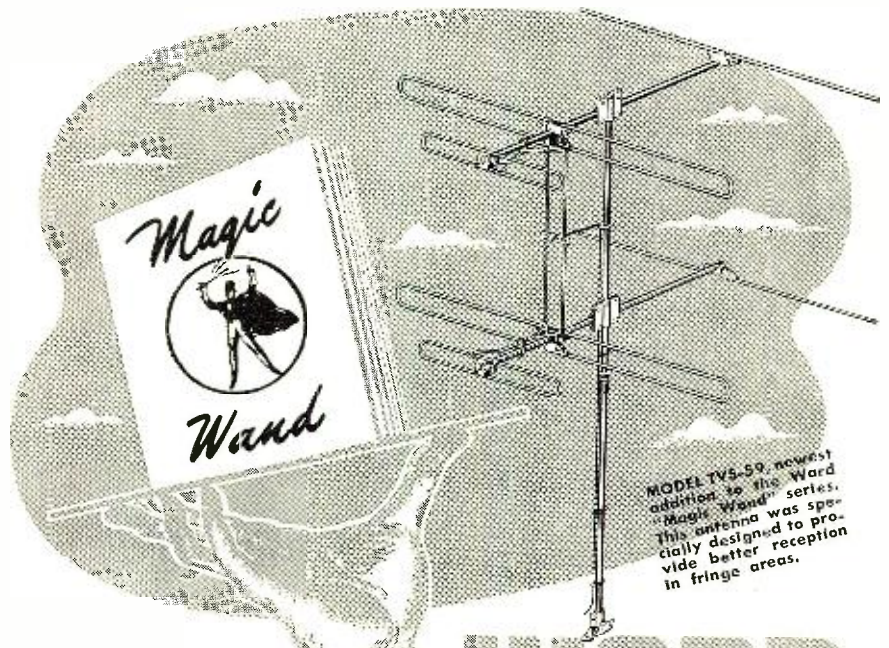

Another chapter in the "SUCCESS STORY OF THE MAGIC WAND ANTENNAS"

More than a thousand power lines snapped! Street car service disrupted by broken trolley wires! Thousands of tree branches crashed to the ground!

But the Chicago area's worst ice storm did not affect a single Ward Products "Magic Wand" TV antenna.

"Magic Wand" antennas are made of Perma-Tube, a special alloy expressly developed for Ward Products by the Jones & Laughlin Steel Corporation. Perma-Tube is a rugged alloy designed to withstand the harmful, corrosive effects of ice, sleet, snow, wind, and rain.

In good weather or bad, your TV set will give you the best reception if you have a Ward "Magic Wand" antenna. Tests have proved a medium-priced TV set with a good antenna performs better than an expensive set with a cheap antenna.



Write for our free booklet, "The Story of the Magic Wand." It contains interesting, authoritative information about TV and FM antennas.

WARD PRODUCTS CORPORATION

1523 E. 45th STREET, CLEVELAND, OHIO

Division of the Gabriel Company

Ward is the largest and oldest exclusive maker of television and auto radio aerials.



Get
EMERGENCY BAND
CALLS At Home!

POLIC ALARM

RADIO APPARATUS CORPORATION
310 FOUNTAIN SQUARE THEATRE BLDG.
INDIANAPOLIS 3, INDIANA

• Many fans spend hundreds of happy hours listening to city and state police calls on their Polic-Alarm radios. . . . Polic-Alarm Model PR-31 is a quality radio which will give years of trouble-free service on the 30-50 mc. band. Can be used on either AC or DC current of 115 volts. Besides police calls, the 30-50 mc. band also is used by fire departments, ambulances, border patrol, forestry, maritime, railroads, bus lines, and other services. Enjoy the thrill of listening to these vital messages at home. Polic-Alarm Model PR-8 is available for 152-162 mc. band reception. . . . \$39.95 Model PR-31 as illustrated 44.95 See your dealer or write Dept. RN-5.

NEW TELEKITS

NOW **49⁹⁵**

Jobbers: Write for Confidential Price Information

- NEW TELEKITS**
12-B \$79.95
10-B \$69.95
8-B \$54.50
7-B \$49.95
Less Tubes

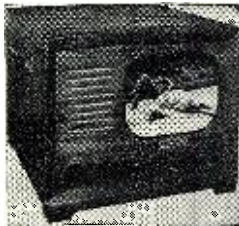

Sparkling new Telekit 12-B has 90-inch screen. Brand new compact lay-out has video tube mounted on chassis. Big illustrated easy-to-follow instruction book guides you step by step through easy assembly. No special knowledge of television is required. All you need is a soldering iron, pliers, and screw driver. 12-B kit can be used with 16-inch tubes. Telekit cabinets \$24.50 to \$35.00. Satisfactory Telekit performance guaranteed by Factory Service Plan.

12-B Telekit (90-inch screen) \$79.95. 10-B Telekit (61-inch screen) \$69.95. 8-B Telekit (48-inch screen) \$54.95. 7-B Telekit (25-inch screen) \$49.95.

Write for catalog listing Telekits and accessories.

TELEKIT BOOSTER
12.95



This Telekit booster will bring in TV signals bright and clear in the fringe areas. Will give brilliant performance with any TV receiver. NOT A KIT. Completely assembled. With tubes. Works with Telekit or any TV receiver.

13 CHANNEL TUNER
12.95

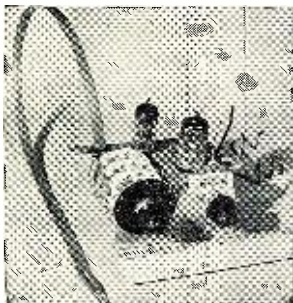

This compact front end has a stage of RF for extra distance. Made to conform with Telekit or any TV set having a video I.F. of 25.75 Mc. Complete with tubes, pre-wired, pre-assembled. Only four connections to make.

Write for catalog of Telekit antennas, boosters, Television kits tuners, television parts and tubes.

TELEKIT
ELECTRO-TECHNICAL INDUSTRIES
 1432 N. BROAD ST. DEPT. R PHILADELPHIA 21 PA.

New Zealand—ZL3, 11.78, ZL4, 15.28, now parallel at 2300-0635 sign-off; ZL7, 6.080, is now off the air. (Balbi, Calif.)

Nigeria—A station heard by Dilg, Calif., on approximately 9.655, with irregular program format, may be *Radio Nigeria*, Lagos. Noted with native singing both before and after 1100.

Radio Nigeria verified by airmail from the Director of Post and Telegraphs, P&T Headquarters, Catholic Mission St., Lagos, Nigeria. By now should be operating 0100-0215, 0600-1700 on 7.255 with 1 kw.; 0100-0215, 0600-1300, on 9.655, 300 watts, 1300-1600, on 4.990, 300 watts; on Sunday should operate 0100-1700. The "morning" sessions are relayed from the BBC's General Overseas Service; native programs are radiated "evenings." Broadcasts are still experimental, quality is not the best. Transmitters are Air Ministry T1509, 300 watts, and RCA 4331, 1 kw. Nigeria plans new stations at Ibadan, Kaduna, and Enigu for 1951. (Cushen, N. Z., via URDXC)

Outer Mongolia—Ulan-Bator, 8.400, noted with oriental-type program to 0800, then with Moscow relay. (Rose-nauer, Calif.) Noted from 0400, fair to excellent. (Balbi, Calif.)

Pakistan—*Radio Pakistan*, Lahore, has been radiating on 6.075 since November 1, 1949. (Sampat, India)

Frequencies and schedules of *Radio Pakistan* seem to be irregular, but at the time this was compiled *English* news periods appeared to be radiated on 9.646 at 2145 and 1015; on 11.885 at 0210; on 11.845 at 0700 and 0820; on 17.825 at 0110 and 0210; on 11.548 at 0700, 0820, 1015; Dacca was using 7.635 for *English* news at 0700 and 1015, and may use 15.335 for *English* news at either 2100 or 2145; however, there is a possibility that the 15.335 outlet heard evenings (from around 2045) may be Karachi. There definitely are two 50 kw. transmitters now operating from Karachi. It is possible, also, that at times Dacca may be using its old channel of 15.27. (Hankins, Pa., Morris, N. Y., Sampat, India)

Panama—A station announcing "*Radio Continental*," located in Panama City, has been heard with news in Spanish ending 1930 on 6.0445; also noted at 0630. (Oskay, N. J.) Noted in Washington signing off 2400. (Treibel) *Radio Sweden* says this station's QRA is believed to be Radio Programas Continental, S. A., Apartado 1795, Panama City, Republic of Panama.

Peru — OAX5C, measured 9.4776, Ica, noted 2315 with classical music. (Treibel, Washington)

Philippines — Balbi, Calif., is still hearing DZH7, Manila, on 9.730, where it is QRM'd by BEA8, 9.735, Nanking; noted in *English* 0400-0500, news at start. Balbi notes that DZH3, 9.50, Manila, has news 0400, 0500.

According to the "Philippines Free Press," weekly news-magazine, the Bacolod Broadcasting Corporation is operating DYBR, 1120 kc., and DYB2, 4.985; this is Bacolod's first station and was formally inaugurated December 25, 1949, although had tested

Suppress TELEVISION Interference
 with **MILLER FILTERS**



NO HERRINGBONE NO SOUND BARS NO JITTERS!

This New TV HIGH-PASS FILTER will reduce interference which may be picked up by the i-f. amplifier of your tv. receiver.

The Miller No. 6168 High-Pass Filter diminishes spurious signals which arise from strong, local fields generated by:
 1. Amateur radio transmitters.
 2. X-ray or medical diathermy equip.
 3. Short wave stations.
 4. Industrial r.f. heating units.
 5. Various electrical appliances.

Filter is designed to attenuate all signals to 40 megacycles. All television channels passed with minimum loss. Installed easily in antenna lead-in. No tuning required. Dim. 1-7/16" by 1-7/8" by 3-1/2" high.



Cat. No. 6168 For 300-ohm line \$5.00
 List Price
 See your Wholesaler or write us for literature

J. W. MILLER COMPANY
 5917 S. Main St., Los Angeles, Calif.

● BUILDERS OF QUALITY RADIO INDUCTANCES SINCE 1924

AD-VANTAGE

Take advantage of the world's biggest Classified Ad opportunity —Your ad in RADIO & TELEVISION NEWS Classified Section will get more action—more inquiries—quicker, and at less cost than in any other magazine. Monthly net paid circulation over 200,000.

BUILD 15 RADIOS ONLY \$14.75

- Absolutely No Knowledge of Radio Necessary.
- No Additional Parts Needed
- Excellent Background for Television.

The PROGRESSIVE RADIO EDU-KIT will help you, if you want an EDUCATIONAL AND INTERESTING HOBBY, or if you want to get into a WELL-PAYING BUSINESS, or if you want to INCREASE YOUR KNOWLEDGE OF RADIO.

Absolutely no knowledge of radio is necessary. The PROGRESSIVE RADIO EDU-KIT is the product of many years of teaching and engineering experience. The detailed instructions and quizzes are clearly written and illustrated, so that they can be understood by anyone between the ages of 12 and 80.

The PROGRESSIVE RADIO EDU-KIT is not merely a collection of radio parts accompanied by a radio diagram. IT IS PRACTICALLY A RADIO COURSE, offered at a mere fraction of its real value. You will be taught to build radios in a progressive manner. First, you will build a very simple 1-tube receiver. The next set is a little more advanced. Gradually you will find yourself constructing elaborate radio sets, and doing work like a professional radio technician. Every part is illustrated. EVERY STEP INVOLVED IN BUILDING THESE SETS HAS BEEN CAREFULLY PLANNED. YOU CANNOT MAKE A MISTAKE.

Each of the 15 radios you will build operates on 110-120 volts, AC or DC. These sets have been designed to teach you the PRINCIPLES OF RADIO. Therefore, you will build a variety of circuits. The PROGRESSIVE RADIO EDU-KIT is EXCELLENT FOR LEARNING THE PRINCIPLES OF RECEIVER, TRANSMITTER, AND AMPLIFIER DESIGN. It is used in many Radio Schools and Colleges in U.S.A. and abroad. It is used by the Veterans Administration for veteran training.

Quizzes are provided as part of the PROGRESSIVE RADIO EDU-KIT. They will be corrected by our staff at no extra cost.



**FREE
1950 EXTRAS:**

ELECTRICAL AND RADIO TESTER
SCREWDRIVER
BOOK ON TELEVISION
GENEROUS HANK OF WIRE

ELECTRIC SOLDERING IRON
ALIGNMENT TOOL
SPOOL OF ROSIN CORE SOLDER
MEMBERSHIP IN RADIO-TV CLUB

ORDER YOUR PROGRESSIVE EDU-KIT TODAY, OR SEND FOR FREE "KIT-KATALOG"
POSTAGE PREPAID ON CASH ORDERS. C.O.D. ORDERS ACCEPTED IN U.S.A.

PROGRESSIVE ELECTRONICS CO.

497 Union Ave., Dept. RN-33
Brooklyn 11, New York

**SOUND POWERED
PHONES**

**IDEAL FOR TV
INSTALLATIONS!**
COMPLETE TWO-WAY COMMUNICATIONS

Sets are ruggedly constructed of high quality lightweight Polystyrene plastic—engineered for extra long service. Practical, fool-proof operation guaranteed up to ¼ mile. NO BATTERIES OR ELECTRICITY REQUIRED! Comes complete with 25 feet of two conductor line. **Unconditional 10-Day Money Back Guarantee** SEND NO MONEY! Just mail postcard today and pay postman only \$3.49 plus postage, or remi in full—postpaid. **\$3.49** Two Units Complete Post Paid

THE ROBIN HOOD COMPANY
Dept. RN-3, 314 Market St., Newark 5, N. J.

RCA RADIO and TELEVISION

Thorough Training in All Technical Phases
APPROVED FOR VETERANS WEEKLY RATES DAYS—EVENINGS

FREE PLACEMENT SERVICE FOR GRADUATES

For Free Catalog write Dept. RN-50
A Service of Radio Corporation of America
RCA INSTITUTES, INC.
350 West 4th St., New York 14, N. Y.

PEN-OSCIL-LITE

Extremely convenient test oscillator for all radio servicing; alignment • Small as a pen • Self powered • Range from 700 cycles audio to over 800 megacycles u.h.f. • Output from zero to 125 v. • Low in cost • Used by Signal Corps • Write for information.

GENERAL TEST EQUIPMENT
38 Argyle Buffalo 9, N. Y.

NEW TWIN-VEX SKYLINER TV ANTENNA ONLY \$37.50

It's T-Versatile!

Welcome news for servicemen! SKYLINERS adapt to any area, thus slash inventory costs. Basic 4-4 Conical, HI and LO Conversion Units—ALL SOLD SEPARATELY—custom-install any TV receiver. Never a shortage or leftover part.
No Loose Hardware • Speed Nut Assembly
• New Non-Slip Mast Clamp • Mounts For Extra Rods • Seamless Tubing

Covers all channels Top overall gain
Four extra rod mounts built-in every SKYLINER permit rod additions and rearrangement. Where more HI or LO gain is needed, rods may be inserted as illustrated or as required. ADDITIONAL RODS SOLD SEPARATELY.

MODEL TV 2 XR
Boxed, 4½ lbs.

Protected Territories Open For Direct Twin-Vex Representatives.
Write For Full Information.

Order your first SKYLINERS today! Include sufficient postage balance refunded. No COD's. Write for FREE Catalog.

TWIN-VEX MANUFACTURING COMPANY
E & HUNTING PARK AVE. • PHILADELPHIA 24, PA.

with popular recordings. (Treibel, Washington) Usually is good level here in West Virginia from 2345 sign-on, and normally has news 2400, BBC news relay 0100.

Spain—Sutton, Ohio, says Madrid's 15.620 outlet appears to be scheduled 0955-1220, at times to 1230.

Suez Canal Zone—“Your Forces Broadcasting Service, Fayid,” is heard testing on 7.220 at 0200-0230 and some days at 0300-0330 by Bert Bluman, Israel. (Radio Sweden)

Surinam—PZC, measured 15.4058, Paramaribo, noted 1755 with popular recordings, announcements, in Dutch. (Treibel, Washington. Had improved signal past month or so, 1645-2030; on rare occasions has opened 1630 and signed off 2055; no *English* noted. (Grove, Ill.)

Switzerland—Aberg, Sweden, reports *United Nations Radio* heard 1045 on 11.725 with news in Hebrew.

United Nations Radio, 6.672, now has *English* weekdays 1420. (Pearce, England)

Berne noted using HE17, 15.320, instead of HER6, 15.305, in the 1730-1815 transmission to North America. (Cox, Delaware)

Syria—Damascus, 11.750, is fair level in Newfoundland 1315-1345. (Peddle)

Taiwan—“Voice of Free China,” Taipei, appears to be scheduled 2300-0100 (first hour in *English*) to the West Coast USA over BED4, 11.725; and 0500-1130 (from 0600 on Sunday) over BED7, 7.1505, with news around 0610. In a letter to Moore, Calif., Chang Shui-yu, Head, Audience Service Section, Taiwan Broadcasting Station, Taipei, Taiwan, China, stated that “the Taiwan Broadcasting Station is situated in Taipei, Taiwan, and is of course anti-Communist. All the calls of the station are BED's, no matter what number affixes them. You also may hear station BCAF which is the broadcasting outlet of the Chinese Air Force, situated in Taiwan also, operated on 910 kc. in the 329-m. band.” BCAF at last report was using the s.w. frequency of approximately 8.996.

During most of the *English* period 2300-2400 on 11.725, there is terrific QRM from CHOL, 11.72, Canada. (Treibel, Washington) BED4 is seldom audible here in the East.

Tangiers—Latest schedules of the “Voice of America” relay station at Tangiers are Tangier I, 7.220, at 1500-1730 to Europe; Tangier II, 11.710, at 1130-1730 to Europe, Tangier I, 15.240, at 1130-1500 to Europe.

Thailand—While “Down Under” sources insist that HS8PD, Bangkok, is operating on 6.235, it has been measured consistently within a few cycles of 6.2408 by Oskay, N. J.; has news 0515, 0615.

Tibet—Although press dispatches from New Delhi reported some months ago that a station calling itself “Radio Tibet” had been heard on approximately 7.200, I have received word from Sampat, Bombay, that he has

been unable to hear any such station. If anyone has actually "heard" this outlet, please let me know.

According to Lowell Thomas, the American newscaster, "Radio Tibet" is being operated by Reggie Fox, AC4YN in English, Chinese, Tibetan. Fox, formerly a representative of the British Political Mission, resigned his post, married a Tibetan girl, now holds a high post in the regime of the Dalai Lama, and is now considered a native of Tibet, it is reported. According to Mr. Thomas, Fox expects to spend the remainder of his life in Tibet. Two of his four children are now attending school in India; they are being trained to fill high government posts in Tibet. (DeMyer, Mich.)

USSR—A Soviet outlet noted in Russian on 7.93 from 0600, powerful signal; the 9.48 outlet heard with Home Service from 0200, strong signal in California. (Balbi)

Vatican—HVJ, 7.28, noted in Sweden with Spanish 1500. (Aberg)

Last Minute Tips

A station reported earlier by *Radio Sweden* as "unknown" has now been identified as *Radio Euscari*, "La Voz de la resistencia Basca"; this clandestine outlet operates on 6.090 at 0200-0230, and on 6.525 at 1600-1630. (Radio Sweden)

A transmitter heard by Bluman, Israel, on 7.075, is probably Bahrein Island in the Persian Gulf; heard before 1050 when the station is blotted out by Ramallah's carrier. (Radio Sweden)

At the time this was compiled, Boice, Conn., reported Paris, 9.55, 9.68, had discontinued the *English* beam to North America 1945-2000.

Radio Sweden says the Lisbon outlet formerly on 15.160 has now moved to 15.147; also reports Portuguese Radio Clube, Oporto, on 7.530 at 1300-1800.

A station heard by Peddle, Newfoundland, on 11.950 at 1230-1300 is believed to be Mecca, Saudi Arabia; poor level. Pearce, England, is hearing this one at 1200-1300, but occasionally continues to test to around 1315 when announces "This is Saudi Arabia Broadcasting System."

A strong station heard on 7.906 at 1200-1300 is presumed to be a new Greek outlet. (Radio Sweden)

The Forces Station, Central Greece, Larissa, noted back on approximately 6.745 from 6.770; sent QSL card; listed *English* program for Thursday 1530. (Pearce, England) Gives schedule as 0000-0200, 0500-0800, 1100-1545. (Radio Australia)

PRL8, 11.72, Rio de Janeiro, Brazil, now heard with fine level to 0355 sign-off; this transmission is relay of m.w. "Radio Maua." (Worris, N. Y.)

I recently noted *Radio Brazzaville*, 11.972, on a Sunday at 1100 with news for the Far East; fair level; announced was operating in the 25-, 31-, and 48-m. bands.

According to *Radio Sweden*, FBS, Middle East, Malta, has been heard

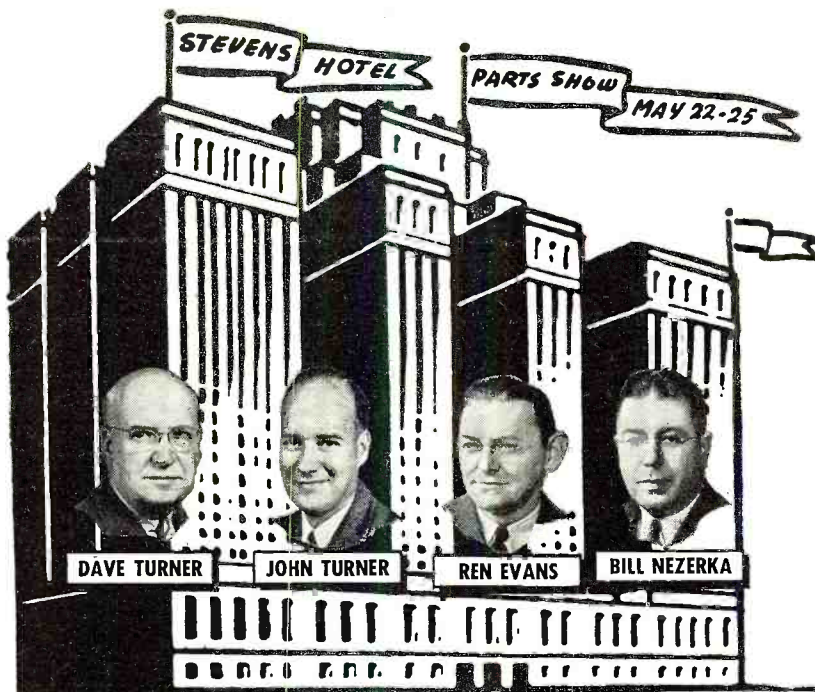

THE TURNER GANG

WILL BE LOOKING FOR YOU

ROOM 509A STEVENS HOTEL, MAY 22-25

THE TURNER COMPANY,

933 17th Street, N.E., Cedar Rapids, Iowa



Microphones BY TURNER



GOLD PLATED CRYSTALS

2 FOR \$1.00 POSTPAID
In the U. S. A.

All fundamental freqs. in Kilocycles	5910	6510	6690	7390
	6350	6610	7270	7480
	6370	6670	7350	7580
	6470	6940	7380	9720

GUARANTEED

ELECTRONICRAFT, Inc.
5 Waverly Place, Tuckahoe 7, N. Y.

AUDIO ENGINEERING SCHOOL

Practical engineering training in Audio fundamentals, Disc. Film, Magnetic Recording, and Audio frequency measurements, simulates Broadcast, Motion Picture, Television, and Commercial Recording work.

Approved for Veterans

HOLLYWOOD SOUND INSTITUTE, Inc.
1040-N North Kenmore, Hollywood 27, Calif.
Correspondence Courses Available
Specify if Veteran or Non-Veteran

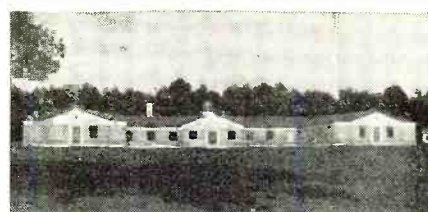

RADIO ENGINEERING TELEVISION ELECTRONICS

Thorough training in all phases of radio and electronics, open to high school and junior college graduates. Old established school specializing in Radio training exclusively. Modern laboratories and courses. Enrollments limited. Approved veteran training.

VALPARAISO TECHNICAL INSTITUTE
Dept. RD Valparaiso, Ind.

DUH5, 11.84, Manila, heard weak around 0230 in Oregon. (Callarman)

Radio Brazzaville now has news 1745 on 11.972 to North America; on 9.440 and 9.987 to South America; first two best here in W. Va.; seems to have dropped newscasts formerly at 1900 and 0030.

A station reported widely on approximately 9.530 around 0000-0130 is believed Warsaw.

OXI, 5.940, Greenland, noted 1735 in Danish; off 1748. (Bromley, Ontario)

A station that may be DYH3, Manila, noted by Dilg and Balbi, Calif., on approximately 6.11; announces as "largest station in the Philippines"; good 0500.

Saigon, French Indo-China, noted by Balbi, Calif., on 11.84, a new channel, from 0355; confirmed here in W. Va. at 0500 with news by woman; at 0515 was buried by LRT, Argentina, same frequency. Noted by Balbi on "old" 11.78 channel at 1015 with French news relay from Paris, signed off 1030. I cannot find it anywhere at 1800—former opening time on 11.78.

The Radio Club of Sweden says Damascus, 6.000, Syria, now has news 1530.

CR6RO, 7.582, Radio Clube do Bie, Silva Porto, Angola, says power soon will be increased from 400 w. to 1 kw. Radio Omdurman, Anglo-Egyptian Sudan, is on 6.115 now in addition to 9.747; has English on Friday 1230-1300. (Radio Club of Sweden)

YDQ3, 11.084, Makassar, Celebes, noted 0745; announced in English 0800. (Sutton, Ohio)

Fargo, Ga., flashes he has picked up Israel on 9.000 with news 1700, then a question-and-answer program about Israel; gave QRA as P.O. Box 754, Jerusalem, Israel, Station IBX; excellent level, in clear.

Moscow announced current daily schedules to North America are 1820-1930, 15.23, 11.88, 9.72, 9.67, 7.36, 7.29; 2000-2100, 15.23, 11.88, 9.72, 9.67, 9.60, 7.36, 7.29; 2200-2255, 15.41, 15.23, 15.10, 11.78, 9.72, 9.67, 7.29; however, 11.96 is also used in each of these transmissions. (Lane, South Dakota) The 11.96 channel is best here in West Virginia most evenings.

Radio Clube de Huambo, 11.925, Nova Lisboa, Angola, is scheduled weekdays 1300-1700, Sunday 0600-0745, 1100-1200. (Radio Sweden)

Radio Sweden reports Mafeking, Bechuanaland, has moved from 5.900 to approximately 8.230; on air daily 1200-1430.

Radio Tananarive, 6.160, Madagascar, heard in Calif. 0815-0915; music with announcements in French; call "Ici Radio Tananarive" is given irregularly; good level. (McPhadden)

Both Ferguson, N. C., and I recently heard a Chinese station on approximately 15.050 from tuning around 0610 to sign-off 0930; had Peking news relay 0830; good level; may have been testing.

Many thanks for the continued FB cooperation! KRB.

May, 1950

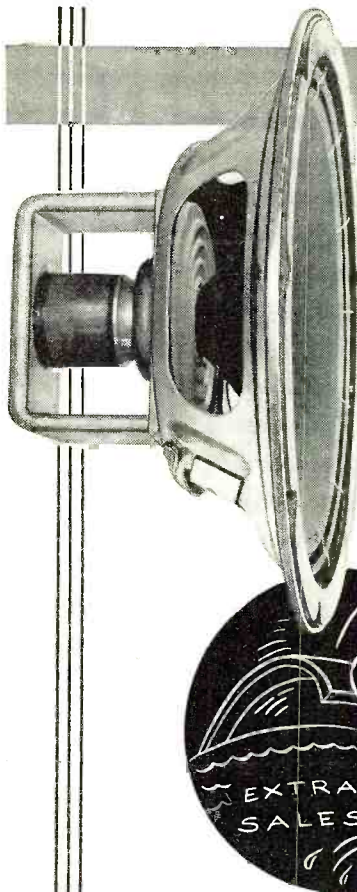

new

Permoflux ROYAL EIGHT" compares with any 12" speaker!

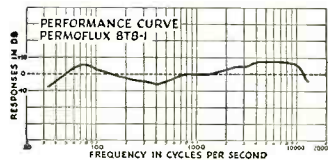

This averaged laboratory response curve of the Permoflux 8T8-1 proves that it compares with the finest speakers regardless of size or price.

It's Your "Springboard" to Extra Sales with Customers who want 12" performance but don't want to pay a 40% higher price.

From the resonant boom of jungle drums to the light warble of the flute, this new 8" speaker reproduces sound with superior sensitivity and fidelity. The tonal qualities of this magnificent speaker can only add to the excellence of any audio equipment.

Special processing provides extra-strong cone; allows cone to be soft-suspended from basket and held at coil-end by extra-large spider. Permits more faithful reproduction at lower frequencies. Deeper, curvical cone greatly extends high-frequency response.

Permoflux Royal Eight" (Model 8T8-1) is ruggedly-built, and simple to install. Provides big speaker performance in a small frame—uses smaller, more economical baffle. List Price \$15.00.

See New Complete Line of PERMOFLUX Products at Booth 603, Radio Parts Show.

PERMOFLUX[®]
"SOUND IN DESIGN"
PERMOFLUX CORPORATION
4900 W. GRAND AVE., CHICAGO 39, ILL. • 236 S. VERDUGO RD., GLENDALE 5, CALIF.

The June issue of RADIO & TELEVISION NEWS will be on sale May 30.
Be sure to reserve your copy with your Newsdealer.

WANTED TO BUY

Large and small quantities of new or used electronic government or manufacturers' surplus tubes and equipment. Highest prices paid. State quantity, condition and best price in first letter.

Box 496, % RADIO & TELEVISION NEWS
185 N. Wabash Ave., Chicago 1, Illinois

LEARN DAY and EVENING CLASSES
TELEVISION
ELECTRONICS-RADIO
Modern Laboratory
Instruction in
• SERVICING
• BROADCAST OPERATING
• ELECTRONIC and TV ENGINEERING
G.I. APPROVED
WRITE FOR ILLUSTRATED CATALOG
ELECTRONICS INSTITUTE, Inc.
21 HENRY DETROIT 1, MICH.

seen. If no change is perceptible it is advisable to let the i.f. remain in its original position and go on to the next stage. It may be noticed that although good vertical wedge information is present, the horizontal wedge information is smeared and very poor. This could be due to improper load resistors in the plates of the video amplifiers or improper setting of the i.f.'s controlling the low video frequency. Low video frequency means high frequency i.f.'s, therefore, the iron core slugs should be pulled farther out of the coil. When the bandpass is properly adjusted the vertical and horizontal wedges will appear in the same blackness and in sharp definition. The horizontal wedges will extend into the very center of the pattern and down to the inner circle whereas the vertical wedge may cut off at something greater than 300 lines.

It is a common receiver fault to receive a signal which at first appears as a ghost followed by other lighter ghosts which cannot be removed by orientation of the antenna. This may be caused by overpeaking the video i.f.'s. Further separation of the low frequency i.f. slugs will minimize this condition and even eliminate it in most cases. This condition is undesirable and is indicative of misalignment. It usually appears after a black line and the black line is followed by a white line which in turn is followed by a grey line, etc. These lines are caused by the damped oscillations set up in the video amplifier with a strong signal and the two i.f.'s too close together in frequency, permitting oscillation.

Low frequency distortion is caused by improper values in video amplifiers and results in blurring of horizontal lines even under fine-focus conditions. This condition is generally accompanied by excessive phase shift. If changing the frequency of the high frequency i.f.'s (low frequency video signals) does not correct this condition the video amplifiers should be checked since the r.f. head is not passing the 6 mc. required for good television reception. Alignment must be performed in the r.f. section of the head by adjusting the r.f. slugs in the coils for low frequency video.

As the vertical wedges become more sharply defined, sound bars will appear on the raster. These are usually horizontal grey bars which travel vertically across the raster. Elimination of these bars is necessary in order that the best bandpass may be selected. Adjustment of the sound trap is necessary. The bars may be eliminated by tuning the sound trap until they disappear or by presetting the sound trap by means of a signal from a signal generator tuned to the audio i.f. frequency. The same vertical bars will appear on the raster if the signal generator is modulated with 400 cycles. The sound trap is in tune when these bars disappear from the raster. It is obvious upon careful study of

SEE LEO FIRST... for HALLICRAFTERS!

Fellows— I'll bend over backward to give you a better deal. My EZ Payment Plan is the lowest in the country. I finance my own paper—it saves you money. No Red Tape, No Delays! Liberal Trade-Ins on your present equipment. Let's get acquainted!



LEO I. MEYERSON W0GFQ

SX-71 RECEIVER

The SX-71 offers superior Ham Band performance in the moderate price range—value packed with features specifically asked for by Hams. Features include Double Conversion sharp selectivity, plus built-in NBFM at moderate cost 10 tubes plus voltage regulator and rectifier.



\$179.50
Low Down Payments

"Guaranteed Satisfaction From The World's Largest Distributor Of Amateur Radio Transmitting Equipment."

S-40A RECEIVER

Frequency Range 540 KC to 43 MC. Temperature compensated oscillator. One RF, 2 IF. 3 Watt Output. 4 Bands. 8 tubes plus rectifier. Internal speaker. Has AF & RF gain controls, AVC, BFO, and Noise Limiter switches.

The finest set on the market at this low price. **\$79.95**
Low Down Payments

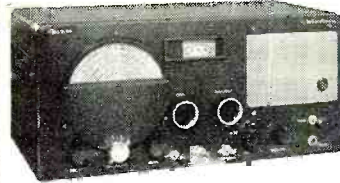

Deal with the "World's Most Personalized Radio Supply House". Send for your new complete WRL Catalog containing everything new in radio.

GIANT RADIO REFERENCE MAP



Just right for your control room wall. Approximately 28" x 42" Contains time zones, amateur zones, leading shortwave stations, monitoring stations. **25c**

FREE

WRITE—WIRE
PHONE 7795

World Radio Laboratories
INCORPORATED
COUNCIL BLUFFS, IOWA

WORLD RADIO LABORATORIES R-5
744 West Broadway
Council Bluffs, Iowa List Of Used Equipment
Please send me: SX-71 Info
 Radio Map New Catalog S-40A Info

Name

Address

City State

ELECTRICAL TRAINING

Intensive 32 weeks' residence course in fundamentals of industrial electrical engineering, including radio, electronics. Prepares for technicians, engineering aides. Approved for veteran training. 57th year. Next classes begin Sept. 5. Write for catalog.

BLISS ELECTRICAL SCHOOL
7609 Takoma Avenue,
Washington 12, D. C.



BARGAIN HUNTING?
RADIO SERVICEMEN!
Write for SENSATIONAL CATALOG
HENSHAW RADIO SUPPLY
3619 TROOST KANSAS CITY, MO.

PROP PITCH MOTORS

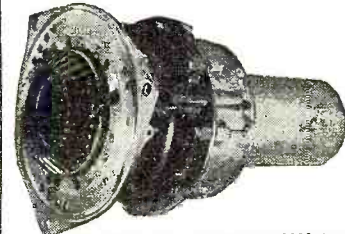

4 Amp 3/4 RPM. Gear Reduction 9000 to one Converted & Tested. Approx. Weight 35 lbs. **\$14.95**

TOBE LINE FILTERS
30 Amp 250 VAC/DC 0.15 to 1000 MC's Cont. duty. \$2.50 Ea. 2 for \$4.00
150 Ass't Resistor All Color 1.00
Coded 1.00
30 Ass't Condensers (Mica & Ceramic) 1.00
Ohio buyers add 3% Sales Tax.



WESTERN SALES CO.
1218 Prospect Ave. Ph. Main 1-1052 Cleveland, Ohio

Get MORE stations...

CLEARER pictures...

make COSTLY TV TUBES LAST LONGER with a

TRYLON TV MAST

As almost every dealer knows by now, built-in television antennas are really satisfactory in only a small percentage of installations. Even indoor antennas often leave a lot to be desired. But that's only part of it!

AVOID TUBE STRAIN!

Indoor antennas of any kind usually mean that sets must be operated at high volume. This means a big reduction in tube life—including the costly picture tubes!

An outdoor antenna mounted on a Trylon Mast assures clear pictures, reduces interference, brings in more stations. Also, it enables the set to operate at lower power with a minimum of tube strain. A leading dealer states: "I'm convinced that a Trylon Mast actually pays for itself in what it saves the TV set owner on tube replacements!"



Trylon TV Masts are easy to install—safe and easy to climb. Supplied in 10-foot sections for heights to 60 feet. Weight is about 2 lbs. per foot at a dealer cost of only about \$1.00 per foot. They're hot dip galvanized against the weather—designed for real dependability under all conditions. Write for Catalog N.

WIND TURBINE CO.
Mast and tower specialists
for over 17 years
WEST CHESTER, PENNA.

the r.f. bandwidth picture that as a higher and higher video response is approached the more sound will be allowed to enter the video i.f. The sound trap tunes very sharply but careful adjustment will always eliminate the sound bars from the picture.

Audio

The television audio uses a band-pass of 50 kc.—25 kc. on either side of the audio carrier. It is advisable to align a television receiver using audio as a basis for determining the best alignment point. The reason for this is that the video is 5.25 mc. wide and is difficult to set accurately even with a trained eye. However, it can be set within a few kc. by means of the audio since the greatest possible error with the audio is only 25 kc. or an error of less than .01 per-cent!

First align the audio i.f.'s by turning the slugs an equal number of turns until the audio is present in the speaker and the picture is visible on the screen. Next while observing the r.f. variable condenser or fine tuning control note the point at which the best picture is received and also the point at which the sound is heard best. If the capacitance or inductance increases its value the sound is below the picture by too great an amount and the audio frequency must be increased, i.e., the slugs must be pulled out of the coils. If the capacitance or inductance decreases when bringing in the best sound, the audio i.f. frequency must be lowered. After each adjustment check again with the highest definition picture to determine the new audio position and verify whether the point of best picture performance has been reached. Do not expect good sound until the discriminator has been properly balanced for each new setting.

The discriminator is balanced if the noise is at a minimum and the sound is not distorted on loud signals. This is important. Since the FM frequency bandpass governs the sound intensity, if only a weak signal is judged, very little can be determined about good FM balance. Test the audio on both weak and strong signals. It should handle both with no distortion and no noise. Although it may seem as if there were a loss in gain remember that a properly balanced discriminator has little or no background noise and handles full signal intensity without distortion. This point should also be the point of greatest video definition. When the audio and video are prealigned with a standard signal generator very little audio-video juggling is necessary. Remember that in using a standard signal generator the discriminator must be detuned and the i.f.'s lined up for greatest audio signal, then the discriminator is adjusted for weak or no audio signal.

Bandpass

At this point the receiver may be checked for bandpass. If the best possible picture has been achieved it

BUY DIRECT SAVE!!
From Factory
New Improved RCA
Licensed 16"—630
Chassis
Plus \$1.90 Fed. Excise Tax (Less CRT)
CHECK THESE IMPORTANT FEATURES
• Completely wired and aligned by expert technicians
• Newly developed keyed automatic gain control.
• Voltage doubler.
• Wide angle deflection yoke will spread any 16" picture tube.
• Latest type Standard Coil tuner for high sensitivity, UHF adaptation, and easy servicing.
• Full tube complement.
19"—630 Chassis—\$154.95 plus \$1.90 Fed. Excise Tax. (Less CRT)
All glass 16" C-R Tubes \$38.90
All glass 19" C-R Tubes \$73.25
No Extra Charge for Rectangular or Black Tube Regular RMA guarantee on all tubes and chassis
Beautiful cabinets for above—available
Terms: \$25.00 deposit on all orders—Balance C.O.D.
F.O.B.—N. Y. Factory
Prices subject to change without notice
IMMEDIATE DELIVERY Visit our showrooms
AD-RITZ MFG. CORP.
158 Grand Street | 231 Centre Street
New York, N. Y. | New York, N. Y.
Phone WO 4-6763 | Phone WO 2-5962

TUBES TESTED GUARANTEED

10BP4.....	\$14.95	12LP4.....	\$18.95
Standard Brand tubes RCA—Sylvania—Hytron			
14B6.....	75c	6N7.....	89c
6AZ5.....	55c	6U4.....	58c
12AW7.....	69c	1B3.....	98c
7AD7.....	89c	6SH7.....	49c
7A7.....	69c	6H6.....	49c
6J6.....	89c	6SC7.....	69c
6AK5.....	89c	6SN7.....	69c
VR53/61K7.....	25c	12SN7.....	69c
Standard Turret Tuner, complete with tubes.....	\$26.85		
RCA Horizontal Output Transformer 211T5.....	3.99		
RCA Horizontal Output Transformer 211T1.....	3.49		
RCA Vertical Output Transformer.....	3.25		
RCA Deflection Yoke.....	3.99		
RCA Focus Coil.....	3.49		
Controls—10 ohms to .25 Megohm W.W. and carbon.....	.29		
1/2 Meg 1 Meg.....	35c	With Switch.....	.45
Selenium Rectifiers			
75 Ma.....	49c	100 Ma.....	59c
200 Ma.....	.79		
Crystal Cartridges			
L-70 L-71 MLP1.....	1.25		
6 Tube Superhet Kit with tubes.....	11.95		
5 Tube Superhet Kit with tubes.....	10.95		
Superhet Variable Condensers.....	.49		
FM Superhet Variable Condensers.....	.99		
Automatic Changers.....	7.95		
Phono-arms Hook-up wire AN connectors, hardware, speakers, antenna loops. Write in for your needs. Famous 16" Wired 31 tube 630 chassis, with C. R. tube.....	\$189.98		
BERGEN RADIO & TELEVISION CO. 345 Bergen St., Newark, N. J.			

FOR BARGAINS IN
Receivers, Transmitters, Amplifiers, Television Sets, Batteries, Surplus Parts, Phonograph Records, and many more items
Read
RADIO AND TELEVISION NEWS
Classified Columns Every Month

ODEGAARD ORIGINAL MAIL POLYETHYLENE STANDOFF
for Ribbon or Coaxial Cable
Saves more labor, time and money than any other standoff! No drilling—just quick, easy hammer strokes. Easily drives into wood, mortar, iron, aluminum, etc. Excellent mast-coupler. Step-locked, permanent installation. Cadmium-plated hardened high-carbon steel nail. Specially punched lo-loss polyethylene.
SERVICEMEN: For free sample and nearest distributor's name, write today to Dept. N.
PARTS DISTRIBUTORS: Choice protected territories still open. For full details, write today to Dept. N.
COPYRIGHT 1950 JOHN ODEGAARD BROOKLYN, N. Y.
ODEGAARD MFG. CO.
5416 EIGHTH AVE., BROOKLYN 20, N. Y.

may be assumed that the greatest available video band is being passed. Trouble may be present in the video amplifiers or the r.f. assembly. A simple tuning tool may first be tried by placing it at the peaking coils of the video amplifiers. There should be no change for the worse when the tool is brought near these coils. Another simple tuning tool may be constructed by fastening a peaking coil of 200 μ hy. to a tuning tool. This coil may be used to shunt the peaking coils in the video amplifiers. This should reduce the picture resolution. If it increases the picture resolution the video coils are not properly designed or have changed value. A peaking coil of less inductance than was originally used in the video should then replace the present one if this effect is noted.

Usually, however, the trouble lies in the r.f. assembly. The bandpass of the r.f. assembly may be less than 6 mc. This is evidenced by good sound, good vertical wedges, but poor horizontal wedges. This may be checked by observing the test pattern as the fine tuning is varied. If the test pattern increases in vertical or horizontal resolution as the audio disappears or becomes louder, then all the required band is not reaching the i.f. amplifiers. This band may be increased by adjusting the r.f. trimmer slugs or condensers. Increasing the inductance for increased low video response and decreasing the inductance for increased high video response is the procedure to be followed. Remember that a good test pattern will show very clearly and have sharply defined lines and spaces of equal intensity both horizontally and vertically with no ringing evident and no phase distortion present.

The well designed receiver will produce over 300 lines vertically and horizontally. When this is achieved the receiver is properly aligned. All of this can be accomplished satisfactorily without employing elaborate test equipment—just the intelligent use of the video test pattern on the cathode-ray screen.

The cathode-ray tube is the handiest possible test instrument since it is always available during servicing procedures.

-30-



May, 1950

THE FAMOUS
Western Electric
728B Loudspeaker

24 ⁹⁵
F.O.B. N.Y.

another terrific Terminal value...

FREQUENCY RESPONSE Essentially uniform from 60 to 10,000 cycles, with negligible distortion.	DIAMETER (overall) 12-11/32"
VOICE COIL IMPEDANCE 4 ohms	DEPTH (overall) 3-25/32"
COVERAGE ANGLE 50°	WEIGHT 17 pounds (approximate)
POWER HANDLING CAPACITY 30 watts continuous	BAFFLE HOLE DIAMETER 10-15/16"
	MOUNTING HOLES Four equally spaced on 11-9/16" diam.
	EFFICIENCY At a distance of 30 feet on axis the 728B will produce a level of 93.5 db. above 10 ⁻¹⁶ watt per sq. cm. at 30 watts. This level is on a basis of a warble frequency covering a range from 500 to 2,500 cycles per second.

Speaker Enclosure
provides 3 cubic feet completely enclosed as recommended by Western Electric for best results with the 728B. Constructed of 3/4" plywood throughout, supplied unfinished ready for painting or 16 ⁹⁵ F.O.B. N.Y. spraying to desired finish.

Write for our New Sound Catalog

TERMINAL
RADIO CORPORATION
Distributors of Radio & Electronic Equipment
85 CORTLAND ST. NEW YORK 7, N. Y. • Phone - WORTH 4-3311 • Cable - TERMRADIO

New and Used Surplus Bargains

APS-13—Transceiver—410 to 420 MC—30 MC IF, New.....	\$13.50	Excellent Condition, Less Crystals, Crystal Drawer & Dynamotor.....	9.95
BC-788—Transceiver—Ideal for Citizens Band, Used.....	10.00	Less Crystals but with Dynamotor.....	12.50
BC-1206—Beacon Receiver—Overseas Packed.....	5.50	With 80 Crystals and Dynamotor.....	24.75
BC-457—Command Transmitter, New \$7.50, Used.....	5.50	BC-603 & 604 Both Complete.....	39.95
BC-458—Command Transmitter, New \$7.50, Used.....	5.50	Case of 80 Crystals for BC-604.....	12.95
RT-7/APN-1—Altimeter Transceiver 418-462 MC FM, Used.....	6.50	DM-34—12v Dynamotor for BC-603.....	3.50
BC-603—FM Receiver 20 to 28 MC Excellent Condition, Less 12v Dynamtr. With Dynamotor.....	14.50 17.00	DM-35—12v Dynamotor for BC-604.....	3.50
BC-604—FM Transmitter 20 to 28MC		BC-683—FM Receiver 27 to 38.9 MC Less Dynamotor—Excellent Condition.....	24.95
		With Dynamotor.....	27.50
		BC-684—FM Transmitter 27 to 38.9 MC Less Crystals, Drawer and Dynamotor.....	27.50
		Less Crystals with Dynamotor.....	29.95
		With Crystals and Dynamotor.....	42.50
		BC-683 & 684 Both Complete.....	67.50

DAVE RUMPH CO. P. O. Box 4178
FORT WORTH 6, TEXAS

Now Available TAYLOR SUPER-MODULATION

TRANSMITTER KITS and TRANSFORMERS

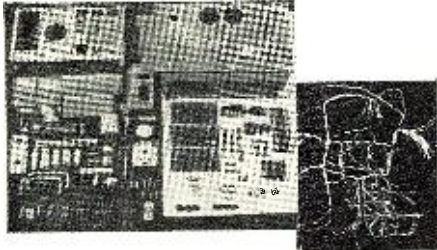

TSM-75K Super-Modulation Transmitter

A revolutionary new high power, compact, light weight amateur transmitter for stationary and mobile use. The "TALK-POWER OUTPUT" is approximately 3 times that of any other type of transmitter with the same power input. Maximum power input of the TSM-75K is approximately 75 watts.

The basic kit now available consists of all metal-work completely finished, and includes punched chassis, front panel, back panel, cabinet, and all brackets and special parts. Also included in the kit are the modulation transformer, meter shunts, special capacitors, and all other special parts. The major feature of the TSM-75K basic kit is the cable harness, which is completely pre-formed and laced, and all wires are stripped, tinned, and numbered for easy assembly. The wires are placed in such a way that when the harness is laid into the chassis all leads are close to the parts to which they are to be attached. Complete assembly, wiring, and adjustment instructions are furnished, and a complete parts list is supplied. All parts not furnished are standard parts available from most jobbers. Tubes required are 1 - 3E29/829B, 2 - 6AK6, 2 - 6AQ5, and 1 - 6AU6.

The modulator is incorporated into the transmitter, and the only accessories required for operation on either phone or CW are a microphone and power supply. Coil data is supplied with the kit for 10 meter operation. Other data available on request. Kits are available at prices shown below.

- TSM-75KB Basic Kit — Net.....\$79.50
- Set of Matched Tubes — Net..... 20.40
- Set of 4 Coils — Net..... 12.50

Super-Modulation Transformer



MODULATION TRANSFORMER for any Super-Modulation transmitter up to 500 watts, with data for proper use. Weight 13 oz.
CS-3261 — Net..... \$7.50

Super-Modulation Transformer

MODULATION TRANSFORMER for any Super-Modulation transmitter up to 1000 watts, with data for proper use. Weight 27 oz.
CS-3262 — Net..... \$9.50



All Prices F.O.B. Los Angeles
25% Deposit Required With All Orders.
Orders Accompanied by Full Payment
Shipped Prepaid.
California Sales Add Sales Tax.

The Gaertner Co.

3614 Maple Ave.
Los Angeles 11, Calif.
Licensees Under United States and Foreign
TAYLOR Super-Modulation Patents.

LETTERS

from our readers

MORE FORGOTTEN MEN

PLEASE add my name to the list of those in 100 per-cent agreement with the sentiments voiced so ably by Mr. Van Slyck (February issue). Last November I became a charter member of the 'Forgotten Men' fraternity.

"I have handled the receivers of a prominent manufacturer for over three years. I have built them up to a position at the top of the customer acceptance list in this territory. Suddenly—no more radio sets. I lost about \$450.00 at Christmas, and will lose much more in the months to come. I have written to nearly every vice-president they've got and the best I have had is the wish that I will be able to hold out until 'television gets to Mena.' Mena, Arkansas, has a population of 5000 and is 85 and 95 miles respectively from the nearest FM stations!

"In the last three years I have sold nearly \$25,000 (list) worth of this manufacturer's products. They won't sell that much TV in the whole dad-burned state of Arkansas in the next five years!

"I don't know what is going to happen to the organization of once-loyal dealers which has been built up so laboriously over the years. Certainly the companies are going to have to start all over again to get any goodwill out of us, if the rest are like me. My contention is this. Radio has a large listening audience. What percentage of these use a \$19.95 midget or \$39.50 table model? How many years will it be before TV advances to the point where they can provide the mass market with a table model selling for less than \$50.00? Einstein's new theory may provide the answer—I certainly can't."

Jack Darr
Ouachita Radio Service
Mena, Ark.

* * *

THE GAIN SET

I READ with a good deal of interest the article on the audio oscillator and gain set in the January issue but would like to make a point.

"Mr. Bumbaugh leaves the impression that no matter what his gain set is terminated into, beyond the loading resistor, that he need not bother to include the loss of the termination in the total loss of the input attenuator. In other words, no mention is made when referring to Fig. 6, that when building out to high impedance, one must add the loss of the pad thus created to that of the gain set. He is not wrong, true, but too many people don't know the difference.

"In the case cited, adding the 100,000 ohms to an assumed 100,000 ohm grid (itself assumed as a pure resistance which is not so since there is always an appreciable capacity at audio frequencies in the measure band) would create an impedance ratio of 200 to 1 or an additional bridging loss of 26 db. This additional loss must be added to that of the gain set before we can evaluate the single frequency gain of the equipment under test. The same thing applies to the matching network for the low impedance case cited. I will say, however, that the low impedance case is a lot easier to evaluate than the high.

"Conventional practice uses two methods. One, a matching transformer of good design and two, the matching pad, a variation of which Mr. Bumbaugh has shown. I would like to see a clarification of the added loss made public just in order to keep a lot of well-meaning radiomen from running into trouble over something which is far from well-known even in the broadcasting industry.

"As a sidelight, I might add that I seriously doubt if there are more than two per-cent of the engineers presently using audio measurements in the broadcast industry who actually know how to use the decibel properly. Call any Master Control you like, even here in Chicago, and two-to-one when you ask for a level you will be told 'It's leaving here at 0 db.' Now you know that doesn't mean a darn thing. What is the reference point for such a statement? Take it further and ask the same engineer what reference he is using and I'll bet again he doesn't know. That has been my experience for years and I have fought it like mad. The average radio engineer has an idea that the db. is an actual value of voltage. That is the big reason for going to the v.u. system where the reference is part of the definition of the v.u. and where a reading of so many v.u. means what it says."

Hilton Remley
Station WGN
Chicago, Illinois

* * *

TV IN HIGH SCHOOLS

WE FEEL that you may be interested in knowing that television is definitely spreading into the high schools.

"Our senior class play was televised and aired on our local outlet, WTTV. The televising was accomplished with one RCA camera located in our auditorium balcony where the cameraman was able to traverse the entire stage. The image orthicon tube used required no extra light or makeup. The camera

RADIO & TELEVISION NEWS

was connected to the transmitter by a coaxial cable—the same one used to carry our athletic events. The cable has been permanently installed and is being used to carry special programs in addition to a regular weekly telecast produced by students of the radio classes.

"Technically these telecasts are proving to be no problem at all to school officials or to WTTV engineers."

Wm. T. Voorhies
Dir., Radio & Dramatics
Bloomington High School
Bloomington, Indiana

* * *

ANOTHER PLEA FOR HELP

I HAVE read with interest Donald Chadwick's letter in the December issue.

"I, too, am working for my ham ticket and looking forward to the day when I shall be able to pump some r.f. up the feeder lines, but like Donald, do not seem able to go past the 8-10 w.p.m. level. Anyway, on thinking of the many other fellows who have, I am encouraged to continue fighting. I am 20½ years old and shall be pleased to correspond with other prospective hams in any part of the world, 'CQ Jamaica.'

"Your magazine is always interesting to me, especially the 'Letters from our Readers' page and I'll close by saying 'Keep up the good work!'"

Garnett W. Green
40 Arnold Road
Cross Roads P.O.
Jamaica, B.W.I.

* * *

NO SPACE

IN THE March issue I missed the 'Letters from Our Readers' department. Could I have been so blind as to overlook it? Or can it be that the readers have not been writing? In case it is the latter, I am sending along my letter for next month's column as I enjoy the department very much.

"I get a big kick out of reading 'Mac's Radio Service Shop' by John T. Frye. As well as pointing out some very good ideas about the radio service shop he also adds a lot of humor to his story which makes it all the more interesting.

"I also like the editorial in the March issue warning people about the care needed in handling television picture tubes and about the high voltages involved in television.

"I also found in the March issue (at the bottom of page 158) a little item on checking voice coils that I would like to comment on. I would suggest to the writer to first place the ohmmeter test leads across the primary circuit of the output transformer. If the click is then heard it would indicate that the primary and the secondary circuits of the output transformer are OK as well as the voice coil circuit. This way all three circuits can be checked in one operation!"

Paul Anderson
Ah-Gwah-Ching, Minn.

—30—

CHE SEA *Spotlight* VA UES

BY POPULAR DEMAND
Another Limited Number of

12" PICTURE TUBES \$15.95

FACTORY-FRESH IN SEALED CARTONS
2 Guarantees—RMA and Chelsea



Latest Improved **19" LIC. RCA CHASSIS**

COMPLETE WITH PICTURE TUBE

\$199.95 JUST PLUG IT IN...IT WORKS BEAUTIFULLY

plus \$1.80 Fed. Tax



A SET
NOT A KIT

A price-shattering offer of our superior C-4 Receiver, completely wired, factory-engineered, aligned and tested . . . quality controlled all the way, with improved AGC and AFC, and Standard Coil Front End down to 45 microvolts.

2 Guarantees—RMA and Chelsea

Completely wired, factory-engineered, aligned and tested
LATEST 630 TYPE LIC. RCA 16" CHASSIS—30 TUBES, VOLTAGE DOUBLER

Improved AGC and improved high gain front end down to 45 microvolts.

COMPLETE WITH PICTURE TUBE . . . \$184.95

Same chassis for 19" operation, with voltage doubler and picture tube . . . **\$233.45**

Some chassis, less CRT, . . . \$145.95

plus \$2.25 Fed. Tax

Plus \$2.25 Fed. Tax

Highly Sensitive No-Drift AM and FM Tuner \$31.50 plus \$1.80 Fed. Tax

High and Low Frequency All-Channel Antenna from \$6.71 to \$471.00

WHY PAY MORE ELSEWHERE?

Write Dept. R for latest literature and prices—and COMPARE Phone and mail orders filled on receipt of certified check or money order for \$25 as deposit . . . balance C.O.D., F.O.B. N. Y. For Free Demonstrations, visit our street-level showroom.

The House of Bargains

CHELSEA TELEVISION CENTER, INC.

187 Seventh Ave., New York 11, N. Y. CHelsea 3-4425-6-7

Prices subject to change without notice.

RADIO ENGINEERING!

Complete Radio Engineering course incl. Telev., U.H.F., and F.M. B.S. Degree Courses also in Civil, Elect. Mech., Chem., and Aero. Eng., Bus. Adm., Acct., visit campus, see well equipped labs. Low cost. Prep courses. Personalized instruction. Grade successful. Founded 1884. Enter June, Sept., Jan., March. Write for Catalog.

TRI-STATE COLLEGE

1650 College Ave.
Angola, Indiana

WALKIE TALKIES \$3.99 PER SET OF 2

POCKET SIZE
—Electronic
Voice Powered



No tubes, batteries, adjustments, license or permit needed! Should last for years.
Guaranteed to work anywhere up to ¼ mile with extra wire. Clear tone. Swell for room to room—garage to house, etc! Your own private, talk-listen phone. Not war surplus. Brand new. Solid Aluminum Case. Guaranteed. Two absolutely complete units with wire—READY TO USE! DeLuxe model has phone and mike in each unit. Swell for television antenna work. SEND ONLY \$1.00 deposit and pay postman \$2.99 plus postage charges on arrival. Ideal gifts for boys—girls. Order Now! Today! THE MIDWAY COMPANY, Dept. WRT-5, KEARNEY, NEBRASKA.

5 TUBE AC-DC RADIO KIT

4" PM Spkr. Great for schools. Less tubes. . . \$ 5.95
Tubes for above, \$2.50; Plastic Cabinet, Knobs. \$ 1.45

Pwr. Trans., 90 MA, 6.3 V. Fil., 5 V. Fil., 110 Pri., 350-0-350 Plate Winding. \$ 2.49

½ Meg. Vol. Contr. w/Switch, 2" D Shaft, GE Box 39c

Auto. Record Changer, 78 RPM, McGuire. . . . \$ 7.95

5" Field Spkr., 450 Ohm, w/Output Trans. . . \$ 1.95

6" Dynamic Auto Speaker. \$ 1.95

N7 Webster Phono Crystal. \$ 1.15

R.M.S. Television Booster. \$19.80

3 Spd. Phono Mtr. w/Turntable, Top Brand. . \$ 4.95

3 Spd. Phono Pickup, Turnover Type, w/2 Inds. \$ 4.95

10% Discount on orders over \$25.00. 25% Deposit, Bal. C.O.D. Plus postage. Write for FREE bargain list.

M. FISHER & SON

2941 N. 5th St.

Philadelphia 33, Pa.

Another TVAE best buy!

TVAE's Low-Cost ROOF SADDLE

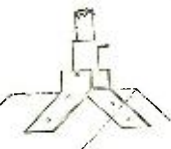

ON THE PEAK



ON THE SLOPE



ON THE FLAT



ON THE SIDE

ONLY \$55
In lots of six

Installed by anyone in 60 seconds

Adaptable to any situation

Heavy gauge steel No castings

Takes masts 1 3/8" and smaller

NEVER before has such cleverly devised, such sturdy roof saddle been offered at so low a price.

SIMPLE to install in all situations, a broad base gives it strong purchase against any face, eliminating danger of its being worked loose. Made of steel, it may be hammered into the desired shape without fear of its weakening.

INSTALLERS are stocking this all-around device in quantities in place of maintaining an assortment of brackets.

Single brackets—\$1.70 plus 15 cents mailing costs

TV Accessory Engr. Co.
2105 Lagrange St. Toledo 8, O.

RADIO Surplus Buys

ROTARY BEAM PROP PITCH MOTOR

Heavy Duty prop motor... ideal for rotating largest beams. Operates on 28-35 V. ac or dc.



1 RPM..... **\$13.95**
Crating charge.... **\$2.00**

- PE-103 DYNAMOTOR with base & cables **\$14.95**
- BC454 Command Receiver **\$ 5.95**
- BC455 Command Receiver **\$ 6.95**
- R-5/ARN-7 Compass Receiver... **\$14.95**
- BC433G Compass Receiver..... **\$14.95**
- HS33 Headsets with cord and plug **\$ 1.95**
- 12DPT Cathode Ray Tube (new) **\$ 9.95**
- Linesman Tool & Safety Belt Web Type (new)..... **\$ 3.95**

All Equipment Used Good Unless Otherwise Specified
SEND 10c FOR OUR COMPLETE SURPLUS CATALOG!

Enclose Full Amount with Order
All Equipment F.O.B. Pasadena

C & H SALES CO.
2176-R5 East Colorado St., Pasadena 8, Calif.

CODE SENDING SPEED

CODE RECEIVING SPEED

Free Book

HIGH SPEED

WITHOUT NERVOUS TENSION

REVEALING BOOK shows how "crack" operators develop high speed and proficiency. Learn code for Amateur or Commercial Radiotelegraph License, or improve your sending and receiving with the Candler System which develops radiotelegraph experts and code champions.

CANDLER SYSTEM Box 928, Dept. 2-E, Denver, Colorado

Classified

Rate 35c per word. Minimum 10 words

RADIO ENGINEERING

PANELS for electronic, nucleonic construction projects. Complete service for designers, custom builders. Circular upon request. Gilpin Instrument Works, P. O. Box No. 8, Mt. Clemens, Mich.

RADIO Engineering Broadcasting, Aviation and Police Radio, Servicing, Marine Operating and Electronics taught thoroughly. Expenses low. Write for catalog. Valparaiso Technical Institute, Dept. N, Valparaiso, Ind.

ADVANCED Practical-Engineering strikingly different new methods for radio-TV-electronics. High caliber correspondence, instruction. Simplified, streamlined, fast, practical methods for the practical man. Very reasonable rates. Write: Superior Procedures, Twenty-one Sixty-six Market St., San Francisco, Calif.

SALE

18 TUBE Oscilloscope, Laboratory type, \$129.00. Write: Robert Augsburger, Route No. 1, Monclova, Ohio.

R.C.A. Coin Operated Radios (used). Box 233, Cedar Falls, Iowa.

AMATEURS who own BC342, BC348, BC224, etc., may obtain high gain 10 meter performance with the use of our guaranteed RF24 3 tube 20-30 mc converters measuring only 5"x7"x10" and furnished with 3 spare tubes and adequate instructions, these units cost but \$16.00 each postpaid. Write for yours today! Overbrook Co., Overbrook 81, Mass.

1947 GENERAL Electric 30-44 Mc. Fm. Mobile Receiver, Transmitter and Home Station Receiver, Transmitter. With all accessories. \$780.00. John Kirby Jr., Box 299, R.17, Indianapolis, Ind.

SCREWDRIVER adjustment rheostats, 10 watt, 100 ohms, 6 for 50c; Solenoids 24V 35c; Micro switches 3 for 50c; Relays 24V 8 for \$1.00; Toggle switch guards 12 for 50c. Postpaid. Stuart Sales, 6402 Pittsburg, Detroit, Mich.

CARBON Tetrachloride, cleaner, solvent, 27 oz., \$1.50. Polystyrene high frequency coil and splice dope, \$1.00 pint. Special thinner, 65c pint. Craft Chemical Lab., 453 1/2 E. Exchange St., Akron 4, Ohio.

RECORD Changer Parts for leading makes. We ship everywhere. Friend's Wholesale Distributors, 106 N. 6th St., Philadelphia 6, Pa.

FIVE Element TV Yagi Beams. High Band, \$6.75. Low Band, \$8.50. Aluminum Tubing, etc. Willard Radcliff, Fostoria, Ohio.

BARGAINS. New and reconditioned Hallicrafters, National, Collins, Hammarlund, RME, Meissner, other receivers, tuners, television receivers, transmitters, amplifiers, speakers, etc. Lowest wholesale prices. Terms. Shipped on trial. Liberal trade-in allowances. Write Henry Radio, Butler, Mo., and 11240 W. Olympic, Los Angeles, Calif.

LOWEST Prices Radio Tubes, parts. Bargain lists, 3c. Potter, 1314 McGee, Kansas City 6, Mo.

HOTTEST surplus list in the country. Electronics-Hydraulics, Aircraft-Gadgets. Dick Rose, Everett, Wash.

RADIOMEN, Servicemen, Beginners. Make more money, easily, quickly, \$250 weekly possible. We show you how. Information free. Merit Products, 216-32T 132 Ave., Springfield Gardens 13, N. Y.

TRANSFORMERS, UTC, Audio, like new, guaranteed; LS-40, \$9.00; HA-135, \$7.50; HA-107, \$9.00. J. A. Fisher, 126 Richland, Pittsburgh 8, Pa.

RADIO Diagrams 50c; Record Changers, Recorders 60c; Television Diagrams with service data \$1.00 up. State Manufacturer and model number. Kramer's Radio Service, Dept. RX, 36 Columbus Ave., New York 23, N. Y.

EDISON storage batteries, Nickel-Iron-Alkaline type. Government surplus sets 32 volt 25 cells assembled in 5 cell trays ready for service 125 watts normal discharge 19 ampere-hour capacity. Only \$40.00 complete set. Factory price over \$160.00 guaranteed perfect. Only few more sets left. Good for many years. John L. Pulster, Battery Specialist, 510A Audubon Bldg., New Orleans 16, La.

HALLICRAFTERS S-47 perfect condition, \$175. Sams Photofacts, 1 to 84 complete in 7 binders \$150. Value for \$100. Jensen B 81 Reflex cabinet with PM 8 CT Speaker \$17.50. Eilers Radio & Appliance Co., Box C, Gladbrook, Iowa.

SWEDGAL declares a Buyer's DIVIDEND!

GET THIS PLASTIC PILLOW FREE! Folds to match book size, blows up easily as a sturdy, waterproof, no metal parts, anti-allergic, for beach, picnics, etc. Has 100% of uses! GET YOURS FREE for every \$5 order. A \$10 order brings 2 Plastic Pillows FREE, Etc. You'll want one for every member of your family.

TUBES

GUARANTEED BRAND NEW Individual Cartons

DEDUCT 5c from each tube when ordering any 20!

24c	6AR5	6SS7	26	5Z3
6C4	6AT6	6U6	27	5Z4
12A6	6B8	6V5GT	35/51	14B8
34c	6BA6	6V6	35B5	14Q7
6X4	6BE6	6W4	35Z5	25Z5
36	6C5	6X5	47	58c
46	6C8	6Y6G	56	OZ4
79	6D6	7A4/XXL	71A	6BG6G
38c	6F6	7B6	75	50L6
1R5	6H6	7C6	76	VR150
1S5	6J5	7H7	77	69c
1T4	6J6	12BA6	78	6AC7
1U4	6K5	12BE6	85	117L7/M7
1U5	6K6	12J5	117Z3	117Z6
5Y4G	6SA7	12K7	1251	89c
6AG5	6SH7	12SA7	2051	49c
6AL5	6SJ7	12SC7	49c	6L6
6AL7	6SK7	12SN7	49c	50A5
	6SN7	12SQ7	49c	6U5/6G5
	6S7	24A	1A5	25A7GT
		25L6	1A7	

TO SPEED DELIVERY! Order Now! Minimum, \$2.50. For C.O.D. shipments enclose 25% deposit. Include adequate postage, excess will be returned. All prices F.O.B. New York, N. Y. WRITE FOR FREE CIRCULAR.

SWEDGAL RADIO, INC.

96 Warren St., Dept. N-2 New York 7, N. Y. Cortlandt 7-6753

SPEAKERS

All made this year... brand new fresh magnets... specially low priced... guaranteed quality!

ALL ALNICO V		EA.	Lots of 5 Asst.
4" P.M. .68 oz.	\$.89	\$.85 ea.
4" P.M. 1 oz.99	.95 ea.
4" P.M. 1.47 oz.	1.05	.99 ea.
4" x 6" P.M. 1 oz.	1.49	1.39 ea.
5" P.M. .68 oz.89	.85 ea.
5" P.M. 1 oz.95	.89 ea.
5" P.M. 1.47 oz.	1.05	.95 ea.
6" P.M. 1 oz.	1.29	1.19 ea.
6" P.M. 1.47 oz.	1.39	1.29 ea.

RCA # 209X1 Crystal Pickup..... \$2.95 Complete

OUTPUT TRANSFORMERS		
10,000 ohms, center tapped to 3.2 ohms voice coil, channel mounting, Push-Pull.....		25c ea.
300 Output.....	34c ea.	
50L6 Push-Pull.....	34c ea.	
Output.....	38c ea.	
6V6 Push-Pull Output.....	38c ea.	
6V6 PUSH-PULL, RATED 15 WATTS. Secondary taps are 4, 8, 15, 250 and 500 ohms. Fully shielded.....		89c ea.

VOLUME Centralab-Mallory-Stackpole, etc. CONTROLS With switch & long shaft 100,000 ohms • 250,000 ohms • 350,000 ohms • 500,000 ohms • 1 megohm.....34c ea. Any ast. of 10, Only \$3.00. SPECIAL BUY! 100,000 ohms, 1-3/16" shaft... 9c ea.

RC348 110 volts. Almost unused. \$65.00. A. C. Woodrich, Wellsville, N. Y.

PROJECTION television sets 19"x25" picture, UST, used, with AM, FM, Shortwave: Cabinet 69"x42"x19", complete \$185.00. Murray Barlowe, 880 59th St., Brooklyn 20, N. Y.

COIL Forms: Iron slug tuned; Polystrene; half inch diameter; 1 1/2 inch winding length; adjustable terminals. Mounts in quarter inch hole. 50c each, prepaid. WOPMU, 1429 Anna Ave., St. Louis 14, Mo.

WANTED

SNIPERSCOPE & Snooperscopes wanted. Any type, any condition. Needed immediately. Box 495, % Radio & Television News, 185 N. Wabash Ave., Chicago 1, Ill.

HELP WANTED

INSTRUCTORS in Electronics and Radio. Prefer former Navy Radio Technician instructors willing to locate in the Detroit, Mich., area. Write to Box 452, c/o Radio & Television News, 185 N Wabash Ave., Chicago, Ill.

RADIO Instructors. For theory and lab. Write for application form. Paterson Radio Institute, 217 Paterson St., Paterson, N. J.

ELECTRICAL Design Engineer by large, modern, Eastern Manufacturing Firm for Experimental Development work in Industrial Electronics. Applicant must have degree in Electrical Engineering with Communications or Electronic Option or equivalent in 10-15 years practical experience. Give details including age, education, experience, references, availability and salary expected. Box 502, % Radio & Television News, 185 N. Wabash Ave., Chicago 1, Ill.

PATENT ATTORNEYS

LANCASTER. Allwine & Rommel Registered Patent Attorneys. Patent practice before U.S. Patent office. Validity and Infringement investigations and opinions. Booklet and form "Evidence of Conception" forwarded upon request. Suite 414, 815 15th St., N.W. Washington 5, D.C.

HERMAN Lewis Gordon, Registered Patent Attorney. Patent Investigations and Opinions. Warner Building, Washington, D. C.

CORRESPONDENCE COURSE

AMATEUR radio licenses. Complete code and theory preparation for passing amateur radio examinations. Home study courses. American Radio Institute, 101 West 63rd St., New York 23, N. Y.

USED Correspondence Courses and Books sold and rented. Money back guarantee. Catalog free. (Courses bought.) Lee Mountain, Pisgah, Ala.

MISCELLANEOUS

YOU'LL never use pliers again to install F.P. condensers. Time-saving new tool loosens old lugs, tightens new ones. Slim, long reach for tightest places. Can't slip. One-hand operation. 69c postpaid in U.S.A. No stamps. Pays for itself on one tough job. Order today. K.D. Clayson, Box 1032, Bethlehem, Pa.

WIRE Recorder Fans! Recorded comic party spool, for adults, so good you will never erase, \$4.95, express collect. Brown, R.4, Box 33, Edgerton, Wis.

GOING to try for your Amateur Radio Operator's License? Check yourself with a written test similar to those used by the F.C.C. Complete coverage multiple-choice questions with answer key. Class B&C Test \$1.75. Class A Test \$2.00. Amateur Radio Supply 1013 7th Ave., Worthington, Minn.

BIG money, part-full time, Radio, Television, Electronics. Complete instructions free. R. Johnson, 326A Park Row Bldg., New York 7, N. Y.

WOULD you pay 3%, first \$350 made? Book "505 Odd Successful Enterprises" free! Work home. Expect something odd! Pacific 9K, Oceanside, Calif.

"RAPID Radio Repair" now being published. Order now, \$1.25. Postpaid or C.O.D. Book written since my letter September Radio News. "Well written, wealth of good practical information," says Engineer Weiss, Hickok Co. John D. Burke, 168-08 90th Ave., Jamaica, New York, N. Y.

QSL'S, SWL'S! Free samples. WIHJI, Box 32C, Manchester, N. H.

SPEAKER Reconing. Guaranteed, send your speakers to us or write for information. Sweeney's Reconing Service, Dept. A, Winona, Minn.

RADIOMEN, Servicemen, Beginners. Make more money, easily, quickly, \$250 weekly possible. We show you how. Information free. Merit Products, 216-32R 132 Ave., Springfield Gardens 13, N. Y.

May, 1950

No. 630 Chassis Still the Best in TV . . . Now more Outstanding than Ever! OFFERED TO YOU AT NEW LOW DEALERS' PRICES

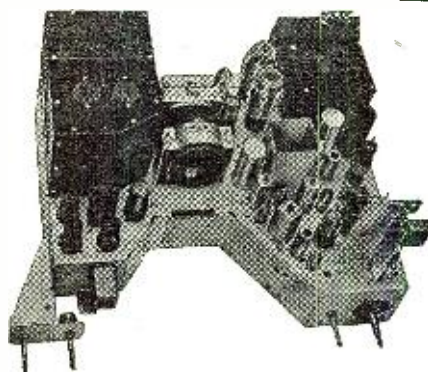

16" TELEVISION CONVERSION KIT MODERNIZE YOUR 10" #630 IN ONE HOUR

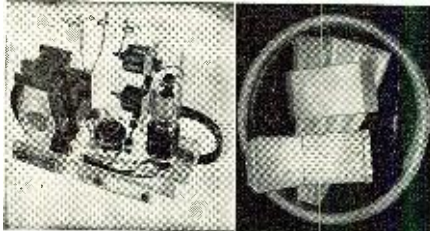

VOLTAGE DOUBLER DELUXE Complete with Simple, Easy to Follow Instructions

- WIRED SUB-ASSEMBLY
- FLYBACK TRANS #211T5
- 1B3/8016 TUBE
- SET OF MOUNTING BRACKETS
- PLASTIC SLEEVE & RING
- RESISTORS & CONDENSERS

\$19.63

BROOKS RADIO DIST. CORP. DEPT. B 80 VESEY ST., NEW YORK 7, N. Y.

KNOWN MFR. . . . LICENSED BY RCA

STANDARD 10" & 12 1/2" (29-tube chassis) engineered in strict adherence to the genuine RCA No. 630. DELUXE 16" & 19" (31-tube chassis) have added features of voltage doubler, keyed AGC and 70° deflection systems. CHASSIS delivered as pictured ready to play with all tubes, hardware, knobs and choice of 5"x7" or 12" speaker (less CRT).

Kit delivered complete with 29 tubes and instructions (Less CRT)

19" —Deluxe Chassis \$ 169.67
16" —Deluxe Chassis 159.59
10" or 12 1/2" Standard Chassis 149.97
10" or 12 1/2" Standard Kit . . . 129.44

19" METAL CRT, Known brand \$ 66.97
19" GLASS CRT, Known brand 62.94
16" METAL CRT, Known brand 39.89
16" GLASS CRT, Known brand 37.82

PARTS FOR #630 IN COMPLETE SETS

VIDEO AND I.F. KIT (19 items) \$ 7.84
PAPER CONDENSER KIT (37 condensers) 4.28
ELECTROLYTIC CONDENSER KIT (6 cond.) 7.37
CERAMIC CONDENSER KIT (28 condensers) 3.02
MICA CONDENSER KIT (12 condensers) 1.90
CARBON RESISTOR KIT (107 resistors) 4.93
WIREWOUND RESISTOR KIT (4 resistors) 2.31
OCTAL WAFER SOCKET KIT (13 sockets)72
MINIATURE WAFER SOCKET KIT (10 sockets)63
MINIATURE MOLDED SOCKET KIT (2 sockets)22
KNOB KIT, decal included (8 knobs)98
BRACKET AND SHIELD KIT (18 brackets) 8.63
TERMINAL STRIP KIT (19 terminal strips)59
VOLUME CONTROL KIT (9 volume controls) 6.19
COMPLETE TV TUBE KIT (29 tubes [less CRT]) . . 21.27

RADIO COURSES

- RADIO OPERATING • CODE
- RADIO SERVICING • ELECTRONICS
- F.M. TELEVISION
- REFRIGERATION SERVICING

Write for Catalog T.S. and Picture Brochure

TRADE & TECH. SCHOOL 229 W. 46 St., N. Y. 23
Tel: CA 2-8117

BRILLIANT NEW AMPLIFIER!

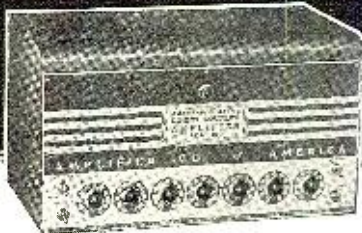

- ★Wide-Range
- ★Scratch Suppressor
- ★Volume Expander

Supreme performance with any variable reluctance pickup.

EXCLUSIVE G.E. PICKUP CIRCUIT

New circuits enable you to attain full benefit from the new G-E Variable Reluctance Magnetic pickup. Employs an exclusive, humless pre-equalized pre-amplifier to produce the most satisfying musical amplifier the world has ever known. If you are a perfectionist, you are the one for whom the ACA-100GE was designed. Send for technical literature.

AMPLIFIER CORP. OF AMERICA

398-2 Broadway New York 13, N. Y.

ATLAS "Multi-Cellular" TWEETER

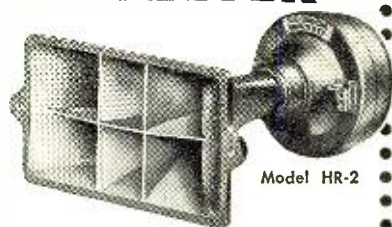

Model HR-2

SIX CELL, WIDE ANGLE DISTRIBUTION: 100° x 50°
Clean and efficient to 15,000 cycles
25 watts of program material above 1000 cycles

"Alnico-V-Plus" super efficient magnetic circuit. Heavy die cast sectoral horn, flush mounting 6 3/4" wide, 3 1/2" high, 8" deep. A new high in realism—smooth and clean musical brilliance. Perfect articulation and Sibulance in voice reproduction.

Variable High Pass Filter
Model FN-1



WRITE FOR COMPLETE DESCRIPTIVE CATALOGUE

ATLAS SOUND CORPORATION
1446 39th St. Brooklyn 18, N. Y.

WHERE TO BUY IT . . .

WHOLESALE RADIO of Baltimore

FLASH! Just Received The Sensational New ANCHOR 2 STAGE BOOSTER

Operates in fringe areas formerly unworkable.
Will outperform any other booster. **\$26⁹⁷**

Convert Any 630 Type TV SET For Use with Kinescopes Up to 19"

TECHMASTER TV VOLTAGE MULTIPLIER KIT



15 KV. can be had with full sweep using a single 1B3 rectifier. Type T77J1 flyback transformer, special wind coil and all components are included in this Deluxe hi-sweep kit. Plus schematic wiring kit. For 16" round tubes order type A. For 16" rectangular tubes order type B. **\$9⁴⁵**

UNBEATABLE TV RECEPTION BEST FOR THE FRINGE AREAS

Snyder Lazy XX TV ANTENNA

Complete with three 3 1/2 ft. masts & adj. mounting base

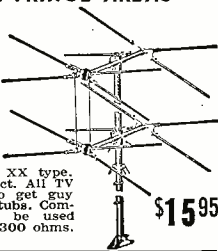

Extremely high-gain. Superior construction. Designed to withstand all weather conditions. Easily stacked double conical lazy XX type. Just unfold, tighten and erect. All TV channels and FM. You also get guy wire rings, and connecting stubs. Completely pre-assembled. Can be used with any type lead-in 72 to 300 ohms. Order model TX-2. **\$15⁹⁵**

T.V. ANTENNA ACCESSORIES

Everything for "Perfect-Picture" Installations at low prices!

- STEEL EXTENSION POLES. Weather Treated.
 - 10 ft. long, 1 1/4" di. crimped end. . . \$1.49
 - 5 ft. long, 1 1/4" di. crimped end.89
 - 3 1/2 ft. long, 1 1/4" di. crimped end.69
- ANTENNA SWIVEL BASE. Aluminum.39
- Fits 1 1/2" O.D. mast section.
- GUYWIRE. 6 stranded No. 20 per 50 ft.29
- 24 coils, 50 ft. ea. interconnected.6.00
- 72 OHM COAXIAL CABLE RG5U. 4c per ft.
- Per 100 ft.3.75
- 300 OHM TWIN LEAD (\$1.45 per 100 ft.) 1000 ft. . .11.75
- CHIMNEY MOUNT BRACKETS complete with strap. .1.39
- 5 1/2" - 300 OHM STAND OFF INSULATORS. Wood screw-in type. (3c ea.) per hundred.2.75
- WALL BRACKETS. Adjustable up to 18" from wall. Will hold masts 1" to 1 1/2" di.3.75
- SAMS TV ANTENNA MANUAL.1.25
- SNAP-ON TWIN LEAD INSULATORS. Fit 1 1/4" masts. .06
- HI-BAND ADAPTER. Folded dipole and reflector. Clamps on existing pole. HP-3.1.49
- DOUBLE POLE DOUBLE THROW KNIFE SWITCH. . . .39

For Complete TV Servicing 9 TOOL TV SERVICE KIT



In Leatherette Case Here's the low-priced servicing Kit you've been waiting for, including the latest TV servicing tools for complete servicing job. You get: tran-aligner, Dual-aligner, sim aligner, core-aligner, tuning wand, tuning wrench, deep-nib aligner, big-stretch aligner, channel tuner, all for only **\$3⁹⁵**

Build Your Own Booster and Save Over 50%

TECHMASTER TV BOOSTER KIT

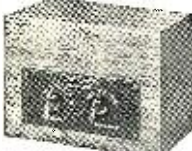

Complete with Tube, pre-aligned coils, pre-stamped chassis and hand-some cabinet. **\$9⁹⁵**

Improve TV reception in low-signal, low terrain and fringe areas by building this latest design booster. Tested to reduce noise from 3 to 5 db. Get brighter, sharper pictures you hardly thought possible. Simplified step-by-step wiring instructions.

WRITE FOR FREE MONTHLY "FYI" BULLETIN
ADDRESS ORDERS TO DEPT. QR 29
OR PHONE MULBERRY 2134

WHOLESALE RADIO PARTS CO., Inc.

311 W. Baltimore St.
BALTIMORE 1, MD.

INDEX OF Advertisers

MAY
1950

While every precaution is taken to insure accuracy, we cannot guarantee against the possibility of an occasional change or omission in the preparation of this index.

ADVERTISER	PAGE	ADVERTISER	PAGE
Aaron Electronic Sales	124	LaPointe-Plascomold Corp.	114
Acorn Electronics Corp.	132	Leotronic Research Labs.	173
Ad-Ritz Mfg. Corp.	170	Leotone Radio Co.	136
Adson Radio & Electronics Co.	96		
Allied Radio Corp.	9, 105	MacKay Television Corp.	166
Almo Radio Co.	144	Mallory & Co., Inc., P. R.	4th Cover
Alleg Lansing Corporation	110	Mass. Radio School	144
Alvradio Supply Co.	158	Midway Company	151
American Phenolic Corporation	24	Miller Company, J. W.	162
American Radio Supply Co.	129	Milwaukee School of Engineering	112
American Television & Radio Co.	126	Mosley Electronic Specialties	104
Amplifier Corp. of America	139, 175	Murray Hill Books, Inc.	130
Approved Electronic Inst., Corp.	168	McGee Radio Company	85, 86, 87
Arrow Sales, Inc.	123		
Ashe Radio Co., Walter	103	National Company, Inc.	111
Atlas Sound Corporation	156, 175	National Radio Institute	3
		National Schools	11
Baltimore Technical Institute	158	Newark Surplus Materials Co.	140
Barb City Industries Inc.	96	Niagara Radio Supply Corp.	82, 83, 167
Belden	99	North American Philips Company Inc.	12-13
Bell Telephone Laboratories	89		
Bergen Radio & Television Co.	170	Odegaard Mfg. Co.	170
Bliss Electrical School	169	Offenbach & Kelmus Co.	137
Boyce-Roche Book Co.	142	Omite Manufacturing Company	25
Brook Electronics, Inc.	116	Olson Radio Warehouse, Inc.	92, 93
Brooks Radio Dist. Corp.	175	Onan & Sons, Inc., D. W.	90
Browning Laboratories, Inc.	142	Opad-Green Company	127
Buffalo Radio Supply	135		
		Peak Electronics Co.	168
C & H Sales Co.	174	Peerless Electrical Products, Division	
Candler System	174	Altec Lansing Corp.	136
Cannon Electric	18	Penn Boiler & Burner Mfg. Corp.	128
Capitol Radio Engineering Institute	81, 177	Permoflux Corp.	167
Cascade Television	148	Phonox Electronics, Inc.	136
Centralab, Division of Globe-Union, Inc.	28, 29	Phoenix Sales	159
Certified Television Laboratories	140, 153, 168	Platt Electronics Corp.	121
		Poly-Tech	166
Channel Master Corp.	14	Prenax Products	142
Chelsea Television Center, Inc.	151	Premier Radio Tube Company	100, 101
Chicago Industrial Instrument Co.	102	Progressive Electronics Co.	164
Cincinnati Ventilating Co. Inc., The	116	Pyramid Electric Company	30
Cleveland Electronics, Inc.	157		
Cleveland Institute of Radio Electronics	5	Quam-Nichols Co.	152
Clippard Instrument Laboratory Inc.	90		
Columbia Electronic Sales	90	RCA Institutes, Inc.	164
Comet Electronic Sales Co.	143	Radiart Corporation, The	91
Communications Equipment	141	Radio Apparatus Corporation	161
Components Supply Co.	157	Radio Corporation of America	95, 116, 149, 2nd Cover
Cornell-Dubilier Electric Corporation	33	Radio Craftsmen Incorporated, The	106
Covideo	157	Radio Ham Shack, Inc.	113
Coyne Electrical & Radio-Television School	150, 160	Radio Parts Company	131
		Radio Shack Corp., The	146
DeForest's Training, Inc.	7	Radio Supply & Engineering Co.	144
DuMont Laboratories, Inc., Allen B.	3rd Cover	Radio Warehouse	150
		Rider, Publisher, Inc., John F.	98
Editors and Engineers, Limited	84	Robin Hood Co., The	164
Eddie Electronics, Inc.	134	Rose Company, The	128
Electric Auto-Lite Company	158	Rumph Co., Dave	171
Electric-Spot, The	138		
Electro Devices, Incorporated	149	Sams & Co., Inc., Howard W.	150, 151
Electro Products Laboratories, Inc.	162	Sangamo Electric Company	27
Electro-Technical Industries	32	Sarkes Tarzian	17
Electro-Voice, Inc.	163	Schott Company, Walter L.	139
Electronic Chemical Corp.	6	Senco Radio, Inc.	86
Electronic Instrument Co., Inc.	119	Simpson Electric Company	168
Electronic Supplies	165	Sovereign Television Co.	16
Electronieraft, Inc.	167	Sprague Products Co.	19
Electronics Institute, Inc.	148	Stahl, Inc., Michael	80
Electronics Research Publishing Co., Inc.	129	Standard Transformer Corporation	155
Emmons Radio Supply	124	Star Electronic Distributors, Inc.	160
Erie Resistor Corp.	139	Sun Radio & Electronics Co., Inc.	148
Espey Manufacturing Company, Inc.	145	Sun Radio of Washington, D. C.	94
Fair Radio Sales	152	Sutton's Wholesale Electronics, Bill	155
Feiler Engineering Co.	151	Swedgal Radio, Inc.	174
Fisher & Son, M.	154	Sylvania Electric	97
G. L. Electronics	172	TAB	178
Gaertner Co., The	21, 73	TV Accessory Engr. Co.	152
General Electric	107	Technical Radio Parts Co.	153
General Electronic Distributing Co.	164	Telemarine Communications Company	109
General Test Equipment	96	Television Supply Co.	153
Greenlee Tool Co.	153	Telrex, Inc.	166
Greylock Electronics Supply Co.	132	Terminal Radio Corporation	171
		Transvision, Inc.	160
Halldorson Company, The	34	Triplet Electrical Instrument Company	20
Hallierafters	79	Tri-State College	151
Harvey Radio Company, Inc.	74, 75, 76, 77, 78	Turner Company, The	165
Heath Company, The	108	Twin Vex Mfg. Co.	164
Henry Radio Stores	169		
Henshaw Radio Supply	165	University Loudspeakers, Inc.	120
Hollywood Sound Institute	157	V & H Radio & Electronics Supply	163
Hollywood Technical Institute, Inc.	31	Valparaiso Technical Institute	165
Hytron Radio & Electronics Corp.	155		
		Waldom Electronics, Inc.	102
Indiana Technical College	163	Ward Products Corporation	161
Instructograph Company	124	Waterman Products Co., Inc.	122
Instrument Associates	108	Weller Manufacturing Company	8
Insuline Corporation of America	22, 23	Wells Sales, Inc.	115
International Resistance Co.	102, 132	Western Sales Co.	169
JFD Manufacturing Co., Inc.	125	Wholesale Radio Parts Co., Inc.	176
Jackson Electrical Instrument Co.	10	Wind Turbine	170
Jensen Manufacturing Company	160	Workshop Associates, Inc., The	177
Jewelbox	166	World Radio Laboratories, Inc.	169
Klein, Manuel	140		
Koenig Engineering Company, H. G.		YMCA Trade & Tech. School	175
		Ziff Davis Publishing Company	147, 154, 162

DOCKET 9295

A MEETING of the Federal Communications Commission held March 21, 1950 discussed the various developments in connection with the proposed new amateur regulations. Comments filed by interested parties included requests for a formal hearing, oral argument, and a poll of amateur licensees. The Commission decided that a formal hearing would not be warranted in view of the comments filed. It appeared to the Commission that little evidence would be adduced at such a hearing to aid the Commission in resolving the issues at stake. Accordingly the requests for a formal hearing were denied along with the request for a poll of the amateur licensees.

A general oral argument on the subject of the proposed rules has been set for May 19, 1950 in Washington, D.C. All interested parties who desire to participate in the General Oral Argument should notify the Commission in writing to that effect not later than May 10, 1950. The notification should consist of an original and three copies and refer to Docket 9295. The specific sections of the proposed rules to be discussed should be mentioned, together with an estimate of the time required for the presentation. -30-

S.T.E.N. HAMFEST

THE annual convention of the South Texas Emergency Net will be held in Cuero, Texas, on May 27th and 28th.

The event is a real hamfest with emphasis on emergency and net operation. All amateurs, XYL's, and interested parties are invited to attend. There will be a transmitter hunt as part of the program.

Registration will begin at Legion Hall in Cuero at 9 a.m. and the program will begin at 1 p.m. On both days there will be entertainment as well as technical information interspersed with contests. The YL's and XYL's will have special programs arranged for them.

Tickets may be obtained in advance from Robert Crossman, W5OUA, Box 214, Rockport, Texas. -30-

ERRATUM

The following resistor values were inadvertently omitted from the parts list accompanying the circuit diagram for the article "A Versatile Recording and Playback Amplifier" by Glen Southworth appearing in the March issue of the magazine. R₂₈ is a 5000 ohm, 10 w. unit, R₂₉ is a 25,000 ohm, 2 w. resistor, and R₃₀ is a 50,000 ohm, 2 w. unit.

PHOTO CREDITS

Page	Credit
40, 41	Andrea Radio Corporation
42	Robert Vondran
43 (top), 114	Radio Corporation of America
44	Radio Manufacturers Association
47 (top)	David Bogen Company
47 (bottom), 55, 57	Altec Lansing Corporation
48, 49, 50, 94, 112	General Electric Company
54, 126	Radio Nacional, Brazil
58 (top)	Harris & Ewing
59	Philco Corporation
60, 62	Simpson Electric Company
66	Channel Master Corporation
84	Sylvania Electric Products Inc.
100	MARS
110	Air Materiel Command, Wright-Patterson Air Force Base
130	Precision Apparatus Co., Inc.

There's a BIG Future for YOU in
**TELEVISION
RADIO-ELECTRONICS**

**Builds Your Career in a Minimum of Time
Industry Needs More Trained Men Now
Day and Evening Classes Now Forming**

GRADUATES of CREI Residence School are preferred by industry because of their training and ability. This recognition is the reason that CREI men quickly find good jobs. With 23 years of practical teaching experience in these highly technical fields, CREI offers an outstanding faculty, modern and complete laboratories, shops and equipment.

New students are accepted twice monthly and each may advance as rapidly as he is capable.

CREI is recognized as one of the country's leading technical institutes, offering college-calibre education for the young man who wants a practical career education that leads to a good-paying job in a minimum of time.



Approved for
Veterans' Training

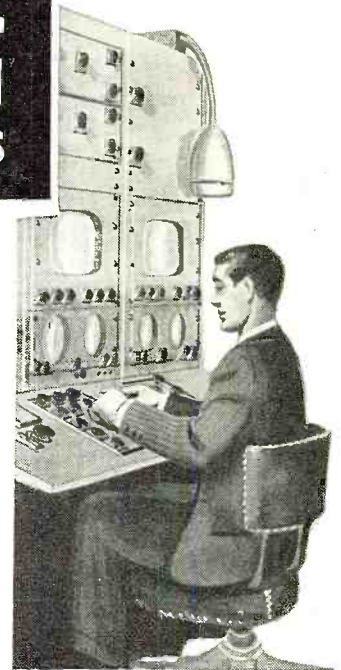

Mail Coupon for FREE Catalogue

**CAPITOL RADIO
ENGINEERING INSTITUTE**

Dept. 135-B, 16th & Park Rd., N.W.
Washington 10, D. C.

Please send me your illustrated catalog and complete details about the CREI Residence School.

NAME

AGE..... If in school, what term?.....

STREET

CITY..... ZONE..... STATE.....

I am entitled to training under G.I. Bill
 Send information on Home Study Courses

After several months of intensive research, the WORKSHOP ASSOCIATES is introducing a new television antenna which provides outstanding performance on all channels at very low cost. This new antenna—Model W—is the first to employ a radical but well-established principle that satisfactorily balances all the components of the TV antenna problem.

Exceptionally high gain, sharp directivity, and close matching to 300 ohm line are all engineered into a simple array that fits all channels. Elaborate field tests show gains up to 10 db., with single Model W arrays actually outperforming many double-stacked arrays of other types. The sharp directional pattern insures high gain with consequent reduction in noise and interference.

Modern, dynamic styling, with a minimum number of elements, gives Model W a clean-cut appearance that is unobtrusive on your roof.

Rugged construction and quick, easy assembly round out the story of this new WORKSHOP antenna which is believed to give clearer, steadier, more brilliant reception, at low cost, than any other popular TV antenna. Production is now in full swing, and shipments are being made daily from the new Workshop plant. The new Model W is available at your distributor on May 1st. *The Workshop Associates, Inc., 133 Crescent Road, Needham Heights 94, Mass.*

Watch for the
**NEW
Sensational
WORKSHOP
TV
ANTENNA**
All Channel
Low Price

"A B U"

THAT'S A BUY

HEADSETS

8000 ohms - HS-18, 2revrs w/PL54 & COT8A, Less Band 98c
 600 ohms - HS-32, 2revrs w/ Band, Cushion, Plug, \$1.98
 250 ohms - HS-30, 2revrs w/ Band & Cord, \$1.65
 Use HS-30 as Sound Power Unit, 2 for, \$2.98

KEY CLICK FILTER - Brand New, RF Chokes, Mica Condensers, Resistor - Mtd, Ready to Use 45c

UHF ANTENNA 12"/30cm

ATS/ARRI Usable Citizn&HfBand Ins CoaxTerm SilvPCon w/Plug&Gask&Hware Mobile Mtg New 39c; 4/21 PL259 for Above, 23c
 ANT AN130B, 33" Whip 98c
 ANT MS49-52, 12 1/2ft \$1.69
 MS49-33, 16 ft 3.49
 MS49-33&extra 19 ft 3.69
 MS49-56(2-53"), 26 1/2ft 5.98
 ANT AN131A, 11 1/2ft 1.89
 NP22 Mica Bases 8.95
 NP37 \$3.95 MP48 3.98

G-E 2J1G1 SELSYNS

400cy.usable24V or 110vac. Tested, used, Guaranteed. W/data \$1.49
 G-E Liquid Level Transmitter

Approx Gov't Cost
 Indication of Liquid present in tank. New, 2 for, 89c

MOTOR 1/40 HP/1 or 3 ph/3450 RPM/G-E-Deico-Diehl w/Condns&Cont Dry Oper 115V/60cyc 5/8 shaft, \$3.49

OA3/VR75	\$0.98	2132 \$14.85
OA4G 94	2133 18.95
OB2 1.74	2134 2.64
OB3/VR90 74	2137 13.85
OC3/VR105 75	2138 12.70
OD3/VR150 88	2139 12.90
OZ4 56	2147 49.95
CI1A 4.80	2148 45.00
CI1A 45	2149 22.50
IA3 42	2150 39.00
IA4 1.00	2156 81.00
1A5GT 78	2161 39.00
1A6 78	2162 39.00
1A7GT 63	2225 23.75
1B3/8016 88	2226 24.95
1B4 98	2229 24.95
1B5/255 84	2230 49
1B7G 2.98	2232GT 32
1B7A/471A 98	2242 36
1B22 4.50	3A4 3.6
1B23 9.00	3A5 9.8
1B24 49.95	3A6 9.8
1B26 4.50	3B7/1291 29
1B27 8.49	3B22 2.64
1B29 74.99	3B40 40.00
1B32/532A 2.75	3B25 4.85
1B37 45.00	3B28 5.89
1B38 3.98	3B31 3.98
1B41 49.95	3C31/C1B 3.75
1B42 7.50	3C45A/1239 12.85
1B43 49.95	3D21A 1.20
1B54 49.95	3E29/829B 7.98
1B56 49.95	3F22 1.45
1C6 87	3G4 3.05
1C7G 89	3Q5GT 65
1D5GG 95	3V3 67
1E1 94	4C33 81.00
1E2 1.08	4C34 93.00
1E7G 4.00	4J31 95.00
1F4G 75	4J32 95.00
1F7GT 1.55	4J47 98.00
1G4G 69	4K29 9.95
1G5G 69	5C30/CSB 8.49
1GG6GT 63	5D21 24.50
1H4G 36.99	5J29 17.39
1H5G 54	5J32 99.00
1HG 99	5T4 86
1J5G 94	5U4G 42
1J6 45	5W4 66
1L4GT 99	5X4G 71
1L8A 64	5Y4GT 45
1LCS 54	6B5GT 51
1L5GT 85	6C6A 7.85
1NGGT 59	6A3 9.98
1NG 54	6A4 1.29
1PSGT 85	6A6 8.88
1P25 59.50	6A7 6.8
1P25A 96	6B4 6.9
1Q26 75.00	6B84 1.69
1R4/1294 65	6B85/6NS 8.8
1R5 94	6C6T/1853 7.7
1R4 96	6AC5GT 8.9
1S5 48	6AC7 7.0
1T4 51	6B7G 8.4
1T5GT 1.05	6AD6G 8.1
1U4 49	6AD7 1.17
1U5 49	6AG5 5.9
1V 49	6AG7 9.7
1X2 78	6A15 7.3
1X3 3.98	6AK5 8.0
2A3 84	6AL5 5.5
2A4G 1.04	6AL7 1.00
2A5 78	6AO5 4.7
2A6 78	6AO6 5.4
2A7 78	6AO7 5.4
2B22/GL559 73	6A85 5.9
2C21/1642 81	6A86 5.9
2C22/7193 25	6A87 5.9
2C26 25	6A88 5.9
2C34/RK34 2.70	6A89 5.9
2C40 2.00	6A90 5.9
2C43/464A 9.39	6A91 5.9
2C44 8.10	6A92 5.9
2C51 8.10	6A93 5.9
2D21 1.10	6A94 5.9
2E2 1.89	6A95 5.9
2E22 4.00	6A96 5.9
2E25/HY65 4.00	6A97 5.9
2E30 2.35	6A98 5.9
2G5 1.11	6A99 5.9
2I1 11.98	6B00 5.9
2I21A 11.45	6B01 5.9
2I22 9.75	6B02 5.9
2I23 9.75	6B03 5.9
2I27 14.50	6B04 5.9
2J31 9.95	6B05 5.9

Bantam 1-Wattor Foundation Unit

Free Instructions. Takes 2 Plug-in FT-243Xtals & Coil. W/140mmCndrs&xtal Socket. Imped bet 250 Complete with XTals 98c

RCA UNIV OUTPUT XFMR

10Watts to 10 Kc. Matches Any Line or Spkrs w/V/C's to 4 or 150 ohms to ANY Load&Tube Imped bet 200 10240 ohms; over 1000 combinations; Acts as Exc B n d Foss or Froq Atten for Dyn Mike. Cuts His or Lows. Ideal Q3 action CW or Phone. \$1.39

Hi-Gain Dyn Mike & Xfmr

Xfmr - JTC/SuperRec Swgd 600 ohmCTC & 4000 ohms Tapped 250 & 150 ohms, fully shielded H'Sid. Mike - Exc. Fidelity. \$1.49

RM29A Control Unit

Self-Contained incl Ringer Ckt. 3 Pos Locking-type Selector for Monitor, Direct or Radio Control, or use as Telephone. BRAND NEW \$8.49; 2 for \$14.98

STORAGE BATTERIES

2V/11AH Willard BB206U \$1.89
 2V/27AH Willard BB51 1.75
 6V/25AH Willard ER25-6 3.98
 6V/25AH Willard ER25-6 Hydrometer 1.08 to 1.24SG 98
 Electrolyte Meas. Tube, 12" 25
 Spec Grav Ind. & Merc. Thermom. 1.25

Sig Corps Dry Batteries - Gtd. BRAND NEW Shelf Dated - Tested

BA34 7 1/2 V 6/4 1/3 1 1/2 Neg V 35c
 BA35 1 1/2 V 500mAh BURG 4FH 35c
 BA36 9 V 2 1/2 V 7 BU/308 98
 BA37 1 1/2 V Walky-Talky 29c
 BA38 10 1/2 V Walky-Talky \$1.49
 BA39 15 V 7 V BURG 4FB 79
 BA40 9 V 1 1/2 V BURG 4GB60 89
 BA43 9 V 45 1 1/2 V 98
 BA205U 3V BURG P2P 8 for 1.00

OIL CONDENSERS

Lowest Prices Ever! 2x5mfd 1.0mfd/0.1MITE to W.Espec 3500V, 16, 20, 25, 30, 35, 40, 45, 50, 55, 60, 65, 70, 75, 80, 85, 90, 95, 100, 110, 120, 130, 140, 150, 160, 170, 180, 190, 200, 220, 250, 280, 300, 330, 360, 400, 450, 500, 550, 600, 650, 700, 750, 800, 850, 900, 950, 1000, 1100, 1200, 1300, 1400, 1500, 1600, 1700, 1800, 1900, 2000, 2200, 2500, 2800, 3000, 3300, 3600, 4000, 4500, 5000, 5500, 6000, 6500, 7000, 7500, 8000, 8500, 9000, 9500, 10000, 11000, 12000, 13000, 14000, 15000, 16000, 17000, 18000, 19000, 20000, 22000, 25000, 28000, 30000, 33000, 36000, 40000, 45000, 50000, 55000, 60000, 65000, 70000, 75000, 80000, 85000, 90000, 95000, 100000, 110000, 120000, 130000, 140000, 150000, 160000, 170000, 180000, 190000, 200000, 220000, 250000, 280000, 300000, 330000, 360000, 400000, 450000, 500000, 550000, 600000, 650000, 700000, 750000, 800000, 850000, 900000, 950000, 1000000, 1100000, 1200000, 1300000, 1400000, 1500000, 1600000, 1700000, 1800000, 1900000, 2000000, 2200000, 2500000, 2800000, 3000000, 3300000, 3600000, 4000000, 4500000, 5000000, 5500000, 6000000, 6500000, 7000000, 7500000, 8000000, 8500000, 9000000, 9500000, 10000000, 11000000, 12000000, 13000000, 14000000, 15000000, 16000000, 17000000, 18000000, 19000000, 20000000, 22000000, 25000000, 28000000, 30000000, 33000000, 36000000, 40000000, 45000000, 50000000, 55000000, 60000000, 65000000, 70000000, 75000000, 80000000, 85000000, 90000000, 95000000, 100000000, 110000000, 120000000, 130000000, 140000000, 150000000, 160000000, 170000000, 180000000, 190000000, 200000000, 220000000, 250000000, 280000000, 300000000, 330000000, 360000000, 400000000, 450000000, 500000000, 550000000, 600000000, 650000000, 700000000, 750000000, 800000000, 850000000, 900000000, 950000000, 1000000000, 1100000000, 1200000000, 1300000000, 1400000000, 1500000000, 1600000000, 1700000000, 1800000000, 1900000000, 2000000000, 2200000000, 2500000000, 2800000000, 3000000000, 3300000000, 3600000000, 4000000000, 4500000000, 5000000000, 5500000000, 6000000000, 6500000000, 7000000000, 7500000000, 8000000000, 8500000000, 9000000000, 9500000000, 10000000000, 11000000000, 12000000000, 13000000000, 14000000000, 15000000000, 16000000000, 17000000000, 18000000000, 19000000000, 20000000000, 22000000000, 25000000000, 28000000000, 30000000000, 33000000000, 36000000000, 40000000000, 45000000000, 50000000000, 55000000000, 60000000000, 65000000000, 70000000000, 75000000000, 80000000000, 85000000000, 90000000000, 95000000000, 100000000000, 110000000000, 120000000000, 130000000000, 140000000000, 150000000000, 160000000000, 170000000000, 180000000000, 190000000000, 200000000000, 220000000000, 250000000000, 280000000000, 300000000000, 330000000000, 360000000000, 400000000000, 450000000000, 500000000000, 550000000000, 600000000000, 650000000000, 700000000000, 750000000000, 800000000000, 850000000000, 900000000000, 950000000000, 1000000000000, 1100000000000, 1200000000000, 1300000000000, 1400000000000, 1500000000000, 1600000000000, 1700000000000, 1800000000000, 1900000000000, 2000000000000, 2200000000000, 2500000000000, 2800000000000, 3000000000000, 3300000000000, 3600000000000, 4000000000000, 4500000000000, 5000000000000, 5500000000000, 6000000000000, 6500000000000, 7000000000000, 7500000000000, 8000000000000, 8500000000000, 9000000000000, 9500000000000, 10000000000000, 11000000000000, 12000000000000, 13000000000000, 14000000000000, 15000000000000, 16000000000000, 17000000000000, 18000000000000, 19000000000000, 20000000000000, 22000000000000, 25000000000000, 28000000000000, 30000000000000, 33000000000000, 36000000000000, 40000000000000, 45000000000000, 50000000000000, 55000000000000, 60000000000000, 65000000000000, 70000000000000, 75000000000000, 80000000000000, 85000000000000, 90000000000000, 95000000000000, 100000000000000, 110000000000000, 120000000000000, 130000000000000, 140000000000000, 150000000000000, 160000000000000, 170000000000000, 180000000000000, 190000000000000, 200000000000000, 220000000000000, 250000000000000, 280000000000000, 300000000000000, 330000000000000, 360000000000000, 400000000000000, 450000000000000, 500000000000000, 550000000000000, 600000000000000, 650000000000000, 700000000000000, 750000000000000, 800000000000000, 850000000000000, 900000000000000, 950000000000000, 1000000000000000, 1100000000000000, 1200000000000000, 1300000000000000, 1400000000000000, 1500000000000000, 1600000000000000, 1700000000000000, 1800000000000000, 1900000000000000, 2000000000000000, 2200000000000000, 2500000000000000, 2800000000000000, 3000000000000000, 3300000000000000, 3600000000000000, 4000000000000000, 4500000000000000, 5000000000000000, 5500000000000000, 6000000000000000, 6500000000000000, 7000000000000000, 7500000000000000, 8000000000000000, 8500000000000000, 9000000000000000, 9500000000000000, 10000000000000000, 11000000000000000, 12000000000000000, 13000000000000000, 14000000000000000, 15000000000000000, 16000000000000000, 17000000000000000, 18000000000000000, 19000000000000000, 20000000000000000, 22000000000000000, 25000000000000000, 28000000000000000, 30000000000000000, 33000000000000000, 36000000000000000, 40000000000000000, 45000000000000000, 50000000000000000, 55000000000000000, 60000000000000000, 65000000000000000, 70000000000000000, 75000000000000000, 80000000000000000, 85000000000000000, 90000000000000000, 95000000000000000, 100000000000000000, 110000000000000000, 120000000000000000, 130000000000000000, 140000000000000000, 150000000000000000, 160000000000000000, 170000000000000000, 180000000000000000, 190000000000000000, 200000000000000000, 220000000000000000, 250000000000000000, 280000000000000000, 300000000000000000, 330000000000000000, 360000000000000000, 400000000000000000, 450000000000000000, 500000000000000000, 550000000000000000, 600000000000000000, 650000000000000000, 700000000000000000, 750000000000000000, 800000000000000000, 850000000000000000, 900000000000000000, 950000000000000000, 1000000000000000000, 1100000000000000000, 1200000000000000000, 1300000000000000000, 1400000000000000000, 1500000000000000000, 1600000000000000000, 1700000000000000000, 1800000000000000000, 1900000000000000000, 2000000000000000000, 2200000000000000000, 2500000000000000000, 2800000000000000000, 3000000000000000000, 3300000000000000000, 3600000000000000000, 4000000000000000000, 4500000000000000000, 5000000000000000000, 5500000000000000000, 600000000000000

the new DUMONT type 12LP4A TELETRON*



Bent-Gun, exclusive DuMont design, bends the electron beam only once instead of twice as in other designs. Permits sharper spot focus.

Featuring
the

BENT-GUN

Specifications

Overall Length	18 ³ / ₄ "
Diameter of Bulb	12 ⁷ / ₈ "
Useful Screen Diameter	11"
Base	Duodecal 5 Pin
Bulb Contact	Recessed Small Cavity Cap
Anode Voltage	11,000 Volts D. C.
Grid No. 2 Voltage	250 Volts D. C.
Focusing Coil Current	110 Approx. Ma D. C.
Ion Trap Current	120 Approx. Ma D. C.
Grid No. 1 Circuit Resistance	1.5 Max. Megohms

DUMONT
Teletrons

FIRST WITH THE FINEST IN T-V TUBES

For the first time this popular tube type is offered with all the refinements of the Du Mont design.

Modification of the Bent-Gun makes possible the use of single or double magnet beam-benders thus assuring direct interchangeability with other 12LP4's, yet assuring that extra sharpness possible only with the Du Mont gun structure.

An ideal tube for improving the performance of existing receivers, using the Type 12LP4. or for incorporation in new receiver design.

Literature and quotations on request

*Trade-Mark

ALLEN B. DU MONT LABORATORIES, INC., Tube Division, Clifton, N. J. Plants at Allwood and Passaic, N. J.

Because
**They're Dependable
Starters . . .**

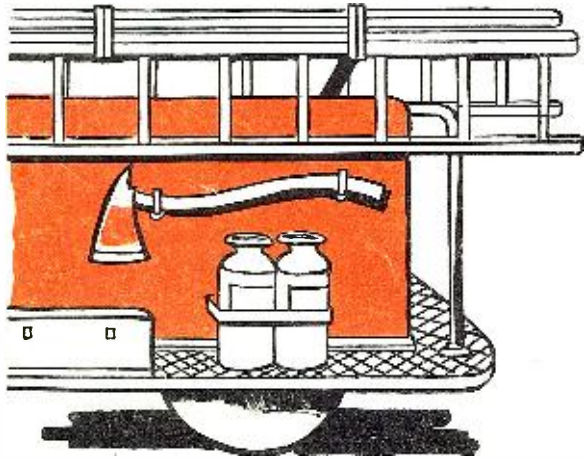

MALLORY Vibrators Give Better Service !

An exclusive combination of Mallory-engineered and Mallory-made contacts retard oxide formations...on the shelf. A unique "self-cleaning" action prevents oxidation in service. Therefore, Mallory Vibrators are dependable starters and dependable performers.

And the patented tuned mechanism of the Mallory Vibrator provides low contact wear, low resistance and reduced arcing and pitting.

That's why more Mallory Vibrators are used in original equipment than all other makes combined. When you use Mallory Vibrators for replacement, you can be sure of dependable starting, long life and high output efficiency. See your Mallory distributor now!

More Mallory Vibrators Are Used In Original Equipment Than All Other Makes Combined



P. R. MALLORY & CO. INC.
MALLORY

CAPACITORS • CONTROLS • VIBRATORS • SWITCHES • RESISTORS
• RECTIFIERS • VIBRAPACK* POWER SUPPLIES • FILTERS

*Reg. U. S. Pat. Off.

APPROVED PRECISION PRODUCTS

P. R. MALLORY & CO., Inc., INDIANAPOLIS 6, INDIANA