

APRIL
1950

RADIO-ELECTRONIC
ENGINEERING
EDITOR

RADIO & TELEVISION NEWS

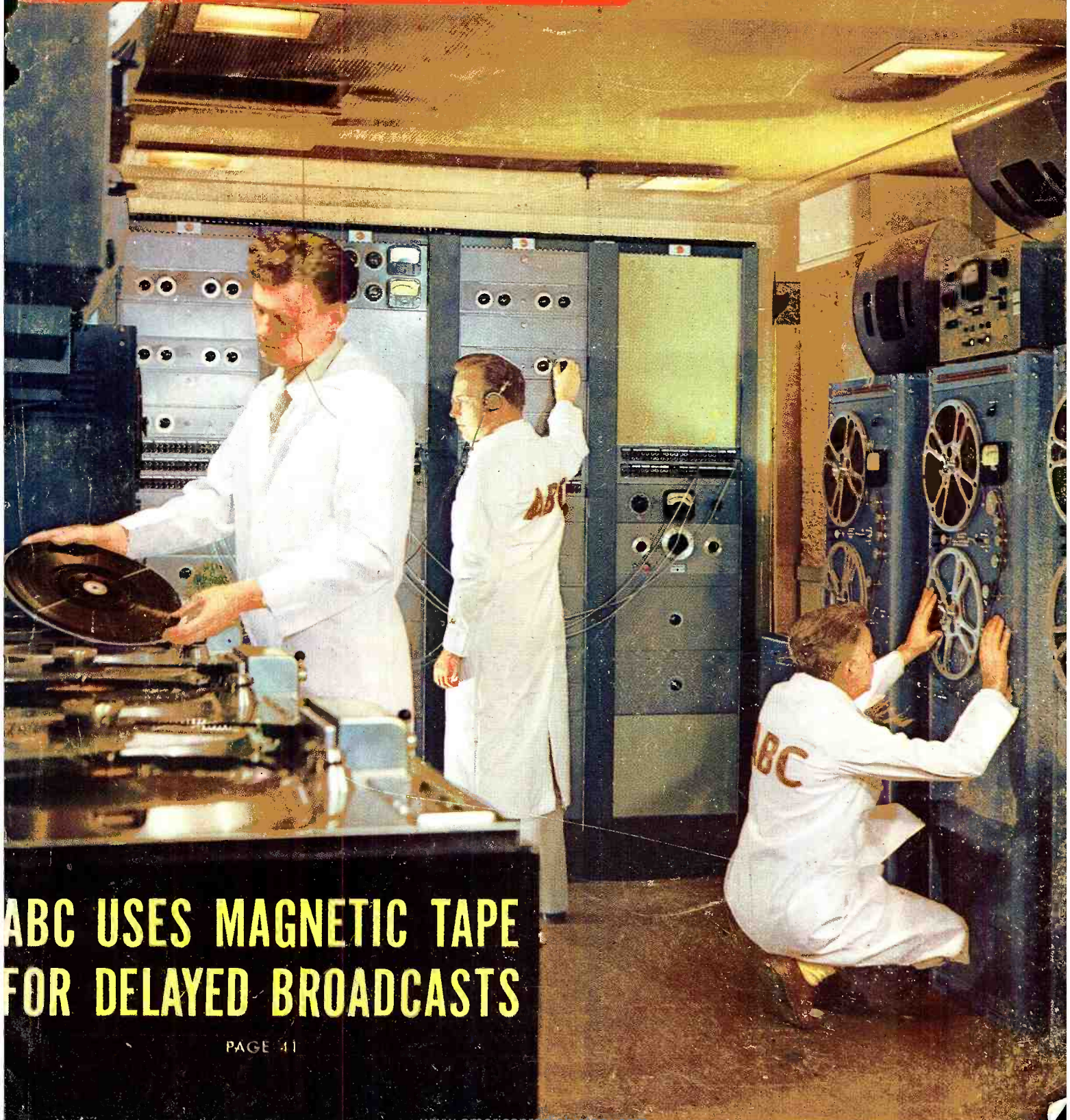

ABC USES MAGNETIC TAPE
FOR DELAYED BROADCASTS

Built for Service... **SINCE 1915**

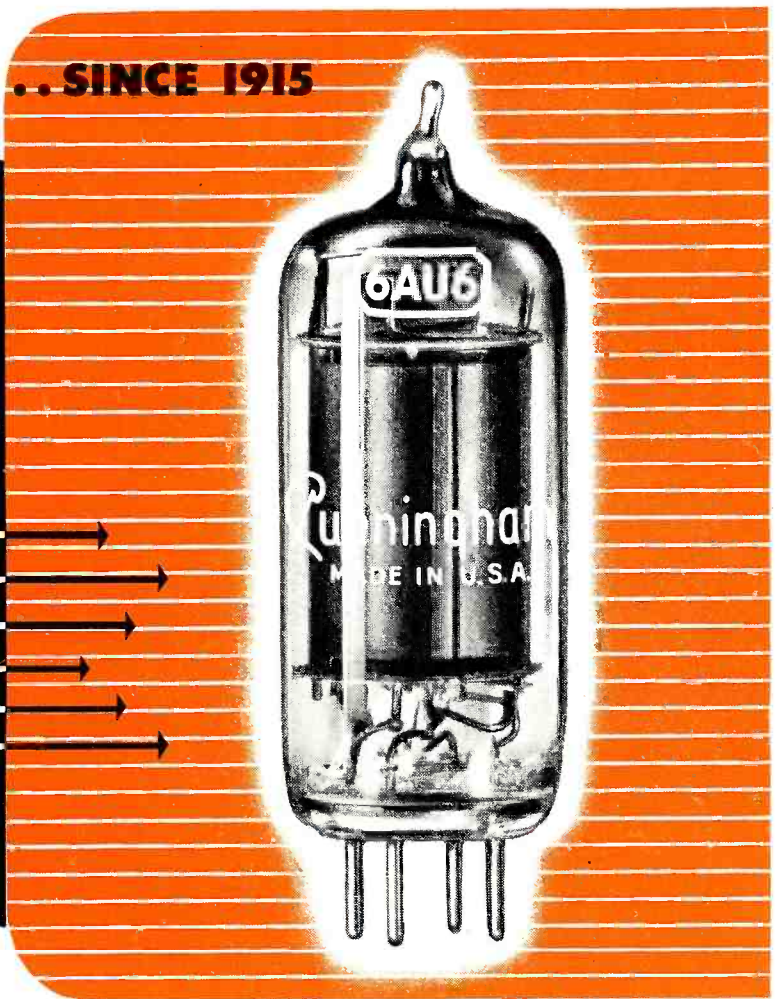
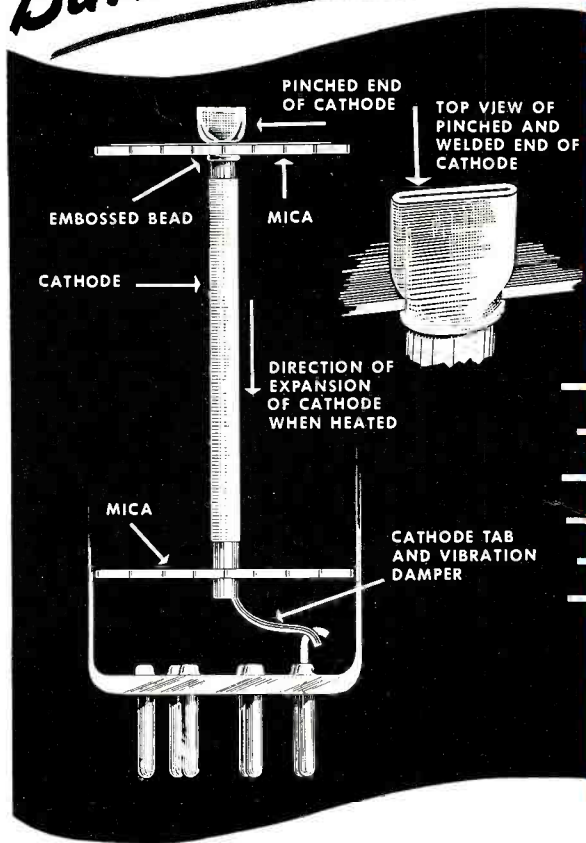

he inside story of

Cunningham **quality**

1. How Cunningham "Inverted" Pinched Cathodes Minimize Microphonics

Engineering progress is part and parcel of Cunningham quality. For instance . . . unlike most tubes Cunninghams use "inverted" *pinched cathodes* to minimize microphonics by preventing cathode vibration or displacement.

These important features are achieved by clamping the mica firmly between the embossed bead and the pinched top end of the cathode. This arrangement holds the upper end of the

cathode rigidly, but permits the heated cathode to expand freely downward through the bottom mica without producing cathode strain. The lower end of the cathode is prevented from vibrating by means of the damping tab connected between the cathode and a stem lead.

The "inverted" pinched cathode is only one of the many improvements which account for the *first-line* quality of Cunningham tubes. It serves to explain why experienced servicemen use Cunninghams consistently.

ALWAYS KEEP IN TOUCH WITH YOUR CUNNINGHAM DISTRIBUTOR



RADIO CORPORATION of AMERICA

ELECTRON TUBES

HARRISON, N. J.

I Will Train You at Home for Good Jobs in RADIO- TELEVISION



**I Send You Many
KITS OF PARTS
for practical experience**

You conduct many tests and experiments with equipment built from materials I furnish. Some of the equipment from my Servicing Course and some from my Communications Course is shown below. Everything I send is yours to keep.

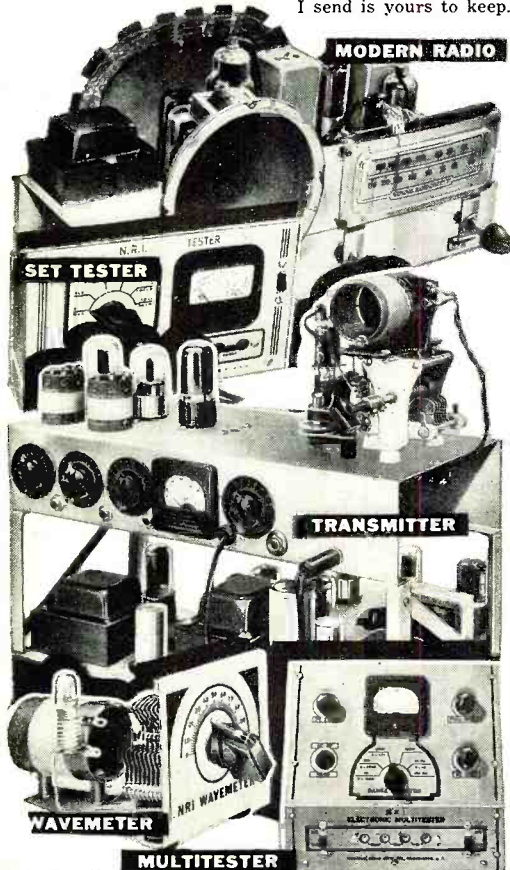

VETERANS GET THIS TRAINING
WITHOUT COST
UNDER G. I. BILL

America's Fastest Growing Industry Offers You GOOD PAY--SUCCESS

Want a good-pay job in the fast growing RADIO-TELEVISION Industry? Want a money-making Radio-Television shop of your own? Here's your opportunity. I've trained hundreds of men to be successful Technicians . . . MEN WITH NO PREVIOUS EXPERIENCE. My tested and proved train-at-home method makes learning easy. You learn Radio-Television principles from illustrated lessons. You get practical experience building, testing, experimenting with MANY KITS OF PARTS I send. All equipment yours to keep.

MAKE EXTRA MONEY IN SPARE TIME

The day you enroll, I start sending SPECIAL BOOKLETS that show you how to make \$5, \$10 a week or more EXTRA MONEY fixing neighbors' Radios in spare time while learning. From here, it's a short step to your own shop or a good-pay Radio-Television servicing job. Or be a licensed Radio-Television Operator or Technician.

TELEVISION OFFERS BRIGHT FUTURE

Today there are nearly 2700 Radio stations on the air—and within three years experts predict there will be over 1000 Television Stations. Then add developments in FM, Two-Way Radio, Police, Marine, Aviation and Microwave Relay Radio! Think what this means. New jobs, more jobs, good pay for qualified men.

ACTUAL LESSON FREE

Act now! Send for my FREE DOUBLE OFFER. Coupon entitles you to actual lesson, "GETTING ACQUAINTED WITH RECEIVER SERVICING." It shows you that learning at home is easy, practical. You also get my 64-page book, "HOW TO BE A SUCCESS IN RADIO-TELEVISION." It tells what my graduates are doing and earning. Send coupon in envelope or paste on penny postal. J. E. SMITH, President, Dept. ODR, National Radio Institute, Pioneer Home Study Radio School, Washington 9, D. C.

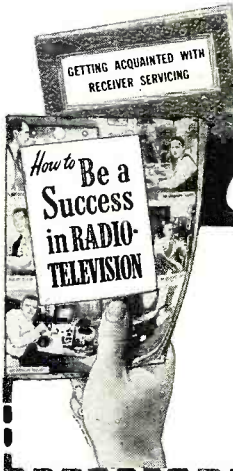

I TRAINED THESE MEN

- "I am operating my own Radio Sales and Service business. With FM and Television in the offing, we have a very profitable future." A. Patrick, Tampa, Fla.
- "N.R.I. was my stepping stone from a few hundred to over \$4,000 a year as a Radio Engineer. Make extra money servicing Radios." A. Michaels, Trenton, Ga.
- "Before finishing course, I earned about \$10 a week fixing Radios in spare time. Recommend N.R.I." S. J. Petrucci, Miami, Florida.
- "My first job was obtained for me by your Graduate Service Dept. Am now Chief Engineer, Police Radio Station WQOX." T. S. Norton, Hamilton, Ohio.
- "Am tied in with two Television outfits, and do warranty work for dealers. Use N.R.I. texts often." Robert Dohman, New Prague, Minn.
- "Four months after enrolling for N.R.I. course, was able to service Radios; averaged \$10-\$15 a week in spare time." W. B. Weyde, Brooklyn, N. Y.
- "N.R.I. helped me get position as Radio Mechanic with United Airlines. Have Radiotelephone 2nd Class License." Lehman Hauger, San Bruno, California.

Good for Both--FREE

MR. J. E. SMITH, President, Dept. ODR
National Radio Institute, Washington 9, D. C.

Mail me Sample Lesson and 64-page book about How to Win Success in Radio-Television—both FREE. (No salesman will call. Please write plainly.)

Name..... Age.....
Address.....
City..... Zone..... State.....
 Check if Veteran Approved Under G. I. Bill

Editor
OLIVER READ, Litt.D., W9ETI

Managing Editor
WM. A. STOCKLIN, B.S.

Technical Editor
H. S. RENNE, M.S.

Associate Editor
RAY FRANK, W9JU

Contributing Editor
R. HERTZBERG, W2DJJ

Television Consultant
MILTON S. KIVER

Short-Wave Editor
KENNETH R. BOORD

Editorial Assistants
I. M. CARROLL

E. V. HITZEL

P. B. HOEFER

Staff Artist
R. S. KUPJACK

Advertising Manager
L. L. OSTEN

Midwest Adv. Manager
JOHN A. KONAN, JR.

Art Director
HERMAN R. BOLLIN



COVER PHOTO: J. J. Barry, Wm. Thomas, and B. H. Speirs record off-the-line programs at ABC's Central Division, Chicago, for later broadcast to network outlets. (Kodachrome by Arthur E. Haug)

Chairman of the Board and Publisher
WILLIAM B. ZIFF

President
B. G. DAVIS

Secretary-Treasurer
ARTHUR T. PULLEN

Vice-Presidents
MICHAEL H. FROELICH
Dir. Eastern Div.

H. J. MORGANROTH
Production Director

H. G. STRONG
Circulation Director

BRANCH OFFICES

NEW YORK (1)
Empire State Bldg., WI 7-0400

LOS ANGELES (14)
815 S. Hill St., TUcker 9213
Manager, **WILLIAM L. PINNEY**

RAD O & TELEVISION NEWS

First in
radio-television-electronics

Average Paid Circulation over 200,000

Radio News Trademark Reg. U.S. Pat. Office No. 378427 • Television News Trademark Reg. U.S. Pat. Office No. 517468
Radio & Television News Trademark Reg. U.S. Pat. Office No. 517025

CONTENTS

APRIL, 1950

Putting TV on the Air.....	Charles F. Abel	35
The Electronic Switch.....	Victor Beckstrom	41
ABC Uses Magnetic Tape for Delayed Broadcasts.....	Byron H. Speirs	41
The Mini-Rack Modulator.....	John F. Clemens, W9ERN	42
Multiplex TV Antenna Systems for Stores.....	Robert L. Donaldson	45
Radioactivity "Sniffer".....	Alvin B. Kaufman	46
Constant-Resistance Network Inductor Design.....	Jack D. Gallagher, W5HZB	48
A TV Linearity-Pattern Generator.....	Robert N. Vendeland	49
Design Considerations for High-Quality Reproducing Systems (Part 1).....	Herb Matthews	52
Linearity Distortion in Audio Equipment.....	Glen Southworth	54
Mac's Radio Service Shop.....	Jonn T. Frye	56
Modern Television Receivers (Part 24).....	Milton S. Kiver	57
No Space for an Antenna?.....	Stan Johnson, WØLBV	60
R.F. Power Output Meter for V.H.F. and U.H.F.....	J. A. Houser, W2VCM	63
Transmitter Keying and Biasing Problems.....	James N. Whitaker, W2BFB	64
An L-C-Q Meter.....	Wm. K. Brookshier	67
An Intercom from the BC-605.....	Daniel Schulman	140
FM Quiz	Ed Bukstein	152

DEPARTMENTS

For the Record.....	The Editor	8	What's New in Radio.....	81
Spot Radio News.....		16	Letters from Our Readers.....	86
Within the Industry.....		26	Manufacturers' Literature	90
Short-Wave.....	K. R. Boord	62	New TV Products.....	98
MARS		77	Technical Books	123
AFCA News		154		



COPYRIGHT 1950
ZIFF-DAVIS PUBLISHING COMPANY
185 North Wabash Ave., Chicago 1, Ill.
VOLUME 43 • NUMBER 4



Member
Audit Bureau of
Circulations

RADIO & TELEVISION NEWS is published monthly by the Ziff-Davis Publishing Company, 185 N. Wabash Ave., Chicago 1, Ill. Subscription Rates: in the United States \$4.00 (12 issues), single copies 35c; in Canada \$4.00 (12 issues), single copies 40c; in Mexico, South and Central America, and U. S. Possessions, \$4.00 (12 issues); in British Empire, \$5.00 (12 issues)—all other foreign countries \$5.00 (12 issues). Subscribers should allow at least 2 weeks for change of address. All communications about subscriptions should be addressed to: Director of Circulation, 185 N. Wabash Ave., Chicago 1, Ill. Entered as second class matter July 21, 1948, at the Post Office, Chicago, Illinois, under the Act of March 3, 1879. Payment made at our current rates, covers all authors', contributors' or contestants' rights, title and interest in and to accepted material, including photographs and drawings.

RADIO & TELEVISION NEWS

Which Do You Want?



Better Pay



A Nice Home



A New Car



Greater Security



Happy Vacations and Travel

Get Your FCC Ticket
Jobs leading to
\$3,000 to \$7,500
(Average Pay Reported by FCC
Nationwide Survey)
are opening up
right now for
**FCC Licensed
Radiomen.**

Add Technical Training to Your Practical Experience and

Get Your FCC COMMERCIAL RADIO OPERATOR LICENSE in a Few Short Weeks



It's EASY if you use CIRE Simplified Training and Coaching AT HOME in SPARE TIME

Get your license easily and quickly and be ready for the jobs open to ticket holders which lead to \$3000-7500 yearly (average pay reported FCC Nationwide Survey).

OURS IS THE ONLY HOME STUDY COURSE OF COACHING AND TRAINING PRIMARILY PLANNED TO LEAD DIRECTLY TO AN FCC COMMERCIAL LICENSE

Your FCC ticket is always recognized in all radio fields as proof of your technical ability

CIRE Job-Finding Service Brings Amazing Offers of Jobs!

"I have found and accepted a position at KWAD in Wadena, Minn. I am indebted to CIRE for I secured this position through the help of the CIRE Job-Finding Service. I had six other offers from stations receiving my employment application and CIRE reference.

Student No. 2760 AT

"I now hold ticket Number P-10-3787, and holding the license has helped me to obtain the type of job I've always dreamed of having. Yes, thanks to CIRE, I am now working for CAA as Radio Maintenance Technician, at a far better salary than I've ever had before. I am deeply grateful."

Student No. 3319N12

"I am working at WRJM as transmitter engineer, and I received this position in response to one of the employment applications sent me upon completion of my course and the receiving of my Diploma. I received my 1st class Radiotelephone License on March 2, 1949. I want to express my sincere appreciation to the staff of CIRE."

Student No. 2608 AT

CLEVELAND INSTITUTE OF RADIO ELECTRONICS
Desk RN-16 4900 Euclid Bldg. Cleveland 3, Ohio

Approved for Veteran Training under "G.I. Bill of Rights"

April, 1950

GET THIS AMAZING NEW BOOKLET

1. Tells of Thousands of Brand New Better-Paying Radio Jobs Now Open to FCC License Holders.
2. Tells How We Guarantee to Train and Coach You Until You Get Your FCC License.
3. Tells How Our Amazing Job-FINDING Service Helps You Get the Better-Paying Radio Job Our Training Prepares You to Hold.



Get All 3 FREE Send Coupon Now!

CLEVELAND INSTITUTE OF RADIO ELECTRONICS

Desk RN-16, 4900 Euclid Building, Cleveland 3, Ohio
(Address to Desk No. to avoid delay.)

I want to know how I can get my FCC ticket in a few short weeks by training at home in spare time. Send me your FREE booklet "Money Making FCC License Information," as well as a sample FCC-type exam and FREE booklet, "How to Pass FCC License Examinations," (does not cover exams for Amateur License).

Name

Address

City.....Zone.....State.....

Veterans check for enrollment information under G. I. Bill.

**YOU BUILD 'EM
IN ONE EVENING
BUT...**

THEY LAST A LIFETIME!

SAVE 50% WITH

**LABORATORY
PRECISION**



**INSTRUMENTS
& KITS**

SENSATIONAL NEW

**EICO Model 360-K TV-FM SWEEP
SIGNAL GENERATOR**

• Crystal marker oscillator with variable amplitude. • Covers all TV and FM alignment frequencies between 500 kc. and 228 mc. • Sweep-width variable from 0-30 mc. with mechanical inductive sweep. • Extremely wide sweepwidth allows gain comparison of adjacent RF TV Channels. • Provides for injection of external signal generator marker. • Phasing control included. • Large, easy-to-read dial is directly calibrated in frequencies. Vernier tuning condenser. Comes complete with all tubes (including new, high-frequency miniature types): 6X5GT, 12AU7, two 6C4's. Crystal not included. 10"x8"x6 3/4". 5 Mc. Crystals available for above, each \$3.95.

\$29.95

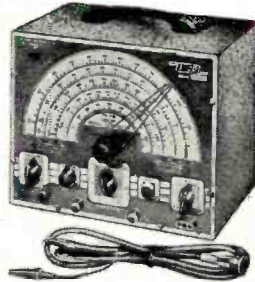

Model 360. Ready to use Sweep Signal Generator. \$39.95
See it at your local jobber!

**ANYONE
CAN BUILD
THEM!**



\$19.95

**NEW! MODEL 320-K
SIGNAL GENERATOR**

For FM, AM alignment and to provide TV marker frequencies. Highly stable Hartley oscillator has range of 150 kc. to 102 mc. with fundamentals to 34 mc. Colpitts audio oscillator supplies pure 400 cycle sine wave voltage for modulation. Vernier tuning condenser. Use audio oscillator voltage to test distortion in audio equipment, bridge measurements, etc.

FACTORY-WIRED AND TESTED \$29.95
Model 320. Ready to use.



\$18.95

**VERSATILE MULTI-
SIGNAL TRACER**

Model 145-K. High gain—high frequency. Self-contained test speaker permits audible signal tracing of RF, IF, FM, audio and video circuits. Provision for visual tracing with VTVM. Response is well over 200 mc. 3-color hammettone panel. 110-125 V. AC. Size: 10"x8"x4 3/4". Comes complete with tubes and diode probe in kit form.

FACTORY-WIRED AND TESTED \$28.95
Model 145. Ready to operate.

**NEW PUSH-PULL
5" TV
OSCILLOSCOPE
Model 425-K Kit**

\$39.95

ALL-NEW laboratory precision scope has Push-Pull deflection and .05 to .1 volts per inch sensitivity. Wide range, flat from 5 cps to 500 kc. with full gain settings, useful to 2 1/2 mc. Wide-range, multi-vibrator, sweep circuit from 15 cps to 75,000 cps. Direct connection to plates of CRT available at rear of cabinet. Z axis intensity modulation feature included. Size: 8 1/2"x17"x13" high. Complete with 3—6SN7s, 2—6J6s, 2—6Y8s, and 5BP1 CRT.

FACTORY-BUILT OSCILLOSCOPE \$69.95
Model 425. Fully wired and tested



**HIGH PRECISION
VACUUM TUBE
VOLTMETER
Model 221-K**

\$23.95

Tops in workbench versatility—15 different ranges! AC and DC ranges: 0/5/10/100/500/1000 volts. Electronic ohmmeter ranges from 2 ohms to 1000 megohms in 5 steps. New features include Zero Center for TV discriminator alignment. 26 Meg. DC input impedance. Accurate, 4 1/2" meter cannot burn out. Double triode balanced bridge circuit assures guaranteed performance. Sturdy portable steel base with etched rubproof panel. Will measure up to 30,000 V. and 200 MC. when used with our HVP-1 or P-75 probes. 110-130 V. AC 50-60 cycle. Size: 9 7/16"x6"x5".

FACTORY-WIRED AND TESTED \$49.95
Model 221. Same, but completely wired, calibrated, and tested.



**DELUXE SIGNAL
GENERATOR**

MODEL 315

Completely wired, ready-to-use Signal Generator with 1% accuracy! A wonderful instrument with dozens of expensive features. Frequency range: 75 kc to 150 mc. Has microcycle band-spread vernier tuning for FM, AM, and TV. Voltage regulator. Write for full details. **\$59.95**

Model 511-K. A "Must" for every serviceman! Small, handy instrument used a thousand times a day. Large 3" meter, beautifully etched panel. A perfect kit for beginners. Simple to assemble. Ranges: DC—0/5/30/250/500/2500 volts. AC—0/10/100/500/1000 volts. Output—0/10/1/10. DC A m.p.s.—0/10. Ohm meter — 0/500/100,000 ohms/0/1 meg. DB meter — 8 to +55 DB. **\$14.95**

ASSEMBLED—READY TO USE \$17.95
Model 511. Completely wired, tested, and assembled at the factory. Rugged, built for heavy duty.

**VOLT-OHM
MILLIAMMETER
Complete Pocket Kit**



\$14.95



HIGH VOLTAGE PROBE

Complete top-quality Voltage Test Probe Measures up to 30,000 Volts. Special Helical-Wound Ceramic HV Multiplier Resistor adaptable to most VTVM's and all 20,000 ohms per volt meters with 1000 or 5000 volt scales. Lucite head, plywood bakelite handle, large flashguards for additional safety. Specify your instrument. Complete, ready to use. **\$6.95**

**SEE THEM—TRY THEM—
AT YOUR LOCAL JOBBER!**

EICO Instruments and Kits are on display at your local jobber—the nationally advertised kits which you can see and use before you buy. You take no chances with EICO!

**Write For New Catalog "R"
Prices Higher on West Coast**

**Model
HVP-1**

HIGH FREQUENCY RF PROBE

Model P-75K germanium crystal probe for visual RF signal tracing and measurements to over 200 megacycles. Can be used with models 221 or 113A Eico instrument (state which when ordering). 6 1/2" long, 1/2" O.D., with wire, plugs, and all components.

IN KIT FORM \$3.75
Model P76K same as above, but for oscilloscopes; in kit form. **\$3.75**
Models P75 or P76 similar to above but factory wired, ready to operate. Each... **\$7.50**

**EASY-TO-FOLLOW SCHEMATIC & EICO
PICTORIAL DIAGRAMS**

Come complete with every EICO instrument kit. Each kit fully guaranteed to operate perfectly when assembled according to our simple instructions!

EXCLUSIVE LIFE-TIME REPAIR SERVICE: For a nominal charge, we will repair and service your EICO instrument, regardless of its age!



ELECTRONIC INSTRUMENT CO., INC.
276 Newport Street, Brooklyn 12, N. Y.

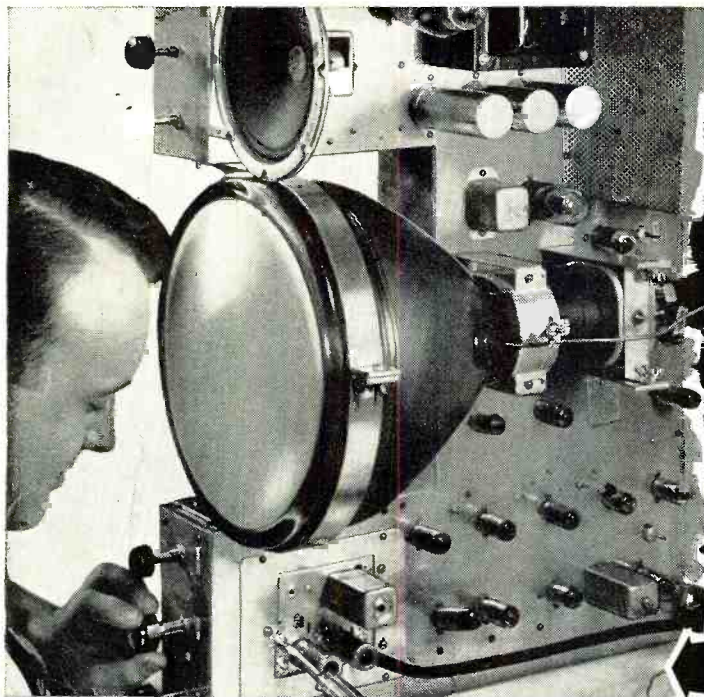

Only D.T.I. offers you the "BIG 5" TELEVISION RADIO-ELECTRONICS Laboratory Type HOME TRAINING

Build and Keep 10, 12½ or 16 inch Picture Tube Quality TELEVISION RECEIVER as you prepare for a Profitable Future

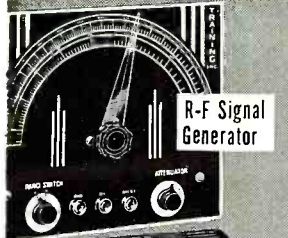

R-F Signal Generator

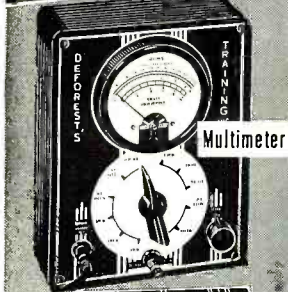

Multimeter



Oscilloscope

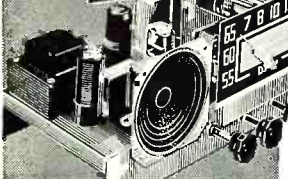

6 Tube Radio Receiver

Here is everything you need to prepare you at home for FASCINATING WORK, GOOD MONEY and a THRILLING FUTURE in one of America's most promising fields.

This includes the opportunity to build and keep the top quality Television Receiver shown above—with choice of a 10, 12½ or 16 inch picture tube that gives big, bright, sharp, steady pictures. Get the complete facts. This is an optional feature — available when you complete your training described below. See how D.T.I.'s wonderfully practical "BIG 5" method meets industry's needs. No previous experience needed. Mail coupon today!

16 Big Shipments of Parts — Plus Lessons

Work over 300 electronic experiments and projects from 16 big shipments of parts. This includes building and keeping all test equipment and radio set shown at left side of page. Modern easy-to-read lessons with handy fold-out diagrams simplifies your entire training.

You Also Use Home Movies

D.T.I., alone, includes the modern, visual training aid . . . MOVIES to help you learn faster, easier at home. See electrons on the march and other fascinating "hidden action"—a remarkable home training advantage that speeds your progress.

EMPLOYMENT SERVICE

When you complete your training, our effective Employment Service helps you get started toward a real future in Television-Radio-Electronics.

Modern Laboratories

If you prefer, you can get ALL your preparation in our new, Chicago training laboratories . . . one of the finest of its kind. Ample instructors . . . modern equipment. Write for details!



You Learn-By-Doing from D.T.I.'s HOME LABORATORY

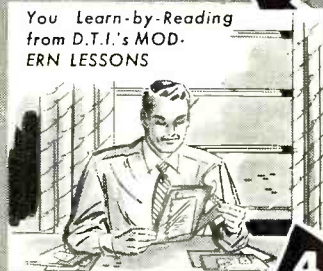

You Learn-by-Reading from D.T.I.'s MODERN LESSONS

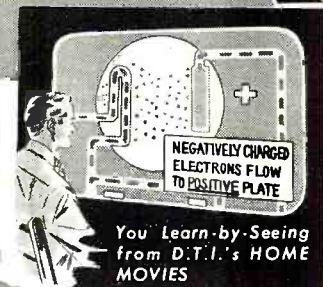
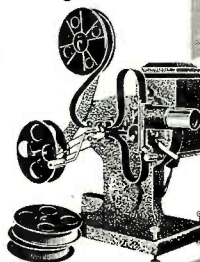

You Learn-by-Seeing from D.T.I.'s HOME MOVIES

MAIL THIS COUPON TODAY!

DeFOREST'S TRAINING, INC.
2533 North Ashland Avenue, Dept. RN-G-4
Chicago 14, Illinois.

Without obligation, give me complete facts showing how I may make my start in Television-Radio-Electronics.

Name _____ Age _____

Street _____ Apt. _____

City _____ Zone _____ State _____

DeFOREST'S TRAINING, INC.

Chicago 14, Illinois

A DeVry Institution

For the **RECORD.**

BY THE EDITOR

OUR EXPANDING COMMUNICATIONS



You can do every kind of soldering with this new 250 watt Weller Gun. Power-packed, it handles heavy work with ease—yet the compact, lightweight design makes it equally suited for delicate soldering and getting into tight spots.

Pull the trigger switch and you solder. Release the trigger, and off goes the heat—automatically. No wasted time. No wasted current. No need to unplug the gun between jobs. 'Over and under' position of terminals provides greater visibility with built-in spotlight. Extra 5 1/4" length and new RIGID-TIP mean real soldering efficiency.

Chisel-shape RIGID-TIP offers more soldering area for faster heat transfer, and new design gives bracing action for heavy jobs. Here you get features not found in any other soldering tool... advantages that save hours and dollars. Your Weller Gun pays for itself in a few months. Order from your distributor or write for bulletin direct.

SOLDERING TIPS—get your copy of the new Weller guide to easier, faster soldering—20 pages fully illustrated. Price 10c at your distributor, or order direct.



WELLER
MANUFACTURING COMPANY

810 PACKER STREET • EASTON, PA.

IT IS generally agreed that there is plenty of opportunity for trained technicians in the rapidly expanding television field. We have stressed the necessity for adequate training many times. It is also agreed that the public itself is demanding more service than can often be given. Television itself as an entertainment medium has become so important to many families that they are ready to sacrifice any other form of entertainment as long as they are able to follow their weekly programs.

There are many radio, television, and engineering schools in the United States supplying a vast army of new technical talent in radio, electronics, and television. In spite of this new blood, there still remains a critical shortage of qualified technicians.

Everyone is not concentrating on television. There still remains a huge radio market that will provide a lucrative source of income for many years to come, as well as a greatly expanding communications industry.

We believe that there is still a bright future for the aggressive "radioman"; for example, during last year alone there were a total of nearly 650,000 radio operators in the following classifications: Aircraft, Amateur, Citizens, and Commercial. These radio services continue to grow in spite of the terrific impact of television and the drain on available technicians.

Mobile radio has mushroomed to well over 200,000 units. Operation of more than 300,000 transmitters are covered in nonbroadcast radio authorizations by the *Federal Communications Commission*. Of these, there are approximately 100,000 fixed or land stations and over 220,000 portable or mobile units.

In the classification Safety and Special Services, are a total of nearly 300,000 units comprising 196,000 portable or mobile and 26,000 common carrier transmitters. In addition there are the 2200 fixed or land stations and about 24,000 additional portable or mobile units.

Most radiomen are not too familiar with the many applications for radio communications and as a result fail to discover the many opportunities in Aircraft, Ground Aviation, Police, Fire, Forestry, Highway Maintenance, Special Emergencies, Ship, Postal and Marine Relay, Radar, Railroad, Transit Utilities, Busses and Trucks, Taxicabs, Power, Petroleum, and Industrial Services.

All of the above services require

both operating and maintenance personnel. Even local radio service technicians are often called in to handle service on equipment designed for the above applications.

There are several other fields of opportunity, some old and some new. They include Common Carriers, such as: International Fixed Public Service (Telephone and Telegraph), Domestic Public Land Mobile Service, and Domestic Fixed Public Service, to name only a few.

There will always be many opportunities in Manufacturing (Industry) for trained engineers in Television, Industrial Electronics, and Radio. The public is still purchasing radio receivers in substantial quantities and nearly all of these units will eventually require maintenance and replacement of tubes and parts. One need only look at the figures compiled by RMA during the past year to appreciate that the opportunities for radio service technicians will be at hand for many years. During 1949 over 9,680,000 radio receiving sets were produced as compared to the 2,413,897 television sets produced during the same period.

As a matter of record, many dealers complained that they could not get sufficient radio sets to meet the demands of their customers, in spite of the fact that nearly 10,000,000 sets were produced.

There are plenty of opportunities to earn a livelihood in our Industry for trained personnel, but there is plenty of competition for the untrained.

In addition to the strictly radio and communications fields, there are many opportunities in the field of industrial electronics for the trained man. As the subject of industrial electronics is so closely allied to that of radio, any competent radioman can quickly gain the needed knowledge.

Manufacturers frequently prefer to have this type of maintenance handled on a contract basis, rather than to depend on their own maintenance departments. Payment for services is prompt and adequate.

* * *

HAM CONTEST

THE contest launched by this publication in January 1949 closed officially March 1, 1950.

As explained in the rules, the judges will determine the official licensed status of all new licensees by the Spring 1950 edition of the *Radio Amateur Callbook*. As soon as decisions are reached the winners will be notified by mail O.R.

RADIO & TELEVISION NEWS

THERE'S ONLY ONE COMPLETE CATALOG FOR EVERYTHING IN RADIO AND TV!

IT'S YOUR **FREE**
ALLIED 196-PAGE
 VALUE-PACKED CATALOG!

SEND FOR IT TODAY

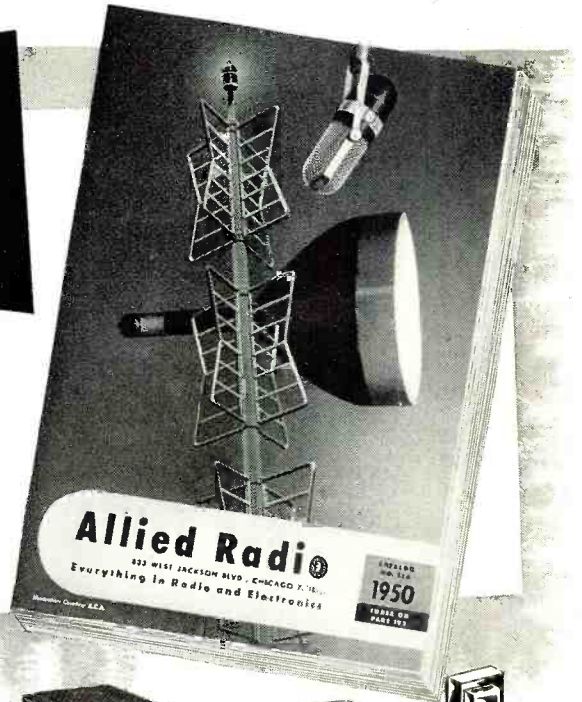

Here's the only *complete* Buying Guide to everything in TV, Radio and Electronics—packed with the world's largest selections of quality equipment at lowest money-saving prices! See the latest in TV, AM and FM receivers; radio-phonos; new Sound Systems and P.A. equipment; high-fidelity custom sound components; recorders and accessories; full selections of newest Amateur receivers and station gear; test instruments; builders' kits; huge listings of parts, tubes, tools, books, diagrams—all in stock for immediate shipment.

ALLIED gives you every buying advantage: speedy delivery, expert personal help, lowest prices, assured satisfaction—plus the most liberal Time Payment plan in radio. Get the 1950 ALLIED Catalog—it will save you time and money. Send today for your FREE copy!

ALLIED IS YOUR TELEVISION HEADQUARTERS



You keep up with TV when you depend on ALLIED! Count on us for the latest releases and largest stocks of picture tubes, component parts, antennas and accessories—plus the latest in TV receivers, tuners and kits. If it's *anything* in TV—we have it in stock! So remember—for TV—it's ALLIED First!

ALLIED RADIO

THE WORLD'S LARGEST RADIO SUPPLY HOUSE

Everything in Radio, TV and Electronics

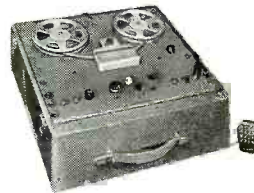

WORLD'S LARGEST STOCKS

*Radio Parts Unlimited
 Test Instruments—All Makes
 Television & Home Radios
 P. A. and Hi-Fi Equipment
 Amateur Station Gear
 Experimenters' Supplies*

QUICK, EXPERT SERVICE

Send for Radio's Leading Buying Guide

FREE

ALLIED RADIO CORP.
 833 W. Jackson Blvd., Dept. 1-D-0
 Chicago 7, Illinois

Send FREE 196-page 1950 ALLIED Catalog.

Name

Address

City..... Zone..... State.....

Wins 30% more business with SYLVANIA DEALER CAMPAIGN

"Last summer we obtained your coordinated campaign and mailed the postal cards to just certain sections. Then we kept track of service business, and found we received 30% more from the sections which got the cards.

"We're convinced . . . your campaign is the best insurance against a summer slump in service business.

"This year, May, June, July, and August are going to be our big profit months."

Albert Gale

Gale Radio and Television Lab., New Rochelle, N. Y.



- 1—Displays
- 2—Window Streamers
- 3—Post Cards
- 4—Ad Mats
- 5—Radio Spots

You, too, will cash in BIG with this powerful, new summer campaign

Right now is the time to send for the new, complete advertising campaign that's bound to bring you extra business . . . all through May, June, July, and August.

Look at all the colorful, sales-making material you get! Everything from large 3-dimensional window- and counter-displays, to complete newspaper ad mats and postal cards. Even radio spot announcements to be broadcast over your local station. It's all yours . . . and it's all FREE . . . you pay only the postage on the postal cards, 1¢ for each card.

Written and designed to tie in with Sylvania's big national magazine advertising which your customers will see in the Saturday Evening Post, Collier's, Look, Life and other publications.

So, don't delay! Mail the coupon for full details TODAY!



RADIO TUBES; CATHODE RAY TUBES; ELECTRONIC DEVICES; FLUORESCENT LAMPS, FIXTURES, WIRING DEVICES, SIGN TUBING; LIGHT BULBS; PHOTOLAMPS

SYLVANIA ELECTRIC

Sylvania Electric Products Inc.
Advertising Dept. R-1204-A, Emporium, Pa.
Please send me full information about the May-June-July-August Service Dealer Campaign.

Name _____

Company _____

Street _____

City _____ Zone _____ State _____

Another **Rauland** "First"!

NEW "Indicator Gun" CR TUBE

Assures perfect ion trap magnet adjustment instantly
... positively

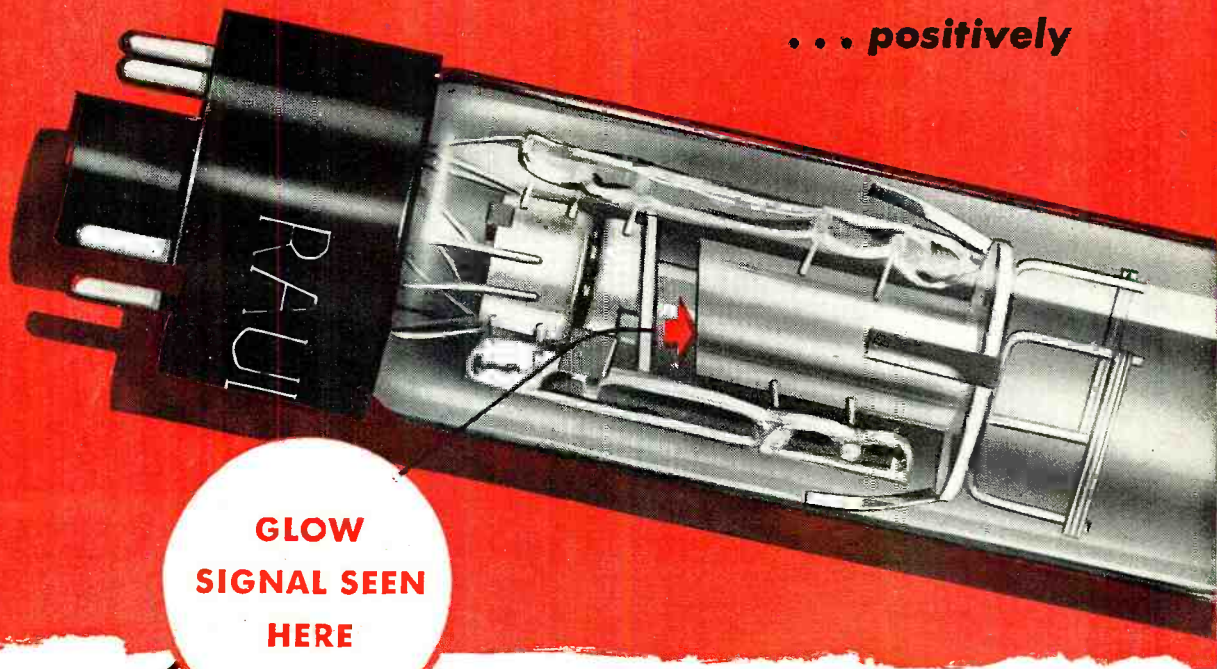

**GLOW
SIGNAL SEEN
HERE**

Here at last— is a fool-proof solution to the problem of ion trap magnet adjustment... a development which Rauland is happy to offer for the benefit of both set makers and service men.

The new Rauland "Indicator Gun"—patent pending—gives a brilliant visible signal easily seen from the rear of the set while magnet adjustment is being made. A bright green glow within the Anode Tube signals when adjustment is incorrect—dims as correct adjustment is approached—disappears when adjustment is correct.

All guesswork is eliminated—risk of screen damage through incorrect magnet adjustment is ended—and adjustment time is reduced to seconds. Assemblers or service men *know* that magnet adjustment is right—*know* that any remaining picture defect is in other controls.

The Rauland "Indicator Gun" adds nothing to the price of Rauland picture tubes. First production is in the 12LP4-A with Luxide Screen—available now!

THE RAULAND CORPORATION



Perfection Through Research

4245 N. KNOX AVENUE • CHICAGO 41, ILLINOIS



NOW..A NEW, WIDER LINE

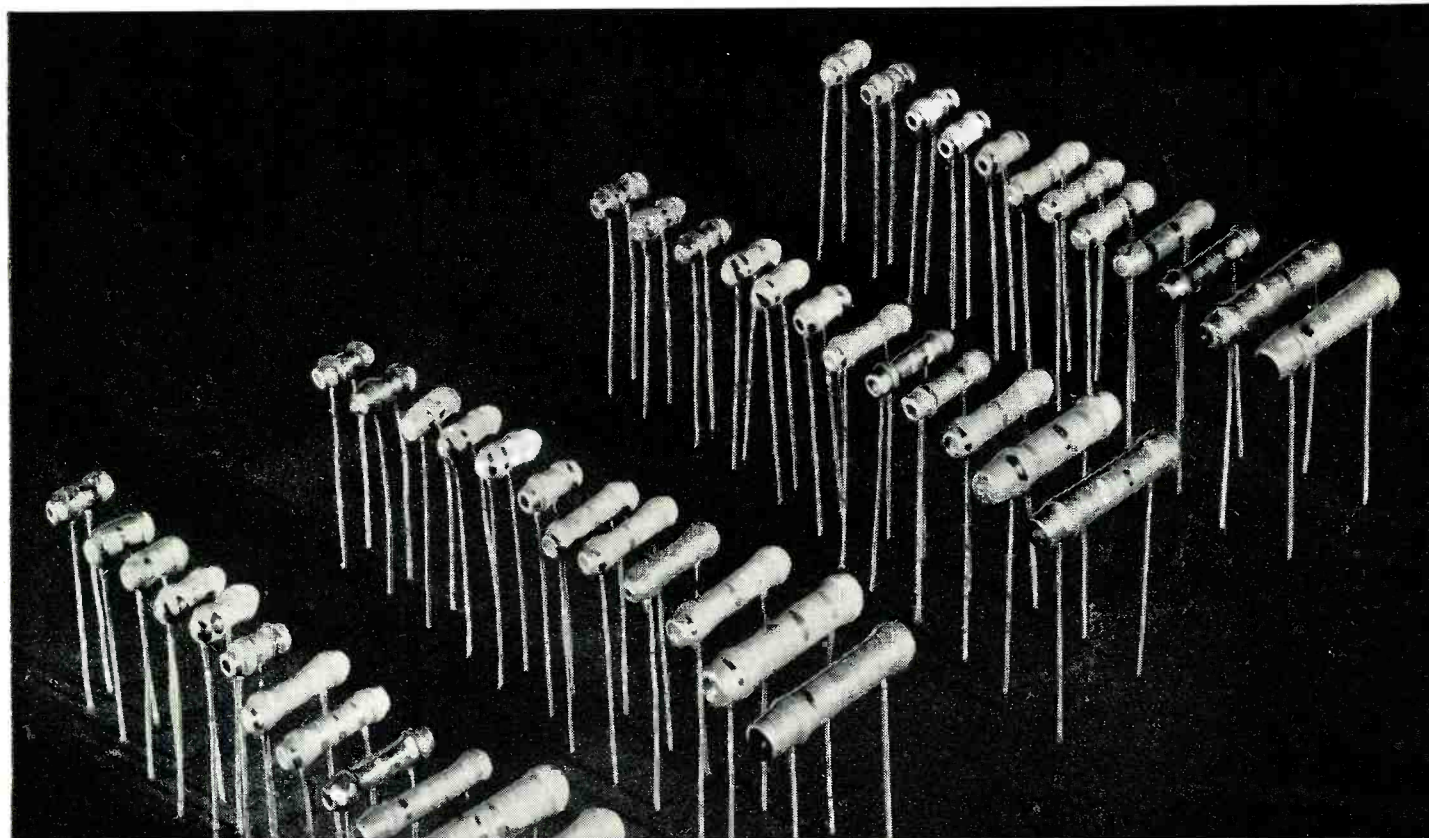

Choose from this Complete Ceramic Capacitor Line

Your radio parts distributor can supply you with these BC HI-KAP Tubular Ceramic By-pass and Coupling Capacitors in the following values — all rated at 600 WVDC, flash tested, 1000 VDC. Packaged in cellophane envelopes, 5 of one value per envelope.

Capacity	CRL Cat. No.	Capacity	CRL Cat. No.	Capacity	CRL Cat. No.
10MMF	D6-100	120MMF	D6-121	1,000MMF	D6-102
12MMF	D6-120	150MMF	D6-151	1,200MMF	D6-122
15MMF	D6-150	180MMF	D6-181	1,500MMF	D6-152
18MMF	D6-180	200MMF	D6-201	1,800MMF	D6-182
20MMF	D6-200	220MMF	D6-221	2,000MMF	D6-202
25MMF	D6-250	250MMF	D6-251	2,200MMF	D6-222
27MMF	D6-270	270MMF	D6-271	2,500MMF	D6-252
33MMF	D6-330	300MMF	D6-301	2,700MMF	D6-272
39MMF	D6-390	330MMF	D6-331	3,000MMF	D6-302
40MMF	D6-400	390MMF	D6-391	3,300MMF	D6-332
47MMF	D6-470	400MMF	D6-401	4,700MMF	D6-472
50MMF	D6-500	470MMF	D6-471	5,000MMF	D6-502
56MMF	D6-560	500MMF	D6-501	5,600MMF	D6-562
68MMF	D6-680	560MMF	D6-561	6,800MMF	D6-682
75MMF	D6-750	680MMF	D6-681	7,500MMF	D6-752
100MMF	D6-101	750MMF	D6-751	10,000MMF	D6-103

For other ceramic capacitor replacement needs, use CENTRALAB's line of TV HI-VO-KAPS, KOLORDISKS and TC capacitors.

OF TUBULAR BC HI-KAPS!

Mr. Service Engineer . . . If your profits and reputation depend on guaranteed repairs, then this message is for You! Centralab . . . the First name in ceramic components . . . gives you famous ceramic tubular BC Hi-Kaps in 48 different and many new values. Check their advantages . . . see why CRL BC Hi-Kaps are absolutely safest for guaranteed repairs.

The present trend to *guaranteed service policies* demands that service engineers take no profit-risking chances with replacement parts of doubtful performance and durability.

Chart below gives you the facts. Read them. See why we say *no other tubular by-pass and coupling capacitors made will outperform or outlast CRL Tubular Ceramic BC Hi-Kaps!*



DIVISION OF GLOBE-UNION INC., MILWAUKEE, WIS.

Check these Features . . . See for Yourself why CRL BC Hi-Kaps are "safest"

"HI-KAP" FEATURES	DESCRIPTION			WHAT IT MEANS TO YOU
1. Impervious to moisture	Ceramic-X is non-hygroscopic. Moisture absorption is .007% or less.			No deterioration, no shorting. Longer life even under the most adverse conditions of humidity.
2. Low mass weight	AV. WT.	DIMENSIONS	VALUES	For unit size and weight, Centralab BC "Hi-KAPS", made with Ceramic-X, are the only capacitors on the market which provide these voltage ratings.
3. Small Size	.029 oz.	D—.260" L—.530"	10—390 mmf.	
	.044 oz.	D—.260" L—.810"	400—3000 mmf.	
	.050 oz.	D—.280" L—.900"	3300—5000 mmf.	
4. High capacity	.082 oz.	D—.330" L—1.200"	5600—10,000 mmf.	
	Ratings: 600 WVDC — 1000 flash test.			
5. Special insulation	Low power factor resin and high temperature wax coatings, with an additional special phenolic jacket.			Prevents any possibility of shorting to adjacent leads, chassis or components.
6. Convenient side leads	Heavy No. 22 gauge tinned copper, silver soldered to electrodes.			Permit rapid, close-coupled connections. No tricky bending or fitting required.
7. Low power factor	Initial — .6%. After 100 hours, 95% humidity test — 3.0%.			More efficient circuit operation, fewer failures.
8. High leakage resistance	Initial — 5000 megohms. After humidity — 500 megohms.			Long life, more efficient performance.
9. Maximum dependability	Pure silver electrodes, electro-bonded to Ceramic-X dielectric. Protected against oxidation or mechanical damage by coatings of electrolytic copper and solder.			Moisture and puncture proof. Will not short or become intermittent.
10. Factory tested	For your protection, all units 100% factory tested before packaging and shipping.			Your guarantee to your customers of reliable service and performance.

Stop! WHY PAY MORE?



Take Advantage of
Extra-Liberal Allowances
on Your Used Test and
Communication Equipment
in our . . .

GIGANTIC "Surprise" TRADE-IN EVENT

Your old (factory-built) Test Instrument, Communication Receiver or Transmitter taken in trade for Brand New Test or Communication Equipment, Television Set or TV Custom Chassis ● Easy terms on your new equipment purchase ● What have you to trade? For astounding bargains, wire, write, phone or use the handy coupon.

Save on These Bargain Specials!

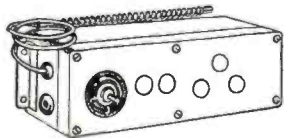

TV or Amateur Rotator Motor Ideal for turning TV or lightweight amateur beams. A Surplus item originally used for heat Bombers. 1/2 to 2 RPM, reversible. Simple instructions included for use on 115 VAC. Shpg. Wt. 6 lbs. Only **\$4.95**

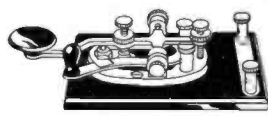

Radio or Telegraph Key Has large coin silver contacts. Bakelite mounting base with circuit closing switch. Model J-38. Shpg. Wt. 2 lbs. Only **98c**



Harvey Wells Aircraft Receiver Model AR-3-A Just the thing for listening to the 195 to 405 KC aircraft band. Also covers standard BC band, 550 to 1500 kc. 5 tube superhet circuit. Dry battery operation. Complete with tubes, connecting cable and instruction manual. Shpg. Wt. 13 1/2 lbs. Only **\$19.95**
(Note: Quoted price does not include battery, but we will supply for limited time, Free, outdated battery 1 year old, NOT guaranteed.)

All prices F. O. B. St. Louis
Phone: **CHestnut 1125**

Walter Ashe RADIO CO.
THE HOUSE OF "SURPRISE" TRADE-INS
1125 PINE ST. • ST. LOUIS 1, MO.

FREE!
New 164 page catalog. The treasure chest of values. Send for your copy today!

WALTER ASHE RADIO CO.
1125 Pine St., St. Louis 1, Mo. RN-50-4

Rush Special "Surprise" Trade-in offer on my _____
(describe used equipment)

for _____
(show make and model of new equipment desired)

Send new Free 1950 Catalog.

NAME _____
ADDRESS _____
CITY _____ ZONE _____ STATE _____



*These three braves
scalp TV Capacitor
problems!...*



SANGAMO'S TV TRIO

Tops for original equipment — Tops for replacement needs

Sangamo offers three top television capacitors that you can use with confidence. You'll like these tested, *proved* performers for their quality, their small size and their stability.

The **REDSKIN** is a plastic molded paper tubular that is easy to work with—on production line or on the bench—because its strong, tough casing stands rough handling and the flexible leads can't pull out! It gives long life at 85° operation.

The **CHIEFTAIN** is a dry electrolytic that fits anywhere! Tiny, but durable, it is ideal for application in tight spots beneath a chassis. Bare tinned-copper wire leads make it easy to mount. Maintains uniform capacity when subjected to heat and high ripple currents.

The **SIoux** is a 6,000 volt paper television capacitor with a new standard of permanence. Designed to withstand continuous operation at 85° C, it is mineral oil impregnated to provide longer life and more stable performance over a wide range of operating temperatures.

Write for Sangamo's new Jobber Catalog #800 . . . It gives you the information you need.



Your Assurance of



Dependable Performance

SANGAMO ELECTRIC COMPANY
SPRINGFIELD, ILLINOIS

IN CANADA: SANGAMO COMPANY LIMITED, LEASIDE, ONTARIO

ONLY

SPRAGUE

ELECAP[®]
MOLDED PHENOLIC
TUBULARS

GIVE YOU

**PREMIUM
QUALITY**

AT

NO EXTRA COST



Sprague Telecaps are the only paper tubular capacitors oil-impregnated and solder-sealed AFTER dry assembly molding in genuine non-flammable Bakelite phenolic. Unaffected by continuous operation at 185° F. (85° C.), these "Black Beauties" provide unusually high insulation resistance . . . give you top capacitance stability. Write for Bulletin today!

SPRAGUE PRODUCTS CO.

51 Marshall Street
NORTH ADAMS • MASS.

Spot Radio News

★ Presenting latest information on the Radio Industry.

By RADIO & TELEVISION NEWS'
WASHINGTON EDITOR

THE COLOR IN TELEVISION saga entered what every one prays will be the final chapter as the first days of Spring approached, with experts pouring into the Commerce Auditorium in the nation's capital to voice their views, views that will make headline news in the days to come.

Reappearing to testify, and in many instances offer vigorous rebuttal to many points, were the two representative groups of industry, JTAC (Joint Technical Advisory Committee) and RMA, and ten others in and out of industry which included *RCA*, *CBS*, *CTI*, Dr. Charles Willard Geer, *Philco*, *Du Mont*, *Webster-Chicago*, *American Television*, *A.T.&T.*, and *Western Union*.

Testimony this time appeared to be more conclusive, covering not only the actual results of systems, which in the earlier sessions were mere paper projects, but new procedures, also demonstrated, which were not even mentioned in the hearings of '49. *RCA*, for instance, revealed its new color method, which had received its first viewing a few weeks prior to the '50 recall, at a special show for the press in the Washington studios of *NBC*, with programs originating in the Wardman Park Hotel color studios. A highlight of the showing, viewed on 10-inch and 16-inch television receivers, was the absence of instability which had affected earlier demonstrations. The use of brief synchronizing radio pulses did the trick, according to the boys in the lab who perfected the method. They pointed out that when these pulses reached the receiver, they served to automatically lock the three primary colors into perfect phase. Specifically, the method involved the use of a 10 to 15-cycle burst of signal at a sampling frequency, which was adjusted to follow the horizontal sync signal. This burst controlled an oscillator in the receiver, directing the correct color signals to each of the three picture tubes used in the system.

Dr. E. W. Engstrom, in charge of research at *RCA*, presided at the showing and pointed out that the new color setup had six features, high definition pictures (claimed to be 70 per-cent greater in detail than the

mechanical sequential system), unlimited picture size and brightness, flickerless pictures without color breakup, automatic color phasing (described above), complete compatibility with present black and white TV, and all electronic, with no mechanical or moving parts.

"These characteristics are of major importance to the public," Dr. Engstrom emphasized, "for they mean that color TV can be introduced with no disruption to the present service."

CBS' testimony also was quite revealing and a bit on the explosive side, with reports of a long list of tests made on a variety of fronts. At the Walker Building demonstrations, *CBS* reps pointed out that Senators, members of the House and their wives appeared and were quite enthusiastic. At a series of special demonstrations, members of the Cabinet, the Supreme Court and the Defense Department, also appeared, according to *CBS* spokesmen. And at a test at the National Art Gallery, members of the Condon committee and two members of the FCC appeared; Newbern Smith, chief of the Central Radio Propagation Section of the Bureau of Standards; George Bailey, executive secretary of the IRE; W. L. Everitt, dean of the College of Engineering of the University of Illinois; Don Fink, JTAC chairman; and FCC members Frieda B. Henneck and Robert F. Jones.

In an effort to keep pace with *RCA*, *CBS* also indicated that they, too, could provide color with electronic circuitry, using a single multicolor tube. At the last session, a tri-color tube was hinted at by *RCA*, and the actual tube was scheduled for presentation before the Commission in the late Spring. The *CBS* tube was described as being usable without any change in standards which they had previously recommended.

Color Television, Inc., the third of the contenders for the standards' prize, also presented substantial test testimony, describing the results of transmissions over *KPIX*, operating on channel five, in San Francisco, California. Seven tests were involved in the viewing, the receivers all located in the Bay area. Plans for additional tests in a downtown hotel in San Francisco were also detailed.

RADIO & TELEVISION NEWS

Ac

*Quiet
as a mouse*

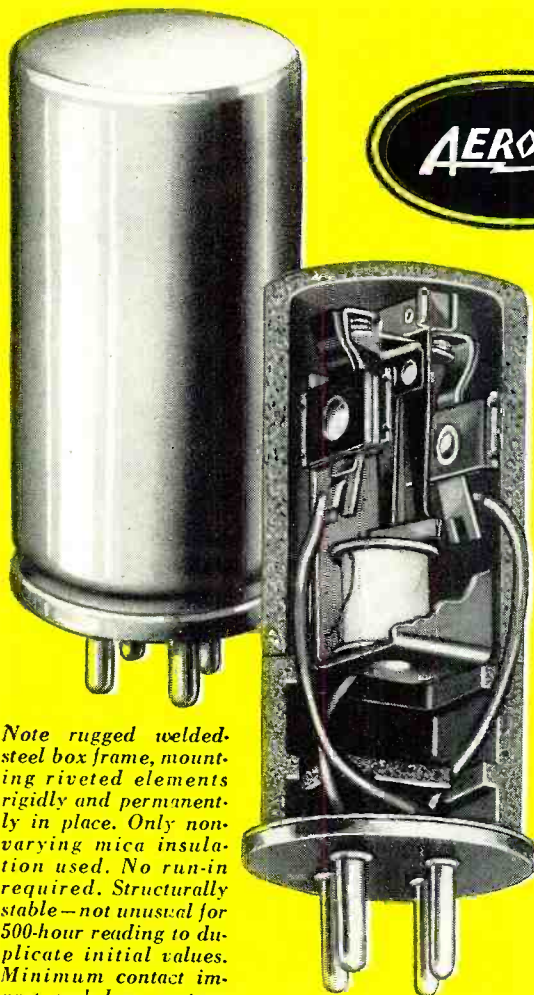

VIBRATORS

• So very quiet! You'll doubt the Aerovox Vibrator* is running until you've turned up the volume control.

Here's *the first postwar vibrator*. Radically new design—outcome of systematic engineering effort to eliminate annoyances experienced with vibrators. Provides brand new performance thrill with any auto-radio or other vibrator-powered equipment. Definitely another milestone in vibrators.

Just compare!

Yes sir, comparative tests are invited. Literature on request. Let us collaborate on your vibrator problems and needs.

Note rugged welded-steel box frame, mounting riveted elements rigidly and permanently in place. Only non-varying mica insulation used. No run-in required. Structurally stable—not unusual for 500-hour reading to duplicate initial values. Minimum contact impact and low contact-point erosion. Almost impossible for unit to close or stick. Heat generation low enough to sustain operation at 185° F.

**U.S. Patents Pending*

Standard and special types. Also Universal Replacements serving greatest number of auto-radio models with minimum inventory. For the best in replacements, insist on the "Quiet Mouse" yellow - and - black carton vibrator stocked by Aerovox distributors!



VIBRATORS

FOR AUTO-RADIO • POLICE RADIO • AVIATION RADIO • LABORATORY AND OTHER POWER PACKS • MARINE RADIO • PORTABLE RADIO • FARM RADIO • INDUSTRIAL ELECTRONICS • ETC.
AEROVOX CORPORATION • NEW BEDFORD • MASSACHUSETTS

**MEISSNER
ANNOUNCES...**

5 NEW *Engineered
RADIO KITS**

*MEISSNER kits incorporate the latest circuits and most modern tubes — assuring highest efficiency and TOP PERFORMANCE! Not "sweep-ups" or factory surplus, each part in a MEISSNER kit is the EXACT AND BEST PART for the job. All MEISSNER kits come with detailed pictorial and schematic diagrams.

**MEISSNER MODEL T2BK
2-TUBE BATTERY TRAINER KIT**

- *High Performance
- *Low Drain Battery Tubes
- *Powerful Pentode Audio
- *Regenerative Circuit
- *Tubes & BC Coil Included
- *Additional Coils Available

Model T2BK 2-Tube Battery Trainer Kit, Less Batteries, Headphones, Wire & Solder, Net.....\$ 7.35

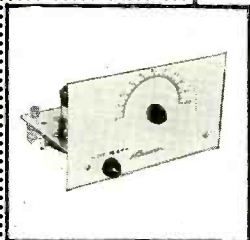

**MEISSNER MODEL T3BK
AC-DC TRAINER KIT
(Similar in appearance to T2BK)**

- *"Beam-Power" Audio Stage
- *Range — 175 Kc to 34 Mc
- *3 Tubes & BC Coil Included
- *Additional Coils Available

Model T3BK AC-DC Trainer Kit, Less Headphones, Wire & Solder, Net.....\$ 8.98

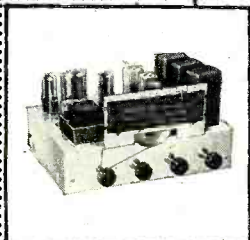

**MEISSNER MODEL T6BK
3 BAND AC KIT**

Practical, up-to-date instruction in the latest receiver technique. Detailed pictorial diagram and schematic easy to understand.

ALL STAR FEATURES!

- A new, Husky, superb-fidelity amplifier.
- *6 Tubes included with kit
- *"Beam-Power" Amplifier
- *535 Kc to 18 Mc In 3 overlapping bands
- *Continuous Tone Control

Model T6BK 3 Band AC Kit, less speaker, wire & solder, Net Price.....\$32.85

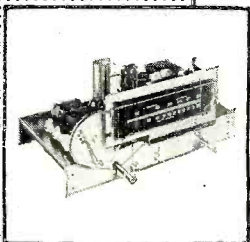

**MEISSNER MODEL T8CK
FM RECEPTOR KIT**

Popular MEISSNER FM Receptor now in kit form. Converts AM receiver to static-free, high fidelity Frequency Modulation.

- *Covers New FM Band 88 to 108 Mc
- *Top Quality Components
- *8 Tubes (including Rectifier) Supplied
- *Easily Assembled

Model T8CK FM Receptor Kit, less wire & solder, Net Price.....\$29.97

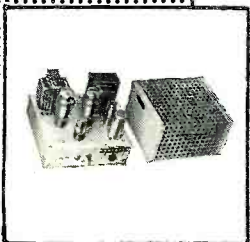

**MEISSNER MODEL T4AK
POWER AMPLIFIER KIT**

- *Flat Within 2 db from 45 to 20,000 Cycles
- *Tubes: One 6SN7GT, Two 6L6G & One 5Y3GT
- *3 Volts RMS Input Required
- *20 Watts Output With 5% Harmonic Distortion
- *All Parts Furnished Including Drilled-Punched Chassis

Model T4AK Power Amplifier Kit, less wire & solder, Net Price.....\$30.98

In special interviews in Washington and New York, Arthur S. Matthews, *CTI* prexy, told the newsmen that in the line-sequential system which they used, only minor changes were required in the regular black and white transmission equipment. At the camera, three pictures (red, green and blue) are taken simultaneously by means of a special three-lens optical system, he said, with the 525-line standard being used at the receiving end.

"We feel that the picture our system puts out is good enough, but the important thing is that the system has not reached its limitations and more improvements are possible," Matthews went on to say. "If the FCC does not approve our method, there are other uses, such as closed circuit work in hospitals, in which our technique could be applied without serious difficulties."

Industry, in the form of RMA, JTAC and experts from pioneering companies in TV, was quite bold, too, in its in and out-of-court testimony. RMA's official commentary had been preceded by the general distribution of a booklet, entitled "Is Color Television Ready for the Home?" which was about the bluntest report on the controversy to date. In the report, the association disclosed that the majority of the television set manufacturers have urged that no color broadcasting standards be approved by the FCC until the proposed systems have been thoroughly field tested. This, they said, is the only way to determine whether color reception is basically satisfactory under everyday conditions, as contrasted with the carefully controlled demonstration setups which have been used so far by all the sponsors. Once basic standards are set, the report continued, they cannot be changed without involving obsolescence of every piece of transmitting equipment and every receiving set then in existence. When standards are set, all future improvements must be within the framework of those standards, RMA went on to say in their appraisal of the situation. Accordingly they added, the original framework must be a sound one, one suitable for years to come. And since color television will need not one, but a dozen such standards, the harm that could be done by over-hasty action is apparent. Answering the question as to whether all broadcasts would be made in color, when color TV becomes available, RMA boomed a decided *no*, citing the case of the motion picture industry, where at least 85 per-cent of all feature pictures are still produced in black and white, even though the color processes were developed years ago.

In an extensive survey of the CBS system, RMA declared that pictures broadcast over the proposed *Columbia* setup would have a definition of only 405 lines, as compared with 525 (Continued on page 125)

MEISSNER

**MFG. DIVISION
Maguire Ind., Inc.
Mt. Carmel, Illinois**

**WRITE TODAY FOR
NEW MEISSNER
RADIO KIT FOLDER**

APRIL, 1950

**RADIO &
TELEVISION
NEWS**

RADIO-ELECTRONIC

Engineering



TELEVISION

RADAR

ELECTRONICS

RESEARCH

COMMUNICATIONS

MAINTENANCE

RADIO-ELECTRONIC

Engineering

ELECTRONICS • COMMUNICATIONS • TELEVISION • RESEARCH • MAINTENANCE

APRIL, 1950

MULTIPLE CHANNEL CATHODE-RAY
INSTRUMENTATION J. N. VanScoyoc and G. F. Warne 3

MICROWAVE COMPONENTS J. Racker 7

D.C. AMPLIFIER OF IMPROVED STABILITY Samuel Freedman 10

FORCED AIR COOLING FOR ELECTRONIC EQUIPMENT B. E. Parker 12

WIDE-BAND CHAIN AMPLIFIER FOR TV Walter V. Tyminski 14

CHARACTERISTIC IMPEDANCE OF LINES 32

DEPARTMENTS

NEWS BRIEFS 22	PERSONALS 26
NEW PRODUCTS 24	TECHNICAL BOOKS 28



RADIO-ELECTRONIC ENGINEERING is published each month as a special edition in a limited number of copies of RADIO & TELEVISION NEWS, by the Ziff-Davis Publishing Company, 185 N. Wabash Avenue, Chicago 1, Illinois.

VOLUME 14, NUMBER 4, Copyright, 1950, Ziff-Davis Publishing Company

COVER PHOTO—Courtesy of General Electric

Dr. Albert W. Hull of the General Electric Research Laboratory, who has been credited with the invention of more types of electron tubes than any other man, has retired from his post as assistant director of the laboratory, but will continue to serve as a consultant. The cover photo is a recent portrait taken of Dr. Hull in his laboratory.





Fig. 1. Interior view of the trailer containing the multiple channel cathode-ray installation.

Multiple Channel Cathode-Ray Instrumentation

24 channels are available for simultaneous recording of dynamic or transient phenomena.

By J. N. Van SCOYOC and G. F. WARNKE

Armour Research Foundation of Illinois Institute of Technology

MULTIPLE channel oscillography finds one of its greatest uses in the recording of dynamic and transient phenomena of a non-electrical nature. Many experiments can be repeated only to a statistical accuracy, if indeed they are repeatable at all. In such cases it becomes necessary to obtain the time "history" of the experiment by means of a number of simultaneous recordings; the number of data channels depending on the variable elements, cross checks required, or the size and shape of the object or field being investigated. Electrical

This article is based on a paper presented at the 1949 National Electronics Conference.

measurements are usually reproducible enough not to fall into this category.

General

The design, construction, and use of multiple channel instrumentation is inherently more complicated than its single channel counterpart because of the following problems:

1. *Identification of Simultaneity*—When two or more measurements are taken some relative time reference must be supplied, with an accuracy required in the interpretation of the records.
2. *Recording of Data*—Since observation of non-repetitive phenomena

is practically impossible, it is necessary to record the measurements in a form that will permit checking and evaluation on a vastly expanded time scale as well as permanence for repeated reference.

3. *Operation*—Manual control of more than two operations becomes difficult, and as the speed and number of operations is increased automatic control becomes necessary. This must be well timed and completely automatic to eliminate as far as possible the error element introduced by operators.
4. *Identification of Records*—Since many records are being taken at the same time, and often several in quick succession, with considerable time elapsing between recording and analysis, it is necessary to make provision for permanent positive identification of the records.
5. *Versatility*—Since the utility of the equipment generally depends on the number of applications to which it can be adapted it is necessary that the basic units be designed and constructed in such fashion that modification is simple.

There are two basic methods that may be used in multiple channel oscil-

lographic recording. In the first, a still picture is taken, using commonly triggered horizontal sweeps on all cathode-ray tubes. Although all sweeps start at one time they may be of different durations so that expanded or contracted time records may be obtained. If the time scale is important, timing marks must be introduced in the form of x , y , or z axis markers.

In the second method a sweep is not used but a spot is photographed on continuously moving film. In this way the film provides the time axis, and variations in time scale are obtained by running the cameras at different speeds. An additional method of recording timing markers is available in this system, this being the use of pulsed glow tubes which can provide a common time scale for a group of traces.

For either of the above systems multiple beam tubes or nests of single beam tubes can be used. This reduces the number of cameras necessary and sim-

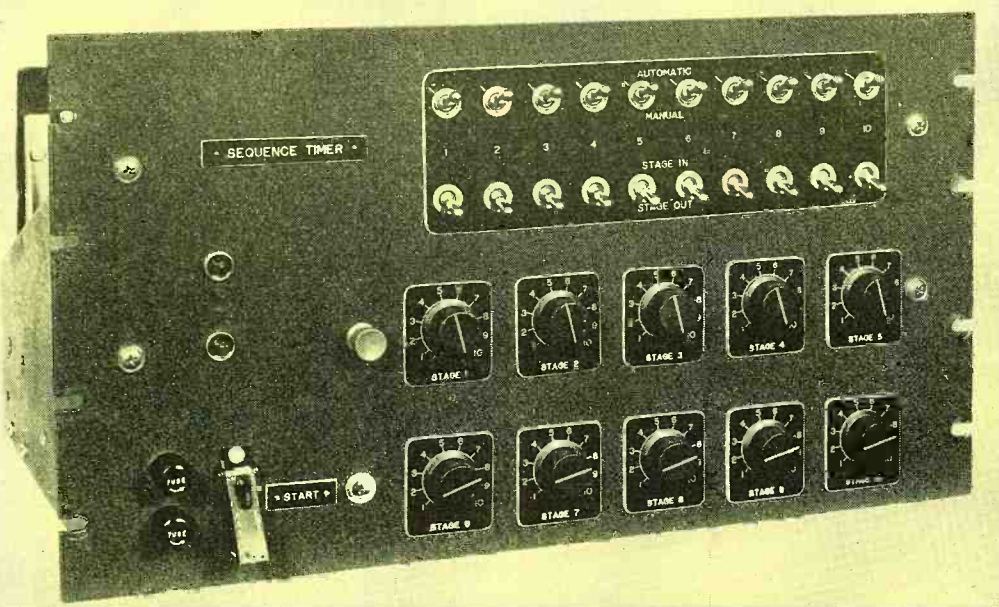

Fig. 2. Front view of the sequence timer control panel.

plifies processing and analysis of the records.

A recently completed 24 channel unit will be described to illustrate the functioning of a system which employs single beam tubes photographed by continuously moving film cameras. Some of the more specific technical problems such as elimination of cross-talk and hum, grounding circuits, etc., will not be discussed for lack of space.

In order to be able to conduct experiments in the field, remote from laboratory facilities, the twenty-four channels of oscillographic instrumentation, along with necessary auxiliary equipment and service and maintenance facilities, were mounted in an air conditioned semi-trailer. Fig. 1 shows an interior view of the installation. All units are relay rack mounted on a shock mounted frame. Space is provided

behind the rack so that testing or maintenance can be accomplished without removal of the units. The twenty-four channels are arranged in six bays of four channels each, all identical. The center bay contains control equipment common to all channels. This figure will be referred to after a description of the operation of the system is given.

The functional block diagram shown in Fig. 3 illustrates the operation of a typical channel and the units common to all channels.

Resistance strain gauge or piezoelectric gauge input circuits are connected to the terminal unit which incorporates matching networks and acts as a junction point for input, calibration and amplifier circuits. In the case of strain gauge input, the bridge power supply is used to supply current to the strain gauge bridge circuits.

Input signals are fed to the amplifier, which operates from the amplifier power supply, and thence to the oscilloscope unit. The oscilloscope unit derives all its operating voltages from the oscilloscope power supply. The camera records the signals from four cathode-ray tubes of one oscilloscope unit on one 35 mm. continuously moving film. The controlling relay and power connections for the camera are located in the amplifier power supply unit.

Interval timer A derives its frequency from a secondary frequency standard and supplies timing pulses to one glow modulator tube in each of the six oscilloscope units.

Interval timer B supplies timing pulses derived from a tuning fork to all cathode-ray tubes and to one glow modulator tube in each four channel oscilloscope unit. It also provides a vertical sweep for test purposes and a zero time pulse for establishing a simultaneous point on all records.

Two glow tubes are provided for each oscilloscope unit (see Fig. 7), each of which records a timing trace along the outside edge of each film record as shown in Fig. 11. Two timing records of different frequencies are thus recorded which may be used to:

1. Interpolate time intervals or periods.
2. Facilitate counting of long time periods while maintaining short period accuracy.
3. Check one frequency source against the other.
4. Eliminate timing errors due to irregularities in film speed.
5. Provide baselines for amplitude measurements.

The accuracy of the frequency of the secondary frequency standard or the tuning fork may be checked by comparison with signals broadcast by WWV which are picked up in the receiver supplied.

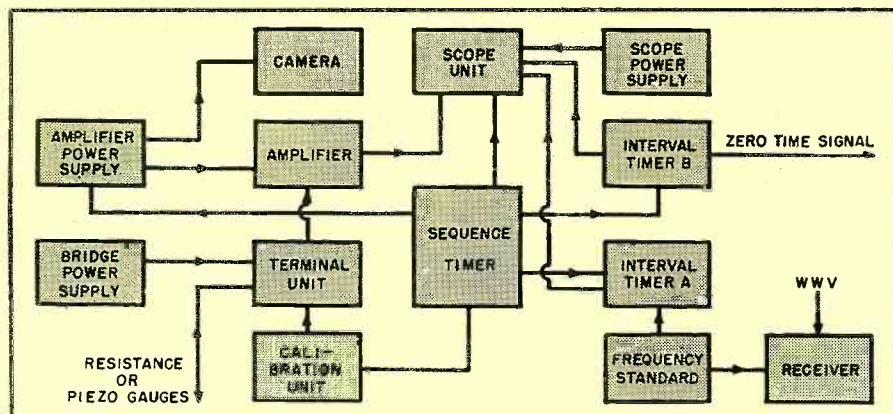
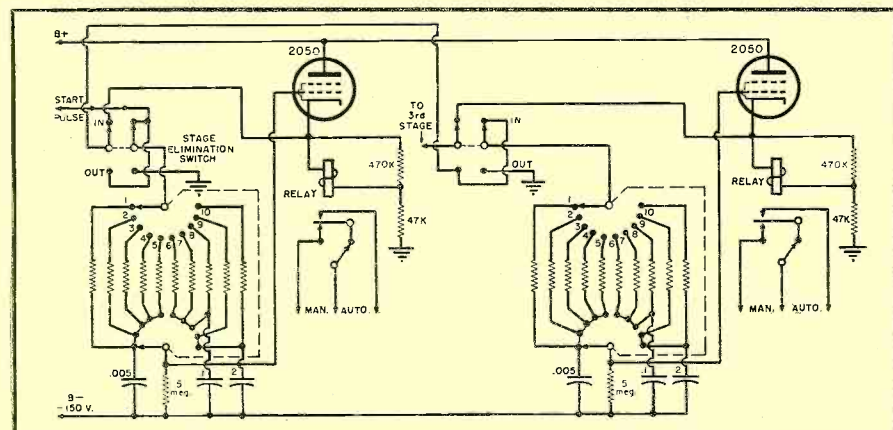

Fig. 3. Functional block diagram of a typical channel.

Fig. 4. Basic schematic diagram of the sequence timer.



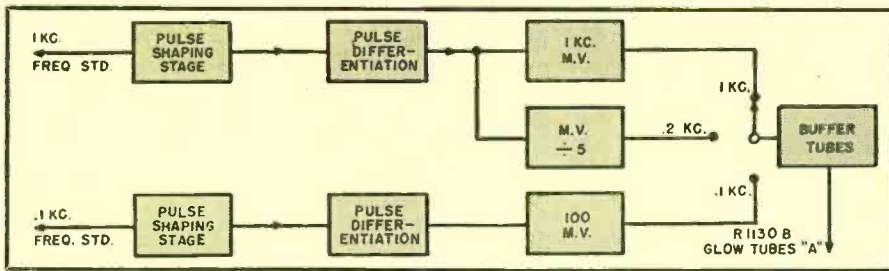

Fig. 5. Block diagram of interval timer A.

The sequence timer automatically controls all equipment operation during test, and since we have discussed the functional interdependence of all the instrumentation units, a description of the operation of this timer is in order.

Two of ten identical stages of thyatron delay circuits are shown in Fig. 4. Selection of ten time delays ranging from 10 milliseconds to 2 seconds is provided for each of the ten stages by means of *R-C* networks. Relays are used in the cathode circuits of the thyratrons, and the triggering voltage for the succeeding stage is derived from the thyatron cathode rather than from the relay. This prevents the relay time errors from being cumulative. Any stage may be bypassed by means of the stage elimination switch provided, and manual simulation of all automatic relay operations may be obtained by means of switches in the relay circuits.

The arrangement of these controls on the front panel of the unit is shown in Fig. 2. The top row of toggle switches controls the manual operation of each stage, while the bottom row of toggle switches is used to eliminate any stage which controls an operation unwanted for the particular test. The rotary switches are used to select appropriate time delays for each thyatron stage. Start and stop buttons are provided although the unit can be remotely controlled if it is so desired.

The arrangement for recording may best be described by reference to Fig. 7 which shows the front panel of the oscilloscope unit. Four 3 inch cathode-ray tubes are nested together to decrease the area of the field to be photographed. The vertical center lines of the tubes are two inches apart to provide one inch deflection on either side of center without overlap of traces. Two glow modulator tubes are mounted, one in either corner, on the horizontal center line of the two rows of tubes and a counter is mounted in the lower left corner. This counter is edge lighted by a concealed lamp for photographic identification of the record.

The cast aluminum frame supports a 45 degree front surface mirror. The camera is mounted on the front panel of the amplifier power supply below this unit with the lens vertical; the picture being taken by means of the 45 degree mirror. Tube face to film distance is such as to obtain a 9 to 1 reduction. The advantages of this system are its rigidity, freedom from differential vibration and saving of space.

Each channel is provided with individual intensity, focus and vertical positioning controls to take care of individual tube variations but all tubes are brightened simultaneously by one relay control. Three such units, twelve cathode-ray tubes, are supplied by one well regulated high voltage source

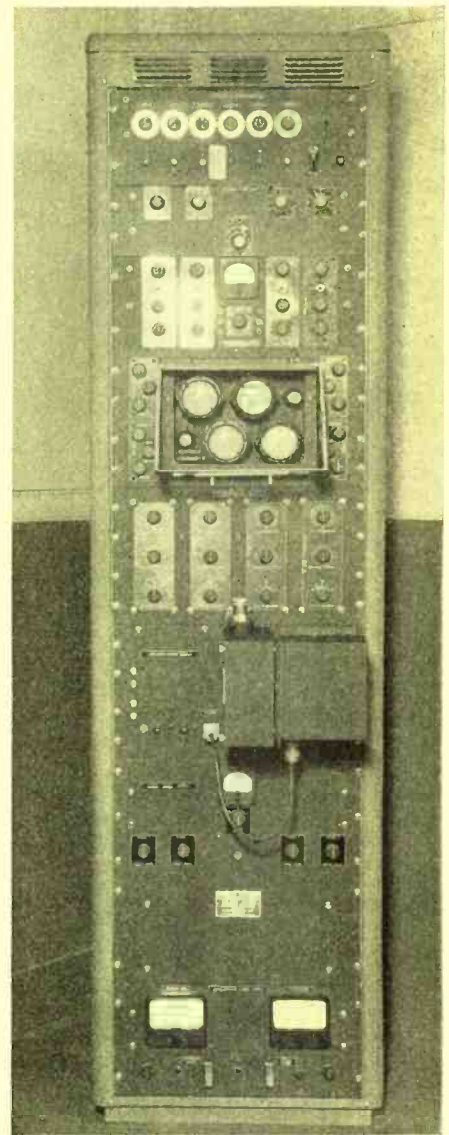
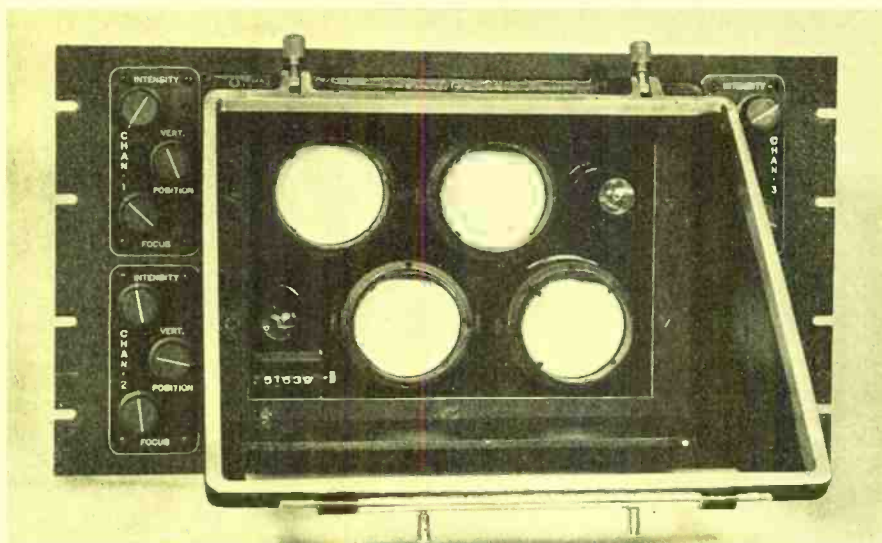

Fig. 6. Front view of a completely assembled 4-channel unit.

Fig. 7. Front view of an oscilloscope showing mirror mount (mirror removed).



which is capable of delivering 2000 volts + and - with respect to the second anode. The second anode of these tubes is not at ground potential but is designed to operate at approximately 320 volts above ground because of the direct coupling of the amplifiers.

The modulated glow tube in the upper right corner (Fig. 7) is the tube referred to as glow tube "A", being supplied by interval timer A, while the one in the lower left corner, "B", is supplied by interval timer B and is used for the zero time indication. A brief description of the timing unit operation will be facilitated by reference to Fig. 5 which shows a block schematic of interval timer A.

The 1000 and 100 cycle sine wave inputs, derived from a frequency standard, are amplified, clipped and differentiated. These pulses are used to trigger multivibrators which are of the single shot type. This prevents off-frequency pulses being generated and recorded if the frequency standard

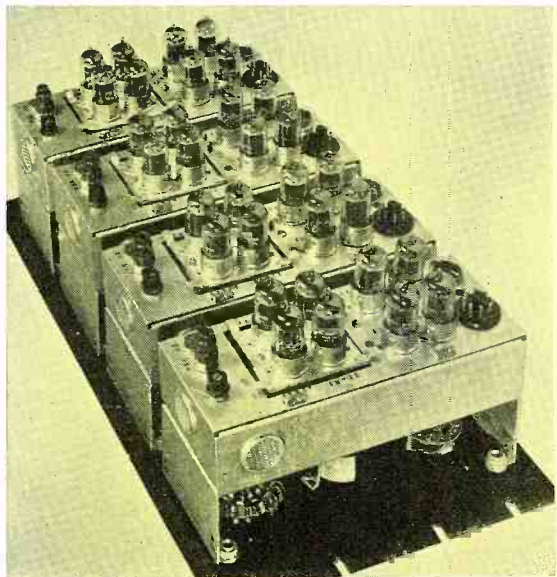

Fig. 8. The amplifiers which form the connecting link between the input circuits and the cathode-ray tubes are arranged in groups of four, as shown.

fails. A buffer tube is provided for each of the six glow tubes supplied from this timer. By six three position switches any one of three frequencies may be independently selected for each glow tube.

Fig. 9 shows a block diagram of

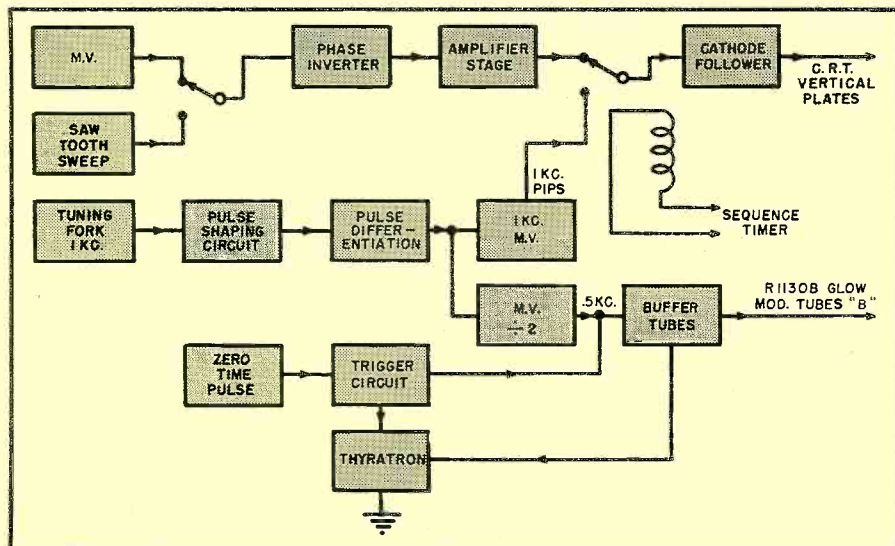

Fig. 9. Block diagram of interval timer B.

Fig. 10. Four channel record showing timing markers.

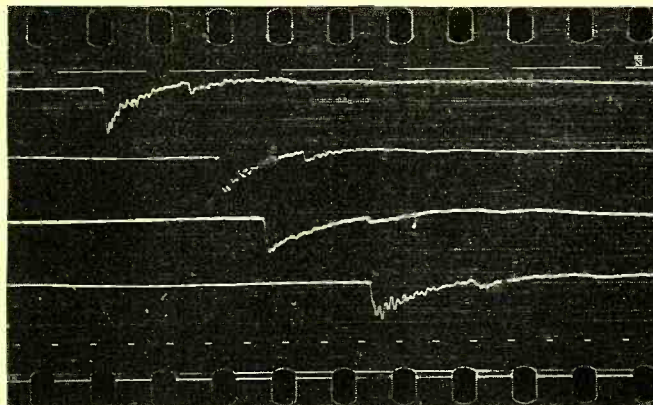
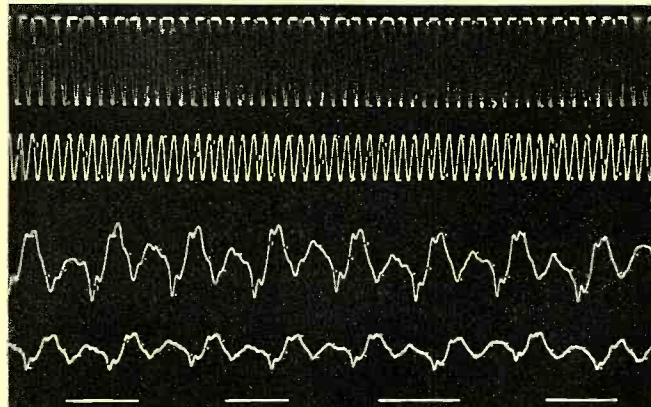

Fig. 11. The effect of timing pulses on vertical plates.



interval timer B. Two sweep circuits are provided, one a conventional sawtooth sweep and the other a multivibrator. This latter is used when high intensity traces are being focused to avoid possible burning of a line on the screen. The square wave produces a high velocity of spot travel across the usable portion of the tube face with the area of high intensity being off the face of the tube. Either of these signals is amplified and fed into push-pull cathode followers which provide low impedance output to the long interconnecting cables.

A 1000 cycle, temperature compensated tuning fork is used as a frequency source for the timing pulses in this unit. The sinusoidal output of the tuning fork is amplified, clipped, and differentiated, these differentiated pulses being used to trigger two multivibrators. The first multivibrator has a 1000 cycle repetition rate with adjustable pulse width and is connected to all the cathode-ray tube vertical plates at the same time the sweep is removed, by means of a sequence timer controlled relay. The effect of this is to produce small timing pips on all traces. The

second multivibrator divides by two and has an output of 500 cycle pulses which are applied to the control grids of six buffer tubes supplying glow modulator tubes B in each oscilloscope unit.

These glow modulator tubes do not operate until initiated by the zero time pulse circuit which operates as follows. A pulse provided by an external device such as a fuse or switch triggers a multivibrator which simultaneously applies a pulse to the buffer tube and fires a thyratron completing the ground circuit of the glow modulator tubes enabling them to fire. The duration of the zero time pulse is adjustable and, after it ends, the 500 cycle pulses are recorded. The effect of the timing pulses on the vertical plates is shown in Fig. 11. The timing traces along the edge of the film are those supplied by the glow tubes while the timing pips on the four traces are supplied by the 1 kc. multivibrator of interval timer B.

The recording cameras used were specially designed for the instrumentation. The motor and transmission are permanently mounted while the magazine is separately removable to facilitate handling. Film speeds of 0.6 ft./second to 10 ft./second are available and the lens has adjustable focus and aperture.

The amplifiers form the connecting link between input circuits and cathode-ray tubes and are also arranged in groups of four as shown in Fig. 8. Both d.c. and a.c. amplification are provided, the latter through the use of a pre-amplifier cascaded with the d.c. amplifier. The d.c. amplifier may be used by itself, having a maximum gain of 50,000 variable 40 db. in 2 db. steps and a frequency response from 0 to 50 kc., or the combination of preamplifier and d.c. amplifier having a maximum gain of 2,000,000 with a frequency response from 0.2 cycle to 50 kc. The preamplifier has 20 db. of attenuation in 5 db. steps. These amplifiers embody a new input stage which permits use

(Continued on page 26)

MICROWAVE COMPONENTS

By J. RACKER

Federal Telecommunication Laboratories

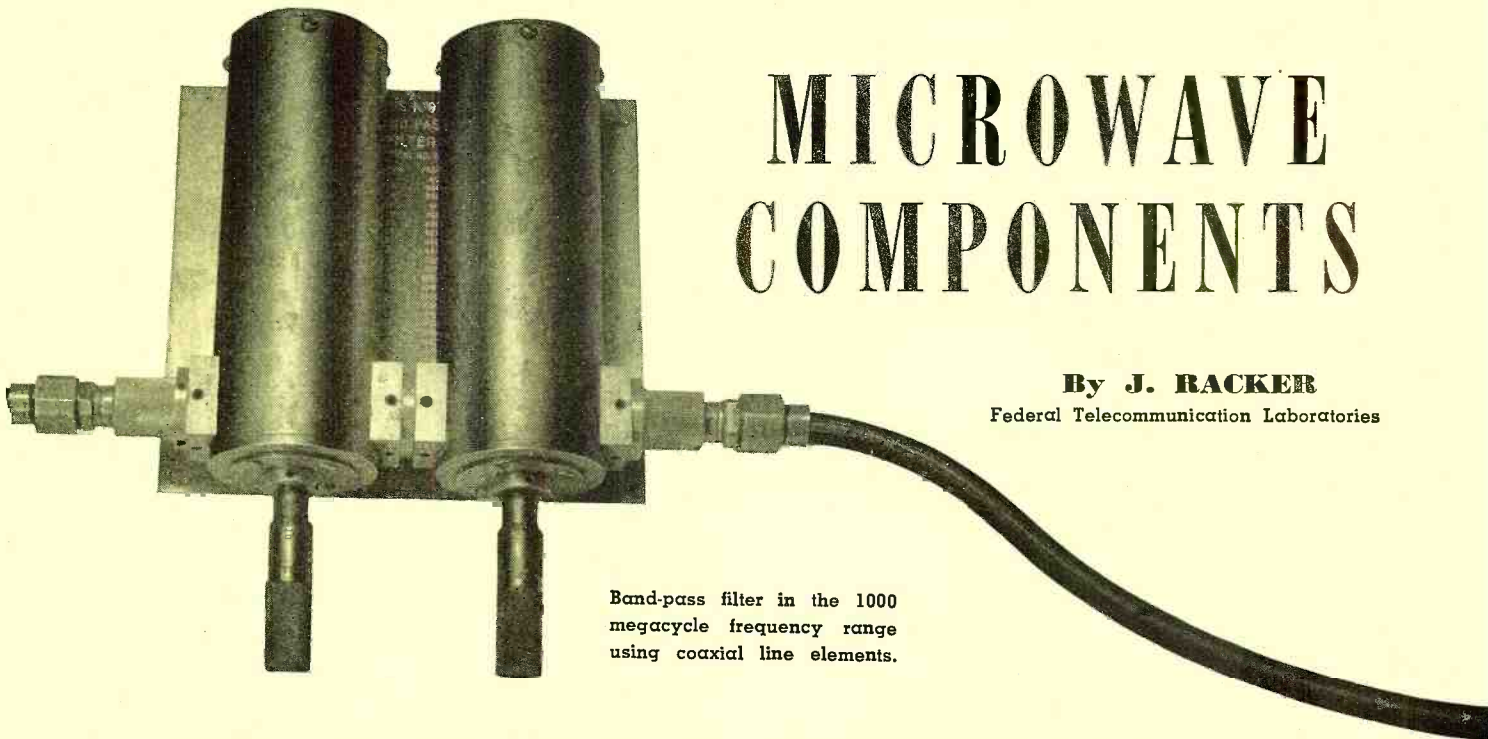

Band-pass filter in the 1000 megacycle frequency range using coaxial line elements.

A discussion of such coaxial line and wave guide components as quarter wave transformers, stub transformers, resonant lines and filters, etc.

IN the discussion given in the previous articles^{1, 2} frequent reference has been made to the use of transmission lines as transformers, inductive and capacitive elements, filters, and other components. All of the general equations developed for transmission lines also apply when these lines are used as circuit elements. However, there is a major difference in approach between the use of transmission lines for the transfer of energy (as considered in the last article) and their use as components. This difference is: In the former case the problem is primarily one of selecting the best available manufactured line, while in the latter case the engineer must frequently actually design and build appropriate lines to meet his individual requirements. It is therefore necessary, in considering element design, to delve into the details of transmission line construction. Hence, a separate article on microwave components.

Coaxial Line Elements—Quarter Wave Transformer

This article, as the previous one, will be divided into two general sections; one considering the use of coaxial line elements for frequencies up to about 2000 mc. and the other, the utilization of wave guides for frequencies above 2000 mc. Coaxial line elements will be considered first, starting with quarter-wave transformers.

It has been shown that two purely resistive impedances can be matched to each other through the use of a quarter-wave transformer whose characteristic impedance is equal to:

$$Z_{0T} = \sqrt{R_0 R_L} \quad (1)$$

where R_0 is impedance at sending end and R_L is load resistance. The characteristic impedance of a coaxial line is equal to:

$$Z_0 = \frac{138}{\sqrt{K}} \log_{10} \frac{D}{d} \quad (2)$$

where D is outer conductor diameter, d is inner conductor diameter, and K is the dielectric constant. This equation is plotted on the nomograph on page 32.

Generally, the problem is to match a line with characteristic impedance, Z_0 , to a load representing a complex impedance. In considering the input impedance of such a line versus distance from the load, it will be found that for each half wavelength of line traversed, two points of purely resistive impedance exist; one equal to $Z_0 \eta_v$ (η_v voltage standing-wave ratio) located at maximum voltage points, and the

other equal to Z_0/η_v located where voltage minimums occur.

It is usually more convenient to select a point of minimum resistance rather than the one of $Z_0 \eta_v$, since in this case the characteristic impedance of the transformer required is less than that of the line. A line of lesser impedance can be obtained readily by utilizing a "sleeve" within the existing line as shown in Figs. 2A and B, while to increase the impedance involves increasing the outer diameter or decreasing the inner diameter, neither of which can be done simply.

The procedure for matching with a quarter-wave sleeve is as follows:

1. Measure the voltage standing-wave ratio at the input and determine the location of a minimum voltage point.

2. Design a sleeve which is a quarter of a wave long and whose diameters are equal to:

a) If sleeve is on inner conductor, its outer diameter d_1 should be:

$$d_1 = \left(\frac{D}{d}\right)^{\eta_v - 1/2} \quad (3)$$

(derived from Eqts. (1) and (2) and the equation for voltage standing wave ratio¹).

b) If sleeve is inside the outer conductor, its inner diameter should be:

$$D_1 = d \left(\frac{D}{d}\right)^{\eta_v - 1/2} \quad (4)$$

3. Insert this sleeve in the line at a position where the end of the sleeve facing the load is at the point previously determined to be a voltage minimum or an integral number of half waves from this position.

Fig. 1. Ideal exponential coaxial line.

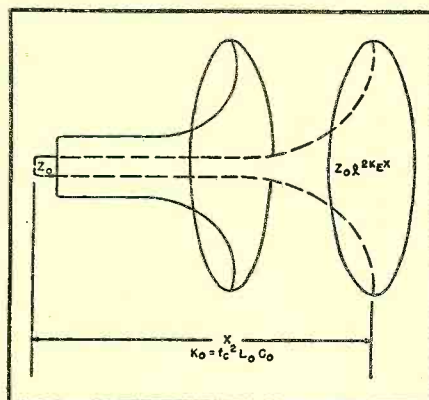

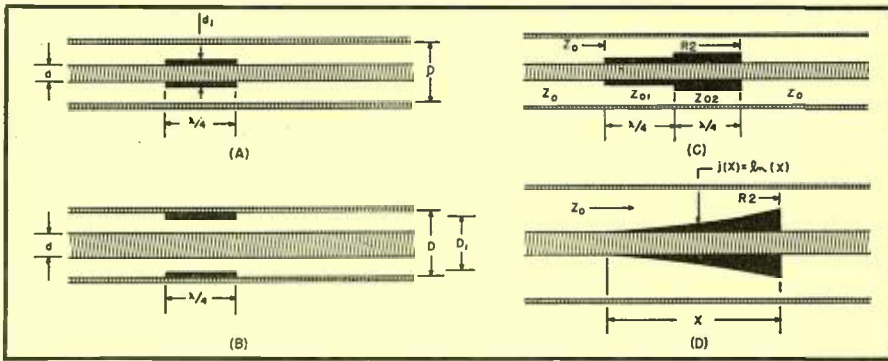

Fig. 2. (A) and (B) Quarter wave "sleeve" transformers. (C) Double sleeve transformer. (D) Tapered section matching Z_0 to R_2 .

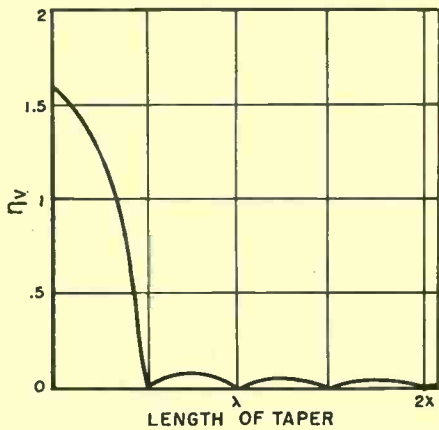

Fig. 3. Voltage standing wave ratio introduced by tapered section of coaxial line from 75 to 46 ohms.

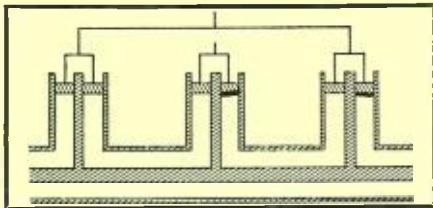
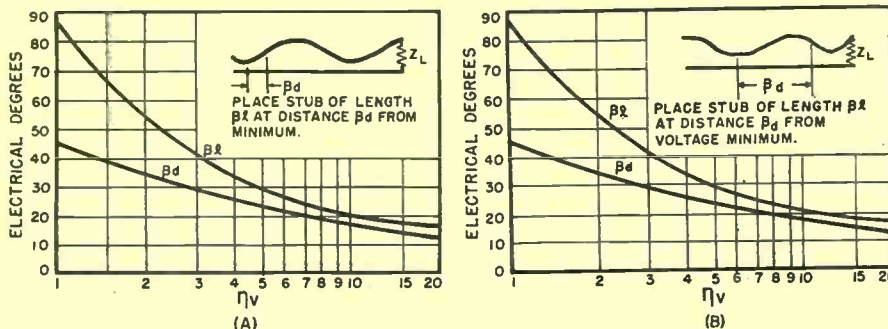

Fig. 4. Triple stub transformer.

A single quarter-wave sleeve used as a transformer has the disadvantage that it is resonant, i.e., it matches perfectly at one frequency only. The bandwidth over which the match is good can be extended by using two or more quarter-wave sleeves placed together and properly chosen in size.

Fig. 5. Impedance matching stub length (for distance Bd) for single stub transformer. (A) is for inductive and (B) a capacitive load.



A double-sleeve transformer such as the one shown in Fig. 2C should meet the following relationships:

$$\frac{Z_0}{R_2} = \frac{Z_{01}^2}{Z_{02}^2} \dots \dots \dots (5)$$

and

$$\left(\frac{Z_0}{Z_{01}}\right)^2 = \frac{Z_{01}}{Z_{02}} = \left(\frac{Z_{02}}{R_2}\right)^2 \dots \dots (6)$$

For a three-sleeve network the relationships between successive sleeves should be:

$$Z_0 R_2 = \frac{(Z_{01})^2 (Z_{03})^2}{(Z_{02})^2} \dots \dots (7)$$

$$\left(\frac{Z_0}{Z_{01}}\right)^3 = \frac{Z_{01}}{Z_{02}} = \frac{Z_{02}}{Z_{03}} = \left(\frac{Z_{03}}{R_2}\right)^3 \dots (8)$$

As more and more sleeves are used, the matching network is made less and less frequency sensitive, the limit being reached as the impedance variation approaches that of an exponential line. An exponential line, which effects reflectionless matching between two resistive impedances that is independent of frequency, is defined as a line whose characteristic impedance varies in accordance with the following equation:

$$Z_x = Z_0 e^{2K_0 x} \dots \dots \dots (9)$$

where Z_x is the characteristic impedance at point x , and Z_0 is the characteristic impedance of the line at the point $x=0$. (K_0 constant of equation determines cutoff frequency f_c by $f_c^2 = K_0^2/LC_0$). Fig. 1 is a graphic presentation of a coaxial exponential line.

Since both inner and outer diameter of such a line must be varied, it would be mechanically difficult to connect such a line to two coaxial sections of equal diameter. However, by making a sleeve whose inner conductor diameter varies logarithmically starting with a characteristic impedance of Z_0 and ending with that of R_2 , it is possible to achieve a very broad band matching network. Such a sleeve is shown in Fig. 2D, and this section is usually referred to as a tapered line.

The reflection introduced by a tapered line is given by:

$$\frac{V_2}{V_1} = \frac{\lambda (.434) \log_{10} R_2}{j 8 \pi x Z_0} \left(1 - e^{-\frac{4 \pi j x}{\lambda}}\right) \dots \dots \dots (10)$$

The variation of reflection with length of taper as calculated by this formula is illustrated in Fig. 3 for a taper from 46 ohms to 75 ohms.

Stub Transformers

Thus far we have considered matching two resistive impedances, assuming that no reactance exists. However, in many cases it may be simpler to choose a point along the line whose input impedance is equal to $Z_0 + jX$. Then by placing a reactance of equal magnitude to X , but opposite polarity at this point, the reactive component is tuned out and the input impedance becomes equal to Z_0 . This is achieved through the use of stub transformers.

Shorted stub sections of line in shunt with the main transmission line, as shown in Fig. 6A, act as shunting reactances. Since this reactance varies in accordance with the following relation:

$$Z_{in} = j Z_0 \tan \beta l \dots \dots \dots (11)$$

The reactance may be either inductive or capacitive and have any value between zero and infinity (neglecting losses).

The points along the line whose input impedance has a resistive component equal to Z_0 can be determined from the Smith calculator (as described in previous article). For example, if the load Z_L were located at a point on the circle shown in Fig. 6B, the points corresponding to A and B represent a resistive component equal to Z_0 . The stub for matching should be located at either A or B. If at point A, the input admittance of the stub should be capacitive and of magnitude X to balance out the inductive component of the input impedance of the line. Similarly, if the point B is chosen, an inductive stub should be used.

A correlation exists between standing-wave ratio, position of stub, and length of stub. Figs. 5A and B give the stub position and length in electrical degrees for any standing wave ratio η_v . As indicated on these curves, η_v

should be measured from a minimum toward the load. The shorting bar in the stub can be made adjustable for fine tuning after stub is placed in position.

A transformer suitable for matching any two impedances can be constructed by placing three adjustable shorting stubs in shunt with the line, as shown in Fig. 4, spaced a quarter-wave apart and ganging the first and third adjustable stubs. This transformer has only two adjustments which are varied by the trial-and-error method until a minimum standing-wave ratio is achieved.

Resonant Lines and Filters

It has been shown in the article "Microwave Techniques", that a quarter-wave shorted line is equivalent to a parallel resonant tuned circuit, while a quarter length open circuited line is equivalent to a series resonant circuit. Hence, it is seen that coaxial lines can be used as a tuned circuit or filter.

The expression derived in the first article assumed the existence of lossless lines. This is equivalent of considering a tuned circuit with no resistance. For many purposes it is possible to neglect the attenuation of the line; however, when designing a resonant line for use in an oscillator or filter, the losses in the line must be considered to obtain the actual impedance and bandwidth of the circuit.

The most convenient parameter to use for determining the bandwidth and impedance of resonant lines is the *Q*. The *Q* of any line is defined to be:

$$Q = 2\pi \frac{\text{Peak energy storage}}{\text{Energy dissipated per cycle}} \quad (12)$$

and in a coaxial line is:

$$Q = \frac{\omega\sqrt{LC}}{2\alpha_T} \quad (13)$$

where

$$L = .46 \mu_1 \log_{10} b/a \times 10^{-9} \text{ henries/meter}$$

$$C = \frac{.241\epsilon_1}{\log_{10} b/a} \times 10^{-10} \text{ farad/meter}$$

α_T is line attenuation as given in previous article².

The parallel and series resonant impedances may be expressed in terms of *Q* by the following relationships:

$$Z = \frac{Z_0 \beta l}{2Q} \text{ (series)} \quad (14)$$

$$Z = \frac{2Z_0 Q}{\beta l} \text{ (parallel)} \quad (15)$$

Defining the bandwidth as $(\omega - \omega_0)$, with ω the angular frequency at which the input impedance is $\sqrt{2}$ times the series resonant impedance, and $1/\sqrt{2}$ of the parallel resonant frequency, the relation between bandwidth and *Q* is given by:

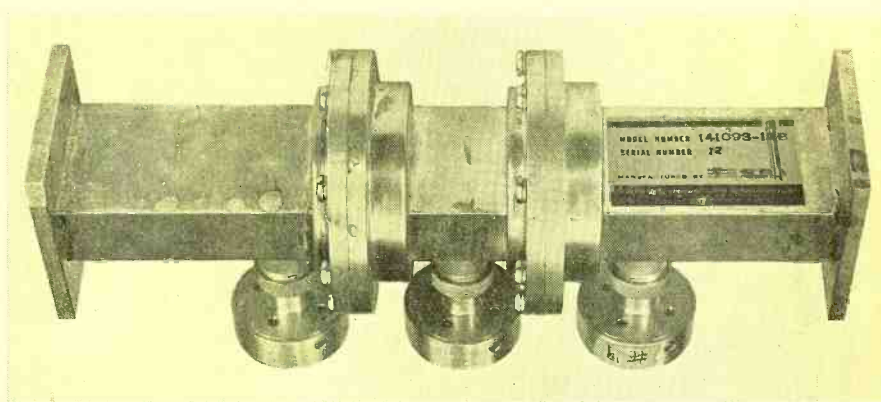

Typical band-pass filter using wave guide elements.

$$Q = \frac{\omega_0}{2(\omega - \omega_0)} = \frac{f_0}{2\Delta f} \quad (16)$$

In general, the *Q* of a line is increased by increasing either the size of the conductors or the spacing between conductors. Increasing the size of conductors decreases the skin effect, whereas increasing the spacing between conductors increases the inductance per unit length.

It can be shown that the attenuation constant of a coaxial line becomes a minimum when *D/d* is equal to 3.6. This corresponds to a characteristic impedance of 77 ohms. Since the factor $\omega\sqrt{LC}$ is independent of *D* and *d*, the maximum *Q* likewise occurs when *D/d* is 3.6. Fig. 7 plots the *Q* of air-dielectric copper coaxial lines as a function of frequency for various sizes of lines, all having the optimum value of *D/d* = 3.6.

Where a high degree of power must be handled by the coaxial resonant line, such as when it is used in a transmitter output stage, the dimensions of the line should also be selected on the basis of

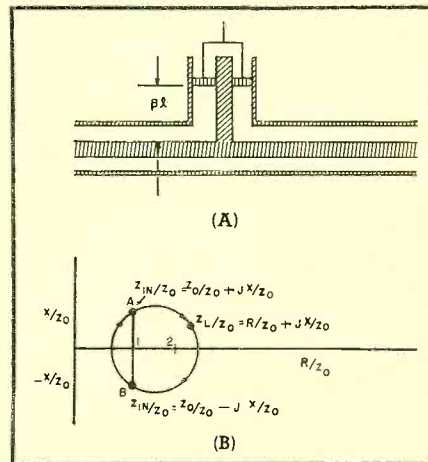
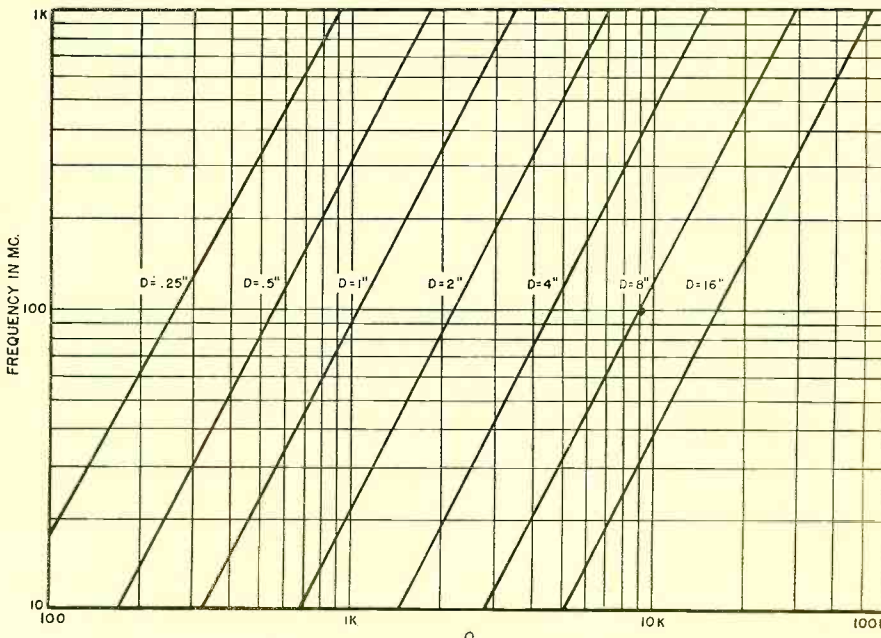

Fig. 6. (A) Single stub transformer. (B) Typical normalized impedance diagram showing location of points where resistance component is equal to Z_0 .

power handling capability. The theoretical power that can be handled by an air-dielectric line using the breakdown voltage as 15,000 v./cm. is equal to: (Continued on page 18)

Fig. 7. *Q* of copper coaxial lines with optimum *D/d* ratio of 3.6.



D.C. AMPLIFIER OF IMPROVED STABILITY

By
SAMUEL FREEDMAN

**The d.c. to be amplified modulates an a.c. signal.
This a.c. signal is then amplified and rectified.**

THE MAIN purposes of this type of amplifier are to provide a more stable method of and an electronic system and apparatus for amplification, indication and measurement of direct current as well as slowly fluctuating d.c. not readily attained with conventional so-called direct current amplifiers.

Ordinary direct current amplifiers depend upon direct coupling between the output of one vacuum tube stage and the input of the next stage, wherein the direct current or varying voltage under test is directly applied to the tubes. This often results in false and erratic indications due to the picking up of spurious currents and to small plate or filament voltage fluctuation occurring in the vacuum tube circuits themselves.

The d.c. amplifier described in this article is designed to have greater stability and dependability, as well as increased voltage amplification. It achieves this by incorporating certain

conventional frequency techniques, such as the employment of the principles of intermediate frequency stages as used in radio receiving systems between the various amplifying sections. The amplification of direct current is obtained by generating an alternating current by means of a suitable oscillator and modulating this alternating current with the direct current where amplification is desired. The result is an amplitude modulated signal with the direct current as its envelope of modulation. This signal is then amplified by means of a suitable high gain alternating current amplifier, detected and translated.

Fig. 1 shows a block diagram of the major components of this amplifier. Fig. 2 shows a circuit diagram of the entire amplifier. A set of circuit values is indicated although the tuned circuits may be any value depending on the desired frequency of the oscillator.

Referring to the major block components in the sequence given in Fig. 1,

operation can be described as follows:

Oscillator

The oscillator comprises a tube (V_1 Type 6SF5). The oscillation needs to be small but constant in amplitude. Any convenient frequency may be employed for interstage coupling by means of tuned circuits commonly used in i.f. or r.f. interstage coupling techniques. The amplitude stability is very important. In the figure, the circuit of the oscillator coil T_1 is a tuned grid circuit with a coupling coil to provide the necessary feedback in the plate circuit. The oscillator can, if desired, be any other convenient type of oscillating circuit. A proper amount of negative feedback is injected in the cathode by the 1000 ohm resistor. This negative feedback tends to keep the amplitude of the oscillation small and to increase the amplitude stability. "OSCILLATOR CONTROL" potentiometer in the plate circuit provides means of adjusting the amplitude of the output without affecting the stability of the oscillator. Switch B provides means to switch the coupling circuit on and off without changing the previous adjustments. The coupling circuit as shown in the figure is of the double-tuned type marked T_2 . The coupling should be loose enough so as to prevent the small load changes due to adjustments in the following circuits from affecting the amplitude of the oscillations. The tuned circuits are the usual i.f. circuits tuned, trimmed, coupled and shielded as currently used in i.f. techniques. The filter section comprising a .05 μ fd. condenser and 3000 ohm resistor in the plate circuit helps in keeping constant the amplitude of the oscillation.

Modulator

The modulator consists in Fig. 2 of a type 6SK7 tube (V_2) which has a remote cutoff characteristic that makes

Fig. 1. Block diagram showing basic operating principles of the d.c. amplifier.

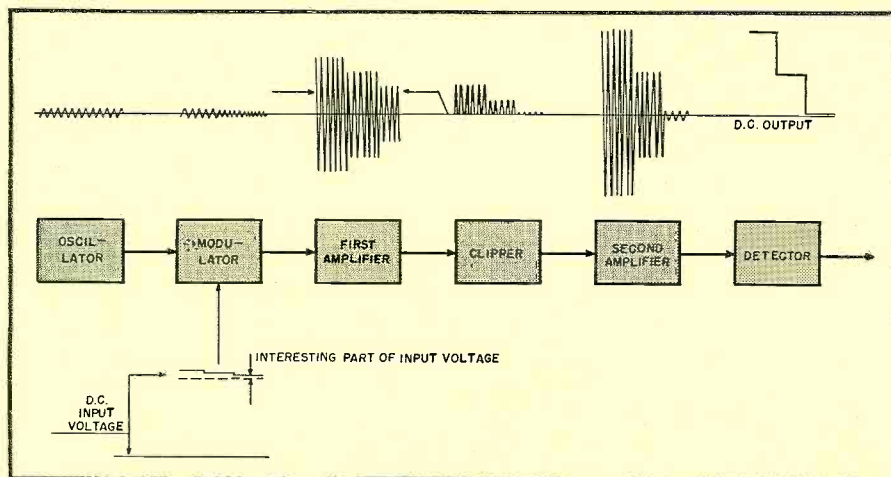

it possible to have the variations of output amplitude proportional to the variations of grid bias. This happens where the characteristic curve follows closely enough the square law (i.e. where the current is proportional to the square of the signal voltage). The average value of the grid bias should therefore be kept around that point. This means that the adjustment of the modulator must be always kept at the point of best linearity. This may not be the same as the point corresponding to the desired amplification of the small voltage fluctuations. This is possible by means of the "AMPLIFIER CONTROL" potentiometer which covers all values of d.c. input signals from 0 to 100 volts. A 2 meg. resistor in the

FIER CONTROL" potentiometer, as well as good regulation of the screen voltage of V_2 . The 4000 ohm resistor in series with the tubes up to the B supply is the ballast resistor. This voltage regulating section is also connected with the following stage to provide a similar control of the cathode and screen voltages of the clipper tube V_4 (type 6SJ7).

Clipper

Since the best operating point of the modulator with respect to linearity does not correspond to the best operating point with respect to the gain of small fluctuations, a clipper tube is used to eliminate everything except the abnormal amplitude fluctuations

pentode of the 6SJ7 type (V_4) may be used to reproduce the amplified d.c. signal on the meter when switch A is connected in position #3. "DETECTOR CONTROL" potentiometer is used to have zero current with zero signal. This is indicated on the meter when switch A is in the "READING" or #3 position. In the event greater sensitivity is desired, the meter may be arranged in a bridge circuit or in connection with other suitable modifications thereof, since a bridge circuit is more sensitive than a simple meter arrangement.

Alignment

Referring to Fig. 2, the unit may be aligned by adhering to the following sequence of instructions:

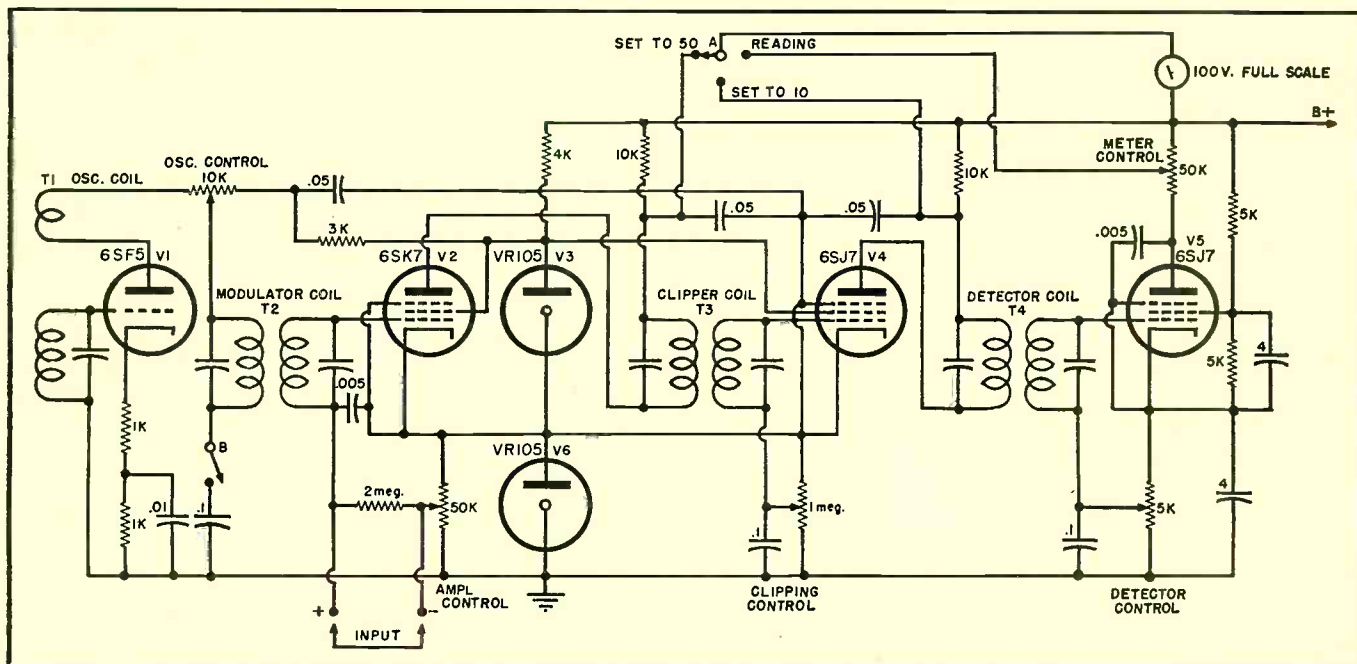

Fig. 2. Complete circuit diagram for the d.c. amplifier, including some component values.

input circuit provides a d.c. connection for the grid during the preliminary adjustments when no signal is present at the input terminals. The 10k resistor in the plate circuit in connection with the meter and Switch A in position #1 makes it possible to adjust the "AMPLIFIER CONTROL" until the operating point falls in the square law portion of the characteristic curve. In this particular circuit version, the meter is set to 50 which will show that the right current corresponding to the proper bias is flowing through the tube. Tube V_2 in addition to serving as modulator is also the first amplifier indicated in Fig. 1 by virtue of being connected to tuned circuit T_3 .

Voltage Regulating Section

In this circuit version, two voltage regulating tubes of the VR105 type (V_3 and V_6) provide good regulation of the cathode voltage across the "AMPLI-

that represent the desired signal. The use of a sharp cutoff pentode (6SJ7) V_4 provides a sharp clipping of the input oscillation if the grid bias is beyond cutoff. In this case only a part of the positive peak of each oscillation draws current to the plate. The tuned plate circuit T_4 functions as a class C amplifier thereby making V_4 also function as the second amplifier as shown in block diagram (Fig. 1). The grid bias is adjusted by means of the "CLIPPING CONTROL" potentiometer. The 10k ohm resistor in the plate circuit in connection with the meter and the switch A in position #2 helps in finding out the proper bias. In the circuit version shown it will be about 10 volts although the optimum value is determined by experimentation.

Detector

An ordinary biased detector using a

1. Throw switch A in the "set to 50" position # 1 (to the left in Fig. 2).
2. Throw switch B "on".
3. Turn potentiometer "OSCILLATOR CONTROL" P1 all the way to the right and then bring slightly back.
4. Adjust "AMPLIFIER CONTROL" potentiometer to read 50 on the meter.
5. Throw switch B to the "off" position.
6. Throw switch A in the "set to 10" position #2.
7. Adjust "CLIPPING CONTROL" potentiometer to read ZERO. The adjustment should not be allowed to go below zero. It should be stopped when the meter reaches zero.
8. Throw switch B in the "on" position.
9. Adjust potentiometer "OSC. CONTROL" to read 10.
10. Throw switch A in the "READING" position #3.

(Continued on page 31)

Forced Air Cooling for ELECTRONIC EQUIPMENT

Basic principles and practical methods for the correct design of air cooling systems.

By B. E. PARKER

Engineering Head, FM dept., Gates Radio Co.

THE primary purpose of any air-cooling system is either to remove heat or to prevent heat concentration at some specific point. This may be done by making use of natural thermal circulation or by forced air. Amplifiers and small transmitters are usually cooled by the natural thermal circulation resulting from the draft created by the rising of the hot air. Louvres and ventilator holes at the bottom and top of the enclosure permit the air to circulate through the cabinet, over the hot components and thence out. This is satisfactory only where the amount of heat dissipated is relatively small.

Where a large amount of heat must be removed, some form of forced air circulation is used. Fig. 1 is an example of an efficient system of the forced draft type. In this particular system turbulence is purposely created in order to flush all parts of the cabinet. This system is most effective when the heat radiating components (mostly plate and filament dissipation of the various tubes) are well separated. It has the advantage of removing relatively large amounts of air at comparatively low velocity, which produces little noise. In this particular example the cabinet tends to serve as a quieting chamber, and a baffle plate at the top further serves in muffling the air noise.

In this, as in all air cooling systems,

Fig. 2. Performance curve of the Fasco model 50749 blower.

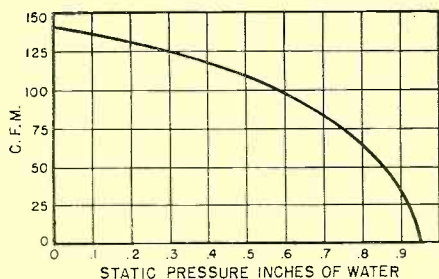
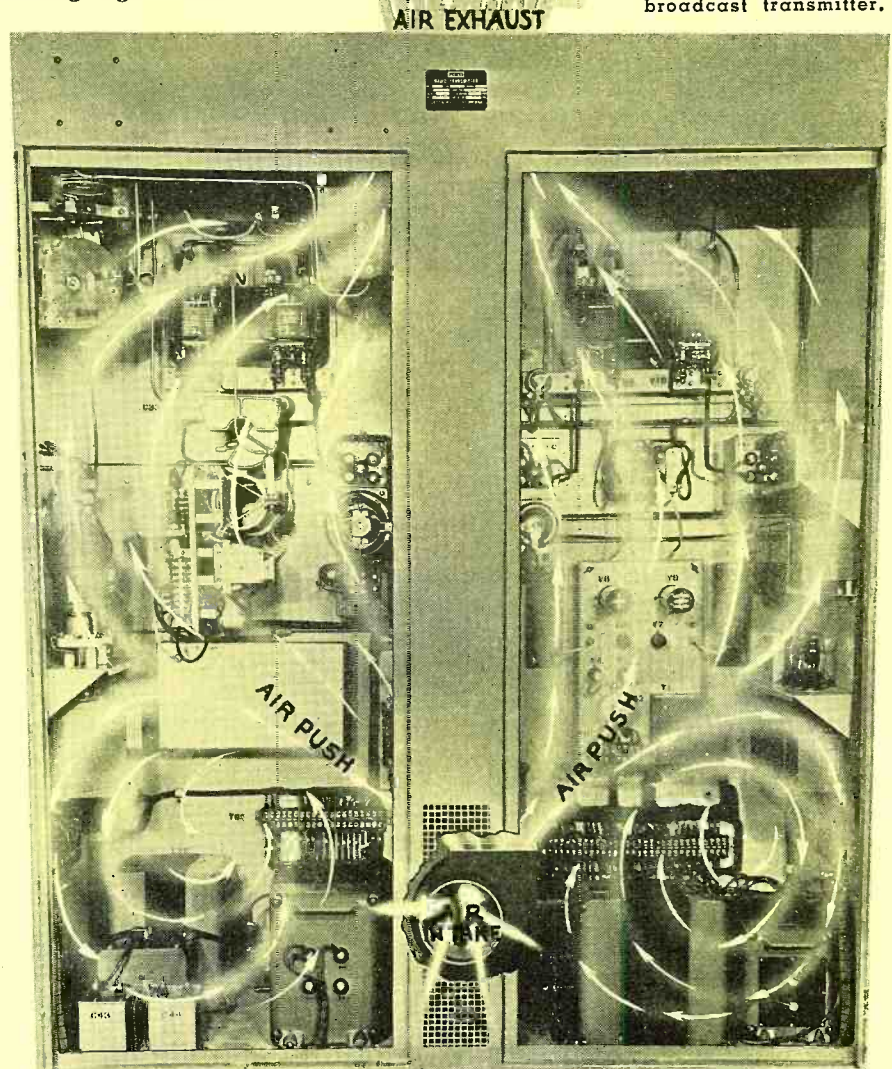

Fig. 1. Cooling system of a well-known 1 kw. broadcast transmitter.



the hot air must be expelled from the cabinet and replaced with cool air, otherwise the heat will be merely distributed throughout the cabinet by the blower or fan.

While a blower or fan placed at the air outlet would be equally as effective, the air noise level would be much higher and the effectiveness of the dust filter at the air intake would be largely defeated. When the blower is located at the air intake, the cabinet is pressurized, preventing entry of dust and dirt through the small cracks due to doors and other necessary openings.

The tube handbook or manual usually

makes a specific recommendation for cooling the tube used. In general it is unwise to depart radically from these recommendations unless the tube manufacturer is consulted regarding the intended change. Tube data sheets are usually available from the manufacturer or supplier which give the amount of air, the pressure drop, and maximum seal temperature for the tube. Most companies have tube application engineers who will gladly supply the above information since all this is available from the tests made at the time of tube design.

Where the cooling required is merely

a blast of air directed at the seals, the cooling system is relatively simple as a blower giving the required c.f.m. (cubic feet per minute) is sufficient.

Fig. 4 shows a 1 kw. FM transmitter using a pair of 4-400A tubes in which the cooling system is somewhat complicated due to seal cooling at both the base and anode. The manufacturer's bulletin shows that 14 c.f.m. per tube passing through the base, up over the plate seal is required. This amount of air will result in a pressure drop of .25 inches water column when used with the recommended socket and air chimney assembly. Fig. 6 illustrates graphically this cooling system as developed in the *Eimac* laboratories especially for this series of internal anode tubes.

The pressurized lower chamber serves to equalize the pressure for both tubes and to muffle the blower noise to a negligible amount. The air passes up through holes in the base of each tube, across filament and grid seals, out through the side of the base flange, up between the pyrex chimney and the tube envelope, at which point it is deflected across the anode seal.

The blower used in the transmitter shown in Fig. 4 has air volume and pressure capabilities several times in excess of the recommended tube requirements. The extra air is used in flushing the upper chamber and quickly forcing the hot air out through the top of the cabinet. This was easily accomplished by placing "bleeder" holes in the deck between the chimney and the tube base.

The measured pressure at the bottom of the tubes was .625 inches water column. This represents a safety factor of 150% above the tube manufacturer's rating, which was found by later tests to be most conservative. In fact the air inlet to the blower was obstructed until the pressure dropped to .15 inches water column. This pressure resulted in an anode seal temperature of 150°C with grid and filament seals 10 to 20 degrees cooler. The blower used has the performance curve shown in Fig. 2. From the curve it will be seen that with a pressure of .625 inches the blower will deliver 90 c.f.m. of air.

With the widespread use of external anode tubes, a pressurized system providing a steady stream through the anode fins has become popular in FM, television, and high power broadcast transmitters. Fig. 5 is a typical example of this type of cooling used in a recently announced 5 kw. broadcast transmitter.

Three *Eimac* type 3X2500F3 triodes are employed. Two tubes serve as the class B modulator, shown on the right. One tube, extreme left, is used as the modulated Class C r.f. power amplifier. The blank socket to the right of it is used for an additional r.f. tube to increase the power output to 10 kw. when

desired by the station operator.

The tube manufacturer's bulletin specifies an airflow of 120 c.f.m. through the anode cooler. This will result in a pressure drop of 1.6 inches water column. In addition a minimum of 3 c.f.m. must be directed toward the filament stem structure, between the inner and outer filament conductors. Referring to Fig. 5 it will be seen how this is accomplished with a single blower cooling all three anodes as well as the filament seals. By means of a large blower in the lower right hand corner, just out of sight, the air is conducted by the heavy canvas duct up to the pressurized chamber which serves as the deck. The air is distributed by this chamber to the bottoms of the ceramic bowls which support the anode socket connections. The air passes up through the cooling fins of the tubes and on out through the top of the cabinet expelling the heated air. For 5 kw. operation, the unused tube socket is blocked off to prevent the escape of air and a consequent loss of air pressure.

Air for the filament seal requirements is provided by half inch tubing serving as air ducts. Referring to Fig. 5 it will be seen that these ducts extend up from the pressurized chamber and terminate in nozzles which force the air down into

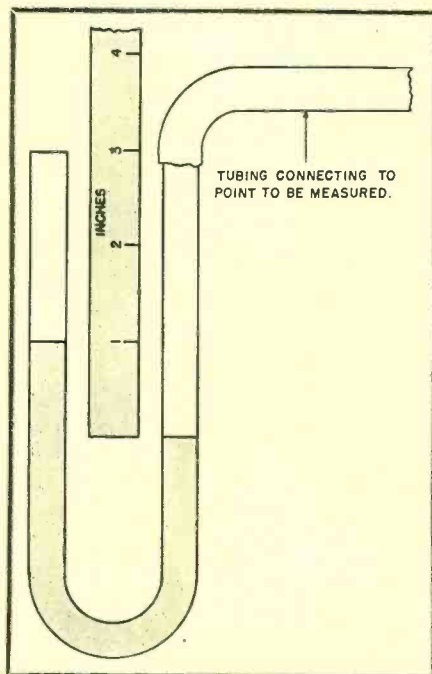

Fig. 3. Simple manometer construction.

the space between the inner and outer filament conductors.

Final measurements showed a pressure of 1.7 inches water column at the base of the tubes. In actuality, this was adjusted to this pressure value by bleeding off considerable air from one end of the pressurized chamber for flushing an adjacent cabinet. Temperature of the tube seals and anode coolers was

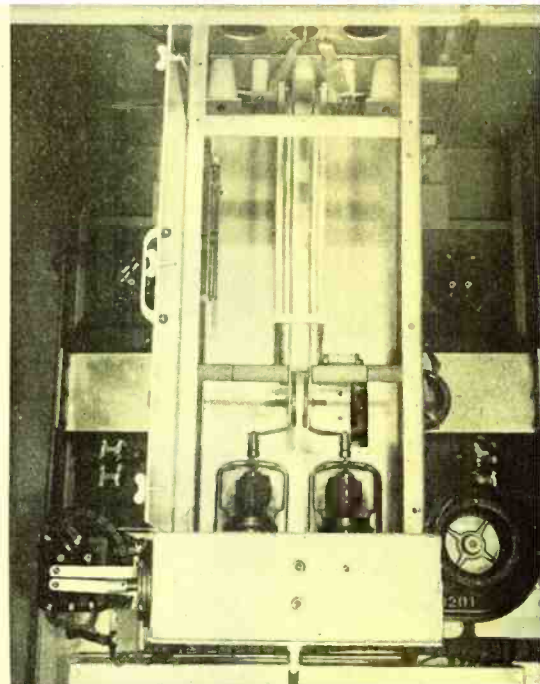

Fig. 4. Typical air cooling system used with internal anode tubes.

well under 150°C for continuous operation at full output.

The blower used for this system has a certified rating of 1.75 inches pressure at 800 c.f.m. This provides better than 400 c.f.m. for other purposes.

The selection of the blower depends largely on two factors, the air volume required in cubic feet per minute, and the air pressure at which it must work. Fig. 2 is the performance curve of a *Fasco* model 50749 blower. It is plotted as air volume in c.f.m. against air pressure in inches water column. Working into a static pressure of .625 inches, it will deliver a guaranteed volume of 90 c.f.m. This is the operating point for the blower used in the *Gates* 1 kw. FM transmitter shown in Fig. 4. If this blower is used in some other application where the pressure is only .3 inches, it will deliver 125 c.f.m.; or should it be allowed to exhaust in free space, the air

(Continued on page 27)

Fig. 5. Cooling system of 5 kw. transmitter using external anode tubes.



By **WALTER V. TYMINSKI**
Spencer-Kennedy Laboratories, Inc.

Fig. 1. This single amplifier will cover the entire television and FM band. Left, top-front view. Below, bottom view with cover removed.

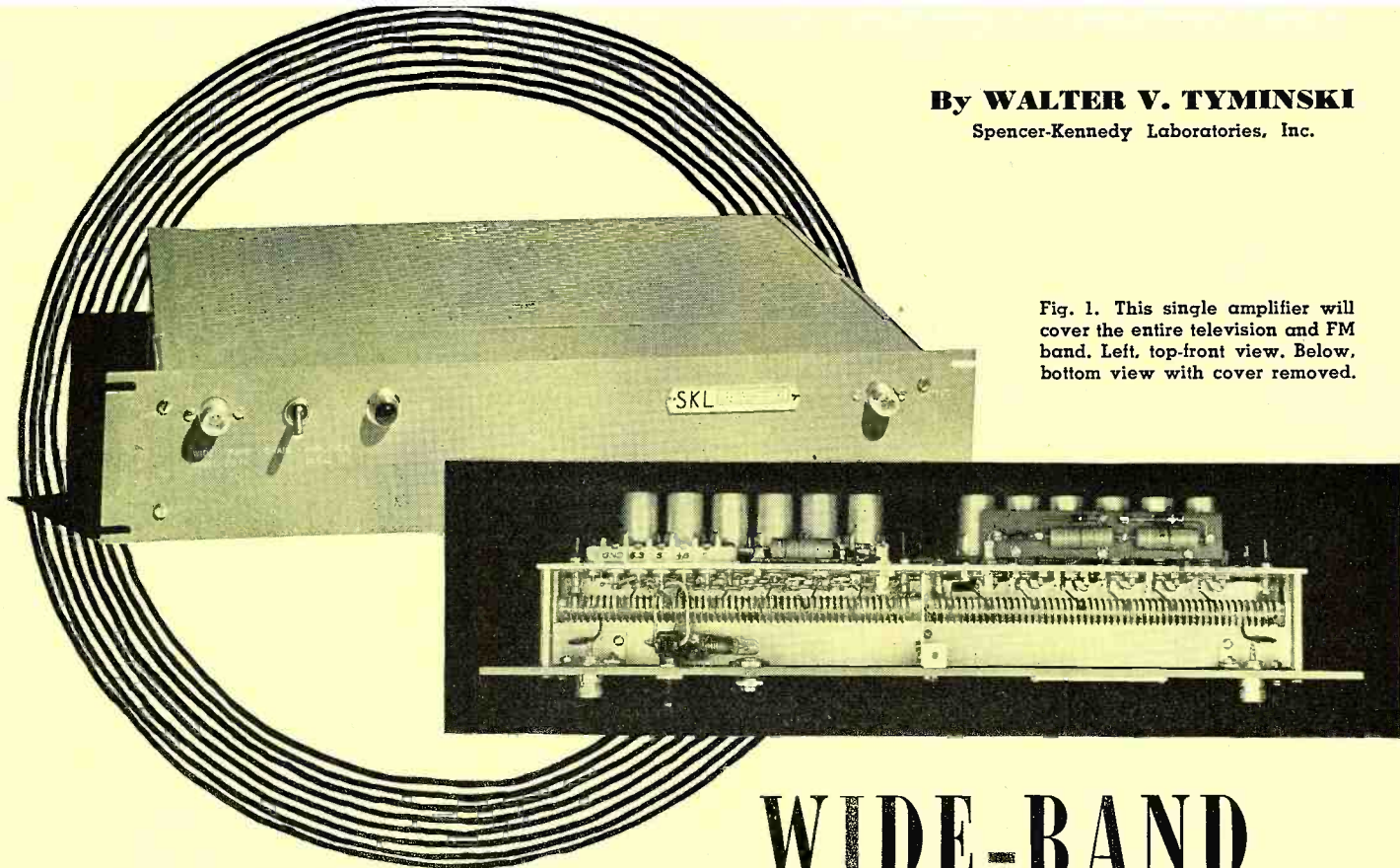

WIDE-BAND CHAIN AMPLIFIER FOR TV

The chain amplifier principle can be applied in producing an amplifier with a bandwidth of 200 mc.

IN many applications it is necessary to amplify a television signal before the picture quality is acceptable. Using conventional amplifier design a booster amplifier can be built to cover the bandwidth of an individual channel and a switching arrangement can be provided to cover the television spectrum. This solution is considered satisfactory by most individual users even though there is an additional control to manipulate. But many other uses require that the booster be placed at a remote position, such as directly at the antenna, and this necessitates the use of a non-tunable system. Individual channel amplifiers can be used with a means of combining the outputs into a common transmission line, but in some metropolitan areas where as many as seven television amplifiers and an additional one for FM would be needed, this method becomes complex and expensive. Another solution is the use of one amplifier to cover the entire television and FM band, and such an amplifier will be described in this paper. (See Fig. 1).

Experience with conventional amplifiers has shown that increased band-

width is obtained at the expense of decreased gain. One of the coupling systems designed to increase bandwidth is the low-pass filter illustrated in Fig. 2 in which the output and input capacities are used as elements. For a given tube, the gain can be increased by raising the value of the line impedance, but this results in a smaller bandwidth. Conversely, decreasing the plate load reduces the gain, but increases the bandwidth. There is a theoretical gain-bandwidth product which cannot be exceeded no matter how complex a coupling system is devised for cascading stages.

The solution is to increase the transconductance without increasing the tube

capacities. In conventional tubes this is difficult because once the cathode emission has been made as large as practical, further increases in transconductance are usually obtained by placing the grid closer to the cathode. But this smaller physical separation results in a higher value of input capacitance. Placing tubes in parallel does not help because while the transconductance is doubled the input and output capacities are also doubled. One solution is the use of a new type of tube construction such as a secondary emission type tube, but these tubes are still relatively expensive and a method of using conventional tubes is to be preferred. Percival, in his British patent, suggested that more than one tube be used per stage with the tube capacities arranged in filter sections as shown in Fig. 3. This effectively adds the transconductance without increasing the tube capacities.

An analogy can be drawn between the filter containing the input capacities and a regular transmission line. When a wave enters the input terminals (A.A. of Fig. 3) it travels down the line and excites each grid in turn. Since the line is terminated in its characteristic impedance the entire wave is absorbed in the termination and there is no reflection. The individual tube then am-

Fig. 2. Filter type coupling using tube input and output capacities.

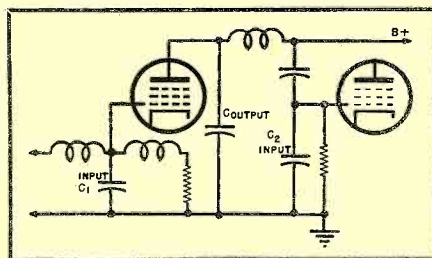

plifies its grid voltage and a plate current of $G_m E_g$ is available at the plates, where E_g is the grid voltage. While it is convenient to consider the grid line from a voltage standpoint, a current analysis is preferable for the plate line. Each of the tubes can be considered a constant current generator which feeds a current to the junction of the output capacity and the two inductances. (Fig. 6). A portion of the current flows through the capacity to ground, but the remainder splits, half going toward each termination. If the plate and grid filters are designed to have the same cut-off frequency the phase shift per section will be the same in both lines. The portions of the currents moving toward the load will add in phase because the signal has traversed the same number of filter sections regardless of the path considered. Thus, the total current in the load is n times the contribution of each tube, where n is the number of tubes used. The currents moving toward the reverse termination (CC in Fig. 3) are not in phase because of the different number of sections encountered in the parallel paths, and no useful output is available at this point. But, to avoid reflections the output must be matched at both ends and thus the reverse termination cannot be omitted.

The gain per tube is $G_m Z_p / 2$ and the gain per stage is $n G_m Z_p / 2$ where n is the number of tubes in the stage. In this type of amplifier there is an additive effect and thus an individual tube can have a gain of less than unity while the combination of tubes have any desired gain. This feature makes the chain type of amplifier especially attractive. From the standpoint of economy the tubes should be arranged such that a "stage" or "chain" has a gain of $e(2.72)$. For additional gain the stages should then be cascaded. The essential difference between chain amplifiers and the conventional amplifier is that in the former more than one tube is used per stage while in the latter, individual tubes are cascaded. Stagger-tuned amplifiers are not in reality distributed amplifiers in the sense that a number of different responses are multiplied, while in the chain amplifier each tube amplifies the entire bandwidth in the same manner and the individual responses are added in the load.

Design Parameters

There are a number of filter section arrangements that can be used but the low-pass constant k type filter was chosen because of the simplicity of construction and the rising gain that is obtained with increasing frequency. In television applications the transmission lines and associated system usually have a rising loss characteristic with fre-

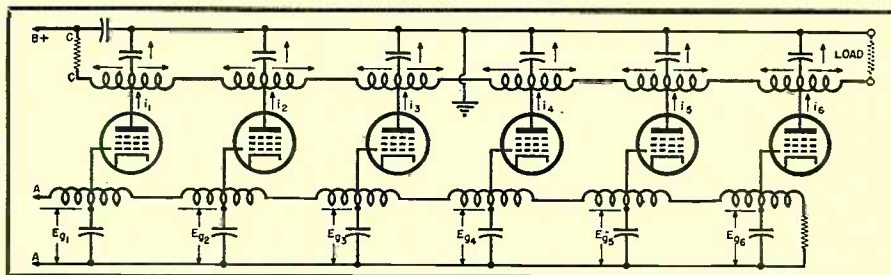

Fig. 3. Schematic diagram of a typical wide band chain amplifier stage.

quency and the amplifier compensates in part for this loss to make the overall response flatter. The theoretical gain of this arrangement is:

$$\frac{n G_m R_p}{2\sqrt{1-x^2}} \dots \dots \dots (1)$$

- where n = no. of tubes
- G_m = tube transconductance
- $R_p = \sqrt{L_p / C_p}$
- L_p = inductance element of plate line filter
- C_p = capacitance element of plate line filter
- $x = f / f_c$
- f = actual frequency
- f_c = cut-off freq. of filter

This function is plotted in Fig. 4. But in practice, it will be found that the gain will not rise as much as shown. The resistive component of the input impedance of a tube decreases with frequency and the loading produced on the line decreases the over-all gain. Other effects that reduce the gain in practice are such things as skin effect, transit time, and lead inductance.

The design equations for a low-pass constant k filter are shown in Fig. 7. A study of these equations shows that the greatest bandwidth and gain can be obtained by making the capacitance as small as possible. In the grid line the lowest value of capacitance possible is the combination of the input capacity together with the associated strays. It can be used directly as a filter element. A choice of the cut-off frequency determines the value of the inductance and thus the characteristic resistance of the line. Previously it was mentioned that plate and grid lines must have the same cut-off frequency but not necessarily the same characteristic impedance. But when amplifier stages are cascaded it is more convenient to have the same value of impedance for each line. The plate

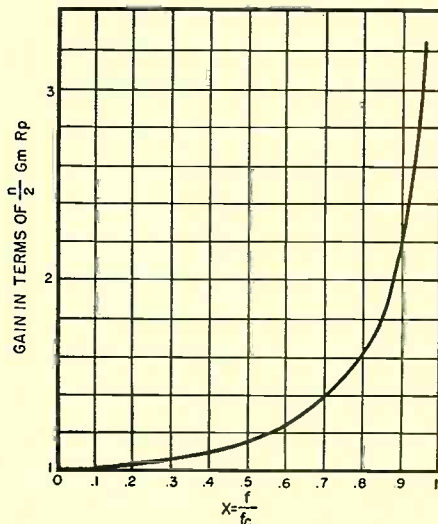
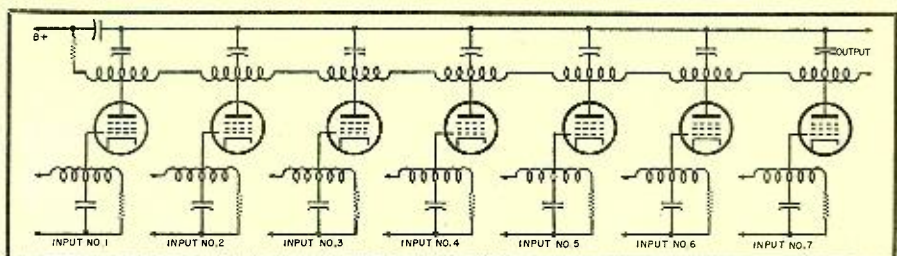

Fig. 4. Plot of theoretical gain frequency response of chain amplifier using constant K low pass filter sections.

line should then have the same value of inductance and capacitance as the grid line. Since the output capacity of pentodes is lower than the input capacity a padding capacitor must be added in the plate line whose value is the difference between the tube input and output capacity.

Filter theory requires that the load be matched to the line so that there are no reflected signals from the terminations. The necessary value of impedance is determined from an analysis of a single section terminated in Z_c , with the input impedance also being equal to Z_c . For the filter section used in this amplifier the value of impedance is $Z_c = R_c \sqrt{1-x^2}$. This impedance is purely resistive in the pass band, starting out at $Z_c = R$ for zero frequency and decreasing to zero at cut-off. In the stop band the impedance is a pure inductive reactance which increases with

Fig. 5. Combining several inputs into common output for use as an antenna coupler.



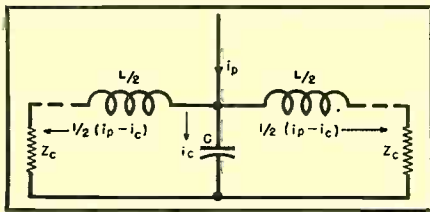

Fig. 6. Method of plate current division.

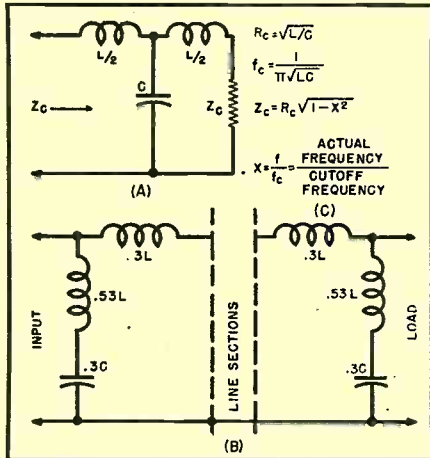

Fig. 7. (A) Typical series section filter. (B) M derived terminating sections to match constant resistance generator and load to the filter. (C) Design equations for the end and intermediate sections.

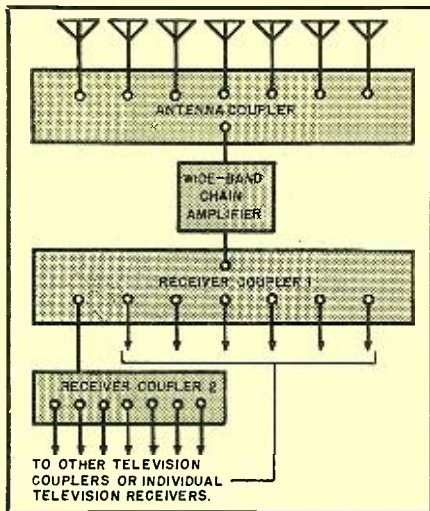
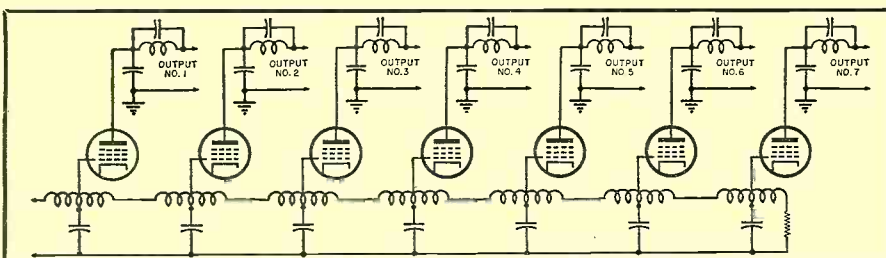

Fig. 8. Multiple television installation with as many receiver couplers and multipliers as necessary in the particular installation.

Fig. 9. Plate line altered to provide a number of outputs from a single input.



frequency. Since the impedance is not constant with frequency a constant resistance is not a good match, and if used, will result in reflected signals the magnitude of which will rise with frequency. This reflection in the grid line would cause a portion of the current propagated towards the load to be reflected. The effect of mismatches is to cause a standing wave in the gain frequency response of the amplifier. Thus the line termination must be made to look like a falling resistance with frequency. This can be done by using conventional half section filters as shown in Fig. 7 together with the design equations. The input, which is usually applied to a generator of constant impedance with frequency, is matched to the line in the same way.

An amplifier using the principles described was constructed and is shown in Fig. 1. The cut-off frequency is 250 mc., and a line impedance of 180 ohms was used so as to obtain a nominal voltage gain of 9 db. for a stage using six tubes. In the model shown, two stages were cascaded so as to provide a total gain of 18 db. Since 180 ohms is not a common television impedance, transformers were provided to bring the input and output of the amplifier to an impedance level of 72 ohms. Since the input transformer is used in the step-up position while the output transformer is used in the step-down position, with both transformers having the same turns ratio, the over-all gain of the transformers is unity. Almost any impedance can be obtained by the use of transformers and this is particularly simple in the case of unbalanced impedances because a simple autotransformer winding will suffice.

Uses

The wide-band chain amplifier has several advantages over conventional amplifiers, some of which are:

- (1) One chain amplifier can amplify the twelve television channels, both old and new FM bands, the short wave frequencies, and even the broadcast band if desired. Using conventional amplifiers a large number of individual amplifiers would be needed to accomplish the same purpose.
- (2) Tube failure in a chain amplifier is not fatal to the system, but

merely results in a slightly reduced gain without appreciably affecting the form of the gain frequency response. In a conventional amplifier, tube failure means complete loss of the signal.

(3) The chain is extremely stable and will not drift appreciably even under wide temperature conditions.

(4) When individual channel amplifiers are used, amplification of a television signal through any of the other channel amplifiers will produce multiple images such as ghosts, because of the different time delays of the amplifiers. This cannot happen in a chain amplifier.

(5) Unlike the chain amplifier, the use of several channel amplifiers increases the possibility of cross-modulation. Weak signals of other stations may produce an objectionable amount of cross-modulation in the output of the individual amplifier and the picture quality is impaired.

An amplifier of the wide-band type finds extensive applications in radar, oscillography, nuclear physics, television testing and distribution systems, and general laboratory measurements. Pulses, transients and low-level antenna signals can be amplified to useful levels by cascading several stages. The sensitivity of vacuum tube voltmeters and oscilloscopes can be made greater by the amount of gain provided in the amplifier. The output voltage of wide-band oscillators, signal, sweep and pulse generators can be increased with a convenience and stability no tuned amplifier can provide.

In many television installations it is found that a simple antenna system consisting of a separate low and high band antenna connected by a divider network is satisfactory. In these applications the amplifier can be inserted in the single transmission line. Other installations require a more elaborate antenna system and in the ideal case an individual channel antenna would be provided. This antenna could be cut for the desired frequency and then oriented for best signal reception. When more than one antenna is used the outputs must be combined before being applied to the amplifier. The other alternative is to run an individual line from each antenna and then switch the receiver input to the desired antenna. If amplification is desired the amplifier can be placed between the switch and the receiver. But this system requires a large amount of cable plus the nuisance of another control. Thus, the more convenient arrangement would be to combine the antenna outputs and run only one transmission line to the receiver.

There are a number of methods of
(Continued on page 29)

*Do you have
This Helpful
Helipot
and
Duodial
Catalog?*

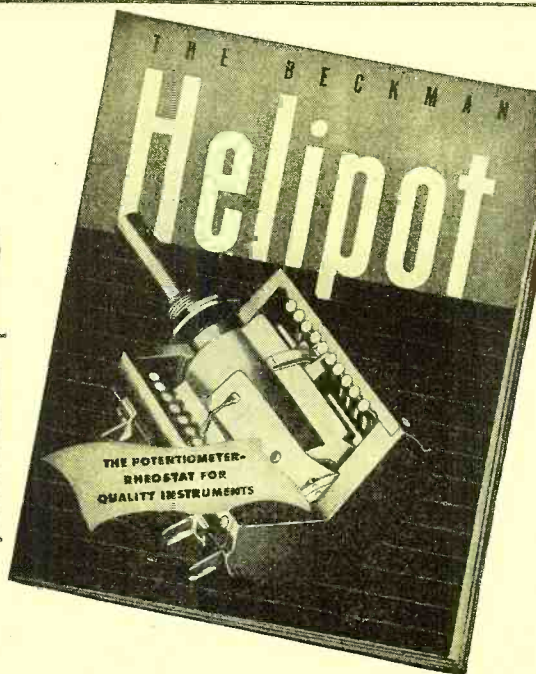

Do you have complete data on the revolutionary new HELIPOT—the helical potentiometer-rheostat that provides many times greater control accuracy at no increase in panel space?... or on the equally unique DUODIAL that greatly simplifies turns-indicating applications? If you are designing or manufacturing any type of precision electronic equipment, you should have this helpful catalog in your reference files...



It Explains—the unique helical principle of the HELIPOT that compacts almost four feet of precision slide wire into a case only 1 3/4 inches in diameter—over thirty-one feet of precision slide wire into a case only 3 1/2 inches in diameter!

It Details—the precision construction features found in the HELIPOT...the centerless ground and polished stainless steel shafts—the *double* bearings that maintain rigid shaft alignment—the positive sliding contact assembly—and many other unique features.

It Illustrates—describes and gives full dimensional and electrical data on the many types of HELIPOTS that are available... from 3 turn, 1 1/2" diameter sizes to 40 turn, 3" diameter sizes... 5 ohms to 500,000 ohms... 3 watts to 20 watts. Also Dual and Drum Potentiometers.

It Describes—and illustrates the various special HELIPOT designs available—double shaft extensions, multiple assemblies, integral dual units, etc.

It Gives—full details on the DUODIAL—the new type turns-indicating dial that is ideal for use with the HELIPOT as well as with many other multiple-turn devices, both electrical and mechanical.

If you use precision electronic components in your equipment and do not have a copy of this helpful Helipot Bulletin in your files, write today for your free copy.

THE Helipot CORPORATION, 1011 MISSION ST. SOUTH PASADENA 4, CALIF.

Microwave Comp.

(Continued from page 9)

$$P_{max} = 4.05 \times 10^8 d^2 \log_{10} D/d \quad (17)$$

In practice, it is necessary to limit maximum power to considerably less

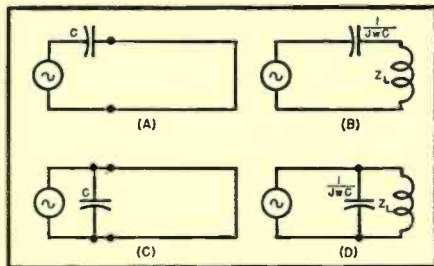

Fig. 8. Resonant lines (A) and (C) with capacitive inputs. Equivalent circuits are shown in (B) and (D).

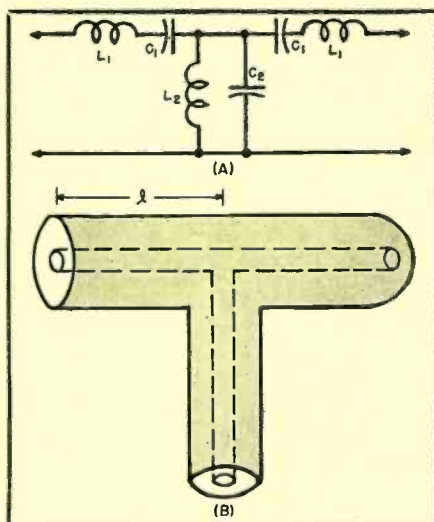

Fig. 9. (A) Coaxial line equivalent of simple "T" filter (B).

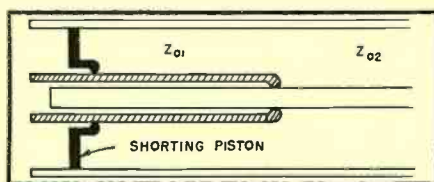
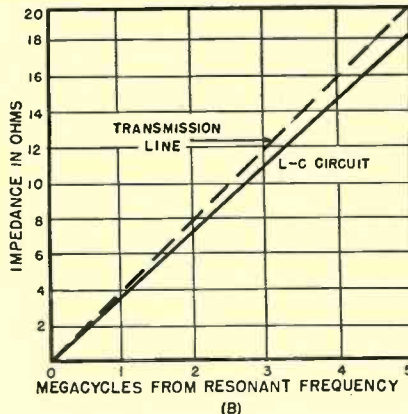
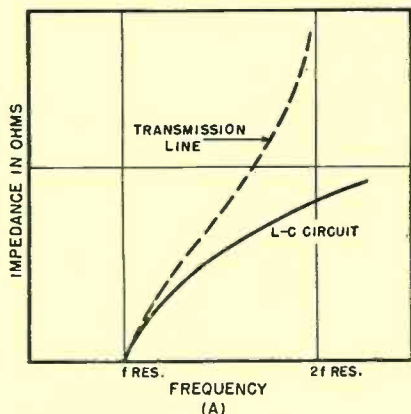

Fig. 10. Dual impedance line.

Fig. 11. Impedance vs. frequency for (A) single impedance resonant line and L-C circuit and (B) dual impedance line and L-C circuit.



than maximum limit due to higher gradients at stub supports and terminating joints.

In many practical applications, the input to the line will have a capacitive reactance, as shown in Fig. 8, in which case the line must be foreshortened to cancel out this reactance. This is done by making the reactance of the line equal and opposite to that of the capacity, or:

$$\tan \beta l = - \frac{1}{Z_0 \omega_0 C} \text{ (shorted) } \quad (18)$$

$$\tan \beta l = Z_0 \omega_0 C \text{ (open) } \quad (19)$$

Filter Networks Using Transmission-Line Elements

Resonant lines are used in a microwave system as narrow band filters. Many of the expressions that have been derived for tuned circuits at ordinary radio frequencies can be applied with equal accuracy to resonant lines at microwave frequencies. In fact, the general procedure in the design of any type of filter usually begins with determining the filter parameters on the basis of lumped constant elements in the conventional manner, and then calculating the coaxial line elements that will duplicate the filter configuration desired.

The simplest filter is, of course, the resonant line. The loss in such a line is given by the following expression:

$$\text{Db. loss} = 10 \log_{10} \frac{Q_u}{Q_u - Q_L} \quad (20)$$

where Q_u is the unloaded Q of the line and Q_L is the loaded Q .

Another simple filter is the band pass "T" filter shown in Fig. 9A. An equivalent coaxial line circuit is shown in Fig. 9B. The length, l , of the series arm is chosen so that the circuit will resonate at the frequency $f_0 = 1/2\pi\sqrt{L_1 C_1}$. The parameters of the line are chosen so that its equivalent inductance and capacitance at f_0 is equal to L_1 and C_1 , respectively. The shunt arm

is similarly designed to resonate at $f_0 = 1/2\pi\sqrt{L_2 C_2}$, and have equivalent inductance and capacitance to L_2 and C_2 at this frequency.

It should be noted that the off-resonance impedance of Fig. 9A is not exactly equal to that of Fig. 9B. The reason for this is that the impedance variation of a coaxial line is a tangential function, while that of a lumped constant element is linear. This difference, shown in Fig. 11A for an LC circuit, may or may not be important depending upon the individual application.

There are a number of methods that can be used to minimize this effect. Again the one used will be primarily a function of the results desired. For example, it is possible to minimize the impedance variation near the resonant frequency by using a dual impedance line such as the one shown in Fig. 10. The impedance variation of this line compared to that of a lumped constant circuit is shown in Fig. 11B.

Wave Guide Elements—Inductive and Capacitive Windows

If a wave guide contains a non-uniform discontinuity such as the step discontinuity of Fig. 12, a certain portion of the energy will be reflected and cause standing waves. Such a discontinuity corresponds to a reactance. Normally the discontinuities are made symmetrical to the parallel walls and are called windows. For a $TE_{1,0}$ mode, a window parallel to the "b" side of the guide² represents an inductance; a window parallel to the "a" side a capacity, as shown in Fig. 13.

A window is used in much the same manner as a stub in coaxial lines. In the article on "Microwave Transmission Lines", the method of matching a wave guide to any load was discussed, and as indicated in this article, normalized susceptance is the most convenient parameter to employ. The theoretical normalized susceptance of an inductive window is:

$$B = - \frac{\lambda_g}{a} \cot^2 \frac{\pi r}{2a} \quad (21)$$

λ_g is the guide wavelength, and r the opening of the window. The actual susceptance obtained from a window is somewhat greater than the theoretical value. This is because of the finite thickness of the window which is not included in the simple theory and effectively increases the susceptance of the window.

The normalized susceptance of a capacitive window, assuming a window of zero thickness, is:

$$B_0 = \frac{1.7 b}{\lambda_g} \log_{10} \text{cosec} \frac{\pi r}{2b} \quad (22)$$

The thickness of the window has an appreciable effect in this case. An ex-

10 Times More Rugged-

New Sylvania shock-tested tubes withstand shocks greater than 400 G's

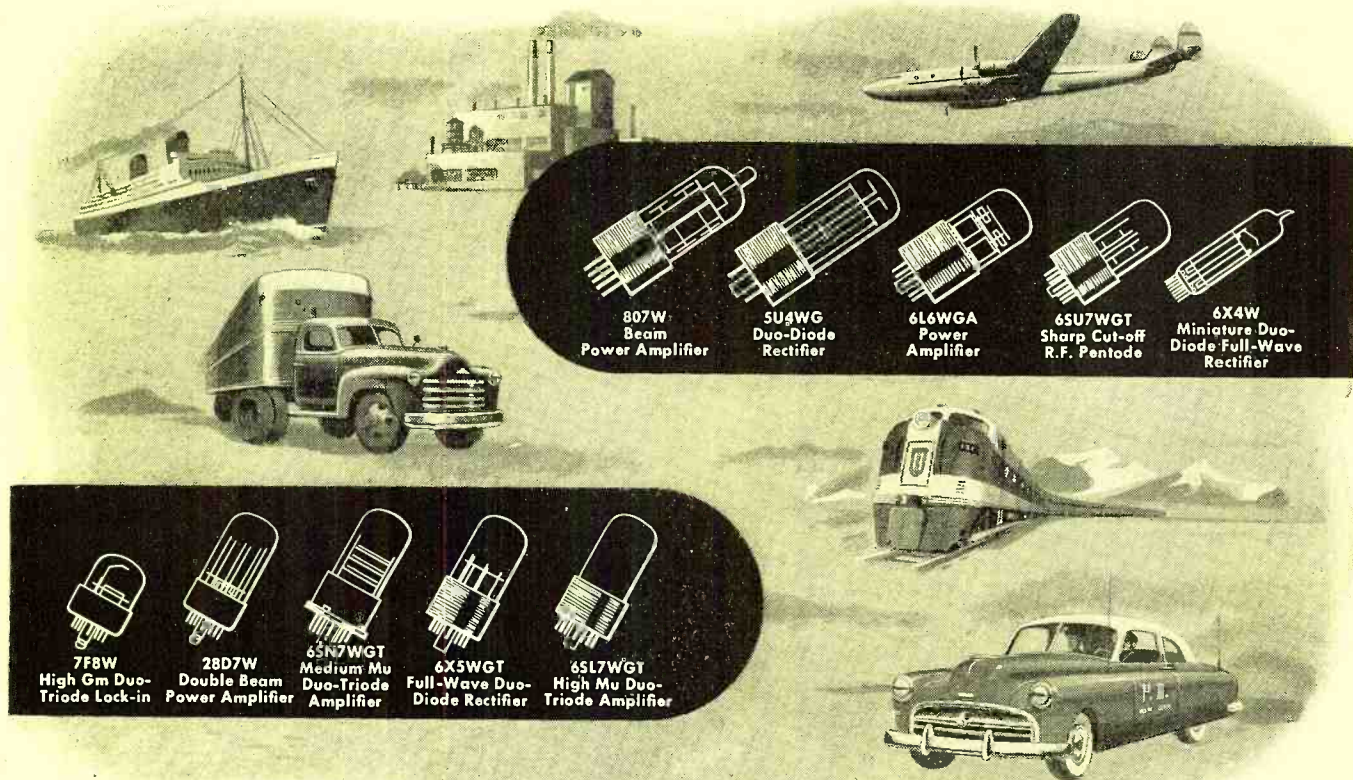

807W
Beam
Power Amplifier

5U4WG
Duo-Diode
Rectifier

6L6WGA
Power
Amplifier

6SU7WGT
Sharp Cut-off
R.F. Pentode

6X4W
Miniature Duo-
Diode Full-Wave
Rectifier

7F8W
High Gm Duo-
Triode Lock-in

28D7W
Double Beam
Power Amplifier

6SN7WGT
Medium Mu
Duo-Triode
Amplifier

6X5WGT
Full-Wave Duo-
Diode Rectifier

6SL7WGT
High Mu Duo-
Triode Amplifier

**Ideal for industrial radio applications...
for aircraft...buses...trains...police cars...
or wherever shock and vibration are problems**

Troublesome problems of tube failure resulting from shock or heavy vibration are now being solved... for keeps... by these new Sylvania "Ruggedized" or "W" tubes. Originally designed to government specifications to withstand shock and vibration caused by artillery action, these tubes keep operating under vibration up to 2-1/2 G's... withstand shocks more than 400 times the force of gravity.

A dozen new design techniques have gone into the perfection of these tubes. More than that, they are *precision*-built from

precision parts. Exhaustive lab and field tests have definitely proved them as much as 10 times more rugged than ordinary tubes. Electrical characteristics are similar to those of standard types.

Note too, their reduced overall length and their straight glass bulbs... features which make possible smaller and more compact equipment design.

Maximum ratings and other characteristics of these new "Ruggedized" types are available from Sylvania Electric Products Inc., Dept. R2304, Emporium, Pa.

**✓ CHECK THESE 10
"RUGGEDIZED" FEATURES
for longer life and
better performance**

1. Double thickness micas
2. Heavier side-rod supports
3. Shorter leads
4. Straight glass bulb
5. Flat, circular header
6. Fewer internal connectors
7. Shorter elements
8. Reduced overall height
9. Additional mount supports
10. Low-loss phenolic base

SYLVANIA ELECTRIC

RADIO TUBES; CATHODE RAY TUBES; ELECTRONIC DEVICES; FLUORESCENT LAMPS, FIXTURES, SIGN TUBING, WIRING DEVICES; LIGHT BULBS; PHOTOLAMPS

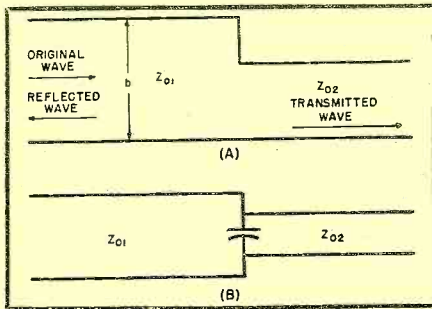

Fig. 12. (A) Wave guide with step discontinuity. (B) Equivalent circuit.

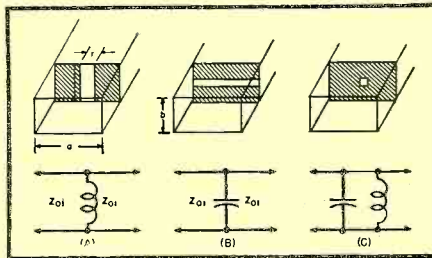

Fig. 13. Three types of wave guide windows and their equivalent circuits.

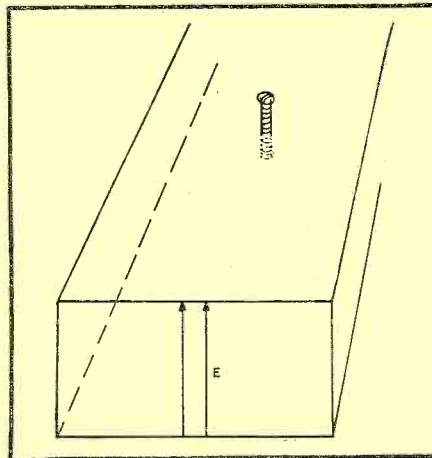

Fig. 14. Tuning screw in wave guide.

pression which provides results that are much closer to actual values is the following:

$$B = B_0 + \frac{2\pi w}{\lambda_g} \left(\frac{b}{r} - \frac{r}{b} \right) \quad (23)$$

where w is the window thickness, and B_0 the normalized susceptance for $w=0$.

Fig. 15. (A) Rectangular wave guide cavity. (B) Reentrant cavity and equivalent circuit. (C) Cylindrical wave guide cavity.

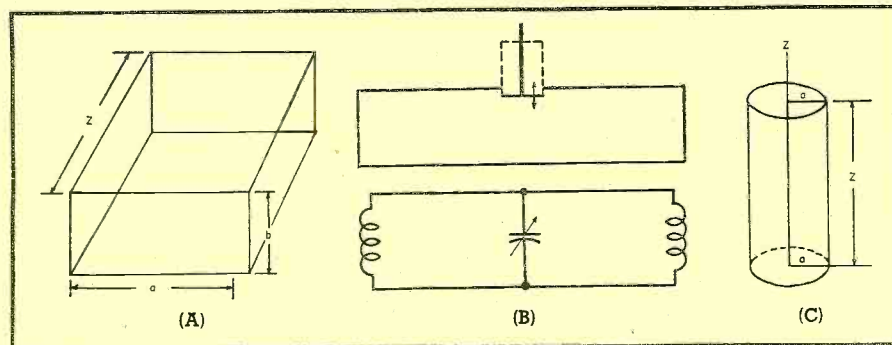

The capacitive window is limited in application to low power systems because it greatly enhances the possibilities of breakdown.

Tuning Screws

A tuning screw is a cylindrical probe extending into the wave guide parallel to the electric field as shown in Fig. 14. The screw acts essentially as a shunting reactance in the guide. The magnitude of susceptance varies with depth into the guide. Short lengths of probe are equivalent to shunting capacities, the susceptance increasing with depth until a length of approximately a quarter-wave is reached in which case the resonance occurs and substantially all of the incident wave is reflected. For still greater lengths the screw becomes inductive. In most applications it is used in the capacitive region. The sharpness of resonance is a function of the diameter of the screw and higher Q 's are found with smaller diameters. Typical measured susceptance of this screw as a function of r is shown in Fig. 16.

Three tuning screws separated from each other by one-quarter of a wavelength is a commonly used combination for broad tuning. To match a load to a line, the center screw and only one of the outer screws are varied.

Quarter-Wave Transformer

A quarter-wave transformer in a wave guide can be achieved by reducing the dimensions of the wave guide by a quarter-wave section whose dimensions are calculated from the following expression:

$$\frac{Z_{0T}}{Z_0} = \frac{b_T a \lambda_{gT}}{b a_T \lambda_g} \quad (24)$$

In addition to the change in characteristic impedance, a shunt susceptance is introduced at each junction, which may be calculated from Eqts. (23) and (22). These susceptances must then be tuned out by methods indicated previously.

A more practical method of achieving a quarter-wave transformer is through use of the asymmetrical capacitive transformer shown in Fig. 17. The in-

put admittance seen at the generator side when the load end is matched is given by:

$$\frac{Y}{Y_0} \approx \left(\frac{b}{b_T} \right)^2 \quad (25)$$

This type of transformer has the advantage that it can be slipped into the guide, just as a sleeve, and adjusted for minimum standing-wave ratio by drilling a small hole in the center of the guide and positioning transformer with a dielectric rod.

Wave Guide Cavity Resonators

As in the case of the resonant coaxial line, it is possible to design a wave guide so that it will act as a tuned circuit, or resonate, at the desired frequency. Such a wave guide, which usually takes the form of an enclosed box, shown in Fig. 15A, is called a cavity. (Resonant coaxial lines are also sometimes referred to as cavities but usually a "cavity" implies an enclosed wave guide.)

Much of the material given for coaxial line resonators holds true for the guide cavity with the exception that all three dimensions of the guide must be properly designed to propagate the mode desired with maximum efficiency. The a and b dimensions are governed to a large degree by the same factors, i.e., cut-off frequency and attenuation for mode desired, that were described in the last article for transmission of energy. The z dimension determines the frequency of resonance. The expression for the resonant wavelength of a rectangular cavity is given by:

$$\lambda = \frac{2}{\sqrt{\left(\frac{l}{z}\right)^2 + \left(\frac{m}{a}\right)^2 + \left(\frac{n}{b}\right)^2}} \quad (26)$$

where l is the number of half wavelengths down the guide in "z" direction. For a $TE_{1,0,1}$ (last subscript representing half wavelengths in the z direction) $l = m = 1$, and $z = a$,

$$\lambda = \sqrt{2} a \quad (27)$$

The Q of a wave guide must be worked out individually for each type of mode used, starting with the definition given by Eq. (12). In general, the Q will be proportional to:

$$Q \approx \frac{1}{\delta} \frac{V_{0L}}{S} \quad (28)$$

where V_{0L} is volume of guide and S is its surface, and δ is the r.f. resistance of guide conductor.

The Q of the cavity defined by equation (27) is:

$$Q = .353 \frac{\lambda}{\delta} \frac{1}{1 + \frac{a}{2b}} \quad (29)$$

The shunt impedance of this cavity at resonance is given by:

(Continued on page 30)

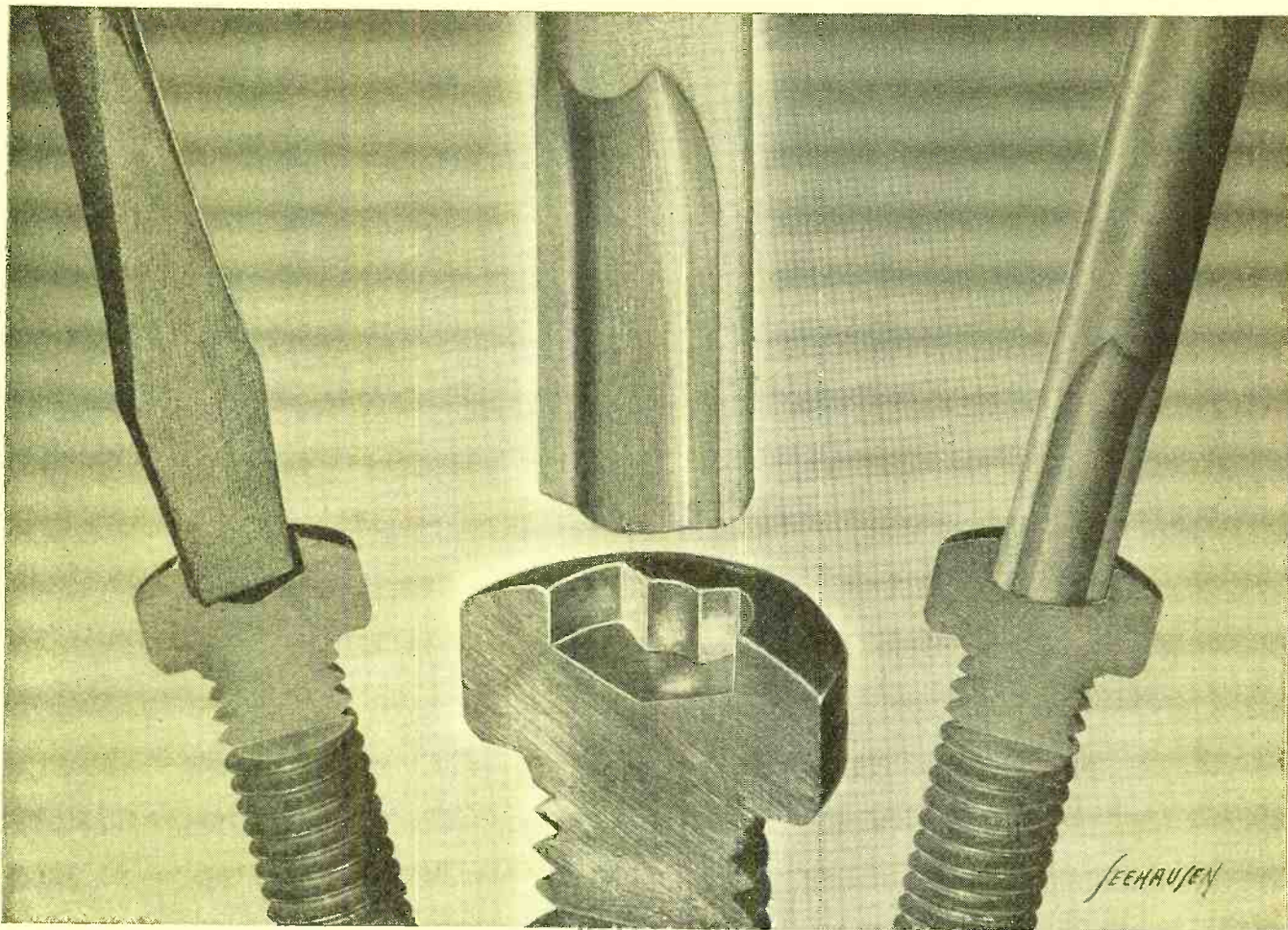

Here's How CLUTCH HEAD Brings New Safety, New Speed in Line Assembly

- Q.** What is the main cause of driver skidding?
- A.** "Ride-out" as set up by tapered driving.
- Q.** How does CLUTCH HEAD overcome this "ride-out"?
- A.** By elimination of the tapered recess.
- Q.** How does the CLUTCH HEAD engagement differ?
- A.** With straight sides of driver matching straight recess walls.
- Q.** What safety benefit results from this engagement?
- A.** No slippage, so no damage to operators or work.
- Q.** Does this eliminate need for end pressure?
- A.** Yes. No "ride-out" to combat; no end pressure; no skids.
- Q.** Do CLUTCH HEAD users support this skid-free claim?
- A.** Many. Norge says "Cabinet damage eliminated."
- Q.** What of this feature as a fatigue factor?
- A.** Effortless driving means more screws driven per day.
- Q.** How does the Center Pivot Column add to safer driving?
- A.** It prevents canting by guiding bit into dead-center entry.
- Q.** Why is CLUTCH HEAD "America's Most Modern Screw"?
- A.** Because it has features unmatched by any other screw.

Q. What are these features?

A. They include a recess engagement to match the ruggedness of the Type "A" Bit construction for driving up to 214,000 screws . . . non-stop; simple 60-second bit reconditioning; the Lock-On for easy one-handed driving, and basic design for common screwdriver operation.



Q. And how may we check them?

A. You may check all of these features by sending for package assortment of screws, sample Type "A" Bit, and illustrated Brochure. These will come to you by mail and will give you an understanding why CLUTCH HEAD users report 15% to 50% increases in assembly production.

UNITED SCREW AND BOLT CORPORATION

CLEVELAND 2

CHICAGO 8

NEW YORK 7

NEWS BRIEFS

ELECTRONIC DEVELOPMENT

In a recent article on "Electrical and Allied Developments of 1949" published by *General Electric Company* was included the outstanding design of an x-

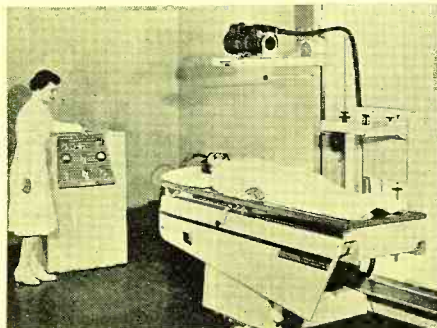

ray machine based on the building-block principle which will permit the physician's x-ray facilities to grow as his practice grows.

The complete unit shown actually consists of 15 subassemblies, which can be added to one another according to the scope of the physician's x-ray work and practice. The basic unit is composed of table top, table frame, legs, and Bucky diaphragm. When used with a mobile or portable type of x-ray tube-transformer assembly, it comprises the simplest unit for radiography. As his practice grows, the physician may add a special higher-powered tube and transformer, together with floor rail on which the tube can be moved alongside the table.

The same building-block system applies to fluoroscopy. The fluoroscopic carriage containing shutters and screen may be incorporated. Later a spot-film device for making radiographs of views as seen with the fluoroscope may be added.

LAUD ENGINEERING SCIENTISTS

In a recent address to the Machine Design Division of The American Society of Mechanical Engineers, Joseph B. Armitage, a director-at-large of the society and vice president of *Kearney & Trecker Corp.*, Milwaukee, Wisc., pointed out the tremendous advance in electronics during the war and its application to peacetime uses.

According to Mr. Armitage, although the great majority of our research men and scientists are still at work devising instruments of war, the relatively small

portion of technical men available to apply the results of the engineering progress of the last ten years to peacetime uses have done a marvelous job.

EFFECT OF SHOCK ON ELECTRON TUBES

Members of the American Institute of Electrical Engineers learned at their recent Winter General Meeting of exhaustive scientific studies of electrical noise produced in electron tubes as a result of shock and vibration.

Lester Feinstein of the Product Development Laboratories, *Sylvania Electric Products Inc.*, Kew Gardens, New York, who revealed the study, said that structural causes of microphonism in electron tubes stem principally from rattle of elements, motion of the mount



as a unit and resonance of tube elements. Laboratory studies which he revealed were carried on for the development of new types of subminiature tubes.

Experimental procedures used in which methods and equipments have been developed to impart controlled motion to tubes and for measurement of electrical response were outlined. Included in methods which Mr. Feinstein reported were electromagnetic vibration tests run at either constant velocity or constant acceleration throughout a range between 25 and 10,000 cycles.

RADIO DISTURBANCE WARNINGS

The radio disturbance warning notices broadcast regularly from radio station WWV of the National Bureau of Standards are based on comprehensive observations of radio, ionospheric,

solar, and geomagnetic phenomena at stations throughout the world.

Warnings are given in code following the time announcements at 19 and 49



minutes past each hour. A series of N's signifies that radio propagation conditions are normal, a series of U's that they are unstable, and a series of W's that they are disturbed or are expected to become so within 12 hours.

The direction of arrival of radio waves from transatlantic stations is measured with the instrument shown.

SYLVANIA ABSORBS COLONIAL

Sylvania Electric Products Inc., has absorbed its wholly-owned subsidiary, *Colonial Radio Corporation*, manufacturers of radio and television sets. The operations will be continued in Buffalo, New York, as the Colonial Radio and Television Division.

E. E. Lewis, formerly president of *Colonial*, has been elected vice-president of *Sylvania* in charge of the Colonial Radio and Television Division, and the personnel and policies will continue unchanged.

X-RAY MICROSCOPE

A microscope which makes it possible to examine directly minute details of internal structure in materials through



which light cannot pass has been announced by *General Electric's* Research Laboratory.

Miss Charlys M. Lucht, who developed the x-ray microscope in collaboration with other *GE* scientists, is shown
(Continued on page 30)

EL-MENCO CAPACITORS

Hold!



UNDER STRAIN

In capacitors performance depends on dielectric strength to withstand strain. Before *El-Menco* capacitors leave the factory they must pass severe tests for dielectric strength — at *double the working voltage*, insulation resistance and for capacity value. El-Menco fixed mica condensers meet and beat strict Army-Navy standards. That's why you can rely on El-Menco performance in *your* product.

SO ALWAYS

Specify Pretested Capacitors by El-Menco . . .

THEY HOLD UNDER

STRAIN

El-Menco CAPACITORS

MOLDED MICA

MICA TRIMMER

FOREIGN RADIO AND ELECTRONIC MANUFACTURERS COMMUNICATE DIRECT WITH OUR EXPORT DEPT. AT WILLIMANTIC, CONN. FOR INFORMATION.
ARCO ELECTRONICS, INC. 135 Liberty St., New York, N. Y.—Sole Agent for Jobbers and Distributors in U.S. and Canada

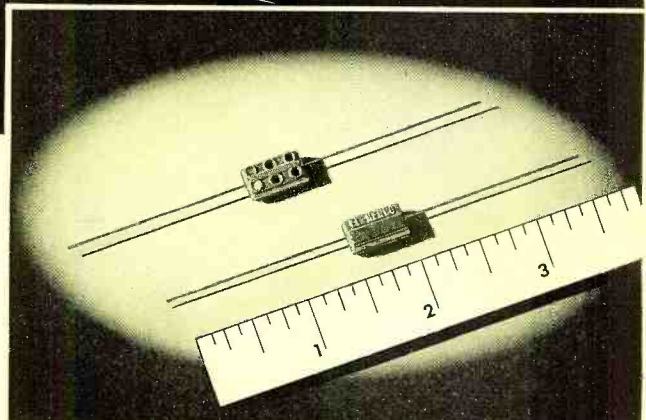

CM 15 MINIATURE CAPACITOR

Actual Size $\frac{3}{16}$ " x $\frac{1}{2}$ " x $\frac{3}{16}$ ". For Radio, Television and Other Electronic Applications.

2 to 420 mmf. capacity at 500v DCw.

2 to 525 mmf. capacity at 300v DCw.

Temp. Co-efficient ± 50 parts per million per degree C for most capacity values.

6-dot color coded



THE
ELECTRO MOTIVE MFG. CO., Inc.
WILLIMANTIC CONNECTICUT

Write on your firm letterhead for Catalog and Samples

NEW PRODUCTS

AIR METER

Hastings Instrument Company of Hampton, Virginia has announced that its Model G Air-Meter is the first elec-



trical anemometer to be free of the effects of rate of change of temperature.

This instrument provides instantaneous, direct, accurate readings of air velocities from 5 to 6000 feet per minute with an expanded scale in the low velocity ranges, and is now available with built-in temperature compensation to prevent momentary error in velocity reading when the probe is subjected to sudden changes of temperature.

A group of practical accessories is available, including a carrying case with battery operated power pack for use when 110 volt a.c. power supply is not available. For those now using *Hastings* Air-Meters, special probes which compensate for rate of change of temperature are available.

ELECTRONIC RELAY

Servo-Tek Products Co., 4 Godwin Ave., Peterson 1, N. J., has developed an electronic relay system to provide



super sensitivity in industrial control applications. This miniature unit, which

mounts on a standard 4" electrical connection box, incorporates simplicity of design and a minimum number of components.

The unit operates from the 115 volt 50-60 cycle line and uses no filament to draw standby power with the relay circuit energized. The load relay contacts are arranged to permit a choice of either opening or closing a circuit, or simultaneously to open one circuit and close another.

Additional data is available on request and the manufacturer will assist in application problems.

TV POWER CONTROL

RCA Engineering Products Department, Camden, N. J., has added to their TV equipment line a power control unit for mobile television pickup equipment

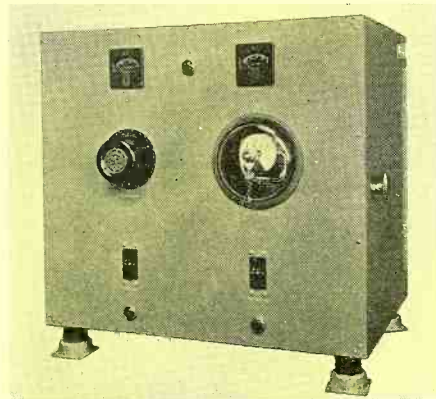

which provides power consumption readings and permits regulation of both input and output voltages from a central point in the mobile unit.

The control unit, consisting of transformers, circuit breakers, and other control apparatus for manually regulating both input and output voltages, is housed in a shock-mounted cabinet designed for mounting in the television truck.

Shown is the front view of the power control unit capable of operating from any two-wire system providing input voltages between 100 and 120 volts, or between 200 and 220 volts, 60 cycles at 5 kva.

AIR-COOLED TRANSFORMER

Larger-sized, air-cooled transformers, identified as *AmerTran* Type GS, are now being manufactured by the *American Transformer Company*, Newark,

N. J. They are manufactured in standard ratings from 15 to 200 kva., single-phase, 60 cycles, and with either 240/480- or 600-volt, high-voltage windings. Low-voltage windings which are rated 120/240 volts are suitable for supplying lighting, motor and distribution loads.

According to the manufacturer, *AmerTran* Type GS provides adequate and

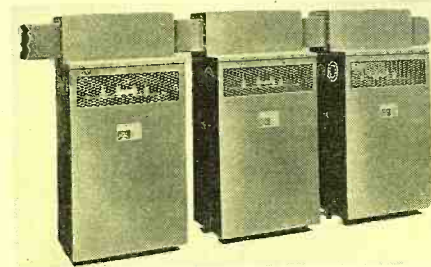

convenient accommodations for wiring connections in all types of installations without the need of specially fabricated fittings. In installing transformers for single-phase service, ample space for all required wiring is available in a large built-in wiring compartment located at the top of the transformer directly above a terminal board to which coil leads are connected.

MINIATURE POTENTIOMETERS

High precision miniature potentiometers are now being offered by *Technology Instrument Corporation*, 1058 Main Street, Waltham 54, Mass. Only $\frac{7}{8}$ " in diameter, and $\frac{3}{8}$ " in depth, these miniature potentiometers are available in resistance ranges of 100 to 25,000 ohms.

The accuracy of total resistance may be specified as close as $\pm 1\%$, and linearity to $\pm 0.8\%$ of total resistance as required. These units may be ganged together with adjusting clamp ring to permit individual phasing.

Additional information may be obtained by writing direct to the company.

BETA GAMMA MONITOR

Model 2610A, beta-gamma portable count-rate meter, is being offered by the *Nuclear Instrument and Chemical Corp.*,



223 West Erie St., Chicago, Illinois. This model is housed in a water-tight

case and incorporates a proven electrical circuit which has been manufactured by the company for several years.

The interior is tropicalized to eliminate effects of humidity or other adverse atmospheric conditions. The probe is also water-tight and contains a plug-in type Geiger tube to facilitate servicing. Internal parts are arranged for ease in servicing and circuit components are mounted in the cover. The easy-to-read meter is calibrated in both milliroentgens per hour and in counts per minute.

The instrument is supplied complete with an attached radioactive source for checking calibration, batteries and crystal earphones.

THERMO-REGULATOR

The *H-B Instrument Co.*, 2633 Trenton Ave., Philadelphia 25, Pa., has announced their Quick-Set Thermo-regulator on which the control setting can be varied over a wide range in a matter of seconds. Once set within 10° F. of the control temperature, adjustments of several degrees down to 0.01 and even smaller under favorable conditions, are made by merely turning a ring knob.

The compact, self-controlled Quick-Set Regulator fits into the medium to be controlled and, through an *H-B Electronic Relay*, can handle up to 30 amperes at 110 volts a.c. One model covers a range from approximately plus 30° to 600° F. or higher. Another model covers a range from minus 38° F. to about 50° F.

Full particulars may be obtained by writing to Dept. T-65.

DEMONSTRATION UNIT

A demonstration magnetic amplifier for educational purposes in schools and industry is being introduced by *Vickers Electric Division*, of *Vickers Incorporated*, 1815 Locust St., St. Louis 3, Missouri.

This unit is arranged so that all basic single-phase self-saturating circuits may be studied. By arrangement of the external connections either d.c. or a.c. output is available and either d.c. or a.c. control power may be used. Aside from the basic purpose to show the principle of the high-performance self-saturating magnetic amplifier, the new demonstration unit may be used in operating control circuits.

Reference material and bulletins in-

cluded with each unit give the wiring diagrams of several control circuits, as well as a series of laboratory experiments arranged to help the student

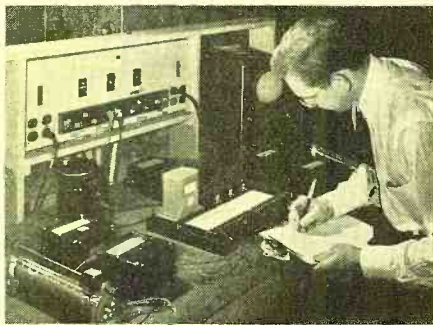

determine magnetic amplifier static characteristics, internal impedance and optimum load, dynamic characteristics, and types of control circuits.

All colleges, universities, laboratories and other groups who are interested in the *Vickers Demonstration Magnetic Amplifier* are invited to write for complete details.

MAGNETIC CORE MATERIAL

Westinghouse Electric Corp., P. O. Box 2099, Pittsburgh 30, Pa., has developed two magnetic core materials for transducer application. These materials, Hipersil and Hipernik V, have rectangular, very narrow hysteresis loops, and are especially suited for electronic applications such as magnetic amplifiers, saturable reactors, and the new type of contact rectifiers.

Available in several thicknesses of lamination for various frequency and response requirements, the materials can be supplied in continuous toroidal or rectangular and butt-joint cores.

For further information, write direct to *Westinghouse*.

FREQUENCY-DEVIATION MONITOR

Motorola Inc., 4545 Augusta Blvd., Chicago 51, Illinois, is now offering to operators of 2-way FM radio systems a highly sensitive frequency-deviation monitor to measure the relative strength



of signals being transmitted, the magnitude of frequency modulation, and the error displacement of the signal from its assigned center frequency.

Designed for 117 volt, 60 cycle operation.
(Continued on page 31)

Here are
a couple of
GOOD LEADS

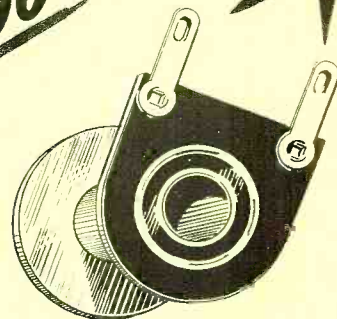

— another advantage
of using

PRECISION Coil BOBBINS

The lug-type terminal leads you can specify for the flanges of Precision Coil Bobbins allow faster, more trouble-free connecting than open-wire leads. Entire bobbin is impregnated to meet Underwriters' standards. We can give you flanges with leads (as above), with slots, holes, or plain—and all types can be furnished flat, recessed, or embossed—to fit any mounting. Tube ends swaged to lock flanges in place. Spiral-wound cores, heat-treated under compression, provide greater strength with less weight. Insulation strips are unnecessary—permitting closer winding, more compact coils.

Let us help you
with bobbins
designed
to fit YOUR
particular product!

Any shape, any size
... round, square,
rectangular ...
in dielectric Kraft,
Fish Paper, Cellu-
lose Acetate, or
combinations. Let
us make up a free
sample for you
NOW!

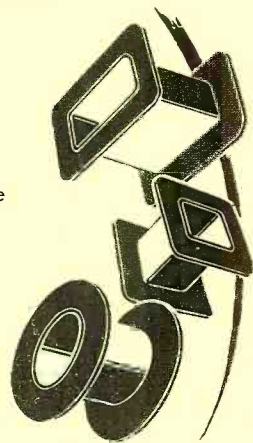

PRECISION PAPER TUBE CO.

Also Mfr's of Precision Di-formed Paper Tubes
2063 W. CHARLESTON ST., CHICAGO 47, ILL.
Plant #2, 79 Chapel St., Hartford, Conn.

Personals

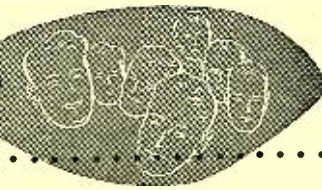

GABRIEL V. BUREAU has been appointed field engineer for the equipment sales department of the Radio Tube Division, *Sylvania Electric Products Inc.*, New York, N. Y. Mr. Bureau was formerly technical commercial manager for the *North American Philips Co.*, and assistant sales manager for the *Amperex Electronics Corp.* He received his B.S. in electrical engineering from the University of Southern California and is a member of the IRE and AIEE.



LAWRENCE L. FERGUSON, assistant executive engineer at *General Electric Company*, has been appointed to take charge of the West Milton Area Project at West Milton, N. Y., where an experimental atomic power plant is under construction as part of the *GE* laboratory facilities. Mr. Ferguson, who is a graduate of the California Institute of Technology, will be responsible for coordinating all phases of design and construction.



B. K. V. FRENCH has been appointed application engineer of the Electronic Parts Division of *Allen B. Du Mont Labs., Inc.*, with headquarters in the East Paterson plant. Mr. French began his active radio career in 1923 with *Federal Telegraph & Telephone* as development engineer and has been associated with *American Bosch, RCA, Case Electric*, and *P. R. Mallory Co.* He is a Senior Member of IRE and a member of The Radio Club of America.



RALPH E. GOULD, chief of the time section at the National Bureau of Standards, has retired after over thirty-one years of service. Mr. Gould is the author of many articles in *Bureau of Standards'* and other publications concerning the technical aspects of time computation and the construction and testing of timepieces. Mr. Gould will devote his time to duties as Secretary of the Horological Institute of America.



R. L. GROVE has been appointed chief engineer of *Cornell-Dubilier's Ceramic Division* in New Bedford, Mass. Mr. Grove, a graduate of Ceramic Engineering from the University of Illinois, was previously with *Westinghouse Electric Corporation* as Ceramic Engineer in the company's electrical porcelain plant at Derry, Pa., and more recently with the *Centralab Division of Globe Union, Inc.*, Milwaukee, Wisconsin.



DR. JOHN McELHINNEY recently joined the staff of the Radiation Physics Laboratory of the National Bureau of Standards where he will use the Bureau's new 50-million volt betatron for research in nuclear reactions and high-energy x-rays. Dr. McElhinney is co-author of several articles concerning the thresholds of photo-nuclear reactions and is a member of the American Physical Society, Sigma Xi, and Phi Kappa Phi.

Instrumentation

(Continued from page 6)

of single ended, push-pull, or differential input.

Various types of input circuits may be used with the amplifiers and the recording system considered here. However, the present equipment was constructed specifically to use strain gauge and piezoelectric transducers. Strain gauges are normally employed in Wheatstone bridge circuits which are often referred to as full, half, or quarter bridges to designate the number of strain gauges employed, the remainder of the circuit being composed of fixed precision resistors.

Since the effect of strain on the gauges is to increase or reduce their resistance the same effect may be obtained by inserting resistance in series or in shunt with one of the gauges. The shunt method was adopted in this instrumentation as a means of calibration. The calibration steps are recorded immediately before the test record is taken and form a reference for analyzing the record that eliminates calculation of:

1. Amplifier gain.
2. Oscilloscope sensitivity.
3. Bridge current.

A piezo gauge input is normally single ended and requires extremely high input impedance, the input impedance of the amplifiers being 100 megohms and the remainder of the input cables, condensers, switches, etc., exhibiting an input shunt resistance in excess of 1000 megohms. A charge calibration is imposed on the circuit immediately before firing. This makes possible computation of blast pressures without necessity of determining cable shunt capacitances, signal attenuation, amplifier gain, etc.

Immediately after this calibration is applied the blast is fired and Fig. 10 shows a sample four channel record taken during recent tests. The outside timing markers are provided by the pulsed glow tubes. The pressure peaks occur at different times due to the varied positions of the input transducers, which were in this case Tourmaline crystal gauges.

The basic operation of the units has been traced from recording system to input networks, but the preliminary discussion of the physical layout was rather sketchy. Let us take another look at Fig. 1. Each of six bays of instrument units consists of the following, from top to bottom:

1. Calibration Unit.
2. Terminal Unit.
3. Oscilloscope Unit.
4. Amplifier Unit.
5. Amplifier Power Supply.
6. Bridge Power Supply.

Bays 2 and 6 contain oscilloscope power supplies. The central bay contains all the control equipment, or units whose function is common to all operations. A truck, used for transporting and reeling necessary cables, is shown in the background.

Each of these bays may be used separately as a four channel unit, with the addition of control units if desired.

Conclusion

The equipment described above fulfills in design and practice the necessary requisites for a versatile, smoothly operating, multichannel cathode-ray oscillographic unit. The complete versatility of the basic unit has not been discussed at length, but suffice it to say that with minor redesign a great number of uses can be accommodated.

The twenty-four channel mobile oscillographic measuring unit was designed and constructed for the Ballistic Research Laboratories of Aberdeen Proving Ground. The authors wish to acknowledge the aid and assistance rendered by Dr. C. W. Lampson and Messrs. C. L. Adams and W. E. Curtis of that organization.



Forced Air Cooling

(Continued from page 13)

volume would increase to 140 c.f.m. Most blower manufacturers include curves of this nature in their catalogues or bulletins. Where they are not included, they are almost always obtainable from their engineering or sales departments.

Since most radio laboratories do not have facilities for readily measuring the actual performance curves of the blower, it is wise to choose a blower manufactured and measured under NAFM or made by a reputable manufacturer who will guarantee the performance curve. A rough check may be made by checking the pressure at the point where the blower ceases to deliver air. For the blower of Fig. 4 this will be approximately .95 inches water column. The output of the blower should be exhausted into a cardboard box sealed sufficiently tight to prevent air leakage at the cracks or at the blower outlet connection. The pressure developed inside the box should then be measured by means of a manometer. If there is excessive leakage past the air rotor or the motor speed is too low resulting in low tip velocity, then it will be impossible to build up pressure to this point.

Noise is another factor which must often be considered. This is especially true in locations such as studios where the noise level must be relatively low at all times. In general, it will be found that high pressure cooling systems will

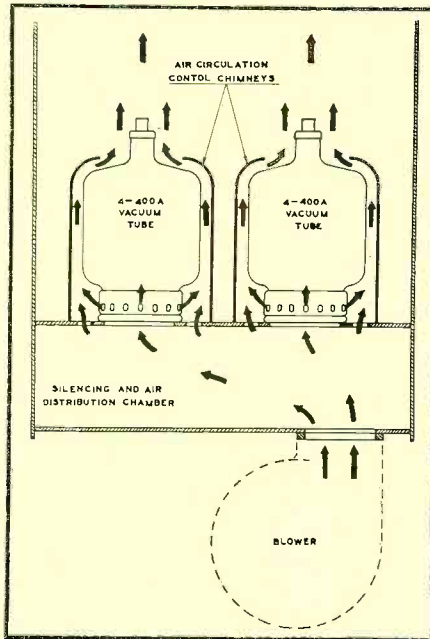

Fig. 6. Air path of system using internal anode tubes shown in Fig. 2.

result in higher noise levels. This is due to the high tip velocity necessary in generating the required air pressure. Low pressure systems, such as Fig. 1, have relatively low tip velocity and consequent low noise. This particular example has a pressure drop of only .125

inches water column at the rated volume flow of 400 c.f.m. In low pressure systems the air rotor turns at relatively low speeds, seldom more than 1800 r.p.m. and delivers a volume which is dependent on the physical size of the blower. High pressure blowers operate at high tip velocity or high peripheral speed and have less space between the air rotor and the housing resulting in the higher noise level.

Upon completion of the initial model, it is mandatory that the cooling system be checked as to its actual performance. This is not as difficult as it might seem and can be accomplished readily with quantitative results.

Obviously the first step is to measure the static pressure at the point specified by the tube manufacturer. A simple "U" tube manometer is sufficient for this measurement. A suitable unit may be purchased or may be made on the spot. A manometer sufficiently good for the static pressure measurements may be made by bending a short length of uniform cross-sectional area glass tubing into a "U" shape. Fig. 3 illustrates such a unit. Inside diameter should be on the order of one-fourth inch to minimize errors due to surface tension. Glass tubing of the required type is readily available from chemical supply houses or neon sign companies.

The measurement is essentially a wa-

Large or Small

SQUARE, ROUND OR RECTANGULAR PAPER TUBES

FOR COIL WINDING



Inside Perimeters from .592" to 19"

With specialized experience and automatic equipment, PARAMOUNT produces a wide range of spiral wound paper tubes to meet every need . . . from 1/2' to 30' long, from .592" to 19" inside perimeter, including many odd sizes of square and rectangular tubes. Used by leading manufacturers. *Hi-Dielectric, Hi-Strength.* Kraft, Fish Paper, Red Rope, or any combination, wound on automatic machines. Tolerances plus or minus .002". Made to your specifications or engineered for YOU.

Write on Company Letterhead for Arbor List

Paramount PAPER TUBE CORP.

613 LAFAYETTE ST., FORT WAYNE 2, IND.

Manufacturers of Paper Tubing for the Electrical Industry

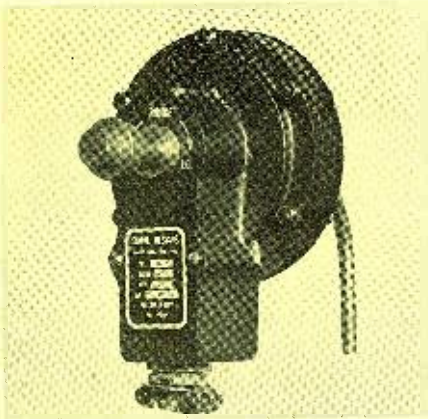

Fig. 7. Pressure type air interlock sw.

ter displacement process. One end of the tubing is left open, the other end is fastened by means of an air tight hose connection to the pressure point to be measured. The air pressure difference between the outside air and the pressurized chamber displaces the water. The difference between the water level of both legs of the tube represents the static pressure in inches water column and is measured directly in inches. In making the measurements it should be borne in mind that the tubing must be held in a vertical position for accurate results, and that the pressure is measured between the levels in the legs. For example, a static pressure of 1 inch would push the level of one leg up a half inch and that of the other leg down a half inch.

If the static pressure measured is equal to or greater than the tube manufacturer recommends, it may be safely assumed that the tube is being sufficiently cooled providing there are no obstructions past the tube which could introduce a pressure drop.

A further check is often desirable, however, and most conservative engineers or manufacturers do so as a matter of policy. This may be accomplished effectively by measuring the actual seal temperature and temperature of the anode coolers. This is difficult to do even at low frequencies due to inability to establish good heat conductivity between the seal under measurement and the thermometer bulb. In fact, such measurements may be so unreliable as to make them useless. At v.h.f. it is next to impossible to use bulb type ther-

Fig. 8. Vane type air interlock switch.



mometers due to the electrical conductivity of the mercury column or chemical used in the indicator column.

Chemicals have been developed which can be smeared directly on the spot to be measured and which will change color or crystallize when a given temperature is reached. One of these which has found ready acceptance in the tube industry is *Tempilac*. It may be purchased in a wide variety of temperature ranges. A small brush may be used to dab it on the spot to be checked. When the temperature reaches the melting point of the *Tempilac*, say 150°C, it may be observed melting and crystallizing. The crystals remain as mute evidence that the temperature of that particular spot has at some time reached or exceeded 150°C.

Safety Or Protection Devices

Where forced air cooling is required it is mandatory that some kind of safety protection be provided to prevent damage to the tubes or equipment should some part of the cooling system fail.

In the past, air velocity type switches have been popular as an air interlock. These are usually of the vane type. The air blowing past and against the vane actuates a switch which removes the high voltage to the tubes. Upon failure of this air stream the air pressure against the vane will drop actuating the switch. These types of air interlock switches are operated by the movement of the air stream only. Fig. 8 illustrates a modern example of a positive air interlock switch of this nature.

Interlocks of this type are used in cooling systems having relatively large air volume with low pressure. They can not afford protection should air leakage occur after the point where the switch is placed. They do have the advantage of affording protection should an obstruction occur any place in the air stream sufficient to reduce the air flow to a predetermined value.

Pressure actuated air switches have become popular with the increasing use of external anode tube cooling systems. Fig. 7 illustrates a pressure interlock developed by *Coral Designs* which has proved popular in electronic applications having air pressure from .2 inches up. It is essentially a diaphragm instrument having a large cross-sectional area diaphragm which actuates a snap-action switch at a predetermined pressure. The large cross-sectional area of the diaphragm makes possible positive action at low pressure. The transmitter shown in Fig. 4 employs a switch of this type. It may be seen mounted on the left side of the lower pressure chamber. The *Gates BC-5B* shown in Fig. 5 also uses an interlock of this type mounted in the center of the rear side of the pressurized chamber. —(E)—

TECHNICAL BOOKS

"COMMUNICATION CIRCUIT FUNDAMENTALS" by Carl E. Smith. Published by *McGraw-Hill Book Company*, 330 W. 42nd St., New York, N. Y. 401 pages. \$5.00.

This book is the second of four books designed for a complete course in radio and communication engineering prepared by the author for home study. The first book of the series was *Applied Mathematics for Radio and Communication Engineers*, which contained material prerequisite for a complete understanding of this text.

This is an important new text in circuit fundamentals for students, operators, technicians, and engineers. It covers the physics of circuit elements, including vacuum tubes, and presents the fundamentals of a.c. and d.c. circuits. Circuit constants are discussed first and then used in a treatment of d.c. circuits. After a study of magnetism, inductance, and capacitance, the principles of alternating currents are treated.

Although the text was planned to serve as a study of fundamentals in residence or correspondence courses, it should also prove of value for reading or reference for those who do not have the time to undertake a complete course.

"ELECTRON-TUBE CIRCUITS" by Samuel Seely, Prof. Electrical Engineering, Syracuse University. Published by *McGraw-Hill Book Company*, 330 W. 42nd St., New York 18, N. Y. 529 pages. \$6.00.

This college text is the outgrowth of several courses organized by the author on electron-tube circuits and applications that covered many of the important circuits in use during the second world war. It seeks to give a clear analytical method in the study of electron-tube circuits, and presents for study the various classes of circuits which find widespread application.

Examples indicating the procedure for combining circuits of various types to achieve either one or a multiplicity of operations is an important feature of this book. A discussion of tube circuits for performing mathematical operations and of those developed in connection with radar applications is found to be considerably more in detail than found in most textbooks of today.

The student should have completed his basic studies in a.c. circuit theory and basic electronics before undertaking a study of this material. The instructor will find that sufficient diversity exists to allow a choice of topics to satisfy almost any course requirements.

Wide-Band Amplifier

(Continued from page 16)

combining antenna outputs such as transformers, cathode followers, filter networks and stub arrangements. The wide-band amplifier can also be modified to provide a number of inputs with a common output. This can be accomplished by keeping the same arrangement in the plate line but changing the grid line. The simplest change is to enter the grid line after each filter section, and terminate the filter in its characteristic impedance, such as shown in Fig. 5. Thus each tube can be used for a separate input. The operation is similar to that previously described except that each tube has a different input. The signal applied to input No. 1 of Fig. 5 will excite the grid of the first tube and a current carrying this signal will travel toward the line and appear as a voltage at the receiver. Similarly, a signal applied to the input of the other tubes will also appear at the load and in this manner the output of the separate generators, in this case receiving antennas, are combined into a single transmission line. The use of this system provides nearly infinite attenuation between generators, thus eliminating interaction between antennas through the coupling unit. The receiving antenna's bandwidth can be sharpened in the stop band by using *m*-derived band pass sections in the grid line while using the conventional low-pass filter section in the plate. Thus any undesired frequencies received on the individual antennas will be further discriminated against. For further flexibility a method of gain control for each input can be added to the antenna coupler. This can be accomplished by use of resistance pads, variation of grid bias, or a variation of plate and screen voltages.

Many apartment house owners will not allow individual tenants to install antenna systems because of the large numbers of antennas that would have to be accommodated. This not only provides an unsightly appearance but breeds discontent because all of the positions on the roof do not provide good television reception. Also, interaction between antennas and receivers is likely to take place, all to the detriment of the picture quality of the reproduced signal.

But many of these same owners will agree to the installation of a master antenna system to which the individual sets can be connected. The problem then becomes one of splitting the single output into a number of loads. Additional amplification will usually be found necessary even in metropolitan areas because of the considerable loss found in long transmission line runs. The individual receivers must also be isolated

from one another so as to minimize interaction between receivers. Numerous multiple installations have been engineered and the problem has been solved in a number of ways. Some installers have used resistance pads (of about 30 db.) in each outlet so that the path between receivers would have a total of twice that amount. Others have used transformers, cathode followers, filter arrangements, and the like. The wide-band amplifier can also be used in this application by what amounts to the inverse solution of the antenna coupling problem.

In providing a receiver coupler the grid line remains as in the amplifier but the plate line is altered to provide a number of outputs from a single input as shown in Fig. 9. The input signal produces the same grid voltage at each tube and a current appears in the plate line. The currents now, instead of being combined in a single output, each go into their individual load, thus providing a number of outputs from the single input. The outputs are isolated from one another and from the input by an almost infinite impedance and thus no interaction can take place through the coupler.

Thus the wide-band amplifier technique can be used to combine a number of inputs into a common line, amplify the entire spectrum, and then to split the output into a number of loads. This problem is exactly the one encountered in the multiple television installations (See Fig. 8) and is also applicable to the testing and repairing of television receivers with a minimum of equipment. A number of signal generators can be located at a central point and the outputs can be combined, amplified to the desired level, and then distributed to the test positions. The tester has available several channel signals at the one outlet, without the necessity of providing individual generators at each outlet and without switching. Each set can be aligned at one position without signal generator switching or the necessity of having different test positions for each channel. This is a similar problem to the multiple installation of television receivers and Fig. 8 applies with signal generators substituted for receiving antennas, and test positions for TV outlets.

BIBLIOGRAPHY

1. Percival, W. S., *British Patent Specification No. 460,562, applied for July 24, 1936.*
2. Ginzton et al, *Distributed Amplification, Proceedings of IRE, p. 956, August 1948.*
3. Kamen, Ira, *Television Master Antennas, RADIO & TELEVISION NEWS, p. 31, April, 1949.*
4. Rudenberg & Kennedy, *200 MC Traveling Wave Chain Amplifier, Electronics, p. 106, December, 1949.*
5. Kallman, H. E., *Television Antenna and RF Distribution Systems for Apartment Houses, Proceedings of IRE, P. 1153, September, 1948.*
6. Kennedy and Rudenberg, *Wide-Band Chain Amplifier, Electrical Manufacturing, P. 56, November, 1949.*
7. Wheeler, H. A., *Wide-Band Amplifiers for Television, Proceedings of IRE 27, P. 437, 1939.*

NOT JUST
A PRODUCT*



BLILEY TYPE BH8 CRYSTAL UNIT ASSEMBLY SHOWING A 100 KC QT CUT CRYSTAL SILVER PLATED, AND RIGIDLY CLAMPED BETWEEN RESONANT PINS. STABILITY + 0.0004% PER DEGREE CENTIGRADE WITH Q OF APPROXIMATELY 100,000.

* BUT... A COMPLETE APPRECIATION OF DESIGN INTEGRITY AS APPLIED TO HIGH PRECISION FREQUENCY STANDARDS.

Always Specify Bliley!

Bliley CRYSTALS

BLILEY ELECTRIC COMPANY
UNION STATION BUILDING
ERIE, PA.

News Briefs

(Continued from page 22)

demonstrating an experimental machine. On the far right, contained in a cylinder, is the x-ray source. The x-rays come from the aperture in the cylinder, pass through the sample, and are then magnified by two mirrors contained in the unit on which Miss Lucht's fingers rest. The magnified x-ray image is finally cast on a photographic film mounted behind the optical system to the right.

GE scientists believe that x-ray microscopes may someday compete with electron microscopes and make possible examination of live specimens at much higher magnifications than ever before.

ELECTRONIC TORCH

Dr. J. D. Cobine, scientist of the General Electric Research Laboratory, has developed an electronic torch which can melt firebrick and even tungsten which melts at 3370 degrees centigrade. The flame consists of nitrogen being passed through a high-frequency arc.

The arc is formed by radio waves at the extremely high frequency of one thousand megacycles, generated by a magnetron tube. Dr. Cobine, shown melting a quartz rod in the flame, explained that the radio waves break up



nitrogen molecules which consist of two atoms into individual atoms. When these atoms reunite to form molecules again, heat is released.

No uses have been found as yet for the extremely hot torch which is still at the laboratory stage of development.

JET PILOT TRAINER

From Wright-Patterson Air Force Base, Dayton, Ohio, comes the announcement of the new "Linktronic" trainer which is the latest device in training equipment for jet pilots providing indoctrination in the use of radio navigation systems.

The compartment of this new trainer looks exactly like the cockpit of a modern, single-engine, jet fighter. The gauges and indicators operate and register just as they would in a real plane.

The eight instruments across the trainer's panel shown are synchronized to those in the cockpit so that the instructor is at all times able to follow the student's performance. The lights below the instruments flash to indicate error, result of error, and operating

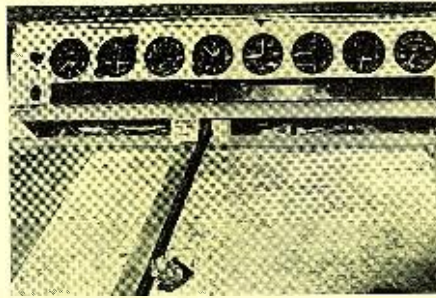

condition of the plane, while the flight recorder pen, mounted on a traveling arm, records simulated cross-country flights up to 1000 miles.

Microwave Comp.

(Continued from page 20)

$$R = 120 \frac{\lambda}{\delta} \frac{b}{a} \frac{1}{1 + \frac{a}{2b}} \dots (30)$$

In practice it has been found that finer tuning and stabler performances can in some cases be obtained using a reentrant cavity such as the one shown in Fig. 15B. In this case the center discontinuity acts as a capacitance and the two side arms act as inductances. By varying the depth of the discontinuity,

Fig. 16. Typical normalized susceptance vs. screw length curve ($x = 5.5$ cm., $b = .872''$, $a = 1.872''$, and screw diameter = $.126''$).

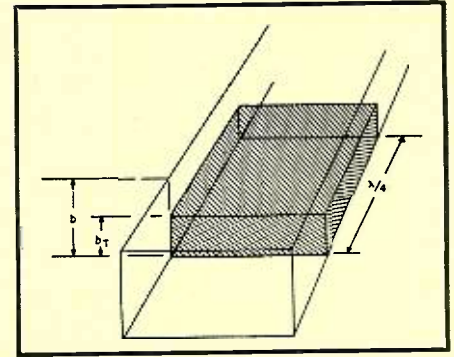
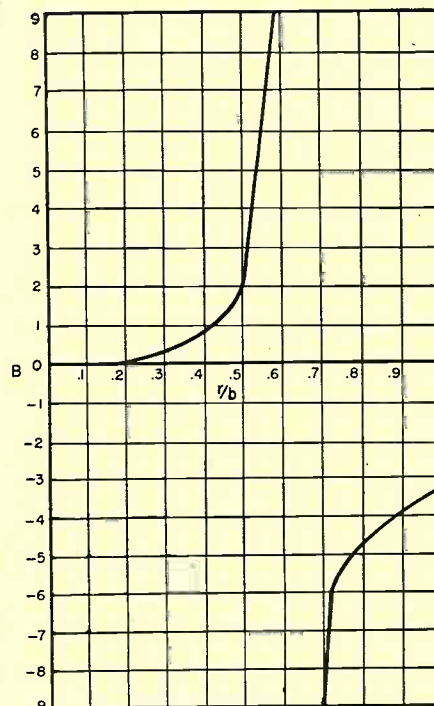

Fig. 17. Asymmetrical capacitive quarter-wave transformer.

the cavity can be made to resonate over a relatively wide range of frequencies.

Cylindrical cavities, such as the one shown in Fig. 15C, are employed in many applications. The characteristics of these cavities, which in many cases depend upon roots of Bessel Functions, are summarized below:

$$\lambda = \frac{1}{\sqrt{\left(\frac{1}{3.42}\right)^2 + \left(\frac{1}{2z}\right)^2}} \text{ for } H_{1,0,1} \text{ mode} \dots (31)$$

$$\lambda = \frac{1}{\sqrt{\left(\frac{1}{2.61a}\right)^2 + \left(\frac{1}{2z}\right)^2}} \text{ for } E_{1,0,1} \text{ mode} \dots (32)$$

$$\lambda = \frac{1}{\sqrt{\left(\frac{1}{1.64a}\right)^2 + \left(\frac{1}{2z}\right)^2}} \text{ for } H_{1,0,1} \text{ and } E_{1,1,1} \text{ modes} \dots (33)$$

$$Q \text{ (for TE modes half-wave long)} = \frac{Z_0}{\delta} \times$$

$$\frac{\left(u_{n,m}^1 + \frac{\pi a}{2z}\right)^2 \left(1 - \frac{n}{u_{n,m}^1}\right)}{\left(\frac{z}{a} u_{n,m}^1 + \frac{a^2 \pi^2}{4z^2} + \frac{a(2-a)\pi^2 n^2}{4z^2 u_{n,m}^1}\right)} \dots (34)$$

$$Q = \frac{a}{\lambda} \frac{1}{1 + \frac{a}{z}} \text{ for TM modes, } n \neq 0 \text{ (35)}$$

If $n = 0$, Q is given by:

$$Q = \frac{a}{\lambda} \frac{1}{1 + \frac{a}{2z}} \text{ (TM mode, } n = 0) \text{ (36)}$$

The use of many of the components described in this article will be clarified as the design of microwave equipment is covered.

BIBLIOGRAPHY

1. Racker, Joseph, "Microwave Techniques", RADIO-ELECTRONIC ENGINEERING, Feb. 1950.
2. Racker, Joseph, "Microwave Transmission Lines", RADIO-ELECTRONIC ENGINEERING, 1950.
3. Bronwell & Beam, "Theory and Application of Microwaves", pp. 176-210, McGraw-Hill Book Company, Inc. 1947.
4. "Reference Data Book for Radio Engineers", pp. 307-359, Federal Telephone and Radio Corporation, N. Y.

New Products

(Continued from page 25)

ation, the unit monitors up to five carrier frequencies in either the 25-50 mc. band or the 152-174 mc. band. Additional frequencies may be monitored by the simple exchange of control crystals.

An important part of the *Motorola* monitor is an AM receiver pre-tuned to Washington, D. C. station WWV, by which the monitor may be accurately checked and calibrated.

MARINE RADAR

Raytheon Manufacturing Co., Waltham, Mass., has introduced the newest in its series of commercial marine radar equipments, the *Mariners Pathfinder Jr.*, designed to meet the demands of operators of tugs, ferries, fishing vessels, yachts and other smaller craft for a compact, low-power drain and lower cost radar.

The system, comprised of an antenna, transmitter-receiver and indicator, op-

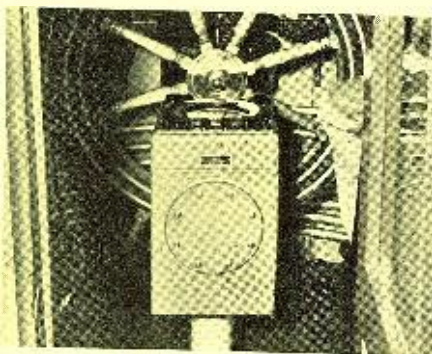

erates on a wavelength of 3.2 centimeters. The *Mariners Pathfinder Jr.* has a minimum range of 75 yards and a maximum of 20 miles. Range accuracy is within 2 per-cent and bearing accuracy is within 2 degrees. This unit is available for vessels equipped with 32-volt d.c., 110-volt d.c., 220-volt d.c. or 115-volt a.c. power systems. Power consumption in all cases is less than 750 watts.

Photograph showing the indicator of *Mariners Pathfinder Jr.* radar installed in wheelhouse of the tug "Eileen Ross" illustrates compactness of the equipment.

DUAL TIMING DEVICE

Two individual timing elements, each able to control a specific operation, accommodated in a single housing is the *Tandem Recycling Timer* manufactured

by *Industrial Timer Corporation*, Newark, N. J.

When the timer dials are set to the respective time intervals required, each cycle of operation will follow the other continuously in regular sequence. ON

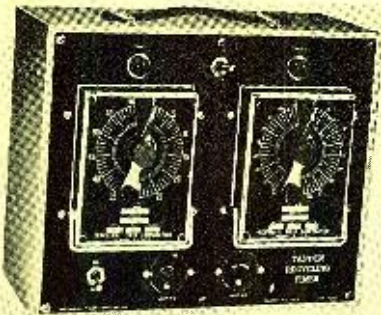

and OFF Toggle Switch, Load Control Switch and Pilot Lamp are integrated with other components to give a compact, clean-cut, portable assembly. The complete control cabinet measures 11½ x 9 x 7 inches and contains two sockets into which the timing elements are plugged so that they control a single-pole, double-throw load relay. The contact circuit of this relay is unpowered, permitting application of the particular voltage and current necessary for test or production.

D. C. Amplifier

(Continued from page 11)

11. Throw switch B in the "off" position.

12. Adjust "DETECTOR CONTROL" potentiometer to read ZERO. Do not allow to go below zero.

13. Throw switch B in the "on" position.

Now the d.c. amplifier is ready to function. Operations (1) to (13) are made before the amplifier is used and represents the basic alignment of the amplifier. They do not need to be repeated every time. They are made with no d.c. signal at the input terminals. The potentiometers involved in operation 7, 9 and 12 must never be touched again except for checking the alignment periodically by repeating all of the above operations.

Operating Instructions

To operate the d.c. amplifier after once aligned in accordance with the alignment instructions above, the following are the sequences:

(1). Throw switch "A" in the "set to 50" position No. 1.

(2). Turn the "AMPLIFIER CONTROL" potentiometer all the way down.

(3) Connect the terminals "input". The right polarity must be used. No reading is possible with wrong polarity.

(4) Turn the "AMPLIFIER CONTROL" potentiometer up to read 50 again. This position will be reached

sooner than 4 of the alignment procedure. It should therefore be done carefully.

(5). Throw the switch "A" in the "Reading" position No. 3.

(6). Adjust the "METER CONTROL" potentiometer to read 50. Now any increase of the d.c. signal will increase the reading while any decrease will decrease the reading a proportional amount.

The meter may be calibrated by checking with known signals in case an actual measure is required instead of only an indication of d.c. voltage change. The maximum d.c. input voltage is 100 volts. The meter is a voltmeter with 100 volts full scale deflection and having an internal resistance as high as possible.

ZOPHAR



WAXES COMPOUNDS and EMULSIONS

FOR
INSULATING and WATERPROOFING
of ELECTRICAL and
RADIO COMPONENTS

Also for
CONTAINERS and PAPER
IMPREGNATION

FUNGUS RESISTANT WAXES

ZOPHAR WAXES and COMPOUNDS

Meet all army and navy
specifications if required

Inquiries Invited

ZOPHAR MILLS, INC.

FOUNDED 1846

122-26th ST., BROOKLYN, N. Y.

C.T.I. TRAINED MEN ARE AVAILABLE!

Each month C.T.I. graduates ambitious young men who have completed an intensive course in Radio and Television maintenance and repairing. Their training has been practical. They've learned by working on modern equipment under personal, expert supervision.

If you need a trained technician, we invite you to write for an outline of our course, and for a prospectus of the graduate. (No fees, of course). Address:

Placement Manager, Dept. P106-4

COMMERCIAL TRADES INSTITUTE

1400 Greenleaf • Chicago 26

PHOTO CREDITS

Pages

3, 4, 5, 6. Armour Research Foundation
7, 9. Federal Telecommunication
Laboratories
12, 13. Gates Radio Company
14. Spencer-Kennedy Laboratories

CHARACTERISTIC IMPEDANCE OF LINES

This chart gives theoretically exact values for solid dielectric concentric lines for any scale of dimensions if lossless dielectric (completely filling space between conductors) and perfect conductors are assumed.

$$Z_0 = \frac{138}{\sqrt{\epsilon}} \text{LOG}_{10} \frac{D}{d}$$

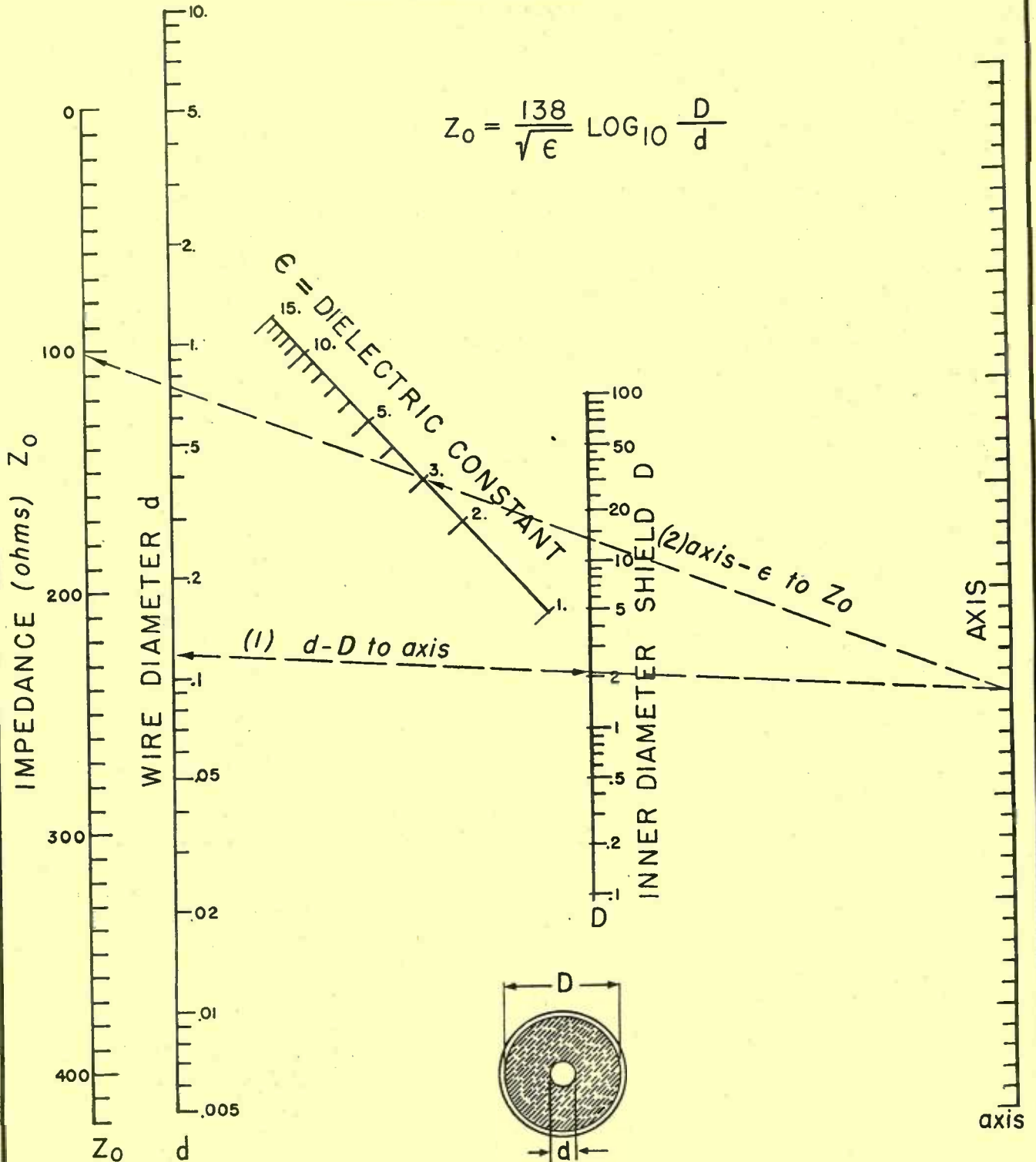

Courtesy of Federal Telephone and Radio Corporation.

HERE IS THE LONG SOUGHT ANSWER IN TELEVISION TRAINING FOR THE MAN ALREADY IN RADIO! TRAIN AT HOME—FULL PROGRAM—4 TO 8 WEEKS!

Low Cost—Monthly Payments. Everything You Need to Learn...

TELEVISION

I Send You NOT JUST an Ordinary TV Kit—But a Complete Training System Including TV Test Equipment

Here is the NEW Combination Sprayberry Television Training System

Out of my laboratory has come an entirely new Television Training...cutting months off the time required in old methods. I give all the knowledge and experience you need in weeks instead of months. I start where your present radio experience ends. The same day you enroll with me, I rush the first of many big Television kits that I will send during your training. From the first hour you are experimenting and testing practical TV circuits...and you keep right on from one fascinating experiment to another. You build the remarkable new Television Receiver-Tester illustrated at the left and useful TV Test Equipment. I give you theory, too, but it's 100% practical stuff that will make money for you in Television.

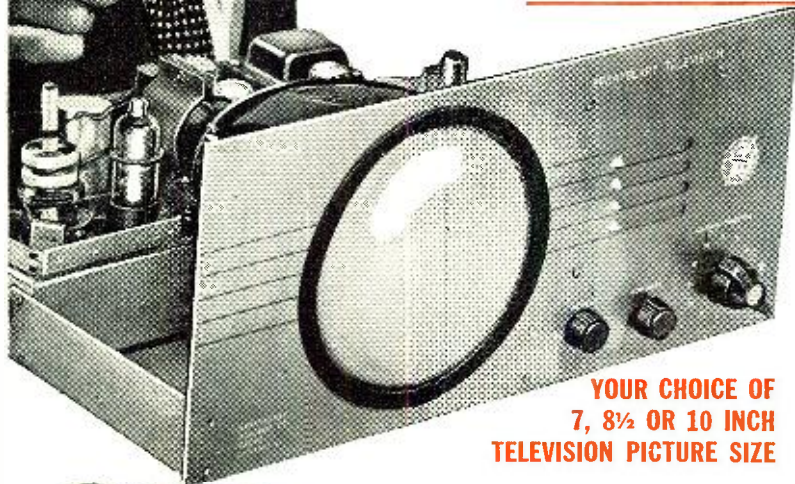

YOUR CHOICE OF 7, 8½ OR 10 INCH TELEVISION PICTURE SIZE

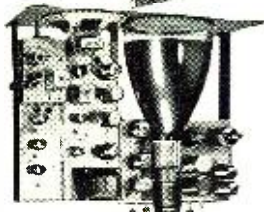

Exclusive THREE-UNIT Construction

You build my Television Receiver-Tester in three separate units—one unit at a time...each complete and self contained within itself. With each unit you perform dozens of important experiments—and each unit may be used in actual Television receiver servicing. In this way my training may save you many dollars by eliminating the need for costly TV Test Equipment. With these three units you can locate most TV Receiver troubles quickly and easily.

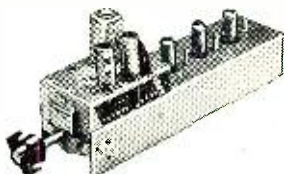

TV Tuner—I. F. Unit

Contains the RF amplified local oscillator, mixer and three stages of broad band IF amplification and the video second detector. The output constitutes the video signal and audio IF signal. For training, it is used to build and test video second detector, and stagger tuned IF amplifier obtaining 4.5 mc band pass. For TV servicing, it becomes a TV calibrator for IF alignment, substitute tuner, IF signal injector and second detector.

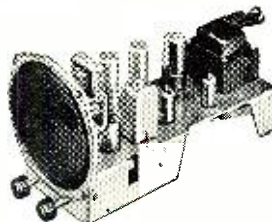

Video-Audio Amplifier Unit

Provides 4.5 mc IF ratio detector, low voltage power supply. For TV, it becomes the audio output, including speaker, video output and low voltage power supply for RF and IF stages. For training, it is used to build and test transformer type power supplies, audio, video, IF amplification and FM detection. For TV servicing, it is an audio signal tracer, IF signal tracer, video signal tracer and low voltage power supply.

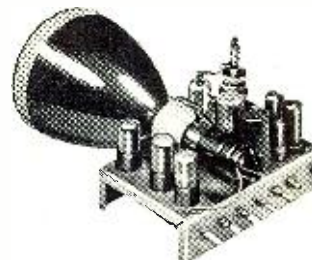

Video Tube "Scope" Unit

Scope unit contains low and high voltage (6000 V.) power supply for independent operation. For television, it becomes the sync, vertical and horizontal sweep circuits and their power supplies. For training, it is used to build and test most TV power supply, deflection, sweep, oscillator, and sync circuits. For TV servicing, it is a video signal tracer and sweep signal analyzer as well as substitute high and low voltage power supplies.

BE READY FOR TOP PAYING TELEVISION JOBS

If you are a radio-serviceman, experimenter, amateur or advanced student... **YOUR FUTURE IS IN TELEVISION.** Depending upon where you live, Television is either in your town now... or will be there shortly. This is a vast new industry that needs qualified trained men by the thousand to install and service TV sets. There's really big money in Television, but you **MUST** know what you are doing to "cash-in" on it. I will train you in a few short weeks if you have had previous radio training or experience.

IMPORTANT—FOR MEN JUST STARTING OUT IN RADIO-TELEVISION

If you have no previous experience in Radio work, be sure to mark that fact on the coupon below. I will send you complete information about my Radio-Television training that starts with basic fundamentals and carries you right through my new Radio and Television Training. I will send you my two big Radio-Television books, including an actual lesson selected from my course. I want you to know exactly what this great industry has in store for you. There is no obligation, of course, and **NO SALESMAN WILL CALL.**

VETERANS—Radio portion of training available under G. I. Bill



FILL OUT AND MAIL COUPON
Get these Valuable Books FREE!

Every Radio Serviceman today realizes his future is in Television. He knows he **MUST** have training—the right kind of practical training such as I am now offering—to protect his job, his business for the future. This is equally important for the man just starting out. And so I urge you to get the facts I offer you **FREE** and without obligation. Learn how quickly and easily you can get into Television. Fill out and mail the coupon **TODAY.**

SPRAYBERRY ACADEMY OF RADIO, Dept. 25-H
111 North Canal St., Chicago 6, Ill.

Please rush to me all information on your Radio-Television Training plan. I understand this does not obligate me and that no salesman will call upon me.

Name..... Age.....

Address.....

City..... State.....

Please Check Below About Your Experience

Are You Experienced? No Experience

SPRAYBERRY ACADEMY OF RADIO, 111 N. Canal, Dept. 25-H, Chicago 6, Ill.

April, 1950

2 Pages of TEST EQUIPMENT at prices every serviceman can afford!

OUR POLICY

MONEY BACK? Every unit we advertise is offered on a strict "money-back-if-not-satisfied-basis." No if's—no but's—no maybe's. If you are not

completely satisfied after a 10-day trial—return for complete refund. No explanation—you are sole judge. Plain enough?

GUARANTEE? Every unit sold by us is covered by a one-year guarantee.

KITS? We have discontinued advertising Test Equipment in kit form. After handling kits for a period of three months, we have come to the conclusion that it is impractical to successfully complete instrument

kits at home without the expensive calibration standards and other equipment available when instruments are factory produced.

THE NEW MODEL 200

AM and FM SIGNAL GENERATOR

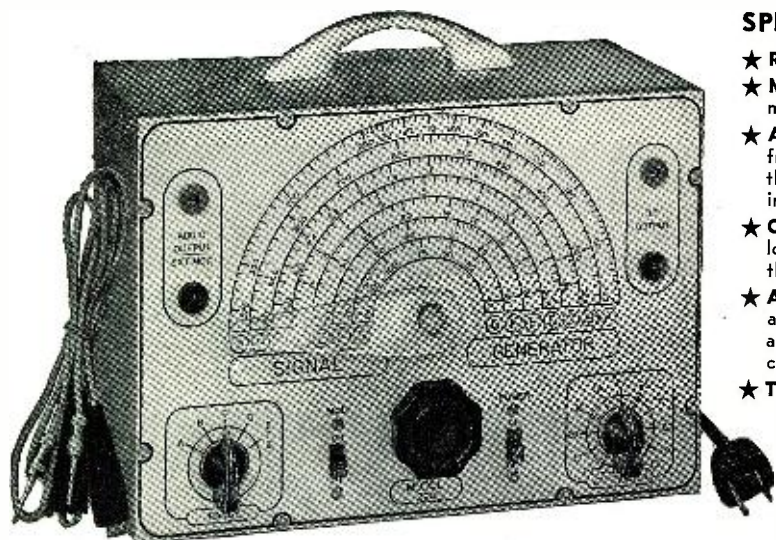

SPECIFICATIONS

- ★ **R.F. FREQUENCY RANGES:** 100 Kilocycles to 150 Megacycles.
- ★ **MODULATING FREQUENCY:** 400 Cycles. May be used for modulating the R.F. signal. Also available separately.
- ★ **ATTENUATION:** The constant impedance attenuator is isolated from the oscillating circuit by buffer tube. Output impedance of this model is only 100 ohms. This low impedance reduces losses in the output cable.
- ★ **OSCILLATORY CIRCUIT:** Hartley oscillator with cathode follower buffer tube. Frequency stability is assured by modulating the buffer tube.
- ★ **ACCURACY:** Use of High- Q permeability tuned coils adjusted against 1/10th of 1% standards assures an accuracy of 1% on all ranges from 100 Kilocycles to 10 Megacycles and an accuracy of 2% on the higher frequencies.
- ★ **TUBES USED:** 12AU7—One section is used as oscillator and the second is modulated cathode follower. T-2 is used as modulator. 6C4 is used as rectifier.

The Model 200 operates on 110 Volts A.C. Comes complete with output cable and operating instructions.

\$18⁸⁵
NET

SUPERIOR'S NEW MODEL TV-10

TUBE TESTER



SPECIFICATIONS

- ★ Tests all tubes including 4, 5, 6, 7, Octal, Lock-in, Peanut, Bantam, Hearing Aid, Thyratron, Miniatures, Sub-Miniatures, Novals, etc. Will also test Pilot Lights.
- ★ Tests by the well-established emission method for tube quality, directly read on the scale of the meter.
- ★ Tests for "shorts" and "leakages" up to 5 Megohms.
- ★ Uses the new self-cleaning Lever Action Switches for individual element testing. Because all elements are numbered according to pin-number in the RMA base numbering system, the user can instantly identify which element is under test. Tubes having tapped filaments and tubes with filaments terminating in more than one pin are truly tested with the Model TV-10 as any of the pins may be placed in the neutral position when necessary.
- ★ The Model TV-10 does not use any combination type sockets. Instead individual sockets are used for each type of tube. Thus it is impossible to damage a tube by inserting it in the wrong socket.
- ★ Free-moving built-in roll chart provides complete data for all tubes.
- ★ Newly designed Line Voltage Control compensates for variation of any line voltage between 105 Volts and 130 Volts.

The Model TV-10 operates on 105-130 Volt 60 Cycles A.C. Comes housed in a beautiful hand-rubbed oak cabinet complete with portable cover.

\$39⁵⁰
NET

----- TO ORDER—USE RUSH ORDER FORM ON NEXT PAGE -----

GENERAL ELECTRONIC DISTRIBUTING CO.

98 PARK PLACE
DEPT. RN-4
NEW YORK 7, N. Y.



Superior's new model 770

AN ACCURATE POCKET-SIZE VOLT-OHM MILLIAMMETER

(SENSITIVITY: 1000 OHMS PER VOLT)

FEATURES

- ★ Compact—measures 3 1/8" x 5 7/8" x 2 1/4".
- ★ Uses latest design 2% accurate 1 Mil. D'Arsonval type meter.
- ★ Same zero adjustment holds for both resistance ranges. It is not necessary to readjust when switching from one resistance range to another. This is an important time-saving feature never before included in a V.O.M. in this price range.
- ★ Housed in round-cornered, molded case.
- ★ Beautiful black etched panel. Depressed letters filled with permanent white, insures long-life even with constant use.

The Model 770 comes complete with self-contained batteries, test leads and all operating instructions.

SPECIFICATIONS

- 6 A.C. VOLTAGE RANGES:** 0—15/30/150/300/1500/3000 VOLTS
- 4 D.C. CURRENT RANGES:** 0—1.5/15/150 MA. 0—1.5 AMPS.
- 6 D.C. VOLTAGE RANGES:** 0—7.5/15/75/150/750/1500 VOLTS
- 2 RESISTANCE RANGES:** 0—500 OHMS 0—1 MEGOHM

\$13⁹⁰
NET

Superior's new model 670



SUPER-METER

A COMBINATION VOLT-OHM MILLIAMMETER PLUS CAPACITY REACTANCE INDUCTANCE AND DECIBEL MEASUREMENTS

SPECIFICATIONS:

- D.C. VOLTS:** 0 to 7.5/15/75/150/750/1,500/7,500 Volts.
- A.C. VOLTS:** 0 to 15/30/150/300/1,500/3,000 Volts
- OUTPUT VOLTS:** 0 to 15/30/150/300/1,500/3,000 Volts
- D.C. CURRENT:** 0 to 1.5/15/150 Ma. 0 to 1.5 Amperes
- RESISTANCE:** 0 to 500/100,000 Ohms 0 to 10 Megohms
- CAPACITY:** .001 to .2 Mfd. .1 to 4 Mfd. (Quality test for electrolytics)
- REACTANCE:** 700 to 27,000 Ohms 13,000 Ohms to 3 Megohms

- INDUCTANCE:** 1.75 to 70 Henries 35 to 8,000 Henries
- DECIBELS:** -10 to +18 +10 to +38 +30 to +58

ADDED FEATURE:

The Model 670 includes a special GOOD-BAD scale for checking the quality of electrolytic condensers at a test potential of 150 Volts.

The Model 670 comes housed in a rugged, crackle-finished steel cabinet complete with test leads and operating instructions. Sizes 5 1/2" x 7 1/2" x 3".

\$28⁴⁰
NET

The model CA-11

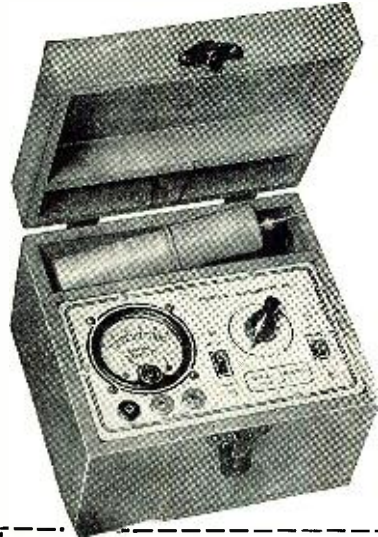

SIGNAL TRACER

SIMPLE TO OPERATE . . . BECAUSE IT HAS ONLY ONE CONNECTING CABLE—NO TUNING CONTROLS!

FEATURES

Introduced in 1939-1940 Signal Tracing, the "short-cut" method of Radio Servicing quickly became established as the accepted method of localizing the cause of trouble in defective radio receivers. Most of the pre-war testers (including ours) were bulky, requiring a number of connections before the unit was "set for operation" and included a tuned amplifier, which had to be "returned" to compensate for signal shift.

- ★ **SIMPLE TO OPERATE**—only 1 connecting cable—NO TUNING CONTROLS
- ★ **HIGHLY SENSITIVE**—uses an improved Vacuum Tube Voltmeter circuit. Tube and resistor-capacity network are built into the Detector Probe.
- ★ **COMPLETELY PORTABLE**—weighs 5 lbs. and measures 5" x 6" x 7".
- ★ Comparative Signal Intensity readings are indicated directly on the meter as the Detector Probe is moved to follow the Signal from Antenna to Speaker.
- ★ Provision is made for insertion of phones.

The new Model CA-11 affords all the advantages offered by the pre-war models and only weighs 5 lbs. and measures 5" x 6" x 7". Always ready for immediate use without the necessity of connecting cables, this amazingly versatile unit has NO TUNING CONTROLS.

The Model CA-11 comes housed in a beautiful hand-rubbed wooden cabinet. Complete with Probe, test leads and instructions.

\$13⁵⁰
NET

GENERAL ELECTRONIC DISTRIBUTING CO. DEPT. RN-4, 98 PARK PLACE, NEW YORK 7, N. Y.

RN-4

GENTLEMEN: PLEASE RUSH THE MATERIAL LISTED BELOW:

Quantity	MODEL	PRICE
TOTAL		

Name _____
 Address _____
 City _____ Zone _____ State _____
 \$ _____
 (Payment in Full Enclosed) (Deposit Enclosed—Ship Balance C.O.D.)

CHANNEL MASTER'S Super-Fan!

• STRENGTH • RIGIDITY • SENSITIVITY

SUPERSEDES
THE BM 312
FAN FLECTOR
SERIES

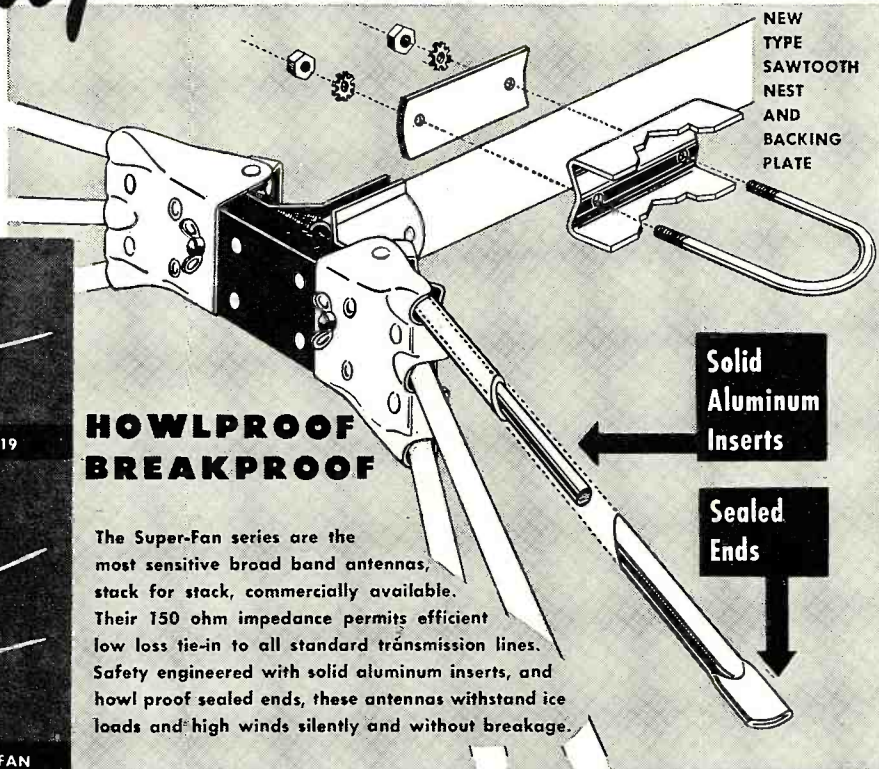

- LOWER PRICES
- SMALLER BOX
- SUPERIOR PREASSEMBLY

HOWLPROOF BREAKPROOF

The Super-Fan series are the most sensitive broad band antennas, stack for stack, commercially available. Their 150 ohm impedance permits efficient low loss tie-in to all standard transmission lines. Safety engineered with solid aluminum inserts, and howl proof sealed ends, these antennas withstand ice loads and high winds silently and without breakage.

These models also feature *Swing-Lock-Action*, the patented preassembled feature of all Channel Master antennas. Just swing out elements and lock them in place — as easy as that.

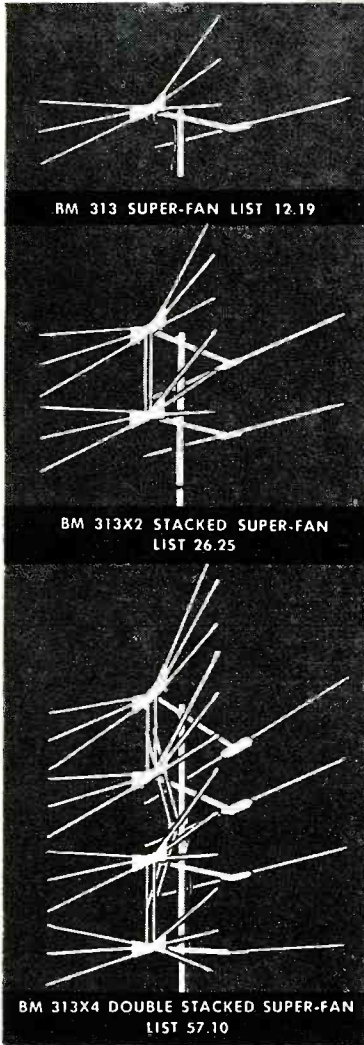

A TELEVISION SET IS NO BETTER THAN ITS ANTENNA
THERE IS NO BETTER ANTENNA THAN THE SUPER-FAN

Send for **FREE** Technical Literature

GAIN OF THE SUPER-FAN SERIES

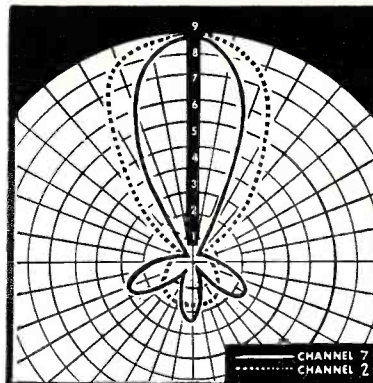

HORIZONTAL POLAR DIAGRAMS

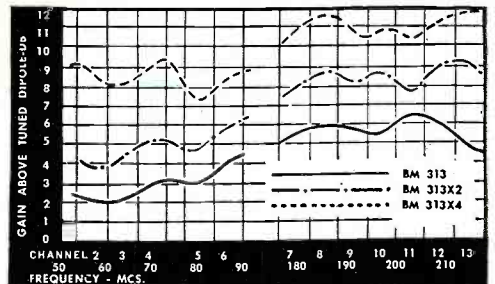

GAIN CURVES

CHANNEL	2	3	4	5	6	7	8	9	10	11	12	13	
313	2.1	2.2	3.0	3.0	4.0		5.5	5.8	5.8	5.7	6.5	6.0	4.7
313X2	4.8	5.0	6.1	5.7	6.8		9.0	9.7	9.3	9.4	8.8	9.8	10.0
313X4	9.0	8.2	9.0	7.5	8.5		11.0	11.4	10.6	10.8	10.3	11.3	11.9

GAIN IN DB. ABOVE TUNED DIPOLE



FIRST IN PREASSEMBLED ANTENNAS

ELLENVILLE, N. Y.

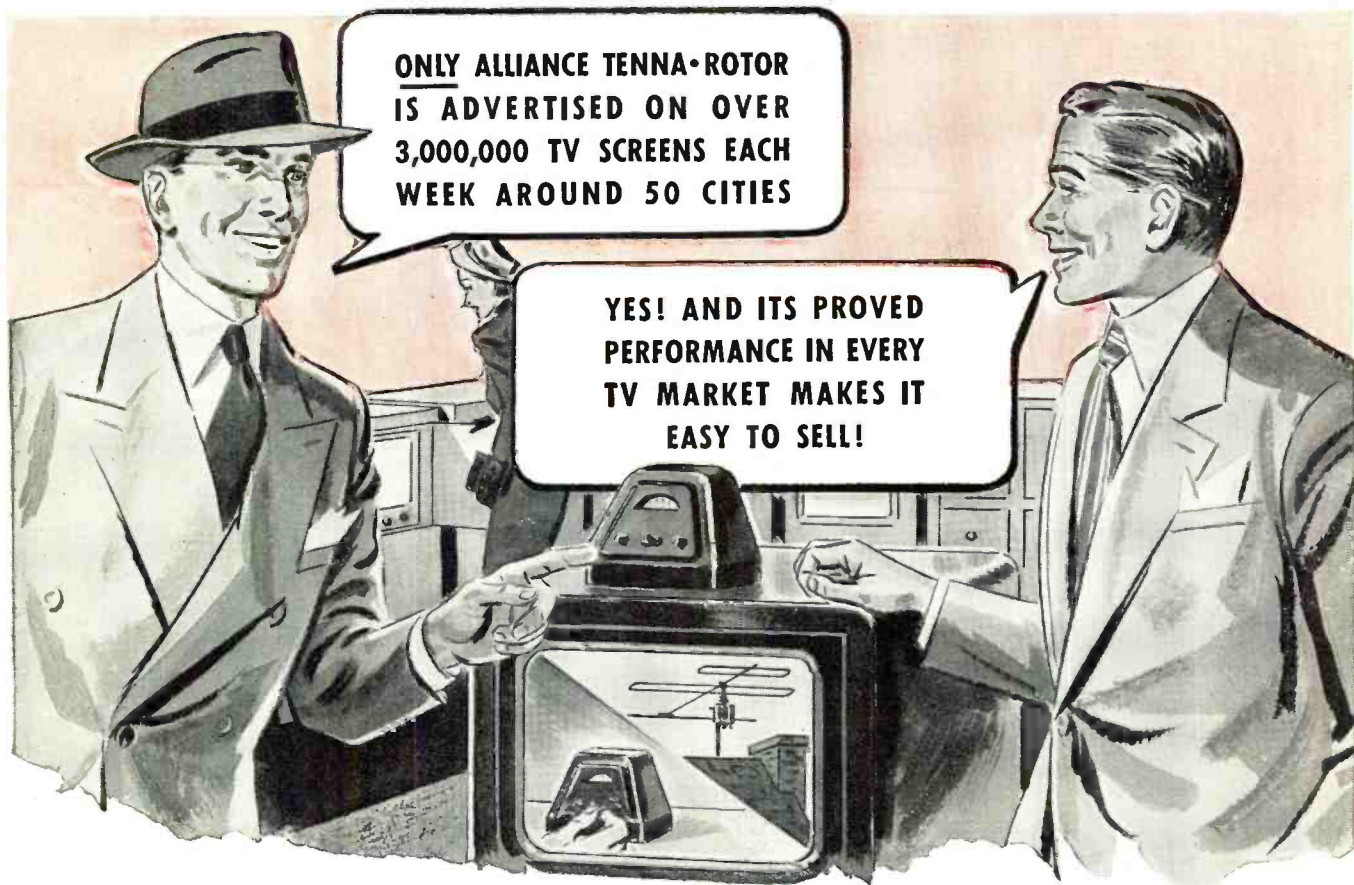

No wonder **ALLIANCE TENNA-ROTOR** is the fastest profit maker in television today!

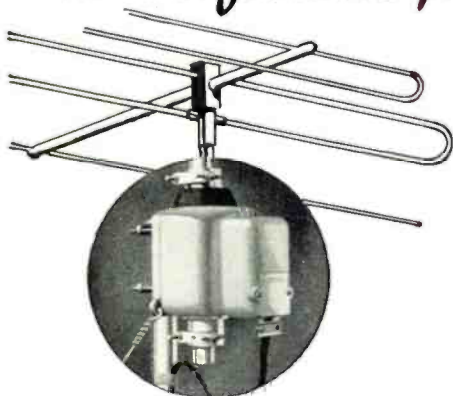

Tenna-Rotor comes complete in one package!
Both standard Model ATR and Deluxe Model DIR available!

New Model DIR as illustrated has indicator control case to show compass direction!



There's Only One TENNA-ROTOR! Here's Why!

- 1** Only Tenna-Rotor blankets the nation with advertising . . . every week your customers see Alliance film demonstrations right in their homes!
- 2** Only Tenna-Rotor can point to nearly 200,000 satisfied users from coast to coast!
- 3** Only Tenna-Rotor has Underwriters' Laboratories approval and a one year guarantee!
- 4** Only Tenna-Rotor has special 4-conductor cable with "ZIP" feature for faster, easier installations!

E. T. L. Laboratory tests prove operation in sub-zero, rain and icy weather!



Trade Mark Reg. U. S. Pat. Off.

ALLIANCE MANUFACTURING COMPANY • ALLIANCE, OHIO
Makers of Alliance Phonomotors and Powr-Pakt Motors

NOW...in all G-E Variable Reluctance Cartridges...at no extra cost!



"BATON" STYLUS



An Exciting New Discovery in High Fidelity Reproduction!

THERE'S terrific sales appeal—as well as listening pleasure—in this revolutionary General Electric Stylus! Like a baton in the hands of a skilled symphony conductor, it brings out the full tonal quality of recorded music as you've never heard it before!

Its feather-light tip, on the end of a dual-twist cantilever arm, follows every curve and dip of the record groove with a compliance so delicate it picks up frequencies through 10,000 cycles per second! The blasting, buzz, and hum so annoying in most record reproduction are virtually wiped out. Above all—the tone fidelity of the Baton Stylus is unsurpassed by any other commercially available unit! Equipped with diamond or sapphire tip, it fits any G-E replaceable stylus cartridge.

HOW COMPLIANT CAN A NEEDLE BE?

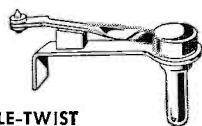

SINGLE-TWIST STYLUS

Until the development of the Baton Stylus, this model afforded unsurpassed fidelity. The single-twist arm and single damping block were designed for a tracking pressure of 21 grams. It was recognized, however, that lighter pressure would lengthen both record life and stylus life.

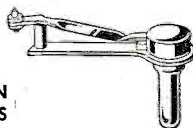

BATON STYLUS

Bending and twisting to every undulation of the record groove, this stylus reproduces each tone value with amazing clarity. Tracks at 6 grams—thus providing the maximum degree of compliance that may be used successfully with commercially available tone arms. Double damping blocks filter out superfluous vibrations.

Dealers and Servicemen!

There's a big market for the Baton Stylus among present users of General Electric cartridges. Hi-fi fans and record enthusiasts everywhere will want this sensational new model in their phonograph tone arms. Be sure you get your share of this business... the coupon below can open the door to new customers, new sales, new profits.

FREE Baton Stylus Folder!

General Electric Company, Section 940
Electronics Park, Syracuse, New York

Send me FREE folder on the new Baton Stylus.

NAME _____

ADDRESS _____

CITY _____ STATE _____



You can put your confidence in—

GENERAL  ELECTRIC

ANOTHER **HYTRON FIRST** YOU'LL BE BUYING SOON



new HYTRON 12BH7

does more for less

- **Ideal Sweep Amplifier**
- **Higher-Perveance Twin Triode**
- **Designed for TV**
- **Permits Lower-Cost TV Sets**
- **Another Hytron TV First**

Here's another Hytron original you'll be buying soon. New 12BH7 twin triode is enthusiastically hailed as tops for sweep circuits by leading makers of TV sets. One half 12BH7 sweeps wide-angle 16-inch picture tube at 14 kilovolts. One section alone matches performance of: Paralleled 6SN7GT. Or equivalent single triode. Or triode-connected beam pentode. Other half of 12BH7 is free for other uses—such as blocking oscillator.

How does Hytron do it? Higher perveance (lower tube loss)? Yes. Also the Hytron 12BH7 is: designed for TV. Rated for TV. Tested for TV. Again a Hytron TV first. Again a Hytron contribution to lower-cost TV for the mass market. Watch for the 12BH7. Write for Bulletin E-149.

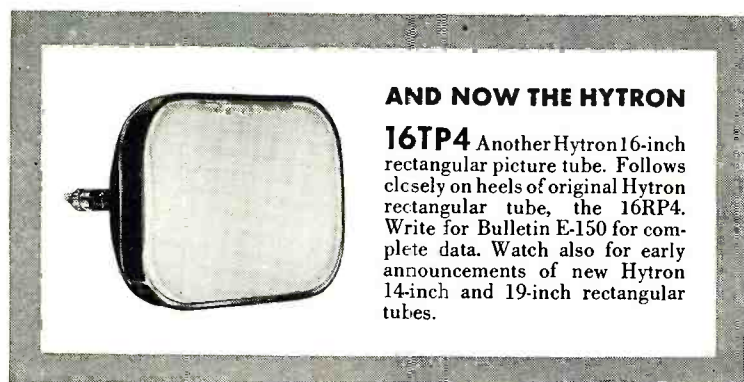

AND NOW THE HYTRON

16TP4 Another Hytron 16-inch rectangular picture tube. Follows closely on heels of original Hytron rectangular tube, the 16RP4. Write for Bulletin E-150 for complete data. Watch also for early announcements of new Hytron 14-inch and 19-inch rectangular tubes.

MODERN LOW-COST 16-IN. DESIGN

A Hytron contribution to lower TV costs. All-Hytron: 1X2, 6BQ6GT, 6U4GT, 12BH7, 16TP4 or 16RP4. For application and circuit details, write for Bulletin E-151.

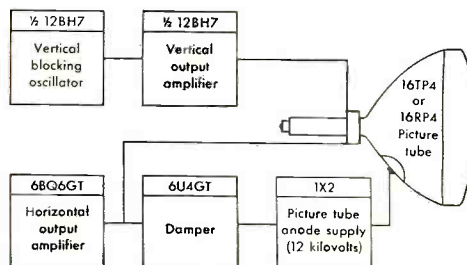

OLDEST MANUFACTURER OF RECEIVING TUBES
HYTRON
RADIO AND ELECTRONICS CORP.



MAIN OFFICE: SALEM, MASSACHUSETTS

the New
PYRAMID
"Humidi-Seal"

(TUBULAR PAPER CAPACITOR)



Ruggedly built to withstand undue vibration and rough handling

Outer tube plastic impregnated to prevent moisture-absorption

Light outer coat of high-temp wax provides double protection

Each end plastic sealed against moisture

Leads anchored securely in solid plastic end



Type B5TOC "Humidi-Seal" capacitors are specially designed for 85° C. operation, even in the most humid atmospheres, and will meet the severe present-day demands of endurance in television receivers, auto radios, etc.

WRITE FOR COMPLETE LITERATURE

Representatives and Distributors throughout the U.S.A. and Canada



PYRAMID

PYRAMID ELECTRIC COMPANY

155 Oxford Street
Paterson, N. J., U.S.A.

TELEGRAMS: WUX Paterson, N. J.
CABLE ADDRESS: Pyramidusa

Within the
INDUSTRY

CHARLES GREENWOOD ROBERTS, JR., product manager for radio and television broadcast equipment in *General Electric Company's* commercial equipment division, died recently in Syracuse after a short illness.



Well-known in the broadcast equipment industry both here and abroad, Mr. Roberts joined *General Electric* in 1928 upon graduation from Union College. He transferred to the international division of *Radio Corporation of America* in 1930 where he was engaged in new product development and sales. In this capacity, Mr. Roberts traveled all over the world.

In 1935 he was loaned to the *Philips Company* of Holland as a sales advisor and then rejoined *General Electric* in 1942. He later became manager of the electronics and merchandise department for the *International General Electric Company*, a position he held until 1948 when he was assigned to sales work in the Electronics Department.

ROBERT D. HICKOK, president and founder of *The Hickok Electrical Instrument Company*, passed away recently in Cleveland, Ohio, at the age of 70.



An active RMA member and a Fellow of The American Institute of Electrical Engineers, Mr. Hickok was a well-known figure in the electrical industry. Throughout the past 40 years of manufacturing he was actively interested in his company and its engineering department.

Mr. Hickok started his career as a watchmaker in Greenville, Michigan. He moved to Atlanta, Georgia, and founded the company which bears his name in 1910. In 1913 the company was moved to Cleveland where the two main *Hickok* plants are now operating.

His son, Robert D. Hickok, Jr., has been named president of the firm to succeed his father.

WILLIAM DUBILIER, founder and technical director of *Cornell-Dubilier Electric Corporation*, has been awarded the Chevalier Cross of the French Legion of Honor for his outstanding contributions to the development of the French and International electri-

cal industry and for his humanitarian activities.

This is the third honor that France has bestowed on Mr. Dubilier within a year. He previously received the Honorary Medal of the Association des Ingenieurs-Docteurs de France and the Diploma of the Officer of the Academy and the Order of Academic Palms decreed by the French Government.

PAUL H. ECKSTEIN has rejoined *The Hallicrafters Company* of Chicago as television sales manager. He was formerly associated with the company's home radio division as sales manager.



Mr. Eckstein returns to *Hallicrafters* from the *Gibson Refrigerator Company* of Greenville, Michigan, where he was assistant general sales manager responsible for the company's field organization. He was also associated with *Westinghouse* and *Stewart-Warner* during his 24 years in major appliance merchandising.

At the same time, the company also announced the appointment of Harold J. Adler to the post of chief television engineer for the *Hallicrafters* line of video receivers. Mr. Adler will be in direct charge of all television chassis development. He has been active in the television field since 1932 when, as a consulting engineer, he began experimenting with the scanning disc.

For the past 16 years he has been associated with *Sentinel Radio* of Chicago as chief engineer on both radio and television.

TELEVISION ZOOMAR CORPORATION, manufacturer of the *Zoomar* lens, has moved its offices to 500 Fifth Avenue, New York . . . **AMERICAN TRANSFORMER COMPANY** has consolidated operations, including its general offices, under one roof in a large and modern building located at 285 Emmet Street, Newark 5, New Jersey . . . **EMERSON RADIO & PHONOGRAPH CORPORATION** has purchased the *Continental Can Building* in Jersey City, New Jersey, which will give the radio firm an additional 450,000 square feet of production space for the manufacture of radio and TV receivers . . . The Broadcast Receiver and Television Division of **BENDIX AVIATION CORPORATION** has acquired additional factory space which will double the company's output capacity for video receivers . . . **ALLEN B. DU MONT LABORATORIES, INC.** has opened a re-

RADIO & TELEVISION NEWS

Brush has it!

MIKES AND PHONES THAT ARE "CRYSTAL CLEAR"

HAND OR DESK MICROPHONE

(BA-116)



Rugged dependability and uniform frequency response. Unbeaten in its price range for PA, home, institutional and industrial use. Use in hand or on desk without need of stand. But also equipped for use with standard 5/8" 27 thread stand. Brown metallic finish, 8' cable. List, \$14.75.

"VIBROMIKE" (VM-1)

Miniature contact-type microphone with unusually wide frequency response. 7/8" x 3/4" x 5/8". Output volume from .05 to .1 volt or higher. Complete with mounting clamp and 25' cable. List, \$19.50.



NEW MICROPHONE (BA-109) FOR PA, HOME AND AMATEUR

A beautiful new microphone for applications that require natural reproduction of both music and voices. Uses an advanced development of the "Acoustical" cartridge pioneered by Brush. Pickup pattern non-directional in the horizontal plane. Essentially flat frequency response from 40 to 10,000 cps. Designed for use with 5/8" 27 thread stand. Finished in maroon plastic and brushed chromium List, \$22.50.

GENERAL PURPOSE MICROPHONE (BA-106)



Using the exclusive "Acoustical" cartridge. Vibration, shock, low frequency wind noise or humidity do not affect the high fidelity. Excellent for general use. Output level Minus 50 db. below 1 volt/bar List, \$19.75.

LAPEL MIKE (BL-2)

Virtually flat response. Small and rugged. Can be used as hand or instrument mike, as well as lapel. 1 1/2" x 2 1/4". Complete with 25' cable. List \$25.00.



High fidelity Model "A-1", \$18.00



Model "A" general purpose, \$12.00



Model "A" single phone, \$6.45

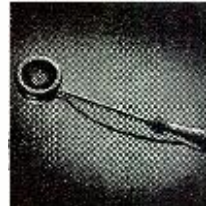

Model "A" lorgnette phone, \$9.75



"BA-303" Hushatone \$9.75

You can get it!

Brush products are distributed all over U. S. A. If your own radio parts jobber does not have it, write to us and we will send you name of nearest jobber.

THE BRUSH DEVELOPMENT COMPANY
3405 Perkins Avenue • Cleveland 14, Ohio

NOW, you can tell your Customers

it covers TELEVISION, too!



The famous RAYTHEON Bonded Electronic Technician Certificate now covers *Television* as well as *Radio*. And the aggregate cash protection of each registered dealer certificate has been increased to \$400.00.

Think of it... your 90-day guarantee on TV and Radio repairs and replacement parts — backed by American Mutual Liability Insurance Company's assets of close to \$100,000,000.00.

Here's the one, sure way to win and hold customer confidence, and it's

FREE — to qualified service dealers

If you're not yet a Raytheon Bonded Electronic Technician get in touch with your Raytheon Tube Distributor at once. It costs you nothing but it puts you first in line toward better volume and profit from your television and radio service work.



ACT NOW! Ask your Raytheon Distributor how to become a **BONDED ELECTRONIC TECHNICIAN**

RAYTHEON

RAYTHEON MANUFACTURING COMPANY

Excellence in Electronics

RADIO AND TELEVISION RECEIVING TUBES, CATHODE RAY TUBES, SPECIAL PURPOSE TUBES, SUBMINIATURE TUBES, MICROWAVE TUBES

Radio Receiving Tube Division
Newton, Mass., Chicago, Ill., Atlanta, Ga., Los Angeles, Calif.



MODEL "S"

CONVERT BATTERY RADIOS to AC ALL-ELECTRIC

... converts dry battery radio into dependable hum-free AC receiver. The Model "S," with selenium rectifier, operates any 1.4-volt, 4-, 5- or 6-tube battery radio from 115-volt, 60-cycle source. Eliminates fading and noise.

Pioneer Manufacturers of Battery Eliminators



MODEL "Q"

USE RADIOS LONGER on FARMS, AUTOS, BOATS, CAMPS

Provides A and B power for over 3 weeks on one storage battery charge. Operates any 1.4-volt 4-, 5- or 6-tube radio from 6-volt storage or dry battery or Wincharger. Entirely eliminates fading and noise accompanying battery reception.

Unmatched Performance, Quality and Price!



ELECTRO PRODUCTS LABORATORIES, INC., 4509 N. Ravenswood Ave., Chicago 40, Ill.

gional receiver sales office at 30½ Highland Park Village, Dallas 5, Texas... **CORNING GLASS WORKS** has expanded its research and development facilities through the construction of a new Pilot Plant and a new Engineering Building at Corning, New York. The Pilot Plant facilities will be used initially for the development of new production methods for television bulbs... **STEVENS MANUFACTURING COMPANY, INC.** has moved to a new plant at 69 South Walnut Street, Mansfield, Ohio which will provide enlarged facilities for all of the company's operations... **RADIO MERCHANDISE SALES, INC.** has moved its factory and offices to 1165 Southern Boulevard, New York 59, New York. The move was necessitated by a greatly increased demand for the company's line of television products... **THE A. W. HAYDON COMPANY** of Waterbury, Connecticut consolidated all of its engineering, manufacturing, and administrative departments under a single roof when it recently moved to new quarters at 232 North Elm Street... **FEDERATED PURCHASER INCORPORATED** has taken new enlarged quarters at 66-68 Day Street in New York City. The company was formerly located at 80 Park Place... **THE RAY-DYNE MANUFACTURING CORPORATION** has opened a new plant at White Rock, S. C. for the production of cabinets and the company's line of radios and phonographs... **REEVES SOUND CRAFT CORP.** has moved its sales office to a new three-story building at 35-54 36th Street, Long Island City in order to accommodate production facilities for its new line of magnetic recording tape as well as its sales department. The new building will also house *Reevesound Co., Inc.* as well as the sales office for the company's two *Soundcraft* subsidiaries, *Tele-Video Corp.* and *Airdesign, Inc.*

JOHN H. HAUSER, former assistant manager of distributor sales at Emporium, Pa., has been transferred to the Chicago Sales Office of the Radio Tube Division of *Sylvania Electric Products Inc.*



He will direct and coordinate distributor sales activities in 24 midwestern and southern states which include five of the company's sales divisions. Mr. Hauser joined the company's distributor sales department in 1941 and during the war served as production engineer in charge of product simplification in the cathode-ray department.

AUDIO ENGINEERING SOCIETY, San Francisco Section, has elected a new slate of officers for 1950.

Named at a recent meeting were: Ross H. Snyder, KJBS-FM, chairman; Walter T. Selsted, *Ampex Electric* (Continued on page 110)

RADIO & TELEVISION NEWS

To a \$60 a week man interested in earning \$100 a week and more in

ELEVISION and FM SERVICING



TELEVISION SERVICEMEN \$100 PER WEEK
 Inside of business man with no skill and no cap. We pay car expenses! Modern air-conditioned shop! Vacation with pay! Group hospitalization! Plus employee discount privileges! Time and one-half for all overtime work! Wonderful opportunity for advancement!
 Dept. 114-B, Star

TELEVISION INSTALLERS
 One of Washington's largest and most successful TV companies has an opening for a permanent and experienced installer.
 \$100 PER WEEK
 Must have car, license, tools, etc.
 DEPT. 114-B, STAR
 TELEVISION SERVICEMEN
 \$100 PER WEEK

CREI can show you how to qualify for jobs like these!

QUALIFIED TV REPAIRMEN are in demand. The ads shown (taken from a single issue of the Washington *Sunday Star*) prove it. Every area with TV stations has openings for servicemen. Every area with TV stations planned (750 stations by 1955 is a conservative estimate) will have more openings.

Anyone in the field—if he is to get ahead—needs to know how to use test equipment, how a TV set works, why it works, and how to make it work better. You can't repair "by ear" anymore. You need *knowledge*. CREI's practical course in TV-FM servicing provides it. Designed by teaching specialists, taught by practical TV instructors, reviewed and checked by qualified service experts, **KEPT UP-TO-DATE** through daily contact with CREI's affiliated retail sales-and-servicing stores (one of

Washington's largest retailers of TV sets), the CREI course equips you to qualify for the \$100-a-week jobs.

TV is developing fast. Now's the time to get on the bandwagon! CREI offers you—in one practical course at a popular price—greater earnings and a secure future. Don't delay. Start your training now—and start applying your new-found knowledge in your daily work. The facts are yours for the asking. Mail the coupon now for complete data.

Veterans: CREI training is available under the G.I. Bill. For most veterans, July 25, 1951 is the deadline. **ACT NOW!**

FREE SAMPLE LESSON

"Television & FM Trouble Shooting" devoted to live, "dollar-and-cents", practical practice based on day-to-day servicing problems. Read this interesting lesson! See for yourself how CREI training can help you. Mail coupon for sample lesson, free booklet and details.

THE THREE BASIC CREI COURSES:

- ★ **PRACTICAL RADIO ENGINEERING**
 Fundamental course in all phases of radio-electronics
 - ★ **PRACTICAL TELEVISION ENGINEERING**
 Specialized training for professional radiomen
 - ★ **TELEVISION AND FM SERVICING**
 Streamlined course for men in "top-third" of field
- ALSO AVAILABLE IN RESIDENCE SCHOOL COURSES



CAPITOL RADIO ENGINEERING INSTITUTE

An Accredited Technical Institute Founded in 1927
 Dept. 114B, 16th Street & Park Road, N. W.
 Washington 10, D. C.

Branch Offices

New York (7) 170 Broadway • San Francisco (2) 760 Market St.

MAIL COUPON FOR FREE BOOKLET

CAPITOL RADIO ENGINEERING INSTITUTE
 Dept. 114B, 16th & Park Rd., N. W., Washington 10, D. C.

Gentlemen: Send me FREE SAMPLE LESSON and complete details of the TV and FM Servicing home study course. Also send brochure that explains the CREI self-improvement program and gives complete details and outline of course. I am attaching a brief resume of my experience, education and present position.

- Check the Field of Greatest Interest:
- | | |
|---|---|
| <input type="checkbox"/> TV, FM & Advanced AM Servicing | <input type="checkbox"/> Aeronautical Radio Engineering |
| <input type="checkbox"/> Practical Television Engineering | <input type="checkbox"/> Broadcast Radio Engineering (AM, FM, TV) |
| <input type="checkbox"/> Practical Radio Engineering | <input type="checkbox"/> Radio-Electronics in Industry |
- I AM ENTITLED TO TRAINING UNDER G.I. BILL.

NAME.....AGE.....
 ADDRESS.....
 CITY.....ZONE.....STATE.....

SEND DETAILS ON RESIDENCE SCHOOL.

SAVE 25 TO 52% BY BUILDING YOUR OWN LABORATORY PRECISION TEST INSTRUMENTS!

**"You build 'em in
one evening—
they last a lifetime"**

NEW TV-FM SWEEP SIGNAL GENERATOR KIT

EICO
Model 360-K
\$29⁹⁵



Crystal marker oscillator with variable amplitude. Covers all TV and FM alignment frequencies between 500 kc. and 228 mc. Sweepwidth variable from 0-30 mc., with mechanical inductive sweep. Extremely wide sweepwidth allows gain comparison of adjacent RF TV Channels. Provides for injection of external signal generator marker. Phasing control included. Vernier dial calibrated in frequencies. Complete with tubes (6X5GT, 12AU7, 2-6C4). In sturdy steel case. Less Crystal. Size: 10 x 8 x 6 3/4". 110-125 v., 60 cycle AC. Shpg. wt., 12 lbs. IN KIT FORM.
No. 32P24370: Lafayette's Price **\$29.95**
No. 32P24371: 5 Mc. Crystal for above **\$3.95**

NEW SIGNAL GENERATOR KIT

EICO
Model 320-K
\$19⁹⁵



For FM, AM alignment and to provide TV marker frequencies. Highly stable Hartley oscillator has range of 150 kc. to 102 mc. with fundamentals to 34 mc. Colpitts audio oscillator supplies pure 400 cycle sine wave voltage for modulation. Use audio oscillator voltage to test distortion in audio equipment, bridge measurements, etc. In sturdy steel case. Size 10 x 8 x 4 3/4". 110-125 v., 60 cycles AC. Shpg. wt., 10 lbs. IN KIT FORM.
No. 32P24562: Lafayette's Price: **\$19.95**

**Complete with
STEP BY STEP INSTRUCTIONS
and
EASY-TO-FOLLOW DIAGRAMS**

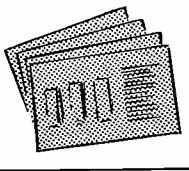

Each EICO kit fully guaranteed to operate perfectly when assembled according to the simple directions.

NEW 5" OSCILLOSCOPE KIT *Push-Pull, Wide-Range, High Sensitivity!*

EICO
Model 425-K
\$39⁹⁵



All-new laboratory precision scope has Push-Pull deflection and .05 to .1 volts per inch sensitivity. Wide range, flat from 5 cps to 500 kc. with full gain setting, useful to 2 1/2 mc. Wide-range, multi-vibrator, sweep circuit from 15 cps to 75,000 cps. Direct connection to plates of CRT available at rear of cabinet. Z axis intensity modulation feature included. Size: 8 1/2" x 17" x 13" high. Complete with 3-6SN7, 2-6J5, 2 of 5Y3, 5BP1 CRT. 110-125 v., 60 cycles AC. Shpg. wt., 30 lbs. IN KIT FORM.
No. 32P24552: Lafayette's Price: **\$39.95**

**HIGH VOLTAGE PROBE
(Not a Kit)**
EICO Model HVP-1 \$6⁹⁵



Measures up to 30,000 volts. Special HV Multiplier Resistor for all 20,000 ohms per volt meters with 1000 or 5000 volt scales and most VTVM's. Lucite head, plywood bakelite handle, large flashguards for additional safety. Assembled, ready to use. Supplied for 221-K VTVM unless other instrument is specified. Shpg. wt., 1 lb.
No. 25P21463: Lafayette's Price: **\$6.95**

order your
EICO
INSTRUMENT
KITS
direct from
**Lafayette
Radio**

VACUUM TUBE VOLTMETER KIT

**EICO Model 221-K
\$23⁹⁵**



Tops in workbench versatility—15 different ranges! AC and DC ranges: 0/5/10/100/500/1000 volts. (Use HVP-1 probe to get 30,000 volt range.) Electronic ohmmeter ranges from .2 ohms to 1000 megs in 5 steps. Uses double triode balanced bridge circuit. New features include Zero Center for TV discriminator alignment, 26 Meg. DC input impedance. Accurate 4 1/2" meter cannot burn out. Sturdy portable steel case with etched, rubproof panel. 110-125 v., AC, 60 cycles. Size: 9 1/2" x 6" x 5". Shpg. wt., 10 lbs. IN KIT FORM.
No. 32P24540: Lafayette's Price: **\$23.95**

HIGH FREQUENCY RF PROBE KIT

EICO Model P-75K \$3⁷⁵



Germanium crystal probe for visual RF signal tracing and measurements to over 200 megacycles. 6 1/2" long, 12" O.D. Shpg. wt., 8 oz. IN KIT FORM.
No. 32P24533: Lafayette's Price: **\$3.75**

**Lafayette
Radio**

100 Sixth Avenue, New York 13, N. Y.
901 W. Jackson Blvd., Chicago 7, Ill.
(Showrooms also in Boston, Newark and The Bronx)

LAFAYETTE RADIO, Dept. RD-50
100 Sixth Avenue, New York 13, N. Y.
901 W. Jackson Blvd., Chicago 7, Ill.

Enclosed is \$..... (Include shipping charges. Any excess will be refunded.) Rush me the following EICO equipment:

.....

Send me FREE Lafayette's 1950 Catalog. (Please do not check if you have already received a copy.)

Name

Address

City..... Zone..... State.....

**DO YOU
HAVE
LAFAYETTE'S
1950
CATALOG?**



—The most famous jobber catalog in the field for 29 years!
All well-known makes at the market's lowest prices.
TV and Radio Parts—High Fidelity Equipment—P.A. Systems—Test Equipment—Tools—etc.
NO RADIO MAN CAN AFFORD TO BE WITHOUT THIS VALUABLE 164-PAGE BUYING GUIDE
SEND FOR YOUR FREE COPY TODAY!

new

TINY
MIKE[®]

miniature ceramic
disc capacitors



NOW—take advantage of these new, space-saving, miniature ceramic disc capacitors, designed for bypass and coupling in ultra-compact assemblies. These ceramics incorporate the same dependable performance built into the highly specialized C-D ceramic capacitors, used for years by the world's largest manufacturers of instruments and transmitter equipment.

C-D TINYMIKES OFFER YOU DISTINCT ADVANTAGES IN CAPACITOR DESIGN:

- Ideal for cramped chassis layouts: only 19/32" in diameter, only 5/32" thick.
- TINYMIKES are lighter than other types of same capacity and voltage rating.
- Short current path and parallel leads reduce inductance to lowest possible level.
- Resistance is fixed at a low level by solder-connected leads directly to the high-purity silver electrodes.
- Use of two electrodes accurately positioned in relation to each other reduce eddy current losses to a minimum and increases the Q.

- High dielectric strength of C-D ceramic, high insulation resistance and low power factor assure constant and dependable service.
- Protected against the effects of humidity by a special phenolic coating and high-temperature wax impregnation.
- Presently available in capacities of 50 to 150 mmfd. at $\pm 20\%$ and 500 to 5,000 mmfd. guaranteed minimum capacity over a temperature range of $+10^{\circ}\text{C}$ to $+65^{\circ}\text{C}$, at 500 volts DC working.
- All C-D ceramics for servicemen are stamped with capacity ratings in micro-microfarads.
- C-D ceramics for servicemen packed 10 to convenient carton.

If your jobber doesn't have the new C-D TINYMIKE ceramic capacitor yet, write direct to the factory. We'll supply you promptly through the nearest C-D jobber stocking them. Bulletin on request. Address: CORNELL-DUBILIER ELECTRIC CORPORATION, Dept. RN40, South Plainfield, New Jersey. Other plants in New Bedford, Brookline and Worcester, Massachusetts; Providence, Rhode Island; Indianapolis, Indiana and subsidiary, The Radiart Corporation, Cleveland, Ohio.

C-D Best by Field Test!



1910-1950

CONSISTENTLY DEPENDABLE
CORNELL-DUBILIER

CAPACITORS — AUTO VIBRATORS
TV AND FM ANTENNAS — ROTATORS — CONVERTERS



April, 1950

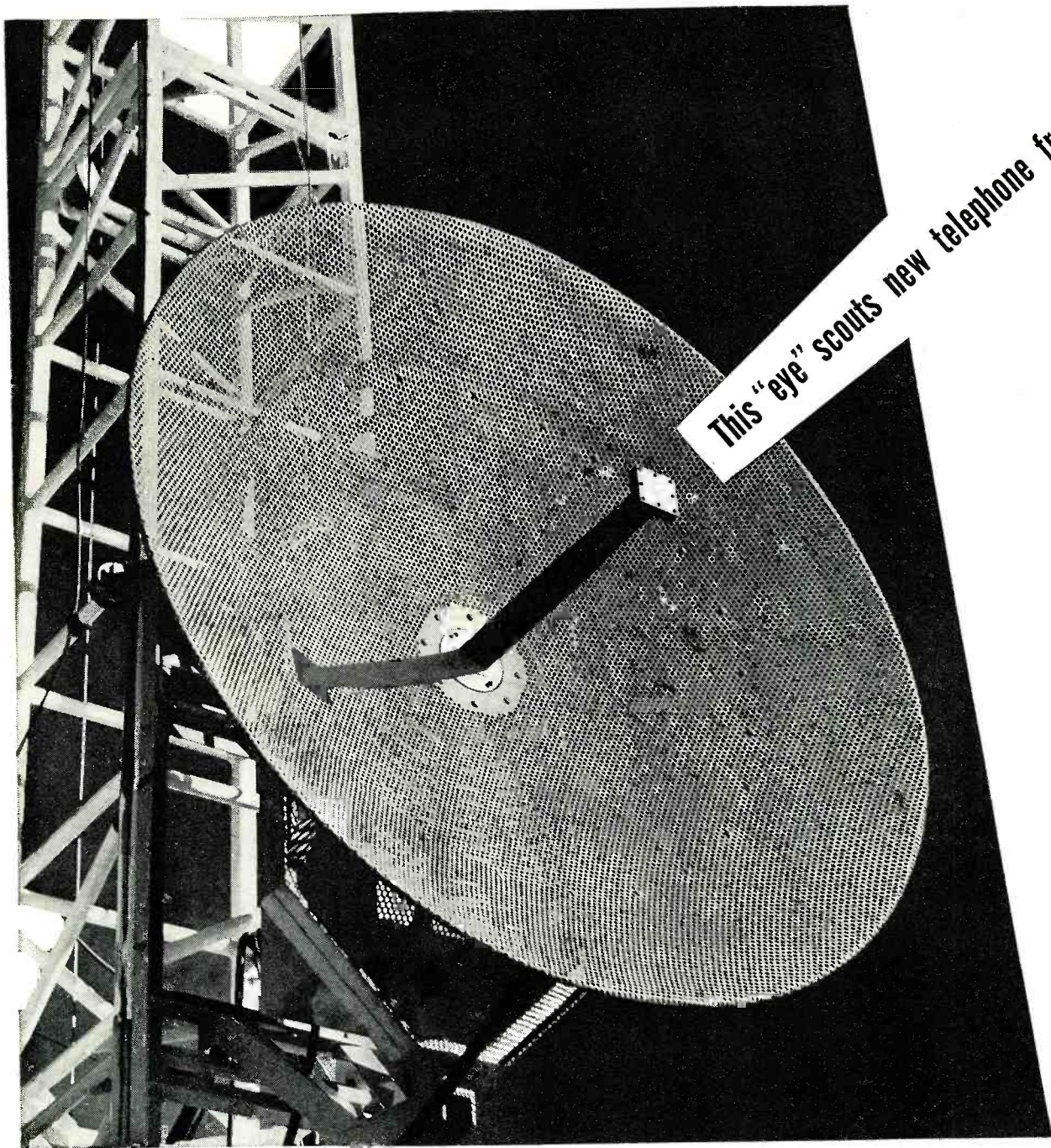

This "eye" scouts new telephone frontiers

Throughout history, scouting parties have gone out ahead of man, ahead of settlements, ahead of civilization itself. Today, Bell System scouts are engaged in a new kind of exploration — charting a path for microwaves — using equipment specially designed by Bell Telephone Laboratories.

The portable tower shown is constructed of light sections of aluminum and in a few hours may be built up to 200 feet. Gliding on roll-

ers, the "dish," with its microwave transmitter or receiver, is quickly positioned for line-of-sight transmission, then oriented through electric motors controlled from the ground.

Test signals show how terrain and local climate can interfere with microwave transmission. Step by step, Bell's explorers avoid the obstacles and find the best course for radio relay systems which will carry television pictures or hun-

dreds of simultaneous telephone conversations.

A radio relay link similar to the one between New York and Boston will be opened this year between New York and Chicago. Later it will be extended, perhaps into a nation-wide network — another example of the way Bell Telephone Laboratories scientists help make the world's best telephone system still better each year, and at lowest cost.

BELL TELEPHONE LABORATORIES



EXPLORING AND INVENTING, DEVISING AND PERFECTING, FOR CONTINUED IMPROVEMENTS AND ECONOMIES IN TELEPHONE SERVICE
RADIO & TELEVISION NEWS

For Reliability, I use
OHMITE



BROWN DEVIL RESISTORS

Sturdy, wire-wound, vitreous-enamelled resistors for voltage dropping, bias units, bleeders, etc. In 5, 10, and 20-watts; values to 100,000 ohms.



FIXED RESISTORS

Resistance wire is wound over a ceramic core, permanently locked in place, insulated and protected by Ohmite vitreous enamel. In 25, 50, 100, 160, and 200-watt stock sizes; values from 1 to 250,000 ohms.



DIVIDOHM RESISTORS

You can quickly adjust these handy vitreous-enamelled resistors to the exact resistance you want, or put on taps wherever needed for multi-tap resistors and voltage dividers. In sizes from 10 to 200 watts, to 100,000 ohms.



LITTLE DEVIL COMPOSITION RESISTORS

Tiny, molded, fixed resistors—individually marked with resistance and wattage rating— $\frac{1}{2}$, 1, and 2-watt sizes, $\pm 10\%$ tol. Also $\pm 5\%$ tol. 10 Ohms to 22 megohms.



DUMMY ANTENNA RESISTORS

For loading transmitters or other r.f. sources. New, rugged, vitreous-enamelled units are practically non-reactive within their recommended frequency range. 100 And 250-watt sizes, 52 to 600 ohms, $\pm 5\%$.



MOLDED COMPOSITION POTENTIOMETER

A high-quality, 2-watt unit with a good margin of safety. Resistance element is solid molded—not a film. The noise level is low and decreases with use.



CLOSE CONTROL RHEOSTATS

Insure permanently smooth, close control. Widely used in industry. All ceramic, vitreous enamelled; 25, 50, 75, 100, 150, 225, 300, 500, 750, and 1000-watt sizes.



DIRECTION INDICATOR POTENTIOMETER

Compact, low cost. Used in a simple potentiometer circuit as a transmitting element to remotely indicate the position of a rotary-beam antenna.



HIGH-CURRENT TAP SWITCHES

Compact, all-ceramic, multipoint, rotary selectors for a-c use. Self-cleaning, silver-to-silver contacts. Rated at 10, 15, 25, 50, and 100 amperes. Two or more can be mounted in tandem.



POWER LINE CHOKES

Keep r.f. currents from going out over the power line and causing interference with radio receivers. Also used to stop incoming r.f. interference. Has a ceramic core and moistureproof coating. In 5, 10, and 20 amps.



RADIO FREQUENCY CHOKES

Single-layer wound on low power-factor steatite or bakelite cores, with moistureproof coating. Seven stock sizes for all frequencies, 3 to 520 mc. Two units rated 600 ma, others rated 1000 ma.



OHM'S LAW CALCULATOR

Figures ohms, watts, volts, amps—quickly, easily, with one setting of the slide. Has all computing scales on one side. Resistor color code on back. Send 25c in coin.



SEND FOR FREE CATALOG

Stock catalog lists hundreds of units, gives helpful information.

OHMITE MANUFACTURING CO.
 4884 Flournoy St. Chicago 44, Ill.

Be Right with **OHMITE**

Reg. U. S. Pat. Off.

FREE

with purchase of
100 Sylvania Receiving Tubes...
or 3 Sylvania TV Picture Tubes

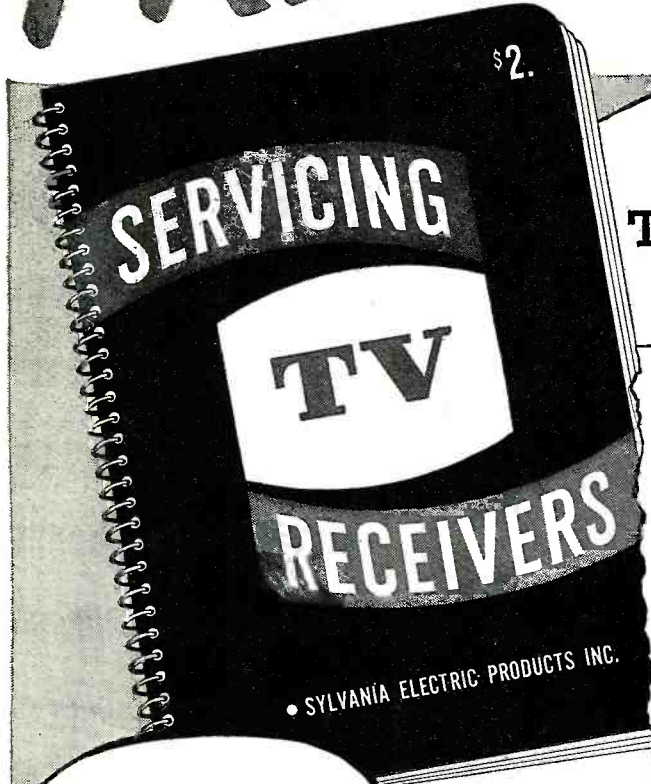

The clearest
 and most complete
Television Servicing Book
 ever printed

JUMPING PICTURE—NOISY SOUND

Characteristics
 1. Picture is unsteady, jumps and is erratic
 2. Thin white horizontal lines through picture
 3. Sound is distorted by noise

Cause
 A loose connection in antenna system

Remedy
 Check and tighten all connections of the antenna system

Lead in wire is touching or shorting against the side of the building (insulation frayed at point of contact)

Excessive pickup of electrical noise (outside) by receiver

Relocate antenna after probing the roof for the most advantageous position where electrical noises are minimized

97

SPLIT PICTURE (VERTICALLY)

Characteristics
 1. Horizontal bar in center of screen
 2. Half of picture on each side of bar
 3. Picture returns top on button
 4. Two pictures vertically in a single frame

Cause
 Vertical hold control not properly set (R16)

Remedy
 Manually reset vertical hold control

Resistor in vertical hold circuit amplifier section changed in value (R16)

Shorted or leaking condenser (C167) in vertical hold line amplifier circuit

Shorted turns in vertical holding oscillator transformer (T20)

Check for resistance value with ohmmeter referring to manufacturer's servicing guide

Check for short in circuit ferrite component

Check transformer for continuity or a short with ohmmeter. Replace if defective

23

FREE

during April, May, June, July and August

Here are 2 sample pages from "Servicing Television Receivers." Note the easy-to-read type arrangement and the simplified photographic instructions.

HERE at last is a guidebook to help simplify TV set service for you. You'll be amazed how it will enable you to quickly identify trouble . . . solve tricky problems.

Contains more than 100 pages with scores of actual photographs and easy-to-read diagrams, to help you increase and improve your TV set repair business.

Not for sale . . . it's FREE!

This valuable book is yours absolutely free, from your regular Sylvania distributor, with your order of 100 Sylvania receiving tubes . . . or just 3 TV Sylvania picture tubes. Spirally bound with a sturdy board cover to stay open and lie flat on your bench.

NOTE: This important booklet offer is open for a limited time only. So don't delay. Send your order for the tubes you need today to your Sylvania distributor and he'll mail this free, helpful guidebook to you immediately.

Quickly answers scores of questions

- Shows more than 80 actual photos of screen test patterns. Shows how to identify trouble by pattern behavior.
- Gives simple, concise instructions for making repairs, proper adjustments.
- Contains complete circuit diagrams of typical television receiver.
- Explains latest television developments such as "Intercarrier sound."
- Tells about television test equipment and what each instrument will do.
- Provides a practical dictionary of television set trouble.

SYLVANIA ELECTRIC

RADIO TUBES; CATHODE RAY TUBES; ELECTRONIC DEVICES; FLUORESCENT LAMPS, FIXTURES, WIRING DEVICES, SIGN TUBING; LIGHT BULBS; PHOTOLAMPS

PUTTING TV IN THE AIR

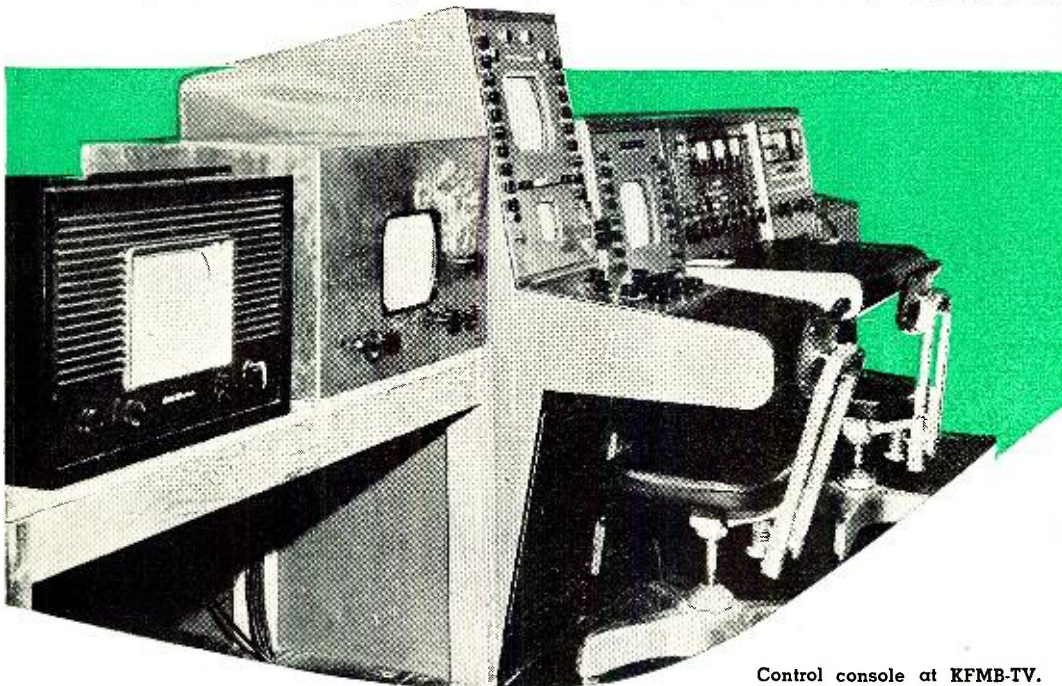

By

CHARLES F. ABEL

Engineer, KFMB-TV

KFMB-TV beams its programs via microwave relay from San Diego to Mount Soledad. All film and slide material originates at transmitter site.

NO DOUBT you have or in the future will, sit in a television studio and watch a live video show being produced. As you watch the timed and exact movements of the camera crew and production staff you may be tempted to say to yourself, "simple, anybody can do it." But television isn't simple! To convince you that there is more to it than meets the eye, let's step behind the scenes and see what really takes place in a television station.

All the components used in regular radio broadcasting are required in television plus an extensive illumination system, camera chain, video monitoring equipment, microwave relay system, and the video transmitter, located at a specially chosen spot permitting line-of-sight transmission to the largest possible receiving area. KFMB-TV in San Diego, California is unique among television stations in that steps were taken in its design to reduce required personnel and equipment as far as possible by making several deviations from standard station planning. Some of the more important changes were the inclusion of the film equipment room in the transmitter building, and adapting the transmitter operating console as the master

control console enabling all audio and video switching to be done at the transmitter. This arrangement permits the studio to remain dead during afternoon periods when films are telecast. That these changes have proved successful are borne out by the fact that performance of KFMB-TV has brought many favorable comments and congratulations to its owner-manager, Jack Gross. Despite this planned economy in men and equipment the station still requires 10 men, not including writers, cast, or musicians, and has in operation more than 1000 tubes during the production of a live TV show. Live programs are dispatched via microwave relay and telephone line from the studios in downtown San Diego to the transmitter located atop Mount Soledad, just outside La Jolla, some 10 airline miles away. Microwave signals from the studio are picked up by a specially housed parabolic antenna located atop the transmitter building.

Selection of the transmitter building site is of primary importance. Other conditions being equal, the higher the antenna, the greater the coverage. The top of KFMB-TV's antenna is just a little over 1000 feet above sea level. Since San Diego is

a coastal city, it rises, saucer like, away from the coast where the station is located, providing excellent coverage. To the north of La Jolla the coastline curves gently westward for a distance of more than 100 miles, providing over-water "line-of-sight" reception for much of this area. The transmitter building is a concrete brick and redwood structure and is 750 feet above sea level (the antenna and mast tower some 250 feet above the building site).

Inside the transmitter building are several rooms which have been specifically designed for various items of telecasting equipment, including a utility room, film equipment room, washroom, work shop, emergency announcing booth and master control, and transmitter room. Sitting at the control desk the operator sees five enclosed equipment racks to his right. The first of these racks contains the frequency monitors for both the aural and visual transmitters, as well as the program amplifier, monitor amplifier, and five audio amplifiers. All incoming audio lines terminate in a patch panel included in this rack. From this point connection can be made to any of the six lines which feed audio to the main operating console. Gen-

Control console at KFMB-TV. Receiver at far left has since been replaced with a shielded unit. The receivers are used for picking up programs from Los Angeles for relay. Large unit in center is camera control console with monitor unit and master control desk beyond.

Turntable is barely visible at the right. The transmitter for Station KFMB-TV is located atop Mount Soledad, on the edge of the Pacific Ocean near La Jolla, California. Small enclosure on the top of the building houses microwave dish. Space has been provided for a second receiving dish if future operations warrant.

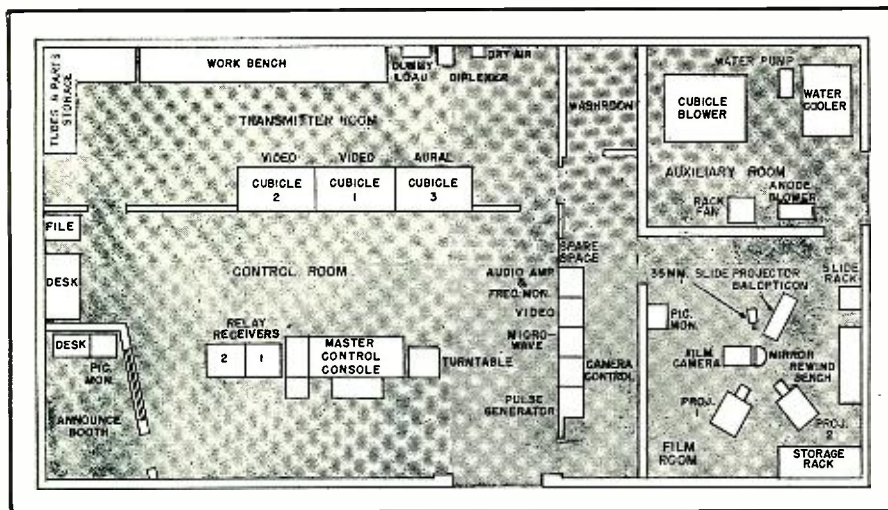

Layout of transmitter building at station KFMB-TV, San Diego, California.

eral purpose video amplifiers occupy part of the space in the second inclosed rack. Also included is the video and sync mixing amplifier, a high capacity, well regulated, low voltage power supply, the master switches for the film machines and equipment in the other racks and the video patch panel where all incoming video signals are terminated. Three coax lines feed video signals from this point to the master console; two of these are program lines while the third is used for monitoring purposes.

Incoming microwave signals are fed into the microwave receiver control unit which is located in a third inclosed rack along with the microwave receiver power supply. Also in this rack is a power supply for the audio amplifiers plus relays for switching sound from film projectors and a relay for automatic picture fade. Camera equipment contained in the fourth rack includes a regulated, low voltage power supply, a high voltage supply used for beam acceleration, a line amplifier for in-

creasing the amplitude of the camera signal, and the sweep generator used for scanning.

The final auxiliary equipment rack contains a regulated, low voltage power supply feeding the shading generator and the pulse generator unit. The pulse generator supplies all synchronizing signals for the transmitting equipment and also supplies the pulses radiated by the transmitter to synchronize all receivers tuned to the station.

Directly in front of the operator are the video and audio transmitters. The transmitters are housed in fully inclosed compartments with only the front doors showing in the main control room. Near the center front of the main control room is the master operating console. From this point the operator can see most of the important station equipment with the exception of the film room. The film room operator is in touch with the master control desk at all times by means of an intercom system.

The master control console is of

Diagram showing how equipment in transmitter building is interconnected.

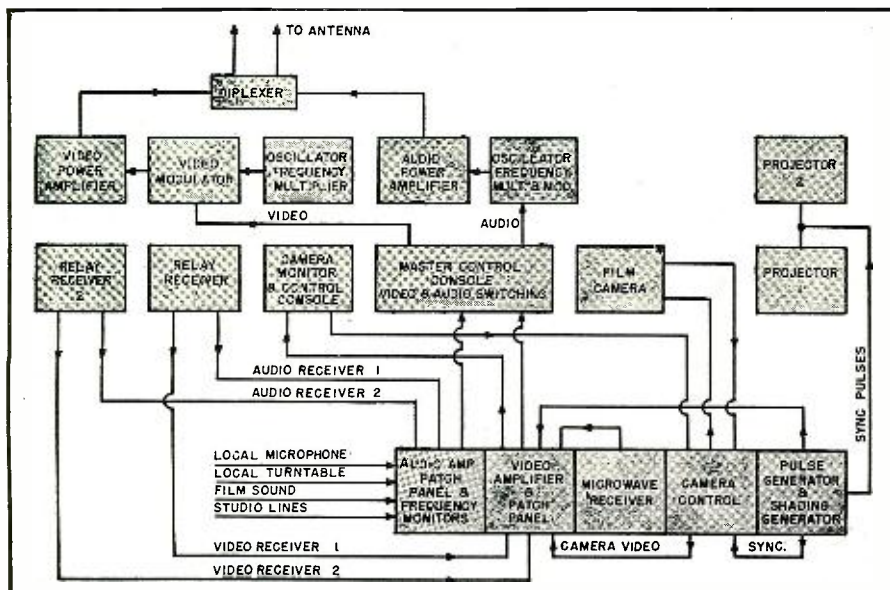

considerable interest because it is here that each of the elements to be transmitted are checked for quality and proper relation to each other. The control console at KFMB-TV has been modified so that it functions as the chief control center for all programs except live shows. From two to four programs, taken from as many as three different channels, are relayed nightly, as well as films, and several studio shows. Although video mixing cannot be done on the console most of the functions of a mixer desk are performed at the console with the help of the video patch panel over in the racks. As the operator views the control desk the left half is devoted to control of the incoming video signal, while the right half is audio control. The video side of the console has two cathode-ray tubes which make up the picture monitor. On one tube, a 10FP4, appears a completed picture of the object being televised. Below this kinescope tube is a waveform monitor using a 5 inch cathode-ray tube with a green screen. The waveform monitor shows picture pulses or the waveform equivalent of the object on the screen above. Input to this equipment is controlled by two rows of push-buttons located on the console panel adjacent to the picture monitor. The picture and waveform monitors are independent of each other but both can be used to analyze the same signal whenever desired. The push-buttons allow the operator to make a quick check of the signal from any one of several points as it passes through the transmitter. For instance, either of two incoming video lines can be monitored directly, transmitter input, modulator output, transmitter output or the monitor line from the video patch panel can be instantly checked. The latter position is provided so that video shows can be checked and adjustments made prior to their being put on the air. Video controls on the master control panel in addition to the monitor are; peak power, r.f. gain, sync stretch, picture line attenuator, and a selector switch for either incoming video line. There is also a picture fade control and a peak clipper which is used to prevent overmodulation of the video carrier.

The right half of the master console is devoted to control of the sound transmitted along with the picture. Six audio lines come into the master console and are controlled by three attenuators, that is, two lines are fed into each attenuator. Either of the two lines can be selected by throwing a switch. Output from these three controls can be mixed when desired. After selecting the proper sound level on the incoming lines a master gain control regulates the output of the program amplifier which is used to modulate the FM sound transmitter. A monitor speaker is provided and is controlled with push-buttons in a manner similar to that of the picture monitor. It can be used to monitor any of the incoming lines or the input

or output of the transmitter. It is used, along with the video monitor, for setting up the next program, but is always left in "transmitter output" position to keep a check on the sound going on the air. Meters are used to check percentage of modulation of the FM transmitter and one each to indicate frequency deviation of the FM and video transmitters. A v.u. meter is provided to indicate the level into the program amplifier and a reflectometer meter to indicate a mismatch or the reflected energy on the transmission line. Such faults as moisture in the transmission line would cause an abnormal deflection of the meter. The transmitter is turned on and off by means of push-buttons on the right end of the console. A master switch inside cubicle one, of the transmitter, turns on the air blowers, water cooling system, and the tube filaments. After a short warmup period an automatic time cycle operates a relay which makes the transmitter ready for the air. Push-buttons on the console control the plate voltage and are the final step to putting the transmitter on the air. The control buttons are duplicated on the doors of the transmitters and again in the second cubicle of the visual transmitter. To take the station off the air only two master buttons need to be pushed; these shut off the plate voltages. Then the master switch is thrown turning off the filaments and starting an automatic cycling unit which keeps the blowers and water cooling system going for a cool down period, which lasts about two to three minutes and then everything shuts down automatically. A turntable assembly is provided at the right of the master console for emer-

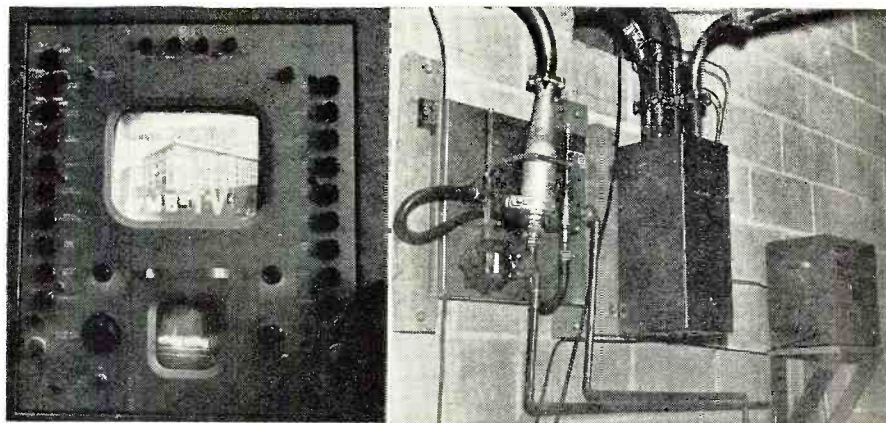

(Left) Output of KFMB-TV as it appears on monitor. Large scope shows picture as it is transmitted, while the waveform monitor below shows composite video signal. Bottom two lines show sync amplitude and above second line is picture signal. (Right) Dummy load appears at left along with water inlet and outlet thermometers. Square box below left thermometer is flow meter. Dummy load checks power output of transmitter. The Diplexer at the center of photo feeds combined video and audio signals to the antenna. Device at right is dryer unit which supplies dry, filtered air to coax line.

gency use in case of interrupted programming. At the left end of the master control unit is the camera control console. Part of the saving in personnel at KFMB-TV was accomplished by including this unit and the film room in the transmitter building. When films or slides are being shown the video engineer sits at the desk of the camera control unit and monitors the output of the camera as he watches the output in picture form on a regular television screen and also on a waveform monitor. During the showing of a film the output of the camera is monitored for shading and amplitude. Shading is simply adjustment of the shading generator controls to compensate for dark and light spots or areas in the picture caused by spurious response

of the iconoscope. To the video operator's left as he sits at the master control desk are two modified television receivers used to pick up and relay programs originating in the Los Angeles area some 120 airline miles away. Program relay is a regular part of KFMB-TV's telecasting and has been rather highly developed by the station. Channels 4, 5, 7, and 13 are regularly picked up and relayed on Channel 8. Noteworthy is the fact that an adjacent channel, No. 7, is being relayed successfully. This is accomplished by using a specially constructed receiving antenna plus a modified commercial receiver.

Adjoining the main control room is the film equipment room. One look inside and it can easily be seen that

(Continued on page 149)

Rear view of power output and amplifier section of video transmitter. The 9C24's appear at center right in their water jackets with feeder hose attached. Modulator unit is at lower left. Tube compartment cover plates were removed for photo.

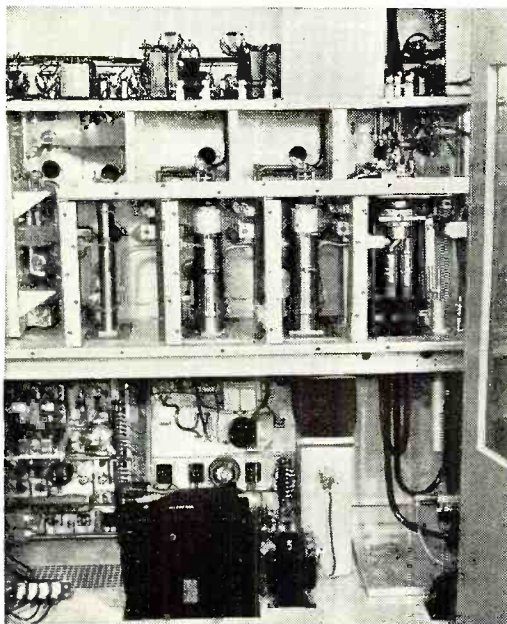

Engineer demonstrates the pivoted mirror which enables any of the film projectors or slide machines to be fed into the camera which is shown in the photograph to the rear of the mirror. The Balopticon unit and a 35 mm. projector are located at the right (partly obscured by the engineer) and the 16 mm. film projectors may be seen in the left foreground of photo.

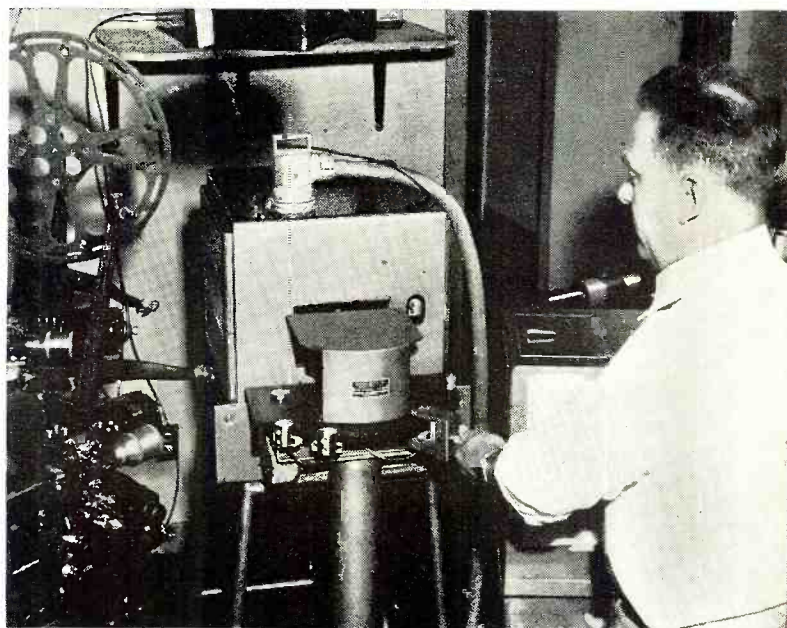

THE ELECTRONIC SWITCH

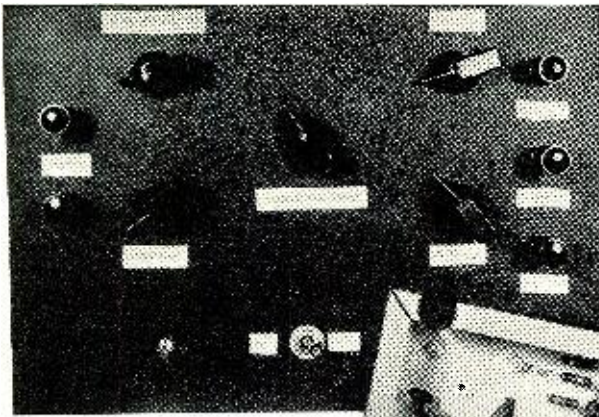
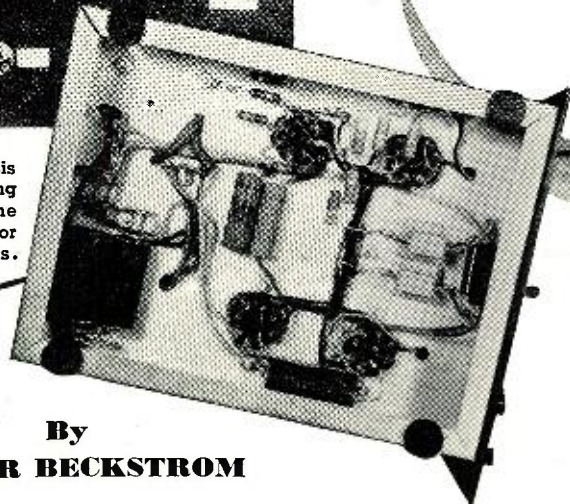

Fig. 1. Front and under-chassis views of completed unit showing layout of panel controls and the correct positioning of the major under-the-chassis components.



By
VICTOR BECKSTROM

The design, construction, and operation of an economically-built electronic switch test unit.

THE oscilloscope is becoming one of the most important pieces of test equipment used in present day servicing and in the design of electronic equipment. It has become even more important with the advent of television. The oscilloscope's versatility will be increased when used in conjunction with an electronic switch, not only in television and radio servicing, but also in the design of electronic equipment. It also should be remembered that the electronic switch is a source of square-wave frequency over a limited range, and may be used in square-wave testing.

In most cases the literature available to the service technician or experimenter does not contain much information on the electronic switch; therefore it would be well to discuss briefly the theory of an electronic switch so that a better conception of the unit's construction may be had. The electronic switch consists of three units; a multivibrator stage or square-wave generator which may be a gas tube, a blocking stage, and an amplifier stage, as indicated in Fig. 2. Thus when amplifier B is blocked, signal input A appears at the output of the electronic switch. Then the process reverses and amplifier A is blocked and input B appears at the output of the electronic switch. If the square-wave switching frequency is greater than 30 cycles per second, the two waves will appear to be on the screen of the oscilloscope simultaneously due to the persistence of vision.

Referring to Fig. 3, the tube V_{1a} , V_{1b} is the tube used in the multivibrator circuit. Potentiometer R_1 , along with condensers C_1 , C_2 , and C_3 , controls half the switching frequency, and potentiometer R_2 , with condensers C_4 , C_5 , and C_6 , controls the other half of the switching frequency. To secure a symmetrical wave output from the multivibrator, condenser C_1 must equal condenser C_4 , condenser C_2 must equal condenser C_5 , and condenser C_3 must equal condenser C_6 . Thus two identical condensers are used at one time. By selecting different values of condensers, a coarse control of the multivibrator frequency is obtained. The

potentiometer used is a dual control which serves as a fine control of the switching frequency. Resistors R_3 and R_4 serve only to maintain some resistance from grid to ground when potentiometers R_1 and R_2 are adjusted to zero resistance. If resistors R_3 and R_4 were omitted when the potentiometers R_1 and R_2 are adjusted to zero, the time constant of the multivibrator would be zero; therefore there would be no switchboard frequency.

The square-wave output is obtained from the plates of the multivibrator tube and fed to the grids of tube V_{2a} and V_{2b} , which is used as the blocking stage. In the blocking stages, each stage is half of the 6SN7 tube and is actually a cathode follower circuit. Condensers C_7 and C_8 are blocking condensers, and resistors R_9 and R_{10} are the bias resistors for the amplifier tubes. Each amplifier tube has a common cathode resistor with the blocking tube. During half of the square-wave voltage, one blocking tube is held positive by the square-wave voltage. The tube will then draw heavy current through the cathode resistor causing a voltage to appear across the cathode resistor that is large enough to bias the amplifier to cut-off. At the same period of time, the current through the cathode resistor resulting from the blocking tube is zero. Therefore the bias on the amplifier is due to the plate current of the amplifier tube only, and the amplifier functions properly. The process then reverses, the other amplifier being blocked.

The input A is fed to the grid of tube V_3 through potentiometer R_{15} and part of potentiometer R_{16} , depending on the setting. Input B is fed to the grid of tube V_4 through potentiometer R_{16} and part of potentiometer R_{15} . The vertical positioning of the wave on the screen of the oscilloscope is obtained by potentiometer R_{15} by feeding a portion of the "B plus" voltage to each side of the potentiometer R_{15} to ground. Theoretically potentiometer R_{15} should have equal resistance

Fig. 2. Block diagram of electronic switch.

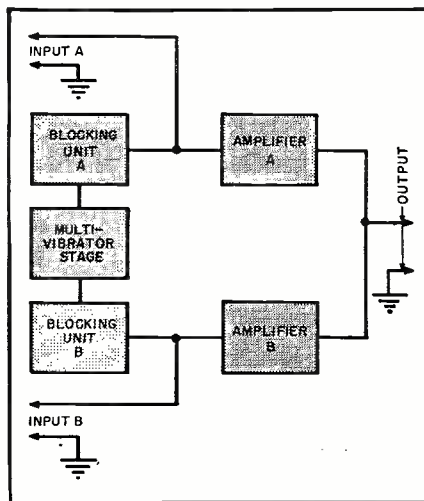

on both sides of the midpoint when both traces are on top of each other as indicated in Fig. 4. When potentiometer R_{15} is set to one side, such as position L in Fig. 3, the traces will separate due to the difference in voltage on the grid of the two amplifier tubes. The result of this is indicated in Fig. 5A. If the potentiometer setting is moved to point L' , traces A and B will exchange position from those shown in Fig. 5A.

We have found, up to this point, that the traces may be placed upon each other, as in Fig. 4, or may be separated, as in Fig. 5A, into two separate traces. With this in mind, it would be well to check to see if the amplifiers are functioning properly. With the position control adjusted so that the traces will be that of Fig. 5A (that is, the position control set to one side), then apply a signal to input A and gradually increase the gain control. A 60-cycle test signal may be used for this purpose. The wave will appear on one of the traces, and the other trace will not be affected. If the test signal should be large, the gain of the amplifier will be large enough so that the wave will be too big for the screen of the oscilloscope. Therefore in most cases, the gain required for proper amplification will be small. The results of this test may be seen in Fig. 5B.

With the 60-cycle test signal applied to input A, apply a signal to input B. With this accomplished and if both amplifiers A and B are operating properly, the waveform should be similar to that of Fig. 5C. If a duplicate of the waves shown in Fig. 5C is desired, apply a 60-cycle test signal through a .001 μ fd. condenser to input B. The distortion in the waveform is due to the condenser. It should be noted here that the traces and waveforms are solid lines, and not dashed lines. The dashed effect is due to the scale markings on the oscilloscope screen.

In this design the power supply used was a voltage doubler circuit consisting of two selenium rectifiers. A four ampere transformer, T_1 , was used to feed from the line. The input was stepped down to 6.3 volts and then stepped up to 117 volts through a 1.2 ampere transformer, T_2 , for rectification. By using two transformers as indicated, isolation was obtained. It is the best practice to use an isolation system as the electronic switch is used with other equipment and the possibility of shock between pieces of equipment is avoided. The "B plus" voltage obtained by this method is 250 volts. It may be noted here that, if desired, another power supply system may be used with equal results. This method was used for experimental purposes and yielded excellent results.

The complete electronic switch is small and compact. It was purposely designed with a panel large enough so that sufficient room is available to mount the unit either on a bench

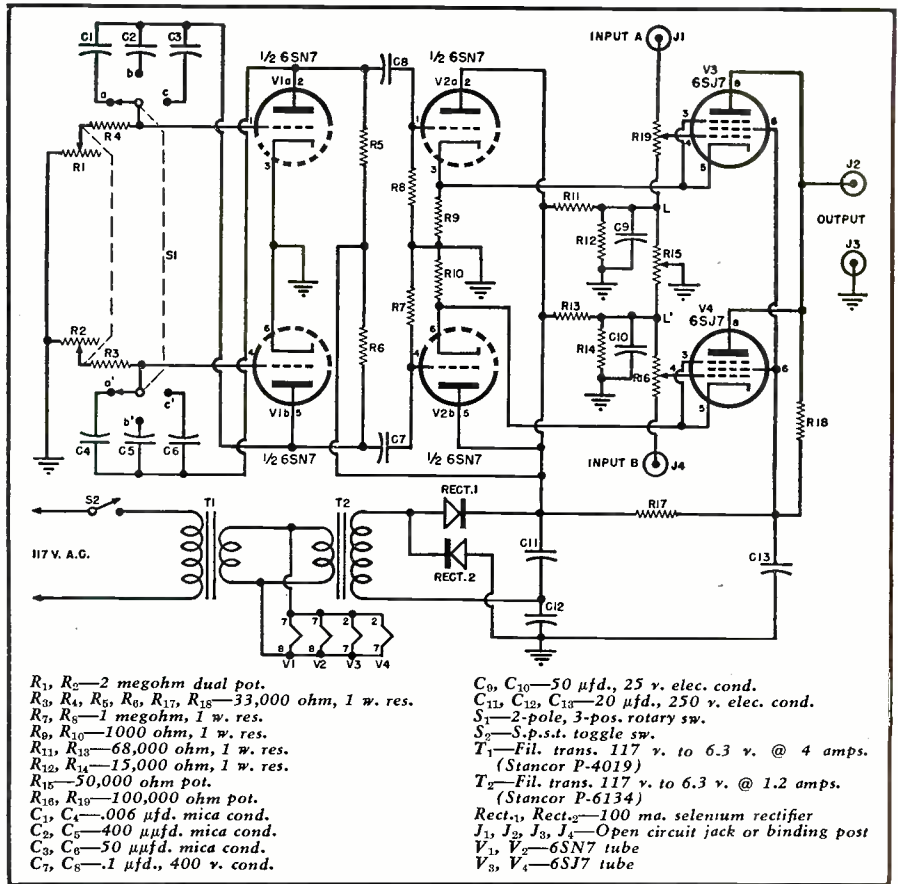

Fig. 3. Circuit diagram of electronic switch using selenium type power supply.

panel or in a cabinet by drilling holes along the edge of the panel.

So far we have considered only the operation and construction of the electronic switch. It would be well to become familiar with a few of its many applications.

For example, you might be interested in designing an amplifier. In order to maintain good amplification along with good quality of reproduction of tone, the output wave should be the same as the input wave. If the bias is too high, the tube will be driven beyond cut-off during a portion of the cycle, and the waveform would be as indicated in Fig. 6A. If the grid bias is too low, the grid will be driven positive over a portion of the cycle and the grid driving voltage will drop because of the grid current flow-

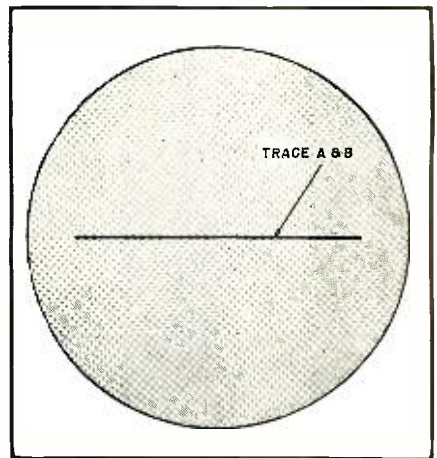
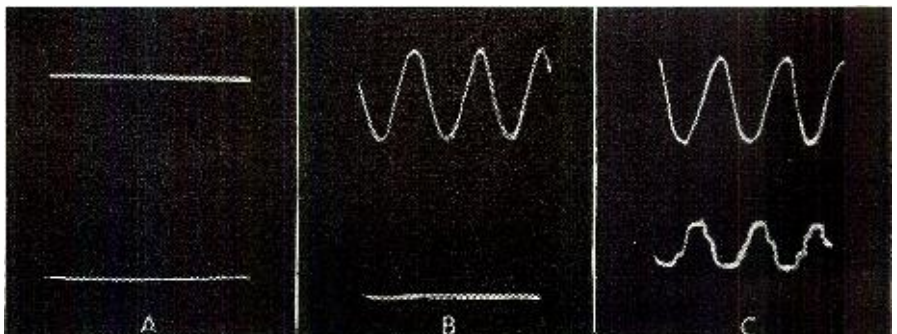

Fig. 4. Two superimposed oscilloscope traces.

Fig. 5. (A) Two traces on oscilloscope obtained from electronic switch. (B) A 60-cycle wave applied to input A, with trace B unaffected. (C) The 60-cycle signal applied to input A, and a distorted wave applied to input B.



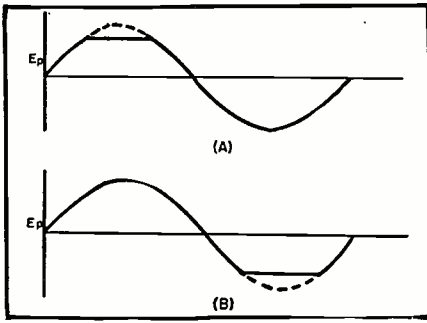

Fig. 6. (A) Clipping due to excessive grid bias. (B) due to insufficient grid bias.

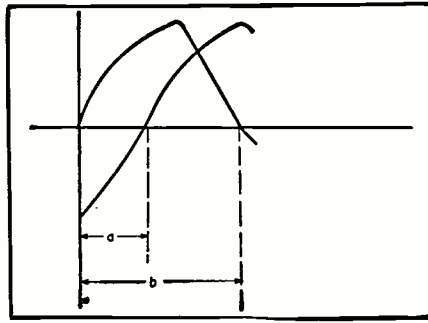

Fig. 7. The a and b distances used in calculating the phase shift of a waveform.

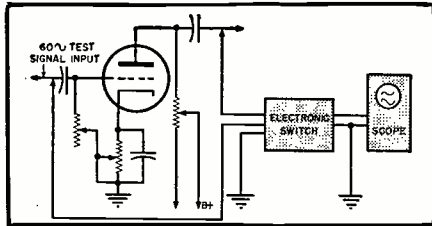

Fig. 8. Test setup used in checking operating condition of audio amplifier stage.

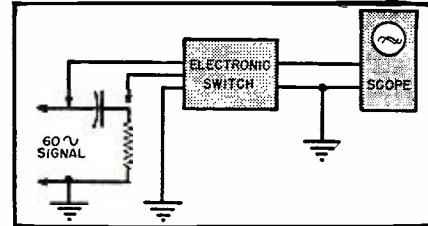

Fig. 9. Diagram of test setup for using the switch to demonstrate phase shift.



Fig. 10. Top chassis view of unit showing location of back-of-the-panel components.

ing through the impedance of the driving stage. This grid current will result in an output wave as indicated

in Fig. 6B. Therefore, it is obvious that if the waveform could be viewed going into the amplifier along with the output waveform, the choice of the proper grid bias could be made. If the bias is correct, a sine wave would be obtained if the input is a sine wave. Thus if the bias is adjusted to this value, the maximum output voltage may be obtained without distortion.

By the use of an electronic switch, the viewing of two waves may be obtained. Variable resistors or potentiometers can be inserted in the cathode, grid, and plate circuits and adjusted while watching the operation of the stage on the oscilloscope. The method used to obtain this proper grid bias is shown in Fig. 8. It may be seen that this method of designing an amplifier, stage-by-stage, may be used to view the wave obtained and to check the amount of distortion in a receiver, stage-by-stage. It may be noted that by this method of designing an amplifier, many mathematical calculations are eliminated.

In order to get a better understanding of this application, refer to Fig. 11A. In this case the electronic switch, oscilloscope, and a cheap four-tube table model radio were connected

Fig. 11. (A) Distortion in table model radio illustrated by the difference in two waves. (B) Phase shift as in wave of Fig. 7. (C) Square-wave obtained from electronic switch.

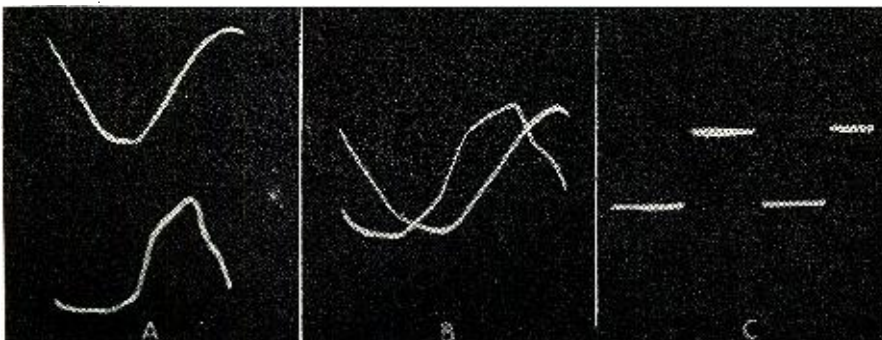

as in Fig. 8. The top wave is the input 60-cycle sine wave; the bottom wave is the output. In comparing the input and output, the output is highly distorted and shows that an insufficient grid bias exists, as discussed earlier in the article.

Another very important use of the electronic switch is that of finding phase shift. The phase shift may be found in an LC circuit or through one or more stages of an amplifier or receiver, or any other type of circuit. For the purpose of illustration of phase shift, we shall use a circuit as in Fig. 9. Before impressing the input signals A and B to the electronic switch, superimpose the traces with the positioning control. Apply the signal to the inputs and bring the waves to equal amplitude with the gain controls. The waveform should be that of Fig. 7 or Fig. 11B. Measure the a and b distance, shown in Fig. 7, with any convenient scale, as long as both a and b distances are measured with the same scale. Most oscilloscopes have a celluloid scale that may be used. If the phase angle is indicated by θ , then:

$$\theta = 180 a/b \text{ degrees.}$$

If $a = 10$ units, and $b = 23$ units, then the phase angle is $\theta = 180 a/b = 180 \times 10/23$ which is equal to 78.2 degrees. In this case there exists a phase angle along with distortion of the 60-cycle test signal. There are numerous other methods to find phase angle, but the other methods require either higher mathematics or the memorization of numerous configurations. Therefore, it is believed that this method is by far the simplest for all practical purposes.

It has been previously mentioned that the electronic switch is an excellent source of square-wave frequency over a limited range. The useful range of the square-wave frequency of this electronic switch is 80 to 600 cycles per second. The switching rate is 60 to 8000 times per second. The square-wave frequency covers a much larger range that is lower and higher, but at these frequencies the waveform is not a true square wave. The available square-wave frequency is of sufficient quality to be used in square-wave testing. Fig. 11C shows the square wave that may be obtained at mid-frequency. It may be stated here that in some cases at higher frequency, a slight transient effect will be indicated when viewed on an oscilloscope. This transient effect will have no effect upon the square wave.

A number of examples have been used to illustrate the very valuable use of an electronic switch. The complete unit may be constructed for less than 20 dollars. If surplus tubes are used, as in this case, the cost of the completed unit is less. When building the unit, all parts should be mounted first, then all filaments and the power supply should be connected. It was found that if the unit is then wired stage-by-stage, less error in wiring will be encountered.

ABC Uses MAGNETIC TAPE For Delayed Broadcasts

By

BYRON H. SPEIRS

AM Recording Supervisor
Central Division, ABC

THE seasonal adoption of Daylight Saving Time by the major cities during the summer months creates a problem for the broadcast networks. The portions of the country which do not adopt Daylight Time must be supplied with network programs at their accustomed times to avoid confusion and its attendant loss of listeners.

In the past it was the practice of the major networks to record the programs for the areas remaining on Standard Time on acetate discs. The programs were then fed back to the network at the proper time, and the stations in Standard Time areas took these programs off the line and in turn fed them to their transmitters. The same technique was also used for the stations which operated in the different time zones of the nation.

Obviously, this type of operation required the use of large quantities of discs with their attendant storage problem and high cost. In addition, the recording and playback machines needed frequent service to maintain them in proper operating condition. A bank of recording machines of the disc type also requires a considerable amount of space.

Prior to 1948, the *American Broadcasting Company* did none of their own recording, preferring to have this work done by independent companies equipped to handle this operation. With the advent of high quality tape recorders, several of the problems were automatically solved.

Tape machines have the advantage of requiring little service except routine maintenance, and the tape may be used over and over, with a very low cost per recording, and no storage problem. The fidelity of tape greatly exceeds that obtained with the best disc equipment, and recordings of almost any length may be made with no interruption. A standard sixteen inch disc can only record slightly over 15 minutes of program before it is necessary to change machines. Quite often it is difficult to time the disc to place the end of a recording at a point where the continuity is not disturbed.

Occasionally it is desirable to be able to edit portions of a program to eliminate errors and allow breaks for local spot announcements. Editing is difficult if not impossible with discs,

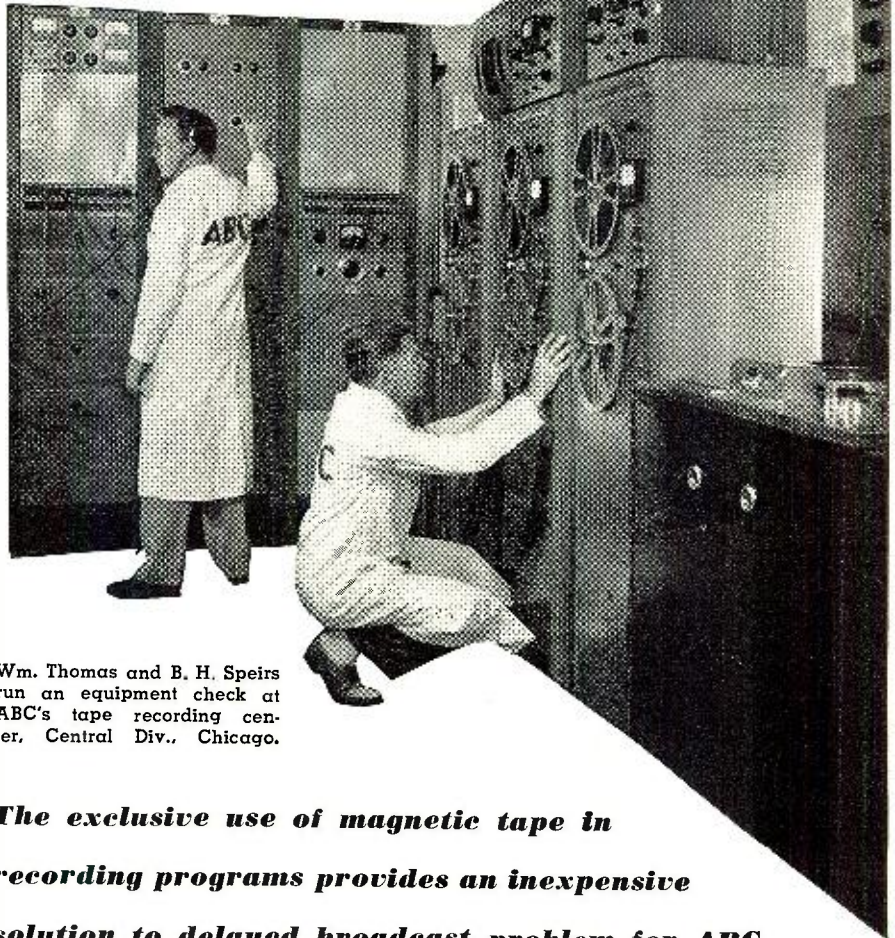

Wm. Thomas and B. H. Speirs run an equipment check at ABC's tape recording center, Central Div., Chicago.

The exclusive use of magnetic tape in recording programs provides an inexpensive solution to delayed broadcast problem for ABC.

but is a very simple matter when tape is used. The undesired portion is simply cut out and the ends of the tape spliced.

With the use of tape it is also possible to pick out any desired portion of the program, as the tape itself may be readily marked with the content of that portion.

The Chicago studios of ABC use a total of ten tape machines. Four units (*Stancil-Hoffman*) are mounted in relay racks. The units mounted in the consoles (as shown on front cover) are *Ampex* machines and are used for the bulk of the recording.

A block diagram showing the basic control and switching system is shown in Fig. 1. By means of this switching system any machine may be selected for either record or playback. All recording and playback is made in duplicate to insure against equipment failure although experience has shown that this feature is seldom needed.

In feeding a program to the net-

work, two machines with duplicate tapes are run in synchronization. The master machine feeds one line while the safety or emergency machine is feeding the second line and is preset to feed the first line in the event of failure, simply by means of pressing an "Operate" button on any control panel. Each machine is equipped with its own control panel and monitor speaker.

The tape equipment was installed in the spring of 1948 and at this time has been in use for approximately 7100 hours. During 1948 the total time lost due to tape breakage was only three minutes. This represents the extremely low figure of .002%. No time whatsoever was lost during 1949.

It has been the experience of the engineers that the tape is constantly being improved in both mechanical and electrical quality. Although accurate records are not kept on the life of the tape, one tape which was checked,

(Continued on page 134)

The MINI-RACK MODULATOR

By JOHN F. CLEMENS,
W9ERN

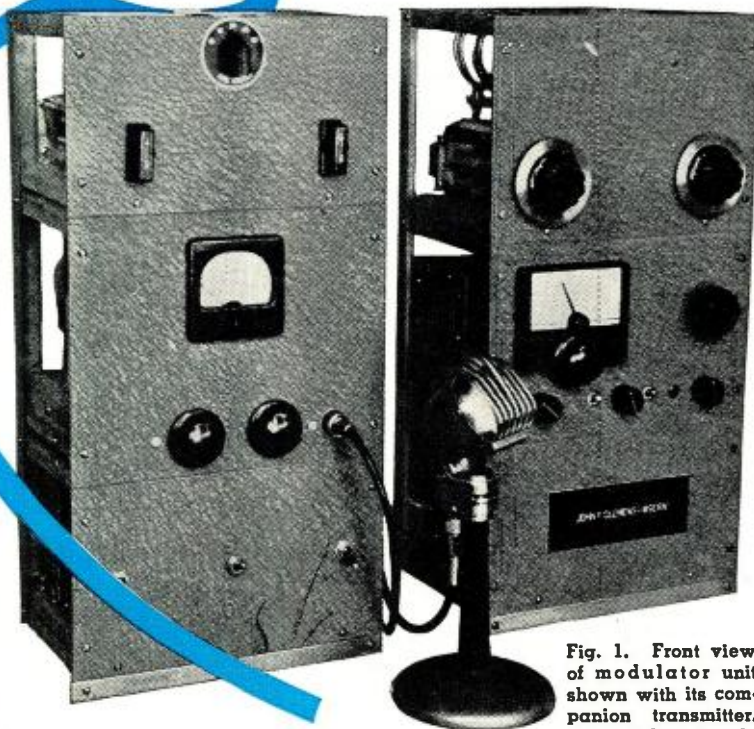

Fig. 1. Front view of modulator unit shown with its companion transmitter, covered last month.

This 50-watt modulator is designed as a companion unit to the "Mini-Rack Transmitter" described in last month's issue. It may, however, be used to modulate any c.w. transmitter of up to 125 watts input. An antenna matching network and a splatter suppressing clipper unit are also included.

RECENT circuit development by the tube division of RCA has opened up new possibilities for the versatile 807 beam tube in audio service. The operating characteristics published for the 807 as a beam tetrode are perhaps the most tempting of any tube for audio powers of up to 120 watts, since such outputs may be obtained with but a fraction of a watt of driving power. Nevertheless, the requirement of a stabilized, low-impedance bias source of about 25 volts has deterred many hams from using the 807 for class AB2 audio applications. Operating conditions for the 807 as a zero-biased

high-mu triode are now available and will be hailed by those who dislike C batteries and multiple power supplies as the answer to a ham's prayer.

It will be noticed that the driver transformer drives the 807 screen grids with the control grids connected through resistors to their respective screen grids. The value of the series resistance in each control grid, 22,000 ohms, is the "magic number" which has been found to produce a family of plate characteristic curves ideal for class B zero-biased operation. Since the effective value of grid impedance is approximately 7100 ohms, a driver transformer having a 1:1 ratio be-

tween primary and one-half of the secondary may be used to couple the modulator to a beam tube such as the 6L6.

In the modulator pictured, a single power supply is used for both modulator and speech amplifier, thereby reducing the cost. Choke input is used to obtain good voltage regulation of the power supply and the speech amplifier acts as a constant load in lieu of a bleeder. For good regulation of the supply output voltage with a filter choke of 8 henrys a bleeder resistor of 8000 ohms would be necessary. This resistor would draw 62 ma. from a 500 volt supply—practically the same amount of current that the speech amplifier consumes. Thus, it is apparent that by eliminating the bleeder and low-voltage power supply we are gaining a considerable amount of over-all efficiency.

A unique virtue of zero-biased class B tubes is the constancy of the load they present to the driver tube. For this reason, in addition to the high value of grid impedance, no special precautions need be taken to obtain good regulation in the driver stage. As a result, distortion-free operation may be obtained with a beam tube rather than the more common low efficiency triode as a driver. By introducing 6 db. of inverse voltage feedback around the driver tube, its effective internal impedance is reduced to the point where distortion does not appear even on audio peaks.

If greater power output is desired, up to 100 watts may be obtained by merely increasing the 807 plate voltage to 750. If the maximum rated power output of 120 watts is required the driving power should be increased. A pair of push-pull 6V6's is suggested for this application. The single 6L6 in the present unit operates at 350 volts on the plate and 200 volts on the screen. The plate voltage for the two speech amplifier stages is obtained from the 200 volt point at the driver screen.

The single power supply uses one of the very common 600 volt, 200 ma. power transformers and supplies, in addition, all filament voltages to the modulator, rectifier, and clipper tube. With choke input, the output voltage is 500 volts with good regulation. The single section filter is quite sufficient since the push-pull connection of the modulator balances out power supply hum and the speech amplifier stages have the additional filtering of the voltage-dropping circuit plus the audio decoupling circuit. The hum level of the power supply itself is approximately 1% or 40 db. down. Plate and filament voltages are turned on together and it is therefore necessary to use a slow heating rectifier tube to avoid a high voltage surge which might damage the audio decoupling condensers. With a 5V4G, the speech amplifier has time to warm up and act as a load on the power supply itself to prevent condenser input conditions occurring.

RADIO & TELEVISION NEWS

A high resistance bleeder is connected across the power supply as a safety measure to assure discharge of the power supply if it is operated while disconnected from the modulator.

For the speech amplifier, two high-gain, pentode-connected 6SJ7's are used in cascade. The gain is such that full modulation is obtained when speaking a foot or more from the mike pictured, a Turner model 33D with an output of -54 db. below one volt. The hum level of the modulator is extremely low due partly to the fact that the heaters are operated at a slight positive potential with respect to the cathodes, as recommended by the tube manufacturers. This positive potential is secured by returning the center-tapped filament resistor to the 6L6 cathode rather than to ground. Both filament leads are above ground so that no 60 cycle current flows in the chassis.

Since the frequency response of amateur-line modulation transformers is limited, the speech amplifier range should be similarly restricted so that distortion will not be produced by driving the transformers outside their distortionless range. To limit the low frequency response, the screen bypass condensers on the two 6SJ7's are made somewhat smaller than usual so that screen grid degeneration will occur at low frequencies. With the specified values of grid and plate load resistors the response will drop off above 5000 and below 150 c.p.s.

The modulators require a plate-to-plate load impedance of about 4000 ohms. A variable transformer is desirable in order to adjust the load to the correct value for least distortion and greatest output power. A measured undistorted output of 54 watts is obtainable from the secondary of the output transformer. For speech work the modulator will modulate transmitters of up to 125 watts input.

A clipper tube has been incorporated in the modulator to prevent

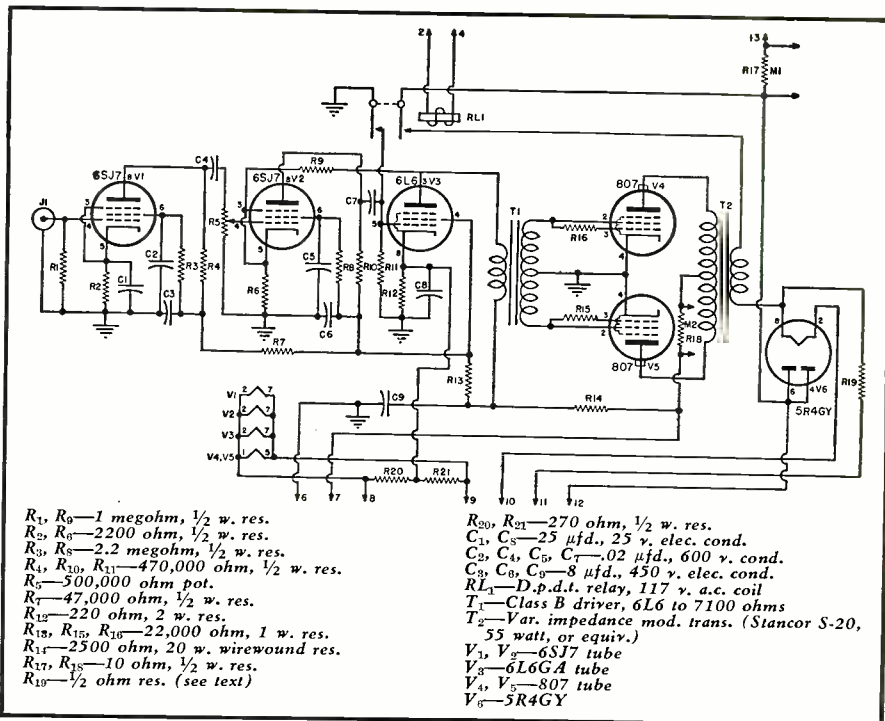

Fig. 2. Schematic diagram and parts list for the 50-watt modulator unit.

slatter due to negative overmodulation. The circuit used is a high-level type clipper which was originated by Howard Johnson, W7MU. This circuit has some advantages over low-level clippers and other types of high-level clippers because it requires no additional filter and there is no arbitrary adjustment necessary. The leakage reactance of the modulation transformer is used in conjunction with the plate bypass condenser to form a low-pass filter which does not pass the distortion frequencies generated by the clipping. The clipping action never occurs until 100% modulation in the downward direction has been exceeded. Excessive upward modulation does not produce slatter and therefore is not objectionable. Since

two filament windings are available on the 600 volt windings of the transformer, the extra 6.3 volt winding is used on the clipper tube. The voltage is dropped to the required 5 volts at 2 amps. by the resistance of an 8-inch piece of number 22 soft iron wire used as one of the hookup leads between power supply and modulator chassis. Approximately one-half ohm is required and the exact value may be ascertained by measurement of the voltage on the 5R4GY filament. The filament voltage is not critical and the full 6.3 volts could probably be safely used on the tube filament. Using the 5R4GY with both plates in parallel, the clipper tube is responsible for a voltage drop of 30 volts at 200 ma. With the trapezoid pattern on an oscilloscope

Fig. 3. Under chassis view of modulator. The bottom cover has been removed to show simplicity of wiring. Ceramic sockets are recommended to prevent leakage and the d.p.d.t. meter switch is of the ceramic wafer type. The lead from the mike connector to the grid of the amplifier must be as short as possible.

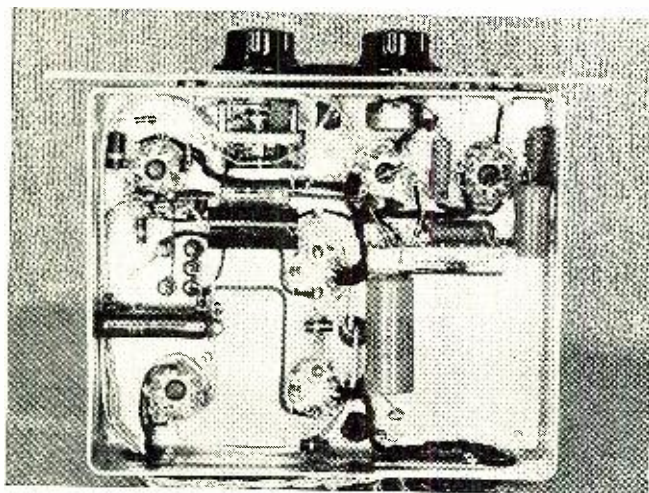
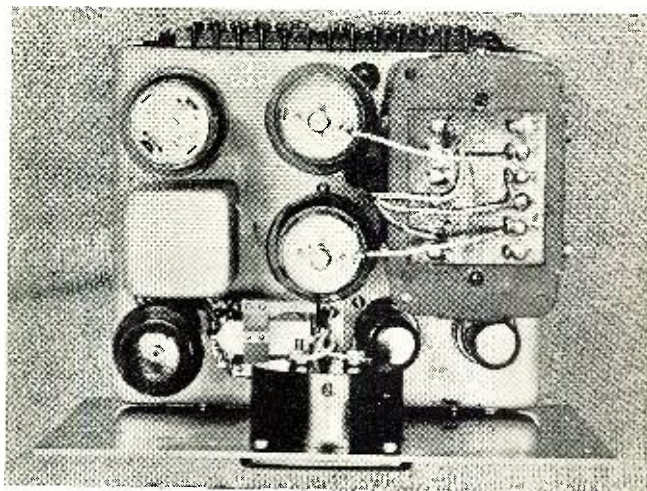

Fig. 4. Top view of the modulator chassis. Directly behind the panel are the two speech amplifier tubes and the audio relay and driver tube in a row. The 5R4GY in one corner of the chassis is the high-level clipper used in this circuit to prevent the overmodulation slatter which is generally encountered.



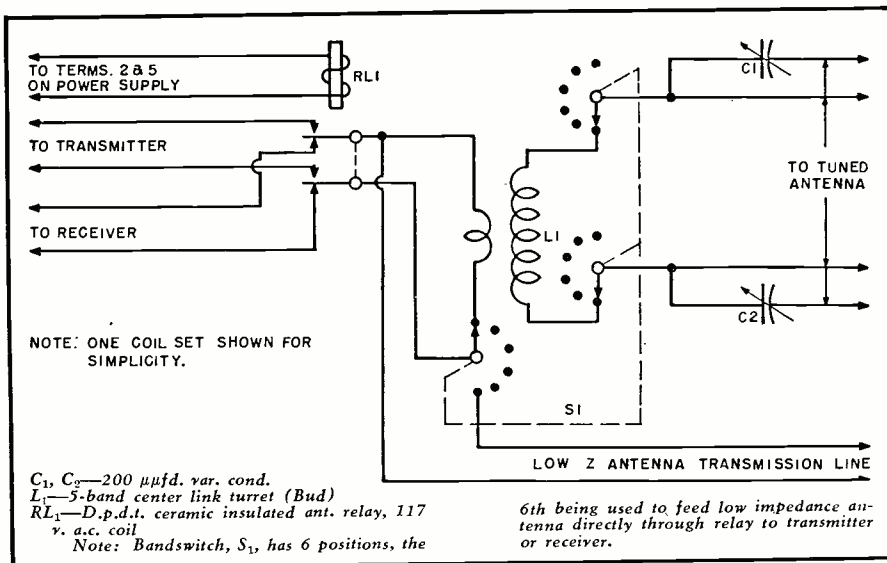

Fig. 5. Circuit diagram of the 5-band antenna tuner used with the 50-watt modulator.

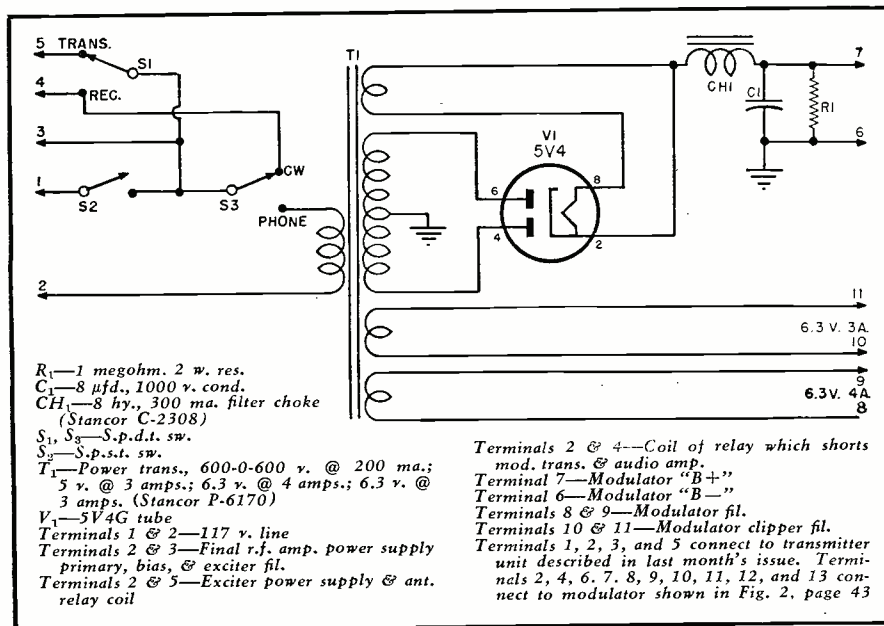

Fig. 6. Circuit diagram and parts list covering the power supply for the modulator.

Fig. 7. Over-all view of antenna tuner. A 300-ohm twin-lead is used to make the connection from the antenna relay to the receiver terminals as well as the connections between transmitter and tuner. The five coils cover 80, 40, 20, 15, and 10 meters.

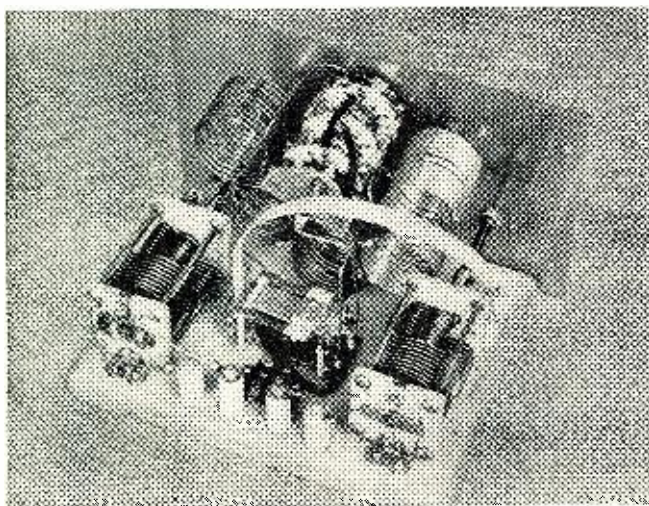
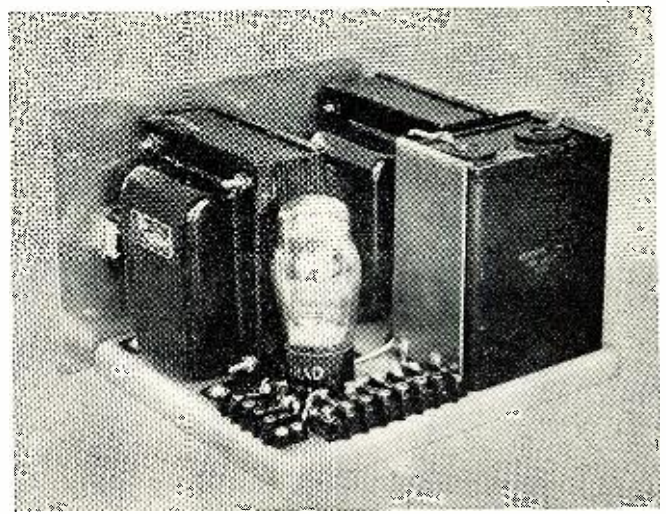
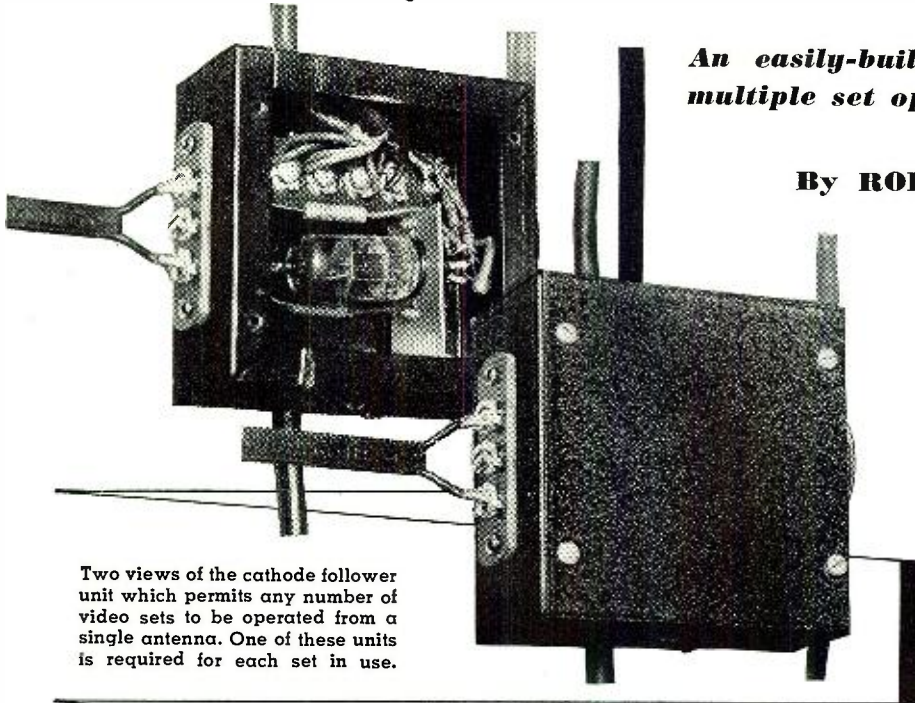

Fig. 8. The modulator power supply. All components are assembled on a 3/4" deep chassis to conserve space. All transmitter switching is controlled from the power supply panel through connections to the terminal strip on the rear of the chassis.



MULTIPLEX TV ANTENNA

Systems for Stores



Two views of the cathode follower unit which permits any number of video sets to be operated from a single antenna. One of these units is required for each set in use.

An easily-built cathode follower unit for multiple set operation from single antenna.

By **ROBERT L. DONALDSON**

not loading the line, and low output impedance that may be made equal to the input impedance of the set used, thus assuring maximum power transfer. It is also a "one way" device that effectively prevents oscillator energy from a set going back into the line and causing interference with other sets.

The particular arrangement that has proven very effective is where a 300 ohm twin lead is run down from the antenna and is routed around the showroom. At intervals along this line the cathode follower units are placed, attached to the wall, and merely shunted across the line. Any reasonable number of coupling units may be used, (Continued on page 110)

ONE of the problems faced by operators of television receiver showrooms is that of multiple operation of several TV sets from one antenna system. The usual evasion of the problem by installing a switch system that allows but one set at a time to be connected is not satisfactory. The impossibility of showing direct comparisons between sets, and the bother of constantly operating the switch are annoying factors. If two or more sets are connected in parallel across the lead-in the signal power is shared by the sets, and so the signal available to each set gets poorer as more sets are added. The very low load impedance of the combination causes extreme standing wave effects, and reflections result in degeneration of the image on all sets. Resistance pads between the sets and the lead-in help to maintain proper impedance match, but result in even greater attenuation of the signal at the set. In addition, there is usually severe interference between sets, limiting simultaneous operation. What is needed, then, is a simple system that would overcome this general problem.

Such a system is herein described. It operates by employing a number of cathode follower units between the lead-in distribution line and the set inputs. The cathode follower circuit has the desirable characteristics of extremely high input impedance, thus

Circuit diagram of the cathode follower unit for multiple receiver operation.

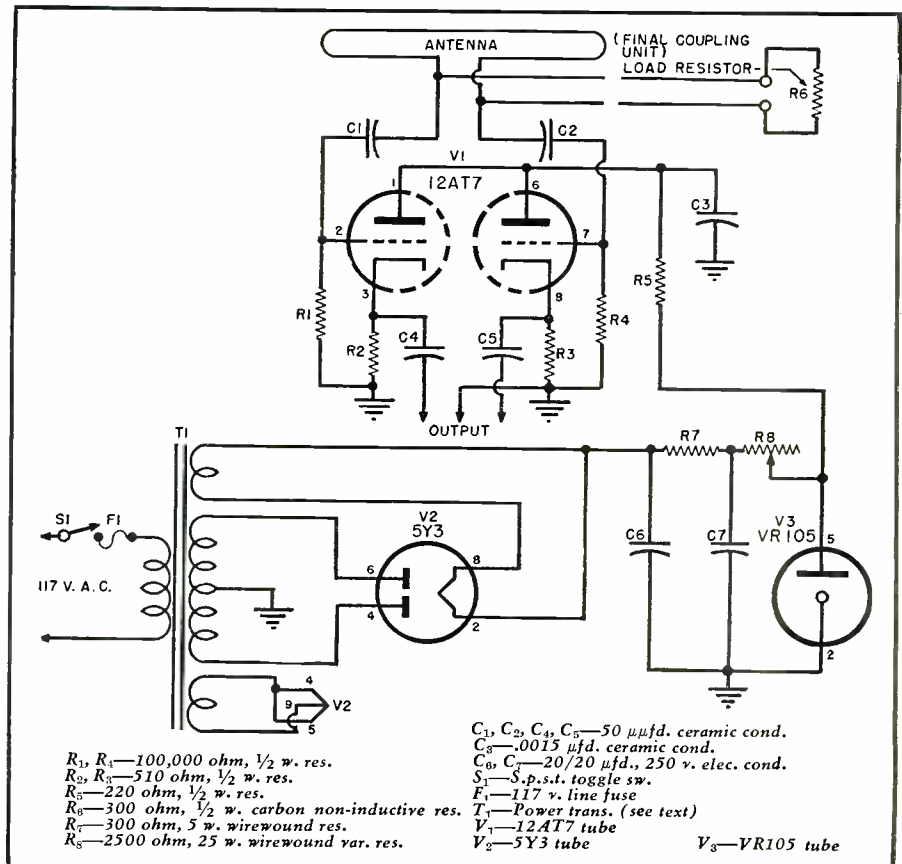

Prospector's portable Geiger counter in a trial test of a sandstone deposit for uranium content.

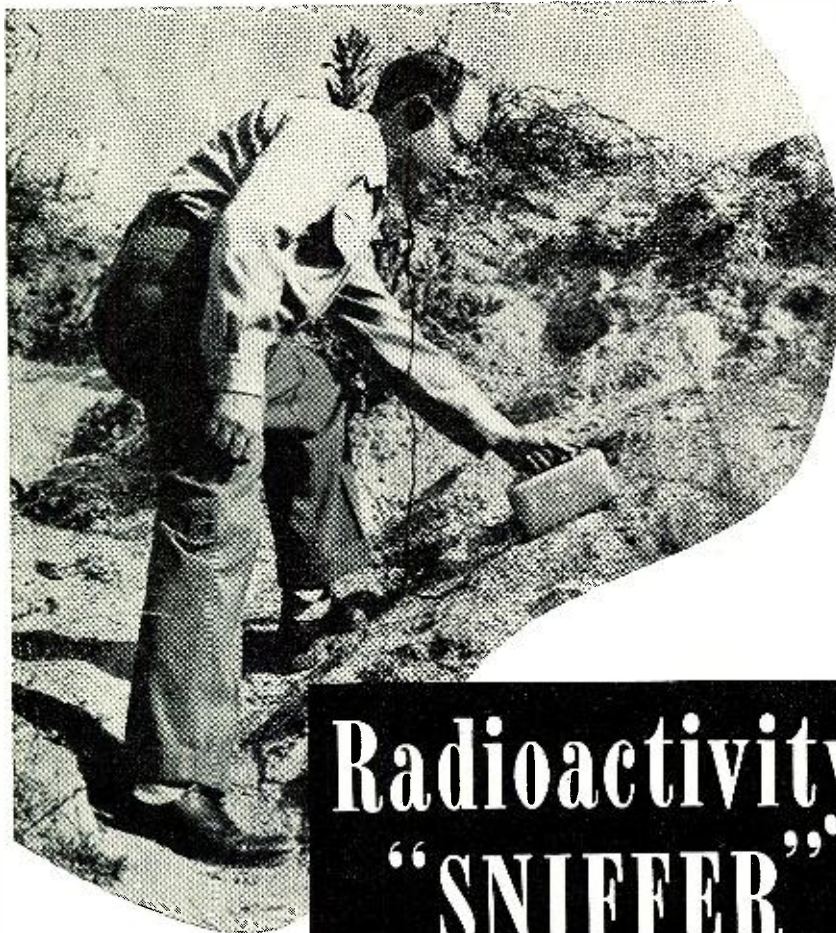

Radioactivity "SNIFFER"

By ALVIN B. KAUFMAN

Details on the construction and operation of one type of commercial Geiger-Mueller detector unit.

THE construction of a Geiger-Mueller unit for the detection of radioactive ores or waste products has probably been considered by every amateur and professional electronics engineer interested in this field. The inducement to build such a unit for personal use or sale has been spurred on by the U. S. Government, through the Atomic Energy Commission, offering bonuses and subsidization for discovery of any new uranium deposits.

An outline of the inducements offered by the Atomic Energy Commission might not be amiss at this point. A \$10,000 bonus is offered for the discovery of any new uranium deposit that yields 20 tons or more of uranium ore or concentrates assaying 20% or higher in uranium oxide. This bonus offer does not apply to carnotite-type or roscoelite-type ores located in the Colorado Plateau area. A guaranteed minimum price of \$3.50 a pound for small lots of domestic refined uranium is pledged by the government for

a ten year period, for 10% or better uranium oxide concentrates. The same guarantee is made for low grade ores, except the offered price is less refining costs. Lower grade ores containing as little as 0.2% uranium oxide will be purchased by the government. Further details on marketing or securing assay information may be secured by writing to the Atomic Energy Commission, Raw Materials Operation at 70 Columbus Ave., New York, N. Y., or to the Colorado Raw Materials Office at Grand Junction, Colorado.

This article is not concerned solely with the design of a Geiger-Mueller detector, but with the technical problems encountered in searching for and identifying a strike, valuable radioactive minerals, or in determining roughly the contamination of an area. Several articles which the author has read note that valuable ore may be determined as such from the equipment's counting rate. These statements do not take into consideration the mass of the radioactive material, distance

to the probe, or possible variations between equipment or Geiger tubes. The number of counts per minute depends on the number of radioactive particles striking the G-M tube. This, in turn, depends upon the tube used and the strength of the radioactivity in its vicinity. Counters of normal sensitivity will register some counts even when there is no radioactive material present. This is the background count. These indications are mainly due to cosmic rays, but can be produced by other weak sources such as the luminous paint on watches. The increase in counts over the background count indicates, when properly interpreted, the value of ore or the danger in a contaminated area. In prospecting with Geiger equipment, the most important thing to remember is to allow for the background count. The reading in any specific location, or for any ore sample, is not significant until the background count has been subtracted or noted. In addition, this count will not be the same at all times on the same instrument, as the Geiger tube ages or the batteries become weak. Temporary variations may also occur in the field. Some types of bedrock contain radioactive materials. For example, limestone is usually inert, while granite frequently contains some proportion of radioactive minerals; hence, crossing a limestone-granite contact may increase the background count. A drop in the background count can occur when entering a depression, because the sides of the depression shield the counter from incoming cosmic rays. Relatively large areas of weak radioactivity may raise the background count, causing a response similar to that of a vein of high grade ore. The operation of the counter in the vicinity of an x-ray machine may also give incorrect information. Such changes in the counting rate cannot be controlled, and the prospector must learn to make allowances for them. Samples and specimens should never be carried within the Geiger-Mueller carrying case. The counter otherwise could become contaminated by radioactive dust and dirt entering the case and its background count or operation might be impaired.

The design of a portable G-M radioactive detector brings up problems common to the design of previously designed portable equipment; the use of meters, batteries, carrying case, extensions, and allowable weight. From experience in the field, prospectors, and I've been one, have determined that bulky equipment, regardless of weight distribution, is not desirable. Two or three unit pieces of equipment, where one section is carried on the belt or back, usually indicate excessive weight and clumsiness of use. Meters are not desirable on field equipment as they have high fatality rates and cannot be watched when walking through

RADIO & TELEVISION NEWS

rough terrain anyway. Extension cords wherein the detector or G-M tube is placed on the end of a cord to form a probe does have some advantages but generally at the expense of weight and bulkiness.

The most important considerations in the design of an instrument are weight, circuit, and batteries (which go hand in hand) and cost. The high voltage supply is probably the most important section of such a unit. The design of this establishes the weight and cost of the equipment. In present equipment this power supply depends on one of the following systems to supply the 900 volts required by most G-M tubes. Probably the simplest system is to supply the high voltage required by three 300 volt *Eveready* No. 493 batteries in series. These batteries have a long life, but their weight (size of three 67½ volt *Mini-Max*) and wholesale cost of approximately \$27-33 was considered excessive. Replacement cost of the batteries alone would be a deterrent to the average prospector. To lower initial and maintenance cost many engineers have designed relaxation oscillator power supplies. These are similar to television receiver high voltage supplies working from the sweep kickback section of the scanning circuit. The only batteries required are a filament and plate voltage battery or two of the miniature portable size. The operation of this circuit is simple. A neon tube (such as the NE-2) is placed in the grid circuit of a tube and arranged to operate as a relaxation or saw-tooth oscillator, in the manner of the simplest cathode-ray tube type of sweep circuit. This action in the grid circuit of the tube will slowly build its plate current up and then sharply cut it off as the neon tube fires. Any large inductance in the plate circuit of this tube will develop a high voltage across itself at the moment the plate current is cut off. This high voltage is rectified by any one of the miniature high voltage rectifiers and filtered for supply to the G-M tube. At the same time this tube's "B" battery may be used with any amplifier tubes. This circuit is very good, costwise, but still possesses excessive weight and its voltage regulation is not too satisfactory. A third method, also popular, is the use of a vibrator-type high voltage supply. The circuit used is similar to the high voltage supply used in car radios. Two power sources have been used commonly with this vibrator circuit, either a 6 volt dry cell battery or a rechargeable 2 volt wet cell.

Considering the over-all situation, the use of a vibrator type high voltage supply seems desirable from the standpoint of simplicity and cost. There was, however, one desirable feature not obtainable with any of these "electronic" power supplies. That was good power supply regulation.

About this time a commercial Geiger-Mueller unit was placed on the market by *Nuclear Instrument & Chemical Corp.* which exceeded by far

my requirements as to weight and cost of batteries. A few simple calculations indicated that its method of design if applied to a home constructed unit would give a much cheaper and smaller unit than that previously obtainable by the experimenter. Its low net price makes it optional and up to the individual as to whether purchase or construction is preferable. The commercial unit to be described is trade-named the "Sniffer." It weighs two pounds and employs a vibrator high voltage power supply using two ordinary flashlight batteries for the power source, and, in conjunction with special regulator tubes, supplies a regulated high voltage for the Geiger-Mueller tube.

The components for building a unit similar to the "Sniffer" may be obtained from many companies. *Nuclear Instrument, Raytheon, Technical Associates,* and other companies manufacture Geiger tubes for sale at prices ranging from eight dollars for uncased units to completed probes selling as high as several hundred dollars. Special 900 volt regulator tubes are available from *Raytheon,* and the *Victoreen Company.* Subminiature amplifier tubes are available from a variety of sources.

A commercial "Sniffer" was obtained and examined both electronically and in the field. Its performance and mechanical construction were excellent, and it was found to be adaptable to home construction. Its amplifier gain and sensitivity gave a background count of 20-30 a minute which is good for portable equipment. One word here. Even with this high background count, the individual pulses may at times appear so far apart that the instrument may sound defective. This will not be the case. The cosmic ray background counts will be quite erratic, many times coming close to-

* Leslie, Eric: "The Geiger Counter—How Does it Work?" *Radio-Electronics*, September, 1949.

gether with large time gaps between groups or single impulses. The only way to be sure of your instrument is to count the total clicks or impulses per minute.

The radiation-sensitive element of the "Sniffer" is a special Geiger-Mueller tube. For the uninitiated, it consists of a thin wire (usually tungsten) centered axially in a metal envelope. The tube is filled with a gas. Effectively it is a gas-filled diode with enough d.c. voltage applied between cathode and anode to bring it almost, but not quite, to the firing point. When the voltage is at this critical point, a single particle striking the tube from a radioactive source causes the gas to ionize. The tube then breaks down or fires and conducts heavily. This current is quite minute, so it is run through a high value resistor which has two functions. The first function is to supply enough voltage to an amplifier tube grid to obtain headphone volume. Secondly, since a gas filled tube will continue to conduct until the voltage across it is lowered, the circuit also quenches the G-M tube by lowering its voltage immediately after each click. Complete fundamentals of G-M tube operation are beyond the scope of this article and have been covered in other articles.*

The Geiger tube impulse current develops a voltage across the 3.9 megohm grid resistor of the subminiature *Raytheon* CK522 triode. The one megohm resistor in series with the tube's grid is to limit any possible grid current from the signal voltage and to possibly give a slight negative bias to the tube from any gas grid current. Tube bias is obtained as outlined in the power supply discussion. As the circuit schematic indicates this single amplifier tube receives its filament current through a 100 ohm dropping resistor from the three volt bat-

(Continued on page 136)

Circuit diagram of *Nuclear Instrument & Chemical Corp.*'s radioactivity "Sniffer."

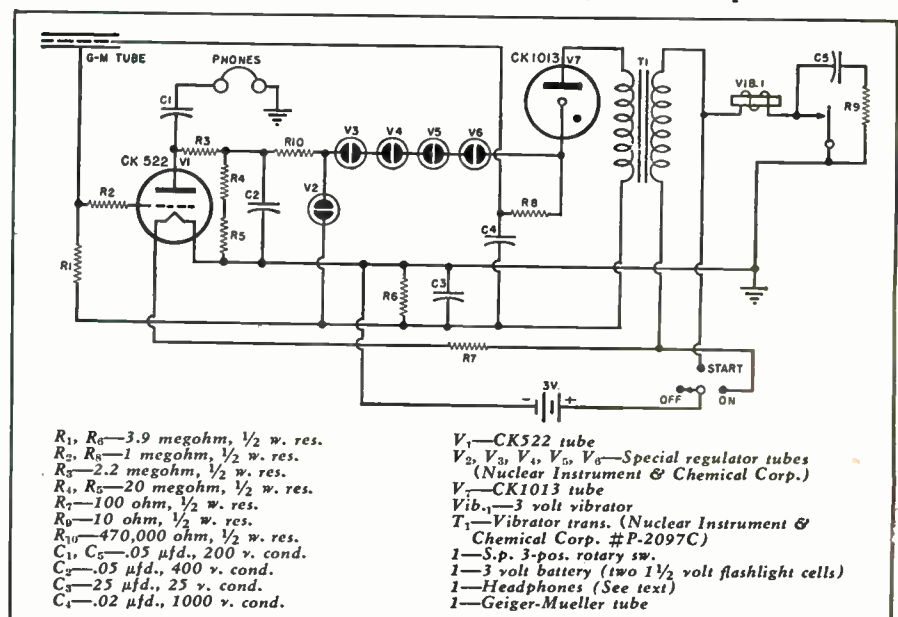

CONSTANT-RESISTANCE

Network Inductor Design

By JACK D. GALLAGHER, W5HJZB

A useful formula for winding your own constant resistance inductances for dividing networks.

IT IS unfortunate that articles which have been written concerning dividing networks have failed to give the reader an idea of how to wind inductances for these networks. The reader is usually given information about the types of circuits, the values of components used therein, and the fact that the inductance should be wound with heavy wire on non-magnetic forms, but usually no information is given about the size of form needed, the size of wire, and the number of turns of wire required for a given value of inductance.

Various circuits for dividing networks were described in the article "Dividing Networks" which appeared

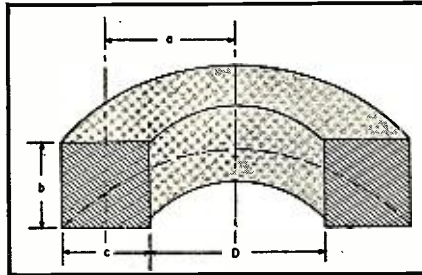

Fig. 1. Cross-section of coil. For maximum inductance c equals b ; and c should be .66 of radius a . See text for explanation.

in the December issue of RADIO & TELEVISION NEWS, therefore it is the purpose of this article to present suit-

able information which can be used to determine the approximate number of turns required for a given value of inductance.

Unfortunately, there has been no exact, simple formula derived whereby it is possible to calculate the number of turns to wind on a form of given dimensions to obtain a desired inductance. However, there are several formulas available which are sufficiently accurate for practical purposes and these can be employed, providing they are used with discretion. Wheeler's simple approximate formula for a multiple-layer inductance of the type shown in Fig. 1 is:

$$L = \frac{0.8(a)^2 (N)^2}{6a + 9b + 10c} \text{ microhenrys}$$

where dimensions are in inches.

In order to obtain the maximum inductance and the most economical construction, the cross-section of the winding should be a square and the side of the cross-section should be 0.66 times the mean coil radius, " a " in Fig. 1. Then L reduces to:

$$L = 0.043(a)(N)^2 \text{ microhenrys}$$

In the parallel constant-resistance type of dividing network, as shown in Fig. 2A, the value of the inductance L is given by the formula:

$$L = \frac{225,000 (R_o)}{f_c} \text{ microhenrys}$$

Equating the two values of L above and noting that the mean coil radius " a " is equal to one-half of the inner diameter of the coil plus the depth of the winding " c ", then simplifying, the formula for the number of turns of wire to wind on a form of given dimensions for a parallel constant-resistance network becomes

$$N = \frac{2650 \sqrt{R_o}}{\sqrt{D} f_c}$$

where D is the inner diameter of the coil in inches. Since no dimensions other than the inner diameter of the coil exist in the equation above, it may seem to be incomplete. It can be shown that the inner diameter of the coil is approximately twice the winding depth. To obtain the number of turns to wind on a form for the series constant-resistance type of network multiply the value of N for the parallel circuit by .707.

As an example consider R_o as 8 ohms, the desired crossover frequency as 600 cycles, and the form as 1½ inches in diameter. Substituting in the formula and solving for N we get 250 turns. The diameter of the form is 1½ inches, therefore the depth and width of the winding space

(Continued on page 161)

Fig. 2. Inductance and capacitance of parallel (A) and series (B) circuits. Graphs shown are for R_o equal to 8 ohms. L-C equations for other values of R_o are included.

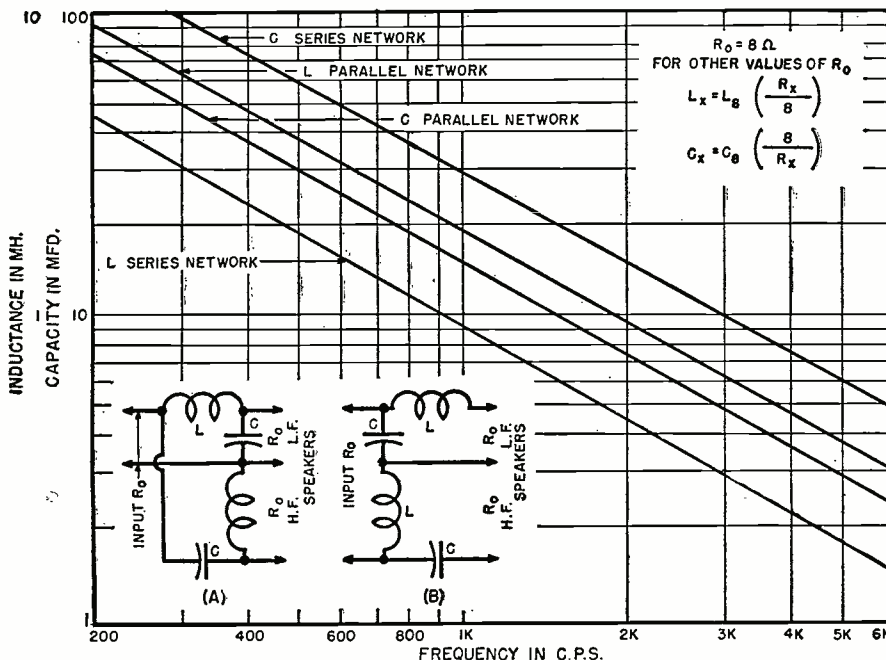

A TV Linearity-Pattern GENERATOR

By

ROBERT N. VENDELAND*

LOOK, the wedge on the left hand side of the circle is at least a quarter of an inch bigger than the wedge on the right hand side of the circle. I paid for a year's guarantee on that set and I want it right. Is it a lemon? If it is I'll send it right back to that dealer! I want it right! I want it right!" Before this little scene reaches the mayhem stage let's take a look at one answer to this service technician's problem, a portable crosshatch generator.

This piece of TV test equipment is a customer persuader and looks like an instrument that is capable of speeding up the television service call—especially the nuisance call. We all know that most television service calls, on warranty, are strictly educational calls the salesman of the receiver should have made, but didn't. We also know that some perfectly satisfactory installations have been turned into headaches by some first-hand-cousin that saw a television receiver once and is therefore an expert, so he is perfectly qualified to tell the customer that his linearity is out, or something like that.

Going out on a call of this type puts you, as a service technician, on the defensive right away. You have to say that the picture is good and the customer doesn't believe you!

The linearity pattern generator is an instrument designed to place horizontal and vertical lines on the screen of the cathode-ray tube in the television receiver. It serves as an accurate guide for setting the linearity controls of a receiver when a test pattern is not on the air. However, its chief value lies in its ability to cope with the nuisance call. Let's take one case for an example. The customer isn't satisfied (for no other reason than somebody told him that he shouldn't be getting ignition noise on his receiver—they don't on theirs).



Fig. 1. Crosshatch pattern on screen permits service technician to demonstrate set's operation to customer.

Hickok's new signal generator provides test pattern at any time for TV alignment and troubleshooting.

You make the call, check the antenna, connect the crosshatch generator to the terminals of the set, disconnect the antenna, and throw a crosshatch on the screen. The customer sees the pattern and sees that the ignition noise has disappeared. While you have the instrument connected you trim up the linearity and record the setting of the output controls. If you were lucky enough to have recorded similar settings at the original installation you can compare the two sets of readings and show the customer that his set hasn't changed—and, therefore, there is nothing to service. The fact that you are using an instrument to check his set, and not just your judgment, carries a great deal

more weight. With this method you can definitely show that the noise is external and that the trouble may have developed in the neighborhood after the set was installed. If you explain effectively you may sell him a better antenna installation.

The possibilities of an instrument of this type are unlimited as a customer persuader and also as a service aid. You can readily appreciate the value of a crosshatch generator as a time saver in setting controls when a test pattern is not on the air. As television grows in your community you are going to have less and less test pattern time as morning programs take over.

Before the application of the crosshatch generator as a service instrument in the home and the shop is discussed, perhaps we had better describe exactly how it works.

* The author is Supervisor of the Technical Department of the National Radio School, Cleveland, Ohio, and Vice-President of the Cleveland Television Clinic, Inc.

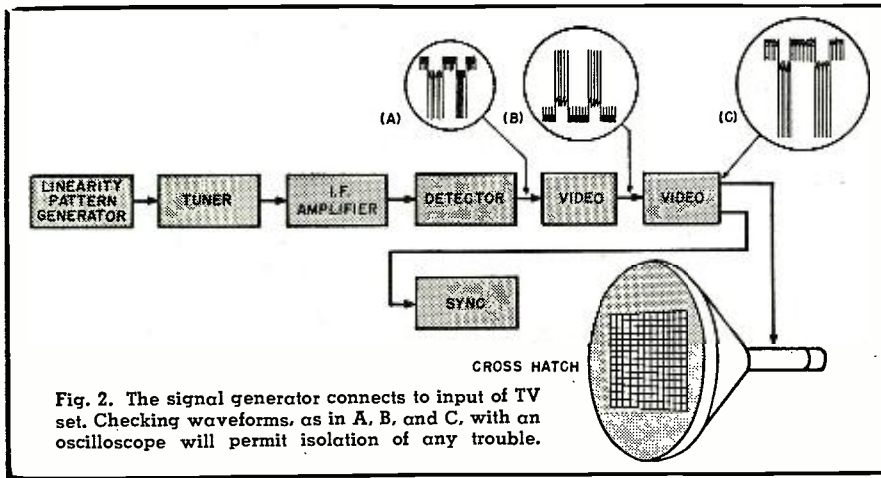

Fig. 2. The signal generator connects to input of TV set. Checking waveforms, as in A, B, and C, with an oscilloscope will permit isolation of any trouble.

The *Hickok* Model 620, Linearity-Pattern Generator (which will be described in this article), connects directly to the antenna terminals of the receiver and has an output that is continuously variable from 50 to 90 mc. Since the output can tune through this range, patterns can be generated in channels 2 through 5. The reason that channel selections are available is to permit use on a channel where no station is operating.

If reference is made to the block diagram, Fig. 5, the following discussion should be easy to follow.

The purpose of the Linearity-Pattern Generator is to modulate the grid of the cathode-ray tube with a signal that places horizontal and vertical lines on the tube. If the hold circuits of the television receiver are working properly, it is a simple matter to adjust the hold controls until the correct number of lines appears on the screen. At this point the linearity controls are adjusted until the lines are equally spaced.

As we already know, the beam

sweeps across the screen of the television receiver 15,750 times every second. Since the Linearity-Pattern Generator has its r.f. carrier modulated by the output of a 219.24 kc. crystal, it is easy to see that the beam will be interrupted at regular intervals by the much higher frequency. These interruptions, or blanking of the beam, will occur visually 12 times for each line. So, when the horizontal hold control is set up properly, 12 vertical lines will appear on the screen. It should be easy to see, then, that if the beam is interrupted at regular intervals (by a crystal oscillator, Fig. 5) the lines must have equal spaces. If the linearity of the receiver is not properly set, the lines will not be spaced equally and then adjustment must be made.

Checking the block diagram, Fig. 5, we see that the 219.24 kc. crystal-controlled oscillator feeds directly into the mixer where a frequency of 540 cycles joins it to modulate the r.f. oscillator set at the channel frequency.

The 540 cycles is obtained by stepping down the 219.24 kc. through a series of multivibrators and blocking oscillators so that the two frequencies have a very definite relationship.

Checking the 540 cycles, we see that this, too, is a higher frequency than 60-cycle vertical sweep rate. Therefore, we obtain 9 horizontal lines on the screen where the 540 cycles interrupt the beam as it sweeps down in 1/60 of a second. Vertical linearity can then be adjusted in the same manner as horizontal linearity.

The *Hickok* Linearity-Pattern Generator has a switching arrangement whereby the 540 cycles or 219.24 kc. can be used singly or together. As a result, very accurate settings of the linearity controls can be made.

Since the generator has a variable output from 50 to 5000 microvolts, the sensitivity of receivers can be checked by noting the settings of the output control. When the sensitivity to vertical hold and the sensitivity to horizontal hold is recorded at the installation, you have a definite check on the future operation of the set.

To amplify on this statement, let's say, for example, that an output setting of 30 was recorded for minimum vertical hold of the lines during installation, but an output setting of only 25 was recorded for horizontal hold at the same time. At some future date the customer complains that the set is not holding horizontally. When you check the set you find that the vertical hold still pulls in at 30, but this time the horizontal pulls in at 75. We can then be reasonably sure that the trouble is *not* in the r.f. of the receiver or the i.f., but somewhere after the detector, or some place where the sync splits. But, on the other hand, if the vertical and horizontal both require an output increase from the crosshatch generator we could see that the trouble is common to both circuits. If the lines were dim and did not hold we would suspect the i.f., the front end, or the video amplifier, probably not the sync circuit. But, if the lines were sharp and didn't hold, then it would probably be in the sync circuits of the receiver.

This then, sets up a perfect instrument for quick service calls and tube substitutions in the customer's home. All you have to do is connect your crosshatch to the antenna post, and go ahead with your tube substitution—watching the crosshatch—in exactly the same manner as you do on the station. With this instrument you have the added advantage of being able to vary your output for either horizontal or vertical sync.

In the shop, the generator is as handy as it is in the home. Connecting it to the antenna of the receiver and using a scope you can check almost every circuit in the receiver for operation. A quick discussion of this method (using block diagrams) should help in the application of the Linearity-Pattern Generator to troubleshoot-

Fig. 3. Panel view of Hickok's Model 620 crystal controlled Linearity-Pattern Generator.



ing. In Fig. 2, the Model 620 is connected to the antenna terminals of the television receiver.

The scope is connected to the detector load and the waveform at "A" should appear. To check the contrast control (if it is used as a bias circuit for the i.f. amplifiers) merely turn it clockwise and counter-clockwise. The height of the pattern will vary. To check the operation of the a.g.c., merely increase the output of the Model 620 until the pattern on the scope screen at "A" doesn't increase with further output from the Model 620. This reading is the point where the a.g.c. takes over. From this point on, you can check the video amplifiers and the sync circuits exactly as you would with a station on the air. You should get a reversal of the pattern and an increase in amplitude as the scope is moved back through each video stage ("C"). Calibrating your scope for peak-to-peak readings will give you a very accurate check of the exact gain of the stage and an indication of whether or not the video signal is strong enough to drive the cathode-ray tube.

Some indication can also be obtained as to the frequency response of the video amplifier since you can connect the plates of the scope directly to the output of the last video amplifier and compare the relative heights of the 219.24 kc. pulse with the 540 cycle pulse. The ratio at the output of the last video amplifier should have the same amplitude relationships as the signal at the detector load. If there is a change in ratio, then you have an indication of poor frequency response in the video amplifier.

For accurate checks you must connect the plates of the scope directly to the output of the video stage and check the shape of the pulse. Read any good text on square wave testing of amplifiers for the theory behind this last statement.

The manufacturer's instruction book for the receiver is based on sync waveforms from the transmitter. Of course, the waveforms you see will be slightly different in shape, but a little practice in using the Linearity-Pattern Generator on a set that works will make you familiar with the difference in pulse shapes and frequencies.

As you use the generator more and more in service you should find countless applications not mentioned in this article.

Circuit Analysis

Since the instrument must be extremely stable in order that proper adjustments of the television receiver can be made, the operation of the circuits in the Model 620 is dependent on an internal crystal oscillator operating at 219.24 kc. To further increase the stability, all "B plus" voltages are supplied from a voltage regulated power supply.

Referring to Fig. 4, we see that the

(Continued on page 117)

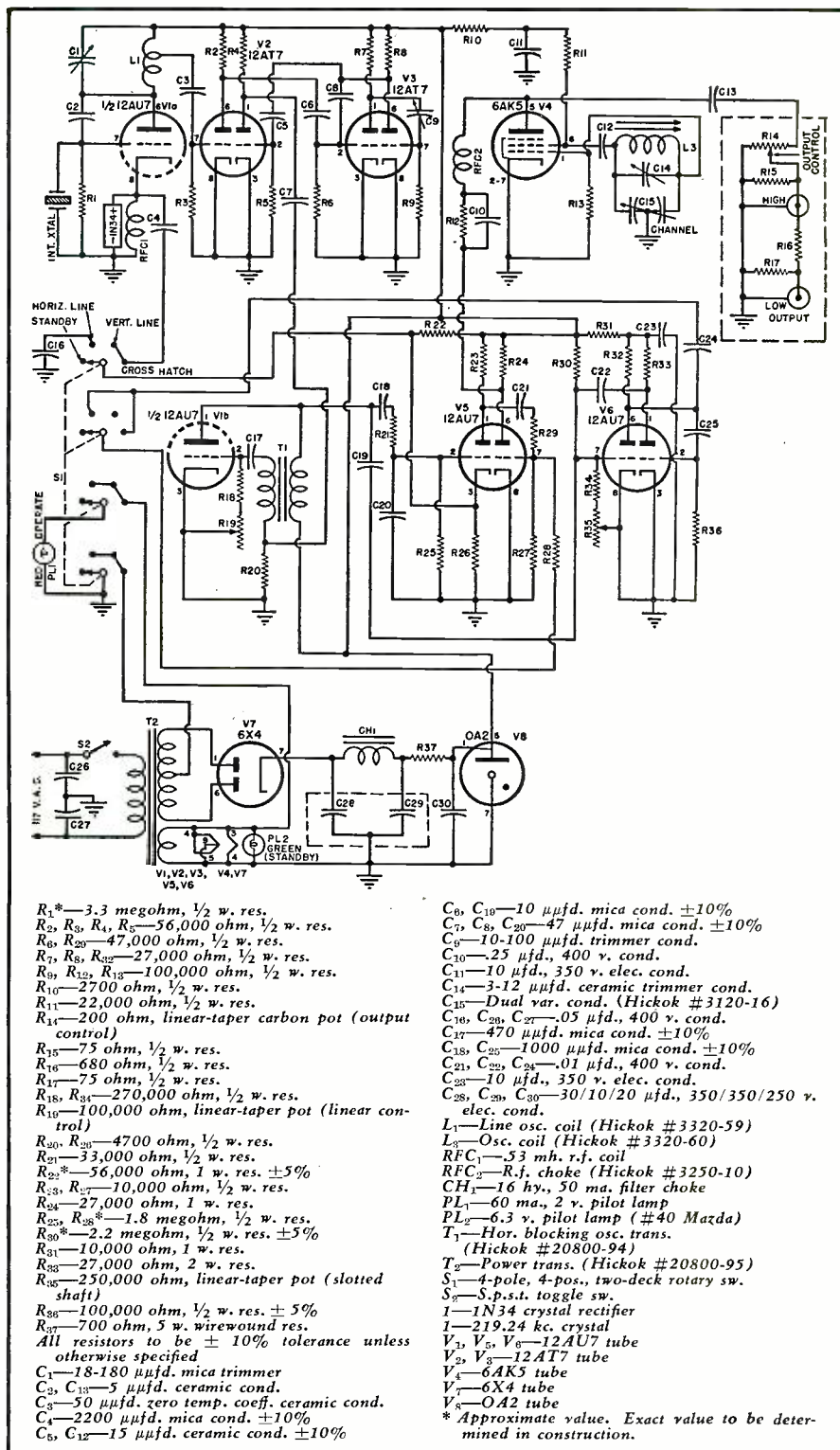
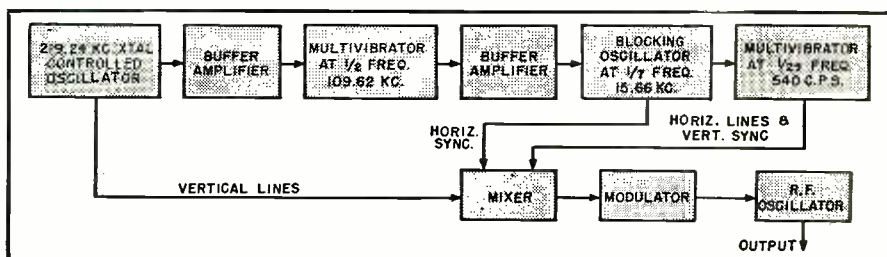

Fig. 4. Complete schematic diagram and parts list for Linearity-Pattern Generator.

Fig. 5. Block diagram shows functional operation of the new Hickok Model 620 unit.



Design Considerations For High-Quality Reproducing Systems

By **HERB MATTHEWS**

Part 1. Points to remember when designing your own audio systems. Final part will appear next month.

THE "audio philosophy factor" is all too often overlooked in amplifier design. Lack of serious consideration of this factor frequently leads to disappointment with the final result.

There is a good deal more to consider than control function, physical layout, and type of chassis construction. The good designer must also consider which factors may be compromised with cost, what are the over-all requirements of the system, and what is the actual purpose behind his construction of the unit. If the builder is interested in learning more about audio, or if he seeks the joy of creating, then his goal is clearly marked. If his sole purpose is to obtain a reproducing system of the highest quality, he may actually find it more economical to obtain one of the better laboratory-engineered units now on the market.

Before an audio system can be designed, many factors must be taken into consideration. The average experimenter usually begins with only the rough notion that he is going to build a "high fidelity" amplifier and proceeds to assemble assorted components into one of several basic designs.

A consideration of the several fundamental factors may help the reader crystalize his own audio philosophy.

High Fidelity: What is it? High fidelity has always been broadly interpreted to mean faithful reproduction of the original sound. When the term was first foisted on the public it was taken to mean any wide range system with better than 50 to 10,000 c.p.s. response and less than 5% distortion. High fidelity amplifiers have been sold for many years without

any real thought being given to their behavior with various types of loudspeaker systems or their transient response to a complex audio wave. As long as the amplifier was flat ± 3 db. and it faithfully reproduced sine waves in the desired frequency range, the system had "high fidelity." As a result of this fallacious reasoning, the public has been educated to believe that a radio could not approach realistic reproduction, that it must "sound like a radio." Until fairly recently the "best" engineers were insisting that the public did not want 20 to 20,000 c.p.s. reproduction. They had proven, by "actual listening tests," a preference for 5000 c.p.s. cut-off.

Present audio men shy away from the term "high fidelity" because of its past connotation and we now find terms like wide range, high quality, presence, etc., used in literature.

Obviously a minimum of 50 to 10,000 c.p.s. response with low distortion is a basic requirement. It should be apparent that there are certain "negative factors" which must be eliminated from a reproducing system if high quality is to be achieved.

The most objectionable of these is noise. Because most noise is considerably reduced in a 5000 c.p.s. system, the layman has shown a preference for the limited range. With the increasing popularity of FM and with the advent of new, improved suppressor circuits, particularly those of the vertical gate type, wide range, noiseless reproduction is a practical reality.

The second most important negative is distortion. With good, conservative design, distortion can usually be held to a negligible factor.

Hangover is the third important negative. Hangover produces an unpleasant, muddy quality which is often described as the lack of "presence." In an otherwise perfect system, hangover adds the one sour note which marks mechanical reproduction as decidedly different from original performance. Hangover is the tendency of a system to continue vibrating after the exciting signal has ceased. This effect may be compared to the tendency of timpani to sound, once struck, until the musician places his hand on the drumheads to stop them, or, perhaps more familiarly, to a piano string which continues sounding until the action of the damper pads it out.

Good damping, therefore, is another important *must* in a reproducing system. Damping may be present in an amplifier (expressed in terms of low internal generator resistance), or it may be present in the speaker system (expressed in terms of high field flux density and stiffness of the vibrating system). Ideally, both the loudspeaker system and the amplifier should be well damped at all working frequencies. Generally speaking, a well damped system exhibits a smooth peak-free frequency response characteristic. Distortion and noise are not emphasized in a well damped system because the tendency to overshoot on transient peaks is reduced.

Frequency Response Considerations: Ideally, an amplifier should be flat from 20 to 20,000 c.p.s. It should have good response from 10 c.p.s. to 40,000 c.p.s. The practical designer, who must consider cost as a factor, may decide to compromise his ideals and limit his equipment to a range of 8 or 10 kc. In this event it should be remembered that to preserve good upper and lower balance, the product of the upper and lower cut-off frequencies should be about 400,000 or 500,000. This would indicate a range

of 40 to 10,000 c.p.s. or 50 to 8000 c.p.s. with an over-all flat system utilizing sharp cut-off at both ends of the spectrum (Figs. 1A and 1B).

It should be remembered, however, that most practical systems do not cut off sharply at both ends of the spectrum, but generally taper off, particularly at the upper end (see Fig. 1C). For this reason some discretion must be exercised in selecting an optimum characteristic; although these figures are a very useful guide, it is far better to let the ear be the final judge. It should also be pointed out that a sharp cut-off characteristic is undesirable because it produces a peculiarly harsh kind of frequency distortion. Fig. 2A illustrates a 5000 c.p.s. waveform with a complex harmonic structure. If this wave is reproduced by a system with the response of Fig. 1C it will look something like Fig. 2B, not badly distorted. If it is reproduced in a system with the response of Fig. 1A it will resemble a sine wave (Fig. 2C), considerably distorted from its original form. These examples should help explain the difference between horizontal and vertical high frequency attenuation and also explain the superiority of the newer vertical gate suppressor circuits recently introduced.

A very common fallacy which has been allowed to continue without contradiction is the premise that, when an amplifier with flat response is utilized, the entire system will yield flat reproduction. This statement is only partially true in the rare case of some of the better high priced speakers mounted in well-designed enclosures. To obtain a reasonably accurate picture of amplifier performance, a frequency run should be made with the output meter connected across the voice coil of the speaker and with the speaker mounted in the final baffle in which it is to be used. Even when this precaution is taken it must be remembered that the actual transient response of most systems may be somewhat different from the steady state response as measured with slowly varied sine waves. This disparity is particularly noticeable in a poorly damped system.

It has been this writer's experience that a U-shaped curve with boost at both ends of the spectrum may be required, particularly with speakers in the \$10 to \$20 price range. Figs. 1D and 1E show typical curves using the boost. Note that as much as 25 db. boost at 60 c.p.s. may be required and that the response may not start rising until about 300 c.p.s. This is a typical requirement where undersized or inefficient baffling or perhaps poor speaker performance cause low frequency loss below 200 or 300 c.p.s. Note, too, that the upper boost may occur from 2000 c.p.s. up, depending on where the highs begin to fall off. High frequency droop may occur in

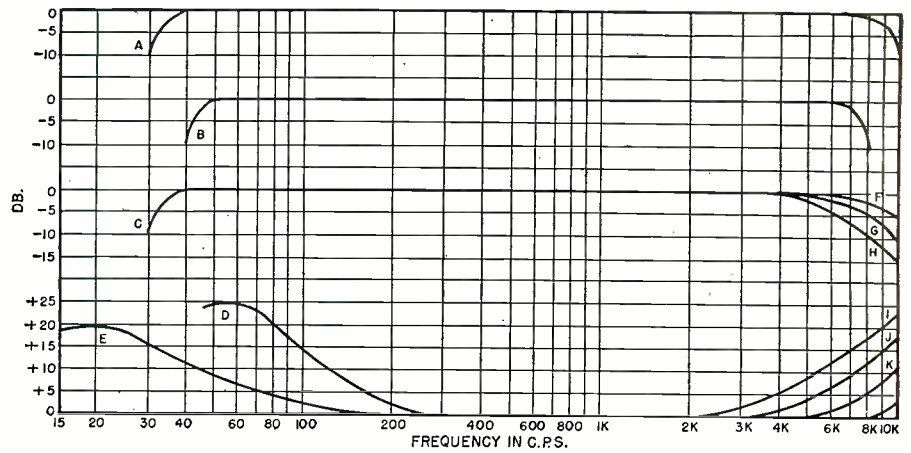

Fig. 1.

a system even though a tweeter is used. Again, here is a case where the ear is the most reliable available judge of a system's quality. Listening tests should be made over some extended period of time on live local programs known to have good quality. It is difficult to form any accurate opinion of the worth of a reproducing system in one sitting. The ear and the brain are both subject to day-to-day variations which make subjective analysis a difficult, though worthwhile, method.

If an audio oscillator is available it should be used as a guide to system

performance. Frequency runs should be made at normal volume levels with the speaker system placed in its normal position in the room and as many pairs of trained ears as are available should be used as volume level indicators. Moving around in the room will show up standing wave conditions. Experience has shown that if a system sounds reasonably flat when tested by this means, the balance will be reasonably good at normal levels. The effect of changes in volume level on tonal balance, as reported by Fletcher & Munson in

(Continued on page 120)

Fig. 2.

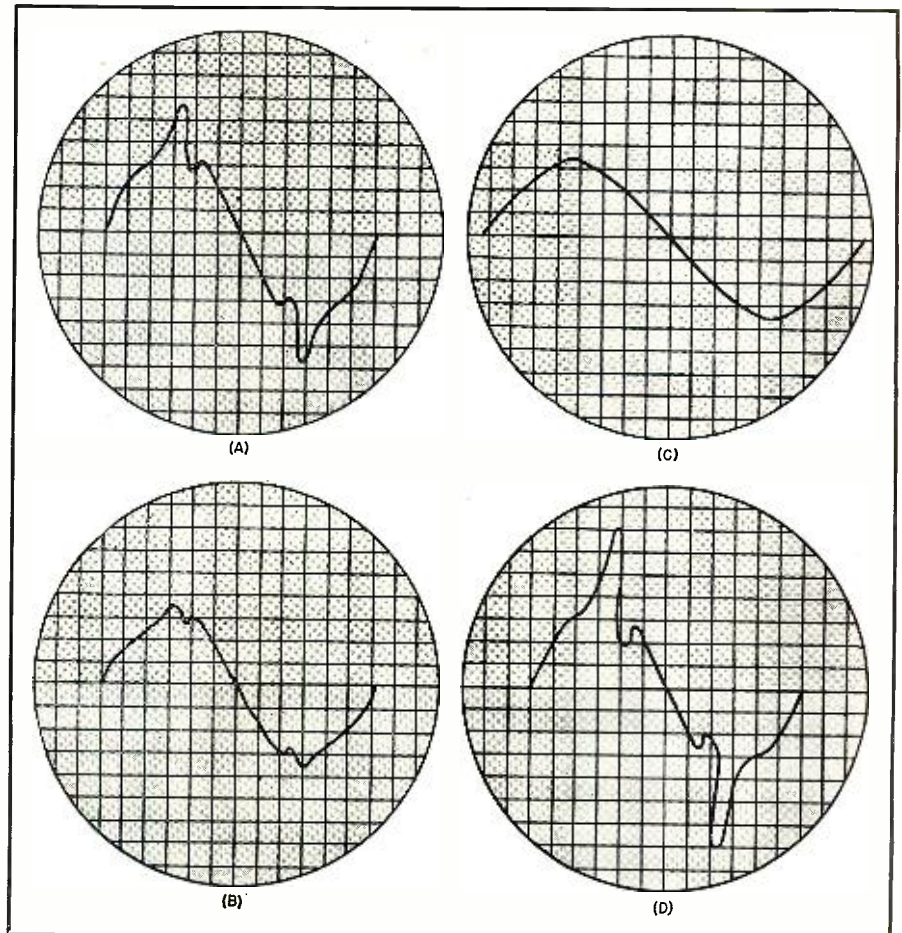

Linearity Distortion In Audio Equipment

By
GLEN SOUTHWORTH

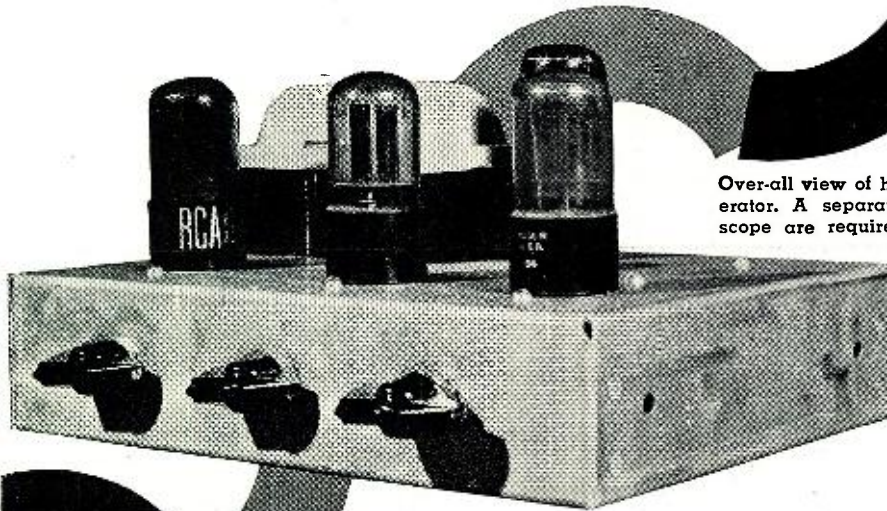

Over-all view of home-built sweep amplitude generator. A separate audio oscillator and oscilloscope are required to check linearity distortion.

Details of a sweep amplitude generator designed specifically for checking input-output relations of audio equipment. It is easy to build.

THE relative importance of various distortions is often dependent upon the state of the audio art. As a result, present day means of reproducing wide dynamic ranges, such as FM broadcasting and new recording developments, indicate the importance of achieving linear input-output relations in audio equipment.

Although the reader may be more familiar with the problems involved in noise levels and volume compression or expansion, nonlinearity gives rise to another serious problem which is seldom mentioned. Many important components of speech and music may have a level thirty decibels or so below the average level. If a reproducing system exhibits a definite amplitude cut-off at low levels, these components may be partially or wholly suppressed.

An extreme example of this is in a system in which an amplifier grid is driven positive by a defective coupling condenser. Although excessive harmonic distortion results, which should mean an increase in high frequency output, the opposite is often the case and a loss of high frequencies, accompanied by excessive "mushiness," is the result. The reason for this is that relatively low-level, high-frequency components do not have sufficient amplitude to reach beyond the nonlinear portion of the tube curve, while the peaks of the higher level low frequencies may have sufficient amplitude to be reproduced. Although by present standards one per-cent harmonic or intermodulation distortion is considered low, one per-cent of this type of amplitude distortion may produce noticeable

changes in reproduction quality and is probably an important contributing factor to "listening fatigue."

An examination of hearing sensitivity curves will show that the average listener may have a sensitivity for frequencies in the two- to three-thousand cycle region that is one hundred times as great as for frequencies below one hundred cycles at the threshold of hearing. As a result, even though two different frequencies may have the same apparent loudness, their actual intensity may be widely different and nonlinearity in the reproducing equipment may produce decided dynamic frequency response variation. For example, a system with greater gain at low levels than at high levels may tend to emphasize low-amplitude, high-frequency components. Two fairly common cases of this nature are the speech clipper and the volume compressor. The opposite case, a system in which gain is greater at high levels than at low, will tend to produce the reverse and low-level highs will tend to be suppressed. Several types of noise suppressors make use of this principle.

Audio amplifiers represent a particular case in nonlinearity, as in complex waveforms the high frequency component will be operating over varying portions of the characteristic curve, often resulting in periodic variations in gain, known as intermodulation distortion. As a result, in systems in which the gain decreases with increasing input, high frequencies may suffer considerable compression when accompanied by high-amplitude, low-frequency waveforms. Likewise, other effects derived from different departures from linearity may be noticed.

In amplifiers it may be generally assumed that nonlinearity will mean modulation rather than constant attenuation where complex waves are concerned. In some instances, notably electromechanical devices, this does not appear to hold entirely true and low level components may be attenuated regardless of whether occurring alone or in combination. One example of this is in the record manufacturing

Simple forms of nonlinearity. The characteristic in (A) may be obtained by overbiasing push-pull amplifiers while that of (B) often occurs in beam power amplifiers. (C) Illustrating the result of a sharp, low-level amplitude cut-off. Signals below a certain level are not reproduced, while many other low-level signals may suffer serious attenuation.

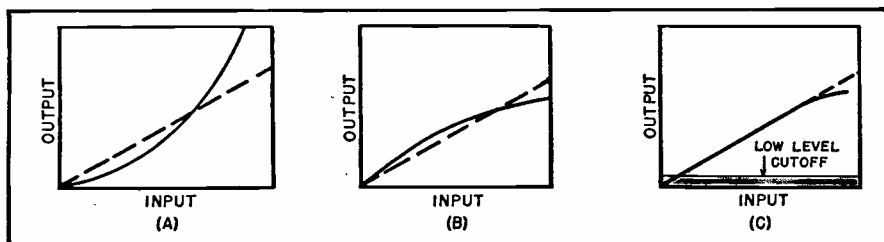

process wherein a slight discontinuity in pressing may have a decided effect on low level components though producing negligible distortion of high amplitudes. Similarly, record wear will tend to obliterate weak passages sooner than high level ones. The effect in both of these instances is similar to a factor having a subtractive coefficient of one such as illustrated in the graph. This will produce a negligible effect on high amplitude waveforms but results in complete attenuation of waveforms having an amplitude of unity or less.

It is fairly well known that certain types of electroacoustic equipment, such as microphones and loudspeakers, do not perform well at low input levels. The nonlinear characteristic thus indicated may produce several undesirable effects. In one instance the nonlinearity may result in the attenuation or suppression of important low level harmonics with resultant "colorless" reproduction. In another case the system may have a nonlinear characteristic in respect to frequency, such as shown in the scope photos, and give undesirable emphasis to certain harmonic components. Likewise, a sharp upward bend in the amplitude curve may generate an unpleasing effect.

Microphone technique may be considerably simplified by use of equipment with improved sensitivity and linearity. With poor equipment it is usually necessary to use a "close up" microphone technique in order to provide adequate input to operate the microphone over a fairly linear portion of its range, likewise wall reflections may tend to suppress the direct sound and introduce an unnatural reverberation decay period due to nonlinearity in the microphone, thus making controlled acoustics desirable. On the other hand, when superior equipment is used, a single microphone placed at some distance from the orchestra is often sufficient, and room acoustics need not be so carefully controlled due to the more natural reproduction of the decay characteristics. In fact, in some instances it is possible to secure clearer reproduction than that the listener would hear if seated next to the microphone.

Linearity distortions may give rise to effects similar to those produced by transient distortions and in several respects the two phenomena may be related, as both studies are concerned with the ability of a system to reproduce sounds of varying amplitude. In connection with this it is interesting to note that seldom is the ability of electroaudio equipment to handle modulated waves mentioned. As many musical instruments represent shock excited resonant systems which emit waveforms of a pulsating nature, this is a problem of some interest in discussions of high fidelity. A casual study of loudspeaker characteristics indicates that the ability to reproduce modulated waves is related to the speaker resonance frequency. Small speakers with high resonance points

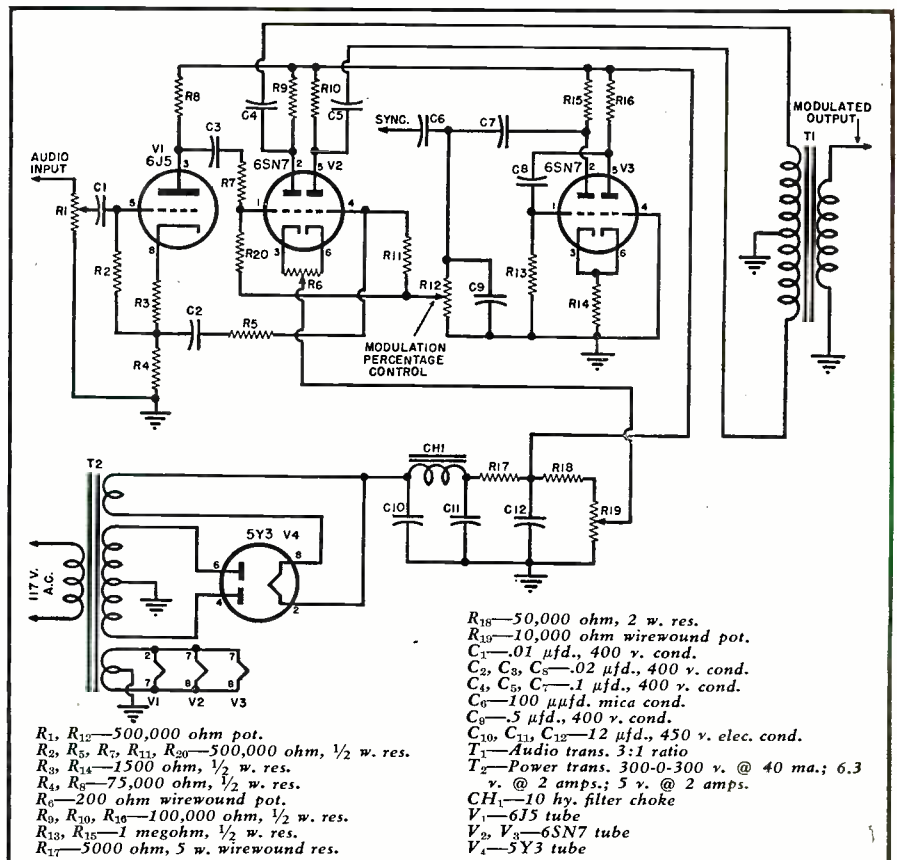

Schematic diagram and parts list covering the sweep amplitude generator.

appear to be superior in this respect to larger diameter speakers with heavier cones. A simple and interesting test is to use loudspeakers in place of microphones. Tolerable quality may be maintained by the small three- or four-inch speaker, providing the primary resonance is not too objectionable, while in large diameter speakers the quality may be greatly degraded

and exhibit the characteristic "mushiness" of poor linearity.

Although data on linearity is seldom published, transmission measuring sets capable of a high degree of accuracy have been available for some time. Unfortunately, conventional procedure is a tedious and time consuming process requiring point-by-point checks

(Continued on page 128)

Oscilloscope patterns resulting from tests made using the sweep amplitude method of linearity measurement. (A) Pattern of 30-watt beam power amplifier at low levels into a resistive load without feedback. (B) Pattern of same amplifier at medium power levels. (C) Pattern of same amplifier with square top distortion just occurring at maximum amplitude. (D) Six-inch loudspeaker reproducing a 4000 cycle note at medium peak power levels. (E) Same speaker at same level but with a 6000 cycle signal. Both harmonic distortion and amplitude distortion are present but in varying ratios. (F) Same speaker overloaded with 7000 cycle note. While excessive nonlinearity and modulation introduced by transient vibrations are present, little harmonic distortion appears.

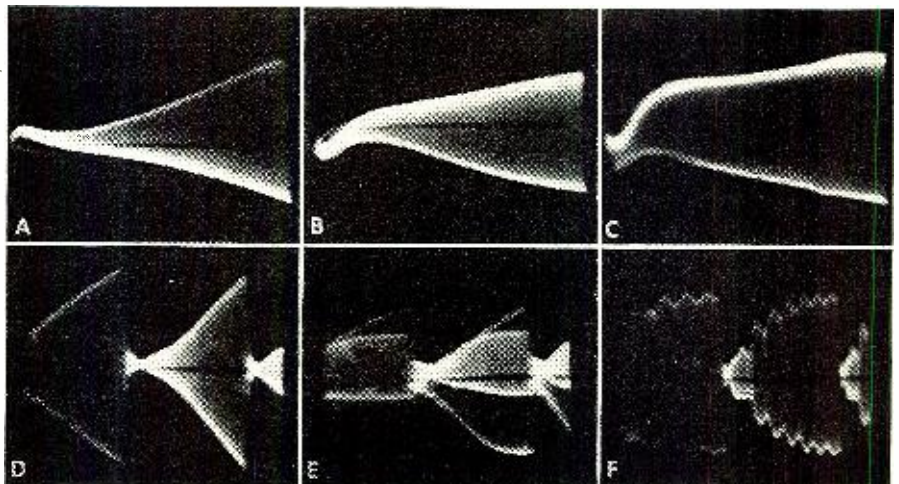

Mac's RADIO SERVICE SHOP

By JOHN T. FRYE



PORTABLE PATTERN

“HOLY cow! Wha’ happen?” Barney asked as he stood in the open door of the service shop and surveyed the sea of portable receivers that almost completely engulfed Miss Perkins’ desk.

“That’s the first day’s answer to our special ‘check-your-portable-for-only-a-dollar’ offer, and don’t overlook that TV portable that one joker ran in on us,” the office girl told him. “And let me warn you that your story about being sick Saturday had better be good. Mac half suspects you of playing an April Fool joke on him.”

The apprentice service technician walked over to the service department and cautiously tossed his battered felt hat through the door.

“Come on in here, you red-headed Irishman!” Mac’s voice instantly boomed forth. “Let me get a good look at you. If you look healthy, you won’t long. Of all the days I ever needed you, Saturday was it, and—Hm-m-m-m,” he broke off as he caught sight of Barney’s pale but grinning countenance, “your freckles *do* look a little more three-dimensional than usual. I’m not surprised, though. I knew that sooner or later that billy-goat appetite of yours would cause you to founder yourself.”

“The trouble,” Barney announced loftily—“and I quote—‘was an attack of migraine, probably induced by intense cerebration.’”

“I’ll buy the migraine part of it,” Mac conceded, “but I’ve got to see a sample of that cerebration; and come to think of it, where could you find a better place to demonstrate than on these portables? Before you start, though, perhaps we had better have us a little chalk talk:

“Naturally, we shall check all of the tubes; but tube-checking in portable sets can fool you, especially on some kinds of emission checkers. As you know (I hope), the emission of a filament type of tube depends pretty closely on the temperature of the filament; but watch the filament of the 1A7 in the checker when I push this ‘Test’ button.”

Barney, with his chin hooked over Mac’s shoulder, saw the dull red thread of the tube filament glow noticeably brighter as the button was depressed and then return to its former appearance as the button was released.

“The plate current,” Mac explained, “flows through that portion of the filament that lies between the ‘B-minus’ end and the point where the electrons take off for the plate. In many tube checkers, this emission current during test is quite heavy, being a husky percentage of the fifty-milliamperere current that is normally supposed to flow through the filament; and when this emission current is added to the filament current, it raises the temperature of the filament considerably above normal. The result is that one of these 50-ma. tubes will frequently show ‘Good’ in the emission tester when its emission at the normal filament current is well below what it should be.”

“What do you do about it?”

“If there is any doubt in your mind, try substituting a new tube in the set. If this makes a marked improvement, a new tube is needed, no matter what the tube-tester says. With experience you will learn to detect a certain sluggishness or hesitation in the swing of the meter pointer on one of these low-emission tubes; but for now, just remember that a playing set and a sub-

stitute set of tubes constitute the practical serviceman’s Tester of Final Decision.

“And now let us take up the case of those radios which their owners say are too hard on batteries. Most of these complaints, while made in all sincerity, are not deserved. Some people have a most optimistic idea of how long batteries *should* last; others simply forget when the batteries were purchased or how many hours the set has been used since; and finally, never overlook the battery salesman’s best friends: small children who just love to turn on these sets and let them run when Mama and Papa are not around.

“We cannot, though, dismiss all complaints as being unfounded; so here is what I want done with every one of these portables that has a reputation of being a battery-eater:

“Open up the positive filament and plate leads and insert current meters in each. Then turn the set on and check the currents drawn. Compare these values with what the set *should* draw, getting this information either from the service manuals or by computing it from tube manual data. Then, with the meters still in place, turn the set off and make sure the currents drop to zero. Finally, in the event the radio is a three-way portable, see if the currents remain at zero when the set is playing on a.c.

“If any of these tests reveal anything funny, find out *why*. If not, when you give the set back to the customer, remind him that batteries are like human beings in that they last much longer if they are given time to rest and recuperate between periods of activity than they do if they are kept going steadily. If the set is a three-way portable, strongly suggest that it be used on batteries only when an a.c. outlet is not available. As a clincher, remind him always to be sure and get *fresh* batteries, like the kind he always gets at Mac’s Radio Service Shop!”

“Gotcha!” Barney grinned. “Tell me more!”

“Well, one thing you want to watch is to see that the chassis and batteries are in place in the cabinet when you align the r.f. trimmer that is across the loop; otherwise the loop will be seriously detuned when these items are placed inside its field. This is especially true where the loop is wound on the inside of the cabinet. If the loop is fastened to the back of the cabinet, this should be in its normal position before adjusting the trimmer.

“In most sets, provision is made for doing this; but there are a few that offer no porthole for reaching this trimmer with the chassis and back in their normal operating positions. When the cabinet is of wood covered with airplane cloth, I usually drill a small hole in the cabinet that allows me to adjust the trimmer and then I close this opening with a snap button hole plug.”

“And if the cabinet is made of a plastic material?”

“Sometimes there is room to use a
(Continued on page 118)

MODERN

Television RECEIVERS

Part 24. Concluding article of the series—a review of recent developments in TV receivers.

By

MILTON S. KIVER

IT HAS been almost two years since the first article of this series was written and during that period television has become a dominating factor in the radio manufacturing and the home entertainment fields. In April, 1948, there was slightly under a million television sets in use. Today, we are rapidly approaching the five million mark.

As is true of every new development, numerous changes are being made continually, with the major emphasis in the television receiver being directed toward a simplification in set construction, a reduction in set cost, and an improvement in image detail. In the preceding twenty-three articles every effort was made to keep the reader abreast of the latest developments. However, new changes in design are appearing even while this article is being written and it might prove of interest to stop and note just what some of these are.

Cathode-Ray Tubes

Perhaps the greatest change that is taking place within the television receiver is occurring at the cathode-ray tube. Present tubes with their 50° deflection angle are gradually being replaced by shorter, stubbier tubes utilizing a 70° deflection angle. As an illustration of the space saving achieved by the use of a wider deflection angle, the new 19AP4 with its 70° deflection angle has an over-all length of 21½ inches while the 20BP4 with a 50° angle, has an over-all length of 28½ inches. To swing the electron beam through the wider angle, more efficient horizontal output transformers have been designed, such as the new *General Electric* ceramic core transformer requiring only a single driving amplifier. Changes are taking place, too, in the shape of the tube. It has long been evident that a cathode-ray tube using a circular screen is wasteful not only

Fig. 1. A 16RP4 video tube. It provides a useful screen area of 139 sq. inches and is 18¾ inches long. The deflection angle is 70°.

of screen area, but of cabinet space as well. The obvious solution was a rectangular-shaped screen, designed in the standardized 4 to 3 aspect ratio of the transmitted image. Manufacturing difficulties have prevented the introduction of this tube in any appreciable quantity until recently, when the glass industry announced that it can supply rectangular tubes in quantity. As an indication of the space saving feature of these tubes, the 16RP4, shown in Fig. 1, will fit any cabinet now housing a circular 12-inch tube and provide a useful screen area of 139 square inches. Its over-all length is but 18¾ inches, with a deflection angle near 70°.

Additional modifications, besides size and shape, have also been made in the cathode-ray tube. Of these, the most important from the standpoint of the viewer has been the increase in image contrast. It was found, after television receivers had been in use for some time, that many observers reported eyestrain after viewing the screen continuously for more than an hour. Investigation revealed that this was due primarily to the poor contrast of the reproduced image. The viewer, being dissatisfied with this poor contrast in which the difference in shading between the white and black portions of the image was limited, usually turned the contrast control up. This caused the white portions of the image to receive excessive illumination, and produced the illusion that the blacks became blacker. Actually, the blacks did not become blacker by this procedure, but the illusion was created be-

cause of eye fatigue produced by the greater intensity of the whiter portions of the image.

Two methods for improving the contrast of the image have been advanced and are in use at this time. One method employs a special type of filter glass (known commercially as *Tele-glas*) for the face of the tube. This glass acts as a filter by absorbing more of the light passing through it than an ordinary glass does. This has two effects. First, light from the room striking the face of the image tube is absorbed to a greater extent than it is with clear glass, reducing the ability of this light to destroy the contrast between various sections of the image. Second, there is a reduction in the amount of scattered light present between the inner and outer surfaces of the glass face. In ordinary tubes, these reflections cause light from a bright point to scatter over a relatively large surrounding area, reaching areas that should be dark and causing a decrease in detail contrast. The use of a light absorbing glass reduces the extent of this scattering.

The second method, employed to date only by *American Television* in Chicago, incorporates a special binder with the fluorescent crystals which restricts the light at any one point from going in any direction other than forward. The result, again, is a reduction in light scattering.

Finally, cathode-ray tubes not employing ion traps, such as the 12JP4 and 15AP4 have been replaced by the 12RP4 and the 15DP4, which do require traps. The newer tubes contain



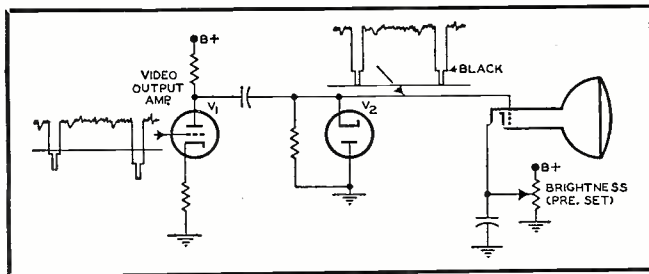

Fig. 2. One typical and widely-used d.c. restorer circuit.

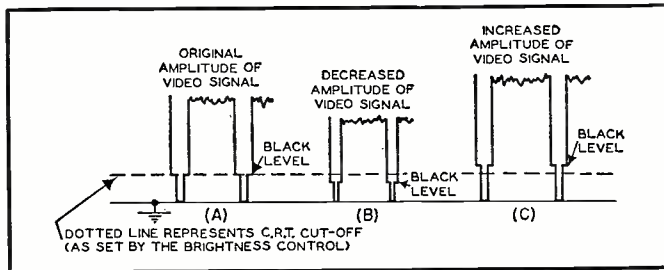

Fig. 3. Effect of contrast control setting on video signal.

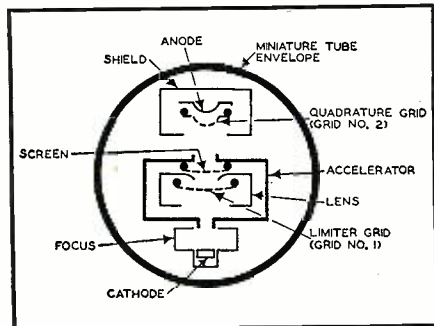

Fig. 4. The internal construction of the 6BN6 beam-gated tube used by Zenith.

a bent gun which, in conjunction with an external ion trap, removes the ions from the scanning beam. It is these ions, it will be recalled, which produced blemishes on the face of the tube. Other image tubes which employ the diagonal-cut gun and an external ion trap are still used.

I.F. System

The r.f. systems, on the whole, have retained the circuits reviewed in previous articles of this series. The i.f. frequencies, however, have risen until now they reach as high as 45.75 mc. The use of such high i.f. values has, as its immediate purpose, a reduction in the number of spurious responses to which all television circuits are subject. Why a higher i.f. will reduce the interference present in television sets can be seen from the following brief analysis.

1. *Direct I.F. Interference.* One of the major sources of interference to a television receiver is direct i.f. pickup of the interfering signals. To solve this problem, a band of i.f. frequencies should be chosen in which no other

Fig. 5. The variation in the length of current pulses passing through the 6BN6 when an FM signal is being received at the set.

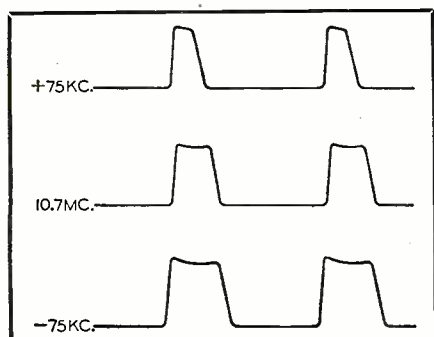

commercial or industrial services are present, or if present, are permitted to employ only small amounts of power. A further limitation of the choice of a suitable i.f. is that it should be below the lowest television channel, in this instance channel 2, 54 to 60 mc. Examination of existing FCC allocations between 20 and 50 mc. reveals that the band of frequencies extending from 41 to 45 mc. is better suited for this purpose than the 21 to 26 mc. frequencies originally recommended by the FCC.

2. *Oscillator Radiation.* It is a common experience with present television receivers to have the oscillator voltage radiation from one set cause interference to another set tuned to some other channel. Thus consider two television receivers located within the same building, one tuned to channel 2, the other to channel 5. With a video i.f. value of 25.75 mc., the local oscillator in the set tuned for channel 2 will be at 55.25 mc. plus 25.75 mc., or 81 mc. Channel 5 extends from 76 to 82 mc. Hence, any signal emanating from the channel 2 receiver will cause a narrow bar pattern to appear on the receiver tuned to channel 5. Similar disturbances can occur, in various degrees, on other channels.

By raising the i.f. value, we also raise the operating frequency of the local oscillator and by choosing an i.f. value between 40 and 50 mc., the resulting oscillator frequencies fall outside the present v.h.f. television band.

A similar analysis with other types of spurious responses will reveal that as the i.f. value rises, the effects of the spurious responses decrease.

Now, this desirability of high i.f. frequencies has long been known but has only become economically practical recently due to advances made in fabricating miniature components and high gain pentodes.

There is still another reason for desiring the high i.f. values, and this stems from the fact that within a relatively short period of time, use will be made of the ultra-high frequencies for the transmission and reception of television broadcasts. Since r.f. amplification of u.h.f. signals yields less gain than a similar amplification of v.h.f. signals, conversion to a lower i.f. frequency will be made as soon as the signal is received. The choice of a high i.f. is advantageous at u.h.f. for the same reasons that it is at the lower v.h.f. frequencies. In addition, in the u.h.f. band (between 475 and 920 mc.), the local oscillator will, in all proba-

bility, be placed below the incoming signal frequency rather than above, as it is at the present frequencies. In this respect, use of a high i.f. is also desirable, since the higher the i.f. value, the lower the oscillator frequency.

A.G.C. Systems

The trend in recent television receivers has been toward a.g.c. systems wherein the a.g.c. tube is permitted to conduct only when the horizontal synchronizing pulse appears in the received signal. Throughout the remainder of the video signal, the a.g.c. tube is completely inactive since a pulse from the horizontal output transformer is required for the tube to conduct. This pulse is developed at approximately the same time that the horizontal sync pulse appears in the received signal.

The advantage of keyed a.g.c. systems lies in the fact that they are active only 5% of the time, thereby eliminating the effects of any strong noise pulses that might arrive during the remaining 95% of the time. Furthermore, with a keyed a.g.c. system, short time-constant filters can be used in the a.g.c. distribution network. These are extremely helpful in eliminating certain types of interference, especially airplane flutter. Full information concerning the actual circuits used in such a.g.c. systems can be obtained from an article on the subject appearing in the December, 1949 issue of RADIO & TELEVISION NEWS.*

Automatic Brightness Control

It is common experience that whenever the contrast control setting of a receiver is changed, the brightness control must likewise be readjusted. A circuit designed to eliminate the need for this continual resetting of the brightness control has been devised by Sparton television engineers and is known as an automatic black level system.

In most television receivers, the video signal at the output of the final video amplifier is applied to a d.c. restorer where sufficient variable bias is developed to restore all sync pulse tips to the same level. See Fig. 2. In essence, what the d.c. restorer does is to develop a positive voltage which, when added in proper amount to the video signal, raises all sync pulse tips to a common level. The brightness control

* Buchsbaum, W. H.: "Need For Fast Acting A.G.C. Systems"

is then adjusted until the image tube electron beam is cut off at the black level of the video signal.

Consider what happens, now, as the contrast control is varied. When the control is turned counterclockwise, the amplitude of the signal decreases, as shown in Fig. 3B. This change in amplitude also affects the position of the black level of the signal. On the other hand, when the contrast control is turned clockwise, the amplitude of the signal increases, again changing the position of the black level. (In this instance the vertical retrace lines become visible). For both conditions, adjustment of the brightness control would be necessary in order to have the electron beam cut off at the black level of the signal.

The interaction between contrast and brightness controls can be eliminated if the d.c. restorer circuit is made to operate at the black level of the video sync pulses rather than at the sync pulse tips themselves. Since it is the black level that, when combined with the proper image tube bias, sets the point at which the beam is cut off, maintaining this black level constant irrespective of the contrast control setting, will remove the need for continual readjustment of the brightness control.

At the same time, d.c. restoration will be achieved since the relationship between the black level and the sync pulse tips is fixed and establishing a fixed level for one will automatically fix the level of the other.

The circuit for the automatic black level system is shown in Fig. 8. Its basic action is similar to that of any diode d.c. restorer with the exception that the circuit in the receiver is so arranged that negative sync pulses of greater amplitude than the sync pulses of the video signal (appearing at the cathode of V_2 , Fig. 8) are applied to the plate of the diode, as shown. These negative sync pulses effectively cut off the d.c. restorer during the period when the sync pulses of the video signal appear at its cathode. The d.c. restorer then conducts only on the most negative portions of the remaining signal, that is, on the front and back

porches of the blanking pulse which represent the true black level of any picture. Operating in this manner the d.c. restorer sets the black level of the video signal directly at a definite reference level at the image-tube grid instead of setting the sync pulse peaks at the reference level and letting the black level fall where it may, depending on video signal amplitude.

Beam-Gated Tubes

The most recent *Zenith* television receivers contain a 6BN6 beam-gated tube which represents a new approach to a combined limiter-discriminator circuit. This tube, designed by Dr. Robert Adler of the *Zenith Radio Corporation*, possesses a characteristic such that, when the grid voltage changes from negative to positive values, the plate current rises rapidly from zero to a sharply defined maximum level. This same maximum value of plate current remains, no matter how positive the grid voltage is made. Current cut-off is achieved just as abruptly when the grid voltage goes about two volts negative.

The reason for this particular behavior of the tube stems from its construction. See Fig. 4. The focus electrode, together with the first accelerator slot, form an electron gun which projects a thin sheet electron stream upon grid No. 1; the curved screen grid, together with the grounded lens slot and aided by the slight curvature of grid No. 1, refocuses the beam and projects it through the second accelerator slot upon the second control grid. This grid and the anode which follows are enclosed in a shield box. Internally, the focus, lens, and shield electrodes are connected to the cathode. The accelerator and the screen grid receive the same positive voltage because both are connected internally.

The foregoing design is such that the electrons approaching the first grid do so head-on. Hence, when grid No. 1 is at zero potential or slightly positive, all approaching electrons pass through the grid. Making the grid more positive can not, therefore, increase the plate current further. When, on the other hand grid No. 1 is made nega-

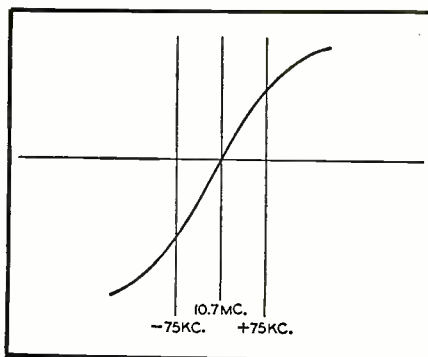

Fig. 6. The discriminator response of circuit shown in the diagram of Fig. 9.

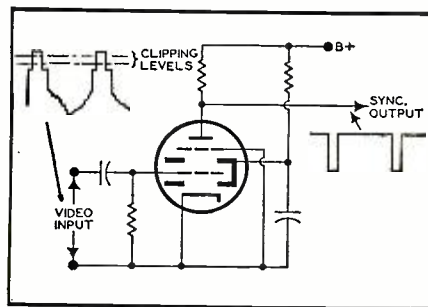

Fig. 7. A 6BN6 connected as sync separator.

tive, those electrons that are stopped and repelled back toward the cathode do so along the same path followed in their approach to the grid. Due to the narrowness of the electron beam and its path of travel, electrons repelled by the grid form a sufficiently large space charge directly in the path of other approaching electrons to cause an immediate cessation of current flow throughout the tube. In conventionally-constructed tubes, the spread of the electron beam traveling from cathode to grid is so wide that those electrons repelled by the grid return to the cathode without exerting much influence on other electrons which might possess greater energy and therefore be able to overcome the negative grid voltage. It is only when the control grid voltage is made so negative that no emitted electrons possess sufficient energy to overcome it that

(Continued on page 138)

Fig. 9. A limiter-discriminator circuit using the 6BN6.

Fig. 8. The basic circuit of the d.c. restorer as used in the automatic black level system described herein.

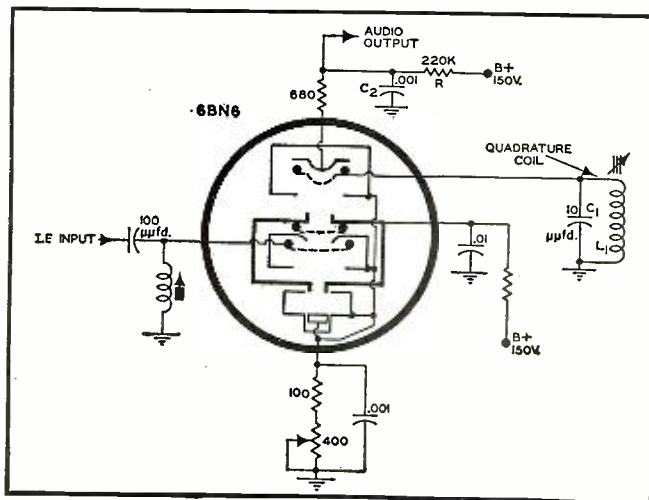
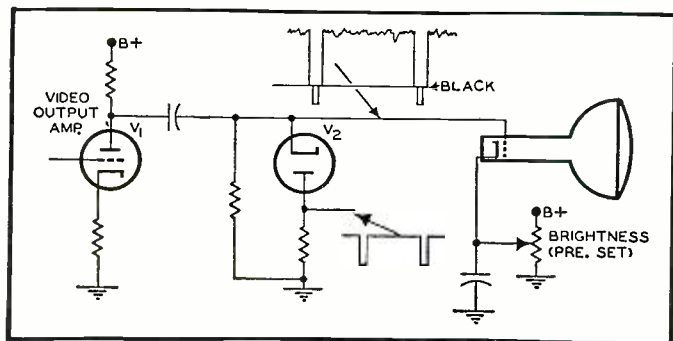

NO SPACE FOR AN ANTENNA?

By STAN JOHNSON, WØLBV

Two solutions to the problem of getting on the air without the necessity for erecting a bulky and often forbidden antenna array.

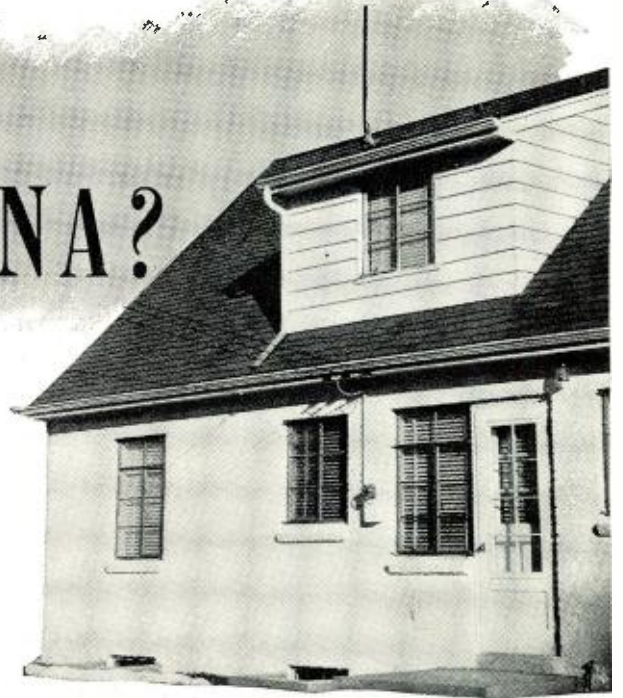

MANY a ham, or would-be ham, would be on the air were it not for an uncooperative landlord, belligerent neighbors, or an XYL with a will of iron—who doesn't want the landscape cluttered up with a transmitting antenna. To these luckless hams this article is dedicated, for it describes two practical antennas, both tested in months of operation, which should enable almost anybody to go on the air.

Both antennas to be described are for the 10 meter band. This band is the logical choice for the ham with space problems, since it is the highest frequency band consistently useful for both "ground wave" and "DX" work. And, of course, the higher the frequency the shorter the antenna—and

the better the chance of finding a spot for it.

The antennas are of two types, one a non-directional low-angle radiator, and the other a two-element beam.

First, the beam, which is a natural for those whose best chance for an antenna is to park it in the attic where only mice, and perhaps an inquisitive woodpecker, will ever see it.

Choosing a beam for an attic is no cinch, since unless you live in a mansion (in which case you probably own the place and have neither landlord nor neighbor problems) you are not apt to find enough space to rotate the beam. True, there are "bent" and "folded" beams—but the writer has tried this approach and takes a dim view of the results.

Since we are stuck with a non-rotating beam, the best bet is to make it bi-directional, so that we have two chances to work stations instead of one. The logical choice is an "end-fire array," or as the old-timers know them, an "8JK." This antenna, once top favorite for 10 meters, is still a good one. It gives a gain of over 4 db. in two directions, in theory, and in practice seems to do considerably better than that.

The 8JK can be made up in many different ways but the easiest way at the moment is to utilize the various "ribbon" lines which are on the market today. Essentially, the antenna consists of two folded dipoles, spaced a quarter-wave apart and fed 180 degrees out-of-phase. The dipoles are made up of standard 300 ohm ribbon, as shown on page 61, and both dipoles are fed with lengths of 150 ohm line. This line is used on the assumption that the quarter-wave spacing of the two radiators lowers the radiation resistance of each of the dipoles to ap-

proximately one-half of that usually found at the center of a folded dipole in free space. The two lengths of 150 ohm line can be any equal length over 9 feet. As shown in the drawing, one of these lengths of 150 ohm line should be twisted one-half turn, to allow feeding the dipoles out-of-phase. At the juncture point of the two 150 ohm feeders a 72 ohm transmitting type twin-lead is attached and run to the transmitter.

Dimensions should be calculated for the most-used frequency, following the formula given in the diagram. The 72 ohm line should be made somewhat longer than needed to reach the transmitter, and then carefully pruned a couple of feet at a time to find the length which gives best antenna loading. The fact that the line needs pruning proves that there are standing waves present but they do not seem to be high. After the feeder has been pruned, the antenna will take power over a surprisingly wide range of frequencies.

The photograph (page 61) shows one practical way to mount the antenna in an attic. Of course, the antenna is directional at right angles to the length of the dipoles, and it should be oriented with this in mind. Running the antenna north and south is recommended, for example, if you are located in the middle of the U.S.A. and want to work both coasts.

The luck you will have with the antenna will depend upon a lot of things, including, the writer found, upon whether the antenna is installed above or below the insulation! Mounting the antenna above the insulation in the attic gave noticeably better results than when the antenna was mounted directly below it—apparently even rock wool will soak up radio waves. The

Construction details on "Inside-Outside" ground plane unit for 10 meter operation.

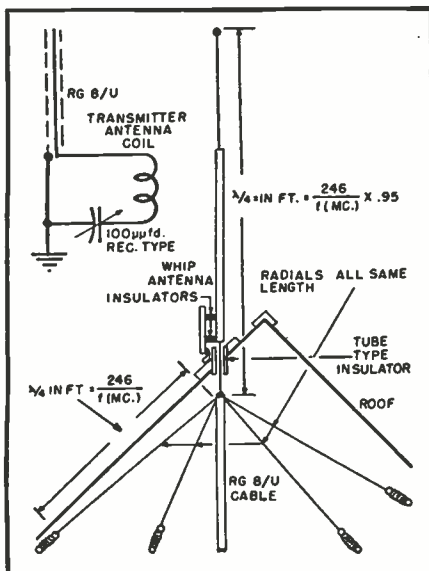

material used for roofing will undoubtedly have some effect, as will the proximity of water pipes, etc.

As explained previously, the 8JK is quite directional in each of its two directions. So if you want to work in all directions, at the sacrifice of gain, or if your house is oriented in such a way that the 8JK would dump its signal into regions inhabited largely by fish and polar bears—you will need another way out. A variation of the "drooping ground plane," popularized by W6FFF, is a nice solution.

This antenna consists of a radiating portion, which is made from an ordinary "whip" antenna, with four radials at the base. The use of the radials leading off at an angle (not critical) results in an antenna which is a fairly good match for a standard 52 ohm cable such as RG8/U. The whip can be mounted on the roof of the house, since it is neat by nature, and the rather messy radials hidden beneath the roof, where even the nosiest neighbor won't know they are there.

One large manufacturer of whip antennas makes a telescoping 12 foot antenna, complete with mounting bracket and insulators, which sells for less than five dollars, which is ideal for this type of installation. Notice that the *inside* of the coaxial cable connects to the bottom end of the whip, and the braid connects to the four radials. For purposes of measurement the "antenna" consists of everything from the point at which the coax braid ends (and the radials are attached) to the top end of the whip. The whip is mounted on a block of wood, which is screwed to the roof, using the angles furnished with the antenna. This antenna does require drilling a small hole through the roof, but if you plug it with a piece of caulking compound after dark the night you move out, the landlord will never know what happened. Incidentally, the same caulking compound is recommended for plugging the space around the wire which is pulled through the tube insu-

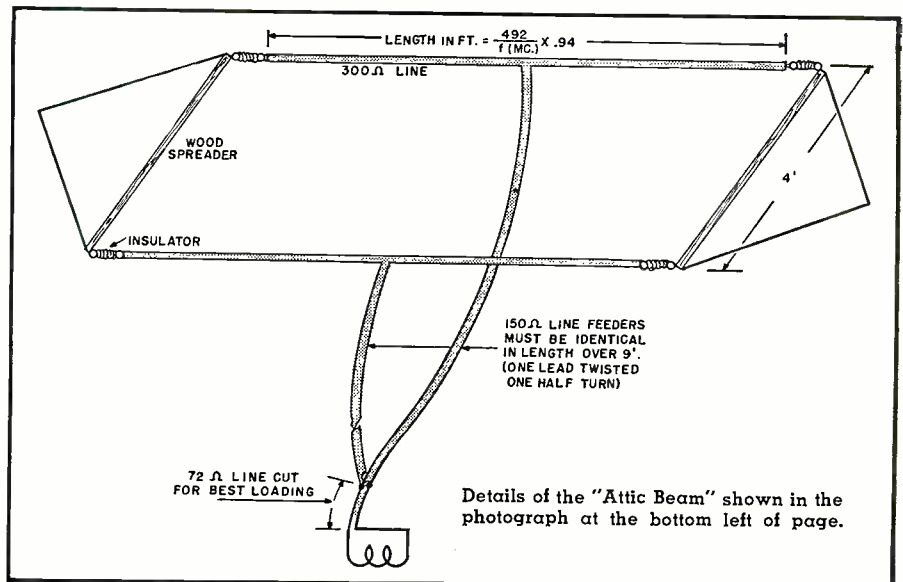

Details of the "Attic Beam" shown in the photograph at the bottom left of page.

lator at the base of the antenna. The writer used a piece of coax with the braid stripped off, as this lead-in, taking advantage of the extra insulating material which remained on the coax.

The drooping ground plane is reputed to be equally good in all directions, and experience with it seems to bear this out. Of course, it will not lay down a signal like a beam, but it does concentrate your power at low angles, which helps. It will receive DX stations surprisingly well—along, alas, with auto QRM, if there happens to be some nearby. The best "DX" which the writer has worked with the antenna shown in the photograph is Guam, which, while nothing to shout about, is quite a long haul with a 50 watt phone rig.

You will notice that the diagram shows a tuning condenser connected to the pick-up coil at the transmitter. This makes it possible to tune out the reactance, which means simply that the antenna will load up with looser antenna coupling. The little condenser (voltage is low so an ordinary receiving type condenser will do) is simply

adjusted to the point which makes the transmitter load up the best. The ground plane antenna really soaks up r.f., and apparently is not too critical as to frequency.

After using the two antennas shown, the writer still has one more antenna to try before pulling out all stops and doing a selling job on the XYL to convince her that a wide spaced four element beam would blend well with Colonial architecture. The antenna to try would utilize *two* 8JK's as radiators. According to the book, if these antennas are spaced along in a line a full wavelength apart (as measured from center-to-center) it is possible to get either a cloverleaf or a bi-directional pattern, simply by feeding the two antennas in—or out—of-phase. The gain is supposed to be about 7 db., which would be quite an "assist" for the 50 watter.

And perhaps if the power were hiked to a couple of hundred watts, the r.f. would melt snow off the roof.

Not that it matters. The writer has talked to Miami, Florida, right *through* 8 inches of snow on the shingles! —50—

↓ This two-element end-fire array (8JK) is easy to install in attic where it will turn in better performance than standard folded dipole under same conditions.

→ The "Inside" portion of the antenna shown in the photo on opposite page. The radials at the base of the antenna are in attic, neat "whip" is only element outside.

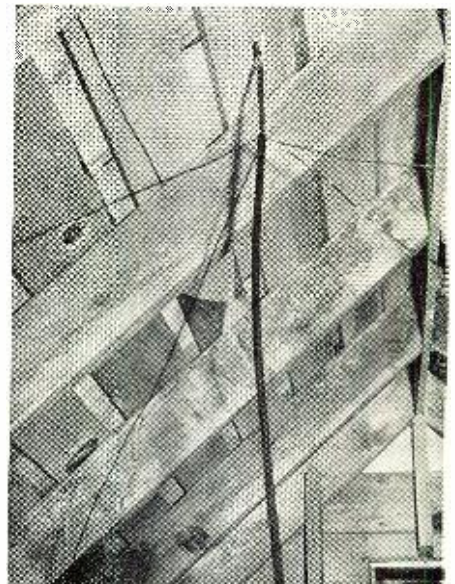
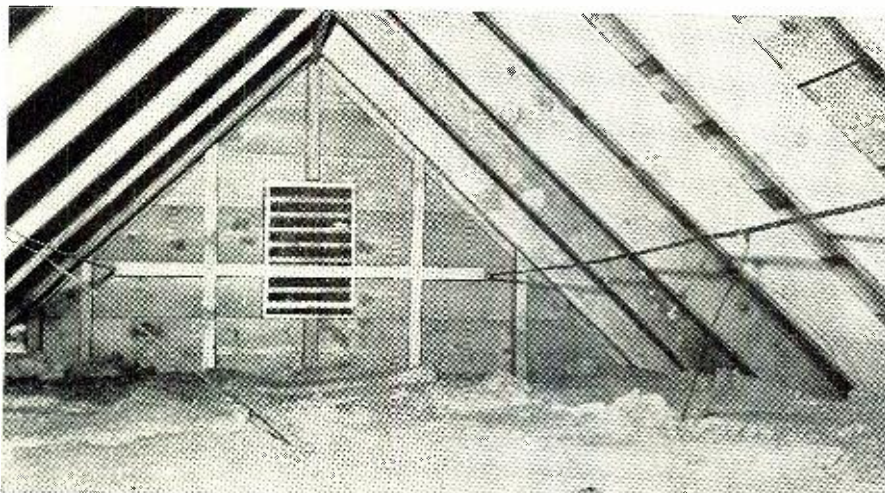



International SHORT-WAVE

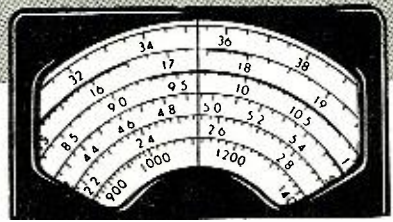

Compiled by **KENNETH R. BOORD**

DGAR W. PARMENTER, General Manager of the International Monitoring Service, informs me that IMS wishes to expand its services to short-wave broadcasters. Says Mr. Parmenter:

"The International Monitoring Service—which is in the business of publishing and cataloging short-wave broadcasting information and technical data—wishes to expand its *free* foreign broadcast monitoring service.

"For many years, the IMS has given freely of its time, effort, and experience to foreign broadcasting stations which operate in the short-wave bands, in the interest of good will and understanding between nations through the medium of short-wave broadcasts. It has been the sincere belief of the directors that there was a need for a reliable method of getting reception data without cost to the individual broadcasters. With this thought in mind, IMS surveyed its position and found that the necessary equipment and manpower was available. So it was, after the end of World War II, and as liberated and free broadcasting stations returned to the air, that IMS-1 station, San Carlos, California, was put into operation. Since then, IMS-1 has voluntarily served broadcasting stations on all continents and in every corner of the globe.

"The time has now come when we must attempt to expand these listening posts to every strategic location in

the United States and its possessions. Once this is done, coordinated checks on reception over a large area of North America will be available to broadcasters.

"IMS is asking SWL's who would be interested in serving as a monitor, to write to The International Monitoring Service, P.O. Box 485, San Carlos, California. A descriptive folder and questionnaire will then be mailed, outlining the requirements and many benefits obtainable by the volunteer. We would like to stress that IMS does not and will not change or cause to be changed any of the services it or its affiliates and associates render to the broadcasters."

Our best wishes go to IMS in this worth-while effort!

* * *

Radio Tibet

According to press dispatches from India, at long last Tibet has gone on the air. A few days before this was written, it was reported from India that "a thin, wavering voice calling from a station that announced itself as 'Radio Tibet'" had been heard in the 41-meter band on a frequency of

(Note: Unless otherwise indicated, all time is expressed in American EST; add 5 hours for GCT. "News" refers to newscasts in the English language. In order to avoid confusion, the 24 hour clock has been used in designating the times of broadcasts. The hours from midnight until noon are shown as 0000 to 1200 while from 1 p.m. to midnight are shown as 1300 to 2400.) The symbol "V" following a listed frequency indicates "varying." The station may operate either above or below the frequency given.

approximately 7.200. The broadcast stated that the Government of the Dalai Lama was "shocked" by the threat of a Chinese Communist invasion and an appeal was made to all neighboring countries for aid in fighting possible aggression.

A dispatch from Kalimpong, in northern Bengal near the Tibetan frontier, said that "Radio Tibet" would start regular broadcasts the following day in *English*, Chinese, and Tibetan.

A report from New Delhi said it was believed that "Radio Tibet" had been set up in behalf of the Tibetan Government by Reginald Fox, a British citizen who has lived in Lhasa, the capital of Tibet, for many years and who is married to a Tibetan.

Any further information regarding "Radio Tibet" will be welcomed.

* * *

"A Little About DX-ing"

Of interest is this comment by Sidney Pearce, England, a valuable monthly contributor to this Department, as it appeared in a recent issue of *NATTUGGLAN* (Night Owl), house organ of the Scandinavian DX Club, Sweden:

"I actually started being a short-wave fan in December 1935, when I used a home-built OV. Z battery bandspread receiver. I got quite a thrill when I heard my first DX-station, Boundbrook, New Jersey, in the 16-meter band. But I think my biggest thrill in those days was one February afternoon when I logged the old VK2ME in Sydney, Australia, and in due course received its QSL card. In some ways, I got more thrill in those days using a small receiver than with my present communications receiver, although most stations were low-powered. I think we had more chance of logging some of the stations at that time than today, because there were not so many stations on the bands and especially no very high-powered local transmitters as today which 'swamp' many weaker signals on adjoining frequencies.

"To be successful in short-wave listening, I think you need up-to-date news of stations on the air, schedules, et cetera, and a good station list. . . . You also should have a fair knowledge of geography. Another tip is, although most of the weaker signals are the ones worth investigation for DX, never turn down a strong signal un-

(Continued on page 102)

General view of Radio Tahiti at Papeete, Tahiti. The station is on the air daily, mostly in the French language, from 2315-2400 EST on 6.982 and 12.080 megacycles.

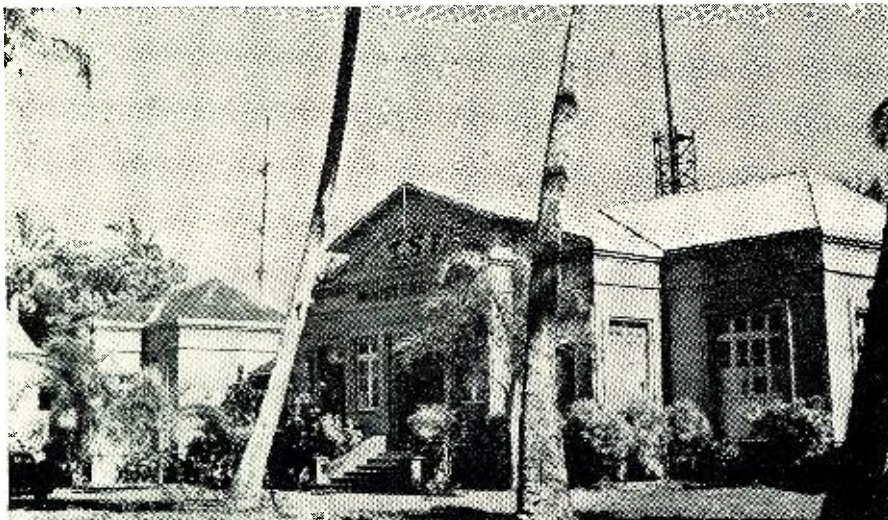

R. F. Power OUTPUT METER for V.H.F. and U.H.F.

This unit has a useful frequency range of between 3 and 300 mc. which covers most amateur and many commercial bands.

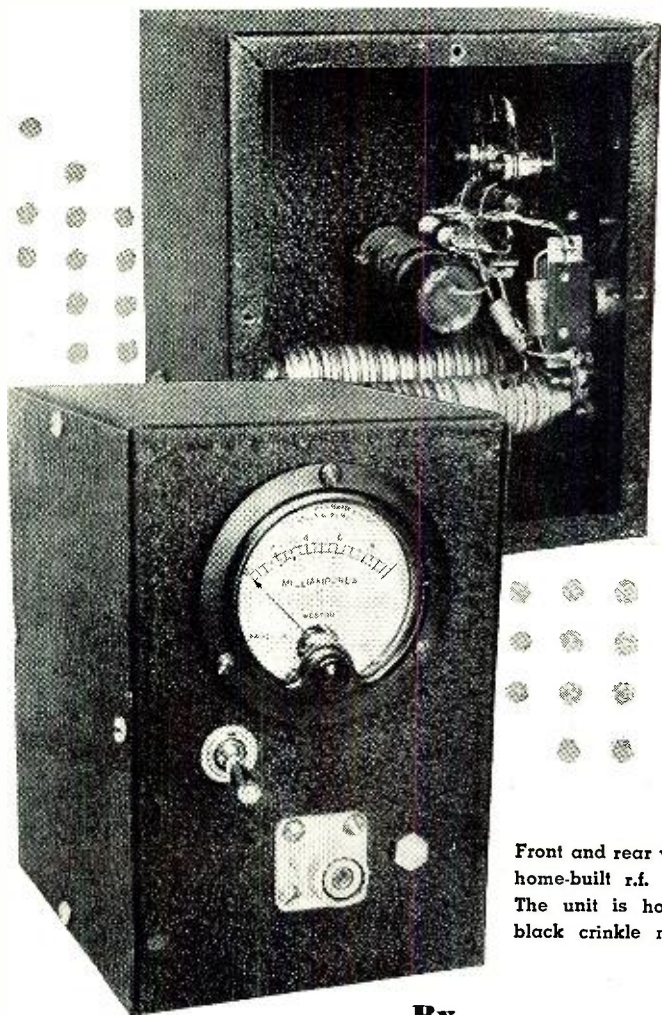

Front and rear views of the compact, home-built r.f. power output meter. The unit is housed in a standard black crinkle metal utility cabinet.

By
J. A. HOUSER,† W2VCM

BY THE application of established theory and practice it is a comparatively simple matter to measure the power output of low-powered AM or FM carriers without elaborate or expensive equipment such as concentric slotted lines and the like.

The meter to be described is low in cost, simple to build, and easy to calibrate. It has a maximum standing wave ratio of 1.3 at 150 megacycles. Compared to some of the most expensive power output meters which guarantee their standing wave ratio to 1.1 or 1.15, but taking into consideration the difference in cost, this 0.2 increase in standing wave ratio is negligible.¹

As far as the writer has been able to determine, the discrimination over an extremely wide frequency range is also negligible. The useful frequency range seems to be approximately 3 to 300 megacycles, which includes most of the amateur bands and many commercial services.

The writer has found this instrument especially useful for checking taxi, truck, and police transmitters operat-

ing in the 35 to 45 and 152 to 162 megacycle bands, where it is literally worth its weight in gold. (It weighs only a couple of pounds and is completely self-powered, self-contained, and extremely portable and convenient to use).

The entire unit is housed within a Bud CU-728 metal utility cabinet of black crinkle, measuring 3" deep x 5" wide x 4" high. This cabinet has two removable side plates which makes it most convenient for making all connections. The switch selected must have sufficient positions for the various

ranges the constructor wishes to calibrate. The numerical limits of the power ranges will be governed by the number of switch positions. The power ranges themselves will be discussed later in connection with the metering circuit.

The photographs show the construction very well. The switch S_1 is a single-pole, double-throw type. The low position is for 10 watts full scale, readable to 1 watt with accuracy, and the high position is for 100 watts. These power ranges are wholly and completely at the discretion of the constructor within the limits of the calibrations he wishes to make and the light bulbs available. A 0-1 ma. meter was used, but this proved to be superfluously sensitive. Anything up to the limit of the rectifier may be used.

The input is through an 83-1R type chassis receptacle mounted with four 6/32 brass, nickel-plated machine screws, although it is necessary to drill out the holes in the 83-1R to take these standard screws. Brass nuts were used. The usual scraping procedure for good ground, and fastening of a heavy ground lug through one of the screws on the rear was followed.

The heart of the meter, the resistance element, is composed of carbon discs which were purchased as war surplus. They are copper plated and

(Continued on page 114)

Complete schematic diagram of the r.f. power output meter.

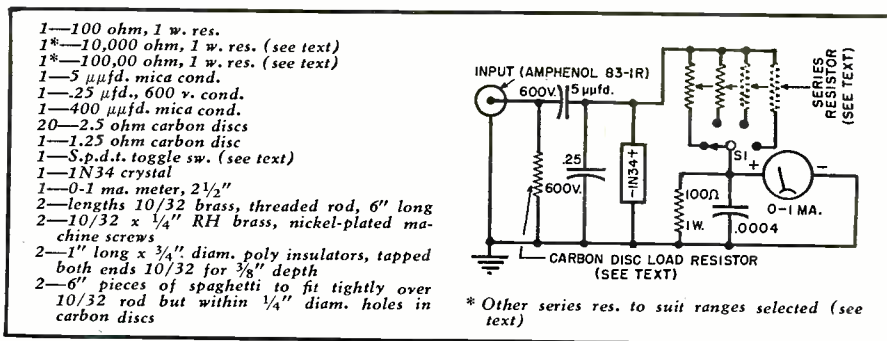

† 23 Washington St., Rensselaer, N. Y.
¹ Graham, R. C.; "Developments in Solid Dielectric R.F. Transmission Lines," RADIO NEWS, Oct., 1946, page 46.

TRANSMITTER KEYING AND BIASING PROBLEMS

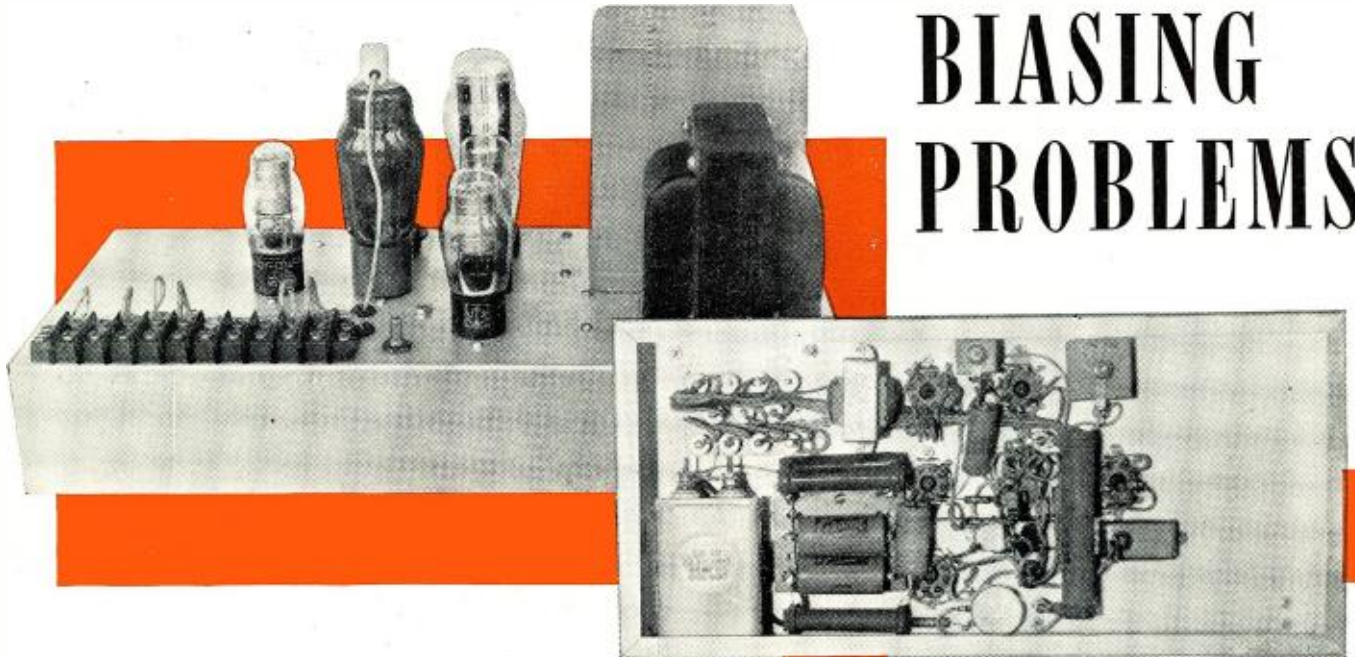

By
JAMES N. WHITAKER,
W2BFB

Fig. 1. Top and under chassis views of the keyer unit shown schematically in Fig. 4.

Analysis of some causes of keying transients, and a means of eliminating interaction between stages due to the use of a common biasing supply. Specifications and a description of a unit combining a vacuum tube keyer and biasing system, which is applicable to an existing phone transmitter, are also given.

THE present trend toward telephony and new modulation systems appears to have captured the amateur's fancy to the extent that c.w. telegraphy is considered old art, with all problems nicely solved and adequately described. A few minutes expended in critically listening over the c.w. portions of the amateur bands will quickly dispel this idea. There are still plenty of chirps and an abundance of key clicks.

Clickless keying is not always easily obtained, nor are the causes of key clicks always understood. The transients produced by sharp keying waveforms are the types most generally treated in popular texts. This type of keying transient is usually eliminated by a simple RC filter network in the keying circuit. This does not always eliminate the click or thump, although theoretically shaping the keying waveform.

If the power supply regulation is poor, the radiated power may be considerably higher at the start of the keying pulse, dropping sharply to the normal level as shown in Fig. 3A. This output wave shape will cause a bad "thump," but may not necessarily cause a "click." It is caused by the increase in power supply voltage un-

der no-load conditions. In some instances, this increase may be as much as 50%, even in power supplies normally considered adequately designed. Excessive power supply filtering of the "brute force" type is a common cause of poor regulation under keying conditions.

A secondary result of poor regulation may be spurious oscillations at the start of each keying pulse. The power amplifier (or, in fact, all keyed stages) although stable for all practical purposes at the normal plate potentials, may break into violent self oscillation with an appreciable increase in plate potential. This spurious oscillation may disappear as soon as the plate potential approaches normal, and therefore may not be recognized as anything other than "key clicks." This is the type of "key click" that appears to spread out over a very wide band, the bandwidth depending upon the spurious frequencies generated. The presence of these spurious frequencies is easily detected by examining the keyed transmitter output with an oscilloscope. The keyed stages should be free from spurious oscillations even with more than twice the normal applied plate potential. If spurious oscillations are present, they

must be eliminated before clean, clickless keying can be obtained.

The high amplitude at the beginning of the keying pulse, described above and in Fig. 3A, is due to the rise in power supply potential between keying characters. The load is removed when the key is up, permitting the voltage to rise appreciably. A power supply that is quite satisfactory for telephony may be entirely unsatisfactory for c.w. operation. The regulation is more important than the a.c. ripple, although the ripple should not exceed 10% under full load conditions. A single section filter using choke input is usually adequate, and will provide better regulation than the conventional two section filter.

With a power supply having inherently good regulation, and with complete freedom from spurious oscillations, the keying waveform may be shaped as desired using conventional methods. The method will depend upon the type of keying used. In setting up any keying system, the r.f. envelope should be observed in an oscilloscope while the wave shaping network is being adjusted. The wave shaping network may be adjusted to compensate for a reasonable amount of power supply regulation.

The perfect keying waveform is very difficult to obtain. The waveform shown in Fig. 3B will provide a clear, crisp sounding signal with no "tailing." Fig. 3C illustrates a wave front which is much too steep, and which will produce objectionable keying clicks. Fig. 3D illustrates over-compensation, which will produce a "ringing" type of signal.

The owner of a phone rig will usually find he is faced with at least three problems when converting to phone/c.w. First, the power supply was probably designed to operate with a constant load, and may have poor regulation in keyed service. Some modifications may be required to prevent a dangerous rise in voltage under no-load conditions. Secondly, it will be necessary to effectively remove the secondary winding of the modulation transformer from the PA plate supply circuit when keying. This is very important. If the modulation transformer is left in the circuit and the PA is keyed, the peak transient voltage resulting from the sudden change in current through the modulation transformer winding can easily reach seven to ten times the applied d.c. voltage, depending upon the "Q" of the transformer winding, keying waveform, etc. Such peak potentials can be very destructive indeed.

It is generally much easier to short circuit the secondary winding of the modulation transformer than to disconnect it from the circuit. A high voltage switch will be required for this purpose. It is not at all difficult to obtain a high voltage switch with several contacts. These other contacts may be used to change the power supply filter connections for c.w. or phone operation. The exact connections will depend upon the power supply, but as an example, the modification of the transmitter at W2BFB is shown in Fig. 2A. Note that this arrangement takes care of problems one and two. (For a complete schematic diagram and other details, see RADIO NEWS, April and May 1947 issues.)

The third problem will be the installation of a keying system. This is frequently not one problem, but a series of problems. Low level or oscillator keying may be the easiest to apply, but leads to other difficulties. First, a system must be devised which will be free from frequency shift or "chirps" when the key is closed. Secondly, a phone rig probably will use grid resistor biasing systems in the multiplier and amplifier stages. This system is very satisfactory providing grid excitation is applied at all times. If grid excitation fails or is removed, the overload relays will operate, or the tubes will dissipate destructive amounts of power because of the loss of grid bias. It therefore becomes necessary to supply at least a protective bias to all stages normally designed for grid resistor bias only. This bias need not be the normal operating bias, but must be of such a value as to bias the tubes sufficiently to prevent excessive plate dissipation. For economical reasons, the bias should reduce the plate current to substantially zero.

If a common bias supply is to be used in a multiple stage transmitter, the regulation must be good or serious reaction between stages may occur due to grid current, which tends to increase the biasing potential.

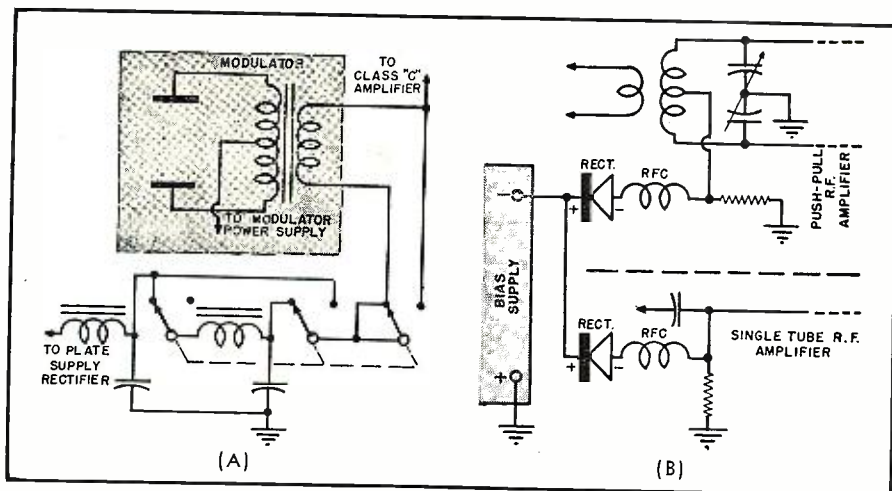

Fig. 2. (A) A phone-c.w. switching system, and (B) a grid bias supply isolating system.

One method of preventing interaction between stages is shown in Fig. 2B. In this system, a rectifier is used as a valve between each grid resistor and the bias supply. Current will flow through the rectifier and grid resistor from the bias supply, as long as the voltage appearing across the grid resistor from any source is less than that produced by the bias supply. When excitation is applied to the tube, grid current will also flow through the grid resistor. When the grid current produces an IR drop across the grid resistor which equals or exceeds the potential of the bias supply, the grid resistor will be effectively isolated from the bias supply by the rectifier which will not conduct any appreciable current in the reverse direction.

The power delivered by the bias supply need only be sufficient to provide a cut-off bias across the various grid resistors. This bias will seldom exceed 150 volts, and the current is relatively small, enabling a VR150 tube to be used for stabilizing the power

supply voltage. If large triodes are used and the current required from the bias supply exceeds the capabilities of a VR150 regulator, a simple vacuum tube voltage regulator using a 6L6 will suffice.

It is often desirable to key the transmitter at some point beyond the oscillator for "chirpless" keying, or other reasons. The keying should be applied at least one stage ahead of the PA, if possible, unless the driving stage is of very low power, to guard against "key up" radiation.

In most modern transmitters, at least the driver stage is a "beam" type of tube. Often the lower stages and the PA are also "beam" tubes. These tubes lend themselves very nicely to vacuum tube keyers of various types.

Several vacuum tube keying systems have been described elsewhere in recent literature. The system to be described in the following paragraphs is particularly applicable to beam pentode or tetrode keying, and is a part of a bias supply system designed to apply grid bias to a transmitter nor-

Fig. 3. (A) High amplitude at the start of the pulse indicates poor power supply regulation. This waveform produces "thumps" because of greatly increased power at start of the keying pulse. Note that the keying waveforms are at a rather high keying speed (75 w.p.m.) to accentuate the slopes for easier observation. (B) Ideal keying waveform. Well rounded start of pulse assures clickless keying. (C) Insufficient time-constant circuit with steep wave front. Relay contact bounce produces spike at the beginning of the pulse. This waveform will produce loud clicks that spread out over a wide range of frequencies. (D) Keying waveform showing excessive time-constant. This results in a "ringing" signal which will be difficult to copy. However, this waveform combined with poor power supply regulation, as in A, will produce good keying, as shown in B.

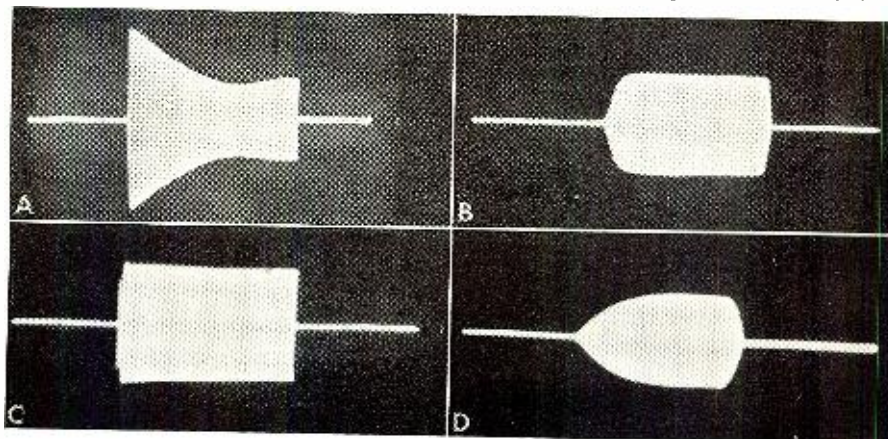

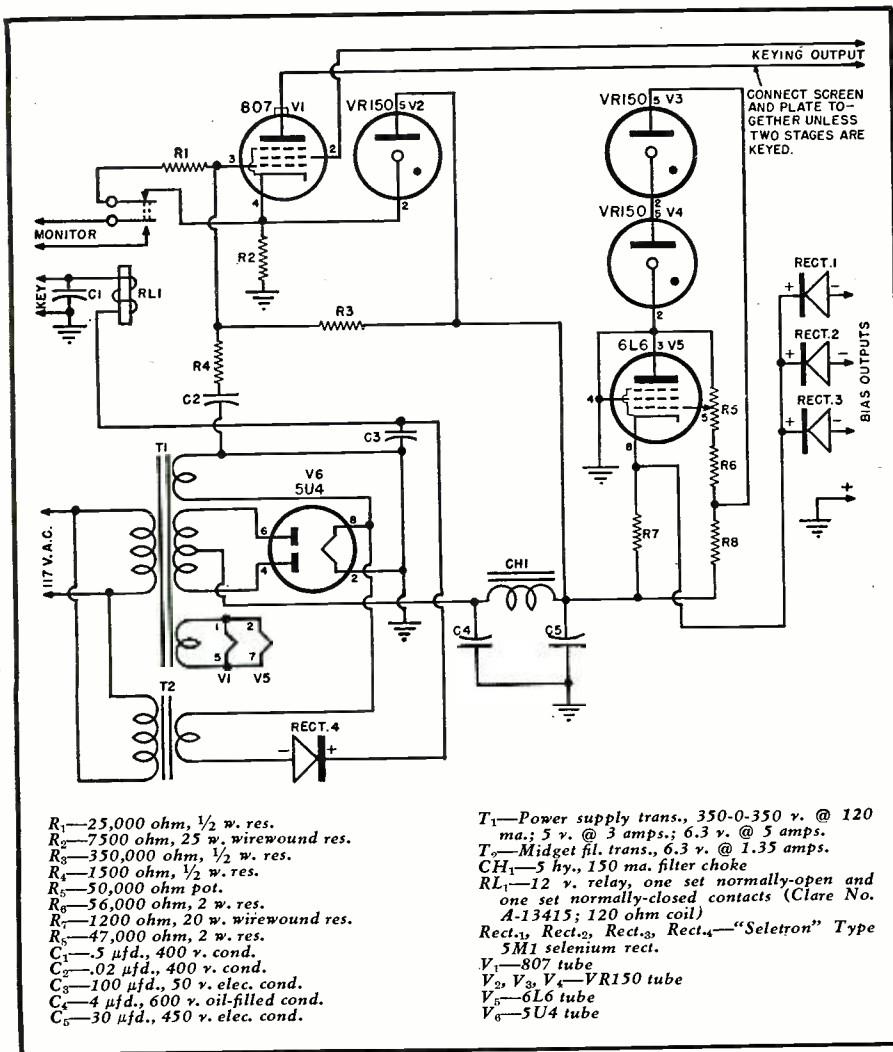

Fig. 4. Schematic diagram showing circuit details of a vacuum tube keyer and bias supply.

mally provided with grid resistor biasing only.

The circuit is shown schematically in Fig. 4. The bias supply system includes a 6L6 voltage regulator, capable of holding the power supply output voltage constant within 5%, from no load to full load. The vacuum tube keyer circuit includes an 807 keyer tube, in a circuit which is designed to change the screen grid of an 813, HK257B, 4-125A, 4-250A, or any smaller tube from its normal positive

value to a negative value when the key is up. It is necessary that the screen potential for the keyed stage be obtained from the plate supply through a series dropping resistor when using this system.

The voltage regulator provides a constant load for the power supply. It is somewhat less complicated and less susceptible to oscillations than some of the other forms of regulators, and is entirely adequate for the purpose intended.

Fig. 5. Schematic of a circuit which permits the simultaneous keying of two stages.

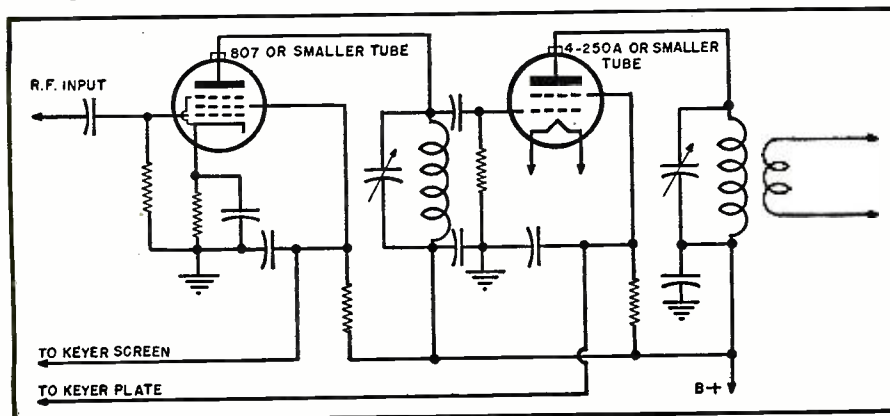

The keying relay is arranged with two sets of contacts. The normally-closed contacts connect the grid of the keyer tube to its cathode through resistor *R₁* in the “key up” position. The voltage drop across the tube is less than 10 volts. The anode of the tube is, therefore, approximately 100 volts negative with respect to ground, and the screen grid of the keyed tube is also held correspondingly negative with respect to ground.

When the key is “down” and the relay coil is energized, a negative cut-off bias is applied to the keyer tube, preventing the flow of screen and plate current, and the screen of the keyed tube receives its normal positive potential.

If it is desired to key two stages simultaneously, the screen grid of the keyer tube may be connected to the screen of a preceding stage in the transmitter as shown in Fig. 5. This system will operate satisfactorily providing the stage keyed by the screen of the keyer tube is an 807 or smaller pentode or tetrode type, and further, providing the screen grid potential for this stage is also obtained from the plate supply through a series dropping resistor.

The keying wave shape is determined by *R₁*, *R₃*, *R₄*, and *C₂*. The values indicated produce the keying wave shown in Fig. 3B, which leaves little to be desired. The values of *R₃* and *C₂* may be changed to compensate for poor power supply regulation. The values of *R₃* and *C₂* will largely determine the shape of the start of the keying pulse, while the values of *C₂* and *R₁* will determine the shape of the end of the keying pulse.

The keying relay is equipped with two normally-open and two normally-closed contacts. The normally-closed contacts are used for transmitter keying, and the two normally-open contacts are used for keying an audio oscillator for monitoring purposes.

The keying relay is supplied with rectified a.c. from the 5 volt filament supply of the rectifier tube plus 6.3 volts a.c. from the midget filament transformer, *T₂*. The 11.3 v. a.c. is rectified by a selenium rectifier, filtered roughly by *C₃*, and applied to the relay coil through the telegraph key. The telegraph key is bypassed by condenser *C₁* to absorb the inductive surges from the relay coil. If *C₁* is omitted, slight but unpleasant shocks may be felt at the telegraph key. The use of low voltage plus *C₁* precludes the possibility of shock to the operator of the telegraph key.

When the proper constants for correct keying have been determined, they will be essentially correct for any of the keying speeds normally used.

Your neighboring hams will never know you are on the air unless they tune across your signal. And the stability resulting from the changes will go far in reducing TVI caused by parasitic oscillations.

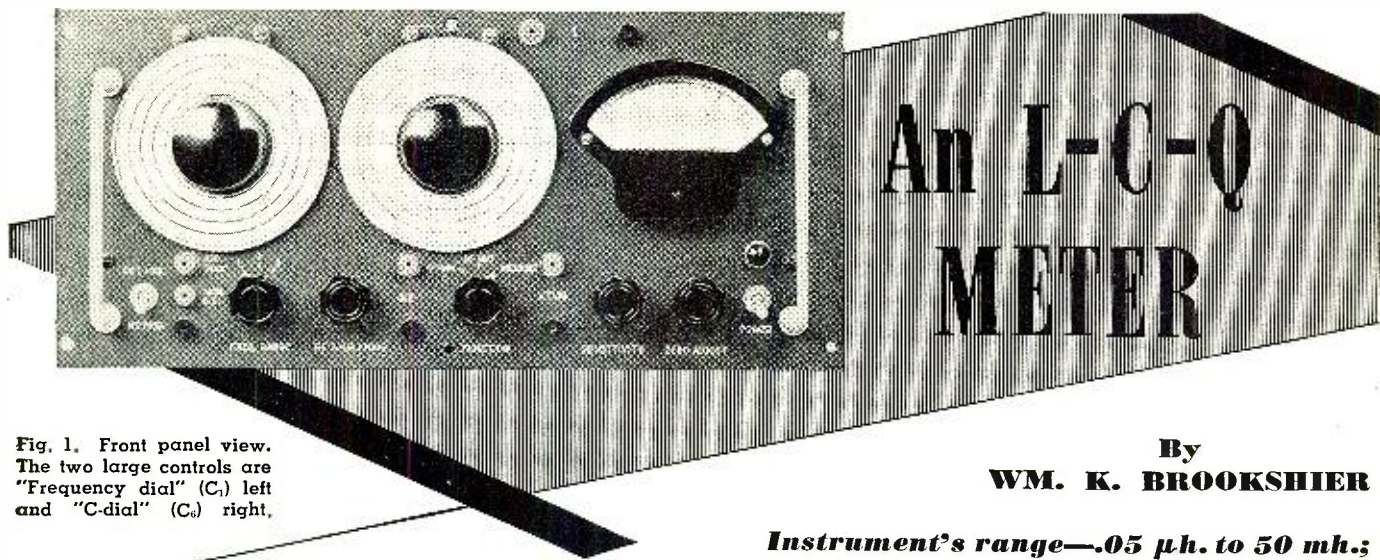

Fig. 1. Front panel view. The two large controls are "Frequency dial" (C.) left and "C-dial" (C.) right.

By
WM. K. BROOKSHIER

**Instrument's range—.05 μ h. to 50 mh.;
1 μ fd. to .01 μ fd.; and "Q" of 10 to
200. Can also be used as an r.f. signal generator.**

THIS instrument was originally designed for the purpose of measuring inductance over a useful part of the r.f. spectrum. Its resultant capabilities, however, proved to be numerous, and can best be presented by giving some specifications.

Inductance from .05 μ h. to 50 mh. can be measured. If the value of inductance lies between 1 μ h., and 16 mh., it can be read directly from a calibrated scale. The accuracy of these measurements depends upon many factors—primarily the accuracy of calibration. A reasonable figure would be 1 to 3 per-cent.

Values of capacity from 1 μ fd. to .01 μ fd. can be measured by means to be described later. Again a reasonable figure for the accuracy of these measurements is 1 to 3 per-cent. Under some conditions the accuracy may be better—under others, much poorer.

The "Q" of inductances may be measured by the 70.7% method, which is further described under "Operation." A range of about 10 to 200 can be covered with an accuracy that depends almost entirely upon the exact methods employed.

The instrument may be used as an r.f. signal generator covering a frequency range from 125 kc. to 12 mc. in three ranges: (1) 125 to 570 kc. (2) 570 kc. to 2.65 mc. (3) 2.65 mc. to 12.4 mc. The r.f. voltage available at 125 kc. is about 40 volts, decreasing to about 3 volts at 12 mc. Provisions are made for external amplitude modulation.

This instrument may be used as an uncalibrated vacuum-tube voltmeter. Five ranges, with full scale a.c. deflection voltages of .43, 1.53, 4.7, 14.5, and 46, were obtained in the original instrument. The input impedance at the front panel of the instrument is approximately 1.7 megohms shunted by 10 μ fd. The frequency range of the voltmeter extends from about 200 cycles to 100 mc. However, due to the absence of a probe, its usefulness above 10 mc. would be limited.

The functional diagram of the in-

strument as used to measure inductance and capacity is shown in Fig. 2. The oscillator is represented by a variable-frequency voltage in series with the output impedance Z_0 of the oscillator, which is quite low compared with the value of the resistor R_6 . Parallel resonance is used, with the unknown inductance and the capacity of the calibrated condenser forming the tuned circuit. The vacuum-tube voltmeter circuit measures the r.f. voltage appearing across the tuned circuit. In measuring inductance, either the C-dial or the Frequency dial is set at a convenient value, and the other dial is tuned to give a peak reading on the meter. If the "Q" of the inductance coil is 10 or greater, which is almost always the case, the error involved in assuming that the reactance of the condenser equals the reactance of the coil will be 1 per-cent or less. Thus, to a high degree of approximation, we may assume that:

$$2\pi fL = \frac{1}{2\pi fC}$$

and the inductance may be calculated by:

$$L = \frac{1}{4\pi^2 f^2 C}$$

when the frequency and capacity are known.

The complete circuit diagram is shown in Fig. 3. The oscillator employs a 6SK7 in a conventional Hartley-type circuit. An unusually high value of tuning capacity, obtained by

paralleling both sections of a two-gang condenser, was used to obtain somewhat greater frequency coverage than could be had in three bands if only a single gang were used.

The lower section of the bandswitch S_1 (Fig. 3) is used to short across L_3 when the switch is on band 2, and to short across L_2 when the switch is on band 3. This was found to be necessary. The self-resonant frequency of L_3 fell within band 2, and, due to the close coupling between coils caused by their physical placement, the calibration of the frequency dial on band 2 was seriously distorted at the resonant frequency of L_3 . A similar effect was noted on band 3 due to the self-resonant frequency of L_2 . Shorting of the coils in the manner shown completely eliminates this trouble.

The potentiometer R_5 , marked "RF Amplitude" on the front panel, controls the voltage applied to the measuring circuit when S_2 is in position 1, and controls the amplitude of the r.f. voltage appearing at the "RF Output" jacks when S_2 is in position 2. When S_2 is in position 1, which is the position used for measuring inductance, the vacuum-tube voltmeter circuit is connected across the tuned circuit. When S_2 is in position 2, marked "RF Output," the voltmeter circuit monitors the r.f. voltage appearing at the "RF Output" jacks. When S_2 is in position 3, the vacuum-tube voltmeter circuit alone may be used externally. One section of S_2 then disconnects plate and screen voltages to the oscillator to prevent any stray coupling to the meter circuit causing an initial reading.

The vacuum-tube voltmeter circuit contains a conventional shunt-diode rectifier circuit, with its d.c. output voltage being applied to the grid of the first half of the 6SN7. This half acts as a d.c. amplifier. The correct grid bias for this triode is had by the proper choice of the value for R_{16} . It

Fig. 2. Fundamental diagram of unit as used to measure inductance and capacity.

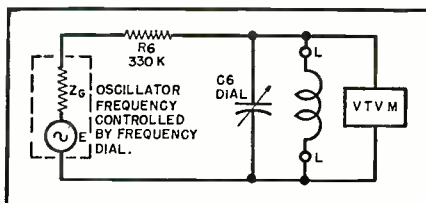

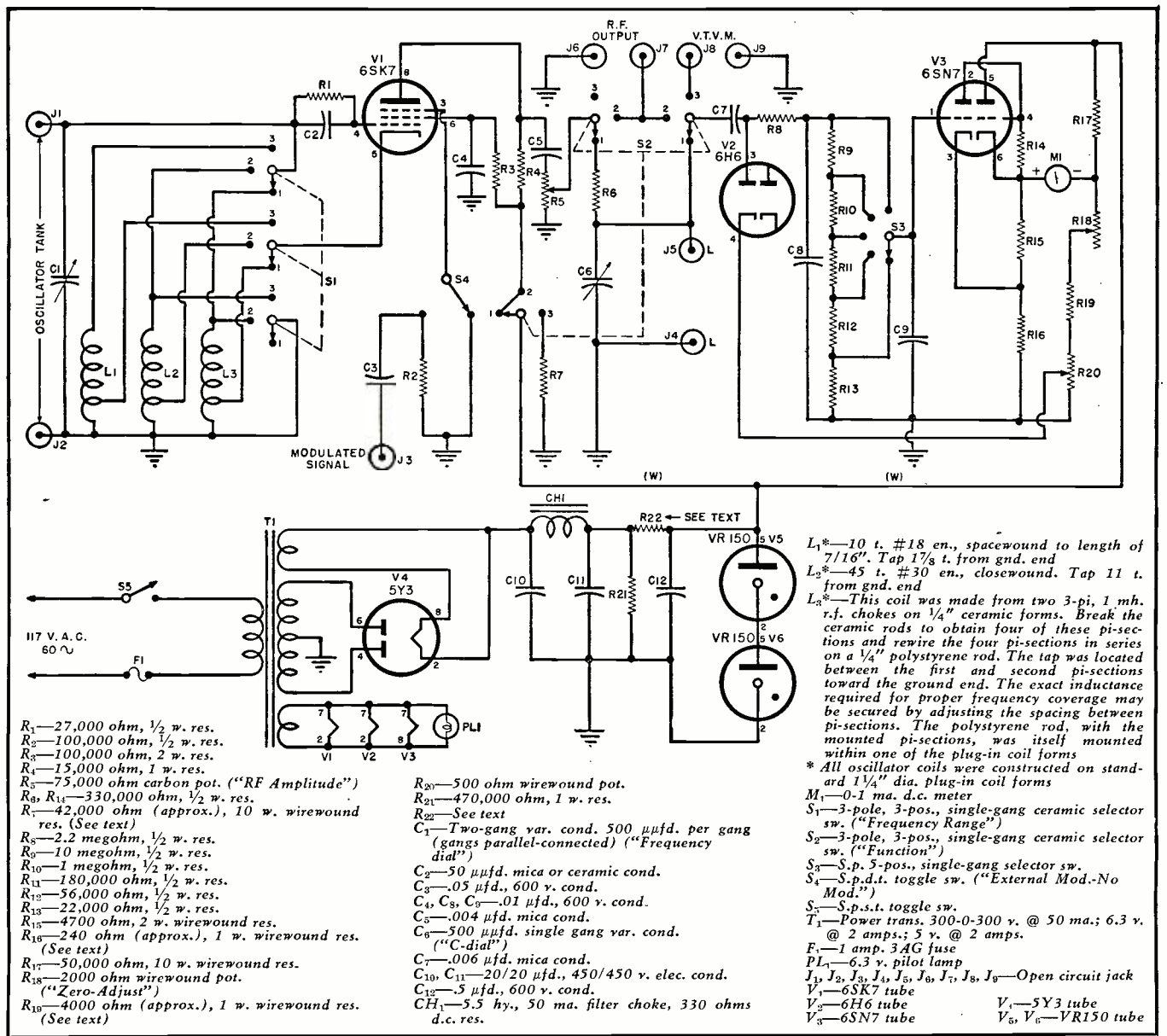

Fig. 3. Schematic diagram of meter. Position 1 of S_1 is low frequency band, position 2 is middle frequency band, position 3 is high frequency band. For switch S_2 , position 1 is "Measure," position 2 is "RF Output," and position 3 is "VTVM."

was found that the value of this resistor was relatively critical, as far as affecting the sensitivity of the voltmeter circuit is concerned. For this reason several values of resistance near 240 ohms should be tried until maximum sensitivity is obtained from the voltmeter circuit. A sensitivity of between .3 and .5 volts r.m.s. (required for full-scale deflection of the milliammeter) should be obtained with S_3 in position 1.

The second half of the 6SN7 forms one of the elements in a Wheatstone bridge circuit. The change in voltage across R_{14} causes the unbalance resulting in current flow through the milliammeter. R_{18} is the zero-adjust for the voltmeter circuit. Resistor R_{19} determines the range of operation for the zero adjust and should be chosen so as to cause the voltmeter to adjust to zero when R_{18} is near its mid-position. R_{20} controls the amplitude of a positive voltage applied to the cath-

ode of the 6H6 for the purpose of balancing out the contact potential developed by it. With the pointer on R_{20} turned all the way toward the ground end, a d.c. vacuum-tube voltmeter connected to the top of R_9 will read the negative contact potential voltage, which may be between .5 and 1 volt. As the pointer on R_{20} is turned up, this negative voltage will decrease toward zero. The proper adjustment for R_{20} is at a point where the voltage measured has not quite reached zero. If it is attempted to counteract the contact potential completely, an extreme loss of sensitivity will result. The author adjusted R_{20} for a voltage of about .03 volt, as measured on a 3-volt scale, at the top of R_9 . The resulting variation in zero-signal current through the meter was about .1 ma. as the range switch S_3 was changed from position 1 to position 5.

A certain amount of instability is to be expected in a voltmeter circuit such

as this. However, since the voltmeter is not intended to measure voltage magnitudes, but merely to indicate peaks of voltage, the basic requirement is to establish a degree of stability that is not too annoying. To accomplish this, it is necessary to use resistor R_7 . This resistor acts as a substitute load, replacing the load of the oscillator tube when S_2 is in position 3. Without it the "regulated" 300 volts developed across the voltage regulator tubes may increase by as much as 5 to 10 volts when the load of the oscillator is removed. The value for R_7 should be determined by experiment after the instrument has been completed. The author used three resistors in series for R_7 , which can be seen in the middle of the chassis in Fig. 5.

Since the sensitivity of this vacuum-tube voltmeter circuit would be affected greatly by the changing of tubes, aging of components, and other

factors, it is definitely inadvisable to attempt permanent calibration. However, if the builder should desire a calibrated voltmeter, any other circuit meeting a few basic requirements may be substituted. These requirements are: (1) Reasonably high input resistance—1.5 megohms or higher (2) Reasonably low input capacity of 10 to 12 $\mu\text{fd.}$ or lower (3) Fairly high sensitivity. A full scale sensitivity of 3 volts, r.m.s. value, would be usable, although 1 volt would be much more satisfactory. This sensitivity is required in order to make small inductance measurements.

The power supply circuit is conventional, except for the lack of a dropping resistor in series with the voltage regulator tubes. It may be necessary, depending upon the particular power transformer and filter choke used, to add such a dropping resistor (R_{22}) in the circuit. It should be chosen or adjusted to provide a current of about 30 to 35 ma. through the voltage regulator tubes when the wires "W" are disconnected.

In order to secure reliable performance, it is highly recommended that quality components be used throughout. All carbon resistors should be of the metallized type. Resistors R_{16} through R_{20} should be wirewound. It is not necessary to use any precision resistors.

Mechanical Construction

The original instrument was built on a homemade chassis $15\frac{1}{4} \times 6\frac{1}{4} \times 2\frac{1}{2}$ ". The front panel was made of $\frac{1}{8}$ " aluminum by cutting down a standard $8\frac{3}{4} \times 19$ " rack panel to dimensions of $16\frac{1}{2} \times 7\frac{5}{8}$ " to fit the case from a BC-375 tuning unit.

Two National Velvet-Vernier dial mechanisms, one of which may be found in each BC-375 tuning unit, were used for the Frequency dial and C-dial. The $4\frac{1}{2}$ " dial plates were cut from .040" sheet aluminum. These plates were then faced with white production enamel paper, obtainable from most office supply stores, and the lettering was done with black drawing ink. Sanford's rubber cement was used to fasten the paper to the dial plates. The dial indicator glasses were cut from Plexiglas, the hairline being in-

scribed with a sharp knife and filled with black drawing ink. The front panel lettering was accomplished with straight pen and white drawing ink, and given a coat of clear lacquer.

The layout of parts is not too critical. However, the same general placement of parts as indicated in Figs. 1, 4, and 5 would seem advisable. In order to secure short leads in the oscillator circuit wiring, the oscillator band-switch was mounted behind the front panel, with the shaft coming out through a panel bearing. Most of the wiring in the r.f. circuits was done with No. 12 bus bar.

Pin jacks were used for the front panel terminals. The non-grounded "RF Output," "VTVM," "Osc. Tank," and "L" pin jacks were mounted in polystyrene inserts cut from $\frac{1}{2}$ " polystyrene rod.

Calibration

Since methods of frequency measurement are relatively well-known, little will be said about the calibration of the Frequency dial. The Frequency dial should be calibrated before the C-dial.

There are several possible methods that might be used in the calibration of the C-dial. Perhaps the simplest requires a coil with known inductance and distributed capacity, with the value of inductance lying between 100 and 500 $\mu\text{h.}$ Specifications for the construction of a 100 $\mu\text{h.}$ coil are as follows: Wind $100\frac{1}{4}$ turns of No. 30 enameled wire on $\frac{3}{4}$ inch form. This should be closewound. The winding should be about 1.11 inches long. If these specifications are followed closely, an accuracy of 1% may be expected. The distributed capacity of this coil is about 1.3 $\mu\text{fd.}$ A figure of 1 $\mu\text{fd.}$ should be sufficiently accurate for calculations. For illustration, let us assume that a coil with an inductance of 100 $\mu\text{h.}$ and a distributed capacity of 1 $\mu\text{fd.}$ is used. To determine the point at which to mark "300 $\mu\text{fd.}$ " on the C-dial, first calculate the frequency at which 100 $\mu\text{h.}$ resonates with 300 plus 1 $\mu\text{fd.}$ This frequency, in megacycles, is given by:

$$f = \frac{159.2}{\sqrt{LC}}$$

Calibration point on C-dial in $\mu\text{fd.}$	Frequency in mc.
30	2.86
40	2.49
50	2.23
60	2.04
70	1.89
80	1.77
90	1.67
100	1.58
150	1.295
200	1.12
250	1.005
300	.918
350	.850
400	.794
450	.750
500	.711

Table 1. Data for the calibration of the "C-dial" (C_0) using a 100 $\mu\text{h.}$ coil with a distributed capacity of around 1 $\mu\text{fd.}$

with L in $\mu\text{h.}$ and C in $\mu\text{fd.}$ In this case:

$$f = \frac{159.2}{\sqrt{100 \times 301}} = .918 \text{ mc.}$$

Set this frequency up on the Frequency dial, and, with the "Function" switch on "Measure," tune the C-dial for a peak reading on the meter. This is the point at which 300 $\mu\text{fd.}$ is to be marked on the dial. A similar process must be followed to obtain as many calibration points as are desired. A suggested list of calibration points is: Every 10 $\mu\text{fd.}$ from 30 through 100, and every 50 $\mu\text{fd.}$ thereafter. Linear interpolation between these calibration points will generally be quite satisfactory. The necessary calculations, based upon the use of a 100 $\mu\text{h.}$ coil with a distributed capacity of 1 $\mu\text{fd.}$, are given in Table 1. One word of caution. Since a peak reading will be obtained every time the tuned circuit is tuned to a harmonic of the oscillator's fundamental frequency, it will generally be necessary to determine the nature of the indicated peak. This task is a simple one, though, and the methods involved should become readily apparent to the user.

After the capacity scale on the C-dial has been calibrated, the calibration points for the inductance scale may be determined entirely by calculation. At any single frequency, for every value of capacity on the C-dial the value of inductance required to resonate to the given frequency is uniquely determined. Thus, if the frequency dial is fixed at some particular

Fig. 4. Top chassis view of the completed L-C-Q Meter.

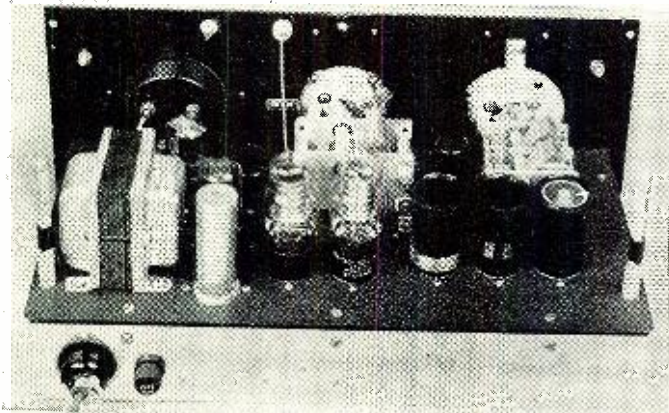
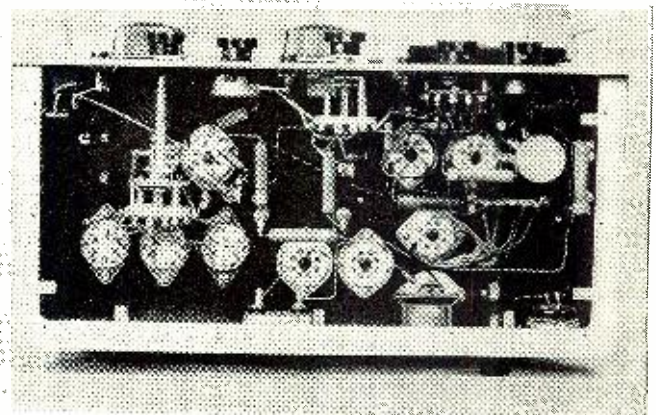

Fig. 5. Under chassis of meter showing construction.



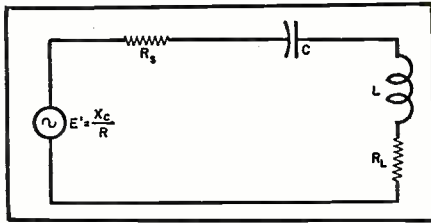

Fig. 6. The approximate equivalent series circuit of the L-C-Q measuring instrument.

Freq.	Multiplying Factor
7.13 mc.	1
2.25 mc.	10
.713 mc.	100
.225 mc.	1000 (read scale in mh.)

Data for Inductance Scale			
L in μ h.	C in μ fd.	L in μ h.	C in μ fd.
1.0	500	4	125
1.1	455	5	100
1.2	417	6	83.3
1.3	385	7	71.5
1.4	357	8	62.5
1.5	333	9	55.5
1.6	313	10	50.0
1.7	294	11	45.5
1.8	278	12	41.7
1.9	263	13	38.5
2.0	250	14	35.7
2.5	200	15	33.3
3.0	167	16	31.3
3.5	143		

Table 2. Calculations for inductance scale.

frequency, an inductance scale may be laid out on the C-dial, with each value of inductance being that value required to resonate with the corresponding C-dial capacity at the fixed frequency. For example, suppose that the fixed frequency is 7.13 mc. The value of inductance required to resonate with 500 μ fd. at 7.13 mc. is found by the expression:

$$L = \frac{25,400}{f^2 C}$$

with L in μ h., C in μ fd., and f in mc. In this case:

$$L = \frac{25,400}{(7.13)^2 (500)} = 1 \mu\text{h.}$$

which is the value of inductance that should appear in line with 500 μ fd. on the C-dial. To determine the calibration point for a given value of inductance, simply solve for C in the last equation, obtaining:

$$C = \frac{25,400}{f^2 L}$$

The calibration point for $L = 1.1 \mu$ h. would be

$$C = \frac{25,400}{(7.13)^2 (1.1)} = 455 \mu\text{fd.}$$

Although, as may be noted in Fig. 1, the original instrument was calibrated with three separate inductance scales, it is only necessary to calibrate a single scale if the operating frequencies are chosen so that multiplying factors of 1, 10, 100, etc., may be used. The recommended frequencies are 7.13 mc., 2.25 mc., .713 mc., and .225 mc., which will provide inductance scales of 1 to 16 μ h., 10 to 160 μ h., 100 μ h. to 1.6 mh., and 1 to 16 mh., respectively. Calculations for an inductance scale using these frequencies are given in Table 2. The measurement of inductance

with this instrument should be fairly straightforward. In using the calibrated scales, it is only necessary to set the frequency dial at one of the calibration frequencies, and apply the correct multiplying factor.

When it is desired to measure values of inductance below about 5 μ h., the differential method is to be preferred. Connect a pair of test leads to the "L" terminals, short them, and measure their inductance. Add the unknown inductance in series, and measure the new value of inductance. The difference between the two readings is the value of the unknown inductance. The position of the test leads should remain fixed during this process.

To measure values of capacity below 470 μ fd., first connect some inductance coil across the "L" terminals. Its value need not be known or measured. Set the C-dial on some even value of capacity—to illustrate, say 100 μ fd. Then tune the frequency dial for resonance. Connect the unknown condenser in parallel with the inductance coil, and retune to resonance by decreasing the capacity of the C-dial. If the final C-dial reading were 60 μ fd., the value of the unknown would be 40 μ fd. This method is useful in measuring the small values of tube interelectrode capacitances, stray wiring capacity, etc., since useful accuracy down to 1 μ fd. may be had.

Suppose that it is desired to measure a value of capacity that is greater than 470 μ fd., say a value near .01 μ fd., or 10,000 μ fd. Set the C-dial on some even value of capacity—for illustration, say 200 μ fd.—and connect a known value of inductance (previously measured) across the "L" terminals. Tune the Frequency dial for resonance. If the value of the inductance were 100 μ h., and the resonant frequency were 159 kc., the value of the total capacity paralleling the inductance would be:

$$C = \frac{25,400}{(159)^2 (100)} = 10,000 \mu\text{fd.}$$

Since this value includes the capacity of the C-dial, subtraction of 200 μ fd. gives the answer of 9800 μ fd. for the capacity of the unknown.

In order to make "Q" measurements, it is necessary to determine the point on the scale of the voltmeter that represents 70.7% of full-scale voltage. This should be done for one or more of the 5 ranges, preferably all, by the use of another calibrated r.f. vacuum-tube voltmeter connected to the "RF Output" jacks. Since the meter would have an extremely non-linear scale if calibrated for a.c., the .707 mark will not be too close to the linear scale reading of .707 ma.

There are two ways of making a "Q" measurement, one involving frequency variation and the other capacity variation. For the first, connect the coil whose "Q" is to be measured to the "L" terminals as usual. Set the C-dial at a relatively large value of capacity—above 400 μ fd.—and tune

the Frequency dial for the resonant peak. Note the resonant frequency f_0 . Check the zero adjustment on the voltmeter with the "RF Amplitude" control turned down, and then adjust the "RF Amplitude" control until the amplitude of the peak is exactly full-scale for whatever range is being used on the voltmeter. Vary the frequency dial until the voltmeter reading drops off to the previously determined .707 mark, and note the frequency. In a similar manner determine the frequency on the other side of the peak at which the voltage has dropped off to the .707 mark. The "Q" may be determined by the expression:

$$Q = \frac{f_0}{\Delta f}$$

where Δf is the difference between the two frequencies on either side of the resonant frequency f_0 .

The capacity variation method is very similar. The frequency dial is left fixed at the resonant frequency, and the C-dial is varied to obtain 70.7% deflection. The "Q" may then be determined by the expression:

$$Q = \frac{2C_0}{\Delta C}$$

where C_0 is the value of capacity at resonance, and ΔC is the difference between the two C-dial readings on either side of resonance.

Fig. 6 shows a series circuit that is equivalent, within close approximation, to the actual circuit shown in the functional diagram of Fig. 2. The value of the capacity C is that of the C-dial, the value of the inductance L is that of the coil connected to the L terminals, R_L is the r.f. resistance of the inductance, and the resistance R_s has a value equal to:

$$\frac{X_s^2}{R} \text{ or } \frac{L}{RC}$$

where R is 330,000 ohms, the value of resistor R_s in the circuit diagram. In order to minimize error in measuring the "Q" of a coil, it is highly desirable to keep R_s small, since the "Q" that is measured is:

$$\frac{X_L}{R_L + R_s}$$

This is the reason for setting the C-dial at 400 μ fd. or more when making the "Q" measurements described. With a small value of inductance, this may not be necessary. If the L to C ratio, with L in μ h. and C in μ fd., is kept smaller than one-third, the value of R_s will be 1 ohm or less. If it is kept smaller than one-sixth, the value of R_s will be .5 ohms or less. In order to obtain a small L to C ratio when L is large, additional capacity may be connected in parallel with the coil. If the frequency variation method is used, the value of this capacity need not be known accurately.

The difficulty in determining either ΔC or Δf accurately by reading directly from the dials of the instrument is perhaps the greatest factor tending

(Continued on page 153)

IF IT'S NEW

KEN-RAD DEALERS HAVE IT!

IN RAPID radio-TV progress, your neighborhood reflects a national trend. Receivers of brand-new design, with new circuits—*new tubes*—are being installed daily. Here is potential service business you want! With Ken-Rad tubes, you can get it—by having the new types ahead of time, in order to meet new socket requirements as they arise . . . 6CB6 is one of many Ken-Rad tubes geared to 1950 servicing needs. You'll come on this 7-pin pentode soon in both the video-i-f and r-f-amplifier stages of TV receivers. Have the 6CB6 and other new tubes *available when you need them* . . . by stocking the Ken-Rad brand! Widen your market—increase your income—by drawing profitably on the big fund of research and engineering which General Electric offers you in the form of up-to-the-minute Ken-Rad types, TV-picture, metal, glass, and miniature! Your Ken-Rad distributor will be glad to help. Phone or write him today!



A sharp-cutoff r-f-amplifier miniature pentode, Type 6CB6 differs from the 6AG5 (among existing similar tubes) by having the suppressor brought out to a separate pin connection, instead of connected internally to the cathode. This improves performance—particularly in the new 40-mc i-f applications—by enabling the TV designer to reduce inter-action effects between input and output circuits. Transconductance of the 6CB6 is higher than the 6AG5 by approximately 1,100 micromhos. Grid-plate capacitance is lower—an especially desirable feature in h-f work.

182-JA3

KEN-RAD *Radio Tubes*

PRODUCT OF GENERAL ELECTRIC COMPANY

Schenectady 5, New York



HOT THIS MONTH!

New Ken-Rad tube display and storage cabinet jumps up sales, speeds selection of tubes . . . saves space! You'll want this jimdandy accessory once you set eyes on its stunning dark blue crinkle finish, test its heavy 24-gage welded steel construction, glimpse the good-looking Ken-Rad electric sign at the top. Cabinet is 28" high, 21" wide, 8" deep. The six shelves hold over 150 tubes. Additional shelf units can be added, if desired, for still greater storage. Here's a real sales winner that comes in first every time! It's ready now! Ask your Ken-Rad tube distributor how you can get one.

NEW 1950

Heathkits

have all the Features

New 1950 Heathkit

PUSH-PULL EXTENDED RANGE 5" OSCILLOSCOPE KIT

Features

- The first truly television oscilloscope.
- Tremendous sensitivity .06 Volt RMS per inch deflection.
- Push-pull vertical and horizontal amplifiers.
- Useful frequency range to 2½ Megacycles.
- Extended sweep range 15 cycles to 70,000 cycles.
- New television type multivibrator sweep generator.
- New magnetic alloy shield included.
- Still the amazing price of \$39.50.

The new 1950 Push-Pull 5" Oscilloscope has features that seem impossible in a \$39.50 oscilloscope. Think of it—push-pull vertical and horizontal amplifiers with tremendous sensitivity only six one hundredths of a volt required for full inch of deflection. The weak impulses of television can be boosted to full size on the five inch screen. Traces you couldn't see before. Amazing frequency range clear useful response at 2½ Megacycles made possible by improved push-pull amplifiers. Only Heathkit Oscilloscopes have the frequency range required for television. New type multi-vibrator sweep generator with more than twice the frequency range. 15 cycles to 70,000 cycles will actually synchronize with 250,000 cycle signal. Dual positioning controls will move trace over any section of the screen for observation of any part. New magnetic alloy CR tube shield protects the instrument from outside fields. All the same high quality parts, cased electrostatically shielded power transformer, aluminum cabinet, all tubes and parts. New instruction manual now has complete step by step pictorials for easiest assembly. Shipping Weight 30 lbs. Order now for this winter's use.

CONVERSION FOR OTHER MODEL HEATHKIT OSCILLOSCOPES

A conversion for all 03 and 04 scopes is available changing them to the new push-pull amplifiers (does not change the sweep generator). Complete kit includes new chassis, tubes and all parts. For a small investment, add the latest improvements to your present oscilloscope (Except C.R. Tube Shield). Shipping weight 10 lbs. Order 05 Conversion Kit No. 315. **\$12.50**



\$39.50

THE NEW Heathkit

HANDITESTER KIT

MORE Features THAN EVER BEFORE

- Beautiful streamline Bakelite case.
- AC and DC ranges to 5,000 Volts.
- 1% Precision ceramic resistors.
- Convenient thumb type adjust control.
- 400 Microampere meter movement.
- Quality Bradley AC rectifier.
- Multiplying type ohms ranges.
- All the convenient ranges 10-300-1,000-5,000 Volts.
- Large quality 3" built-in meter.

The instrument for all—the ranges you need—beauty you'll enjoy for years and you can assemble it in a matter of minutes—an instrument for everyone. The handiest quality volt-ohm-meter of all. Small enough to put in your pocket yet a full 3" meter. Easy pictorial wiring diagrams eliminate all assembly problems. Uses only 1% precision ceramic divider resistors and wire wound shunts. Twelve different ranges. AC and DC ranges of 10-30-300-1,000-5,000 Volts. Ohms ranges of 0-3,000 ohms and 0-300,000 ohms. Milliampere ranges of 10MA and 100MA. Hearing aid type ohms adjust control fits conveniently under thumb for one hand adjustment. Banana type jacks for positive low resistance connections. Quality test leads included. The high quality Bradley instrument rectifier was especially chosen for linear scales on AC. The modern case was styled by Harrah Engineering for this instrument. The 400 microampere meter movement comes already mounted in the case protected from dust during assembly. An ideal classroom assembly instrument useful for a lifetime. Perfect for radio service calls, electricians, garage mechanics, students, amateurs and beginners in radio. The only quality volt-ohm-meter under \$20.00. An hour of assembly saves you one-half the cost and quality parts give you a better instrument. Order today. Shipping weight 2 lbs.



\$13.50

Note
HANDY
OHMS
ADJUST.

EXPORT DEPT.
13 East 40th St.
NEW YORK CITY (16)
CABLE: ARLAB-N.Y.

The **HEATH COMPANY**

... BENTON HARBOR 15, MICHIGAN

MORE QUALITY in

1950 Heathkits

The NEW V-4 Heathkit

VACUUM TUBE VOLTMETER KIT

Features

- Meter scale 17% longer than average 4½" meter.
- Modern streamline 200 ua meter.
- New modern streamline styling.
- Burn-out proof meter circuit.
- 24 Complete ranges.
- Isolated probe for dynamic testing.
- Most beautiful VTVM in America.
- Accessory probes (extra) extend ranges to 10,000 Volts and 100 Megacycles.
- Uses 1% precision ceramic divider resistors.
- Modern push-pull electronic voltmeter circuit.
- Electronic AC circuit. No current drawing rectifiers.
- Shatterproof plastic meter face.

The new Heathkit Model V-4 Vacuum Tube Voltmeter has dozens of improvements. A new modern streamlined 200 microampere meter has Alnico V magnet for fast, accurate readings. The new electronic AC voltmeter circuit incorporates an entire new balance control which eliminates contact potential and provides greater accuracy. New simplified switches for quicker assembly. New snap-in battery mounting is on the chassis for easy replacement.

The Heathkit VTVM is the only kit giving all the ranges. Check them — DC and AC full scale linear ranges of 0-3V, 0-10V, 0-30V, 0-100V, 0-300V, 0-1000V and can be extended to 0-3000V and 0-10,000V DC with accessory probe at slight extra cost. Electronic ohmmeter has six ranges measuring resistance accurately from .1 ohm to one billion ohms. Meter pointer can be offset to zero center for FM alignment.

The DC probe is isolated for dynamic measurements. Has db scale for making gain and other audio measurements.

The new instruction manual features pictorial diagrams and step-by-step instructions for easy assembly. The Heathkit VTVM is complete with every part — 110V transformer operated with test leads, tubes, light aluminum cabinet for portability, giant 4½" 200 microamp meter and complete instruction manual.

Order now and enjoy it this entire season. Shipping weight 8 lbs., Model V-4

Accessory: 10,000V high voltage probe, No. 310, \$4.50.
Accessory: RF crystal diode probe kit extends RF range to 100 Mc., No. 309, \$6.50.

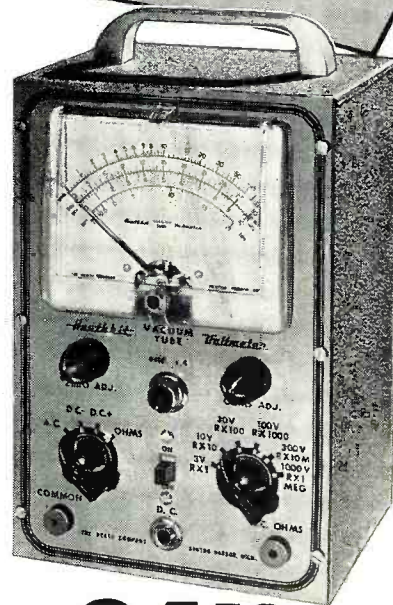

\$24⁵⁰

New 1950 VERNIER TUNING R.F. Heathkit

SIGNAL GENERATOR KIT

Features

- New 5 to 1 ratio vernier tuning for ease and accuracy.
- New external modulation switch—use it for fidelity testing.
- New precision coils for greater output.
- Cathode follower output for greatest stability.
- 400 cycle audio available for audio testing.
- Most modern type R.F. oscillator.
- Covers 150Kc. to 34Mc. on fundamentals and calibrated strong harmonics to 102 Mc.

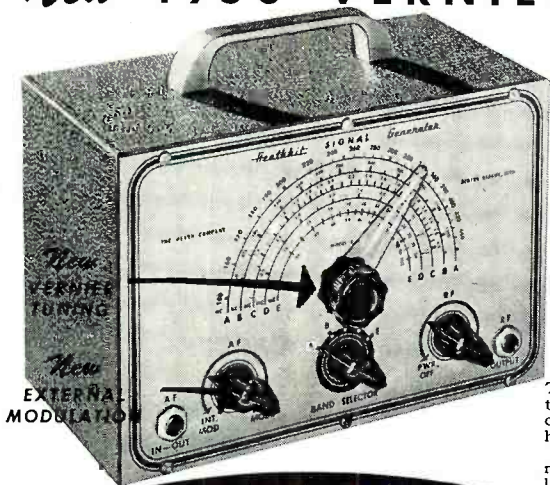

\$19⁵⁰

The most popular signal generator kit has been vastly improved—the experience of thousands combined to give you the best. Check the features in this fine generator and consider the low price \$19.50. A best buy for any shop, yet inexpensive enough for hobbyists. Everyone can have an accurate controlled source of R.F. signal voltage.

The new features double the value—think of being able to make fidelity checks on receivers by inserting a variable audio signal. Internal 400 cycle saw-tooth audio oscillator modulates R.F. signal and is available externally for audio testing. The new 5 to 1 ratio vernier drive gives hairline tuning for maximum accuracy in scale settings. The coils are already precision wound and calibrated. Uses turret type coil and switch assembly for ease of construction. The generator is 110 V. 60 cycle transformer operated and comes complete in every detail—cabinet—tubes—coils—beautiful two color calibrated panel and all small parts—new step-by-step pictorial diagrams and complete instruction manual make assembly a cinch even for novices. Why try to get along without a signal generator when you can have the best for less than a twenty dollar bill. Better order it now. Shipping weight 7 lbs. **\$19.50**

CONVERSION KIT FOR G-1 GENERATORS

Conversion kit for G-1 generators for vernier tuning and external modulation includes new high band coil for greater output. Gives all the features of new G-5 listed above. Order G-5 Conversion Kit No. 316. **\$4.50**

EXPORT DEPT.
13 East 40th St.
NEW YORK CITY (16)
CABLE: ARLAB-N.Y.

The **HEATH COMPANY**

... BE TON HARBOR 15, MICHIGAN

Beauty · Quality · Economy



Only
\$69.50

Nothing
ELSE TO BUY

New Heathkit IMPEDANCE BRIDGE KIT

A LABORATORY INSTRUMENT NOW WITHIN
THE PRICE RANGE OF ALL

Measures Inductance from 10 microhenries to 100 henries capacitance from .00001 MFD to 1000 MFD. Resistance from .01 ohms to 10 megohms. Dissipation factor from .001 to 1. "Q" from 1 to 1000.

Ideal for schools, laboratories, service shops, serious experimentors.

An impedance bridge for everyone — the most useful instrument of all, which heretofore has been out of the price range of serious experimentors and service shops. Now at the lowest price possible. All highest quality parts. General Radio main calibrated control. General Radio 1000 cycle hummer. Mallory ceramic switches with 60 degree indexing — 200 micro-amp zero center galvanometer — 1/2 of 1% ceramic non-inductive decade resistors. Professional type binding posts with standard 3/4" centers. Beautiful birch cabinet. Directly calibrated "Q" and dissipation factor scales. Ready calibrated capacity and inductance standards of Silver Mica, accurate to 1/2 of 1% and with dissipation factors of less than 30 parts in one million. Provisions on panel for external generator and detector. Measure all your unknowns the way laboratories do — with a bridge for accuracy and speed.

Internal 6 volt battery for resistance and hummer operation. Circuit utilizes Wheatstone, Hay and Maxwell circuits for different measurements. Supplied complete with every quality part — all calibrations completed and instruction manual for assembly and use. Deliveries are limited. Shipping weight, approximately 15 lbs.

Heathkit CONDENSER CHECKER KIT

\$ **9.50**



Features

- Power factor scale
- Measures resistance
- Measures leakage
- Checks paper-mica-electrolytics
- Bridge type circuit
- Magic eye indicator
- 110V. transformer operated
- All scales on panel

Checks all types of condensers, paper-mica-electrolytic-ceramic over a range of .00001 MFD. to 1000 MFD. All on readable scales that are read direct from the panel. NO CHARTS OR MULTIPLIERS NECESSARY. A condenser checker anyone can read without a college education. A leakage test and polarizing voltage for 20 to 500 volts provided. Measures power factor of electrolytics between 0% and 50%. 110V. 60 cycle transformer operated complete with rectifier and magic eye tubes, cabinet, calibrated panel, test leads and all other parts. Clear detailed instruction for assembly and use. Why guess at the quality and capacity of a condenser when you can know for less than a twenty dollar bill. Shipping weight, 7 lbs. Model C-2.

New Heathkit TELEVISION ALIGNMENT GENERATOR KIT



\$39.50

Nothing ELSE TO BUY

Everything you want in a television alignment generator. A wide band sweep generator covering all TV frequencies 0-46.54 to 100 — 174 to 220 Megacycles, a marker indicator covering 19 to 42 Megacycles, AM modulation for RF alignment — variable calibrated sweep width 0-30 Mc. — mechanical driven inductive sweep. Husky 110V. 60 cycle power transformer operated — step type output attenuator with 10,000 to 1 range — high output on all ranges — band switching for each range — vernier driven main calibrated dial with over 45 inches of calibration — vernier driven calibrated indicator marker tuning. Large grey crackle cabinet 16 1/8" x 10 3/8" x 7-3/16". Phase control for single trace adjustment. Uses three-high frequency triodes plus 5Y3 rectifier — split stator tuning condensers for greater efficiency and accuracy at high frequencies — this Heathkit is complete and adequate for every alignment need and is supplied with every part — cabinet — calibrated panel — all coils and condensers wound, calibrated and adjusted. Tubes, transformer, test leads — every part with instruction manual for assembly and use. Actually three instruments in one — TV sweep generator — TV AM generator and TV marker indicator.

EXPORT DEPT.
13 East 40th St.
NEW YORK CITY (16)
CABLE: ARLAB-N.Y.

The **HEATH COMPANY**

BENTON HARBOR 15, MICHIGAN

all in HEATHKITS...

Heathkit

TUBE CHECKER KIT

Features

- | | |
|--|--|
| 1. Measures each element individually | 5. Checks every tube element |
| 2. Has gear driven roller chart | 6. Uses latest type lever switches |
| 3. Has lever switching for speed | 7. Uses beautiful shatterproof full view meter |
| 4. Complete range of filament voltages | 8. Large size 11" x 14" x 4" complete |
| 9. Checks new 9 pin piniaures | |

Check the features and you will realize that this Heathkit has all the features you want. Speed — simplicity — beauty — protection against obsolescence. The most modern type of tester — measures each element — beautiful Bad-Good scale, high quality meter — the best of parts — rugged oversize 110V. 60 cycle power transformer — finest of Mallory switches — Centralab controls — quality wood cabinet — complete set of sockets for all type tubes including blank spare for future types — fast action gear driven roller chart uses brass gears to quickly locate and set up any type tube. Simplified switching cuts necessary time to minimum and saves valuable service time. Short and open element check. No matter what arrangement of tube elements, the Heathkit flexible switching arrangement easily handles it. Order your Heathkit Tube Checker today. See for yourself that Heath again saves you 2/3 and yet retains all the quality — this tube checker will pay for itself in a few weeks — better build it now.

Complete with detail instructions — all parts — cabinet — roller chart — ready to wire up and operate. Shipping Wt., 15 lbs.



Only
\$29.50

Nothing
ELSE TO BUY

Heathkit

SINE AND SQUARE WAVE AUDIO GENERATOR KIT



Nothing
ELSE TO BUY

\$34.50

Experimenters and servicemen working with a square wave for the first time invariably wonder why it was not introduced before. The characteristics of an amplifier can be determined in seconds compared to several hours of tedious plotting using older methods. Stage by stage, amplifier testing is as easy as signal tracing. The low distortion (less than 1%) and linear output (\pm one db.) make this Heathkit equal or superior to factory built equipment selling for three or four times its price. The circuit is the popular RC tuning circuit using a four gang variable condenser. Three ranges 20-200, 200-2,000, 2,000-20,000 cycles are provided by selector switch. Either sine or square waves instantly available at slide switch. All components are of highest quality, cased 110V. 60 cycle power transformer. Mallory F.P. filter condensers, 5 tubes, calibrated 2 color panel, grey crackle aluminum cabinet. The detailed instructions make assembly an interesting and instructive few hours. Shipping Wt., 13 lbs.

New Heathkit

BATTERY ELIMINATOR KIT

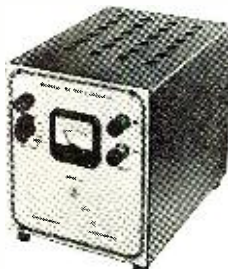

Nothing
ELSE TO BUY

\$22.50

Now a bench 6 Volt power supply kit for all auto radio testing. Supplies 5 - 7 1/2 Volts at 10 Amperes continuous or 15 Amperes intermittent. A well filtered rugged power supply uses heavy duty selenium rectifier, choke input filter with 4,000 MFD of electrolytic filter. 0 - 15 Volt meter indicates output. Output variable in eight steps. Excellent for demonstrating auto radios. Ideal for servicing — can be lowered to find sticky vibrators or stepped up to equivalent of generator overload — easily constructed in less than two hours. Complete in every respect. Shipping Wt., 18 lbs.

NEW Heathkit

SIGNAL TRACER AND UNIVERSAL TEST SPEAKER KIT



Nothing
ELSE TO BUY

\$19.50

The popular Heathkit signal tracer has now been combined with a universal test speaker at no increase in price. The same high quality tracer follows signal from antenna to speaker — locates intermittents — defective parts quicker — saves valuable service time — gives greater income per service hour. Works equally well on broadcast — FM or TV receivers. The test speaker has assortment of switching ranges to match push pull or single output impedance. Also test microphones, pickups — PA systems — comes complete — cabinet — 110V. 60 cycle power transformer — tubes, test probe, all parts and detailed instructions for assembly and use. Shipping Wt., 8 lbs.

EXPORT DEPT.
13 East 40th St.
NEW YORK CITY (16)
CABLE: ARLAB-N.Y.

The **HEATH COMPANY**

BENTON HARBOR 15, MICHIGAN

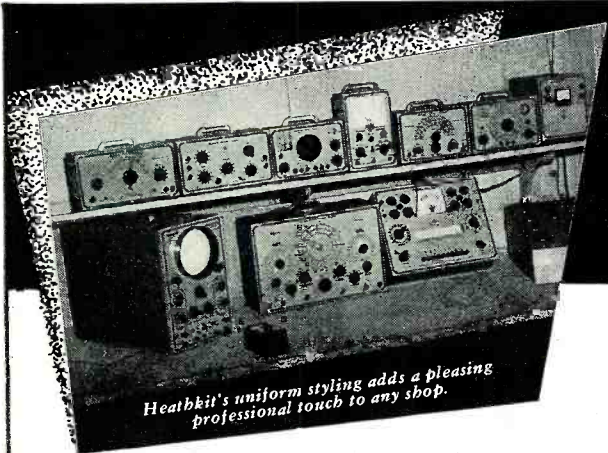

Heathkit's uniform styling adds a pleasing professional touch to any shop.

Heathkits PROVIDE PROFESSIONAL LABORATORY APPEARANCE

New Heathkit BROADCAST AND 3 BAND SUPERHETERODYNE RECEIVER KIT

BROADCAST MODEL BR-1
550 to 1600 Kc.

\$19.⁵⁰

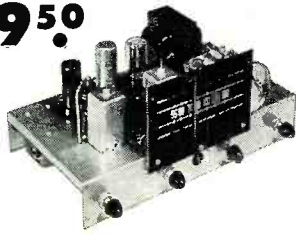

Two new Heathkit Superheterodynes featuring the best of design and material. Beautiful six inch slide rule dials — 110 V. 60 cy. AC power transformer operated—metal cased filters—quality output transformers, dual iron core metal can IF transformers — two gang tuning condenser. The chassis is provided with phono-radio switch—110 V. outlet for changer motor and phono pickup jack. Each kit is complete with all parts and detailed instruction booklet. Pictorial diagrams and step-by-step instructions make assembly quick and easy.

3 BAND MODEL AR-1
550 Kc. to 20 Mc.

\$23.⁵⁰

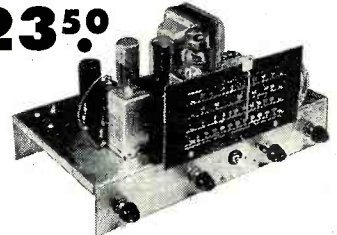

Enjoy the thrill of world wide short wave reception with this fine new AC operated Heathkit 3 band superheterodyne — amazing sensitivity 15 microvolt or better on all bands. Continuous coverage 550 Kc. to over 20 Mc. Easy to build with complete step-by-step instructions and pictorial diagram. Attractive accurately calibrated six inch slide rule dial for easy tuning. Six tubes with one dual purpose tube gives seven tube performance. Beam power output tube gives over 3 watts output.

Separately assembled coil turret with band switch eliminates difficult construction. Conservatively rated 110 V. power transformer supplies full operating voltages to all tubes for maximum reception. Has band switch, tuning, volume, tone and phono-radio controls. Chassis size 2 1/4" x 7" x 12 1/2" — supplied complete — punched chassis — tubes — controls — transformers (quality output to 3.4 ohm voice coil) — all small parts — hardware and instructions (less speaker). Shipping Wt., 10 lbs. No. AR-1 Receiver \$23.50.

- Ideal AC operated superheterodyne receiver for home use or replacement in console cabinet. Comes complete with attractive metal panel for cabinet mounting. Modern circuit uses 12K8 converter, 12SH7 input IF stage, 12C8 output IF stage and first audio 12A6 beam power output stage, 5Y3 rectifier. Excellent sensitivity for distant reception with selectivity which effectively separates adjacent stations.
- The husky 110 V. cased power transformer is conservatively rated for long life. The illuminated six inch slide rule dial is accurately calibrated for DX reception. Enjoy the pleasure of assembling your own fine home receiver. Has tone, volume, tuning and phono-radio controls. Chassis size 2 1/4" x 7" x 12 1/2" Comes complete with all parts including quality output transformer to 3.4 ohm voice coil, tubes, instruction manual, etc. (less speaker). Shipping Wt., 10 lbs. No. BR-1 Receiver \$19.50.
- No. 335 Communications Type Table Model Metal Cabinet..... \$4.50
- No. 320 High Quality 5" PM Speaker for above..... 2.75

- No. 335 Communications Type Table Model Metal Cabinet..... \$4.50
- No. 320 High Quality 5" PM Speaker for above..... 2.75

Heathkit

PUSH-PULL HIGH FIDELITY AMPLIFIER KIT



\$12.50

Build this high fidelity push-pull amplifier and save two-thirds the cost—has two pre-amplifier stages, phase inverter stage and push-pull beam power output stage. Comes complete with six tubes—quality output transformer (to 3-4 ohm voice coil) tone and volume controls—varnish impregnated cased 110V. power transformer and detailed instruction manual and all small parts. Six watt output with output flat within 1 1/2 db between 50 and 15000 cycles. Build this amplifier now and enjoy it for years. Shipping Wt. 7 lbs. Model A-4 12" PM Speaker for above..... \$6.95

ORDER BLANK

HEATH CO. BENTON HARBOR MICHIGAN N		FROM _____ _____ _____	SHIP VIA <input type="checkbox"/> Parcel Post <input type="checkbox"/> Express <input type="checkbox"/> Freight <input type="checkbox"/> Best Way
Quan.	DESCRIPTION	Price	Total

ENCLOSED FIND CHECK . . . MONEY ORDER FOR _____
PLEASE SHIP C.O.D. . . . POSTAGE ENCLOSED FOR _____ POUNDS

EXPORT DEPT.
13 East 40th St.
NEW YORK CITY (16)
CABLE: ARLAB-N.Y.

The **HEATH COMPANY**
BENTON HARBOR 15, MICHIGAN

MARS

Station of the Month

MARS AND NAVY SPONSOR DOUBLE-HEADER PROGRAM MAY 20TH

MARS and the Navy will co-sponsor a double-header program for amateurs on Armed Forces Day, May 20, 1950. The two-fold program will consist of receiving competition, similar to the old Navy-Day Copying Contest, and a QSO and message relay contest which will emphasize the handling of traffic.

The Honorable Louis A. Johnson, Secretary of Defense, will issue a special message to the amateurs. This message will be broadcast on 13 military frequencies at 25 w.p.m. as follows: May 20, 1950 at 2100 EST and at 2300 EST. NSS, Washington, D. C., will transmit on 122 kc., 4390 kc., 9425 kc., 12,630 kc. and 17,000 kc. WAR, Washington, D. C., will transmit on 3497.5 kc., 6997.5 kc., 14,405 kc., 20,994 kc., and 27,994 kc. May 20, 1950 at 2000 PST. NPG, San Francisco, will transmit on 115 kc., 9255 kc., and 12,540 kc.

Anyone who can receive and transcribe the message without error may send his transcribed copy to Headquarters MARS, Room 5 B 519, The Pentagon, Washington 25, D. C., where it will be checked for accuracy. All who submit a perfect copy will receive a special Certificate of Merit attesting to their code copying proficiency.

The QSO and message relay contest will last 12 hours and will have for its main purpose the demonstration on a national scale of the effectiveness of point-to-point or person-to-person communication by amateur radio as a back-up system for normal communications systems which might be knocked out by flood, fire, storm, ice, or sabotage. The contest will begin at 1700 GCT (1200 EST, 1100 CST, 1000 MST, and 0900 PST). Any radio amateur licensed by the FCC or by the Armed Forces of the United States is eligible to compete in the contest. All amateur bands, either fone or c.w. may be used. Single or multi-operator stations will be considered separately for purposes of scoring the contest. Contest log forms (or additional information on the Armed Forces Day program) may be obtained by writing the Headquarters MARS, Room 5 B 519, The Pentagon, Washington 25, D. C.

3PGO/W3PGO, club station at the Baltimore Signal Depot, has been named MARS Station-of-the-month by Captain E. L. Nielsen, Chief of MARS—Army. Lt. Louis Aclin, A3KIZ, is the station trustee and technical advisor to the club.

The Baltimore Depot ham club was organized in January, 1949. Members donated spare time, evenings, and weekends repairing a Depot building and in March, 1949, the club moved into its new quarters. The clubhouse now houses two BC-610 transmitters and operating consoles. A third transmitter is set up for two-meter operation.

W3PGO became a MARS member station in September, 1949, and was assigned the call A3PGO. On Janu-

ary 9, 1950, Colonel Harry E. Storms, Commanding Officer of the Depot, formally dedicated the station and Colonel Arthur Pulsifer, Signal Officer, Second Army, was on hand to welcome the Radio Club into the MARS.

Bernard Custodero, W3NYB, was the station's first ham operator. B. Harris, J. Finlayson, A. Gnacyk and J. Davis conduct regular classes in radio theory and code practice at the clubhouse. The club publishes its own newspaper with Irene Nowicki as editor.

The MARS Club has set itself a lofty goal—to encourage all employees of the Baltimore Signal Depot to learn the fundamentals of radio theory and operation and thus to be prepared to assist in emergency radio networks whenever they might be needed. —50—

The 80 meter position at A3PGO/W3PGO, club station at the Baltimore Signal Depot.



April, 1950

The big book that shows you how!



Cash in on TV SERVICING PROFITS!



PRACTICAL TELEVISION SERVICING

By J. R. Johnson and J. H. Newitt
375 pages, 6x9, over 230 illustrations
Price only \$4

Get where the big servicing money is—in television! Now is the time to prepare for this fast-growing business—and here is the book that makes the training far easier and faster than you may have thought possible! PRACTICAL TELEVISION SERVICING is a complete, down-to-earth guide that tells you step by step just what to do, what mistakes to avoid, what tools, parts, and equipment to use—in short, how to handle every phase of television receiver servicing promptly and efficiently.

MAKES TELEVISION REPAIR WORK EASY TO UNDERSTAND

This isn't a book of theory, mathematics and general discussions. The authors—one a radio editor, the other a well-known engineer—actually owned and operated a television service shop to get the specific, how-to-do-it information they now pass along to you in easily understood form. In addition to a clear explanation of how television components, construction and operation differ from radio they show exactly how to perform all specific operations in troubleshooting, diagnosing and remedying television receiver troubles. You don't bother with needless theory. You are actually shown how to do the work!

Here are the subjects covered:

- | | |
|--|---|
| 1. Television Is Here | 10. Test Equipment and Alignment |
| 2. Fundamentals of the Television System | 11. Wiring and Repair Techniques |
| 3. The Radio-frequency, Intermediate-frequency and Detector Sections | 12. Common Troubles in Television Receivers |
| 4. Video Amplifiers | 13. Troubleshooting |
| 5. Cathode Ray Tubes | 14. Servicing Hints and Case Histories |
| 6. Synchronizing and Sweep Circuits | 15. Color Television |
| 7. Power Supplies | A. Intermediate frequencies of Standard Receivers |
| 8. Antennas and Wave Propagation | B. Receiver Layout Diagrams |
| 9. Television Receiver Installation | C. Glossary |

TIME AND MONEY-SAVING TIPS

- How to test for an intermittent peaking coil or transformer
- How to get a signal over a mountain
- What to do when the linearity of the picture is poor
- How to guy a mast properly
- Checking video response with a square wave
- When to use mica capacitors in place of other types . . . and scores of other practical problems

HERE'S PROOF! "An excellent text for both the student and television serviceman for its methodical presentation of servicing techniques."—Journal of the Franklin Institute. "The section on receiver installation alone is well worth the price of the book."—Radio Electronics. "Nothing difficult to understand—it starts with fundamentals and proceeds carefully and thoroughly."—Radio News.

10-DAY MONEY-BACK GUARANTEE

Dept. RN-40, MURRAY HILL BOOKS, Inc.,
232 Madison Ave., New York 16, N. Y.

Enclosed find \$4 (\$4.50 outside U.S.A.) for a copy of PRACTICAL TELEVISION SERVICING; or send C.O.D. for this amount plus postage. In either event, if the book is not satisfactory, it is understood I may return it in 10 days and you will refund my \$4. (No C.O.D.'s outside U.S.A. Cash only—same return privilege.)

Name

Address

City, Zone, State

MOTOROLA-8 TUBE MODEL 708-T6 AUTO RADIO AT McGEE'S \$44⁹⁵ for

AUTO AERIAL REGULAR \$6.95
McGEE'S SCOOP LIST PRICE \$2.95

Top cowl or fender mounting auto aerial, 3 section. You will know the famous antenna maker when you see the antenna. A regular \$6.95 list. Stock DC-F3T, made for Tucker. Shipping weight 2 lbs. McGee's scoop price \$2.95. Offered either for your replacement stock or buy one with a Motorola auto set.

BRAND NEW MODEL 708-T6 MOTOROLAS
FITS MOST CARS AND TRUCKS
8-WATTS HIGH FIDELITY AUDIO
\$44⁹⁵

MOTOROLA SETS SOLD TO TUCKER, BUT ARE CONVENTIONAL SETS THAT MAY BE PUT IN MOST CARS

Brand new and in the original factory cartons. These 8 Tube Motorola auto sets, Model 708-T6, 8 tube superhet with tuned RF stage for best long distance reception. Push pull 6V6 audio (8 watts). Wide range audio, tone control. Compact size (9 1/2"x5 1/4"x6 3/8") fits most all cars and trucks. 6" FM speaker for dash mounting. Price does not include remote control, but does include cables and mounting hardware. You can buy any custom remote control head from a Motorola jobber. Or for \$1.95 extra, we have a universal underdash control. A limited number of custom controls are available at \$1.95 each for the following cars: 40 Ford-Mercury, 42-46-47 Hudson, 40 Plymouth (fits all other Chrysler cars), 40 Pontiac, 40-41 Nash, 41-46-47 Packard, 40-42-46 Lincoln Zephyr, 42-46 Cadillac. Motorola auto set No. 708-T6, Shipping weight 17 lbs. Net price \$44.95. Underdash control kit, \$1.95 extra.

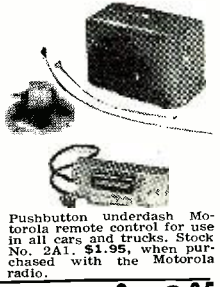

Pushbutton underdash Motorola remote control for use in all cars and trucks. Stock No. 2A1. \$1.95, when purchased with the Motorola radio.

Buy a "WEBSTER" \$187⁰⁰ LIST AMPLIFIER AT McGEE FOR \$ 2⁹⁵

★ McGEE DOES IT AGAIN ★ CARLOAD OF BRAND NEW AMPLIFIERS ★ DISTRESS PRICES
"EVERY AMPLIFIER GUARANTEED" ★ A FEW JENSEN P.M.'S—AT RIDICULOUS PRICES

SAVE ON A WEBSTER P.A.

WEBSTER MODEL 12-TN COMPLETE 12-WATT PORTABLE PUBLIC ADDRESS SYSTEM SALE \$59⁹⁵ PRICE

Complete portable public address system. Webster Racine Model 12TN-1 consists of one Model 41-12 amplifier, one carrying case, two S6025 heavy duty PM speakers and 50 feet of rubber cord with plug. All equipment is contained in the split type amplifier case. A small American crystal mike and desk stand is included. This PA system is conservatively rated for 12 wats. Input for one mike and one phono player. Ship. weight 41 lbs. Less than 50 of these portable PA systems are available at the ridiculous price of \$59.95.

20 WATT \$187.00
List Webster Model 16A20 McGee's SALE PRICE \$42⁹⁵

Webster Electric Model 16A20, conservatively rated at 20 watts. Original retail price was \$187.00. Housed in a heavy metal case, 16" long, 7" wide and 9" high. Two in-circuit pickup, 1 volt required for rated amplifier output. Two crystal pickup. Two microphones (crystal or hi Z dynamic), 1 phono input for puts for microphones (crystal or hi Z dynamic). One phono control and one dual mike volume or fader controls. One phono control and one dual tone control. Wide range frequency response, plus or minus type one control. Output transformer taps, 2-4-8-250 and 500 ohms. Electron-ray eye tube indicates rated power output when eye is closed, in order to prevent overload distortion. Complete with tubes 6SN7, 2-6L6, 3V4, 6X6 and 5Y4. Shipping weight 33 lbs. This is one of the finest public address amplifiers that we have ever seen. We have only 250 to sell, at the ridiculous price of only \$42.95. Remember this amplifier's original retail list was \$187.00. Amplifiers are new and in factory cartons. Better order now.

WEBSTER PORTABLE SPEAKERS

WAS \$156.00 LIST McGEE'S SALE PRICE \$44⁹⁵

Model DS12-50HN comprises 2-12" A12PM-54.00 list heavy duty Jensen PM speakers, housed in a split leatherette carrying case. The original retail list on these speakers and case was \$156.00. McGee's scoop price, \$44.95. Shipping weight 49 lbs. Only 50 pieces.

Webster-Jensen \$41.00 List A12-PM \$13.95
 12" Jensen PM speaker, Model A12-PM, 8 ohm voice coil. Webster Racine Stock No. S-4626. Original list price was \$41.00. Ship. wt. 19 lbs. McGee offers them to you, while stock lasts, at \$13.95 each.

10" watt permanent magnet speaker, Webster Racine Stock No. S6026, 6 ohm voice coil, Oxford. \$3.95
 Net price, each.

12" Jensen PM speaker Model PM-12C, 6 ohm voice coil. Webster Racine Stock No. S-4482. The original retail list on this speaker was \$22.95. Net \$7.95.

NEW 1950 MODEL PORTABLE TAPE RECORDER
McGEE SALE PRICE \$99⁵⁰
RESPONSE 60 TO 8000 CFS

Our brand new 1950 model portable tape recorder. A new and smaller size, leatherette covered case, size 10x13x14". Full 6" speaker. A complete self-contained unit, for recording and playback of standard magnetic tape. Top response 60 to 8,000 cps. Makes a more natural recording than any other recorder in its class. Comparable to units selling up to \$220.00. Tape speed 7 1/2 feet per second. Twin track type. Twice as much recording time as older model recorders. Makes a 30 minute recording on a 15 minute reel of tape. Input for crystal mike, phono pickup or radio tuner. External speaker jack. AC transformer amplifier. Hinged lid covers mechanism and 30 minute spool of tape. Model ELT-3. Shipping weight 29 lbs. McGee's price \$99.50. 5" reel of recording tape \$1.50 each, 10 for \$13.95. 7" reel of tape (one hour) \$2.70 each, 10 for \$24.95.

10 CONTROL HEADS \$14⁹⁵
ALL MOTOROLAS

10 assorted genuine Motorola remote control heads. New factory cartoned. We assort them from our stock, 5 each pickup and manual types. Yours will come from this selection. Automatics: D-522, D-923, D-730, D-717, D-924, D-528, D-68A, D-530 and 61NA. Manuals: D-829, D-820, 71NM, 74P-430, D-823, 61DM, 61NM, D-429, 6CCM, D-420, D-628 and 2A1. If you want to pick any particular numbers listed. Price \$1.95 each. 10 assorted, our choice, no more than one of each type. 10 for \$14.95.

15 INCH CAPEHART COAXIAL SALE PRICE \$29⁹⁵

15" Capehart Coaxial Permanent Speaker. Made by Jensen. Response from 50 to above 15,000 cps. Capehart No. JAP-60 C4690. This is a coaxial speaker of the finest quality, with a tweeter in a duty speaker for a woofer and a coaxially suspended 5" tweeter. Each speaker has a 16 ohm voice coil. Each speaker has connections for a woofer and a cross-over network. Shipping wt. 25 lbs. Stock No. JAP-60 C4690. Net Price \$29.95.

6-TUBE—3 BAND RADIO
ANOTHER McGEE SCOOP ONLY \$15⁹⁵

LIGHTED SLIDE RULE DIAL BEAUTIFUL PLASTIC CABINET FULL 2-GANG SUPERHET

Another red hot McGee special. We made a lucky purchase of 250 6 tube 3 band ac dc 3 band radios. Attractive ivory plastic cabinet with lighted slide rule dial. Receives standard broadcast, foreign short wave and police. A full 6 tube 2 gang superhet with AVC. Made by a well known radio factory. Stock No. FR-63. Ship. weight 10 lbs. Sale price, \$15.95, two for \$30.00.

CABINETS FOR S-56 HALLICRAFTERS OR WITH BLANK PANEL

Armchair radio- phono combination cabinet, ready-cut to house the S-56 Hallicrafters. 24" high x 22" x 16 1/2". Hinged lid covers record changer compartment. Will accommodate up to a 12" speaker and space for a record changer up to 14 square. Changer board is blank, you cut to fit your changer. Dial knob and mounting holes cut for S-56 Hallicrafters. Cabinet is of top quality and has furniture type finish. Shipping weight 40 lbs. Available in walnut, mahogany or blond. Walnut armchair cabinet, cut for S-56. Net price, \$29.95. Mahogany armchair cabinet, cut for S-56. Net price, \$29.95. Blond armchair cabinet, cut for S-56. Net price, \$34.95. Any of the above may also be had with blank radio panel. (Specify blank radio panel when ordering.)

6-TUBE BROADCAST SET \$11.95

A full hundred of these ivory plastic 6 tube broadcast radios available at the scoop price of \$11.95. Full 6 tube 2 gang supers with loop and lighted slide rule dial. Ship. weight 9 lbs. Stock No. FR-87. Sale price \$11.95.

MODEL JA-70 RECORD PLAYER RADIO \$14.95

with loop antenna, wired in the Farnsworth factory, a Ballentine 78 RPM phone motor, a crystal pickup for standard 78 RPM records and a walnut finish cabinet. Uses tubes 12SA7, 12SK7, 12SQ7, 50L6 and 35Z5. When you receive your radio-phonograph combination all that is necessary is about an hour's work, drill combination all that is necessary is about an hour's work, drill six small round holes and mounting the wired radio chassis, phono motor and pickup in the cabinet. On-off switch and phono switch mount on top of the cabinet. This is the nicest deal we have been able to offer for your children's radio and record player combination. Shipping weight 13 lbs. Stock No. JA-70. Net price, \$14.95. Automatic radio-phonograph combination. The same as JA-70 described above, only furnished with a 78 RPM G. E. automatic record changer. The same Farnsworth wired 3 tube broadcast chassis and walnut cabinet. Stock No. AUT-JO. Net, \$24.95

Radio-Phono Combination ON SALE AT McGEE \$14⁹⁵
ONLY 300 TO SELL RED HOT CLOSEOUT SPECIAL

McGee's red hot value of the month. For the children's or recreation room. You can have a radio-phonograph combination for less than the price of just a record player. Here is what you get for only \$14.95. A radio-phonograph 6 tube superhet broadcast chassis, a Ballentine 78 RPM phone motor, a crystal pickup for standard 78 RPM records and a walnut finish cabinet. Uses tubes 12SA7, 12SK7, 12SQ7, 50L6 and 35Z5. When you receive your radio-phonograph combination all that is necessary is about an hour's work, drill six small round holes and mounting the wired radio chassis, phono motor and pickup in the cabinet. On-off switch and phono switch mount on top of the cabinet. This is the nicest deal we have been able to offer for your children's radio and record player combination. Shipping weight 13 lbs. Stock No. JA-70. Net price, \$14.95.

S-56 HALLICRAFTERS 11-TUBE FM-AM CUSTOM CHASSIS. A \$110.00 VALUE \$59⁹⁵ AT McGEE FOR ONLY.

- WIDE RANGE • AUTOMATIC FREQUENCY CONTROL ON F.M.
- Receives 88 to 108 MC F.M. and Broadcast 550 to 1650 K.C.

Model S-56 Hallicrafters, 11 tube FM-AM radio receiver chassis for broadcast and FM 88 to 108 mc. Automatic frequency control on FM, holds the receiver in perfect control on FM, holds the receiver in perfect control on FM, holds the receiver in perfect control on FM. Full range tone control with bass boost. Push-pull 6K6 tubes in audio system. Frequency response essentially flat, from 50 to 14,000 CPS. Wide vision accurately calibrated slide rule dial with pre-selection on broadcast band. Output transformer matches any 8 ohm speaker. 4 antenna terminals, two for AM and two for FM. This is the finest type of home radio that we know of today. Better get your order in early. Designed to be used in commercial radio selling in the \$400 to \$600 class. The regular dealers' net on this chassis is \$110.00. However, a lucky purchase enables us to offer these brand new, factory cartoned S-56 Hallicrafters chassis, complete with tubes and operating instructions, at only \$59.95.

Chassis size 12 1/2"x4 1/4"x3 1/4". Weight 25 lbs. Brand new factory cartoned. Buy your S-56 with a wide range PM speaker of your choice. All from the prices listed below and save.

Pre-amplifier for S-56 \$3.95
 Dual purpose preamplifier for either S-56. Only 4 wires to connect (instructions furnished with it). This unit can convert set to operate either a G.E. variable reluctance pick-up or a crystal or dynamic mike, making your S-56 a home P.A. system. Preamp Model S8-69. Size 3 1/2"x4 3/8". Shipping weight 2 lbs. Net price, \$3.95. Crystal mike and desk stand, \$4.95 extra.

S-56 chassis with our \$62.50 list 15" coaxial (P15-S) PM speaker, on sale for \$77.95.

S-56 chassis with our \$32.50 list 12" coaxial (CU-13X) PM speaker, both for \$69.50.

S-56 chassis with our new 12" curvilinear cone (1202-X) PM speaker, both for \$67.95.

VM-406 Tri-O-Matic, 3 speed changer \$33.21.

VM-406GE, 3 speed changer with new GE RPX-050 V.R. cartridge \$36.01.

5000-\$32.50 1ST 2" COAXIAL P.M. SPEAKERS AT McGEE FOR ONLY \$9.95 each

**MODEL CU-13X
12-INCH "COAXIAL"
WIDE RANGE SPEAKER
★ NEW 1950 MODEL \$9.95
★ Regular \$32.50 List
On Sale at McGee's for**



McGee announces its new 1950 Model 12" coaxial P.M. speaker. A regular \$32.50 list speaker, but mass production enables a new low price of \$9.95. Made especially for McGee by a famous speaker manufacturer, to our own specifications. It's a new 1950 model. The sale of 10,000 coaxial speakers assures you that this speaker is a smart choice. The speaker consists of a 12" Alnico V P.M. magnet with 1" voice coil and heavy one piece ribbed cone. This responds to the lower register of the audio spectrum. The tweeter has a 6.8 ohm, Alnico V magnet with 1" voice coil and heavy one piece ribbed cone. This responds to the frequency from reaching the tweeter. The 3" tweeter has a very stiff cone and responds as simple to connect as any ordinary P.M. only two wires to connect. Input impedance is 8 ohms. Designed especially for the critical music listener with a keen ear for the higher audio register. Response is from 40 to 17,000 cps. 18 watts. This speaker is the ideal for the home music system. Generally used in only \$400 to \$800 radio installations. The high piano, cymbal and violin notes will reproduce clearly with our new 12" coaxial speaker Model CU-13X. Shipping weight 8 lbs. Net price \$9.95, 2 for \$19.00.

**MODEL P15-8
15-INCH "COAXIAL"
WIDE RANGE SPEAKER
★ NEW 1950 MODEL
★ Regular \$62.50 List \$10.95**



**On Sale at McGee's for
"IT WOOF'S AS IT TWEETS"**

This 15", 35 watt peak coaxial P.M. speaker is not surplus. It is manufactured by a leading speaker company, to our own specifications. We buy them by the hundreds in order to offer them to you at this low \$19.95 price. They are comparable to any \$62.50 list speaker on the market. The 15" woofer will reproduce down to 20 cycles. It has a 22 oz. Alnico V magnet and molded cone with 1 1/2" voice coil. The high frequency tweeter is coaxially built in, with a special cone that will produce notes up to 17,500 cycles. The input impedance of both reproducers combined, is 8 ohms. Matching network is concealed under the pot cover. Just hook this up like any other 8 ohm speaker and hear the difference. Shipping Wt. 18 lbs. Stock No. P15-8. Sale price \$19.95. Two for \$38.00.

**15" 40 WATT P.M.
20-12500 CPS
KING JUKE
MODEL 15-LS \$15.95**



A regular \$45.00 list 15" molded cone Alnico V P.M. speaker. 2 1/2 oz. Alnico V magnet, with molded cone and 1 1/2" 8 ohm voice coil. Truly a super heavy duty speaker that will take 35 watts with ease, up to a 50 watt peak. King Juke P.M. Response down to 20 cps and up to 12,000 cps. Shipping weight 4 lbs. Model 15-LS. Net price \$15.95, 2 for \$30.00.

Model 15-KR, standard Juke box P.M. 1 1/2" wide range voice coil and 12 ohm Alnico V magnet. Shipping weight 10 lbs. Net price \$9.95, 2 for \$19.00.

**12" 40 WATT P.M.
A Rugged Duty
SPEAKER \$13.95
McGee Sale Price
MODEL A-50**



Model A-50. 12" 40 watt super heavy duty permanent magnet speaker. Has 1 1/2", 8 ohm treated voice coil and one piece molded cone. Heavy half inch machined pot, with bolt secured 21 oz. Alnico V magnet. Frame is of heavy construction with metal pot cover. Finished in silver-grey enamel. This speaker is the best possible value today. Efficiency is two or three that of ordinary speaker. Especially recommended for all public address systems and high fidelity home audio systems. It is able to operate for only \$13.95. This is the latest production. Model A-50. Shipping wt. 7 lbs.

**12" WIDE RANGE P.M.
35 TO 12500 CPS
AT McGEE FOR \$9.95
MODEL 1202X
A-1950 MODEL**



Why pay more? McGee's new 1950 model 1202-X Music Lovers Reproducer. A full heavy duty 14 1/2 oz. Alnico V magnet P.M. speaker, full 1 1/2" 8 ohm voice coil. One piece molded curvilinear cone forms a trumpet for the high note distribution. An ideal speaker for high fidelity music system and P.A. work. The rugged construction of this speaker enables handling of low notes down to 35 cps; organ lows, etc. Hires us to 12,500 cps. Made for us by a famous speaker builder, to our own specifications. Lustrous grey finish, metal pot cover. Shipping weight 7 lbs. Stock No. 1202-X. Net price \$9.95, 2 for \$19.00.

**McGEE'S SUPER
High Fidelity
OUTPUT
TRANSFORMER \$6.95
20-20,000
CPS.
Best Value in
U.S.A.**



A-403-5600 ohms. Plate to Plate. Why pay \$20.00 or \$30.00 for an output? Superior quality and high fidelity output transformer. Designed to match push-pull plates (2-6L6, 2-6V6, or 2-6AQ5) class AB, to 4-8-15-250 and 500 ohm 100% feed-back winding. Housed in a compound filled case, 3 1/2" x 4 1/2" x 3". Actual net weight, 6 lbs. If you want the best quality from your audio system, order this transformer. Response essentially flat from 20 to 20,000 cycles. We have tried several high fidelity outputs in our lab and find this to be the best value. Even though your amplifier only puts out 10 or 15 watts, this 34 watt job is what you should have. Connecting instructions are furnished. Stock No. A-403. Shipping weight 8 lbs. Net price \$6.95.

**40-WATT CAPEHART
High Fidelity
Output Worth \$7.95
\$20.00**



Specially built for Capehart for this finest combination. 40 watt capacity all windings interwound to increase high frequency response and decrease capacity losses. High efficiency in coils makes for best efficiency. Inductance in coils makes for best efficiency. This high fidelity output transformer is fully shielded and has a net weight of 6 lbs. Made to match push-pull 6L6 tubes 5,000 ohm plate to plate. Has tertiary winding for 100% feed back and voice coil windings of 8 and 8 ohms. Frequency response plus or minus 2 BD from 30 to 15,000 cycles. Down 6dB below 20 cycles and above 20,000 cycles. Furnished with connecting instructions. Size: 3 1/2" x 4 1/2" x 3". Stock No. SX-55. Net price \$7.95. Stock No. SX-44. Same as SX-55 only 25 watt capacity. Same winding. Shipping weight 5 lbs. Net price \$4.95.

**30 WATT COMMERCIAL QUALITY
PUBLIC ADDRESS AMP. KIT \$19.95**



- TWO MIKE INPUTS
- READY PUNCHED CHASSIS
- UNIVERSAL OUTPUT TRANS.
- SCHEMATIC DIAGRAM AND PHOTOS

A complete kit of parts to build a factory quality 30 watt public address amplifier. Servicemen, you can wire this amplifier and have a commercial looking unit. Fun and cover are ready punched and grey splatter finished. Size 5 1/2" x 12". Inputs for two output. With tubes: 2-12AX7, 6SN7, 2-6L6 and 5U4. All small parts furnished, nothing else to buy. Printed diagram furnished. Shipping weight 25 lbs. Stock No. ZZ-30. Net price \$19.95. Why not order a mike? See our specials below.

**34-WATT MUSIC LOVERS AMP. KIT
• 20-20000 CPS WIDE RANGE RESPONSE
• ELECTRONIC BASE AND TREBLE BOOST
MATCHED PARTS— \$29.95
COMPLETE KIT.....**



It's the newest thing in audio amplifiers. McGee's wide range, 34 watt amplifier kit with inputs for crystal or dynamic mikes and any crystal phono cartridge, as well as the new G.E. variable reluctance cartridge. Output transformer is wax impregnated, weighs 6 lbs. Voice coil taps: 4-8-15-250 and 500 ohms. Push-pull 6L6 output tubes. Separate electronic base and treble boost. Inverse feedback input tube filament is DC heated to reduce hum level to nil. Frequency response from 20 to 20,000 cps. Stock No. SS-51D. Net price \$29.95. Complete with tube photos and chassis. Every part furnished, including tubes: 2-6L6, 5V4, 3-12AX7. Shipping weight 25 lbs. Stock No. XX-34. Net price \$29.95. Why not order a mike? See our specials below.

**12" PM Speaker and
Wall Baffle \$7.95**



Combination deal, 12" 12 watt Alnico V P.M. speaker and 12" plastic front baffle, both for \$7.95. Combination deal (pictured) 8" 7 oz. Alnico V P.M. speaker, duty and plastic front baffle, both for \$4.79. 8" 7 oz. Alnico V P.M. made especially for Juke Boxes. Shipping weight 3 lbs. Stock No. SE-BX speaker only \$2.95 each, 10 for \$27.50.

**ALUMINUM VOICE COIL
REPLACEMENT SPEAKERS—FACTORY PRICES**

McGee's Aluminum Voice Coil Double X Line. McGee offers you our Double X line of replacement P.M. Speakers. Made by a pioneer of the aluminum voice coil speakers. All of the Double X speakers have Alnico V magnets. All aluminum voice coils with RMA standard 3.2 ohm impedance. Why pay twice as much for a replacement speaker? McGee buys them by the carload and sells them for half price. Every speaker is unconditionally guaranteed.

Double X Aluminum Voice Coil, Alnico V Magnet, RMA 3.2 ohm V.C.

Stock No.			
4XX	4" square	1 Oz. Mag.	\$1.09 ea., 10 for \$10.00
5XX	5" round	1 Oz. Mag.	1.09 ea., 10 for 10.00
6XX	6" pincushion	1.47 Oz. Mag.	1.69 ea., 10 for 14.95
6XX2	6" pincushion	2.15 Oz. Mag.	1.95 ea., 10 for 17.95
46XX	4x6"	1 Oz. Mag.	1.49 ea., 10 for 13.95
57XX	5x7" oval	1.47 Oz. Mag.	1.95 ea., 10 for 17.95
7XX	7" pincushion (Auto set)	3.15 Oz. Mag.	2.79 ea., 10 for 24.95
8XX	8" pincushion	3.16 Oz. Mag.	2.95 ea., 10 for 27.95
69XX	6x9" oval	3.16 Oz. Mag.	2.95 ea., 10 for 27.95

Universal replacement output transformers for any push-pull or single plate 2500 to 13,000 ohms from 2 to 16 ohm voice coil. Standard size, strap mounting with long leads and lugs for voice coil connections.

U-5	5 watt universal output	.79 each, 10 for \$ 7.50
U-8	8 watt universal output	.99 each, 10 for 9.50
U-15	15 watt universal output	1.19 each, 10 for 11.00
U-20	20 watt universal output	1.49 each, 10 for 13.95
JJ-4	Single universal output. Any plate to 3.2 ohm voice coil. 4 watt, small size. 49c each, 10 for \$4.50	

**12-WATT AMP. KIT
INPUT FOR
G. E. \$9.95
PICK UP**



Kit Model TM-12. 12 watt amplifier kit. Ideal for a high quality record player, as a P.A. system or recording amplifier. Matched component parts, ready punched chassis. One control fades from phono to tone. Input compensation for G.E. variable reluctance pickup. Output matches 8 ohm voice coil. 100 ml power transformer. Complete with tube photos and diagram. 2-6V6, 2-12AX7 and rectifier. Variable tone control. Model TM-12. Weight 10 lbs. Net price \$9.95. AA-49 crystal utility mike and desk stand \$4.95 extra.

12 watt Musical, P.A. and Paging amplifier kit. A complete AC type amp kit. Portable case 8" PM speaker. 2-12AX7, 2-6AQ5, plus rectifier. Two inputs for use with mike, instrument pickup or phono pickup. Kit complete with instructions and diagram. Model MM-12RC. Weight 18 lbs. Net price \$12.95.

8" Jensen P.M.
9 watt 8 inch 6.8 ohm, alnico V magnet pm speaker made by Jensen. A red hot value. Stock No. S-8R. Net price \$2.95.

12" Aluminum V.C. P. M.
18 Watt 12 inch aluminum voice coil pm speaker with 6.8 ohm, alnico V magnet and 8 ohm voice coil. Stock No. 12-XX. Net price \$5.95.

DYNAMIC MIKE \$9.95
Our leader dynamic mike Model D-4. Our leader high impedance dynamic mike. Shipped with 12 ft. cable. Net price \$9.95 each.

McGEE RADIO COMPANY Prices F.O.B. K.C. Send 25% Deposit with Order, Balance Sent C.O.D. With Parcel Post Orders, Include Postage. **TELEPHONE VICTOR 9045. WRITE FOR FLYER 1422 GRAND AVE., KANSAS CITY, MISSOURI**

McGEE HAS
SARKES-TARZAIN 13 CHANNEL
TELEVISION FRONT END
WITH TUBES
AND DIAGRAM
A SCOOP AT ONLY
\$7.95

This popular Sarkes-Tarzain television front end is widely used today. The 13 channel rotary switch type with individually tuned coils. Price includes a schematic diagram and 3 tubes. 6C4 oas, 6BH6 RF and 6AG5 mixer. Regular factory cost is twice our price. Each tuner and its own tube sockets are wired, ready to hook up to a video and sound IF strip. May be used with either intercarrier or separate sound IF circuits. Built in fine frequency control. Ship. weight 3 lbs. Sarkes-Tarzain Type 2 TV tuner with tubes net. . . . \$7.95
 Combination deal, Sarkes-Tarzain TV tuner and 205-XX video coil kit both for . . . \$14.95
 Sarkes-Tarzain Type 3—Same as Type 2 only has input IF coil built-on. Tapped for sound IF channel. Net. . . . \$3.95

- A. Power transformer suitable for RCA 630 circuit 760 volts CT at 300 MA. 5 volts 3 amps, 5 volts 3 amps, and 0.3 volts 8 amps. Jefferson built. Shipping weight 12 lbs. Stock No. MB-4F. Net price. . . . \$5.95
- B. Deflection Yoke 201 for 12 or 19 inch picture tube. Net price \$2.95 ea.
- C. Focus Coil 202D1. 247 ohms DC resistance, for 10" or 12" picture tube. Scoop price . . . \$1.95 each
- D. Vertical deflection output transformer 204T2 for 10, 12 or 16" picture tube. Net price . . . \$1.95 each
- E. Vertical oscillator transformer 208T2, for 10, 12 or 16" picture tube. Net price . . . \$1.50 each
- F. Horizontal scanning output transformer (Hyback) supplies H.V. to picture tube. Has rect. filament winding for 10 or 12" picture tube. Also, feeds horizontal scanning coil of deflection yoke. Net price . . . \$3.49

REGENCY T.V. BOOSTER \$17.61
 Regency Model DB-213 all channel Television Booster. Tuned grid, tuned plate with 8½ triodes, two boosters can be hooked in series without circuit instability. Size 3¼ x 3¼ x 4". Shipping wt. 3 lbs. Anchor \$22.05
 Anchor Model ARC-101-50 Television Booster. Research organizations accept this as a number one booster. Tuned plate, tuned grid circuit. All tubes. Net price \$2.95 x 4. Shipping wt. 6 lbs. Net \$22.05.
 Astatic \$29.10
 Astatic Model AT-1, "Channel Chier" Television Booster. Two tuned circuits and two broad channels on all channels. Higher gain, equivalent to two ordinary boosters. Dual controls tune speed. Net price \$2.95 x 4. Size 8½ x 6½ x 7¼". Shipping wt. 6 lbs. Net price \$29.10.
Regular \$25.00 Television Magnifier SALE PRICE \$7.95

Stock No. HA-22 FOR 7-10-12 INCH TUBES
 Stock No. HA-22 12 x 17 in. television magnifier. Made of crystal, mica and oil-filled. Magnifies your present 7-, 10-, or 12-inch television picture up to four times. We offer you these new factory cartoned magnifiers, you provide your own means of mounting to your set. Edge of magnifier may be drilled and hung on your set with wood. This lens is a \$25.00 value, but McGee offers them to you for only \$7.95. Shipped by express only. Ship. wt. 22 lbs.

RECORD PLAYER \$9.95 KIT
 Complete record player kit, for 78 RPM records. All parts, tubes and diagram building a 70L7 type amplifier. Attractive ready cut walnut base (speaker cut out on top). Beautifully finished and Astatic pickup with permanent needle. Shipping weight 10 lbs. Model No. MD-78. Net price \$9.95.
 Three-speed model No. D-3378, same as above only has 2 speed motor and Webster flip-over pickup and twin needles. Net price \$14.95.

PHONO MOTORS
 Heavy duty 78 RPM phono motor with weighted recording type turntable. Stock No. RM-4. Scoop price, \$5.95.
 Ballentine 78 RPM best quality phono motor with turntable. Net price, \$2.95 each.
 3 speed phono motor with turntable. Net price, \$5.49.

VM-406 Tri-O-Matic 3-Speed Changer \$33.21
 The new VM model 406 Tri-O-Matic automatically plays all record sizes, and speeds now on the market. Protective features: records are lowered, not dropped, no wobbling down the spindle, no slip or scrape, no possibility of the tiny grooves on the new type records being being damaged. Plays 12, 10, 33 1/3, or 78 RPM records of the same type intermixed, 12 7" 33 1/3 RPM and 12 7" 45 RPM records. Automatically shuts off on the last record, base size 13 13/16 x 12 1/4". 7 1/4" high overall. Equipped with flipover crystal cartridge and needles. Model 406GE. Shipping weight 12 lbs. Net price \$33.21. New 1950 Model VM-406 with All-in-one General Electric Variable Reluctance Cartridge and Twin Needles. Model 406GE. Specify VM406-GE. Add \$2.85 to above cost.

Television all band conical antenna, as pictured with 8 foot mast and mounting hardware. You furnish your own 300 ohm lead. Stock No. RT-44LL. Net price \$6.75
 Conical elements only, same as above antenna, but less mast. Stock No. SK-22. Net price \$4.69. Stacking bars 90c per pair. Order one each of the above for a stackable conical TV antenna. Stock No. RB-T1 Rabbit Ear or V antenna for the top of your TV set. Has heavy weighted base. Best quality. Net price, \$2.29.

DETROLA—SCOOP COILS, GANG, DIAL, PAN \$2.95

Genuine Detrola Chassis pan with 6 octal sockets. Heavy glass slide rule dial, 3 Gang Tuning condenser. All RF and IF coils and band switch for standard broadcast and foreign short wave. Buy these parts for less than the coil value alone. These parts all fit the chassis properly. Only material pictured and listed above is offered. It is not a complete kit. You supply your own tubes, speaker, resistors, condensers, etc. Stock No. DET-1. Shipping weight 9 lbs. Net \$2.95.

3-SPEED AUTOMATIC PLAYER KIT \$39.95
 Walnut cabinet, automatic 3 speed record player kit. Attractive cabinet with hidden lid. Two tube amplifier kit of parts including diagram, tubes and Alico V PM speaker. Latest 3 speed automatic changer that intermixes records of the same speed. 33 1/3, 78 and 45 RPM changer Model VM-406, with twin needles. Record pickup easy to assemble kit with instructions. Shipping weight 20 lbs. Stock No. LL-374. Net price \$39.95.
 Model LL-23 same as above only with 78 RPM changer, \$24.95.
 We have a few walnut record player cabinets only, to offer by themselves, for the builders. Changer area is 12 1/2 x 16 x 5 1/2", cut for 5" speaker. Stock No. BJC-1, weight 10 lbs. Net price \$6.95.

PHONO NEEDLES
 DUOTONE 99 Sapphires, 59c ea.; 10/\$4.95
 DUOTONE Ruby with Record Brush. . . . \$2.95
 DUOTONE NYLON, very popular. . . . \$1.25
 DECCA-CHEEP BRASS NEEDLES, 50 for \$3c

Copehart Automatic Record Changer SCOOP \$6.95
 While our stock lasts we offer these Copehart changers for only \$6.95 each. Plays 10-12" or 12-10" records automatically. These changers are in good condition but have been removed from sets to make way for 3 speed changers. They need adjusting, however, you service men with a little ingenuity can put them to profitable use. These changers are equipped with True Timber Variable Resistance Cartridge with permanent needle. (Requires same gain as G.E. Variable Reluctance. Connecting instructions furnished. Base size 4 1/4 x 1 1/4". Shipping weight 23 lbs. Extra pickup arm with Standard Crystal Cartridge \$1.00 extra. Stock No. 71-WL. Net \$6.95 each. 2 for \$12.95.

TELEVISION VIDEO COIL KIT
20 MATCHED COILS FOR
SEPARATE PICTURE & SOUND I.F.
A RED HOT SCOOP AT
STOCK #205-XX \$7.95

★ BUY SARKES-TARZAIN FRONT END and COIL KIT for \$14.95
 20 matched TV coils; video and sound I.F. McGee Scoop price \$7.95. Television video coil kit, for TV sets up to 16", using separate sound and picture circuits. Consists of 20 coils for use in the nationally famous 30 tube and 22 tube TV circuit. All coils are of the finest construction, furnished to you, just like they go to a TV set maker. Each coil is identified. These are not made by RCA, but by a top quality coil company, especially for McGee. If you are going to use the RCA circuit, you can use this set of coils.
 Coil kit has 1-180 uh, 1-250 uh, 2-120 uh, 2-93 uh peaking coils, 4 picture IF coils for 25.75 mc, 1 cathode trap, 2 sound IF's 21.25 mc, 1 discriminator, 1 converter and 5 filament chokes. Stock No. 205-XX, shipping weight 3 lbs. McGee's sale price \$7.95. These coils match the Sarkes-Tarzain TV front end listed at left. Why not order both the tuner and the coils?

10" T.V. CABINET \$5.95
 Buy this 10" streamlined mahogany television cabinet at less than the manufacturers cost. Originally intended for use in the Farnsworth factory. Top quality and good looking. Size 13 x 19 x 11 high. Shipping weight 33 lbs. Stock No. RY-10. Net price \$5.95.
 Buy both the RY-10 cabinet and partially wired GVZ-60 television chassis. Plenty of usable resistors and condensers. Chassis is made for cabinet. Both cabinet and chassis for \$7.95.
 1948 Supreme TV manual has GVZ-60 diagram and many others \$3.00 extra.

15-INCH NATIONALLY ADV. T.V. CHASSIS \$149.95
COMPLETE WITH PICTURE TUBE
FULL DESCRIPTION ON REQUEST

A complete television receiver chassis made by a manufacturer whose name you will recognize. Not a kit, but a 15" TV set with all tubes, 8" speaker and 15DP4 picture tube. Has 19 tubes, plus three rectifiers. Supplied with wood frame for wall or cabinet mounting. Size 19 1/2 x 23" wide and 21 1/4" deep. Price was \$259.00. Now at McGee for \$149.95. Stock No. 520E. Shipping weight 80 lbs. Complete technical information and manufacturers name furnished on request.

TOP QUALITY RADIO KITS COST LESS AT McGEE
RED HOT VALUES IN COMPLETE RADIO KITS
6 TUBE AC SUPERHET KIT
BROADCAST AND SHORTWAVE
MATCHED PARTS \$9.95

A complete kit of parts, tubes and ready punched chassis to build a fine 6 tube, 2 band AC power transformer type radio chassis. (No cabinet.) We furnish all pieces that come on when lid opens. Bugged, 1877 MC shortwave, 3 gang tuning condenser used on both bands, 90 mill power transformer and GY6 output tube. The chassis, dial mechanism and coils used in this kit were manufactured for use in a high quality Detrola radio. The heavy plate glass dial has etched-in numerals and this is a complete radio transformer is furnished but the speaker is not. Use any standard PM speaker. Stock No. 6-ACX5. Net price \$9.95.
 10" Heavy duty PM speaker, \$3.95 extra.
 8" Heavy duty PM speaker, \$2.95 extra.
 12" Heavy duty PM speaker, 4.95 extra.

GAROD PERSONAL PORTABLE KIT
 Complete Garod personal portable kit, Model X-45. Made from genuine Garod factory-matched parts. A complete kit to build a broadcast battery-operated 4-tube receiver. Small in size, 6 1/2 x 3 1/4 x 4 1/2". Weight 3 1/2 lbs. 2-gang superhet circuit. Net comes on when lid opens. Bugged metal case with colored plastic front and back. Loop antenna in lid. Furnished with diagram, photos and tubes. 67 1/2 volt B battery and flashlight cell, \$1.65 extra. Will go together like a factory-built radio. Shipping weight 6 lbs. Model X-45. Net price, \$9.95.
 Model X-45WT portable radio is X-45 wired ready to operate. Net, \$14.95.

NEW 1950 MODEL 5-TUBE SUPERHET RADIO KIT MODEL \$9.95 NS-5
 McGee's new 1950 Model 5 tube AC-DC superheterodyne radio kit. Has loop antenna and 2 gang condenser, with lighted slide rule dial and attractive plastic cabinet. Receives broadcast, 550 to 1650 kc. Full size dynamic speaker, matched 5E6, 2BA8, 12AT6, 6X4, 6AR5, 6BD6, 6BE6, 12AF6, 60B5 and 35W4. Shipping weight 7 lbs. Stock No. NS-5. Net price, \$9.95.

BUILD YOUR OWN MINIATURE RADIO STATION KIT MODEL DE-6X \$6.95

Kit Model DE-6X. With this simple kit you can build your own radio station in miniature. Has 4 tubes. Broadcast on frequency from 800 to 1500 KC. from either a crystal microphone or phonograph record. (This transmitter will transmit about 170 feet, with the short antenna lead furnished.) One control fades from mike to record. Price includes parts, diagram, instructions, photo and tubes. Everyone will enjoy your miniature broadcast station. Kit Model DE-6X. Shipping weight 4 lbs. Net price, \$6.95.
 Model DE-6XWT, miniature transmitter, wired and tested. Net price, \$8.95.
 Crystal mike and desk stand, pictured with transmitter, \$4.95 extra.
 Dynamic mike, same as above, \$3.95 extra.
 Stock No. T-001 small aluminum cased crystal mike, response 40 to 9000 CPS. About the size of an overcoat button. Furnished less cable. Just solder on connections for concealed use, \$3.95 extra.

Our Leader Changer Scoop \$11.95, 2 for \$22.95
 Our leader, automatic changer scoop. Base size 13 x 13". Plays 10 1/2" or 12 1/2" 78 RPM records automatically. Has 12L7 L-70 cartridge. Priced complete with a metal base, which can be used in slide away compartment or as a table top base, or changer can be lifted off base to fit your needs. Stock No. AD-12. Shipping weight 17 lbs. Scoop price, \$11.95 each; 2 for \$22.95.

6-110V. POWER SUPPLY KIT \$14.95
 New utility power supply kit, works on either a 6 volt storage battery or 110 volts AC. Furnishes Power for a 25 watt amplifier (135 mls B at 300 volts) and will run a turntable (110 volts AC at 25 watts) from a storage battery. Kit 6-110 K complete with diagram, \$14.95. 6-110 volt 60 cycle vibrator only \$1.98. Thermador 6-110 power transformer, \$5.95.

YAZ MOTOR

Barber-Colman Company of Rockford, Illinois, is currently offering a reversible geared head motor with a high starting torque and electrodynamic braking for rapid stopping for antenna positioning and remote tuning in the amateur as well as commercial fields.

The "Barcol YAZ" has a shaded-pole induction-type motor without brushes. Vibration is minimized by an accurately balanced rotor mounted on a finely ground stainless steel shaft. Backlash and noise are minimized by speed reductions through hardened machine cut gears.

For applications requiring high output, capacitors or high impedance

What's New in Radio

For additional information on any of the items described herein, readers are asked to write direct to the manufacturer. By mentioning RADIO & TELEVISION NEWS, the page, and the issue number, delay will be avoided.

reductions from 20:1 to 360:1. Closed types can be supplied with reductions from 7.2:1 to 1,333,800:1.

NEEDLE CLIP

The Mueller Electric Co., 1583 East 31st Street, Cleveland, Ohio, is currently introducing a new, solid bronze needle clip for making quick electric contact by piercing the insulation of wires.

The new clip is particularly useful in electrical and radio test work because the sharp needle in one jaw will make quick contact through the insulation, thus eliminating the necessity for disconnecting the wire to make a test.

The clip is made of non-corrosive bronze and is equipped with brass screw connection.

MAGNETIC RECORDER

A high-fidelity magnetic tape recorder, designed for custom installation in studios, schools, homes, and industrial plants, has been announced

by *Berlant Associates*, 9215 Venice Blvd., Los Angeles 34, California.

Designated the "Concertone," the new unit features instantaneous monitoring from the tape while recording; separate heads for high frequency erase, record, and playback; forward and reverse high speed rewind; three dynamically balanced motors; record level indicator; instantaneous choice of 7½ or 15 inches per second tape speed; independent azimuth adjustment for each head; and operation with either 7 inch or NAB 10½ inch reels.

The Basic Recorder No. 401 can be easily converted for either console or portable use.

NEW PICKUP ARM

Pickering & Company of Oceanside, New York, has announced a new pickup arm, the Model 190, which has been designed to overcome the disadvantages inherent in conventional arms and permit a high quality cartridge to meet the stringent require-

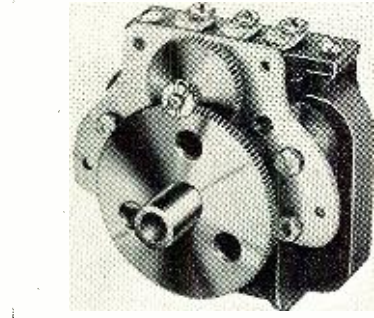

shading coils can be controlled by electronic circuits.

The company's open-type geared head motors are available with speed

VALUES LIKE THIS AT McGEE—10-1950 PRODUCTION 4 PRONG VIB. FOR \$8.95

MOLDED PLASTIC CAPACITORS
★ LATEST 1950 PRODUCTION ★
Scoop prices on .85 degree Hi-Temp, molded plastic tubular condensers. All 600 volt. Order 100 and take 10% off. We guarantee your satisfaction. Specify McGee XX quality plastic hysenses when ordering. .001, .002, .005 10c each; .01 11c each; .02 12c each; .05 14c each; .1 16c each. 1600 degree 1600 volt plastic buffers. .005, .0075 and .01 19c each.

1950 PRODUCTION 600 VOLT TUBULARS
Top quality 600 volt paper tubular condensers. Wax dipped for all radio replacement use. McGee's type PP. The best for less. .001, .002, .005, .01, .02, 6c each; .05, 7c each; .1, 8c each.
Type PP 1600 volt buffers. Same quality as used by set manufacturers. .005, .008, .01, 12c each.
Order 100 Type PP assorted and take 10% off.

SCOOP PRICES ON ELECTROLYTICS

MN-8.	8 mfd 450 volt.....	29c
MN-16.	16 mfd 450 volt.....	39c
MN-20.	20 mfd 150 volt.....	29c
MN-40.	40 mfd 150 volt.....	39c
MN-220.	20-20 mfd 150v.....	39c
MN-53.	50-30 mfd 150v.....	49c

Save on these. One year guarantee. All single condensers are in sealed metal tubes with paper insulating sleeves. Dual banks in cardboard tubes with long flexible leads. Not surplus, but the best. All 1950 production. You must be satisfied.

Standard brand tubes. Locals, etc. 69c ea.

1LN5	1N5	31F4	1T5
1LG5	1G4	1A5	117Z6
1N5	1LA5	1C5	35A5
10A5	6SN7	50A5	
1LD5	1N5	6SL7	11L65
1LG5	3B5	1A4	

Hy-Vac 6J6, 6AK5, 49c
Hy-Vac 6BG6, 69c
Standard Brand. Every day numbers—12A7GT, 12A7GT, 35L6GT, 50L6GT, 59c.

25 WATT 12 INCH P.M. \$5.95

Rege duty public ad, dress replacement. 25 watt consolidated speaker. 32 ohm. Alnico 3 voice magnet. 8 ohm voice coil. Molded cone. A regular \$17.00 list speaker. Shipping weight 3 lbs. Stock No. CN-1232. McGee's scoop price \$5.95 each, 4 for \$24.00.
Magnavox 12" 20 ohm. Alnico 3 magnet. PM 8 ohm voice coil. \$4.95 each, 10 for \$27.50.
Magnavox 8" 20 ohm. Alnico 3 magnet. PM 8 ohm voice coil. \$2.95 each, 10 for \$27.50.

McGEE DOES IT AGAIN, 15,000 BEST QUALITY VIB. REPLACEMENT FOR MOTOROLA, ETC. 99c EACH 10 FOR \$8.95

Made by a vibrator maker who knows how. Standard 4 prong 6 volt non-symm. Short enough for Mopar sets. Perfect for Motorola. A value guaranteed to please you. Stock No. VK-42. Scoop price 99c each, 10 for \$8.95, 25 for \$21.25, 100 for \$80.00.

GUARANTEED—CARTONED—HYVAC 39c
McGee carries a tremendous inventory of individually cartoned and branded Hy-Vac tubes. These are made by a nationally known tube manufacturer. These tubes are available at this low price because they do not fall within the rigid testing limits of this factory. However, every tube is guaranteed by us. 39c each.

184	5Y4	6BA7	6K5	6SN7	12A7	12SA7
1R5	6AC5	6BE6	6K7	6SNT	12AUG	12SF7
1S5	6AG5	6BF6	6P5	6S57	12AU7	50B5
1T4	6AL5	6BH6	6SR	6SU7	12AX7	50C5
1U4	6AD5	6B16	6SA7	6V6	12BA6	70L7
2A4	6AQ6	6C4	6SD7	6W4	12BE6	19T8
3Q4	6AT6	6C5	6SF5	6X4	12BF6	9001
4X4	6A9	6F5	6SL7	6X5	12B7	9002
3V4	6AU7	6CS	6SK7	12A8	12K8	35C5
5Y3	6BA6	6K6	6SL7	12A6	12S8	35W4

STANDARD BRAND RADIO TUBES 49c
Standard brand radio tubes. Some are cartoned individually, some are not. We acquired these tubes from manufacturers over-run, radio receiver over-stock, JAN, etc. We cannot give you a choice of brands, but we will give you a good quality standard brand tube. Every tube guaranteed. 49c each.

024	1G4	3S4	6D6	6L7	6SK7	7A5	7E7	12A6	12Q7	1447	30	4525	50Y6
1A4	1H6	5T4	6D8	6N7	6SL7	7A6	7E7	12A8	12SC7	14B6	32	50B5	41
1A6	1H6	5V4	6F5	6R7	6SQ7	7A7	7H7	12AH7	12SF5	14C7	33	56	35B5
1A8	1J6	5Y3	6F7	6S7	6SR7	7B4	7L7	12AT6	12SF7	14H7	34	57	3Q4
185	1L4	6A3	6H6	6SA7	6S7	7B5	7W7	12B5	12SG7	14Q7	35	58	14A4
106	1R5	6AB7	6J5	6SC7	6T7	7B6	7Q7	12BE6	12SH7	14R7	35W4	70	12J7
107	1S5	6AC7	6J7	6SD7	6V6	7B8	7E7	12BD6	12SJ7	19	35V4	75	6AT6
105	1T4	6AG7	6K5	6SF5	6X5	7C4	7S7	12C8	12SL7	25L6	35Z4	76	6BA6
107	1V	6B8	6K6	6SF7	6V6	7C5	7V7	12F5	12SN7	25Z5	35Z5	77	
1D8	2A5	6C4	6K7	6SG7	6T7	7C6	7Y4	12H6	12SQ7	25Z6	38	78	
1F4	2A6	6C5	6K8	6SH7	6Z5	7C7	7Z4	12J5	12SR7	26	39	80	
1F5	2A7	6C6	6L5	6S17	7A4	7E5	10Y	12K8	12Z3	26	43	6BE6	

BOES MODEL 103 REG. \$7.77 SIGNAL TRACER PROBE WHILE OUR STOCK LASTS \$2.95
Boes signal tracer probe, with instructions. Made to sell to you for \$7.77. McGee's sale price only \$2.95. You get this: a heavy bakelite probe containing a 6F5GT tube. (The end of the probe is secured by three screws and may be taken apart easily.) A 5 foot lead with 3 circuit amphenol plugs and receptacle and Mueller peewee clip. You can connect this probe to any AC amplifier and have a signal tracer or you may buy this just for the parts to build a HV multiplier or HF probe for VFM use. Usable inside space for building purposes is 1 1/4 x 4". Overall length is 5". Price includes 6F5GT tube. A red hot special. Stock No. 103. Shipping weight 1 lb. Net. \$2.95; 2 for \$4.95.

SCOOP ON CARTRIDGES
Astatic N1-J Nylon 1 volt output cartridge with needle. Response to 8,000 cps. Net. \$2.79.
MLP-1 Astatic cart. with needle. Net. \$1.19.
Astatic 1-72 or Webster equal, 3 volt output. Net. \$1.79.
Astatic 1-70 or Webster equal, 1 volt output. Net. \$1.79.
Flip-over cartridge with twin needles. Net. \$2.98. Take 10% off in lots of 10.

G.E. RPX010 V.R. CART. \$2.95
G.E. RPX010, with permanent needle, \$2.95 each; 10 for \$24.95.
Kit of parts to build 12AX7 type preamplifier. \$2.49 extra. A lucky purchase by us enables this terrific General Electric cartridge value.

12AX7 type preamplifier. \$2.49 extra.
GE-RPX-040, new removable needle, 3 mill microgroove cartridge. Net. \$5.85.
GE-RPX-050, new all in one variable reluctance cartridge, triple play, as currently advertised. Net. \$8.20.
Kit of parts, including 12AX7 to build a VR preamp. Power for same to be picked up from your radio or amp. \$2.49 extra.

Utiliphone Speaker Intercom Multiplier
Utiliphone Model 3020 Multiplier and two sub-speakers. A pair of P.M. speakers housed in attractive grey wrinkle metal cases, size 4 x 4 1/4 x 5 1/4", with one detachable multiplier base and 4 position selector switch. 2 50-foot coils of a conductor interconnecting wire. Use the speaker to expand any single station intercom to a 4 station job. This is not a complete intercom, just 2 speakers and detachable switch.
Stock No. 3020. Shipping weight 7 lbs. Sale price, \$6.95.
McGrade Intercoms. Plastic case. Master and one sub. Stock No. M1-2. Net. \$11.95. Buy a M1-2 and 3020 Multiplier. Makes a 4 station intercom. Both for \$17.00.

McGEE RADIO COMPANY Prices F.O.B. N.C. Send 25¢ Deposit with Order. Balance Sent C.O.D. With Parcel Post Orders, Include Postage. **TELEPHONE VICTOR 9045. WRITE FOR FLYER 1422 GRAND AVE., KANSAS CITY, MISSOURI**

SOUND POWERED HANDSETS

\$12⁹⁵

PER PAIR

Complete with
6-Foot Cord



Famous Navy Units

**Operates without batteries!
No electricity needed!
Practically no installation
— just hook up with a pair of wires.**

PRACTICAL USES EVERYWHERE— Ideal for

Television antenna adjustment
Kitchen to garage
House to barn, workshop or field



Boats
Camps
Construction jobs
Office intercommunication

HUNDREDS OF OTHER USES!

PRICE ONLY \$12⁹⁵
per pair

25% with order — balance c.o.d.
plus postage. Remit in full and
save postage and c.o.d. charges.

WESTERN ELECTRONIC CO.

2793 SHATTUCK AVE., BERKELEY 5, CALIFORNIA

PHONE BERKELEY 7-7038

ments for playing LP records without distortion.

Features of this new arm include a low vertical-to-lateral moment of inertia, a minimized vertical mass in

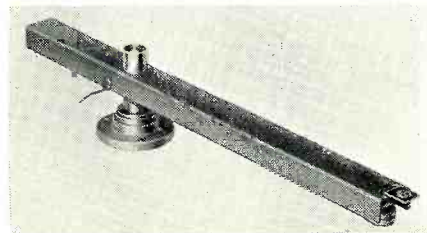

order to track any record without imposing extra vertical load on grooves, absence of spurious arm resonance at any frequency, lower than 3 gram centimeters pivot friction, static balancing about the vertical axis to eliminate tendency to jump grooves when subjected to bumping or jarring, an offset head to reduce tracking error to less than $\pm 2\frac{1}{2}$ degrees, and protection of the stylus point against contact with anything but the record grooves.

PORTABLE SCOPE

Another portable model oscilloscope has been added to the *Waterman Products Company, Inc.*, line of test equipment.

The new Model S-14-A Pocketscope is especially engineered to meet the requirements of the electronic designer. Weighing only 12½ pounds, its 12" x 5¼" x 7" dimensions permit easy handling for bench work as well as portable needs.

Characteristics include identical vertical and horizontal channels with 10 mv./in. sensitivity, response from 0 to 200 kc. within ± 2 db., non-frequency discriminating attenuators and gain controls, internal calibration of trace amplitude, linear time base oscillators with \pm sync for either repetitive or trigger sweeps, for ½ cycle to 50 kc., trace expansion, filter screen, and a Mumetal shield.

KNIGHT RECORDER

A new low-priced magnetic tape recorder has been released by *Allied Radio Corporation* of 833 W. Jackson Blvd., Chicago, under the "Knight" tradename.

Light and compact, the new unit in-

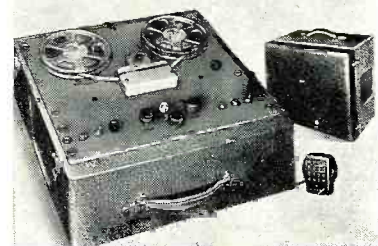

corporates the latest engineering features for ease of operation, including simplified tape threading which eliminates fumbling, and only one control for the tape transport mechanism.

(Continued on page 130)

RADIO & TELEVISION NEWS

WE'RE BEING SWAMPED!



*Dealer Inquiries Invited

WITH ORDERS FOR THE NEW NIAGARA HI-PASS FILTER KIT. You don't have to be plagued with TV Interference. We guarantee positive protection against amateur, diathermy, industrial and all other R.F. interference. No loss in brightness or clarity. Money back if it does not work. Designed for 300 ohm antenna feedline.

*Cat. No. N-281—We can supply every one at the **\$1.95** plus 15c shpg. in U. S. A. fabulously low price of.....

BARGAINS IN SOUND POWERED PHONES

Talk up to 10 miles without batteries. Ample volume. May be paralleled. Two types—both complete with cord and plug. Type "O" Chest set mike with headset phones. RCA #MI-2475. Our Cat. No. N-299. Special

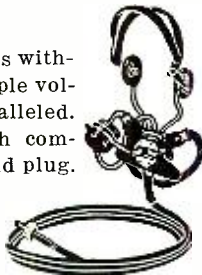

\$4.95 each



Type "Q" Headset with "Swing-Away" Mike attached. RCA #2454. Our Cat. No. N-300. Special ...

\$9.95 each

T-24 CARBON HAND MIKE

A rugged mike with push-to-talk switch, ideally suited for mobile or marine use. Features—7 ft. flexible rubber cord, PL-106, anti-noise choke and JK-38 jack into which two other mikes may be plugged, making a 3-way parallel talking circuit. Cat. No. N-278. Very special



\$1.00 ea. Postpaid in U.S.A.

BT CUT 1000 KC. CRYSTAL

Fine precision crystal originally used in frequency standard. Low drift, moisture sealed. BT cut. Brand new in 3/4" pin spaced holders. Cat. No. N-189. YOUR COST

\$4.95

MORE BARGAINS IN SURPLUS EQUIPMENT

1—2 or 3 of each • Check every line!

Wilcox CW-3-110V Superhet Rcvr. New	\$ 75.00
Antenna Rotating Motor—RL—42A Reel Exc.	2.95
W.E. XMTR. MOD. Comp. w/controls spares—New	225.00
MN 26C Radio Compass—New	32.00
MN26C Radio Compass—Used	26.95
734D Localized Receiver Exc.	6.95
AN-APN-1 Altimeter—L.N.	18.95
274N Modulator BC456A w/tubes Exc.	2.65
274N Modulator BC456A Fair less tubes	1.49
SCR522 XMTR-BC625 Exc. less tubes	11.95
BC 1000A Transceiver New	300.00
BC 645 Transceiver, Contr. Box, Dyn. Instruction book, New	17.95
T-17 Handmike 200 Ohm Imp. Exc. 69c, 3 for	1.95
PE 94 24V. DYN. for SCR522 Used L.N.	2.95
Surplus Radio Conv. Manual Vol. 1 or 2	2.50
BC 654 80 Meter XMTR & RCVR w/tubes & XTAL—L. N.	24.95
ASD Radar Set Complete—New (Price on Request)	
ASD Parabolic Antenna—Rotable—L.N. (Price on Request)	
2601A Parabolic Rot. Ant.—L.N. (Price on Request)	
R784 APS 15A Electronic Camera (Price on Request)	
BC221 Freq. Mtr. w/XTAL & Calib. Book L.N.	\$75.00
LM Freq. Mtr. w/XTAL. Book. Mod., Exc.	90.00
TBY, Navy 6 & 10 Mtr. Bat. Transceiver	34.95
RME69 RCVR, w/SPKR—GD	59.00
BC-375 Tuning Units New—cased	4.95
BC-375 Tuning Units New—cased	3.46
GE 25 Watt Phone XMTR Model GF4A Pow. Sup. Exc.	29.95
ATD 50 Watt XMTR New	49.95
JQ Navy 6V. Port. Audio Ampl. w/V1B. Sup. NY. GD.	9.95
BC 614 Speech Amplifier For BC610 L.N.	55.00
W1252 Electronic Wavemeter 22-30 Mcs. Exc.	44.95
BC 939 Ant. Tuner for BC610 L.N.	59.00
BC 342 Navy Comm. RCVR. Exc.	69.95
McMurdo Silver, RCVR. Mod. 801 G-80 Mtrs. w/tubes L.N.	29.95
Gon-Set 50-54 Mc. Conv. L.N.	24.95
Beach 80 Meter VFO New	19.95
Handy 28.5-29.7 Mc. Conv. New	24.95
BC-347C Interphone Amplif. L.N.	2.95
Dynamotor SA 5088 Imp. 18V./Out P. 450V	4.95
GP7 Tuning Units—New—cased, Range A-D.	4.95
GP7 Tuning Units—Used—cased, Range A-D.	3.95
GP7 Tuning Units—Used—no case, Range A-D	2.95
BC-610 plug in tuning unit. new. TU47-TU54.	3.50

HAMS—DON'T BE BLAMED FOR TV!

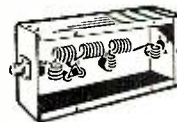

Tests have proven that Niagara's New LOW PASS FILTER KIT attenuates frequencies above 40 MCS. Passes all frequencies below 40 MCS. Less than 1/60 of 1 DB insertion loss. Will take up to a full KW. Directions included.

*Cat. No. N-279 **\$4.95** plus 25c shipping in U. S.

ATTENTION MOBILE HAMS!

Noise suppression Kit coming next month.

TERRIFIC PRICE SLASH! BRAND NEW TUBES

TRANSMITTING		RECEIVING	
E1148	\$.34	1H5GT	\$.50
2C26	.28	3A4	.27
5B7P	1.70	3B7	.29
10Y	.28	3D6	.29
211	.28	6C4	.20
803	3.63	6AR5	.54
805	3.63	6D6	.42
813	6.90	6K7GT	.43
815	1.37	6SH7	.27
843	.38	6SS7	.53
954	.18	704	.28
955	.18	12A6	.15
957	.18	12H6	.22
958A	.18	12K7GT	.49
1619	.18	12SH7	.29
1625	.18	12SR7	.29
1626	.18	28D7	.29
7198	.47	35L6GT	.49
9004	.18	50B5	.49
9006	.18	50L6GT	.48

ALL QUANTITIES LIMITED

SEND FOR COMPLETE NEW TUBE LISTING "N"

MEET THE WINNER! of last month's TALL TALES CONTEST



James M. Bowden (W2LD) of Boonton, New Jersey, walked off with this month's \$5 prize since he bowled our judges over with this whopper—"Recently, while adjusting the element on my ten meter beam I lost my balance and dropped sixty feet to the ground. Was I hurt? Naw. You see I had on my light fall coat!" You may be \$5 richer next month. Send your entry in—today.

Niagara Radio Supply Corp. Phone Dlgby 9. 1132-34

DEPT. N40 160 Greenwich Street, New York 6, N. Y.



Olson Radio Warehouse, Inc.
73 E. Mill St. • Akron 8, Ohio

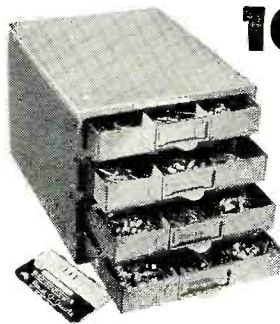

1000 RESISTOR KIT

A famous resistor manufacturer (you know who it is, too) called to tell us they had a terrific quantity of INSULATED resistors, all brand new, clean, fresh stock. We grabbed the whole works and Olson is passing the slashed price on to you.

Every resistor is color coded and insulated. Guaranteed by the manufacturer and Olson. Included are 1/4- and 1/2-watt values from 100 ohms to 10 megohms in popular ranges.

Stock No. AS-29
SPECIAL EACH \$15.95

Packed in a handsome steel 4-drawer chest with 48 compartments. Size 8 1/2 x 7 1/2 x 10 1/2".

Here's your chance to get a full thousand Insulated Resistors at less than distributor's cost. Your cost is only about 1 1/2¢ per resistor. Regular price is 9¢ each or \$90.00. Shpg. wt. 12 lbs.

Limit: positively only ONE DEAL to a customer. None sold to Jobbers.

Color Code Guide Included **STOCK No. AS-29..... \$15.95**

GENUINE ASTATIC MICROPHONE

with **ON-OFF Switch!**

Universal high output crystal for public address, home recording and communications. Equipped with handle which plugs into desk base. 7-ft. shielded cable. Switch in handle. A beauty, too, for this price. Shpg. wt. 3 lbs.

M-66. Special from OLSON, each..... **\$5.95**



Same as above but less switch M-67..... **\$4.95**

MUSICAL INSTRUMENT MIKE

Nationally-famous quality! Regularly sells for about twice our sale price. Easily attached. Delivers brilliant tone from string instruments. Equipped with 4'-shielded cable.



M-61. With Volume Control..... **\$5.95**

RECORD CHANGER MOTORS

Genuine and exact replacement motors for VM, Detrola, Erwood, Crescent, Westinghouse, GE, Emerson, Belmont, Milwaukee, RCA and many other popular record changers. 115 volts AC. Shpg. wt. 3 lbs.

Reg. 54.95 X-151..... **\$17.95**



RIM DRIVE PHONO MOTORS

Famous Makes! Real bargains at these low prices. Self-starting; complete with turntable. All parts included. Shpg. wt. 4 lbs.

M-52. 78 rpm for 115 volts AC..... **\$2.75**
M-63. 3-speed, 33 1/3, 45 and 78 rpm..... **4.95**

GENUINE ASTATIC PICKUP ARM

With crystal cartridge... at less than you'd normally pay for the cartridge alone.

M-53. Lots of 10. Each..... **\$1.99**
Single, each..... **2.19**

PHONO AMPLIFIER

Easily connected to any phono and speaker... or just the thing for a portable. Uses 1 each: 12SQ7, 50L6, 35Z5 tubes. 2 controls: on/off volume and tone. 7"x3"x2" chassis. Shpg. wt. 2 lbs.

RA-19..... **\$2.98**
AS-22. Tubes for above 1.87

ASTATIC 3-SPEED TONE ARM

Latest model crystal tone arm. Plays all records, 33 1/3, 45 and 78 rpm. Includes precious tip needle.

M-68..... **\$3.95**
Only at Olson's, ea...

TV TRANSFORMER

Vertical oscillator blocking transformer, same as RCA type 208T2. Shpg. wt. 1 lb.



T-81 Special, each..... **98c**

TV BOOSTER KIT

Build your own TV-FM booster. Improves reception in low-signal "fringe" areas. 3 to 5 db gain in signal to noise ratio. All channel tuning. Complete instructions. Shpg. wt. 5 lbs.



RA-26. Complete..... **\$9.95**

HOOK-UP WIRE KIT



How can we give you so much high grade wire for so little? Olson bought the wire in sight and is passing the bargain on to you. Kit contains 5 rolls, each 100' total 500 ft. Various colors, push back, plastic and rubber insulation; solid and stranded copper. Shpg. wt. 3 lbs.

AS19. 500 feet..... **\$2.50**

COIL FORMS

Low-loss plastic. Size 3/8" dia., 1 1/4" long. Terminal lugs included. Perfect for coils, chokes, stand-offs, etc. Our price isn't much more than 1/2 cent each.



X-202. Only at OLSON'S, per 100..... **69c**

OLSON TELEVISION SCOOP!

NEVER OFFERED BEFORE—TV CHASSIS WITH 12" TUBE!

NOT A KIT—READY TO USE! COMPLETELY ASSEMBLED!

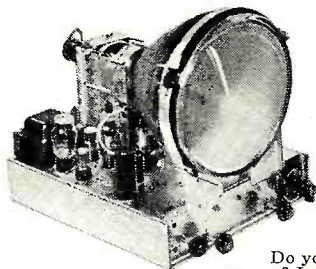

Do you know a bargain when you see one? Look at this TV chassis...

Check over its features... then RUSH your sample order for just one set. You'll wonder how Olson could bring you such a terrific TV receiver at such a ridiculously low price.

Every set is brand new and comes to you in original factory packing. Tube line-up: 3—6AG5; 2—6AU6; 2—6AL5; 1—6BG6G; 3—6SN7; 1—6AC7; 1—6J6; 1—6T8; 1—6V6; 1—6W4; 1—1B3G/8016; 1—5U4G.

Set is pre-aligned and tested. All parts are the finest and the workmanship is really precision. PM speaker is furnished. There is absolutely nothing in the country to compare with this terrific Olson bargain in TV. Pictures are the steadiest, clearest and brightest you ever saw. You get superb performance even in fringe areas. Here's a TV set that defies comparison. Comes to you complete with all tubes including 12LP4 picture tube, speaker, knobs, cables and mounting template. Chassis size: 16" wide, 18" deep, 17" high. Operates on 115-v AC. Shpg. wt. 70 lbs.

RA-33 Olson's great TV bargain, ONLY..... **\$129.95**

SAFETY GLASS and MASK

For above set or any 12" TV set. Double shatter-proof glass and handsome mask.



X-200. Both for only..... **\$4.95**

TV FOCUS COIL

Same as RCA Part No. 202D1. Perfect for all RCA 630-type or similar TV sets. Regular list price is \$6.50. Shpg. wt. 2 lbs.

T-80. Only at OLSON'S, Each..... **\$1.49**

MATCHED PAIR AM-FM CONDENSERS

Beautifully built! 3-gang. Build a tuner or AM-FM set. AM sections are 365 MMFD; FM is 15 MMFD per section. Can be operated by push-buttons, too. Shaft 3/8" dia. Condenser 3"x1 1/2"x4". Shpg. wt. 3 lbs.

X-201. Only at OLSON'S, pair..... **69c**

4-DRAWER STEEL CABINET GIVEN WITH OLSON'S GIGANTIC, NEW AKRAD KIT

You get \$45.20 list worth of "Akrad" Condensers plus the 4-drawer steel cabinet, size 8 1/2"x7 1/2"x10 1/2". Shpg. wt. 11 lbs.

AS-20. Only..... **\$14.95**

42 "AKRAD" BY-PASS CONDENSERS! ALSO 27 "AKRAD" ELECTROLYTIC CONDENSERS

Qty.	Cap. V.	List Total	Each	Qty.	Cap. V.	List Total	Each
2	.001 600	\$25.50	12.75	2	10	25.75	\$12.88
2	.002 600	25.50	12.75	2	25	25.85	12.93
2	.005 600	25.50	12.75	5	20	150.95	30.19
5	.01 600	30.15	6.03	5	40	150.110	30.02
5	.02 600	30.150	6.03	4	20	150.130	37.53
10	.05 600	40.400	4.04	5	450	95.75	19.15
10	.1 600	45.450	4.545	4	16	450.135	112.54
2	.005 1600	55.110	27.555	69	Total List	545.20	7.89
2	.008 1600	55.110	27.555		Value.....	545.20	
2	.01 1600	60.120	30.060		Plus the Steel 4-drawer chest FREE		

FREE SEND FOR OUR LATEST RADIO AND TELEVISION BARGAIN CATALOG

Thriftover
 Costs less than 75c...
 Weighs less than 2 lbs...
 ... per Foot!

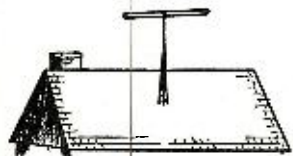

SELL THE BULK! Low price sells lower and middle income groups.

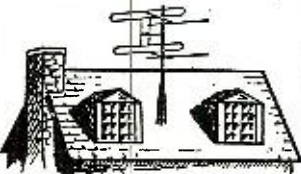

SELL THE CREAM! Improved reception sells upper income brackets.

Right along, tripod-type towers of sectional construction have been the choice of the "cream" of television's market. Through elevating antennae, such towers extend fringe area and improve reception. Now — Penn offers a tripod tower priced within reach of the ever-expanding "bulk" market. Be among the first to profit — write today for details about the still-available Penn dealer proposition.

Prices to Retailers

THRIFTOWER "30" — Composed of 20' of tower welded as a single unit with 10' 1" O.D. adjustable pole, total approximately 30' overall\$24.75

THRIFTOWER "40" — Composed of 20' of tower, same as Thriftover 30, with 20' 1" O.D. doubly reinforced adjustable pole giving a total overall extended height of approximately 40'\$29.75

PENN Teletower
 Penn Boiler & Burner
 Mfg. Corp.
Makers of Penn
Packaged Heat
 ESTABLISHED SINCE 1932
 LANCASTER, PA.

LETTERS from our readers

'MODEL T' TELEVISION

CONGRATULATIONS on your editorial in the January issue ('Is Television Going Model T?'). It was an interesting article and will really make some of these radio-minded persons 'wake up and smell the coffee.'

"I have built two 12" television sets from *Transvision* kits using the *Mal-lory* Inductuner (*Du Mont* Inputuner). That was over two years ago. The parts I used then are as good as new and even the resistors have their original color codes. I'll give the manufacturers credit for putting quality in those sets two years ago. Now the sets are coming through with parts under-rated because of the price factor.

"Your article was 100 per-cent as far as I'm concerned!"

Bernard Deckelmann
 Chicago, Ill.

WE READ your editorial in the January issue and found it interesting—but you only skimmed the surface.

"So much TV junk is being manufactured and advertised as the last word in picture clarity and stability that I wonder where the industry is going.

"We have had to repair almost every set that we sell, some sets are continuously in and out of the repair shop from the time they are sold—all of this within the warranty period. In some brands, replacement parts warranties are a farce. And who started this 12 channel TV business? Four or five higher definition 800-1000 line TV channels would have been superior service. Many customers with only one station in their service areas will never use the other channels in their sets."

John Martich
 Johnstown, Pa.

A HANDY SCOPE

AS a service technician working on my own, I service special equipment, i.e., movie sound projectors, p.a. systems, flash guns, timers, cameras, etc. I have found your magazine invaluable. The material is particularly well balanced. I have constructed many of your special devices and they are all doing yeoman work in my servicing and installation business.

"In particular, I would like to comment on the television oscilloscope by L. H. Van Arsdale, Jr. in the April and May 1948 issues. Until one has built it, used it, and compared it with

others, he cannot appreciate its features and performance. Due to the design, it is more stable and outperforms some of the \$500.00 instruments on the market. This instrument is far ahead of its time."

Edwin C. Libhart
 Stockton, Cal.

THE CODE

JUST a few lines from a fellow who still hopes 'to get' the code and then a ham ticket. Your recent pro and con letters should consider such items as: If you don't require code training below 100 mc. where DX is good at times or constant, how could a ham stop operation or render assistance in case of an SOS or similar distress signal? He'd never know. This procedure is part of the FCC and International Radio Law. Next, ham radio, like 'Freedom' and 'Liberty,' must have some rules and requirements for the game. Then, why does the younger generation (only a few at least) feel too sophisticated to do the 'lowly' job of studying code? After all, they do require certain skills to drive a car! Besides look at all the retired folks, young kids, and women that get the code—anyone can do it if he is willing to study and practice religiously.

"Finally, some talk has been around that above 300 mc. code may be optional, but I wonder how many 'no code' boys would have the real stuff to gadgeteer home-built gear stations of advancing quality above this region? I suspect 90 per-cent wouldn't do anything. The 'Law of Probability' comes into the picture with the other 10 per-cent who are scientists at heart and would do a wonderful job—at least until the other 90 per-cent were waiting for 'store-boughten' and plug-it-in-and-it-works equipment to be offered for sale—complete with built-in antenna!"

Frank E. Brooks
 Colonial Beach, Va.

SECOND THE MOTION

AND many hearty 'me-too's' on F. R. Redwine's letter in the January issue. To hit the nail more solidly on the head would be impossible. Mr. R. does a fine job of exposing how really little regard business propagandists have for the American people. We are expected to swallow any brand of hot air pumped out—with no questions asked—and there seems to be no defense against it!"

Daniel Lazare
 Metuchen, N. J.



THE COMPLETE QUALITY LINE at Budget Prices

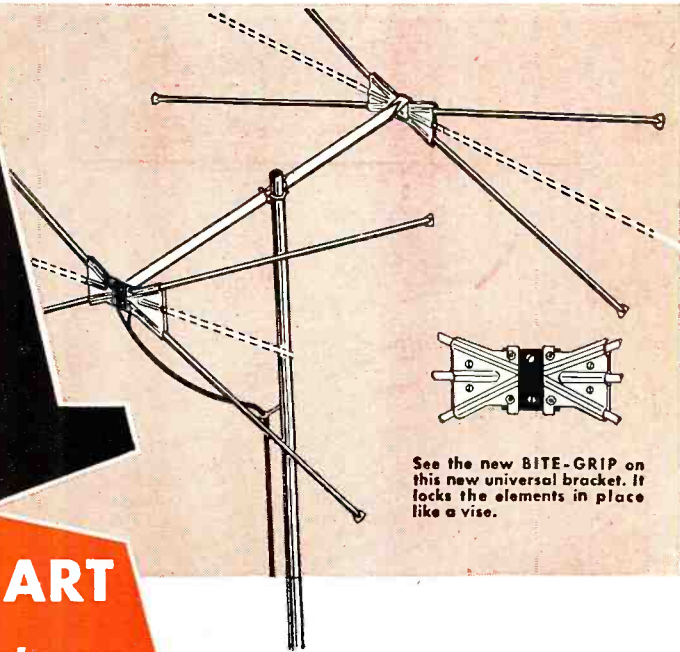

See the new BITE-GRIP on this new universal bracket. It locks the elements in place like a vise.

RADIART TELE ROTOR

RADIART TV Antennas

POWER To Rotate TV Antennas Under Even The Most Adverse Conditions

THERE IS A RADIART ANTENNA... for EVERY Condition... all of the highest quality... at the lowest possible prices!

RADIART was among the first to build quality TV and FM antennas and has pioneered many advance ideas that have improved TV reception! Recognizing that there is a SPECIFIC TYPE that works best under certain conditions... RADIART has a COMPLETE line... all at popular prices! Jobbers recognize... and SERVICEMEN know... that what they need is RADIART... to do the job best... because RADIART has everything!

Radiart Has a Complete Variety of Models Within These Basic Classifications:

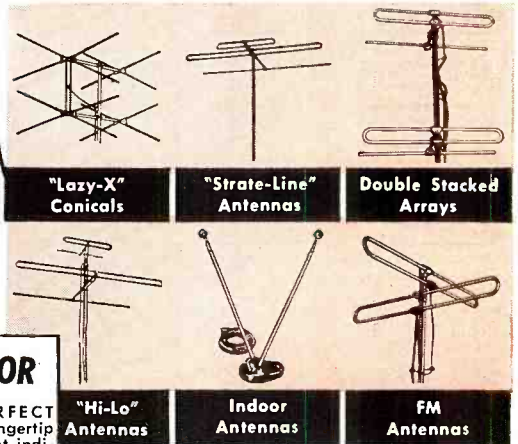

- ★ Streamlined WEATHER-PROOF Housing! Keeps Out Water, Snow and Ice.
- ★ Powerful heavy duty Motor that Reverses Instantly! Handles 150 pound loads Easily!
- ★ Heavy Duty Precision STEEL Gears For Years and Years of Wear!
- ★ Twelve Heavy Duty Ball Bearings in Two 6½-in. diameter Races for Smooth, Easy Rotation.

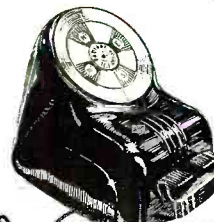
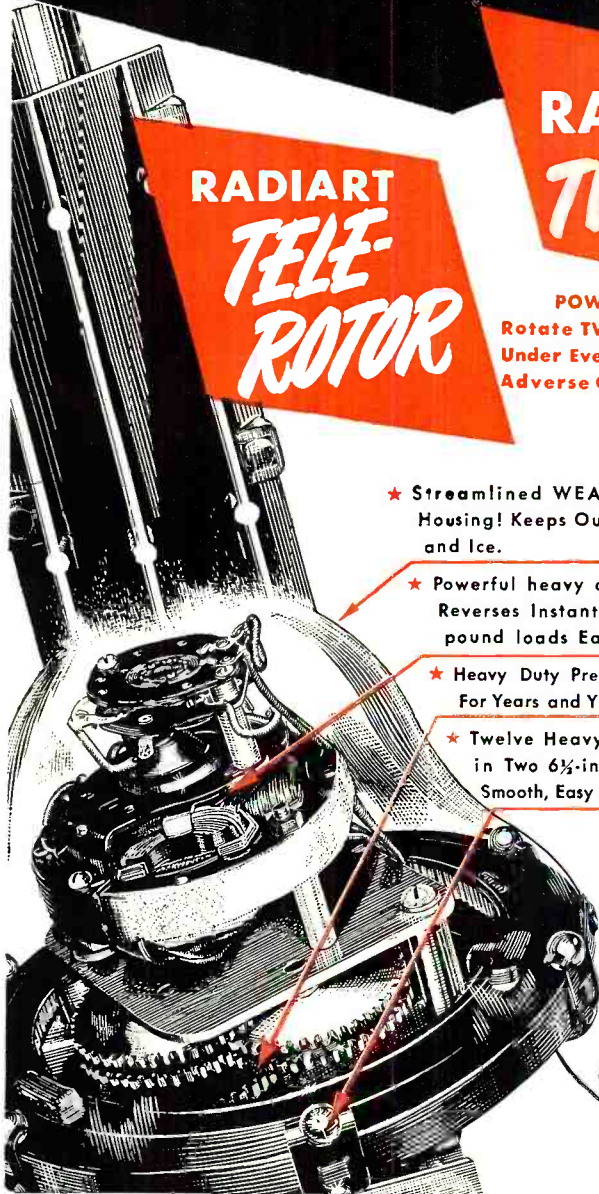

RADIART TELE-ROTOR CONTROL
... with the PERFECT PATTERN dial... fingertip control with instant indication of antenna position shown on the illuminated two-tone face.

Available in These Models:
TR-1... Rotor and control unit with end of rotation light (uses 4 wire cable)..... \$39.95
TR-2... Compass Control Rotor with illuminated "Perfect Pattern" dial (uses 8 wire cable)..... \$44.95



IT'S RIGHT WHEN IT'S RADIART

THE RADIART CORPORATION
CLEVELAND 2, OHIO



* You Can't Beat a RADIART ANTENNA on a TELE-ROTOR... It's TOPS!

- ROTATORS
- VIBRATORS
- TV ANTENNAS
- AUTO AERIALS
- POWER SUPPLIES

PHOTOFACT BOOKS HELP YOU 4 WAYS!

1. SAVE TIME 2. SAVE WORK

3. EARN MORE 4. LEARN MORE



PHOTOFACT TELEVISION COURSE

The book bought and studied by thousands. Gives you a clear understanding of TV principles, operation and practice. Complete coverage of all phases. 216 pages; profusely illustrated; sturdily bound, 8 1/2 x 11".
Order TV-1.....Only \$3.00

TELEVISION ANTENNAS

All you need to know about TV antennas—describes all types, tells you how to select, how to install, how to solve troubles. Saves time; helps you earn more. 166 pages; illustrated; handy pocket size.
Order TAG-1.....Only \$1.25

THE RECORDING & REPRODUCTION OF SOUND

A complete, authoritative treatment of the entire subject, written by Oliver Read, editor of *Radio News*. Covers all phases of recording and amplification. 364 pages, 6 x 9", cloth binding.
Order RR-1.....Only \$5.00



1948 RECORD CHANGER MANUAL

Covers 45 models made in 1948, including LP and dual-speed changers, plus leading wire recorders. Entirely original data based on actual analysis of the equipment. Over 400 pages; de luxe bound, 8 1/2 x 11".
Order CM-2.....Only \$6.75

AUTO RADIO MANUAL

Complete PHOTOFACT Service data on more than 100 post-war auto radio models. Complete, accurate, uniform information. Makes auto radio servicing easier and more profitable. Over 350 pages. Sturdy binding, 8 1/2 x 11".
Order AR-1.....Only \$4.95

NEW! DIAL CORD STRINGING GUIDE

New Volume 2, covering receivers produced from 1947 through 1949. The only book that shows you the one right way to string a dial cord in thousands of receivers. Handy pocket size.
Order DC-2.....Only \$1.00

HOWARD W. SAMS & CO., INC.

Order from your Parts Jobber Today, or write direct to HOWARD W. SAMS & CO., INC., 2201 E. 46th St., Indianapolis 5, Ind.

My (check) (money order) for \$.....enclosed.
Send the following books:

- TV-1 RR-1 AR-1
 TAG-1 CM-2 DC-2

Name

Address

CityZone.....State.....

Manufacturers' Literature

Readers are asked to write directly to the manufacturer for the literature. By mentioning RADIO & TELEVISION NEWS, the issue and page, and enclosing the proper amount, when indicated, delay will be prevented.

INSTRUMENT TRANSFORMERS

Westinghouse Electric Corporation, P. O. Box 2099, Pittsburgh 30, Pa., has recently issued a 12-page booklet which describes the construction features of the company's complete line of instrument transformers.

Methods of insulating current and potential transformers using oil, plastic, or dry-type construction are explained for all voltage classes. Types of cores are shown and reasons why high-permeability Hipersil core material saves weight and reduces size are given. Illustrations show how instrument transformer impulse levels are coordinated and built up to provide a high degree of protection against surges.

A 2-page table with illustrations shows typical shapes, construction, and applications of the *Westinghouse* line of instrument transformers. In requesting this catalogue please specify booklet B-4319.

WELDING CHART

A two-color wall chart which contains valuable welding information is being offered by *Eutectic Welding Alloys Corporation* of 40 Worth Street, New York 13, New York.

This illustrated chart, measuring nearly 2 feet by 3 feet, lists over one hundred "EutecRods" and "Eutec-Trodes" with their standard sizes, giving for each rod such technical data as type of joint for which suitable, metal on which used, bonding temperature, tensile strength, Brinnell hardness, degree of color match, electrical conductivity, resistance to corrosion, flame adjustment, etc.

Requests for copies of the chart must be made on your company letterhead.

AUDAK FOLDER

A 4-page folder, covering the company's new polyphase reproducer system, is currently available from *Audak Company*, 500 Fifth Avenue, New York 18, New York.

The pamphlet carries a description of the unit and performance data. A listing of the various components in the system, along with their prices, is also included.

TV COMPONENTS

Philco Corporation has announced publication of the "Television Components Handbook," a companion volume to the company's "Radio Components Handbook."

The new handbook covers the application of component parts in television receivers together with general

component and television data. The volume is cloth bound, contains 160 pages, measures 6 x 9 inches, and carries an index. The price is \$2.50 and the book is available from *Philco* distributors or direct from the Accessory Division of *Philco Corporation*, Philadelphia, Pa.

RECORDING DATA

Magnecord, Inc., has announced a new monthly publication "Magnecord INK" which will be devoted to the latest news and developments in the field of magnetic tape recording.

Written by authorities in the field and staff experts, the magazine is available free of charge to persons interested in tape recording. To get your name on the mailing list, address your request to Dept. H, *Magnecord, Inc.*, 360 N. Michigan Avenue, Chicago 1, Illinois.

BEARING CATALOGUE

The newly released Technical Bulletin No. 50, covering the company's "Micro" Ball Bearings, is currently available from *New Hampshire Ball Bearings, Inc.*, Peterborough 1, N. H.

The 12-page catalogue describes a full line of standard and special ball bearings including Conrad radial, full race radial, extra light radial, angular contact, self-aligning and pivot, in 1/8" to 3/8" o.d. of alloy steel, stainless steel, and beryllium copper, with data on tolerances, loads, speeds, life, lubrication, mounting, fits, etc.

OXFORD SPEAKERS

A new catalogue which provides a complete listing of *Oxford* speakers has just been released by *Oxford Electric Corporation*, 3911 S. Michigan Avenue, Chicago, Illinois.

This 4-page, multi-colored catalogue tabulates all the pertinent data on the company's PM, electro-dynamic, television, p.a., auto, intercom, and weatherproof speakers. Six of the speakers are illustrated.

PRECISION RESISTORS

Cinema Engineering Company of 1510 West Verdugo Avenue, Burbank, California, has announced publication of its Catalogue No. 11Ax, covering precision resistors, resistive devices, and sound equipment.

The 36-page catalogue includes mixer attenuation curves, mixer circuits, data on loss calculations of mixer circuits, voltage ratio table, pad formulas, and dimensions at attenuator frames. Equipment listed includes amplifiers, attenuators, db. meters, decade boxes, equalizers, faders, gain

RADIO & TELEVISION NEWS

sets, pads, resistors, speaker controls, transmission measuring sets, and volume indicator panels and boxes.

Various accessories for different types of sound equipment are also listed and described. Complete specifications are tabulated on the company's line of resistors, attenuators, and potentiometers.

ELECTRIC PLANTS

An 8-page, 2-color booklet covering the complete line of gasoline-driven electric plants manufactured by the company has been issued by *D. W. Onan & Sons, Inc.*, of Minneapolis 5, Minnesota.

Included are units ranging from 260 watts to 35,000 watts in all standard voltages, frequencies, and phases. Direct current models in standard voltages are described in ranges from 750 to 15,000 watts. Battery-charging electric plants in 6, 12, and 32 volts, 400 to 2000 watts are also listed.

When requesting copies of this catalogue, please specify *Onan Line Folder A-168*.

SELENIUM RECTIFIERS

Seletron Division of *Radio Receptor Co., Inc.*, 251 West 19th Street, New York 11, New York, is currently offering a 4-page pamphlet on the design, application, and servicing of selenium rectifiers.

Besides including a complete description and tabulation of test and repair procedures, the pamphlet sup-

plies information on troubleshooting methods for half-wave circuits. Rectifier repair and replacement techniques are also described fully.

TV REPLACEMENTS

Merit Transformer Corp., 4425 N. Clark Street, Chicago 40, Illinois, has issued a 1950 TV "Repl" Guide which lists approximately 400 popular television receivers, made by 60 manufacturers, and then lists the appropriate replacement parts for each receiver.

Designed to cut bench time, this complete and up-to-date listing is to be revised periodically. At the same time the company has introduced ten new flyback focus coils and deflection yokes and twelve new TV transformers to round out its line of television replacement components.

"LABORATORY STANDARDS"

A comprehensive catalogue which lists its line of standard signal generators, television signal generators, pulse generators, square-wave generators, megacycle meter, v.t.v.m. and other laboratory-type equipment has just been issued by *Measurements Corporation* of Boonton, New Jersey.

This 44-page Catalogue C provides a general description of each unit, special features of the instrument, and application data. A block diagram of the unit and a concise listing of specifications is also included.

The company also announces publication of the first issue of "Measure-

ment Notes," a 4-page illustrated brochure describing the use of the Model 59 megacycle meter in the design and construction of traps and filters for the elimination of television interference.

DATA SHEETS

Rotron Manufacturing Co., Inc., of 7-9 Schoonmaker Lane, Woodstock, New York, has recently made available a series of new catalogue sheets describing its Models "B" and "C" exhaust fans.

These fans have been designed for continuous duty operation in high ambient temperatures. Because of their small size, these new units are particularly well adapted for use inside enclosures such as radio transmitters and instrument cabinets where quiet, trouble-free operation is required.

The catalogue sheets cover mechanical specifications and performance curves for the two models. A data sheet on the use of dust filters is also included.

GENERATOR BULLETIN

General Electric Company, Schenectady 5, New York, is currently offering a new 8-page, 2-color bulletin covering its line of Tri-Clad high-speed synchronous generators.

The bulletin, GEA5415, deals with generators for standby, portable, and prime source power in various fields of applications. Construction features,

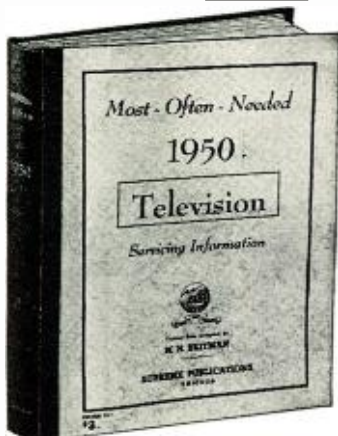

New 1950 TELEVISION manual contains complete service data on all popular present-day television sets of all makes. Gives description of modern circuits, test patterns, response curves, oscilloscope waveforms, alignment tables, service hints, diagrams in the form of double-spread blueprints, test points, voltage charts, etc. Large size: 8 1/2"x11 in., manual style binding, flexible covers. \$3 at your jobber or by mail, only. \$3

New SUPREME 1950 T-V Manual

DATA ON ALL POPULAR TV SETS

In this new giant volume of 1950 television factory data, you have everything you need to repair every present-day television set. You receive easy-to-understand explanations of circuits, 144 pages of alignment procedure, test patterns, response curves, waveforms, voltage charts, adjustment hints, and diagrams on mammoth 11 x 15-inch blueprints. This newly published 1950 TV manual is a virtual treatise on practical television repairs. By normal standards, such a large manual packed as it is with practical facts, hundreds of illustrations, diagrams, charts, photographs, and expensive extra-large blueprints, should sell for \$10—but as another SUPREME special value, it is priced to servicemen at only \$3, postpaid. Only a publisher who sold over one million TV and radio manuals can offer such bargain prices based on tremendous volume-sales.



Compiled by M. N. Beitman, radio engineer, teacher, author, and serviceman.



AMAZING BARGAIN IN TV MANUALS

For 17 years, radio servicemen received remarkable values in SUPREME PUBLICATIONS service manuals. The television series is the most amazing bargain and defies competition. There is nothing else like it. The new 1950 TV manual is described at left. Above are illustrated the earlier volumes covering 1949, 1948, and 1947 TV and F.M. Use these on-the-job manuals to repair any television set. Yes, these manuals will tell you where to look and what to do. Stop guessing. Cut hour-wasting jobs to pleasant moments. Use any of these manuals without risk for 10 days. Just send coupon below.

SUPREME RADIO DIAGRAM MANUALS



1949 1948 1947 1946 1942 1941 1940 1939 1926-1938
SUPREME Most-Often-Needed RADIO DIAGRAMS
 Each Manual only \$2. (1949 is \$2.50); 192 pages of diagrams, alignment data, voltage values, parts lists, and service hints; large size, 8 1/2"x11". To order, see coupon → Price, \$2.50

Supreme Publications

Sold by all Leading Radio Jobbers

NO-RISK TRIAL ORDER COUPON

SUPREME PUBLICATIONS, 3727 W. 13 St., Chicago 23, Ill.

Send television manuals checked below and radio diagram manuals at right. I am guaranteed satisfaction or my money back.

- New 1950 TV Manual, \$3. — 1949 TV, \$3.
 1948 TV, \$3. — 1947 TV & F.M. only \$2.
 I am enclosing \$ Send postpaid.
 Send C.O.D. I am enclosing \$ deposit.

Name:
 Address:

Most-Often-Needed Radio Diagram Manuals

- New 1949 Manual, \$2.50
 1948
 1947
 1946
 1942
 1941
 1940
 1939
 1926-1938 Manual, \$2.50
- PRICED AT ONLY \$2 EACH**

SELENIUM RECTIFIERS

— and —

ELECTRONIC COMPONENTS

THREE PHASE FULL WAVE BRIDGE RECTIFIERS

Input 0-234 VAC	Output 0-250 VDC	Price
Type No.	Current	
3B13-1	1 AMP.	\$ 22.00
3B13-2	2 AMP.	32.00
3B13-4	4 AMP.	56.00
3B13-6	6 AMP.	81.50
3B13-10	10 AMP.	105.00
3B13-15	15 AMP.	120.00

CENTER TAPPED RECTIFIERS SINGLE PHASE FULL WAVE

Input 10-6-10 VAC	Output 0-8 VDC	Price
Type No.	Current	
C1-10	10 AMP.	\$ 6.95
C1-20	20 AMP.	10.95
C1-30	30 AMP.	14.95
C1-40	40 AMP.	17.95
C1-50	50 AMP.	20.95

RECTIFIER MOUNTING BRACKETS

For Types B1 through B6, and
Type C1 \$.35 per set
For Types B13 \$.70 per set
For Types 3B \$ 1.05 per set

SINGLE PHASE FULL WAVE BRIDGE RECTIFIERS

Input 0-18 VAC	Output 0-12 VDC	Price
Type No.	Current	
B1-250	250 MA.	\$0.98
B1-1	1 AMP.	2.49
B1-1X5	1.5 AMP.	2.95
B1-3X5	3.5 AMP.	4.50
B1-5	5 AMP.	5.95
B1-10	10 AMP.	9.95
B1-20	20 AMP.	15.95
B1-30	30 AMP.	24.95
B1-40	40 AMP.	27.95
B1-50	50 AMP.	32.95

Input 0-36 VAC	Output 0-26 VDC	Price
Type No.	Current	
B2-150	150 MA.	\$0.98
B2-250	250 MA.	1.25
B2-300	300 MA.	0.50
B2-2	2 AMP.	4.95
B2-3X5	3.5 AMP.	6.95
B2-5	5 AMP.	9.95
B2-10	10 AMP.	15.95
B2-20	20 AMP.	27.95
B2-30	30 AMP.	36.95
B2-40	40 AMP.	44.95

Input 0-115 VAC	Output 0-90 VDC	Price
Type No.	Current	
B6-250	250 MA.	\$2.95
B6-600	600 MA.	5.95
B6-750	750 MA.	6.95
B6-1X5	1.5 AMP.	10.95
B6-3X5	3.5 AMP.	18.95
B6-5	5 AMP.	24.95
B6-10	10 AMP.	36.95
B6-15	15 AMP.	54.95

CUSTOM DC POWER SUPPLIES

Built to your specifications
We will be pleased to quote on your requirements.
Kindly send for our specification form.

RECTIFIER CAPACITORS

CF-14	3000 MFD	12VDC	\$1.69
CF-15	6000 MFD	12VDC	2.95
CF-1	1000 MFD	15VDC	.98
CF-2	2000 MFD	15VDC	1.69
CF-20	2500 MFD	15VDC	1.95
CF-3	1000 MFD	25VDC	1.25
CF-4	2X3500 MFD	25VDC	3.45
CF-5	1500 MFD	30VDC	2.49
CF-6	4000 MFD	30VDC	3.25
CF-7	3000 MFD	35VDC	3.98
CF-8	100 MFD	50VDC	3.25
CF-19	500 MFD	50VDC	1.95
CF-16	2000 MFD	50VDC	3.25
CF-21	1200 MFD	90VDC	3.25
CF-10	200 MFD	150VDC	1.69
CF-12	500 MFD	200VDC	3.25
	125 MFD	350VDC	2.49

Mounting clamps for above capacitors...15c ea.

RECTIFIER TRANSFORMERS

All Primaries 115VAC 50/60 Cycles

Type No.	Volts	Amps.	Shpg. Wt.	Price
XF15-12	15	12	7 lbs.	\$ 3.95
TXF36-2	36	2	6 lbs.	4.95
TXF36-5	36	5	8 lbs.	3.95
TXF36-10	36	10	12 lbs.	7.95
TXF36-15	36	15	20 lbs.	11.95
TXF36-20	36	20	30 lbs.	17.95
XFC18-14	18VCT	14	10 lbs.	5.95

All TFX Types are Tapped to Deliver 32, 34, 36 Volts. XFC Type is Tapped to Deliver 16, 17, 18 Volts Center Tapped.

RECTIFIER CHOKES

Type No.	Hy.	Amps.	Dc Res.	Price
HY5	.02	5	.25	\$3.25
HY5A	.028	5	.20	3.95
HY10	.02	10	.30	6.95
HY10A	.014	10	.04	7.95
HY15	.015	15	.30	13.95
HY20A	.007	20	.02	12.95

Type "A" low resistance chokes are specially suited to circuits requiring excellent voltage regulation.

ADDITIONAL SELENIUM RECTIFIER TYPES AND GENERAL INFORMATION MAY BE FOUND IN OUR CATALOG No. 719



VACUUM CAPACITORS

Standard Brands
12 Mmfd. 20 Kv \$4.95
50 Mmfd. 32 Kv 5.95
Overall length 6 3/4", diameter 2 1/4",
terminal diameter 3/4". Shpg. wt. 2 lbs

EDISON THERMO TIME DELAY RELAY

Heater voltage 115 V. Norm. open SPST contacts. 15-30 sec. delay. Contact rating 115 V 3A., 440 V 2A. Size 3 1/2"x1 1/2" diam. Standard 4-prong tube base. Ea. 98c



WHILE THEY LAST METER SPECIALS

0-300 VDC, Basic 0-1 ma. 2" rd. Bakelite case Shpg. wt. 2 lbs. Bargain price. \$2.25

KLIXON 40 SECOND DELAY SWITCH

Heater operates on 115 VAC or DC. Contacts SPST rated at 30 A., 115 V. or 20 A., 220 V. Auxiliary contacts for lighter loads. Each \$2.49



DIEHL MOTOR

Fan duty, brushless induction type (no TV interference). For 115 VAC 60 cycles, 46 watt, 1800 R.P.M. Shaft 1/2" diam. 1" long. Noiseless ball-bearings—heavy cast construction. Shpg. wt. 6 lbs. Brand new \$4.50

D-C PANEL METERS

Attractive, rugged, and reasonably priced. Moving vane solenoid type with accuracy within 5%.
0-6 Amperes D-C Any range \$2.49 each
0-12 Amperes D-C
0-15 Volts D-C

SILVER CERAMIC TRIMMERS

820-Z 5-20 Mmfd. Zero Temp. 24c
822-N 5-20 Mmfd. Neg. 300 24c
822-AZ 4.5-25 Mmfd. Zero Temp. 24c
823-AN 20-125 Mmfd. Neg. 650 33c

ATTENTION!!!

Bulletin No. 713, listing various government and commercial surplus items, is now available upon request.

DC POWER SUPPLY

Limited quantity—
Gov't Surplus

Ready to operate Full-wave bridge, copper-oxide rectifier, heavy-duty multi-tapped transformer. Input: 85/95/105/115 VAC 50/60 cps. Output: 2.5/24/28/32/36 VDC at 5 amperes, unfiltered. For wall or bench mounting. Overall dimen. 9"x8 1/2"x8 1/2" high. Shpg. wt. 30 lbs. Like new. Tested and guaranteed. \$36.00
Filter Kit, 2% ripple \$6.65

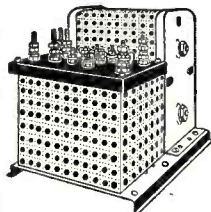

POWER SUPPLY KITS 24 to 28 VDC Filtered

Designed for continuous duty ground operation and bench testing of air conditioning equipment, these kits provide a reliable means of obtaining a source of low-ripple 24 VDC, from a 115 VAC 60 cycle line. Full-wave bridge Selenium Rectifiers insure instantaneous and efficient operation. Adjustment of the DC output voltage is accomplished by transformer primary taps. Ripple is limited to within 2% of the average DC output by choke-input filters.
Kit No. Amperes DC Net Price
242 2.0 \$16.39
245 5.0 22.39
2410 10.0 47.44
2420 20.0 79.44
Write for descriptive Bulletin No. 201

RECTIFIER KIT No. 612-10 6 and 12 VDC at 10 Amperes

This unit will deliver unfiltered direct current for operation of motors, dynamotors, solenoids, relays and similar equipment. Employs full-wave Selenium Rectifier and heavy-duty primary tapped transformer. The two output voltages can be used simultaneously and may be adjusted between 6.7-7.5 VDC and 13-15 VDC under full load. For 115 VAC 60 cycle input. With schematic diagram and instructions. Shpg. wt., 12 lbs. \$15.95

FILTER KITS FOR No. 612-10

1 section choke input 10% ripple \$9.64
2 section choke input, 2% ripple 19.28

Minimum order \$3.00. No C.O.D.'s Add 10% for Prepaid Parcel Post and Handling. Terms: Net 10 days in the presence of approved credit.

All prices subject to change without notice. Prices and delivery F.O.B. our NYC Warehouse. All merchandise subject to prior sale.

WESTERN ELECTRIC BLOWER



/KS5881—Brand New—Heavy-duty Sirocco type blower, capacitor start, 1/40 H.P., 340 RPM, 115 VAC, 60 cycles. Displaces 84 C.F.M. Extremely quiet operation. Opening 2 3/4", overall size 7 1/2" long, 6" diam. Moisture and fungus resistant. With capacitor. Shpg. wt. 15 lbs. Quantity limited. \$13.95

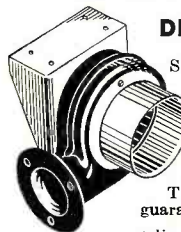

DIEHL BLOWER

Sirocco type, displaces 100 C.F.M. 115 VAC, 60 cps. Moisture and fungus resistant. Flange diameter 4". Overall size 7 1/2"x6 1/2". Removed from equipment. Shpg. wt. 10 lbs. Tested and guaranteed. \$9.95

Adjustable right angle aluminum extension tube to fit flange. 98c

WESTINGHOUSE AIRCRAFT MOTOR

Brand new—24 VDC or AC. 2 AMPS. Reversible on both. 1/50 H.P. 4800 RPM continuous duty. Length of leads 18". Dimensions 3 1/2"x2 1/4", shaft 1/4" diam. by 3/8" long. \$2.95
Price.....
Reversing switch with "off" position. Each. 79c



OPAD-GREEN ★ COMPANY ★

71-3 Warren St.
New York 7, N. Y.

Phone: BEEkman 3 7385-6

HICKOK Leads!

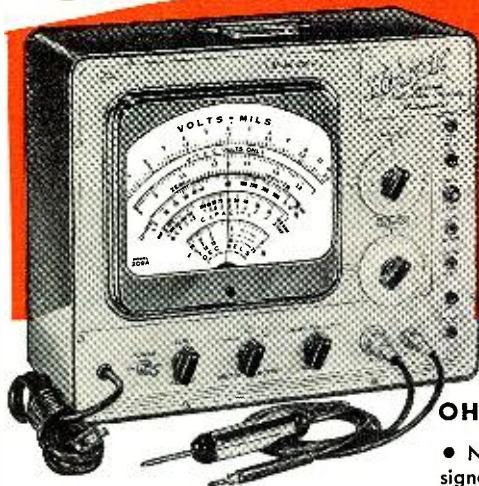

WITH NEW TELEVISION VTVM

MODEL 209A

ELECTRONIC VOLT OHM CAPACITY MILLIAMMETER

• Now even more sensitive — Especially designed to save you time in television servicing. Measures any resistance, capacitance, voltage or current you would ever encounter in AM, FM or TV receivers.

New Peak-to-Peak voltage measurements— An absolute necessity for TV servicing.

Zero-center DC scale increases speed and accuracy of TV and FM readings.

Model 209A is a quality instrument built to the high HICKOK standard, with lasting accuracy for years to come.

The most used instrument on the technicians bench, where top-quality is the most economical buy.

See the 209A at your jobber's or write for literature Today!

THE HICKOK ELECTRICAL INSTRUMENT COMPANY

10524 Dupont Avenue • Cleveland 8, Ohio

FEATURES

- Easy to read, long scale 9" meter.
- Zero-center DC scale for faster alignment.
- Resistance measurements as low as 1/10 ohm.
- New 1200 Volt AC range.
- Low capacity, high frequency probe. Peak-to-Peak or RMS — Flat frequency response to 300 megacycles.

Send me full information on the New HICKOK Model 209A.

NAME _____
ADDRESS _____
CITY _____ STATE _____

1910

Our 40th Anniversary

1950

WANTED TO BUY

Large and small quantities of new or used electronic government or manufacturers' surplus tubes and equipment. Highest prices paid. State quantity, condition and best price in first letter.

Box 496, % RADIO & TELEVISION NEWS
185 N. Wabash Ave., Chicago 1, Illinois

SO YOU WANT TO GET MORE TECHNICAL!

Read . . . RADIO-ELECTRONIC ENGINEERING edition of RADIO & TELEVISION NEWS.

In addition to regular RADIO & TELEVISION NEWS content you get at least 5 extra articles every month on important advances in electronics and engineering . . . by subscription only. . . .

USE ORDER CARD ELSEWHERE
IN THIS ISSUE

mechanical modifications, and performance data are provided on the line which includes units rated from 12½ to 1250 kva. and speeds from 1800 r.p.m. to 514 r.p.m.

SURPLUS MANUAL

The Office of Technical Services of the U.S. Department of Commerce has just issued a second simplified manual to guide users of the more common types of electronic equipment purchased from government surplus stocks.

The new volume, entitled "A.M. Receivers and Transmitters," provides purchasers with the basic circuit diagrams, parts, values, and voltages of the equipment listed.

These assemblies include AN/TRC-2, BC-453 receiver, BC-454 receiver, BC-455 receiver, BC-456 modulator, BC-457 transmitter, BC-458 transmitter, BC-459 transmitter, BC-696-A transmitter, BC-946-B receiver, DM-40-A dynamotor, DM-41-A dynamotor, DM-42-A dynamotor, DM-43-A dynamotor, GN-44-A generator, SCR-284-A receiver and transmitter, SCR-288 receiver and transmitter, SCR-506 receiver and transmitter, and SCR-694 receiver and transmitter.

Copies of Volume 2, publication PB 99539, are available from the Office of Technical Services, U.S. Department of Commerce, Washington 25, D.C. Orders must be accompanied by a check or money order for \$1.00 payable to the Treasurer of the United States.

Copies of the first volume are also available from the same source at the same price. Ask for publication PB 98487.

AUDIO EQUIPMENT

A pocket manual, entitled "1950 Audio Equipment," has just been published by *Sun Radio & Electronics Co., Inc.*, of 122-124 Duane Street, New York 7, New York.

Written by Irving Greene, manager of the company's audio engineering department, the booklet covers radio AM and FM tuners, phonograph pickups, records, amplifiers, and speakers in addition to data on the installation.

The manual also includes a condensed listing of a variety of such equipment for ready reference. Copies are free of charge on request. —50—

TV OUTPUT UP

ACCORDING to the most recent report received from Radio Manufacturers Association, television set production by member-companies continues at a record level.

Contrary to expectations, January production of television receivers reached 335,588 for the four-week period. The January output topped all 1949 months except November which had five weeks.

Radio output remained substantially the same with 660,195 sets being produced. FM and FM-AM receivers totaled 89,136 with an additional 34,087 TV sets equipped with FM. —50—

RADIO & TELEVISION NEWS

Mini-Rack Modulator

(Continued from page 44)

charges of the filter condensers would impose an extra strain on the components.

An antenna tuning network is included to complete the transmitter. The circuit utilizes an all-band turret and a pair of variable condensers in a versatile arrangement which allows setting up the following tuning methods: (1) series tuning with either one or two condensers, (2) parallel tuning with one or two condensers, (3) combination series-parallel tuning in an unbalanced circuit, (4) pi-network for tuning random lengths of antenna. These combinations take care of virtually all antenna circuit possibilities in conjunction with the swinging link output of the transmitter for low-impedance loads. The *Bud* turret has a six position bandswitch although only 5 positions are used for coil connections. The sixth switch point is, therefore, available to connect the antenna relay directly to a pair of terminals for low-impedance loads such as folded dipoles, etc., which require no antenna tuning network. The other tuning arrangements are set up by means of jumpers across the appropriate standoff insulators along the rear of the antenna tuner chassis. The antenna relay switches the low-impedance link of the antenna tuner to the receiver during the standby period. This method of antenna switching puts the relay in the low voltage part of the circuit where relay insulation is a relatively unimportant factor and allows the use of the tuning network to match the antenna to the low-impedance input found in most communications receivers.

The power supply, modulator, and antenna tuner are constructed in miniature relay rack style to match the

Fig. 9. The rack framework is assembled from $\frac{3}{8}$ " aluminum (24ST) angle stock. Small triangles in the corners prevent hinging of the various parts and make the whole assembly rigid. All pieces are fastened by means of self-tapping screws.

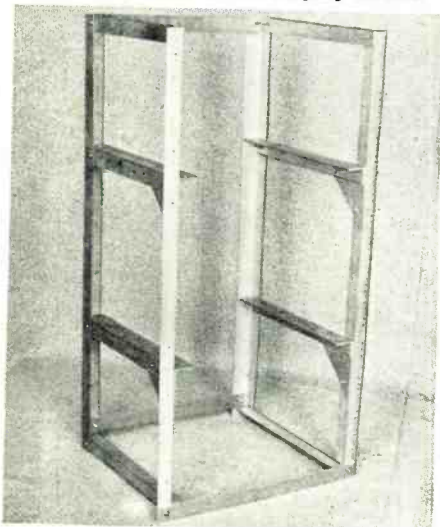

CHE SEA *Spotlight* VA UES

10" PICTURE TUBE \$15⁹⁵

BP4—IN SEALED CARTONS

Two Guarantees—RMA & Chelsea

Latest, Improved, 30 Tube

630 TYPE LIC. RCA 16" CHASSIS

WITH VOLTAGE DOUBLER . . . COMPLETE WITH

PLUG IT IN-AND IT WORKS!

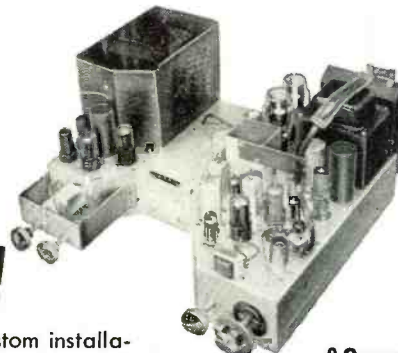

PICTURE TUBE

\$184⁹⁵

plus \$2.25 Fed. Tax

Completely wired, factory engineered, aligned and tested.

A Set—Not a Kit.

Nothing finer for custom installations—with Improved AGC and Improved High-Gain Front End down to 45 microvolts.

2 Guarantees—RMA & Chelsea

SAME CHASSIS FOR 19" OPERATION, with voltage doubler—complete with picture tube \$233.45 plus \$2.25 Fed. Tax

Latest Improved 16" LIC. RCA CHASSIS

Completely wired, factory-engineered, aligned and tested

COMPLETE WITH PICTURE TUBE

\$159⁹⁵

plus \$1.80 Fed. Tax

A SET—NOT A KIT

Our superior C-4 receiver—quality controlled all the way, with Improved AGC and AFC, and Standard Coil Front End down to 45 microvolts.

2 Guarantees—RMA & Chelsea

Highly Sensitive No-Drift AM and FM Tuner \$31.50 plus \$1.80 Fed. Tax

High and Low Frequency All-Channel Antenna from \$6.71 to \$471.00

WHY PAY MORE ELSEWHERE?

Write Dept. Q for latest literature and prices—and COMPARE!

Phone and mail orders filled on receipt of certified check or money order for \$25 as deposit . . . balance C.O.D., F.O.B. N. Y. For Free Demonstrations, visit our street-level showroom.

The House of Bargains

CHELSEA TELEVISION CENTER, INC.

187 Seventh Ave., New York 11, N. Y. CHelsea 3-4425-6-7

Prices subject to change without notice.

SOLVE your hi-fidelity problems with

University TWEETERS

WIDEST SELECTION • BEST VALUE • HIGHEST QUALITY

SINGLE UNIT TWEETERS

MODELS 4408, 4409—600 CYCLE TWEETERS: Recommended for highest quality reproduction systems requiring a low crossover frequency. Cobra shaped horn results in perfect wide angle distribution. Frequency response 600 to 15,000 cycles. Model 4408 handles 6 watts and 4409 25 watts.



MODEL 4407 ADAPTER MOUNTS 4401 TWEETER IN ANY 12" CONE UNIT: Converts any 12" cone speaker into a wide-range coaxial reproducer in a few minutes. Installation is extremely simple and results in a dual speaker occupying little more space than the original cone speaker. Complete with 4401 tweeter.



MODEL 4401—2000 CYCLE TWEETER: An economical 6 watt unit for converting any good 10-15" cone speaker for extended response to 15,000 cycles. Wide Angle horn, compact design and low price bring excellent high fidelity well within the popular price range.

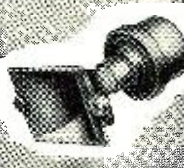

DUAL TWEETERS



MODEL 4402, MODEL 4404: Model 4402 reproduces to 15,000 cycles. Crossover at 2000 cps, Horizontal dispersion 100°, Vertical 50°. Handles 12 watts. Compact design mounts in any radio, phono, or speaker cabinet. Model 4404 incorporates 4402 tweeter in handsome walnut cabinet complete with high-pass filter and high frequency volume control. Anyone can install.

CROSSOVER NETWORKS



MODEL 4405 HIGH PASS FILTER: An effective and economical unit for preventing lows reaching the tweeter unit. Contains high frequency control to balance highs and lows. Cutoff frequency 2000 cycles.

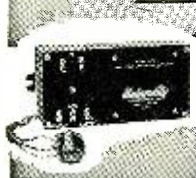

MODEL 4410, 4420 LC CROSSOVER NETWORK: Genuine LC frequency dividers for segregating highs and lows. Not to be confused with ordinary high-pass filters. Crossover frequencies: Model 4410 600 cycles, Model 4420 2000 cycles. Attenuator controls included and wired.

Write today for illustrated literature — address inquiries to Department A

University

LOUDSPEAKERS • INC

80 SO. KENSICO AV., WHITE PLAINS, N.Y.

transmitter. The panel space is 10x19 inches and the rack is 8 inches deep. The modulator is built on a readily available surplus drawn aluminum chassis with a bottom cover for complete shielding while the power supply and antenna tuner are each constructed on one of the 3/4 inch deep covers. Aluminum angle stock fastened together with sheet metal screws completes the assembly. The use of the bottom shielded modulator chassis is no doubt an aid in obtaining freedom from r.f. and audio feedback and the stability is such that the modulator may be run at full gain without hum or feedback.

The aluminum panels were first cleaned with naphtha and then sprayed with gray wrinkle finish enamel with a paint spray attachment and a household vacuum cleaner. An electric heat lamp was then waved slowly over the panels until the wrinkling began and covered the entire surface. Needless to say, the panels should be laid on a flat surface during the painting to avoid runs in the paint. Once the paint has wrinkled, the panels may be allowed to dry in the air. At least 24 hours should be allowed for complete drying.

To adapt the original Mini-Rack transmitter to phone/c.w. operation the following minor modifications were

made: (1) The 117 volt input to the bias supply was rewired in parallel with the final r.f. amplifier power supply so that bias for the r.f. tubes appears immediately when the line switch is closed; (2) Screen and plate bypass condensers on the modulated push-pull 807 stage were reduced to .002 each; (3) All the original parasitic-suppressing resistors in the grid, plate, and cathode leads were removed and the parasitic-suppression system of Don Mix, W1TS, was installed. This consists of an r.f. choke of 8 turns of number 14 wire, wound on a 5/16 inch form in each plate lead and a choke of 15 turns of number 22 wire close-wound on a 1/4 inch form in each grid lead. The screens are bypassed directly to ground without any resistors or chokes. This method has resulted in a perfectly stable modulated amplifier on all bands.

This economically constructed modulator has brought many favorable comments on its excellent quality. The no-signal resting plate current of the zero-biased 807's is 6 ma. so that even though the plate current on speech peaks is in excess of the rating of the power transformer, the average current is well below the rated 200 ma. This circuit seems to be ideal to fill the gap between 6L6's and 811's in audio work.

-30-

USE YOUR MULTIMETER AS A CONDENSER LEAKAGE TESTER

By

EDWIN W. HILL, Chief Eng., WDHL

A VOLT-ohm-milliammeter, when used with one of its high voltage ranges, makes a handy and very sensitive condenser leakage tester. The writer has used his meter for this purpose so often that he has come to depend on it and to prefer it to the exclusion of other condenser tests. It is particularly effective in locating leaky coupling condensers in audio amplifiers.

The low side of the condenser to be tested is disconnected, leaving the other end of the condenser undisturbed in the circuit. The low side of a condenser is that end which is grounded or which has no voltage on it. The positive test lead of the v.o.m. is then attached to the disconnected condenser lead, and the negative test lead to the negative of the power supply of the receiver or amplifier. Use the 500- or 1000-volt range of the multimeter.

The receiver or amplifier is then switched on. If the condenser being tested is a good one, the meter will first indicate some reading and then fall back to zero. If it does not go back to zero there is some leakage in the condenser, the amount being in proportion to the meter reading. If the leakage is intermittent, the meter reading will go back to zero and then suddenly and erratically jump as the condenser leaks. Sometimes this condition does not show up until some r.f. or audio is applied across it, so that it is a good idea to tune the receiver to some station, or to play a record through the amplifier, while the test is being made.

In effect, the multimeter is being used as a high-resistance milliammeter, and, consequently, it is quite sensitive to the smallest currents passing through it. This condenser testing method will not work, of course, unless there is some d.c. voltage across the condenser.

-30-

Setup (A) for testing coupling condensers and (B) for testing bypass condensers.

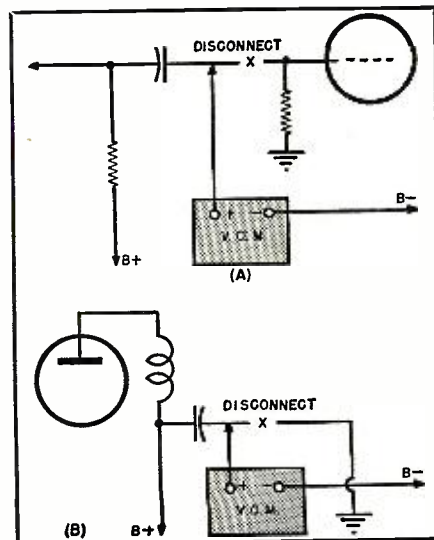

RADIO & TELEVISION NEWS

NEW TV PRODUCTS On The Market

HOFFMAN CONSOLE

Hoffman Radio Corp., 3851 S. Hill Street, Los Angeles 7, California, recently introduced its new 1950 Decorator line of television receivers.

One of the outstanding sets in the

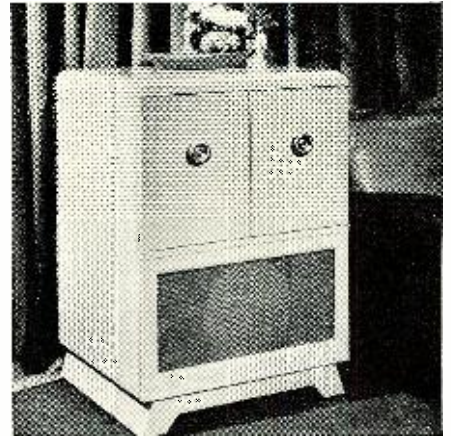

line is the Model 847 with a 16" rectangular black tube. Housed in a modern blonde cabinet, the new set features the company's "Easy Vision Angle" lens, "In-Dor" antenna for simplified operation, and an electronic black-and-white, lighted channelized station selector.

The receiver has 23 tubes plus 4 rectifiers and uses a 12-inch speaker. The cabinet is of hand-finished blonde oak which measures 36½" high, 25" wide, and 22½" deep.

"THE AVENUE"

The Magnavox Company of Fort Wayne, Indiana, has added "The Avenue" to its line of radio-phonograph

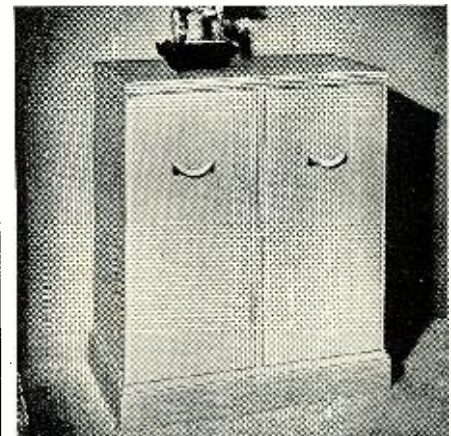

consoles. This new receiver includes the company's exclusive "Add-A-Television" feature that allows installation of a Magnascope "90" television

RADIO & TELEVISION NEWS

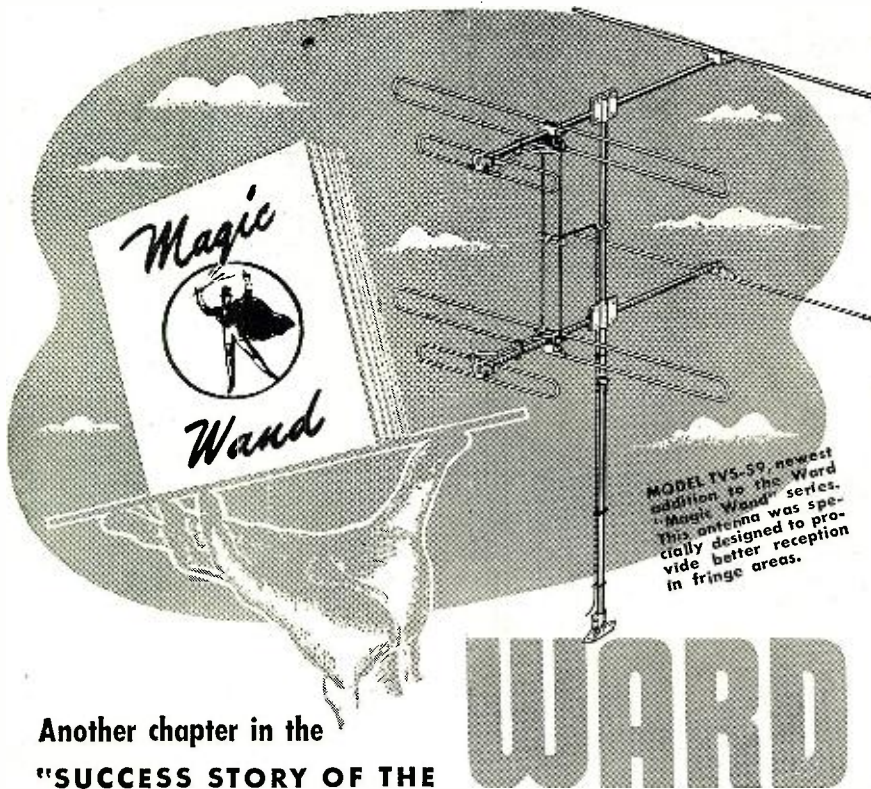

MODEL TV5-59, newest addition to the Ward "Magic Wand" series. This antenna was specially designed to provide better reception in fringe areas.

WARD

Another chapter in the "SUCCESS STORY OF THE MAGIC WAND ANTENNAS"

More than a thousand power lines snapped! Street car service disrupted by broken trolley wires! Thousands of tree branches crashed to the ground!

But the Chicago area's worst ice storm did not affect a single Ward Products "Magic Wand" TV antenna.

"Magic Wand" antennas are made of Perma-Tube, a special alloy expressly developed for Ward Products by the Jones & Laughlin Steel Corporation. Perma-Tube is a rugged alloy designed to withstand the harmful, corrosive effects of ice, sleet, snow, wind, and rain.

In good weather or bad, your TV set will give you the best reception if you have a Ward "Magic Wand" antenna. Tests have proved a medium-priced TV set with a good antenna performs better than an expensive set with a cheap antenna.



Write for our free booklet, "The Story of the Magic Wand." It contains interesting, authoritative information about TV and FM antennas.

WARD PRODUCTS CORPORATION

1523 E. 45th STREET, CLEVELAND, OHIO
Division of the Gabriel Company

Ward is the largest and oldest exclusive maker of television and auto radio aerials.

TELEVISION KITS • SETS PARTS

FACTORY TO YOU — LOWEST PRICES!

- 8½" KIT \$49.50 less tubes
- Electromagnetic Kit for 10", 12½", 16" \$79.50 with tubes incl. CR tube
- Tubes \$84.50 less tubes
- Above Chassis wired up—Ready to operate \$104.50 less tubes
- 10" Kit with Tubes including CR tube. \$129.50
- 12½" Kit with Tubes including CR tube. 137.50
- 16" Kit with Tubes including CR tube. 157.50
- Above Kits wired up ready to operate \$20.00 add.
- **RCA—630 TYPE CHASSIS**
- 30 tube, keyed A.G.C., Volt. Doubler. Completely wired, aligned & ready to operate. For 16" or 19" CRT.
- Only..... \$159.50 with all tubes except CRT
- 5-DAY FREE TRIAL—MONEY BACK GUARANTEE
- Write for free catalogue

Certified TELEVISION LABORATORIES
5507 — 13th AVE. BKLYN. 19, N. Y.

RADIO COURSES

- RADIO OPERATING • CODE
 - RADIO SERVICING • ELECTRONICS
 - F.M. TELEVISION
 - REFRIGERATION SERVICING
- Write for Catalog T.S. and Picture Brochure

Y.M.C.A.

TRADE & TECH. SCHOOL 229 W. 66 St., N. Y. 23
#NDict 2-8117

SEND TODAY FOR YOUR BIG FREE 16 PAGE BARGAIN BULLETIN

DOW TRADING 70 W. UNION PASADENA, CALIF.

Peerless Performance

RMA 70 Volt Line Matching Transformers

Complete coverage from ¼ to 64 watts, with an insertion loss less than 0.6 db at full power, makes the Peerless 70 volt line the best buy for RMA-standardized sound distribution systems! Available in three sizes (¼-4, 3-24, 8-64 watts), each provides five primary taps for overlapping coverage through entire power range in steps never greater than 3 db. Five secondary impedances match speakers of 2 to 16 ohms, singly or in combination. Because efficiency is high, these transformers will stand considerable abuse and may be safely up-rated with only a slight reduction in frequency range and efficiency. Furnished potted or in open frames. Mounting flanges provided.

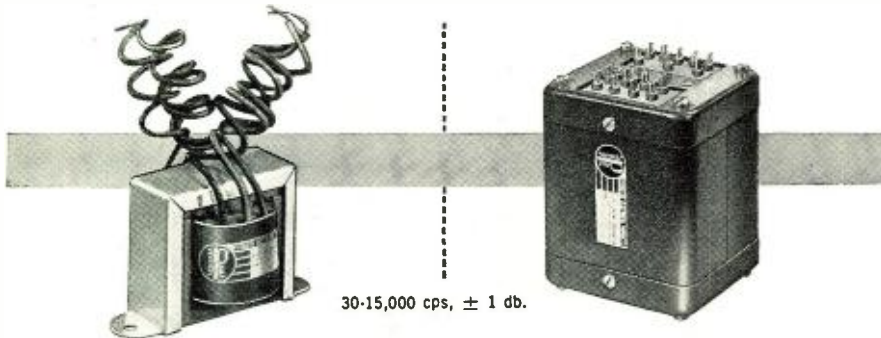

30-15,000 cps, ± 1 db.



PEERLESS ELECTRICAL PRODUCTS
DIVISION

1161 N. VINE ST., HOLLYWOOD 38, CALIF. • 161 SIXTH AVE., NEW YDRK 13, N. Y.



receiver at whatever later date the owner may choose.

The equipment in the set includes an AM-FM receiver, a 12" dynamic speaker, and a three-speed record changer with a single tone arm.

The cabinet, of white oak finish, stands 36" high, 30" wide, and 18½" deep. Besides housing the radio and phonograph instruments, the cabinet provides ample storage space for 14 large record albums. Part of the album space is designed to accommodate the television receiver when this installation is desired.

TELEVISION CAPACITORS

A new series of paper tubular capacitors, designed for television applications, has just been introduced by Sangamo Electric Co. of Springfield, Illinois as its Type 13.

Available in nine different capacities, these 6000 volt units are mineral



oil impregnated to give longer life and more stable performance over a wide range of operating temperatures. The new series is designed to withstand continuous operation at 85 degrees C.

Special polyester end seals which will not crack or pull away from the varnished cardboard tube make the capacitors moisture-proof. These same polyester ends also provide excellent insulation for high voltage applications, according to the company.

A single page flyer, which carries comparison test and performance data as well as catalogue information on the Type 13 series, is available from the company on request.

NEW VIDEO TUBE

Production is now under way at the Allwood, New Jersey plant of Allen B. Du Mont Laboratories, Inc. on the new "Teletron," Type 12LP4A tube.

Designed to be used in initial equipment, this new tube uses the Du Mont bent-gun ion-trap design and features the new gray filter face plate. The elimination of ion blemishes by use of the bent-gun is said to result in sharper spot resolution. Modification in the bent-gun design in the Type 12LP4A permits the use of either a single or double magnet beam bender yet assures direct interchangeability with all Type 12LP4 tubes. —50—

CLEVELAND HAMS MEET

THE Cleveland Area Council of Amateur Radio Clubs in cooperation with the 145th Infantry, Ohio National Guard, is staging a gala hamfest on Saturday, April 8th at the Central Armory in Cleveland.

Varied types of entertainment have been provided. Full details are available from W8LYD, 12101 Brighton Ave., Cleveland 11. —50—

RADIO & TELEVISION NEWS

it's yours for the asking

FREE

SENCO'S
New ... 1950
RECEIVING TUBE
INTERCHANGEABILITY
CHART

Lists over 150 tube types that are directly interchangeable. Saves you time ... save you money.

NOTHING TO BUY... Just Fill In Coupon... MAIL TODAY!

NAME

ADDRESS

CITY..... ZONE... STATE.....

SENCO RADIO, INC., Dept. T
71 West Broadway, New York 7, N. Y.

Radio Men Who Know
SAVE AT SENCO

BARBER-COLMAN CONTROL MOTOR

TYPE AYLC 5091

24 Volts D.C. .7 Amp. 1 R.P.M., Torque 500 in. lbs. Contains two adjustable limit switches with contacts for position indication. Ideal for use as a remote positioner or beam or television antenna rotator. Will operate on 60 Cy. Complete with instructions. **\$6.50** Ea. Net

GENERAL ELECTRIC SELSYN

Type 2JIG1

Will operate from 110 volts, 60 cycle by using a resistor or a condenser in series. Size is 2¼" in diameter x 4¾" long. Ideal for beam position indicator.

Price **\$2.75**
per pair — removed from new equipment

INSTRUMENT ASSOCIATES
37 EAST BAY VIEW AVE.
GREAT NECK, N. Y.
IMperial 7-1147

The electron tube that rivals the human eye

Invention of the iconoscope—
TV's first all-electronic "eye"—led to
supersensitive RCA image orthicon
television cameras

No. 3 in a series outlining high
points in television history

Photos from the historical collection of RCA

● Had you attempted to invent a television camera from scratch, odds are you'd have followed the same path as early experimenters—and tried to develop it on mechanical principles.

Illogical? Yes, in the light of what we now know about electronics. But electronics was young in television's infancy. At that time the best way to take television pictures was with a mechanical scanning disk, invented in 1884.

Revolutionary was the invention of the *iconoscope* by Dr. V. K. Zworykin, now of RCA Laboratories. Here was an all-electronic "eye" for the television camera... no moving parts, no chance of mechanical failure!

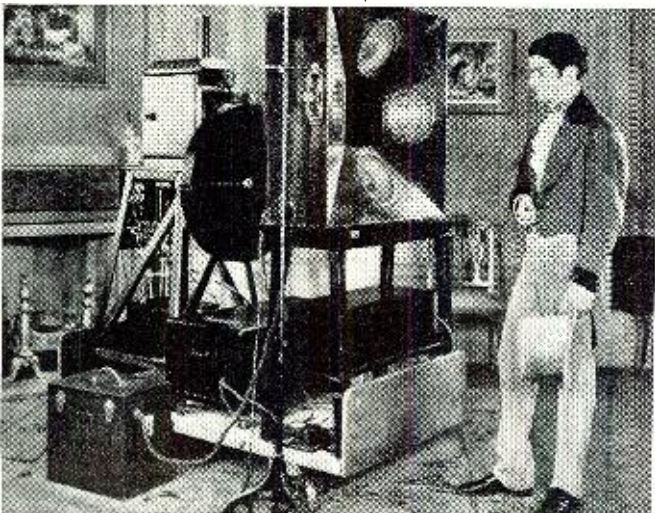

Mechanical scanning equipment, used at RCA-NBC experimental television station W2XBS in 1928, long before the present RCA image orthicon camera came into existence.



Dr. V. K. Zworykin of RCA Laboratories with his iconoscope tube. Its successor, the image orthicon, has been developed by RCA scientists to have up to 1000 times greater sensitivity.

Carrying forward the development of television pickup tubes, RCA scientists have developed the image orthicon—eye of today's supersensitive RCA image orthicon television camera. So keen is this instrument's vision that it sees by candlelight or by the faint flicker of a match.

Despite its simplicity of operation, the RCA image orthicon tube is a highly complex electronic device. Integrated, within its slim 14-inch length, are the essentials of 3 tubes—a phototube, a cathode ray tube, and an electron multiplier!

The phototube converts a light image into an electron image which is transferred to a glass target, and scanned by an electron beam to create a radio signal. The electron multiplier then takes the signal, and greatly amplifies its strength so that it can travel over the circuits which lead to the broadcast transmitter.

Inside the tube itself, more than 200 parts are assembled with watchmaker precision. For example, a piece of polished nickel is pierced with a hole one-tenth the thickness of a human hair... a copper mesh with 250,000 holes to a square inch is used... and the glass target is bubble-thin! Yet all are assembled and made to work—at RCA's Lancaster Tube Plant—with precision.

Actually 100 to 1000 times as sensitive as its parent the *iconoscope*, RCA's image orthicon pickup tube literally rivals the human eye. And when an outdoor telecast may start in daylight and wind up in the dim light of dusk—that's a necessity!



Radio Corporation of America

WORLD LEADER IN RADIO—FIRST IN TELEVISION

(Advertisement)

POSITIVE PROTECTION

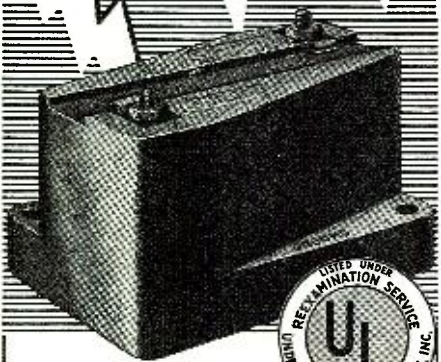

Approved by Underwriters Laboratories Inc.



VEE-D-X TWIN LEAD LIGHTNING ARRESTOR

1. For outdoor or indoor use
2. High frequency — low loss
3. Easy to install
4. Unnecessary to cut transmission line for installation
5. Unnecessary to change spacing of transmission line
6. Does not vary impedance
7. High dielectric — low loss plastic material. Will not absorb moisture.

\$2.00 list

The Pioneer Lightning Arrestor for Television and FM

VEE-D-X

VEE-D-X means video distance

LA-POINTE-PLASCOMOLD CORP., 3 Unionville, Conn.

Please send me further information about your TV antennas and accessories.

Name _____

Address _____

City _____ Zone _____ State _____

International Short-Wave

(Continued from page 62)

less you *know* who it is—as occasionally very tiny-powered stations peak in quite strongly at periods and are stronger than stations using many times their power. When I first started listening, I passed over Nairobi on 6.05 for many weeks as I thought by its strength and programs it was a BBC short-wave outlet!"

* * *

Club Notes

England—J. Whitehead, editor of "QRP" for the International Short Wave League, London, writes that "QRP" is dedicated to the advancement of low-power radio. I am anxious to include occasional notes on QRP conditions, activities, and other points of interest connected with QRP in America." Mr. Whitehead would like to contact someone in America who is interested in low-power radio to send him notes on developments in America in this field. His QRA is J. Whitehead, 6, Abbot's Tilt, Hersham, Walton-on-Thames, Surrey, England.

USA—The Newark News Radio Club will hold its 1950 annual convention on Sunday, June 25, at the home of Vice-president and Mrs. Harold Robinson, Lansdale, Pennsylvania. The Convention Committee is headed by Mr. Robinson and Director Dick Daneker.

* * *

This Month's Schedules

(NOTE: Some stations will be going on Summer Time soon; in such cases, schedules may be *one hour earlier* than listed herein.—KRB)

Albania—ZAA, 7.845.5, Tirana, noted

1515 with news* by man; heavy CWQRM at times; musical program 1545; signed off 1602. (Oskay, N. J.)

Andorra—Radio Andorra, 5.985, is now announcing its frequency at closedown 1900; signal much improved lately but still has bad CWQRM after 1820. (Balfe, Mass.)

Angola—Nova Lisboa, approximately 9.245, is heard around 1400 to sign-off 1504; mentions "Radio Club do Huambo"; closes with Portuguese National Anthem. (Hankins, Pa.) *I would like to know the correct call of this station; it has been reported to me in various combinations.*

Antarctic—Vandecar, Mich., has received a letter from the Norwegian-British-Swedish Antarctic Expedition to the South Pole which stated: "Base will be busy until April; after that will be working as an amateur on 7-, 14-, and 28-megacycle bands, with call LA40C; operator's name is Rockstadt; *he speaks good English.*" Signed by E. W. Walton.

Argentina—Stark, Texas, says the Latin station heard on approximately 5.985 is Buenos Aires; LRS1, "Radio Splendid," is listed on 5.986.

By this time, LRU, 15.29, was to have inaugurated broadcasts in Swedish and German, in addition to languages scheduled earlier; time for these additional languages was unknown at press time. (Serrano, Brazil)

All Argentina stations are required by law to mention the year 1950 as "The Year of the Liberator, General San Martin"; SRI is now transmitting many programs about the life of General San Martin, liberator of Argentina, Chile, and Peru, who died 100 years ago. (Serrano, Brazil)

Australia—At the time this was compiled, Radio Australia was using

This ingenious machine for aircraft communications records up to 28 sound tracks on a single magnetic paper tape less than three-quarters of an inch wide. Engineered by The Brush Development Co. of Cleveland, the new unit is hailed as a great advance for aviation safety. For the first time it makes possible a permanent record of all communications between pilots and control towers, thus permitting a detailed study of factors leading to air crashes. The unit was introduced to the aviation industry at the recent National Airways Communications Conference held in Cleveland.

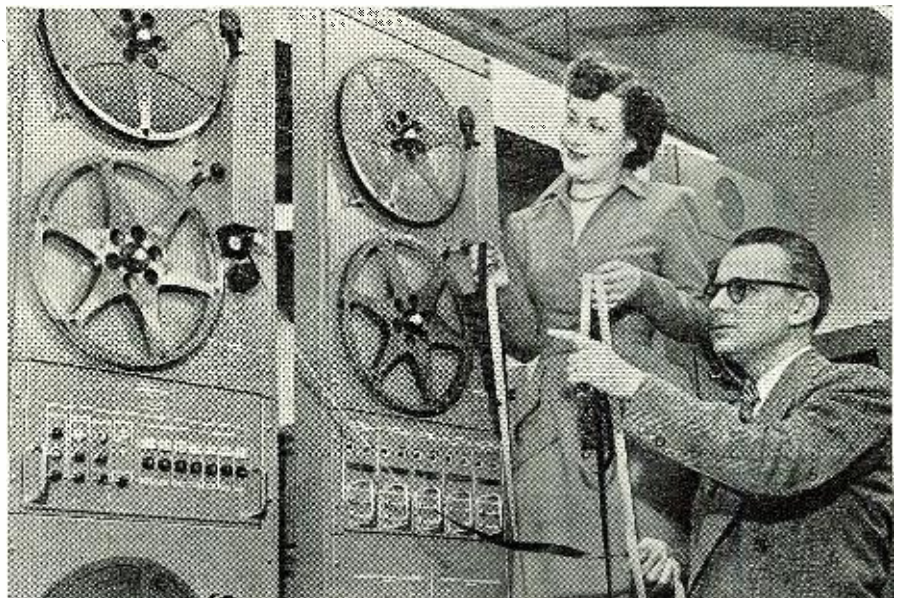

POOR PLATT!

HE'S GIVING EVERYTHING AWAY BUT HIS PANTS

SPECIALS-OF-THE-MONTH CATHODE RAY TUBES

- 3CP1 59c
 - 801A 39c
 - 211 39c
- In lots of 10—10% off



Everything—but everything—MUST GO! That's why Platt's priced these items so low that he's practically giving them away. BUT ACT NOW—ORDER TODAY—because the supply will go FAST!

TUBES

Standard Brands All New Tubes

- 304TL \$1.95
- 5BP4 2.45
- 872A 1.19
- 10Y39
- 24P1029
- 4CP1 2.25
- 832A 4.89
- 725A 6.95
- 726A 13.95
- 316A39
- 162539

BEACON RECEIVER BC-1206-C

Manufactured by Setchell-Carlson

Frequency Range—195 KC to 420 KC. IF Frequency—135 KC. Receiver Sensitivity—5 Microvolts for 10 Milliwatts output. Output Impedance—300 Ohms and 4000 Ohms to be selected internally. Power Output—24.0 Milliwatts. Volume Control—RF Gain Control, Power Supply—24-28 Volts AC or 1.50 Battery. Current—.75 Amperes. BRAND NEW—ONLY

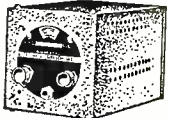

\$6.95

GN-45 HAND GENERATOR

6 Volts, 3 Amps
500 Volts, 0.14 Amp

Used with Signal Corps Radio Set SCR-284. Has many applications. Brand New. Original Packing.

ONLY \$12.95



RECONDITIONED SCR-522

With New Components

Very High Frequency TRANSMITTER-RECEIVER

100-156MC, 4 Channels. Crystal Controlled. Amplitude Modulated Voice. Electrically Tested. Complete as shown

Only \$79.50



COUNTER

20 POUNDS OF ASSORTED RADIO PARTS



Transformers, Chokes, Wire, Condensers, Knobs, Sockets, Switches, Dynamotor. **ONLY \$2.39**

100 ASSORTED RESISTORS

Non-insulated, various ohmage and wattages.



SPECIAL 97c

KIT OF 15 CONDENSERS

Bathtubs and Electrolytics.

NOW 98c

Multitester Foundation BIAS METER 1-97A

Contains a zero center 3 1/4" round Marlon voltmeter calibrated 0-100 volts each side. Movement is one mill each side of center. The unit is mounted in a steel box 7" x 5" x 4 1/2" and contains 8 condenser push buttons. Line cord dual 100 MFD at 200 V DC condenser, a potentiometer 8 1/2% wire wound non-inductive resistors; one 400 ohm, two 250 ohm, one 5000 ohm, one 10,000 ohm, one 15,000 ohm.

Excellent for building a zero center multitester with ranges of 1, 10, 100, 1000 volt.

COMPLETE BRAND NEW **\$3.95**



BC-223 TRANSMITTER



30 Watt Transmitter with crystal or MO control on four pre-selected channels, 2000 to 5250 KC, by use of three plug-in coils. Five Tubes: 2-801 & 3-46. With TU-17, SCIT-634 and SCIT-284. Complete. New Condition. Prices Sent Upon Request.

Specially Priced.

BRAND NEW. Only **\$25.95**

- BC-348 Receiver—NEW \$165.00
- BC-224 Receiver—Excellent Condition 135.00
- BC-342 Receiver—Excellent Condition 135.00
- BC-221 Frequency Meter—Excellent Condition 79.50
- BC-939 Antenna Tuner for BC-610. NEW..... 75.00
- SCIT-634 and SCIT-284. Complete. New Condition. Prices Sent Upon Request.
- MN-26C Compass Receiver. NEW 29.50
- 433G Compass Receiver—Excellent Condition 39.50
- ARNT Compass Receiver—Excellent Condition 49.50
- 735D Localizer Receiver—NEW 8.95

DYNAMOTORS

Dynamotor for DY-12 Power Supply for ART-13 Only **\$7.95**

Type DM-33-A, in. 28 V. out. 540 VDC, 250 mills. Brand New 1.95 (Excellent—Used \$1.25)

Type DM-53-A, 24 V. in. 220 V, 80 MA out. Brand New 4.95

INVERTER—PE-206, 28 V. in. 80 V at 500 VA, 800 cy. out. Brand New 3.25

BD-77 Used 5.95

DM-32 Used 7.95

PE-94C New 5.95

PE-73C New 3.95



FILTERS

FL5 Lazy Q Radio Filter Unit, high impedance, NEW \$0.75

FL8 Filter. Good Condition 1.29

SELSYN INDICATOR

For use with beam antennas for indicating direction of antennas. I-S2-B, 5" type. Now **\$4.95**



FIELD TELEPHONES

Army surplus, completely reconditioned and electrically tested. LIKE NEW. **\$8.95** Only



TYPE MN-20E ROTATABLE LOOP UNIT

8" diameter, used with MN-26 Compass and RA 10DB. Manufactured by Bendix.



A TERRIFIC BUY! **\$11.95** ONLY

HEADSETS—Excellent Buys!

HS-33 with cord and plug, used, good condition \$1.19

HS-23—Brand New with ear pads 2.75

HS-33—Brand New with ear pads, cord and PL54 plug 2.75

TH-37A—1200 ohms with dual plugs 2.95

HS-16A—520 ohms 2.95



CORDS AND PLUGS

CD 508A Cord Assembly with SW 14-U Switch and 2 cord attachments with JK 48 Jack and PL 68 Plug. Value—\$5.00. Our Special Low Price, Brand New 59c

CD 307A with PL 55 and JK New 59c

JK 26 Jack with cord, good condition 12c

JK 26 Jack only—Brand New 8c

PL 55 Plug—NEW 35c

PL 68 Plug—NEW 15c



VISIT THE NEW PLATT STORE AT 489 BROOME ST., N. Y. C.

PLATT ELECTRONICS CORP.

DEPT. A, 489 BROOME ST., NEW YORK 13, N. Y.

PHONES: RE 2-8177 and WO 4-2915

MICROPHONES

- T-24-G, 200 ohms, single button, 8 ft. rubber cord with PL-106 Plug and JK 38 Jack. BRAND NEW. **\$1.95**
- T-17-B, Handheld carbon microphone for use in voice communication. Effectively covers the audio frequency range from 300 to 2800 CPS. 200 ohms, wide press-to-talk switch, 5 ft. rubber cord and plug. NEW \$1.95
- T-30 Microphone suitable for aircraft use. Responds to frequencies in the range of 400 CPS to 2000 CPS. Complete with cord and plug. Original Packing. NEW 1.29
- T-36-C Hand Carbon Microphone, 24 ft. cord, 3 contact amphenol plug. 2.95



OIL FILLED CONDENSERS

- Famous Make TJH 50020, 2 MFD, 5000 VDC. \$4.25
- Nationally Advertised, 2 MFD, 600 VDC.29
- Famous Makes, 4 MFD, 600 VDC79
- Highest Quality 23F47, 2 MFD, 4000 VDC. 3.25
- Highest Quality 23F47, Mu-f, 6000 VDC.25
- Highest Quality 23F47, Mu-f, 90 V, 3 Phase, 60 cycles 1.19
- Mica Capacitor, type G1 ceramic .04 1000 Volts, 25 amps at 1000 KCS. 1.29
- Type DT-4W1, CAP. 1 MFD, 400 Volts. Tubular, Box of 25 2.98



274-N COMMAND EQUIPMENT

Sensational Buys!	USED	BRAND NEW
BC-442 Remote Control	\$ 1.85	\$ 2.75
BC-450, 3 Receiver	.89	1.95
BC-453	12.95	21.95
BC-454	4.95	6.95
BC-455	6.95	9.95
BC-456	1.95	2.95
BC-437	5.95	7.95
BC-458	5.95	24.95
BC-459	1.95	2.95
BC-696	14.95	24.95
3 Receiver Rack	1.35	2.35
2 Transmitter Rack	1.50	



TRANSMITTER-RECEIVER

Conversion of BC-645 Bringing Excellent Results.

Navy Model ABA-1 (CG-43AAG)

Army Model SCR-515A known as the BC-645

450 MC—15 Tubes

BRAND NEW—ORIGINAL CARTON. Can be easily converted for phone or CW 2-way communication. Covering for the following bands: 420-450 MC ham band, 450-480 MC for fixed or mobile, 460-470 MC for citizens, 470-500 MC television experimental. Size 10 1/2 x 13 1/2 x 4 3/4. Contains 15 tubes: 4-7F7, 4-7H7, 2-7Z6, 2-6F6, 2-955, 1-WE-316A door knob. Complete as shown above. only \$17.95



- BC-645 ANTENNA. only **39c**
 - BC-645 TRANSMITTER-RECEIVER. **\$12.95**
- Immediate Delivery—Send 25% deposit on C.O.D. orders. All shipments F.O.B., N.Y.C. (N.Y.C. residents add sales tax to your remittance.)

SURPLUS RADIO CONVERSION MANUAL IN TWO VOLUMES

THE ONLY BOOKS OF THEIR KIND

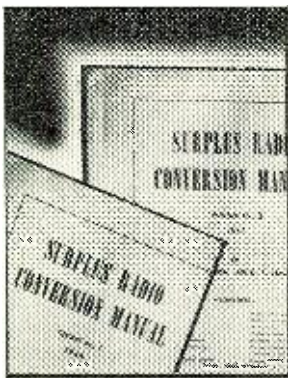

Now available is this set of reference data which has become standard for most commonly used items of surplus electronic equipment. All conversions shown are practical and yield a useful item of equipment; all have been proven by testing on several units.

VOLUME I

BC-221 Frequency Meter
 BC-342 Receiver
 BC-312 Receiver
 BC-345 Receiver
 BC-412 Oscilloscope as a test scope or as a television receiver
 BC-645 420-Mc. Transmitter/Receiver
 BC-453A Series Receivers
 BC-457A Series Transmitters
 SCR-522 144-Mc. Transmitter/Receiver
 TBY Transceiver with Xtal Control
 PE-103A Dynamotor
 BC-1068A V-h-f Receiver
 Electronics Surplus Index
 Cross Index of VT-Number tubes

VOLUME II

ARC-5 and BC-454 Receivers for 28 Mc.
 ARC-5 and BC-457 Tx for 28-Mc. Mobile
 AIR-13 and ATC Xmitter
 Surplus Beam Rotating Mechanisms
 Selenium-Rect. Power Units
 Hi-Fi Tuner from BC-946B Receiver
 ARC-5 V-h-f Transmitters
 GO-9 and TBY Xmitters
 9-W Amplifier from AM-26
 TA-12B & TA-12C Xmitters
 AVT-112A Aircraft Xmitter
 BC-375 & BC-191 Xmitters
 Model LM Freq. Meter
 Primary Power Requirements Chart
 ARB Recr. Diagram Only

\$2.50

FOR EITHER VOLUME AT YOUR DEALER
 By mail, \$2.60 (plus any tax)



RADIO AMATEUR NEWCOMER

Ideal for those just getting started (or interested) in radio. You need no other book to get your license and get on the air. How-to-build simple equipment for a complete station; operating instructions; simple theory; study questions needed to pass license exams; U.S.A. Amateur radio regulations. WRITTEN BY THE EDITORS OF "RADIO HANDBOOK."

\$1.00

AT YOUR DEALER — On mail orders from us, \$1.10 postpaid. Add sales tax in California.



WORLD'S RADIO TUBES (Radio Tube Vade Mecum)

The only book of its kind in the world. 18 languages with more than 15,000 tubes listed. The most complete set of tube data in existence. Many carefully prepared charts. Tube characteristic data of U.S., British, French, Czech, German, Swiss, Australian, Italian, Russian, Japanese, Scandinavian and all other available types... all in one book!

\$3.00

AT YOUR DEALER — On mail orders from us, \$3.20 postpaid. Add tax in Cal. Foreign, \$3.35

OTHER U. S. A. ELECTRONIC BOOKS: You may order from us any such currently advertised book at standard prices; we maintain extensive stocks for prompt shipment.

"SURPLUS" DIAGRAMS: We can furnish schematics of many surplus electronic items not included in our Conversion Manuals. Send stamp for list.

FOREIGN RECEIVER SCHEMATICS: We can furnish schematics for most foreign-made receivers at \$2.00 each (including air mail from Europe to you). No list available, but \$1.65 refunded if we cannot furnish promptly.

Editors and Engineers
 1302 KENWOOD ROAD, SANTA BARBARA, CALIFORNIA

VLC5, 9.54, to East Coast North America 0700-0900, and to Central North America 0900-0945; VLC7, 11.81, was still in use, however, to West Coast North America 1000-1115. A 25-m. outlet (most likely 11.81) was to be added soon for the period 0700-1000. For the 1643-1815 beam to Eastern North America, VLA6, 15.220, has been put into use, fine signal.

V LX, 4.897, Perth, is good level in Delaware 0700. (Cox) Is good signal here in West Virginia at 0800 when relaying BBC news.

Austria—Pearce, England, says the Blue Danube Network seems to vary around 9.533 to 9.560; has been heard 0600-0700 and at other times.

Belgian Congo—Leopoldville, 11.645, requests reports on its new transmission to Belgian seamen 1630-1845. (DX Journal) This transmission is in French, in parallel with 9.767. (Grove, Ill., others)

Belgium—Ruysede, 17.845, heard recently at 1100 calling Leopoldville; at 1115 was buried by CKNC, 17.82, Canada, and WCBX, 17.83, U. S. (Drummond, N. J.)

Brazil—The Police Department of Rio de Janeiro station is now on a new channel of 9.290 and with a new call PRN9 (formerly PYZ2); transmissions are daily except Sunday 1730-1830 (approximately). A new station on 4.115 has just been identified as Radio Difusora Acreana, Rio Branco, capital of the Territorio do Acre: this Federal Territory lies on the border of Brazil and Peru, has an area of 148,000 sq. km. and a population of 80,000; it produces rubber of high quality. Rio Branco signals are quite weak, due to terrific QRN on the band; heard best around 1920 with news in Portuguese, followed by music. (Leven, Brazil)

Radio Ministerio da Educacao, Rio de Janeiro, PRL4, 9.77, 1 kw., has severe CWQRM in daylight and is QRM'd by OTC2 at night. (Serrano, Brazil)

Burma—A station believed to be Radio Mandalay (may be Communist-controlled?) is heard by Cushen, N. Z., on 7.370 with news and messages in English from residents in North Burma at 0630-0700. (Radio Sweden)

Canary Islands—Tenerife, 7.520, closes 1800 with "Viva Franco!" (Aberg, Sweden)

China—Short Wave News, London, lists QRA of Peking Radio as 3 Chang An Tse Kai, Peking, China.

At the time this was compiled, the Chinese Communist outlet heard earlier on 6.100 had reappeared but on a lower channel of approximately 6.090 where it suffers QRM; carries Peking news relay 0830; this outlet is not announced and location is not known definitely as yet. Has been heard by Balbi, Calif., in phone contact with Nanking, 9.735, around 0230-0330, and in contact with Peking, 10.26, as late as 1115.

Darien, 7.100, is again audible with news relay from Peking 0830; is just above Jogjakarta, Indonesia, both

The BROOK High Quality AUDIO AMPLIFIER

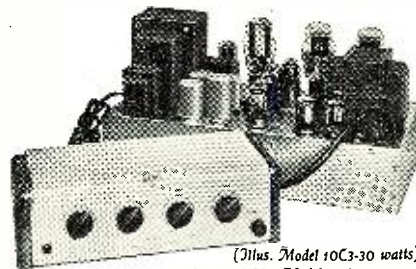

(Illus. Model 10C3-30 watts)
 Also available: Model 12A3-10 watts.

All Low Mu Triodes Plus Brook made Transformers Plus Brook's own Circuits	}	=	Finest Audio Quality you ever listened to Minus Listening Fatigue Plus High Quality at extremely low volume Plus High quality at the full loudness of a band or symphony
---	---	---	--

"You can believe your ears when you listen with a Brook Audio Amplifier"

Write TODAY for FREE Technical Bulletin and Detailed Distortion Analysis

BROOK ELECTRONICS, Inc.
 Dept. RD-0, 34 DeHart Place • Elizabeth, N. J.

THE ORIGINAL And Still the BEST Design...Still the BEST Money-Maker



APPROVED!

for OUTDOOR-Indoor Use!
JFD SAFE TV GUARD
 Twin Lead
Lightning Arrester
 Protects Television Sets Against Lightning and Static Charges **\$225** LIST

Can be mounted directly on mast by ingenious strap fastening arrangement. No special hardware or tools necessary.

SIMPLE TO INSTALL...attaches to any grounded object—pipe, radiator, roof, wall—at any position between antenna and set, Outdoor or Indoor. All hardware furnished.

NO WIRE STRIPPING or CUTTING or SPREADING of lines necessary.

CONFORMS with Fire Underwriters and National Electrical Code requirements.

LOOK for the JFD Trademark!

JFD MANUFACTURING CO., Inc.
 6105 16th Avenue, Brooklyn 4, N. Y.
 First in Television Antennas & Accessories

RADIO & TELEVISION NEWS



Control console of Radio Tahiti's modern station. Higher powered transmitters are reportedly under construction at present.

claim 7.100, but one must be off about 3 kc. (Dilig, Calif.)

Peking, 1026, is usually buried in QRM mornings here in West Virginia but occasionally the news 0830 can be read; is good level signing on 1800 with long march-anthem but is soon buried in QRM.

Colombia—HJEX, 6.053.4, Cali, noted with good signal at 1845 with English grammar lesson transcribed from BBC. (Oskay, N. J.)

Cyprus—Sharq-al-Adna heard on 11.720 from around 0930 to 1150; heard also on 6.790 and 6.135 afternoons to sign-off 1506 after news in Arabic at 1500.

Denmark—Gerran, N. Y., reports OZU, 7.260, "Danmarks Radio," listed 6 kw., heard on a Sunday 0430, probably with Home Service. Radio Sweden reports this outlet heard to 1730 sign-off carrying domestic programs.

Dominican Republic—HI4T, 5.970, Ciudad Trujillo, in parallel with HI2T, 9.735, now closes 2300. (Grove, Ill.)

Egypt—SUX, 7.863, Cairo, is heard some days around 1555 to sign-off 1620; has bad QRM. (Ferguson, N. C.) Heard by Hagen in Ala. at 1730-1800 recently when had five pips followed by the announcement, "Huna El Kahera," then anthem.

Patrick, England, confirms that two high-powered s.w. transmitters have been ordered by the Egyptian State Broadcasting System from a well-known British firm, for installation at a new station now under construction at Abu-Zabal, 12 miles from Cairo.

Ethiopia—Radio Addis Ababa, "The Voice of Ethiopia," has been heard on approximately 15.035 in Britain on Sundays with missionary broadcasts such as "Voice of Prophecy" and "Hymns You Love to Hear," around 1000-1115; weekdays has been heard with English 1020-1100; announces as operating in the 19-, 31-, and 49-m. bands. (Pearce, England)

Finland—Peddle says Helsinki's 17.800 outlet puts in a good signal in Newfoundland at 0715 with news.

Formosa—Taipei recently moved to the old Chungking channel of approxi-



A TERRIFIC SCOOP!!!

FL-8 FILTER BRAND NEW BOTH FOR

"FILTER FACTS" BOOKLET 98¢

An amazing combo offer made possible by a quantity purchase at a low price... a highly effective audio filter to reduce noise and interference and a big "plus," our exclusive booklet, "FL-8 FILTER FACTS," to tell you the complete FL-8 story! At this price you can't miss—get yours now!

Power Supply for Any 274-N Receiver



Here it is—at last! Just plug it into the rear of your 274-N RECEIVER... any model! Complete kit, and black metal case, with ALL parts and diagrams. Simple and easy to build in a jiffy. Delivers 24 volts plus B voltage. No wiring changes to be made. Designed especially for the 274-N receiver. All necessary parts for conversion of rest of receiver also included. ONLY \$7.95. TUNING KNOB for 274-N Receiver, 59c ea.

NOISE LIMITER FOR ANY 274-N RECEIVER

Use this effective double-diode circuit between receiver output and phones to clip positive and negative noise peaks! Fully adjustable for wide audio levels. Simple—effective. Kit form, aluminum chassis, tube, all parts, complete instructions.

NL-GR (6V. fil.).....\$4.20
NL-24R. (24V. fil.).....\$4.58

CONDENSER TESTER

One of our best sellers! Useful, versatile laboratory item, in kit form. Simple, and easy to build in less than an hour. Checks condenser leakage and continuity up to 8 megohms. Will test any paper, electrolytic, mica or oil capacitor from 50 mmf. to 50 mfd. Self-contained power supply and neon bulb indicator with socket and bezel. Drilled metal cabinet. Complete instructions and diagrams included with each kit. Only \$4.85.



6L6 METAL. .90c ea. Four for \$3.40

6L6 GLASS. .79c ea. Four for \$3.00

BRAND NEW... STANDARD BRANDS

HANDESET HANGER



Accommodate all makes and models, (Kellogg, W. B. American etc.) Beautiful, cast aluminum shell finished in rich black wrinkle. Felt facing protects handset. Provision to fasten directly to desk or to telephone equipment. An extremely useful, well-made item.....\$1.95 ea.

TS-10 Sound Powered Handsets

Brand New! \$16.95 per pair

RM-29A TELEPHONE: Brand New...\$12.95 ea.

EE-89A TELEPHONE REPEATER: New.....\$9.95 ea.

EE-8 Telephones. Used, good condition. Tested before shipping.....\$8.95 ea.; \$16.00 pair



R-1/ARR-1 RECEIVERS

See January "Radio News" for dope on making a fine converter from this receiver. Clearance price! Now, only.....\$6.95

Push-Button Tuner

P-B tuner assembly from P-C-603. Has ten PB with adjustable cams, 50 mmf variable and 10 air trimmers. A precise unit with many uses. Trimmers alone worth far more than the asking price. Brand new, original packing. Only \$1.95 ea.



A SCOPE FOR A SCOPE!

Beautiful 5" cathode-ray tube, Type 5NP1. Green phosphor, medium persistence, standard type, 6.3V heater. Here is the heart of a good scope... at a scoop price, \$2.50 each



\$2.50 Each

OR... A SCOPE COMBO OFFER...

Use the following basic parts to make a good, simple scope suitable for checking modulation and dozens of other tests and measurements. Circuit is furnished.
1—5NP1, C/R tube.
1—Hi-voltage transformer with heater windings for 5NP1 and 2X2 rectifier.
1—2X2 hi-voltage rectifier tube.
All three of the above items (with circuit) only...\$7.45

FONE PATCH!

Now available, the superior new O-R, #6008 phone patch. Provides you with exactly what you need to patch your phone into transmitter or receiver. Featuring a hi-impedance input suitable for all make. Both hi and lo impedance outputs to insure proper match to your particular receiver. Unit is complete—"sure-fire" ready to go to work for you. Only.....\$3.95 ea.



HEAVY-DUTY FILTER CHOKE

A hermetically sealed unit, conservatively rated at 10 henries @ 200 ma. Has hum-bucking tap. Steel cases—ONLY \$1.98 each.



HOT SPECIAL ON OIL CAPACITORS

8 mfd., 1000V, oil-filled. Made by Aerovox. Rect. case grey finish, complete with mounting brackets.

4 mfd., 600V, oil-filled. Round case, upright single-hole mounting. With mfg. hardware.....95c ea.; 5 for \$3.75



COMPLETE POWER SUPPLY—COMBO OFFER

1—Filter choke.....(as above).....\$1.95 ea.; 5 for \$8.95
2—4 mfd., 600V condensers. Oil-filled
1—Power transformer. Pri. 110V, 60 cy. AC. Sec. 730V, AC. CT. @ 200 ma. 5V @ 6A. 6.3V @ 8A.
1—5U4G rectifier tube.....\$1.95 ea.
All of the above items only.....\$6.95



ALUMINUM CHASSIS

A beautiful little drawn, .025" aluminum chassis, 3 1/4" long, 3 1/8" wide, 1 7/8" deep. Bright-dipped finish. U's e for RF stages, TV filters, amplifiers, etc. Only 49c ea.; 3 for...\$1.35

RU-16 RECEIVERS

With conversion sheet.

With 3 coils, used, good condition. Only \$ 4.95

NEW, with 5 coils and plug.....16.95



HS-16 HEADPHONES

This medium impedance headphone is without doubt the best buy in surplus phones! Only.....\$1.35 ea. Postpaid in U.S.A.

HI-LEVEL NEGATIVE PEAK CLIPPER! 836 RECTIFIER TUBES

Use an 836 high-vacuum, high-voltage rectifier tube, ideal for "clippers"—no "hash" troubles. Same tubes also used to replace 865's in normal, high-voltage rectifier applications. Rock-bottom price on a really "hot" tube, 2 for \$1.10

High-voltage Filament Transformer for "Clipper" or Rectifier applications. Pri. 110V, 60cy. AC. Sec. 2.5V @ 10A, 10,000V insulation.....\$2.76 ea.

AN-75-D WHIP ANTENNA

A great buy for you mobile men. 7'3" collapsible to 14". Has 9 sections—corrosion-proof brass. Sturdy bakelite mount with jiffy wing-nut fastener. These sold formerly at \$2.50 ea. Now, BRAND NEW, only.....\$1.95 ea.

NARROW-BAND PHASE OR FREQUENCY MODULATION FOR YOUR XMTR

These highly effective O-R, NFM and NPM units offer you a sure-fire means for adding modulation to your xmtr, lo-power or a full KW. They come to you in complete kit form—aluminum chassis completely punched—tubes, parts, full instructions. Assure yourself of positive results at fractional cost of other units. Use FM-3R on your 1200 for full swing on all bands. Use PM-3R if ECO starts at 160—won't change osc. calibration. Either one will give excellent results and represents a typical O-R top-dollar value.
FM-3R—NFM—FM kit. Complete.....\$8.45
PM-3R—NPM—PM kit. Complete.....8.45

* 4-HOUR MAIL-ORDER SERVICE. WE SHIP ANYWHERE.

20% DEPOSIT MUST ACCOMPANY ALL ORDERS. BALANCE C.O.D.

OFFENBACH & REIMUS CO.

372 ELLIS ST. SAN FRANCISCO, CALIF.

'PHONE—ORway 3-8551

CANNON PLUGS
Quality
in Every
Part
"AN" SERIES

EXPLODED VIEW

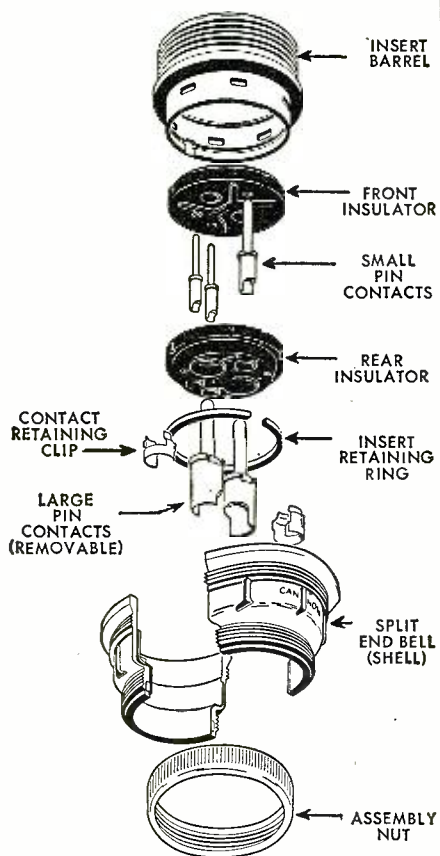

TYPE AN3101B
 CABLE CONNECTING RECEPTACLE

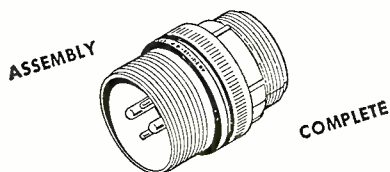

One of six shell types in the "AN" line: AN3100A, AN3102A, AN3106B, AN3107B, AN3108B.

Cannon Electric Development Company, Division of Cannon Manufacturing Corporation, 3209 Humboldt St., Los Angeles 31, California. Canadian factory: Toronto. World Export: Frazer & Hansen, San Francisco, New York, Los Angeles.

SINCE 1918

CANNON ELECTRIC

REG. U.S. PAT. OFF.

mately 7.150 where it has news around 0610; good signal here in West Virginia at that time but it soon is buried in ham and c.w. QRM. Schedule is around 0500-1130. Calls seems to be BED2, BED4, BED7, and m.w. BED24. Oskay, N. J., has measured this one as 7.151.5.

Sanderson, Australia, airmails she is still hearing BCAF on 8.996 at 0545 with Chinese-English lesson, then Western music.

France—Widely reported is a Paris high-powered transmitter testing in French, English, German, and perhaps other languages on approximately 6.034 around 2330, giving QRA as Manager, Civil Aeronautic-Telecommunication Signals, 155 Rue de la Croix Nivert, Paris 15, France; asked for detailed reception reports; strong signal. Also reported heard around 0645-0830 on 20.090.

Paris, 6.145, noted with strong signal 1600-1630 sign-off. (Oskay, N. J.)

French Equatorial Africa—Radio

Brazzaville, 11.972, noted on Sunday ending Mail Bag session (in English) at 1100.

French Indo-China—Saigon is reported moved from 11.780 to 9.524 where it has bad QRM from Hong Kong and South Africa.

Sanderson, Australia, reports FZS on 18.406 at 0605; news 0635, then Western music, chimes; she reports "Voice of Vietnam" on 9.670 at 0600 with recorded music, news 0615-0630, then news in Vietnamese; the "Voice of Vietnam" program is heard also in parallel on 7.205 which is the Radio Hue channel.

French West Africa—Bluman, Israel, says Radio Dakar appears to be testing a new transmitter irregularly on 15.340 around 1320-1700 in parallel with 11.896; the 15.340 outlet is not heard when the 11.896 transmitter reopens 0200.

Patrick, England, says Radio Bamako, FGJ9, 15.025, is now in operation with 2 kw., daily with weather

NEW AIR-SEA RESCUE TRANSMITTER-RECEIVER

THE Wright-Patterson Air Force Base at Dayton, Ohio recently unveiled a new air-sea rescue transmitter-receiver which is particularly outstanding because of its small size.

The unit, which was designed and developed by the Air Materiel Command's Communication and Navigation Laboratory, Electronics Sub-Division, is a miniaturized battery-operated unit which will, in time, become standard equipment for every USAF pilot and airman, replacing the old curvaceous "Gibson Girl." The unit is already in production in the Los Angeles plant of the Hoffman Radio Corporation and is the product of several years of research and labor on the part of the Wright Field and Hoffman engineers.

The new set, known technically as the URC-4, is small—not much larger

than a ration kit. It can be held in one hand. The mercury-type battery is a separate unit with a rubberized cable connection attaching it to the transmitter-receiver section. The cable is just long enough to allow the battery to be slipped into a pocket while the set is in use.

Operating on two channels, v.h.f. and u.h.f., the set can be switched from one to the other instantaneously. Technicians are impressed by its stability and by the fact that the midget set is able to transmit and receive both voice and code signals.

The mercury-type battery will not deteriorate with lack of use or with age, while the entire unit is completely impervious to salt water and is designed to withstand temperature extremes ranging from +160 degrees F. to -50 degrees F. -30-

The Air Materiel Command's answer to the problem of faster air-sea rescues is shown in a close-up view of the midget transmitter-receiver developed by the Electronic Subdivision at Wright Field. Known officially as the URC-4, the unit is being manufactured by Hoffman Radio Corp. of Los Angeles. (Right) J. S. Horrigan, the USAF's Air Materiel Command project engineer on the URC-4, is shown demonstrating how the battery of the midget transmitter-receiver can be slipped into the pocket of an ordinary flying suit.

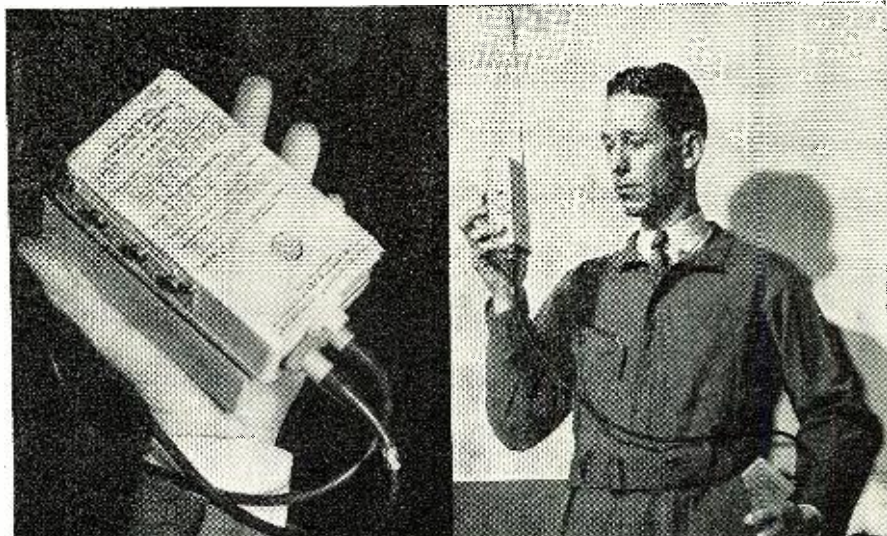

RADIO & TELEVISION NEWS

LOWEST PRICES TUBES and PARTS

29c ea.	1U4 2C26 2C34 3A4 6S8GT 01A 4A6G	6A3 10 12A 39/44 47 50 71A	112A 182B 183 25S 482B 483	1A4 1A4P 1A6 1B5 1D5GT 1D7	1D8GT 1F4 1F5G 1G4GT 1G6GT E1148 7193	1H6GT 1J6G 1619 1626 E1218 7193
-------------------	--	--	---	---	---	--

FREE! \$20.00 List Value
Cornell-Dubilier,
Mallory, Aerovox,
Sprague, Solar, Filter Condensers
—ten fast moving filters FREE
with each 100 tubes.

79c each	1B3GT 2A3 2A4 3D24 3Q5 6A7 6AK5 6BG6G 6E5 6G5 6U5 19BG6G RK-34 RK-39	50A5 307A 350B 371B 446A 615 707B 807 813 837 864 117L7GT 117N7GT 117P7GT
--------------------	---	--

39c ea.	1T4 5Y3GT 35W4	35Z5GT 6C4 6F8GT	6S7GT 6X5GT 14X7	25Z6GT 32 33 34	35 35Z4GT 36 37 38 39	46 57 VT-52 58 59 76	80 89 HY-615		
49c ea.	3Q4 3S4 3V4 5W4GT 5X4G 5Y4G 6AB4 6AC4 6AC5 6AC5GT 6AG5	6AL6 6AQ5 6AR5 6AS5 6AT6 6AU6 6A8G 6A8GT 6B6 6BA6 6BD6	6BE6 6BH6 6BJ6 6C5 6C8G 6D6 6F5GT 6F6GT 6G6 6H6 6H6GT	6J5 6J5GT 6J6 6J7G 6J7GT 6K6GT 6K7GT 6K8GT 6P5GT 6S4GT 6S4GT	6SG7 6SG7GT 6SH7 6SJ7 6S7GT 6SL7GT 6SK7GT 6SQ7GT 6SR7 6U6G 6U6GT	6U7G 6U7GT 6V6GT 6W4 6X4 6X5GT 6Z4 6A8GT 6A9GT 6A9GT 6A9GT	12AX7 12BA6 12BA7 12BE6 12F5GT 12H6 12J5GT 12J7GT 12K7GT 12K8GT 12S6G	12SA7GT 12SF5 12SF7 12SH7GT 12SN7GT 12SR7GT 1629 (eye) 24A 25L6GT 25X6	35B5 35C5 35Z6GT 50B5 50C5 50Y6 51 77 78 85 99

59c ea.	1LA4 1LE3 1Q5GT 1T5GT 1V 1C5GT OZ4 1A5GT	5V4 5Z3 5Z4 6A8 6AC7 6AJ5 6AK6 6AL5	6AR5 6AS5 6AV6 6B4G 6BA7 6B8 6C6 6D8	6D8G 6F5 6F8G 6K7G 6R7 6S8 6S5GT 6SN7GT	6SS7 6S7 6Q7GT 6T7G 6T8 6U7 6W7G 6Y6G	6Z7G 7E5 7E6 7E7 7F7 7G7 7H7 7J7	7C6 7E5 7E6 7E7 7F7 7G7 7H7 7J7	10Y 12A7 12A7T 12AV6 12BF6 12C8 12J5 12Q7GT	12SG7 12S7GT 12SK7GT 12SL7 12SQ7GT 12Z3 19T8	20 32L7GT 35/51 35L6GT 36 40 41 42	43 50L6GT 53 75 84/6Z4 117Z3 VR150 XXL
-------------------	---	--	---	--	--	---	--	--	--	---	---

69c ea.	1A3 1AB5 1AD5 1H5GT 1LA6	1LB4 1LC5 1LC6 1LH4	1LN5 1NSGT 1P5GT 1S4	2C34 2V3G 2X2 25Z5	35Z3 3LF4 4A6G 6B7 6L6 7C4	6BF6 6J8G 6LG6 6L6 7C4	6S7G 6SU7GT 7A8 7A8 7A8	7C5 12A6 12BF6 14A4 14A4	14A5 14A7 14AF7 14B6 14H7	14B8 14E6 14E7 14W7	14J7 14N7 14Y4 35Y4 45	2050 2051 50C6 70L7GT 9001 XXB
-------------------	--------------------------------------	------------------------------	-------------------------------	-----------------------------	---	------------------------------------	-------------------------------------	--------------------------------------	---------------------------------------	------------------------------	------------------------------------	---

Tube prices are for 50 tubes or more—may be assorted. Individually boxed—Standard factory guarantee.

50L6, 35Z5, 12SK7,
12SQ7, 12SA7... 5 tubes for **\$2.19**

1R5, 1S5, 1T4, 3V4 Battery
Tube Special... 4 tubes for **\$1.49**

10BP4
Picture Tube, Each **\$17.95** | 12LP4
each **\$24.95**

Miniature tubes 12AT6, 12BA6,
12BE6, 35W4, 50B5... 5 tubes for **\$1.89**

3-Way Portable Tube Kit, 117Z3,
1U5, 3V4, 1R5, 1T4... all for **\$1.99**

3S4, 1T4, 1S5, 1R5
... 4 tubes for **\$1.49**

1U4, 3S4, 1S5, 1R5
... 4 tube kit **\$1.49**

3Q4, 1T4, 1R5, 1S5
... 4 tube kit **\$1.49**

50A5, 35Y4, 14A7, 14B6,
14Q7... 5 tubes for **\$2.95**

Best Quality SPEAKERS Alnico 5 PM

10 or more
Each **5" - 95c - \$1.05**

2 1/2", 3", 4" - 95c - \$1.05

6"	\$1.49	\$1.59
8"	2.95	3.25
10"	4.25	4.50
12"	4.95	5.95

Utah Speaker Baffles—completely enclosed
for 8" speakers and smaller... ea. \$2.00

Jobbers: write for quantity prices.

FILTER CONDENSERS

Very best brands
Fresh stock

10 or more
assorted
5% discount

30-450 V with 20-20...
25 V... ea. 29c
8-8-450 V... ea. 39c
8-8-450 V-50-50 V... ea. 39c
8-8-450 V... ea. 39c
8-8-450 V-50-50 V... ea. 39c
10-10-450 V... ea. 43c
20-20-450 V... ea. 49c

150 Working Volts
10-10-150 V... ea. 24c
10-10-10-150 V... ea. 29c
15-150 V... ea. 21c
16-150 V... ea. 23c
20-150 V... ea. 25c
30-150 V... ea. 29c
40-150 V... ea. 29c
15-15-150 V... ea. 29c
20-10-150 V... ea. 24c
20-20-150 V... ea. 29c
20-20-150 V... ea. 29c

450 Working Volts
8-450 V... ea. 21c
10-450 V... ea. 24c
10-450 V w/20-20-25 V... ea. 29c
15-450 V... ea. 29c
20-450 V... ea. 39c
30-450 V... ea. 49c

BY-PASS CONDENSERS

100 Condensers assorted
in package... **\$5.95**

.001	ea. 6c	.0005	
.002	ea. 6c	.00025	
.005	ea. 6c	.00005	
.01	ea. 7c	500 mmf	} 600 V. 6C MICA 6C
.02	ea. 7c	250 mmf	
.05	ea. 8c	100 mmf	
.1	ea. 9c	50 mmf	

400-VOLT BY-PASS CONDENSERS
.05 mfd... ea. 6c
.2 mfd... ea. 8c
.25 mfd... ea. 10c
.5 mfd... ea. 15c

BUFFER CONDENSERS
.005 mfd. 1600 WV }
.008 mfd. 1600 WV } **15c** ea.
.01 mfd. 1600 WV }

VARIABLE CONDENSERS
Two gang for superhet or TRF... ea. **69c**

IF TRANSFORMERS

Standard Replacement
Regular size... ea. **29c**
Midget... ea. **35c**

Red Hot Vibrator Special. 4-prong, small
size Universal, fits 80% of all jobs... ea. **89c**

Jobbers: Write for quantity price.

4 PRONG VIBRATORS—VERY BEST BRANDS
Standard replacement—Sensational Value... **\$129** ea.

OCTAL SOCKETS... 10 for **49c**
MINIATURE TUBE SOCKETS... 10 for **49c**

Standard replacement crystal
cartridge. Each... **\$1.39**

Nylon 1J CARTRIDGE... \$2.59

WESTON DC VOLTMEETER 0-15, 0-600
volts, 500 microamp movement... **\$3.49**

Oscillator Coils for any 5 tube
AC-DC... **19c**

RF and Antenna Coils... **29c** ea.

Standard Broadcast Band... **29c** ea.

OUTPUT TRANSFORMERS
For 50L6,
etc. **39c** ea.

For 6V6, 6F6, 3Q5,
etc. **45c** ea.

UNIVERSAL OUTPUT TRANSFORMER SPECIAL
Up to 12 watts to any speaker... **98c** ea.
(while they last)

TV PARTS and ANTENNAS

TV Antennas:
Conical price leader with 8-ft. mast... \$5.75
World's Best Delux Conical with 9-ft. mast
and heavy cast fittings... 8.95
Hi-Lo folded dipole array, 8-ft. mast... 6.95
300-ohm line \$1.59 per 100 ft. \$14.95 per 1000 ft.
Horizontal output, RCA Type Flyback... \$3.45 ea.
Discriminator Transformers... \$1.17
TV Screen Filters with suction cups... 10"
—best quality IND. BOXED for 12"
highest re-sale value... 16"
1.95
2.55

SPECIAL—CONDENSER KITS

Kit of 25 BY-PASS CONDENSERS
best assorted brands and sizes... **\$1.75**

Kit of 50 BY-PASS CONDENSERS
very best, assorted sizes... **3.25**

Kit of 50 MICA CONDENSERS
complete... **2.79**

100 resistors—packed in a box IRC etc.
Best values only—1/2 watt, 1 watt,
2 watt... **\$1.98**

SELENIUM RECTIFIERS
Standard 100 mil.
Each... **79c**

PUSH-BACK WIRE 100-ft. rolls **39c** each

Special on No. 47 Pilot Lights Only—
100 Bulbs... \$3.95 Box of 10... \$4c

PILOT LIGHTS—100 BULBS \$490

Box of
10 bulbs.
No. 40 6-8 V. 15 Amps. | No. 44 6-8 V. 25 Amps.
No. 41 2.5 V. 50 Amps. | No. 46 6-8 V. 25 Amps.
No. 51 6-8 V. 20 Amps.

6-FT. LINE CORDS

Appliance Cord, up
to 1,000 watts, 1
rubber plug... **99c**
5 for

Good Rubber with
plug... **\$1.25**
10 for

Appliance Cord as
above, with
UL label 5 for **\$1.29**

Underwriters' Ap-
proved... **\$1.69**
10 for

APPLIANCE CORDS

Good Rubber with
plug... **\$1.25**
10 for

Appliance Cord as
above, with
UL label 5 for **\$1.29**

Underwriters' Ap-
proved... **\$1.69**
10 for

VOLUME CONTROLS
10 or more
Each **29c** **35c**

VERY BEST BRANDS
1/2 meg. or 1 meg. or 1/10 meg.
with switch—long shaft... **29c 35c**

2 meg. for battery sets—
switch, long shaft... **29c 35c**

1/2 meg., 1 meg., 1/10 meg. or 2
meg., long shaft, less switch **16c 19c**

PREMIER RADIO TUBE COMPANY
551 West Randolph St., Chicago 6, Ill.
Phone: Andover 3-1590
"Your Tube Source Since 1926"

**Rated accounts—10 days—all others 20% deposit
with order, balance COD. 50c handling charge for
orders less than \$5.00. All shipments FOB Chicago.
Prompt attention paid to foreign orders. ORDER
TODAY. Our parts and tubes are warranted to be
100% replacements for the prototypes in the listings
above. Satisfaction Guaranteed. To speed up deliv-
ery, sign your order and your remittance with the
same name. Ill. residents add 2% sales tax.**

CURRENT ADVERTISED PRICES APPLY.

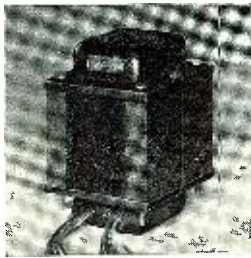

L-211

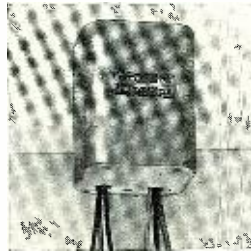

N-91

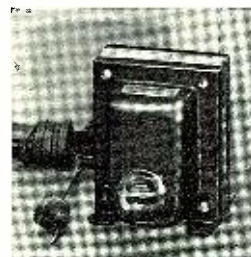

P-2040

The Halldorson Company
4500 N. Ravenswood Ave.
Chicago 40, Illinois

Complete TV and Radio TRANSFORMER SERVICE

• Select your exact requirements from over 300 standard types for replacement, amateur and laboratory work. A wide choice of special outputs, semi-universal and universal outputs . . . impedance matching units . . . powers, vibrators, filaments and chokes. A complete ham line . . . special application units . . . one of the most comprehensive transformer lines available to the service trade today.

TELEVISION L-211—Power—365-0-365V., 250 M.A.
D.C.—5V., 3A.—5V., 2A.—6.3V., 6A.—6.3V., .8A.
One of a growing line of dependable Halldorson TV units, available in exact duplicates and for general application.

AUTO VIBRATORS N-91—6V. to 250V., 50 M.A.
Available in exact duplicates and for general application.

STEP DOWN P-2040-230V. to 115V., 1000 Watt.
Supplied in capacities from 65 to 1000 Watts.

Sold by Leading Parts-Jobbers, Everywhere.
Every Halldorson Unit Is Triple Inspected and
Guaranteed Against Mechanical Defect.
Write for Free Catalog Today, Dept. 4-A.



NOW AVAILABLE

At your RCA Distributor

**MODEL
515S1**



PRICED RIGHT!
ONLY \$55
Suggested List

**The sensational RCA
15" Duo-Cone Speaker**
... proud offspring of the
famous RCA LC-1A

*Nothing
Finer!*



**CHICAGO
FEATHERWEIGHT MULTITESTER**

**The New Wider Range
Model 453**

DC Volts:
0-15/30/150/300/1500/3000
AC Volts:
0-15/30/150/300/1500/3000
Ohms Full Scale:
5000/50,000/500,000
DC Milliamperes: 0-150

A compact, pocket-size instrument
with laboratory accuracy.
Size: 4"x2⁷/₈"x2". Price \$14.00.

We manufacture a complete line of
portable multitesters.

Chicago

Send for Circular

INDUSTRIAL INSTRUMENT CO.

536 W. ELM ST. • CHICAGO 10, ILL.

reports, government news, and occasionally some music; no definite schedule is listed by the station, but has been heard in England around 1300.

Germany—Radio Leipzig advises Gates, Conn., that its new interval signal is composed of the musical notes "B, A, C, and H" (?) to commemorate the 200th anniversary of the death of Bach.

Gold Coast—For a time, Balbi, Calif., was hearing ZOY, 7.295, Accra, at 0300-0400; native drums at opening, announced "This is the Gold Coast Station"; announced as operating on 41.4 meters; BBC records announced by woman; at 0343 had orders regarding troops, then news by a man; announced, "This is the end of the news from Accra," then the woman announced, "We now sign-off on the 41-meter band at 9 o'clock"; not heard lately, however.

Is heard in England on 4.915 with news 1250; closes 1300 with "God Save the King."

Greece—Hagen, Ala., reports the Greek Army Radio on 7.050 at 0000-0145; fair signal; comes on with chorus singing Greek song; has some band music; woman announcer.

Bluman, Israel, airmails that the Greek outlet on 6.340 he previously reported as "unidentified" is the Greek Forces station in Athens; heard from 0000 and at 1100-1645.

Kios, 6.520, is audible until 1500. *Guatemala*—TG2, Radio Morse, on 6.621, now closes 2330; TG3, 6.410, is not in parallel. (Grove, Ill.)

Haiti—4VRW, Port-au-Prince is still moving around; at last report was again on approximately 10.210, heard mornings and evenings (EST).

Honduras—HRN, 5.880, Tegucigalpa, now closes 2300 with Ted Lewis' recording of "Good Night"; heard 2000-2300 sign-off; all-Spanish. (Grove, Ill.)

Hong Kong—ZBW3, 9.525, heard with news 1015, signing off 1130. (Balbi, Calif.)

Iceland—NNRC reports Reykjavik testing on 9.200 at 1437 after which went into inverted speech.

India—Madras, 4.920, continues to be heard well in the East at 0730 with news relay from Delhi which usually is followed by "local" (Madras) news, also in English.

Indonesia—Djakarta appears to be using YDF2, 11.785, now for the 1115-1400 transmission to Asia, Near East, and Europe; probably will add English at 1400-1500 soon. Although the press services list the new name of this city (formerly Batavia) as "Jakarta," the station gives it "Djakarta," and the "D" is definitely heard when it is pronounced over Djakarta Radio.

YDE, listed 11.77, Djakarta, noted in French to 1100 closedown, but seemed slightly higher than 11.770. (Dilg, Calif.)

Stark, Texas, has heard an Indonesian on 4.945 identifying at 0700; uses Indonesian language; may be YDB2, listed 4.910?

RADIO & TELEVISION NEWS

Iran—Chatfield, N. Y., Hagen, Ala., and others report *Radio Teheran* on 9.660 with news 1400 followed at 1415 with popular music; news in French 1430. *Radio Sweden* says this outlet is heard in Europe 1330-1400.

Bluman, Israel, says Teheran, 6.155, now opens 0830 with French-type music; Tabriz, 6.090, opens 0900 with Turkish half hour; from 0930 has Persian.

Iraq—YI5KG, 7.092, Baghdad, is heard in Europe at good strength 1000-1515. (Radio Sweden)

Israel—Tel Aviv is back on 9.000 from 8.900; news 1530.

Japan—WLKS, 6.105, Kure, noted closing down 0830; has Latin QRM from shortly before 0800; earlier is in clear. (Stark, Texas). Now relays (announced) AFRS news 0300-0315.

JKM, Tokyo, has moved from 4.93 to 4.95; fine, clear signal now; heard from 0300; much Western music noted lately. (Balbi, Calif.)

The chief of the International Broadcasting Section, N.H.K. (Nipon Hoso Kyokai or the Broadcasting Corporation of Japan), sent this list of Japanese s.w. stations (exclusive of those operated by occupation forces) to *DX Journal*:

A—First transmission relay and communications for Domestic Service—JKI, 4.910, 5 kw., Nazaki, 1525-1715 and 0255-0900; JHK, 7.257.5, 5 kw., Yamata, 1525-0900; JKI2, 9.655, 5 kw., Nazaki, 1725-0245.

B—Second transmission relay for Domestic Service—JKJ, 7.285, 5 kw., Nazaki, 1555-2200 and 0325-0900; JKM, 4.930, 5 kw., Kawachi, 0325-0900; JKM2, 9.695, 5 kw., Kawachi, 1555-2200.

C—AFRS, Far East Network of the Armed Forces Radio Service—JJK, 6.015, 5 kw., Nazaki, 1545-0930; JKL, 4.860, 5 kw., Yamata, 0355-0933; JKL2, 9.605, 5 kw., Yamata, 1545-0345.

D—Overseas transmission (for Japanese listeners abroad awaiting repatriation)—JBD, 9.505, 7½ kw., Kawachi, 0255-0900; JBD2, 9.560, 5 kw.,
(Continued on page 143)

Bill Wood, W4JWR, stands beside his car which is equipped with the special license plates that the state of Florida is issuing to amateurs. Lloyd F. Boyle, W4IMJ, state representative from Sanford, Florida, sponsored the bill authorizing the use of these special plates.



April, 1950

THIS ONE BOOK ANSWERS THOUSANDS OF TV QUESTIONS... USE IT TO INCREASE YOUR INCOME!

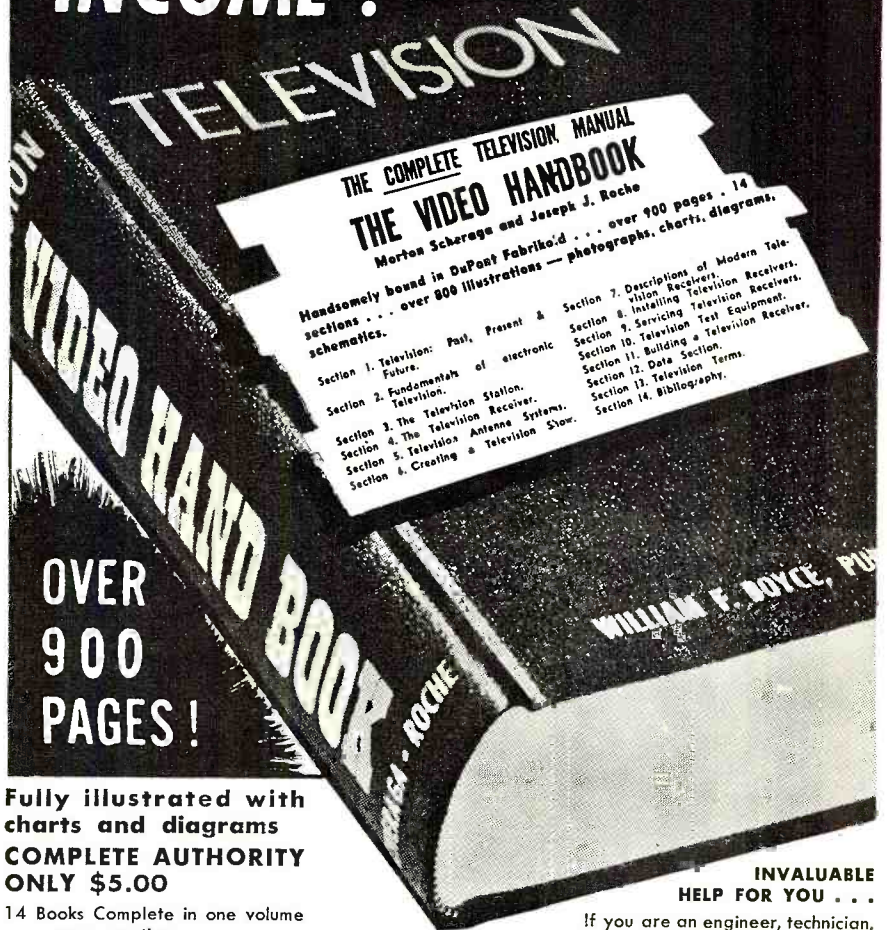

OVER
900
PAGES!

Fully illustrated with charts and diagrams
COMPLETE AUTHORITY ONLY \$5.00

14 Books Complete in one volume . . . saves you time.

INVALUABLE HELP FOR YOU . . .

If you are an engineer, technician, student, or in television work of any kind.

When trouble shooting, testing, installing, constructing, either receivers or transmitters, you can use the data and basic knowledge found in this one handy reference book. It can help you solve basic problems quickly in your shop, drafting room, studio, or in the field. You have just one source to find the answers quickly to all problems. If your income depends on any one of the many phases of television you cannot afford to be without this reference book.

Get them at your favorite dealers. If he cannot supply you, order direct, using the coupon.

MAIL ORDER COUPON NOW

BOYCE-ROCHE BOOK CO. MONTCLAIR, NEW JERSEY RTV-4

Please send me the following, postpaid:

... Radio & Video Library @ \$9.00
... Radio Data Book @ \$5.00
... Video Data Book @ \$5.00

Check or M. O. enclosed in amount of \$.....
Send them C.O.D.

Name.....

Address.....

City..... State.....



VIDEO HANDBOOK

Over 900 pages, 860 illustrations, 14 sections.
ONLY \$5.00.

COMPLETE RADIO & TV LIBRARY

Both Radio and Video Hand Book in attractive slip case. Buy both books and save money.
ONLY \$9.00.





...HAS NO APPRECIATION OF TONE...

It is possible to produce amplifiers that measure up to the most rigid requirements and tolerances of a "mechanical ear"... amplifiers that show perfect laboratory measurements, BUT may, despite their mechanical and technical perfection fall short of providing enjoyable "listening-quality."

When you buy a phonograph amplifier you buy one thing... listening quality. That elusive characteristic which, after all, is any amplifier's prime reason for being.

Newcomb amplifiers must not only measure up to the highest standards electrically... but in addition are subjected to critical "listening quality" tests by trained experts. That is why Newcomb amplifiers provide more real listening pleasure.



Insist upon hearing a Newcomb. Compare the listening quality of Model KXLP30 from the standpoint of enjoyment with that of any other amplifier. Your ear will readily hear the pure natural quality and true character of each deep bass note. Now, listen to the clear, undistorted, brilliant, high tones with their remarkable freedom from surface noise made possible by Newcomb's exclusive MAGIC RED KNOB. A comparison will convince you that Newcomb Sound is without question the closest you can get to "Live Music" quality.

Newcomb Phonograph Amplifiers from \$59.50



AUDIO PRODUCTS CO.

Dept. F, 6824 Lexington Avenue, Hollywood 38, Calif.

Within the Industry

(Continued from page 28)

Corp., vice-chairman; Frank Halock, secretary; and Harold W. Lindsay of Ampex, treasurer.

Members of the executive board include Dr. Vincent Salmon, Stanford Research Institute; Bob Hugh Smith, electrical engineering department of the University of California; and R. M. Beck of R. M. Beck Co.

* * *

ROBERT L. SHEARER has been appointed sales manager of the new Cleveland district office of *The Brush Development Company*.



In his new post Mr. Shearer will supervise magnetic recording sales in twenty counties in Northeastern Ohio and in Mercer County, Pennsylvania. Seven sales engineers will serve customers in these areas under Mr. Shearer's direction.

Prior to joining the *Brush* organization, he was associated with the British Broadcasting Corporation and served in the British Army from 1939-1946. He attended the University of Edinburgh, Heriot Watt College, and Swarthmore College in Pennsylvania. He is a member of the IRE and the Royal Scottish Society of Arts.

* * *

HARRY J. MAYER, former manager of Technical Products Service of the *RCA Service Company* in the Chicago district, has assumed new duties as New York district manager of the company's Technical Products Service Division... **HAROLD W. SCHAEFER** has been named special assistant to Leslie J. Woods, vice-president-director of Research and Engineering of *Philco Corporation*. He was formerly assistant manager of the *Westinghouse* home radio division... **DAVID DAVIS**, until recently corporate radio and television manager for all *R. H. Macy's* stores, has been appointed merchandise coordinator for radio and television receivers in the *General Electric Company's* Electronics Department... **B. L. STILPHEN** is the new director of industrial relations for *The Magnavox Company*... **WICKHAM HARTER** is the new sales manager of the distributor division of *Centralab Division of Globe-Union Inc.* He was formerly vice-president and sales manager of *Solar*... **CLARE C. FISHER** has been named chief engineer for *Utah, Inc.* of Chicago. He has been associated with many well-known radio and component manufacturers in the past... The appointment of **GEORGE L. MC KENNA** as assistant to W. W. Watts, vice-president in charge of the *RCA Engineering Products Department*, was announced recently by the company... **A. GEORGE ROGERS** is the new assist-

ant manager of the *Westinghouse* home radio division. He will be responsible for radio and television engineering and manufacturing...

KENNETH C. MEINKEN, JR. has been appointed to the post of Midwestern sales manager of tube sales to initial equipment manufacturers for *National Union Radio Corporation*... *General Electric Company* has named **E. B. EVERY** as district representative for the sale of replacement tubes and receiver parts in the Atlanta, Georgia area... **M. D. SCHUSTER** who was formerly general manager of the *Hoffman Sales Corporation* of Los Angeles, has taken over as district sales manager for *The Magnavox Company* in the Los Angeles area... **DOUGLAS DAY** has relinquished his post as executive vice-president of *Buchanan & Company, Inc.* to take the post of director of advertising for *Allen B. Du Mont Laboratories, Inc.*... The Premium Sales Division of *Emerson Radio & Phonograph Corporation* has a new manager. **LEO HAHN** has returned to the company to take over the post... **ROBERT HOOD** has been named chief mechanical engineer for *Gertsch Products, Inc.* of Los Angeles... **KENNETH E. PITNEY** is the new research engineer at *The J. M. Ney Company*, Hartford specialists in the application of precious metals for sliding electrical contacts.

-30-

Multiplex Systems

(Continued from page 45)

since they do not load the line or otherwise consume the signal energy on the line. At the end of the line a 300 ohm carbon non-inductive resistor is installed so as to properly terminate the line in its own impedance, preventing standing wave effects and reflections. It will be recalled that if this is done, it will be unimportant where the coupling units are bridged across the line, since all points on the line will have the same impedance and current-voltage relationship.

The individual coupling units consist of a 12AT7 connected as a balanced dual cathode follower. Output for 300 ohm sets is taken from cathode to cathode, whereas that for low impedance sets is taken from one cathode to ground. Power for the coupling units is run in from a four wire cable that connects all the units to a common power supply. This supply is of standard design and need only supply 6.3 volts at .3 amp. and about 10 milliamperes at 100 or so volts d.c. for each unit. The total requirement can easily be calculated by multiplication. For instance in a setup of 10 units, the power supply is designed to provide 6.3 volts a.c. at 3.0 amps. and 105 volts d.c. at 100 ma. This is easily provided by the circuit suggested. It is important that an a.c.-d.c. supply is *NOT USED*. Use a transformer in order to isolate from the power line.

RADIO & TELEVISION NEWS

MAIL ORDER ADDRESS
1060-2 N. ALLEN AVE.
PASADENA 7, CALIF.
SYCAMORE 4-7156
RYAN 1-8271

PHOTOCON SALES

RETAIL SALES STORE
1240 EAST COLORADO ST.
PASADENA 1, CALIF.
SYCAMORE 6-7217

APRIL SPECIALS

Please write for our 1950 complete catalog

BASSETT AIRCRAFT RADIOS & ACCESS.

Two-Way Radio Freq. 3105 K.C.

ALL NEW EQUIPMENT

Sound Powered Head and Chest Sets
T. V. Installations
Field Telephones Home Installations
Light Weight Type
Manufactured by U. S. Instrument Corp.
New \$6.95 per set \$13.50 per pair
Excellent Used 4.95 per set 8.50 per pair
Fair Used—tested 2.95 per set 5.00 per pair

IE-19A TEST SET FOR SCR-522 Brand
new, complete with manual. \$375.00
Excellent Used Condition 250.00

FL-8 Range Filter. NEW \$1.95
HS-23 HEADSET—BRAND NEW 8,000 ohm
with ear pads. 2.45
HS-33 HEADSET—with ear pads. 1.29
HS-33 HEADSET—complete with matching
transformer, 6' cord and PL 55 plug. NEW 1.95
HS-30 HEADSET95
DYNAMIC HEADSET AND MIKE-P.O. MARK
II NEW 1.95
HEADSET EXTENSION CORD-CD-307A with
PL 55 and JK 26.49
HEADSET ADAPTER MC-385D—High to low
impedance NEW .35
T-17 HAND MIKE. NEW 1.95
T-32 DESK MIKE—USED \$1.95 NEW 3.00

ARC-1 AIRCRAFT TRANSMITTER-RE-
CEIVER—10 channel RT18/ARC-1
Excellent Condition with tubes. \$695.00

APN-1 ALTIMETER INDICATOR, basic movement
0-1 ma.; 5 ma. shunt, 270° dial.
An excellent basic movement for constructing
your own meters. NEW \$ 1.95
METER RECTIFIER, full wave midget Sele-
nium 10 volts, 30 ma.29
APN-1 ALTIMETER, Complete NEW 34.50
I. F. Transformer—1st, 2nd or 3rd, from
SCR-522, 12,000 K.C. Iron Core tuning,
can be tuned to television I.F. frequency
by removing padder cond. 3 for \$1.00
. EACH .35

BC-348 Mounting Base. \$2.25
BC-348 Outlet Plug.69
BC-348 Mounting Base and Outlet Plug. 2.50

MC6—1½ Watt Trans-Recr. Tubes, crystal,
battery case, antenna. \$31.50
MC6B—8 Watt Trans-Recr. tubes, crystal,
vibrapack, antenna, 12 volts. 44.50
MR3A Receiver Range, weather and tower
freq. 13.50
MCUI Aircraft Microphone. 4.95
HEADSET and PLUG. 2.95
MODEL TR 15—Trailing Antenna Wire Set. 6.95

INTERPHONE AMPLIFIER-BC-709—Ideal
for Aircraft, booster for telephone sys-
tem, etc. NEW \$4.50

400 Cycle INVERTER—G.E. 5DZ1N3A Input
27 V., 35 amps. Output 115 V. 485 V.A.
Single phase \$12.50
400 Cycle INVERTER—G.E. PE-218 Input
27 V., 100 amps. Output 115 V. 1,500
V.A. Single phase. NEW 29.50
800 Cycle INVERTER—PE-206. NEW 5.95
800 Cycle Blower and Motor—1 ph. 6700
R.P.M. 120 V. CAY-21773. 1.50
24 V. D.C. Blower and Motor—1700 R.P.M.
—1.35 amps. A. G. Redmond Co. 1.95

PE-103 DYNAMOTOR POWER SUPPLY.
COMPLETE with dynamotor, filter,
relay unit, battery cables, and shock
mount. Part of SCR-284. BRAND NEW \$19.50

BC-464—TARGET RECEIVER—5 Channel
remote, battery case, antenna 68-73
MC NEW \$14.95
INTERPHONE AMPLIFIER—CMX50128A,
12 V. 6 Watts P.O. T.C.S. Equipment—
tubes and dynamotor. 8.50
HANDY TALKIE Crystal and Coil Sets—3885
K.C. to 5,500 K.C. Specify frequency—
2 crystal and 2 coils per set. NEW 2.25

TUBE SPECIAL
5CP1-5" CATHODE RAY TUBE.
4 for \$4.25. EACH \$1.45

TRANSFORMERS—6200 V. @ 325 Ma. sec-
ondary—easily C.T. for 3100-0-3100 @ 650
ma.—Primary 105/110/115 V. 60 cycles—
American Transformer Company. NEW \$39.50
2.5 V. @ 10 amps. C.T.—15,000 Volt insula-
tion—115 V. A. C. primary—Kenyon S-9883. 5.95

200-0-200 @ 50 ma.—6.3 V. @ 3 amps. \$115
V. A. C. Primary. NEW \$ 1.95
115 V. A. C. Primary—700 volts C.T. @ .075
amps; 6.3 V. @ 1.2 amps; 5 V. @ 3 amps. 2.25
WELDING TYPE W. TRANSFORMER—190 amps—
5 volt secondary—115 V. A. C. primary, mfg.
by American Transformer Co. BRAND NEW 16.95

SOUND POWERED HEAD AND CHEST SET—
Made by Automatic Elec. Co. PAIR \$11.00
NEW—EACH 5.95

WESTON ELECTRICAL TACHOMETER METER,
Model 545 for use with Model 724 magneto.
Speed 0-2,000 R.P.M. Ratio 2:1 BRAND NEW \$17.50
WESTON TACHOMETER GENERATOR, Model
724, Type C. GOOD USED 16.75

TEST EQUIPMENT
BC-221 Freq. Meter—125 K. C. to 20,000
K.C. Excellent Cond. \$69.50
I-122 Signal Generator by Espy Mfg. Co.
15-27, 95-127 M.C. 79.50
I-200 Calibrator, 115 V., 60 cycles, 345 and
621 cps. Western Electric. 39.50
LM Frequency Meter—Excellent Condition
with calibrated book. 69.50
I-222 Signal Generator—Excellent. 75.00

MN-26C-Bendix Radio Compass Receiver 150-
1,500 K.C. Tubes. Excellent Condition. \$17.50

SCR-522 Transmitter-Receiver, with tubes.
Excellent Cond. \$60.00
PLUGS—Set for SCR-522. NEW 3.75
PE-94C-24 Volt Dynamotor. Used \$2.50
BC-602 Control Box NEW 4.50
BC-631 Jack Box. NEW .95
AN-104A Antenna. NEW STEEL \$1.95
COPPER 2.95

MINE DETECTOR-SCR-625A Used for locating
metal, underground pipes, gold, etc. NEW
WITH MANUALS \$59.50. USED EXC. COND. \$39.50

BC-620 Mobile FM Transceiver—P. O. SCR.
610, includes 10 meter band. Excellent
condition with tubes. \$11.95
PE-120 Power Supply with tubes. Excellent
Condition 5.50
Combination BC-620 and PE-120. Both for 14.95

ELECTRONIC MEGAPHONE—Light weight portable
for use by coaches, cheer leaders, police, fire
depts., etc. Ready to operate, includes LS-6C
Speaker, BC-641C Amplifier, Carrying Case and
batteries \$39.50
BC-641C AMPLIFIER only 9.95

SURPLUS RADIO CONVERSION MANUAL, Vol. 1,
115 pages of circuits and data. Postpaid \$2.50
CD-501 CABLE for PE-103 BC-654. NEW 1.95
SPEAKER—3" P. M. Compartment, 25 watts,
50-6,000 ohms. Waterproof. Excellent. USED 8.95
TERMS: Prices f.o.b. Pasadena. 25% on all C.O.D.
orders. Californians add 3% sales tax.

For Greater Earnings . . . LEARN RADIO-ELECTRONICS

This fast-growing science of RADIO, TELEVISION, RADAR and ELECTRONICS, offers tremendous opportunities, and in no industry is RADIO-ELECTRONICS more important than in aviation. A skilled technician who *knows* the modern application of electronic devices, as used in the aircraft industry, is always in demand . . . not only in aviation, but in many other industries. Many large organizations call on Spartan regularly for graduates. Often, students are hired months before graduation.

Don't confuse the RADIO-ELECTRONICS course offered by SPARTAN with other courses, offered anywhere! As a graduate from this famous school you will know the application to industrial control devices; to the search for petroleum; and the important uses of radar, television and other electronic equipment.

SPARTAN offers two complete and thorough courses. You will work on the most modern and complete equipment. You will build equipment. You may join the SPARTAN "Ham" Club. Either course prepares you for Federal Communication Commission license tests—first class radio telephone, second class radio telegraph, or class "B" radio amateur.



SPARTAN'S 21 years of teaching civilian and army personnel is your assurance of receiving the best possible training in the least possible time. You'll not need MORE than Spartan training—you cannot afford to take LESS.

BIG CATALOG—Free

NAME _____ AGE _____

ADDRESS _____

CITY _____ STATE _____

G. I. APPROVED—Write TODAY for Complete Information

SPARTAN
SCHOOL OF RADIO AND ELECTRONICS

SCHOOL OF AERONAUTICS
MAXWELL W. BAUFEL, DIRECTOR

COLLEGE OF ENGINEERING
ADDRESS DEPT. RN-40

TULSA, OKLAHOMA

HARVEY HAS THE BARGAINS

Get your free copy of "TVI Can Be Cured". Just drop us a postcard with your call, name and address and we'll shoot it right to you.

ELDICO TRANSMITTER FILTERS



Transmitter Dual Low Pass Filter 40 Mc cut off—over 75 db harmonic attenuation. 52-72 ohm input and output. For use at other impedances use an antenna tuning network. Good for 1 KW input—Negligible fundamental attenuation. No effect on antenna performance.

Model TVT-62 \$ 7.99 in kit form
Coax Dual Filter 10.99 wired and tested

ELDICO RECEIVER FILTERS



40 MC Cut off—No attenuation to signals above 40 Mc. Efficient on any manufactured set. Will not affect picture, quality or strength. Available for coaxial or twinax installation.

TVR-300 for Twinex..... \$1.98 in kit form
TVR-62 for coax..... 3.98 wired and tested

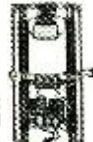

BRUTE FORCE LINE FILTER

Similar to ARRL's—Page 508 ARRL Handbook 1949 Edition. Will handle 1 KW—Completely filtered and shielded. \$5.98 in kit form

8.98 wired and tested (Add 25c To Cover Packing and Shipping Each Filter.)



Matches impedance of pair RG8U or RG58U—or Twinex cables RG22U, RG57U, or any other approx. 100 ohm line. Same characteristics as TVT-62.

TVD-104. Kit Form..... \$14.50
TVD-104. Wired and Tested..... \$17.95

GDA GRID DIP KIT

The most valuable piece of test equipment in the ham shack is the Grid Dipper. Build one with this kit and save countless hours in building, improving and de-bugging your rig. The GDA Kit builds an exact duplicate of the "Grid Dipper" and includes everything from the special handy case permitting one-hand operation down to a complete application and instruction book. With tube and internal power supply, range 3 Mc to 250 Mc in 6 steps, size 5 1/2" x 2 3/4" x 3". Complete Kit \$21.50



TR-75 TRANSMITTER KIT



Loafing along at 75 watts this is the c.w. man's buy of the year. Simple enough for the beginner to assemble. Punched chassis. Uses the time proven 6L6 oscillator-807 amplifier combination. Pi-network output. Husky power supply delivers 600 volts to the 807. Complete. Shpg. Wt. 50 lbs. Only \$34.95

BC-221

FREQUENCY METER

These won't last long so order now for one of these famous freq. meters. They are just like new, with original calibration charts. Range 125-20,000 kc, with crystal check points in all ranges. Complete with crystal and tubes.

Special Price \$79.50

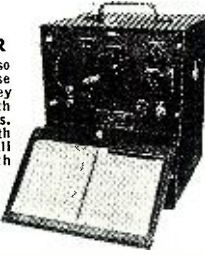

SOUND-POWERED PHONES



Army type EE-108. Any number can be hooked together. Max. range 12 miles. No batteries needed. Genuine leather case. Shipping Weight 10 lbs. Each.....\$24.50

All prices Net. F.O.B. N.Y.C. Include ample postage with your remittance, any excess will be refunded. Prices subject to change without notice.

Telephone: **hrc** LUXemburg 2-1500

HARVEY RADIO COMPANY INC.

103 West 43rd St., New York 18, N. Y.

The VR-105 regulator tube is not absolutely necessary, but by its inclusion the power supply for the units is made quite constant irrespective of the number of units used or variation in the line voltage. When the system is first set up, it is only necessary to adjust the series resistor to such a point that the VR tube lights up to a normal brilliance. Then any small variations will be automatically compensated for by the regulator action of the tube. If desired, this point may be accurately placed so that a meter inserted in series with the VR tube to ground lead reads 25 ma. under normal conditions. This current is in about the center of the tube's range, and a difference of 15 ma. more or less will be compensated for by the tube.

The coupling units are constructed in 4"x4"x2" steel boxes, and each has on the 4"x2" top side a strip of three screw terminals. These are the cathode-ground-cathode connections and from them a piece of 300 ohm or 75 ohm twin-lead is run to each set. Thus it takes only a moment to change connections for either type of set. In making up the coupling units it is suggested that the layout shown in the photograph be followed rather closely to avoid headaches. The tube is mounted inside the steel box, in order to prevent accidental damage or tampering. The two-terminal input strip is run across the narrow dimension of the 4"x2" bottom so that the lead-in line is merely run through continuously from one unit across to the next. The wires of the twin-lead, being bared of insulation and held under the screw terminals, make a straight-through connection.

The 4"x4" back plate is drilled so as to pass two wood screws which then hold the whole unit to the wall. The power cable is run in one side and out the other through rubber grommets, and connections are made inside by means of a four-terminal strip mounted on standoff spacers bolted to the back plate. The nine-pin tube socket is similarly mounted on the bottom and placed so that short equal connections will be obtained between the grid terminals and the input strip, to prevent unbalancing the line. The length of the output leads is not critical. Nothing is mounted on the 4"x4" front plate, so that it is merely a cover, and may easily be removed for tube changes, etc. The various condensers and resistors are mounted by their own leads from point to point.

With this setup it is possible for any or all sets to be operated simultaneously, without mutual interference. Sets can be easily moved about, connected and disconnected. The signal delivered to each set is only about 2 1/2 db. down from that delivered by the antenna, and therefore no trouble is encountered because of a weak signal. A good antenna installation with small line loss will more than make up for this slight loss. In weak signal

THE FINEST 16" TELEVISION SET EVER DESIGNED!

WITH AUTOMATIC GAIN CONTROL (AGC)

Now you can have the finest 1950 model Voltage Doubler Giant Screen Television Set ever designed. Custom built and improved with unusually high brilliance—will give you thousands of hours of fine entertainment during day or evening hours. A bright, clear steady picture is assured by the most famous television set ever produced. The RCA designed 630 type chassis. This identical type TV set is used by more Radio & TV Engineers than any other set ever manufactured!

The 30 tube circuit is more sensitive than any of the cheaper sets having less tubes and the new Standard Tuner has a pentode RF stage which acts as a high-gain built-in Television Booster on all channels. Also featured is an automatic frequency control system that keeps the picture steady and makes tuning easier.

Factory wired and tested, ready to operate. Shipped complete with tubes, less 16" picture tube **\$149.50**

Extra-Clear 16" glass picture tube—guaranteed for one year—**\$39.50**

SPECIAL!

Super-Giant 19" Television Set. 630 type similar to above, but modified to provide a whopper-sized picture. Factory-wired and tested, ready to operate. Shipped complete with tubes, less 19" picture tube. Price **\$169.50**

Extra-Clear 19" glass picture tube—guaranteed for one year—**\$79.50**

12 1/2" 630 chassis—\$149.50
12 1/2" tube—1 year guarantee—\$24.95

DE LUXE TELEVISION CABINETS

Beautifully designed to match the 630 chassis without any cutting or drilling. Solidly constructed like the finest furniture with a satin piano finish. Shipped complete with mask and protective glass window.

16" Table Model—Mahogany or Walnut **\$39.95**

19" Table Model—Mahogany or Walnut **\$44.95**

16" Console—with drop panel to conceal knobs when desired. Mahogany or Walnut..... **\$69.50**

Blonde..... **\$79.50**

19" Console—with drop-panel as above—Mahogany or Walnut..... **\$79.50**

Blonde..... **\$89.50**

4-TUBE AC/DC TELE-BOOSTER

CHECK THESE FEATURES

- Uses type 6AK5's in an extremely stable and efficient wide-band amplifier circuit.
- Self-contained power supply.
- Covers all television channels in use.
- Eliminates need for outdoor antennas in many locations.
- Will actually make difference between "Flat" and very bright pictures on weak stations.
- Improves receiver immunity to off-channel interference. Can be tuned to boost weak station or turned off to provide normal reception.
- Simple to install and operate, requires only external connection to receiver.
- Operates on 110 volts AC or DC.

ONLY **\$16.95**

TWO STATION INTER-COMMUNICATION SYSTEM

Radiomen—provide yourself with an additional source of income by selling and installing these high quality—low cost intercoms.

Selling Features: • For the nursery (baby sitting) or sickroom • In private homes—room to room—garage to house—basement to attic, etc. • Busy businessmen • Ideal for use in television antenna installation and servicing—instead of unhandy earphones • Simple installation—only 2 wires to connect • Housed in an attractive walnut case, 1 master and 1 slave station, complete with tubes.

Price..... **\$10.95**

Extra for 50 feet twin-lead cable...\$1.00

For complete listings of special buys for experimenters, radio technicians, laboratories, schools and engineers. Write for catalog R4.

EDLIE ELECTRONICS, INC.

154 GREENWICH ST. NEW YORK 6, N. Y.

areas stacking of two antennas would be advisable, since stacking affords a gain of about 4 db. over a single antenna, and thus the loss in the coupling unit is more than made up. No ghosts or reflections are noted due to the coupling system, and the picture on every set is equal to its eventual performance on its own antenna.

The above discussion and circuit is based on the use of a folded dipole having its center connected to the mast and grounded. With other types of antennas where the dipole arms are not grounded at its midpoint, there will be a strong 60-cycle a.c. component on the twin-lead lead-in. If this is not eliminated it will tend to drive the 12AT7 into cut-off and operation will be very poor. In addition, with any type of antenna, if the location is very close to an AM transmitter, that will also tend to do the same thing.

Both of these effects can be completely eliminated by placing a trap across the lead-in at any convenient point. The trap consists of one of the popular double slug-tuned FM traps with the small condensers removed and the center point between the coils brought to a good ground. The outside end of each coil is connected to either side of the twin-lead. The slugs may be tuned in or out for best operation. The coils themselves usually consist of about 5 turns on a $\frac{3}{8}$ " form and may be easily constructed if not already on hand. The object is to obtain a shunt inductance of about $1 \mu\text{hy}$, so as to short out all frequencies lower than the bottom of the TV band. This will protect the 12AT7 from any interference, and result in the properly operating circuit.

Another recommendation is to use two 150 ohm resistors center-tap grounded instead of the single 300 ohm resistor, R_o , specified.

Formulas for cathode follower design are:

$$\text{Gain} = M = \frac{\mu \times R_o}{R_o(\mu + 1) + r_p}$$

$$\frac{55 \times 500}{500(56) + 10000} = \frac{27500}{38000} = .73 =$$

2½ db. loss

$$\text{Output Impedance} = Z_o =$$

$$\frac{1}{G_m + 1/R_o + 1/r_p} = \frac{1}{.004 + .002 + .0001} = 1/.0061 = 164 \text{ ohms}$$

each side, or total Z_o (cathode to cathode) = 328 ohms which is within 10% nominal tolerance of input circuit of receiver.

The various terms in the above equation are defined as follows:

μ = Mu of the tube

R_o = Cathode resistance

r_p = Plate resistance

Z_o = Output impedance

G_m = Mutual conductance of the tube

-30-

CLIMB ABOARD

for **EXTRA PROFITS**



and **GREATER SALES**

with the

Super Sonic

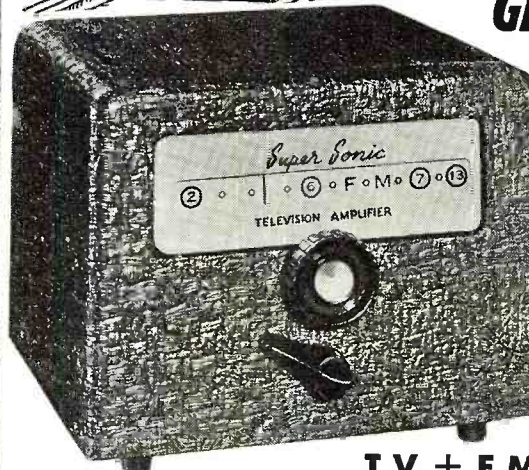

MODEL IT4

TV + FM AMPLIFIER

(2 INSTRUMENTS IN 1)

Impartial and exhaustive tests prove that the new SUPER SONIC-MODEL IT4 TV+FM AMPLIFIER delivers a higher usable gain with full bandwidth and higher signal to noise ratio than other leading brands at ANY PRICE!



- Improves TV reception in weak signal areas, with indoor or outdoor antenna.
- Continuous tuning of all 12 TV channels, also FM with ONE knob control.
- Reduces electrical, diathermy interferences and minimizes "ghosts and snow" effects.
- Frequency range: 50 mc to 220 mc, continuously tuned.
- Bandwidth: Adequate at all channels.
- Insertion gain: Minimum of 18 db at any frequency with 300 input and output impedances.
- Highest signal to noise ratio.
- Input and Output Impedances: 300 ohm balanced to ground and 72 ohms unbalanced.
- Inductances wound with PURE SILVER wire.
- All moving contacts heavily silver plated.
- Isolation transformer.

CHOICE TERRITORIES STILL AVAILABLE

Write for Free Brochure to Dept. RN2

SONIC INDUSTRIES INC.

"MANUFACTURERS OF DUOSONIC PHONOGRAPHS"

221 WEST 17th STREET, NEW YORK 11, N. Y.

TUBE SPECIALS!!

832A Each \$2.69
..... 4 for \$10.00
..... 6 for \$14.99
6L6 METAL 12 for \$5.00
All tubes are guaranteed perfect, although some show signs of exposure.

ATTENTION, AERONAUTICAL RADIO MEN
MG-149-H, brand new, orig. pack, 400 cy ADF inverter. While small quantity lasts. \$27.50
125 INSTALLATION BAGS for J-box and I-101-C, includes hardware, barrier fern, strip and 3DK12 250 non-polarized 1250 mfd. cond. to shunt indicator \$3.50
INDICATOR -101-C new \$7.50
These are just a few of our aeronautical values. Please mail us your inquiry list.

ATTENTION, MARINE RADIO MEN!

(1) G.L. "MARINER" XMTR. 100 to 125 W RF to antenna, 90% modulated, 4 chan. xtal. cont., 12 or 24 V input (specify voltage & freq. when ordering) w/Dyna. connecting cord xstals, tubes (#13 final), mike; all aligned & ready to operate. Controls are On-Off switch, chan. selector, antenna tuner to match any antenna. Built-in, built-in, built-in. In addition to ant. switching relay. Panel has RF curr. meter & total curr. meter. This xmtr. built from \$1200 govt. cost surplus. We offer it at the astounding price of \$225.00

(2) G.L. "MARINER" REGR., specify 12 or 24 V DC, BFO ON-OFF, AVC-MVC, long wave, Etc. Includes Marine, Short Wave, A beautiful conversion of a doggone good Navy surplus reocr., entirely new front panel, vernier on-the-nose resetting tuner, all controls on front panel, no plugs needed. Ready to go. \$49.50

(3) DU-1 Manual Direction Finder, specify 12 or 24 V. Converted for Marine band still retains half of Broadcast band and all the lighthouse and beacon band. 2-tube pre-amplifier. No. 180° ambiguity, true bearing immediately. Goes ahead. G.L. "Mariner" or any other receiver. NEW, converted. \$32.50

(4) BC-223 TRANSMITTER. 15 watts. Brand New. With used 12 V Dynamotor PE-55, connecting cable, 4 marine freq. xstals, mike. Specify freq. \$89.50

(5) 12 V DYNAMOTOR FOR 100 watt xmtr, DM-42, two outputs, 1030 V @ 215 ma. for final, and 515 V @ 260 ma. NEW \$9.95

(6) PE-55 DYNAMOTOR, 12 V for BC-223, 500 V @ 400 ma. w/relay, filter, etc. EXC. USED \$9.95

(7) CONNECTING CORD with plugs, 10' long. PE-55 to BC-223 \$1.50

(8) TCS-7 XMTR DYNAMOTOR, 12 V input, output 440 V @ 200 ma. NEW \$5.95

(9) DM-35 DYNAMOTOR, 12 V input, output 625 V @ 200 ma. EXCELLENT USED \$9.95

(10) 24 V DYNAMOTOR FOR 100 watt xmtr (dynamotor of DY-12/ART-13) 1150 V @ 350 ma. plus 400 V @ 400 ma. NEW \$7.50

(11) BULKHEAD SPEAKER, HiFi, phenolic cone, waterproof, extra heavy PM, Universal xformer, all in waterproof case. Battle handles 25 W \$9.95

MODULATOR BC-456. New, orig. pack \$3.95
Excellent used \$2.95
Used, less tubes and top cover \$1.25
Add for DM-33 dyn., NEW \$2.75

AN RF & AF SIGNAL TRACER FOR 79c!

BZ-5. Tiny dual vibrator, 4 V DC in, 2 AC out, at 1700 cps. Harmonic to 4 mc. Use as tubeless tone osc. for code or MCW. NEW.

LOOK WHAT \$2.65 WILL BUY!

6 V DYNAMOTOR. Very low battery drain. Multiple windings! 250 v DC @ 100 ma to 85 v @ 50 ma. Second winding 20 v DC @ 70 ma. No brushes to add or shift around! No mechanical work! Complete dope sheet furnished, connections BRAND SPARING NEW ONLY \$2.65

CITIZEN'S BAND ANTENNA w/director, radiator, reflector, hardware. PAIR for \$98c

R-89/ARN-5. Revr less tubes and top cover, plenty of parts, 432-435 MC RF, xtal cont., local osc. 200 v. Broad band and 20.7 MC IFS. Dual inst. rectifiers and 90 and 150 cy. pass filter \$2.95

COIL KIT. 125 all new coils! Contains IF cans, tuners, chokes, less than 2c per unit. \$2.19
A real treasure chest for \$2.19

SCOTT HI-FI OUTPUT TRANSFORMER. Essentially flat 20-20,000 cy. 25 w, hermetically sealed. Impedance 5000 ohms pri., 2 CT secondaries 600 and 60 ohms, this providing 150 and 15 ohm secondaries also. NEW \$1.89

METALLIC MINE DETECTOR SCR-625 with BA-38 battery. For non-ferrous or ferrous metals. Also operates under water. Brand new, export packed \$29.50

3-DIGIT resettable Vocoder-Root counter with pilot lamp assembly, w/after switch, nice case. NEW .79c
Willard 2-V wet cell battery, new, 20AH .98c
R-1/ARR-1 Converter. Brand new \$6.95

ATTENTION, EXPORTERS!

BC-375-E. NEW. ORIG. EXPORT PACKED. COM. PLETE \$75.00

RA-34 RECTIFIER for BC-191 or modified BC-375; input 115 or 230v at 50 cy. Filtered DC outputs; 1000 V 350 ma and 12 V 3.2 ma. AC output: 12 V 14.5 amps. All of these units have been completely checked out, guaranteed operative, with spares, cables and tech manual \$105.00

BC-191 XMTR UNIT, EXCELLENT USED \$29.95
BC-375 XMTR UNIT, EXCELLENT USED \$29.95
Will check out, guaranteed operative, with spares, cables and tech manual \$105.00
Tuning Units & Antenna Loading Coil for BC-191 or B-375. EXCELLENT USED \$19.95
TUNING UNITS, AS IS \$98c

WANTED! Your Spare Surplus Equipment and Tubes! Dynamotors, Recrs, Smtrs, Test Equipment. Send list, stating condition and your rock bottom price.

G.L. ELECTRONICS

1260 S. Alvarado St. Los Angeles 6, Cal.
All Prices F.O.B. L. A. Calif. Buyers add Sales Tax.
SEND FOR OUR LATEST CATALOGUE!

SCHEMATICS—CONVERSIONS FOR SURPLUS GEAR

PARTIAL LIST:

NEW BC-433-G Conversion \$2.00

R-5/ARN-7 Conversion \$2.00

ARC-4 schematic, parts, cabling \$1.00

Another \$2.00 for 2-meter AC conversion with all specs, tune-up, color-coded wiring diagrams.

BC-375-E original schematic, tuning units, complete parts list, values, characteristics, circuit functions, plate and ant. currents \$2.00

BC-645 original and conversion \$2.00

ARC-8 schematics, all units \$2.00

SCR-522-A, AM, and C schematics, parts lists with circuit functions, explanation of differences, chart for xtal selection \$2.00

Please remit with order. We pay postage 5c and 25c and stamped addressed envelope for comprehensive list, cross-indexed for BC and SCR. Includes chart explaining code used in Army-Navy nomenclature.

R. E. GOODHEART 345 1/2 N. PALM DRIVE BEVERLY HILLS, CALIF.

R.F. Output Meter

(Continued from page 63)

silver coated over the copper on the faces. The diameter is 0.75" and the thickness 0.25" with a hole 1/4" in diameter in the center of each. The outside periphery is lathe-turned to standards of accuracy by cutting the rim until the resistance accurately matched the standard, and the ones the power meter was made from were stamped with the resistance on one face, either 2.50 or 1.25 ohms being the only resistances so far obtainable. These were used in high-current voltage regulators for automotive equipment by army contractors. The resistance of comparable discs is uncannily uniform and accurate by all meters against which compared. If otherwise unobtainable, sets of these discs may be obtained from the writer.

It can be seen that practically any resistance can be secured just by counting the number of discs to be mounted on the rods. The writer used 10/32 threaded brass rod, over which spaghetti of proper size was used to fit within the 1/4" disc holes. Then discs were mounted on the high (live) input side, and ten 2.50 discs plus one 1.25 ohm disc on the ground side. This gives a total of 51.25 ohms for 51.5 ohm circuits and thus inaccuracy is negligible for practical measurements. As these discs came in 2.50 and 1.25 ohm resistances it is possible to come within 0.625 ohm of any desired termination resistance.

The principle of operation, as seen from the diagram, is essentially that of a capacitive voltage divider with an extremely small condenser in the live (high) leg. This is the type of high-frequency divider made so popular for measurements by *General Radio Co.* many years ago, and used in the input circuit of the "Chanalyst" for h.f. voltage attenuation.

The constants were chosen carefully for the purpose in mind. The extremely low capacity in the high leg of the divider is the determining factor which contributes to the wide frequency range and allows such a high frequency determination without appreciable error. The writer used 5 μ fd. after considerable theoretical analysis and found it so completely reliable and suitable that experimentation with other values seemed futile (as so many other factors had to be considered and changed subsequently). Briefly, however, this value was chosen as less capacity was considered unstable and more capacity would affect the standing wave ratio which was to be kept to a minimum. In addition the frequency discrimination might become critical.

The other series condenser in the voltage dividing network is an 0.25 μ fd. unit (*Sprague*) which must be reasonably new and have a very high resistance. 100 to 200 megohms is satisfactory for this condenser.

Across this 0.25 μ fd. condenser, the low side of which is grounded to the low side of the load resistor, ground bus and case, 83-1R shell, etc., is the 1N34 crystal rectifier. That is, the 1N34 crystal is directly in parallel with the 0.25 μ fd. condenser. In parallel with both of these components is the resistive voltage dividing network for the meter indication.

This network consists of two resistors. One is in shunt across the meter itself, and in this case was arbitrarily made 100 ohms, 1 watt. The series resistor in combination with this shunt combination governs the meter range. With the resistances, crystal, condensers, and meter used by the writer, for 10 watts full-scale this series resistor was 10,000 ohms. A 5%, 1-watt, resistor was used.

It can be readily seen that once the meter is calibrated for one range and the value of the series resistor determined, other ranges can be calculated so the cut and try for these other ranges can be reduced to a minimum for accurate calibration.

The old trick of using a higher resistance in shunt with the series resistor chosen to reduce its resistance, or a very low 1-watt resistor value in series to increase it, will provide as accurate calibration as the constructor wishes.

For 100 watts full-scale the series resistor will be around 100,000 ohms. The 1-watt resistors were found completely adequate. And while on the topic of the adequacy of the resistors, it might be well to mention the power ranges which the meter can handle and the caution which should be exercised.

On 20 watts, the meter can be used continuously. The writer has even used it for a few hours at a time on 80 watts without any discernible heating. On wattages greater than 100, it has been found that eventually the element will heat up, although the resistance change under heat was not evident. Even on up to 500 watts it can be used for periods up to 6 to 10 minutes without getting more than lukewarm.

Back to the construction, the insulation for the high side of the 10/32 brass rod running through the discs (in order to further reduce the capacity and leakage to ground) is comprised of two polystyrene standoffs 1" long x 3/4" diameter, threaded 10/32 (tapped) both ends for 3/8" depth.

The two carbon stacks are connected together at the rear end by two #6 a.c. cable connectors with #8 solid copper wire run into both. The whole combination is soldered together with plenty of solder to make a good solid low resistance joint.

The ends of each carbon stack (except the ground end of one) must be insulated from the compression nuts on the rod ends with fiber bushings. All wiring is kept as direct and short as possible.

The 1N34 rectifier was placed across the very low impedance circuit in

At the Head of the Parade Every Time



3-Gang Broadcast Band Permeability Tuner. Was \$3.50. Now \$1.50.

Eliminate the danger of fatal shock. Use our G.E. Interlock Safety Switches priced at only \$1.00 each.

\$12.95 TAKES ALL THREE BIG BARGAINS

1. SENSATIONAL FASCINATING MYSTERIOUS SELSYNS made by G. V. Company. Two or more connected together perfectly on 110V AC. Rotation of the shaft of one Selsyn and all others connected to it will rotate exactly as many degrees in the same direction, following unerringly as if the units were connected together by shafting instead of wire. This is true whether you twist the shaft of the master unit a fraction of a revolution or many revolutions. Useful for indicating direction of water vanes, rotating directional antennas, or controlling innumerable operations from a distance. Complete with diagram and instructions. Matched pair \$4.95. **2. ALUMINUM GEAR BOX 18x8x7** that contains two powerful electric motors and two matched gear trains, 62 gears in all varying in size from 1/2 to 4 inches in diameter. This unit is readily converted to rotate a beam antenna or for any other similar use. \$5.00. **3. HOME WORKSHOP AT BARGAIN PRICE.** Accurate and precise 2 speed guaranteed hobby lathe, the essential machine for the home workshop. Sturdy enough for light production work or factory standby service. Supplied with 56" of belt for connecting to any available electric motor or power take-off. Included in this unbelievable offer are such accessories as a 1/2" drill chuck with specially hardened tool steel jaws, a 4" electric furnace, high speed grinding wheel, a cotton buffing wheel with a large supply of buffing compound, and a steel wire scratch brush. Your cost \$6.00. Sole export agent. Distributor inquiries invited.

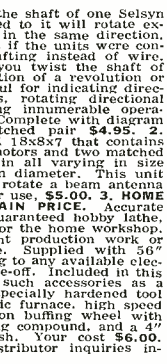
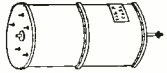

Sensational Value in AC-DC POCKET TESTER

This analyzer features a sensitive repulsion type meter in bakelite case. The result of 15 years in the instrument field by a large company specializing in electronic test equipment. Specifications of the AC-DC Model Voltmeter: AC-Volts 0-25, 50, 125, 250; DC Volts—0-25, 50, 125, 250; Milliamperes AC—0 to 50; DC Milliamperes 0 to 50; 50 Ohms Full Scale—100,000; Ohms Center Scale—2400; Capacity—0.5 to 15 Mfd. Total Price, prepaid in U.S.—\$7.00. **Model DC Meter**, without the AC operated ranges of above, \$5.50 prepaid.

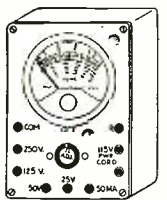

BUFFALO RADIO SUPPLY, Dept. RN-4, 219-221 Genesee St., BUFFALO 3, N. Y.

PHONO SCRATCH ELIMINATOR
Consists of 2 condensers and powdered iron core choke connected in filter network. Same as used in most jukeboxes. Connects instantly between pick-up and amplifier. \$2.00

TWIN COAXIAL CABLE at a Sensational Price
Two No. 12 stranded conductors within a copper shielded, vinyl jacketed, polyethylene core. Can handle over 5 KW. of R.F. power. The ideal TV lead-in for the most exacting installations such as apartment house antenna systems. Perfect for any twinax use calling for cable within the range of 70 to 95 ohm nominal impedance. Regular price 72c per ft. Your cost \$15.00 per hundred feet. Ask for RG-57U.

RG-59U 72 Ohm Coax. The most popular TV type. Regular price 17c per ft. Your cost 5c per ft. or \$4.50 per C.

LINE FILTERS—Each unit contains two 4 Mfd. oil filled condensers and a high inductance 50 Amp choke in fully shielded case. Suitable heavy current connectors are provided to attach to the input and output connectors at each end of the filter from your input and output wires. A filter with innumerable uses on oil burners, refrigerators, boats, automobiles and wherever noise is to be suppressed or interference abolished. A \$17.00 value for \$2.98.

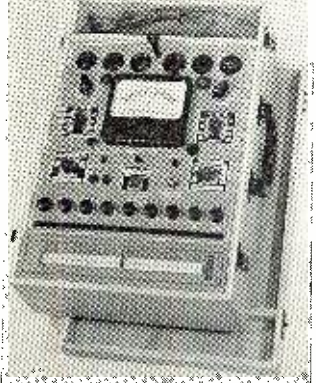

NO FOOLING

A real professional serviceman's tube analyzer that makes it possible to predict the life expectancy of a tube. The new, different, sensational **1350 Model Dynamic Mutual Conductance Tube Tester** checks all tubes for gas, microphonics, hum, emission, shorts and mutual conductance in microhms. Detects more weak tubes. Unexcelled in accuracy. Completely new switching arrangement that is really obsolescence proof. Imagine the exclusive advantage of a tube tester with the astounding ability to instantly test all tube types or tube types not listed on the built-in roll chart. No other tester can make such a claim!!! **Model \$68.50; Counter Model \$64.50.**

Brand new APNI Altimeters. Both 24 volt and 12 volt models available. Not just chassis, but complete with everything. Original factory packing. Descriptive literature on request. \$45.00 and \$75.00.

"AN" Government approved connectors built to Army-Navy specifications. Most complete stock in U.S.A. Inserts interchangeable between plugs and receptacles. Many besides those listed.

3100 20-3S 20-8S 30-8S 32-18P 12S-4S 8S-4S 20-16S	3101 18-12P 20-3P 20-8P 3-16D 32-6P	3102 32-101S 28-101P 20-19P 10S-2S 10S-4P 20-8S 18-22 20-24P 20-11P 20-3P 18-13S 16-7S	16S-1P 16-7S 24-4S 24-8S 14S-1P 14-3P 16S-4S 16S-5P 16S-19P 18-12P 20-3P 20-8P 3-16D 32-6P	18S-1P 16-7S 8S-1S 20-27S 20-9S 20-9P 12-5S 28-12S 18-12S 32-1S 18-3S 16-11S 16-11P 32-9P 14S-7P 18-1P 18-1S 18-20S 24-7S 24-8P 22-18S 24-4P 20-19P 20-14S 22-14S 20-27S 24-25S 18-11S 20-22P 16-5P 22-30P 22-8S 12S-3S	16-11S 22-10P 22-14S 12S-4P 22-14S 16S-1S 16S-8S 18-12S 20-3P 18-3S 18-19 16S-4S 22-2S 22-12S 20-23P 20-23S	18-8S 22-10P 22-14S 12S-4P 22-14S 16S-1S 16S-8S 18-12S 20-3P 18-3S 18-19 16S-4S 22-2S 22-12S 20-23P 20-23S	PL Numbers PL63 PL74 PL103 PL108 PL112 PL121 PL151 PL152 PL169 PL171 PL175 PL181 PL228 PL263 97-5107	28-7S
--	--	--	---	---	--	---	---	-------

All Price Quotations Based on Quantity Ordered

POWER RHEOSTAT

Exceptionally Rugged. Trouble-free design. Withstands severe overloading to many times 25 watt rating without burning or smoking. Perfect motor speed control or line voltage adjuster. 3 sizes available: 50, 60 and 200 ohms. Regular price \$5.20. Special—\$1.00.

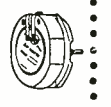

P.M. SPEAKERS
Latest type PM Speaker in a fully-enclosed metal cabinet. Speaker and case match combination receivers, in addition make perfect intercom remote stations. \$4.50. Including output transformer \$4.95.



SUPER SPECIAL

FAIRCHILD bombproof POWER UNITS. Our quantity of these is too limited to justify the space needed to describe them, but each unit is brand new, comes with 9 tubes which alone have a total value of \$15.00; 8 electric motors or generators, 6 of which are of the permanent magnet field type; relays; and 20 valuable precision resistors plus a multitude of the ordinary kind, in addition to many condensers and potentiometers. All for only \$14.95. We will ship but one to a customer while our small quantity lasts.

CLEARANCE BARGAINS



MICROPHONES
Super Special—Highest quality all chrome bullet shaped CRYSTAL MIKE of top-flight nationally known brand. **BULLET DYNAMIC MIKE \$7.95**
LAPEL MIKE \$5.95 (Specify whether with desk or carbon or magnetic stand netic) 93c \$2.95
PUSH-TO-TALK MIKE with switch on handle 60c 98c

SOS EMERGENCY TRANSMITTER

Famous Gibson Girl Transmitter that saved so many lives during the war. Distress call transmitter for boats and airplanes. No external power supply required for operation. It is merely necessary to turn the crank on the top of the transmitter and power is generated and the distress signal is automatically sent out on the international distress frequency. Brand New Gibson Girl Transmitter complete with tubes, \$9.95.

ANTENNA KIT

For Gibson Girl transmitter, 300 ft. antenna wire, 2 balloons, 2 hydrogen generators, box kite for windy weather, searchlight. Complete kit. \$9.95.

RT-1711 Brand New
12 Tube, 110 Volt Receiver-Indicator-Oscilloscope complete with all tubes and power supply (Govt. APAL Radar Set). Scope tube is equipped with a detachable calibrated screen. \$39.95.

FCC AUTHORIZES RADIO FOR PRIVATE SERVICE!!!

(The FCC announced that effective June 1, any American over 18 years of age is eligible for a 5 year station permit. In the "Citizens" band, neither code test nor technical knowledge is necessary.)
GENERAL ELECTRIC 15 TUBE TRANSMITTER-RECEIVER SET. This brand new 15 tube transmitter-receiver was designed for mobile storage battery powered service. It will operate in the "Citizens" band where no amateur license to transmit is necessary. It's a cinch for any experimenter to connect this unit for 110V AC operation by following the instructions and diagrams supplied, which cover numerous applications, including television. For those intending to use on car or boat, a new dynamotor, exactly as originally supplied, costs only \$15.00. Don't fail to write for FREE descriptive bulletin. Order our RT-1248 for only \$29.95, or two for \$53.90.

HURRY

Get your 2 gang midset superhet tuning condensers with 1/2" shaft and trimmers. Reg. \$1.25 each, now 5 for \$2.00.

STROMBERG CARLSON

Power Switching Relay Box. Net 3 1/2 x 4 x 5 1/2". Steel case with tight fitting cover finished in Stromberg's beautiful crackle finish. \$1.00.
Bayonet type radio pilot light sockets. \$1.00 a hundred.
Mazda licensed bulbs, per 10, 50c.

ACRO TELEVISION CHASSIS CRADLE

Pays for itself in a week—Saves and eliminates broken tubes, coils, dials, etc. Cadmium plated steel, finger-tip control. A necessity for Television Service. Your Cost.....\$4.99

DELUXE SUPERHET A.C.-D.C. RADIO KIT

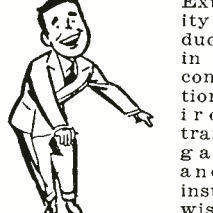

Extra high quality standard production line radio in kit form with complete instructions. Features 2 iron core I.F. transformers, a 2 gang condenser, and polyethylene insulated edge-wise wound antenna loop. Tubes include 12AT6, 12BA6, 12BE6, 50B5 & 35W4. Receives broadcast band from 550 to 1700 KC. Kit form \$8.75 or 2 for....\$17.00 Assembled, Wired & tested \$12.95 or 2 for..... 25.00

Get Set for LAND OFFICE BUSINESS on the Astatic TELEVISION BOOSTER

Soon to be Advertised Nationally
on TELEVISION

OWNERS OF TV RECEIVERS, and their friends, the nation over, will soon see the Astatic Television Booster in operation . . . and hear its exclusive advantages explained . . . from their favorite TV stations. It doesn't take a crystal ball to forecast the impact of TV advertising on sales of Astatic Boosters. When set owners in your area actually see weak, washed-out pictures on a TV screen changed to bright, clear action by the Astatic Booster, the skyrocketing of sales will be automatic. They'll be asking — by the thousands — for the "four-tube booster" with "variable gain control," "dual-tuning," "handsome furniture-finish mahogany cabinet," and other exclusive features they've seen and heard about ON TELEVISION. They'll ask by name for the Astatic Booster.

If there is anything you don't know about the Astatic Booster, write for specifications and complete details. Get behind this surefire program to help you sell. Check your stock. Order TODAY for your needs.

Astatic Crystal Devices manufactured under Brush Development Co. patents

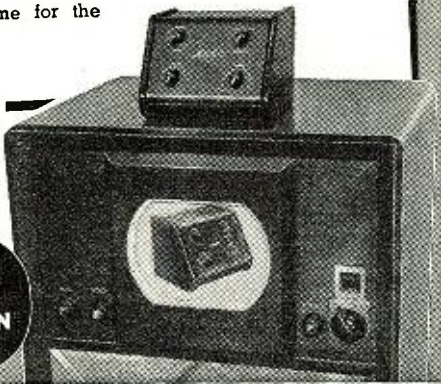

order that the voltage across the rectifier would be within its limit of 40 to 50 volts. The total voltage necessary at 20 watts on a $P = E^2/R$ basis would be equal to the square root of $P \times R$ or about 30 volts, since P is 20 watts and R approximately 50 ohms.

For 10 watts, on the basis of the capacitive voltage divider, the ratio would be 1/50,000 of 22 volts. On the basis of the d.c. voltage division across the resistive network, the ratio across the meter would be 1/100, therefore the voltage appearing across the meter would be approximately $1.4 \times 1/5,000,000$ of 22 volts (a.c.).

In the design and calibration of the original model, the full-scale values were purposely held low to prevent meter burnouts in experimentation, for fear that the transmitters on which this was checked might exceed their normal rated output, which may occur when all components are new and in extra-good condition.

Light-bulbs were used as comparisons, each one properly matched to the transmitter. The illumination was then recorded on a grease-spot photometer standard. (Full details on this simple box-on-yardstick type of photometer can be secured from any good elementary physics book, and constructed for less than a dollar). The power output was recorded. Then the transmitter was connected to the power output meter and a meter recording was made. By varying the power output of a transmitter and making various recordings, a calibrated scale for the meter can be drawn (on the basis of 0-1 ma. scale).

When a 1 ma. meter is used there is a slight crowding at the low end of the scale due to the nonlinearity of the rectifier. This is not serious and for most uses may be disregarded. If desired, a new scale calibrated against a standard may be used, and pasted over the meter face.

-50-

MICROPHONE ADAPTER

By G. MARKHAM

HERE is a hint that I thought worth passing on to your readers.

If a microphone adapter is not available, a satisfactory one can be made by using the screw-on case from an old jack plug, an item usually found in most junk boxes.

The back end is attached to the microphone case and the threaded end will fit most types of microphone stands.

-50-

Details for constructing mike adapter.

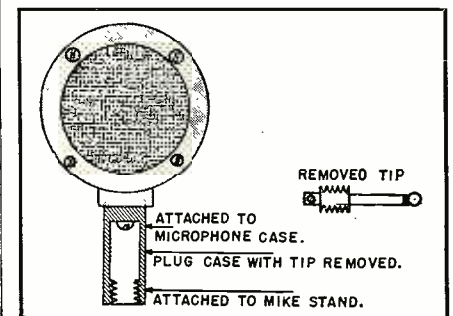

TOP QUALITY TELEPHONES

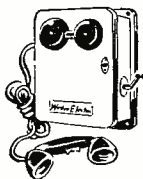

Standard magneto ringer type as used for farms, factories, intercoms, etc. Connect with two wires or single wire and ground. Range 15 miles or more. Ringer box, new, with handset, good. Instructions . . . \$8.95

RCA 6 Inch Weather Proof Speaker

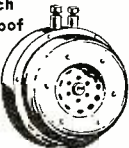

Plastic cone. Made to stand salt water exposure. Ideal for all outdoor installations. Makes fine Hi-Fi tweeter. Includes RCA universal output transformer matching any line or tube impedance from 50 ohms to 10240 ohms. Used, perfect operating condition . . . \$4.95

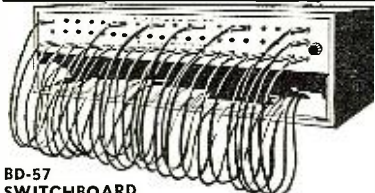

BD-57 SWITCHBOARD
Perfect for Audio patch panels, etc. 60 jacks, 27 plugs & cords, the manual included. NEW. \$9.95

5BP4 SPECIAL
Television or Scope tube . . . \$1.59

G. E. TRANSFORMERS
110 V. 60 Cy. AC
850V CT. 6.3V @ 5A.
6.3V @ 3A, 5V @ 3A.
Conservatively rated @
148 Mil, tested @ 250
mil and will handle more.
A steal . . . \$2.95

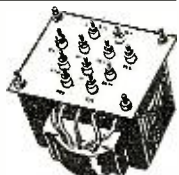

G. E. 12 HENRY CHOKE
Made as companion to above, only . . . \$1.95
F.O.B. Oakland, 25% cash with order. Bal. C.O.D.

EMMONS RADIO SUPPLY
405 - 10th ST. OAKLAND, CALIF.
Phone TWinoaks 3-9103

Have you ever really heard FM?

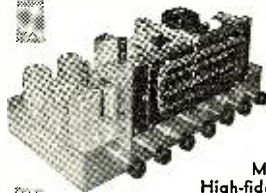

MODEL RJ-20
High-fidelity FM-AM Tuner
incorporating tone controls

To truly enjoy FM . . .

and the unmarred brilliance Armstrong-circuit FM alone makes possible — you need the performance of the RJ-20. The man who knows radio knows nothing less will give equal performance.

Music is flawless, noise-free — every instrument sounds true . . . speech is clear, with astonishing "presence". Tuning is precise and drift-free.

And for better AM . . .

Superior performance with maximum tonal quality. Wide-range tone control to suit your taste; 20 db. treble and bass boost.

Also available: RJ-12A FM-AM tuner with triple tuned IF transformers in AM, RV-10 FM tuner only. All with same Armstrong FM circuit.

Free Bulletin RN-150 gives performance curves and data on these high-fidelity tuners.



TV Generator
(Continued from page 51)

crystal-controlled oscillator is half of a 12AU7 tube, V_{1a} . The output of this oscillator is taken off at two places, the cathode (for direct use as vertical lines), and the plate (for use as trigger voltage in the frequency divider chain). Note that a 1N34 crystal is used across the cathode take-off choke, RFC_1 . The purpose of this crystal is to shape the pulse for fine sharp lines on the crosshatch pattern. On the plate side, C_3 couples the 219.24 kc. output to a buffer amplifier (half of a 12AT7, V_2). The amplified 219.24 kc. is used to trigger the multivibrator V_3 , a 12AT7 tube operating at one-half the fundamental frequency of the crystal-controlled oscillator. C_9 , a trimmer condenser, is an internal factory adjustment of the multivibrator frequency. The 109.62 kc. from V_3 is then fed back (through C_5) to the right hand section of V_2 which is operating, in this case, as another buffer amplifier.

The amplified 109.62 kc. is coupled through C_7 into V_{1b} , a blocking oscillator, operating at 1/7 of 109.62 kc. This half of a 12AU7 generates 15.66 kc. which is used as horizontal sync for the television receiver (coupled into the mixer through C_{18}) and is also used as a trigger pulse for a multivibrator operating at 1/29 frequency (540 cycles). The trigger pulse for V_6 , the 540 cycle multivibrator, is coupled through C_{19} . R_{19} is a potentiometer, adjusted at the factory, which determines the frequency of V_{1b} . R_{25} is an adjustment of the 540 cycle multivibrator and is accessible through an opening in the back of the instrument. This 540 cycle output gives the 9 horizontal lines that appear on the television screen.

V_5 , a 12AU7, is used as a mixer for the three signals that must modulate the main oscillator, V_4 . Note that the output selector, S_1 , has a standby position that removes "B plus" from the tubes. Filaments of the tubes can be kept hot while the instrument is inoperative. This is a handy feature since the 620 should be allowed to come to operating temperatures before adjustments are attempted on the receiver. The next position on the switch allows the output of V_6 , the 540 cycle multivibrator to be coupled through C_{24} and R_{25} into the right hand section of the mixer. Note that in this position, the cathode signal from V_{1a} is open so that only horizontal lines and the 15.66 kc. sync pulse will modulate the oscillator. In the next position of the switch marked "Vert Line," the output of the 540 cycle oscillator is not coupled into the mixer, but a connection is made from the 219.24 kc. cathode take-off on V_{1a} . This allows the signal to be fed into the cathode on the left hand section of the mixer tube, V_5 . This will allow the vertical lines to appear on the

NOW . . .
A TELEVISION TOWER
YOU CAN AFFORD TO BUY!

All steel, welded construction, made of 1/2" Thinwall conduit, 1/2" Rod Braces, and 1" Steel Bands. Made in 10 ft. triangular shaped sections, tapered, 18" at base to 3 1/2" at top. Lined mounting plates and 2" mounting hole for Mast, with Guy Rings. 30 foot Tower is self-supporting when mounted on ground. Weight: 75 lbs. Towers dipped in aluminum paint for weatherproof protection and long life.
PRICE: 30 Foot TOWER, delivered anywhere in U.S.A. . . . **\$38.40**
Additional 10 Foot Sections—delivered, Ea **\$11.70**
GUY WIRE: 3/16" 7x7 Strand Aircraft Type, only **2c** per Ft. WIRE CABLE CLAMPS: **1.0c** Each. TURN-BUCKLES: 5/16" @ **25c** Each; 9/16" @ **70c** Each.



BLOWERS:

110 VOLT 60 CYCLE (Picture), 4" intake, 3" outlet. Approx. 100 Cu. Ft. Dis. Motor size: 3"x3", 1750 RPM. Quiet running. Prices: NEW: **\$6.95**—Motor only **\$3.95**
24 VOLT DC or **36 VOLT AC**—6" intake, 3" outlet. Approx. 200 Cu. Ft. Dis. Also has adapter for Dual outlet. Unused. Price . . . **\$5.95**
6 VOLT DC CAR DEFROSTER KIT—Complete with Hose, Blower, Hardware, and instructions for easy installation . . . **\$4.95**

MARK II B-19 TRANSMITTER AND RECEIVING SET

15 TUBES 2—8 MC., 240 MC., AND INTERCOM. IDEAL FOR MOBILE OR STATIONARY USE!

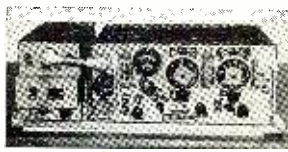

Set transmits and receives 2 to 8 MC. Phone, C W and M C W 25 Watt Master Oscillator Control. Transmits and receives 240 MC. Phone. Also an intercommunicating set. Comes complete with 15 Tubes, Headset, Micro., Antennas, Control Box, 12/24 Volt Power Supply, and instructions—ready to operate. Set size: 27"x10"x13 1/4". Prices: **\$39.50** NEW. **\$59.50**; USED (Tested) . . .

Also Available—All Parts and Accessories for B19 Mark II Sets!

BC-645-A TRANSCEIVER—ALSO
110 VOLT TRANSFORMER AND CHOKE

15 Tube Transceiver, ideal for conversion to 460 MC. Frequency coverage 435 to 500 MC. With conversion instructions.
Price: New and Boxed . . . **\$14.95**
TRANSFORMER for BC-645-A—110 Volt 60 cycle input; output 400 Volt 150 MA. after filter. 12, 9, and 6 V. AC. 4 amps and 5 V. 3 amps.
No. NH-645 . . . **\$6.95**
CHOKE—15 Hv. 150 MA. Order No. NH-646 . . . **2.95**
PE-101 DYNAMOTOR—13/28 V. input . . . **2.95**

SELSYN TRANSMITTER AND INDICATOR SYSTEM—Ideal for antenna direction indicator, to remote position. Complete with Autosyn Trans., 3" x 1 1/2" Indicator, Transformer, and instructions . . . **\$6.75**
Autosyn Trans. only: **\$2.95** Plug f/T-81: **\$1.00**

WHIP ANTENNA EQUIPMENT
MAST BASES—INSULATED:
MP-132—1" heavy coil spring, 2" insulator, overall length: 11 1/2". Wt.: 2 1/2 lbs. Price . . . **\$2.95**
MP-22—Spring action direction of bracket, 4"x6" mounting. Price: . . . **2.95**

MAST SECTIONS FOR ABOVE BASES:
Tubular steel, copper coated, painted, 3 foot sections, screw-in type. MS-53 can be used to make any length, with MS-52-51-50-49 for taper. Price—any section . . . **50c Ea.**
BAG BG-56 1/carrying 5 mast sections . . . **50c**

DYNAMOTORS:

INPUT:	OUTPUT:	STOCK NO.:	PRICE:
12 V. DC	680 V. 210 MA.	DM-680	\$7.95
@ 6 V. DC	300 V. 150 MA.		
9 V. DC	450 V. 60 MA.	DM-950	
@ 6 V. DC	275 V. 50 MA.	w/Blower	3.95
12/24 V. DC	440 V. 200 MA.		
	& 220 V. 100 MA.	D-104	9.95
18 V. DC	450 V. 60 MA.	DM-175	2.95
12 V. DC	600 V. 300 MA.	BD-86	7.95

PERMANENT MAGNET FIELD DYNAMOTORS:
12/24 V. DC 275 V. 110 MA. USA/0516 **3.95**
12/24 V. DC 500 V. 50 MA. USA/0515 **2.95**

PM FIELD DYNAMOTOR POWER SUPPLY—Completely filtered. Has two PM Dynamotors as listed directly above . . . **\$5.00**

WRITE FOR QUOTATION ON OTHER INVERTER OR DYNAMOTOR NEEDS!

GEARED MOTOR

Ideal reversible motor for rotating antennas, displays, etc. Weight: 4 lbs. Overall size: 7" long, less shaft. Gear Box size: 3 3/4" x 3 3/4". Motor size: 4" x 2 1/4". Shaft size: 3/8" x 1 1/2". Threaded. Operates from 24 volt DC, 2.9 A., 9 RPM or 36 volt AC at 75 lbs. per inch torque. Price . . . **\$5.95**
TRANSFORMER—110 Volt 60 cycle primary, secondary 36 Volt AC. 2.5 A. Price: **\$2.95**. RHEOSTAT to control speed 120 ohm, 50 Watt **97c**



FT-237 MOUNTING BASE f/BC-604 & 603's, & f/BC-684 & 683's. Prices: NEW . . . **\$9.95** USED . . . **\$7.00**
BC-1206 REC. 5 Tubes, 24-28 VDC. 200-400 Kc. **6.95**
Address DEPT. RN Minimum Order **\$2.00** Prices F.O.B., Lima

GUN SIGHTS

Illuminated Sight Mark 8—Mod. 3. Contains the following lenses: 2 1/4" Concave-Convex PL 4 1/2"; 3 1/4" Double Concave PL 5"; 3 1/4" Double Convex PL 3 1/2"; 3 1/2" Plain and Convex PL 3 1/2" (Contains also 1 3/4" Plain Rd., 5" x 3 3/4" x 1/4" Oblong Plain Optical—all mounted in a 4 1/2" Barrel with light socket level indicator and pistol sight holder.
PRICE—only . . . **\$6.95**

NEW LOW PRICES

TRANSMITTERS AND RECEIVERS:

	USED:	NEW:
BC-453 Receiver—100—550 KC.	\$11.95	
BC-455 Receiver—6-9.1 MC.	6.95	
BC-454 Receiver—3-6 MC.	4.95	
Transformer f/Com. Rec. See NH-109 below		\$3.50
	USED:	NEW:
BC-696 Transmitter—3-4 MC.	\$12.95	
BC-459 Transmitter—7-9 MC.	9.95	
BC-457 Transmitter—4-5.3 MC.	5.95	
BC-458 Transmitter—5.5-7 MC.	5.95	
BC-456 Transmitter Modulator	1.95	\$ 2.95
Transformer f/Com. Trans. See NH-108 below		7.75
Choke—13 1/2 in. 250 MA. No. NH-121		4.95

CONDENSER ASSEMBLIES:

5 Gang with vernier tuning, 25 MMFD to 450 MMFD each section. Size: 7 1/2"x3 3/4"x3 1/4". Price . . . **\$2.95**
3 Gang Condenser, 25 MMFD to 450 MMFD each section. Size: 6"x3 1/4"x3". Price . . . **\$1.95**

BC-223 TRANSMITTER



30 Watt Transmitter with crystal or MO control on four pre-selected channels, 2000 to 5250 KC., by use of three plug-in coils. Five Tubes: 2—801 & 3—46. With TU-17 Tuning Unit 2000 to 3000 KC. and 4 Cable. Less Mtg. Prices
NEW: **\$24.95**
USED: **\$19.95**

TUNING UNITS: TU-18 3 to 4.5 MC. TU-25 4.5 to 5.2 MC. Either: NEW: **\$3.50**—USED: **\$2.50**
PE-125 VIBRATOR POWER SUPPLY f/BC-223 Transmitter, 12/24 volt input; output 500 V. 150 MA. Designed for Army surplus transmitters. Prices: NEW: **\$9.95**—USED: **\$7.95**
CABLE only—Trans. to Power Supply . . . **\$1.75**

NEW TRANSFORMERS And CHOKES

ALL FOLLOWING TRANSFORMERS—CASED 115 V.A.C. 60 CYCLE INPUT:
OUTPUT: 750-0-750 V.A.C. (600 V.D.C. after choke input filter at 250 MA.) Includes 6.3 V.A.C. winding at 5 amps and 5.0 V.A.C. winding at 4 amps. NH-106 . . . **\$8.75**
OUTPUT: 600-0-600 V.A.C. at 250 MA. 12 V.A.C. at 3 amps; 12 V.A.C. at 3 amps and 5 V.A.C. at 3 amps. Designed for Army surplus transmitters. NH-108 . . . **\$7.75**
OUTPUT: 250-0-250 V.A.C. at 60 MA. 24 V.A.C. at .6 amps; 6.3 V.A.C. at .6 amps. Designed for Army Surplus Receivers. NH-109 . . . **\$3.50**
TRANSFORMERS—110 V. 60 CYCLE PRIMARIES:
SEC.: SEC.:
12 V. 1 amp. . . **\$1.50** 24 V. 2 amps. . . **\$2.25**
24 V. 1 amp. . . **1.95** 24 V. .5 amp . . . **1.50**
Sec. 36 VAC. 2.5 amps. . . **2.95**
Sec. 14-14 or 28 V. 7 1/2 or 15 amps. . . **4.95**

CHOKES—CASED:
NH-115—8 Henries at 500 MA. filter choke, 5,000 volt insulation . . . **\$10.95**
NH-116—5-20 Henry 500 MA. swinging choke, 5,000 volt insulation . . . **\$10.95**
NH-117—8 Henries at 700 MA. filter choke, 7,500 volt insulation . . . **\$16.50**
NH-118—5-20 Henries at 700 MA. swinging choke, 7,500 volt insulation . . . **\$16.50**
NH-121—13 Henries at 250 MA. filter choke, 1,500 volt insulation . . . **\$4.95**
NH-412—4-12 Henries 81 ohm. Gov't conservative test voltage 2500 V. 300 MA. . . **\$4.95**

PAE-I Portable ELECTRIC MEGAPHONE EQUIP. Complete w/6 V. DC battery charging rack. Price **\$39.95** and 110 Volt AC charging rack. Price

GENERATOR 12 Volt 100 Amp. Mfg. by Emerson. 5400 RPM with 3/4" x 3/4" shaft and 7 3/4" x 1 1/2" . . . **\$12.95**
Price . . . **\$30.00**
P1 GENERATOR 24 Volt 200 Amp. NEW . . . **\$30.00**
FL-8 A FILTER 1020 CPS. . . **\$1.95**
CABLE—4 Conductor, shielded, 50 ft. length. 2.00
CABLE CD—280 one #6 wire, shielded RC 15 ft. 1.00

TRIPLEX WAVE MASTER

YOUR BEST ANTENNA BUY!!!!

TRIPLE DIRECTORS

1/4 Wavelength Stacked

Conical with 3-Element Dipole

GHOST FREE RECEPTION ALL CHANNELS

NO BOOSTER REQUIRED

YOUR COST \$990

INSTANT ASSEMBLY

MATCHES ANY OHM WIRE 75-150-300

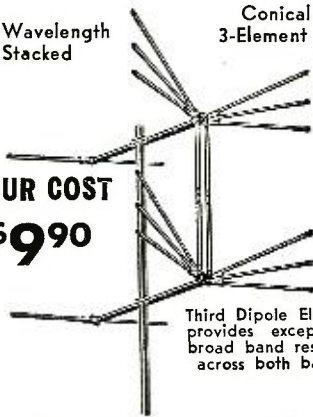

Third Dipole Element provides exceptional broad band response across both bands.

EASY INSTALLATION APPROX. WT. 7 POUNDS

Price List

\$2690

UNDER ACTUAL TESTS...PROVED!

- Most advanced design to date.
- Easier tuning, added selectivity on any receiver.
- 30% more gain than former 4X antennas.
- These tests conducted in fringe areas and locations up to 250 miles from transmitting stations—not by meter or laboratory tests, but under average home installation.
- Reception available in fringe and formerly unsatisfactory locations, all channels.

SOLD DIRECT—WRITE—WIRE—CALL—FA IR FAX 9171

RAYTRON MFG. CO.

441 SUMMIT ST.

TOLEDO, OHIO

A NEW APPROACH! RIDER'S *Bigger and Better* book for the

- ★ Commercial Radio Operator
- ★ Broadcast Station Operator
- ★ Television Station Operator
- ★ The Student who wants to get his Commercial Ticket
- ★ The Individual who wants his Amateur Radio License

Kaufman's

RADIO OPERATOR'S LICENSE Q and A MANUAL

is more than a presentation of the questions and answers for FCC examinations. The "follow-through" discussions, a new feature of great value, give the answers infinitely more meaning and serve as refreshers of pertinent radio theory. Useful appendices, which include Small Vessel Direction Finders and Automatic Alarm, not ordinarily found in a book of this type, provide other valuable extras.

608 Pages. 193 Explanatory Diagrams. \$6.00

— MAIL THIS COUPON NOW —

JOHN F. RIDER PUBLISHER, INC.
480 Canal Street, New York 13, N. Y.

Please send me "Radio Operator's License Q and A Manual".....at \$6.00 Postpaid

Name.....

Address.....

City.....Zone.....State.....

Check M.O. C.O.D.*

*Slight Postage Charge on C.O.D.'s.



ACORN

BRAND NEW—NOT SURPLUS!
POWER TRANSFORMER
(can be used for TV)



Pri. 115 v. 50/60 cy. Sec. #1. 800 v. c.t. @ 260 mls. #2. 6.3 v. @ 10 amps. #3. 6.3 v. @ 1.2 amps. #4. 5 v. @ 3 amps—mtg. centers 3 1/8" x 3 3/8". Ht. 4 1/2". Diam. 4 3/8". Width 3 3/4". Wt. 13 lbs.

\$879

POWER TRANSFORMERS

(RCA Part No. 941580-1)	(RCA Part No. 941583-1)
Pri. 115 v. 50/60 cy. Sec. #1. 750 v. c.t. @ 225 mls. #2. 6.3 v. @ 3 amps. #3. 6.3 v. @ 1.2 amps. #4. 5 v. @ 3 amps. Mtg. centers 3 1/8" x 4". Wt. 12 lbs.	Pri. 115 v. 50/60 cy. Sec. #1. 760 v. c.t. @ 160 mls. #2. 6.3 v. @ 4 amps. #3. 6.3 v. @ 1.2 amps. #4. 5 v. @ 3 amps. Mtg. center 3 1/4" x 3 3/4". Wt. 8 1/2 lbs.



\$6.97

\$3.49

RCA High Fidelity OUTPUT TRANSFORMERS

(Part No. 970758-1)	25 w., 6L6's. Pri. plate imp. 9000 ohms, turns ratio 24.5 to 1; Voice coil 13 ohms. Mtg. centers 2 7/8" x 2 3/4". Wt. 7 1/2 lbs.
---------------------	--



\$4.95

TV & FM BARGAIN COUNTER

FILTER CHOKE for RCA 630

2 1/4 hy. 235 mls. Strap mount, 60 ohms D.C.	\$1.39 ea.
TV IF Sound Transformers, 21.9 Mc.	89c ea.
TV IF Sound Discriminator, 21.9 Mc.	99c ea.
Mixer Coil for Front End.	89c ea.
4-Gang FM 4-30 MMFD per sec.	\$1.29 ea.
Midget 10.7 IF Transformers.	59c ea.
Ratio Detector, 10.7.	69c ea.

FLY BACK TRANSFORMERS
RCA Part No.
211T-1 \$3.89 ea.
211T-3 3.89 ea.
211T-5 4.95 ea.

FILTER CHOKE
Hermetically sealed. 10 hy. @ 60 mls. 400 ohms D.C. res. Mtg. centers 1 1/2" x 1 5/8". H. 4" x D. 2 1/8" x W. 2 1/4". Ship. wt. 3 lbs. 69c ea.
10 for \$6.25

Phone: WOrth 4-3270

TERMS: 20% cash w/order. Bal. C.O.D. Prices F.O.B. our warehouse in N. Y. C. Min. order \$2.50.

ACORN ELECTRONICS CORP.
76 Vesey St. Dept. N-4 New York 7, N. Y.

screen of the television receiver. In the next position, "Cross Hatch," both the 540 cycles and the 219.24 kc. are allowed to modulate the main oscillator, V₄.

The novel method of mixing in this circuit is interesting. Note that the 219.24 kc. (vertical lines) feeds into the left hand section of V₅ through the cathode. The 15.66 kc. output of the blocking oscillator V_{1b} (horizontal sync) is fed into the grid of this same section. The mixed output of these two signals is then coupled (through C₂₁) into the grid of the right hand section of V₅. Here it is mixed with the output of the 540 cycle multivibrator, V₆ (horizontal lines). The composite signal is then used to modulate the r.f. oscillator V₄. The output of V₄ (which tunes through the low frequency television channels) can then be used as a signal to the television receiver being adjusted. Since the output is r.f. in the television band, the crosshatch can be injected by a loose coupling to the 300-ohm antenna lead. If a coax input is used, the crosshatch can be injected at the antenna terminals of the receiver. —30—

Mac's Service Shop

(Continued from page 56)

screwdriver with a flexible shaft; but usually I slide the chassis out until I can reach the trimmer, give it an eighth of a turn, and slide the chassis back in. I keep doing this until the output meter shows the maximum reading with everything in place. In order to keep my temper during the tedious process, I play a little game in which I imagine various accidents befalling the muscle-head who designed the set. Falling into a vat of boiling transformer oil is one of the less-gruesome of these pictures."

"How's about those storage battery portables over there in the corner? Do they have any peculiarities I ought to know?"

"Plenty of them; and not the least important is *never* to do what the owner did to that one on the end of the bench: put in a heavier-than-recommended fuse. These sets have a small voltage-dropping transformer and a couple of copper-oxide rectifier assemblies hooked in a full-wave rectifying circuit to keep the two-volt storage battery charged. Occasionally one of the rectifiers shorts out, and then the quarter-ampere fuse in the primary of the transformer is supposed to blow and prevent damage.

"This man found the fuse blown, and a new 1/4 ampere fuse went out, too; so he simply put in a one-ampere fuse and put the set on charge. By the time he saw the smoke curling out of the cabinet the damage was done. Now he needs a new rectifier and a new transformer."

"And a new 1/4 ampere fuse," Barney added; "but how can you check one of these rectifier assemblies for short?"

"After you disconnect them, an ohm-

meter will do the trick. In the conducting direction, they will show almost a dead short; but they should show a resistance of at least 300 ohms in the opposite direction. If they are shorted, of course, they show a very low resistance in either direction. Incidentally, I never replace just one of the rectifier assemblies at a time. It is good insurance to replace them both when one goes bad.

"Finally, there is the matter of the two-volt vibrators. As you know, I am ordinarily opposed to tinkering with vibrators, for as you read in that *MYE Technical Manual* I told you to take home, these gadgets are precision-made and carefully adjusted at the factory with special equipment that the service technician does not have. However, on several occasions I have run into these two-volt vibrators that only operated a few days and then stopped vibrating. By experimenting, I found that the points that were normally supposed to be closed when the reed was at rest were not quite making contact. A slight clockwise adjustment of a screw found at the base of the reed restored the vibrator to action. Careful checks over periods of three and four years showed no later failures of these adjusted units; so I have no hesitancy about making this adjustment on vibrators that do not show excessive wear, burned and pitted points, etc.

"I made up that little adapter there on the bench that allows the vibrator to be in action while it is raised up out of its shield can until I can attach the scope leads to it and also reach the adjusting screw. As you see, the adapter is just an old vibrator base with a vibrator socket mounted on pillars about six inches directly above it and with heavy leads connecting the lower pins to the corresponding upper socket connections.

"The scope should always be used, for it allows you to set the adjusting screw for the optimum pattern as shown in the *MYE Technical Manual*; on top of that, it will show up any other troubles that may be present, such as a leaky buffer condenser."

"Hey, Boss," Barney interrupted, "I think I feel another attack coming on. Maybe I had better go home now."

"Oh no you don't!" Mac exclaimed. "You just grab your soldering iron and see what wonderful curative powers a little hard work has. It will surprise a fellow like you who has never tried it!"

-30-

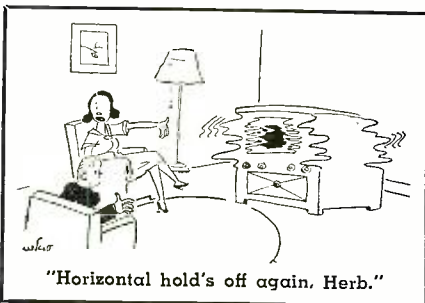

"Horizontal hold's off again, Herb."

April, 1950

Enter a dynamic profession! Become an

ELECTRICAL ENGINEER



• MAJOR IN POWER OR ELECTRONICS

• B. S. DEGREE IN 36 MONTHS

Look at the powerful trends which influence your future in these fields.

Men specializing in *Electronics* enter a science of tremendous, growing value—in communications, radio, television, broadcasting, high-frequency heating, power system control, printing and other fields.

Men specializing in *Power* become equipped to serve the electrical power industry, which must face an 80% expansion of its generating capacity by 1960.

This 47-year-old Technical Institute and College offers important advantages to the young man preparing for these opportunities. He saves a valuable year by gaining his B.S. degree in 36 months of continuous study. He receives *extensive* technical laboratory experience on modern equipment. This is integrated, in each successive term with fundamental education in engineering and the humanities.

The World-famous course in *Power* covers 24 technical specialty subjects in Electrical Power, including 8 in Electrical Design.

MILWAUKEE SCHOOL of ENGINEERING

Founded 1903 by Oscar Werwath

Over 35,000 alumni and 1,555 students. Faculty of 85 specialists.

Practical, military or academic training evaluated for advanced credit. Preparatory programs also available.

TERMS OPEN JULY, OCT., JAN., APRIL

PEN-OSCIL-LITE

Extremely convenient test oscillator for all radio servicing; alignment • Small as a pen • Self powered • Range from 700 cycles audio to over 600 megacycles u.h.f. • Output from zero to 125 v. • Low in cost • Used by Signal Corps • Write for information.

GENERAL TEST EQUIPMENT
38 Argyle Buffalo 9, N. Y.

AUDIO ENGINEERING SCHOOL

Practical engineering training in Audio fundamentals, Disc, Film, Magnetic Recording, and Audio frequency measurements. Audio training includes Broadcast, Motion Picture, Television, and Commercial Recording work. Approved for Veterans.

HOLLYWOOD SOUND INSTITUTE, Inc.

1040-N North Kenmore, Hollywood 27, Calif.
Correspondence Courses Available
Specify if Veteran or Non-Veteran

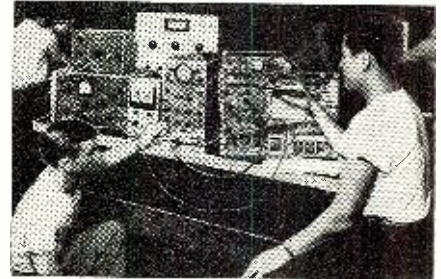

The Electronics Course covers 19 technical specialty subjects in Electronic Engineering, including four in Electronic Design.

In One Year of Study, Become an *ELECTRONIC TECHNICIAN*—This certificate is yours after 12 months of study in the Electrical Engineering (Electronics) course.

Prepare here for a Career in *RADIO TELEVISION*—In 18 months you can become a Technician, trained for receiver and transmitter testing, servicing, sales and production.

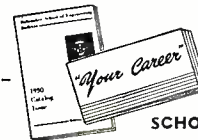

Send coupon or letter today for this free, helpful guidance literature (see below).

MILWAUKEE SCHOOL OF ENGINEERING
Dept. RN-450

1020 N. Broadway, Milwaukee, Wis.

Without obligation send 48-page pictorial bulletin, "Your Career"; 110-page

1950 catalog. I am interested in _____

_____ course.

Name _____ Age _____

Address _____

City _____ Zone _____ State _____

Check if World War II Veteran

STEADY PROFITS

YOUR OWN
BUSINESS WITH
COVIDEO

Coin Operated
Television

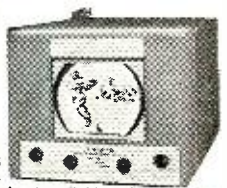

Place these specially built television sets that play 30 minutes for 25c in the thousands of available public places, hotel rooms, tourist courts, etc. They yield immediate profits and steady income. Install Covideo, the finest made. Limited capital required. Send for further information. Write today.

COVIDEO Coin Operated Television, Dept. B

212 Broadway, Phone: BEekman 3-0038-9
NEW YORK 7, N. Y.

STAHL SEZ!

My Bargain Columns
are always worth reading

GIBSON GIRL

The Emergency
Radio
Transmitter



Send SOS signals automatically on 500 Kc., 150-mile range. No batteries required. Has hand-driven generator, tubes, copper wire, 70 sq. ft. parachute, signal lamp, balloon, hydrogen tank, feeder pipe, collapsible box kite and technical manual. Packed in knapsack. Weight 35 lbs. The entire caboodle sold complete for **\$9.95** only

EVEREADY AIR CELL BATTERY

You certainly know what these Batteries are. All we will say is—1.25 volts; 600 amp hour capacity. All brand new, in perfect condition. Made by National Carbon Co. Shipping weight 15 lbs. each. They sell for many, many times our price. While they last: Each..... **\$1.39**

We have available CODE PRACTICE

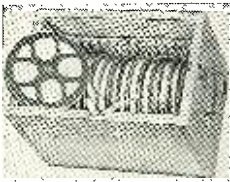

TAPE, which was used for code practice work by the Signal Corps—from slow to fast practice. 15 rolls on 16MM metal reels in heavy wooden slotted case, to be used with McElroy TG10 Keyers, Tone Keyers or any code practice unit using printed tape. **\$9.95** Special..

TRANSMITTER-RECEIVER

Navy Model ABA-1—BC-645

450 MC—15 TUBES, Brand New

Can be easily converted for phone or CW 2-way communication. Covering the following bands: 420-450MC ham band, 450-460MC for fixed or mobile, 460-470MC for citizens, 470-500MC television experimental. Size 10½x13½x4¾. Contains 15 tubes: 4—7F7, 4—7H7, 2—7E6, 2—6F6, 2—955, 1—AVE-316A door knob.

Here is what you get:

BC-645 with 15 tubes Instruction Book **\$15.95**
Dynamotor Keyer Unit, Remote Control Unit. **COMPLETE**

Complete set of plugs, antennas and rack mountings for control box..... **\$9.95**

PORTABLE PUBLIC ADDRESS SYSTEM

Model CS-91-C made by Silman Mfg. Co. for the U.S. Army. Ideal for camps, boat races, ski races, loading platforms, etc., etc. It's a battery operated amplifier with 2 tubes, 1H4—1J6; hand microphone and trigger type switch microphone and loud speaker; 4½' collapsible metal tripod, batteries and carrying case. Brand New. Shipping Weight 25 lbs. While they last..... **\$39.95**



Prompt Delivery—25% deposit required on C.O.D. order. Shipped F.O.B. New York.

Write Dept. RN-4

MICHAEL STAHL, INC.

39 VESEY ST.

WO 4-2882 New York 7, N. Y.

Design Considerations

(Continued from page 53)

their well-known curves showing this effect, will not be covered in great detail here.

These curves do show, however, that as the over-all volume decreases the ear becomes less sensitive to low frequencies; at the threshold of audibility the bass sensitivity falls off below 800 c.p.s. at the rate of 12 db. per octave. At moderate levels this rate is approximately 6 db. per octave. If the system is to be used at several listening levels, means should be provided for adjusting the low frequency response according to variations in level. This is best accomplished by using an aurally compensated gain control such as *Tech Products* #PB-722 or *Livingston Electronics* Type MB loudness control. Greater flexibility is possible, however, by designing the proper characteristic into the bass control.

So much for the general departure from flat amplifier response, but why, you may ask, must we have flat response to begin with? Why must it be flat $\pm X$ db. or Y db.? If the average ear cannot perceive changes in level of less than 3 db., why should any amplifier be made better than perhaps ± 1.5 db.? These questions are important factors in audio philosophy; if the answers are known, a much more intelligent approach can be made to many amplifier design problems.

If a complex audio wave (Fig. 2A) is passed through a system with non-linear frequency response characteristics, its higher frequencies will bear a different amplitude relationship to the lower frequencies and the "tone color" may be markedly changed as in Fig. 2B (resulting from the curve of Fig. 1C, or Fig. 2D resulting from the curves of Figs. 1D and 1E). This analysis indicates that a gradual tilt of the response curve is not nearly as serious as a sharp, resonant peak or dip. Experience bears this out, for the slope of the curve can be tilted in many ways; but as long as tonal balance is maintained, the ear is not greatly offended.

A greater problem is the condition under which a random band of frequencies such as record surface noise, FM or tube hiss, static, etc., passes through a system with a peak. That peak will amplify a relatively narrow band of frequencies more than the rest of the signal. The result is a decrease in the effective signal-to-noise ratio.

Generally, it may be said that in addition to properly balanced frequency characteristics a good system must be reasonably free of peaks and dips. I speak here of the entire system. A ½ db. dip at 2000 c.p.s. at three different points of the system means a total dip of 1½ db. Many parts of a system (microphone, mix-

NEW PRECISION ELECTRONICS SIGNAL TRACERS

MODEL 201 A
\$34.50

MODEL 251 A
\$49.75

Write for literature and name of your nearest Jobber

PRECISION ELECTRONICS, Inc.
641-643 MILWAUKEE AVENUE
CHICAGO 22, ILLINOIS

SIGNAL TRACER SPECIALISTS

ELECTRONIC DISTRIBUTORS FROM COAST TO COAST

Now we can serve you with our J.S.C. 300 Ohm Television Transmission Twin Lead, like we have been serving about 50% of the Television Twin Lead requirements in the Metropolitan Area.

Remember, our prices are right, our quality is the highest, our delivery the fastest.

Write for quotation on quantity. Sold through Wholesale Distributors only.

JERSEY SPECIALTY CO.
Little Falls New Jersey

RADIO & TELEVISION NEWS

ing panels, studio acoustics, recording heads, loudspeakers, etc.) are beyond the control of the individual designer. The more uniform he can make the response of his part of the system the greater guarantee he will have of faithful reproduction of the original sound.

Power Output Requirements

A rather involved and generally misunderstood audio concept concerns the power output rating of an amplifier and the power required to furnish a comfortable level in the average home.

The power output of an amplifier is frequently used as a figure of merit; it is as useless a figure as the maximum speed rating of an automobile. The average listener would no more use 30 watts of audio power than he would drive his automobile at 95 miles an hour. Of course, that reserve power is a nice thing to have available, but when it doubles the cost of equipment one may certainly inquire as to its value.

Measure the voltage across the speaker terminals in your living-room radio while the family is listening at a customary volume and you will readily see what is meant. The power formula $P = E^2/R$ indicates that four volts into an 8 ohm voice coil will produce 2 watts of power. You will be more likely to find fractions of a volt than you will 4 volts. Assuming that your radio will deliver two watts and that your family won't object to the unusual volume, adjust the volume control to deliver four volts of peak power and listen to the way two watts sounds.

Reduce the output to two volts and see if you can detect the 6 db. difference in the resulting 1/2 watt of power. Go even further—check the level with 4 volts and with 1 volt, a difference between 2 watts and 1/4 watt. The same effective 16 to 1 power difference would be true for a 2 watt amplifier and a 32 watt amplifier. Surprising, isn't it?

Although your individual requirements may call for large amounts of power, these experiments should prove that there are certain fundamentals which some slide rule theorists overlook when they say that one must have 20 to 30 watts of power to faithfully reproduce the impact of a symphony orchestra or the wallop of 18 hep be-bop artists. Variations of 6 to 10 db. between various types of speakers make any specific amplifier power rating meaningless since it is possible, with a highly efficient speaker, to produce more acoustic watts with 3 watts of electrical power than 20 watts (of electrical power) would produce with an inefficient speaker.

It should be pointed out here that in the special case where bass or treble boost is used to compensate for speaker system deficiencies (Figs. 1D and 1E), the total power will have to be raised to deliver the same

SEE LEO FIRST... for HALLICRAFTERS!

Fellows— I'll bend over backward to give you a better deal. My EZ Payment Plan is the lowest in the country. I finance my own paper—it saves you money. No Red Tape, No Delays! Liberal Trade-Ins on your present equipment. Let's get acquainted!

SX-71 RECEIVER

The SX-71 offers superior Ham Band performance in the moderate price range—value packed with features specifically asked for by Hams. Features include Double Conversion sharp selectivity, plus built-in NBFM at moderate cost. 10 tubes plus voltage regulator and rectifier



\$179.50
Low Down Payments



LEO I. MEYERSON WØGFQ

"Guaranteed Satisfaction From The World's Largest Distributor Of Amateur Radio Transmitting Equipment."

S-40A RECEIVER



Frequency Range 540 KC to 43 MC. Temperature compensated oscillator. One RF, 2 IF. 3 Watt Output. 4 Bands. 8 tubes plus rectifier. Internal speaker. Has AF & RF gain controls, AVC, BFO, and Noise Limiter switches.

The finest set on the market at this low price. **\$79.95**

Low Down Payments



Deal with the "World's Most Personalized Radio Supply House". Send for your new complete WRL Catalog containing everything new in radio.

GIANT RADIO REFERENCE MAP



Just right for your control room wall. Approximately 28" x 42". Contains time zones, amateur zones, leading shortwave stations, monitoring stations. **25c**

FREE

WRITE—WIRE
PHONE 7795

WORLD RADIO LABORATORIES
744 West Broadway
Council Bluffs, Iowa

R-4

List Of Used Equipment
 Radio Map
 New Catalog
 SX-71 Info
 S-40A Info

Name
Address
City State

World Radio Laboratories
LABORATORIES
COUNCIL BLUFFS, IOWA
Radio
INCORPORATED

Latest Information

RADIO & ELECTRONICS

You'll want

HERBACH & RADEMAN'S

complete 16 page catalog of radio and electronic equipment every month

ABSOLUTELY FREE

Just send your name and address to Dept. TR.

HERBACH & RADEMAN, INC.

522 Market Street

Phila. 6, Pa.



SOUND POWER PHONE AND CHEST SET

RCA M1 2454-B
Complete with 24' of Rubber Covered Wire.
NEW EXPORT PACKED
Shipping weight 6 lbs.
\$6.95 per set
2 for \$13.50

EACH SET FULLY GUARANTEED

Brand New. Government Cost. \$42.00 each.
standards 2 pin holder
CR-28/U brand new \$1.50
INCLUDE POSTAGE WITH EACH ORDER
McCONNELL'S 3834 Germantown Ave.
Phila., Pa. RA 5-6033

WHERE TO BUY IT . . .
WHOLESALE RADIO
of Baltimore

SCOOP!

Hams . . . Now you can DX on 10 & 11 meter bands without creating TVI!

TVI FILTERS
FOR 10 & 11 METER BAND TRANSMITTERS
DRAKE LOW PASS FILTERS

Installs in transmission line. Attenuates antenna and feed system harmonic radiation with no reduction of fundamental signal. Order Model TV-300-10HW for 300 ohm transmission lines. **\$10.95** net

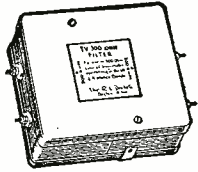

TVI FILTERS FOR TRANSMITTERS 10 METERS AND UNDER
Model TV-52-40LP for 52 ohm coax. **\$12.95** net
Model TV-300 LP for 300 ohm twin lead.

DRAKE TVI FILTERS FOR TV RECEIVERS
Model TV-300-50HP for 300 ohm twin lead. **\$5.95** list
Model TV-72-50LP for 72 ohm small coax.
WRITE FOR DEALER AND AMATEUR NET PRICE

Sensational Antenna Buy!
Snyder HI-LOW ARRAY
With two 3 1/2' mast sections

We don't believe you'll find a finer antenna anywhere near this low price. Two folded dipoles (High and Low) with reflectors. Complete with two 3 1/2' mast sections, guy ring. Ready for quick installation. Model TV21.

\$5.95
6 or more **\$5.75** ea.

T.V. ANTENNA ACCESSORIES

STEEL EXTENSION POLES. Weather treated.	
10 Ft. Long. 1 1/4" di.	\$ 1.49
5 Ft. Long. 1 1/2" di. Crimped end	.85
3 1/2 Ft. Long. 1 1/4" di. Crimped end	.69
ANTENNA SWIVEL BASE. Aluminum.	.39
Fits 1 1/2" O.D. mast section.	
GUYWIRE No. 6, stranded No. 20. Per 50 ft.	.29
24 reels, 50 ft. each, interconnected.	6.00
72 OHM COAXIAL CABLE RG59U.	
4c per ft. Per 100 ft.	3.75
300 OHM TWIN LEAD (\$1.45 per 100 ft.), 1000 ft.	11.75
CHIMNEY MOUNT BRACKETS, complete with strap	1.35
3/2"-300 OHM STAND-OFF INSULATORS.	
Wood screw-in type. 3c ea. Per 100.	2.75
WALL BRACKETS. Adj. up to 18" from wall. Will hold masts 1" to 1 1/2" di. With 2.	3.75
SAMS TV ANTENNA MANUAL.	1.25
SNAP-ON TWIN LEAD INSULATORS. Fit 1 1/4" masts	.06
HI-BAND ADAPTER. Folded dipole and reflector.	
Clamps on existing pole. HP-3.	1.49
MAST COUPLINGS. Galvanized steel 8" long. Will couple masts of 1 1/4" or 1 5/16" di.	.45

STOP PICTURE JUMPING!
NEW! AGG for 630 Type TV CHASSIS
Techmaster Keyed AGC Kit
Install It In 15 Minutes

For any 630 type TV receiver. Keyed automatic gain control eliminates picture jumping caused by noise and overloading by strong signals. Special bracket mounts on existing holes in chassis. Operates from sync pulse. Simplifies tuning and adjustment. Complete with 6AU6 tube, bracket with mounted tube socket, resistors, condenser, coil and pictorial wiring instructions. **\$4.45** net.

ADJUSTABLE TV TABLES
Adjustable to any width or depth from 19 1/2" **\$11.75** Net to 26". 25" high. Rich mahogany finish.

MECHANICAL PHONO PICK-UP COMPLETE

\$2.30 net
TONE ARM—\$1.34. HEAD—95c

WRITE FOR FREE MONTHLY "FYI" BULLETIN
Address Orders to Dept. QR-26 or Phone MUlberry 2134
All Prices Net Unless Otherwise Specified

WHOLESALE RADIO PARTS CO., Inc.
311 W. Baltimore St.
BALTIMORE 1, MD.

acoustic power at the peak of the curve as is delivered to the lowest point on the curve. In the case previously illustrated, where 25 db. total is used to compensate for speaker losses, it will be necessary to provide 25 db. more power to produce an equivalent volume. Obviously this presents a special problem and it should be seen that careful planning of the entire system is essential to good design.

The greatest dynamic range of the system will be the difference between the maximum undistorted power output and the hum and noise level. A more accurate expression of dynamic range is the difference between maximum power delivered with the volume control at its normal setting and the hum and noise level existing at that particular setting. To be inaudible, the amplifier hum and noise level should be 60 to 75 db. below a 10 watt power level when a high efficiency speaker is used. With less

efficient speakers, particularly when the speaker system has a high and low frequency droop, 30 to 50 db. may suffice.

Controls

One of the major considerations of amplifier design concerns panel controls. These may include any of the following:

Master gain, mixing, plate, filament and a.c. master switches, program selector switches, bass and treble, recording turnover and equalizer, expansion, compression, and noise suppression, switching facilities for maintenance metering, power switching for phono motors and other auxiliary equipment, and any other beneficial control that the specific application requires.

These considerations must be based on the purpose for which the equipment is to be built and their selection will govern the electronic design to follow. *(To be continued)*

HIGHER EFFICIENCY FOR LOOP ANTENNAS

By WILBUR J. HANTZ

THE smaller radios equipped with built in loop antennas which are usually of the high impedance type could be made to perform much better if pains were taken to install a low impedance loop. It is very true that this type of loop is not so readily available and neither is the low impedance coupling coil that must be used with it. However, it is a simple matter to construct the loop, and the coupling coil (connected in series with the loop) is easy to find if you know where to look.

The particular coupling coil, as specified in parts list, was chosen because of its low impedance windings and ad-

justable iron core slug. It will provide proper coupling between the loop and the grid circuit of the tube.

Only the secondary or grid winding is used on the coil. This same circuit was used on a Zenith radio, model 6D815, and the results were more than satisfactory.

The loop was wound of bare copper wire in the shape of a rectangle 11x8 inches and is self-supporting. It had four turns spaced about 1/2 inch for each turn. In Fig. 1 is shown a conventional loop circuit and the changes necessary. This should be self-explanatory. -30-

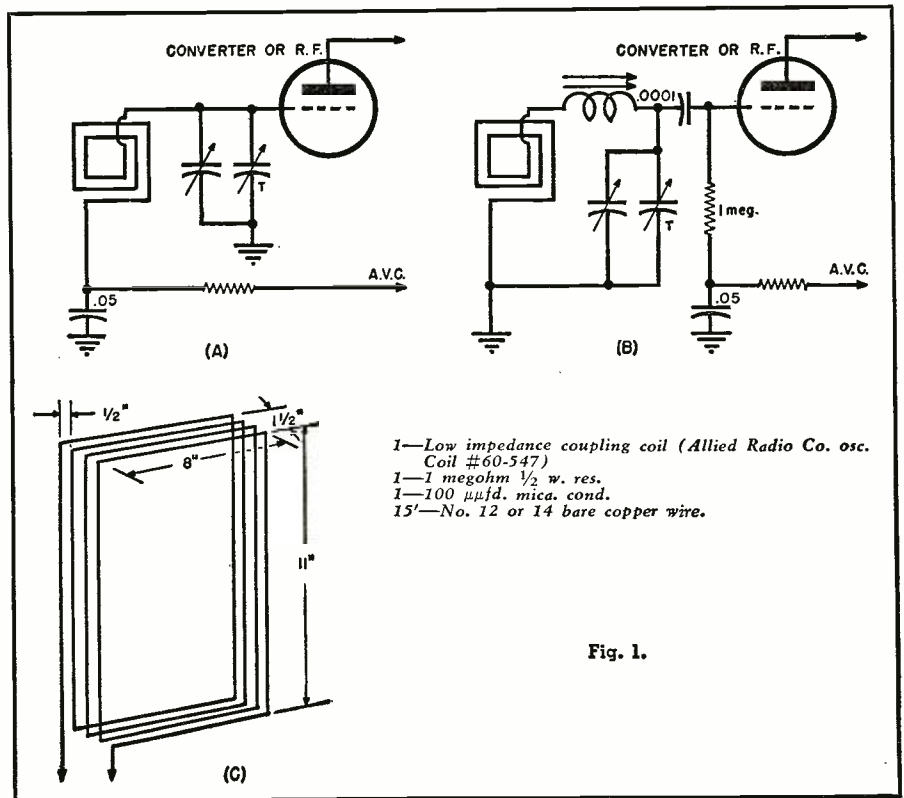

Fig. 1.

Technical BOOKS

"THE RECORDING AND REPRODUCTION OF SOUND" by Oliver Read. Published by *Howard W. Sams & Co., Inc.*, Indianapolis. 358 pages. Price \$5.00. (Second Printing.)

This comprehensive text on all phases of the recording art contains much valuable information for both the professional and amateur recordist.

Where other books have limited their treatments to one phase of the recording medium, this volume covers wire, tape, film, and disc recording.

Beginning with an elementary and non-technical discussion of the behavior of sound waves, the author continues with a brief history of acoustical recording. The next four chapters are devoted to a discussion and an analysis of the basic recording methods and a description of lateral disc recording techniques, sound on wire and tape, and magnetic tape recorders. Space is devoted to the decibel, reproducers, filter networks, tone controls, attenuators and mixer controls, amplification, and audio amplifier measurements. An entire chapter is devoted to Microgroove and LP records.

The final chapter reproduces the "Proposed NAB Recording and Reproducing Standards," and the *American Standards Association's* "Acoustical Terminology" standard. The appendix contains many valuable charts and tables needed by the practical recordist.

For practical recording work, this text should prove to be a valuable addition to the recordist's library.

"THE BUSINESS HELPER" by Leslie C. Rucker. Published by *John F. Rider Publisher, Inc.*, New York. 133 pages. Price \$2.00.

This handy little book packs a lot of good common sense into its 133 pages. It is written by a practical businessman who has had experience "on both sides of the counter."

Presented in a breezy, man-to-man style, the text covers such important points as the types of businesses, locations, customers and how to handle them, buying and stocking the store, selling, estimating for service type businesses, contracts, overhead, banking, bookkeeping, collections, advertising, employees, insurance, new business, partnerships, the use of the telephone as a business aide, being identified with associations and clubs as a business stimulus and credit.

The book is thoroughly readable and completely practical. It makes no pretensions of being the complete guide to business success but the points covered are well worth noting.

"THE RADIO HANDBOOK" edited by R. L. Dawley. Published by *Editors and Engineers, Ltd.*, Santa Barbara,

April, 1950

SAVE 95% SENSATIONAL SURPLUS VALUES!



BRAND NEW APS-13 WARNING RADAR

17 tubes as follows: 9-6AB5, 5-616, 2-2021, and VR-105. 410 to 420 Mc. and 30 Mc. IF. Good deal for conversion and citizen band. With instruction book. Originally over \$100. **\$16.95**

COMMAND RECEIVERS

Tested Before Shipping
190-550 KC Used. Orig. \$40. Now **\$9.95**
3-6 MC Used. Orig. \$30. Now **4.95**
3-6 MC New. Orig. \$35. Now **6.50**
6-1.9 MC Used. **7.95**
1.5-3 Meg. Used. Excellent. **14.95**
ARR-2. Used. 234-258 Meg. **9.95**

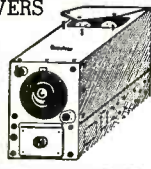

COMMAND XMITTERS

BC-459. 7-9.1 Mc. Excell. Cond. **\$8.95**
T-22ARC-5. 7-9.1 Mc. New. Orig. \$50. Now **12.75**
3-4 MC. Used. Orig. \$50. Now **12.50**
5-3-7 MC. Used. Orig. \$30. Now **3.95**
T-21 ARC-5. 5-3-7 Mc. New. Orig. \$40. Now **5.95**
4-5-3 MC. Used. Orig. \$30. Now **3.49**
T-20 ARC-5. New. Orig. \$40. Now **6.95**
2-1-3 MC. LN. Orig. \$40. Now **9.95**

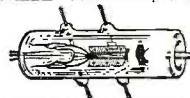

8012
Oscillator up to 500 meg. 30 W output. 6.3V filament. A fine citizen's band. P.A. New. Each \$1.30; 4 for **\$3.95**

100 WATT BENDIX TRANSMITTER TA-12

3-807 tubes, 4-12SK7's, 2" 5 amp. RF meter and separate master oscillators. Easily changed to cover 20-40-80 meters and using crystal 10 meters also. Thus giving you a complete coverage transmitter. 7 section and position switch changes ECO. IPA and output tank simultaneously. Comes with MP-28 Mod. & dynamotor. **USED \$29.50 NEW \$45.00**



BC-611 "HANDIE-TALKIES"

FREQ. 3-6 MC
No wires to attach. Easy to operate. Push button controlled. No skill necessary. Already tuned to set frequency. Crystal controlled. Transmitter and receiver in same case. Only 5 1/2 lbs. with batteries (batteries can be supplied). Small: 1 5/8" x 3 3/4" x 5 3/4". Aluminum case. Complete with tubes, crystals and 1 set of batteries. Used, good cond. **PRICE ON REQUEST**

BC-1072 XMITTER

157-187 MC. Input 117VAC 60 cy. Has parallel rod OSC using 2-826 PP, contains power supply, general radio variac 1.5A. 3 1/2" 0-5 kilovoltmeter, 10 tubes and loads of other parts too numerous to mention. **\$19.75**
With tubes. Less Blower. Used.
815 TUBE. New. each \$1.95; \$4.95 4 for



BC-474 FIELD TRANSMITTER RECEIVER



Receiver tunes from 2.3 megs. to 6.5 megs. using 1 RF stage. Power requirements 90 V and 1.5 V. Transmitter tunes from 3.5-6.3 megs., phone or CW using 6V6CO, 6V6PA, and 6V6 modulator. Uses 100 mil. plate meter and 0-1 amp. RF ammeter. Power requirements 300 V 100 mil. Excel. used cond. with tubes and receiver **\$39.95**

ASB-7 INDICATOR

Makes a beautiful scope foundation kit. Has 5BP1, 4-6AC7, 3-6H6. Can also be used for remote television indicator with conversion. Good cond. Orig. \$30. **\$10.75**

10 ASSORTED OIL CONDENSERS—up to 10 MFD \$5.95

BC-924 FM XMITTER

Freq. range 27-39 Mc. 35 watts output 4 channels, tunable throughout entire range, band width 20 Kc. ECO controlled, 2-6SJ7, 2-615, 1-6AG7, 1-6V6, 1-VR-150/30, 1-6SL7, and 2-815. Complete with tubes, with dynamotor. Used. **\$21.95**



SCR-522 VHF TRANSCEIVER

An all time favorite for all 2 meter ham operators. This unit consists of 2 chassis, BC-625 transmitter and BC-624 receiver, transmitter being xtal controlled and having an am output of approx. 15 watts. Freq. range 100-156 meg. w/diagram. Used. Complete. Good cond. **\$29.95**
Xmitter or Revr. Separate **\$14.95**

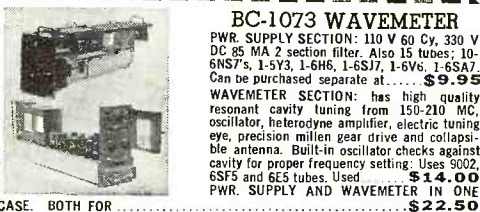

BC-1073 WAVEMETER

PWR. SUPPLY SECTION: 110 V 60 Cy. 330 V DC 85 MA 2 section filter. Also 15 tubes: 10-6NS7's, 1-5Y3, 1-6H6, 1-6SJ7, 1-6V6, 1-6SA7. Can be purchased separate at **\$9.95**
WAVEMETER SECTION: has high quality resonant cavity tuning from 150-210 MC. oscillator, heterodyne amplifier, electric tuning eye, precision millen gear drive and collapsible antenna. Built-in oscillator checks against cavity for proper frequency setting. Uses 9002, 6SF5 and 6E5 tubes. Used **\$14.00**
PWR. SUPPLY AND WAVEMETER IN ONE CASE. BOTH FOR **\$22.50**

WESTERN ELECTRIC AUDIO AMPLIFIER TYPE D-150300



An excellent mod. driver or PA system with hi-quality components and construction. Input stage consists of parallel 6L7's feeding parallel 6C5's impedance couple to 6L6's in PP parallel. Class A 40 W output 225 ohms output impedance. Power supply 110V 60 cyc. using 2-5T4's. Has built-in limiter and compression circuits. Maximum gain 110 DB. Fits standard 17" rack. Tube sub-chassis is hinged and folds back for easy servicing in rack as shown. Excell. cond. COMPLETE WITH TUBES. **\$49.95**

ARB RECEIVER

6-Tube, 4 Band Super Het. Frequency Range 196 Kc to 9 Mc. Covering Range Broadcast, Boat and Amateur Frequencies. The Unit also has facilities for Loop Input, with Tubes, Dynamotor. Used. With Control Box, Plugs, Remote Tuner, and Flex. Shaft. Very clean condition **\$34.50**



LAVOIE VHF FREQ. METER. Type 105SM. Tunes from 375-725 MC. 1%. Brand new. Complete. **\$59.95**

ARC-5 VHF SET

IR-28 RCVR: Superhet operating on 4 xtal channels; 100-156 Mc remote control to actuate turret-tuning mechanism. 12 tubes—4-717A, 1-12A6, 3-12SH7 and 2-12SL7GT w/dyn. Originally \$65.00.
MD-7 MODULATOR: Contains all necessary circuits, and components for plate mod of T-23 Xmitter, w/dyn. which supplies plate and screen voltages for mod. Used. Originally \$36.00.
T-23 XMITTER: MCW and phone on 4 channels, 100-156 MC, automatic turret-tuning, tank circuits remote controlled. 4 tubes—2-1625, 2-832A. Originally \$50.00.
COMPLETE SET OF THREE UNITS, USED **\$42.50**

WRITE FOR NEW 1950 CATALOG

V&H RADIO & ELECTRONICS SUPPLY
DEPT. R-8, 2033-37 W. VENICE BLVD.
LOS ANGELES 6, CALIFORNIA



RADIO and TELEVISION

Thorough Training in All Technical Phases
APPROVED FOR VETERANS
WEEKLY RATES DAYS—EVENINGS
RCA GRADUATES ARE IN DEMAND
For Free Catalog write Dept. RN-50
A Service of Radio Corporation of America
RCA INSTITUTES, INC.
350 West 4th St., New York 14, N. Y.



BARGAIN HUNTING?
RADIO SERVICEMEN!
Write for SENSATIONAL CATALOG
HENSHAW RADIO SUPPLY
3619 TROOST KANSAS CITY, MO.

IMPORTANT

NO ORDER LESS THAN \$5.00. Send 30% deposit on cost of item or full amount to save COD charges. Do not send shipping costs. It will be COD only. Shipments sent via railway express unless other instructions given. Merchandise subject to prior sale. Prices subject to change at any time.

FOR BEST UHF PERFORMANCE

New Trough Line Front Ends Featuring



2-Stage RF Amp.-Mixer-Oscillator. Hottest and most stable front end available.

- High Gain, High Image Rej., Low-noise Factor
- Can be used as Converter or fed direct into IF amp.
- Stock Models for (1) Amateur 2-meter and Mobile Phone (140-160MC) (2) FM Broadcast Band (80-120MC) priced at \$18.95 each
- Special models for freq. between 75-300 MC including fixed freq. Crystal Control
- Special Purpose Receivers
- High Gain 10.7 MC IF Amp.—\$50.00

WARDELL SMITH

Manufacturing Communications Engineering
65 Glenwood Rd. Upper Montclair, N. J.

SCR-522 RECEIVER-TRANSMITTER: 100-156 mcs. One of the hottest 2-meter rigs. Complete with all tubes and push-button control box. Excellent cond.\$24.95



FAMOUS PE-103 DYNAMOTOR: 500 VDC at 160 ma. with input of 6 or 12 V. Complete with filter base. New.....\$16.75

ACCESSORIES FOR 522 RECEIVER-TRANSMITTER
 PE-98 12 V. Power Supply. Used.....\$12.95
 PE-94 24 V. Power Supply. Low price..... 2.85
 AN-104-A Antenna. Brand new..... 1.95
 PN-12 110 V. 60 cyc. power supply. Excel..... 37.50
 Set of 7 plugs. New..... 3.95

LOW PASS FILTER—NEW! Flat to 3000 cycles 30 db. down at 3100 cycles. Fine for clipping those sidebands\$4.50

SPECIAL! MOTOROLA CONTROL HEADS!
 We just received 200 of 'em. Same kind the cops use. Brand newEa. \$2.49

KW. POWER SUPPLY

Here's the unit you've been waiting for. 2900 VDC. After filter consists of 2 Kenyon Xfms. 1-2.5V. 10 amp. Fil. Xfmr. 2-366A Tubes and 2 sockets. 3-2 mfd. 4000 V. G.E. Cond. Chassis and Bleeder.....\$29.50

TRANSFORMERS 115 V. 60 CY. PRI:

2.5 V. @ 10 amp.\$ 4.00
 Kenyon 200 ma. 3200 V. No center tap..... 7.95
 ORDER 2 of these Kenyons for 15.00
 400-0-400 @ 200 ma. 5V. @ 3 amp. 6.3V @ 5 amp 3.95
 Choke, 1 henry @ 800 ma..... 8.95

EE-8 FIELD TELEPHONE: Uses 2 flashlight batt. Has crank for ringing other phone. Ideal for use in field, mines, camp, house to lab. or garage, etc. Excel. operating condition. Each\$ 6.75
 ORDER A PAIR for ONLY 12.95

METERS! HOT BUYS! METERS!

2" G.E. or Westinghouse Rd. 2" Weston Rd.
 0-1 ma. DC with 3 scales: 0-25 ma. DC\$2.79
 0-140 ma. DC. 0-140 VDC. 0-1.5 amp RF 3.49
 0-500 ma. DC w/3 0-2 amp RF 2.99
 shunts\$4.50 20-0-20 amp DC. 1.75
 0-1 amp R.F. 3.49 2" Westinghouse Rd.
 2" Hickok Rd. 0-9 amp RF\$2.50
 0-1 ma. with 0-10 scale \$3.29 2" Simpson Rd.
 3" Westinghouse Rd. 0-3 VDC\$2.50
 0-15 ma. DC movement with 3" De Jur Sq.
 0-300 scale\$3.49 0-800 ma. DC\$3.49

TUBES: 250 TL Tube\$16.50
 See our ad P. 104 Radio News Feb/50 for more tube buys!

ARC-5 TRANSMITTERS COMPLETE
 4-5.3 mcs. Used, excel. cond. 3.50
 2.1-3 mcs. Excel. for ship use. New\$12.95
 3-4 mcs. Used, excel. cond. 9.95
 7-9.1 mcs. Used, excel. cond. 9.95

S.O.S. BALLOONS. NewEa. \$1.95

12" BRASS ANTENNA. Shuts to 15". Used..... 2.75

OIL CONDENSERS BATHTUB CONDENSERS
 10 mfd., 600V......99c .5 @ 400V39c
 2x8 mfd., 600V.....89c .25 @ 400V33c
 4 mfd., 600V49c .1 or 1 mfd. @ 400V.....39c
 2 mfd., 600V29c .001 @ 600V. paper. 10 for \$1.25
 .02 @ 2,000V79c 500V. mica, assorted. 20 for \$1.00
 1 mfd., 3,600V ..\$1.95 40 mfd. 350V. electrolytic. 3 for \$1.00

SEE HERE! SEE OUR SEA GEAR! MARINE EQUIPMENT!

RECEIVER & TRANSMITTER COMBINATION:
 BC-212 Receiver: 8 tubes, covers freq. 1.5 mcs to 18 mcs. 12V operation speaker or headphone output. Good cond.
 BC-223A Transmitter: 4-channel, crystal controlled on marine freq. Has antenna matching network for harmonic suppression and max. power output. A 25-watt job, complete 12V power supply, mike and key, push-to-talk operation. Less crystals.
BOTH UNITS\$99.50
ARB RADIO RECEIVER & LOOP: 195 kes to 9050 kes in 4 bands. Sharp or broad tuning for extra sensitivity. Has DU-1 loop for automatic direction finding. Covers range of 200-1500 kes. Loop contains 2-tube, built-in amplifier.\$47.50
BOTH FOR\$147.00
DON'T GET LOST AT SEA! GET THIS ARN-7 RADIO COMPASS: One of the finest automatic direction finders. Covers 4 bands, 100-1750 kes. Complete with loop, control box, relays, indicators, inverter, flex and loop cables, and plus. Excel. cond.\$67.50
COLLINS ART-13 AUTO TUNE TRANSMITTER. Can be licensed for marine use with absolutely no conversion. 125 watts conservatively rated. Freq. 2-18 mcs. 813 tubes in final; 2-811's in modulator. Excel. cond.! Ready to go. Complete with dynamotor and mike.\$149.50
MN-26 MCF RADIO COMPASS RECEIVER: Made by Bendix. Freq. range 150 kes to 1500 kes. Complete with MN-28 Remote Control, MN-20 Loop, MN-52 Loop Control Box. Good cond.\$59.50
 Only
NOTE: Components of any of above units can be purchased separately. Consult us for UR marine radio gear. If YOU need it—COLUMBIA'S GOT IT!

COLUMBIA ELECTRONIC SALES

522 South San Pedro Street
 LOS ANGELES 13, CALIFORNIA

California. 310 pages. Price \$3.00 (Twelfth Edition).

The latest edition of this well-known radio text is an all-construction work which neither duplicates nor supersedes the Eleventh Edition released some time ago.

Complete and easy-to-follow instructions are given on the construction of antennas, power supplies, exciters and low power transmitters, test and measurement equipment, receiving equipment, high frequency power amplifiers, mobile equipment, single sideband and FM exciter transmitters, speech and amplitude modulation equipment, and transmitting equipment. Pertinent data on TV and broadcast interference, and mobile installations, as well as a listing of amateur station operating conveniences are also given.

The book is clearly written and lavishly illustrated with diagrams and photographs. Recognizing the importance of war surplus equipment to the amateur, the editors have wisely included several pieces of equipment which can be converted for use by the ham.

Service technicians, amateurs, experimenters, and hobbyists should all find this book rewarding and useful.

-30-

HAMFEST

THE Central Wisconsin Amateur Radio Club is holding its second annual banquet and hamfest at the Elk's Club in Wisconsin Rapids, Saturday, April 29th.

The banquet is scheduled to begin promptly at 7:00 p.m. Reservations and further information are available from the secretary of the organization, Edward Fleisner, W9PIW, 1891 Riverview Drive, Wisconsin Rapids, Wis. -30-

ANNUAL PARTY

THE Delaware Valley Radio Association will sponsor its sixth annual "Old Timers' Nite" and banquet on Saturday April 15th. The affair will be held in the Terrace Room of the Hotel Stacy-Trent, West State and Willow Streets, in downtown Trenton, New Jersey. A turkey dinner will be served promptly at 6:30.

Guest speakers will include many personalities from all branches of radio, such as prominent old timers famous in the field of wireless and allied branches of the art. As in the past there will be a "Grand OM" award to the old timer whose experience in radio dates back the greatest number of years. There will also be prizes for the oldest commercial and amateur licenses submitted to the judges. Persons attending the affair are urged to bring along their ham and commercial tickets in order to participate in this competition.

ZI's famous collection of oldtime radio gear will be on display and there will be door prizes and other awards. Reservations should be made before April 8th. Tickets are \$5.00 a head and should be purchased from Ed Raser, W2ZL, 315 Beechwood Avenue, Trenton, New Jersey. For latecomers, the tickets will be \$6.00 at the door. As usual, the party will be stag. -30-



Here's a high speed semi-automatic key any amateur will be proud to own! It's a joy to use — a real precision instrument that encourages faster, better cw.

HAS SMOOTH, SNAPPY ACTION

Main spring and U-spring of the model 114-515 are made of carefully tempered clock spring for smooth, snappy action. Adjustable weight. There are two adjustable black fibre paddles and two sets of 1/8" coil silver contacts. Lock nuts are provided for every adjustment.

HAS ALL ADJUSTMENTS

Steel base is finished in attractive baked black wrinkle enamel. Base is 6-1/4" x 3" x 3/8" with four rubber feet to prevent slipping or tilting. Connector strips are heavy brass.

This amateur model 114-515 represents a truly outstanding value—in quality, performance, price!

Amateur Model 114-515
 Only \$810 (Amateur Net)



JOHNSON

E. F. JOHNSON CO. WASECA, MINN.

Spring clean up sale

We must move bulk and weight, to make space for tons of newly received merchandise now in dead storage. HELP!

- HS-16A, headphonesNEW \$1.45
- HS-33, headphonesNEW \$2.25
- HS-33, headphonesUSED \$0.75
- CD-307, cordsNEW \$0.75
- CD-365, cordsNEW \$0.45
- HS-30, headphonesNEW \$0.75
- CD-604, cords & transformer..... \$0.35
- PE-101C, BC-645 dyn.NEW \$1.50
- PE-94C, 522 dyn.NEW \$2.95
- TU-10, less CS-48,NEW \$2.00
- BC-306,NEW \$2.00
- BC-306,USED \$1.75
- BC-429, less coil set.....USED \$3.95
- BC-430, less coil set.....USED \$3.95
- BC-461, reel control.....NEW \$0.85
- BC-706, impact switch.....NEW \$0.45
- BC-450, rec. controlUSED \$1.10
- BC-442A, antenna relay.....NEW \$2.50

Much more is included in this SALE, such as transformers, chokes, oil filled condensers, and other items of interest to the amateur and the experimenter. Be sure to get our FREE CIRCULAR, Check FULL of MORE RED HOT BARGAINS. This sale ends on Saturday, May 27, 1950. All prices are NET, FOB our warehouse, all merchandise is subject to prior sale. 20% minimum deposit with order, balance COD.

Quad ELECTRICAL SUPPLY, INC.

1650 N. Damen Ave., Chicago 47, Ill.

Spot Radio News

(Continued from page 18)

now used. CBS conceded, RMA pointed out, that there would be a 45 per-cent reduction in the ability to portray detail, which was certainly a step backward as far as picture quality is concerned.

The reorganized National Television System Committee, also described widely in bulletins released prior to the sessions, was discussed at length in the official halls. This group also fostered the development of a commercially practicable system of color TV, and offered vital statistics disclosing why the freeze should be removed immediately and how the ultra-high channels could be allocated to fit within the framework of the present very-high system.

Evidence of blistering testimony which would be heard as the days rolled on, hit the hearing room, as excerpts from earlier talks by Dr. Allen B. DuMont and others were released. Appearing before a group of eight Washington legislators, representing New Jersey, at a breakfast meeting in the Mayflower Hotel, Dr. DuMont had charged that the Commission had interfered seriously with progress of the art by the continuance of the freeze. Criticizing, in particular, the two gentlemen who appeared to be color's most ardent supporters, Senator Edwin C. Johnson and Commissioner Robert F. Jones, Dr. DuMont said: "The Commissioner condemns private interests because these interests think it would be a grave mistake to foist an unsatisfactory color system on the American public. He condemns the more than 100 manufacturers of receivers, television broadcasters, and the manufacturers of transmitting equipment, because we think it a criminal mistake to make the future allocation of additional channels for black and white wait for a decision on the matter of color. A truly intelligent and lasting decision on this matter of color may take years and the spokesmen for our industry do not think that the American people will be willing or should be forced to wait these years to enjoy adequate television reception. . . . I should like to assure both the Senator and Commissioner that television broadcasters and manufacturers alike will reap tremendous benefits from a really good system of color television transmission and reception. If there were such a system in existence, every industry spokesman would be camped on the Commissioner's doorstep urging and pleading for the immediate adoption of standards."

A prior talk by Commissioner Jones, before the Lima Section of the AIEE, also left its volcanic rumble in the halls. Chiding industry, the FCC gentleman declared: "I am amazed at the present thinking of the executives in the radio business. They

MICROPHONES

- Pressure
- Velocity
- Cardioid
- Varacoustic
- Hand Sets
- Sound Power Telephones
- Stands, Plugs, Cables and Connectors



AMPLIFIERS

- Pre-Amplifiers
- Line Amplifiers
- Voltage Amplifiers
- Power Amplifiers
- Remote Amplifiers



SPEAKERS

- Cone Type
- Horns and Drivers
- High-Fidelity Speakers
- Speaker Accessories



SPEAKER HOUSINGS

- Baffles, All Types
- Console Cabinets



INTERCOM SYSTEMS

- All Master Systems
- Master-Remote Systems
- Combination Systems



CUSTOM-BUILT EQUIPMENT

- Consoles
- Desks
- Turrets
- Cabinets



PORTABLE SOUND SYSTEMS

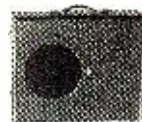

PROGRAM CONTROL UNITS



- Single Channel
- Dual Channel
- Custom-Built

Why shop around?

It's easy to get the right equipment from RCA's full line of matched sound products

Buy your sound products the easy way. The wide variety of RCA Sound Products simplifies your problem of finding the right equipment for your sound jobs.

Every item in RCA's extensive sound line is electronically engineered with its own special characteristics to give top performance, dependable long-life service with quality appearance. Not only is the

RCA Sound Products line built right, it is also priced right to enable you to build a steady volume of profitable business.

No other manufacturer offers so extensive a line of "matched" sound products from the smallest "ballyhoo" system to the largest systems for industrial, educational, institutional, church, hotel, hospital or commercial users.

See your RCA Sound Products Distributor for catalog and new sound sales manual



SOUND PRODUCTS
RADIO CORPORATION of AMERICA
ENGINEERING PRODUCTS DEPARTMENT, CAMDEN, N.J.

In Canada: RCA VICTOR Company Limited, Montreal

WANTED

Junction Box JB70

as used with
Hallcrafters BC610-SCR399
State Condition, Quantity and Price
Box 501, c/o Radio & Television News
185 N. Wabash, Chicago 1, Ill.

AUDIO (SOUND) ENGINEERING HOME STUDY TRAINING

Practical, easy-to-understand lessons, written by competent Audio Engineers and Educators, prepare you for a better job and a good future in the Television, Radio, Motion Picture, and Recorder Industries.
Write today for details - Learn while you earn!!
HOLLYWOOD TECHNICAL INSTITUTE
Div. R.N.
4925 Santa Monica Blvd. Hollywood 27, California



RADIO ENGINEERING TELEVISION ELECTRONICS

Thorough training in all phases of radio and electronics, open to high school and junior college graduates. Old established school specializing in Radio training exclusively. Modern laboratories and courses. Enrollments limited. Approved veteran training.
VALPARAISO TECHNICAL INSTITUTE
Dept. RD Valparaiso, Ind.



JAN. 1950 ISSUE

60 MANUFACTURERS
400 MODELS
MOST COMPLETE
UP-TO-DATE LISTING

Get this easy-to-use, time-saving guide to exact replacements for all popular television receivers. Simplifies servicing, cuts repair-bench time. Write us today for your free copy!

WATCH FOR Merit's
future issues of the
TV "Repl" Guide



have been getting credit for the great changes in radio since 1920. But frequently these changes are not due so much to the ingenuity of the executives of the large corporations, as to the characteristics of radio itself. It is an empirical art, and many who have no big commercial stake in the status quo experiment with it and are responsible for many of the developments. Whereas a year ago I credited the big executives with imaginative genius, I now realize after listening to the manner in which they have approached the introduction of polycasting, opening of the ultra-highs, utilizing FM transmissions and color television, that they have a negative approach until economic necessity drives them to pitching in and finding answers for the Commission, and, of course, for themselves."

Commenting on allocations, and particularly an earlier statement from Walter Evans of *Westinghouse*, which disclosed that one of the major problems faced by the art has been distribution which could be solved by Stratovision, once the larger metropolitan markets have been provided with service, the Commissioner said that this concept of large city service first, appears to be shared by industry. "To me, Stratovision is not something to be considered *after* the large cities have been taken care of in the allocation plan," he added. "It is something to be considered at the very same time that we are trying to allocate stations to the big cities. The order in which allocations are made should not be big cities first and little cities second. Provision should be made for affording service to all the cities at the same time. In other words, if engineering concepts like Stratovision are to really do the job that they potentially have within them, they will have to be considered on a sound engineering basis, uncontaminated by selfish economic interests, or they will fail to achieve their full potentiality. . . . By this I don't mean that economics can be completely removed from the allocations plan. Stations have to make money if they are to survive. But new economic ideas are certainly possible."

TV appears to have sparked some rather searing opinions, which will be bouncing about the rooms of Washington for quite a spell.

TV's problems also prompted Commander Webster of the FCC to issue a blast, this time against the approval to proceed with the *Phonevision* tests, which would provide selected film transmissions over a telephone circuit for a fee. In a sharp dissenting note, the Commissioner said that broadcasting has always been a free service to the listener and the first move to change it should not be made without a public hearing. Amplifying this opinion, he declared: "I do not believe that very much vision is required to see that if the Commission

should authorize subscription television, and it should prove to be the most profitable method of operating a television station, that the best evening hours, every day in the week, will be devoted to subscription television, rather than to free television programming. . . . Every television station licensee will be clamoring for a subscription television franchise and will be pounding on the Commission's door for regulations insuring that there will be no discrimination in the issuance of such franchises or the rates therefore. . . . Television receiver owners will expect the Commission to promulgate rules which will provide to each listener a choice of some free television programs during the best listening hours and which will insure that the listener will be charged a reasonable and non-discriminatory fee for viewing television programs. . . . These considerations point to a common carrier type of regulation of subscription television, not to the broadcast type of regulation."

As this column is being written, plans for telephone-circuit tests are under way among 300 viewers, each to be selected by the sponsors of the system.

RADIO AND THE ART of navigation, an intensely interesting topic, served as the basis of a highly informative talk by Commissioner Webster before the Institute of Navigation in Washington. Describing one of the most striking postwar applications of radio toward the safety of navigation, radar, the Commissioner said that in the marine field alone there are 962 ships which are radar-equipped, with the number increasing daily, even though the installation is not required by law. Its use aboard vessels of all nations is also of considerable proportion, he added.

Commenting on the frequencies used in radar, the Commissioner pointed out: "Three bands of operating frequencies have been made available, namely the so-called 3000, 5000 and 10,000-megacycle bands. There has been much discussion in scientific circles, both internationally and nationally, concerning the relative efficiencies of these frequency bands. . . . Commercial radar equipment in the merchant marine is now divided—using an over-all figure—between the 3 and 10 megacycle bands in about the proportions of 60 and 40 per-cent, respectively. Up to the present time no 5000-megacycle equipment is being offered commercially. This is due apparently to the head start in the development of equipment capable of satisfactory technical operation in the 9000-megacycle band, with the attendant practical equipment advantages and greater precision, and the acceptance of the atmospheric attenuation, which it was earlier thought would make use of the band undesirable. . . . Propo-

nents of the 3000-megacycle radar stated that 10,000-megacycle radar would be easily blocked out by rain and snow. . . . On the other hand, the proponents of 10,000-megacycle radar said that 3000-cycle radar would not provide adequate definition. . . . Both types were provided for and we went further, providing a band of 5000 megacycles in the hopes that such a band would provide a compromise."

The use of radar for peacetime harbor surveillance was also described by the Commissioner. He pointed out that radar systems are being used as an aid to harbor navigation in Baltimore, Maryland and Long Beach, California, and San Francisco will probably have an installation soon.

Probing the problems which are still to be solved in harbor radar installations, the Commissioner declared that one particular problem at hand involves the methods which should be used to effect an exchange of information between shore-based radar and ships. "Obviously some means of radio communication will be required," he said, "but there is a question of what delay, if any, can be tolerated in such a system. . . . There is also the related question of the number of radio communication circuits required. . . . Another unsolved problem is how to identify accurately and with sufficient speed the individual ships which are seen on the radarscope. And finally there is the question of whether frequency assignments to shore-based radar should be different so as to avoid interference to ship radar."

Describing with enthusiastic satisfaction the significant advancements this country's engineers have achieved in radio aids to navigation, the Commissioner said: "The U. S. leads the world today insofar as *know-how* in the telecommunications field is concerned. . . . However, we must protect our ideas and insure that the huge sums which American concerns have spent will not be wiped out at an international conference, where in the bargaining process of diplomacy, some other country is better able to sell its wares to the rest of the world. . . . L.W.

Like peas in a pod

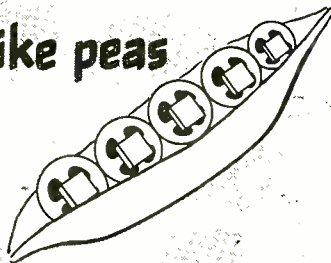

except for

QUAM

Only Quam offers more! The U-Shaped Coil Pot, providing an unbroken path for the magnetic lines of force, thus producing a stronger magnetic field with higher efficiency and improved performance, is an exclusive Quam feature.

The Quam Adjustable Voice Coil, permitting accurate centering after assembly and virtually eliminating rubbing voice coils, is also found *only* on Quam Speakers.

No other speaker offers such outstanding extra features—such extra value. For all your replacements, specify Quam.



QUAM-NICHOLS CO.
522 E. 33rd Place
Chicago 16, Illinois

Please send me Quam catalog.

Name
Address
City State

MAKERS OF QUAM FOCALIZER UNIT

MAIL THIS
COUPON FOR
FREE CATALOG

April, 1950

LOOK
who's
excited...

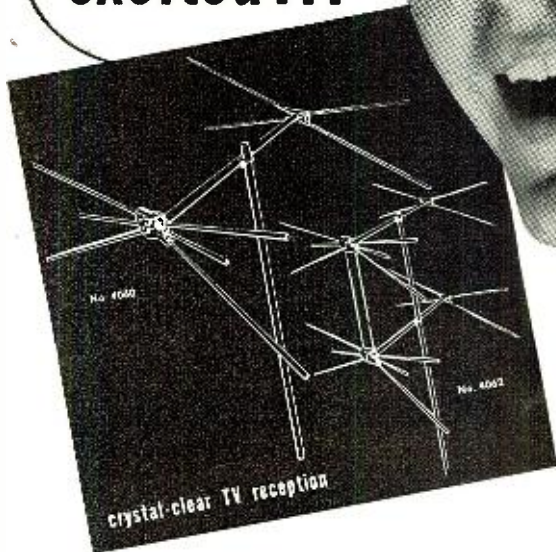

"selling

WALSCO

faster than all others!"

It's no trick to sell WALSCO. Dealers and jobbers from coast to coast report amazing sales volume with WALSCO TV Antennas.

WALSCO offers several exclusive advantages available in no other antenna.

ONLY WALSCO features a silicone-treated styron molded insulator.

ONLY WALSCO uses marine type high tensile chromium aluminum alloy for elements . . . with a yield point 94% higher than ordinary aluminum.

ONLY WALSCO uses butt-seamed tubing for elements to assure the highest elasticity.

WRITE FOR FREE ILLUSTRATED CATALOG 94-R

WALSCO new TV Alignment Tools are used everywhere. Available at your local jobber,

WALTER L. SCHOTT CO

Beverly Hills, California • Chicago 6, Illinois

*this is it—
this is the tuner
you designed!*

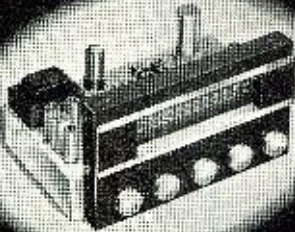

the
CRAFTSMEN RC-10
HIGH FIDELITY
FM-AM TUNER

This new tuner was your idea. It is the precisely engineered answer to hundreds of questions . . . the solution to scores of problems . . . the outgrowth of countless suggestions we've received from you. Developed from your ideas—and a few of ours—the RC-10 retains every feature of the famous RC-8. And it offers a host of innovations.

- Built-in pre-amplifier compensated for reluctance pickups.
- Automatic Frequency Control entirely eliminates drift, simplifies tuning.
- 5 microvolt sensitivity on both FM and AM.
- 10 kc filter on AM eliminates inter-station squeals.
- Base and treble tone controls for boost, cut, or 20—20,000 cycle flat response.

SEE . . . the RC-100A ultra-sensitive, custom TV with built-in booster.

HEAR . . . the RC-2 high fidelity amplifier. All units finished in chrome.

Write for information—or send 50¢ for instructions and schematics.

THE RADIO
craftsmen
INCORPORATED

Dept. F, 1617 S. Michigan Ave., Chicago 16, Ill.

Linearity Distortion

(Continued from page 55)

over a wide range of amplitudes and frequencies in audio amplifiers, while in associated electroacoustic equipment the problem is even more complicated.

A technique used by the author for rapid experimental and test work is to use an adaptation of the increasingly popular panoramic method of analysis. In this procedure, modulated wave trains are used to secure rapid amplitude variations over a range of thirty to forty db. An oscilloscope with calibrated screen is then used as a means of recognizing and measuring the departure from linearity of the equipment under test. One means of doing this is borrowed directly from the conventional procedure for checking the modulated output of radio transmitters. In this case the output of the equipment under test is applied to the vertical input of the oscilloscope and the modulating frequency applied to the horizontal axis. This results in the familiar triangular pattern and nonlinearity may be detected by irregularities in the sides of the triangle. This system, however has the disadvantages of requiring a modulator with low distortion and, in certain cases, such as testing recording and playback equipment, it may be difficult to secure proper phase relationships between the horizontal reference frequency and the output of the equipment under test.

A second, more flexible system, is to use a sweep amplitude generator. This device modulates an audio frequency carrier with a saw-tooth wave to provide an essentially triangular pattern such as shown on the accompanying photographs. In operation, the output of the generator is applied to the scope and the outline of the triangular pattern traced upon a celluloid mask which, in turn, may be marked with a convenient reference scale. The output of the equipment under test may then be applied to the scope and departures from the original trace noted. This system has the advantage that perfect triangular modulation and absolute linearity in the scope sweep circuits are not required as the tracing on the celluloid mask provides the reference basis for the system. Similarly, a logarithmic or semi-logarithmic test pattern might be used if desired.

The panoramic method makes it possible to observe the amplitude characteristics of an audio system in a few minutes by tuning an oscillator through the audio range. An eighty decibel characteristic may be analyzed in two ranges by this method. Some of the oscilloscope patterns obtained by this system are illustrated in the photographs.

The schematic shows the circuit of a simple sweep amplitude generator, comprising a saw-tooth oscillator and balanced modulator, and together with

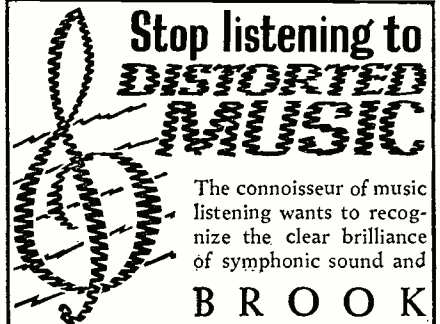

The connoisseur of music listening wants to recognize the clear brilliance of symphonic sound and

BROOK
All Triode High Quality
AUDIO AMPLIFIER
Gives It To Him

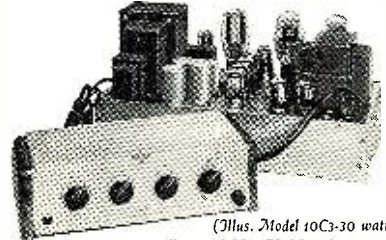

(Illus. Model 10C3-30 watts)
Also available: Model 12A3-10 watts.

with

- Distortion and intermodulation at a new low.
- Reduction of listening fatigue.
- Brilliant, clear tone.
- Separate controls-stepped-for Bass and Treble.
- Extremely low volume without any loss of quality.

Write TODAY for FREE Technical Bulletin and Detailed Distortion Analysis

BROOK ELECTRONICS, Inc.
Dept. RD-02 34 De Hart Place, Elizabeth, N.J.

Grip hard to reach nuts



SLIP ON A TOUCH 'N' GRIP

Grips nuts and bolts wrench-tight in hex opening. Adjustable to any size finger. Head bends to any working angle.

GRIPS HARD TO REACH NUTS

Instant connection. No fumbling. No disassembly of confining parts in working areas.

39¢ FOR A SET OF 4

. . . a set of 4 wrenches that fit the 4 most popular hex nut sizes — 1/4", 5/16", 11/32" 3/8" across the face.

Look for the colorful Touch 'N' Grip display on the counter of your neighborhood dealer.

Order direct if your dealer can't supply you. Send 39¢ plus 1¢ for postage—coin, check or money order No C.O.D.'s please.



TOUCH 'N' GRIP
F. E. REDFIELD CO.
DUMONT 1, N. J.

RADIO & TELEVISION NEWS

the photograph illustrate the modest character of the unit. Controls shown are audio input level, modulation level, and modulator bias control. A separate potentiometer is located at the rear of the chassis to balance the two halves of the 6SN7 modulator. The circuit constants given are for a modulation rate of approximately twenty cycles per second, a range covered by nearly all oscilloscope sweep circuits, and permit the observation of a one-hundred cycle waveform although the distance between peaks makes it necessary to interpolate the linearity curve at low frequencies.

A separate audio oscillator is required and on the modulation percentage as well as the linearity of the modulation will depend the adjustment of the modulator bias control. The two halves of the 6SN7 should be balanced for maximum suppression of the transient produced by the saw-tooth wave. Provision is made for oscilloscope synchronization by coupling the oscilloscope sync input to the output of the saw-tooth generator through a small condenser. This allows a stable trace to be obtained when testing audio amplifiers or other equipment with relatively little phase shift, but is usually inefficient when a relatively large lag is concerned, such as in testing recording or other electroacoustic equipment.

In making tests with this technique, the recovery time, or transient characteristics, of the equipment under test should be considered. For example, if it is desired to examine the dynamic characteristics of a limiting amplifier by this method, the recovery time of the amplifier should be low or else modulations following the initial one will tend to show the characteristics of the system under constant compression. A similar phenomenon may sometimes be found in conventional amplifiers when amplitude peaks cause grid current flow or secondary emission to occur, with consequent gain variations over an appreciable period.

In conclusion, it should be noted that the ear itself is a nonlinear device, both with respect to amplitude and frequency, and is capable of perceiving sounds over a dynamic range greater than one hundred decibels. As a result, the accurate reproduction of the various components of a complex wave at their original relative intensity is a prerequisite of naturalness. Due to the characteristics of hearing, the linearity of a reproducing system may affect the apparent frequency response of the system as much as the static frequency response characteristics taken at an arbitrary level.

The increasing attention being paid to this subject is illustrated by the fact that one manufacturer now offers high quality loudspeakers with a power handling ratio of five million to one, and the audio constructor would be well advised to pay attention to this factor in endeavoring to secure good audio reproduction.

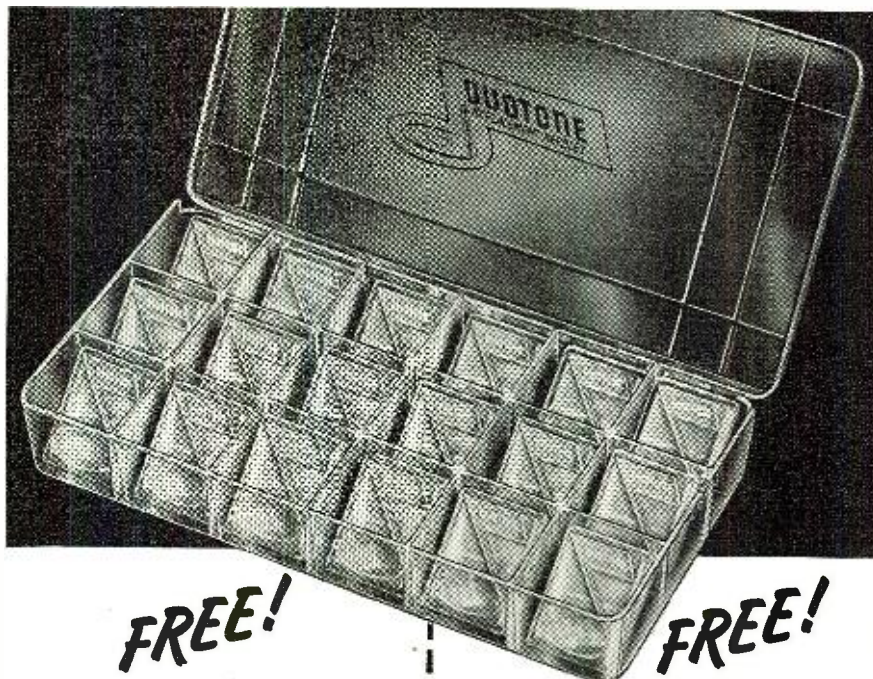

FREE!

FREE!

DUOTONE'S CLEAR LUCITE REPLACEMENT NEEDLE DISPENSER!

See your stock at a glance! Holds the 18 basic Duotone needles in separate compartments. Makes inventory simple; reordering a cinch! Each needle is packed in a magnifying lucite case for quick identification, easy selling.

ABSOLUTELY FREE with your order of one set of Duotone's 18 Basic Needles. Write today for this unusual deal that offers you *more money* from needles and needle servicing!

DUOTONE'S COMPLETE CROSS-INDEX SERVICE CHART!

Handsomely mounted, ready to hang on your wall. At a glance—*all* the information you need to serve customers better, faster.

THE DEAL IN A NUTSHELL

18 Basic Duotone Needles (retail) \$44.75

Your cost **22.37**

YOUR PROFIT 22.38

FREE! Lucite Dispenser and Wall Chart



RADIO ENGINEERING!

DEGREE IN 27 MONTHS

Complete Radio Engineering course incl. Telev., U.H.F., and F.M., B.S. Degree Courses also in Civil, Elect., Mech., Chem., and Aero. Eng.; Bus. Adm., Acct. Visit campus, see well equipped labs. Low cost. Prep courses. Personalized instruction. Grads successful. Founded 1884. Enter June, Sept., Jan., March. Write for Catalog.

TRI-STATE COLLEGE 1640 College Ave. Angola, Indiana

TELEVISION RECEIVER—\$1.00

Complete instructions for building your own television receiver. 16 pages—11" x 17" of pictures, pictorial diagrams, clarified schematics, 17" x 22" complete schematic diagram and chassis layout. Also booklet of alignment instructions, voltage and resistance tables and trouble-shooting hints—All for \$1.00.

CERTIFIED TELEVISION LABORATORIES
5507-13th Ave., Brooklyn 19, N. Y.

BRAND NEW GUARANTEED TUBES

1R5	6AU6	6X5	Any 15 for \$5.00
1U5	6BA6	6T8	100 FOR \$29.95
2X2	6BE6	12AT6	
5Y3	6BG6	12BA6	
6AC5	6BH6	12BE6	
6AC7	6C4	12AU7	
6AG5	6CG6	12SQ7	
6AL5	6J6	19T8	
6AQ5	6SN7	50B5	
6AT6	6SQ7	50C5	

OUR POLICY
All orders acknowledged • Immediate delivery of entire order or refund • We do not use back orders or credit slips • Satisfaction guaranteed •

TERMS: 20% with order, balance C.O.D. Order NOW limited quantities. New listings monthly

GREENWICH SALES CO.
59 Cortlandt St. New York 7

Easy on the Ears...



TELEX Monoset*—Under Chin Headset

Stethoscope design of the Telex *Monoset* eliminates tiresome pressure—instrument swings lightly *under* the chin. Wear it for hours without fatigue!

TELEX Earset*—Slips onto the Ear

Weighing only 1/2 oz., *Earset's* flat plastic frame slips onto the ear, holds the sensitive receiver securely in place. User's other ear is always free for phone calls or conversation.



TELEX Twinset*—Nothing Need Touch Ears!

Lightest twin-receiver headset made—weighs only 1.6 oz. Adjust to any head. Flexible, slips into pocket.



Write for Colorful FREE Specifications Folder Today!

TELEX

DEPT. H-20-4, TELEX PARK
MINNEAPOLIS, MINNESOTA

In Canada, Atlas Radio Corp., Toronto



What's New in Radio

(Continued from page 82)

The unit records for a full hour on a 1200 foot reel of tape with 30 minutes for each half of tape width. Recording speed is 7 1/2 inches per second, with rewind speed 20 times as fast. Other features include a special speaker switch that permits muting the speaker when recording from microphone, and a constant speed capstan drive. Proper recording level is assured by the neon bulb level indicator.

The recorder comes complete with a built-in, high-gain amplifier and PM speaker for playback, and also has provision for connection to an external amplifier and speaker. The unit can also serve as a medium coverage p.a. system with an output of 5 watts.

NEW PACK SET

Motorola Inc. is currently marketing a new FM two-way pack radio which has been designed especially for use by law enforcement agencies, fire protection departments, construction companies, forestry services and similar operators of mobile two-way radio equipment.

The new unit incorporates a 16 tube receiver and an 8 tube transmitter into a compact 19 pound station which measures 10 1/2" x 13" x 4 5/16". The set

CHANNEL BUSTER ANTENNA TV and FM ANTENNA

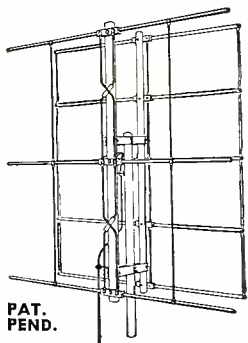

PAT. PEND.

- Will eliminate TV interference from the rear side at a ratio of 30-to-1 on the desired frequency. Other channels vary from 2-to-1—10-to-1 ratio.
- The reflector is tunable to reject any desired frequency from the rear.
- Designed to operate in fringe areas.
- Complete all-channel coverage 2-13.
- One lead-in wire.
- High-gain vertical array.
- Good mechanical construction. **NO VIBRATION.**
- Shipped partially assembled complete with instructions.

LIST PRICE \$42.00

BARB CITY UNIVERSAL FOOT MOUNT No. 250

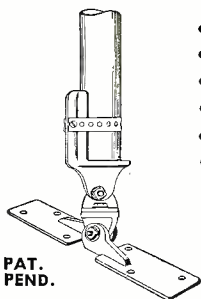

PAT. PEND.

- Rotatable 360°.
- Will fit any size pipe, tube or conduit from 3/4" to 2 1/2".
- Can be swiveled on vertical and horizontal axis.
- Allows raising mast on ridge, valley or slope of any roof.
- Allows clearance in swinging around chimneys, branches, wires, etc.
- Base can be mounted on any shape, angle, slope or ridge.

LIST PRICE \$3.95

BARB CITY INDUSTRIES, INC.

1150 SOUTH FOURTH STREET

DE KALB, ILLINOIS

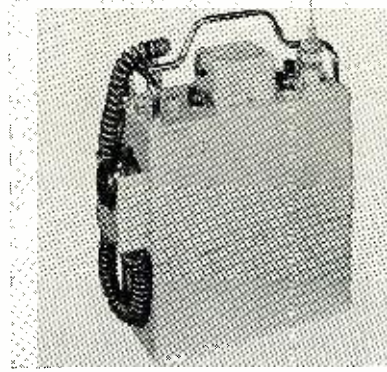

can be hand carried, back carried, or used as a semi-fixed installation.

Equipped with a tip-up loudspeaker and a patented adjustable squelch circuit, it will broadcast directly over the operator's shoulder when back carried, or to nearby working areas when the set is left stationary, yet remains quiet during standby periods.

The set is designed for operation in either the 25-50 mc. band or the 152-174 mc. band and is available in three versions, the single frequency transmitter and receiver; two-frequency transmitter, single receiver; and dual transmitter, single receiver. All come complete with batteries, antenna, and microphone.

DISC CONDENSERS

Erie Resistor Corporation of Erie, Pa., is now manufacturing a .01 µfd. disc Ceramicon in a new small size.

RADIO & TELEVISION NEWS

This new midget condenser measures only $1\frac{1}{32}$ " in diameter and has been designed for easy application in small spaces. According to the company, capacity of the new Ceramicon is .01 μ fd. + 100%-0%. Voltage rating is 400 volts d.c., which is based on a life test of 800 volts d.c. at 85 degrees C for 1000 hours. The power factor is 2.5% maximum at 1 kc. at not more than 5 volts r.m.s. Insulation resistance is 7500 megohms minimum.

FREQUENCY RELAY

A line of 400 cycle frequency sensitive relays, designed for the protection of instruments, accessories, etc., from the effects of under frequency or over frequency, has been announced by Varo Mfg. Co., Inc. of Garland, Texas.

Known as the 900 series, these new units consistently operate with a frequency differential of $\frac{1}{4}$ of 1%. The pull-in and drop-out spread can be set from 2 to 40 c.p.s. to operate within $\frac{1}{4}$ of 1% of the two independent settings.

These relays are hermetically sealed against moisture, salt spray, fungus, and foreign matter. Multiple contacts may be used to either open or close a desired circuit. The design is said to be "fail-proof" inasmuch as a failure of the frequency sensitive relay removes all loads. The relay may be manually bypassed for emergency operation in case of relay failure.

PICKUP CARTRIDGE

A new development in miniature sized crystal phonograph pickup cartridges has been announced by The Astatic Corporation of Conneaut, Ohio.

Known as the "AC" series, these new units are said to provide exceptionally smooth response, better tracking characteristics, low needle talk, and assurance of long life for both needle and record.

There are four models in the "AC"

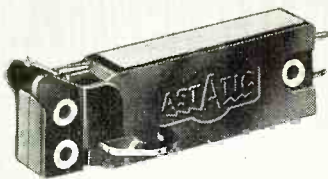

series. The Model AC-78 has a three-mil radius stylus tip, either precious metal or sapphire, for standard 78 r.p.m. records; Model AC, a one-mil stylus for narrow-groove, slow speed records, the Model AC-AG has the new All-Groove stylus for playing all three types of records, and the Model ACD, a turnover cartridge with dual needles to play narrow-groove records on one side and 78 r.p.m. on the other.

Frequency range is from 50 to 10,000 c.p.s. in all models. Needle pressure

THE BEST IN ELECTRONIC SURPLUS

MOBILE DIRECTIONAL ROTARY ANTENNA FOR 20 TO 40 MC



One antenna for complete 20 to 40 mc directive transmission and reception! Four simple plug-in inductors permit this wide coverage, eliminating necessity for changing antenna. Powerful 12 V. motor rotates array clockwise $2\frac{1}{2}$ rpm. Designed for use with FM Transmitters- Receivers SCR508, 608, etc., and for vertically polarized radiation, but design permits changes for horizontal radiation and for use with practically any transmitter or receiver. Design is 4-element Adcock, and includes an audio oscillator with coded (8 characters) discs to send different character signal every 15 degrees, for homing or bearings. Coding discs and audio oscillator easily removed. Equipment is all NEW, and includes: Antenna Array with antenna mount and motor in weatherproof housing, code discs, audio oscillator, phase load box, 4 plug-in inductors, field strength and wavemeter, valuable compass and tripod, control panel, all necessary cables and complete technical manuals. Export packed, 2 cases per complete set.

PRICE, PER COMPLETE SET..... **\$79.50**

'SNOOPERSCOPE" TUBE

Infra-Red Image Converter Tube (British) to make "Snooperscopes," "Sniperscopes," and other devices that see in the dark. Has many useful industrial applications. Operates with invisible infra-red rays, without scanning or amplifiers. See article Oct. '49 Radio Electronics or Nov. '49 Electronics. Supplied with technical data and diagrams. Every tube guaranteed! **WE WILL NOT BE UNDERSOLD.**
EACH.....\$5.00
6 for.....\$25.00
BAUSCH & LOMB Front-End Lens Assembly, for best images. F2.1. 3.5 in. E.F. EACH.....\$10.00
MOUNTED LENS UNIT, also for front-end, results as good as B & L unit. Speed F1.9 f.l. 91.44 mm. outside dia. at one end 60 mm. length of mount 64 mm. PRICE, EACH.....\$7.00

BEACHMASTER PORTABLE ANNOUNCING SYSTEMS, 250 and 500 Watt Units, complete with Speaker Racks, Trumpet Units, Cables, Tubes, etc. Mfd. by W.E. Ready for Immediate Operation, from 110 volt 50/60 cycles AC. Some AC Gas-Engine Generators, for field use, available. **ALL NEW to EXCELLENT** Condition equipment. Ideal for Airports, Stadiums, Ball Parks, Carnivals, Marine, and Military use. These are good fidelity units, to 6,000 cps. and can be used for entertainment (music) as well as speech and modulator applications. **WRITE FOR PRICES AND DESCRIPTIVE SHEET.**



32 VDC-110V AC CONVERTER

Mfd. by Kato Engineering, for marine or farm installation. Rotary type, compact and ruggedly built for continuous duty. Rubber shock mounting on filter case, with complete input and output filtering. Output 110 volts, 60 cycles AC. 225 watts, but will operate efficiently on loads up to 300 watts. New units only.

PRICE, EACH.....**\$39.95**

Quantities, 3 or more, each...**\$35.00**

BIGGEST BARGAIN — FOR PUBLIC ADDRESS MEN! RCA—25-Watt Mobile Amplifier—with RCA

Dynamic Microphone

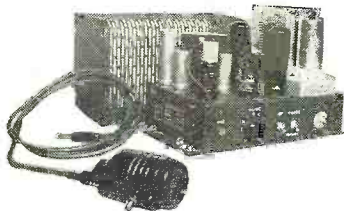

This is a swell buy for sound men, for installation in trucks, excursion boats, carnivals, etc. The unit operates from 12 volts DC (storage battery power), is extremely compact, and delivers 25 watts peak power on speech or music with extremely good fidelity. Amplifier measures: $1\frac{1}{2}$ " x $8\frac{1}{2}$ " x $3\frac{1}{2}$ ". Incorporates a 6J7 driving a 6SN-7, driving 2—6L6 Beam Power tubes. A self-rectifying 12-volt vibrator pack is mounted within the amplifier. A fine close-talking dynamic hand microphone with cable and plug connector (all RCA mfr.) is also supplied. Value of this beautifully constructed equipment is over \$250.00. New. Surplus, and guaranteed!

NEW, COMPLETE, ONLY \$42.50

All Material Subject to Prior Sale

Minimum Order \$5.00, 25% Deposit—Balance C.O.D., F.O.B. New York City

TELEMARINE COMMUNICATIONS COMPANY

PHONE—Longacre 4-4490

280 NINTH AVE., N. Y. 1, N. Y.

ELECTRICAL TRAINING

Intensive 32 weeks' residence course in fundamentals of industrial electrical engineering, including radio, electronics. Prepares for technicians, engineering aides. Approved for veteran training, 57th year. Next classes begin Sept. 5. Write for catalog.

BLISS ELECTRICAL SCHOOL
7607 Takoma Avenue,
Washington 12, D. C.

TRANSFORMERS MADE

PLATE AND FILAMENT

For 304 TL, 851, 872 A, etc.

Also made to your specifications.

Write for Prices

CHAPMAN LABORATORIES

5042 Locust Street

Philadelphia 39, Pa.

PRINT YOUR OWN POST CARDS

COMPLETE
OUTFIT
only

\$7.50

Amazing results in sales, inquiries and contacts... saves time and money... very easy to use GEM STENCIL DUPLICATOR is ideal for Advertising, Announcements, Notices, Labels, Forms, Price Lists—hundreds of uses for every type of business and organization. Comes complete with all supplies, instructions and 60-page Book of Ideas.

FREE TRIAL OFFER: Try it before you buy it! Write and a GEM OUTFIT will be sent you postpaid. After 10 days, send only \$7.50 or return the GEM, no questions asked. The GEM must sell itself; you be the judge.

BOND EQUIPMENT CO. - Dept. 111
6633 Enright • St. Louis 5, Mo.

SEND NO MONEY FREE TRIAL OFFER

INVENTORY SALE

ALL PRICES CUT TO BONE

25c TUBE SALE—# 53-2A7-55-27-01A-85-31 6 for \$1.00

12 BRAND NEW 10" PHONO RECORDS—Ass't. Jazz—Pop—Hillbilly—Polkas \$1.79

WOOD MIDGET CAB. 8 1/4"x5 7/8"x4 1/4" 69c

Slightly used Phono Records, Popular, Jazz, etc. Ass't. 8 for \$1.00

POWER PACK KIT

COMPLETE COMPONENT PARTS for Heavy Duty Power Pack, Made from Signal Corps Brand New Parts—Delivers approx. 350 volts—150 mls. Plate Trans., 1 Filament Trans., 2 Chokes and Schematic Diagram. U. S. Gov't cost over \$60. Shipping wt. 30 lbs. SPECIAL PRICE \$3.00

JONES 20 TERMINAL BARRIER TYPE STRIP 25c

TRANSMITTING FILTER CHOKES

63 Henries, .018 Amp., 930 Ohms 75c

Signal Corps Phones—2 M. Ohms (8 M. Ohms Imp.) \$1.00

2 Ft. Ext. Cord (and Plug) 40c

OIL FILLED FILTER CONDENSERS

1—MFD—2000 volts 75c ea.

1—MFD—1000 working volts 6/99c; 12/\$1.75

FAMOUS BRAND RECORD CUTTING HEAD

Size 1 3/8"x2 1/2" ready to fit your cutting arm or bracket. SPECIAL \$2.95

TOBE TUBULAR ELECTROLYTICS

20-20 MFD. 150 V. 25c 30-30 MFD. 150 V. 30c

40-40 MFD. 150 V. 32c

2 1/2 M.H. R.F. CHOKE COIL—27c ea. 5 for \$1.00

3 BAND OVAL DIAL—7 1/2" L x 5 1/2" H 60c

100 RESISTOR ASST. 1/4-1/2-1 WATT 95c

Low-Loss Short Wave Variable Condensers

1/4" Shaft Type 10c

5 Plate—20 MMFD 20c

14 Plate—55-60 MMFD 27c

Lock Type Air Trimmer Variable Condensers

3 Plate—12-15 MMFD 10c

5 Plate—20 MMFD 11c

8 Plate—30-35 MMFD 13c

10 Plate—40 MMFD 14c

14 Plate—56 MMFD 16c

20 Plate—80-100 MMFD 25c

27 Plate—100-110 MMFD 35c

of the AC model is 5 grams, the others six grams. Output at approximately 1000 c.p.s. is 1 volt.

RECORDING TAPE

Minnesota Mining and Manufacturing Co. of St. Paul 6, Minnesota, has developed and is marketing a new sound recording tape.

The new recording medium is a paper-backed tape that is said to provide better frequency response, lower noise level, and higher output than its predecessor. The tape, designed for home, school, and other non-professional use, is "Scotch" brand sound recording tape No. 101.

Its improved performance is said to be largely due to a new paper backing, and an improved binder which permits a smoother coating of oxide particles.

The new tape is made in 600 and 1200 foot lengths on both metal and plastic reels.

HIGH VOLTAGE PROBE

Electronic Instrument Company of 276 Newport Street, Brooklyn, New York, is currently marketing a new, low-cost high voltage probe which is capable of measuring up to 30,000 volts.

This probe, designed specifically for television service technicians, utilizes a special helical film, statite rod

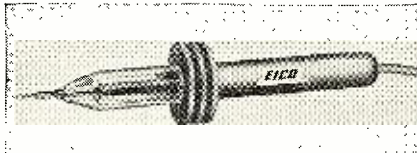

type, removable multiplier resistor.

Easily changed for various resistance values, the new EICO probe can be used with several different instruments. Both direct view and projection TV sets can be serviced with the unit. The probe matches most 20,000 ohm/volt meters as well as most v.t.v.m.'s now in use. Safety features include plywood bakelite handle and large guards for complete protection against flashovers.

The Model HVP-1 is being marketed through the company's regular parts jobbers.

DU MONT SCOPE

Allen B. Du Mont Laboratories, Inc. of Clifton, New Jersey, has recently introduced a new cathode-ray oscillograph, the Type 250-AH, which features an improved sweep circuit, fast sweep starting time, and high light output.

Recurrent, single, or driven sweep durations are continuously variable from 5 seconds to 10 microseconds. The cathode-ray beam rests at the left side of the screen, resulting in negligible sweep starting time on driven sweep. On the return cycle the trace is automatically blanked out. A Z-axis input is provided for intensity modulation.

The Type 250-AH uses a Du Mont

OUTSTANDING - TV - VALUES

ANTENNAS • ACCESSORIES

MODEL #300
Folded dipole complete with reflector and high frequency adapter. Covers 13 channels. All alum. construction. Includes 5' section alum. mast. Shpg. wt. 5 lbs.
PRICE: \$4.95

MODEL #200-D
Stacked array. Consists of 2 complete conicals and connecting bars. Very rigid construction. Covers all 13 channels. Matches 300 Ohm or 72 Ohm. Center impedance 150 Ohm. Ideal for low signal areas. An outstanding buy. Shpg. wt. 8 lbs. SENSATIONAL \$8.25 OFFER at less mast.

MODEL #200-S
Single array. Same construction as above. Shpg. wt. 4 lbs.
Price, less mast. \$3.75

MODEL #500
All-band folded dipole antenna. Ideal for rotator use. Maximum gain on 100 channel. Alum. construction. Complete with 5' alum. mast. Shpg. wt. 5 lbs.
\$4.95

Antenna rotator complete with control unit and 60' coil of 3 wire insulated interconnection cable. Shpg. wt. 11 lbs. **\$17.50**
Complete package consisting of Type #500 antenna with mast and antenna rotator kit. Shpg. wt. 16 lbs. SPECIAL PRICE \$22.00

MODEL #Y-100
5 element Yagi Hi-Gain beam designed specifically for fringe area use. Guaranteed to get the station you want. All alum. construction. Cut to specific channels. Shpg. wt. 2 lbs. Channel #7, \$6.50; Channel #9, \$6.25; Channel #11, \$6.25 and Channel #13, \$6.00. The prices are less mast.

ANTENNA ACCESSORIES

Type CM 100 Chimney Mount \$1.25
Type WM 100 3" Wall Bracket (pr.) 60c
High Quality 300 Ohm Transmission Line \$1.00
100 ft. \$1.25; 1,000 ft. \$11.00

72 Ohm Coaxial Cable \$3.50
100 feet \$3.75
5 foot 1 1/4" Plated Steel Mast \$2.50
10 foot 1 1/4" Plated Steel Mast \$1.20

TERMS: All shipments F.O.B. Newark, New Jersey. 25% deposit with order, balance C.O.D. Minimum order \$2.00.

ELECTRONIC ASSOCIATES

40 St. Francis Street Newark 5, New Jersey

FOR BARGAINS IN

Receivers, Transmitters, Amplifiers, Television Sets, Batteries, Surplus Parts, Phonograph Records, and many more items

READ

RADIO & TELEVISION NEWS
Classified Columns Every Month

Master Mobile

ANTENNAS

(A)

MOUNTS

(B)

(C)

(D)

(E)

(F)

(G)

(H)

(A) BODY MOUNTS: Swivel Base. (A) Mod. 126, straight spring. (B) Mod. 132, double tapered spring. Shpg. wt. 3 1/2 lbs. Net price each. **\$7.95**

BUMPER MOUNTS: (C) Mod. 138, straight spring. (E) Mod. 140, double tapered spring. Shpg. wt. 3 1/2 lbs. Net price each. **\$5.95**

(D) Mod. 142, less spring insulated for direct mounting for Series 100 Antenna or Extension 92. Shpg. wt. 2 lbs. Net price. **\$2.95**

WHIP ANTENNAS: (H) Stainless steel. Tapered. 72", 78", 86", 90" and 96" length. Postage rate 10 lbs. min.

Series 100, 3/4"—SAE stud fitting. Net price. **\$4.77**

Series 106, plain end. Net price. **\$4.11**

EXTENSION: (F) Mod. 92, 18". Shpg. wt. 14 oz. Net price. **\$2.95**

ALL BAND MOBILE ANTENNA: (G) Center loaded, 8'10" length with either 20, 40 or 75 meter coils. Specially req. coil desired. Shpg. wt. 3 lbs. Net price antenna with one coil. **\$7.95**

Extra coils, 20, 40 or 75 M. Each. **\$2.95**

Order from your dealer or write

MASTER MOBILE MOUNTS, Inc.
5200 Wilshire Blvd. Los Angeles 36, Calif.

MINIMUM ORDER \$2.00—NO C.O.D.
SHIPMENTS—PLEASE INCLUDE POSTAGE

NEWARK

SURPLUS MATERIALS CO.
Dept. AP

324 Plane Street NEWARK 1, N. J.

Type 5RP-A high voltage cathode-ray tube. The over-all accelerating potential for this tube, supplied by an external power supply, is 13,500 volts. This high potential makes possible the observation and photographing of high-speed signals recurring either at random or at slow, recurrent intervals.

Detailed information on this new oscillograph is available on request from the company.

EXPLOSION-PROOF SPEAKERS

Underwriters' Laboratories has granted approval to *University Loudspeakers, Inc.*, for two new hazardous duty speaker units.

Both models are complete reflex trumpet speakers with integral 25 watt driver unit and built-in multitap line matching transformer. The Model 7101 is UL approved for Class I, Group C and D which includes locations in which flammable volatile liquids, highly flammable gases, mixtures, or other flammable substances



are manufactured, used, handled, or stored. The Model 7102 is approved for Class I as well as Class II Group E, F, and G, which includes those locations in which combustible dust is thrown or suspended in air producing explosive mixtures, and in places where such dust may collect or settle on motors, lamps, or other electrical devices.

Specifications on the two models and complete details are available on request. Write to the company at 80 South Kensico Avenue, White Plains, N. Y.

MAGNEFILM UNIT

Movie-Mite Corporation, 1105 Truman Road, Kansas City 6, Missouri, has added a new magnetic film recorder to its line of sound photographic equipment.

Tradenamed the Magnefilm Recorder, the new unit is a synchronous motor-driven 16 mm. magnetic film recorder. The recorder can be used for location sound recording for film producers, radio stations, TV stations. The complete unit is housed in a single case.

Complete specifications and performance data on the new film recorder are available from the company.

REPLACEABLE STYLUS

The *General Electric Company*, Syracuse, New York, has announced the availability of a modified replace-

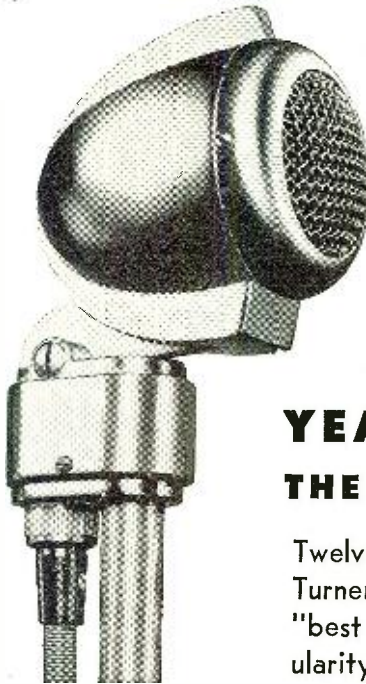

A Sound Performer YEAR AFTER YEAR THE TURNER MODEL 22

Twelve years have rolled by since the Turner Model 22 was introduced. A "best seller" from the start, its popularity must be deserved.

Welcome to
509 A
Our Headquarters at The
Stevens during The Parts
Show
May 22-25

Write for Complete
Microphone Literature

THE TURNER COMPANY 900 17th Street N. E., Cedar Rapids, Iowa

IN CANADA: Canadian Marconi Co., Montreal, P.Q., and Branches
EXPORT: Ad. Auriema, Inc., 89 Broad Street, New York 4, N. Y.

Crystals licensed under patents of the Brush Development Company



When answering Ads please mention
RADIO & TELEVISION NEWS

RADIO ENGINEERING 27 MONTHS DEGREE IN

Radio engineering is a big field. There's room for you in it—if you're good. Get first-class training at Indiana Tech. Intensive specialized course, including strong basis in mathematics and electrical engineering, advanced Radio Theory and Design. Modern laboratory. Low tuition. Also 27-month courses in Aeronautical, Chemical, Civil, Electrical and Mechanical Engineering. Approved for C.E.S. Enter June, September, December, March. You can earn part of your expenses right here in Fort Wayne while you are studying.

INDIANA TECHNICAL COLLEGE

940 E. Washington Blvd., Fort Wayne 2, Indiana
Please send me free information on B.S. Engineering Degree in 27 months as checked.

Radio-Television, Aeronautical,
 Civil, Mechanical, Electrical

Name
Address

Compare TESCO'S PRICES

1215—Swift-Rig Folded Hi & Lo. \$4.43
1219—Swift-Rig Folded Hi Straight

Lo	4.07
1213—Single Bay Conical	4.50
1214—Two-Bay Conical	9.88
1226—Four-Bay Conical	21.00
1872—Drive-in Standoff Insulator	.03
1870—3 1/2" Wood Screw Standoff Insulator	.03
1871—7 1/2" Wood Screw Standoff Insulator	.05
1873—3 1/2" Mast Standoff Insulator	.09
1801—3 1/2" Guy Wire Turnbuckle	.09
1802—4 1/2" Guy Wire Turnbuckle	.10
1302-1306—Five El. TV Yagi Any Lo Channel	11.25
1307-1313—Five El. TV Yagi	
Any Hi Channel	4.95
1860—Chimney Mount	1.40

Send for quantity prices and complete list

TELEVISION SUPPLY CO.
Box 213 Gracie Square Station
New York, N. Y.



LET PRICES TALK



FILAMENT TRANSFORMER

6.3V, 12 amps Pri, 110 Volts 60 Cy.
Size: 3 3/8" H. x 2 7/8" W. x 2 3/4" D.
Wt. 3 1/2 lbs. Fully shielded as illus-
trated. Worth \$4.50—While They
Last **BRAND NEW**
Only \$1.69 ea.



SENSITIVE RELAY

SPDT breaks at 3 ma; delicately
pivoted. Housed in dust-proof alu-
minum shield, plugs into standard
5-prong socket. Approx. 2000 ohms
DC.
Only 99c ea. 3 for \$2.75

BARGAINS OF THE MONTH

.001 600 VDC Pigtail Micas.....	20 for \$.99
.004 1000 VDC Pigtail Micas.....	12 for .99
250 mmf Midget Variable, Steatite Ins....	2 for .88
325 mmf Midget Variable, Steatite Ins....	2 for .98
1/2 meg Potentiometers.....	.23 ea. 5 for .95
50,000 ohm 1% WW Precise, Resist. .19 ea.	6 for .95
6 Henry 50 ma Filter Chokes.....	4 for .99
2" GE Meter 0-5 ma. (amp scale).....	ea. 1.79
2" GE Meter 0-30 amps DC.....	ea. 1.79
3" Triplett Meter 0-75 amps AC.....	ea. 1.99
.07 1000 VDC Xmitting Mica.....	3 for .99
.02 600 VDC Xmitting Mica.....	6 for .99
.001 600 VDC Xmitting Mica.....	10 for .99
3/3 mfd 600 VDC Oil Condenser.....	ea. .49
6 mfd 1000 VDC Oil Condenser.....	ea. .99
.1 mfd 7500 VDC Oil Condenser.....	ea. .88
.35 mfd at 16 KV plus .7 mfd 8 KV.....	ea. 3.95
1 x 1 x 1 mfd 1200 VDC Oil Cond.	ea. .39
100 ohm 100 Watt Adjustable Resistor.....	ea. .29
500 ohm 50 Watt Adjustable Resistor.....	ea. .19
1.5 or 50 ohm 25 Watt Adjustable Resistor.....	ea. .99
.02 400 Volt Tubulars.....	.20 for .99
10 K or 15 K pots.....	.19 ea. 6 for .95
.0006 mfd Pigtail Silver Micas.....	12 for .99
.006 mfd 600 VDC Pigtail Micas.....	10 for .99
.01 mfd 600 VDC Pigtail Micas.....	10 for .99
2 mfd 250 VAC GE Oil Cond.	6 for .99
Miniature Headphones Type HS30.....	ea. .59
Transformers for above.....	.39
3" Westinghouse Meter 0-20 ma.....	2.79

PANEL METERS—BRAND NEW

3" 0-1 ma Basic.....	\$2.95	3" 0-1 ma DC.....	\$3.95
3" 0-30 ma Basic.....	1.75	3" 0-100 ma DC.....	3.50
3" 0-10 V. AC.....	2.50	3" 0-80 ma DC.....	2.95
3" 0-30 V. DC.....	2.95	3" 0-2 ma DC.....	3.95
3" 0-300 V. AC.....	2.95	3" 0-200 ma DC.....	3.95
3" 0-1 amp R.F.....	2.45	3" 0-20 ma DC.....	3.50
3" 0-200 micro amp.....	8.75	2" 0-100 ma DC.....	1.95
3" 0-50 microamps 12.95			

HIGH CURRENT TRANSF. 820 Volts CT at 775
Ma. Pri. 110/220 Volts 60 cycles. Fully Cased. \$5.95

RELAY SPECIALS

Advance Antenna Relay 110V 60 Cy Coil Ce- ramic insulation DPDT.....	\$1.89
Dunco Relay Volt 60 Cy Coil. Ceramic in- sulation. DPST.....	1.69
Allen Bradley Solenoid.....	110V 60 Cy. ea. 2.95
DPST, 23 amp contacts.....	ea. 2.95
GE "PBC" Instantaneous overload relay adj. 100-200 Ma DC. reset 110V 60 Cy.....	7.50
4PDT.....	ea. 2.50
GE overload relay 640 Ma DC, easily made adjustable. elect. reset 110V 60 Cy. Only.....	ea. 2.50

UTC type PA 5000 ohm plate to 500 ohm line and
6 ohm v.c. 10 watt. 60 to 10,000 cps. \$1.99

FILAMENT TRANSFORMERS

110 V 60 Cy Pri Fully Cased.....	\$3.49
2.5 Volt CT 21 Amp.....	4.75
5.2V CT 21A 7.5V 6A, 7.5V 6A.....	4.95
5 Volt 4A, 6.3V, 3A.....	2.45
2.5V CT 20A, 2.5V CT 20A.....	6.95

OIL CONDENSERS

2 mfd 600 vdc—	.39	10 mfd 2000 vdc—	\$5.95
4 mfd 600 vdc—	.59	2 mfd 4000 vdc—	4.95
6 mfd 600 vdc—	.79	1 mfd 5000 vdc—	4.50
8x8 mfd 600 vdc—	1.39	.1/.1 mfd 7000 vdc—	2.25
10 mfd 600 vdc—	.89	1 mfd 7500 vdc—	9.25
20 mfd 600 vdc—	2.15	.01/.01 mfd 12 kv dc—	5.75
4 mfd 1000 vdc—	.95	.005/.01 mfd 12KV dc—	5.50
2 mfd 1500 vdc—	1.25	.65 mfd. 12,500 vdc—	12.95
4 mfd 1500 vdc—	2.25	2 mfd 18 kv dc—	\$9.50
6 mfd 1500 vdc—	2.95	1 mfd 15 kv dc—	15.95
1 mfd 2000 vdc—	1.45		
2 mfd 2000 vdc—	2.25		
8 mfd 2000 vdc—	5.95		

CHOKE BARGAINS

6 Henry 80 ma 220 ohms.....	2 for \$0.99
8 Henry 150 ma 140 ohms.....	.99
1.5 Henry 250 ma 72 ohms.....	.59
5.2V CT 21A 7.5V 6A, 7.5V 6A.....	3.75
Swing. 1.6/12 Hy 1 Amp/100 ma 15 ohm.....	19.95

SCOPE TRANSFORMERS

Pri 110V 60 Cy—Hermetically Sealed	
2500V RMS @ 12 Ma.....	\$2.95
1050V RMS @ 20 Ma, 20V 4.5A, 2.5V 5A.....	4.75
4400V RMS 4.5 Ma., 5V 3A, 15KV Ins.....	4.95

GENERAL PURPOSE TRANSFORMERS

Ideal for Bias, Filament, Isolation, Stepdown, etc.
2 isolated 110v pr. sec. 110v at 900 ma plus 6.3
@ 2 amps. Fully cased..... Now \$1.49 ea.

30 WATT WIRE WOUND RESISTORS

OHMS 100-150-2500-3k-4k-4500-5k-5300.....	
10k-15k-18k.....	.15 ea. 8 for \$0.99

Eimac Vacuum Condenser 50 mmf 32 KV Type
VC50-32 ea. \$5.95

PEAK ELECTRONICS CO.

188 Washington St. MR
New York 7, N. Y.

able stylus assembly for use with its variable reluctance phonograph cartridge.

The new design, in which the horizontal stylus arm has been given a

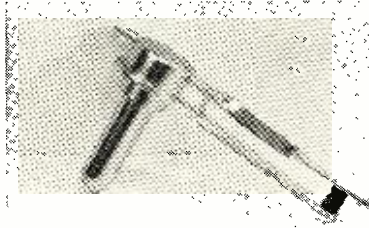

double twist and is double damped, has been named the "Baton" stylus. As a result of this modification, the GE cartridge performs with much higher compliance and improved tracking ability, according to the company. The double damping greatly reduces needle talk, preventing it from being induced in the tone arm.

The modified stylus assembly, which

fits any GE cartridge with the replaceable stylus feature, is currently being sold in new cartridges and as a replacement stylus.

NEW CONDENSERS

A new line of tubular paper condensers, the "Humidi-Seal" type, has been developed by Pyramid Electric Company of 155 Oxford Street, Paterson, New Jersey, for applications where high humidity and high temperatures are present.

The Type 85TOC condensers will operate at up to 85 degrees C and perform satisfactorily in television receivers, auto radios, etc., where high humidity might be a factor.

The outer tube is plastic impregnated to prevent moisture-absorption, and the ends are plastic sealed against moisture. The new line is available in seven different capacities ranging from .001 to .1 µfd. at 600 volts.

A data sheet is available on request.

-30-

ABC's Tape Recording

(Continued from page 41)

showed a life of 287 complete record-playback cycles.

When using the Ampex machine, tape is purchased in 5400 foot reels to allow about 34 minutes of recording. Tape speed is 30 inches per second, both for better fidelity, and to allow

for ease in editing. The same size reels on Stancil-Hoffman machines will permit 67 minutes at a tape speed of 15 inches per second.

The recording day begins at 7 a.m. during Daylight Saving Time and runs for an average of 16 1/2 hours per day. More network stations are fed from the delayed net than the regular net due to the limited use of Daylight Saving Time.

-30-

Fig. 1. Block diagram showing basic control and audio switching system. The PB line relays have "Preset" and "Operate" controls. In feeding a program, duplicate copies are run in synchronism. The "Master" feeds Line 1 while the "Safety" feeds Line 2 and is any control to feed Line 1. If the master unit fails, pushing an "Operate" button on any control panel will switch Line 1 to operate the "Safety" machine.

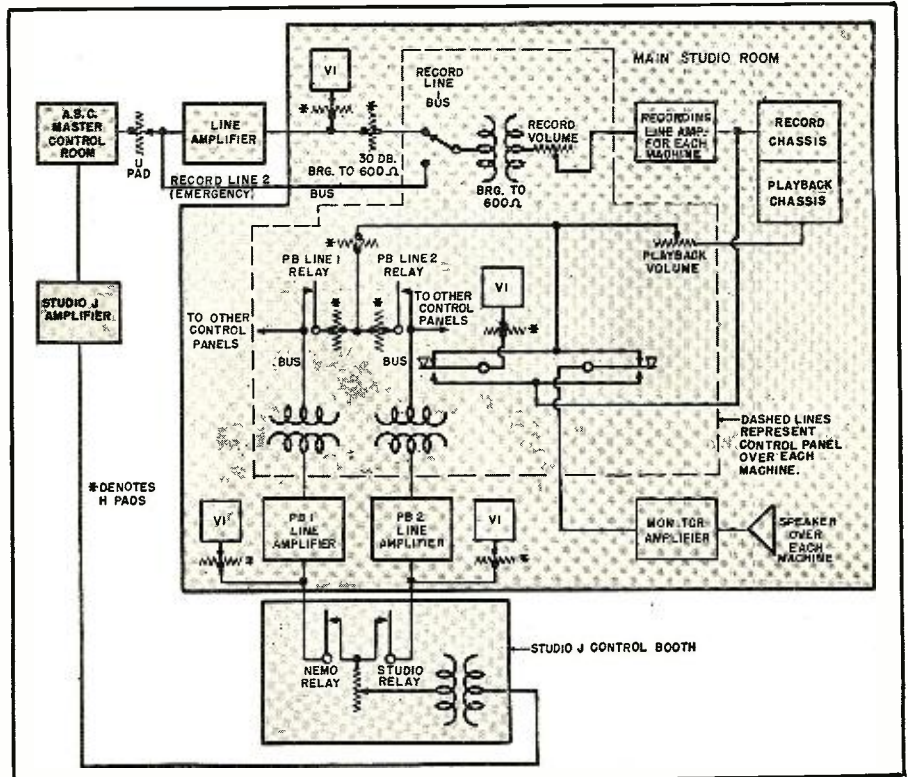

SAVE

THAT GOOD LOOKING OLD CONSOLE
WITH THE OBSOLETE RADIO!

install a modern

ESPEY AM/FM CHASSIS

and your favorite console is "right-up-to-date"

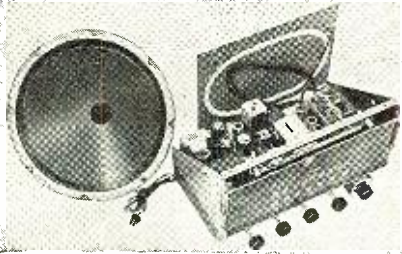

Rated an excellent instrument by America's foremost electronic engineers. Fully licensed under RCA patents. The photo shows the Espey Model 511, supplied ready to play. Equipped with tubes, antenna, speaker and all necessary hardware for mounting.

ATTENTION SERVICEMEN—Did you know there are over 19 million consoles waiting to have a modern AM/FM chassis installed? Here is a gigantic sales market just waiting for you to develop. In fact there are thousands of out-moded radios in your "backyard" just waiting to be replaced.

Makers of fine radios since 1928.

Write for literature RN for complete specifications on Model 511 and others

ESPEY TEL. TRRefalgar 1-7000
MANUFACTURING COMPANY, INC.
528 EAST 72nd STREET, NEW YORK 21, N. Y.

TWIN-TRAX* TAPE RECORDERS

feature

- WIDER FREQUENCY RESPONSE
- GREATER DYNAMIC RANGE
- LONGER PLAYING TIME
- --- and lower price!



For the Home \$285



Broadcast Studio \$375



Educational Institution \$335



Wired Music System \$495

Professional-type specifications that mean professional quality, operating ease, and trouble-free construction that you would normally associate with recorders selling at \$1000 and more. Yet the Twin-Trax Recorder series is available to you direct from the factory at low factory prices, starting at \$285 for complete high-fidelity recorders, and \$89.50 for precision-built basic tape transport mechanisms.

If you are thinking of buying a tape recorder, or if you use recorded sound for any purpose—for personal enjoyment or in your business, there is a Twin-Trax instrument for you. There are more than 30 standard and special Twin-Trax models available, including continuous-playing instruments, two-speed models, 24-hour recorder, etc.



Experimenter \$89.50

Learn why Twin-Trax is the only professional recorder in the popular-price field. Save many dollars by dealing direct with the factory. Write today for illustrated 16-page catalog, including complete technical data.

*TRADE MARK REG. U.S. PAT. OFF.

AMPLIFIER CORP. OF AMERICA

398-2 Broadway

New York 13, N. Y.

BIG MONEY IN RADIO and TELEVISION NOW!

See **COYNE'S Brand New 7 Volume Set**

APPLIED PRACTICAL RADIO-TELEVISION

FREE!



A BRAND NEW Set of books written for men who want to "go places" in TELEVISION and RADIO . . . men who know how a PRACTICAL working knowledge helps to get the BIG MONEY. Over 2500 pages of the latest Radio and Television "know how"; easy to understand with hundreds of crystal-clear illustrations. It's ALL here! EVEN COLOR TELEVISION AND UHF. How to install, service, align, balance ALL radio and TV sets . . . how to use new and old testing instruments for TV service . . . latest data on adapters, converters and MORE. Complete volume on Electronics and handy Radiomen's Handbook included. You name it and COYNE'S GOT IT, in this amazing new money-making 7-Volume Radio-Television Library.

PRACTICAL! CLEAR! COMPLETE! 7 fact-packed volumes - 1400 illustrations and diagrams with step-by-step photographs which "break down" the equipment to show what makes it "tick". Up-to-the-minute, complete, easy to follow.

SEND COUPON—SEE SET FREE FOR 7 DAYS

You must SEE these new books to know how easy it is to prepare for the big jobs in radio and television. Here's our special offer—we'll send the complete 7-volume set for your 7-Day FREE Examination. And with it, we'll include our valuable, new guide for all radiomen. "150 New Radio-Television Diagrams Explained," absolutely FREE! If you keep the 7-

volume set all you pay is \$3.00 within 7 days after the books arrive and \$3.00 per month until \$23.50 is paid—or you can pay \$22.00 cash price. If you don't want the set, return it and you OWE NOTHING. But either way you keep "The Radio and Television Diagrams Book" as a gift. That book is ABSOLUTELY FREE.

SEND NO MONEY Coupon is just a request to see Set free and get FREE BOOK. Offer limited—act now.

COYNE Electrical and Radio-Television School

500 S. Paulina St., Dept. 40-T3, Chicago 12, Ill.

Color Television Is Here!

Set contains most complete section ever published on Color Television and UHF, adapters and converters. FULLY ILLUSTRATED AND PRINTED IN 4 COLORS.

Act Now and Get FREE Book

Now you can see these new Coyne books for 7 days without cost and get Coyne's Book of "150 Radio and Television Diagrams Explained," FREE. It's free just for examining the new 7-Volume Set. Full details of this sensational Coyne "prove it" offer are given below. Mail the coupon at once.

Mail This Coupon NOW

Educational Book Publishing Division
COYNE ELECTRICAL & RADIO-TELEVISION SCHOOL
500 S. Paulina St., Dept. 40-T3, Chicago 12, Ill.

O.K. Send me postpaid, your new 7-volume set, "Applied Practical Radio-Television," on 7 days Free Trial per your offer. Be sure to include as a gift the book of 150 Radio-Television Diagrams absolutely FREE.

NAME _____ AGE _____

ADDRESS _____

TOWN _____ ZONE _____ STATE _____

Where employed _____



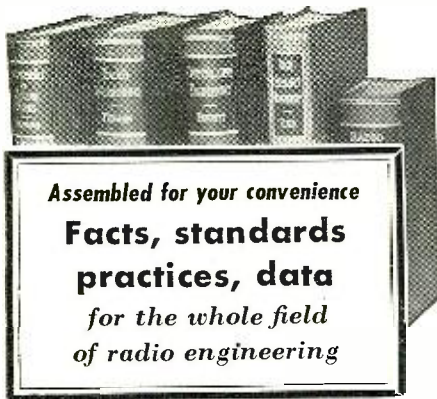

Assembled for your convenience
**Facts, standards
 practices, data**
 for the whole field
 of radio engineering

Radio Engineering Library

RADIO specialists of the McGraw-Hill publications selected the books for this library as those giving the most complete, dependable coverage of facts needed by engineers whose special fields are grounded on radio fundamentals. They cover circuit phenomena, tube theory, networks, measurements, and other subjects . . . give specialized treatment of all fields of practical design and application.

- ★ **Special Low Price**
- ★ Bought singly, the five volumes would cost \$30.50. Under this offer you save \$3.00.
- ★ Pay in easy installments

FREE 10 Day Trial!

McGraw-Hill Book Co., 330 W. 42nd St., N.Y.C. 18
 Send me Radio Engineering Library, 5 vols., for 10 days' examination on approval. In 10 days I will send \$2.50, plus few cents postage, and \$5.00 monthly till \$27.50 is paid, or return books postpaid.

Name.....
 Address.....
 City..... Zone..... State.....
 Company.....
 Position..... RN-4-50

Library includes:

1. Fundamentals of Vacuum Tubes—Eastman
 2. Radio Engineering—Terman
 3. Communication Engineering—Everitt
 4. High-Frequency Measurements—Hund
 5. Radio Engineering Handbook—Henney
- 3559 pages!
 2558 illustrations!

RADAR, COMMUNICATIONS AND SONAR TECHNICIANS W-A-N-T-E-D For Overseas Assignments

Technical Qualifications:

1. At least 3 years practical experience in installation and maintenance.
2. Navy veterans ETM 1/c or higher.
3. Army veterans TECH/SGT or higher.

Personal Qualifications:

1. Age, over 22—must pass physical examination.
2. Ability to assume responsibility.
3. Must stand thorough character investigation.
4. Willing to go overseas for 1 year.

Base pay, Bonus, Living Allowance, Vacation add-up to \$7,000.00 per year. Permanent connection with company possible.

Apply by Writing to
**D-4, P.O. Box 3575,
 Philadelphia 22, Pa.**

Men qualified in RADAR, COMMUNICATIONS or SONAR give complete history. Interview will be arranged for successful applicants.

Radioactivity "Sniffer"

(Continued from page 47)

tery supply. The plate of the tube connects to a regulated "B" supply through a 2.2 megohm plate loading resistor and feeds high impedance magnetic headphones through a .05 μ fd. coupling condenser. Electronically and technically the operation of 2000-3000 ohm headphones across a plate-loading resistor of 2.2 megohms is unsatisfactory. However, in practice, plenty of volume is secured with the inexpensive phones supplied with the instrument. Purely as a check an expensive pair of high impedance phones was used with the instrument and the volume was excessive, hurting my ears. Technically a set of crystal headphones would really match this amplifier's output impedance, but again excessive volume would necessitate a volume control—so it would be a needless expense.

The high voltage power supply is of the vibrator type, employing a special three volt vibrator. In order to insure starting of the vibrator, a special three-position power switch is used. Moving from the "Off" position to the "Start" position places the full three volts of the series flashlight batteries on the vibrator, while the "On" position places the high voltage transformer primary in series with the vibrator and at the same time connects the amplifier tube filament. To start the "Sniffer" operating, move the switch directly from "Off" to "On." When the batteries age it may be necessary to hesitate at "Start" for a few seconds, and then go to "On." Never leave this switch in "Start" position more than five seconds, to do so will use up the batteries rapidly and possibly damage the vibrator. Average battery life is estimated at 50 hours when the instrument is used for four hours per day.

The high voltage from the secondary of the power transformer is rectified by a Raytheon CK1013, a cold cathode rectifier. This voltage is held constant by five special regulator tubes in series across the supply. A tap off of the fifth regulator tube gives regulated "B" voltage for the amplifier tube. The high voltage (and plate supply) negative lead is above ground and connects to ground through a 3.9 megohm resistor shunted by a .25 μ fd. condenser. Thus all the grounded amplifier tube's plate current must flow through this resistor to the "B" negative supply. This is used to supply bias for the amplifier tube. The amplifier's grid return connects to the negative end of this resistor.

The G-M tube anode connects to the high voltage supply through a one megohm resistor. This resistor, at the anode, connects through a .02 μ fd. condenser to the high voltage negative lead, above ground, and supplies filtered d.c. to the Geiger tubes. The Geiger tube cathode returns through

Replacement or Experimental?

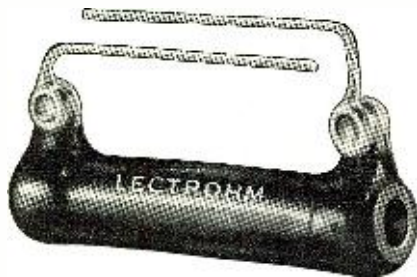

INSIST ON LECTROHM RESISTORS by name when you stock up next time. Then you'll never have to worry about your resistor performance again.

Quality is foremost with Lectrohm. You get permanent electrical bond because the resistance wire is silver soldered to the lugs. The

LECTROHM Wire-Wound RESISTORS Proved Ultimate in Dependability

entire unit is integrally embedded in high temperature vitreous enamel, assuring constantly safe heat dissipation. Wide selection in 5, 10, and 25 watt and other sizes . . . resistances up to 50,000 ohms. REMEMBER the name—LECTROHM—for the BEST in Resistors.

At Better Dealers
 Everywhere.



5907 Archer Avenue, Chicago 38, Illinois

Division of

National Lock Washer Co., Newark, N. J.

the 3.9 megohm grid resistor to the same condenser negative.

Several words on the field use of this instrument are indicated. Generally speaking, if the recorded count of an area, vein, or rock is three or four times the background count, the prospector may assume that he is in the vicinity or has an interesting radioactive prospect.

A comparison test with a known sample of uranium ore is the best bet for determining roughly the value of an ore sample. This is done by placing the counter on a flat place and recording the background count. Then a sample in which the uranium content is known is placed close to the G-M unit. Its count is recorded and it is moved far enough away so it does not affect the counter. The unknown sample, of approximately the same size as the known sample, is placed in the same position as the known sample and its count taken. The background count subtracted from these readings will give a basis for computing roughly the uranium content of the unknown sample. Samples of uranium bearing rock may be purchased at a number of mineralogical dealers.

The danger of mining or handling uranium bearing ores is negligible as long as they do not come in direct contact with the skin for long periods of time.

Contamination measurements are best made with equipment designed for this purpose.

-30-

A HANDY GADGET

By NEIL A. JOHNSON, W2OLU

I HAVE found this handy construction aid of value in my work and would like to pass the idea along to other readers.

I use a piece of flexible cardboard—the back of a QSL card will do fine—and with the various socket punches that I ordinarily use, I make holes through the cardboard. After the punching is done, I label the holes with the proper sizes.

Now when there is any doubt in the constructor's mind as to what diameter hole to use for mounting that choke, tube socket, or condenser, it is very simple to slip the part to be mounted through the holes in the cardboard gauge (if we can call this thing a gauge) and thus ascertain the best size for the particular component under consideration. This idea surely makes it a lot easier for the occasional constructor or experimenter to turn out a nice looking job.

-30-

A handy guide for determining proper hole sizes to be drilled for mounting components.

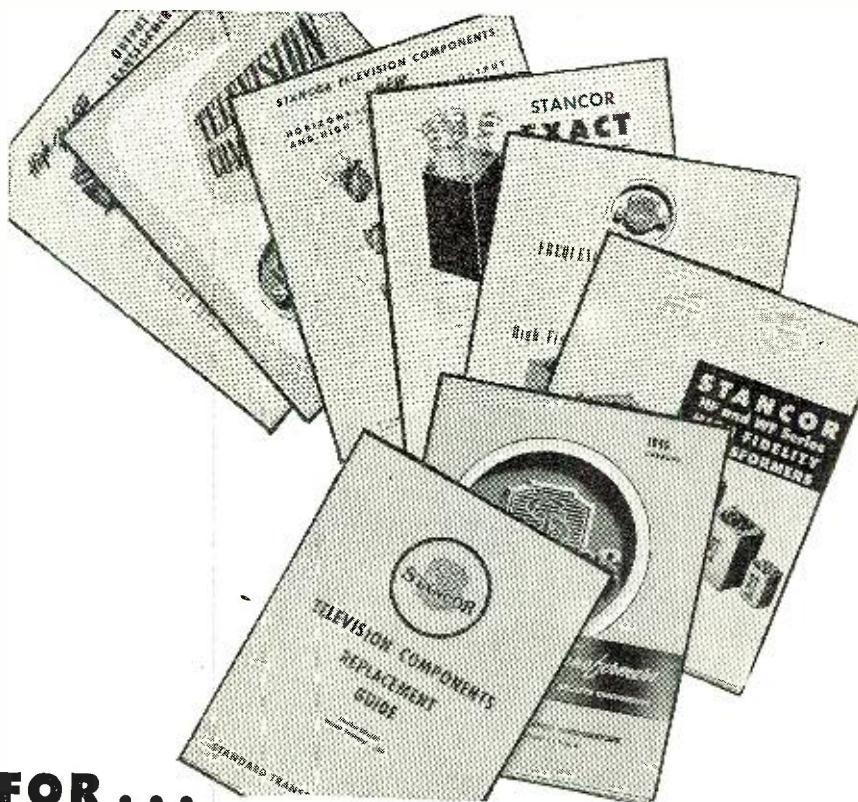
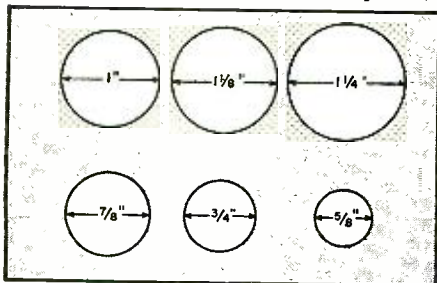

FOR . . .

- RADIO SERVICING
- TELEVISION SERVICING
- AMATEUR RADIO
- HIGH FIDELITY SOUND

Stancor transformers are original components in thousands of radio and television receivers made by the biggest names in the industry—they have to be good to be specified by critical design engineers and value-conscious purchasing men!

Why shop around? Specify Stancor for your replacement work. You will get a dependable, honestly-rated transformer. You'll cut down on expensive call-backs. You will keep your customers.

FREE For complete, accurate specs and prices of the complete Stancor stock line, write for your copies of the literature illustrated above. Just ask us for the Stancor transformer library. Standard Transformer Corporation, 3584 Elston Avenue, Chicago 18, Illinois.

Hi Stancor

FOR TRANSFORMERS

MOST COMPLETE LINE IN THE INDUSTRY



The May issue of RADIO & TELEVISION NEWS will be on sale April 28. Be sure to reserve your copy with your Newsdealer.

CODE SENDING RECEIVING SPEED

Free Book

HIGH SPEED WITHOUT NERVOUS TENSION

REVEALING BOOK shows how "crack" operators develop high speed and proficiency. Learn code for Amateur or Commercial Radiotelegraph License, or improve your sending and receiving with the Candler System which develops radiotelegraph experts and code champions.

CANDLER SYSTEM Box 928, Dept. 2-D Denver, Colorado

PROGRESSIVE NOW! **BUILD 15 RADIOS \$14.75** COMPLETE KIT ONLY.

PROGRESSIVE RADIO "EDU-KIT" teaches amplifier, receiver and transmitter design and construction principles. Excellent background for television. No knowledge of radio necessary. Used by radio schools and the Veterans Administration. Quizzes provided, and corrected at no extra charge. Free Electrical and Radio Tester and tools. Order today or send for free "Kit-Katalog." Postage prepaid on cash orders. C.O.D. orders accepted in U.S.A. Dealerships available.

PROGRESSIVE ELECTRONICS CO.
497 Union Ave. Dept. RN-4 Brooklyn 11, N. Y.

24 HOUR CLOCK

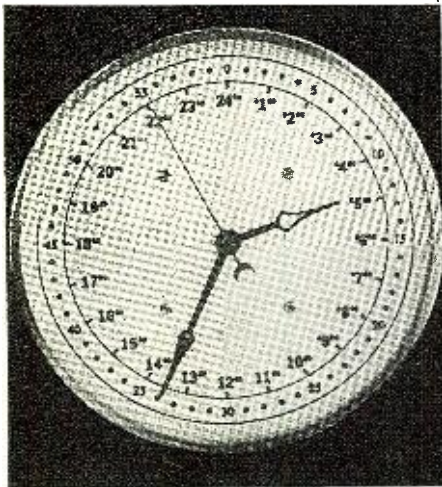

**Reads Directly to
2400 Hours**

ENGINEERED BY } **THE**
ENGINEERED FOR } **HAM**
SOLD EXCLUSIVELY TO }

SPECIFICATIONS

- 9" Dial
- Convex Crystal
- Sweep Second Hand
- Steel Case (Black Finish)
- Chromium-Plated Bezel
- Self Starting
- 110 Volt - 60 Cycle A.C.
- Wall, Table or Panel Mounting

OPTIONAL
Additional Red Hour Hand for GMT
Table Mount or Panel Drilling

\$12 including Fed. Tax
only and Shipping

WRITE NOW

To AMERICAN TIME CORP.
15 Park Street, Springfield, Mass.

Please send:

- 2400 Hour Clock (\$12.00)
 - Stand For Table Mount (50c)
 - Am Forwarding Panel To Drill Out (50c)
 - Include GMT Hour Hand (50c)
- Total \$.....
- Check Money Order

Name..... Call Letters.....

Address

Modern TV Receivers

(Continued from page 59)

current through the tube ceases. The reader may, if he wishes, compare these differences between tubes to the difference between the flow of traffic along narrow and along wide roads. Along the narrow road failure of one car to move ahead can slow down traffic considerably; along the wide road, more room is available and the breakdown of one car has less effect.

The electron beam leaving the second slot of the accelerator approaches grid No. 2 also in the form of a thin sheet. Thus, this section of the tube may also serve as a gated-beam system. If this second grid is made strongly negative, the plate current of the tube is cut off no matter how positive grid No. 1 may be. Over a narrow range of potentials in the vicinity of zero, the second grid can control the maximum amount of current flowing through the tube. However if the second control grid is made strongly positive, it also loses control over the plate current which can never rise beyond a predetermined maximum level.

So much for the operating characteristics of the tube. Now let us see how it can be made to function as a limiter-discriminator. A typical circuit is shown in Fig. 9.

It has been noted that when FM signals reach the discriminator they contain amplitude variations. When the 6BN6 gated-beam tube is used, these signals are applied to control grid No. 1. If the signal has received sufficient prior amplification, it will have a peak-to-peak value of several volts. Upon application to grid No. 1, current through the tube will start to flow only during the positive part of the cycle, and remains essentially constant no matter how positive the signal may become or what amplitude variations it may contain. Thus, signal limiting is achieved in this section of the tube, the electron beam being passed during the positive half-periods of the applied signal and cut off during negative half-periods. The groups of electrons that are passed then travel through the second accelerator slot and form a periodically varying space charge in front of grid No. 2. By electrostatic induction, currents are made to flow in the grid wires. A resonant circuit is connected between this grid and ground and a corresponding voltage of approximately 5 volts is developed at grid No. 2. The phase of this voltage is such that it will lag the input voltage on grid No. 1 by 90 degrees, assuming that the resonant circuit is tuned to the intermediate frequency. Due to this 90° difference between grid voltages, grid No. 2 is often referred to as the quadrature grid.

In the gated-beam tube, both control grids (No. 1 and No. 2) represent electron gates. When both are open, current passes through the tube. When either one is closed, there is no current

CHANNEL CHIEF

High Gain Square Corner Radar Type T.V. Antenna. Broad Band response covers all High Band Channels but peak may be chosen to boost your weakest picture. "Mirror Focus" Beam Action

increases Gain and decreases Ghosts and Noise. All Aluminum Construction for Durability and Quick Assembly.

300 Ohm Impedance.
State Weakest Channel

ONLY
10.95 NET

(Mast Not Included)

Order Direct and Save.

No Dealers. No Distributors.

25% Deposit with C.O.D. Orders.

CHANNEL CHIEF CO.

37 Mali Drive N. Plainfield, N. J.

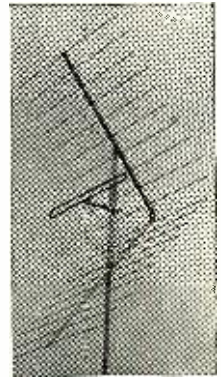

PREAMP FACTORY CLEARANCE

Ever-so-slightly scratched, priced for fast sale. Famous Roger equalizing preamplifier for variable reluctance pickups, all speeds. Circuit in Feb. 1948 Audio Engng., p. 15, adapted for 110 V. operation. Beautiful black-crackle steel can with gray aluminum cover. Amply rated power transformer, selected 6SC7, hum and noise way, way down! Thousands sold at \$13.95. 10-day money-back trial. We pay postage when money accompanies order.

RA-20HF with built-in power supply \$6.95 net.

ROGER TELEVISION INC.

86 Walker St., New York 13, N. Y.



**EVERY
RADIOMAN**

Can Use These
SERVICE HINTS!

Valuable Manual Yours—FREE!

Every page of "How to Simplify Radio Repairs" is packed with on-the-bench, practical ideas. Contains photos, charts, diagrams—no fluff—no vague theory. In plain every-day language it gives you priceless suggestions—new servicing ideas. You'll use and benefit from the experience of experts. Partial list of contents: How to Localize Trouble; How to Service Amplifiers; How to Test for Distortion; How to Test Audio Circuits; How to Test Speakers; How to Find Faults in Oscillators; How to Test Radio Parts—and it's all yours—FREE! No obligation.



SEND COUPON OR PENNY
POSTCARD FOR YOUR
FREE COPY TODAY!

FEILER ENGINEERING CO., Dept. 4H5
1601 S. Federal St., Chicago 16, Illinois

Please RUSH my FREE copy of "How to Simplify Radio Repairs."

Name

Address

City..... Zone... State.....

RADIO & TELEVISION NEWS

Lowest prices!

SYNCHRON TIMING MOTOR

Model 600, 1 RPM, 115 Volts, 60 cycles. Brand New. Special Price \$2.45 each



Use to rotate beam antenna, actuate boat rudder control, etc. Contains 24 V. motor, clutch, relays, etc. Reversible. Size overall approx. 10 1/2" x 8 1/2" x 6 1/2". Ideal for light hoisting. Make your own garage door opener.



PRICE \$8.95

C-1 AUTOPILOT VERTICAL GYROS

May be used to conduct many interesting and amusing experiments. Operates from 24 V. DC or may be operated for short periods on 110 V. AC Gyro will run for approx. 15 minutes after actuating. Size—approx. 8" x 8 1/2" x 8 1/2". Govt. Cost \$1500.00. Special.....\$4.95



C-1 AUTOPILOT AMPLIFIERS

Three channel servo amplifier consisting of many valuable electronic parts including 6 relays, 7 tubes, etc. Unit removed from new aircraft.

Super Special \$4.95



DYNAMOTOR

Winco Type 41S6 input 13 Volts DC 13 amps. Total output 250 volts at .06A and 300 volts 0.225A. Ideal for boat or mobile use. NEW at \$3.95 each.

SELSYN SPECIAL heavy duty bronze case 115 V. 60 cy. NEW at \$13.50 a pair.

400 CYCLE INVERTER

G.E. 5DZ1N3A. Input 27 V., 35 amps. Output 115 V.—485 V.A. single phase.....\$8.50

BEAM INDICATOR

I-82F 8-12 V. 60 cy. 0-360°—5 in. dial. New Price \$2.95 each

NEON BLOWN FUSE INDICATORS

110-220 volts either AC or DC. Price....39c

PIONEER AMPLIFIERS

Shock-mounted case and chassis includes many transformers, condensers, potentiometers, etc. Supplied less output transformer and tubes.

Our Low Price 98c

EDISON TIME DELAY RELAY

Vacuum sealed in glass, s.p.s.t. contacts normally closed. 30 v. 7 second delay to open. Many experimental applications.

Special Price 59c each

TERMS: 20% cash with order—balance C.O.D. Orders accompanied by payment in full must include sufficient postage, otherwise shipment will be made via Railway Express collect. Minimum order \$2.00.

Electro Devices
INCORPORATED
BOX NO.1941 PATERSON, N.J.

An INTERCOM From The BC-605

By

DANIEL SCHULMAN



A simple conversion produces a very serviceable intercom.

Commercial panel and speaker grilles give converted unit a professional appearance.

OPERATORS of factories, warehouses, parking lots, garages, etc. can set up an inexpensive intercommunicating system for such locations by using the popular BC-605 intercom as the basic unit and then making a few simple circuit changes.

The BC-605 intercommunication set was originally part of the SCR 538 radio set which included the BC-604 transmitter and BC-603 receiver and was widely used in tanks, half-tracks, etc., during the war.

Because the original unit contains high quality components and is housed in a strong and sturdy steel case, it is particularly suitable for conversion for use in commercial establishments. Both the input and out-

put transformers are wound on high grade silicon steel laminations and are moistureproofed, which will help to assure long life and trouble free operation under the fairly rugged conditions encountered in garages, factories, etc.

The conversion process, as outlined herein, was accomplished in just one hour and thirty-five minutes. There is nothing particularly complicated about the procedure and the reader should experience no difficulty in making the transformation.

The first step is to remove all of the wiring in the set. A highly skilled technician probably can utilize some of the wiring that is in the unit but, in the long run, a simpler and neater job will result from using an unwired

A view of the wiring after the conversion has been carried out.

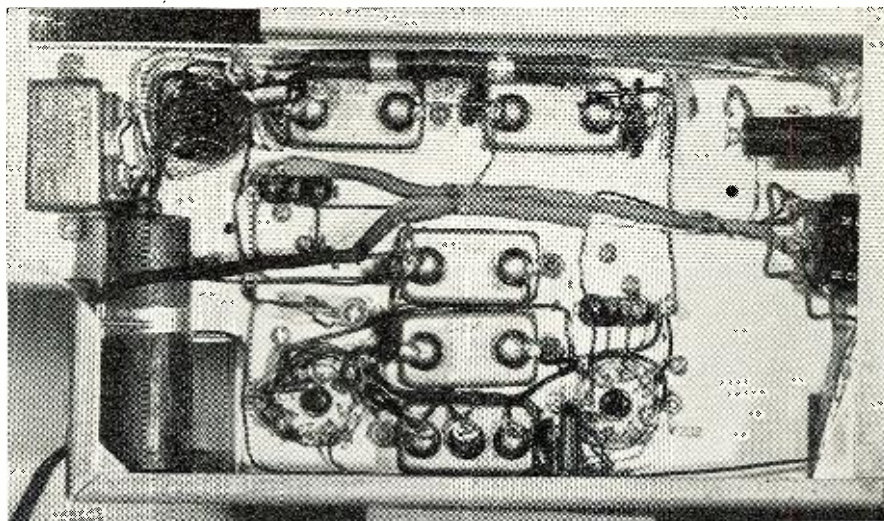

FACTORY-TO-YOU MIDWEST RADIO and TELEVISION



EASY TERMS
NEW GIANT 16" PICTURE TUBE
30 DAYS TRIAL
MIDWEST Model CX-26
A Complete 16-Inch TELEVISION Chassis

Here is Television at its best! . . . brought to you by Midwest, the world's oldest and largest Exclusive Factory-To-You radio and television manufacturer. For 1950 Midwest offers a complete line of Television Consoles and complete, ready-to-operate chassis (not kits) featuring the new giant 16-inch tube, clear, steady pictures, synchronized sound and pictures that a child can tune perfectly. Buy your Television direct from Midwest at Low Factory Prices, on Long EASY TERMS and 30 DAYS TRIAL. Send coupon for FREE 32 - page, 4 - color catalog TODAY.

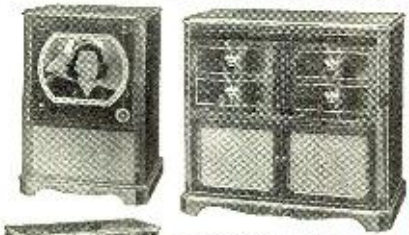

Also a Complete New 1950 Line of
MIDWEST RADIOS
with new long distance
FM Circuit and new
3-Speed Phonograph.

Read What Midwest Owners Say:

"I Am Amazed at the Clearness of the Picture"

Bayonne, N. J.—I am more than satisfied with my new Midwest "Constellation" Television Receiver. I really am amazed at the clearness of the picture, the fine reception, and the general attractiveness of the set. Midwest Television is everything you said it was, plus a whole lot more.
Charles Maraza, 661 Avenue "E"

"Midwest Television is So Easy to Operate"
Port Clinton, Ohio—I received my Midwest Television set about a month ago and I want to tell you how pleased I am with its performance. I can get clear pictures from Toledo, Cleveland, and Detroit without moving the antenna. Midwest Television is so easy to operate, too, I am certainly very proud to own such a wonderful television set.
Harry W. Winure, 217 Fulton St.

"My Midwest Television and Radio Are the Best I've Seen"

Wilkesburg, Pa.—Recently I bought a Midwest Television Receiver Chassis to supplement my Midwest Series 16 AM-FM Radio and I am well pleased with both. In my estimation, my Midwest Television and Radio are the best I've seen. Please let me know if I can secure one of your large console cabinets to hold my complete outfit.
David M. King, 751 Ross Avenue

Write for FREE 32-Page, 4-Color Catalog
or Paste This Coupon on 1c Post Card

Midwest Radio & Television Corp.
Dept. X379, 909 Broadway, Cincinnati 2, Ohio
Please send me your new FREE 1950 Midwest Catalog

Name _____
Address _____
City _____ Zone _____ State _____

chassis at the beginning. Next, the bank of five resistors, which is to be found on the tube side of the chassis, is removed. The 80 ohm, 10 watt resistor, R_8 , is then removed and mounted in place of the 1.25 ohm, 10 watt resistor which is located between C204 and C205 in the original set. C210, the 2 μ fd., 600 volt condenser is now removed. The mounting hole left by this condenser makes room for the installation of the 35Z5 tube (V_3) socket. A socket punch or a reamer will be needed at this stage of the conversion to enlarge this mounting hole to one and one-eighth inches to accommodate the socket.

Next, remove plugs 201 and 202 and then the 12 volt relay. Remove J201, the fuse mount 202, and the magnetic microphone jack from the front panel of the BC-605. Insert the d.p.d.t. intermittent switch, S_1 , in the hole left on the panel when the fuse mount was removed.

In the commercial adaptation of this unit, a special etched panel and speaker grille were used in order to give the finished product a "professional" look. However, a thin sheet of aluminum may be used by the home builder as it is easier to work. It can, of course, then be lettered any way the user may desire.

The next step is to mount a PM speaker in the door compartment. A back plate, made of Masonite, is mounted in the rectangular opening which was vacated by the removal of plug 201. The speaker is mounted on this plate and then holes are drilled in front of the speaker cone to permit the sound to emerge through the plate.

The set should then be wired as indicated on the schematic diagram and as shown in the photographs. The intermittent switch, S_1 , is connected so that the normal position of the unit will be the "Listen" position. In this way sounds originating at the remote position will be carried to the master unit without the switch being operated. When the switch is in the depressed position it then becomes possible with the master station to communicate with the remote position or positions. With this arrangement there can be no "eavesdropping" on the master station by the remote position when the switch is in the "normal" position. The spring return on the switch automatically closes off the master station when the lever on the switch is released.

Although the 50,000 ohm potentiometer, R_1 , across the secondary of transformer T_1 , is not the conventional way of providing a volume control, it works satisfactorily and eliminates the necessity for buying a new rheostat as the pot is part of the original BC-605. This unit is rugged and so far has not produced excessive noise, at least not in the hundreds of units converted by the author.

It will be noted that the screen bypass condenser for the 12SJ7 tube, V_1 , consists of two .1 μ fd. condensers in

FREE Write for Our Monthly Bulletin

SURPLUS EQUIPMENT
TROUBLE SHOOTING MANUALS
(includes schematics)
BC-348-J N Q SCR-522 \$1.00 ea.
BC-779 BC-610

Build Your Own Geiger Counter
(See Radio & Television News—July, 1949)

1B98 Gamma Counter Tubes . . . Only \$9.87

SELSYN INDICATOR KIT
FOR 110V, 60 CYCLE OPERATION
Includes I-82A 5" indicator, Selsyn transmitter, transformer and instructions.
All items brand new—\$6.15

I-82A indicator only—NEW . . . \$3.95

SPECIAL!!
FL-8A FILTERS . . . \$1.37

ASB YAGI ANTENNA
ADJUSTABLE STUB TUNING
5 ELEMENT ROTATABLE ARRAY—450 TO 560 MC \$7.00
SAME EXCEPT DOUBLE STACKED 6 ELEMENT 450 TO 560 MC \$12.70
Same Except Double Stacked 6 Element 370 to 430 MC \$29.40

Suitable for citizens, VHF TV and amateur 420MC bands.

TS-10 SOUND POWER HANDSETS
BRAND NEW . . . \$17.60 a pair

COAXIAL CABLE
RG-8/U—6c ft. \$25.00/500 ft.
RG-59/U—4 1/2 ft. 20.00/500 ft.
RG-62/U—6c ft. 20.00/500 ft.

OTHER TYPES IN STOCK
RCA 913—1" CATHODE RAY TUBE—ORIGINAL CARTONS . . . \$4.90

RAYTHEON SUB-MINIATURE TUBES
OUTPUT PENODES
CK-503AX } ANY TYPE Lots of 10 — \$1.47 ea.
CK-506AX } ANY TYPE Lots of 100 — \$1.00 ea.
CK-507AX }

RT-7/APN-1 Radio Altimeter, complete with 14 tubes—Excellent used cond. . . . \$7.95
10 Henry 400MA Filter Choke, 900 DC res.—Hermetically sealed; high voltage insulation . . . 3.77
G.E. 2J1G1 Selsyns, removed from capt.88
Same as above—Brand Newea. 1.16
Caps for connection to 2J1G1 Selsynsea. .39
RCA Sound Power Unit. Use as Mike or Receiverpr. 2.22
AN/AP-13. Exc. Cond. \$4.95
FILTER CHOKE—13H 250MA 120 ohm—Full Shield Upright \$3.22

TUBE SPECIALS
GUARANTEED BRAND NEW
STANDARD BRANDS ONLY
SELECTED FROM OUR COMPLETE LISTING

1A3 \$0.45	6Y6G \$0.88	5HP4 \$3.35
1B3GT 1.18	7C419	1P2429
2A389	7E529	205149
2X249	10Y19	2C2222
5V4G84	12A624	2C2627
5Y3GT38	12AT659	FK-3428
5Y4G46	12A7T99	24G44
5Z366	12AU672	21162
6AC779	12AU786	304TL 1.25
6AG589	12AX786	316A66
6AK589	12B A678	4A6A75
6AK682	12BA786	80715
6AL569	12BE664	8107.25
6AQ572	12SA7GT59	8111.91
6AT654	12SK759	8136.95
6AU667	12SL7GT69	8151.72
6B665	12SN7GT78	829G 4.91
6BE665	12SQ7GT59	832 3.95
6BG6G 1.72	19T8 1.04	832A 4.91
6BH672	25Z555	837 1.38
6BJ672	25Z6GT49	838 2.93
6C449	35W445	161361
6J521	35L6GT49	866A95
6J689	35Z5GT44	161919
6K6GT52	60B569	122469
6L6GA67	50L6GT57	162519
6SL7GT89	2AP1 3.65	162629
6SN7GT64	3AP1 4.63	162929
6T8 1.04	6B7 2.59	900142
6V6GT59	5BP1 2.40	900239
6W4GT65	6CP1 2.87	900339
6X459	6CP7 3.76	900439
6X5GT59	5FP757	900629

COAXIAL CONNECTORS

83-1AC \$0.42	UG-12/U \$0.63
83-1AP09	UG-21/U67
83-1F 1.12	UG-22/U86
83-1H10	UG-23/U63
83-1J80	UG-24/U67
83-1K28	UG-27/U68
83-1RTY45	UG-29/U83
83-1SP28	UG-30/U67
83-1SPN28	UG-58/U57
83-1T 1.12	UG-85/U62
83-22AP85	UG-86/U 1.22
83-22F28	UG-87/U68
83-22R48	UG-175/U15
83-22SP60	UG-176/U15

Full Line of Coaxial Connectors in Stock.
Prices Sent on Request.
Include Postage with Orders
ELECTRONIC RESEARCH LABS.
1021-R Callowhill St. Phila. 23, Pa.

TRANSVISION

Eliminate the Variables
in Television Installation
with the Transvision
FIELD STRENGTH METER

Improves Installations!
Saves 1/2 the Work!



NEW LOW PRICE
Model FSM-1, complete with tubes Net \$79.50

**Service-Dealers:
WORRIED ABOUT
COMPETITION?**

Become the
**TV SALES
and SERVICE
CENTER**

IN YOUR COMMUNITY

- Beat competition at a profit.
- Stop being undersold!

FILL OUT AND MAIL THIS
COUPON NOW!

TRANSVISION, INC.
NEW ROCHELLE, N. Y.

Please ship THROUGH YOUR NEAREST
LOCAL OUTLET: RN 4-50

I am enclosing 10% DEPOSIT in the
amount of \$..... balance C.O.D.
() Send details of TV CENTER PLAN.

Name
(please print)

Address

City & State

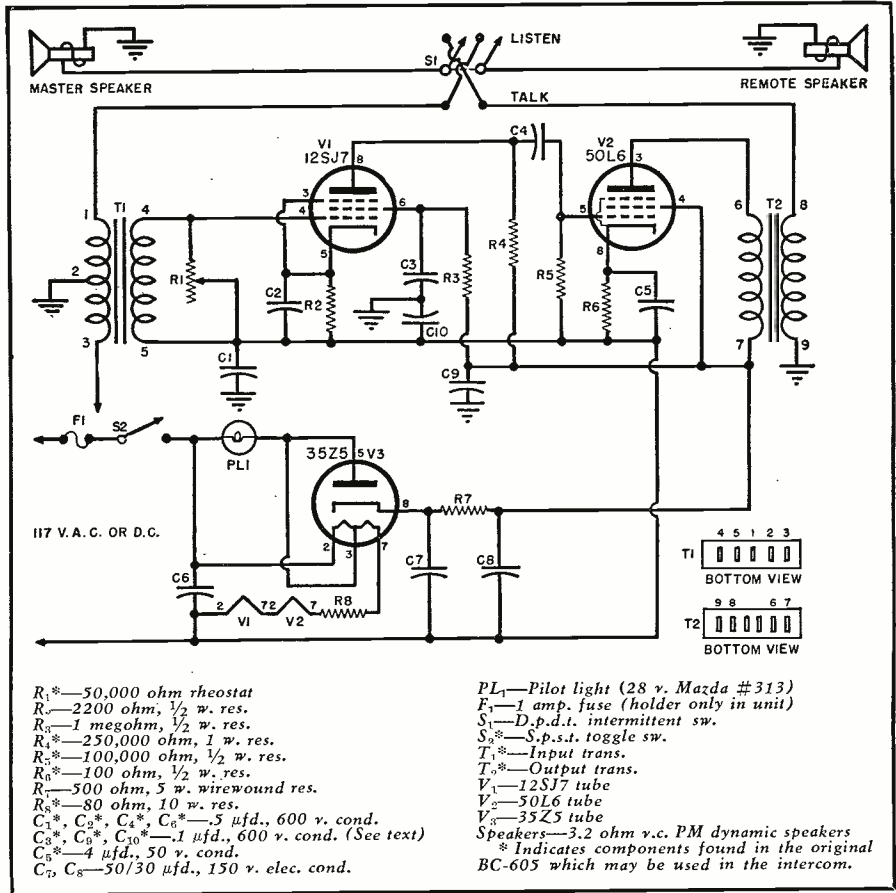

series, with the center point grounded. This was done in order to make use of the triple .1 μfd. bathtub condenser (C203) which was already in the unit. If desired, a single .1 μfd., 400 volt paper condenser, connected from the screen to "B—" may be used in place of the bathtub unit and C₅ omitted. As many as three speakers can be handled by this amplifier. When more than one remote speaker is used, how-

ever, all remotes should be connected in parallel. The unit will operate on either a.c. or d.c. Excessive hum on a.c. may be eliminated by reversing the plug. Non-functioning on d.c. should be cured by reversing the power line connection. With a little work and only a few new or junk box components the BC-605 can be readily converted into a neat and useful intercom.

Side view of the converted unit with the cover removed.

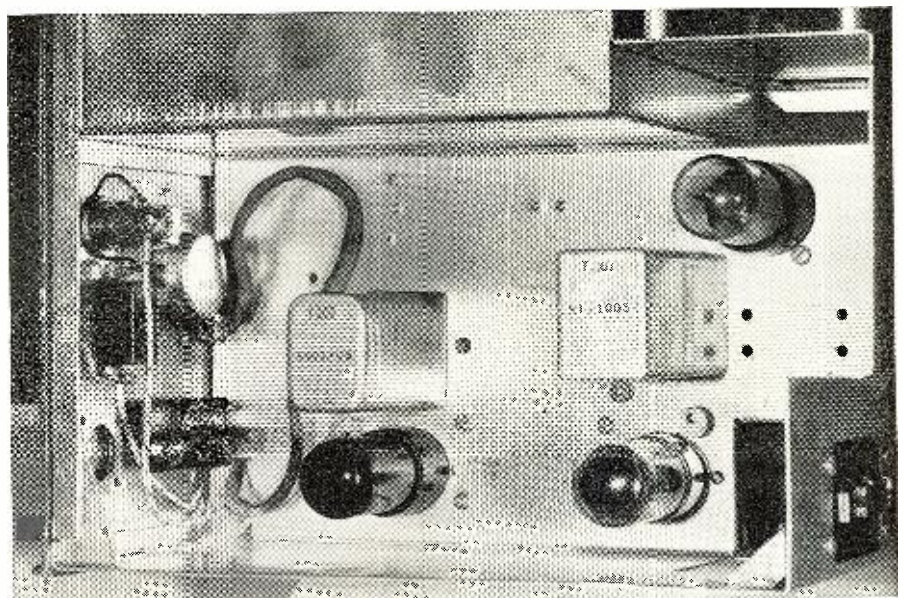

International Short-Wave

(Continued from page 109)

Kawachi, 0255-0900; JBD3, 15.225, 7 1/2 kw., Kawachi, 1750-0230; JBD4, 15.235, 5 kw., Kawachi, 1750-0230.

Stations in the "A" and "B" groups relay m.w. programs to local stations; JKI and JKH should have "English Conversation Lessons" at 0400, and at 1630 should have a "Basic English Lesson."

It was explained that the short-wave transmissions are carried on for two specific purposes—inter-communication between the key stations of N.H.K. and for the benefit of Japanese nationals awaiting repatriation.

Kashmir—Radio Kashmir, Srinagar, sent letter verification by registered airmail from Officer on Special Duty, AIR, Radio Kashmir, Srinagar, Kashmir; gave no schedule but seemed surprised the station on 4.860 with power of only 1 kw. had been heard in England, and asked for further reports. This one has been heard in England 1030 relaying news from AIR. (Pearce)

Korea—Alcock, Ky., says he has positively identified the station heard 0400-0630 sign-off on 7.933 as Korea; usually is good 0600-0630; has English identification on the quarter-hour. Also heard by Oskay, N. J.

Lebanon—Beirut, 8.030V, heard 1530 in Australia with French news, then music; good signal. (Sanderson)

Luxembourg—Radio Luxembourg, 15.35, noted 0645 with news in French, then music; bad QRM. (Sanderson, Australia)

Malta—From Israel, Bluman confirms that the Forces Broadcasting Service, Middle East, is now using two s.w. transmitters in parallel; listed schedule as 4.965 at 2330-0200 (Saturdays 2330 to 0215 Sundays), and 0845-1700; 11.895 (replacing 6.140) at 2330-0200, 0430-1700 (Saturdays 2330-1700 Sundays); 7.270 at 0430-0830 (Sundays 0230-0830); occasionally uses 11.785 around 0430-0845. At times, 6.140 may be used afternoons to 1700 closedown in parallel with 4.965. The transmitters were still radiating experimentally and more changes may have been made by this time. Bluman has heard Malta, 7.270, at 0300 point-to-point to Cyprus, FBS Benghazi, and FBS Tripoli, in turn.

According to a letter from the station, QRA is Forces Broadcasting Service, M.E.L.F., Chief Broadcasting Officer, Middle East Land Forces, Malta. (Cox, Delaware)

Mauritius—NNRC reports V3USE, 15.050, Forest Side, signs on 2159 with a march; then relays BBC news in English, followed by popular recordings; around 2225 has an English lesson; French news 2230; signs off 2315 with "God Save the King"; slogan is "Tci le poste de l'Ile Maurice"; signal usually very poor. Has been reported direct to me by Ferguson, N. C., DeMyer, Mich., and others; this one is

Record-Breaking Values COMPARE THESE PRICES

AN/APN4 INDICATOR SCOPES

ID6B, APN-4 complete with 25 tubes and 100 KC calibrated crystal to time sweeps and marker pips at 2, 20 and 100 KC. 5CP1 tube—easily converted to test scope. Greatest value ever—**ALL BRAND NEW.** **\$29.95 Ea.**
Our price
Approx. Weight 45 Lbs.

BC 605—INTERPHONE AMPS.

Ideal for Home Intercom., Office to Office, Airplane Intercommunications, etc. Complete with Tubes, Diagram and Case. Uses DM34 Dynamotor. All New. (Appr. wt. 25 lbs.) Our Price less Dynamotor. Each **\$3.95**

BENDIX SELSYN MOTORS

110 V. 60 Cy. AC. Similar to type 5. (Appr. wt. 12 lbs.) Pair **\$5.95**
Brass Heavy Duty. (Appr. wt. 22 lbs.) Pair **9.95**

COMMAND RECEIVERS

190 KC to 550 KC (Appr. wt. 12 lbs.) **\$8.95 Ea.**
3 MC to 6 MC (Appr. wt. 12 lbs.) **6.95 Ea.**
All used but complete and in good condition.

6 INCH WATERPROOF SPEAKERS

Plastic Cone V.C. IMP. 6-8 ohms. Ideal for all outdoor purposes. Limited Supply. Used but in excellent condition. Approx. wt. 15 lbs. Our price ea. **\$4.95**

RECTIFIER POWER UNITS

PP87/APT 4—115 V. 400 Cy. Input. Output 3000 V. 350 Mills and Low voltage receiver supply. Complete with four 836 Tubes and one 115 V. 50 Sec. Time delay. All new—Complete. (Appr. wt. 48 lbs.) **\$5.95 Ea.**

LP 21 A LOOP ANTENNAS

Used with BC 433 or R5/ARN 7. Radio Compass Receivers. Excellent condition. (Appr. wt. 15 lbs. ea.) **\$8.95**
LP 19 Loop Antennas **\$5.95**

SPECIAL DYNAMOTORS

18 V. Input. 450 V. Output. SS-2869. New. Low Priced at (Appr. wt. 9 lbs.) Each **\$1.50**

WILLARD 2 VOLT BATTERY

NEW. Uncharged (Appr. wt. 4 lbs.) Each **\$1.05**
Complete set of three with Box and Connections to make a 6 Volt, 20 Amp. Hrs. Battery Uncharged (Appr. wt. 15 lbs.) Set **\$3.95**

METERS

Weston—2"; 0 to 30 VDC and 0 to 120 Amps. DC. **\$3.95 Ea.**
Weston—2"; 0 to 30 VDC and 0 to 240 Amps. DC. **3.95 Ea.**
(Both meters listed above are complete with a 50 M.V. Shunt)
Weston or G.E.—2"; Antenna Current Meter, with thermo-couple **\$2.50 Ea.**
3" 0-100 Micro Amp. **6.95 Ea.**

ROTARY SWITCHES

Four Pos. Heavy Amp. Contacts on Ceramic Base, with knob. All New. **75c Ea.**

U. S. NAVY FLASHLIGHTS

Deita type P.O. Prefocus Gray Plastic Case, and all New, with Batteries. **50c Ea.**

6 VOLT VIBRATORS

4 Pin, Non-Synchronous. **\$1.00 Ea.**
New (12 or 24 Volt Vibrators—3 for \$1.00)

VACUUM CONDENSERS

New—50 MMFD. 5 KV. **\$1.00 Ea.**

Mail Orders Promptly Filled. All California Orders—Add 3% Sales Tax. Outside of California—No Sales Tax. Write for our free booklet listing our stock and prices on Radios, Tools, Hardware, Motors, Wire, Meters, Batteries, Aluminum Sheets, etc. 20% Deposit on all C.O.D. orders. All items subject to prior sale.

MINE DETECTOR, AN/PRS-1

Easy to operate, easy to carry. Can be used for detecting ore deposits, both metallic and non-metallic. Now being used extensively by Miners, Prospectors, Beachcombers, and Explorers. These sets are brand new and come complete with Detector head with antenna; Reflector meter and housing and exploring rod; a bag for carrying equipment while operating and a wooden case for storing or transporting unit when not in use. These units contain Tubes and instruction books. Shipping weight is 125 lbs. Weight when operating unit is 22 lbs. All New—Complete with Batteries and ready to operate. Set **\$29.95**

MIDGET SELSYNS

AT type operates from 6-12 Volts 60 Cycle. Use as both transmitter and receiver. These compact little units draw almost no current and work fine for all remote position indicating applications. OD 2 1/4 x 2 1/4 x 2 1/4". All New (Appr. wt. 1 lb.) Each **98c**

PORTABLE BEACH MASTER

Ideal for Ball Parks or Any Open Public Address System. 250 Watt Audio Output Amplifier and 9 Horn Speaker Bank with Tripod. Both Units **\$300.00**
Operates from 110 V., 60 Cy., A.C.

Single Units of above, 250 Watt Amp. **\$250.00**
9 Horn Speaker Bank **75.00**
110 V., 60 Cy., 1500 Watt Gas Driven Generator for above **200.00**
Quantity Price on request

ELECTRIC MEGAPHONES

Complete with Amplifier, Horn and Carrying Case. Dry Cell Battery operated. Ideal for Coaches, Sports Events, Cheer Leaders, Fire and Police Dept., etc. Lightweight and portable. Approx. 10 watts output. All new. (Approx. wt. in use **\$42.50** Set 38 lbs.) Our Price

R-14 HEADPHONES

Complete with rubber ear cups and cord with a P1-55 Plug. High. Imp. (Appr. wt. 1 lb.) Pair **\$1.25**

FRICTION TAPE

3/4" width, approx. 83 ft. VACUUM PACKED for \$1.00 protection indefinitely. 6 Rolls to a can. **\$1.00**
TL-192 Insulating Rubber Tape 2 for 15c

HEINEMANN CIRCUIT BREAKER

15 Amp.—120 Volts AC **\$.97 Ea.**
7 Amp.—24 Volts DC **\$.50 Ea.**
ALL NEW (Appr. 1 lb. ea.)

MG-149F INVERTER

Input 24 V. DC 36 Amps. Output 115 V. 400 Cy. AC. 500 V.A. Output at 90%. Excellent condition. **\$7.95**

SPECIAL ON TUBES	CAPACITORS
417A \$7.50 Ea.	Pyranol—C.D. Solair—New
832A 3.50 Ea.	1 Mfd. 500 V. DC. 2 Ea.
832B 3.95 Ea.	1 Mfd. 2000 V. DC. 1.00 Ea.
832C 4.00 Ea.	2 Mfd. 4000 V. DC. 2.95 Ea.
832D 4.00 Ea.	4 Mfd. 600 V. DC. 49 Ea.
5BP4 1.75 Ea.	10 Mfd. 600 V. DC. 79 Ea.
VR 150-30. 50 Ea.	10 Mfd. 1000 V. DC. 1.49 Ea.

C-1 SERVO UNIT

Part of C-1 Gyro. Contains 24 V. DC. Servo Motor Clutch 4 Relays which control rotation of motor and a set of differential gears which control speed of output shaft in either direction. Can be used by itself to rotate beam antenna or as a boat rudder control. Excellent condition. **\$4.95 Ea.**

ADDITIONAL SPECIALS

Rheostats; 5000 Ohm; 150 Watt. **\$.75 Ea.**
Crystal Holders for SCR 522. **50c Ea.**
PE, 103 Cables. **2.95 Ea.**
Throat Mikes, with Extensions. **1.00 Set**

STANDARD SURPLUS 1230 Market St., San Francisco 3, Cal. Telephone HEmlock 1-3106

When answering Advertisements please mention **RADIO & TELEVISION NEWS**

RCA DETENT EXCHANGE

We will exchange your defective RCA TV Tuner Switch Detent Assembly for a factory rebuilt one. ***59c** Prepaid. No C.O.D.

Unconditionally Guaranteed for 3 months

TECHNICAL RADIO PARTS CO.
557 McDonald Ave., Brooklyn 18, N. Y.

**You must mail us your defective detent.*

EASY TO LEARN CODE

It is easy to learn or increase speed with an Instructograph Code Teacher. Affords the quickest and most practical method yet developed. For beginners or advanced students. Available tapes from beginner's alphabet to typical messages on all subjects. Speed range 5 to 40 WPM. Always ready—no QRM.

ENDORSED BY THOUSANDS!

The Instructograph Code Teacher literally takes the place of an operator-instructor and enables anyone to learn and master code without further assistance. Thousands of successful operators have "acquired the code" with the Instructograph System. Write today for convenient rental and purchase plans.

INSTRUCTOGRAPH COMPANY

4711 SHERIDAN ROAD, CHICAGO 40, ILLINOIS

SAVE \$ ON SUN SURPLUS AND STANDARD SPECIALS!

CRYSTALS Low Freq.

FT-241A holder 1/2" pin spacing for ham and general use. Xtal controlled Signal Generators; marked in army Mc harmonic frequencies—directions for derived fundamental frequencies enclosed. Listed below by fundamental frequencies, fractions omitted.

412 426 442 475 493 504 515	372 381	390 401
413 427 443 477 494 506 516	374 383	391 402
414 429 444 479 495 507 518	375 384	392 403
415 431 445 481 496 508 519	376 386	393 405
416 433 446 483 497 509 522	377 387	394 405
418 434 447 484 498 511 523	379 388	395 408
419 435 448 485 503 512	380	396 409
420 436 462 487	each	400
422 437 468 488	each	397 411
423 438 472 490	49¢ each	
424 440 473 491	39¢	79¢
425 441 474 492	10 for \$4.50	each

450 531.944	Frequency	SPECIAL—200
452.777	Standard	kc Xtals without
461.111	98 356 kc 3-	holders— 21-32"
464.815	P.R. holder	x23-32"
455.277		
526.388	99¢	69¢ each
529.166	\$3.98	3 for \$2.00
530.555		

HAM CRYSTALS

FT-243 holders 1/2" pin spacing, for ham and experimental use. Fractions omitted.

4190 6140 6940 7973	3735 5825 6373 6706 7506
5030 6150 6973 7975	5305 5842 6406 6740 7540
5485 6173 7740 8240	5675 5850 6425 6806 7573
6006 6206 7773 8273	5677 5873 6440 7306 7640
6040 6208 7806 8306	5700 5873 6450 7340 7673
6073 6773 7890	5706 5900 6473 7373 7706
6075 6840 7873	5725 5916 6475 7406 7806
6100 6873 7906	5740 5925 6506 7440 8173
6106 6906 7925	5750 5940 6540 7473 8340
each	5760 5973 6573
49¢	5773 5973 6606
10 for \$4.50	5775 6273 6640
	5806 6340 6673
	10 for \$9.00

SCR-522 XTALS

5910 6610 7580	2045 2260 2415 3215 3570
6370 7350 7870	2105 2262 2435 3237 3580
6450 7480 7930	2125 2300 2442 3250 3945
6470	2145 2305 2532 3322 3955
6497.9	2155 2320 2545 3510 3995
6522.9	2220 2360 2557 3520
6547.9	2258 2390 3202 3550
each	
1.29	

BC-610 XTALS

2 banana plugs 3/4" spacing	3215 3570
2045 2260	2415 3237 3580
2105 2262	2435 3250 3945
2125 2300	2442 3322 3955
2145 2305	2532 3510 3995
2155 2320	2545 3520
2220 2360	2557 3520
2258 2390	3202 3550
	each
	1.29

• Payments must accompany order. Enclose 20c for postage and handling. Minimum order—\$2.00 plus postage.
Crystals are shipped packed in cloth bags inasmuch as they are shock mounted. All shipments guaranteed.

REDUCED FOR CLEARANCE!

Bendix TA-12 Transmitter 100 Watt

4 separate ECO's with tubes 3807 4-12SK7 Complete instructions for converting to 10, 20, 40, and 80 meters supplied.
Only a few left at this low price.

Used **\$19.95** Like New **\$29.95**

PHONO ARMS FOR REPLACEMENT

ASTATIC—SL 8 or D-9 with L-26 cartridge. New in original boxes. Original list price \$4.95.
Reduced to **\$1.65**

PHONO ARMS less cartridge with all necessary hardware. Five (5) for **\$1.95**

2-SPEED RECORD PLAYER in portable carrying case, including 3-tube amplifier speaker, and 3 1/2 and 78 rpm Green Flyer motor. 115 volt AC or DC operated. Used reconditioned. **\$12.50**
Only

METERS: Weston 2" round 500 micro amp. movement with scale calibrated for 0.15/600 volts DC **\$2.97**
Triplet 2" square 0-40 volt DC **2.97**

TERMS: All items F.O.B., Washington, D.C. All orders \$30.00 or less, cash with order. Above \$30.00, 25 per cent with order, balance C.O.D. Foreign orders cash with orders, plus exchange rate.

SUN RADIO
OF WASHINGTON, D. C.
938 F STREET, N. W. WASH. 4, D. C.

also on the air daily 0930-1200 but has severe QRM.

Mozambique—Lourenco Marques informs Grove, Ill., it has effected new schedules: In *English*—CR7AA, 6.137, and CR7BU, 4.932, 2300-0200 Sunday-Friday; CR7BJ, 9.766, and CR7AA, 6.137, 0200-1200 daily; CR7BU, 4.932, and CR7AB, 3.490, 1200-1600 daily. In Portuguese—CR7BE, 9.671, 0000-0100 daily, 0430-0630 Monday-Saturday (0400-0700 Sunday), 1100-1500 daily, power 10 kw., wants complete reports on these transmissions. CR7BV, 4.819, 7.5 kw., 1100-1500 daily. CR7BG, 15.196, test transmission on Thursdays 1500-1530; wants complete report on this transmission. Did not list powers of transmitters used for *English* broadcasts; QRA is Radio Clube de Mocambique, Lourenco Marques, Mocambique (Mozambique); letter signed by J. Pinheiro, Manager. However, Laubscher, South Africa, airmails me that *English* programs on Sundays on 9.766 and 6.137 now begin at 0000, weekdays at 2300, and that on Saturdays the sign-off on 4.932 and 3.490 is an hour later than other days—that is, at 1700.

North Korea—Pyongyang, 4.498, noted fair in New Jersey 0645. (Os-kay)

Outer Mongolia—Ulan-Bator heard with fine signal on 5.260 at 0300-0355, 0500-0600; all-native programs lately. (Balbi, Calif.)

Pakistan—Radio Pakistan was still wandering about the various bands when this was compiled. Was being heard in 0700 news on 7.635, 11.546, 11.845; at 1015 with news on 9.645, 11.546, and at 2145 with news on 9.645, 15.335. Karachi, 9.645, is reported in

Afghan-Persia at 1200-1240; 11.885 at 1245-1300, 1400-1445 in Arabic. Bluman, Israel, reports Pakistan heard on 17.835 in *English* to 0330 sign-off when a clock chimes two o'clock. *Radio Australia* reports that a talk in *English* is given from a Pakistan outlet on 6.075 at 1100-1115; I presume this is Lahore.

Panama—Sutton, Ohio, reports HP5G is again active on 11.780, evenings (EST).

Philippines—Simpson, Australia, has had a letter from the Philippines which states DYB2, 4.985, is not at Davao on Mindanao, as reported earlier by Cushen, N. Z., but is at Bacolod City on Negros Island; DYBR operates on 1120 kc. and DYB2 on 4.965; stations are still testing, operating under construction permits; appear to be privately-owned by Mario Lizares; proposed power for DYB2 is 250 watts.

DZH7, listed 9.740, Manila, may move to 9.770 soon. (Cushen, N. Z.) This station operates 0500-1400 and desires reports. Power is now 3 kw. Station officials notified Halvorsen, Norway, that news is given daily at 0500 followed by dinner music for 15 minutes with announcements in *English* and that *English* is also radiated 0700-0800 on both 9.740 and 6.030. The m.w. channel is 680 kc. Stated that the new "V" beam is directed through Bombay, India, toward the Near East and Europe. This is a non-commercial, missionary broadcaster.

Portugal—CS2MF, measured 9.727.3, has been noted off regular channel some evenings 1900-2030; at times has been on measured 9.746, but at last report was back on normal fre-

DISASTER NET DEMONSTRATION

MEMBERS of the South Plains Amateur Radio Club recently held an emergency demonstration in McKenzie State Park, adjacent to Lubbock, Texas.

Present at the demonstration were the Chairman of the Red Cross Disaster Committee, the sheriff, the fire chief, the traffic manager of the local gas company, the superintendent of the city utilities, a representative of the Lubbock police department, and the commander of the Naval Reserve Unit, in addition to other interested citizens. Three BC-654A's were set up at the

scene with five 10-meter mobile stations. Contacts were established with Raton and Albuquerque, New Mexico, and Borger, Amarillo, Rule, Odessa and other Texas points.

Another series of demonstrations is planned by the club in the hopes of extending the emergency net to a 60-mile area. Additional information on the emergency disaster plan may be obtained by writing the SPAR Club secretary, W. T. Ward, W5INM, 2805 N. 1st Street, Lubbock, Texas.

-30-

Rogers Orr, W5NIC, SPARC president, operates a battery portable on 75 meters for visitors.



quency. (Oskay, N. J.) Lisbon, 15.145, appears to be carrying out tests from around 0700. (Radio Australia)

Portuguese India—Halvorsen, Norway, says *Radio Goa*, 9.610, has an *English* transmission each Sunday 0100-0230; power is 500 watts, but is to install a new 7.5 kw. transmitter soon.

Sao Tome (St. Thomas)—Sao Tome, Portuguese West Africa, is heard 1000-1200 over CR5SE, 17.677, and 1300-1500 over CR5SA, 9.615. (Bluman, Israel) The only time I have been able to hear CR5SA, 9.615, here in West Virginia has been from around 1445 to after 1500 (or until WNRA puts its carrier on the air and buries Sao Tome).

Saudi-Arabia—*Radio Arabia*, 11.950, Mecca, is heard erratically in England around 1200 to 1300, and occasionally as late as 1330; 5.98 is heard in parallel with better level. Transmitters may be at Djedda? (Pearce, England)

Suez Canal Zone—Bluman, Israel, airmails me that Fayid has been heard testing 0200-0230 on 7.220, announcing "This is Your Forces Broadcasting Service, Fayid," or "This is Your Forces Broadcasting Service, Middle East, calling from Fayid" (is easily confused with Malta); a later report says Fayid, 7.220, is now heard 0300-0330 (which may not be complete schedule).

Tahiti—Balbi, Calif., reports improved signals from Papeete, 6.982, 12.080, at 2315-2400.

Tangier—EA9AA, 7.060, "*Radio Africa*," noted with French 1030 and 1200. (Aberg, Sweden)

Thailand—Bangkok appears to be using 15.910, approximately 7.205 (at times may be as high as 7.250), and 6.235 for the overseas transmission 0500-0630; news 0515, 0615; definitely announces now as "The Overseas Station of Thailand."

USA—WWV now gives GMT in code each 5 minutes (24-hour system), and EST in voice each 5 minutes (12-hour system); interval tone now is 400 and 1000 cycles in alternate 5-minute periods; ionospheric-disturbance notices are still radiated in code at 19 and 49 minutes past each hour. (Grove, Ill.)

USSR—Khabarovsk, Siberia, is using 4.275, replacing 6.020, sometimes is dual with 8.82; is heard irregularly after 0200 and as late as 0600; Soviet transmitters are heard on 6.03, 6.18 around 1000 in Home Service. The Soviet on 6.075 is not Petropavlovsk at 0245; at 0300, Petropavlovsk comes on the air, after which both Soviet transmitters can be heard, with Petropavlovsk the stronger; all-Russian. (Balbi, Calif.)

Radio Tashkent, 6.820, is heard almost daily at 2100 sign-on; clear announcement 2115. (Moore, Calif.)

Moscow noted on approximately 6.010 opening Home Service in Russian 0030; good signal, in clear. (Fargo, Ga.)

Vatican—Patrick, England, reports that when the Vatican's new 100 kw.

transmitter is installed, HVJ will carry the "Voice of the Vatican" to millions of people all over the world in 18 different languages. The transmitter, is being built by *Phillips* of Hilversum, Holland, and is to be completed this year. It will be presented to his Holiness Pope Pius XII on behalf of Dutch Catholics to commemorate the Holy Year which began last Christmas Eve. The new transmitter, when completed, should be heard over a world-wide area.

HVJ, 6.190, noted with good signal 1545 in Hungarian, in parallel with 7.262.2; latter had poor modulation. (Oskay, N. J.)

Venezuela—YVKO, 5.020, Caracas, noted recently in *English* 2000-2020,

with program of music talks, poems. (Cox, Delaware)

* * *

Last-Minute Tips

The "mystery" station widely reported throughout the U.S. at 0045-0100 on approximately 9.460, has been identified as the "*Free Greek Radio*."

Balbi, Calif., reports *Radio Pakistan* on 11.885 at 1115-1145 in native. Hagen, Ala., hears this channel with Arabic music 1300-1330.

A last-minute report from Dilg, Calif., said he was hearing Communist Chinese outlets 6.090, 10.260, 7.100, 7.500 to 1120 sign-off; 6.090 was very good, others weak.

NATTUGGLAN, Sweden, has had a vague report of a station heard in

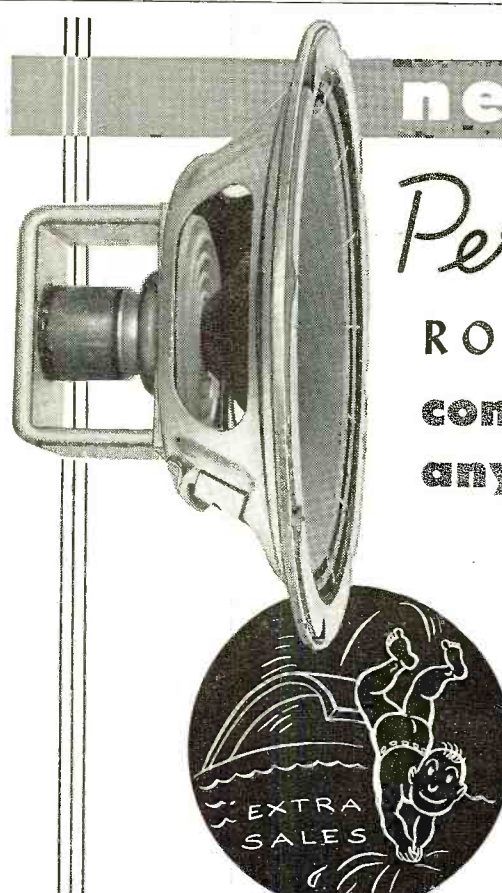

new

Permoflux

ROYAL EIGHT"

compares with any 12" speaker!

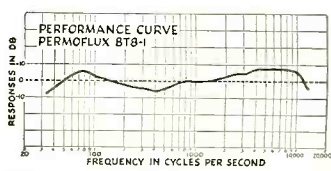

This averaged laboratory response curve of the Permoflux 8T8-1 proves that it compares with the finest speakers regardless of size or price.

It's Your "Springboard" to Extra Sales with Customers who want 12" performance but don't want to pay a 40% higher price.

From the resonant boom of jungle drums to the light warble of the flute, this new 8" speaker reproduces sound with superior sensitivity and fidelity. The tonal qualities of this magnificent speaker can only add to the excellence of any audio equipment.

Special processing provides extra-strong cone; allows cone to be soft-suspended from basket and held at coil-end by extra-large spider. Permits more faithful reproduction at lower frequencies. Deeper, curvical cone greatly extends high-frequency response.

Permoflux Royal Eight" (Model 8T8-1) is ruggedly-built, and simple to install. Provides big speaker performance in a small frame—uses smaller, more economical baffle. List Price \$15.00.

TRADE MARK
PERMOFLUX[®]
"SOUND IN DESIGN"

PERMOFLUX CORPORATION
4900 W. GRAND AVE. CHICAGO 39, ILL. • 236 S. VERDUGO RD., GLENDALE 5 CALIF.

another
NATIONAL
TELEVISION
FIRST!



MODEL TVB-2

**A SENSATIONAL NEW
BOOSTER FEATURING
A TURRET TUNER**

The turret tuner is recognized as the most efficient television input tuning device yet designed because of (1) its exceptionally high gain and (2) its uniform bandwidth on all channels. It is used in today's finest television receivers. Now, for the first time, National makes available all the advantages of a turret tuner in a truly sensational-performing new television booster.

COMPARE THESE FEATURES:

- (1) Turret tuner with an individually tuned set of coils for each channel.
- (2) Removable polystyrene coil-mounting contact panels.
- (3) A single 6AK5 for maximum usable gain.
- (4) A built-in power transformer (not AC-DC—no "hot" chassis).
- (5) Selenium rectifier for long life.
- (6) Channel selector and fine tuning in a single, easy-to-operate, dual-purpose control.
- (7) Pilot light illuminates selected channel.

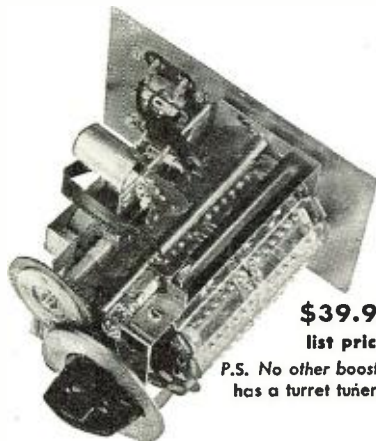

\$39.95
list price

P.S. No other booster has a turret tuner!



Arabic on 7.040 announcing as "Hona Radio Tripoli"; may be Tripoli?

Hannaford, South Africa, airmails that Salisbury is now using 3.320 and that 3.658, formerly in parallel, is now off the air; no schedules were given.

Aberg, Sweden, airmails he is hearing a station on approximately 6.440 in Spanish at 1100-1120 closedown; call sounds "Radio El Scana"; strangely enough, announces frequency as in the 49-meter band; he believes this may be a Spanish station in the Basque province of Spain; he says "Radio Euzkadi" on 6.095 gives call at end of transmission in Spanish and in another dialect, probably Basque; "Radio Euzkadi" is listed on 6.094 as a "Clandestine Basque" outlet. Aberg did not list schedule for "Radio Euzkadi."

Serrano, Brazil, flashes that he has heard PRL5, 11.95, in parallel with m.w. PRA2, 800 kc., instead of s.w. PRL4, 9.77; transmitter seems to be the same as PRL4 (1 kw.); signal good, stronger than PRL4 had been, but with CWQRM; PRL5, 11.95, is listed 15 kw. and as "inactive." May have moved from 9.77 to 11.95 to escape severe QRM from Leopoldville's 9.767 outlet. QRA is Radio Ministerio da Educacao e Saude, Praca da Republica 141-A, Rio de Janeiro, Brazil. Serrano reports that ZYB8, 11.765, Radio Tupi, was off the air; that a Spanish program, "Aquarelas do Brazil," is radiated daily except Sunday at 2030-2100 (closedown) over ZYB9, 15.156.

Radio Clube do Bie, Silva Porto, Angola, hopes to increase power soon from 200 watts to 1 kw. (Pearce, England)

A Swedish DX-er reports Damascus on a new channel of 6.165 at 0530-0612, broadcasting news in English and French, some music; asked for reception reports. However, a Danish listener reports he is hearing Damascus on its old frequency of 6.000 at 1000-1100. (Radio Sweden)

Laubscher, South Africa, flashes that Mauritius, approximately 15.050, has been heard with a weather report in English at 1045 and with an English talk at 1130, but that the station definitely does not have English news at 1145 as reported by some sources; signs off 1200 with "God Save the King."

Late tips from Balbi, Calif., include "Vietnam," 9.67, heard at 0500 under KGEI; is in clear 0530-0545. DZH7, Manila, is on 9.730, not 9.74 as reported from "Down Under"; is heard "below" Nanking's 9.735 channel from 0400; the 9.735 Nanking outlet signs on 0400 with regular program in parallel with 6.090.

A new station, Radio Nigeria, at Lagos, Nigeria, was operating experimentally with 300 watts on 9.655 and 6.035 at 0100-0215, 0600-1700. But shortly was to be radiating at 0100-0215, 0600-1700 on 7.255 with 1 kw., 0100-0215, 0600-1300 on 9.655 with 300 watts, and 1300-1700 on 4.990 with 300 watts; on Sundays, operation was to be continuously 0100-1700. Transmit-

TV CHASSIS SPECIAL!

LIC.
by RCA

10"-12½"-16"



A SET—NOT A KIT

- 22 Tubes
 - Hi-gain Turret type Tuner
- \$11850** Fed. Tax \$1.80
less GRT

Completely wired, factory engineered, tested and guaranteed. Perfect for custom installation. F.O.B. Long Island City—20% deposit, Bal. C.O.D.

MACKAY TELEVISION CORP.

12-01 44th Ave., Long Island City, N. Y.

WILL BUY

Any quantities of new or used Electronic Surplus Equipment: APN-9, RTA-1B, TS-67, TS-170, ARC-1, ARC-3, ART-13, BC-221, BC-348, SCR-522, etc.

State Condition and Best Price.

BOX 491, c/o RADIO & TELEVISION NEWS
185 N. Wabash Ave. Chicago 1, Ill.

YORK RADIO & REFRIGERATION
265 W. MARKET ST.
York, Pa.
HAS THE SENSATIONAL NEW
EICO 425-K
5" Scope Kit
IN STOCK!
\$39.95

LEARN
Radio-Television
OR
Electricity
IN THE GREAT SHOPS OF **COYNE**

GOYNE 51st ANNIVERSARY

TRAIN QUICKLY!
OLDEST, BEST EQUIPPED
SCHOOL of ITS KIND in U.S.
2 Opportunity Fields

Come to the Great Shops of COYNE in Chicago during our 51st Anniversary Year! Get quick, practical training in RADIO-TELEVISION or ELECTRICITY. G.I. Approved. Finance plan for non-veterans. Mail Coupon Today for complete details.

NOT "HOME-STUDY" COURSES!
You learn on real, full-size equipment, not by mail. Finest staff of trained instructors to help you get ready quickly for a better job, a fine future.

FREE BOOKS Clip coupon for big illustrated Coyne book on either ELECTRICITY or RADIO-TELEVISION. Both books sent FREE if you wish. No obligation; no salesman will call. Act NOW!

B. W. COOKE, Pres.
COYNE Electrical & Radio-Television School,
500 S. Paulina St., Chicago 12, Ill. Dept. 40-85H

Send FREE BOOK and full details on:

RADIO-TELEVISION ELECTRICITY

NAME

ADDRESS

CITY STATE

ALMO SPOTLIGHT SPECIAL

- PHILCO Phonograph Motor Only—78 RPM**
 Philco Part No. 35-1304 . . . ea. \$1.25
 RCA 12" 350-ohm field speakers 2.95
 RCA 7DP4 tubes 15.00
 RCA Beam Benders95
 12" Television Filters39
 Punched Chassis—5 and 6 tubes .19
 4-prong Universal Vibrator 1.39
 10W Adjustable Resistors—15k. .15
- 4-WATT WIRE-WOUND POWER RHEOSTATS**

- 1 k
 2 k
 3 k
 5 k
 7500
 10 k
 15 k
 20 k
 50 k

29¢

- SAPPHIRE NEEDLE** \$0.79
 #44 Dial Lamps,
 Per hundred \$4.50
 #50 Dial Lamps,
 Per hundred \$4.00

- 25W Rheostat, 10-ohm }
 25W Rheostat, 30-ohm } **49¢**
 25W Rheostat, 100-ohm }
 50W Rheostat, 185-ohm }

- 10W Resistors,
 2200-ohm fixed }
 10W Resistors,
 2750-ohm fixed } **10¢**
 10W Resistors,
 4500-ohm fixed }

- 20W Fixed Resistors,
 1-ohm, 6k }
 20W Fixed Resistors,
 15-ohm, 12k } **15¢**
 20W Fixed Resistors,
 125-ohm }
 20W Fixed Resistors,
 600-ohm }
 20W Fixed Resistors,
 800-ohm }

10% Cash With Orders

ALMO RADIO CO.
 509 ARCH STREET • Philadelphia
 6205 MARKET STREET • West Phila.
 6th & ORANGE STS. • Wilmington
 4401 VENTNOR AVE. • Atlantic City

FOR BARGAINS IN

Receivers, Transmitters, Amplifiers,
 Television Sets, Batteries, Surplus
 Parts, Phonograph Records, and many
 more items

Read
RADIO AND TELEVISION NEWS
 Classified Columns Every Month

TELEVISION

PREPARE FOR A GOOD JOB!
 BROADCAST ENGINEER
 COMMERCIAL OPERATOR (CODE)
 RADIO SERVICEMAN

Television Servicing

(Approved for Veterans)
 SEND FOR FREE LITERATURE
BALTIMORE TECHNICAL INSTITUTE
 1425 EUTAW PLACE, BALT. 17, MD.

ters are not regular broadcasting equipment; the 300-watt transmitter is an Air Ministry T1509, while the 1 kw. job is a RCA 4351. Programs are relayed from the BBC's General Overseas Service *except* during the last period of broadcast. Verified for Cushen, N. Z., and welcomes reports to Radio Nigeria, c/o Post and Telephone-Telegraph Headquarters, Lagos, Nigeria, Africa. (Radio Australia) I believe this is the "unknown" station heard by Dilg, Calif., on 9.655 with native singing around 1015 and with Western music around 1100 and later.

The station at Bacolod City, Negros Island, Philippines, is DYB2, 4.985, and the station at Davao, Mindanao Island, is operating on 3.950, no call-sign yet but relays m.w. DXAW, 1180 kc. (Cushen, N. Z., Simpson, Australia, via Radio Australia)

Cushen, N. Z., reports a station he believes to be *Berliner-Rundfunk*, Germany, on 6.115 from 0200 when GSL leaves 6.110; *Radio Sweden* says that while *Berliner-Rundfunk* is announcing 6.115, it has been wandering around the 41-meter band on such frequencies as 7.035 and others until 1430.

Radio Sweden confirms that EQC, 9.660, Teheran, has replaced EPB, 15.100, for the transmission to Europe 1330-1530, news 1400; says *Radio Shkodra* at Scutari, Albania, 8.220, gives schedule of 0100-0200, 0730-0900, and 1130-1500; that Sao Tome on 11.785 is being heard again to close-down 1600; that *Radio Nacional de Espana*, Madrid, has changed frequency from 15.620 to 15.636, according to station announcement, and is on the air daily *except* Sunday 1130-1200; that Ulan-Bator, Outer Mongolia, is operating on 8.400 to 1000 when it signs off with choral music; that an unidentified station has been heard in Sweden on about 5.050 announcing as "British Forces Network," no location mentioned; that *United Nations Radio*, 6.672, Geneva, Switzerland, has changed its schedule to 1420-1440, news in *English* 1420 and in *French* 1430, and that it has been heard testing on 11.715 at 1145-1200 directed to Middle East; confirms that Radio Ministerio da Educacao, Rio de Janeiro, is on 11.950 now with call of PRL5, heard from 1400, relaying m.w. PRA2; says that Lourenco Marques, CR7BJ, has moved from 9.653 to 9.600 where has been heard 1230-1330, 1430-1500.

Lourenco Marques, Mozambique, now appears to be using approximately 11.765 (widely reported in U.S.), 9.763, and 6.135 in parallel weekdays from 2300, Sunday from 0000, in *English*; announces the 25-m. outlet as "testing" and asks for reception reports on that channel.

Stark, Texas, reports South Africa (SABC) heard lately opening 2345 weekdays (0055 Sunday) on approximately 9.680; short newscast 0000. He flashes he has heard *Radio Tananarive*, 9.694, Madagascar, opening 2300 in *French*; has two or three series of notes on stringed instrument (presumably Malgache guitar), identifies as

SAVE \$40.00 AT ALLIED!

ON THE FAMOUS MODEL WR-67A



SIGNAL GENERATOR



WAS \$89.50 NOW ONLY \$49.50

Now! ALLIED offers you this famous test instrument at far below regular price!

QUANTITY LIMITED! ORDER WHILE THEY LAST!

Own this famous test instrument—at a saving of \$40! The RCA WR-67A is a highly stable signal generator that meets every requirement for servicing all types of AM receivers. Covers 100 kc to 30 mc in 6 bands, all on fundamentals. Also has 3 fixed frequencies: 455 kc, 600 kc, and 1500 kc. Internal 400-cycle modulator adjustable for up to 75% modulation. Has jack for external audio oscillator to provide essentially flat carrier modulation to 10 kc. 400-cycle output provided for audio tests. RF output, 5 microvolts to 1 volt. Employs compensated Hartley-type oscillator to provide stable output. Harmonics of last band may be used for VHF testing. Thoroughly shielded against RF leakage. Calibration accuracy, ±2%. Supplied with signal-injection probe for injecting RF, IF or audio test signals into any part of receiver. Brushed aluminum anodized panel. In blue-gray Hammeroid portable case, 9 3/4" H, 13 1/2" W, 7 1/2" D. For 105-125 volts, 50-60 cycles AC. Drain, 30 watts. Shpg. wt., 20 lbs. **84-055. CASH PRICE, ONLY \$49.50**

ONLY \$4.95 DOWN

Available on Easy Terms: \$4.95 down, \$5.25 monthly for 9 months.

ORDER WHILE THEY LAST!

ALLIED RADIO

833 W. Jackson Blvd., Dept. 1-DD-0
 Chicago 7, Illinois

- Enter my order for RCA WR-67A Signal Generator. Enclosed \$
 Full Payment
 Down Payment (balance on monthly payment plan).

Name

Address

City Zone State

SAVE \$180!

"KLEEN-AIRE" ELECTRIC AIR CIRCULATOR (PATENTED FILTER) FOR COOL-CLEAN AIR WINTER & SUMMER

BRAND NEW

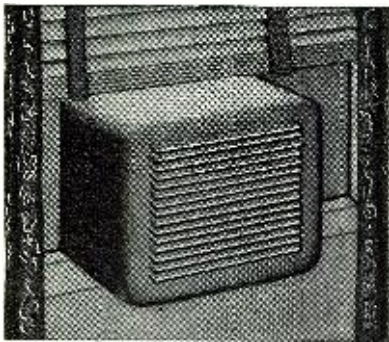

**No Dirt—No Draft—No Noise
Continuous Variable Control**

PERFECT VENTILATION. Air filtration is assured by use of PATENTED FILTER for ELIMINATING DUST, DIRT, and POLLEN from outdoors.

Ventilates your room with CLEAN, COOL, FILTERED AIR SUMMER or WINTER. Enables you to SUBDUCE outside NOISES by keeping windows closed and to get the amount of air you want, whether calm or stormy.

Easily ADAPTED TO ANY WINDOW without cutting or marring; mounted flush with inside of window for pleasing appearance.

Cabinet is made of HEAVY STEEL with "BAKED ON" BRONZE HARMERTONE FINISH. Will blend with all home, office, or factory surroundings.

- HOMES
- OFFICES
- SCHOOLS
- FACTORIES
- SHOWROOMS

DELIVERS 695 (C. F. M.) CUBIC FEET PER MINUTE IN FREE AIR

A SENSATIONAL BUY!

110V 60 Cycle AC
MODEL AI
4 FOR \$175.00

\$44⁹⁵

F.O.B.
N.Y.C.

110 V.D.C. \$59.95 10% U. S. Excise Tax
220-250 V.D.C. \$59.95

TERMS: 20% Deposit, Balance C.O.D., F.O.B. N. Y. C. Rated firms open a/c net 10 days.

MANUEL KLEIN

76 CORTLANDT STREET
NEW YORK 7, N. Y. REctor 2-6460

"Ici Tananarive," and uses "La Mar-seillaise" at start.

Press dispatches indicated that the name of Guatemala, Central America, was to have been changed to "ISTH-MANIA" on February 1; however, on the day this was compiled, a check of TGWA, 15.170 (daytime) and 9.760 (nights) indicated the station was still announcing as "La Voz de Guatemala" in the Republic of Guatemala.

Station heard on approximately 7.090 with Near East singing 0950 is believed to be Baghdad, Iraq. (Dilg, Calif.)

DYH2, 6.139.6, Cebu City, Philip-pines, heard signing off 1100. (Trie-bel, Washington State, via Oskay, N.J.)

Officials of *Radio Australia* airmail me that VLC5, 9.54, will be continued in use at least for some months to East and Central North America daily 0700-0900 and 0900-0945, respectively; it is now impossible for *Radio Aus-tralia* to use 11.81 in parallel for these transmissions although that channel, as VLC7, will continue to be used to Western North America daily 1000-1115.

On March 11 at 1630 and 2300, a 15-minute special DX broadcast was radiated by Kol-Israel, 9.000, Tel Aviv, Israel, for the International Short Wave Club, London; it featured Her-berth Bluman, Israel, valuable con-tributor to the ISW DEPT. I learned of this projected broadcast too late to announce it in the March issue—but if anyone picked up the broadcast, a re-port would be appreciated to Kol-Israel, Box 17, Hakiryra, Tel Aviv, Israel. Thanks!

Sutton, Ohio, reports Khabarovsk, 4.275, Siberia, USSR, has been heard 0600 with news (presumably in *Eng-lish*). At the time this was compiled, 4VRW, Port-au-Prince, Haiti, was still wandering about; was heard in *Eng-*

lish at 0800 to announce channel of 10.130; however, at times has been as high as 10.210.

Slutter, Pa., reports Godthaab, 5.942, Greenland, is heard very weak at 1650. Boice, Conn., has been hearing *Radio Omdurman*, 9.747, Anglo-Egyptian Sudan, on Fridays in *English* 1230-1300; he reports Lourenco Mar-ques, 15.23, Mozambique, is back on the air daily from before 1400 to 1500 sign-off, may be testing. Leopold-ville, Belgian Congo, notified Lein-bach, N. Y. that the 11.645 channel, which has been used lately in parallel with 9.767 in French 1630-1845 to Bel-gian seamen, soon will be used at that time for Spanish and Portuguese lan-guage programs (presumably to Latin America). In a DX broadcast, Leo-poldville said that ZKG, 8.290, Pit-cairn Island, is now on the air; no further details were given.

Although station officials informed me the 19.345 channel of former *Ra-dio Indonesia* (Batavia, now Djakar-ta) was to have closed down some time ago, at press time I received word from Fuller, Rhode Island, that he had heard the station to 1200 close-down. Taylor, Ill., reports HC2RL, 6.635, Guayaquil, Ecuador, has opera and concert music with announce-ments in both Spanish and *English* on Tuesdays around 2130 to closedown 2315-2330; station verified from Esta-cion HC2RL, Quinta Piedad, Guaya-quil, Ecuador. He says HP5K, 6.005, Colon, Panama, has *English* program 2030-2200; QRA is Cadena Panamena de Radiodifusion, Apartado 33, Colon, Republic de Panama.

* * *

Acknowledgement

Thanks for the continued FB sup-port, fellows! Keep your reports com-ing to 948 Stewartstown Road, Mor-gantown, West Virginia, USA. . KRB.

This group of Philippine amateurs turned out for a recent hamfest, at the home of Jess Escalante, DU1VVS, held in conjunction with Cavite City's fiesta. Those in the picture include: (kneeling) Pedro Aguinaldo, Jr., DU1DO, and Gregorio Orbeta, DU1AW. Standing from left to right are: Jorge Illenberger, DU1JL, David K. Pope, W3IJW, Mary E. Pope, XYL-W3IJW, Rose Illenberger, Celestina Marcelo Illenberger, XYL-DU1JL, Mrs. Jesse Escalante, XYL-DU1VVS, Lita Contreras, Nunilon Lim, DU1NL, and Jess Escalante, DU1VVS. In the back row are: Jack Santaromana, DU1JS, Gregorio Trin-dad, DU1GT, Fred Hashim, Miguel Contreras, DU1MC, Victor Valenzuela, DU1AQ, Emmett M. Johnston, W7CEV, and Frank Tunison. E. G. DeCastro is club secretary.





STANDARD AND HEAVY DUTY INVERTERS



For Inverting D. C. to A. C.
Specially Designed for operating A. C. Radios, Television Sets, Amplifiers, Address Systems, and Radio Test Equipment from D. C. Voltages in Vehicles, Ships, Trains, Planes and in D. C. Districts.



AUTO RADIO VIBRATORS

A Complete Line of Vibrators . . .
Designed for Use in Standard Vibrator-Operated Auto Radio Receivers. Built with Precision Construction, featuring Ceramic Stack Spacers for Longer Lasting Life.

NEW MODELS NEW DESIGNS
NEW LITERATURE
"A" Battery Eliminator, DC-AC Inverters, Auto Radio Vibrators.
See your folder or write factory

AMERICAN TELEVISION & RADIO CO.
Quality Products Since 1931
SAINT PAUL 1, MINNESOTA-U.S.A.

prises the exciter unit and is mounted in one cubicle of the complete transmitter. The modulator and power amplifier are housed in a cubicle adjacent to the exciter. The output of the 815 tripler is link-fed to an 832 in this cubicle which is the modulated stage. The modulator driving this stage consists of three 4D32's as video amplifiers feeding into push-pull 807's which act as output cathode couplers. The modulator also employs two 6AG7's as amplifiers and sync stretchers plus a pair of 6AL5's for d.c. insertion (d.c. insertion controls the average picture brightness). Included in this same cubicle are the linear r.f. amplifier stages. Output of the modulated 832 is fed into an 829B which is the first linear amplifier. This is followed by push-pull 5588's which, in turn, feed push-pull 5513's followed by another pair of push-pull 5513's. All tubes in the transmitter unit thus far are cooled by filtered air forced through the cooling fins and around the grid and filament connection. The final amplifier, consisting of a pair of 9C24's, is both air- and water-cooled, however. It is most interesting to note that the filaments of these tubes draw 125 amps. each and that the cooling water enters a special chamber inside the tube where it can directly absorb heat from the filament. Both the grid and plate are water-cooled as well. Suppression of the lower sideband has been somewhat of a problem in television. This problem has been licked in the TT-6-D by employing a system of bandpass coupling in each amplifier stage. No high-level sideband filter is required because all but the standard vestigial sideband signal is eliminated by the amplifier bandpass tuning. Tuning the transmitter is also performed in a very interesting manner. It can be likened to the alignment of the i.f. strip in the conventional TV receiver. The transmitter has a built-in sweep and marker generator and provision has been made for connecting an external oscilloscope for a visual check of tuning. Tuned and ready for operation, the video transmitter feeds its output to the Diplexer where it joins the FM sound signal before being put out over the air.

We have already followed the video signal from the camera through the transmitter. It is logical, then, that we should return at this point and pick up the sound signal. Monitored sound signals from the master console are fed into the FM sound transmitter which works in a manner very similar to the video transmitter except for the system of modulation. Modulation of the sound transmitter is accomplished by means of the GE Phasatron Unit. Standard broadcast stations and the video transmitter use amplitude modulation while FM broadcast stations and the sound transmitter of television stations modulate by varying the frequency. The Phasatron unit accomplishes this

Approved MODEL A-460
TELEVISION FIELD STRENGTH METER
\$79.50 ONLY

Field Strength Meter; television 12 channel tuner; video IF channel; large 6" directly calibrated meter; ham-mer-tone finished panel; ideal for locating antenna systems; testing transmission lines; testing efficiency of indoor antennas; checking booster efficiency, etc.

Model A-460 is housed in a heavy gauge steel cabinet, battleship grey finish with 6 tubes (standard brands) 1N34 Crystal, operating instructions, circuit diagram and guarantee. Weight 25 lbs. D-8" x H-10" x W-12".

Write for 12-page catalogue.

APPROVED ELECTRONIC INST., CORP.
142 Liberty St. N.Y.C.

telrex INC.
CONICAL "V" BEAMS
ASBURY PARK, NEW JERSEY

- THE SKILL TO DESIGN
- THE FACILITIES TO PRODUCE
- THE ABILITY TO DELIVER

MANUFACTURERS OF THE CONICAL "V" BEAM FOR TV AND FM RECEPTION

Available through Authorized **TELREX Distributors**

WRITE DEPT. R FOR CATALOG

NEW SPEAKERS!

First quality, fresh magnet, manufactured in 1950 by leading makers! Guaranteed Perfect. All *Alnico V*.

	Each	Lots of 5
3 1/2" P.M. .68 oz.	\$.79	\$ 75 ea.
4" P.M. .68 oz.	.89	.85 ea.
4" P.M. 1.02 oz.	.99	.95 ea.
4" P.M. 1.47 oz.	1.05	.95 ea.
4"x6" P.M. 1.02 oz.	1.49	1.39 ea.
4" P.M. .68 oz.	.88	.85 ea.
4" P.M. 1.02 oz.	.95	.89 ea.
4" P.M. 1.47 oz.	1.05	.95 ea.
4" P.M. 1.02 oz.	1.29	1.19 ea.
4" P.M. 1.47 oz.	1.39	1.29 ea.
5" P.M. .68 oz. w/50L6 Output	1.24	1.15 ea.
MCA Type #209X1 CRYSTAL PICK-UP		\$2.95

SWEDGAL RADIO, INC.
96 Warren St., Dept. N-1, N. Y., N. Y. CO 7-6753

Mass. Radio School
273 Huntington Ave., Boston 15, Mass.
Offers Training Courses for Radio Technician (Pre-Television) and Licensed Radio Operator (All Types) including maintenance and operation of General Electronic Equipment. Over 20,000 Alumni and 30 years' radio-training EXPERIENCE. Courses approved for Training for Veterans.

Send for Catalog
Licensed by Commonwealth of Mass.
Department of Education

TECH-MASTER

"Super 16"

BETTER THAN EVER
the Model 630-TK TV Kit

with Voltage Doubler
and KEYED A.G.C.

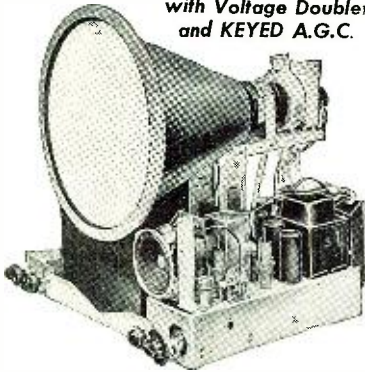

Circuit is the exact duplicate of the RCA 630TS, PLUS Voltage Doubler and Keyed Automatic Gain Control. All components mounted, ready to wire over a weekend.

Complete, less Kinescope
At your distributor—Write
Dept. RN-4 for literature. **\$169.50**



TECH-MASTER PRODUCTS CO.

443-445 Broadway, New York 13, N. Y.

More leading engineers and technicians have built Tech-Master for their own use than any other Television Kit.

PHOENIX
Speed-Tennas
DO A BETTER JOB!

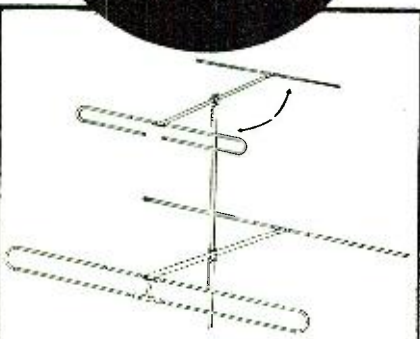

Strong—light in weight—fast, easy installation. Engineered to give highest quality electrical performance . . . and designed to withstand the toughest weather conditions. Pre-assembled—no loose hardware.

PHOENIX
ELECTRONICS, INC.
Lawrence, Mass.

AT LEADING
JOBBER'S
Write for
folder V of
complete line
of television
accessories.

by shifting the phase of the carrier in accordance with the modulating signal. This phase shift, after being fed through successive stages of doubling and tripling, becomes an actual frequency shift of the carrier.

Output of the transmitters is converted from push-pull to single ended output by a device called the Balun, better known as a Bazooka. Output from the transmitter is fed into the Diplexer. This device combines the aural and visual signals in a bridge arrangement, that is, the antenna appears as the resistor element in two arms of the bridge circuit with the video fed across one diagonal and the aural across the other. The combined signal leaves the Diplexer via coax line which is kept under constant dry air pressure to prevent arcing, and travels up the tower to the antenna from whence it is radiated.

The antenna mast is grounded by means of heavy copper strip to the main ground system of the transmitter, terminating in a bed of copper sulphate for the best possible ground. All precautions have been taken against lightning and winds up to 120 miles per hour. The antenna proper is a six-bay, super-turnstile, bat-wing radiator, constructed of seamless steel tubing. Impedance of the antenna is 51.5 ohms. Phase displacement between East-West and North-South pairs is 90 degrees. Antenna gain over a half-wave dipole is more than six times the power output of the transmitter.

Frequent checks are made of the power output of the station. This is accomplished by making use of a dummy load. This device is a resistor of 51.5 ohms (same resistance as the impedance of the antenna). The output of the transmitter is fed into this load while cooling water flows through it at a constant rate of 3.8 gallons per minute. Two thermometers check water temperature, one checks water temperature prior to entry into the load and the other the exhaust water temperature. At the standard rate of flow the power output of the transmitter will be equal to the difference in temperature of the incoming and exhaust water. As an example, a three degree rise in temperature would indicate a power output of 3 kw.

Both station and studio bustle with activity long before the station is to be on the air for the day's telecasting. At least an hour is required to warm up all equipment and establish normal operating characteristics. For a live show more than 450 tubes in the camera chain alone must be warmed up and their operation checked. The image-orthicon camera tube, with a life expectancy of as low as 100 hours, responds differently each time it is used and corresponding camera adjustments must be made. Remote equipment must be given an operation check since its characteristics will generally change with a shift of location or tempera-

2 IMPORTANT NEW PHOTOFACT BOOKS

"TELEVISION TUBE LOCATION GUIDE"

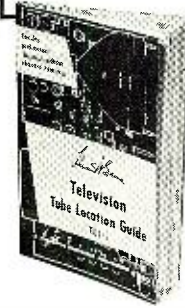

Gives Tube position and function in hundreds of important TV receiver models, made by 56 manufacturers.

FIND THE TROUBLE AND REPLACE TUBES WITHOUT REMOVING CHASSIS

Nothing like it! The only book that shows the position and function of tubes in hundreds of TV receivers. Often an operational check in the customer's home . . . looking at the picture tube and listening to the sound . . . can give you a clue to the trouble. Many times only a tube failure is responsible. TGL-1 makes trouble diagnosis and tube replacement quick and simple, in most cases without removing the chassis! Each model has its own clear, accurate diagram. Book fully indexed for quick reference. Over 200 pages, handy pocket size, 5½ x 8½". Get two copies . . . one for outside calls and one for your bench. Pays for itself on the first job!

ORDER TGL-1 Only \$1.50



"DIAL CORD STRINGING GUIDE"

NEW!
SECOND VOLUME
Covers models from
1947 to October 1949

Over 45,000 servicemen bought the first volume of this invaluable book! New second volume includes 511 different dial cord stringing diagrams used in almost 1000 receivers produced from 1947 to October, 1949 (all new data continuing from where the first volume left off). There's only one right way to string a dial cord . . . and here's the only book that shows you how. Saves time—saves effort. Handy pocket size. Order copies for your tool kit and work bench today.

ORDER DC-2 Only \$1.00

HOWARD W. SAMS & CO., INC.

Order from your Parts Jobber today, or write direct to HOWARD W. SAMS & CO., INC., 2201 East 46th Street, Indianapolis 5, Ind.

My (check) (money order) for \$ enclosed. Send the following books:

- TGL-1 "TV Tube Location Guide" \$1.50
- DC-2 "Dial Cord Stringing Guide" \$1.00

Name

Address

City Zone State

TELEVISION SCOPE

SUPERIORITY AT A GLANCE!

The vertical response of this economy TV scope is usable to 5000 kc, not 50 kc. Response is flat to 750 kc, down 3 db at 1000 kc. Amplifier supplies a voltage gain of 20 at 5000 kc.



AR-3

Check this necessary feature before you buy any scope for TV use.

The R.S.E., AR-3 Scope has been built by Ross Armstrong to our rigid specifications. It's a complete unit that embodies standard horizontal amplifier and sweep circuits with normal sensitivity.

The case is 8" high x 5" wide x 14" long, attractively finished in "hammered" opalescent blue enamel. Operates on standard 110 volts—60 cycles—40 watts. Tubes, 3BP1-6AC7-6SJ7-6X5-5Y3-884. Instructions included. Complete specifications upon request. Satisfaction or your money back.

PRICE
\$4995

AVAILABLE TO JOBBERS
IN QUANTITY

F. O. B.
DETROIT

I TERCOM & RADIO

AT A
PRICE
THAT
CAN'T
BE BEAT



6 tube superhet—3 tube intercom permits communication between radio-master and up to 4 sub-stations.

WHILE THEY LAST
\$2995

With 1 sub-station and 50 feet of cable
Extra Sub-stations \$3.95 each

Original cost \$64.50

PUSHBACK WIRE



25% BELOW MILL COST!

1st class, Essex or Lenz, ALL SOLID tinned copper, cable cotton serve, waxed finish.

SIZE	COLORS	100 feet	1000 feet	Production Reel
22	BLACK-BROWN	.39	3.79	3.65M
20	RED-WHITE-BLUE	.49	4.49	3.95M
18	BROWN	.69	5.98	

ORDER INSTRUCTIONS

Minimum order—\$2.00. 25% deposit with order required for all C.O.D. shipments. Be sure to include sufficient postage—excess will be refunded. Orders received without postage will be shipped express collect. All prices F.O.B. Detroit.

Demand This Seal of Quality

Quantity and Export Orders Solicited

RADIO SUPPLY & ENGINEERING CO., Inc.
89 SELDEN AVE. DETROIT 1, MICH.

ture. At the transmitter similar adjustments are required. It can be understood that with a total of more than 1000 tubes involved, and with many different circuit requirements with regard to temperature and frequency, considerable time is required for the various circuits to stabilize themselves. At specific periods tuning adjustments at the transmitter are checked. When the station is ready to go on the air, station engineers, cameramen, film room, studio engineers and the program director are all tied together by an intercom which is also a magneto-power tele-

phone line between transmitter and studio. Instructions from the program director are heard by all personnel at once and all remain on the line during the entire production of the show, making a smooth flowing program possible. Despite the complexity of television, KFMB-TV was on the air in less than 60 days after construction of the building began and only 7 days after the equipment arrived, the first test pattern was transmitted.

No, television isn't simple, but it is destined to be one of the most interesting trades with something new being developed continually. —50—

FM QUIZ

By ED BUKSTEIN

Northwestern Vocational Institute

- On the commercial FM channels (88 to 108 mc.), one hundred percent modulation is defined as a frequency deviation of plus and minus (a) 88 kc. (b) 21.75 kc. (c) 75 kc. (d) 25 kc.
- If a commercial FM station produces a signal whose deviation is plus and minus 60 kc., its percentage of modulation is (a) 20% (b) 60% (c) 80% (d) 100%.
- The rate at which the FM signal swings back and forth is determined by the (a) amplitude of the audio signal (b) frequency of the audio signal (c) height of the antenna (d) effective radiated power.
- The deviation of an FM signal increases when the amplitude of the audio signal (a) increases (b) decreases.
- If a 30 kc. deviation is produced by a 5000 cycle audio signal, the modulation index is (a) 150 (b) 25,000 (c) 0.16 (d) 6.
- The ratio of the maximum frequency deviation to the highest audio modulating frequency is called the (a) aspect ratio (b) deviation ratio (c) ratio detector.
- If an FM signal having a deviation of plus and minus 2 kc. is fed successively through a frequency doubler and a frequency quadrupler, the output signal will have a frequency deviation of plus and minus (a) 6 kc. (b) 8 kc. (c) 16 kc. (d) 32 kc.
- The circuit designed to remove any undesirable amplitude modulation from a frequency modulated signal is known as a (a) limiter (b) reactance modulator (c) voltage tripler.
- In the circuit shown in Fig. 1, tube V_1 is a (a) reactance modulator (b) d.c. restorer (c) ratio detector (d) Wien bridge.
- Tube V_1 of Fig. 1 behaves like (a) an inductance (b) a condenser.
- The second detector of an FM receiver is more properly known as a (a) frequency modulator (b) frequency divider (c) frequency multiplier (d) discriminator.
- The circuit shown in Fig. 2 is a (a) pre-emphasis filter (b) high-pass filter (c) de-emphasis filter.
- As specified by the FCC, the pre-emphasis filter should have a time constant of (a) 25 (b) 75 (c) 500 (d) 10,000 microseconds.
- If C of Fig. 2 has a value of .0015 microfarads, R should have a value of (a) 20,000 (b) 50,000 (c) 2,000,000 (d) 66 ohms.
- An FM signal generator employing a motor-driven variable condenser is known as a (a) selsyn (b) PPI (c) rotating vector (d) wobulator.

Fig. 1

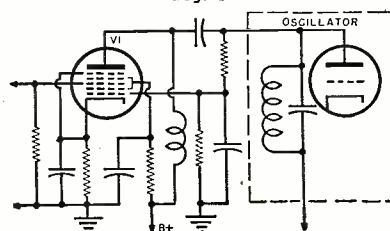

(See page 159 for answers)

Fig. 2

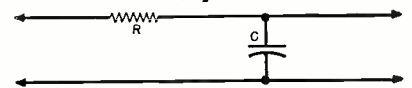

L-C-Q Meter
(Continued from page 70)

toward inaccuracy in "Q" measurements. For this reason, a certain amount of care is required in making these measurements, as well as in calibration. There are several methods, requiring the use of other pieces of test equipment, that may be used for determining Δf or ΔC with greater accuracy, although there is not room for discussion of them here.

If it should be desired to correct for the effects of R_s , the expression:

$$Q_L = \frac{RQ_a}{R - Q_a X_L}$$

may be used. Q_L , equal to X_L/R_L is the corrected value for the "Q" of the inductance L , Q_a is the apparent "Q" as measured by the means described, and X_L is the reactance of the inductance L at the frequency used in making the measurement of Q_a . R is 330,000 ohms, the value of resistor R_s .

A Shure reactance slide rule has proven to be an almost indispensable item.

-50-

FOREIGN SET OWNERSHIP

By J. V. McCARTHY
U. S. Department of Commerce

U. S. Consulates and Embassies in five different countries have submitted radio ownership figures in Madagascar, Iraq, Aden, Nicaragua, and Indochina to the U. S. Department of Commerce for release to interested persons in the United States.

From Indochina comes word that there are an estimated 12,000 radio receivers in use in that country. Of this number approximately 95 per-cent are of French manufacture with the remainder principally of Dutch origin.

Of the estimated 11,360 radio receivers in use in Nicaragua, approximately half of them were manufactured prior to 1939. Almost 90 per-cent of the sets are table models. Of the receivers in use approximately 95 per-cent are equipped to receive medium and short-wave broadcasts.

Aden has approximately 1125 receivers in use as of October 1, 1949. About 35 per-cent of this number were Philips (Dutch), 25 per-cent His Masters Voice (British) and 20 per-cent G.E.C. (British). The remainder were various brands of European and American manufacture. Approximately 50 per-cent of the sets in operation were table models. According to the report, little preference is shown by consumers for quality, appearance, or performance. Low priced sets are preferred.

The Embassy in Baghdad reports an estimated 45,000 radios in use in Iraq. Of this number about 56 per-cent were manufactured after 1939. Approximately 83 per-cent of the sets are table models and about 50 per-cent of all radios are equipped to receive medium and short-wave broadcasts. The remainder are equipped for all-wave reception.

Imports of radio receivers into Madagascar during the period from January through May, 1949 totaled 752 units, of which all but one were from France.

-50-

CIRCLE X ANTENNA

**ENGINEERED TO PROVIDE
CLEAR SHARP
PICTURES ON
ALL CHANNELS**

**COMPARE CIRCLE-X
TO ANY OTHER TV ANTENNA**

No other antenna combines all the mechanical and electrical features engineered into the Circle-X.

The high gain of the Circle-X is equal to stacked arrays. It is made of light weight corrosion resistant aluminum alloys that stand up in all atmospheric conditions.

When you use Circle-X you stock only one type of antenna for all jobs. It has one wire lead-in and weighs only 2 1/2 lbs.

We urge you to compare Circle-X TV Antennas to any other TV antenna on the market.

Use Circle-X on your next tough TV installation. It may save you a lot of "no profit" call backs.

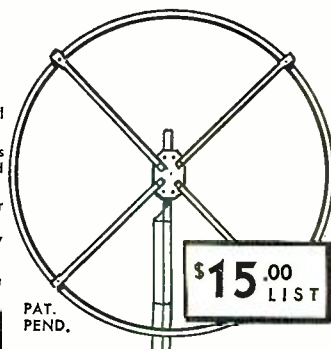

PAT.
PEND.

DEALERS: Air Express or Parcel Post Special Delivery direct from factory to you through your jobber, if he cannot supply you with the Circle-X from his stock.

CIRCLE-X ANTENNA CORP.
507 MARKET ST., PERTH AMBOY, N. J.



Leotone FACTORY SPEAKER REPAIRS SINCE 1927

DPDT G.E. RELAYS 24V. DC.....ea. 59c
PILOT BULBS (No. 1816) 13V. min. bay Box 2 for \$1.00
10 39c
OUNCER INPUT TRANSFORMER for dynamic mikes, low impedance pickups, intercoms, etc. 75c
3/4"x1 1/2" 29c
1/2" PILOT ASSEMBLY; red facet jewel. Plated brass. With 28V. min. bulb.....ea. \$1.00
4 for \$1.00
HEADSET EXTENSION CORD; PL-55/1K-26. 5 1/2 foot Rubber (CD-307) 59c
HANDY CARBON MIKE (HS-83) Press-to-talk. 4 1/2" cord & plug. BRAND NEW! 98c

SPECIAL SERVICERS' KITS
SPEAKER CONES; 4" to 12", moulded & free-die. Less voice coils, kit of 12 asstd. \$1.98
SPEAKER REPAIR KIT: A PROFESSIONAL KIT THAT SAVES TIME & \$\$\$! Contains 25 asstd. mtg. rings, 10 spiders, 25 voice coil forms, 3 yds. felt strip, 20 chamois leather segments, kit of 16 shims, cement & instructions. ALL FOR..... \$2.49
SPECIAL OFFER!!! BOTH "CONE & REPAIR KITS" for only..... \$3.95

RADIO-AMPLIFIER STEEL CABINETS (RCA coin radio type). BEAUTIFUL CHROME GRILLE & SIDE TRIM. Marine Gray finish. Perfect for any ELECTRONIC TEST or MEDICAL EQPT. 16 1/2"x 9 1/2"x10 1/2". Shpg. wt. 12 lbs. \$1.98
MAGNETIC CIRCUIT BREAKERS (Heinemann); 20A/100V. DC, 12A/220V. AC, or 12.5A/220V. AC. Heavy Moulded Black Bakelite. Ea. 98c
18 FT. WHIP ANTENNA; 6 steel screw-in sects. (NS40-54). Shpg. wt. 5 lbs. SPECIAL..... \$2.49
RADIO HARDWARE TREASURE; FULL BOUND OF NUTS, SCREWS, LUGS, WASHERS, ETC. All in handy SELF-SEALING HINGED LID CAN. Shpg. wt. 2 lbs. 49c

BIGGER AND BETTER THAN EVER!!!
LEOTONE'S "JUMBO RADIO PARTS KIT"; 17 FULL POUNDS of selected new & dismantled Radio & Electronics parts: COILS, TRANSFORMERS, RESISTORS, SPEAKER ACCESSORIES, CONDENSERS, WIRE, ETC., ETC. ALL these (slip. wt. 21 lbs.) AND MUCH, MUCH MORE FOR ONLY..... \$2.95

HIGH FIDELITY CRYSTAL MICROPHONE. Sensitive diaphragm, hi-imped. (1 1/4" O.D., 1/4" deep.) Rubber shock-mtd. Less housing. 98c
ALUMINUM HOUSING for crystal mike. 15c
Min. order \$2.00 (slip. wt. 20% deposit on COD's)
Please add sufficient postage—excess refunded.
Full Remittance With Foreign Orders.

LEOTONE RADIO CO.
67 Dey Street,
New York 7, N. Y.

when you use
the **Audax**
POLYPHASE...
ONE single unit
plays **ALL**
your records
SUPERBLY...
and at less
than the cost
of ordinary
magnetic pick-ups

"The Standard by which Others Are Judged and Valued"

Microgroove, 78 r.p.m., etc.

Only \$11.70 net cost to you—believe it or not!

See it at your local distributor or write us

AUDAK COMPANY
500 5th Ave., Dept. 66, New York 18
Fine Music Reproducers Since 1915

NEW TELEKITS

NOW **49⁹⁵**

Jobbers: Write for Confidential Price Information

NEW TELEKITS
 12-B \$79.95
 10-B \$69.95
 8-B \$54.50
 7-B \$49.95
 Less Tubes

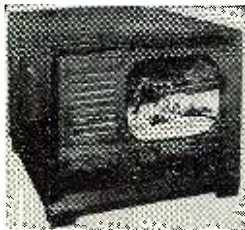

Sparkling new Telekit 12-B has 90-inch screen. Brand new compact lay-out has video tube mounted on chassis. Big illustrated easy-to-follow instruction book guides you step by step through easy assembly. No special knowledge of television is required. All you need is a soldering iron, pliers, and screw driver. 12-B kit can be used with 16-inch tubes. Telekit cabinets \$24.50 to \$35.00. Satisfactory Telekit performance guaranteed by Factory Service Plan.

12-B Telekit (90-inch screen) \$79.95. 10-B Telekit (61-inch screen) \$69.95. 8-B Telekit (48-inch screen) \$54.95. 7-B Telekit (25-inch screen) \$49.95.

Write for catalog listing Telekits and accessories.

TELEKIT BOOSTER
 12.95



This Telekit booster will bring in TV signals bright and clear in the fringe areas. Will give brilliant performance with any TV receiver. NOT A KIT. Completely assembled. With tubes. Works with Telekit or any TV receiver.

13 CHANNEL TUNER
 12.95

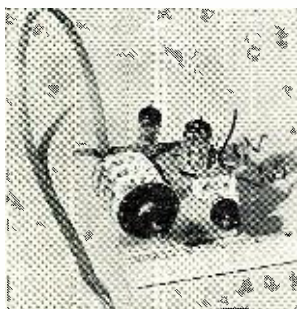

This compact front end has a stage of RF for extra distance. Made to conform with Telekit or any TV set having a video I.F. of 25.75 Mc. Complete with tubes, pre-wired, pre-assembled. Only four connections to make.

Write for catalog of Telekit antennas, boosters, television kits tuners, television parts and tubes.

TELEKIT

ELECTRO-TECHNICAL INDUSTRIES
 1432 N. BROAD ST. DEPT. 2 PHILADELPHIA 21 PA.

AFCA



NEWS

This Association is a patriotic non-profit organization, with chapters in most of the larger cities, dedicated to developing and maintaining efficient personnel, commissioned, enlisted, civilian, for the supply (including design and development), installation, maintenance, and operation of communications and electronic equipment for Army, Navy, and Air Force and their supporting civilian activities. It publishes a magazine "SIGNALS" at its national headquarters in Washington. Every American interested in any way in communications is eligible and invited to join. Dues are \$5.00 per year. Application should be submitted to the secretary at 1624 Eye St., N. W., Washington 6, D. C., who will furnish details upon request.

NEW ADMINISTRATIVE HEAD

Completing the change of original AFCA officers, begun last year when Frederick R. Lack of *Western Electric* replaced David Saranoff as president, AFCA's first Executive Secretary, Brig. Gen. Stephen H. Sherrill, USA, ret., resigned his office on January 3, 1950, and was succeeded the same day by George P. Dixon (Colonel, AUS, ret.), who had retired December 31, 1949, as vice-president of the *International Telephone and Telegraph Company*.

The new Executive Secretary has had an extremely broad and varied experience in the communications field, in industry with the *Bell System*, 15 years in charge of communications at the *National City Bank of New York*, and with the *IT&T*. He has also had a total of some 10 years of active military service in both World Wars and over 22 years of reserve duty. He holds a large number of decorations, including the Silver Star, the Legion of Merit, Bronze Star Medal, Army Commendation Ribbon, Order of the British Empire (Military Division), Legion of Honor, and the Croix de Guerre of France and Belgium.

Colonel Dixon is especially qualified for his new work. He has headed and been active in the work of the AFCA and its predecessor organizations, the Army Signal Association and the American Signal Corps Association, for more than a score of years. He was president of the New York Chapter of the prewar American Signal Corps Association off and on for 16 years, and was the first New York Chapter president of the Army Signal Association, right after World War II.

He was also a national director and executive committee member during the initial years of the former Army Signal Association. He served as president last year, 1948-49, of the AFCA chapter in New York. During the war, while overseas, Col. Dixon also organized and staged several meetings of the former Signal Corps Association in England and France.

Colonel Dixon served approximately 17 years with the *Bell System* during the first part of his communications career, with the *Pacific Telephone & Telegraph Co.*, *Western Electric*, and the *New York Telephone Co.* While with the *National City Bank* he had charge of all types of communications. After World War II, he joined the *IT&T* in August, 1945. He was regional vice-president for 18 months in Brazil, and until his recent retirement from *IT&T* was staff vice-president at the headquarters in New York.

During World War II, his first major assignment from October 1940 to August 1942 was as Signal Officer of the Second Corps Area. After being sent, in the fall of 1942, to the European theater he served first as Signal Officer of the Eighth Air Force. He then became Signal Officer of the U. S. Strategic Air Forces in Europe under General Carl Spaatz, and, in the latter capacity directed the planning for radar use and equipment and for Air Force communications for the strategic air bombing program and the Normandy invasion.

* * *

AFCA CHAPTER NOTES Augusta-Camp Gordon

A vigorous membership drive has put the Augusta-Camp Gordon Chapter in the lead in the AFCA "Chapter of the Year" contest which ends on April 30th.

The chapter opened its second year's activities with the installation of new officers at a dinner meeting at the Sheraton-Bon Air Hotel, Augusta, on January 20th. They are: President—Lt. Col. Henry J. Hort, Commanding Officer, Unit Training Group, Signal Corps Training Center, Camp Gordon; Vice-Presidents—George Weiss, Manager, Radio Station WBBQ, Augusta, and Lt. Col. Thomas K. Trigg, Chief, Training Division, SCTC, Camp Gordon; Secretary-Treasurer—P. K. Jones, *Southern Bell Tel. & Tel. Co.*, Augusta.

Hugh Fleming of *Southern Bell Tel. & Tel. Co.*, the chapter's first president, reviewed the organization of the chapter and some of the highlights of the 1949 activity, and then introduced his successor. The new president, Lt. Col.

Henry J. Hort, paid tribute to the retiring officers and assured the membership that the new leaders would attempt to expand the 1949 program throughout the coming year.

Chicago

The February meeting of the Chicago Chapter was held jointly with the Western Society of Engineers at the latter group's headquarters.

Rear Admiral John R. Redman, USN, recently appointed Chief of Naval Communications, spoke on "Communications in Our Navy."

Col. George P. Dixon, the newly-named executive secretary of AFCA, spoke on the subject, "AFCA—Now and in the Future."

Cleveland

Following its policy of combining chapter meetings with inspections of local communications activities, the Cleveland Chapter visited the *Ohio Bell Telephone Company* on January 12th for a tour of its crossbar toll switching system. The February meeting featured an inspection tour of AM-FM transmitter station WHK, television transmitter station WEWS, and television transmitter station and studio WXEL, Pleasant Valley.

Greater Detroit

Chapter members met at the Michigan Naval Armory in Detroit on January 26th to hear a talk on "Sonar" by Commander W. H. Groverman, head of the Underseas Warfare Branch of the Office of Naval Research in Washington. At the close of the discussion period which followed the address, the group inspected the sonar equipment in use at the Armory.

Kentucky

The February 10th dinner-meeting of the Kentucky Chapter was held at the Officers' Club of the Lexington Signal Depot. Carl Neilson, studio supervisor of radio station WHAS, Louisville, was the guest speaker. He addressed the chapter on the subject of "Inside Glimpse of a 50 kw. Clear Vision Broadcasting Station" and then showed a film entitled "Television Today."

New York

The first meeting of 1950 of the New York Chapter took place on January 25th at the Fraunces Tavern Restaurant, New York, and featured an address by Federal Communication Commissioner E. M. Webster.

Chapter President Thompson H. Mitchell of *IT&T* announced the formation of a convention committee, headed by Brig. Gen. A. W. Marriner, to handle arrangements for the fourth national AFCA convention which will be held May 12th and 13th in New York City and Fort Monmouth, N. J. Col. George P. Dixon, AFCA Executive Secretary was present and reported on the results of the meeting of the convention committee and covered at length the very fine program being arranged by Gen. Lanahan and



HENRY HAS THE NEW hallicrafters

MODEL SX-71 NOW!



This new type of receiver—the first of its kind on the market—has extra sensitivity, selectivity, and definitely superior image rejection. Continuous AM reception from 538 kc to 35 Mc, and 46 to 56 Mc. One RF, 2 conversion, and 3 IF stages. 105-125 volts AC. 11 tubes plus voltage regulator and rectifier. Only \$179.50.



MEDIUM PRICED HALLICRAFTERS MODEL S-40A

540 kc. to 43 Mc. Temperature compensated. One RF, 2 IF, 3-watt output, 4 bands. 115 V. AC. 8 tubes plus rectifier. Internal speaker. Only \$79.95. Other popular Hallicrafters models: S38-A, only \$39.95; S-72, only \$89.95; SX-43, only \$159.50; SX-62, only \$269.50.

I have a complete stock of Hallicrafters receivers and transmitters. I'll make you the best deal on a trade-in for your communications receiver. I give you prompt delivery, and 90-day FREE service. Nobody can beat Bob Henry on a trade-in, and I offer you the world's lowest credit terms. Write, wire, phone, or visit either store today for the best deal.

Bob Henry
WARA

Butler 2, Missouri **HENRY RADIO STORES** 1124 Olympic Blvd. LOS ANGELES 35 CALIF.
"WORLD'S LARGEST DISTRIBUTORS OF SHORT WAVE RECEIVERS"

HEAVY DUTY STEEL DRAWER UNITS

Designed for the Modern Radio Man

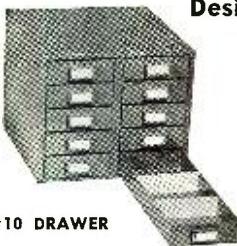

#10 DRAWER

\$4.95 Complete less dividers

\$5.35 Complete with 20 dividers

Sturdy construction, each drawer has a combination drawer pull and label holder. Rubber feet to prevent marring and slipping when used singly or when stacked.

Drawer dimensions: 3 3/8" Wide, 1 3/16" High, 7 7/8" Long.
Outside dimensions: 8" Wide, 7" High, 7" Deep.

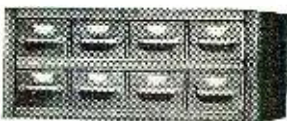

#8 DRAWER

\$10.50 Complete with two dividers per drawer

Made expressly for heavy duty use, of 18 and 20 gauge steel throughout. Each drawer will hold 9 crosswise dividers and one lengthwise divider, thus making 20 compartments per drawer. Each drawer and divider has a labelholder. Drawers will not spill, back of drawer will catch on ledge of shelf.

Outside dimensions 24"x10"x12" Deep
Drawer DIMENSIONS: 11 7/8" Deep, 5 3/8" Wide, 3 1/8" High.

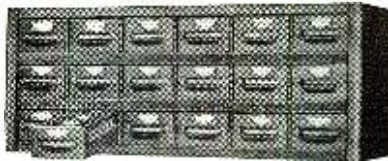

#18 DRAWER

Same construction as #8 Unit. Comes complete with two crosswise dividers per drawer. A total of 54 compartments.

Outside dimensions: 36" Wide, 13" High, 12" Deep.

\$21.50 Complete with two dividers per drawer

Ideal for all sizes of resistors, voltage dividers, condensers bypass, tubular, filter, coils, dials, knobs, pilot lamps, tubes, nuts, bolts, screws, lugs, and other hardware and tools. These handy drawer units will pay for themselves in a short time by affording you a complete inventory at a glance, no more lost parts.

Take advantage of our volume buying, by passing the saving on to you, when you order direct from manufacture agent.

Send for your large FREE catalogue.

All prices F.O.B. Chicago. 25% Deposit with order. Sorry no C.O.D. Send check or money order to

NATIONAL STEEL PRODUCTS

1018 West 86 Street

Satisfaction guaranteed

Chicago 20, Ill.

Boston's famous **RADIO SHACK**
MICROPHONE
SCOOP!

\$2⁸⁵
3 for \$8.00

Record-Low-Price CRYSTAL MIKE!
Lowest price EVER. Exclusive special purchase of a famous-maker's \$6.50-value crystal mike (crystal element alone is exact replacement for his \$10 units)! Excellent response 100-6000 cycles, ideal for public address, entertainers, hams, recording, etc. Streamlined metal case, 6 1/2 ft. cable. Sensitive! Brand new! Only \$2.85 each, 3 for \$8.00.

NEW DELCO DUAL BLOWERS



ONLY \$14.85

Brand new! FAR below regular price! Ideal for darkrooms, cooling xmtr tubes, draft boosting, humidifiers, dryers, ventilation, suction, shipboard, etc. Continuous duty, brushless, 115 V 60 cy. Operates at 2500 rpm. 120 cfm free vol. air delivery 62 watts input. Over-all 10 1/2" by 5 3/4" by 6 1/4". Net 11 lbs.



HUGE PRICE CUT ON FINE RCA TEST EQUIPMENT!

\$89.50 TEST OSCILLATOR REDUCED TO \$49.50!

Save \$40 on WR-67A, while they last. Order today! Frequency range: Fundamental — 100 kc to 30 mc in 5 bands; Fixed — 1500, 600 and 455 kc. Accuracy ± 2%. Output voltage (RMS) continuously variable 5 microvolts to 1 volt. Internal modulation 400 cps adjustable from 0-50%. Power-line filter 10 x 13 1/2 x 7 1/2" \$49.50

\$89.50 RCA VOLTOHMYST REDUCED TO \$39.50!

Battery-operated Type WV-65A, at huge \$48 savings! Ranges: 0-1000 VDC in 5 ranges, input resistance 11 megs all ranges; 0-1000 VAC at 1000 ohms/volt in 5 ranges; 0-1000 megs in 6 ranges; 0-300 milliamps DC in 5 ranges; 0-10 amps DC Complete with tubes and 1 meg shielded probe! Battery kit \$2.52 extra, if desired Only \$39.50 less batts.

\$19.95 G.E. 33 1/3 Record-Player, \$6.66



Brand new General Electric 33 1/3 LP attachment, originally sold for \$19.95! Quiet AC motor, compact plastic case Includes G.E. magnetic cartridge with replaceable sapphire stylus — alone worth almost our fantastically low \$6.66 price for the entire unit! With power cord, switch, instructions. Requires preamp.

The RADIO SHACK Corp.
167 WASHINGTON ST., BOSTON, MASS.

his staff at Monmouth for the second day of the convention.

Commissioner Webster's address on the manifold problems of frequency allocations was most timely as, with the integration of the armed services, it appeared that more frequencies may be made available for commercial communication use. A discussion period followed and many members expressed their agreement with the points made by Mr. Webster.

Philadelphia

Air Force color films, including one on photographic developments and a wartime film shot by Thunderbolts in action over Italy, were shown to an audience of 500 at the Philadelphia Chapter meeting in the Franklin Institute on January 30th. These films were shown in lieu of the scheduled feature on the program—Col. George W. Goddard's tri-dimensional color photography show—which was postponed until the next chapter meeting since Col. Goddard was grounded by bad weather at Wright Field, Ohio. Col. Goddard, who is Chief of the Photographic Laboratory, Engineering Div., Air Material Command, first presented the show to AFCA members at the national meeting in Dayton in 1948 and since then to several AFCA chapters.

After opening remarks by Chapter President W. W. Watts, vice-president of RCA Victor Div., the chairman of the chapter's membership committee, Leslie J. Woods, vice-president of Philco Corp., spoke on the present policies and aims of the AFCA and of the advantages offered to members.

The AFCA national Executive Secretary, George P. Dixon, was present and further elaborated on AFCA's activities in the immediate future. Speaking of the association's publication, Col. Dixon announced that *SIGNALS* would be considerably improved during this year and that it would be published monthly.

Southern California

Following the practice of other AFCA chapters, the Southern California Chapter is varying its meetings with visits to local communications and photographic activities. Its January 12th meeting featured an inspection tour and demonstration of the facilities and operation of the Armed Forces Radio Service in Hollywood.

Washington

Following out its program of service sponsored meetings for the 1949-50 season, Washington chapter members were guests of the Military Transport Service's Airways & Air Communication Service at Andrews Field, Md., January 18th.

A luncheon at Fort McNair was presided over by Chapter President Francis H. Engel (Washington manager of RCA Victor) and was highlighted by a talk delivered by the new AFCA Executive Secretary, George P. Dixon,

TELEVISION KITS
FACTORY TO YOU - LOWEST PRICES!

10"-12 1/2"-16" KIT \$84.50
COMPLETE (Less Tubes)

Complete with All Tubes, Incl. C.R. Tube
10" KIT.....\$129.50
12 1/2" KIT.....137.50
16" KIT.....157.50

MONEY BACK GUARANTEE

RCA-630 TYPE CHASSIS

30 tube, keyed A.G.C., Volt. Doubler, completely wired, aligned & ready to operate. For 16" or 19" CRT. Only \$159.50 with all tubes except CRT. Any model wired, tested, ready to play, \$20.00 additional.

All prices F.O.B. New York. 20% deposit with order. IMMEDIATE DELIVERY

Money-Back Guarantee—Buy it, inspect it. If you don't think it's the best buy on the market, return unused within 5 days and your money will be refunded.
WRITE FOR FREE CATALOGUE

SOVEREIGN TELEVISION CO.
5508 New Utrecht Ave. Bklyn 19, N. Y.

TUBES					
0A2	\$1.55	6AK5	\$.85	6SH7	\$.47
0A3/VR7595	6AQ557	6Y6G69
0B2	1.72	6AU660	12SA756
0B3/VR9070	6BG6G	1.49	12SK756
0C3/VR10575	6C425	811	2.49
0D3/VR15059	6C548	813	7.95
1B3/8016	1.49	6J589	816	1.17
5R4GY	1.10	6N6	1.19	829B	7.95
0	7.50	6X455	866A	1.10
5Y3GT42	616	1.19		
6AC779	6SK755		
6AG579				

3" METERS	
0-50 ua dc WH	\$17.50
0-50 ua dc RS	13.50
0-200 ua dc WH	10.50
0-500 ua 4" sq.	5.95
0-1 ma dc WH	7.50
0-1 ma dc S scale ..	3.95
1-0-1 ma Sp. Scale ..	2.95
0-2 ma dc WH	5.95
0-2 ma dc Simp.	4.95
0-5 ma Sp scale	3.95
0-15 ma dc GE	3.95
0-20 ma dc WH	3.95
0-100 ma dc Dej.	3.95
0-200 ma dc GE	3.95
0-1000 ma dc Dej.	3.95
0-2 amp dc Simp.	5.95
0-500 vdc WH	7.95
0-8 vac West 476	3.95
0-15 vac WH	3.95

MISCELLANEOUS	
FIL. XF0RM 6.3V 12.5 15V 60C input 4 lbs.	\$1.75
FIL. XF0RM 6.3V 1.2A 115V 60C input89
Sens. plug in relay 2000 ohm 2MA SPDT79
NEW H530 Miniature earphones	1.49
NEW H530 earphones & HIGH IMPED XF0RM	1.25
BOWERS SQ. METER OD 2 3/4" 0-100A & Shunt	1.25
BOWERS SQ. METER OD 2 3/4" 0-100A & Shunt	1.25
1000 or 5000 Kc. Mtd. Nial	ea. 2.50
15MF 1000V oil cap. \$2.95; 5MF 2KV oil cap.	5.50
4 dir. Vooder ctr. \$0.99; 10K or 50K 100V RES. \$0.49; 200MMF VARIABLE CAP.	\$0.15

2" METERS	
0-1 ma GE	\$3.95
0-1.5 ma West 506	4.75
0-1 ma West 506	4.75
0-30 vdc GE	3.50
0-1 amp r GE	3.50
0-9 amp r WH	3.50
0-30 amp dc GE	3.50
0-10 vac GE	3.50
0-300 vac Trip	5.95

POLY-TECH
919 Dawson Street New York 59, New York
25% Deposit with Orders, Balance C.O.D.

BENDIX RA-10 AIRCRAFT RECEIVERS
From Army-Navy Stockpiles of BRAND NEW Equipment

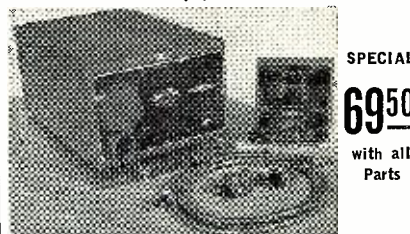

SPECIAL

69.50

with all Parts

This 8-tube Superheterodyne set may be employed for reception of continuous wave, modulated continuous wave, or radio telephone signals in two frequency ranges, 150 to 1100 and 2000 to 10000 KC. Power requirements: RA-10CA is designed for 14 volt DC operation source, model RA-10DA is operated from a 28 volt DC source. Current drain at 14 volt DC is 6.0 amps. Current drain at 28 volts is 3.0 amps. Sensitivity: Modulated continuous wave sensitivity, when measured at signal to noise power ratio of 4:1, is better than 6.5 microvolts.

Write for Latest Bulletin

NORMAN ELECTRONIC SALES
1930 S. State Street Chicago 16, Illinois

CORRECTION

In the January 1950 issue, the item A... S-C personalized radio was listed in error at...\$21.95 This should have been...\$23.95 We regret this error.

WARREN DISTRIBUTORS

3145 Washington St., Jamaica Plain 30, Mass.

AMPERITE

Studio Microphones at P.A. Prices

**Ideal for
BROADCASTING
RECORDING
PUBLIC ADDRESS**

"The ultimate in microphone quality," says Evan Rushing, sound engineer of the Hotel New Yorker.

- Shout right into the new Amperite Microphone—or stand 2 feet away—reproduction is always perfect.
- Not affected by any climatic conditions.
- Guaranteed to withstand severe "knocking around."



Models
RBLG—200 ohms
RBHG—Hi-imp.
List \$42.00

"Kontok" Mikes
Model SKH, list \$12.00
Model KKH, list \$18.00



Special Offer: Write for Special Introductory Offer, and 4-page illustrated folder.

AMPERITE Company, Inc.
561 BROADWAY • NEW YORK 12, N. Y.
Canada: Atlas Radio Corp., Ltd., 560 King St. W., Toronto

How to Get Ahead in TELEVISION RADIO-ELECTRONICS

• Your success in this highly technical field depends on how much you know and how well you apply that knowledge. Graduates of CREI Residence School agree that electronics offers interesting jobs at impressive salaries—to qualified young men.

How to Become Well-Qualified

You can be assured of a professional career as a CREI Residence School graduate because CREI offers:

- College level instruction by outstanding instructors
- Modern teaching facilities, including laboratories, shops, equipment and studios
- 23 years of practical teaching experience
- Industry-wide reputation for superior training

No Time Wasted

New students are accepted twice monthly. Each may advance as rapidly as he is capable. The basic course with one specialized course requires an average of 20 months to complete.

Illustrated Catalog Free

Send for the new CREI catalog and course outline. It tells about opportunities in the expanding electronics field, suggests background requirements, gives examples of CREI teaching methods, tells what CREI training can do for you. Use coupon below.

VETERANS: Training G.I. Approved.

CAPITOL RADIO ENGINEERING INSTITUTE

An Accredited Technical Institute Founded in 1927

Capitol Radio Engineering Institute, Dept. 134B
16th & Park Road, N.W., Washington 10, D. C.

Please send me your residence school catalog and complete details.

Name.....

Age.....If in school, what term?.....

Street.....

City.....Zone.....State.....

I am entitled to training under G.I. Bill. Send information on Home Study Courses.

in his first appearance before a chapter since he took office January 3rd.

Before leaving for Andrews Field, the major air installation near the national capital, the more than 130 members present at the luncheon were welcomed on behalf of the Air Force by Maj. Gen. Francis L. Ankenbrandt, director of communications for the U. S. Air Force.

Nearly a hundred of the chapter members went from the luncheon to the air base, where they were greeted by Brig. Gen. Wallace G. Smith, commanding general of the AACS. On the tour of the field the members watched operations in the communications center; GCA out near the runways; the control room which utilized the AN/CPN-18, a precision search radar with a 40-mile range; and the facsimile center, where weather maps are received from all over the United States and from military installations in Europe and the Far East, and relayed on to other points. —50—

SERVICE GROUP MEETS

THE annual meeting of the Television Installation & Service Association, held at the Stevens Hotel in Chicago, resulted in the re-election of President Frank J. Moch of the Aide Sound & Radio Service Corporation to a third term. Re-elected with him were Irving Kaluzna of Television Engineers, Incorporated as vice-president, and Fred H. Levine of A West Side Radio & Television Service as secretary. Martin Reese of Television Technicians, Incorporated was named to the treasurer's post.

The meeting also considered the television servicing problems which have arisen as a result of attempts at reduction in rates coupled with general poor quality. Amendments to the bylaws of TISA were made to expedite the solution of these and other servicing problems. The organization is also putting on a concerted drive to enroll every ethical service company in the metropolitan Chicago area. —50—

TV DEMONSTRATION

AN international group of television technicians, representing member countries of the C.C.I.R. (International Radio Consultive Committee) of the International Telecommunication Union is currently visiting the United States at the invitation of the State Department.

United States television technicians are conducting demonstrations for the group in the New York, Philadelphia, and Washington areas. After viewing U. S. television operations the group will study the French, Dutch, and British systems as a basis for recommending a single set of standards to their respective governments for adoption on a regional or world basis. If such an agreement can be reached, it will facilitate the interchange of programs among nations, and provide an international television system based on the best available technical knowledge.

Persons from Austria, Belgium, Czechoslovakia, Denmark, France, Hungary, Italy, Netherlands, Sweden, Switzerland, United Kingdom, Yugoslavia, and the United States are members of the group. —50—

WHAT IS YOUR PROBLEM?

You will find the answer in

Radio & Television Mathematics

A Handbook of 721 problems AND SOLUTIONS

Save time and trouble. Arranged under radio and electronic headings and completely indexed for quick reference, these problems give you step-by-step solutions to every problem commonly arising in work on receivers, power supplies, antennas, amplifiers, tubes, transmitters, etc. If you are ever "stuck" on a calculation; if you need a check on your figuring; or if you want to refresh your memory on the formulas to use for a certain problem—you will find your answer quickly and easily in this book.

Good practice for your FCC exams. This book shows you how to solve every problem requiring mathematics in the FCC STUDY GUIDE for licenses of all classes. You will find no better handbook for practice in solving problems with ease, speed and accuracy. \$6.00

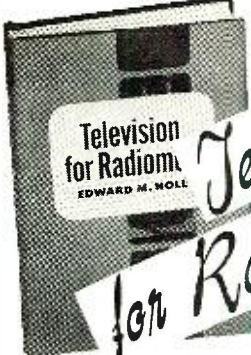

Just Published
Television for Radiomen
EDWARD M. NOLL

The how's AND WHY'S in the practical terms of operation & servicing

This book explains the theory as well as the techniques of television construction, operation, and servicing in the clearest, most practical terms. It gives the radioman all the basic information he needs to meet the increasing demand for skilled television technicians. It shows how and why all modern equipment operates; includes all the essential mathematics and especially good material on antennas. \$7.00

SEE THEM FREE

The Macmillan Co., 60 Fifth Ave., New York 11

Please send me a copy of the books checked below. I agree to remit in full or return the books within ten days without further obligation.

- Radio & Television Mathematics, \$6.00
 Television for Radiomen, \$7.00

Signed.....

Address.....

SPOT SURPLUS! SPECIALS!

MODULATION TRANSFORMER 1KW
Thermador or Sola, Sig. Corp. data: Pri. Imp. 6600 NEW!
Ohm C. T. 500 MA. Sec. 4600 Ohm 400 MA. Sec. \$18.95
2300 Ohm 800 MA. Ship. wt. approx 65 lbs.

PE 103-A DYNAMOTOR
6 or 12 volt input. Output 500 V. 160 MA. Compl. w/all
cables and filter box. Ship. wt. 75 lbs. Guar-
anteed. \$17.95

AMERTRAN TRANSFORMER—5 V. 190 Amp. \$15.95
Pri. 105-125 V. 25 KV. Insul. Wt. 100 lbs.

RELAY-PLATE, SENSITIVE—G.E.
2000 Ohm, S.P.D.T. 5 prong base plug-in type. Sealed.
Operates on 3 MA. Ideal for photoflash slave appli-
cations. With socket and circuit. \$1.95

Complete Kits • All New • Special!

100 INSULATED RESISTORS—NAME BRANDS
RMA color coded. ¼, ½, 1, 2 watt. Many 5% tol.
Over 50 resistance values. Compl. Kit. \$1.75

100 CARBON NON-INS. RESISTORS
RMA color coded. ¼ to 2 watts. Contains over 25
resistance values. Compl. Kit. 95c

50 RF CHOKE COILS
All sizes for plate, grid, filament circuits. For
Trans., TV. Osc., etc. Compl. Kit. \$1.45

50 MICA CONDENSERS
Over 20 values. incl. popular silver mica types.
Compl. Kit. \$1.75

25 PRECISION WIRE WOUND RESISTORS—NAME BRANDS
Many popular numbers. Over 20
values. Compl. Kit. \$1.95

POTENTIOMETER KIT—15 TYPES
Carbon and wire wound. S.D. and shaft types. In-
cludes ¼ and 1 MEG. with switches. \$1.95

50 CERAMIC CONDENSERS
Over 25 values. Color coded. \$1.95

50 BY-PASS CONDENSERS
Tubular. Pop. values, all purposes. A TERRIFIC
BUY! \$1.75

20 ELECTROLYTIC CONDENSERS ONLY!
Tubular, FP types, Upright types. Pop. numbers
for replacement or set building. GUARANTEED. \$2.25

SOCKET KIT—40 ASSORTED
4-5-6-7-8 prong, ceramic types, wafer, 7 pin mini-
ature, acorn, molded, etc. \$1.75

HOOKEUP WIRE KIT
Cut lengths. 2" to 12" asstd. Ends stripped, some tinned.
Solid and stranded. Mixed colors. 2 lbs. approx. \$1.25
400 ft.

TIE POINT ASSORTMENT 95c
2-3-4-5-6-7-8 points per strip. Over 50 strips.

All prices FOB Phila. Check or M.O., no COD's. Please
include sufficient postage. Balance promptly refunded.
Other shipments via express collect.

THE ELECTRIC SPOT

132 S. 11th St. Phila. 7, Pa.

STAR SPECIAL!

**5CP1—CATHODE RAY TUBE
WITH SOCKET**



\$1.95

Brand new, individ-
ually boxed. Popular make
5CP1 at a price much lower
than you would expect to pay. Used in
oscilloscopes, for TV test and for other ex-
perimental purposes. Every tube A-1. Our
low price includes correct socket for tube.
A-259—5CP1 CR Tube and Socket... \$1.95

COMPLETE STOCKS
All Standard Brands Just off the press
BIG BARGAIN BULLETIN



**ELECTRONIC
DISTRIBUTORS, INC.**

Dept. RN-2-7736 S. Halsted, Chicago 20, Ill.

Classified

Rate 35c per word. Minimum 10 words

RADIO ENGINEERING

PANELS for electronic, nucleonic construction
projects. Complete service for designers, custom
builders. Circular upon request. Gilpin Instru-
ment Works, P. O. Box No. 8, Mt. Clemens, Mich.

**RADIO Engineering Broadcasting, Aviation and
Police Radio, Servicing, Marine Operating and
Electronics** taught thoroughly. Expenses low.
Write for catalog. Valparaiso Technical Institute.
Dept. N., Valparaiso, Ind.

SALE

ANTENNAS, yagi arrays, folded dipoles. Write
for free lists. Southwest Engineering & Elec-
tronics, 6520 Itaska St., St. Louis, Mo.

TEN METER Beams, \$14.95. SWL-QSL Cards.
200 for \$2.50. Tubes, Surplus. Write: Royal
Radio Supply, 1920 N. 27th St., Milwaukee 8, Wis.

SIGNAL Generator. Hickok Model 288X Universal
Crystal controlled, unused, \$125.00. Meredith
Radio, Box 214, Meredith, N. H.

FIVE Element TV Yagi Beams. High Band, \$6.75.
Low Band, \$8.50. Aluminum Tubing, etc. Willard
Radcliff, Fostoria, Ohio.

COAXIAL Cable. Identical Characteristics as
RG-58/U. Send dime for 3-foot sample. Harry
H. Van Dick, Box 236, Little Falls, N. J.

TELETYPE Equipment. Model 12, complete plus
Reporformation equipment. Semel, 111-55 77th
Ave., Forest Hills, N. Y.

SCREWDRIVER adjustment rheostats, 10 watt,
100 ohms, 6 for 50c; Solenoids 24V 35c; Micro
switches 3 for 50c; Relays 24V 8 for \$1.00;
Toggle switch guards 12 for 50c. Postpaid. Stuart
Sales, 6402 Pittsburg, Detroit, Mich.

SPRAYBERRY Radio Course. Complete with all
kits. \$50.00. W. Shuster, Rt. 5, Box 439, Niles,
Mich.

BC603, SCR625 MINE detector, TV heatkit gen-
erator, \$75 for all. Robert Ireland, Pleasant
Valley, N. Y.

500 RAZOR Blades 1st quality double edged, \$4.00
postpaid. Money back guarantee. Olander, 68
Mill, Manchester, Conn.

COLOSSAL bargain in radio parts, over 150 as-
sorted radio parts including resistors, condensers,
controls, coils, etc. All new, \$75.00 value, guar-
anteed satisfaction or money refunded, postpaid
in U. S. A., \$2.50. Write for catalog. Buyers
Syndicate, 30 N. Taylor St., Springfield 3, Mass.

WEBSTER No. 80 Wire Recorder, accessories,
Hallcrafters S-38 receiver. All \$110. Martin
Robertson, Hawthorne, N. Y.

HEARING Aids. Zeniths, Western Electrics. Re-
conditioned. Make miniature transmitters or re-
ceivers. Complete with ear piece and cords, \$16.00
each. Gloria Davis, 2135 Caton Ave., Brooklyn,
N. Y.

CARBON Tetrachloride, cleaner, solvent, 27 oz.,
\$1.50. Polystyrene high frequency coil and splice
dope, \$1.00 pint. Special thinner, 65c pint. Craft
Chemical Lab., 453½ E. Exchange St., Akron 4,
Ohio.

RECORD Changer Parts for leading makes. We
ship everywhere. Friend's Wholesale Distributors,
106 N. 6th St., Philadelphia 6, Pa.

MAGNET Wire, all sizes. Write for prices. Peters
Electric Co., Box 1222, Vassar, Mich.

TELEVISION, we specialize on antennas for fringe
areas, yagis conicals circles. Send for free list.
Bevington Service Shop, Bowling Green, Ohio.

WEBSTER Chicago record changer and wire re-
corder replacement parts. We ship everywhere!
Friend's Wholesale Distributors, 106 N. 6th St.,
Philadelphia 6, Pa.

BARGAINS. New and reconditioned Hallcrafters,
National, Collins, Hammarlund, RME, Meissner,
other receivers, tuners, television receivers, trans-
mitters, amplifiers, speakers, etc. Lowest whole-
sale prices. Terms. Shipped on trial. Liberal
trade-in allowances. Write. Henry Radio, Butler,
Mo., and 11240 W. Olympic, Los Angeles, Calif.

LOWEST Prices Radio Tubes, parts. Bargain
lists, 3c. Potter, 1314 McGee, Kansas City 6, Mo.

EMERSON Tubes, 40% to 60% off list. All types.
Year's guarantee. Free listing. Jos. Kase Elec-
tronics, 245 Echo Place, Bronx 57, N. Y.

HOTTEST surplus list in the country. Elec-
tronics-Hydraulics, Aircraft-Gadgets. Dick Rose,
Everett, Wash.

JENSEN QSP tweeters and network, 12" speaker
and audio transformers. Write for list and quota-
tions. Norman E. Wilson, 70 Greenwood Ave.,
East Orange, N. J.

CODE Practice Tapes. For rapidly increasing your
speed, preparing for FCC code tests. Fits most
phototube keyers. For list and prices write:
Ultradyn Electronics, Oswego, Ore.

ONE each Meissner Analyst, Solar Exam-eter,
35% off. Mountain Specialties, Westcliffe, Colo.

PANEL Meters. One half off net prices. Send for
free list. Victor's Radio & Television Co., 105
Union St., Lynn, Mass.

ALL Steel T.V. Towers which can be erected to
70' or more. Built to climb. Shipped direct from
the factory at \$8.50 F.O.B. per 10' section. Weight
20 pounds per section. Write for more details. The
Youngstown Steel Towers, 1316 Wilson Avenue,
Youngstown 8, Ohio.

PARTS for articles described in this magazine.
Reasonable. Leo J. Vince, W8FYA, 2805 E.
117th St., Cleveland 20, Ohio.

RADIO Diagrams under seven tubes, 30c; over
six tubes, 60c; Record Changers, 60c; Television
Diagrams with service data, \$1.00 up. State manu-
facturer and model number. Kramer's Radio Ser-
vice, 36 Columbus Ave., New York 23, N. Y.

FULL Wave Rectifiers, RA-50, In 115/1/60 Out
12KV, 35ma, DC; MG sets 110V DC to 110V AC,
1KW; also 6V Vibrators. Vetsalco, 74-21st Ave.,
Paterson, N. J.

B-29 Surplus Computers, \$25.00. Amplidynes,
\$9.00. Get list. Smead, 5608 Commercial, Everett,
Wash.

B.C. 348 RECEIVERS, \$110. Send for samples of
following. 4" to 6" Fiber glass insulation tape.
Kraft paper insulating tape. Fiber glass treated
sleeving. Clear plastic sleeving: Hanson Van-
Winkle 220-440-3 to 6 volt 100 amp. rectifier with-
out elements. General Electric 5CR120 Rectifier
380 to 500 volts 3ph. to 24 volts 100 amp. con-
tinuous, 550 amps., intermittent. Longo's, 279
Fellsway West, Medford, Mass.

TV ALL Channel Conical Antenna with reflectors,
less mast, \$7.50. Free listing tubes, parts. Will
do your buying any item. Jos. Kase Electronics,
245 Echo Place, Bronx 57, N. Y.

WANTED

WANT to buy BC447, APS-6, ARC-5. Interested
in substantial quantity for parts requirements new
or used condition acceptable. Harry O. Eyrse,
P. O. Box 218, Grand Prairie, Tex.

SNIPERSCOPE & Snooperscopes wanted. Any
type, any condition. Needed immediately. Box
495, % Radio & Television News, 185 N. Wabash
Ave., Chicago 1, Ill.

NAVY Model LR frequency meter in good con-
dition. ARS, Box 2525, Ketchikan, Alaska.

HELP WANTED

TECHNICIANS! Engineers! Interested in a top-
paying electronic position? Send post card for in-
formation on How, Why, Where. Mid Continent
Research Bureau, P. O. Box 121, Wichita, Kan.

TECHNICAL Writer. As collaborator in the writ-
ing of a Practical Radio-Television Home Study
course. State experience fully. Box 500, %
Radio & Television News, 185 N. Wabash Ave.,
Chicago 1, Ill.

INSTRUCTORS in Electronics and Radio. Prefer
former Navy Radio Technician instructors willing
to locate in the Detroit, Mich., area. Write to Box
452, c/o Radio & Television News, 185 N. Wabash
Ave., Chicago, Ill.

RADIO Instructors. For theory and lab. Write
for application form. Paterson Radio Institute,
217 Paterson St., Paterson, N. J.

SITUATION WANTED

SALESMAN, Ex-Ham will represent you in Cali-
fornia. Box 499, % Radio & Television News,
185 N. Wabash Ave., Chicago 1, Ill.

PATENT ATTORNEYS

LANCASTER, Allwine & Rommel. Registered
Patent Attorneys. Patent practice before U.S.
Patent office. Validity and infringement investi-
gations and opinions. Booklet and form "Evi-
dence of Conception" forwarded upon request.
Suite 414, 815 15th St., N.W. Washington 5, D.C.

HERMAN Lewis Gordon, Registered Patent At-
torney. Patent Investigations and Opinions. Warner
Building, Washington, D. C.

CORRESPONDENCE COURSE

RAILWAY Telegraph Instruction. Be a Tele-
grapher. Complete training. Instruments fur-
nished. Positions waiting. Details. Bell Tele-
graph Railway Institute, 10 Parker Ave., San
Francisco 18, Calif.

USED Correspondence Courses and Educational
Books bought, sold, rented, catalog free. Educa-
tional Exchange, Summerville, Ga.

RADIO & TELEVISION NEWS

AMATEUR radio licenses. Complete code and theory preparation for passing amateur radio examinations. Home study courses. American Radio Institute, 101 West 63rd St., New York 23, N. Y. USED Correspondence Courses and Books sold and rented. Money back guarantee. Catalog free. (Courses bought.) Lee Mountain, Pisgah, Ala.

MISCELLANEOUS

CIRCULAR Saw Blades: 8" diameter. Sample \$2.90. H. Van Dick, Little Falls, N. J.

WIHJI, QSL's, SWL's. Samples free. Box 32C, Manchester, N. H.

"RAPID Radio Repair" now being published. Order now, \$1.25. Postpaid or C.O.D. Book written since my letter September Radio News. "Well written, wealth of good practical information," says Engineer Weiss, Hickok Co. John D. Burke, 168-08 90th Ave., Jamaica, New York, N. Y.

24-PAGE Plans "18 Crystal Sets" (SW record 5800 miles), "Radiobuilder" and catalog 25c. Laboratories, 578-H, San Carlos, Calif.

FREE Radio Parts dictionary, Telegraph Code Instructions and Catalog of Kits. Write today! Build your own receivers, transmitters, test equipment with our easy-to-assemble Pict-O-Graph instructions. Start building now, send \$1.00 for complete crystal radio kit. Electronic Kit Co., 326D Park Row Bldg., New York, N. Y.

101 RADIO repairing tips booklet. Send 50 cents. U. S. Radio, 135 E. 28th St., New York 16, N. Y.

EMBOSSSED Cards, Envelopes, Letterheads. Samples. Spada Enterprises, 4 Eastview, Rocky Hill, Conn.

RADIOMEN, Servicemen, Beginners. Make more money, easily, quickly, \$250 weekly possible. We show you how. Information free. Merit Products, 216-32R 132 Ave., Springfield Gardens 13, N. Y.

PHONOGRAPH Records, 15c. Catalogue free. Paramount, VE-313 East Market, Wilkes-Barre, Pa.

PHOTO CREDITS

PAGES	CREDIT
35, 37	William P. Durning
41	Arthur E. Haug
49, 50	Hickok Electrical Instrument Co.
57	Hyttron
62, 105	Radio Tahiti
77	MARS
102	The Brush Development Co.
106	Air Materiel Command, Wright-Patterson Air Force Base
109	Bill Wood
144	South Plains Amateur Radio Club
148	E. G. DeCastro

ERRATA

The photographs accompanying the article "Processing Radio Transcriptions" appearing in the February issue of this magazine were taken by the author at Recorders Labs, Limited, 6916 Santa Monica Blvd., Hollywood 38, California.

In the January issue, in the article "Aircraft Radio," was a misstatement regarding the operation of the "Z" marker. The "Z" marker is modulated by a steady 3000 cycle tone. "Z" markers (also called station location markers) are installed at most radio range stations (low frequency ranges) to identify the cone of silence. They operate on a frequency of 75 mc. and are modulated by a steady 3000 cycle tone. The output is approximately 5 watts.

Radiation is vertically upward into the cone of silence and the radiation pattern conforms roughly with the cone. The cone of silence identifies the station by the absence of the signals from the radio range.

The "Z" marker gives a positive identification of the cone. Signals from the "Z" marker may be converted into visual or aural indications depending on the receiver installation in the particular aircraft.

ANSWERS TO "FM QUIZ" PAGE 152

1. c	6. b	11. d
2. c	7. c	12. c
3. b	8. a	13. b
4. a	9. a	14. b
5. d	10. a	15. d

SCORING TABLE

15 correctexcellent
13 to 14 correctvery good
10 to 12 correctgood
8 to 9 correctfair
7 or less correctpoor

In Fair Weather or

FOUL...

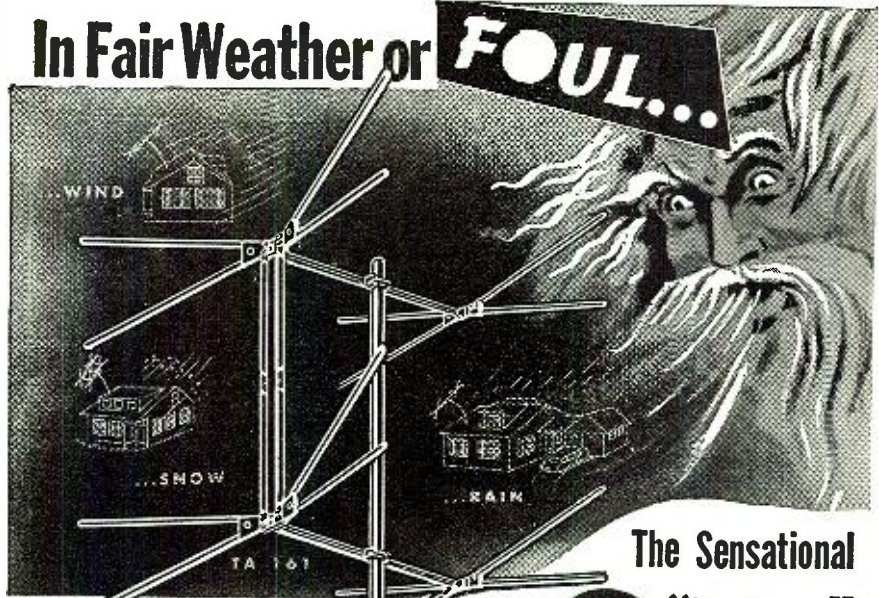

TA 161...Double "D-Xer" All-Band Conical. 1/4 wavelength stacked. Provides exceptionally high DB gain on both bands, Channels 2 to 13.

The Sensational



"D-Xer"

All-Aluminum Conical Antennas

THEY ARE STRONGER!

Rugged construction. The only Conicals with reinforced elements. Will not bend, sag, sway or whip. Withstand all kinds of rough weather - wind, snow, rain, hail, etc.

MORE ECONOMICAL!

Feature-for-feature, quality-for-quality, performance-for-performance, JFD "D-Xer" All-aluminum Conicals give more for the money than any other antenna. The smart serviceman looks for the reinforced element.

AND MORE PROFITABLE!

"D-Xer" Conicals sell faster - more easily. They require minimum servicing. Once put up, they stay put up - and they stay sold!



MANUFACTURING CO., Inc.

6105 16th Avenue, Brooklyn 4, N. Y.

FIRST in Television Antennas & Accessories

Write for Free Descriptive Bulletins

Spectacular!
100 assorted tubes
only **\$27.50**

Terrific Money-Saving Values!
On Guaranteed Quality Tubes!

1B4	6AR5	6L5	25L6
1G4	6AS5	6P5	25Z6
1H6	6AT6	6S8	26
1F4	6AU6	6SA7	27
1C7	6AV6	6SD7	30
1R5	6AW6	6SK7	32L7
1S4	6BA6	6SQ7	33
1S5	6BA7	6SH7	36
1T4	6BE6	6W4	37
1U4	6B5	6X4	38
1U5	6B8	6X5	39
1V	6BH6	12A8	46
2E5	6BJ6	12A5	47
3A4	6BQ6	12A6	53
3A5	6C4	12AU7	55
3Q4	6E5	12AX7	56
3V4	6F7	12BA7	57
6AB4	6F8	12BE6	58
6AG5	6F9	12BN7	77
6AK6	6J5G	12SN7	77
6AL5	6J6	12Z3	9002
6AQ5	6K5	19T8	11723

All orders filled promptly. All tubes individually boxed. Order Now! ... this offer limited to stocks on hand. Hurry!

Any Tube Above 32c Each. Add 50c Handling Charge on Orders Under 100 Tubes.

LOWEST PRICES ANYWHERE ON HIGHEST QUALITY TUBES!

TYPE PRICE	TYPE PRICE	TYPE PRICE	TYPE PRICE	TYPE PRICE	TYPE PRICE
1A5...\$0.49	6A7...\$0.59	6K8...\$0.59	7B5...\$0.49	12SF5...\$0.49	35L6...\$0.39
1A7... .49	6A8G... .49	6L6... .69	7C5... .49	12SF7... .49	35W4... .39
1B3... .49	6AC5... .59	6N6... .69	7F4... .49	12SJ7... .39	35Z4... .39
1C8... .49	6AK5... .69	6Q7... .39	7T4... .49	12SK7... .39	35Z5... .39
1C6... .49	6BF6... .39	6S4... .39	12AT6... .39	12SL7... .49	41... .49
1H5... .39	6BG6... .99	6SC7... .49	12AT7... .59	12SQ7... .39	42... .49
1N5... .49	6C5... .39	6SF5... .49	12AV6... .39	12SR7... .39	45Z5... .49
1X2... .49	6C6... .49	6SF7... .49	12BA6... .39	19BG6... .99	50B5... .39
1P5... .49	6C8B... .49	6SJ7... .39	12BF6... .39	24A... .59	50C5... .39
2X2... .59	6D5... .49	6SL7... .49	12J5... .39	25AC5... .69	50L6... .39
2A7... .49	6F5... .39	6SN7... .39	12J7... .49	25BQ6... .69	70L7... .79
3Q3... .49	6F6... .39	6T7... .49	12K7... .39	25W4... .39	75... .49
3S4... .49	6H6... .39	6U7... .59	12K9... .39	25Z5... .39	76... .49
3U4... .39	6J5... .39	6V6... .49	12Q7... .39	35/51... .49	80... .39
5Y3GT... .39	6J7... .49	6V7... .49	12SA7... .39	35B5... .39	117L7... .79
5Z3... .39	6K6... .39	7A7... .49	12S8... .59	35C5... .39	117P7... .79
5Z4M... .59	6K7... .49	7C4... .39			

Save 5% on Orders of 100 or More!!!

50c Handling Charge on Orders Under \$5.00.

ALL ORDERS SHIPPED C.O.D.

Owl Radio Tube Company

32 BEECHER STREET • NEWARK 2, N. J.



The ROSE CO. TV SCOOP!

630 Type TV
16" Chassis
A Steal At

FACTORY
WIRED



\$159.50

Complete
(Less CR
Tube)

16" Glass
Picture
Tube
(1 yr.
guarantee)

\$44.50

NOTE: This is not a Kit but a **FACTORY CUSTOM ENGINEERED, WIRED, TESTED and aligned TV Chassis.** Just plug in and it works. Full TV Channel Coverage. Voltage Doubler, complete with 30 tubes.

CHASSIS, as above, but with automatic Gain Control, incl. an additional 6AU6 tube, to eliminate interference.

Your Cost.....\$169.50

RCA Lic. 16" Table Model TV Set

"ALL CHANNELS" A BUY AT \$187.15

Complete with Cabinet and Picture Tube. Mfg. by **REGAL**



Giant 140 sq. in. Screen. Improved Regalok to hold picture tube securely. A.C.C. for greater stability and Smart Mahogany Veneer Cabinet.

TV ACCESSORIES

RCA Type Antenna: Folded dipole Hi. & Lo. adjustable reflectors. complete with hardware and 5 ft. mast.....\$5.45

FOLDED DIPOLE and Reflector, hifreq. antenna.....\$2.75

TABLE TOP 3 Section antenna,.....\$2.75

300 Ohm Twin Lead, per 100 ft. \$1.65 per 1000 ft. \$16.95

CHIMNEY MOUNTS complete with straps for mounts up to 1 1/2". List \$4.50..... per pr. \$1.59

WALL MOUNTS—distance from wall to mast is adjustable to 20" clearance from wall. List \$7.00..... per pr. \$3.15

HEAVY STEEL wall mounts—clearance of 4" from wall. List \$1.50..... 49c

NEW TYPE STAND OFF insulators for 1/2" mast, snaps on the mast (You do not need to screw into wall). In lots of 10. 65 each.

Write Dept. RN-4 for Descriptive Literature. All Prices F.O.B. New York. 25% Deposit required on all orders. Minimum Order \$5.00.

THE ROSE COMPANY 98 Park Place
New York 7, N. Y. (Corner Greenwich St.)

JOBS in TELEVISION



TELEVISION TECHNICIANS NEEDED AT ONCE

QUALIFIED MEN ONLY • GOOD PAY
STEADY WORK • GOOD FUTURE

AMERICAN RADIO INSTITUTE

CAN TRAIN YOU FOR THIS JOB

New York 2010 B'way (68 St.)
Buffalo, N. Y. 640 Main St.
FREE EMPLOYMENT SERVICE—GI APPROVED

Syracuse, N. Y. 431 Shonnard St.
Mount Vernon, N. Y. 174 Gramatan Ave.

INDEX OF Advertisers

APRIL 1950

[While every precaution is taken to insure accuracy, we cannot guarantee against the possibility of an occasional change or omission in the preparation of this index.]

ADVERTISER	PAGE	ADVERTISER	PAGE
Acorn Electronics Corp.....	118	MacKay Television Corp.....	146
Aerovox Corporation.....	17	MacMillen Co., The.....	157
Alliance Manufacturing Company.....	23	Mallory & Co., Inc., F. B.....	4th Cover
Allied Radio.....	9, 147	Mass. Radio School.....	150
Almo Radio Co.....	147	Master Mobile Mounts, Inc.....	132
Altec Lansing Corporation.....	100	Meissner Mfg., Division Maguire Ind., Inc.....	18
American Radio Institute.....	150	Merit Transformer Corp.....	126
American Television & Radio Co.....	138	Midwest Radio & Television Corp.....	141
American Time Corp.....	157	Millwaukee School of Engineering.....	119
Amperite Company, Inc.....	135	Murray Hill Books, Inc.....	77
Amplifier Corp. of America.....	150	McConnell's.....	121
Approved Electronic Inst., Corp.....	99	McGee Radio Company.....	78, 79, 80, 81
Arrow Sales, Inc.....	14	McGraw-Hill Book Co.....	136
Ashe Radio Co., Walter.....	116	National Company, Inc.....	146
Astac Corporation, The.....	153	National Radio Institute.....	3
Audak Company.....	147	National Schools.....	3rd Cover
Baltimore Technical Institute.....	148	National Steel Products.....	155
Barb City Industries Inc.....	32	Newark Surplus Materials Co.....	132
Bell Telephone Laboratories.....	131	Newcomb Audio Products Co.....	110
Bliss Electrical School.....	109	Niagara Radio Supply Corp.....	83, 97
Bond Equipment.....	104, 128	Norman Electronic Sales.....	156
Boyd-Roche Book Co.....	116	Offenbach & Reimas Co.....	105
Brook Electronics, Inc.....	27	Ohmite Manufacturing Co.....	33
Browning Laboratories, Inc.....	115	Olson Radio Warehouse, Inc.....	84, 85
Brush Development Company, The.....	137	Opad-Green Company.....	93
Buffalo Radio Supply.....	106	Owl Radio Tube Company.....	159
Candler System.....	29, 157	Peak Electronics Co.....	134
Cannon Electric Development Company.....	12, 13	Penn Boiler & Burner Mfg. Corp.....	86
Capitol Radio Engineering Institute.....	98, 129	Permoflux Co.....	145
Centralab, Division of Globe-Union, Inc.....	12, 13	Phoenix Electronics, Inc.....	151
Certified Television Laboratories.....	32	Photocon Sales.....	111
Chancellor-Chief Co.....	131	Platt Electronics Corp.....	103
Channel Master Corp.....	95	Poly-Tech.....	156
Chapman Laboratories.....	108	Precision Electronics, Inc.....	120
Chelsea Television Center, Inc.....	153	Premier Radio Tube Company.....	107
Chicago Industrial Instrument Co.....	5	Progressive Electronics Co.....	137
Circle-X Antenna Corp.....	121	Pyramid Electric Company.....	26
Cleveland Institute of Radio Electronics.....	139	Quad Electrical Supply, Inc.....	124
Columbia Electronic Sales.....	91	Quam-Nichols Co.....	127
Comet Electronic Sales Co.....	149	RCA Institutes, Inc.....	123
Communications Equipment Company.....	31	Radiart Corporation, The.....	87
Components Supply Co.....	119	Radio Corporation of America.....	101, 108, 125, 2nd Cover
Cornell-Dubilier Electric Corporation.....	135, 146	Radio Craftsmen Incorporated, The.....	128
Covideo.....	7	Radio Ham Shack Inc.....	88, 89
Coyne, Electrical & Radio-Television School.....	98	Radio Shack Corp., The.....	156
DeForest's Training, Inc.....	129	Radio Supply & Engineering Co.....	132
Dow Trading Co.....	104	Rauland Corporation, The.....	11
Duotone.....	112	Raytheon Manufacturing Company.....	28
Editors and Engineers, Limited.....	158	Raytron Mfg. Co.....	118
Edlie Electronics, Inc.....	140	Redfield Co., F. E.....	132
Electric Spot, The.....	28	Rider, John F., Publisher, Inc.....	138
Electro Devices Incorporated.....	154	Roger Television, Inc.....	160
Electro Products Laboratories, Inc.....	132	Rose Company, The.....	90, 151
Electro-Technical Industries.....	161	Sams & Co., Inc., Howard W.....	15
Electronics Associates.....	6, 146	Sangamo Electronic Company.....	127
Electronic Indicator Corp.....	139	Schoff Co., Walter L.....	100
Electronic Instrument Co., Inc.....	116	Senco Radio, Inc.....	123
Electronics Institute, Inc.....	135	Smith, Wardell.....	113
Emmons Radio Supply.....	117	Sonic Industries, Inc.....	156
Espey Manufacturing Company, Inc.....	138	Sovereign Television Co.....	111
Fair Radio Sales.....	149	Spartan School of Radio & Electronics.....	16
Feller Engineering Co.....	114	Sprague Products Co.....	19
Franklin-Ellis Co.....	20, 71	Sprayberry Academy of Radio.....	120
G. L. Electronics.....	24, 21	Stahl, Inc., Michael.....	143
General Electric Company.....	119	Standard Surplus.....	137
General Electronic Distributing Co.....	111	Standard Transformer Corporation.....	158
General Test Equipment.....	161	Star Electronic Distributors, Inc.....	141
Goodheart, R. E.....	129	Sun Radio of Washington, D. C.....	92
Greenlee Tool Co.....	108	Supreme Publications.....	139
Greenwich Sales Co.....	149	Sutton's Wholesale Electronics, Bill.....	150
Halldorson Company, The.....	149	Swedgal Radio, Inc.....	10, 34
Harvard Laboratory.....	112	Sylvania Electric.....	162
Harvey Radio Company, Inc.....	72, 73, 74, 75, 76	TAB.....	162
Heath Company, The.....	123	Tech-Master Products Co.....	143
Henry Radio Stores.....	121	Technical Radio Parts Co.....	123
Henshaw Radio Supply.....	94	Telectro Industries, Corp.....	131
Herbach & Rudeman, Inc.....	119	Telemarine Communications Company.....	133
Hickok Electrical Instrument Co., The.....	125	Television Supply Co.....	130
Hollywood Sound Institute, Inc.....	25	Telex, Inc.....	150
Hollywood Technical Institute.....	133	Telrex, Inc.....	161
Hytron Radio & Electronics Corp.....	143	Terminal Radio Corporation.....	142
Indiana Technical College.....	70	Transvision, Inc.....	129
Instructograph Company.....	104, 159	Tri-State College.....	133
Instrument Associates.....	120	Turner Company, The.....	96
JFD Manufacturing Co., Inc.....	124	University Loudspeakers Inc.....	123
Jersey Specialty Co.....	148	V & H Radio & Electronics Supply.....	125
Johnson Co., E. F.....	30	Valparaiso Technical Institute.....	98
Klein, Manuel.....	102	Ward Products Corporation.....	156
Lafayette Radio.....	136	Warren Distributors.....	8
LaPointe-Plascomold Corp.....	141	Weller Manufacturing Company.....	82
Lectrohm, Incorporated.....	153	Western Electronic Co.....	122
Lectronic Research Labs.....	149	Wholesale Radio Parts Co., Inc.....	121
Leotone Radio Co.....	149	World Radio Laboratories, Inc.....	98
Long Island Radio Co.....	149	YMCA Trade & Tech. School.....	98

Network Inductor Design

(Continued from page 48)

must be approximately equal to one-half the inner diameter (1½ inches). Since the cross-section of the winding has been assumed to be square, the available winding area is $.75 \times .75 = .563$ sq. in. Dividing 250 turns by $.563$ sq. in. will equal the number of turns per sq. in., or 444 in this case. A good copper wire table will give the number of turns per sq. in. for various sizes of wire. Number 18 enamel s.c.c. will wind approximately 454 turns per sq. in., therefore using this size of wire will allow a small margin in winding space.

Suppose the series circuit was used instead of the parallel circuit, then the number of turns would be $250 \times .707 = 176$. This value divided by the winding area (.563 sq. in.) equals 313 turns per sq. in., in which case number 16 s.c.c. should be used.

The value of inductance obtained by this method will not be the exact value required by the network, but it will be approximately correct and satisfactory for practical purposes.

For convenience, values of inductance and capacity can be read directly from the chart in Fig. 2. If the crossover frequency is 600 cycles and R_0 is 8 ohms, then values of C and L can be obtained simply by following the 600 cycle line upward until the appropriate C and L lines are intersected. Thus, if the circuit is the parallel type the 600 cycle line intersects C for the parallel network at 24 μ f., and the inductance L required is 3 mhy. For other values of R_0 the procedure is the same except that the values of C and L obtained are substituted in the formulas shown on the chart.

REFERENCES

Terman, F. E.; "Radio Engineer's Handbook", McGraw-Hill Book Company, New York

Read, Oliver; "The Recording and Reproduction of Sound", Howard W. Sams & Co., Inc., Indianapolis

-30-

NEW ENGLAND IRE

THE Somerset Hotel in Boston will be the scene of a one-day engineering meeting on April 15th.

The 1950 New England Radio Engineering Meeting will feature such well known authorities as Calvin Ellis of General Electric, Osman K. Mawardi and Arthur A. Janszen of Harvard, C. Robert Paulson of Dartmouth, V. K. Zworykin of RCA Labs, E. F. Buckley and T. W. Farnell of MIT, Jack Donald and Donald S. Bond of RCA, and M. W. P. Strandberg of MIT and Dale Pollack, consulting engineer.

Lawrence B. Grew and Hermon H. Scott will preside at the morning and afternoon sessions respectively.

In addition to the regularly scheduled panel sessions, engineers attending the meeting will have the opportunity to visit the television facilities of WBZ, Boston and inspect the toll dialing equipment of the New England Telephone & Telegraph Co.

-30-

April, 1950

HIGH PERFORMANCE TEST OSCILLATOR

AT A LOW LOW PRICE!
One of the Greatest Bargains
Terminal Has Ever Offered



The WR-67A provides speed, accuracy, convenience, and over-all dependability in signal injection and alignment work. A range switch allows the quick selection of three fixed frequencies of 1500, 600, and 455 kc... band-spread dial provides continuously variable fundamental frequencies from 100 kc to 30 Mc, plus useful harmonics out to 90 Mc. Add to this—a temperature compensated oscillator... special signal-injection probe... both step and vernier attenuators... double shielding... six-band drum dial with easy-to-read, four-foot scale spread... scale accuracy of $\pm 2\%$, adjustable modulation level on internal and external modulation positions... power-line filter to minimize rf leakage... and 400-cycle signal source—More features than can be found in most signal generators. Shipping weight, 20 lbs.

• SPECIFICATIONS

Frequency Range: Continuous from 100 kc to 30 Mc
Band A: 100-260 kc; Band B: 260-650 kc; Band C: 635-1600 kc;
Band D: 1.6-4.7 Mc; Band E: 4.4-12.8 Mc; Band F: 10.5-30 Mc
Scale Accuracy, $\pm 2\%$
Fixed Frequencies: 455, 600, 1500 kc
Output Voltage (RMS): Continuously variable, 5 μ v to 1 volt
Internal Modulation: 400 cps; adjustable from 0% to 50%
External Modulation: 2 RMS volts req. for 30% mod.
Audio Output: 25 max. RMS volts across 100,000 ohms
(Varies with attenuator setting)
Dimensions: 10" x 13½" x 7½"

\$49.50

F.O.B. New York

Formerly \$89.50

TERMINAL
RADIO CORPORATION
Distributors of Radio & Electronic Equipment

85 CORTLANDT STREET, NEW YORK 7, N. Y.
WOrth 4-3311 • Cable: TERMRADIO

CUT HOLES FAST IN RADIO CHASSIS

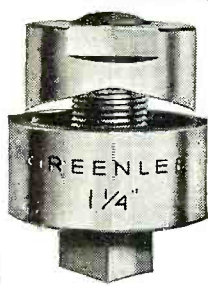

WITH A GREENLEE
RADIO CHASSIS PUNCH

• GREENLEE Punches make this tough job easy. Merely turn with an ordinary wrench... make accurate, clean holes in a hurry. No reaming or tedious filing. There's a GREENLEE punch for each of these sizes: ½"; ¾"; ¾"; ¾"; 1"; 1½"; 1½"; 1½"; 1½"; 1½"; 1½"; 2¼"—for cutting holes to take sockets, plugs, etc. Also GREENLEE makes Knockout Punches and Cutters for conduit and meter holes up to 3½". Write for facts. Greenlee Tool Co., 1884 Columbia Avenue, Rockford, Illinois.

TOOLS FOR CRAFTSMEN

GREENLEE



NEW yagi **by**
ELINCOR

Broad band Yagi
with conical
driven element

Broad band Yagi
with double folded
dipole driven
element

send for #6 catalogue

ELECTRONIC INDICATOR CORP.
259 GREEN ST., BROOKLYN, N. Y.



Get
Into

RADIO, TELEVISION and ELECTRONICS

Master ALL Phases

**YOU
Build This
Superheterodyne**

You receive complete standard equipment, including latest type High-Mu Tubes, for building various experimental and test units. You progress step by step until you build a complete Superheterodyne Receiver. It is yours to use and keep.



YOU RECEIVE THIS PROFESSIONAL MULTITESTER!

You will use this professional instrument to locate trouble or make delicate adjustments—at home—on service calls. You will be proud to own this valuable equipment. Complete with test leads.



SIGNAL GENERATOR

You construct the Transiron Signal Generator

shown here, demonstrating Transiron principles in both R.F. and A.F. stages. You study negative type oscillators at firsthand.

AUDIO OSCILLATOR:

An electronic device, which produces audio-frequency signals for modulating R.F. (radio frequency) carrier waves, testing A.F. (audio frequency) amplifiers, speakers, etc.



T.R.F. RECEIVER

You build several T.R.F. Receivers, one of which, a 4-tube set, is shown

here. You learn construction, alignment, make receiver tests, and do trouble shooting.

Get Complete Training. You Receive and Keep All Tubes, Equipment, Parts and Lessons. No Extra Charges.

GOOD PAY and Unlimited Opportunities in JOBS LIKE THESE:

Business of Your Own. Radio Manufacturing, Sales, Service. Broadcasting Telecasting. Television Manufacturing. Sales, Service. Laboratories; Installation, Maintenance of Electronic Equipment, Electrolysis, Call Systems. Garages: Auto Radio Sales, Service. Sound Systems and Telephone Companies; Oil Well and Drilling Companies; Engineering Firms. Theatre Sound Systems. Police Radio.

And scores of other good jobs
in many related fields

YOU CONDUCT MANY EXPERIMENTS LIKE THESE!

Checking action of condensers
Experiments with AF and RF amplifiers
Experiments with resonance
Producing beat frequencies
Calibrating oscillators
Experiments with diode, grid-bias, grid-leak and infinite impedance detectors
Practical experience in receiver trouble shooting
Application of visual tester in checking parts and circuits
Experiments with audio oscillators
Advanced trouble-shooting
and many, many others.

Complete Training by Practical Resident Trade School, Est. 1905

The same highly trained faculty, instruction materials and methods used here in our large, modern resident school, are adapted to your training in your own home. Shop Method Home Training has been proved by hundreds of successful graduates.

**Both Resident and Home Study
Courses Offered**

YOU LEARN BY DOING

You receive special laboratory experiment lessons to show you how to build with your own hands various experimental units such as those shown at left, and how to conduct many tests.

You will find all lessons easy to understand because they are illustrated throughout with clear diagrams and step-by-step examples that you work out yourself. Every piece of the equipment and complete lesson material we send you is yours to keep and enjoy, including the multitester, experimental equipment, all parts of the Superheterodyne, tube manual, radio dictionary, and complete, modern Television texts. All parts are standard equipment.

Shop Method Home Training . . . Earn While You Learn

With our practical resident Shop Method Home Training, you study in your spare time. You receive Spare Time Work Lessons, which show you how to earn while you learn. Service neighbors' radios and TV receivers, appliances, etc., for extra money and experience. Many National students pay all or part of their training with spare time earnings!

DON'T DELAY! The Radio-Television Industry needs trained men NOW!

**APPROVED
FOR
VETERANS!**
Check coupon below!

For quick action,
mail coupon
today and we'll
rush you full information.

Free!
NEW, ILLUSTRATED
OPPORTUNITY
BOOK AND SAMPLE
LESSON SHOW YOU
HOW WE TRAIN
YOU . . . SEND FOR
THEM TODAY! NO
COST. NO
OBLIGATION.

NATIONAL SCHOOLS

LOS ANGELES 37, CALIF. • EST. 1905



FIND OUT NOW . . . MAIL COUPON TODAY

National Schools, Dept. RN-4
4000 South Figueroa Street
Los Angeles 37, California

Mail in envelope
or paste on
penny postal.

Send me your FREE book "Your Future in Radio" and the sample lesson of your course. I understand no salesman will call on me.

NAME _____ AGE _____
ADDRESS _____
CITY _____ ZONE _____ STATE _____
 Check here if Veteran of World War II



This Little Fellow Is Some Performer!

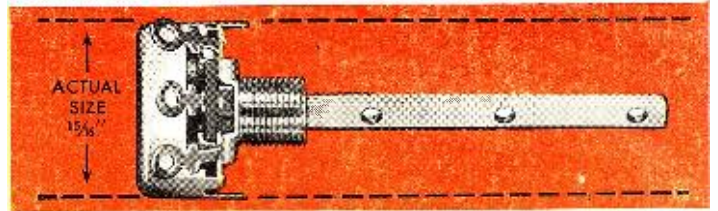

The Mallory Midgetrol

Here's the answer to your control problems... a $\frac{15}{16}$ " diameter precision control with electrical characteristics superior to $1\frac{1}{8}$ " controls, while physical size meets requirements of auto and personal sets. Now you can standardize on *one* control for all of your replacements... profit by the versatility of the Mallory Midgetrol!

And that's not all! Exclusive precision equipment and scientific inspection assure smooth, uniform tapers. Electrical noise is eliminated, because there is no metal-to-metal contact on moving parts except where conductivity is required. The moisture-proof base prevents warping and provides greater stability.

The Mallory Midgetrol has been designed to meet *your* problems. Your Mallory distributor is ready to serve you.

WIDER APPLICATION

The small size allows you to service portables, auto radios and small AC-DC receivers requiring $\frac{15}{16}$ " controls.

LESS INVENTORY

Electrical characteristics allow you to use the Mallory Midgetrol to replace $1\frac{1}{8}$ " as well as $\frac{15}{16}$ " controls. Since no special shafts are required, you carry fewer controls in stock.

SIMPLER INSTALLATION

The new and unique flat shaft design of the Mallory Midgetrol saves installation time with all types of knobs.

See your Mallory distributor for this new standard in carbon controls!

P. R. MALLORY & CO. INC.
MALLORY CAPACITORS... CONTROLS... VIBRATORS...
 SWITCHES... RESISTORS... RECTIFIERS...
 VIBRAPACK® POWER SUPPLIES... FILTERS
® Reg. U.S. Pat. Off.
APPROVED PRECISION PRODUCTS

P. R. MALLORY & CO., Inc., INDIANAPOLIS 6, INDIANA