

RADIO & TELEVISION NEWS

AUGUST
1949

RADIO-ELECTRONIC
ENGINEERING
EDITION



YOU DON'T NEED THESE TUBES

...Yet!

As a serviceman, you don't need the brand new Hytron 1X2, 6BQ6GT, and 25BQ6GT immediately. **But you will soon.** They are first of a new line of Hytron originals for lower-cost TV sets. Designed for the mass market in collaboration with leading TV set manufacturers.

Two new GT firsts by the originator of the Bantam GT. A brand new 9-pin miniature by the pioneer of smaller tubes. Three more Hytron contributions to the growth of TV.

The 6BQ6GT and 25BQ6GT are horizontal deflection amplifiers; the 1X2, a high-voltage TV rectifier. All three do equally well the job of older, much more expensive tubes—in a-c or a-c/d-c TV sets. Watch for them. And for many other Hytron originals in low-cost TV tubes.



SPEED UP AUTO-RADIO SERVICING

After disconnecting control cables from a universal auto radio, how do you tune it? Screw driver? Here's a better way. Try the new Hytron Auto Radio Tool. A contest first-prize winner, this double-ender fits most sets. Helps you work faster with less effort, yet more precisely... to make more money. Only 24c. One job pays for it. Get your Auto Radio Tool from your Hytron jobber today.

IT'S EASY

Detach cables from universal auto radio. Slip Hytron Auto Radio Tool into control fittings. Turn set on/off, tune, adjust volume and tone, realign to dial... smoothly, exactly. Square tip also fits splines. Slotted tip is V-shaped for different thicknesses of spade and similar key fittings. Tool fits over 90% of universal sets with minimum backlash.

Durable one-piece construction. Precision machined steel, bright-zinc plated. Compact size for working under dash. Comfortable handle is large diameter for vernier-like adjustments, hexagon to prevent rolling off bench. Imprint on handle counts dial revolutions. New Hytron Auto Radio Tool is unique. A bargain tool by and for servicemen.

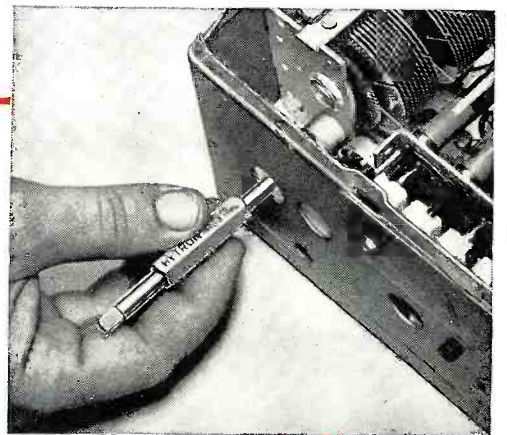

24c NET

SPECIALISTS IN RADIO RECEIVING TUBES SINCE 1921

HYTRON

RADIO AND ELECTRONICS CORP.



MAIN OFFICE: SALEM, MASSACHUSETTS

You Practice COMMUNICATIONS

I Send You Parts To Build This Equipment

As part of my new Communications Course I send you parts to build your own Transmitter. Conduct actual procedure demanded of Broadcast Station Operators, practice many interesting experiments and tests, learn how to put a transmitter on the air.



You Practice Radio SERVICING

On This Modern Radio You Build With Parts I Send

As part of my Servicing Course, I send you the speaker, tubes, chassis, transformer, loop antenna, EVERYTHING you need to build this modern Radio Receiver that brings in local and distant stations. You use it to conduct many tests and experiments.

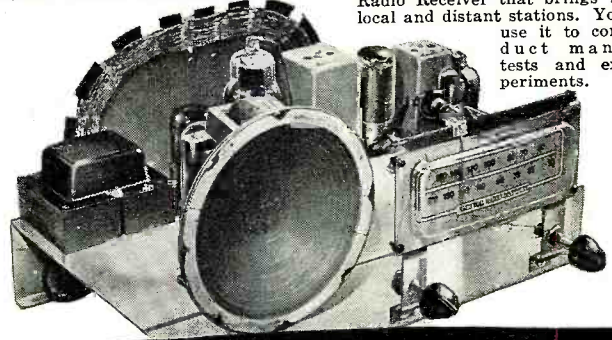

BE A RADIO TECHNICIAN

Learn Servicing or Communications

Learn by Practicing in Spare Time with MANY KITS OF PARTS I Send

YOU BUILD this Tester as part of my Servicing Course. It soon helps you EARN EXTRA MONEY fixing neighbors' Radios in spare time.



YOU BUILD this Power Pack as part of my new Communications Course. Use it to conduct fascinating experiments with frequency amplifiers and multipliers, buffer stages, etc.

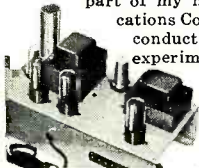

YOU BUILD this Superheterodyne Receiver Circuit and conduct Frequency Modulation experiments and many other tests as part of my Servicing Course.



YOU BUILD this Signal Generator as part of my Servicing Course for more valuable experience. It provides amplitude-modulated signals for many interesting tests and experiments.



VETERANS

GET THIS TRAINING WITHOUT COST UNDER G. I. BILL MAIL COUPON

YOU BUILD this Wavemeter as part of my new Communications Course. Use it with Oscillator you also build that furnishes basic power to transmitter and determines transmitter frequency.



J. E. SMITH, President National Radio Institute

Want a good-pay job in the fast-growing Radio and Television industries or to be boss of your own money-making Radio and Television shop? I've trained hundreds of men with no previous experience to be Radio technicians. I can do the same for you! Or now, for the first time, enroll in my new practical course in Radio—Television Communications—learn to be a Broadcasting and Communications technician. You learn Radio and Television principles from clear, illustrated lessons. You get practical Radio experience with MANY KITS OF PARTS I SEND in my train-at-home method. All equipment yours to keep.

MAKE EXTRA MONEY IN SPARE TIME

As part of my Radio Servicing Course, I send EXTRA MONEY booklets, starting the day you enroll. Use your know-how to make \$5, \$10 and more a week EXTRA MONEY fixing Radios in spare time while training. The next step is your own Radio shop or a good-pay Radio servicing job. Or, if you prefer, get into Government, Police, Aviation or Marine Radio, Broadcasting, Radio Manufacturing or Public Address Work.

BRIGHT FUTURE IN TELEVISION

Think of the present and future opportunities in the fast-growing Television field. New stations are going on the air every month. Television manufacturers are producing over 100,000 sets a month. It's a fast-growing field and the man who knows Television will be in demand.

GET ACTUAL LESSON AND BOOK FREE

Send now for my special DOUBLE FREE OFFER. Get actual lesson on Radio Repairing short-cuts absolutely free. Also get 64-page book, "HOW TO BE A SUCCESS IN RADIO—TELEVISION—ELECTRONICS." See how quickly, easily you can start. J. E. SMITH, President, Dept. 9HR, National Radio Institute, Pioneer Home Study Radio School, Washington 9, D. C.

Good for Both—FREE

MR. J. E. SMITH, President, Dept. 9HR National Radio Institute, Washington 9, D. C.
Mail me FREE Sample Lesson and 64-page book about how to win success in Radio and Television—Electronics. (No salesman will call. Please write plainly.)

Name..... Age.....
Address.....
City..... Zone..... State.....

Check if Veteran APPROVED FOR TRAINING UNDER G. I. BILL

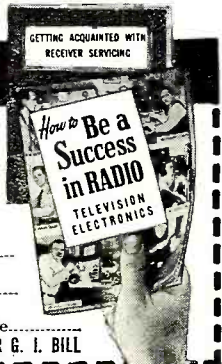

I TRAINED THESE MEN AT HOME



Good Job in Radio Station
"Am Chief Engineer of Station WORD, in charge of four men. Owe all I know about Radio to NRI."—CLYDE J. BURDETTE, Spartanburg, South Carolina.



Makes Extra Cash in Spare Time
"Earned enough spare time cash to pay for my course by time I graduated. NRI training is tops!"—ALEXANDER KISH, Carteret, New Jersey.



Operates Own Radio Business
"Now have two Radio shops servicing about 200 sets a month. Have largest service establishment in Southeast Missouri."—ARLEY STUDVYN, DeSoto, Mo.

MY COURSE INCLUDES

TELEVISION

Editor
OLIVER READ, W9ETI

Managing Editor
WM. A. STOCKLIN

Technical Editor
H. S. RENNE, EX-W8PTS

Associate Editor
RAY FRANK, W9JU

Contributing Editor
ROBERT HERTZBERG, W2DJJ

Short-Wave Editor
KENNETH R. BOORD

Staff Artist
R. S. KUPJACK

Advertising Manager
L. L. OSTEN

Midwest Adv. Manager
JOHN A. RONAN, JR.

Art Director
HERMAN R. BOLLIN

RAD O & TELEVISION NEWS

First in
radio-television-electronics

Average Paid Circulation over 200,000

Radio News Trade Mark Reg. U.S. Pat. Office No. 378427

CONTENTS

AUGUST, 1949

Carrier Communications On "REA" Power Lines.....	P. M. Ohlinger	23
Your First Transmitter.....	Richard L. Parmenter, W1JXF, and C. E. Clark, W1KLS	26
High-Gain Directional Array for Marginal TV Reception.....	Lyman E. Greenlee	28
"Midar".....	Samuel Freedman, W6YUQ	30
Wide Range Bandpass Crystal Tuner.....	Joseph M. Boyer, W6UYH	31
The Service Technician and TV Interference.....	Herbert S. Brier, W9EGQ	32
Crystal Controlled Portable V.H.F. Transmitter....	Robert B. Tomer, W1PIM	34
Mac's Radio Service Shop.....	John T. Frye	36
Putting Microgrooves On The Air....	W. C. McClung and W. H. Flint, Jr.	37
The Buying Motives—Key to More Sales.....	Carle A. Christensen	38
An Inexpensive Audio Frequency Generator.....	J. Whitaker, W2BFB	40
Modern Television Receivers (Part 17).....	Milton S. Kiver	41
The Beginning Amateur (Part 7).....	Robert Hertzberg, W2DJJ	45
A Low-Power Rig for C.W. or FM Phone.....	Otto L. Woolley, WØSGG	48
A Cathode Follower V.T.V.M.....	Ernest J. Schultz	52
The Television Receiving Antenna (Part I).....	B. V. K. French	53
Troop 510 B.S.A. Starts Ham Program.....		58
Testing Precision Audio Equipment.....	Art Davis	70



COVER PHOTO: The testing of precision audio equipment requires the use of laboratory instruments to insure proper operation. Here Ernest Baumeister tests an audio filter in the laboratories of Cinema Engineering Co., Burbank, Calif. Further details are given on Page 70. (Photo by Arthur Haug)

Chairman of the Board and Publisher
WILLIAM B. ZIFF

President
B. G. DAVIS

Secretary-Treasurer
ARTHUR T. PULLEN

Vice-Presidents
MICHAEL H. FROELICH
Dir. Eastern Div.
H. J. MORGANROTH
Production Director
H. G. STRONG
Circulation Director

BRANCH OFFICES

NEW YORK (1)
Empire State Bldg., W1 7-0400

LOS ANGELES (14)
815 S. Hill St., Tucker 9213
Manager, WILLIAM L. PINNEY

TORONTO
21 King Street, East

DEPARTMENTS

For the Record.....	The Editor	8	AFCA News	78
Spot Radio News.....		12	MARS	86
Within the Industry.....		16	Manufacturers' Literature	104
Short-Wave.....	K. R. Boord	51	Technical Books	123
What's New in Radio.....		74	Letters from Our Readers.....	128



COPYRIGHT 1949
ZIFF-DAVIS PUBLISHING COMPANY
185 North Wabash Ave., Chicago 1, Ill.
VOLUME 42 • NUMBER 2



RADIO & TELEVISION NEWS is published monthly by the Ziff-Davis Publishing Company, 185 N. Wabash Ave., Chicago 1, Ill. Subscription Rates: in U. S. and Canada \$4.00 (12 issues), single copies 35 cents; in Mexico, South and Central America, and U. S. Possessions, \$4.00 (12 issues); in British Empire, \$5.00 (12 issues)—all other foreign countries \$5.00 (12 issues). Subscribers should allow at least 2 weeks for change of address. All communications about subscriptions should be addressed to: Director of Circulation, 185 N. Wabash Ave., Chicago 1, Ill. Entered as second class matter July 21, 1948, at the Post Office, Chicago, Illinois, under the Act of March 3, 1879. Entered as second class matter at the Post Office Dept., Ottawa, Canada. Contributors should retain a copy of contributions and include return postage. Contributions will be handled with reasonable care but this magazine assumes no responsibility for their safety. Accepted material is subject to whatever revisions and by-line changes that are necessary. Payment made at our current rates, covers all authors' contributors' or contestants' rights, title, and interest in and to accepted material, including photographs and drawings.

RADIO & TELEVISION NEWS

Want To Double Your Pay?



How To Pass FCC COMMERCIAL RADIO OPERATOR LICENSE EXAMINATIONS

GET THIS AMAZING NEW BOOKLET FREE!

Add Technical Training to Your
Practical Experience and

GET YOUR FCC COMMERCIAL RADIO OPERATOR LICENSE

IN A FEW SHORT WEEKS!

It's **EASY** if you use **CIRE Simplified Training & Coaching AT HOME** in **SPARE TIME**

Get your license easily and quickly and be ready for the jobs open to ticket holders which lead to \$3000 to \$7500 (average pay reported by FCC nationwide survey). CIRE training is the only planned course of coaching and training that leads directly to an FCC license.

CIRE GRADUATES FIND FCC LICENSE PAYS OFF

"I now hold ticket Number P-10-3787, and holding the license has help me to obtain the type of job I've always dreamed of having. Yes, thanks to CIRE, I am now working for CAA as Radio Maintenance Technician, at a far better salary than I've ever had before. I am deeply grateful."
Student No. 3319N12

"I took the FCC examination on March 4th and received my second class radiotelephone license March 9th. I go to work for the Trans-Texas Airways in the maintenance department. Thanks for all the assistance."
Student No. 2394A1

CLEVELAND INSTITUTE OF RADIO ELECTRONICS
Desk RN-8 • 4900 Euclid Bldg. • Cleveland 3, Ohio
Approved for Veteran Training Under the "G.I. Bill of Rights"

1. Tells of thousands of brand-new, better-paying radio jobs now open to FCC License-Holders.
2. Tells how you will benefit by holding an FCC Commercial License.
3. Tells how YOU can get your FCC Commercial Radio Operator License **IN A FEW SHORT WEEKS—EASILY AND QUICKLY**, by using CIRE simplified training and coaching **AT HOME** in your **SPARE TIME**.
4. Tells of hundreds of our successful students who now have licenses and new, better-paying jobs.
5. Tells how we prepare you to pass the new FCC Commercial License Examinations, which now include FM and Television.
6. Tells how we guarantee to train and coach you until you get your license.
7. Tells how we help you get a better-paying, licensed job, with our free and exclusive service, which prepares your employment application for mailing to hundreds of employers, including FM, AM and Television Broadcast Stations, Radio Manufacturers, Police Radio Stations, and Radio-Equipped Taxi, Bus, and Public Utility Companies.

**YOUR FCC TICKET IS ALWAYS RECOGNIZED IN ALL
RADIO FIELDS AS PROOF OF YOUR TECHNICAL ABILITY**



Get All 3 FREE Send Coupon Now!

CLEVELAND INSTITUTE OF RADIO ELECTRONICS
Desk RN-8—4900 Euclid Bldg., Cleveland 3, Ohio
(Address to Desk No. to avoid delay)

I want to know how I can get my FCC ticket in a few short weeks by training at home in spare time. Send me your amazing new **FREE** booklet "Money Making FCC License Information," as well as a **FREE** sample FCC-type exam and **FREE** booklet, "How to Pass FCC License Examinations," (does not cover exams for amateur License).

Name

Address

City Zone State

Veterans check for enrollment information under G.I. Bill
NO OBLIGATION—NO SALESMEN

8 NEW IRC RESISTOR AND CONTROL ASSORTMENTS

... all in sturdy metal

Realistically Priced Starting At

\$4.50

DEALER
NET COST

NEW RESIST-O-KIT

Latest addition to IRC's big family of metal kits. Pocket-size case ideal for service calls. 10 compartments, resistors can't mix. Ranges stamped on resistors. 2 assortments: 45 half watt or 30 one watt resistors—popular ranges, widely found in television.

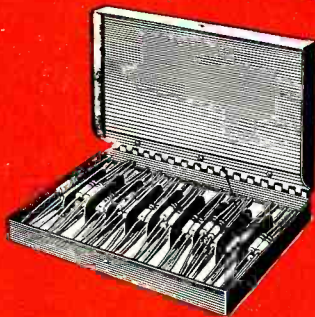

METAL RESIST-O-CABINET

Perfect way to buy and stock resistors. 4 drawers with 28 range identified compartments. 3 fast-moving assortments: 100 half watt, 83 one watt, or Combination Assortment of 91 resistors (includes close tolerance IRC Precistors).



VOLUME CONTROL CABINET

Stocked with 18 new IRC type Q Controls plus switches and special shafts. Handles over 90% of all AM, FM and TV control replacements. Compartments individually marked. 3 drawers are provided for stocking switches, shafts and spare parts.

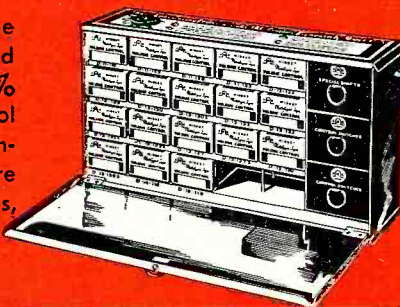

BASIC KIT

Wide variety resistor stock for all daily requirements. Covers 1/2 watts to heavy duty power resistors in selected ranges. Available with Serviceman's Special Assortment—heavy duty resistors omitted leaving space for small tools and parts, 8 new type Q Controls included.



Here's a full family of 8 IRC kits and cabinets tailored to your individual requirements. Each of these new resistor and control assortments comes to you in a beautiful all-metal cabinet at absolutely no extra cost—you pay only the regular price of the merchandise.

You'll want several of these attractive kits. They provide an efficient way to stock parts, add to the appearance of your shop—and save your time in unnecessary buying trips. All ranges have been carefully selected after a detailed analysis of AM, FM and TV requirements.

See these new kits at your IRC Distributor's, or write today for free catalog bulletin. International Resistance Co., 401 N. Broad St., Philadelphia 8, Pa. In Canada: International Resistance Co., Ltd., Toronto, Licensee.



**INTERNATIONAL
RESISTANCE CO.**

Wherever the Circuit Says 



See how YOU may get started toward an Exciting Future in

TELEVISION

RADIO • ELECTRONICS!



MODERN CHICAGO LABORATORIES

Train quickly, using a wide variety of commercial equipment. D. T. I.'s new laboratories are among the finest of their kind. Ample instructors . . . every major training advantage. Write for details!

EMPLOYMENT SERVICE

When you complete your training, our effective Employment Service is available to you without extra cost—a grand aid to help you get started.



YOU ALSO USE HOME MOVIES a D.T.I. Exclusive!

D. T. I., alone, includes the use of one of today's most effective training aids . . . MOVIES . . . to help you learn important fundamentals faster, easier, at home. What an advantage to see electrons on the march; and other fascinating "hidden action" — a remarkable home training advantage that speeds your progress.

OUR GREATEST OFFER IN 17 YEARS!

Here is your big opportunity to get started toward FASCINATING WORK . . . GOOD MONEY . . . a THRILLING FUTURE! Mail the coupon today. See how YOU may prepare to tie in your future with a field that includes one of America's fastest-growing new industries—Television. You'll find out, too, about the many other thrilling opportunities in FM Radio . . . Aviation and Broadcast Radio . . . 2-Way Taxi, Truck and Police Radio . . . Industrial Electronics . . . even the chance to start your own profitable Television-Radio Sales and Service business. And to top it all, you'll see that you don't need to know a thing about this subject at present—that NOW you can get the very training and starting help you need by means of our GREATEST OFFER IN 17 YEARS.

Send for FREE Information

See HOW—in your own home—DeForest's Training, Inc., now brings you one of today's most complete combinations of major home training aids. You (1) Learn-by-Reading from well-illustrated lessons. (2) You Learn-by-Seeing from D.T.I.'s exclusive instructive Home Movies. And (3), you set up your own HOME LABORATORY where you Learn-by-Doing from 16 shipments of Radio-Electronic parts which you use and KEEP to work over 300 instructive . . . fascinating projects. This includes building the valuable 6 tube "Superhet" RADIO and the commercial-type OSCILLOSCOPE, R-F SIGNAL GENERATOR, and Jewel-Bearing MULTIMETER, pictured at the right.

You may use this test equipment to help you earn real money—both in your spare time and later when working full time in the field. Get complete facts. Mail coupon today!

YOU BUILD and KEEP THIS EQUIPMENT TO WORK OVER 300 HOME EXPERIMENTS

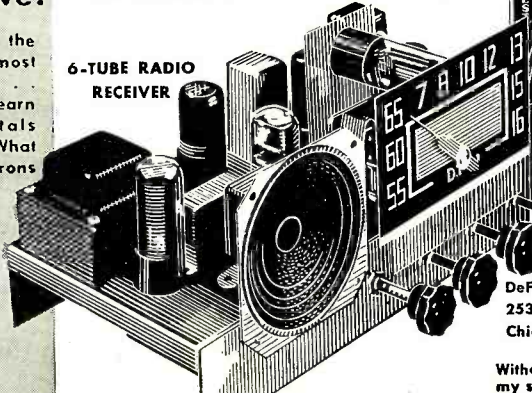
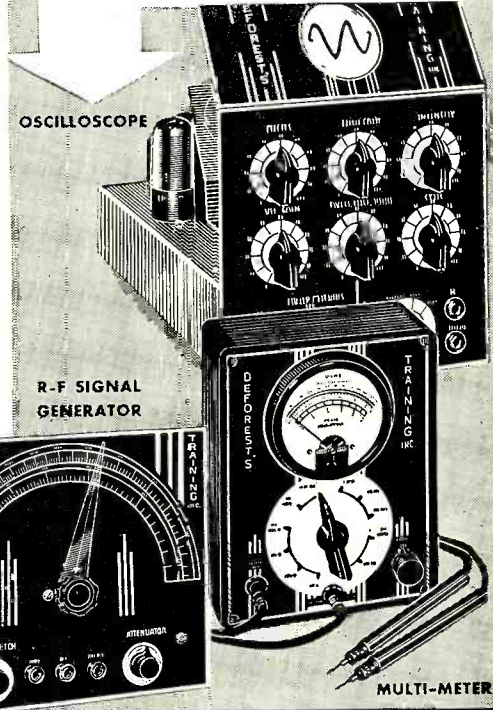

OPPORTUNITY COUPON!

DeForest's Training, Inc.
2533 N. Ashland Ave., Dept. RN-F8
Chicago 14, Illinois

MAIL TODAY

Without obligation, send me complete facts showing how I may make my start in Television-Radio-Electronics.

Name Age
Street Apt.
City Zone State

DeFOREST'S TRAINING, INC.

CHICAGO 14, ILLINOIS

Affiliated with the DeVry Corporation,
Builders of Electronic and Movie Equipment.

**NO MORE
BLIND
SOLDERING**



**THIS
SOLDERING
GUN
SPOTLIGHTS
THE WORK**



Flexitip
easily
formed

Longer Reach—
8" from housing
to tip.

Solderlite—
spotlights
the work

5-Second
Heating—
no waiting;
saves power

Built-In
Transformer
compact,
complete

Dual Heat—
single heat
100 watts;
dual heat
100/135
watts; 115
volts, 60
cycles

Just pull the trigger switch of your Weller Soldering Gun . . . heat and light come "on" together. The pre-focused spotlight picks out the work at once—shows you your way to faster, easier soldering.

Time-saver? Yes—but not the only advantage of Weller Soldering Guns. Check the exclusive features illustrated and you'll see what we mean. Solderlite, extra length and 5-second heating mean hours and dollars saved—your Weller Gun will pay for itself in a few months. For electrical and electronic laboratory or maintenance work, we recommend the 8" model DX-8 with dual heat; or 4" types S-107 single heat and D-207 dual heat. See your distributor or send for bulletin direct.



Be sure to get your copy—**SOLDERING TIPS**, the new Weller Handy Guide to easier, faster soldering—20 pages fully illustrated. Price 10¢ at your distributor's or order direct.

WELLER
MANUFACTURING COMPANY
810 Packer Street • Easton, Pa.

For the **RECORD.**

BY THE EDITOR

DX TELEVISION—ITS POSSIBILITIES

WIDE-AWAKE radio and appliance dealers, in areas not served by television transmitters, are using all sorts of beams, "gimmicks," and boosters which enable them to demonstrate video sets to their prospective future television set owners under "DX conditions."

In cities such as Tucson and Phoenix, Arizona (not as yet served), there are many television sets providing excellent video reception from Los Angeles, Oklahoma City, and other stations at equal, or in some cases, greater distances. With the introduction of beam rotators to television set owners, the dealer has discovered the tremendous advantage of long-used beam techniques employed by the radio amateur.

We receive many confirmed reports of DX television reception. Some are the result of "freak conditions," and others can be attributed to a combination of a well-designed, multi-element beam, a tall mast or tower, a remote controlled rotator with indicator, and in many cases a television booster.

It seems to us that it would be highly profitable to many dealers in non-television areas, to study the possibilities of installing a television demonstration set in their store, provided they can receive at least one DX video station, and to start a bit of spade work in selling television to their future customers.

Even if these dealers fail to receive signals consistently, in many cases they will discover that at certain times of the day or evening they can present a satisfactory picture to their prospects.

If they are successful, there is no surer way to get customers into the store than by this visual means. The dealer in a non-TV area must always remember that even though Mr. and Mrs. Smith have long read about television, very few have actually seen a program. If a DX program is received and produces a satisfactory picture for even a short period of time, it is a simple matter to explain intelligently, in simple terms, the conditions and limitations of a video signal. The very fact that you are able to receive all or part of a program is bound to impress your future prospects.

Don't underestimate the prestige that goes with being first with something new. A little effort on your part to go after some DX television can be a powerful factor in creating good will and in bringing new and regular prospects to the display room. The investment is small compared to the tremendous impact such demonstrations may have on these viewers.

On a recent trip to the Southwest,

we talked to several radio dealers who were waiting for television stations to be set up in their town or in the vicinity thereof. One, a very likeable chap, had a neat, well established shop on Main Street. An old 60-foot windmill tower, long abandoned, stood some 75 feet back of his store. This location was approximately 140 miles from the nearest television transmitter, which had been in operation for several months. We asked if he was contemplating the sale and maintenance of television receivers. His enthusiastic answer was, "Yes—but we aren't going to have it here for at least another year."

We cited several instances where other dealers had taken advantage of this so-called "DX television reception" and urged him to try it in his vicinity. He explained that he was quite busy but hoped to be able to give it a whirl by fall.

Imagine our surprise when two weeks later, while passing through this same town, we spotted this very same tower upon which was mounted one of the latest television antennas, complete with rotator. Needless to say, we dropped in to find out if he had gone ahead with an installation of a television demonstrator. He had. He told us that the set had been in operation for a week, receiving programs from three scattered transmitters, and he was able to demonstrate each evening for periods of approximately two hours with good success.

Literally hundreds of towns throughout the United States are in spots equally well adapted for DX television reception. We feel that many dealers could profitably invest in a "Demo" receiver, instead of just being content to wait for television to come to their very door.

* * *

ILLINOIS HOUSE BILL SHELVED

The proposed bill, No. 702, as discussed in our June Editorial, which would impose severe restrictions upon television-radio service technicians is, at this writing, on its way out. Failure of the bill to pass will be due to the terrific pressure brought to bear by manufacturers, individuals, service technicians, and the television public, not to mention the publication representatives and others involved in attending hearings and writing letters of protest. Accusations flew thick and fast. The consensus of opinion was that the bill, as written, would benefit only the handful of individuals who are behind it. Technicians in all states should be on the alert for the introduction of similar legislation. . . O.R.

RADIO & TELEVISION NEWS

NOW Save Up to 22% at ALLIED

on these famous Hallicrafters models



Famous All-Wave S-53 World-Wide Coverage

Save \$19.55 on this quality, professional-type communications receiver! Covers 540 kc to 54.5 mc in 5 bands. Advanced features include: full electrical bandspread; large slide-rule dial accurately calibrated for all ranges; automatic noise limiter; adjustable pitch BFO; tone control; code-phone switch; headphone jack; phone jack; separate sensitivity and volume controls; built-in PM speaker. Includes all tubes. In satin-black steel cabinet with chrome trim; 12 $\frac{1}{2}$ x6 $\frac{7}{8}$ x7 $\frac{7}{8}$ ". For 105-125 v., 50-60 cy. AC. Shpg. wt., 20 lbs.

Was \$89.50
ALLIED'S PRICE **\$69⁹⁵**

97-573. Hallicrafters S-53, reduced to **\$69⁹⁵**

Available on Easy Payment Terms

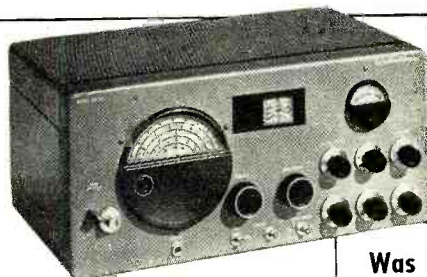

SX-43 Full Short-Wave AM and FM Coverage

Was \$189.50
ALLIED'S PRICE **\$159⁵⁰**

You save \$30 on this great receiver preferred by Amateurs, DX fans and AM-FM listeners! Delivers professional performance over the entire range of 540 kc to 55 mc—plus the 88-108 mc FM range. Features: accurately calibrated main tuning and electrical bandspread dials; accurate carrier-level meter; 4-position control for broad or sharp tuning; variable-pitch BFO; tone control; automatic noise limiter; dual IF system; RF gain control; crystal phasing control; selectivity control; standby-receive switch; 500 and 5,000 ohms output impedances. Complete with tubes. In rich satin-gray steel cabinet; 18 $\frac{1}{2}$ x8 $\frac{7}{8}$ x13". For 105-125 v., 50-60 cy. AC. Shpg. wt., 45 lbs.

97-743. SX-43, less speaker, reduced to **\$159⁵⁰**
97-785. Matching R-44 speaker in steel cabinet. Net. **\$24.50**

Available on Easy Payment Terms

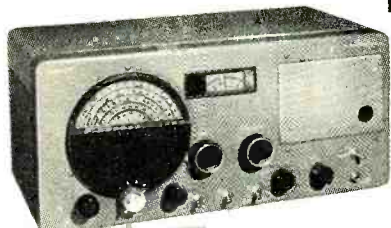

Popular S-40A & S-52 All-Wave Receivers

Here's more value in popular Hallicrafters communications receivers packed with advanced features. Covers 540 kc to 43 mc in 4 bands. Highlights include: full electrical bandspread; inertia flywheel tuning; calibrated main dial; automatic noise limiter; adjustable pitch BFO;

standby switch; code-phone switch; headphone jack; shock-mounted PM speaker; separate sensitivity and volume controls; 3-position tone control. All tubes included. In handsome all-steel cabinet, 18 $\frac{1}{2}$ x9x11". Shpg. wt., 32 lbs.

Was \$99.50
ALLIED'S PRICE **\$79⁹⁵**

97-546. S-40A, for 105-125 v. 50-60 cy. AC.
97-588. S-52, for 117 volts AC or DC.

EITHER MODEL, reduced to **\$79⁹⁵**

Available on Easy Payment Terms



S-38—the Super-Value All-Wave Receiver

The all-star, all-wave value that amazes even the experts. Covers 4 full wave bands, continuous range from 540 kc to 32 mc. Features: full electrical bandspread; Noise Limiter; Band Selector; BFO pitch; Voice-Code switch; Speaker-head-

phones switch; Standby-receive switch; latest PM speaker. In handsome furniture-steel cabinet; 12x7x8". Complete with all tubes. For 105-125 v. 25-60 cy. AC, or 105-125 v. DC. Shpg. wt., 15 lbs.

Was \$49.95
ALLIED'S PRICE **\$39⁹⁵**

97-565. Model S-38, reduced to **\$39⁹⁵**

T-64 TV Chassis

complete with
10" Picture Tube
REDUCED TO **\$179⁵⁰**

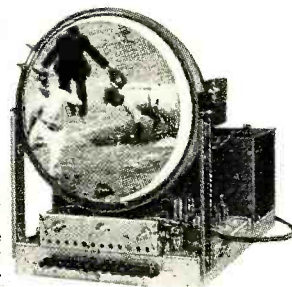

A complete direct-view chassis for 10 or 12-inch tubes. With new Dual-Focus switch—10" tube gives you choice of big 64 sq. in. view for dramatic closeups, or large 56 sq. in. full-range view. Features: 12 channel push-button tuning; RF amp.; 3 IF amps.; 2 video amps.; improved sync circuits; AGC; static-free FM audio system. Complete with power supply, speaker, picture tube and 19 tubes, plus 3 rectifiers. For 105-125 v., 50-60 cy. AC. Shpg. wt., 60 lbs.

Hallicrafters T-64 Television Chassis complete with 10" picture tube. **ONLY... \$179⁵⁰**
Hallicrafters T-64, with 12" tube. **ONLY... \$199.50**

Available on Easy Payment Terms

All Prices Net F.O.B. Chicago

You Save at ALLIED RADIO



FREE Radio's Leading Buying Guide

Used by thousands of expert radio men. Get every buying advantage at ALLIED: widest selections—money-saving prices—speedy, expert shipment—personal attention—complete satisfaction on every order. Send today for your latest ALLIED Catalog.

ALLIED RADIO CORP., Dept. 1-H-9
833 W. Jackson Blvd., Chicago 7, Illinois

- Send FREE ALLIED Catalog
 Enter order for Hallicrafters Model.....
Enclosed \$..... Full Payment
 Part Payment (Bal. C.O.D.)
 Send ALLIED Easy Payment details and order blank.

Name.....

Address.....

City..... Zone..... State.....

FREE
CATALOG

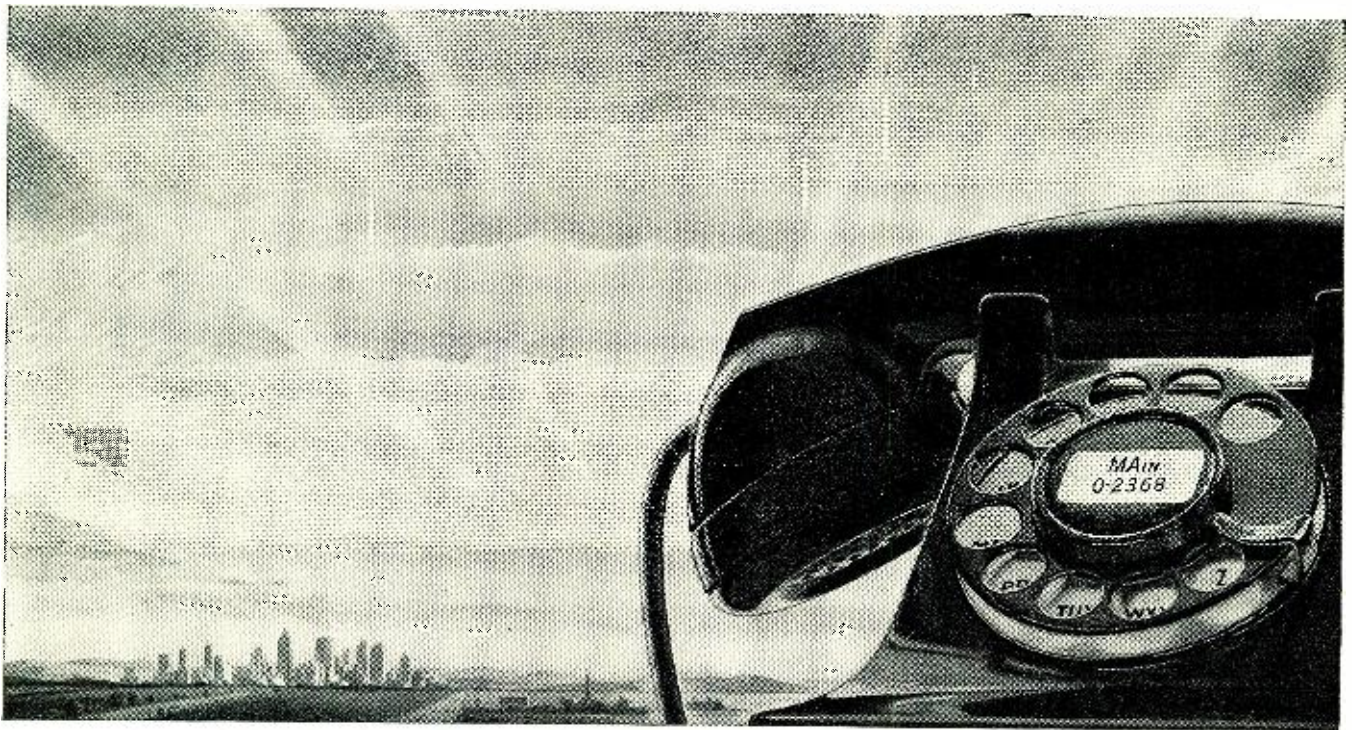

THE FUTURE HOLDS GREAT PROMISE

Neither chance nor mere good fortune has brought this nation the finest telephone service in the world. The service Americans enjoy in such abundance is directly the product of their own imagination, enterprise and common sense.

The people of America have put billions of dollars of their savings into building their telephone system. They have learned more and more ways to use the telephone to advantage, and have continuously encouraged invention and initiative to find new paths toward new horizons.

They have made the rendering of telephone service a public trust; at the same time, they have given the telephone companies, under regulation, the freedom and resources they must have to do their job as well as possible.

IN THIS climate of freedom and responsibility, the Bell System has provided service of steadily increasing value to more and more people. Our policy, often stated, is to give the best possible service at the lowest cost consistent with financial safety and fair treatment of employees. We are organized as we are in order to carry that policy out.

BELL Telephone Laboratories lead the world in improving communication devices and techniques.

Western Electric Company provides the Bell operating companies with telephone equipment of the highest quality at reasonable prices, and can always be counted on in emergencies to deliver the goods whenever and wherever needed.

The operating telephone companies and the parent company work together so that improvements in one place may spread quickly to others. Because all units of the System have the same service goals, great benefits flow to the public.

Similarly, the financial good health of the Bell System over a period of many years has been to the advantage of the public no less than the stockholders and employees.

It is equally essential and in the public interest that telephone rates and earnings now and in the future be adequate to continue to pay good wages, protect the billions of dollars of savings invested in the System, and attract the

new capital needed to meet the service opportunities and responsibilities ahead.

There is a tremendous amount of work to be done in the near future and the System's technical and human resources to do it have never been better. Our physical equipment is the best in history, though still heavily loaded, and we have many new and improved facilities to incorporate in the plant. Employees are competent and courteous. The long-standing Bell System policy of making promotions from the ranks assures the continuing vigor of the organization.

WITH these assets, with the traditional spirit of service to get the message through, and with confidence that the American people understand the need for maintaining on a sound financial basis the essential public services performed by the Bell System, we look forward to providing a service better and more valuable in the future than at any time in the past. We pledge our utmost efforts to that end.

LEROY A. WILSON, *President*
American Telephone and Telegraph Company.
(From the 1948 Annual Report.)

BELL TELEPHONE LABORATORIES EXPLORING AND INVENTING, DEVISING
AND PERFECTING, FOR CONTINUED IMPROVEMENTS AND ECONOMIES IN TELEPHONE SERVICE



RADIO & TELEVISION NEWS

What you should know about...WOMEN!

1.
God Bless Them



2.
... They are our Pride

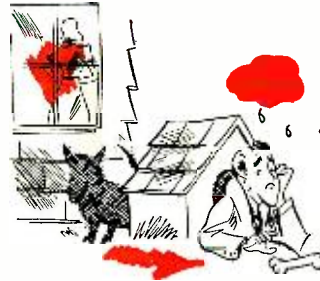

3.
... and DESPAIR!

4.
... When She Goes Shopping—She'll Handle

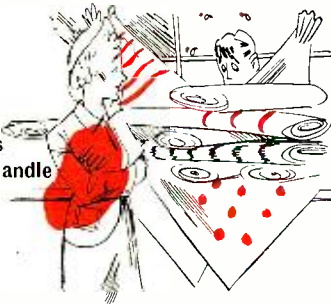

5.
Sniff, Taste and Compare ... and usually leave



6.
With a Vague "No—thank You ... I'm just looking."

7.
... But when she Walks into your Store with the Little "Portable" that doesn't seem to work any more



8.
... THAT'S WHEN SHE LOOKS UP TO YOU ...



9.
... and if it's a new "B" Battery she needs, you can add a "halo" to your stature by recommending ...

The only Radio "B" Battery which is

INTERLOCKED!



Stronger---
lasts longer
... yet costs
no more.



It's
exclusive
with
OLIN

Patented U. S. Pat. 2416576

Available only in the **WINCHESTER** and **BOND** lines

of OLIN INDUSTRIES, INC., Electrical Division, New Haven 4, Conn.

GET SET FOR VACATION SELLING—order complete line Olin Radio Batteries and combination display from your Wholesaler's Salesmen TODAY!

INTRODUCING THE SUPER-INSTANT

QUICK HEATING SOLDERING IRON
A NEW REVOLUTIONARY
INSTANT HEATING IRON

NO TINNING • NO FILING
NO WEAR

**NO THERMOSTAT OR
TRANSFORMER BUT**

COMPLETE HEAT CONTROL IN
A NEWLY DISCOVERED DESIGN
IN HEATING ELEMENTS.

READY TO
USE IN A
MATTER
OF
SECONDS



MAINTAINS
CONSTANT
SOLDERING
HEAT

TIP
3/8" Wide
1/16" Thick

60 WATTS
IN THE TIP

No Transformer
No Thermostat
No Tinning
No Filing
No Oxidation
No Lost Heat
No Lost Time
No Danger of
Fire

ONLY
795
LIST

ON SALE
NOW
AT ALL THE
LEADING
DEALERS

WORKS
ON
AC-DC
110-135 V
50-60 CY.

WEIGHT
6
OZ.

IDEAL FOR
SERVICEMAN
HOBBYIST
AMATEUR
Experimenter
ASSEMBLY
LINES

LITERATURE
AVAILABLE
ON REQUEST
WRITE
Dept. RN

REPRESENTATIVES
JULES BRESSLER
New York
PATTERSON &
CO.
Dallas, Texas
W. E. PRAY
Sales
Massachusetts
L. D. LOWERY
Phila., Penna.
A. J. NELSON
CO.
Colorado
DALE WEBER
Oregon
ASH WOOD
Elmont, Calif.
GENE BERMAN
San Francisco,
California
R. J. HIGGINS
Chicago, Ill.
FRED A. HESS
Auburn, N. Y.
JACK THORPE
Detroit, Mich.
STAN WALLACE
Lutz, Florida
V. HUTTO
Georgia
JACK ODOM
Alabama
J. T. BUTTERS
N. Carolina
BILL JOUDON
Tampa, Fla.
C. L. PUGH CO.
Columbus, Ohio
YOUNG &
MEYERS
Kansas City, Mo.

INSTANT TOOL CORPORATION

GENERAL OFFICES: 231 WEST 29th STREET, NEW YORK 1
FACTORY: BINGHAMTON, NEW YORK



★ Presenting latest information on the Radio Industry.

By RADIO & TELEVISION NEWS'
WASHINGTON EDITOR

AN EPIC DATE in the history of one of the nation's most dynamic agencies, the FCC, was celebrated in Washington shortly before the summer season became official. 'Twas the fifteenth anniversary of the creation of this influential body, which came into existence when the Communications Act of 1934 was signed on June 19.

During the Commission's decade and a half of authority, the radio and wire communications industries over which it has reigned have made striking progress. Looking backward, we find that the first annual report of the Commission indicated that there were around 51,000 stations of all types. Today there are nearly three times that number, not to mention over 200,000 associated mobile units. And fifteen years ago, there were only about 600 commercial broadcast stations. All were AM or standard broadcast, TV being in the "experimental visual" class, and FM was being developed as a "high-fidelity broadcast" service. At the present writing, the number of broadcast authorizations of all kinds exceeds 4000.

Substantial progress has also been recorded in the amateur books, during this fifteen-year period, with the 45,000 ham stations of 1934 having increased to over 80,000. There has also been quite a jump in ship radio licenses, for in '34, there were around 2000, and the records now indicate a total of around 20,000. In the aviation field, the jump in stations and authorizations has been really record-breaking. In '34, there were around 700 aeronautical stations. Today there are over 27,000, with over 100,000 special aircraft radiotelephone authorizations. Police services were comparatively restricted when the FCC was born, with only about 250 stations in operation in widely scattered spots and, in the main, on an experimental basis. But today, there are over 4600 stations integrated into local and urban nets and providing a powerful policing assist throughout the nation. The fifteen-year span also saw the introduction of many new services, including municipal fire stations, of which there are now 100 in operation. Activities in this field indicate that it will not be long before there'll be many hundreds of radio-equipped,

flame-fighting stations throughout the country.

Reviewing the records of '34 reveals that the FCC had only licensed 5500 commercial operators at that time. What a rise the record shows now; over 700,000 have received FCC authorization to operate. During the first year of the Commission's operation, less than 10,000 applications of all kinds had been received, while in '48 over 20,000 requests poured onto the desks of the boys and girls in the New Post Office Building.

Many who joined the government communications-control division in '34 are still with the service. There's vice-chairman Paul A. Walker, who was one of the original Commissioners, having taken his oath of office on July 11, 1934. Commissioner George E. Sterling's government career pre-dates the FCC birth, having served with the predecessor to the FCC, the Federal Radio Commission. And Rosel H. Hyde, now serving as acting chairman, also was a member of the old FCC.

Although the facilities of the art were small when Congress voted in the Commission, the possibilities even then loomed high. When the members of the new body prepared its first report they accented this fact, stating that: "There are no fields of engineering in which new devices and inventions are being disclosed at a more rapid pace than in wire and radio communications. The arts, both in theory and practice, are extremely complex and cover a vast field. New devices and improvements, no matter in what radio or wire services developed, are, as a general rule, immediately reflected in potentialities for improvements and actual application in all other services." How true was that prediction!

Happy Birthday, FCC, and many, many more.

ANSWERS TO radio and television problems puzzling many can be found in the encyclopaedic booklet, "An ABC of the FCC," just released by the Commission. Disclosed, for instance, is the answer to the censoring properties of the agency, with a quotation from the Communications Acts, which states: "Nothing in this Act shall be

RADIO & TELEVISION NEWS



Get
Into

RADIO, TELEVISION and ELECTRONICS

Master ALL Phases

Get Complete Training. You Receive and Keep All Equipment, Parts and Lessons. No Extra Charges.

**YOU
Build This
Superheterodyne**

You receive complete standard equipment, including latest type High-Mu Tubes, for building various experimental and test units. You progress step by step until you build a complete Superheterodyne Receiver. It is yours to use and keep.



YOU RECEIVE THIS PROFESSIONAL MULTITESTER!

You will use this professional instrument to locate trouble or make delicate adjustments—at home—on service calls. You will be proud to own this valuable equipment. Complete with test leads.



R. F. OSCILLATOR:

This is one of the interesting units you will build. You learn how audio-frequency energy is generated and radiated by a vacuum-tube circuit.

AUDIO OSCILLATOR:

An electronic device, which produces audio-frequency signals for modulating R.F. (radio frequency) carrier waves, testing A.F. (audio frequency) amplifiers, speakers, etc.

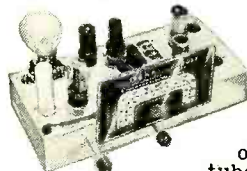
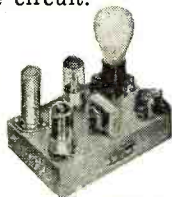

T.R.F. RECEIVER

You build several T.R.F. Receivers, one of which, a 4-tube set, is shown here. You learn construction, alignment, make receiver tests, and do trouble shooting.

GOOD PAY and Unlimited Opportunities in JOBS LIKE THESE:

Business of Your Own
Radio Manufacturing, Sales, Service
Broadcasting, Telecasting
Television Manufacturing,
Sales, Service
Laboratories: Installation, Maintenance of Electronic Equipment, Electrolysis, Call Systems
Garages: Auto Radio Sales, Service
Sound Systems and Telephone Companies; Oil Well and Drilling Companies; Engineering Firms
Theatre Sound Systems Police Radio
**And scores of other good jobs
in many related fields**

YOU CONDUCT MANY EXPERIMENTS LIKE THESE!

Checking action of condensers
Experiments with cathode-ray principles
Experiments with resonance
Producing beat frequencies
Calibrating oscillators
Experiments with diode, grid-bias, grid-leak and infinite impedance detectors
Practical experience in receiver trouble shooting
Application of visual tester in checking parts and circuits
Experiments with inverse feed-back
Advanced trouble-shooting
... and many, many others

Complete Training by Practical Resident Trade School, Est. 1905

The same highly trained faculty, instruction materials and methods used here in our large, modern residence school, are adapted to your training in your own home. Shop Method Home Training has been proved by hundreds of successful graduates.

**Both Resident and Home Study
Courses Offered**

YOU LEARN BY DOING

You receive special laboratory experiment lessons to show you how to build with your own hands various experimental units such as those shown at left, and how to conduct many tests.

You will find all lessons easy to understand because they are illustrated throughout with clear diagrams and step-by-step examples that you work out yourself. Every piece of the equipment and complete lesson material we send you is yours to keep and enjoy, including the multimeter, experimental equipment, all parts of the Superheterodyne, tube manual, radio dictionary, and complete, modern Television texts. All parts are standard equipment.

Shop Method Home Training . . . Earn While You Learn

With our practical resident Shop Method Home Training, you study in your spare time. You receive Spare Time Work Lessons, which show you how to earn while you learn. Service neighbors' radios and TV receivers, appliances, etc., for extra money and experience. Many National students pay all or part of their training with spare time earnings!

DON'T DELAY! The Radio-Television Industry needs trained men NOW!

**APPROVED
FOR
VETERANS!**
Check coupon below!

For quick action,
mail coupon
today and we'll
rush you full in-
formation.

Free!

**NEW, ILLUSTRATED
OPPORTUNITY
BOOK AND SAMPLE
LESSON SHOW YOU
HOW WE TRAIN
YOU . . . SEND FOR
THEM TODAY! NO
COST. NO
OBLIGATION.**



NATIONAL SCHOOLS

LOS ANGELES 37, CALIF. • EST. 1905



FIND OUT NOW . . . MAIL COUPON TODAY

National Schools, Dept. 8-RN
4000 South Figueroa Street
Los Angeles 37, California

Send me your FREE book "Your Future in Radio" and the sample lesson of your course. I understand no salesman will call on me.

NAME _____ AGE _____

ADDRESS _____

CITY _____ ZONE _____ STATE _____

Check here if Veteran of World War II

Mail in envelope
or paste on
penny postal.



New THORDARSON T-32W10 Audio Amplifier. Less T-32W00 Pre-Amplifier — but complete for use with high impedance pickup or tuner.

List Price **\$55.00**



New THORDARSON T-32W00 Plug-in Pre-Amplifier. Necessary when Audio Amplifier is to be used with any of the popular reluctance phono pickups or high impedance microphones. List Price **\$9.90**

Highest fidelity audio amplification — at modest price — is made available in THORDARSON'S new, outstanding T-32W10 Audio Amplifier.

It's versatile, too! There's no need to buy unnecessary extras. Although it is complete for use with the ordinary high impedance pick-up or tuner, it can be instantly converted when operation with reluctance pick-ups or high impedance microphones is contemplated. Just plug in the new THORDARSON T-32W00 Pre-Amplifier (see inset, at left). A pre-wired socket is provided. It's as easy as changing a tube!

Clear, undistorted, brilliant tones and elimination of surface noise place the T-32W10 entirely in a class by itself. Here, truly, is America's outstanding value in Audio Amplification!

Features

- Frequency response from 20 to 20,000 cycles.
- -70 Db hum level below rated output.
- Adequate gain to obtain full output from ordinary high impedance pick-up or tuner.
- Output for 3 to 4 ohms, 6 to 8 ohms, or 15 to 16 ohms which covers all high fidelity speakers.
- Complete with self-contained power supply, 115 volts A.C. and tubes.
- Output — 10 clean watts at less than 2% distortion.

Send for free literature!



THORDARSON

ELECTRIC MANUFACTURING DIVISION
MAGUIRE INDUSTRIES, INC.
500 W. Huron St., Chicago 10, Ill.

**GOVERNMENT SURPLUS!
WORLD'S LOWEST PRICE**

**PHOTO FLASH
EQUIPMENT**



COMES COMPLETE WITH
4 EDGERTON
FLASH TUBES
& REFLECTORS

EASY TO
CONVERT INTO
A 2-WAY PHOTO
FLASH UNIT

OPERATES ON 110V. AC & 12V. BATTERY

Brand new at a fraction of original cost. Contains finest component parts available. All necessary parts and complete instructions included. After conversion, works on 110V AC or 12V battery by a flick of a switch.

\$68.

IMMEDIATE DELIVERY ON ALL MAIL ORDERS

CINEX, INC., 165 W. 46th St., N. Y. 19, N. Y., Dept. RN-8



RADIO and TELEVISION

Thorough Training in All
Technical Phases
APPROVED FOR VETERANS

WEEKLY RATES DAYS—EVENINGS

RCA GRADUATES ARE IN DEMAND
For Free Catalog write Dept. RN-49
RCA INSTITUTES, Inc.

A Service of Radio Corporation of America
350 West 4th St., New York 14, N. Y.

PEN-OSCIL-LITE

Extremely convenient test oscillator for all radio servicing; alignment • Small as a pen • Self powered • Range from 700 cycles audio to over 600 megacycles u.h.f. • Output from zero to 125 v. • Low in cost • Used by Signal Corps • Write for information.

GENERAL TEST EQUIPMENT
38 Argyle Buffalo 9, N. Y.

understood or construed to give the Commission the power of censorship over the radio communications or signals transmitted by any radio station, and no regulation or condition shall be promulgated or fixed by the Commission which shall interfere with the right of free speech by means of radio communications."

The booklet also reveals that there are nearly 75,000,000 broadcast receiving sets throughout the nation.

Commenting on the type of matter barred from the air, the FCC organ states that the United States Code prohibits the broadcast of information concerning lotteries and similar schemes and the utterance of obscene, indecent, or profane language.

Covering the issuance of frequency assignments to government stations, the booklet reveals that all such assignments are made by the President, upon the recommendation of the Interdepartment Radio Advisory Committee (IRAC), a committee of government agencies using radio, on which the FCC is represented.

Other pertinent problems discussed include FCC order enforcing, policing of ether, types of services, means of regulations, etc. Copies of this interesting booklet can be obtained from the Superintendent of Documents, U.S. Government Printing Office, Washington 25, D. C., for ten cents.

THAT VOLATILE TOPIC, the TV freeze, bounced back into the headlines with quite a blare when the FCC released its famous public notice stating that . . . "it will institute further proceedings looking toward the lifting of the freeze on the present band, providing a substantial number of ultra-high channels for commercial service, affording an opportunity for the submission of proposals toward the use of 6 mc. color in all channels in such a way as to permit reception on an ordinary TV receiver with relatively minor modifications, and adopting a nation-wide assignment plan covering commercial operation in both bands."

As reported on several occasions, the Commission had been studying the very-high-ultra-high recommendations offered during recent hearings and found that the problems of both bands were so related that it would not be feasible to lift the freeze without providing a modified allocation plan for the upper and lower channels. Accordingly, the FCC proposes to suggest the use of approximately one-half the lower portion of the ultra-high band for regular TV operation on the 6 mc. channels, appropriating the upper half for research, such as stratosvision, polycasting and high-definition black and white, and color.

At about the time this column appears, the FCC will issue a *notice of proposed rule making*, which will not only cover the contemplated use of channels in the ultra-high band, but also contain a revised allocation table for the present band, taking into con-

(Continued on page 116)

RADIO & TELEVISION NEWS

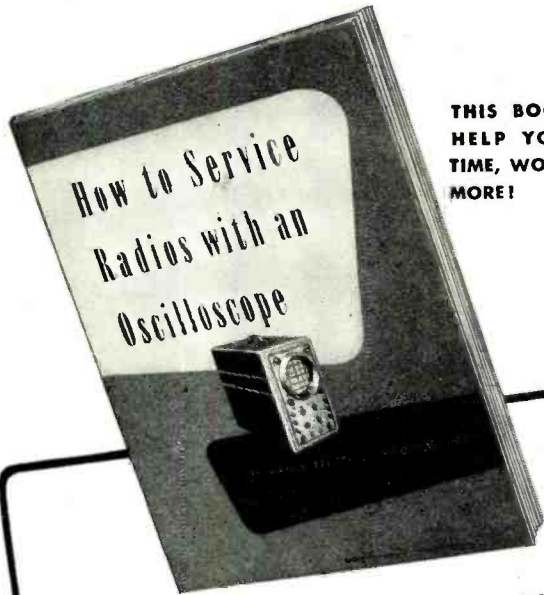

**THIS BOOK WILL
HELP YOU SAVE
TIME, WORK, EARN
MORE!**

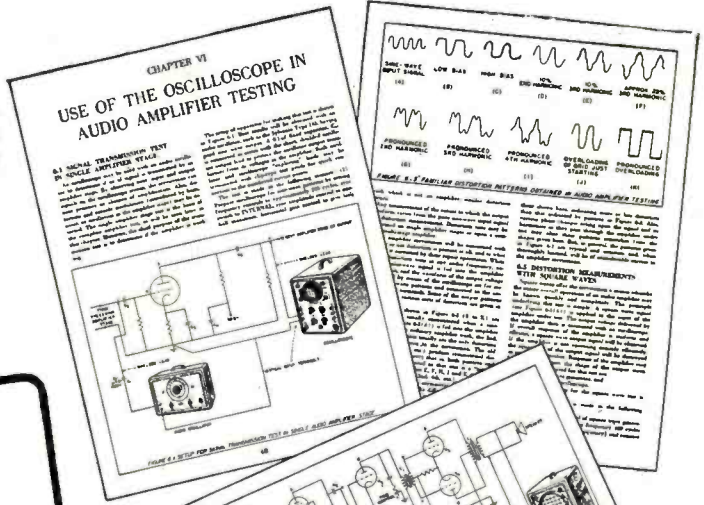

SYLVANIA SHOWS YOU

"HOW TO SERVICE RADIOS WITH AN OSCILLOSCOPE"

Here's a big, complete book that gives you step-by-step instructions for using the oscilloscope in testing and servicing radio receivers, audio amplifiers and transmitters.

The more than 90 illustrations of circuits, 'scope patterns, and set-up arrangements for circuit testing explain over 50 separate oscilloscope applications.

Only
\$1.00

EXPLAINS THESE AND MANY MORE

1. AM and FM receiver alignment
2. Locating hum
3. Signal tracing and trouble shooting
4. Finding receiver faults from oscilloscope patterns
5. Checking AVC action
6. Voltage gain measurement
7. Auto radio vibrator tests
8. Checking peak current in rectifiers
9. Impedance measurement
10. Checking filter capacitors — and many others!

SYLVANIA ELECTRIC

FLOUORESCENT LAMPS; FIXTURES; WIRING DEVICES; SIGN TUBING; LIGHT BULBS; PHOTOLAMPS; RADIO TUBES; CATHODE RAY TUBES; ELECTRONIC DEVICES

- ★ **Get this big 72-page book!**
- ★ **More than 90 pictures and diagrams!**
- ★ **Written in easy-to-follow servicemen's language!**

Sylvania Electric Products Inc.
Advertising Dept. R-1008
Emporium, Pa.

Gentlemen:

Send me "How To Service Radios with an Oscilloscope." Enclosed is \$1.00.

Name.....

Address.....

City..... Zone.....

State.....

You'll Get the **MOST FOR** Your **MONEY** by Specifying **PYRAMID** Capacitors

WRITE FOR COMPLETE LITERATURE

Representatives and Distributors Throughout the U.S.A. and Canada

PYRAMID CAPACITORS

PYRAMID ELECTRIC COMPANY
155 Oxford Street
Paterson, N. J., U.S.A.
TELEGRAMS: WUX Paterson, N. J.
CABLE ADDRESS: Pyramidusa

Within the INDUSTRY

E. E. LOUCKS, has been requested by the U. S. Department of Commerce to act as an adviser on its advisory panel for radio apparatus. Membership on the panel is composed of businessmen, international traders, and industrialists, acting as consultants to the



government agency.

Mr. Loucks, who is manager of the International Division of *Zenith Radio Corporation*, became associated with that company as export manager in 1944. Previous to that, he was affiliated with the *International General Electric Company, Inc.*

GEORGE L. DOWNS, formerly in charge of the methods and cost estimating department, has been placed at the head of transformer operation of *Raytheon Manufacturing Company* at Waltham, Mass. . . .

GEORGE L. MEYER, JR., has been elected to the board of directors of *Stewart-Warner Corporation*, the post which was created by the death of Ralph M. Shaw. A vice-president of the company since 1941, Mr. Meyer was associated with the company from 1907. . . . The new advertising manager of *Noblitt-Sparks Industries, Inc.*, Columbus, Indiana, is **JAMES M. JEWELL**, former advertising copy chief, *Kelvinator Division, Nash-Kelvinator Corp.*, Detroit. . . . Elected chairman of the board and president, respectively, at the annual meeting of *Globe-Union, Inc.*, were **C. O. WANVIG**, president of the firm since 1927, and **WYETH ALLEN**, executive vice-president for the past twenty years. The change in top management, according to Mr. Wanstig, was prompted by a need for a division of increased management duties. . . . **BURNHAM ADAMS**, manager of the California division of *Lear, Incorporated*, was recently elected vice-president of the corporation at a meeting of the board of directors.

DAVID HALE HALPERN, vice-president of the *Owen and Chappell, Inc.*, advertising firm, was chosen president of the American Television Society at its annual election of officers, succeeding Charles J. Durban of *United States Rubber*.

Other officers elected at the meeting were Donald E. Hyndman, *Eastman Kodak Co.*, vice-president; Reynold R. Kraft, *National Broadcasting Co.*, secretary, and Archibald U. Braunfeld, *Braunfeld and Simons*, treasurer.

In accepting the office, Mr. Halpern pledged that the American Television

Society would take a firm stand on the issues of the day and will not be inarticulate and vacillating. Other speakers included E. S. England, *NBC Research Associate*, who spoke on sources of TV research information.

DR. ALLEN B. DU MONT, president of *Allen B. Du Mont Laboratories, Inc.*, was honored with a degree of Doctor of Engineering at the 94th annual commencement exercises of the Brooklyn Polytechnic Institute, held at the Brooklyn Academy of Music.

The citation by H. S. Rogers, president of the Institute Corporation, who conferred the degree, reads in part: "Allen Balcom Du Mont, inventive genius, able and creative engineer, courageous and resourceful industrialist, your achievements in the science, the art, and the industrial management of television have been widely recognized by members of professional societies and trade associations, and by the ultimate beneficiaries of your genius, the American people."

Dr. Du Mont was presented for the degree by Charles E. Potts, chairman of the Institute Corporation.

C. A. STAUB, who has been for the past seven years assistant secretary and



comptroller of *Radiart Corporation*, Cleveland, Ohio, has been appointed treasurer of the *Cornell-Dubilier Electric Corporation*, with headquarters in South Plainfield, New Jersey.

Cornell-Dubilier purchased the *Radiart* stock from the *Maguire Industries* in 1948, and the three plants of *Radiart* are being operated as a subsidiary of the corporation.

Previous affiliations of Mr. Staub include the *Larkin Company*, and the *Van Swearingen Corporation*.

H. W. PFEFFER, of *Struthers-Dunn, Inc.*, at a recent meeting of the National Association of Relay Manufacturers, was chosen president for the coming year, succeeding Ralph T. Brengle, of *Potter & Brumfield Mfg. Co.*

Other officers elected were H. L. Huntsinger of the *RMB Division of Essex Wire Corporation*, vice-president, and J. V. Roughan of the *Price Electric Corporation*, secretary-treasurer.

Five directors were also elected, and standing committees were appointed to evolve uniform standards and nomenclature in the relay field.

TELEVISION

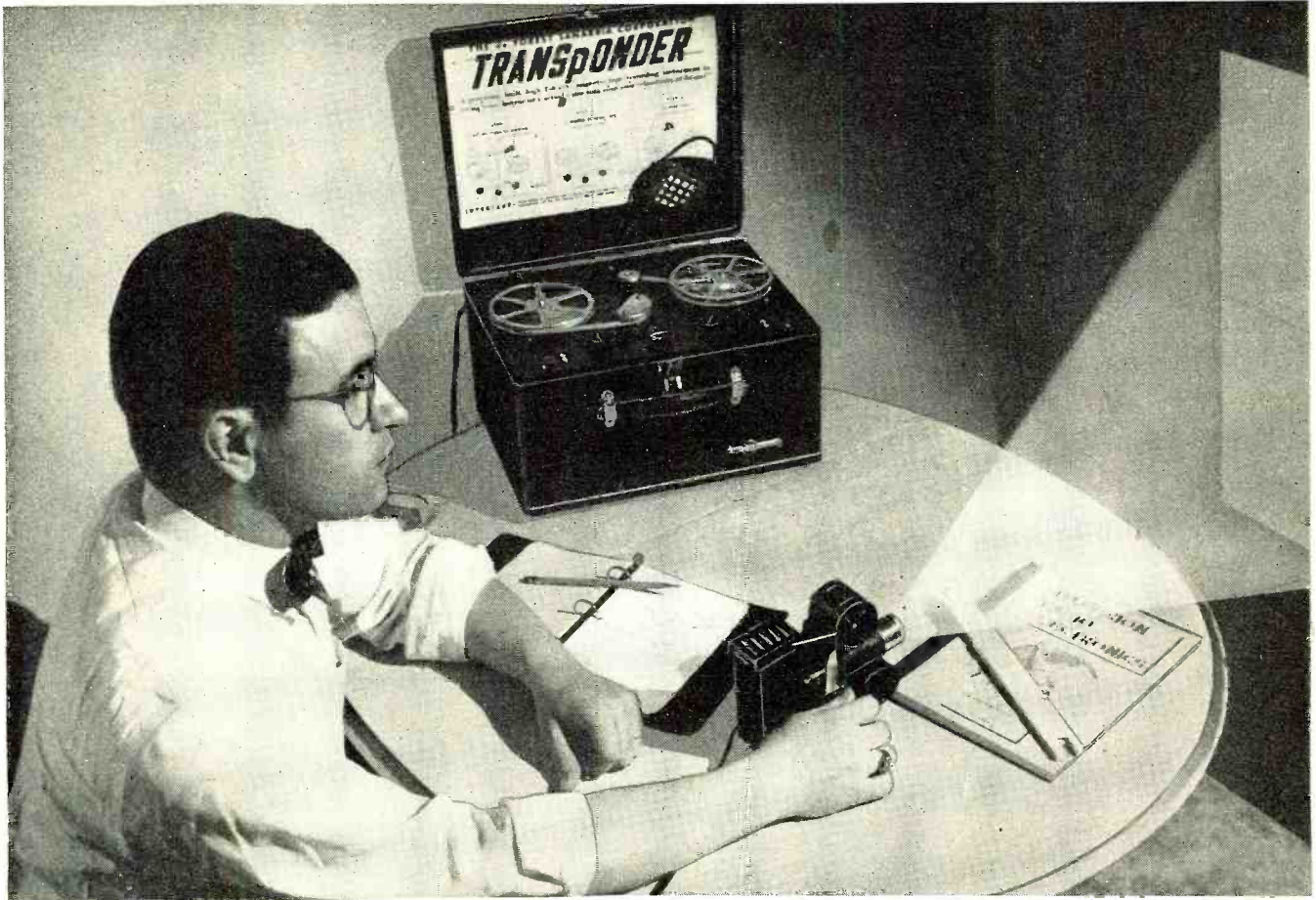

Let *TRANSPONDENCE* Help You Qualify at Home!

In order to speed the training of skilled personnel for the Television Industry, the amazing new Transpondence System of Home Study has been developed by the DeForest-Sanabria Corporation.

Combining the proved principles of visual education with the latest electronic method of sound reproduction, Transpondence offers you the one right way to train at home for Television!

Compare THESE ADVANTAGES WITH ANY OTHER METHOD OF HOME TRAINING AVAILABLE TODAY!

- All lessons recorded in full by expert, experienced instructors.
- All illustrations projected to blackboard size.
- Two-way magnetic sound Transpondence unit keeps you in contact with your instructor by voice!

LEARN TELEVISION EASIER...

FASTER...BETTER at home with

TRANSPONDENCE

-----SEND COUPON FOR FULL INFORMATION-----

DeForest-Sanabria Corporation, 5050 N. Broadway, Chicago 40, Illinois

Please send me free information about Transpondence Training at home.

NAME

ADDRESS

CITY ZONE STATE

Can I trust him to do a good repair job on my radio at a fair price?

How can I convince him that we do good work at reasonable cost?



Only **RAYTHEON** gives both You and your Customers the right answer and here it is-

The Raytheon Bonded Electronic Technician Program...

It's a 90-day BONDED guarantee on your radio set repair work and replacement parts, backed by American Mutual Liability Insurance Co.'s assets of close to a hundred million dollars!

RAYTHEON pays for it—The Raytheon Tube Distributor has this Bond for you — if you qualify. It doesn't cost you a cent. Here's honest-to-goodness customer insurance — the one and only answer that clears away mistrust — the biggest barrier to volume and profit.

Get in touch with your Raytheon Distributor, now. Ask him how to become a BONDED ELECTRONIC TECHNICIAN.



Why RAYTHEON Tubes are Easier to Sell

Universally Recognized Quality—Raytheon's reputation for excellence in electronics is unsurpassed. Your customers and prospects know the name, RAYTHEON, and know it stands for quality all along the line, from tiny hearing aid tubes to huge Magnetrons.

Don't take our word for it, alone

R. W. Roller, Electronics Service, Inc., Denver, Colorado, writes: "The framed Bonded Electronic Technicians Certificate hangs in a prominent place on our show room wall. There is no doubt that it inspires confidence in our place of business."

R. S. Bryant, Lubbock Radio, Lubbock, Texas, writes: "To my knowledge, your Bonded Dealer Program is the best thing for the Service business."



Efficient Merchandising — Your Raytheon distributor is one of the best parts sources in town — a good one to deal with. He has to be as sponsor of the Raytheon Bonded Dealer Program.

Raytheon national advertising and point-of-sale display material constantly reminds your customers of the value of the Raytheon name on every tube.

RADIO RECEIVING TUBES • SUB-MINIATURE TUBES • SPECIAL PURPOSE TUBES • MICROWAVE TUBES

RAYTHEON

MANUFACTURING COMPANY
RADIO RECEIVING TUBE DIVISION

NEWTON, MASSACHUSETTS • CHICAGO, ILLINOIS • LOS ANGELES, CAL.

RADIO MAGAZINE LIBRARY



Another Walter Ashe Exclusive!

Only **50¢**

A brand new way to preserve every treasured issue of Radio and Television News Magazine.

An ingenious, custom-built storage file made of high quality Kraft fibre board printed and constructed to look like a Buckram bound book. Measures 12" x 8 1/2" x 2 3/16".

per set of 2
Set of 2 holds 12 complete issues
(Plus 15¢ per set for pkg. & postg. anywhere in U.S.)

SPECIAL OFFER!
New low prices on QST & CQ Magazine Libraries. Formerly 35¢

Now Only 25¢ each Hold 12 issues
(Plus 6¢ ea. to cover pkg. & postg. anywhere in U.S.)

Walter Ashe RADIO CO.
1125 PINE ST. • ST. LOUIS 1, MO.

ORDER YOURS TODAY!

RADIO ENGINEERING DEGREE IN 27 MONTHS

Intensive, specialized course, including strong basis in mathematics and electrical engineering, advanced Radio Theory and Design. Modern laboratory. Low tuition. Self-help opportunities. Also 27-month courses in Aeronautical, Chemical, Civil, Electrical and Mechanical Engineering. Gov't approved for G.I.'s. Enter Sept., Dec., March, June. Catalogue, INDIANA TECHNICAL COLLEGE
989 E. Washington Blvd., Fort Wayne 2, Indiana

QUAD SMASHES PRICES!

Write for Midsummer Sale Circular—Red Hot Bargains
QUAD ELECTRICAL SUPPLY, INC.
Dept. A, 1650 N. Damen, Chicago 47, Ill.

Twenty-five manufacturers comprise the present membership of the association, including Potter & Brumfield Mfg. Co., Sigma Instruments, Inc., Leach Relay Co., Price Electric Corp., and Allied Control Co., Inc.

J. W. HEAD, founder and president of Electronics Institute, Inc., of Detroit,



was given an honorary Doctor of Law degree by Piedmont College, Demorest, Ga., for distinguished service as an educator, engineer, and practical scientist. It is the highest honor the

school can bestow.

Mr. Head, who also directs the activities of Industrial Electronics, Inc., a professional consultant organization, has attained national recognition as author, lecturer, and engineering consultant in electronics, radio, and television.

A graduate of Oglethorpe University, he became an engineering consultant, and later attracted the attention of Dr. Lee DeForest, with whom he later became associated.

UNIVERSAL RADIO SUPPLY CO. announces that its new address is 533 South Seventh Street, Louisville 3, Kentucky, and that its grand opening will be announced soon for the trade.

HUDSON ELECTRONICS CORPORATION, having moved to larger quarters, reports that the new location is at 110 East Third Street, Mount Vernon, New York. . . . A new plant occupying three times the former space has been opened by J. B. HERMAN COMPANY, on Watson Street, Boston, and with new machinery and improved production methods, will produce the "Hermco" lenses, as well as plastic products for radio and TV fabrication.

. . . New factory branch sales and service buildings have been constructed recently by INDEPENDENT PNEUMATIC TOOL COMPANY, manufacturer of Thor portable power tools. The company's export division will continue to be located at 330 W. 42nd St., New York, N. Y. . . . Two plants have been acquired by OLIN INDUSTRIES, INC., for the manufacture of railway fuses and torpedoes, and are located in Peru, Indiana, and Los Gatos, California. . . . TINNEMAN PRODUCTS, INC., has moved its Detroit district offices to 14550 Third Ave., Detroit, Michigan. The move was announced as a larger, more convenient location.

BERNARR S. WIXON and LAVERNE J. TRAGESSER were promoted from the position of assistant to full buyer in their respective departments in Sears, Roebuck and Co.'s radio department.

Mr. Wixon is the new buyer of all recording, phonograph, and record-playing equipment, having served as assistant since October, 1945. Mr. Tragesser, who since 1946 has served

(Continued on page 137)

AUGUST, 1949

**RADIO
& TELEVISION
NEWS**

RADIO-ELECTRONIC *Engineering*



TELEVISION

RADAR

ELECTRONICS

RESEARCH

COMMUNICATIONS

MAINTENANCE

RADIO-ELECTRONIC

Engineering

Trade Mark Registered U.S. Patent Office No. 445,000

ELECTRONICS • COMMUNICATIONS • TELEVISION • RESEARCH • MAINTENANCE

AUGUST, 1949

ELECTRONICS IN METEOROLOGY.....Norman A. Abbott 3

AN IMPROVED ELECTRONIC PHASE METER..... 8

MEASUREMENT OF QUALITY IN AUDIO REPRODUCTION..David Fidelman 9

SPECIAL LOUDSPEAKER SYSTEMS.....John D. Goodell and Curtis W. Fritze 11

THE MAGNETIC AMPLIFIER.....P. M. Kintner and G. H. Fett 14

DEPARTMENTS

NEWS BRIEFS	20	NEW PRODUCTS	22
PERSONALS	24		



RADIO-ELECTRONIC ENGINEERING is published each month as a special edition in a limited number of copies of RADIO & TELEVISION NEWS, by the Ziff-Davis Publishing Company, 185 N. Wabash Avenue, Chicago 1, Illinois.

VOLUME 13, NUMBER 2, Copyright, 1949, Ziff-Davis Publishing Company

COVER PHOTO — Courtesy of General Electric Co.

Absence of moving parts and long life are features of new magnetic amplifiers applicable to a wide variety of electric control problems in circuits measuring tension, speed, pressure and flow. Coupled with a thermopile, the amplifier forms a flame detector to stop fuel flow to a burner if the flame goes out.



ELECTRONICS in METEOROLOGY

By NORMAN A. ABBOTT

Equipment and techniques such as radiosonde, series, and radar have added materially to our knowledge of the science of meteorology.

THE importance of accurate weather prognostication is not limited to the destruction of plans for Sunday's picnic, but is vital in military planning and operations, in utilities operation and preventive maintenance, and in aircraft scheduling and operation, as well as in many other fields of endeavor. It is expected that with the application of new methods of instrumentation in probing the upper air there is a possibility of obtaining answers to some of the design and operational problems in connection with the propagation of sound, as well as light, heat, and other electromagnetic radiation.

The meteorologist is utilizing the advances in other scientific fields more and more, and electronic equipments are among the most widely used. In what is to follow the descriptions of over-all equipment will be somewhat brief and sketchy in order to permit describing a number of different devices, and some of the more interesting electronic portions of these devices.

The Radiosonde System

In view of the importance to the meteorologist of upper atmosphere conditions let us first look at the radiosonde system which, incidentally, is probably

the earliest application of electronics to the field of meteorology. This system may be broken into three parts. First, that portion which is sent into the upper atmosphere, second, that part which receives the information obtained by the airborne portion, and third, a recording means to retain the received information for study and action. The data obtained, that is, pressure, temperature, humidity, wind speed, and wind direction are utilized for forecasting, flying altitude selection, ballistics corrections, etc.

The Radiosonde

The device sent aloft to make soundings of the atmosphere and to automatically transmit these soundings to the ground stations is termed a radiosonde (Fig. 1). It is fastened to a gas-filled balloon which is carried by the wind in free flight. Generally the balloon used is such as to give a rate of rise of approximately 1000 feet per minute. At its maximum altitude the balloon bursts and the equipment is lowered to the ground by parachute. During flight, radio signals are transmitted which are a function of the atmospheric pressure, temperature and humidity at the radiosonde; and the drift of the balloon provides an indication of wind direction and speed.

The radiosonde is made up of two major components, the meteorological element modulator and the transmitter. As its name implies, the modulator is that portion of the equipment which adds intelligence to the transmitter signals. High speed of response to changes in the atmosphere is a prime requisite of the elements used here because of the rapid motion of the transporting vehicle. The complete radiosonde including batteries for the transmitter weighs only between three and four pounds (Fig. 2).

In the past, the temperature measuring element has been a mercury column with a multiplicity of contacts at points corresponding to different temperatures, or an electrolytically responsive resistance element, but the modern sonde

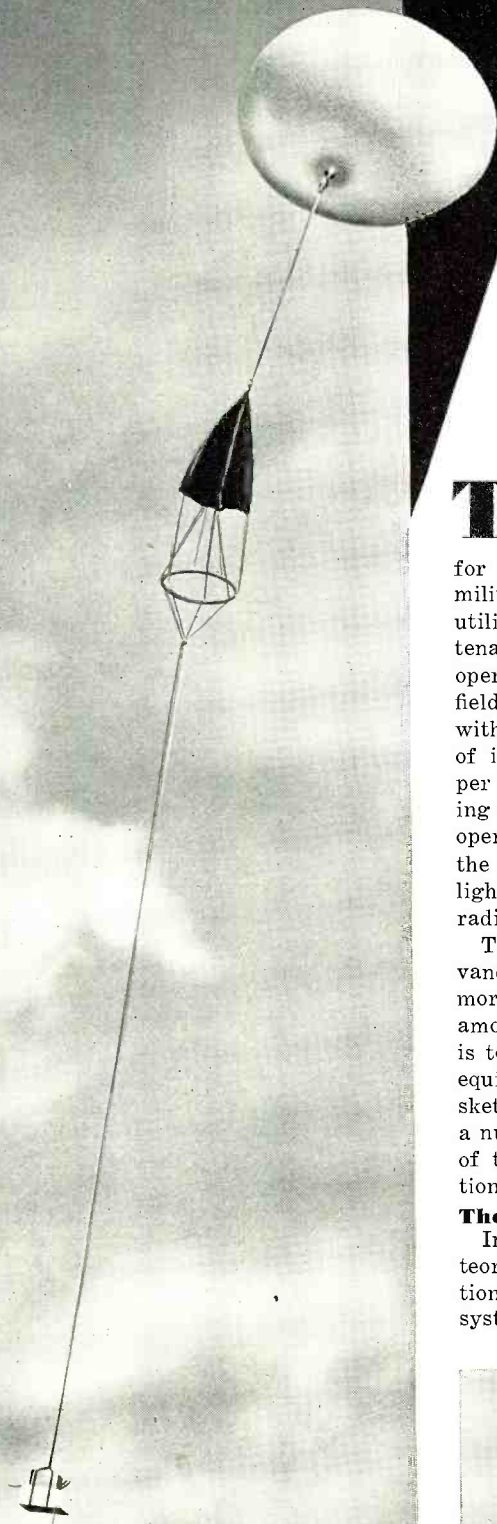
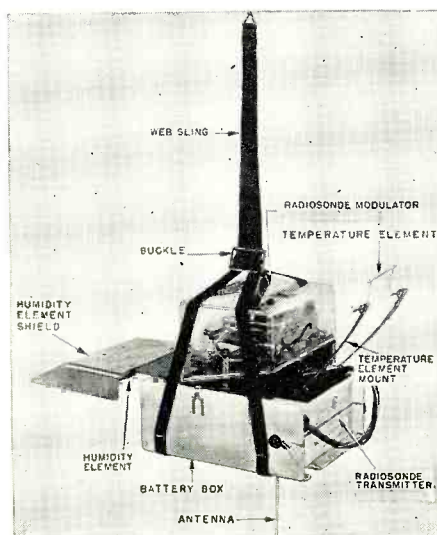

Fig. 1. The radiosonde is carried aloft by a balloon. When the balloon bursts, the equipment is lowered to the ground by means of a parachute.

Fig. 2. Complete radiosonde assembly, including batteries, weighs less than four pounds and is made up of two main components, the meteorological element modulator and the transmitter.



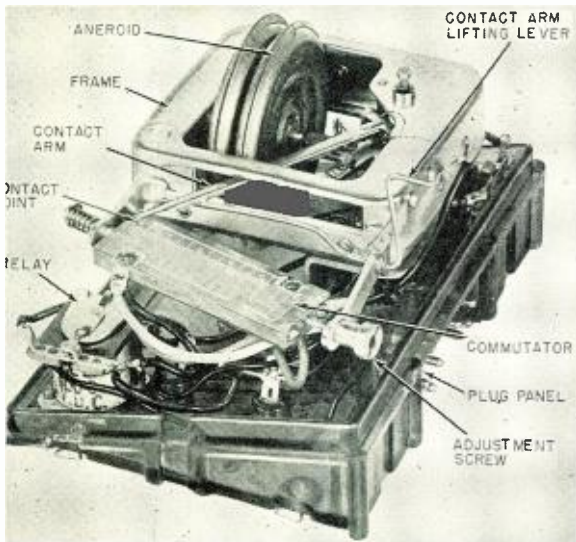

Fig. 3. Radiosonde pressure and commutator assembly. As the pressure varies, the contact arm moves along the commutator. See circuit in Fig. 4.

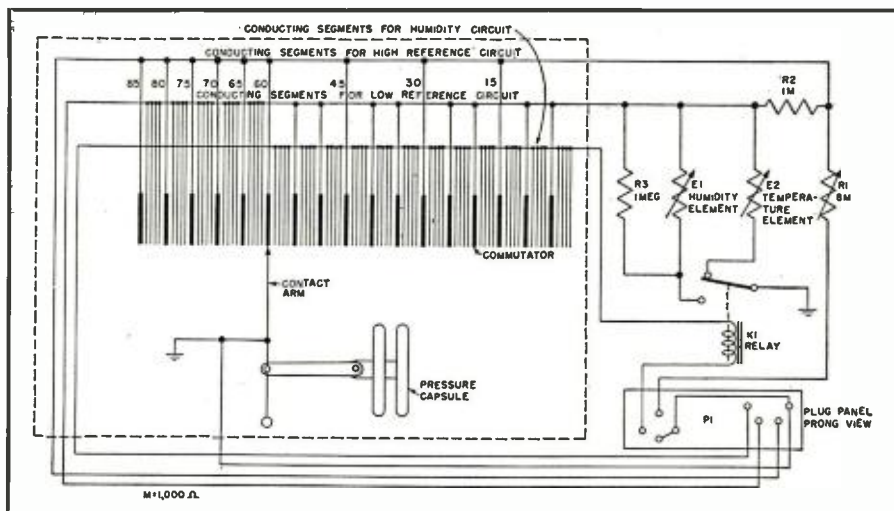

Fig. 4. Schematic diagram of the radiosonde modulator.

utilizes a ceramic resistor which has high speed of response, high stability, is polarization free, and rugged. The resistance of this element is inversely proportional to the temperature (negative temperature coefficient of resistance) and each one is calibrated for operation between temperature limits of $+60^{\circ}$ to -90°C . They are coated white to reflect solar radiation.

Humidity was formerly measured by the effect of moisture on strands of human hair under tension, and, as will be seen a little later, at least one such device is in present use. However, the more popular form of humidity measuring element at present is composed of a simple polystyrene strip with a hygroscopic lithium chloride coating. The resistance between two metallic electrodes along the edges is a function of absorbed moisture and the temperature. These strips are calibrated to measure relative humidity between 15 and 100%.

The pressure unit comprises a bi-metallic temperature-compensated aneroid capsule assembly which is connected to a crank and lever system that moves a contact point across a commutator assembly. The usual pressure unit operates between 10 and 1060 mil-

libars pressure, or in more familiar language, over a pressure range from, roughly, one tenth of a pound per sq. in. to fifteen pounds per sq. in. The commutator is made of a large number of contacts separated by insulating segments. The contact point is connected through the commutator to a relay. The commutator usually contains about 80 to 90 contact segments. A recent technique in this construction is to use plated contact segments on a polystyrene block (Figs. 3 and 4).

Each fifth contact is twice as wide and each insulating segment three times as wide as the intermediate contacts. Each fifth contact below #60, and all contacts above #60, are connected to reference circuits. Numbers 15, 30, 45, 60, and then each fifth goes to what is termed a high reference circuit whereas each fifth contact below #60 (except 15, 30, and 45) and all intermediate contacts above #60 are connected to a low reference. When the contact point is on a high reference contact, resistor R_1 is in the grid circuit of the transmitter modulating oscillator. On a low reference contact R_2 is added in series with R_1 . When the contact is made through one of the intermediate segments below #60 a circuit is completed through the relay which pulls the relay contact arm into a position which connects the humidity element, in series with R_2 and R_1 , in the modulating oscillator circuit. (Resistor R_2 is simply a limiting resistor to assure readings from the humidity circuit below 1 megohm.) When the pressure contact is on an insulating segment, the relay contact arm places the temperature element in series with R_2 and R_1 , in the modulating oscillator circuit. Hence we see that as the balloon rises and the pressure element expands, the contact arm moves over a series of segments which places the resistance due to temperature and humidity ele-

ments in a transmitter circuit. Since the pressure element is calibrated, the pressure is known at each contact segment.

The met element modulator is coupled to the transmitter through the relay and the reference resistors. The modulating oscillator is connected either to the temperature element, the humidity element, or to a reference element, in accordance with the position of the contact arm. The transmitter usually comprises two electron tube sections which may be in separate envelopes or combined as a single multipurpose tube. One of these acts as a generator of carrier frequency while the other performs a modulating function. The modulator is a self-blocking oscillator which operates at about 750 kc. The blocking rate is determined by the value of an $R-C$ combination in the grid circuit, and the value of the resistance in this combination is determined by the position of the contact arm on the commutator. In turn, the modulator is so coupled to the carrier oscillator that when the modulator is on the carrier is off, and when the modulator is off the carrier is on. So we have a form of pulsing or keying in which the interruption frequency of the modulating oscillator, generated as a function of the weather conditions at the radiosonde, is transmitted as an audio frequency modulation of the carrier.

With the high reference resistor in circuit the audio frequency is approximately 194 c.p.s. With the low reference resistor added this changes to 190 c.p.s. During a flight, the audio frequency generated by connecting the temperature or humidity elements into the circuit will vary between approximately 8 and 180 c.p.s.

Note that the meteorological conditions do not vary the frequency of the modulating oscillator but only the rate at which this frequency is interrupted. As a result of this type operation the

Fig. 5. Schematic diagram of a 400 mc. radiosonde transmitter.

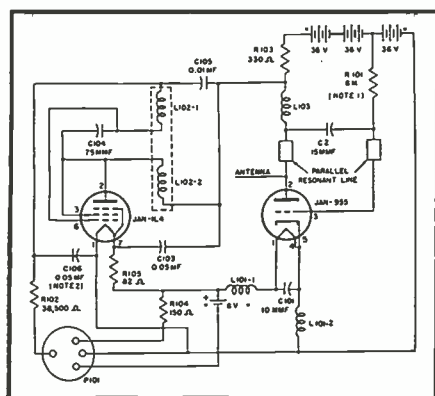

receiver determines a simple comparison of audio frequencies, thereby avoiding many of the variable characteristics which might otherwise have to be overcome.

The earlier systems such as the one just described operated at a carrier frequency of about 72 mc. A more recent system, which is presently in operational use by the armed forces and the U. S. Weather Bureau, operates at approximately 400 mc. (Fig. 5).

At this higher frequency it is possible to use transmission line techniques for the resonant circuits instead of lumped constants, and with tuning performed by adjusting the spacing between lines. In addition, it was found desirable to use frequency modulation rather than the amplitude modulation used in the lower frequency transmitter.

The same meteorological modulating elements are used in conjunction with this transmitter, and the first section of the transmitter (the modulation oscillator) operates in the manner previously described. In this particular case the operating frequency of the modulation oscillator is 2.5 mc. Frequency modulation of the carrier tube is obtained by passing the plate voltage to both modulator and carrier tubes through the same resistor. Then when the modulation oscillator is on, the carrier tube has a lower voltage applied to its plate due to the drop in the common resistor; and when the modulation oscillator is off, the carrier plate voltage increases. Transit time effects at the 400 mc. operating frequency of the carrier tube are sufficiently great to cause a lower frequency of operation at reduced plate voltage than at the higher plate potential. Hence, as the plate

voltage is varied by the blocking action of the modulation oscillator, the carrier frequency is varied and at the same audio rate. (Fig. 6).

One of the latest developments in this same field is a transmitter operating at a frequency of approximately 1700 megacycles. (Fig. 8). At this frequency, remembering the light weight that is required in both tube and power supply, the problem of a suitable tube became quite severe. Under a Signal Corps contract RCA developed a unique tube utilizing coaxial elements, and resonant cavity techniques are used in the transmitter. The cavity oscillator and associated blocking oscillator are enclosed in a plastic bullet-shaped case about 8" long and 1½" in diameter. The cavity itself is only 2" long and ¾" in diameter. Complete with tube and antenna system the transmitter weighs only 50 grams. The cavity is divided into two concentric circuits; one, a grid to anode circuit, and the other, a grid-cathode circuit. Shorting bars are used for adjustment plus a fine frequency capacity tuning slug in the anode circuit. An inclined reflector element, or so-called ground plane, helps prevent antenna radiation from entering the metallic elements of the radiosonde modulator with attendant antenna pattern distortion.

The Receiver

The signals transmitted by the radiosonde are received at the ground stations by one of two general methods and then indicated and recorded for analysis and use.

Where interest lies only in the pressure, temperature and humidity at the airborne instrument a simple receiving-recording system is used. Two vertical

dipole antennas, connected to the receiver by 75 ohm coax line, are located at physically separated positions and are so used that as the balloon-borne radiosonde is carried by the wind the most efficient of the two antenna locations is utilized. That is, although there are two antennas, only one is in use at any one time. The radio receiver in the case of the 72 mc. system has an r.f. stage, a superregenerative detector stage, and three output channels. One of these channels feeds a speaker for aural monitoring purposes, a second channel feeds a signal intensity meter for indicating strength of the modulated

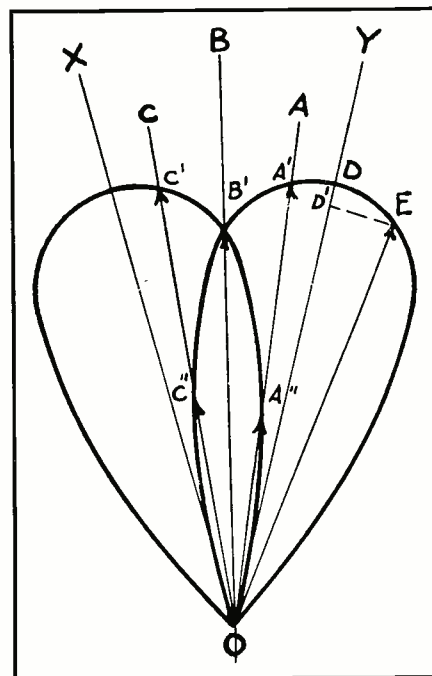

Fig. 7. Split pattern, or lobe switching, tracking.

Fig. 6. The 400 mc. radiosonde transmitter shown in schematic form in Fig. 5.

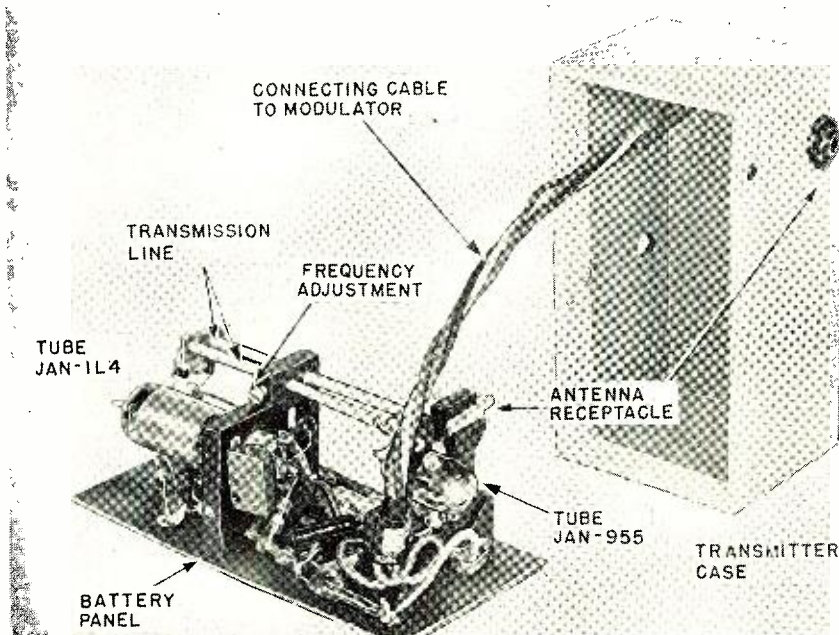
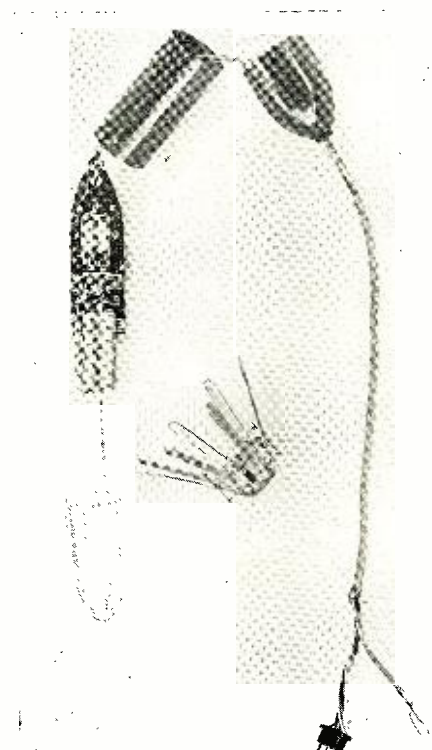

Fig. 8. Partly disassembled view of 1700 mc. radiosonde transmitter.



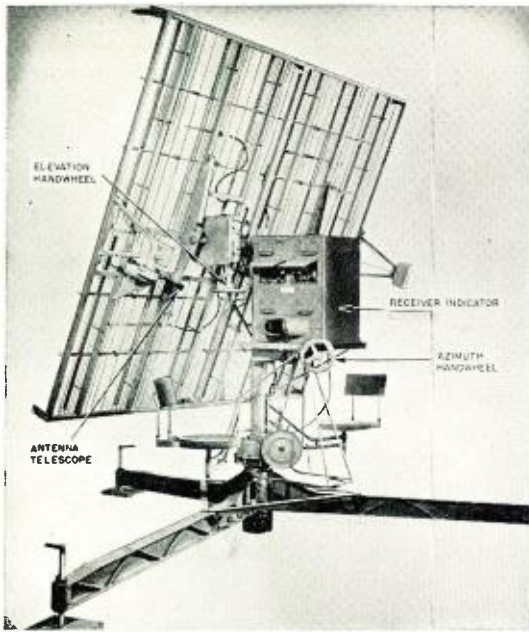

Fig. 9. Radio Direction finder SCR-658.

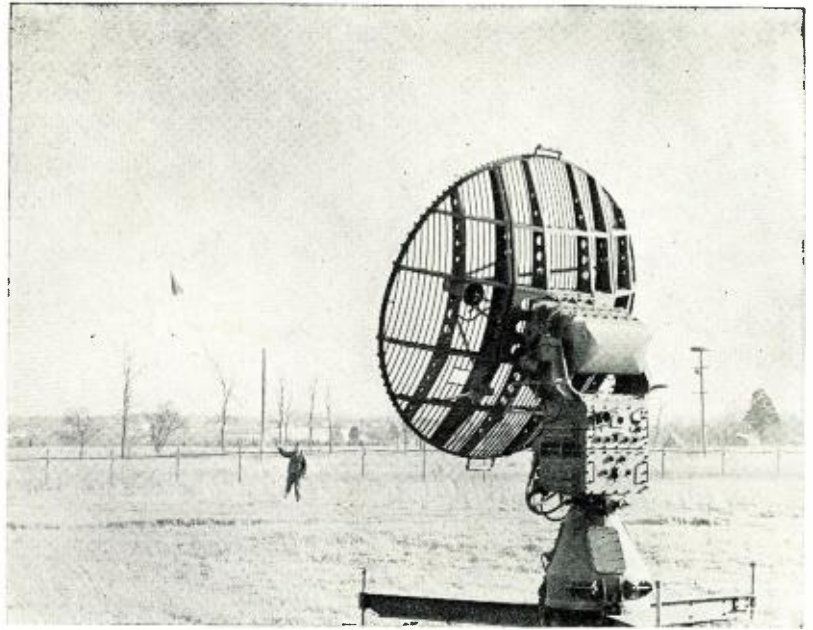
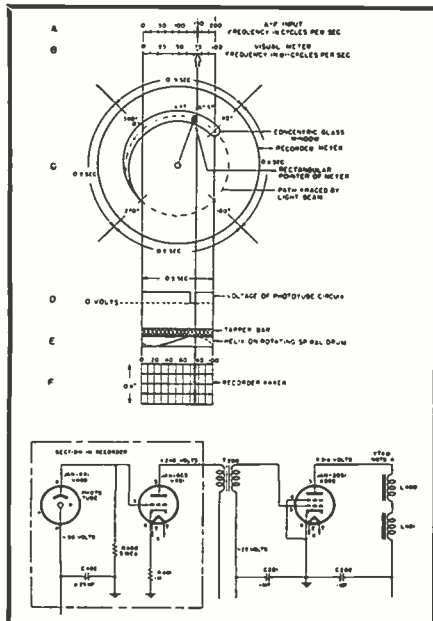

Fig. 10. 1700 mc. radiophone direction finder, automatic tracking.

r.f. signal being received, and the third channel is used to provide audio frequency output signals having a sawtooth waveform, for operation of a frequency meter. Although the waveform of the input signal is distorted by the superregenerative detector, the modulation frequency of the transmitted signals is retained. After amplification and differentiation the negative halves of the signals are removed and a signal produced which consists of a series of sawtooth waves with practically constant amplitude regardless of the modulation frequency or signal intensity. The frequency of the sawtooth wave varies at an audio rate with the modulation frequency of the radiophone.

Fig. 11. Schematic diagram of the printing control, radiophone recorder.



In the more usual case, however, where in addition to pressure, temperature and humidity, information is also desired on wind direction and speed as the radiophone is carried aloft, or if information on wind velocity only is required, a direction finder is used to track the transmitter. Optical theodolites served this purpose until the advent of modern electronics. Optical means fail under conditions of darkness or fog, or when the balloon passes through a cloud, but these conditions are overcome by means of the meteorological radio direction finder. One of these is the SCR-658 developed by the Signal Corps (Fig. 9).

Unlike the more common direction finder which provides azimuth data only, this unit utilizes more recent techniques and provides both azimuth and elevation data. In addition, the receiver has a channel through which the frequency modulated radiophone signals are passed and converted into the amplitude and wave shape required by the recorder unit. The set is transportable, weighing about 2000 pounds fully packed for domestic shipment. It operates on a frequency of approximately 400 mc., and uses a mattress type antenna with vertically polarized radiating elements. It is so arranged that it can be operated by one man or two. The operator, or operators, turn handwheels which rotate the antenna in azimuth and elevation so that it tracks the balloon-borne transmitter. The operators are guided by the indication on a cathode ray tube using a radar type A presentation.

The antenna array contains 32 half-wave elements spaced a half wave apart. These are arranged into four bays which are so connected by means of

a rotary switch as to provide four different combinations in rapid succession. Two adjacent bays are fed directly into the receiver while the other two are passed through a delay line. Then the next two bays are switched in for direct and delayed contact, and so on. As the motor driven switch rotates the antenna lobes take positions of "up elevation," "left azimuth," "down elevation," and "right azimuth" in succession.

This system provides what is termed split pattern tracking (Fig. 7). By connecting two of the antenna bays directly to the receiver whereas the other two bays are connected through a delay line the resultant pattern is displaced from the antenna axis by some angle XOB or YOB just as though the antenna had been physically displaced. By comparing the signal strength obtained from one lobe with that from its companion lobe the direction from which the wave is arriving can be determined and the antenna may be set directly "on target." For example, if a wave front were to arrive along the direction CO , a signal proportional to $C'O$ would be set up when the antenna pattern is directed along the path XO and a signal proportional to $C''O$ when the pattern is along the path YO . However, when the antenna is pointing directly at the transmitter a signal proportional to $B'O$ is received by both lobes.

The four pulses, each representing one antenna lobe position, are applied to the vertical deflection plates of a cathode ray tube indicator whose circuits are switched in synchronism with the antenna pattern by means of contacts mounted on the same motor. One of the sweep contactors has a d.c. bias spread voltage under control of the

operator which displaces every second sweep of the scope slightly to the right of the preceding sweep. While the electron spot is making a single traverse of the oscilloscope screen, the r.f. portion of the antenna switch is rotating through two lobe switching positions. One azimuth and one elevation trace are thus presented. During the following sweep the next azimuth and elevation trace are produced. By comparing the amplitudes of the two sets of traces the operator can keep the antenna pointed directly at the radiosonde, and by recording the azimuth and elevation angles of the antenna, combined with the known altitude of the sonde as obtained from the pressure unit, the position of the balloon and the wind velocity are readily determined.

The radiosonde signals are applied to the r.f. stages of the receiver, which use sections of transmission line for tuned circuits. After amplification at the i.f. of 19 mc., the signal is divided into two channels. The first of these is an FM channel in which the signal is shaped prior to application to the recorder. The second channel is the direction-finder section. The second of two additional i.f. stages amplifies only when the modulation contactor on the antenna switch is closed. As a result, four pulses of radio frequency are rectified by the detector for each revolution of the antenna switch rotor, the amplitude of each of these pulses being proportional to the strength of the r.f. signal at the instant the contactor is closed, and each of these pulses representing one antenna lobe position. As previously mentioned, the pulses then go to the C-R tube.

For use with the 1700 mc. radiosonde equipment a replacement for this device has been developed which even more closely represents radar equipment. (The increase in operating frequency permits more accurate radio direction finding and satisfactory operation at lower angles of elevation.) Instead of the multipole-dipole antenna with rotating switch as previously used, it now becomes feasible to use a rotating, slightly offset reflector in front of the dipole antenna to provide a rotating pattern which is transmitted by the main reflector (Fig. 10). By rotating the reflector rather than the dipole, vertical polarization is maintained. Again, by a suitable switching means the amplitude of the received signal in azimuth and in elevation is compared to put the antenna squarely "on target." However, there is a major difference in operation in the method of tracking. Whereas in the older method the operators turn their handwheels to track the balloon, in this version the set tracks the target automatically and at the same time produces a printed record of

azimuth, elevation, pressure, temperature, and humidity.

The small antenna reflector revolving at approximately 30 r.p.s. establishes a 30 cycle modulation whose amplitude is a function of the amount by which the antenna is off-target and whose phase with respect to the reflector and a connected commutator is a function of the off-target direction. After amplification, detection, and filtering the 30-cycle signal is fed to the commutator and the resulting d.c. voltages then pass through appropriate amplifiers to 2 two-phase motors which drive the antenna in a direction such as to maintain it in the on-target position. The angular accuracy of this equipment is in the order of .03 degrees.

The "meteorologically modulated" radiosonde signals are fed to limiting and shaping circuits as in the case of the equipment previously described, and then to the recording equipment in the usual manner.

The Recorder.

As has been indicated, the modulated r.f. signals emanating from the balloon-borne equipment are received on the ground either by use of a receiver or a direction finder type equipment. In both methods the signals are converted into an audio frequency which varies at a rate depending upon the meteorological conditions at the airborne sonde. The radiosonde recorder makes a printed record of the frequencies measured by a frequency meter fed by the receiver.

The major components of the recorder unit are a receiver, which is not used when operating with the direction finder type equipment, a frequency meter, and a printing mechanism. The frequency meter section produces a direct current having a value proportional to the frequency of the audio input signals. This current is passed to two microammeters whose deflections indicate the audio frequency. The first of these is simply a visual meter for operator observation.

Fig. 13. Typhoon as seen on PPI scope.

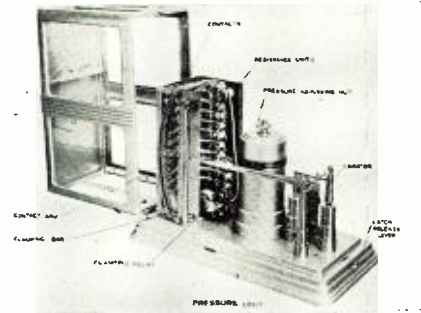

Fig. 12. Pressure unit for an automatic weather station.

The second, however, is located on the recorder chassis and forms the control agent in the printing procedure.

The recorder is an electromechanical device, the principal components of which are the recorder meter, a photoelectric scanning assembly, and the printing mechanism which produces a continuous record of the position of the pointer of the recorder meter with respect to time, thereby recording the measured frequencies which, in turn, represent the intelligence transmitted by the radiosonde.

In terms of electronics, the most interesting part of the recorder is the printing control mechanism (Fig. 11). A light beam in the photoelectric scanner sweeps across the pointer of the meter once during each cycle of operation and produces a pulse whose time phase is dependent upon the position of the meter pointer. This pulse is used to energize the taper bar magnets to cause the printing mechanism to tap a dot on the recorder paper, the horizontal position of which is proportional to the audio frequency measured by the frequency meter.

The window on the recorder meter starts with a tapered section and the meter has a rectangular pointer. As the light beam moves along the tapered portion of the window a gradually increasing amount of light strikes the phototube, resulting in a gradually increasing voltage through a preamplifier into a transformer primary. But since the voltage across the winding is proportional to rate of change of current flow, only a low voltage is developed. This low voltage is insufficient to fire a thyatron in the taper bar circuit. This condition is maintained until the light beam strikes the meter pointer. At this time there is a sudden decrease of current through the transformer primary and a large voltage is produced. However, the polarity of this drop is in a direction opposed to that required to make the thyatron circuit operative. Now, as the beam of light leaves the pointer and again strikes the phototube, there is a sudden increase in the current through the trans-

(Continued on page 29)

Front view of the phase meter. Both dials are calibrated, for convenience, to read 0 for a phase difference of 180°.

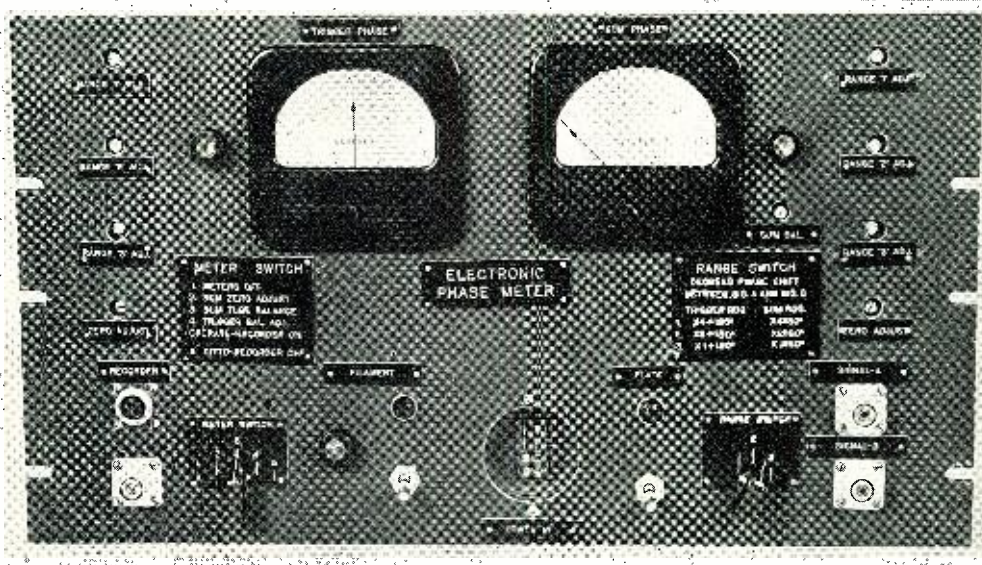

An Improved ELECTRONIC PHASE METER

A new instrument developed at NBS for accurate phase determinations from 100 to 5000 cycles.

A NEW IMPROVED electronic phase meter having significant advantages over previous instruments of this type has been developed by E. F. Florman and A. Tait of the National Bureau of Standards in connection with studies of radio wave propagation. The new instrument, which is designed for a frequency range of 100 to 5000 cycles per second, reads and records directly the phase angle between two sinusoidal voltages having a variation of 1 to 30 volts. The two input voltages are first converted to square waves through two separate channels of amplifier-limiters. A direct comparison of the square waves then gives a measure of the phase difference between the original voltages.

Two methods of comparing the square waves are employed. One involves their direct addition to a circuit having two tubes with a common plate resistor, while in the other method the square waves are used to produce voltage spikes which control a trigger-type phase indicating circuit.

Intensive studies of low-frequency propagation paths are now being made at the National Bureau of Standards to obtain quantitative basic information on the propagation factors which limit the ultimate attainable accuracy of any low-frequency radio navigation system. Such information should be of value in choosing a radio-navigation system for a specific purpose and, ultimately, in

the choice of a practical world-wide system. In this work, differential phase changes caused by changes in the propagation medium over the paths traversed are studied by analysis of the relative phases of incoming waves received at two separate collectors. It was therefore necessary to obtain a phase meter capable of reliable results over the frequency range under investigation. However, it was found that available instruments of this type did not operate satisfactorily over the necessary ranges of voltages and frequencies and were rather unstable during extended periods of observation. NBS undertook the development of such a meter.

To insure stability in the receivers, as well as in the phase measuring instrument itself, it was decided to obtain an audio-frequency beat note at each collector and to compare the phases by means of an audio-frequency phase meter. The resulting instrument has proved to be very stable over long periods, as well as sensitive and reliable over a wide range of voltages. It is thus well adapted to serve as standard test equipment in industrial laboratories. Other possible applications include use in electronic distances measuring devices in surveying; altitude determination for aircraft; navigation systems depending on phase changes; studies of distortion in telephone cables; and measurement of the phase characteris-

(Continued on page 28)

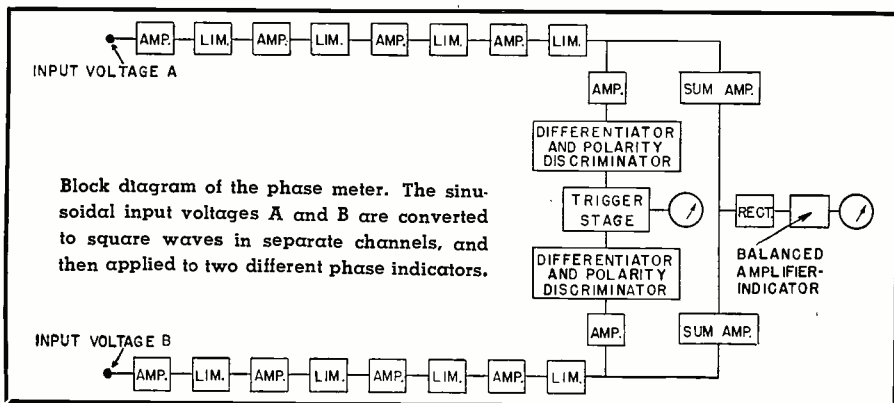

Measurement of Quality in Audio Reproduction

By
DAVID FIDELMAN

IN ALL types of audio work, it is desirable that the various kinds of distortion not only be measured fairly accurately, but be evaluated in terms of the net effect on the reproduced sound. Part II continues with a discussion of specific distortion types, their measurement and evaluation.

(d) *Transient Response*—It is only recently that the importance of transient response has been fully realized, and there are as yet no standardized methods or equipment for measuring the transient response of audio reproducing systems. However, by application of certain basic principles and proper analysis of the results, good measurements can be obtained by using equipment which is generally available in almost every laboratory.

The measurement of transient response must, obviously, consist of measuring the response of the system to some standard transient signal. This transient test signal does not necessarily have to have the same form for all types of systems under test, and may in general depend upon the system being tested and the type of measurements. However, it must in all cases be possible to interpret the response to the test signal in terms of the response of the system to audio frequency transients.

In the theory of transient analysis of any type of physical system (for example, as described by the Heaviside operational calculus or the Laplace transform), the basic input test signal is the unit step function. In electrical measurements this is a voltage which is zero until some given reference time, and then rises with a square wave front to unit voltage and remains at that voltage. This voltage is illustrated in Fig. 2A. The transient response of

the system to all other waveforms can be completely determined by observing its response to this unit step voltage.

In practice, the step voltage can generally be approximated by a square wave to facilitate observation upon the screen of an oscilloscope. However, when this approximation is made, great care must be taken to keep the period of the square wave long enough so that the system has responded completely before the end of the cycle. The transient response of the system may then either be determined qualitatively by visual observation of the oscilloscope trace, or recorded and then analyzed mathematically.

The response is determined qualitatively by comparison of the reproduced wave shape with the applied square wave—for example, by means of a

double-trace oscilloscope. Differences between the two wave shapes are readily recognized and identified, and if the repetition frequency has been chosen properly they will be a measure of the true transient response of the system. The method of analysis of the response to this step-function signal can best be understood by reference to a number of typical responses as indicated in Fig. 3. The response curves shown in B and C of Fig. 3 are of particular interest, since they show that a reproducing system which is insufficiently damped can give rise to a spurious damped oscillation that depends only upon the characteristics of the system and has no relation to the reproduced signal. In a system with negative damping (positive feedback), this oscillation would tend to increase with time rather than to de-



A calibrated microphone which may be used as a standard in performing sound measurements.

Part II includes a discussion of such factors as transient and phase response, wow and flutter.

Fig. 1. Method of taking vectorial sum and difference to measure phase shift.

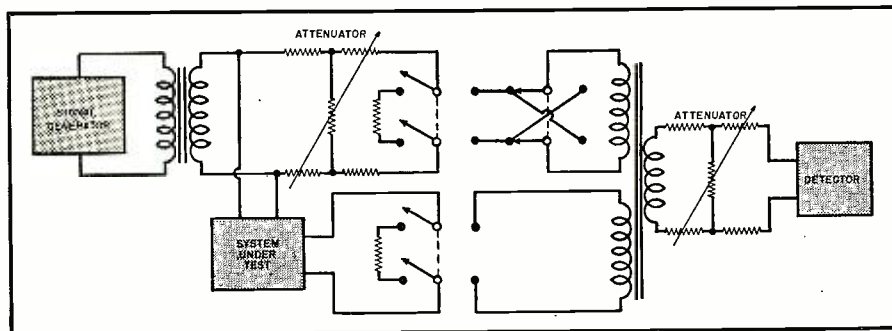

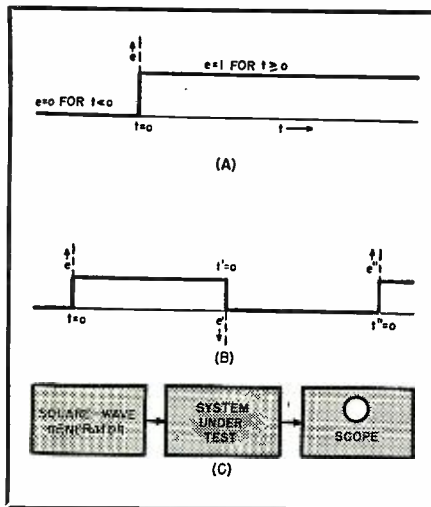

Fig. 2. (A) Graph of unit step voltage used in transient analysis of electrical systems. (B) Representation of unit step voltage by means of square wave of sufficiently long period. (C) Step-function transient analysis of a system by means of a square-wave generator and an oscilloscope.

crease. In general, the response of most audio systems can be derived from the responses shown in Fig. 3, with variations depending mainly upon the repetition rate of the square wave.

The complete transient response of the system can be determined by a mathematical analysis of the measured response to the unit step voltage. However, the mathematical details are too complex to be discussed in a brief space, and may be found in papers on the Heaviside operational calculus and the Laplace transform. A complete treatment of the methods of analyzing transient response would form the subject of a separate article.

In some cases it is not convenient to use the step function or square wave method of transient analysis, either because the proper repetition rate cannot be attained conveniently or because the results are not in a sufficiently convenient form for analysis. In such cases a method may be used which takes closest account of the actual physical form of the sounds occurring in speech

and music. Many of the transient signals which are encountered often have rapid decay as well as build-up times. The transient response of a system to such signals, and the residual vibrations of the system, may therefore be measured by applying short bursts of signal after the signal has been removed.

A method of using this technique to measure the rate of decay of vibration at all parts of the frequency spectrum is illustrated in Fig. 5. The system under test is supplied with a variable test tone through an interrupter giving make and break periods of the order of 1/100 to 1/20 second duration. The output of the system is applied to an oscilloscope whose horizontal sweep is synchronized with the interrupter. The trace on the oscilloscope screen then represents the decay envelope at any frequency. The amplitude at any time after the signal has been removed can be measured by moving a vertical-slit mask across the face of the tube and observing the height of the trace in the slit at the point corresponding to the desired time. The results obtained by this method are an accurate indication of the transient response and residual vibrations in the reproducing system.

(e) *Phase Response*—The phase response of a system can readily be determined by a number of different methods. In general they involve vector addition and subtraction of the applied and reproduced signals, and are quite simple and convenient to use.

One of the simplest methods is to apply the input and reproduced signals to the horizontal and vertical plates, respectively, of an oscilloscope and observe the resulting Lissajous pattern. When the two are in phase (or 180° out of phase) the figure is a straight line. If there is a phase difference between them, the angle can be obtained by measuring the point of intersection with the Y-axis, as indicated in Fig. 6.

A method which avoids the necessity of measuring from the screen of an oscilloscope, and then making a calcula-

tion from this measurement, takes the vectorial sum and difference as shown in Fig. 1. The input and reproduced signals are combined at the same level (by the use of suitable attenuators) and applied through an attenuator to a detector. By use of a changeover switch the vector sum and difference of the two voltages are measured. The phase angle is obtained from the attenuation which has to be introduced in the common path to make the two vectors equal. This method does not involve an elaborate setup of apparatus and gives accurate results. It is particularly useful where small phase angles are involved.

(Continued on page 25)

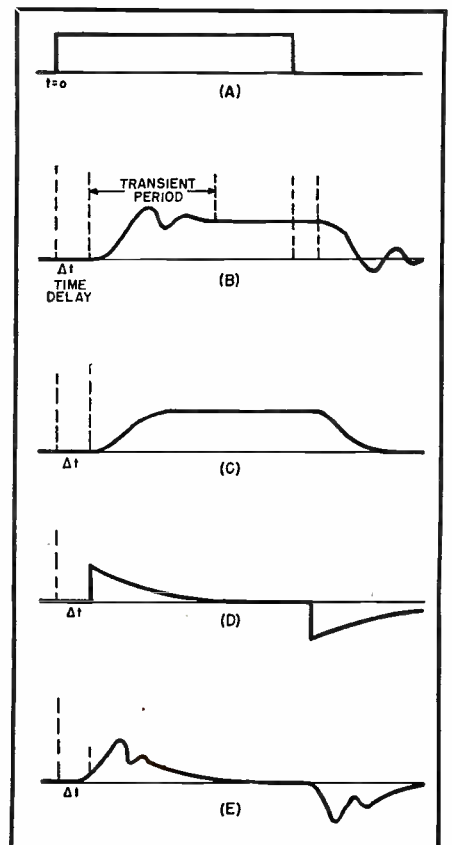

Fig. 3. Transient response to a unit step voltage of a number of common types of audio response characteristics. (A) Input step voltage. (B) Response of low-pass circuit, underdamped. (C) Same, only highly damped. (D) Response of high-pass circuit. (E) Response of band-pass circuit, underdamped.

Fig. 5. Block diagram of a method for measuring the transient response of a system by means of an interrupted sine wave.

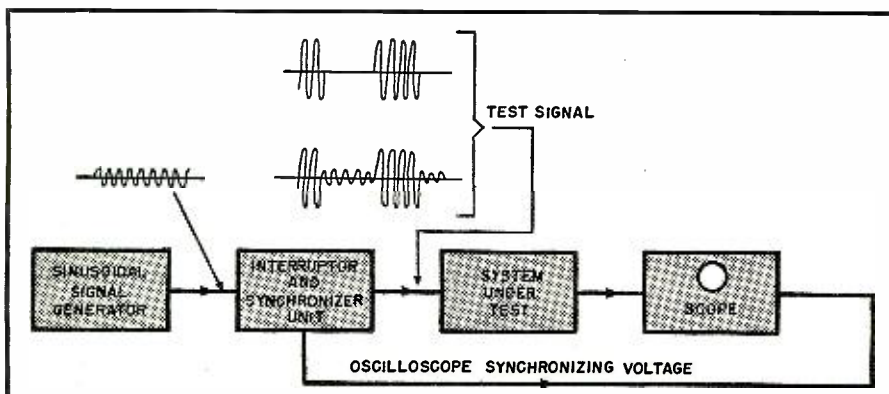
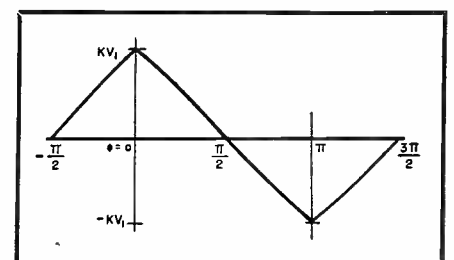

Fig. 4. Output voltage as a function phase angle in the circuit of Fig. 8.



SPECIAL LOUDSPEAKER SYSTEMS

By
**JOHN D. GOODELL and
CURTIS W. FRITZE**
The Minnesota Electronics Corp.

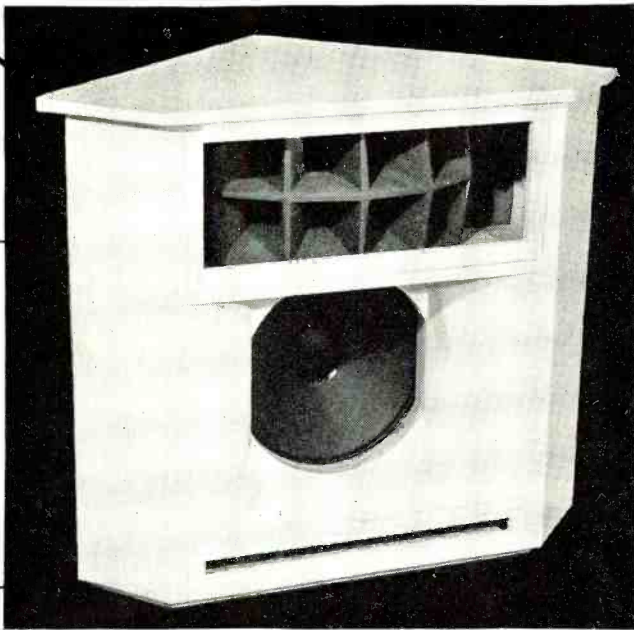

Fig. 1. A corner cabinet for a dual channel speaker system.

Part III terminates this series with a discussion of resonance, damping, feedback and dividing networks.

LOUDSPEAKERS reproduce sound as a result of being driven into forced vibrations by an electrical signal. In order to follow the pattern of the signal waveform perfectly, a loudspeaker system should theoretically have no resonant period within the audio spectrum. As a practical matter it is very difficult indeed to construct a loudspeaker system that will be satisfactory in all other respects and still have no natural period in this frequency range. Most loudspeaker systems will resonate at some low frequency between 50 and 200 cycles per second. These characteristics are principally dependent on the mass (m), the stiffness (s) and the resistance (r). The frequency of the natural period will be directly proportional to the stiffness and inversely proportional to the mass. Hooke's law states that the restoring force is proportional to the displacement, and on this basis it may be mathematically established that

$$f = \frac{1}{2\pi} \sqrt{\frac{s}{m}}$$

assuming the resistance to be negligible. When resistance is introduced into the analysis, the resonant frequency is lowered somewhat and the amplitude of the free oscillations in the system after a given displacement will decay exponentially to zero. The time constant of such a system will be the reciprocal of the damping factor $r/2m$.

When the resistance is increased to the point where it is equal to twice the square root of the product of the mass and the stiffness, the system will be critically damped and there will be no

free oscillations. When the damping is less than critical there will be an "on" effect resulting from oscillation of the system at its resonant period whenever it is set into vibration and before it settles into a steady state condition, and a corresponding "off" effect when the driving force is removed. This is increasingly evident as the driving frequency approaches the resonant period of the system

Resonance versus Damping

In discussions of audio problems it is frequently said that it is undesirable for a loudspeaker to be critically damped, and it is intended here to clarify the factors involved and the relative desirability of approaching or attaining critical damping. In designing an analyzer such as the mechanism of the ear, a compromise must be effected in terms of various desirable characteristics. For very great selectivity it would be desirable that the individual sensing elements, or the elements that feed them, be highly resonant and very sharply tuned so that there would be a strong response to a single frequency to the exclusion of all others. Conditions of sharply peaked resonance, however, are inevitably associated with poor damping factors, and a system with perfect selectivity gained in this manner would suffer from confused patterns of on and off transient disturbances, long oscillation after the signal was removed, and total inability to follow the rapidly changing frequency pattern of speech

and music. The ear is heavily but not critically damped, and although there is no obvious hangover effect apparent in the persistence of audio sensation, it is capable of differentiating with remarkable accuracy between closely adjacent frequencies. The compromise is undoubtedly close to perfection.

If it were practical to set up, say, 10,000 units in a loudspeaker system, each resonated at a single frequency, it would undoubtedly be possible to attain great efficiency but the damping factor would be very low indeed. The resulting sound would be a confused jumble when the system was required to follow the dynamic waveforms of speech and music. At the other extreme is a loudspeaker system so thoroughly damped that there is no resonant period of consequence in the entire audio range. A compromise between these two has often been attempted by running a response curve on the loudspeaker and then building an enclosure housing resonators designed to fill in the valleys of the curve. There are many reasons why such methods have not been notably successful but the principal one is the hangover effect from each resonator. The resulting sound gives music the effect of a selective reverberation time with respect to frequency. With certain types of popular music it is not displeasing but the general result is extremely unsatisfactory.

In the current state of the art the problem of generating very low frequencies efficiently with structures of reasonable dimensions has not been completely solved. The most satisfactory well known method is to use a folded exponential horn. Enclosures designed for use in corners may contain such horns and use the walls of the



Fig. 2. Loudspeaker partially disassembled showing connection to tapped voice coil described in text.

room as extensions and reinforcing surfaces. Another method takes advantage of the mutual radiation impedance characteristics of large numbers of relatively small cones in multiple clusters. A corner enclosure for a dual channel system that gives very good results with moderate dimensions is shown in Figs. 1 and 5.

The most common method of obtaining satisfactory low frequency response is with completely enclosed cabinets using a port near the loudspeaker cone. These enclosures are designed to effect an acoustic phase shift within the cabinet so that the radiation from the port will be in phase with the speaker in a selected low frequency range. If a system of this kind is properly designed it does not necessarily produce serious resonant hangover effects, but neither does it conform to a condition of critical damping.

It is true that when a loudspeaker

Fig. 3. Connection of voice coil circuit using portion of winding as pickup coil for observation of characteristics. Text discusses possibilities of feedback method.

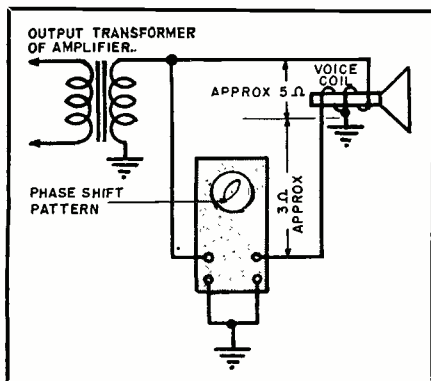

system is critically damped, response at extremely low frequencies is difficult to obtain with efficiency. The corollary to this, however, is that when critical damping is not at least approached, the waveform traced by the loudspeaker cone and impressed on the air does not conform with the electrical pattern of the driving signal and does introduce both on and off transients. From the standpoint of subjective listening this may be a desirable compromise for many observers. There are very few loudspeaker systems capable of smooth reproduction down to 30 or even 50 cycles. For those who have had the opportunity of enjoying such systems for a reasonable period of time with familiar signal sources, the unsatisfactory aspects of any of the compromise methods become very evident.

It would appear more desirable, where it is practical, to allow an adequate margin in the driving power for the deliberate introduction of a rising characteristic in the signal at very low frequencies to compensate for poor acoustic coupling and other factors rather than deliberately to introduce, or leave, resonances in the system to produce a peak that inevitably introduces spurious transients.

Almost all loudspeaker cones have a characteristic resonant period within the audio range. It is a not uncommon oversight to assume this as the resonant period of the system, including the enclosure, although this is clearly not the case. In most instances the loading effect of the enclosure will appreciably lower the resonant period, but it may sometimes have the opposite effect.

Electrical Damping

The effective impedance of the driving source is a consideration of prime importance in connection with the damping of loudspeaker systems. This is not to be confused with the proper matching of the loudspeaker considered as a load in terms of the required turns ratio for the output transformer. This problem has to do with the impedance seen by the loudspeaker looking back into the entire complex circuit of the amplifier output stages. With beam power tetrodes the plate impedance of the tubes is very high, and where degenerative feedback is not used in sufficient quantities the effective internal generator impedance of the output circuit will also be very high. Under these conditions there will be practically no electrical damping of the loudspeaker and its characteristic resonant period will be very pronounced with all the associated undesirable transient effects. With triodes, where the plate impedance is relatively low, the loudspeaker will "see" an effective im-

pedance approximating half its rated impedance when it is connected to the corresponding output transformer tap. With either beam power tetrodes or triodes degenerative feedback may be applied to reduce this impedance still further, and with beam power tetrodes it is entirely practical to reduce it by a factor of four. Except for those conditions where resonance is needed to increase the low frequency response, it would appear desirable to come as close to critical damping by this method as possible.

Feedback and Phase Shift

The most basic characteristic of degenerative feedback in any system is to make the system independent of dynamic variations in the load. There are many factors that affect the impedance of a loudspeaker under dynamic conditions, and it presents a load to the amplifier output circuits that is changing continually and abruptly in terms of the frequency characteristics of the signal. Applying feedback all the way from the output of the loudspeaker back into the amplifier is an intriguing possibility, but the difficulties of holding the phase shift characteristics within the required limits are enormous and no practical system has been developed. In connection with an investigation of such possibilities, the voice coil of a loudspeaker was tapped in accordance with the diagram in Fig. 3. The loudspeaker is shown opened up with a loop of wire indicating the manner in which the connection was made in Fig. 2. Slightly more than half of the voice coil was used to drive the loudspeaker cone. The remaining turns were connected as an exploring coil to observe the motion of the cone in terms of the voltage generated. The first observation was made with the cone mechanically blocked in order to determine whether voltage generated by transformer action between the driving section and pickup section of the voice coil might introduce an anomalous factor. The signal was swept through the audio range slowly at power levels appreciably higher than normal for this unit with no observable signal appearing in the pickup coil. The voltage appearing across the driving section of the voice coil was then applied to the X axis of an oscilloscope and the voltage of the pickup coil to the Y axis so that the relative phase relationship might be observed at various frequencies in terms of Lissajous patterns. Measurements of this kind made with various speakers indicate not only the great difficulties involved in designing a satisfactory system of feedback with a loop containing the mechanical motion, but also reveal a number of interesting phenomena. Undoubtedly careful design of the

loudspeaker specifically for feedback operation might bring about a workable condition within a limited range so that a multiple channel system could be devised. A point that is well known but often overlooked is the fact that the relative phase shift across the mechanical system in most loudspeakers is very large. If there is real validity in recent investigations indicating that phase shift has importance in music reproduction, this condition should be considered as an important aspect of the problem. On the other hand, it may indicate strongly that relative phase shift in other portions of the over-all reproducing system can be of little consequence so long as it is neglected in the loudspeaker. There may also be some additional argument here for dual or triple channel systems where the phase shift in individual units may be minimized. In any event, it is undoubtedly true that this problem is not of sufficient importance to merit great attention until some of the more serious difficulties are corrected.

With one loudspeaker design in this investigation the feedback circuit from the sectionalized voice coil was connected back into the amplifier before the phase shift condition was observed. There was an immediate and obvious improvement in high frequency response, and for a brief period it was believed that with this unit such an arrangement might be practical. Disillusionment came when it was discovered that the high frequency improvement was a result of mild regeneration and that the condition was not stable for all intensity levels.

Dividing Networks and Tone Controls

In multiple channel systems the characteristics of the dividing network are as important as any other link in the chain of units. Simple arrangements use the inductance of the low frequency voice coil as well as the large mass of a relatively heavy cone as the low pass filter, and the high frequency section is fed with a series capacitance. More complex arrangements include inductance/capacitance networks for both sections. The characteristics may vary from a very slow roll-off with a great deal of overlap to cut-offs as sharp as 18 decibels per octave with very little overlap in commercially available units. A sharper cut-off than this is likely to introduce transient distortion and is found in practice to be unnecessary. The selection of cross-over frequency is dictated by many considerations. If the cross-over is low, then (a) the power handling requirement of the high frequency section is increased; (b) the length of the high frequency horn must be increased proportionally; and (c)

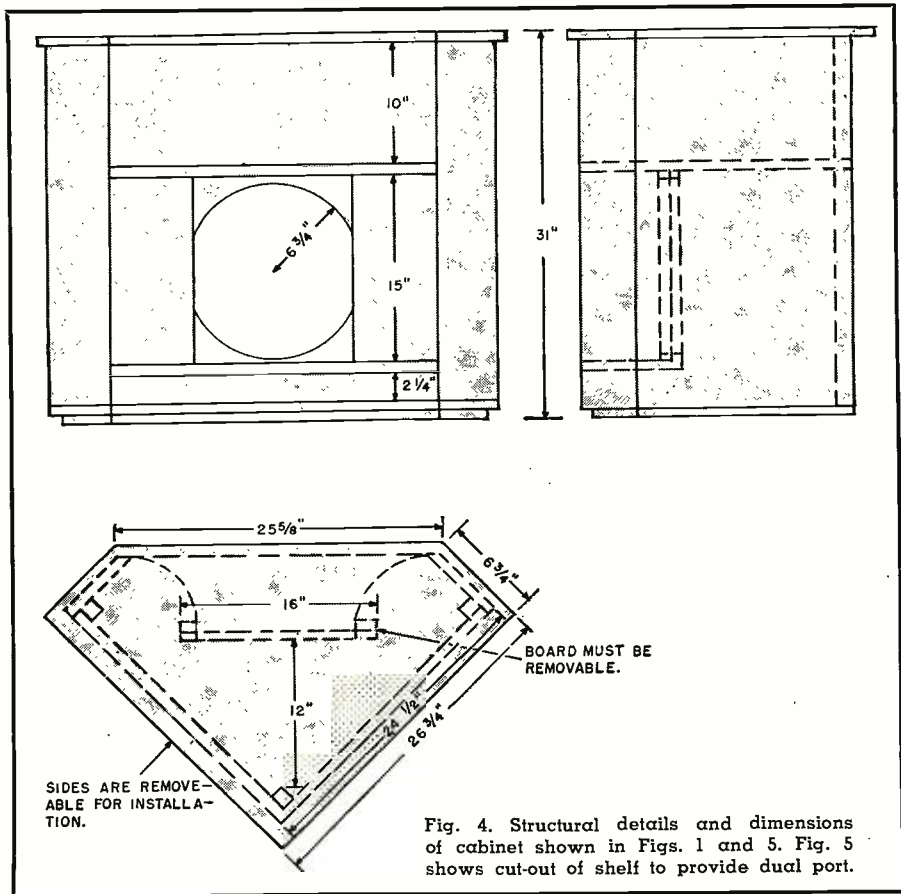

Fig. 4. Structural details and dimensions of cabinet shown in Figs. 1 and 5. Fig. 5 shows cut-out of shelf to provide dual port.

very large capacitors are required for the high frequency section. If the cross-over is high, then (a) the low frequency speaker must handle a wider range with the probability of reaching into the region where the response is not smooth, and (b) if a low frequency horn is used, absorption in the walls may cause a droop in response ahead of cross-over.

In home installations where music only is to be reproduced, the division between speakers does not usually introduce a directional problem of consequence, nor is there difficulty from this source where the speaker units are designed with satisfactory coaxial orientation. However, where speech is to be satisfactorily reproduced from radio broadcast or other signal sources, it is undesirable to place the cross-over point within the central portion of the speech spectrum. This is one reason why some systems that sound excellent in reproducing music have undesirable characteristics in reproducing speech. The same kind of fuzziness and lack of presence may be observed under these conditions with sharply percussive sounds. This phenomenon is observed quite commonly but the source of trouble is often not recognized.

Where space is of relatively little consequence and a satisfactorily long high frequency horn may be used, it is probably desirable to place the cross-over point below 400 cycles per second.

Another approach to this problem, of course, is to use a three-way system so that the mid-frequency range is handled by a single unit, eliminating the problem mentioned above in connection with speech and percussion reproduction and permitting optimum operation of both extreme high and low frequency units. This is not intended to indicate
(Continued on page 24)

Fig. 5. Interior of Fig. 1 with side removed. Cut-away section of top shelf allows upper section to form a second port for low frequency reinforcement.

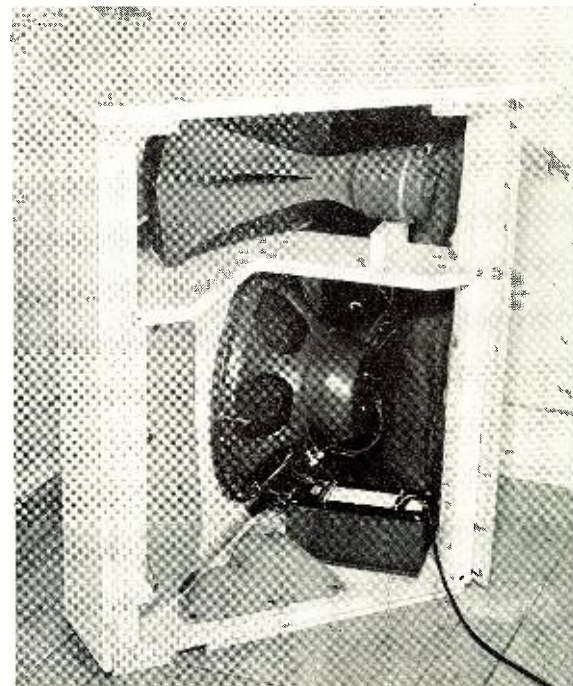

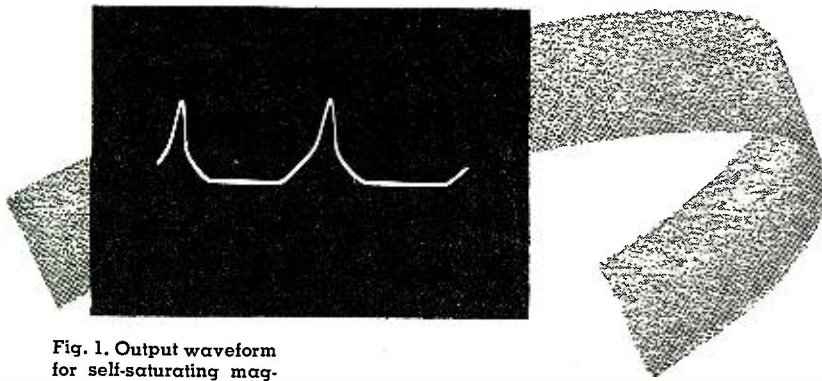

Fig. 1. Output waveform for self-saturating magnetic amplifier with input factor of about 0.2.

The MAGNETIC AMPLIFIER

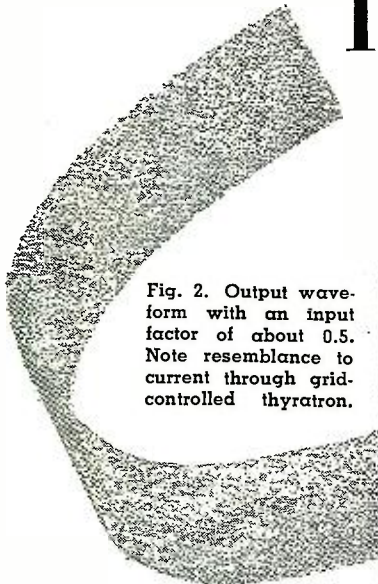
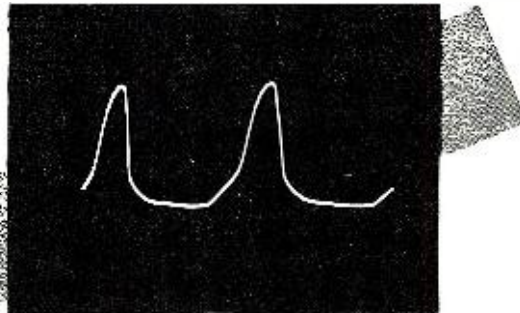

Fig. 2. Output waveform with an input factor of about 0.5. Note resemblance to current through grid-controlled thyatron.



By P. M. KINTNER and G. H. FETT*

An analysis of magnetic amplifiers, together with considerations affecting their design.

AS EARLY as 1916 Alexander, while attempting to raise the frequency of his radio-frequency alternator by means of harmonic distortion, discovered the control properties that can be obtained through the saturation of iron-core reactors. The basic idea was quickly incorporated into devices, usually designated as saturable reactors, and used to control large electrical loads such as theatrical lighting and electric furnaces. However, the use of the saturable reactor was limited in its ability to control the load until the recent development of improved magnetic materials and efficient metallic rectifiers. The incorporation of the saturable reactor into these more refined circuits led to the distinguishing term *magnetic amplifier*. It should be noted that there is no fixed standardization as yet and many regard the terms *saturable reactor* and *magnetic*

amplifier as being synonymous, while the term *transductor* is also in limited use to describe the same device. For

Fig. 3. (A) Basic magnetic amplifier circuit. (B) Self-saturating magnetic amplifier circuit. Rectifier has been added in the output of (A).

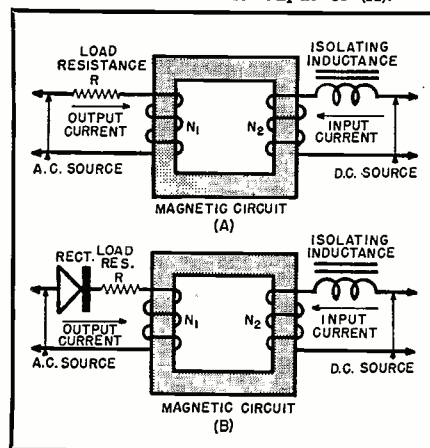

the purposes of this article the term *magnetic amplifier* will be used to cover all power amplifying systems which utilize the saturation of a magnetic core to secure their control properties, since there seems to be no need for distinction and the term magnetic amplifier is apparently in more popular usage.

The advantages of the magnetic amplifier are based mainly on the one fact: the amplifier is a completely static device since its mechanical construction is precisely that of the iron-core transformer. There are no contacts, moving parts, filaments, or other features which make other types of amplifiers subject to operating failures and to the need for constant inspection and maintenance. The life span of the magnetic amplifier is therefore indefinite and it is especially suited for applications where there are adverse operating conditions such as high shock and vibration. Other advantages are that the input and output circuits are physically isolated and it can carry overloads for long periods of time without damage.

These advantages are bringing the magnetic amplifier to the increasing attention of design engineers for many applications requiring power amplification. Since the magnetic amplifier is thereby invading fields where the electron tube was once supreme, and because electron tube amplifiers are sometimes used to drive the magnetic amplifier, its nature and capabilities should be of interest to all electronic engineers.

The Analysis of the Magnetic Amplifier

The magnetic amplifier utilizes the magnetic saturating properties of ferromagnetic materials, which means that the relations between voltage, current, and flux in a magnetic amplifier will inevitably be nonlinear. The exact analyses of these so-called nonlinear relationships are notorious in their difficulty and the problem is made even more difficult because the magnetization curve of the core material can only be expressed satisfactorily by graphical means.

For this reason, a great deal of magnetic amplifier development has been on an empirical basis without much attempt at exact analysis. When theoretical analysis is attempted, it is necessary to resort to assumptions and artifices in an effort to transform the problem into one which can be attacked by linear circuit analysis. It is also for these reasons that gaining a basic understanding of the magnetic amplifier is admittedly difficult and lacks the precise relationships which are obtained from, for instance, linear vacuum tube circuit analyses. In fact, the problems

*Dept. of Electrical Engineering, College of Engineering, University of Illinois, Urbana, Illinois.

involved are reminiscent of the analysis of linear modulation.

Several approaches to the problem will be shown by the analysis of some very simple circuits which have been chosen for illustrative purposes rather than to give quantitative design information. More complicated circuits will be indicated for advanced applications but the exact analysis of the behaviour of these circuits must be a problem for the future.

ELEMENTARY CIRCUIT THEORY

The Basic Circuit

The basic magnetic amplifier circuit is shown in Fig. 3A. The effect of passing direct current through the input or control winding N_2 is to decrease the effective reactance of the output (or anode) winding N_1 , because the direct current increases the magnetic saturation of the core material on which the two windings are wound. This decrease in reactance allows an increase in output current to flow through the load resistance R , the output current being an alternating current derived from the alternating current source E . The fact that the resultant change in power dissipated in the load resistance can be considerably greater than the power necessary to cause the input current to flow, gives rise to the designation *amplifier*. The isolating impedance, which is in the form of an inductance, as indicated in Fig. 3A, is for the purpose of preventing the low impedance of the direct current source in the input circuit from short circuiting the output winding. Means for eliminating the need for this impedance will be discussed later.

Assumption of Independent Reactance

The first approach to the problem of

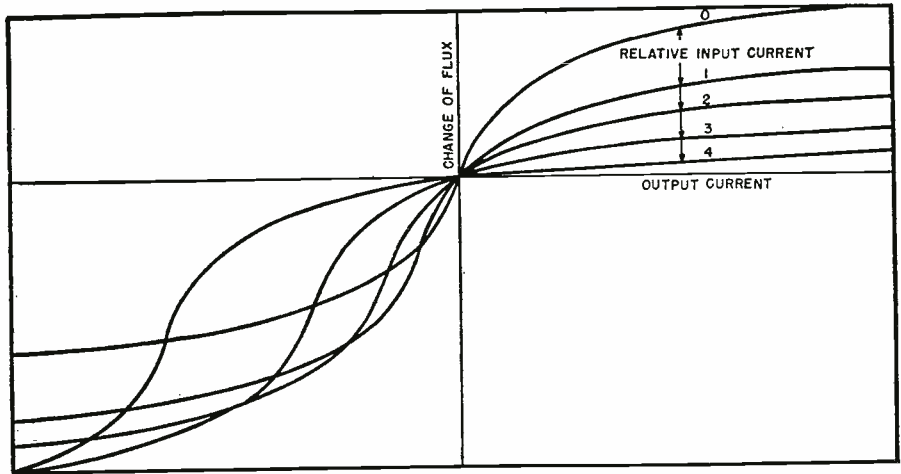

Fig. 4. Change of flux in output winding generated by flow of output current for different values of steady input currents. The slope of the curve at the origin gives the reactance for small signals.

analysis will be made by assuming that the output winding N_1 presents a pure reactance to the output circuit which is independent of the output current, and is fixed directly by the magnitude of input current flow.

The voltage drop across the output winding then is a reactive drop which depends upon the self-inductance (and the frequency). However, the self-inductance is not the traditional value $L=N\phi/I$ since the reactance drop is the result only of *changes* in flux and not the magnitude of flux per unit current. The definition for inductance which must be used, then, is:

$$L = N_1 \frac{d\phi}{dI} \dots \dots \dots (1)$$

Fig. 5. Plots of r.m.s. output winding voltage vs. r.m.s. output current for constant values of input current. Two elliptical operating loci are indicated for an operating voltage of 120 and two values of load resistance, $R = 24$ and 12 ohms.

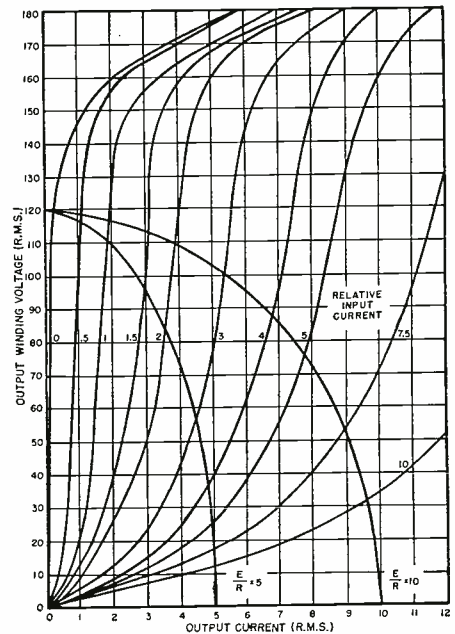

Fig. 7. Current swing vs. B factor for two values of A factor. $A = 5$ and $A = 10$. The B factor should be chosen about equal to the A for maximum current swing without undue reactor size.

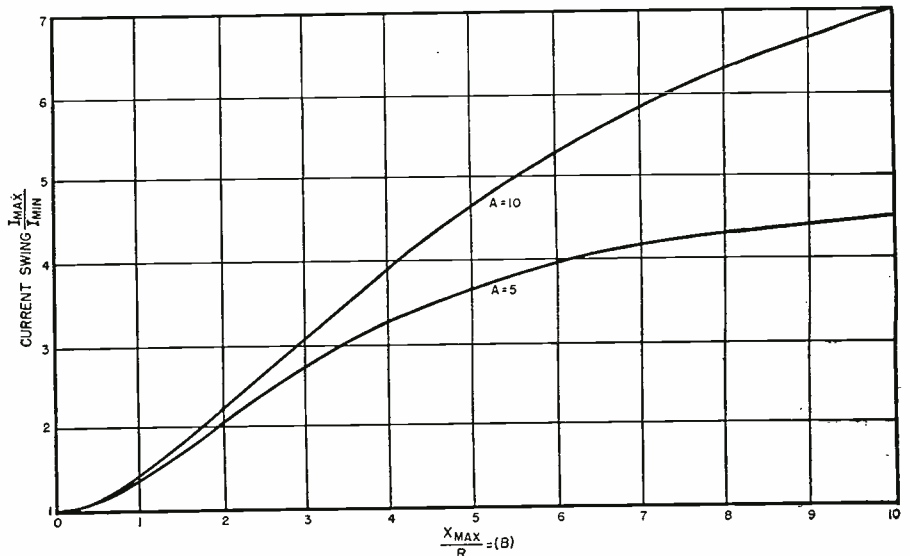
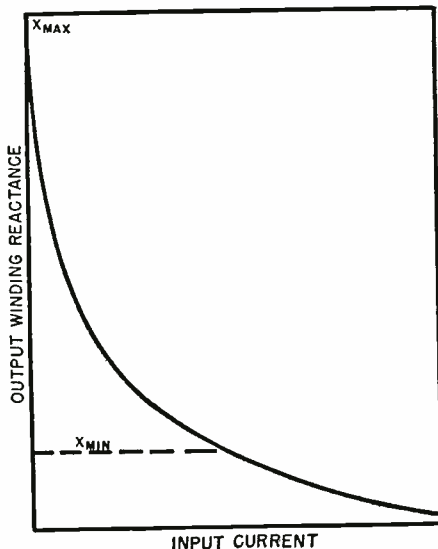

Fig. 6. Output winding reactance vs. input current as based on the slopes of the curves at the origin of Fig. 4.



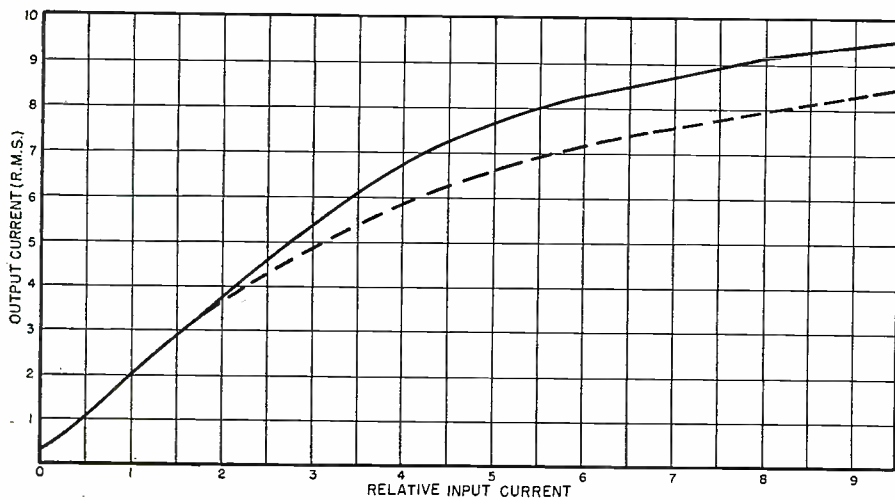

Fig. 8. R.m.s. output current vs. input current as predicted from an operating locus of Fig. 5, where $R = 12$ ohms. Dashed line indicates experimental measurement.

can be used to predict the performance of the iron-core reactor. Both hysteresis and quiescent values of the flux produced by the input current are neglected. Note that the ratio of the y to the x coordinates gives the inductance represented by Eq. (1). If we wish to develop a linear circuit theory we must assume that our excursions in flux are small, so that the operation extends only in the region where the curves of Fig. 4 can be represented by straight lines through the origin. Deviations from the straight line represent changes in the inductance of winding N_1 .

It is obvious that the slope of the family of curves, and thereby the reactance of the output winding, decreases with increase of relative input current. A plot of this reactance versus input current is given in Fig. 6. It is seen that there is a maximum reactance at the point of zero input current and a minimum reactance, an arbitrarily selected point, beyond which operation is uneconomical since the change of reactance would be too small for the amount of input current involved. The ratio of this maximum reactance to the minimum reactance will be termed the reactance swing and designated by the symbol A or:

$$A = \frac{X_{max}}{X_{min}} \dots \dots \dots (3)$$

The reactance swing is fixed by the characteristics of the magnetic material, the more recently developed materials offering larger reactance swings.

Since the amount of reactance swing tends to be fixed, it is desirable to design the output circuit of the amplifier such as to obtain as large an output current swing as possible for a given reactance swing. The minimum output current would be given by:

$$I_{min} = \frac{E}{\sqrt{R^2 + X_{max}^2}} \dots \dots \dots (4)$$

and the maximum by:

$$I_{max} = \frac{E}{\sqrt{R^2 + X_{min}^2}} \dots \dots \dots (5)$$

Then from Eqts. (4) and (5):

$$\frac{I_{max}}{I_{min}} = \sqrt{\frac{R^2 + X_{max}^2}{R^2 + X_{min}^2}} \dots \dots \dots (6)$$

It is evident that the current swing will be determined by the value of R as well as by the reactance swing. Let us define X_{max}/R by the symbol B , noting that for a given current capacity the geometrical size of the magnetic amplifier determines X_{max} . Then:

$$\frac{I_{max}}{I_{min}} = \sqrt{\frac{1 + B^2}{1 + (B/A)^2}} \dots \dots \dots (7)$$

A plot of current swing versus B is given in Fig. 7 for two values of reactance swing: $A = 5$, $A = 10$. A compromise must be made between the desirability of a large value of current swing and a necessity for a small value of B , since for a given load resistance the size of the reactor is proportional to B . Opti-

or the inductance depends upon the slope of the magnetization curve. (The electronic engineer will recognize that this is the same definition as that used in determining the incremental or a.c. inductance of an iron-core filter choke and will understand the precaution which must be taken.) The reactance, then, is:

$$X = \omega L = \omega N_1 \frac{d\phi}{dI} \dots \dots \dots (2)$$

The usual form of the magnetization curve can be transformed into the useful relationships shown in Fig. 4. Here is shown a family of curves of change in flux as a function of output current, with fixed values of input current as parameters. These curves illustrate the flux deviation versus output current and

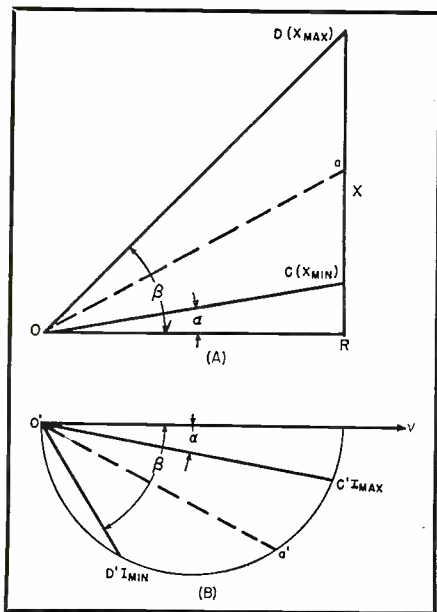
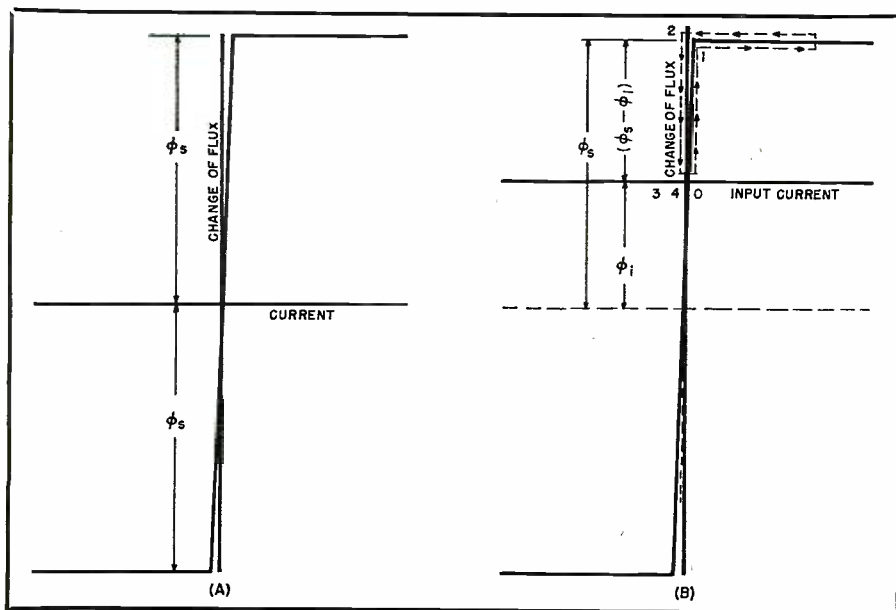

Fig. 9. (A) Impedance diagram and (B) admittance or current diagram for simple magnetic amplifier.

Fig. 10. (A) Representation of an idealized magnetization curve. (B) Operating magnetization curve for the self-saturating magnetic amplifier. The curve is depressed by ϕ_i . Operating path of flux and current is indicated by dashed line.



imum design would seem to make B about equal to A which would give a current swing of approximately $\frac{3}{4}$ of A . Therefore, the maximum current swing obtainable without excessive reactor size is about $\frac{3}{4}$ of the reactance swing.

An instructive description of this characteristic is obtained from the impedance and admittance diagrams of the circuit. The locus of the impedance for a fixed value of load resistance OR and a variable reactance from the output winding is a straight vertical line, as shown in Fig. 9A. The length of the line from O' to a' , a point on the circle in the locus diagram of Fig. 9B, represents the admittance of the circuit and thereby the magnitude of current flow. The reactance measured by RC gives the current $O'C'$, the vector $O'C'$ making the same angle α with its reference as the line OC with its reference. Then DR/CR represents the reactance swing A and $O'C'/O'D'$ the current swing. The quantity B is the ratio of DR to OR , or the maximum slope of the impedance hypotenuse which can be considered feasible. It is seen that a very large increase in B is required to reduce the current vector of the load an appreciable amount. Likewise, a large value of both the A and B ratios are required to provide a large value of current swing.

Assumption of Dependent Reactance.

Small signal vacuum tube theory makes use of linear circuit analysis. If operation is restricted to small signals just to keep in the linear region, the tube is not operated to capacity. Class C or Class A_2 operation is used to develop several times larger power outputs, linear theory is abandoned, and the

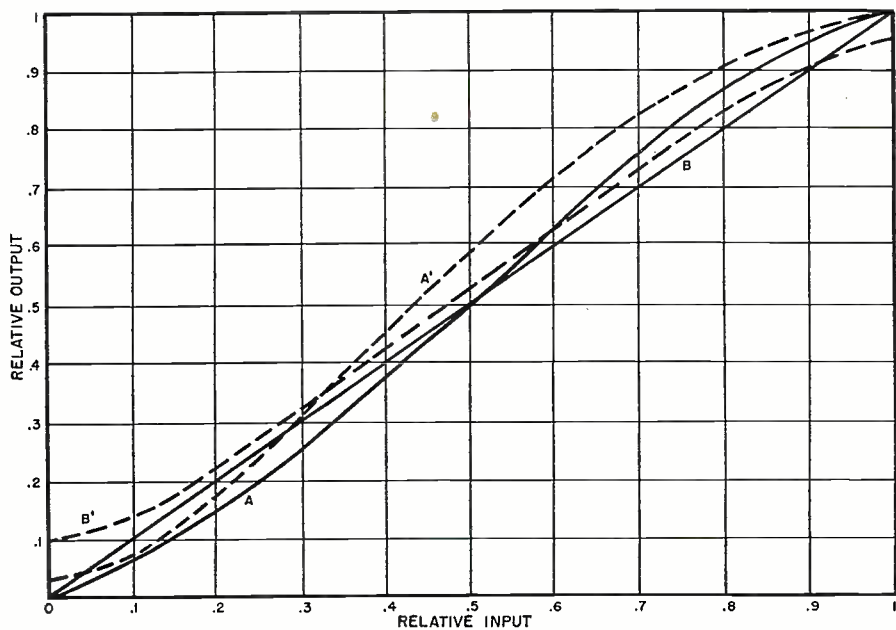

Fig. 11. Relative output vs. relative input for self-saturating amplifier. (A) is r.m.s. and (B) average value of relative output. Dashed lines are experimental measurements.

analysis frequently becomes graphical by the use of the transfer characteristic of the tube. A similar situation is true with magnetic amplifiers.

Thus, in order to take into account the characteristics of the output winding, even with large excursions of output current, let us plot curves of the r.m.s. values of the voltage across the output winding N_1 as a function of the r.m.s. value of output current flow, for constant values of input current flow. The resulting family of curves is indicated in Fig. 5. The shape of the curves may be verified by the inspection of Fig. 4, remembering that the r.m.s. value of the output winding voltage will

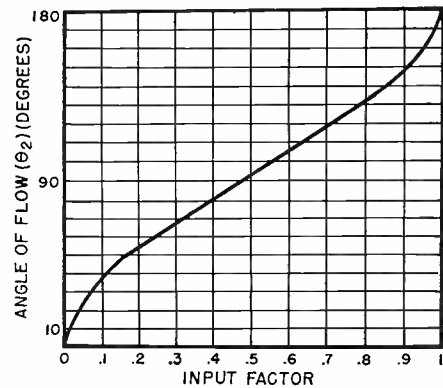
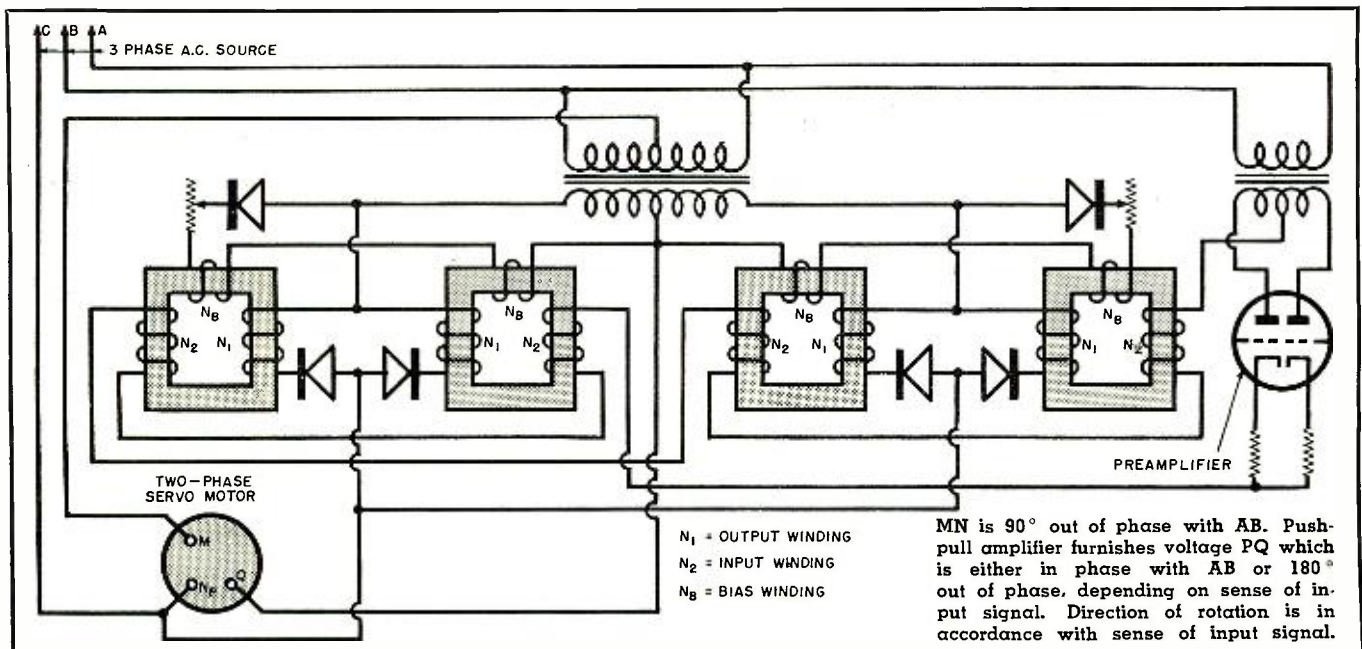

Fig. 12. Angle of flow on current waveform vs. relative input factor. Maximum flow is 180 degrees.

Fig. 13. An application of the magnetic amplifier to servo-motor control.



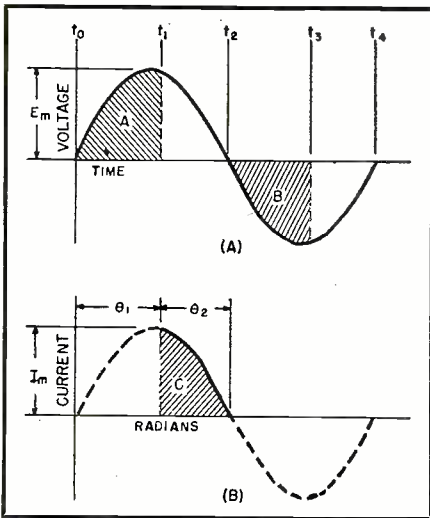
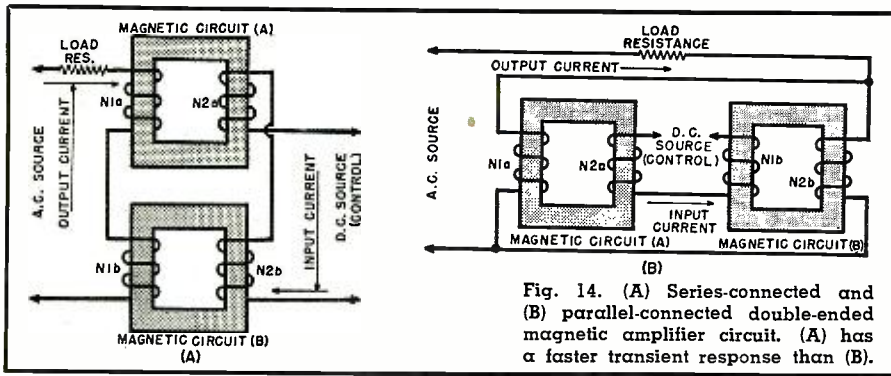

Fig. 15. (A) Voltage and (B) current relationships in the output circuit of the self-saturating magnetic amplifier. The time points on the voltage wave correspond to the points on the operating locus (dashed line) of Fig. 9B.

be approximately proportional to the total flux excursion or change during an alternation of output current.

It will now be assumed that the ratio of the output winding r.m.s. voltage to the r.m.s. value of the current flow through the winding can be considered a linear reactance, which is now not

only a function of input current flow, but is also dependent upon the magnitude of output current flow. The limitation on this assumption lies in the fact that there will be increasingly heavy distortion of the voltage waveform for large excursions of current. However, the usual operation of the amplifier is such as not to involve very large distortions and the assumption is not bad if the magnetization curve does not bend too sharply.

Inspection of Fig. 5 indicates that the curves of the voltage on the output winding versus the output current are analogous to the characteristic curves of a vacuum tube, the locus for constant input current resembling that for constant grid voltage in the vacuum tube. Let us attempt to define an operating locus similar to the load line of the vacuum tube. The voltage across the output winding and that across the load resistance will add in quadrature, if the voltages concerned be assumed sinusoidal, and the output winding is assumed to be a pure reactance. Then:

$$E^2 = E_{n1}^2 + E_R^2 \dots \dots \dots (8)$$

E_{n1} = output winding voltage.

E = supply voltage.

E_R = load resistance voltage.

all values being taken as effective values. But since $E_R = IR$, where I is the output current, then:

$$\frac{E_{n1}^2}{E^2} + \frac{I^2}{(E/R)^2} = 1 \dots \dots \dots (9)$$

Eq. (9) is the equation of an ellipse with an intercept on the y -axis equal to the supply voltage E and an intercept on the x -axis equal to E/R . When superimposed on the curves of Fig. 5, the change in output current for different input current flows can be obtained. Two different loci are indicated for two different values of R . In effect these ellipses represent the vacuum tube load lines. The supply voltage intercept represents the constant E_{bb} value of the plate diagram, and the steeper the slope of the load line, the smaller is the load impedance. The reader will remember that elliptical load lines in vacuum tube analyses are also obtained when the load has self-inductance.

A transfer characteristic can be obtained from this curve giving output current flow versus input current flow. This corresponds to the dynamic transfer characteristic of a vacuum tube. To indicate the type of results that can be obtained using this analysis, Fig. 8 is a transfer locus predicted from curves as in Fig. 5 and the dashed line indicates experimental results that were obtained.

Advanced Circuit Theory

In the discussion of analysis of magnetic amplifier action by the assumption of a linear reactance on the part of the output winding, it was specified that the magnetization curve must not bend too sharply. However, it is the bend in the curve that gives the controlling action in the amplifier and it is reasonable to expect more efficient amplifier operation for magnetization curves possessing sharp bends. To this end, magnetic core materials are being developed which have magnetization curves with extremely sharp breaks at their saturation points. It is evident that the analysis of the preceding discussion will not be suitable for use with magnetization curves of this type, and it is necessary to develop new ideas of a more advanced nature to deal with these curves.

Principle of Non-Rectification.

One of the ideas that will be established is that a magnetic amplifier cannot perform rectification, and there can never be a direct current component in the output circuit of the amplifier, unless a rectifier has been placed in the output circuit. To prove this, we will write the voltage loop equation for the output circuit:

$$E = IR + N_1 \frac{d\phi}{dt} \dots \dots \dots (10)$$

where:

I = output current.

ϕ = flux in core.

(Continued on page 26)

Fig. 16. Three-phase self-saturating magnetic amplifier. The fundamental voltages induced in the input windings cancel around the input circuit. The output is direct current to the load resistance.

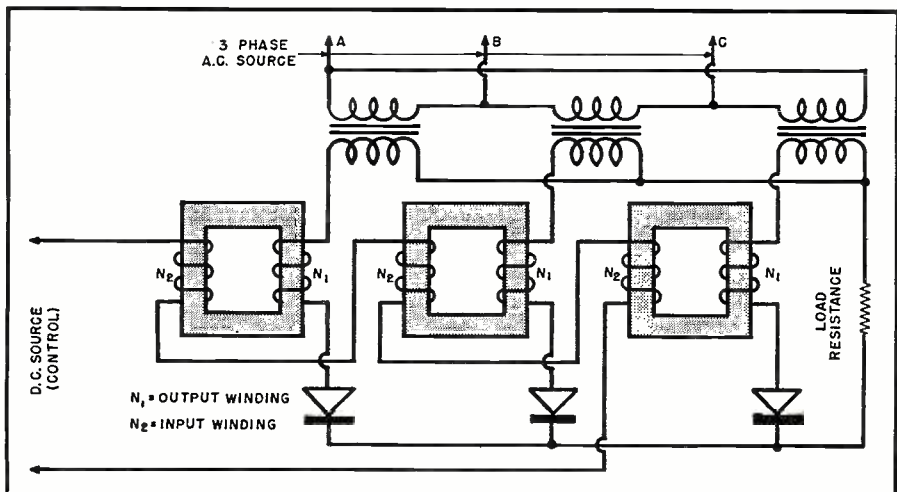

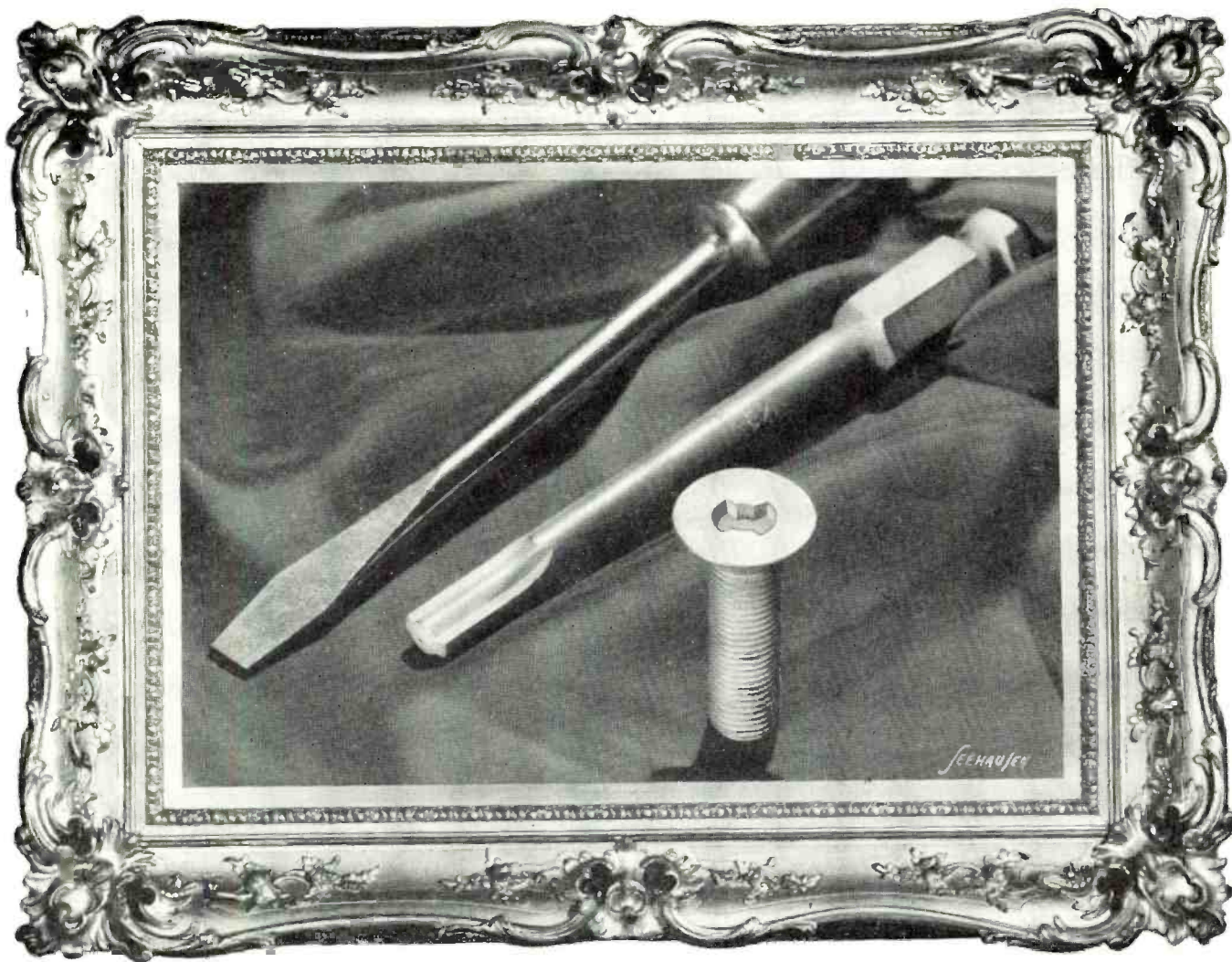

Acclaimed a Masterpiece...

CLUTCH HEAD Brightens the Profit Picture with 15% to 50% Assembly Increases

Here is how CLUTCH HEAD'S modern design meets today's competitive selling problem of "How to Produce More for Less"...by effecting time and cost savings that quicken production steps all the way down the assembly line.

High Visibility of the roomy recess presents an easy-to-hit target. "Green" operators require no break-in. They drive with speed and confidence that checks out slow-down hesitation.

Chewed-up Heads Eliminated because dead-center entry with the Center Pivot Column prevents driver canting and makes straight driving automatic.

Safe Non-tapered Driving eliminates the danger of driver skidding from "ride-out" as set up by tapered driving... an important safety factor for the protection of manpower and material.

Zero in Skid Damage is reported by CLUTCH HEAD users. The all-square contact of the straight-sided driver with the straight-walled recess makes high torque driving almost effortless.

A Fatigue Factor Disposed Of. Absence of end pressure means safer, faster, easier driving. No end-of-the-shift lag means more screws driven for higher production.

Up to 214,000 Screws Driven non-stop by the Type "A" Bit... without interruption for tool change or reconditioning. Add to this record performance the fact that a 60-second on-the-spot operation restores this bit to original efficiency... repeatedly.

The Lock-On Overcomes Fumble Spots. A reverse turn of the bit in the recess forms a frictional hold that unites screw and bit as a unit. This permits quick, easy one-handed reaching to inner spots.

Speeds Field Service Too. With the Type "A" Hand Driver, field service men find it easy to withdraw "frozen" screws undamaged and safely held by the Lock-On on the end of the bit for re-use.

Common Screwdriver Operation. This is the **ONLY** modern screw with a recess basically designed for operation with a flat blade... which need only be reasonably accurate in width. Important to simplified field service.

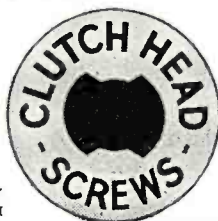

These highlights of America's Most Modern Screw are fully detailed and illustrated in the NEW CLUTCH

HEAD BROCHURE. Send for your copy and indicate the sizes and types of screws that interest you.

UNITED SCREW AND BOLT CORPORATION

CLEVELAND 2

CHICAGO 8

NEW YORK 7

NEWS BRIEFS

ANNIVERSARY OF COAXIAL CABLE

Two *Bell Telephone Laboratories* engineers who invented the coaxial cable system celebrated the 20th anniversary of the invention by comparing their first experimental model with the newest type of cable.

Lloyd Espenschied, left, holds a section of the early, experimental cable which was installed at Phoenixville, Pa.,



late in 1929. His colleague, Herman A. Affel, holds a section of the modern, eight-tube cable now being installed in the *Bell System's* expanding coaxial cable network.

Today's cable can carry 600 simultaneous telephone conversations or two television programs on each pair of the eight tubes, and in view of recent advances at *Bell Laboratories*, this capacity is expected to be at least doubled, and possibly tripled.

NBS APPOINTMENTS

Irving Levine, secretary of the Washington Audio Society, has received one of the many appointments to the National Bureau of Standards. He has joined the Sound Laboratory staff where his variety of projects will include acoustic measurements and ultrasonic investigation.

Wayne Standard Wamsley, formerly electronics project engineer in the Research and Development Laboratories at Ft. Belvoir, Va., will conduct radar, radio, and electronics research in the Ordnance Engineering Laboratory.

Robert Goodrich has joined the staff to conduct research in the Ordnance Mechanics Laboratory. Mr. Goodrich was formerly with Oak Ridge National Laboratory.

Roger E. Robertson, formerly electronics engineer at *Bell Aircraft Corporation*, will conduct engineering research for the Guided Missile Projects, and Jerome Teplitz will do research in the Missile Dynamics Laboratory. Mr. Teplitz is former Assistant Head of Research Coordination for the National Advisory Committee for Aeronautics.

1949 RADIO FALL MEETING

The 1949 Radio Fall Meeting, formerly known as the Rochester Fall Meeting, will be held October 31-November 2 at Hotel Syracuse, Syracuse, New York.

The meeting will be sponsored by the Engineering Department of RMA for its members and members of the IRE. Officers of the Committee include: Virgil M. Graham, Chairman, *Sylvania Electric Products Inc.*; R. W. Ferrell, vice chairman and treasurer, *General Electric Co.*; and R. A. Hackbush, secretary, *Stromberg Carlson of Canada, Ltd.*

RCA PRODUCES MILLIONTH TV TUBE

A milestone in the swift progress of the television industry was recently signified by the manufacture of the one-millionth kinescope at the *RCA* Lancaster Plant.

Estella Fry, below, does the honors

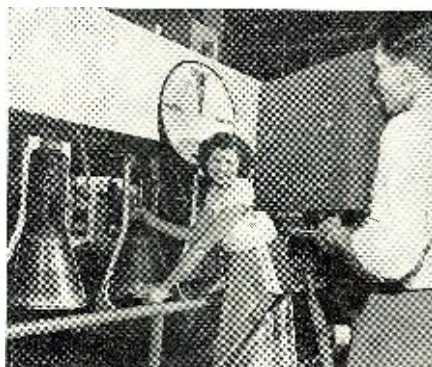

as a special network television broadcast commemorates the occasion.

At the conclusion of the telecast, the tube was installed in an *RCA Victor* receiver and presented to the Valley Forge Hospital for veterans.

Viewers were given an eye-witness report of the actual manufacture of the millionth tube as *NBC* cameras, sta-

tioned along the plant's production lines, followed through various manufacturing processes to the final rigid test.

MOBILE MEASUREMENTS LAB

A 12-ton mobile measurements laboratory containing dozens of electronic instruments for minute scientific measurements was recently displayed in Chicago.

Built by the Armour Research Foun-



dation of Illinois Institute of Technology for the Army Ordnance Department, the unit is the result of a year and a half of research and development. It will be used at the Aberdeen Proving Ground, Md.

James L. Murphy, supervisor of electronics research in the electrical engineering division of the Foundation points out a feature of the newly completed laboratory to Lt. Col. William H. Crown, deputy chief, Chicago Ordnance District.

DEADTIME AND RECOVERY OF GEIGER COUNTERS MEASURED

An electronic gating instrument has been designed and constructed by Louis Costrell at the National Bureau of Standards for the accurate determination of the deadtime and recovery characteristics of Geiger-Muller counters.

Whenever Geiger counters are to be used for precise measurements of nuclear radiation, a knowledge of the operating characteristics is essential.

For complete information see "Accurate Determination of the Deadtime and Recovery Characteristics of Geiger-Muller Counters" available as Research Paper RP1965, price 10c, from the Superintendent of Documents, U.S. Government Office, Washington 25, D. C.

COTTON ACOUSTICAL TILE

The National Cotton Council, Memphis, Tenn., has announced excellent results with the use of cotton acoustical tile.

Use of this tile has proved effective in radio studios across the nation. The 12" square units weigh only three ounces, are flameproof, vermin proof, and easily installed at low cost.



If it's a problem calling for **PRECISION POTENTIOMETERS**

Bring it to Helipot

For many years The HELIPOT Corporation has been a leader in the development of advanced types of potentiometers. It pioneered the *helical* potentiometer—the potentiometer now so widely used in computer circuits, radar equipment, aviation devices and other military and industrial applications. It pioneered the *DUODIAL*—the turns-indicating dial that greatly simplifies the control of multiple-turn potentiometers and other similar devices. And it has also pioneered in the development of many other unique potentiometric advancements where highest skill coupled with ability to mass-produce to close tolerances have been imperative.

In order to meet rigid government specifications on these developments—and at the same time produce them economically—HELIPOT[®] has perfected unique manufacturing facilities, including high speed machines capable of winding extreme lengths of resistance elements employing wire even less than .001" diameter. These winding machines are further supplemented by special testing facilities and potentiometer "know-how" unsurpassed in the industry.

So if you have a problem requiring *precision potentiometers* your best bet is to bring it to The HELIPOT Corporation. A call or letter outlining your problem will receive immediate attention!

*Trade Marks Registered

In this panel are illustrated standard models of HELIPOT multi-turn and single-turn precision potentiometers—available in a wide range of resistances and accuracies to fulfill the needs of nearly any potentiometer application. The Beckman DUODIAL is furnished in two designs and four turns-ratios, to add to the usefulness of the HELIPOT by permitting easy and rapid reading or adjustment.

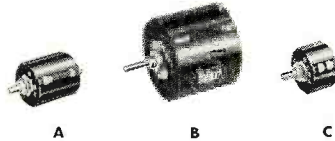

MODELS A, B, & C HELIPOTS
 A—10 turns, 46" coil, 1-13/16" dia., 5 watts—resistances from 10 to 300,000 ohms.
 B—15 turns, 140" coil, 3-5/16" dia., 10 watts—resistances from 50 to 500,000 ohms.
 C—3 turns, 13-1/2" coil, 1-13/16" dia., 3 watts—resistances from 5 to 50,000 ohms.
 — Ask for Bulletin 104 —

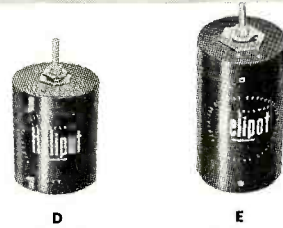

MODELS D AND E HELIPOTS
 Provide extreme accuracy of control and adjustment, with 9,000 and 14,400 degrees of shaft rotation.
 D—25 turns, 234" coil, 3-5/16" dia., 15 watts—resistances from 100 to 750,000 ohms.
 E—40 turns, 373" coil, 3-5/16" dia., 20 watts—resistances from 200 ohms to one megohm.
 — Ask for Bulletin 104 —



MODELS F AND G PRECISION SINGLE-TURN POTENTIOMETERS
 Feature both continuous and limited mechanical rotation, with maximum effective electrical rotation. Versatility of designs permit a wide variety of special features.
 F—3-5/16" dia., 5 watts, electrical rotation 359°—resistances 10 to 100,000 ohms.
 G—1-5/16" dia., 2 watts, electrical rotation 356°—resistances 5 to 20,000 ohms.
 — Ask for Bulletin 105 —

LABORATORY MODEL HELIPOT
 The ideal resistance unit for use in laboratory and experimental applications. Also helpful in calibrating and checking test equipment. Combines high accuracy and wide range of 10-turn HELIPOT with precision adjustability of DUODIAL. Available in eight stock resistance values from 100 to 100,000 ohms, and other values on special order.
 — Ask for Bulletin 106 —



MODELS R AND W DUODIALS
 Each model available in standard turns-ratios of 10, 15, 25 and 40 to 1. Inner scale indicates angular position of HELIPOT sliding contact, and outer scale the helical turn on which it is located. Can be driven from knob or shaft end.
 R—2" diameter, exclusive of index.
 W—4-3/4" diameter, exclusive of index. Features finger hole in knob to speed rotation.
 — Ask for Bulletins 104 and 114 —

The versatility of the potentiometer designs illustrated above permit a wide variety of modifications and features, including double shaft extensions, ganged assemblies, the addition of a multiplicity of taps, variation of both electrical and mechanical rotation, special shafts and mounting bushings, high and low temperature operation, and close tolerances on both resistance and linearity. Examples of potentiometers modified for unusual applications are pictured at right.



MULTITAPPED MODEL B HELIPOT AND 4-GANGED TAPPED MODEL F
 This Model B HELIPOT contains 28 taps, placed as required at specified points on coil. The Four-Gang Model F Potentiometer contains 10 taps on each section. Such taps permit use of padding resistors to create desired non-linear potentiometer functions, with advantage of flexibility, in that curves can be altered as required.

3-GANGED MODEL A HELIPOT AND DOUBLE SHAFT MODEL C HELIPOT
 All HELIPOTS, and the Model F Potentiometer, can be furnished with shaft extensions and mounting bushings at each end to facilitate coupling to other equipment.
 The Model F, and the A, B, and C HELIPOTS are available in multiple assemblies, ganged at the factory on common shafts, for the control of associated circuits.

THE **Helipot** CORPORATION, SOUTH PASADENA 4, CALIFORNIA

NEW PRODUCTS

VIBRATION INTEGRATOR

Vibration displacement, velocity, and acceleration in the audio frequency range may be conveniently measured

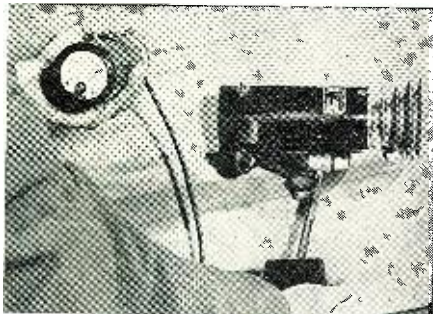

with the Type 410-X5 Vibration Integrator, and Type 410-X6 Calibrated Vibration Pickup designed and manufactured by *Hermon Hosmer Scott, Inc.*, 385 Putnam Ave., Cambridge 39, Mass.

According to the manufacturer, displacement can be measured from 0.14 microinches to 0.028 inches; velocity from 51.3 microinches per second to 10.3 inches per second; and acceleration from 0.15 inches per second per second to 3900 inches per second per second over a frequency range of 3000 cycles.

Types 410-X5 and 410-X6 match the Type 410-A Sound Level Meter with which they are used. A tripod is available for fixed positioning of the Sound Level Meter, and a table is provided for converting decibels to units of displacement, velocity and acceleration.

LOW-VOLTAGE D.C. SUPPLY

The Model "B" Power Supply announced by *Electro Products Laboratories, Inc.*, 549 W. Randolph St., Chicago 6, Ill., is new in design, and includes heavy duty selenium rectifiers,

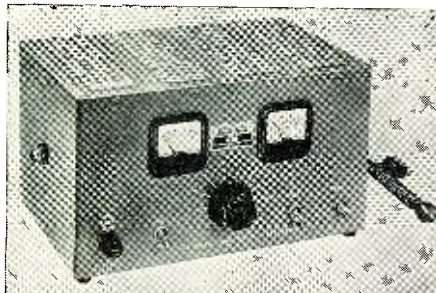

damped voltmeter and ammeter, eight power tap adjustments and heavy duty switch.

Model "B" will deliver from 3 to 9 volts with a rating of 6 volts at 20 amperes continuous and 35 amperes instantaneous from a 50 to 60 cycle, 115 volt power source, according to the manufacturer's report. This power supply measures 12" x 7" x 8½".

Complete information may be obtained by writing the manufacturer.

MOBILE RADIOTELEPHONE

A highly economical mobile radiotelephone unit, known as the FT-145-10, and having a power output of 10 watts at any frequency in the 152 to 162 megacycle band has been developed by *Federal Telephone and Radio Corporation*, Clifton, N. J.

Special features of this unit include special vibration proof r.f. coils, a novel neon squelch, top tuning for easy adjustment and a minimum number of



tube types, all miniature. The FT-145-10 was designed to meet RMA test recommendations and has an over-all size of 5½" high by 12¾" wide by 14½" deep and weighs only 27½ pounds without cables and control unit.

With its small size, low cost, and reported reliable performance, this unit should find wide application not only in the field of mobile communications, but in many new industries where mobile facilities have heretofore been impractical.

LOUDNESS CONTROL

Livingston Electronic Corp., Livingston, N. J., is now offering its Model MB Loudness Control which provides a combination attenuator and equalizing network at high impedance, with 23 separate curves for 23 intensity levels.

This unit automatically compensates for the non-linear characteristics of

the ear and their variation at different degrees of loudness and is designed to replace the conventional potentiometer by substitution.

The company will furnish more detailed information upon request.

PORTABLE SERVO ANALYZER

A portable servo analyzer which provides complete dynamic response data on any systems using 400 or 60 cycle

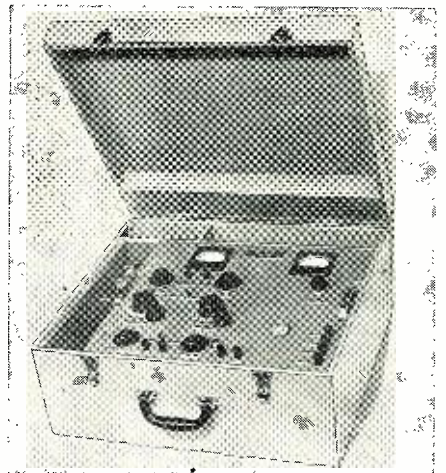

amplifiers, regardless of the type of motor or actuator employed, has been announced by *Flight Research Engineering Corp.*, Richmond, Va.

This Type 6 Servo Analyzer requires no oscilloscope or other auxiliary equipment for making a.c. tests and a demodulator is available for d.c. tests. The wide range a.c. vacuum tube voltmeter which is built into the instrument may be used separately.

Applications include laboratory development work, performance evaluation, routine maintenance and production line testing.

RESISTANCE BOX

Marma Electronic Co., 1632-36 No. Halsted St., Chicago 14, Ill., is manufacturing the Model 10 Decade Power

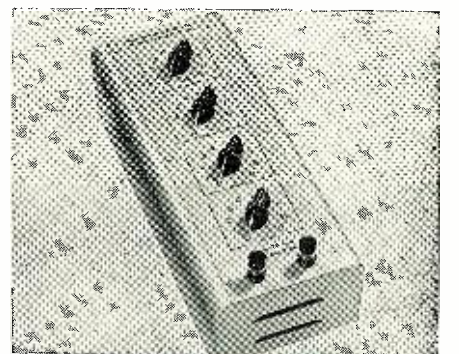

Resistance Box suitable for practically all service and laboratory work.

It is said that this resistance box will dissipate a minimum of 10 watts and a maximum of 30 watts depending on the setting, and that the four dec-

ades make it unusually flexible and provide a total available resistance of 99,990 ohms.

Further information may be obtained by writing the company.

KLYSTRON POWER SUPPLY

Designed to provide extremely well-regulated d.c. power for all electrodes of a high power klystron tube, the Model 910 manufactured by *Furst Electronics*, 12 S. Jefferson St., Chicago 6, Ill., consists essentially of four units.

The first three units, beam supply, reflector supply, and control electrode supply, delivering d.c. power are well regulated. The fourth unit, filament supply delivering a.c. power, is not regulated.

Specifications and further information

may be obtained by writing the company.

RESONANT WINDOWS

Scientifically designed to permit silver soldering, without damage, to microwaveguide systems operating at frequencies ranging from 3000 to 40,000 megacycles, glass waveguide windows have been developed by the Electronics Division of *Sylvania Electric Products Inc.*, 500 Fifth Ave., New York 18, N. Y.

The development of these resonant windows makes available a wide range of window shapes and outside contours for narrow and wide band transmissions. Power losses range from .02 to .1 db. Windows for frequencies above

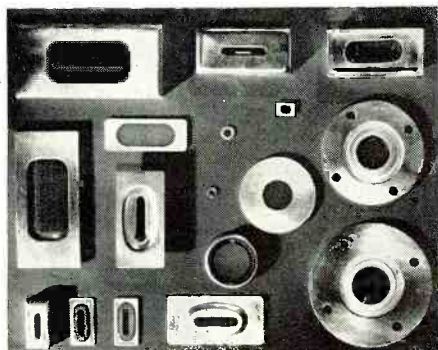

3500 mc. will stand pressures up to 65 pounds per square inch absolute.

The many applications include pressurized or gas-filled waveguide systems for all types of radar.



TRANSFORMERS

New York Transformer Company builds hermetically sealed transformers to meet your most exacting requirements. Specifications are translated by NYT experience and skill into the components you require.

Enlarged facilities for the development and manufacture of fine equipment assure the production of hermetically sealed units in accordance with your schedules. Ten or ten thousand—every transformer is built with the same specialized care. Shop procedures for testing insure the perfection of the seal on every unit. Hermetically sealed transformers from NYT meet all civilian and government specifications — including current JAN T-27, U. S. Navy 16-T-30, and Signal Corps 71-4942. Other sealed type transformers include specially treated, uncased, lightweight units for airborne use, built to government specification.

Engineering and design facilities, as well as production know-how, are always at your service. Write or phone your requirements.

Radio and television power transformers and reactors . . . audio transformers, filters and chokes . . . control and operating transformers . . . calibrators and special equipment for electronics.

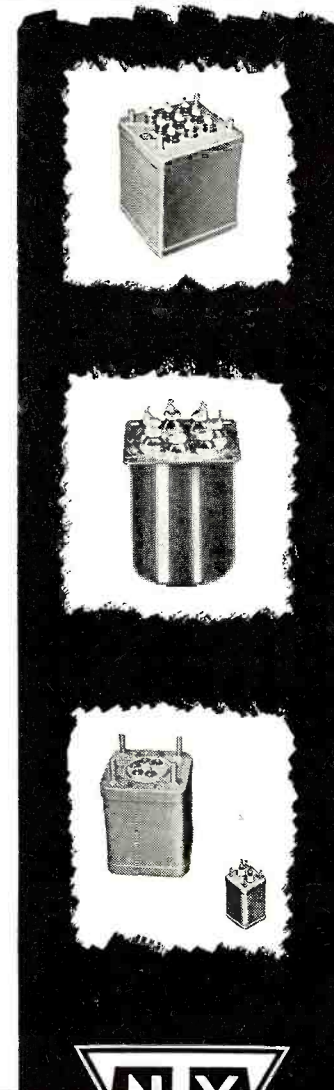

**NEW YORK
TRANSFORMER CO. INC.**

Alpha, New Jersey

Personals

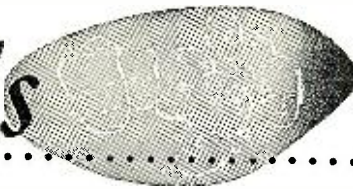

HENRY P. KALMUS, formerly with the research laboratory of the *Zenith Radio Corporation*, will conduct investigations in advanced electronic techniques in the Ordnance Research Laboratory of the National Bureau of Standards. Inventor of the "Cobra" pickup, Mr. Kalmus has developed a number of improvements to the ganging in radio receiving apparatus. He is the author of a number of technical papers and is a Senior Member of the IRE.



DR. HANS KOHLER has been appointed to the staff of NBS where he will do theoretical work in the Electronics Division. Dr. Kohler is a former member of the Research Laboratories of the Signal Corps where he conducted research in electronics. Dr. Kohler was born in Switzerland and received his degree in E.E. from the Federal Polytechnic Institute of Zurich, is a member of the IRE and has published many technical papers in the field of electronics.



WILLIAM E. OSBORNE has been designated Chief of the Electronic and Guidance Division of the *Marquardt Aircraft Company*, Van Nuys, Calif. Mr. Osborne has been engaged in electronic and radar work since 1925, at which time he received his E.E. degree at Queens College, Melbourne, Australia. During 1939 and 1940 he was a British Army captain for the Royal Engineers in radar research and then head of the Australian Army Radiophysics Branch.



CHARLES G. ROBERTS has been appointed Television Equipment Product Manager for *General Electric's* Transmitter Division at Electronics Park. Prior to his appointment, Mr. Roberts was Assistant to the Manager of Sales for the Transmitter Division. Previously associated with *G-E*, Mr. Roberts rejoined the company in 1942 at Schenectady and was assigned to sales work in the Government Division. He is a native of Oil City, Pa.



GEORGE M. WOODS was recently appointed Manager of the Transportation Section, Industry Engineering Department, *Westinghouse Electric Corporation*. Mr. Woods will have the responsibility of coordinating engineering problems originating in the transportation industry with various departments of *Westinghouse*. Following his graduation from Penn State, Mr. Woods joined the corporation as an induction motor design engineer.



LESLIE J. WOODS is the new Vice President-Director of Research and Engineering at the *Philco Corporation*, Philadelphia. Mr. Woods will be assisted by David B. Smith. Associated with *Philco* since 1925, Mr. Woods directed the company's war work in Washington and was vice president and general manager of its subsidiary, *National Union Radio Corporation* to aid the expansion necessary to meet wartime demands of the Army and Navy.

Loudspeaker Systems

(Continued from page 13)

that very high quality results cannot be obtained with cross-over points selected in the mid-frequency range for two-way systems, but to emphasize the fact that optimum conditions satisfying all of the requirements are very difficult to obtain.

With some types of cross-over networks, where feedback is taken from the secondary of the output transformer, a sufficiently large reactive load may be introduced to cause serious instability in the feedback circuits resulting in oscillation. While this can be eliminated by careful design of the feedback circuits, it almost certainly is an indication of other effects that are undesirable though not so apparent. Many commercial cross-over networks have tone control arrangements, usually for adjustment of the high frequency response. In some designs this is a roll-off control while in others it introduces a resistive loss that lowers the drive to the high frequency section. The roll-off type of control often involves networks that present an undesirable type of load for the amplifier. The stepped type of control may be desirable in some installations, but it is important that the user realize the characteristics of this system. A tone control in an amplifier that simply lifted or lowered an entire section of the spectrum would be considered entirely unsatisfactory. Such a control puts a distinct step in the response curve. Where the control is used to compensate for differences in efficiency between the high and low frequency sections of a system, it may be of real advantage but it should not be considered or used as a conventional tone control.

The efficiency of loudspeaker systems is a consideration of greater importance than is always recognized. It is all too common a concept that electrical power is cheap and that for this reason the efficiency of a loudspeaker system is not of first order importance. Electrical power within distortion limits satisfactory for high quality reproduction is by no means so inexpensive that it is of no importance. It is also true that the characteristics of power amplifiers are such that power output is increased in fairly substantial steps, and in-between ratings are not practical. Thus, 10 watts, 15 watts, 30 watts, etc., are relatively common ratings. If 15 watts is not quite enough to allow adequate reserve power for peak passages, it generally means going to 30 watts. Note that increasing the electrical drive to a single speaker from fifteen to thirty watts amounts to only approximately 3 decibels. Under normal listening con-

ditions this will be observed as only a small increase in loudness. Usually it will be found that two fifteen watt amplifiers driving separate loudspeakers will result in greater efficiency and a larger increase in apparent loudness. With this in mind it becomes important that a dividing network introduce a minimum of loss. The insertion loss of practical systems may be kept to one decibel without great difficulty, and it is well worthwhile to reduce it to the practical limit of half a decibel in most systems. One decibel sounds deceptively small, but when it is translated into actual watts it will be noted that it makes a large difference in the power required from the amplifier.

Audio Reproduction

(Continued from page 10)

The phase angle can be obtained in terms of a voltage by use of the method shown in Fig. 6. The two voltages are applied to the two inputs of a simple pushpull phase detector. This circuit obtains and evaluates their vector sum and difference. The output voltage is shown in Fig. 4. The two voltages are a function of phase angle.

(f) *Wow and Flutter*—Measurement of the wow or flutter introduced by a mechanical recording system (such as phonograph turntables, magnetic recorders, motion picture projectors, etc.) consists essentially of measuring the amount of frequency modulation of a steady tone when it is reproduced by the system. See Fig. 7.

A signal of constant frequency is applied to the input of the reproducing system, and the reproduced output obtained in the form of an electrical signal. (In motion picture work, a frequency of 3000 c.p.s. has been chosen as standard for this test signal. This might be a reasonable standard to use for other types of mechanical reproduction, as well.) The reproduced signal is then passed through a bandpass filter which passes only the test frequency and its possible variations, removing any noise and hum which may be present.

Fig. 6. Determination of a phase angle from lissajous pattern on an oscilloscope.

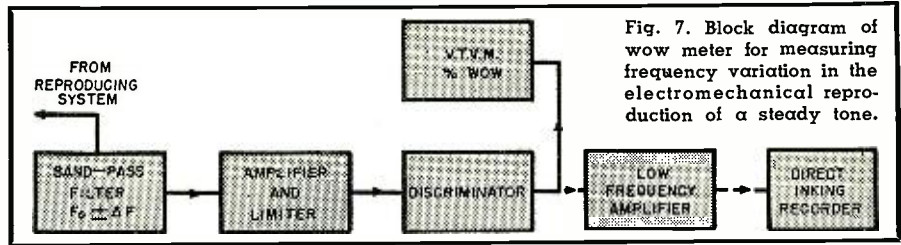
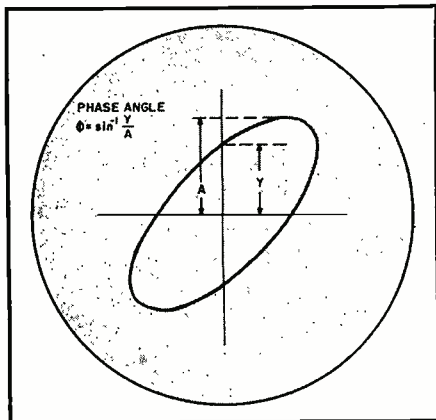

Fig. 7. Block diagram of wow meter for measuring frequency variation in the electromechanical reproduction of a steady tone.

ent. This signal may then be amplified if necessary, and passed through a limiter. The amount of frequency variation is then measured directly by a discriminator, which gives the frequency change as a voltage which may be measured by a low-frequency voltmeter calibrated in percentage frequency change. The output of the discriminator may also be amplified so that a direct-inking recorder may be used to record the actual frequency changes to permit a more complete analysis of speed variations.

The amount of flutter can be evaluated quantitatively from the information obtained by a measurement performed in this way, and certain quantities can be defined which will permit a quantitative comparison and representation of the flutter present in the reproduction. The *per-cent flutter* is the ratio (in percent) of the r.m.s. frequency deviation to the average frequency. The *flutter rate* is the number of complete cycles of frequency deviation per second. The

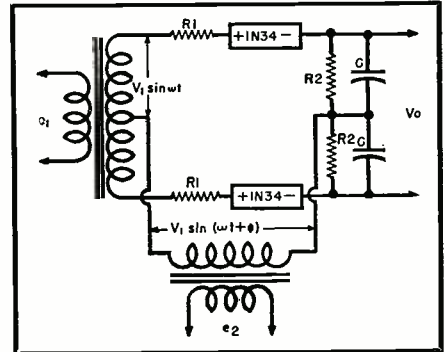

Fig. 8. Push-pull phase detector.

flutter index, I, may be expressed as:

$$I = (f_x/r) \Delta f$$

where Δf is the r.m.s. frequency deviation in cycles, f is the tone frequency, and r the flutter rate. For flutter rates greater than 5 per second $x = 1$, for rates from 1 to 5 per second $x = r/5$, and for rates less than 1 per second $x = r^2/5$. (To be continued)

WHEN IT'S A

PRECISION BOBBIN

YOU
DON'T
NEED
INSULATION
STRIPS . . .



Precision gives you built-in insulation—*other direct advantages*: stronger magnetic fields, closer windings, more room for larger gauge, or more wire of the same gauge on the same size coil base.

Precision Bobbins are heat treated for greater strength and less weight—have swaged tube ends—and entire Bobbin impregnated for better electrical characteristics. Impregnation also permits attachment of terminal lugs to flanges for acceptance with underwriters requirements.

Precision Bobbins make a lighter, stronger coil—at a definite economy and are available in any shape, any size, round, square, rectangular; in dielectric Kraft, Fish Paper, Cellulose Acetate or combinations.

Write for Sample Today

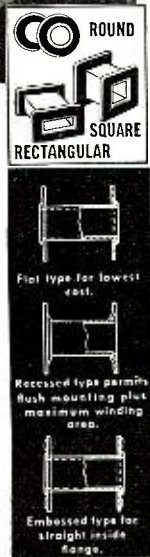

PRECISION PAPER TUBE CO.

2063 W. Charleston St.
Plant No. 2 . . . 79 Chapel St., Hartford, Conn.

Chicago 47, Ill.

Magnetic Amplifier

(Continued from page 18)

Solving for the flux ϕ :

$$\phi = \frac{1}{N_1} \int (E - IR) dt = \frac{1}{N_1} \int (E dt - IR dt) \dots \dots \dots (11)$$

Let us admit the possibility of a direct current component in the output current so that $I = I_{ac} + I_{dc}$, then:

$$\phi = \frac{1}{N_1} \int [(E dt) - (I_{ac} R) dt - (I_{dc} R) dt] \dots \dots \dots (12)$$

Since the first two terms of Eq. (12) are sinusoidal and their contribution to the change in the average flux is nil, it is now seen that as long as I_{dc} flows, there will be a continual change in the average flux, or:

$$\phi_{av} = - \frac{1}{N_1} \int I_{dc} R dt \dots \dots \dots (13)$$

Eq. (13) indicates that an infinite flux must accumulate in order to support a direct current component in the output current. This cannot occur, of course, and the average flux in the circuit always changes so that the direct current component of the output current goes to zero. This average value of flux is in general different from the quiescent value of flux introduced by input current flow, in the same way that the dynamic and static operating points in a vacuum tube circuit are not alike. The distinction is important since it is a determining factor in analyses where the current and flux excursions are large.

The Idealized Magnetization Curve

As pointed out previously, new magnetic materials are being developed which possess very sharp breaks in their magnetization curves. Such curves tend to approach a magnetization curve consisting of two straight line regions, with a discontinuity connecting the two regions. If we assume that the slope of the curve in the saturated region is very small compared to that in the unsaturated region and neglect hysteresis, the resultant curve can be termed an idealized magnetization curve. (Fig. 10A). This is the same as saying that the permeability of the magnetic material is very large compared to that of air in the unsaturated region, but is the same as air in the saturated region.

Analysis by Ideal Magnetization Curves

An analysis can be made of the magnetic amplifier based on an idealized magnetization curve according to the following premises:

The operation of the amplifier will be a switching operation from one region of the curve to the other, with no transients being generated at the point of transfer.

When operation is in the saturated region, the voltage across the output winding will approach zero since the

slope of the magnetization curve and hence the rate of change of flux with current will approach zero. The output current will then simply be given by the ratio E/R .

When operation is in the unsaturated region, the output current flow will approach zero and the IR drop will be negligible. The circuit equation is, then:

$$E = N_1 \frac{d\phi}{dt} \dots \dots \dots (14)$$

or:

$$\phi = \frac{1}{N_1} \int E dt \dots \dots \dots (15)$$

which indicates that when operation is in this region an incremental flux will be generated which is proportional to the time integral of the applied source voltage E . This change of flux will also be proportional to the area underneath the voltage wave. Note the analogy to the charging of a condenser:

$$e_c = \frac{1}{C} \int i dt \dots \dots \dots (16)$$

The flux in Eq. (15) might then be called a *flux charge*, and in a sense this is the purpose of the output winding: to

based on the idealized magnetization curve. The input current is assumed to place a quiescent flux ϕ_i in the core which depresses the magnetization curve downwards (Fig. 10B). The curve is also shifted slightly to the left, although the effect of this shift will be neglected.

The operation can be traced step-by-step along the magnetization curve, as indicated by the dashed line of Fig. 10B. The corresponding output circuit current and voltage relationships are indicated in Fig. 15. The voltage is plotted against time while the current is plotted against radians.

From point 0 to point 1 (see Fig. 10B and 15) the flow of current is negligibly small. (Assume the direction of rectifier conduction to be positive.) According to the principles just enumerated, a flux will be generated equal to $(\phi_s - \phi_i)$. This change in flux must also be proportional to the area A under the voltage wave, Fig. 15A. The output current, then, will be negligibly small during this period, which is for the angle θ_1 on the current wave, Fig. 15B.

From point 1 to point 2, operation is in the saturation region of the magnetization curve and a sinusoidal current flows equal to E/R . Note the sudden change of current at point 1. The flux is constant at the value $(\phi_s - \phi_i)$ during the period and the voltage across N_1 is zero. The current flows for the angle θ_2 .

At point 2, operation moves back into the unsaturated region and a flux change begins to be generated which eventually moves the operating point back to the origin of the magnetization curve, the origin being the shifted origin as represented in Fig. 10B. This flux change is proportional to area B underneath the voltage wave, Fig. 15A, and it is evident that area B must equal area A , because otherwise we should have a net flux accumulation during each cycle. The current flow in this region is negligible and is so indicated on the current wave, Fig. 15B.

At point 3 the output current is zero (considered from a flux change viewpoint). Since the voltage is still negative, the flux tries to go negative, but cannot since this would mean negative current flow which the rectifier will not permit. Thus, during this period the applied voltage is expended entirely across the rectifier. At point 4, the cycle of operation repeats.

When ϕ_i is zero, there will no significant output current flow.* When $\phi_i = \phi_s$, the maximum output current flow will be obtained. Thus, the output current flow will be a function of an input factor defined as ϕ_i/ϕ_s . A plot of the

*This assumes that the circuit is so adjusted that the flux excursion is entirely in the unsaturated region at zero input current.

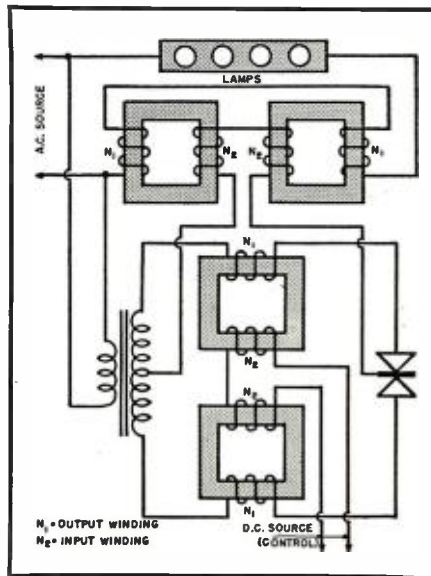

Fig. 17. An application of cascaded magnetic amplifiers to theater lighting control. A double-ended self-saturating amplifier feeds a series-connected double-ended amplifier, which controls the lighting lamps.

store up flux in the magnetic amplifier core during part of the cycle for discharge later in the cycle in such a way as to control the current flow.

Analysis of a Self-Saturating Magnetic Amplifier Circuit

Fig. 3B shows a magnetic amplifier circuit known as a self-saturating magnetic amplifier. The significant addition is that of a single-element rectifier in the output circuit. It is clear that our previous ideas of sinusoidal approximations will no longer serve and we should expect highly distorted fluxes and currents.

However, we can apply an analysis

angle θ_s , the angle of current flow, Fig. 15B, versus this input factor is given in Fig. 12.

It is interesting to note that the shape of the resulting output current waveform is much like that of a grid-controlled gas-tube rectifier. Photographs of the output current observed on an oscillograph for an experimental magnetic amplifier are shown in Figs. 1 and 2. Note that the pulse of current flow is negative rather than positive as indicated on Fig. 15B.

Plots of the relative output versus the relative input factor are given in Fig. 11. These plots neglect the flow of current in the unsaturated region. Curve A gives the r.m.s. current output and curve B the average current output. Note that unity relative output is that obtained when the entire source voltage is applied to the load resistance. The dashed lines in Fig. 11 give experimental curves to indicate the degree of experimental correlation possible with this analysis.

This type of circuit has greatly increased sensitivity compared to the ordinary magnetic amplifier circuit. One way of explaining this is that the direct current component in the output current (due to the rectifier) supplies part of the saturating current needed to obtain control. (Hence, the designation: self-saturating). Another viewpoint is that for this amplifier the center of operations is on the vertical portion of the magnetization curve and control is obtained by introducing quiescent fluxes in the unsaturated region of the curve. For the ordinary amplifier, the input current must move the center of operations into the *saturated region* before output current will flow (otherwise the principle of non-rectification would be violated). It can be shown that in general, for a non-saturating amplifier with an idealized magnetization curve, the input current necessary for maximum output current flow is:

$$I_i = \frac{N_1}{N_2} \frac{2\pi E}{R} \dots \dots \dots (17)$$

whereas, in the self-saturating circuit the input current need only generate a flux equal to ϕ_s in order to obtain maximum output current flow.

ADVANCED CIRCUITS

Double-Ended Amplifiers

In the preceding discussion on elementary circuits, the need for an isolating impedance in the input circuit was indicated so that the low impedance of the direct current source in the input circuit would not act as a short circuit to the output winding. This impedance can be eliminated by interconnecting two reactors in what might be termed a double-ended amplifier. Fig. 14B shows such a circuit where the fundamental

voltage induced in the input windings of the two reactors is in such a direction as to cancel, thereby eliminating loading effects on the output windings.

The cancellation of the induced voltages between the two reactors would be perfect if the voltages were sinusoidal. Since they are not, there will be some circulating currents in the input windings, mostly even harmonics of the fundamental frequency.

The double-ended connection does not change control characteristics as much as it influences transient response. A qualitative appreciation can be gained of this by noting that a change of input current would induce circulating currents between the two output windings. Since the output windings have low resistance, the net result would be a long time constant circuit in so far as the establishment of a change of input current was concerned. This sluggishness must be considered when the magnetic amplifier is used in applications requiring quick transient response.

The circuit of Fig. 14B is considered a parallel-connected double-ended amplifier. A so-called series-connected amplifier is shown in Fig. 14A. This circuit has a better transient response than the parallel-connected amplifier, but achieves the same effect of cancellation of voltage induced in the input wind-

ings of the amplifier. The better transient response arises because of the higher impedance of the output circuits when the output coils are in series.

Three-Phase Circuit

Fig. 16 shows a three-phase self-saturating magnetic amplifier circuit. Cancellation is obtained in the input windings of the three reactors for the fundamental frequency. This circuit gives a direct current output to the load.

Cascade-Connection of Magnetic Amplifiers

It is possible to connect magnetic amplifier circuits in cascade. An example of a two-stage magnetic amplifier is given for a theatre lighting control application in Fig. 17. A self-saturating double-ended amplifier drives a series-connected double-ended amplifier (non-self-saturating). The power gain obtained is very high and the control circuits for presetting, fading, mastering, etc. may be made very small compared to the power controlled.

Two-Phase Motor Servomechanism Application

Fig. 13 is a simplified diagram of a magnetic amplifier designed to control the quadrature phase of a two-phase control motor used for servomechanism applications. A quadrature voltage is

Over 1000 Sizes



PARAMOUNT SPIRAL WOUND PAPER TUBES

SEND FOR ARBOR LIST OF OVER 1000 SIZES

Convenient, helpful listing of over 1000 stock arbor sizes of square and rectangular tubes. Write for Arbor List today. No obligation.

Square • Rectangular • Triangular
Round and Half-Round

With a wide range of stock arbors... plus the specialized ability to engineer special tubes... PARAMOUNT can produce the exact shape and size you need for coil forms or other uses. *Hi-Dielectric, Hi-Strength, Kraft, Fish Paper, Red Rope*, or any combination, wound on automatic machines. Tolerances plus or minus .002". Made to your specifications or engineered for YOU.

Inside Perimeters from .592" to 19.0"

PARAMOUNT PAPER TUBE CORP.

613 LAFAYETTE ST., FORT WAYNE 2, IND.

Manufacturers of Paper Tubing for the Electrical Industry

obtained by center-tapping the input winding of the input transformer, which is supplied by phase *AB* of the three-phase supply, so that the voltage *MN* into the servo-motor is the sum of the voltage *BC* plus one-half of the voltage *AB*. This gives a voltage *MN* which is 90° out of phase with voltage *AB*. The magnetic amplifier consists of a circuit usually referred to as a push-pull magnetic amplifier and is so connected that it has an output which is a voltage either in phase with the voltage *AB* or a voltage which is 180° out of phase with *AB*.

In order to accomplish the change in voltage polarity, the amplifier is so designed that a bias supply (see bias windings on magnetic circuits) places a bias in the magnetic circuits which balances the quiescent signal supplied by the preamplifier. If the signal should increase above this value, the output of the right-hand amplifier circuit increases, while that of the left-hand amplifier circuit decreases, developing an output voltage in phase with *AB*. Should the signal fall below the quiescent value, the output of the left-hand circuit increases, while that of the right-hand diminishes, developing an output voltage 180° out of phase with the supply voltage *AB*. Thus, control of the servo-motor is obtained in accordance with the sense of the input signal and the direction of rotation of the motor will correspond with the polarity of the input signal.

Design Considerations

There are two primary considerations in the design of the reactor for a magnetic amplifier: design for correct flux excursion and design for correct output current excursion; both excursions are considered at zero input current. The two considerations have been repeatedly specified in the theoretical analysis: that the flux excursion at zero input current occupy completely the unsaturated region of the magnetization curve and that the flow of output current at zero input current be small compared to the maximum output current obtained when the magnetic amplifier is completely saturated.

The two conditions can be shown to resemble those for correct power transformer design (as far as the output winding is concerned). The first condition simply corresponds to a transformer working close to the *knee* of the magnetization curve. The second condition for the transformer is that the magnetizing current be small compared to the rated load current of the transformer. Thus, the principles of transformer design can be applied to a considerable extent in the physical design of magnetic amplifiers. The output

winding must be designed to carry the load current, the core must provide reactance enough to develop nearly line voltage across the output winding, and, hence, the size of the magnetic amplifier roughly corresponds to the kva. of the load it is to control.

The design of the input winding will have to be considered somewhat differently. The number of input ampere-turns for a non-self-saturating magnetic amplifier in order to obtain complete saturation can be obtained from Eq. (18):

$$N_2 I_2 = N_1 \frac{2\pi E}{R} \dots \dots \dots (18)$$

and that for a self-saturating amplifier is:

$$N_2 I_2 = \frac{L}{\mu} B_s \dots \dots \dots (19)$$

where:

L = length of magnetic circuit

B_s = saturation point flux density

μ = permeability

The number of turns for *N₂*, the input winding, it is seen, depends upon the type of amplifier to be used, the amount of control voltage available, and the size of the magnetic circuit.

Conclusions

An analysis of the magnetic amplifier has been given using dynamic transfer characteristics similar to the graphical analysis of vacuum tube networks with large signals.

A theoretical analysis using an idealized magnetization curve is developed which gives excellent agreement with test.

The waveform of the magnetic amplifier for a self-saturating circuit and an idealized magnetization curve, is similar to that of a thyatron circuit operated with alternating voltage and phase-shift control.

The design characteristics are shown to depend upon the kva. of the load to be controlled and the current swing, with the design considerations for transformers being applicable.

The ruggedness and stability of the magnetic amplifier indicates that it will supersede the electron control tube in many applications where such qualities are desirable.

REFERENCES

1. Alexanderson, E. F. W., "A Magnetic Amplifier for Radio-Telephony," *Proc. I. R. E.*, Vol. 4, pp. 101-121, April 1916.
2. Boyajian, A., "Mathematical Analysis of Non-Linear Circuits," *G. E. Review*, Vol. 36, pp. 531-537, Sept. 1931.
3. Lamm, A. Uno, "Some Fundamentals of a Theory of the Transductor or Magnetic Amplifier," *AIEE Technical Paper* 66-60, April 1947.
4. "Improved Material for Magnetic Amplifiers," *Electronics*, Vol. 21, No. 8, August 1948.
5. Rez, H. D., "Bibliography on Transductors, Magnetic Amplifiers, etc.," *Instruments*, Vol. 21, pp. 332, April 1948.

Phase Meter

(Continued from page 8)

tics of transmission lines, filters and transformers.

The phase meter developed at the Bureau consists of the two channels of cascaded amplifiers and limiters followed by two types of phase indicating circuits. The two indicating circuits—known as the "sum" indicator and the "trigger" indicator—are based upon different principles in order to afford a direct comparison between them.

Effectively, the sum indicator functions by measuring the algebraic sum of the square waves appearing in the similar channels. This algebraic sum is proportional to the phase angle between the input voltages but is ambiguous about the 180-degree value, that is, the same dial reading is obtained for a phase difference of 170° as for a phase difference of 190°. The two square waves are each applied to the grids of separate tubes having a common plate resistor. The average current through this resistor is directly proportional to the phase angle between the square waves and is therefore proportional to the phase angle between the sinusoidal input voltages. This average value is obtained, by means of a diode rectifier and a balanced amplifier, on a milliammeter which acts as the phase indicator.

In the trigger indicator system, the square waves are first applied to the grids of amplifier tubes, and the amplified square waves are then differentiated in the plate circuits of these tubes. The resultant voltage spikes, which occur at the instant of rise or fall of the square waves, are applied to a diode polarity-discriminator tube, which suppresses the positive voltage spikes and passes the negative impulses to the grids of a modified Eccles-Jordan trigger circuit. The trigger circuit is so connected that when a negative impulse is applied to the grid of one of a pair of tubes, that tube cuts off, simultaneously firing the other tube. In turn, when the second tube receives a negative pulse, it cuts off, again firing the first tube. As a result of this process, the average current flowing in the plate circuit of the trigger tubes is a measure of the time interval between voltage spikes from the two channels of the phase meter, and this time interval corresponds to the relative phase of the sinusoidal input voltage. Both recording and indicating milliammeters are used with shunts to give three ranges of phase-angle measurements: 130° to 230°, 80° to 280°, and 0° to 360°. The phase-angle readings in the trigger indicating circuit are unambiguous, but the circuit is inherently unstable for phase angles in the neighborhood of

0 and 360 degrees, since here the order of firing of the tubes alternates irregularly. However, exact values may be obtained for phase angles in this region by use of the sum indicator.

The new instrument reads and records phase differences with a sensitivity of 0.5 degree. In a series of tests at the National Bureau of Standards, the curve of phase-meter reading versus phase was found to be linear within one degree over a range of input frequencies from 100 to 5000 cycles per second. For very rapid changes in the amplitudes of input voltages from 1 to 20 volts, the readings showed a phase change of but 1.0 degree. Observations were independent of frequency from 100 to 5000 cycles.

Meteorology

(Continued from page 7)

former primary, with a resultant large voltage across the secondary sufficient to fire the thyratron. This energizes the taper coils and causes an imprint on the recorder paper at a position determined by the helix on a rotating drum as in any conventional type recorder. Discharge of a condenser in the plate circuit of the thyratron drops the plate potential below the minimum value required to sustain operation and the taper bar is released until the next surge occurs.

Parachute Sonde

Rather than being sent aloft by balloon as in the preceding case, another type of equipment is dropped from an airplane in flight over some remote or otherwise inaccessible region. During the course of its fall with parachute, this radiosonde transmits meteorological data along the path of fall. This data is received and recorded either by the launching plane, or by weather reconnaissance equipment located at other points. The use of this equipment enables obtaining data on meteorological conditions which might not otherwise be available (Fig. 14).

The over-all dimensions of this "Parachute Radiosonde" including parachutes and batteries are about 10" x 6" x 19" and it weighs about 9 pounds. The meteorological elements are an aneroid cell, and, unlike the previously described units, a bimetallic thermometer, and a hair hygrometer. The modulator is a mechanical device comprising a 3-volt permanent magnet d.c. motor driving what may be described as a sort of phonograph record, and three pickup arms which are positioned on a coded record disc by the pressure, temperature and humidity elements respectively. Each modulator is individually calibrated. The record is a 6-inch plastic disc with a couple of hundred grooves. One 90° sector is offset from the normal plane of the disc by 1/16 inch. All the

codes are impressed in this portion. There are, roughly, 200 two-letter Morse code groups, one for each of the grooves.

As the record rotates, each of the pickups contacts only the raised sector. As the styli are vibrated by the impressed code groups they cause a make and break in a relay which keys the transmitter. The transmitter is a simple 1-tube c.w. oscillator, crystal controlled for frequency. The pickups are spaced to provide a definite cycle of pressure, temperature, and humidity measurements during each revolution of the record. The operator at each signal pickup point receives the transmitted signals and translates the codes into meteorological conditions at the sonde.

Sferics

Another device is utilized to locate and track atmospheric static discharges, also referred to as "sferics." The information obtained by this equipment is useful in plotting the course of lightning storms and is of considerable assistance in forecasting.

Disturbances set up by static discharges occurring in the atmosphere at distances as great as 2000 miles are intercepted and their direction from each sferics station visually indicated on a cathode ray tube. To determine the location of the source of the disturbance, two or more simultaneous observations on the same static discharge are made by stations separated by several hundred miles. The usual triangulation method for centering the storm location is used.

In view of the very brief duration of the signal resulting from a static discharge, a period of less than 5 milliseconds, an instantaneous, non-rotating type of direction finder must be used. An example comprises two directional loop antennas set at right angles to each other, an amplifier for each loop, and a cathode ray tube indicator.

Each loop has about 400 turns of wire inside an aluminum shield and is wound for electrical symmetry with respect to ground. The operating frequency covers the band 8-12 kc., since most atmospheric static discharges set up electromagnetic waves with maximum energy concentration in this frequency band. A split loop type of circuit is used to facilitate tuning and electrical symmetry. The loop voltages are each fed through a cathode follower stage to two identical amplifiers. These amplifiers are required to have identical phase and magnitude characteristics in order to obtain a proper image on the C-R tube. The amplifiers don't have to have perfect amplification and phase characteristics in themselves, but the two amplifiers must be as identical as possible. A phase correcting adjustment is contained in the tuned amplifier section.

Coordination to assure that each of the sferics stations is taking a bearing on the same static discharge is accomplished by means of two-way communication equipment between all stations in the network. Plotting and recording is performed in the usual manner.

Ceilometer

In connection with airport traffic control and flying safety it is desirable to know the height of the cloud ceiling and its rate of rise or fall. By means of an optical device the location of the intersection of a vertical light beam with the bases of clouds may be determined, and then the height of the cloud may be obtained from simple trigon-

FILL THAT JOB WITH A C.T.I. TRAINED MAN!

Solve your man-power shortage by employing well-trained, dependable young men who have been trained by Commercial Trades Institute. Our graduates have completed an intensive course in Radio or Television Servicing. Their training has been practical—in well-equipped shops under expert supervision. They've learned to do excellent work. To enable you to evaluate the efficiency of C.T.I. training, we'll be glad to send you an outline of the course. You'll find the subject matter extensive, complete, thorough.

We probably have men who hail from your vicinity, but most of our graduates will travel anywhere for a good opportunity. We cordially invite employers to write us for detailed information on available men. (No employment fees). Address:

Placement Manager, Dept. P106-7
COMMERCIAL TRADES INSTITUTE
1400 W. Greenleaf Ave., Chicago 26, Ill.

ZOPHAR



WAXES COMPOUNDS and EMULSIONS

FOR
INSULATING and WATERPROOFING
of ELECTRICAL and
RADIO COMPONENTS

Also for
CONTAINERS and PAPER
IMPREGNATION

FUNGUS RESISTANT WAXES

ZOPHAR WAXES and COMPOUNDS
Meet all army and navy
specifications if required

Inquiries Invited

ZOPHAR MILLS, INC.

FOUNDED 1846

122—26th ST., BROOKLYN, N. Y.

ometric computations. The automatic ceilometer is a system for measuring and recording the height of a cloud ceiling above ground level continuously, both day and night. Measurement is made by triangulation of a modulated light beam projected vertically to the cloud, with the reflection from the cloud base picked up at a photoelectric detector located at a known distance from the projector. Signals of pickup and angle of elevation at pickup are recorded on a chart. Modulation of the light beam gives it an identifying characteristic which enables it to be distinguished from the high intensity level of daylight.

The projector uses an air cooled high intensity 25 million candle-power mercury vapor lamp in a parabolic mirror reflector. When operated from a 60-cycle source the lamp produces a light output with about 90% of 120 cycle modulation. The major part of the visible light can be filtered out so that the beam is not seen at night. The projector includes a device containing 3 spare lamps in addition to the one in operation. Should the operating lamp fail, a relay is caused to operate due to the loss of current in a series transformer in the lamp circuit. This automatically causes the next spare lamp to enter the proper operating position. If, after a 20-second delay, this lamp is not operating the next lamp is automatically fed into the operating position. When the fourth lamp fails a limit switch prevents further operation of the changer until manually reset.

Among other things, the detector unit contains a movable drum containing the phototube and optical system, and a high gain amplifier (max. voltage gain 2×10^6) tuned to the light modulation frequency of 120 c.p.s. A preamplifier is located in the drum and the remaining four stages are located in the cabinet. The drum is oscillated by motor drive between 0 and 90° to the horizontal. A synchro system transmits data on the angle of drum elevation to the remote chart recorder.

The major problem encountered in this equipment is to differentiate between the small signal returned from the cloud and the high noise level created by daylight acting on the phototube. Simply modulating the light source and then trying to amplify the 120-cycle signal is not sufficient in itself to separate the modulated signal from the noise, as the noise amplitude may be many times that of the desired signal voltage and it passes through the 80-cycle bandwidth of the amplifier. However, there is one feature of the noise which is different from the desired signal and that is its complete randomness.

Filtered d.c. is used on all tube filaments and the phototube and its pre-

amplifier are contained in completely shielded enclosures. The phototube puts out a signal of about 5 microvolts, a value sufficiently low to require special precautions in amplifier design to avoid false indications from disturbances in the line or other components. By using a high load resistance thermal noise is discriminated against and the passed signal is composed of the desired 120-cycle signal plus shot noise. The pre-amplifier tube operates at only 10 to 20 volts on the plate and with about 30 microamperes of plate current.

The amplifier tubes also operate at relatively low plate voltage (50 to 125 volts) to assist in obtaining proper filtering. After amplification a phasing voltage is combined with the signal voltage and this combination when rectified and integrated provides a d.c. output

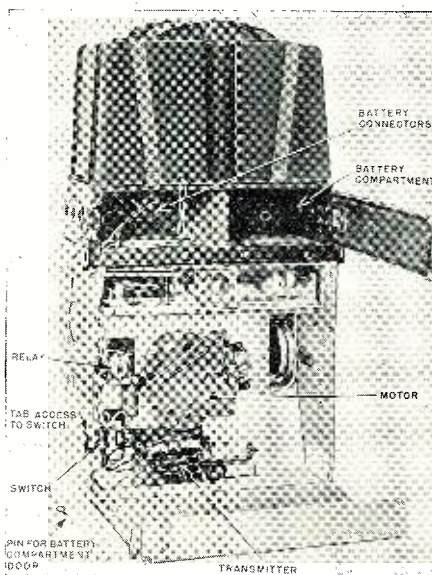

Fig. 14. Parachute radiosonde.

signal proportional to the input signal, whereas random noise signal is time averaged out in a 4 second time constant circuit to a zero value.

The resultant signal is transmitted to a recording meter where the angle of inclination of the drum is indicated at the time of detected cloud ceiling signals.

Automatic Weather Station

Another important application of electronics to the art of meteorology is in connection with the automatic weather station. Basically, the automatic weather station is a collection of more or less standard meteorological elements which is placed in an isolated location such as a mountain peak, a small island or an arctic region and left unattended. Periodic observations of the instrument readings are transmitted by radio to a receiving and recording station which is located in a more habitable region. Among the meteorological elements measured are

surface-wind direction and speed, pressure, temperature, and humidity, amount of rainfall and amount of sunshine.

The variations in meteorological elements, as in the case of the radiosonde, may be converted into a change in electrical resistance which in turn produces a change in the rate of keying a radio carrier wave. Low keying frequencies may be used to enable direct keying of the transmitter and the use of simple frequency measuring equipment at the receiver. Other arrangements are also in use.

The instruments used in this type system may have a relay-operated clamping bar for clamping the instrument pointer against the contacts of a wire wound resistor assembly when an observation from the instrument is desired. The instrument pointer is allowed to swing freely except at the time of making an observation. The wind direction indicator has a number of contact segments with a different fixed resistor connected to each segment. These are placed in the circuit as the weather vane turns. The windspeed indicator is a standard type anemometer with take off contacts, geared up to permit keying the transmitter directly. The other instruments have somewhat similar arrangements (Fig. 12).

As in the case of the radiosonde, an oscillator circuit with a fairly low frequency, say 1 megacycle, is interrupted at a rate determined by the time constant of an *RC* combination in the grid circuit, with the resistance being determined by the variable instrument resistor or a standard of reference. These interruptions are used to operate a relay control tube to key a relay which may be placed in the keying circuit of any of the more common types of radio transmitters.

The power supply is turned on by clock control at preset periods of time shortly before the station is to go on the air, to permit a warm-up period. Then after transmitting identifying and reference frequency signals the various met-element-modulated frequencies are transmitted in a predetermined sequence actuated by means of a rotary switch. After a couple of cycles of such operation, the power is turned off until the next period.

Among the major problems which must be solved for any particular installation are type and size of power plant to use—that is, whether wind or engine driven generator or batteries, frequency and power of radio transmitter in view of location, and fading and interference phenomena. Since the equipment is to be located in an isolated location, maintenance and adjustment problems become of primary magnitude.

Radar

It was known for a long time that cloud and precipitation areas returned radar echoes. At first these effects were considered to have nuisance value only, but more complete study has led to practical applications. The reflection of radar pulses from the rain drops or precipitation in the atmosphere provides the meteorological echo on the radar screen. At a given distance the more moisture in the air, the stronger is the received echo—hence we have a qualitative factor for determining presence and severity of clouds and storms. The radar frequency enters into the problem, as does the transmitter power available at the different wavelengths and atmospheric absorption of the radiated energy. At the shorter wavelengths water vapor and atmospheric gases cause attenuation. Available radar sets at, say, 10 cm. wavelength provide long range detection of storms and higher frequency equipments provide greater detail on size and separation and detect weaker storms. Radar sets can detect showers, storms, warm and cold fronts, hurricanes and tornadoes. Fog or light clouds are generally not detectable. Ranges for storm detection will vary with the storm content but they have been recorded at well over 200 miles.

Echoes obtained from meteorological phenomena are distinguished from those from solid objects by the manner in which they constantly change in size, shape, and intensity. Cloud echoes have a motion distinguishing them from large fixed echoes, are irregular in shape with changing edges and have a vertical extension unlike ground targets. Different types of phenomena may be recognized on the radar screen from their different characteristics. For example, cold front precipitation is usually in the form of a line squall and is very bright, whereas a warm front generally produces indistinct echoes covering a wide, irregular arc on the screen and changes continuously in shape. Thunderstorms have a bright central area with an irregular margin. Hurricanes and typhoons give an interesting and readily identifiable signal with whorls and circular shape to the cloud pattern (Fig. 13).

Among other things, the information obtained from this data may be used to provide flying instructions to pilots to enable flying around bad spots, to find the best route through a front or large area of bad weather, and to get advance warning on storm conditions which may close (or open) airports. Flight tests indicate that severe turbulence is frequently encountered within areas of radar echo. It appears that a plane flying within a radar echo region will encounter gust velocities within 100

miles which if it were flying in a non-radar echo region would not be encountered for about 10,000 miles of flight. Aerologists can use this data to predict quite accurately the time of approach of a storm.

The wind structure of the atmosphere can be obtained by using practically any radar set which can provide range, azimuth, and altitude data. The method used is to send up a balloon with a radar reflector on it. One type which has been used for frequencies of 200 mc. comprises 3 dipoles made from aluminum foil-wrapped balsa wood. To eliminate polarization effects due to swinging of the balloon crossed dipoles are used rather than a single radiator. At 3000 mc. a corner reflector assembly is used (Fig. 15). The corner reflector possesses the property of returning a signal in the same direction from which it was received. A multiplicity of corners is used to maintain directivity as the target swings and turns, and the top corner is designed to prevent undue drag from slowing the rate of ascent of the balloon. The ranges obtained depend upon the capabilities of the particular radar set but ranges greater than 100,000 yards are not uncommon. This type data is particularly valuable to artillery units to enable making ballistics corrections. The fire control radars of the organization can be utilized directly for such reflector target tracking without necessity for adding any additional auxiliary equipment. For even greater ranges, it is possible to utilize a receiver-transmitter type equipment on the order of the wartime beacon or IFF transponder which will retransmit to the radar set the received pulse. Due to the larger output from this type device considerably greater ranges can be obtained. By combining the use of a radar reflector with a radiosonde transmitter accurate altitude data can be obtained without reliance on the baroswitch or estimated free lift rate of the balloon as is required for the simple radiosonde equipment previously described.

By data transmitting and radar relay means, a radar set utilized for meteorological purposes may be located at a favorable site and the data sent to a more conveniently located meteorological center, where it may be utilized and further distributed either by additional radar relay or by facsimile.

Upper Atmosphere

The meteorologist is continually striv-

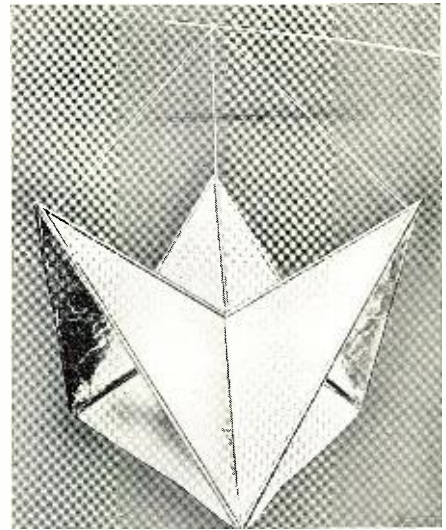

Fig. 15. Corner reflector for use with 3000 megacycle radar.

ing to reach higher and higher into the atmosphere. In pursuit of knowledge to altitudes of about 100,000 feet the meteorological balloon is quite satisfactory and relatively economical. But for altitudes beyond this range the balloon has proved generally unsatisfactory to date. As a result the meteorologist is turning to rockets to carry his instruments to the higher altitudes. This creates a problem in obtaining instruments which are accurate at both high and very low pressures, temperatures and humidities, and which must have a speed of response to conditions commensurate with the speed of travel of the vehicle in which they are contained.

Here again the electronic art is playing a considerable part. Radar equipment on the ground is used to track and plot the position of the missile. Measured parameters are telemetered from the missile to ground stations. Beacons in the missile assist in tracking. Fuel cutoff is controlled from the ground through a special receiver and control valves. Electronic timers are used to operate sample bottle valves to obtain specimens of the atmosphere at the upper altitudes, to cause the emission of devices to enable determining wind velocity and atmospheric temperature, and finally to cause actions such as nose-cone blow-off or parachute ejection to enable return of the instruments to ground for study of film records obtained during flight.

Continued research, development, and application of electronic equipment and methods in the field of meteorology is expected to result in improved instrumentation for weather forecasting, widely increased application to military operations, improved communications, and corrections for vagaries in the propagation of sound, light, heat, and other electromagnetic radiation. ~@~

PHOTO CREDITS

Pages

8.....Nat. Bureau of Standards

11, 12, 13.....

....Minnesota Electronics Corp.

**A MUST Book for
Everyone Interested in**

TWO-WAY RADIO

By
SAMUEL FREEDMAN
Commander S(E)T, USNR

506 Pages of Facts!

MECHANICS—EQUIPMENT—APPLICATIONS
with studies of actual installations

No radio man's technical library can be without this complete text on two-way radio. TWO-WAY RADIO covers the mechanics and applications of two-way radio for all forms of fixed, mobile and portable communication. It is written in non-mathematical form and in language easily understandable by users or intended users of this type of equipment. An excellent guide for servicemen and radio amateurs, as well as engineers, executives, and planners who are interested in a detailed analysis of the applications and equipment in this field.

Answers all questions

TWO-WAY RADIO gives concrete answers to your practical questions: How is it used? What are the potentialities of two-way communication? Is it efficient? Is it economical? What types are best suited for specific uses? What are the technical requirements? What are the licensing regulations? Here, in accurate, complete, and useable form is the data you need for these and a host of other pertinent questions—the basic technical information which will enable you to keep pace with the fast-coming developments in two-way radio communication.

Graphically illustrated

Included in TWO-WAY RADIO are 87 informative illustrations—charts, diagrams, and photographs of equipment and installations, carefully chosen by the author to illustrate his twenty chapters of text material.

The opening chapters are devoted to planning of two-way radio and details of equipment, power supply, mobile and fixed stations, and proper antenna systems. Then follows a detailed analysis of AM and FM equipment, radio and guided carrier systems, and a full discussion of microwaves. Latter chapters describe two-way radio communication as used by railroads and police, fire, highway and forestry services; also marine and aeronautical applications, and personal use by radio amateurs and private citizens. There is ample information on maintenance, repair, and trouble shooting, a full chapter on licenses and regulations, and a description of typical installations by states, communities and border patrol.

**Price \$5.00. Use convenient coupon
with full return privileges**

ZIFF-DAVIS PUBLISHING COMPANY
185 North Wabash Avenue, Chicago 1, Ill.

**Fully Illustrated!
Charts, Diagrams!
Photographs!**

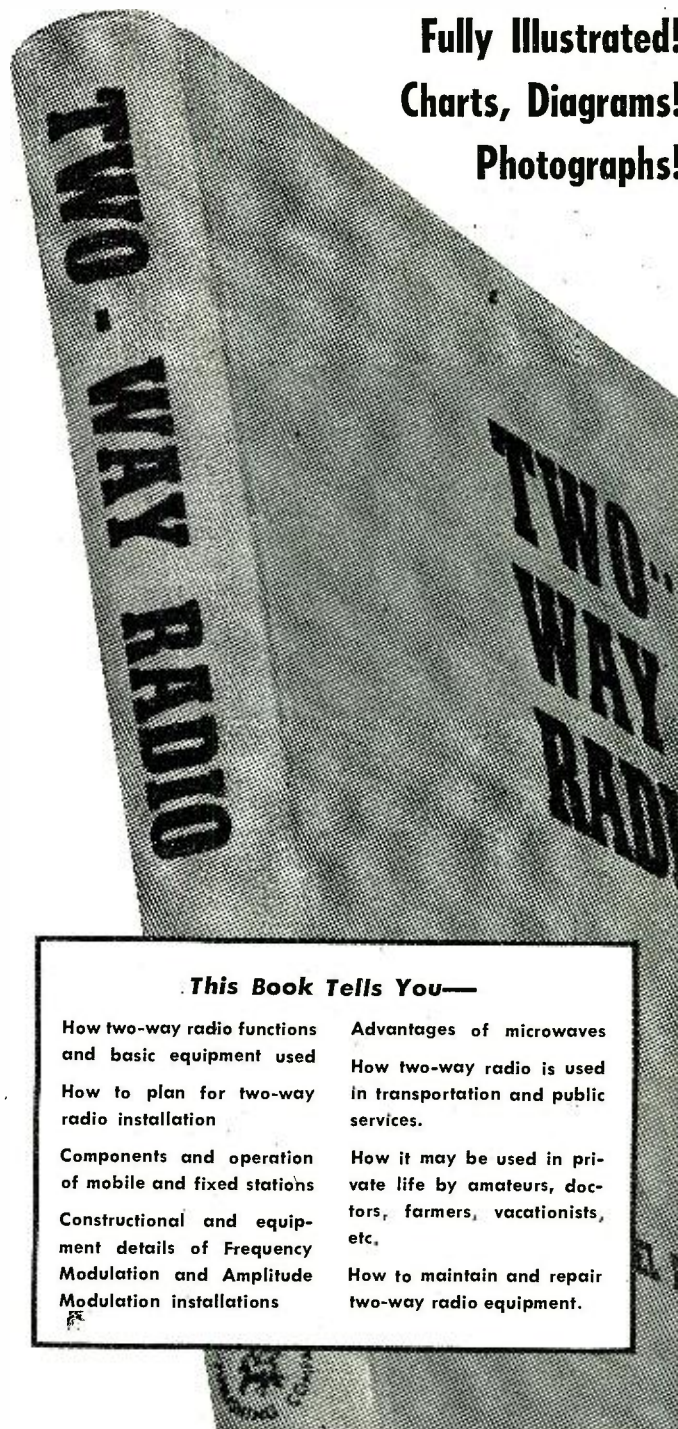

This Book Tells You—

- | | |
|---|--|
| How two-way radio functions and basic equipment used | Advantages of microwaves |
| How to plan for two-way radio installation | How two-way radio is used in transportation and public services. |
| Components and operation of mobile and fixed stations | How it may be used in private life by amateurs, doctors, farmers, vacationists, etc. |
| Constructional and equipment details of Frequency Modulation and Amplitude Modulation installations | How to maintain and repair two-way radio equipment. |

MAIL THIS COUPON TODAY

ZIFF-DAVIS PUBLISHING COMPANY
185 North Wabash Ave., Chicago 1, Illinois

I am enclosing \$5.00 (check or money order) for which please send me one copy of TWO-WAY RADIO. I understand that I may return book within five days for full refund if I am not entirely pleased.

Name.....

Address.....

City.....Zone.....

State.....

REE 8-49

SERVICEMEN: WE'LL PROVE YOU'LL SAVE TIME AND EARN MORE WITH PHOTOFACT-

AT NO COST TO YOU!

... We'll send you absolutely

FREE

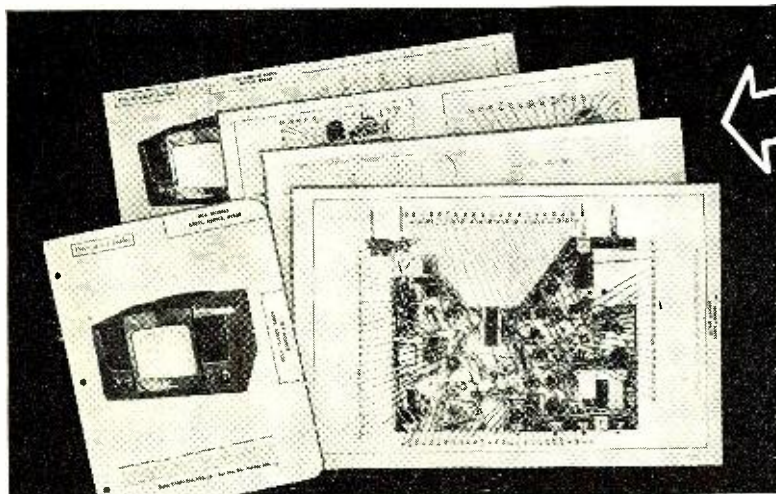

**THIS PHOTOFACT FOLDER
ON THE RCA 630
TELEVISION RECEIVER
OR
A PHOTOFACT FOLDER ON
ANY POST-WAR AM OR
FM SET OF YOUR CHOICE**
(as listed in the PHOTOFACT Cumulative Index)

NOW, you can discover for yourself—at our expense—how PHOTOFACT can make your service work quicker, easier, and more profitable! Examine an actual PHOTOFACT Folder. Use it. You'll learn first-hand why this indispensable service data is used exclusively by thousands of successful service technicians. These men-in-the-know subscribe to PHOTOFACT year after year because it helps them every minute of every working day. No other serv-

ice data gives you PHOTOFACT'S outstanding advantages: *completeness, accuracy, uniformity and ease-of-use.* PHOTOFACT and *PHOTOFACT alone*, is the *only* radio service data prepared from laboratory analysis of the actual equipment it describes. Know the facts—get your FREE Folder now. Examine it—use it—compare it with others—and you will understand why no modern service shop can afford to be without PHOTOFACT.



NOTE: This FREE offer is limited to Service Technicians. Attach coupon below to your letterhead and mention the name of your jobber. If you have no letterhead, send coupon to your jobber. Experimenters and others may obtain the Photofact Folder by remitting 50c.

CURRENT PHOTOFACT BEST-SELLERS

The Recording and Reproduction of SOUND, by Oliver Read. The complete, authoritative treatment of the entire subject of Sound, written by the editor of *Radio & Television News* **\$5.00**

Photofact Television Course. The book used by thousands; gives you a clear understanding of TV principles, operation and practice. **\$3.00**

Television Antennas. Shows you how to select and install the proper antenna, and how to overcome antenna problems **\$1.25**

1948 Record Changer Manual. Covers 45 models made in 1948, including new LP and dual-speed changers, plus leading wire recorders. Based on actual analysis of the equipment **\$6.75**

Auto Radio Manual. Complete Photofact service data on more than 100 post-war auto radio models—a time-and-money-saver. **\$4.95**

HOWARD W. SAMS & CO., INC. INDIANAPOLIS 1, IND.

**HOWARD W. SAMS & CO., INC.
955 N. Rural St., Indianapolis 1, Ind.**

I am a Service Technician:

- Send FREE Photofact Folder on RCA 630 TV Receiver
- Send Photofact Folder for set model.....

I am an Experimenter:

- Send Photofact RCA 630 Folder. (50c enclosed)
- Send FREE Photofact Cumulative Index

Name.....

Address.....

City..... Zone.... State.....

(Offer expires Sept. 30, 1949. Good only in U. S. A.)

TRANSVISION TELEVISION KITS AND INSTRUMENTS

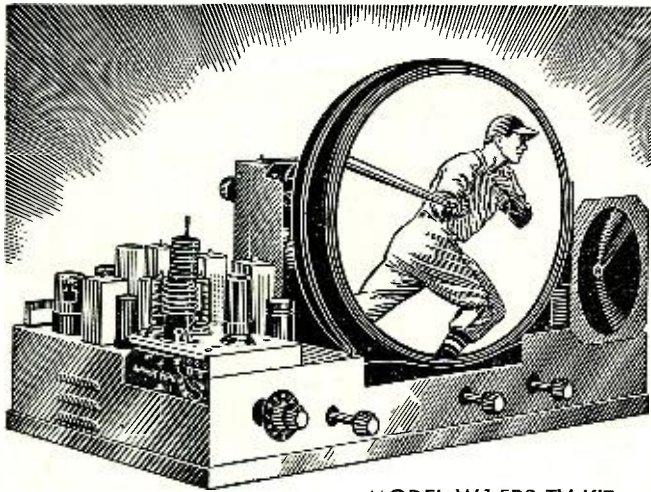

MODEL W15RS TV KIT



CHOICE OF BEAUTIFUL CABINETS best suited to your needs

SERVICE-DEALERS - - -

Be the TV Parts Jobber and Service Center in your community!

- Beat competition at a profit.
- Stop being undersold—by anybody!
- Enjoy an Exclusive Franchise.

Here's a real opportunity to **MAKE MONEY** in Television. If you can qualify, you can become the Transvision Television Center in your community—and **BUY TV and RADIO PARTS AT JOBBER PRICES**. Practically no investment required. This offer is open only to service-dealers in territories where we do not have an authorized distributor.

Contact Transvision Outlets listed below, or write to New Rochelle, for details on Transvision's "TV Center Plan". **DO IT TODAY!**

TRANSVISION, INC., Dept. RN, NEW ROCHELLE, N. Y.

All Transvision Prices are fair traded; subject to change without notice. Prices 5% higher west of the Mississippi.

For **FREE 20-page TV BOOKLET and CATALOG SHEETS, SEE YOUR TRANSVISION OUTLET!**

CALIF: 8572 Santa Monica Blvd., Hollywood
3471 California St., San Francisco
DEL: 4 East 15th St., Wilmington
FLA: 42 Southeast Eighth St., Miami
ILL: 1002 So. Michigan Ave., Chicago
MD: 1912 No. Charles St., Baltimore
MASS: 1306 Boylston St., Boston

N. J.: 601 Broad St., Newark
N. Y.: 1425 Boscobel Ave., The Bronx
485 Coney Island Ave., Brooklyn
167-01 Hillside Ave., Jamaica
75 Church St., New York City
606 Central Park Ave., Yonkers
622 No. Salina St., Syracuse

OHIO: Fourth & Plum Sts., Cincinnati
2001 Euclid Ave., Cleveland
53 W. Norwich Ave., Columbus
PENNA: 235 No. Broad St., Philadelphia
620 Grant St., Pittsburgh
TEXAS: 700 Commerce St., Dallas
CANADA: 465 Church St., Toronto, Ont.

Build it in 1 Day!

GIANT 160 Sq. In. PICTURE

• **Has 16" PICTURE TUBE**

(All-Glass Picture Tube, giving bright, clear, steady picture.)

• **KIT COMES SEMI-WIRED and ALIGNED**
Can be completed in one day!

• **SAVE** by installing the set yourself.

• **NEW LOW PRICES!**

SAVE UP TO 1/2 on the cost of equivalent picture-size sets. For **NEW LOW PRICES**, see your Transvision Outlet listed below.

Transvision Television Kits were ordered by the United States Government for use in Naval Reserve Training Program

ELIMINATE the VARIABLES in TELEVISION Installation with the TRANSVISION FIELD STRENGTH METER

Improves Installations! Saves 1/2 the Work!!

Has numerous features and advantages, including —
(1) Measures actual picture signal strength . . .
(2) Permits actual picture signal measurements without the use of a complete television set . . . (3) Antenna orientation can be done exactly . . . (4) Measures losses or gain of various antenna and lead-in combinations . . . (5) Useful for checking receiver re-radiation (local oscillator) . . . (6) **12 CHANNEL SELECTOR** . . . (7) Amplitudes of interfering signals can be checked . . . (8) Weighs only 5 lbs. . . (9) **Individually calibrated** . . . (10) Housed in attractive metal carrying case . . . (11) Initial cost of this unit is covered after only 3 or 4 installations . . . (12) Operates on 110V, 60 Cycles, A.C.
Model FSM-1, with tubes . . . new low price . . . **Net \$79⁵⁰**





Amazing Sale, Only \$19 for all 9 Supreme Manuals

RADIO DIAGRAMS AND SERVICE DATA ON ALL POPULAR SETS FROM 1926-38 TO 1949

Now you can obtain all nine Supreme manuals for only \$19, total price. Here is your complete source of all popular radio diagrams and service data to help you fix any radio in a matter of minutes. These giant manuals are easy to use for practical fault finding and quick repair. *Supreme most-often-needed* manuals are guaranteed to cut hour-wasting radio repairs to pleasant moments. Yes, here you have all needed material on all sets from old-timers to modern 1949 models, and including auto sets. Clearly printed circuits, parts lists, alignment data, voltage charts, and service hints are the facts you need to be more expert in radio servicing. See these 9 attractive volumes illustrated above. Each manual measures 8½x11 inches; average book has 194 pages of diagrams; sturdy binding. Send coupon below to receive the complete set of 9 manuals at the special price of only \$19, or secure individual volumes at your radio parts jobber. Sold on a 10-day no-risk trial.



Compiled by
M. N. Beitman,
radio engineer,
teacher, author,
and serviceman.

Here Is How You Save Two Ways

You save money by buying the complete set of 9 **Supreme Diagram Manuals** for only \$19. You will save time from now on by having on hand factory data on all popular radio sets of every make. In each of the nine volumes, covering 1949, 1948, 1947, 1946, 1942, 1941, 1940, 1939, and 1926-38 sets, you have large schematic diagrams, needed alignment data, replacement parts lists, voltage values, and information on stage gain, location of trimmers, and required dial stringing pictures. For over 16 years, **Supreme Publications** has aided radio servicemen with on-the-job-style service manuals, always giving biggest values. Today, when dollars must be watched, save again with **Supreme**.

Used by 128,000 Radio Servicemen

Words can tell a story, advantages and benefits of **Supreme Diagram Manuals** can be stated, but the real **proof** of the value and super-usefulness is shown by the 128,000 servicemen who use these manuals day-in and day-out. They know. Because every customer gets a 10-day no-risk trial, we had to satisfy every one of these thousands of servicemen. Some of these were rank beginners and used our manuals to help them on their very first repair. Other radiomen using **Supreme** manuals operate the country's biggest shops. Join these servicemen to save and earn more with **Supreme Publications**—you must be satisfied or you get your money back.

Index Book Included Free

For a limited time only, you will receive **FREE** with every set of nine manuals sold at the special price, a 2-in-1 volume containing advanced instructions on how to use diagrams and a complete cross-index to all 9 volumes. This is an added extra to show you that there is no need to spend large sums for expensive, space-wasting manuals of other publishers, or to buy additional drawings every few weeks; be wise, get the most for your money in **SUPREME** Manuals.

10-Day No-Risk Trial Given

Your set of nine diagram manuals or any of the television or training books described on the left, are sold on trial, with a guarantee of complete satisfaction or your money back. Any of these practical, on-the-job manuals pay for themselves with time saved on several jobs, after that you use them **FREE** for more money-making, time-saving speedy servicing. Send coupon today, or obtain these manuals at your jobber.

TELEVISION & F. M.

New 1949 T-V Manual

Use this new 1949 giant *Cyclopedia* of television servicing as your guide to quick fault finding and repair of any modern T-V set. Easy-to-understand description of circuits, pages of test patterns, response curves, simplified alignment facts, waveforms, voltage charts, service hints, many diagrams in the form of double-spread blueprints, everything to bring you up to date and make you expert in T-V repairs. Factory data on all 1949 Admiral models, Bendix, DuMont, Gard Telesoom sets, eight G.E. models, Hallicrafters, Magnavox, Motorola, Philco, R.C.A. Victor, Sentinel, Stewart-Warner, all 1949 Zenith models, and others. Large size manual, 8½x11", 192 pages, plus 9 giant blueprints, flexible covers, sturdy binding. Amazing new **Supreme** super-value—easily worth **\$3** three times the price of only.....

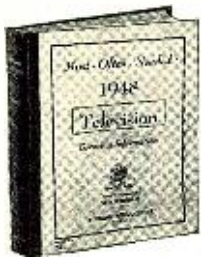

1948 Television

This mammoth volume presents practical factory service data on all popular 1948 television sets. Similar to the volume above. These manuals are all that you need to successfully adjust and repair modern television sets. Available at your radio jobber, or send coupon, your special price only **\$3**

1947 T-V and F.M. Manual

Use this manual of factory instructions for trouble-shooting, repairing, and alignment 1947 popular Television and F.M. sets. Covers every popular make, including F.M. tuners, AM-FM combinations, and modern television receivers. Detail circuit diagrams, theory of operation, test hints, alignment data. This is the material you need to fix F.M. or Television sets. Don't turn this profitable work away for lack of knowledge and information. Data on 192 large pages, 8½x11 inches. Sturdy, manual-style binding. Tremendous **Supreme** value at only **\$2**

TRAINING MANUALS

Radio Servicing Course-Book

Here is your practical radio course of 22 easy-to-follow lessons. Review fundamentals, learn new servicing tricks, all about signal tracing, oscilloscopes, recording, P.A., test equipment, and T-V. Just like a \$100.00 correspondence course. Everything in radio servicing. With self-testing questions and index. Large size: 8½x11". Price **\$2.50** postpaid, only....



Simplified Radio Servicing

Revolutionary different **COMPARISON** technique permits you to do expert work on all radio sets. Most repairs can be made without test equipment or with only a volt-ohmmeter. Many simple, point-to-point, cross-reference, circuit suggestions locate the faults instantly. Plan copyrighted. Covers every radio set—new and old models. This new servicing technique presented in manual form, size 8½x11 inches, 84 pages. Over 1,000 practical service hints, 26 large, trouble-shooting blueprints. Charts for circuit analysis, 114 tests using a 5c resistor. Special price, postpaid.... **\$1.50**



How to Modernize Radios



Cash in by improving and modernizing all out of date radio sets and cabinets. Practical job-sheets with schematics and photographs make the work easy. Size 8½x11 in. Price **\$1** only.....

NEW Record Changers Manual

Service expertly all modern (1945-1948) record changers. Includes every popular make. Just follow simplified factory instructions to make needed adjustments and repairs. Hundreds of photographs and exploded views. Large size: 8½x11 inches. 144 fact-filled pages. Available at your radio jobber, or sent postpaid, only.... **\$1.50**

SUPREME PUBLICATIONS

3727 W. 13 ST. CHICAGO 23, ILL.

Gentlemen: I want to try the set of 9 **Supreme Diagram Manuals** at the special price of only \$19. I am to receive **FREE** the Index Manual. You guarantee complete satisfaction or will refund my money.

Also ship manuals which I list below:

.....

.....

I am enclosing \$....., send postpaid.

Send C.O.D. I am enclosing \$... deposit.

Name:

Address:

New baby in a proud family...

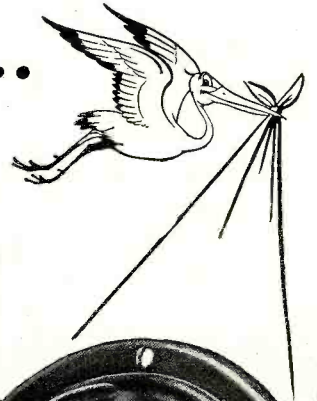

5" ROUND PM LOUDSPEAKER

THERE'S always something new and better in the G-E Speaker Line—Now it's the G-E 5" Round—*specifically designed for service replacement!*

Naturally it has the quality you expect of a General Electric Speaker—sturdy all-weld construction, rock-steady G-E Alnico 5 magnet—plenty of power, sensitivity, fidelity! Give your customers the best—that G.E. gives you! See your G-E parts distributor and stock up today.

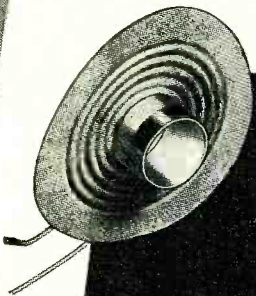
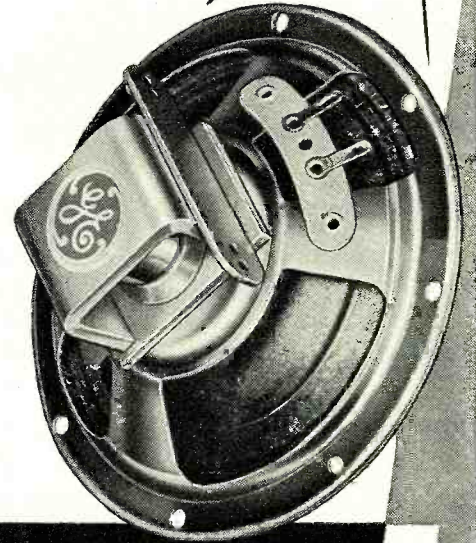

Of course it has the famous G-E Aluminum Foil Base Coil! Not subject to warping resulting from high humidity. Provides much higher power handling capacity. P. S. All G-E Speakers have this Metal Base Voice Coil—don't forget that!

FREE—with all 4", 5" and 5¼" G-E Speakers!

Chassis Mounting Brackets

Save time, money and materials for the hard-working serviceman!

Well, now, here's the story. With the serviceman in mind, G. E. has cooked up these neat little mounting kits to save your temper and please your customers. They're adjustable—up, down or

sideways, for simplified mounting of speakers in small working areas. Less work for you—and a cleaner job for that important fellow—your customer. The brackets are FREE with every 4", 5" and 5¼" G-E speaker you get from your G-E distributor or jobber. *General Electric Company, Parts Section, Electronics Park, Syracuse, New York.*

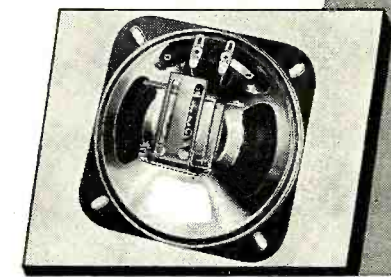
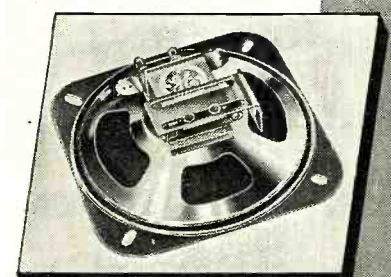
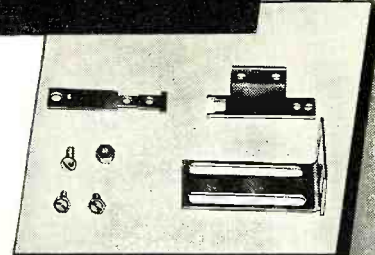

You can put your confidence in—

GENERA  ELECTRIC

CARRIER COMMUNICATIONS On "REA" Power Lines

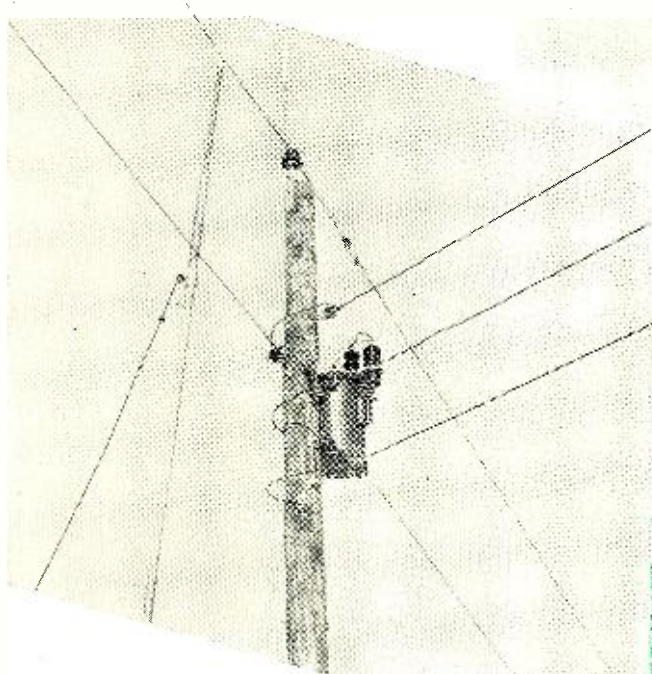
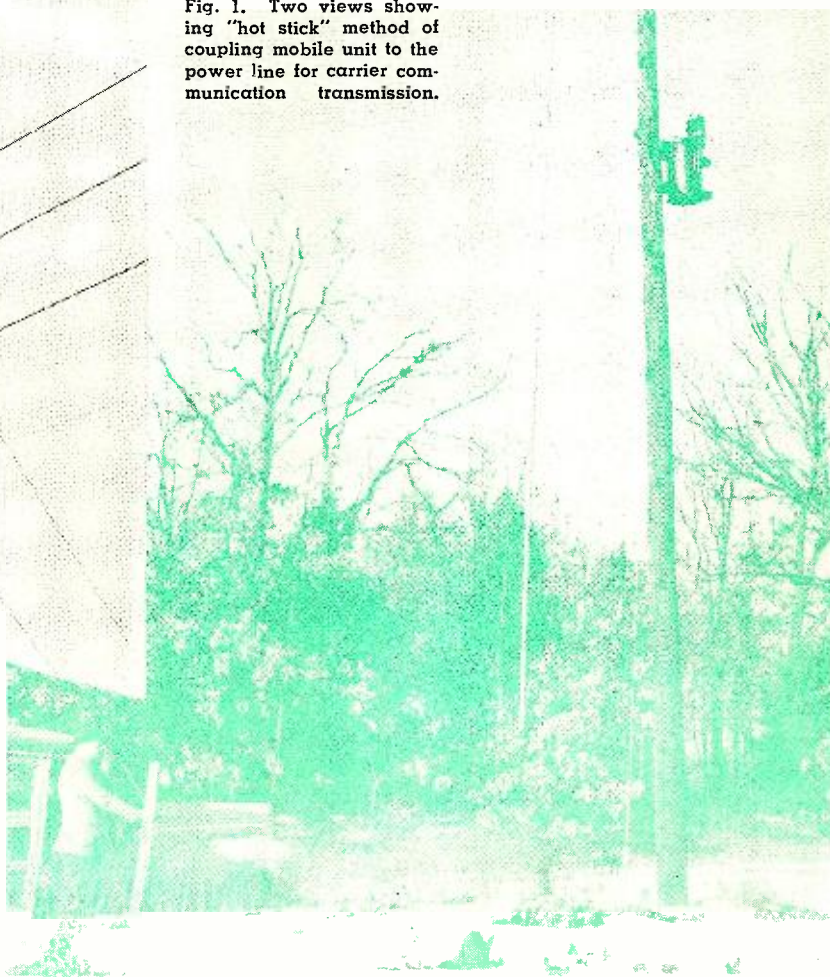

Fig. 1. Two views showing "hot stick" method of coupling mobile unit to the power line for carrier communication transmission.



By
P. M. OHLINGER
Design Engineer

This efficient and low cost system keeps current flowing to millions of rural homes.

THE REA (Rural Electrification Administration), a government financed project, was set up in 1935 to provide electric power service to every rural farmstead desiring it. These systems are now in operation in every state with the exception of two, Connecticut and Rhode Island.

When we think of supplying power to every farmstead in rural America, we begin to realize the magnitude of this project. Therefore, in order to allow a better appreciation of the problems, needs, and advantages of carrier current communication as applied in the operation and maintenance of power lines, a brief description of a typical REA system is given along with a schematic (Fig. 6) of the basic circuit.

Each REA power system is formed into a Cooperative or Public Power District composed of from one to six or more counties in the state. A board

of directors is elected from the local community, and they secure a manager to operate the system within the boundaries established by REA in Washington, D. C.

The first REA construction was started in 1937. To illustrate its growth, 458,000 new meters were connected in the year 1948 alone. Projects which started with a kilowatt-hour consumption per-month-per-consumer of 80 have now reached 200 and more kwh. per-month-per-consumer. Nearly all existing systems are now being redesigned and rebuilt to handle loads of 500 or more kwh. per-month-per-consumer. Any interruption of service to loads of this magnitude would obviously have serious repercussions.

As loads grew and the need for uninterrupted service became more vital, it was found necessary to speed up communications between headquarters and maintenance crews in the field.

The smallest systems have a minimum of 600 miles of line and four or more maintenance trucks to serve 1000 consumers while the larger systems have a network of 4000 or more miles of line, over 8000 consumers, and eight or more service trucks.

The telephone which had been used for communication proved to be unreliable, costly, and time-consuming in this application. Two-way radio was introduced and its use has recently become widespread on REA projects. Two types of communication are being used at present, space radio and induction (or carrier current) radio.

Signals impressed on the power lines provide induction or carrier current radio communication. Signals transmitted in this manner travel for many miles, setting up a strong induction field so that any mobile unit in the vicinity of the lines can pick up the code or voice signals.

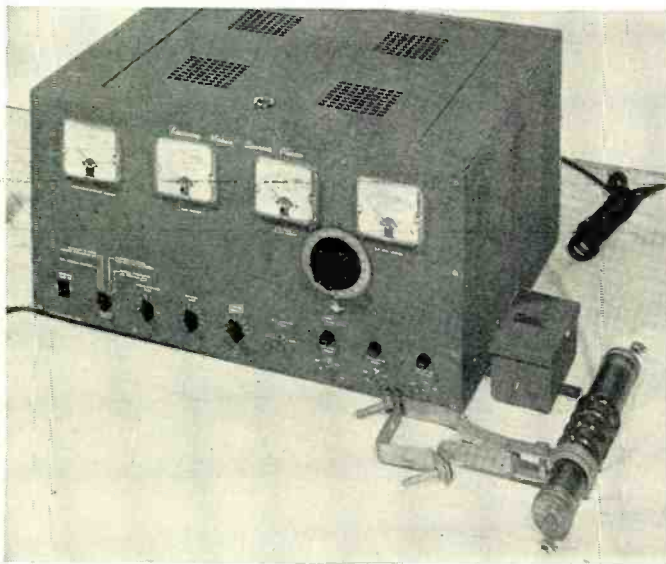

Fig. 2. Front view of main station transmitter-receiver unit.

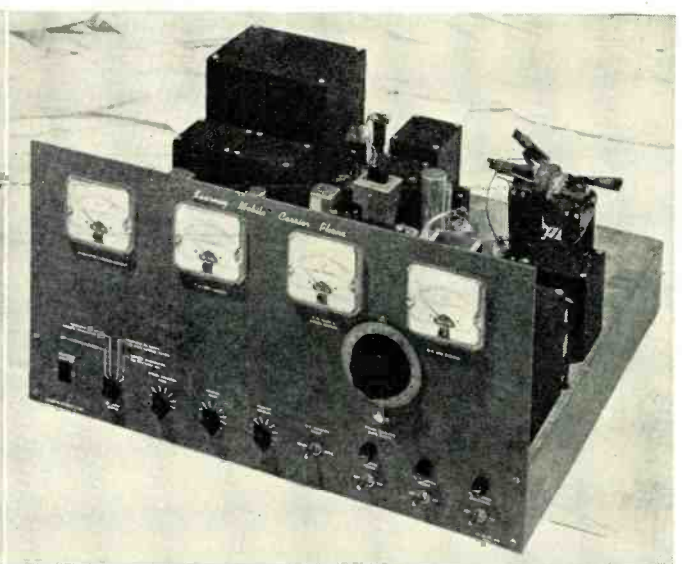

Fig. 3. Main station transmitter-receiver with cover removed.

Carrier systems are particularly suitable for dispatching between mobile units or between mobile units and headquarters. In this application, the system has several advantages over other forms of two-way radio.

Advantages

1. Power output requirements are low.
2. The cost is low for long range operation.
3. Licensing of stations or operators by the Federal Communications Commission is generally not required.
4. The keeping of logs is not required.
5. Interference with other stations is reduced and is more easily corrected when it does occur.
6. Its use, of necessity confined to the immediate vicinity of the power lines, offers a certain amount of privacy.
7. Maintenance problems are not as

critical and can generally be handled by a local radio maintenance man.

Types of Equipment

There are two types of carrier equipment in use, and they are classified according to the type of coupling they employ between the power line and the mobile unit. One type uses a portable "hot stick" with a built-in coupling condenser to couple the mobile transmitter to the power line. This method of coupling (Fig. 1) will be referred to as the "hot stick" method. Because of developments in the design of coupling condensers and the close coupling obtainable, the "hot stick" method is the most efficient and results in extremely long range communication between mobile units or the mobile unit and headquarters. There is, however, a disadvantage in this method in that the truck must be stopped and the "hot stick" attached to the power line before transmitting.

An alternative to the "hot stick" method of coupling is the use of permanently installed coupling condensers at convenient points along the line.

Another type of equipment makes use of a permanently installed loop antenna on top of the service truck. This permits induction coupling between the moving vehicle and the power line. A considerable reduction in transmission distance results from this method, however, and a very marked variation in signal reception and transmission is apparent at the mobile units.

At the present time, amplitude modulated systems predominate but there are some frequency modulated systems in use.

Operation

Carrier systems, in general, operate on a single carrier frequency in the range of 50 to 150 kc. for both direc-



Fig. 4. The mobile unit used in this carrier system is operated through the control head mounted on the instrument panel of the car's or truck's dashboard. Push-to-talk operation is customary.

Fig. 5. The main station transmitter-receiver is remotely operated by the REA dispatcher through the office control unit. Transmitter is linked to office by means of a single circuit phone line.



tions of transmission and are of the simplex or press-to-talk type. Amplitude modulation is usually employed and the carrier and both sidebands are transmitted.

The main station transmitter with an r.f. output (unmodulated) of approximately 75 watts, is usually located under a three-phase line. The transmitter is coupled to each phase by coupling condensers designed to withstand the 7200 volt potential on the REA distribution line.

While the main station transmitter may be operated directly at its location, operation is usually from the headquarters office, possibly several miles distant from the main station transmitter.

The main station transmitter may be remotely operated by means of the office control unit, a single circuit telephone line serving to connect the two units.

The mobile unit consists of a complete carrier transmitter and receiver designed for 6 volt d.c. automobile battery operation.

The main chassis unit is operated through a control cable and by means of a control head mounted on the automobile dashboard. The telephone handset and the loudspeaker are also connected there.

Power output is generally about 40 watts (unmodulated), but the power output requirements of mobile units may vary from 10 to 40 watts depending on the line coupling efficiency and the power distribution system itself. The power requirements of the main station transmitter may vary from 25 to 75 watts output. The succeeding paragraphs will bring out some of the determining factors governing the power output required.

Range

The following factors will, to a great extent, determine the range of the two-way mobile power line carrier communication system;

1. The attenuation of the signal by the transmission or distribution network and the degree to which it is corrected.

2. The usable transmitter output. The total electromagnetic field produced at any point a distance of $157,000/f(kc.)$ feet from the apparatus shall not exceed 15 microvolts-per-meter. To exceed this specification means that the equipment must be licensed by the Federal Communications Commission and the services of a licensed operator required. To secure satisfactory range, "brute force" in the transmitter output cannot be relied upon entirely if radiation limits are not to be exceeded. Signal attenuation and radiation by the distribution system must be counteracted by efficient equipment installation, power line construction, and the "choking" and "trapping" employed.

3. The degree of receiver sensitivity which may be used. Line noise levels and the signal-to-noise ratio directly affect the range. Signal attenuation,

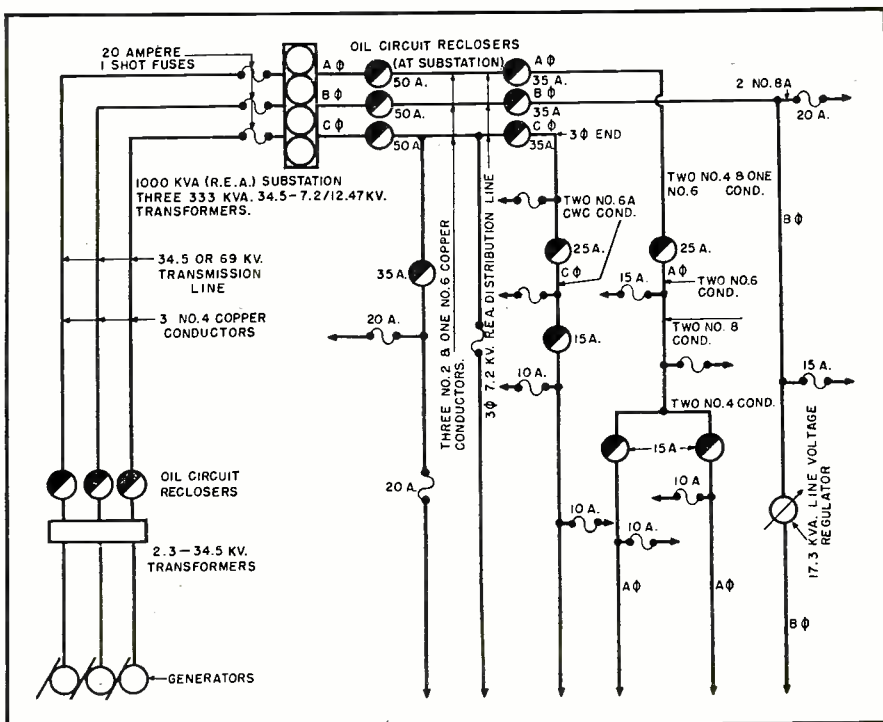

Fig. 6. Schematic diagram of a typical distribution circuit used by the REA.

from REA field tests, has proven to be approximately 2.5 db. per mile in the carrier current frequency range. Sleet on conductors and insulators causes attenuation of carrier signals. In very dry weather, dust and dirt on power line insulators will make for higher noise levels.

4. Methods of coupling the mobile units to the line. When the "hot stick" method of coupling is used, ranges of over 75 miles have been secured between the main station and the mobile unit. A range of approximately 40 miles can be expected when loop coupling is used from mobile unit to the main station. The range could be extended if repeater units were used. Mobile units may receive signals even though out of the vicinity of its own power lines, providing that another line or fence has a short parallel ex-

posure to the system's power lines and allows the induction field necessary for mobile unit pickup.

It is highly desirable to conserve as much of the carrier signal energy to the main line as possible, distributing it to the taps off the main line in amounts proportionate to the length of the line tap so that satisfactory transmission and reception results out to the far ends of the longest single phase taps.

A continuous call signal can be used by the main station to aid in contacting the mobile unit.

Power systems designed for efficient carrier current communication provide higher signal-to-noise ratio, less attenuation and wasteful radiation of the signal and, therefore, require less transmitter power output. Some of

(Continued on page 120)

Fig. 7. A typical mobile transmitter-receiver with its various accessories.

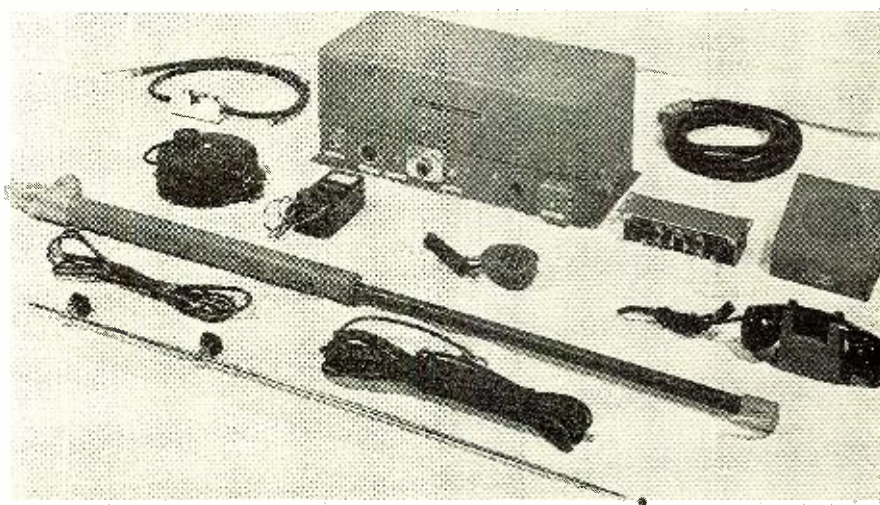

You can work the world with this 80, 40, 20-meter rig. It is easy to build and relatively inexpensive.

**By RICHARD L. PARMENTER, W1JXF
and C. E. CLARK, W1KLS**

ELLOWS, if you are just getting on the air and want to give c.w. a whirl to see what can be done, here's a little rig that can really go places. With a good solid 50 watts output on 80 and 40 meters and nearly as much on 20 meters you can still practically work the world. On 80 meters in the crowded early evening you can get contact after contact, and if you want to get up in the "wee sma' hours" as the authors have done, 20 meter c.w. will provide you with the thrill of DX. On the other hand 40 meters will give consistent results at any time of the day since there is always somebody available on that band. As these three bands are open for your use with a Class B ticket, you can be assured of satisfactory QSO's whenever your leisure time permits. If you are like the authors, you'll find it difficult to put the key aside to take care of other things that need your attention.

In the design of this little outfit, we have stuck to simplicity as much as possible, both for economy's sake and also to keep the constructional problems to a minimum. Yet the transmitter presents some features found usually only in larger rigs. Either crystal control or an external variable frequency oscillator may be used to excite the 807 output tube, and change-over is effected by front panel switching. It has a built-in r.f. indicator for tuning purposes, eliminating the need for a relatively expensive meter. A

high-voltage indicator lamp is used for safety's sake, and this flashes on and off to act as a constant reminder that dangerous potentials are present. Potentials as low as 250 to 300 volts may be used with good results, and as high as 750 volts may be used with increased power output. Parallel plate feed is used in the final, which eliminates dangerous potentials from exposed portions such as the coil and condenser. Since both oscillator and final are keyed, break-in operation may be used, and be assured that this is a big advantage when working through QRM and for pulling through a weak station. If you are interested in traffic handling, you will find that break-in is practically a "must" for network operation. Power output is sufficient for excellent results. (The authors worked Tasmania from Eastern Massachusetts, getting a 459 report with an 807 on 14 mc. 60 watts input.)

Lastly, and this item is not to be ignored if you want to keep peace with the lady of the house, the little transmitter is almost a decorative piece of furniture. Gray and black enamels were used for effective contrast, and they present a semi-commercial finish. Photographic type nameplates were used to identify the components on the front panel as well as to enhance the appearance.

Circuit Design

The circuit shown in Fig. 1 will be

Fig. 1. Circuit is basically a Pierce oscillator capacitively coupled to an 807 final.

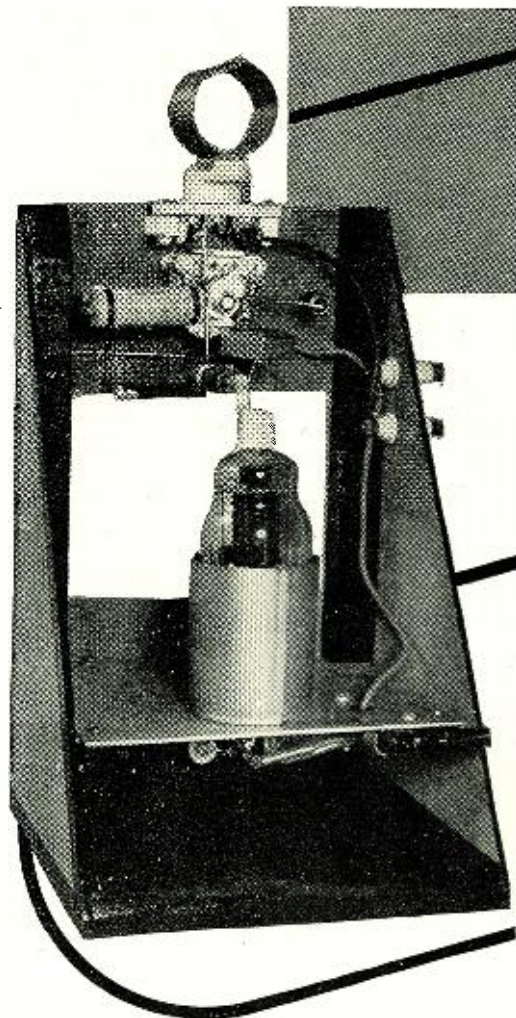
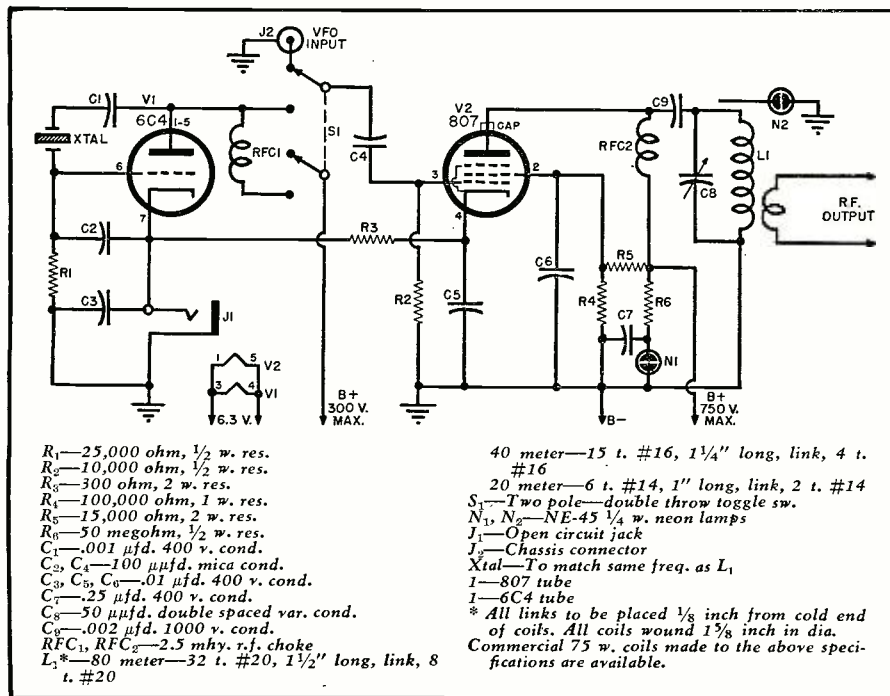

recognized as the Pierce oscillator which is capacitively coupled to the 807 final. This circuit keys well and is a definite improvement over a single-tube transmitter since the antenna circuit is pretty well isolated from the oscillator. By means of switch S_1 the grid circuit of the 807 is shifted from the output of the 6C4 crystal oscillator to external v.f.o., and this simultaneously disables the 6C4 by cutting the plate voltage. Thus the crystal may be left plugged in at all times and the external v.f.o. left connected as well. This setup facilitates network operation when it is desirable to work on spot frequencies some of the time and use v.f.o. at others.

Since parallel plate feed is used in the 807 stage, any danger of coming in contact with high voltages is eliminated, and hand capacity effects are reduced to a minimum. The physical isolation of the input and output circuits of the 807 seems to eliminate any tendency toward parasitic oscillations; consequently, it was not necessary to use parasitic chokes. Also no r.f. choke in the grid circuit of the 807 was found to be necessary.

A one-quarter watt neon bulb (N_1), type NE-45, is used as a high-voltage indicator. This tube flashes intermittently when the plate voltage is on,

YOUR FIRST TRANSMITTER

Front and rear views of the home-built rig. By using gray and black enamels, the semi-professional appearance of the unit can be easily duplicated.

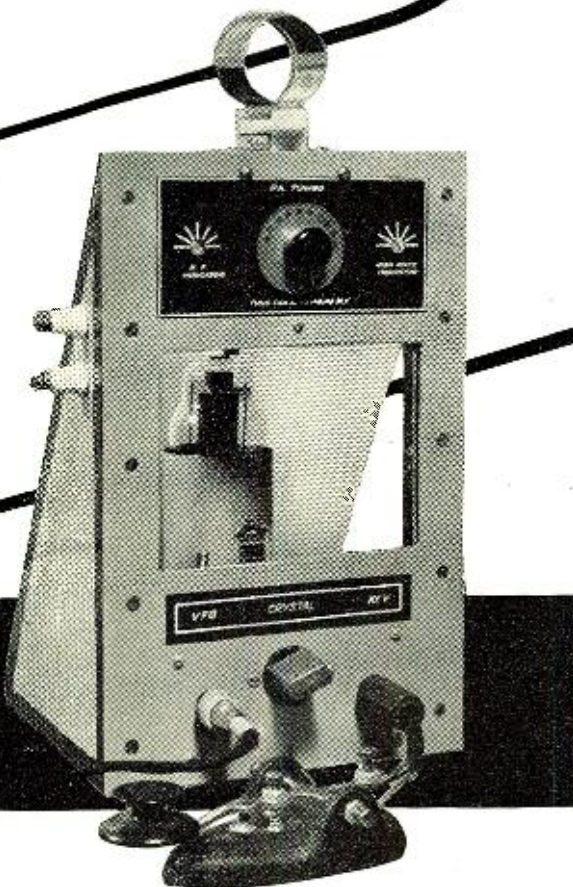

its operation being that of a relaxation oscillator. This idea is not original with the authors, but it is definitely worth incorporating since a flashing light is vastly more effective than a steady glow. Its operation is as follows: When the high voltage is thrown on, condenser C_7 gradually charges up through the resistor, R_6 , to a value high enough to fire the tube. When the tube flashes the condenser is discharged, and then another brief interval elapses before R_6 will pass enough current for the condenser to again charge up to the firing point of the bulb. The value of R_6 for a plate voltage of 600 volts is approximately 50 megohms. Considerable variance is permissible here since the firing voltage range of the bulb is quite wide. Generally speaking, however, if more than 600 volts is used the resistance should be increased and would be decreased if the converse is true. The condenser C_7 should have a voltage rating of 400 volts, at least.

Another one-quarter-watt neon bulb of the same type is used as an r.f. in-

dicator. One side of the bulb is grounded to the busbar which runs up to the tuning condenser. The other side of the bulb is soldered to a short piece of stiff wire which is coupled loosely to the tank coil by bringing it somewhere near it. Experiment here to determine the best location. The bulb should not be too bright, as it will be difficult to determine the point of maximum brilliance.

A microphone connector was used to bring the v.f.o. output to the grid circuit of the 807. A coax connector would be preferable here if available.

Construction

Construction of the little transmitter is not difficult. The solid wooden base is 7 inches square. One rectangle of masonite, 7x12 inches, may be cut diagonally for the side pieces, and a 7½x12 piece is used for the front panel. Two ¾x¾ inch strips of wood 12 inches long are used as braces to hold the front panel to the sides, and assembly is effected by means of ¾ inch flathead wood screws. A piece

of duralumin or aluminum cookie sheet, 6½x6¾ inches, is used for the chassis base, and this is mounted on the side panels by means of small brackets at a height of 2 inches above the wood base.

The socket and shield can for the 807 are mounted quite close to the rear of the chassis, and the socket for the 6C4 in front of it. The change-over switch, S_1 is mounted beside the 6C4 and is thereby easily accessible by reaching through the front panel cut-out. At the top of the front panel, the socket for the tank coil (5 prong) is mounted by small angle brackets or some standoff insulators. The two feed-through insulators for the antenna connections are mounted on a side panel, and these are connected to the socket link prongs by a short piece of 150-ohm or 300-ohm *Amphenol* line. The tuning condenser, C_8 , is mounted on the upper part of the panel by means of the front bearing nut, since there is no r.f. or d.c. voltage present on the rotor.

On the lower front panel the crystal socket (octal), key jack, and the connector for v.f.o. input may be mounted in the approximate positions shown. This makes for fairly short leads.

Power connections are brought up to the transmitter in a five-wire cable. Since a wide variation is permissible in the power supply, no specifications are given. A transformer and choke of at least 125 milliamperes should be used, however, so as to have reasonably good regulation. We used a tap on the bleeder to provide the approximate 250 volts for the 6C4.

The antenna coupler which should be used with this transmitter will depend upon the type of antenna available. For this item the reader is referred to any of the various handbooks available which give excellent data for this rather wide subject. We used a parallel coil condenser combination and a random length of wire with good results and also used an 80-meter doublet.

Operation

After wiring is completed and thoroughly checked, the transmitter may be fired up. With the connections made to the power supply, the key inserted in its jack and a crystal in its socket, key intermittently, meanwhile tuning the tank condenser. Resonance will be indicated by the degree of brilliance of the neon indicator. If desired a 0-150 ma. meter might be inserted in the high-voltage lead to the 807 plate, and then tuning would be for minimum milliamperes as indicated on the meter. It will be found that this reading and the brightest point of the bulb will very nearly coincide, almost enough for ordinary purposes.

The quality of keying should be checked on the station receiver with the r.f. gain reduced. The note should be clean-cut and musical without chirp or weepiness. If these charac-

(Continued on page 93)

**This combination of a folded dipole,
3 directors and a reflector gives
good results in marginal areas.**

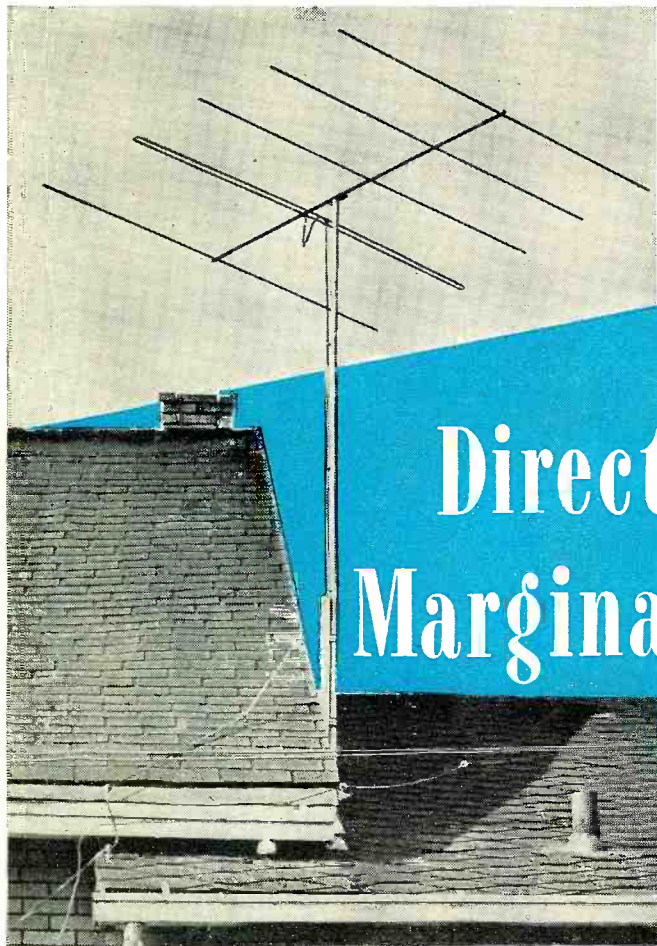

High-Gain Directional Array for Marginal TV Reception

The completed array mounted atop the roof. It will have maximum usefulness only for the specific channel for which it is designed.

By
LYMAN E. GREENLEE

THE antenna to be described herein is highly satisfactory for marginal TV reception and has proved superior in performance to stacked arrays costing several times as much money. Its directional characteristics and high forward gain make it particularly desirable for eliminating ghosts and interference between two stations operating on the same channel. Construction of the array is not difficult, and if the indicated dimensions are carefully followed, the average builder should be able to assemble it with a minimum of effort.

Such a highly directional array with parasitic elements is good primarily to receive the frequency for which it is cut. It is possible, however, to secure satisfactory reception on adjacent channels if the signal strength is high enough. If the array is cut to favor a distant weak station, it will still be possible to pull in the strong locals, although if more than one channel is to be received, it would be more satisfactory to construct a separate array for each frequency.

These separate arrays may be mounted independently, or stacked one above the other; they should be separated by at least half a wavelength. For best results they should

not be coupled to the same transmission line. Run separate 300-ohm lines, and use a switch at the TV receiver to change from one array to the other. If more than one station is to be received on a channel, some method of rotation will be necessary. Since the array is very light in weight, rotation presents no problem, and either a war-surplus motor or a regular stock antenna rotor will be satisfactory for the purpose. If a war-surplus motor is used, be sure it is not free to turn with the current off, as this would allow the array to rotate with the wind.

Fig. 1 shows the dimensions of the various elements, so that actual lengths may be determined by referring to Table 1. These dimensions are correct *only* if the constructor uses the same materials and the method of assembly shown in the photograph and sketches. Note that the folded dipole element is made very narrow and is mounted in a horizontal plane. It is *not* connected to the tube supporting the reflector and directors. The main support and mast should be grounded with #4 copper wire for protection against lightning surges.

Dimensions are given in Table 1 for each channel, also a separate set of dimensions for the middle of the low channels (2 to 6) and the middle of the high-frequency group (7 to 13). These two arrays may be combined and stacked on the same mast to cover all channels. They should be kept about 8½ feet apart, and it is best to run two separate lines to the receiver. Gain will not be uniform

Fig. 1. Length and spacing of the various elements of the antenna.

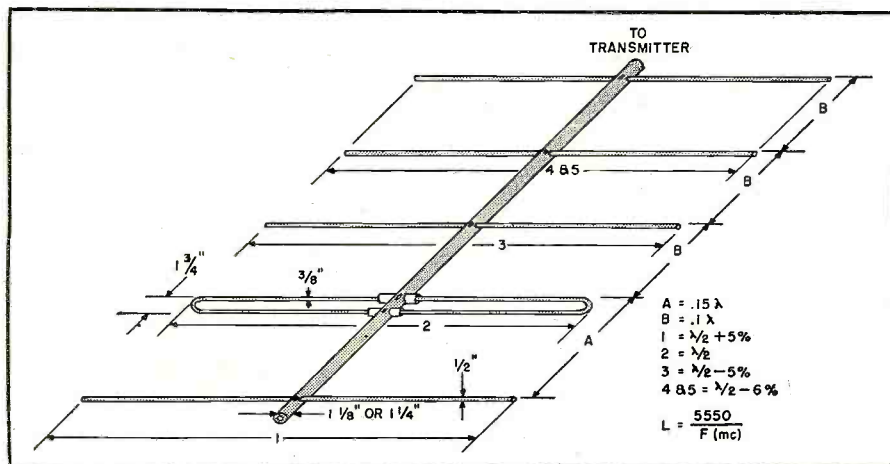

over the various channels, so it is usually best to cut the arrays to favor the stations most wanted. Positioning should be done experimentally, and if a motor is not used, it is a good plan to check with a map and compass since it is often difficult to determine the point of maximum signal by observation.

Construction Details

Use 1 1/4" round or square aluminum tubing for the center support. The length of this support is given in column "C" of the Table. Mark off the tubing to space the various elements and drill 1 7/32" holes to receive the directors, dipole, and reflector. A simple jig should be made to keep these holes in line. This jig consists of a board to which the tubing can be attached with a couple of lag screws. Drill one hole and fasten the tubing to the board at one end. Drill a second hole at the other end of the tubing and fasten to the board. The balance of the holes may now be drilled by hand or in a drill press, and it will be easy to keep them in line so all the elements of the array will be in the same plane. A little care at this point will avoid spoiling the whole job.

Using a small drill, make a hole for a self-tapping screw above each director and the reflector and dipole. Use screws long enough to penetrate the elements. Tighten these screws when the array is finally assembled, and all the elements will be firmly anchored in place. The screws fastening the dipole insulators in place must be tightened with extreme care to avoid cracking the polystyrene. To prevent collection of moisture, it is a good idea to close the open ends of all the pieces of tubing with bottle corks which can then be painted with a couple of coats of coil dope. It is also a good idea to paint each joint of the array with polystyrene dope to prevent the entrance of moisture.

Reflectors and directors are made from 1/2" OD aluminum tubing and require no processing except to cut them to length and to dress off any burrs at the ends with a file. Solid ends may be made from dural rod and fitted into the aluminum tubing if the constructor cares to go to the extra trouble. This type of construction will produce a better looking job, and it will also make the material cut to better advantage on the lower channels, since these solid rods can also be used to extend the length of reflector and director elements.

The dipole element is formed from 3/8" OD hard brass tubing with .025 wall thickness. This element should be plated with chrome on a silver base. Plating is important to add to the gain and prevent corrosion of the metal, and a chrome overlay will prevent the silver from tarnishing. Details of the construction of the folded dipole are given in Fig. 2. Pieces of 1/2" OD polystyrene tubing are used to insulate the dipole from its support. This method of mounting is simple.

TV Channel No.	Range in Mc.	Video Freq. Mc.	Sound Freq. Mc.	Spacing		Reflector	Dipole		Directors		Support C
				A	B		1	2	3	4 & 5	
2	54-60	55.25	59.75	30 3/8	20 1/8	103	98	93	92 1/8	93 3/4	
3	60-66	61.25	65.75	27 1/16	18 5/16	92 1/2	88	83 1/2	82 3/4	85 3/8	
4	66-72	67.25	71.75	25	16 3/4	84	80	76	75 1/4	78 1/4	
Lower Band	54-88			25 1/2	17	84	80	76	75	79 1/2	
5	76-82	77.25	81.75	21 1/8	14 5/8	73 1/2	70	66 1/2	65 3/4	68 3/4	
6	82-88	83.25	87.75	20 3/8	13 5/8	68 1/4	65	61 3/4	61	64 1/4	
7	174-180	175.25	179.75	9 3/4	6 1/2	33	31 1/2	30	29 5/8	32 1/4	
8	180-186	181.25	185.75	9 1/2	6 5/16	32	30 1/2	29	28 1 1/16	31 1/16	
9	186-192	187.25	191.75	9 1/8	6	31	29 1/2	28	27 3/4	30 1/8	
10	192-198	193.25	197.75	8 7/8	5 1 5/16	30 1/2	29	27 1/2	27 1/4	29 1 1/16	
Upper Band	174-216			8 1 5/16	6	30	28 1/2	27	26 3/4	30	
11	198-204	199.25	203.75	8 5/16	5 3/4	28 7/8	27 1/2	26 1/8	25 5/8	28 1 3/16	
12	204-210	205.25	209.75	8 3/16	5 9/16	28 1/2	27	25 3/8	25 1/8	28	
13	210-216	211.25	215.75	8 1/8	5 7/16	27 1/4	26	24 3/4	24 1/4	27 1/2	

NOTE: All dimensions are in inches or fractions of an inch, and all measurements are to be made from the center of one element to the center of the adjacent element as shown in the drawings.
 MATERIAL: Dipole—3/8" O. D. x .025 wall hard brass tubing. Reflector and directors: 1/2" O. D. aluminum or dural tubing. Center support: 1 1/4" O. D. aluminum tubing, square or round. Insulation: 1/2" O. D. x 1/8" wall polystyrene tubing. Lead-in: Standard 300-ohm twin line.

Table 1. Antenna element length.

Since it is difficult to bend the brass tubing, the dipole ends are made from 3/16" solid brass rod, which is easily bent. This rod is sold by welding shops for brazing. Bend two "U" shaped pieces on a 7/8" radius and allow a couple of inches to slide inside the brass tubing. After the array is completely assembled, adjust these ends to give the exact dipole length wanted and then solder them in place. This is the final step in assembling the array. The details of construction of the two polystyrene insulators may be seen clearly from the sketch. Take care to prevent cracking this material while assembling the array. Note that clearance holes drilled in the polystyrene tubing allow the 6-32 screws used to connect the ends of the dipole to the 300-ohm line to come down flush against the brass rod. Insert a short length of solid rod at this point and drill a hole for the 6-32 screws. The solid rod will prevent the thin brass tubing from collapsing when the screw is drawn up tight. Either thread the hole through the dipole element for the screw, or use a couple of nuts on the other side.

The vertical mast may be made from a 10' length of 1 1/4" thinwall

conduit. Weld a small plate to the top with holes drilled for two "U" bolts. Make two "U" bolts from threaded brass rod, and use these to fasten the array to the upright support. Details of this assembly are shown in Fig. 3A. Balance the array by holding it out in one hand and attach the vertical mast at the balance point. Attach stand-off insulators for the 300-ohm line at intervals of about 2 1/2' along the vertical mast. These may be welded in place. They are absolutely necessary to prevent the transmission line from contacting the metal mast and also to prevent it from flopping around in the wind. Do not tape the line to the metal mast. In bringing the line down to the set, avoid long runs, keep it away from metal objects, use enough stand-off insulators to keep it from flopping around but not more than is necessary for support, and twist it about once for each foot of run. Keep it away from power and telephone lines or other possible sources of interference, such as neon signs.

To stack two or more arrays cut for the same frequency, space them about 90% of a half-wavelength apart (ap-
 (Continued on page 88)

Fig. 2. Construction details of the folded dipole element and assembly.

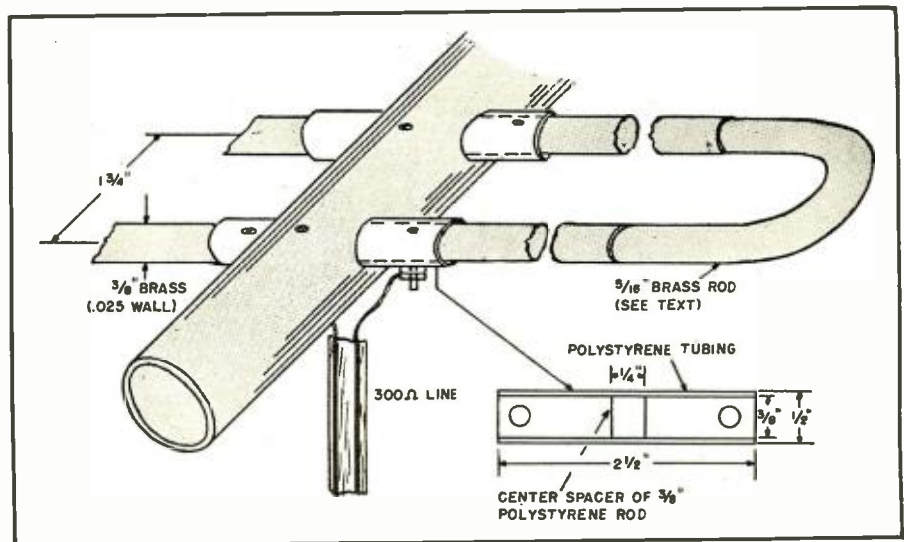

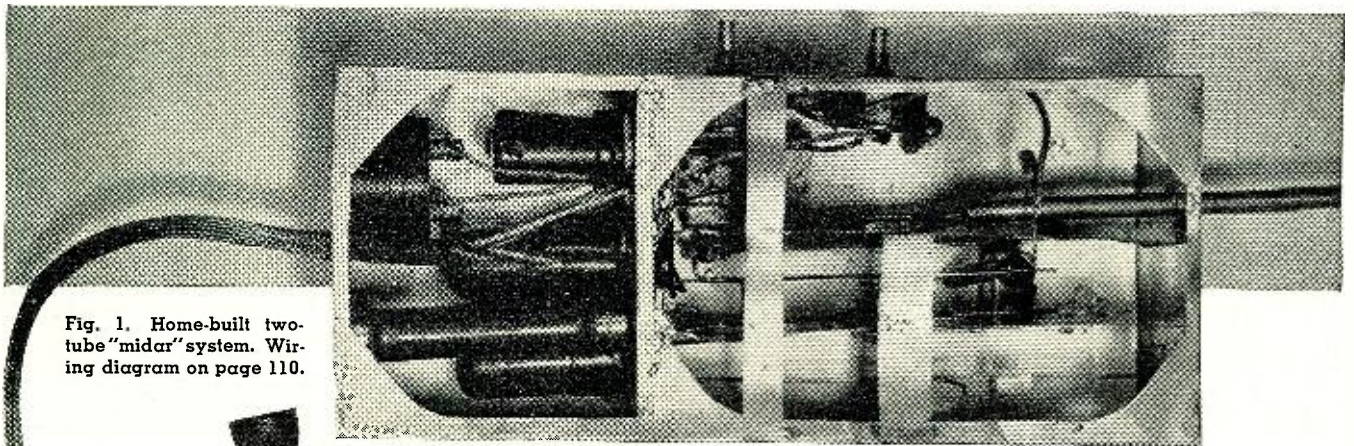

Fig. 1. Home-built two-tube "midar" system. Wiring diagram on page 110.

By **SAMUEL FREEDMAN, W6YUQ**
 Developments Eng., DeMornay Budd, Inc.

"Midar" (microwave detection and ranging) may be called a layman's radar. It differs mainly in that it has limited range, making it more suitable for short-range detection and alarm purposes.

"MIDAR"

STANDARD technique, in the case of radar, has been to transmit very short pulses of pent-up energy separated by very much longer intervals of no transmission. Any object lying in the path of the transmitted pulse reflects energy in various directions, including that part of the energy that returns to the receiver at the transmitting point.

The direction of the target can be determined if the antenna used is a directive type. When the receiver output is fed to a cathode-ray oscilloscope, the outgoing pulse can be made to appear at the left side of the base reference line while the returning, reflected pulse may fall on this line in accordance with time or distance. This makes possible the determination of range of the reflecting object or target. The useful information, however, is only that which is received *after* the outgoing pulse has ended and *before* the next outgoing pulse commences.

During the transmitting duration of the outgoing pulse, any reflected energy, such as that resulting from the first part of the pulsed transmission striking a nearby object, is blanked out by the remainder of the outgoing pulse. Therefore, since the transmitter and receiver components function on identical frequencies, the receiver is "paralyzed" or inoperative during the transmitting duration of each outgoing pulse. It also requires some "recovery time" after each such period of ineffectiveness.

Although the duration of the individual pulses and the recovery time of the radar receiver are very short (a few millionths of a second), every millionth of a second that reflected signals cannot be received corresponds to a 328-yard, one-way trip for radio-wave travel.

This is in accordance with the well-known velocity of radio or light, namely, 186,000 miles per second. Since radar signals go out and come back, they must make a two-way trip. Therefore, each microsecond or millionth of a second that reception cannot take place after the outgoing pulse commences to go out means that 328/2, or 164 yards of minimum range indication, is unavailable.

An indication of the efficiency of any radar is the "minimum range" it is capable of before being detected

on the cathode-ray tube indicator. The finest radars in existence, by using very short pulses (such as a quarter-microsecond) and special provisions to minimize receiver recovery time, are at present incapable of receiving indications closer than about eighty yards. Less elaborate radars may lose as much as a few miles before they can begin to show a range indication.

Because of these characteristics, standard radar is useless in close-in applications, such as would be used in highway and local alarm applications. In addition, radars are both complex and costly, involving at least 50 vacuum tubes and upwards of \$5000 in cost for the simplest types, while the more elaborate ones may be comprised of several hundred tubes and cost as much as \$100,000, or more. It is obvious that these are out of reach of the layman even if the special tubes and components were available to him.

With all these thoughts in mind, the author together with an associate developed a much simpler instrument that is **easier** to construct, which a Navy patent attorney called "midar." The word is coined from the abbreviations for "microwave detection and ranging" to distinguish it from the word radar, coined from the abbreviation of "radio detection and ranging." The system differs from radar in the following conditions:

1. "Midar" uses only two conventional tubes in a typical basic model. One version required only a single tube.
2. It is a c.w. rather than a pulsed system. Indications can be based on the time it takes one cycle or wave to form rather than on the time it takes for a pulse, made up of a number of such cycles or waves, to travel to a given object.
3. There is no receiver, as such, to

(Continued on page 109)

Fig. 2. Block diagram showing principle of operation of a "midar" system.

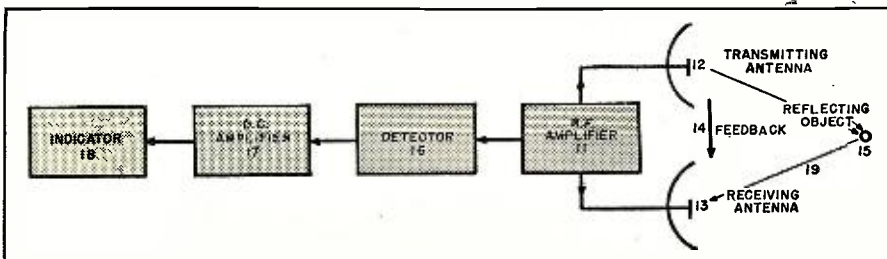

Wide Range BANDPASS CRYSTAL TUNER

Construction details on a novel 540 to 1750 kc. crystal tuner. It has 12 to 18 kc. selectivity without using any vacuum tubes or power supply.



Over-all view of laboratory "breadboard" test set along with its audio amplifier and speaker. The volume control was eliminated in this broadcast band tuner. The one in the audio amplifier is being used in its place. Circuit diagram is shown on Page 112.

By

JOSEPH M. BOYER, W6UYH
Consulting Engineer

purpose, they are sufficient to give good results. A negative mutual coil T_2 and condenser C_3 complete the band-pass circuit.

Only one caution with regard to circuit values need be stressed, and that is to make sure condenser C_3 is .015 μ fd. even if two condensers of standard values have to be paralleled to get this value. While not shown in the illustrations, two precautions in construction were found necessary to avoid hum pickup from random fields. A well bonded bottom plate must be used on the chassis and a double shielded cable, such as war surplus RG5/U, provided to couple the tuner to the amplifier input. With the measured hum level of many good amplifiers down 65 db. and a gain sensitivity of 125 db., such measures are necessary to secure the performance of which the tuner is capable.

It should be pointed out that, unlike the familiar crystal set, the tuner described herein is not intended to drive a pair of earphones. Networks of the bandpass type have a given insertion loss, and hence require quite high gain amplifiers to be used in conjunction with them. Another fact which came to light during measurements of the bandpass characteristics of the tuner is that the particular coils used, when placed in the circuit shown in Fig. 1, only give satisfactory 18 to 20 kc. "flat top" response when from 30 to 50 feet of wire is used for an antenna. This is not due to the "pickup" efficiency of such length of wire, but is due rather to the reactance that this antenna places across the input terminals of the network.

Many readers may think this is getting a little fancy with a *crystal set*, but judgment in this respect should be withheld until the experience of tuning the broadcast band with this unit has been enjoyed. Also note that 18 to 20 kc. selectivity has been mentioned repeatedly. Neither this tuner

(Continued on page 112)

THE old-fashioned crystal set is dead—let it go to a well-earned rest. This article will not be another description of the same weary circuit with a modern germanium crystal detector substituting for the "cat whisker" and galena. The broadcast band tuner to be described is capable of 12 to 18 kilocycle selectivity, without benefit of vacuum tubes or power supply. It contributes no additional hum to the amplifier following it and is free of the heterodyne whistles present in superheterodyne tuners.

Simple in construction, the unit can be built for a total cost of seven dollars and a time investment of one or two hours; or the tuner may be "dolled up" with the addition of a slide rule dial and 10 kc. anti-ring filter for a total of twelve dollars. Connected to a modern high-gain amplifier in a typical American metropolitan area, its performance is indistinguishable from that of many high priced t.r.f. and superheterodyne high-fidelity tuners.

The original model was specifically designed for a large advertising agency, to serve as a fixed frequency, high-quality monitor for spot radio show checks. Later laboratory tests showed it capable of excellent performance over the entire broadcast

band. There is nothing tricky or unusual about the circuit used. It is one of the many well-known bandpass networks with which radio engineers have been familiar for years. The characteristics of such a network are a relatively "flat top" for uniform response over the desired channel and very steep sides or "skirts" to provide good selectivity between adjacent signals. Reference to Fig. 1 will show that special so-called bandpass coils have not been used. Instead high "Q" litz wire r.f. coils, possessing a primary and secondary winding, have been incorporated into the circuit. The primary reason for this is that coils designed for t.r.f. bandpass tuners consist of a single winding usually intended to work into an infinite impedance detector to avoid loading down the network.

In the circuit shown in Fig. 1, severe loading of the output terminals of the bandpass network was avoided by utilizing the *J. W. Miller* 242 r.f. coil, T_3 , backwards; that is, the primary is used as the output winding and carries the crystal current of the 1N34. This provides a stepdown from the high impedance of the network to the relatively low impedance of the crystal circuit. While the turns ratio and coupling coefficient are not ideal for the

The Service Technician and TV Interference

By **HERBERT S. BRIER, W9EGQ**

With special type wave traps and a little shielding TV interference from any source can be minimized.

ALTHOUGH not a major source of television interference, TVI from amateur transmitters often causes more furor than all other causes combined. Fortunately, much of the interference can be eliminated by working on the transmitter causing it and on the television receiver, and this article will discuss the service technician's part of the problem.

It goes without saying that the service technician's special knowledge and training make him the logical person to work on the receiver. Not the least of his assets is the confidence the public has in him. When an amateur radio operator tells a television set owner that often the only cure for interference is to filter it at the receiver, the set owner may suspect this is merely an alibi for a defective transmitter. The service technician, however, being an impartial expert, will

be believed without question. Because there has been little information available to service technicians on the causes and practical cures for that type of interference, most of them have had to work out the answers for themselves. This article is an outgrowth of just such experimentation.

Most TV interference caused by ham transmitters can be brought within tolerable limits. It is obvious therefore that the practice of routinely advising all who complain of such disturbances that "it's the fault of the amateurs; the only thing that can be done is to report this to the Federal Communications Commission," is not a solution. When the commission receives such a complaint, duplicate official notices are sent back to the interfering amateur and the complainant, telling each what he must do and

stressing the need for cooperation. This brings the problem right back where it was originally: both parties will have to work together to solve the problem. Of course, it is not always a mistake to complain to the commission. An official order is sometimes the only way to get the cooperation needed to effect a cure.

With those preliminary explanations out of the way, let us now examine the reasons why television is so very susceptible to interference. The wide channels required for satisfactory pictures easily pick up extraneous signals, and TV signals must be forty db. stronger than the interference in the channel to produce distortion-free pictures.

The required six-megacycle bandwidths in the radio-frequency and intermediate-frequency channels are obtained through low "Q" and stagger-tuned circuits, which means that their selectivity is poor. It is so poor, in fact, that in any service area, a minimum separation of six megacycles between assigned channels is necessary to prevent mutual interference. When this is necessary with signals of equal strength, it is easy to see why local signals a hundred or a thousand times stronger than the television signal can be so annoying. In addition, the standard RMA television intermediate frequency channel of approximately 21 to 27 megacycles is wide open to signals from the amateur 27 and 28 megacycle bands leaking through the receiver's radio frequency stages.

Cures for the disturbances involve eliminating harmonic and spurious radiation from the transmitter, getting the strongest possible television signals at the receiver, and reducing the effects of strong signals outside of the television bands.

Table 1 shows the relationship between the twelve television channels and harmonics of amateur frequencies. Every point where a harmonic and a television channel coincide is a potential trouble spot. Harmonics up to the tenth are listed, although the higher the harmonic, the less likely are the chances for interference. Unless the separation between the transmitter and the receiver is very slight and the television signal is weak besides, interference from harmonics

Table 1. Harmonics of amateur frequencies capable of causing television interference.

TELEVISION CHANNELS	AMATEUR BANDS (mc.)						
	3.5-4	7-7.3	14-14.4	26.96-27.23	28-29.7	50-54	144-148
2. 54-60	...	8th	4th	2nd	2nd	Fund.#	...
3. 60-66	...	9th
4. 66-72	...	9th/10th*	5th
5. 76-82	3rd*
6. 82-88	6th	3rd*	3rd
7. 174-180	6th*
8. 180-186
9. 186-192	7th*
10. 192-198	7th*	7th*
11. 198-204	7th*	4th*	...
12. 204-210	7th*	4th*	...
13. 210-216	4th*	...
Television # i.f. 21-27	6th/7th*	3rd	...	Fund.#	Fund.#

*Where a number of television channels are shown to be subject to interference from the same transmitter harmonic, only one channel at a time will be affected, depending on where in the amateur band the interfering transmitter is operating; therefore, a slight shift in operating frequency may sometimes move an interfering harmonic to an unassigned channel.

#Not harmonic trouble; is actually the result of inadequate receiver selectivity. Listed because is the major cause of interference. Can only be eliminated at the receiver.

above the fourth is rather unlikely. Channel Two is the real hot spot.

The elimination of spurious transmitter radiation is not a direct problem of the service technician. We will let the amateur worry about installing high-Q tank circuits and low-impedance ground returns in his transmitter, operating all radio-frequency stages with a minimum of bias and excitation to reduce harmonic generation, and using shielding, decoupling circuits, and traps to prevent radiation of unavoidably-generated harmonics, but we can wish him luck.

If harmonics were the sole cause of television interference, things could be worse because the harmonics of any amateur frequency can affect a maximum of three television channels, and in most areas, at least part of the actually-assigned ones would be usable. The situation is worse than that—much worse. Most television interference complaints stem from the fact that all channels are wiped out. This is usually caused by the fundamental transmitter signal's blocking the receiver for the reasons discussed previously. The only remedy is put into work at the receiver and this technique will be discussed step by step.

The Television Receiver

All television receivers are not affected in the same degree by interference. Amateur interference on cheaper sets enables some dealers to sell a larger number of the better ones when demonstration showed that they were superior on this count alone. Whatever the type of receiver may be, it should be properly aligned, and not only should it be capable of being tuned to the exact television frequencies, but the owner should be shown how to tune it.

Antennas

Strong signals are half the battle and therefore an efficient antenna is a "must." Whatever advantages indoor antennas may have, when interference enters the picture, the problem becomes too big for them. An antenna should have gain and directivity, the more the better; it should be rigidly mounted in the clear and be connected to the receiver through a firmly-anchored feed line. In addition, the placement should be as far from the interfering antenna as possible (especially important when the separation is less than a few hundred feet) with a null towards the interference. (Nulls are directions of minimum antenna response. They occur off the ends of all resonant antennas, and off the back of those using reflectors and directors.) That last positioning is not always possible if the maximum desired signal is to be received from the same direction as is the interference, but as the maxima are always broader than the nulls, it may be possible to put the interference in a null and still sacrifice very little of the signal.

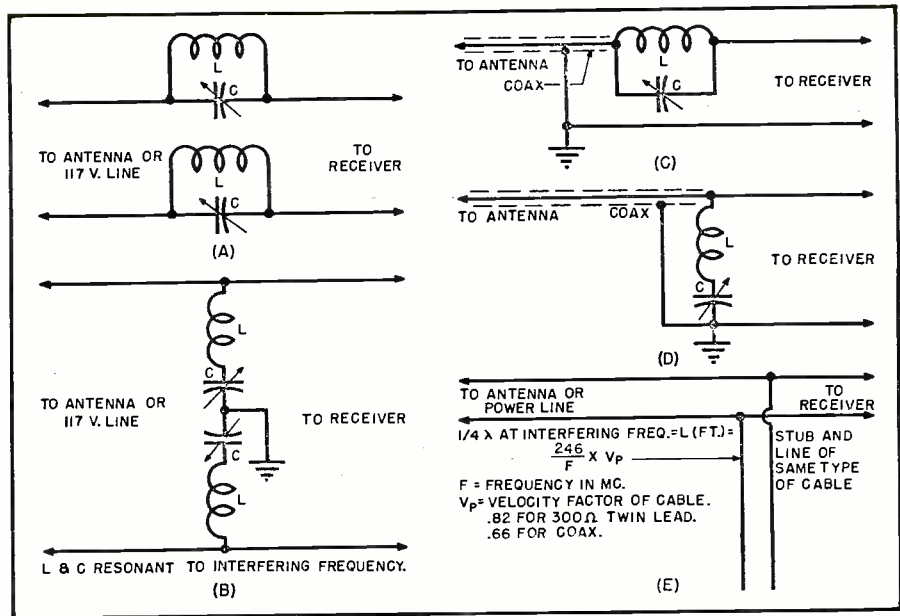

Fig. 1. Methods of connecting traps in antenna feeders or power lines. (A) and (B) Parallel and series resonant traps, respectively, for twin-lead antenna feeders, or power line filters. (C) and (D) Parallel and series resonant traps, respectively, for coaxial lines. (E) Linear type trap. When used at antenna terminals, trap should be of the same material as antenna feeder. If trap is of twin-lead, it must run at right angles to feeder and run in a reasonably straight line (may be tucked under rug). Coaxial type may be taped in parallel with line to keep it out of way. Traps should be placed as close to receiver terminals as possible.

Do not spoil a first-class installation by having a feed line hanging limply from the antenna over the edge of the roof into the window, because sooner or later, the wind will snap it. If one conductor opens, it may make little difference in the desired signal, but it will probably increase the pick-up of the unwanted signals tremendously. Normally any signal introduced into the feeder is equal in strength and opposite in phase in each conductor and is cancelled out, but when one conductor is open the cancelling effect is lost beyond the break. Where long, unsupported stretches are necessary, use the heavy-duty lines designed for the purpose. Those with copper-clad steel conductors are especially good.

Coaxial or twin-conductor shielded antenna feeders are inherently less likely to pick up interference, but much of their effectiveness is lost unless the shield is firmly bonded to the chassis, which, in turn, should be connected to a good direct ground.

As shown in Fig. 1, wave traps are

circuits resonant to the interfering frequency inserted in series with, or across, the antenna feeders or power line to attenuate the interference. Because of their compactness and ease of adjustment, those using coils and condensers are usually preferred, although the linear ones are equally effective. One application where the length of the latter is unimportant, especially at the higher frequencies, is at the power line. A trap of lightweight coax may be taped in parallel with the power cord and thus kept out of the way.

Try the traps first at the antenna terminals, but do not forget that the power line may be a possible interference path. To be effective, the traps must tune to the interfering frequency. The easiest way to find out what it is is to ask the owner of the transmitter at fault, or connect a number of calibrated wave traps in the line, adjusting for minimum interference. Then install permanent traps tuned to the same frequency. A

(Continued on page 119)

Table 2. Complete construction details for both the lumped and linear-type traps.

EAND	LUMPED TYPE		LINEAR TYPES			
	L	C	300-ohm	Twin Lead	Coax	
Mc.	32 T, 1 " dia.	140 μ Mfd	57' 5"	50' 5"	46' 3"	40' 7"
3.5-4	19 T, 1 " dia.	100 μ Mfd	28' 9"	27' 6"	23' 2"	21' 3"
7-7.3	12 T, 1 " dia.	50 μ Mfd	14' 5"	14' 4"	11' 7"	11' 2"
14-14.4	9 T, 1 " dia.	25 μ Mfd	7' 5"	7' 4"	6' 9 1/2"	5' 11"
26.96-27.23	9 T, 1 " dia.	25 μ Mfd	7' 1 1/2"	6' 9 1/2"	6' 9 1/2"	5' 5 1/2"
28-29.7	8 T, 1 1/2" dia.	25 μ Mfd	4'	3' 8"	3' 5"	3'
50-54	8 T, 1/2" dia.	25 μ Mfd	1' 5"	1' 4 1/2"	1' 1 1/2"	1' 1 1/4"
144-148	3 T, 3/8" dia.	25 μ Mfd				

Coils for the three lowest frequency bands are closewound; all others are spaced wire diameter. The last one is self-supporting and is wound with No. 14 enamelled wire. All other coils may be wound with No. 16 or 18 wire, the heavier gauge being recommended for power line traps. Dimensions for linear traps are for the low and high frequency edges of the bands. Intermediate frequencies will require correspondingly different lengths. The ideal method of adjusting them is to cut slightly long and trim for maximum attenuation of the interfering signal.

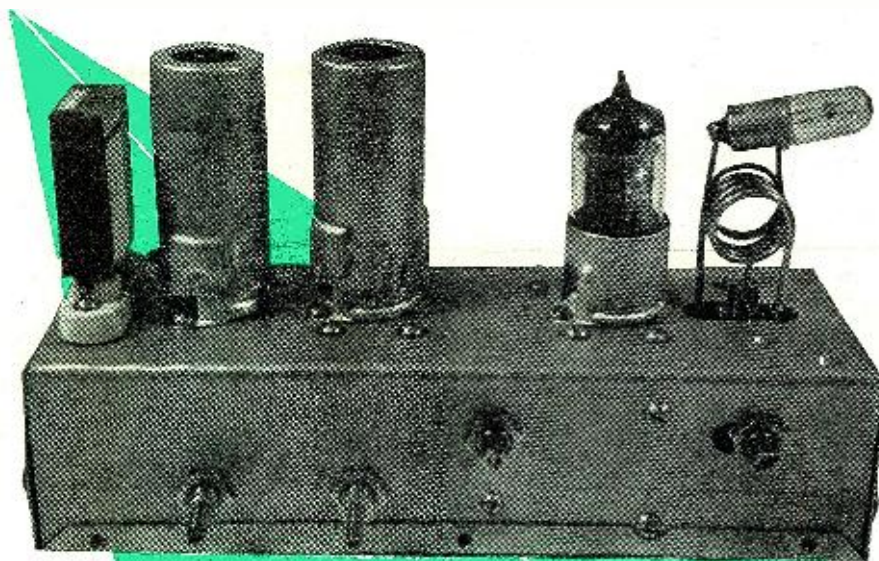

Crystal Controlled Portable V.H.F. TRANSMITTER

By
ROBERT B. TOMER, W1P1M

*By the use of modern design practices,
a high over-all efficiency is obtained.*

IN DESIGNING a transmitter for portable operation at frequencies above 100 mc., most amateurs will probably think in terms of the familiar two-tube, modulated oscillator, super-regenerative, transceiver. While it is true that equipment of this type has served many purposes in the past and may yet find many more applications, present-day technique on two meters requires very much better stability if reception on anything other than a superregenerative receiver is anticipated. Since most of the occupants of this band are now using the 522 receiver and transmitter, the user of a transceiver is finding it practically impossible to obtain contacts. Yet there are many occasions where really portable equipment is needed, such as emergency organizations, and up to now, their choice has had to be be-

tween very heavy and bulky equipment that would meet the technical requirements, or the transceiver.

The growing use by the CAP (Civil Air Patrol) of the frequency 148.140 mc. as an emergency net has spotlighted this need for lightweight, compact, efficient equipment that will meet the absolute requirements of single-channel operation. The device to be described has been designed and built with the above mentioned requirements uppermost in mind. It will operate from four flashlight cells and three portable "B" batteries for eight to ten hours, continuously, or about twice that long, intermittently. It develops between 1 and 1.5 watts of power into a load at 150 mc. It is crystal-controlled from a low-cost, war surplus, 8.0 mc. crystal, the exact frequency, of course, depending upon

The three-tube crystal controlled transmitter operates from four flashlight cells and three portable "B" batteries and develops 1.5 watts at 150 megacycles.

what final output frequency is desired. For two-meter amateur band operation, this is 8,000 to 8,225 mc., and for the CAP frequency, it is 8,230 mc.

The successful design of this unit was not quite as simple as the finished product makes it appear. In order to obtain more than just a few minutes of life from the portable batteries, the efficiency of this transmitter had to be far better than most of the existing commercial equipment, not to mention most ham equipment. Efficiency is a word rarely required in the vocabulary of us hams, because, since most of our equipment is designed to operate from power lines, a few more watts of primary power won't make much difference as long as we obtain the end result we are looking for. For this reason, if I look at my so-called "big rig" here in the shack and consider its over-all power efficiency, I get quite a shock. Making a few very rough approximations gives me an answer of around 5 per-cent. This sounds very inefficient, but take a look at something familiar to most two-meter hams, the good old 522. For portable operation, and that is the only way it is listed, the published data on this equipment calls for 50 amperes at 6 volts for 8 to 10 watts output, or an efficiency of around 3 or 4 per-cent. Now if we take this as a starting point, and set up the required output for a portable transmitter at about 1.0 watt, we can estimate what the required battery power will be. Based on an efficiency of three per-cent, the primary power requirement would be about 30 watts. Arbitrarily splitting this between the high-voltage requirements and the low-voltage, or heater, requirements, we can estimate that we would require 110 mils. at 135 volts and 3 amperes at 6 volts.

One look at these requirements makes the use of portable batteries impractical; in fact, the whole idea seems a little far-fetched when we throw in the added fact that, in general, low-voltage, low-current tubes do not perform well at v.h.f. and, therefore, even the pessimistic outlook taken thus far may be far too optimistic. However, the problem has been met and a surprisingly high order of efficiency obtained through the use of a new miniature beam pentode and some new circuit tricks.

The biggest single loss of efficiency in conventional v.h.f. transmitters is in the multiplier stages. A typical transmitter of this type usually operates from an 8.0 mc. crystal and multiplies eighteen times to reach the final frequency. This is done in a number of ways with a variety of tubes and with varying degrees of efficiency. A study of all of the various combinations and methods reveals that all so called "normal" circuits use up as much, or more, power in the multiplier stages

RADIO & TELEVISION NEWS

as they do in the final. One circuit, a relative newcomer, stands out above all the rest from the viewpoint of efficiency, and that is the feedback crystal oscillator circuit which operates the crystal on one of its higher harmonic modes. This has the immediate advantage of starting off much higher in frequency and therefore eliminates one or more multiplier stages right at the start.

It has been claimed that this circuit will operate crystals at their third, fifth or even seventh harmonic overtones. This is true, except that from an efficiency standpoint, third overtone operation seems to be about the best and most reliable choice.

As in similar applications of this circuit, it is obviously an advantage to the designer to use a dual triode in this application and multiply the output of the oscillator in the second half, thus saving the space and weight of another tube, as well as a probable reduction in heater or filament power. The question of how many times to multiply in this second triode becomes an important one. With certain tubes, tripling at this point might be desirable, but with the tube used in this design, doubling was the best that could be accomplished with efficiency. This left the job of tripling to the next stage. Fortunately, this stage uses a pentode; these are more efficient multipliers as a class, and this one in particular was designed especially for multiplying and for operation at frequencies over 100 mc. With its high-power sensitivity, low-power requirements and v.h.f. characteristics, the 3B4 becomes the natural choice for the tripler as well as the final. It is this tube that accounts for a large part of the success of this design. It is doubtful whether it would be possible to consider such a device without this recent addition to the family of v.h.f. tubes.

So, with only two tubes and a crystal, we have power enough to drive a straight-through amplifier at 150 mc., but this is not the whole story, since much of the efficiency of an otherwise good design can be lost by poor coupling technique. Often, too little attention is given to this item in the fixed station design. We usually keep increasing the driver power until the required number of mils is being delivered to the following stage, and that is all that matters. Here we can not do this, because we must conserve every last milliampere in the driver and multiplier stages so that it can be used in the final where it will do something useful. This requires careful attention to tuned circuits and methods of coupling or impedance matching.

Up to around 50 mc. with most tubes, direct capacity coupling is possible without any appreciable loss in efficiency. At frequencies above 50 mc., this simple device becomes very inefficient and is a great loser of power. Double tuning overcomes this, particularly if series tuning is used in the plate circuit and parallel tuning in

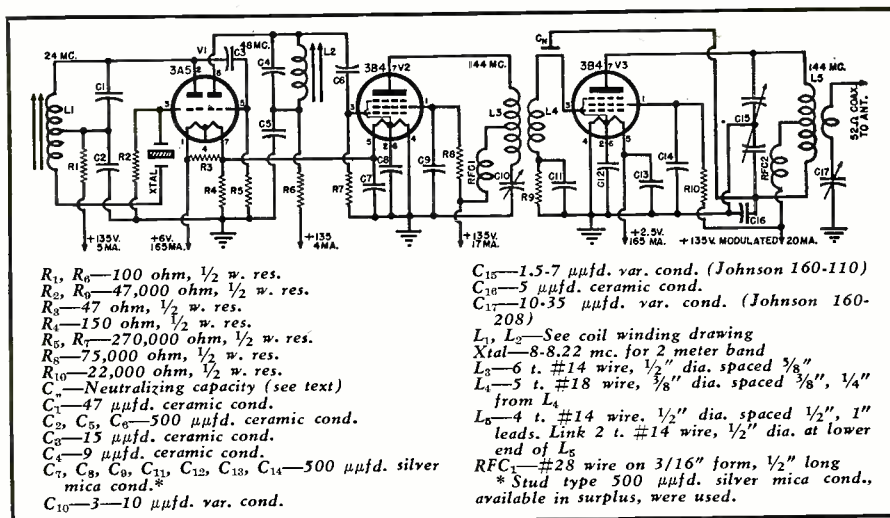

Schematic diagram of completely battery operated v.h.f. transmitter. The 2.5 volt, 165 ma. terminal shown in diagram connects in series with modulator filament.

the grid circuit, with the mutual between the two circuits adjusted to optimum power transfer. The use of series tuning permits the plate of the driver tube to be "tapped down" on its own tank circuit. This permits a larger amount of inductance to be used for any given output capacitance in the tube. By tapping the tube down on the tank circuit, a better ratio between the loaded and unloaded "Q" of this circuit is obtained, with a consequent improvement in plate circuit efficiency. Since the grid of the next tube constitutes a load which is usually lower than that of the plate, it is tuned by simple parallel resonance, the input capacity of the tube, plus circuit capacity, making up the resonating capacity. This parallel resonant circuit is inductively coupled to the high-impedance tank circuit, and at optimum coupling, a high degree of transfer efficiency is accomplished. This same device is used in tuning the final, where again, the plate is tapped

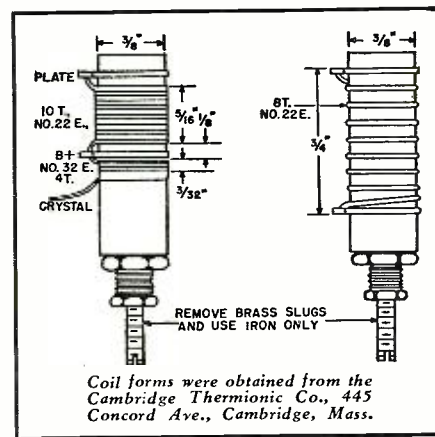

Mechanical details of coil assemblies. Coil L_1 is on left and L_2 is on right.

down on a high "Q" tuned circuit, and this, in turn, is inductively coupled to the low impedance coupling loop. This loop is series tuned as a final precaution. (Continued on page 107)

Bottom view of the completed v.h.f. transmitter showing, left to right, oscillator doubler socket with L_1 mounted above, tripler socket with L_2 mounted above, and L_3 on right. Next in line is L_4 , then the final socket with shield above.

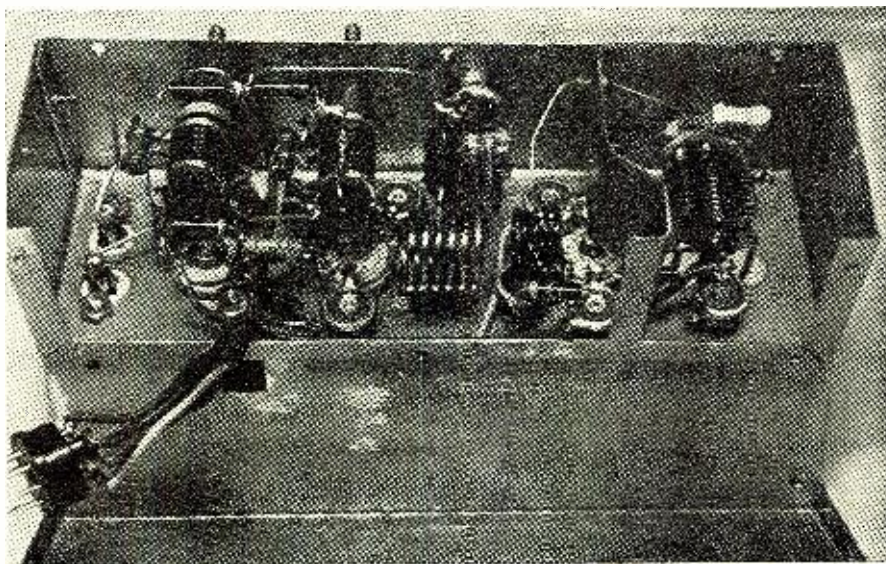

Mac's RADIO SERVICE SHOP

By JOHN T. FRYE



THE LITTLE THINGS

EVEN though it was only eight o'clock in the morning, the cool interior of the service shop felt good to Barney as he stepped into it. The night before had been one of those August scorchers when the thermometer refused to go down with the sun, and already it was showing an eager inclination to lead Old Sol back up.

Barney peered about the apparently empty room and then discovered Mac, his employer, hunkered down underneath the service bench.

"I spy! I spy! Come on out! You can't hide from me!" the youth called.

"Cut out that caterwauling and come down here and hold this light socket for me while I mount it," Mac commanded.

Barney obediently dropped down on his hands and knees and crawled under the bench.

"Now look, Boss," he suggested cautiously; "maybe I ought not to mention it, but did it ever strike you that we are mounting this lamp socket

on the *bottom* of the bench? We work on the top side, you know."

"Yes, it has struck me; and if you don't hold that socket still, something is going to strike you," Mac grunted as he drove home the mounting screws. "I am suddenly sick and tired of crawling around under here on my hands and knees, holding a pen-light in my mouth, while I look for ornery little parts that fall off the bench and roll back into this shadow—as they invariably do. Now I can hardly wait until the first little doohickey jumps off the bench and slinks back here, thinking it is safely hid. Then I'll turn on the hundred-watt bulb that goes into this socket, and said doohickey is going to be as conspicuous as a man's hat in a powder room!"

In a few minutes the light was installed and tested, but Mac showed no inclination to start work.

"I'll bet all the time I wasted looking for things under that bench would add up to whole days," he reflected. "It's the little things like that which cut down on a service technician's efficiency—things like not having exactly the right wrench, or not remembering where a wire you took off goes, or trying to start a nut on an i.f. can lug where there isn't room for your fingers. We spend dozens of dollars on scopes, signal tracers, condenser checkers, and so on, designed to save us hours of servicing time; and then we let the time saved dribble away from us in the form of minutes wasted for the lack of some simple gadget that helps in performing routine jobs.

"All of which," he concluded, "is a devilishly clever build-up for a discussion of the contents of this tray. They are timesavers that I want you to learn to use as naturally as you do your diagonal-cutters. You are familiar with some of them already, but a second look won't hurt you.

"First," Mac went on, "there are the holding screwdrivers. You notice that we have two with spring jaws—one for regular slots and one for Phillips screws. I want to remind you that the one for regular screws is also a very good nut starter. The spring action will hold a nut tightly between the jaws and the end of the blade so that it can be started in a tight place."

"What's that other screwdriver for?"

"When there isn't room for the spring jaws of the other two drivers, or when there isn't space enough to slip the springs sideways off the screw head, we use this one. It has a small screwdriver bit running right down through the center of the main blade. When the button on top of the screwdriver is depressed, both bits are lined up so that they will slip into a screw slot; but when the button is released, the little inside bit twists out against the sides of the slot and holds the screw firmly for starting."

"That thing across the top is used to start screws and nuts, too, isn't it?"

(Continued on page 121)

Mac's tools include surgical clamp, hypodermic, and curved needle shown in the center.

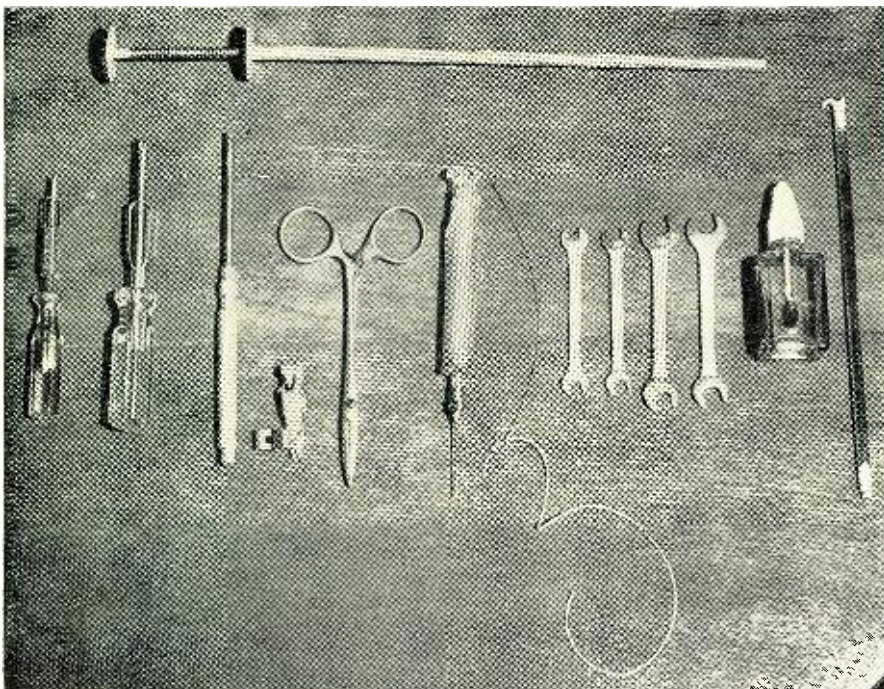

Putting MICRO GROOVES On The AIR



Fig. 1. Typical radio station turntable equipment, adapted for microgrooves. Note conventional pickup arm at right and changeover switch, left rear.

By
W. C. McCLUNG AND W. H. FLINT, JR.*

Microgroove discs have many advantages over conventional records. It will be worth the effort involved in adapting your equipment to accommodate them.

THE Columbia microgroove record has brought a new concept to recorded music—particularly to the fidelity-conscious American radio station. Yet, oddly enough, the greatest single advantage of this new recording method (the “long-playing” characteristic) is least important to the station. The advantages of improved fidelity and reduction in surface noise are of greater value, since the average radio station, possessing several turntables can run even conventional records as long as desired without interruption by sequence playing. The tonal characteristics of L-P records are so superior, however, that even the least critical listener will note the difference. The “highs” are cleaner and the background or residual noise greatly reduced. Long-playing records are so advanced that they easily warrant the effort and research necessary to connect an L-P reproducing system into the station's speech equipment.

At station WGPC, many reproducing systems were tried before a really satisfactory method could be derived. The first involved a “long-playing attachment,” which is really a light 33 1/3 r.p.m. transcription motor with crys-

tal pickup. It was simple enough to match the high-impedance pickup to the station's 50-ohm input, through a high-fidelity microphone transformer using reverse connection. The response curve on L-P records incorporates con-

siderable pre-emphasis of higher frequencies however, and without proper equalization the highs are much too pronounced. Furthermore, surface noise, although inherently low on vinylite, was still objectionable. Continued experimentation disclosed that the over-all frequency response, using the crystal pickup, was irregular and humped. The natural resonant frequency of the arm was unsatisfactory and even when the highs were attenuated and the bass boosted, the inexpensive phono motor caused pronounced rumble and flutter. In short,
(Continued on page 132)

Fig. 2. Schematic diagram for tone compensated pre-amplifier for microgrooves. It can be built on a small chassis and installed in turntable unit.

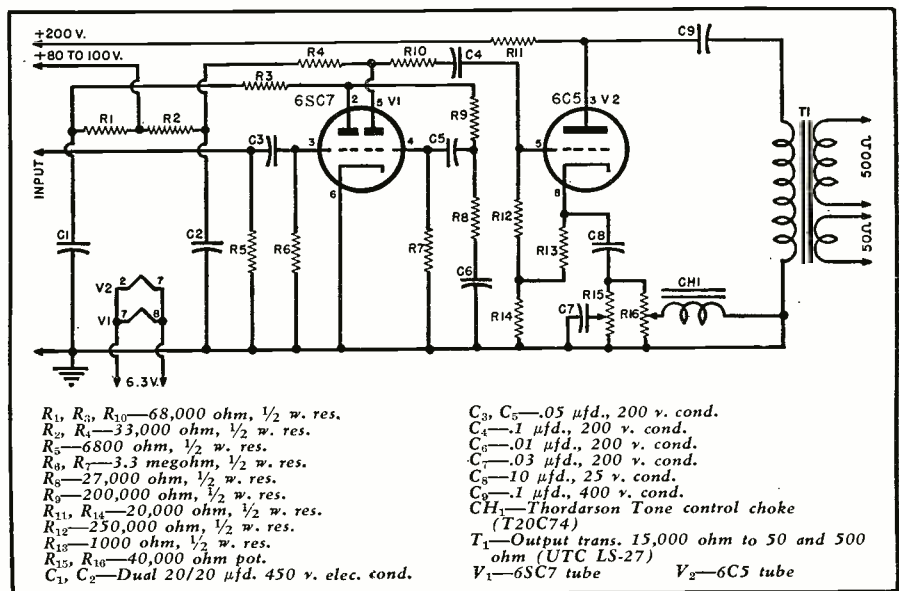

* W. C. McClung and Walter H. Flint, Jr., are Chief Engineer and Program Director, respectively, at Station WGPC, Albany, Ga.

THE BUYING MOTIVES— Key to more Sales



The salesman is showing real enthusiasm in making his presentation. Salesmanship, like servicing, has certain basic principles—the more you understand them and apply them, the more sales you will make.

By

CARLE A. CHRISTENSEN

Sales Consultant

tion!) a pattern of thought and feeling that will cause him to buy what we have to sell.

In radio, if we are going to reach a given listener or group of listeners, we must broadcast on a frequency to which they are tuned. In selling, we must reach the prospect on a "frequency" of thought and feeling to which he will respond.

There are many systems of selling worked out in the past few decades. Most of them are mere formulas that have proven effective in particular instances, with very little in the way of science or logic behind them. Others are elaborate systems of psychology and philosophy which give little actual, practical help as to how one should proceed to make the cash register ring more often.

Why People Buy

People buy something because they want it. They buy it because it appeals to one or more of their desires to possess it.

For example, a man buys a pair of rubbers because he wants to keep his feet dry and avoid illness. A woman buys an extra lock for the door because she desires safety. A man buys a television receiver because he wants the added enjoyment, entertainment, and education that it can bring him.

The only reason people will buy radio equipment from you is because they feel that what you have to offer will satisfy one or more of their desires. If you wish to sell more radios, therefore, it is important that you have a basic understanding of *consumer desire* and how it operates in relation to the buying process.

The Buying Motives

Practical psychologists have spent many years of study and research in seeking to learn more about buyer motivation and how it operates in the selling process. Since they are interested in desire primarily because it *motivates* people to buy, they frequently use the phrase, "buying motives" to describe desire in relation to buying.

Many attempts have been made to classify these motives. Some classifications are simple and some are complex. Here, however, is a seven-fold

Some practical suggestions on how to apply proven principles of psychology to increase your sales.

▼ HERE is no need to dwell upon the fact that the days when customers flocked into the shop and begged for equipment are over. True, as a new area is opened up to television, there may be a temporary shortage of receivers, but, by and large, the radio market has settled down to the point where an aggressive sales effort must be made by the dealer if he wishes to hold his sales up to past standards.

Unfortunately, very few dealers have had much training in salesmanship. And while they would not think of attempting to service a modern television receiver without a background of specialized training and experience, they do not hesitate at all to take on the duties of a salesman with-

out any previous preparation, except for a certain amount of product knowledge and the desire to sell.

Selling, like any other science, is subject to analysis and can be taught. Since it is the backbone of modern commerce, literally millions of dollars have been spent to analyze its workings and to apply them so that sales could be increased. In many ways, the science of selling and the science of radio are parallel. In radio, we try to convey intelligence (speech, music, or code) to another person or persons, with a minimum of distortion, so that he or they may understand and appreciate what we are seeking to communicate. In selling, we endeavor to transfer from our mind to that of the prospect (with a minimum of distor-

classification that will be found both practical and comprehensive.

Seven Principal Buying Motives

In order of importance, the seven primary "buying motives" might be listed as follows:

- (1) Self preservation and protection,
- (2) possession and profit (economy),
- (3) power and ambition, (4) reputation and good will, (5) love and affection, (6) idealism and justice, (7) pleasure and beauty.

These buying motives are the potential power that move your prospects into buying action. They may be represented, schematically, as shown in Fig. 1A, as the battery or source of electromotive force, or e.m.f. When talking sales-wise, we shall refer to this as the *emotional motive force*.

In this same circuit, you will notice the variable resistance, R , symbolizing the *buying resistance* of the prospect.

Also indicated is the useful load R_L , which in our sales analogy is *buying action*. For the purpose of measuring results, we have connected across our useful load a *sales meter*, which measures the "Yes" potential.

Basically, our job is to increase the *emotional motive force* and reduce the *buying resistance* of the prospect, so that a sufficient amount of *emotional motive force* will flow through the circuit to obtain a "Yes" reading on our *sales meter*.

Buying Motives and Television Sales

Let us briefly consider the various buying motives in their relationship to the sale of a modern television receiver. As we proceed, you will observe that these motives are not of equal potential in their power to obtain a "Yes" reading in the prospect's mind. Therefore, in every sale, we should connect as many of these mo-

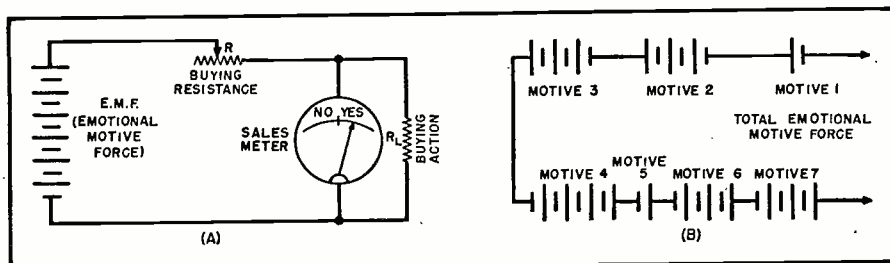

Fig. 1.

tives as possible in series, to obtain the necessary total of *emotional motive force* to produce a "Yes" result in the prospect's mind. This is illustrated in Fig. 1B.

1. Self Preservation and Protection

At first glance, it would not seem as though this buying motive were in any way related to the purchase of a modern television receiver. Yet, there are several important features in the modern receiver which do appeal to it, though they need not come up in every sale.

For example, consider the safety glass window placed in front of the cathode-ray tube. Why is it placed there? (1) To protect the tube from accidental damage, and (2), to protect the viewer from the results of implosion, if the tube is damaged. This latter has a direct appeal to the motive of self preservation and protection.

The protective covering on the rear of the receiver or the plastic cover on the new 16-inch tubes also has an important appeal to self-preservation and protection, because of the danger of shock from the high voltages used.

Now this does not mean that you would bring up these points (which are somewhat negative) at every sale, but if the prospect should raise the question, perhaps noticing the high-voltage warning label at the rear of

the cabinet, your answer should be:

"Yes, Mr. Prospect, high voltages are necessary to operate the modern television receiver, but because of the careful engineering and design of the Blank Receiver, it is just as safe and free from shock as your regular radio. Any time it should become necessary to get inside the set for servicing or for some adjustment that can't be made from the outside, our expert service technician will be at your home in a few minutes, or a few hours at the most, to take care of it for you."

2. Possession and Profit (Economy)

In these days of increasing living costs and reduced incomes, this buying motive becomes increasingly important. Thousands of television receivers have been sold by an appeal to this buying motive. Simply put, it is this:

"Mr. Prospect, this receiver will actually cost you *nothing*, because it will save you the money that you and your family are now spending for movies, entertainment, and sporting events."

3. Power and Ambition

This motive does not, considered superficially, seem to have too strong an

(Continued on page 66)

The modern television receiver appeals to all the buying motives. By dramatizing these appeals in your sales talk, you will make more sales. It is important to emphasize the entertainment value a television set has in the home.

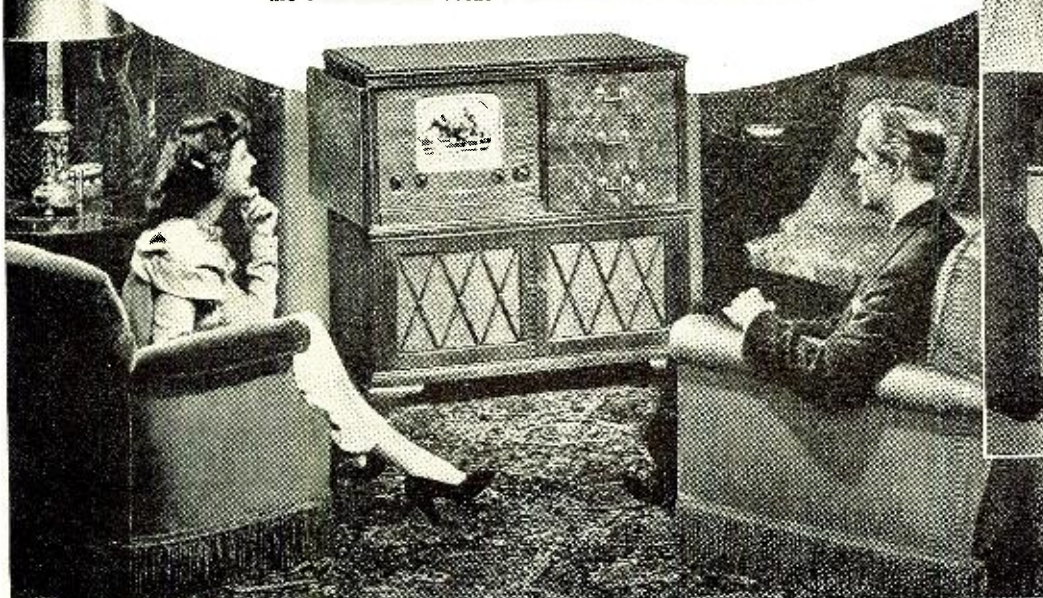

Allow the customer to operate the set—it will appeal to the motives of possession and power and help you make the sale.

An Inexpensive AUDIO FREQUENCY GENERATOR



Fig. 1. Completed oscillator and modified transformer components: (1) bracket, (2) core, (3) coil, (4) wooden block to replace "T" laminations, and (5) "T" laminations to be discarded.

By J. WHITAKER, W2BFB

A resistance stabilized oscillator, providing for one or several output frequencies. A method is described for modifying an inexpensive transformer to yield suitable oscillator inductance.

A TONE generator of some sort is an essential part of the equipment of any electronic experimenter's workshop. Unfortunately, most factory-made instruments of this type are rather expensive. Many radio experimenters must therefore try to get along somehow by borrowing an instrument occasionally or by makeshift means.

The fundamental principles of a tone oscillator are rather simple and understood by most experimenters. Although a useful oscillator can be very simple if a few basic rules are followed, the mechanics of assembling one appears to deter many from the actual construction of such an instrument.

The ultimate design will be dictated more or less by the use to which it is to be assigned. If the oscillator is intended only for International Morse Code practice, the basic requirement will be to produce a tone that is pleasing to the ear and of suitable volume for comfortable copying. A relatively large percentage of distortion can be tolerated, and only a single frequency of approximately 500 c.p.s. will be required. If the oscillator is to be used for general laboratory work, the waveform should be as free from distortion as is practicable, and the design should include provisions for several frequencies. A frequency of 1000 cycles must be provided in any case, as this is the frequency at which most standard measurements are made.

Audio frequency oscillator circuits too numerous to mention have been designed in recent years, all with some particular advantage over every other type of circuit. Perhaps the most simple of all circuits is the Hartley type. This circuit, with the addition of resistance stabilization, not only retains simplicity, but also provides excellent stability and purity of waveform. Then, if the oscillator is followed by an amplifier circuit incorporating some sort of negative feedback, a quite satisfactory and simple instrument can be constructed at a very low cost.

A schematic diagram of such an instrument is shown in Fig. 2. For the sake of simplicity, a single frequency (Continued on page 82)

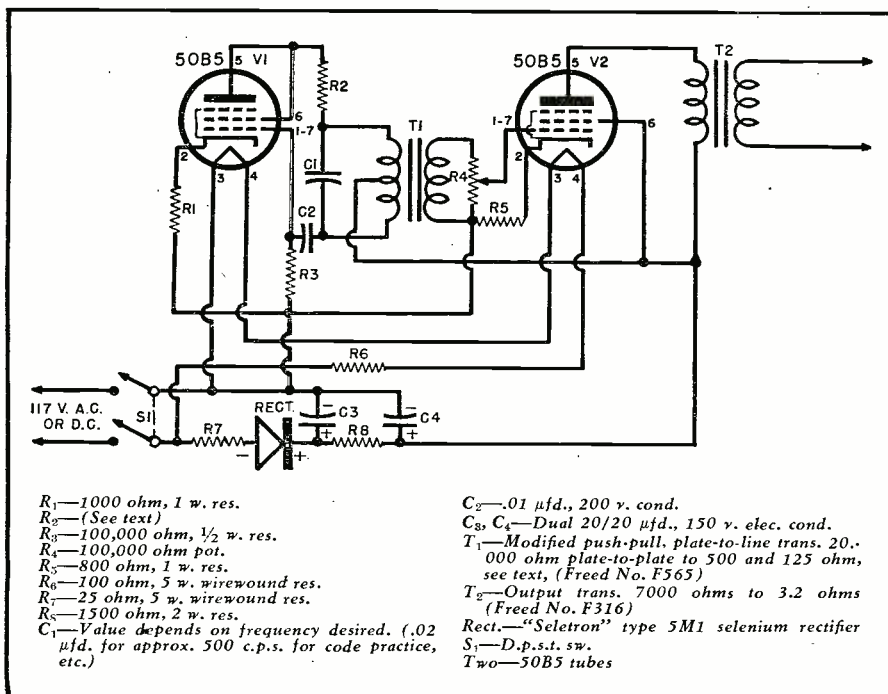

Fig. 2. Complete schematic diagram of the easy-to-build audio frequency generator.

MODERN *Television* RECEIVERS

By
MILTON S. KIVER

WE HAVE followed the progress of the video signal from the antenna terminals to the cathode-ray tube, at each point pausing long enough to analyze the various types of circuits which are employed in modern television receivers. The signal, at the control grid of the cathode-ray tube, will modulate the electrons streaming by in the electron beam, producing a series of spots on the screen, each with a different shade or intensity. If these light spots are properly laid out on the screen, a correct total image will be obtained. If the spots are not properly placed on the screen, the visible pattern will be nothing but a jumbled mess. It is for the express purpose of properly placing each of these tiny bits of video information on the screen that the synchronizing pulses are included with the video signal. Circuits must be provided in the television receiver which will first separate all of the pulses from the video signal and then further separate the vertical and horizontal pulses from each other and direct them into the proper sweep system. Horizontal sync pulses appear at the end of each line and force the electron scanning beam to shift rapidly from the right-hand side of the screen to the left in order to be in position for the following line.

After the electron beam sweeps out the correct number of horizontal lines and arrives at the bottom of the picture, a vertical sync pulse is applied to the vertical deflection system, and the beam is rapidly brought back to the top of the screen again. This vertical pulse is included in the video signal together with the horizontal pulses and is likewise removed by the sync separator tube. The block diagram of Fig. 1 shows the general path of all the synchronizing pulses within a television receiver.

Pulse Separation

Pulse separation stages may be located anywhere between the video detector and the cathode-ray tube. In

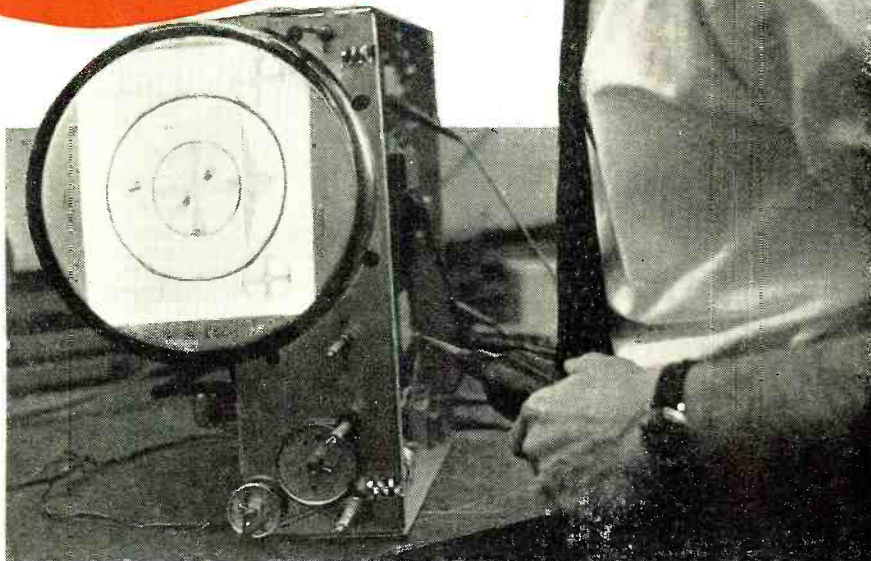

G-E technician static testing a production model to determine sync stability

Part 17. Sync pulse separation and the methods used to achieve it in various commercial receivers.

the preceding article, it was shown how d.c. restorer circuits could be designed to function as sync separators as well. At that time, only the first tube of what is generally a string of two, three, or four stages was shown. We will now show the complete sync separation system as currently found in television receivers.

Diode Clippers. The simplest type of sync clipper or sync separation circuit employs a diode as shown in Fig. 2A. The upper 25 per-cent of the video signal is devoted exclusively to the sync pulses (both vertical and hori-

zontal) and, consequently, all sync separators are based primarily on amplitude separation. That is, they respond only to this section of the video signal and ignore or suppress the rest of the signal containing the image detail. If this job is done properly, only the sync pulses will appear in the output of the tube. In the circuit of Fig. 2A, the diode clipper uses the time constant of R_1 and C_1 to bias the tube so that all but the synchronizing pulses are eliminated. Condensers C_1 and R_1 form a filter with a comparatively long time constant, generally

Fig. 1. Block diagram of the vertical and horizontal scanning systems of a TV receiver.

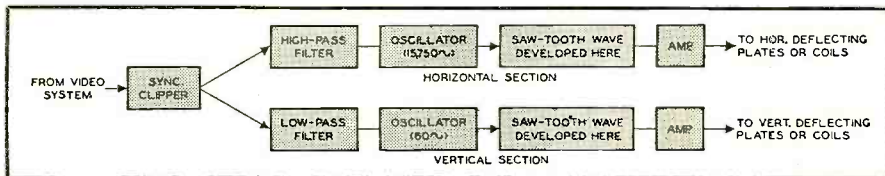

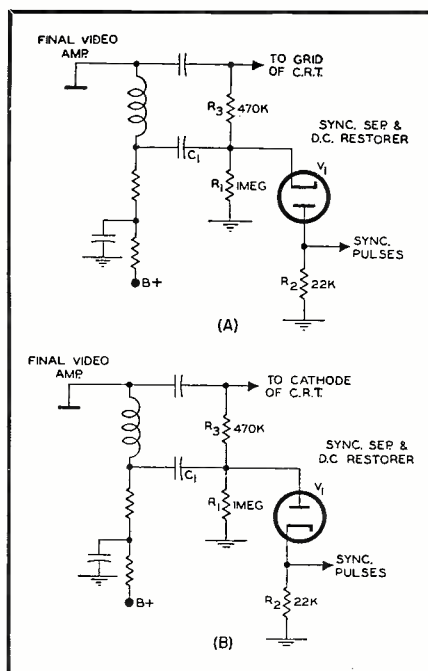
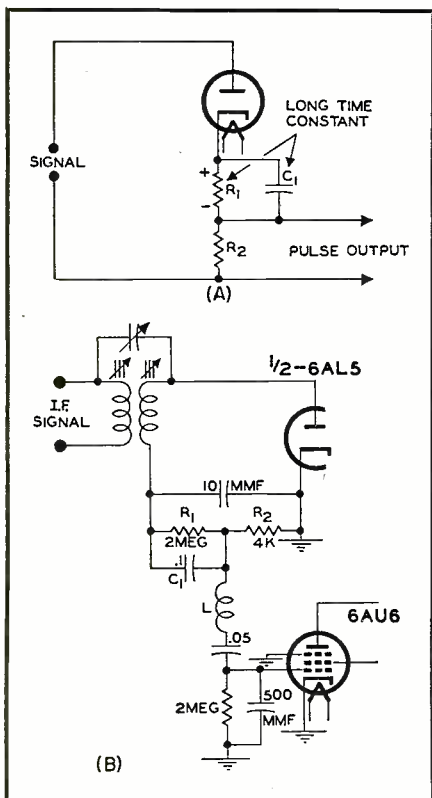

Fig. 3. Combining sync separation with d.c. restoration. See text for explanation.

Fig. 2. A diode sync separator circuit (A), and its commercial application (B).

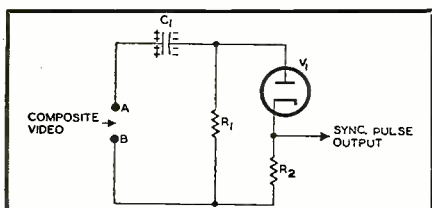

Fig. 4. A more frequently used application of a diode as a sync separator.

equal to about ten horizontal lines. When the video signal (with the sync pulses positive) is initially applied between plate and ground of the diode, current will flow through the tube, charging C_1 to the peak value of the signal. This, of course, is established by the sync pulses. This voltage, it will be seen, is such as to make the cathode positive with respect to the plate. Due to the relatively long time

constant of R_1 and C_1 , the condenser loses very little of its charge during the period of one line (63.5 microseconds). Hence, only the sync pulses are sufficiently positive to overcome the cathode voltage and cause the tube to conduct. Since the current must flow through R_2 , the pulse voltage will appear across this resistor.

A commercial application is shown in Fig. 2B. One half of a 6AL5 is used for picture signal detection (not shown) while the remaining half is devoted entirely to pulse clipping. R_1 and R_2 form the sync separator load with the time constant fixed by R_1 and C_1 . At the arrival of each pulse, a short flow of current occurs, recharging C_1 , and, at the same time, producing a pulse of voltage across R_2 . This voltage is transferred to a 6AU6 sync pulse amplifier.

A more frequent application of the diode sync separator uses the circuit shown in Fig. 4. The composite video signal is applied across terminals A-B. As a start, we will assume that C_1 is uncharged. Upon the application of a signal, electrons flow from cathode to plate of the tube and thence to the nearest plate of C_1 . From the other plate of C_1 , an equal number of electrons will flow to terminal A, through whatever circuit is connected between this point and terminal B, then up through R_2 , and back to the tube again. C_1 thus will become charged, its potential equal to the peak potential of the applied video signal. During the second and all subsequent lines, V_1 will not conduct until the applied signal is able to overcome the negative charge existing across C_1 , and this will only be true when the sync pulses are active. At these moments, current flows through the circuit in the manner prescribed above, and a pulse of voltage appears across R_2 . At all other times, V_1 will be kept cut off by the negative charge across C_1 . When V_1 is not conducting, C_1 discharges through R_1 , and it is actually this discharge through R_1 that makes the plate of the diode negative with respect to its cathode. As before, the time constant of C_1 and R_1 is made sufficiently long so that only the sync pulses cause current flow through the circuit.

If the reader will now refer back to the previous article, he will see that the diode d.c. restorer circuits which also functioned as sync clippers utilized a similar circuit. The d.c. restorer action was obtained from C_1 , R_1 , and V_1 . The negative voltage which developed across R_1 was fed through an isolating resistor, R_3 , to the cathode-ray tube where it combined with the video signal, bringing all sync pulses to a common level. At the same time, R_2 , in series with V_1 , received a pulse of current each time the tube conducted. Since this occurred only when the sync pulses were active, only the sync pulses appeared across R_2 .

When the video signal at the plate of the last video-frequency amplifier is fed to the grid of the image tube, signal phase is positive, which means

Fig. 5. The sync separation circuits used in Rembrandt and Videodyne TV receivers.

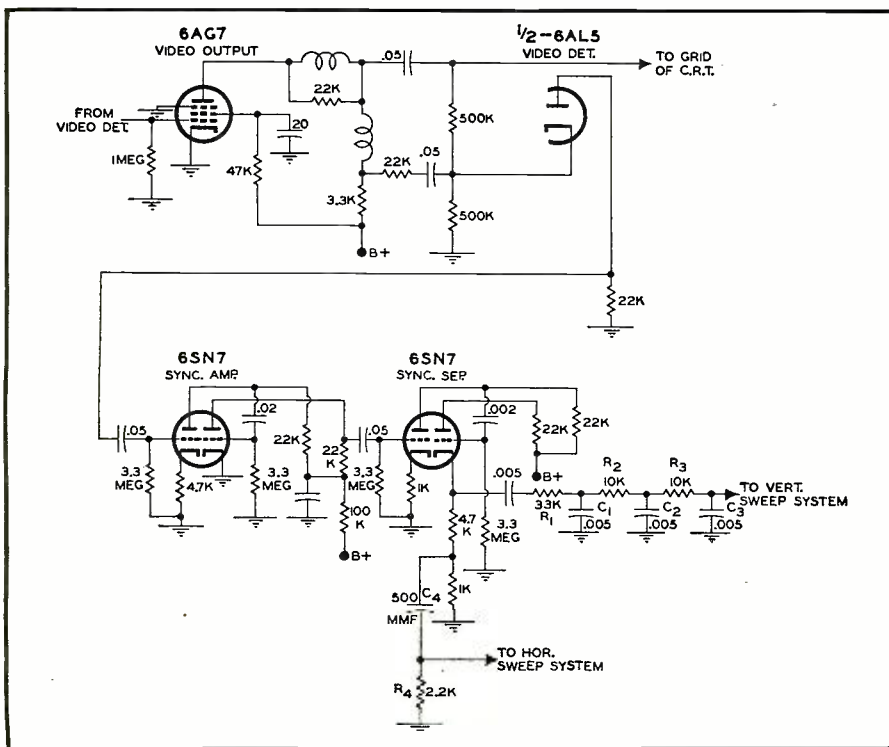

that the sync pulses possess the most negative potential of the signal. Therefore the diode, V_1 , must be inverted. See Fig. 3A. On the other hand, when the video signal is fed to the cathode of the image tube, the sync pulses have the most positive potential of the video signal, and the diode is placed as shown in Fig. 3B. Circuit operation, in either instance, is the same.

In *Rembrandt* and *Videodyne* television receivers, the sync separator shown in Fig. 3A is combined with two 6SN7 tubes, all devoted primarily to the job of clipping and squaring off the sync pulses, before these are applied to their respective sweep oscillators. See Fig. 5. In spite of the different names applied to these duo-triodes (i.e., sync amplifier and sync separator), all perform essentially the same jobs of amplifying and clipping the sync pulses. The final tube is called a sync separator, possibly because the pulses appearing in its cathode circuit are applied to the vertical and horizontal sweep oscillators. Note, however, that the separation of the vertical and horizontal sync pulses from each other is not performed by the tubes but the high- and low-pass filters leading to each oscillator. All of the sync pulses—and these include both vertical and horizontal—must pass through the low-pass filter composed of R_1 , R_2 , and R_3 plus C_1 , C_2 , and C_3 . The low-frequency (60 cycle) vertical pulses are permitted to pass while the effect of the 15,750-cycle horizontal pulses is made negligibly small.

By the same token, the pulses reaching the horizontal blocking oscillator must pass through the high-pass filter consisting of C_4 (50- $\mu\text{mfd.}$) and R_4 (2200 ohms). This circuit is known as a differentiating network and produces a sharp pip at the leading and lagging edge of each rectangular pulse. The pip due to the leading edge is then used to sync the horizontal oscillators.

Maintenance of synchronization is an important consideration in the design of even the cheapest television receiver and one way to achieve sync stability is by successively amplifying and shaping the sync pulses obtained from the video signal.

In the earlier *Farnsworth* television receivers (Model GV-260), the diode sync separator was actually part of the a.g.c. system. The circuit is shown in Fig. 6. One half of a 6H6 serves as a video detector; the other half develops the a.g.c. voltage and, at the same time, clips the sync pulses from the video signal. We know, from the previous description of the operation of this circuit, that the voltage developed across C_1 and R_1 is negative and governed entirely by the amplitude of the sync pulses. Thus, the negative voltage across R_1 will serve very nicely as a regulating or a.g.c. voltage. On the other hand, current flows through the tube whenever the sync pulses are active and these appear across the cathode resistor. The sync pulses appearing in the output circuit of the sync separator are then

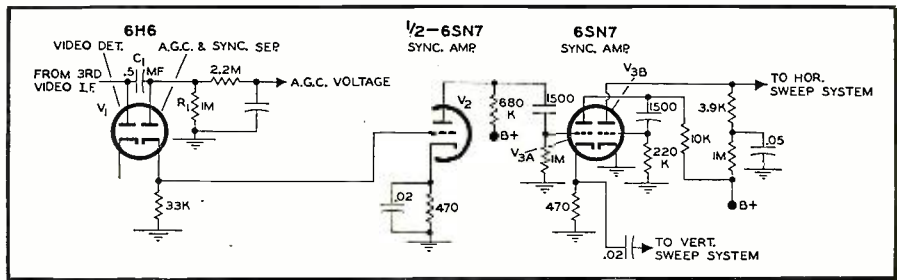

Fig. 6. Diagram showing a combination sync separator and a.g.c. rectifier.

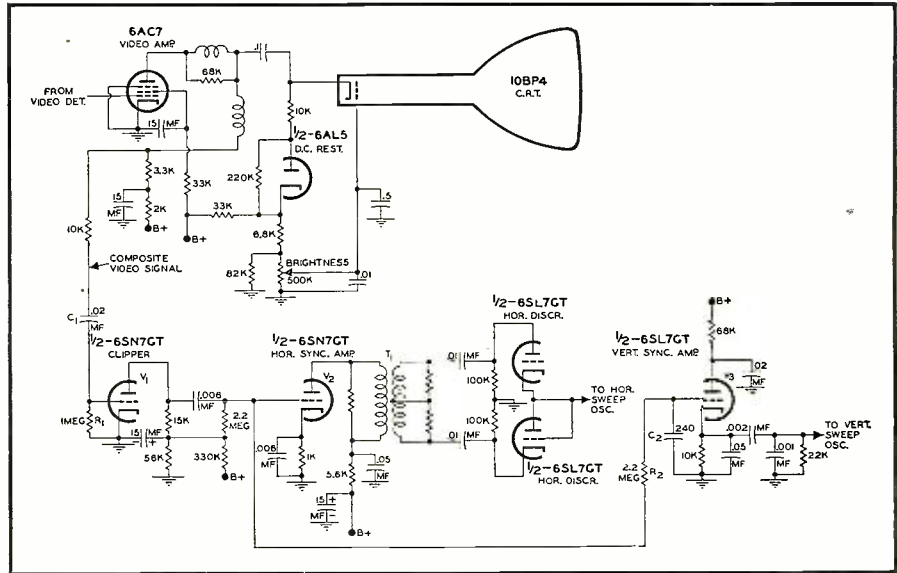
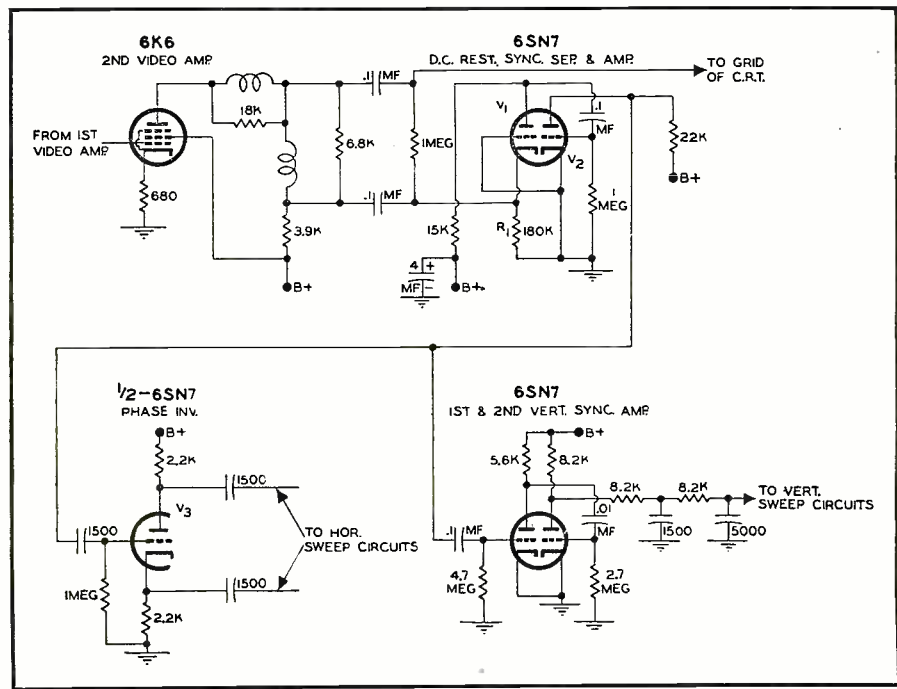

Fig. 7. The sync separation circuit used in many of G-E television receivers.

amplified prior to application to the sweep oscillators. This is the function of V_2 and V_3 . The pulses from the sync separator are positive, and after one stage of amplification, become negative. Since they are negative when applied to V_{3A} , this amplifier may

be operated with very little grid bias. From the cathode leg of V_3 , the negative pulses are fed to the vertical multivibrator through a two-section low-pass filter. The same pulses, however, are not applied to the horizontal control circuits until amplification by

Fig. 8. A triode, V_1 , employed as a sync separator and d.c. restorer.



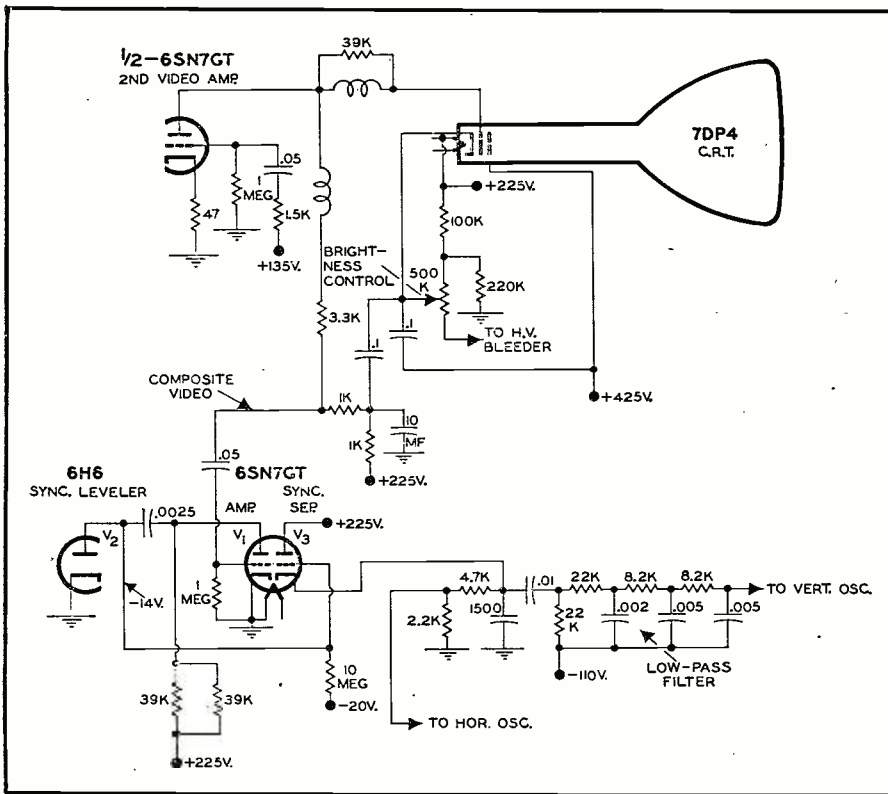

Fig. 9. Diagram showing another example of a triode sync clipper.

V_{3A} and V_{3B} . Belmont television receivers utilize a system which is very similar to the Farnsworth method.

Triode Sync Separators

Since a triode (or a pentode) can do anything a diode can, and provide amplification as well, it is natural to expect to find these tubes used as sync separators. An application involving a triode sync clipper is shown in Fig. 7. The triode is biased by grid-leak

bias developed across C_1 and R_1 . The pulse in the video signal fed to the sync clipper triode, V_1 , are the most positive portion of the signal. When the signal is applied, the sync pulses drive the grid positive. Electrons will then flow in this circuit, charging the coupling condenser. Due to the high value of R_1 , the charge on C_1 will leak off slowly, causing a fairly steady bias voltage to develop across the grid resistor. This biasing voltage prevents

plate current from flowing except for the most positive values of the incoming signal, which are the synchronizing pulses. A low plate voltage (14 volts) causes the tube to saturate readily, thereby tending to square off the sync pulses and to limit any noise pulses that may appear in the signal.

The signal from V_1 is fed to two circuits: a vertical sync amplifier and a horizontal sync amplifier. The signal is fed to the grid of V_3 through an integrating network (R_2 and C_2) which is a low-pass filter. The wide vertical pulses pass through the filter, are amplified by V_3 , and then cathode-coupled to the following vertical multivibrator sweep oscillator. The horizontal sync pulses, on the other hand, do not develop sufficient voltage across C_2 to appreciably influence V_3 . Further integration of the sync signal is provided in the cathode circuit of V_3 . The pulses are then fed to the vertical multivibrator.

The second circuit to which the output of V_1 is fed is the horizontal sync amplifier, V_2 . This tube operates into the automatic frequency control (a.f.c.) network which automatically regulates the frequency of the horizontal sweep oscillator. (More on a.f.c. systems in a later section.) The coupling transformer, T_1 , functions as a high-pass filter or differentiator by virtue of its low inductance, that is, in the secondary, the original sync pulses are transformed into positive and negative pips. Only the pip which is produced by the leading edge of each pulse is used. The foregoing circuit is found in General Electric receivers, Models 801, 802, 803, 901, 910.

The combination of a triode d.c. restorer and sync separator is a common combination. See Fig. 8. The grid and cathode of the triode, V_1 , function as a diode d.c. restorer, providing a positive d.c. voltage across R_1 which is added to the video signal applied to the control grid of the image tube. Since the applied video signal has a positive picture phase (the sync pulses are most negative), the grid of the tube is grounded and the signal is received by the cathode. Current flows through the triode only when the negative applied voltage is sufficiently large to overcome the positive potential developed across the cathode resistor, R_1 . This occurs only during the sync pulse interval, producing amplified sync pulses across the plate load resistor. The pulses receive further amplification by triode V_2 and then are transferred to separate vertical and horizontal sync amplifiers. The vertical system contains two additional amplifiers while the horizontal system contains what is essentially a cathode-follower and phase inverter. This arrangement in the horizontal system is necessary in order to properly feed the sync pulses to the a.f.c. network used here. Garod and, in a modified form, Andrea, use this sync separation method.

Another triode sync separation cir-

(Continued on page 124)

Fig. 10. Schematic diagram of a pentode sync separator.

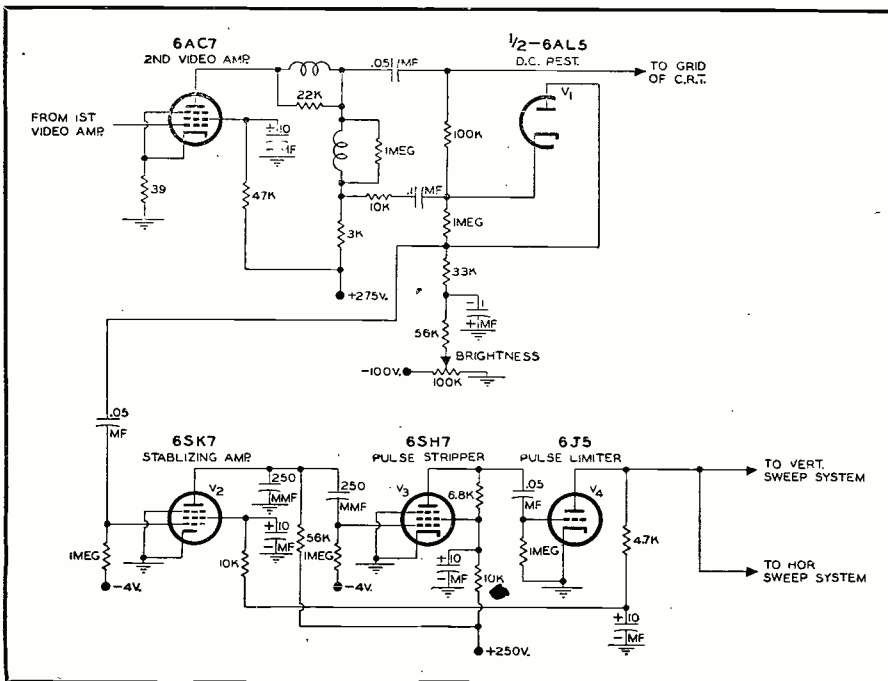

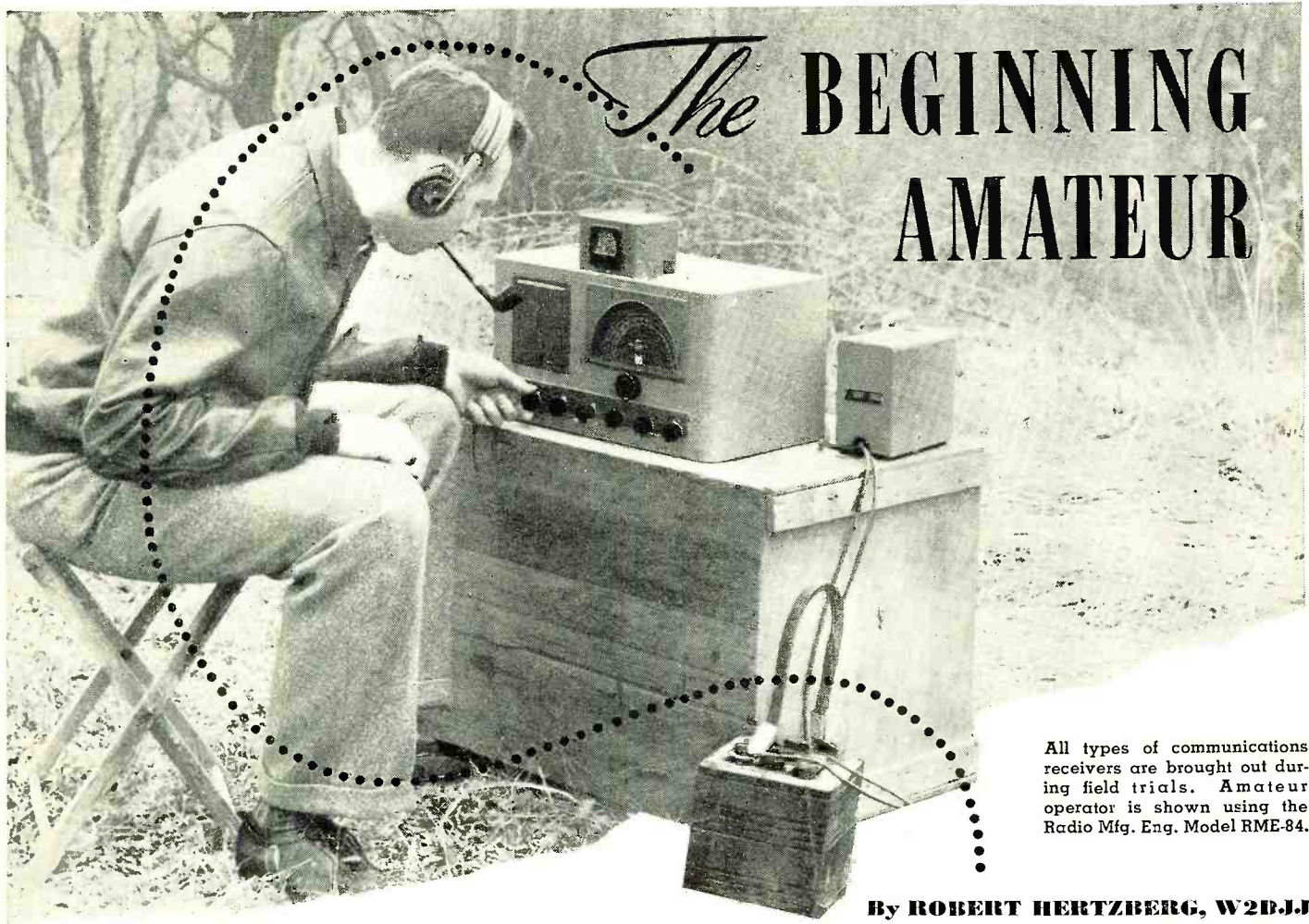

The BEGINNING AMATEUR

All types of communications receivers are brought out during field trials. Amateur operator is shown using the Radio Mfg. Eng. Model RME-84.

By ROBERT HERTZBERG, W2BJJ

THE simple, three-tube regenerative receiver described in Part 3 of this series of articles (April, 1949, issue, RADIO & TELEVISION NEWS, page 47) produces good c.w. signals and serves as a fine piece of introductory equipment. As was carefully pointed out, however, it is less satisfactory for phone reception, mainly because of its poor selectivity; that is, it is unable to separate stations operating on closely adjacent frequencies. As you gain experience listening on the various ham bands, you gradually come to realize that you will hear and work more DX only if you provide yourself with a better receiver.

What makes a receiver *better*? With the "beginner's" regenerative set as the basis for comparison, the universally-used superheterodyne type of receiver has the advantages of superior selectivity, stability, sensitivity, and convenience. Millions of "superhets" for many kinds of receiving service have been built since the basic circuit was invented by Edwin H. Armstrong in 1917, and manufacturers are thus able today to offer highly refined receivers that perform with great reliability.

You should, without fail, buy the best communications receiver you can afford before you spend a cent on a

Part 7. Sure? Your home-built receiver is fine—but it doesn't compare with a commercially-built unit. When you're ready to buy, you'll find a wide choice—from \$50 and up.

phone transmitter. A receiver is a long-term investment, while a transmitter has a relatively short life. Many hams still use and swear by receivers they bought ten or twelve years ago, although they have probably gone through half a dozen different transmitters in that time.

"What about building a receiver and saving some money?" You are quite likely to ask this question after you look over manufacturers' catalogues for the first time and recover from the shock induced by the price listings. My answer, based on long and varied experience, is, "It doesn't pay." It's an odd thing, but most new hams have the idea that receivers are "simple" and transmitters are "complicated." Actually, the opposite is true. Receivers employ more tubes, more parts, and much more critical circuits than are found in transmitters. To line up a home-made receiver, you need expensive test equipment, such as that used by professional service technician; to tune a transmitter, even a big one, you can get by with a couple of cheap milliam-

meters—even a single meter does the trick.

Experienced hams often build special receivers to meet particular requirements, and they have a lot of fun doing so, but invariably these sets merely supplement their standby communications jobs, which they leave strictly alone. By the time a ham earns the rating, "experienced," he has usually also acquired a pretty fair collection of test instruments, so he is adequately equipped to wrestle with a fussy receiver of some "hot" design. If solid signals and quick QSO's are what you want, save your money for a good set that will work the first time you turn it on.

Communications receivers are offered by five key manufacturers of long standing in the radio game: *Collins*, *Hallicrafters*, *Hammarlund*, *National* and *RME*. The sets fit into two general patterns. The first and by far the larger of the two embraces general-utility receivers having a frequency range from approximately 540 kilocycles (the start of the regular amplitude modulated broadcast band)

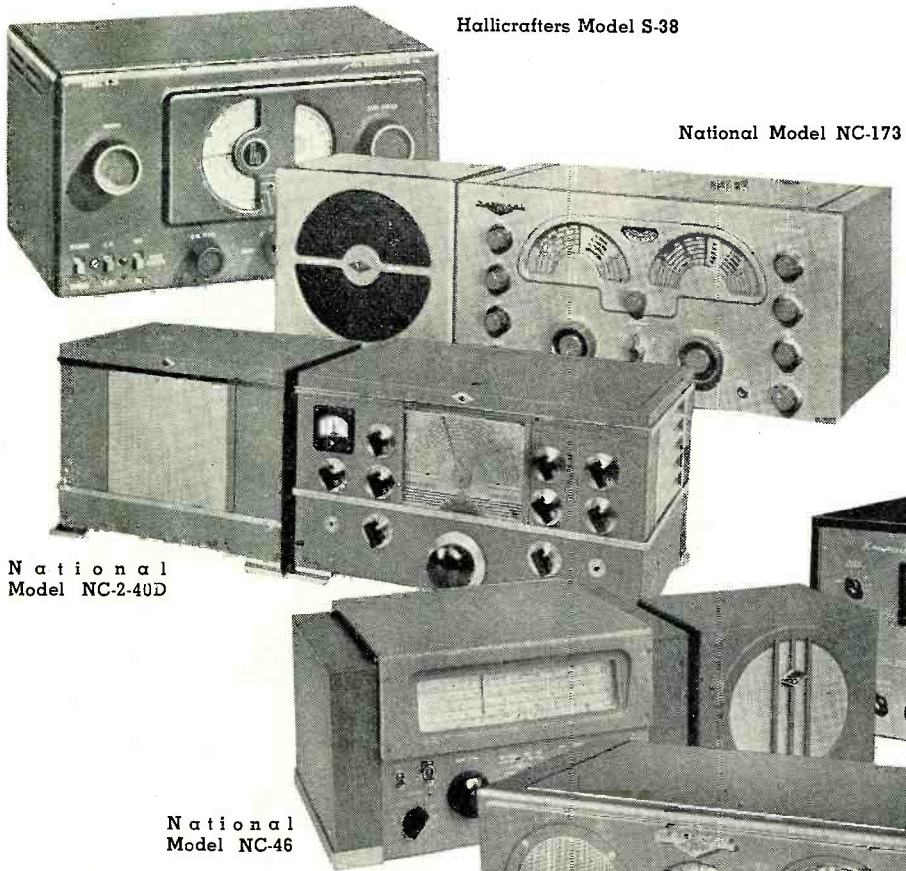

Hallicrafters Model S-38

National Model NC-173

National Model NC-2-40D

National Model NC-46

Hammarlund Model HQ-129-X

Collins Model 75-A-1

National Model NC-33

to 35 megacycles, just beyond the limit of the popular "10-meter" ham phone band. This very wide frequency coverage is made possible by a series of fixed coils, brought into the circuits by means of switches. One notable exception is the *National* HRO, which since its introduction about thirteen years ago has used plug-in coils instead of fixed coils and switches.

Dials are calibrated rather accurately, so that you can be pretty sure of the band you are searching. "Bandspread tuning" is common; this enables you to pull apart the ham bands, or portions of other bands, for ease of station selection. (To help justify the purchase of the set in the eyes of the rest of the family, you can treat the folks occasionally to direct pickups of foreign broadcasts, which can be very interesting and entertaining.) All important circuit functions are controllable from the front panel, which is usually studded with enough knobs, dials, and switches to satisfy the most gadget-minded customer. A typical receiver has a dozen controls for such things as band selection, main tuning, and bandspread tuning; tone, volume, and sensitivity adjustment; choice of automatic or manual volume control; c.w. oscillator and pitch control; etc.

A very important feature of the better sets is a crystal filter, by means of which a very high degree of selectivity is achieved. The crystal often means the difference between working and not working a desirable station that is smothered in interference.

In the second pattern there are just

two models, one each by *Collins* and *Hallicrafters*. These are double-conversion, superheterodynes which cover the ham bands *only* and nothing else and provide the ultimate in stability, selectivity, and band spread. The *Hallicrafters* set is expected on the market shortly.

Without exception, communications receivers use steel cabinets, finished in either crackle black or smooth gray. The smaller sets have built-in loudspeakers; the larger ones have separate speaker units of matching appearance.

Most of the sets are built primarily for 117 volt a.c. service. Some are convertible to battery operation, a convenience for field purposes, with the battery of the car furnishing the juice. A few small sets are a.c.-d.c. jobs.

Altogether, the five manufacturers offer eighteen different receivers. The catalogue descriptions of all of them have a prospective buyer drooling. How do you make a choice among these pearls? The answer to this is easy, because the matter is strictly one of dollars and cents. Determine the state of your personal or family finances, establish a definite price

limit, and just close your eyes to the more expensive sets. It so happens that the prices of available receivers are very good indications of their relative quality and desirability. This does not mean that a \$100 set is twice as good as a \$50 one, because it is impossible to make direct comparisons in this sense. However, a \$100 model with ten tubes and five tuning circuits can certainly be expected to have somewhat better sensitivity and selectivity than a \$50 job with six tubes and three circuits, to put the comparison in broad terms.

The major point of difference between the low-priced sets and the

high-priced ones is more in the direction of selectivity and stability than in sensitivity. Even the smallest receiver will pull in more signals than you'll have time to identify in a lifetime. The trouble is that you'll hear too many signals at one dial setting, which shows poor selectivity; and you may have to readjust the tuning dial continually to keep the signals audible, which means the set has poor stability.

Instability in high-frequency receivers was the last major "bug" licked by circuit engineers. The trouble is caused by uneven expansion of the metallic parts of condensers and coils as the chassis warms up. Some sets don't settle down for an hour or so; some never do simmer down. Receivers with temperature-compensated components become rock-steady in a matter of minutes.

To help in deciding on a receiver to match desires and pocketbooks the available models are arranged in price groups, with brief descriptions appended by way of information. You can readily obtain detailed dope from

the manufacturers themselves or the nearest dealer or mail order house. Don't waste any tears over the \$300 sets if you know very well that you'll be able to raise only \$200. That's like dreaming about an *Oldsmobile* Futuramic when your bank balance makes you settle for a *Chevrolet* coupe.

\$50 Class.

Hallicrafters S-38: Four bands, 540 kc. to 32 mc.; bandsread tuning; built-in loudspeaker; six tubes; a.c.-d.c. operation.

National NC-33: Four bands, 500 kc. to 35 mc.; bandsread tuning; built-in loudspeaker; six tubes, a.c.-d.c. operation.

\$100 Class.

Hallicrafters S-40: Four bands, 550 kc. to 43 mc.; bandsread tuning; built-in speaker; nine tubes; a.c. operation.

Hallicrafters S-52: Same as the S-40, but for a.c.-d.c. operation.

Hallicrafters S-53: Five bands, 540 kc. to 54.5 mc.; bandsread tuning; built-in speaker; eight tubes; a.c. operation.

National NC-46: Four bands, 540 kc. to 30 mc.; bandsread tuning; separate speaker; ten tubes; a.c.-d.c. operation.

Hallicrafters Model SX-43

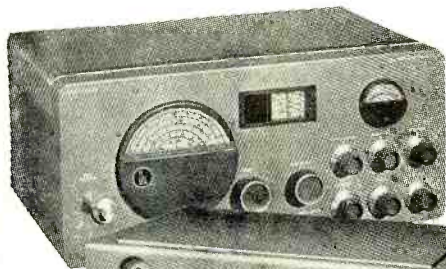

National Model HRO-7

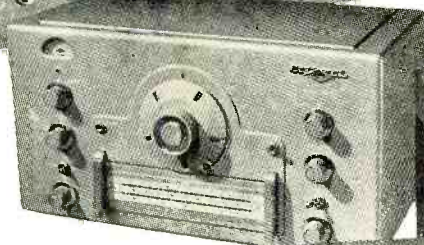

Hallicrafters Model S-53



Hallicrafters Model SX-42

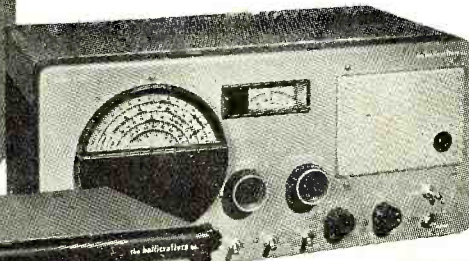

Hallicrafters Model S-52



Radio Mfg. Eng. Model RME-45

National NC-57: Five bands, 540 kc. to 55 mc.; bandsread tuning; built-in speaker; nine tubes; a.c. operation.

Radio Mfg. Eng. RME-84: Four bands, 540 kc. to 44 mc.; bandsread tuning; built-in speaker; eight tubes; a.c. or battery operation.

\$200 Class.

Hallicrafters SX-43: Six bands, AM, 540 kc. to 55 mc., and FM, 44-55 and 88-108 mc.; bandsread tuning; crystal filter; temperature compensated; tuning meter; eleven tubes; separate speaker; a.c. operation.

National NC-173: Five bands, 540 kc. to 31 mc., plus 48 to 56 mc. bandsread tuning; NBFM adapter available; crystal filter; temperature compensated; tuning meter; thirteen tubes; separate speaker; a.c. operation.

Radio Mfg. Eng. RME-45: Six bands, 550 kc. to 33 mc.; NBFM adapter available; crystal filter; tuning meter; nine tubes; separate speaker; a.c. operation.

Hammarlund HQ-129X: Six bands, 540 kc. to 31 mc.; bandsread tuning; crystal filter; tuning meter; eleven tubes; a.c. operation.

\$250-\$375 Class.

Hallicrafters SX-42: Six bands, 540 kc. to 110 mc.—FM on two top channels; bandsread tuning; crystal filter; temperature compensated; tuning meter; separate speaker; fifteen tubes; a.c. or battery operated.

National NC-2-40D: Six bands, 490 kc. to 30 mc.; bandsread tuning; crystal filter; temperature compensated; tuning meter; separate speaker; twelve tubes; a.c. operation.

National NC-183: Four bands, 540 kc. to 31 mc., plus 48-56 mc.; band-

spread tuning; crystal filter; temperature compensated; tuning meter; NBFM adapter available; sixteen tubes; separate speaker; a.c. operation.

National HRO-7: Ten bands, with plug-in coils, 50 kc. to 35 mc.; bandsread tuning; crystal filter; temperature compensated; tuning meter; separate speaker; twelve tubes; separate a.c. power supply; adaptable to battery operation.

Collins 75A-1: Double-conversion superhet for six ham bands only; bandsread tuning; crystal filter; temperature compensated; tuning meter; separate speaker; fourteen tubes; a.c. operation.

You will probably ask, "how about one of the surplus receivers offered at low prices?" Most of these receivers are excellent, but the military requirements differ considerably from those of ham operating. The surplus receivers had to operate under all types of conditions, and consequently are very rugged in construction. However, in most cases the selectivity is not as good as desired for ham use. Military transmitters were frequently of the v.f.o. type with slight chirp or drift and the maximum selectivity of a ham receiver was not usable.

In addition, few of these military receivers covered the broadcast or 28 mc. band. While the broadcast band is not needed, the inclusion of the 28 mc. band is a "must" for most hams. These receivers are also of the general coverage type, and do not have adequate bandsread.

An "S" or similar meter is also desirable for most hams, as well as a crystal filter. While some of the surplus jobs have crystal filters, these are not of the proper characteristics for optimum use, and usually require some alteration to have maximum usefulness.

Many of the surplus units are designed for d.c. operation and require the addition of an a.c. pack.

Among the most popular surplus jobs are the BC-348, BC-224, BC-342, and BC-312. The BC-312 and BC-224 are designed for 12 volt d.c. operation, the BC-348 for 28 volt d.c., and the BC-342 for 117 volt a.c.

(To be continued)

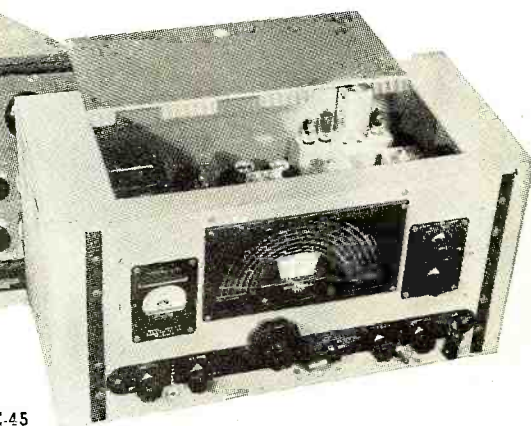

A Low-Power Rig for C.W. or FM Phone

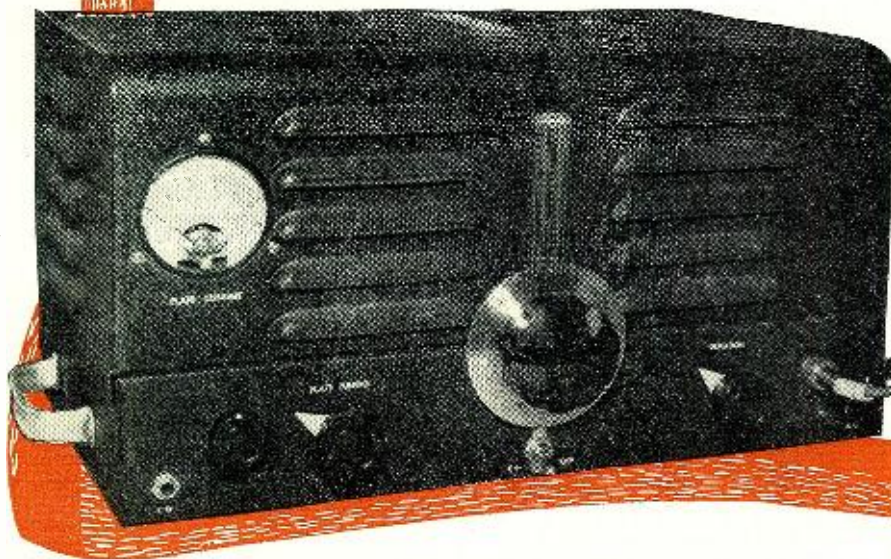

Front view of completed utility transmitter. The meter is mounted with the flange inside the cover. Function switch is directly below the meter. The shielding afforded by use of this chassis will be of interest to amateur operators living in districts where TVI is a problem.

By **OTTO L. WOOLLEY, W0SGG**

This utility transmitter provides v.f.o. controlled c.w. on the 80 and 40 meter bands and v.f.o. controlled NBFM phone for 20 and 10 meters. For c.w. operation the oscillator is keyed, providing for break-in on the operating frequency. The power input to the final amplifier is only 45 watts.

A RIG of this type should be ideal for the newcomer to the ham bands. It can later be used as an exciter for a higher powered final. For field day operation, a low power, compact, flexible rig is useful, and there are many occasions in every ham shack when an extra small transmitter can be used to advantage.

The circuit is conventional and straightforward. Tube lineup consists of a 6SJ7-6J5 speech section, 12A6 oscillator, 12A6 buffer-doubler and 807 final amplifier. The power supply uses a 5Z3 rectifier and a VR150 voltage regulator.

The v.f.o. is an ECO, modulated for FM by the resistance variation method. This type of FM is extremely simple and very easy to get working, as there are no critical adjustments to be made. To provide a stable load for the oscillator, broadband, slug-tuned coils are used in the plate circuit of the oscillator and doubler tubes. Use of these coils also eliminates the need

for tuning controls for these stages, simplifying construction and operation.

Final amplifier circuit details follow usual practice and require little comment. Screen voltage is obtained from a series resistance. Protective bias is furnished with a cathode resistor, and additional operating bias is supplied by grid resistor R_1 . Series feed is used for the plate voltage to the 807.

The speech section provides sufficient gain for any high-impedance microphone. Excellent reports as to quality of voice reproduction have been consistently received. The audio gain control sets the deviation limit, and this adjustment will be covered in a later paragraph.

Choke input is used in the power supply, and the circuit is arranged to provide sizable d.c. drain without excitation when operating c.w. By limiting the voltage fluctuation in this way, the operation of the entire unit is fur-

ther stabilized, an important consideration with any v.f.o. controlled transmitter. Ample filtering is provided by two 2 μ fd. oil condensers in conjunction with the smoothing chokes. Two additional 8 μ fd. electrolytics are employed to further reduce the ripple in the oscillator and speech sections.

An amplifier foundation chassis, 10" x 17" x 3", with cover, is used to house the rig. The parts layout is apparent from the photographs, the speech and r.f. tubes occupying the front edge and one side, with the power supply in the remaining area. Heavy bus wire is run adjacent to all sockets, and all ground returns are made to this bus. This insures more satisfactory ground returns than might be possible with the steel chassis.

Filament and d.c. leads are run around the edges of the chassis. Shielded cable is used for the audio leads as shown in the schematic. All components associated with the v.f.o. are rigidly mounted and wired, and this same attention should be given to the audio coupling condenser C_1 and condenser C_2 .

All final amplifier components are mounted above the chassis to provide better isolation. The tuning condenser is driven by an extension shaft and dial cord to provide a more uniform control layout on the front panel than would be possible with direct drive.

The meter measures the cathode current of the 807. This is the only meter necessary because all other cir-

cuits are tuned by the broadband coils and, after the initial adjustment, will require no further attention. A small two-wire connector in the meter leads allows the chassis cover to be removed when desired. However, the leads are of sufficient length so that the cover may be upended and the coils changed without disconnecting the meter.

Located on the front edge of the chassis are the key jack, function switch, plate tuning, v.f.o. tuning, "B+" control switch, deviation control, microphone input, and pilot lamp. On the rear edge of the chassis are the r.f. output terminals and the a.c. connector. The fuse holder is mounted inside the rear backdrop, near the filter chokes. All the smaller condensers and resistors are mounted securely by wiring to tie points or unused socket lugs. Long and satisfactory operation will result if all wiring is done solidly and nothing is allowed to hang loose or free.

After the wiring is completed, the plug-in coils for the oscillator and doubler should be resonated at the proper frequencies. Start with the 40-meter oscillator grid coil, G2, (Table 1) and plug the 20-meter coil B, into the oscillator plate circuit. Leave the coil shield off for the time being, and with the aid of a flashlight loop, neon bulb or a wavemeter, run the slug into the coil until maximum r.f. indication is obtained. Now plug the 10-meter coil C, into the doubler plate circuit, and repeat the process. This completes the coils for 10-meter operation.

Now place the 80-meter coil G1 in the v.f.o. grid circuit, and resonate the 40-meter coil A, in the oscillator plate circuit. With the 20-meter coil moved to the doubler plate, the coils are complete for 20-meter operation.

For 40-meter work the 80-meter oscillator grid coil is used with an r.f. choke in the oscillator plate, and the doubler plate using the 40-meter slug-tuned coil. The r.f. choke is mounted in a discarded octal based metal tube and plugged into the coil socket.

For 80-meter operation, a similar choke is also used in the buffer tube plate circuit, except that in this case the choke is shunted by a 6000 ohm, non-inductive resistor. This is necessary to prevent overdriving the final amplifier. If the drive is too great, the resistance should be decreased until the proper range is found. On the higher ranges, the slug-tuned coils may be slightly stagger tuned to accomplish this condition and to keep the drive fairly constant over the entire band. Grid drive should run from 2.5 to 5 ma. on all bands, as measured between R, and ground. If so desired, a 160-meter coil may be wound for the v.f.o. grid and an 80-meter slug-tuned coil used in the plate of the oscillator or doubler.

All coils should be checked with some form of wavemeter to insure that they are resonated at the proper harmonic. If the coils are wound exactly as specified, no trouble should be

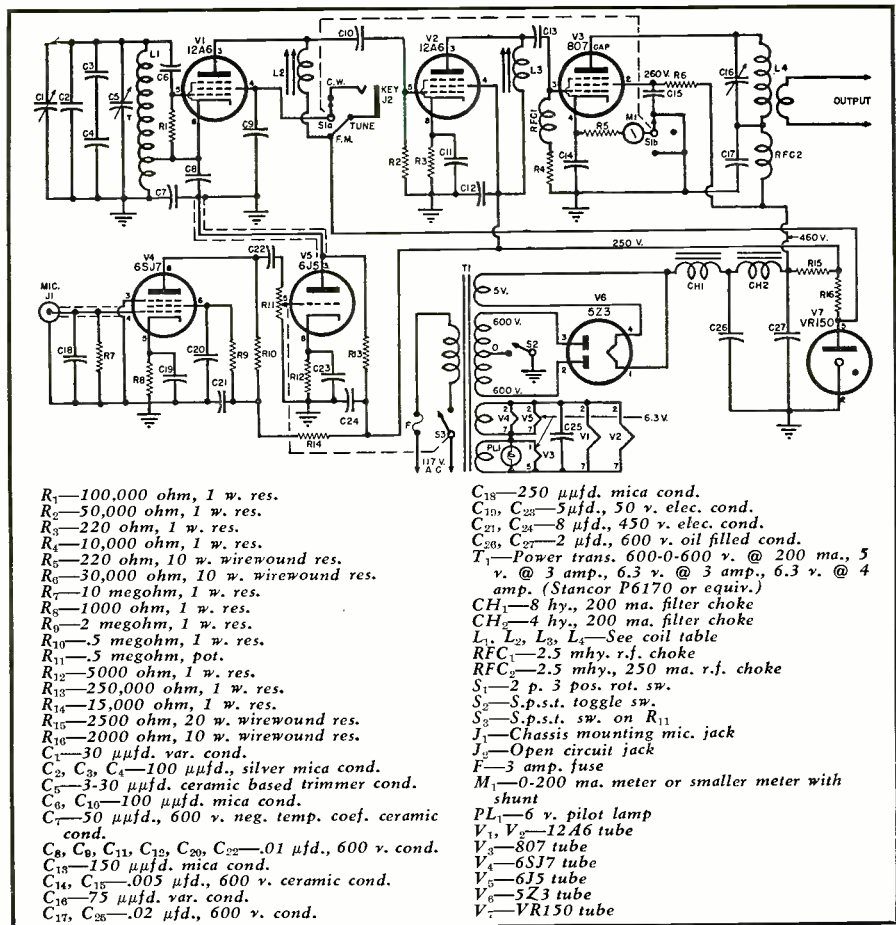

Complete diagram of transmitter, including its self-contained power supply.

encountered in hitting the proper ranges.

The oscillator tuning condenser is a 50 μfd. type with two rotor plates removed, leaving an effective capacity of

about 30 μfd. With the coils designated, the condenser covers from 7.0 to 7.5 mc. with the 40-meter oscillator grid coil G2, and from 3.5 to 3.7 mc. on 80 meters with grid coil G1. The

Looking down on the chassis. The speech tubes, oscillator and doubler tubes are in a line near the front edge. Final amplifier tube and tank components occupy the lower right-hand corner, and the power supply is on the left. The v.f.o. grid coil is mounted in a shield in the center. Pieces of sponge rubber are forced between the coil and shield to eliminate any movement between the two. Note the dial cord drive for the final tank condenser and chassis cutout for oscillator tuning condenser. Connector socket for the meter leads is in the upper right-hand corner.

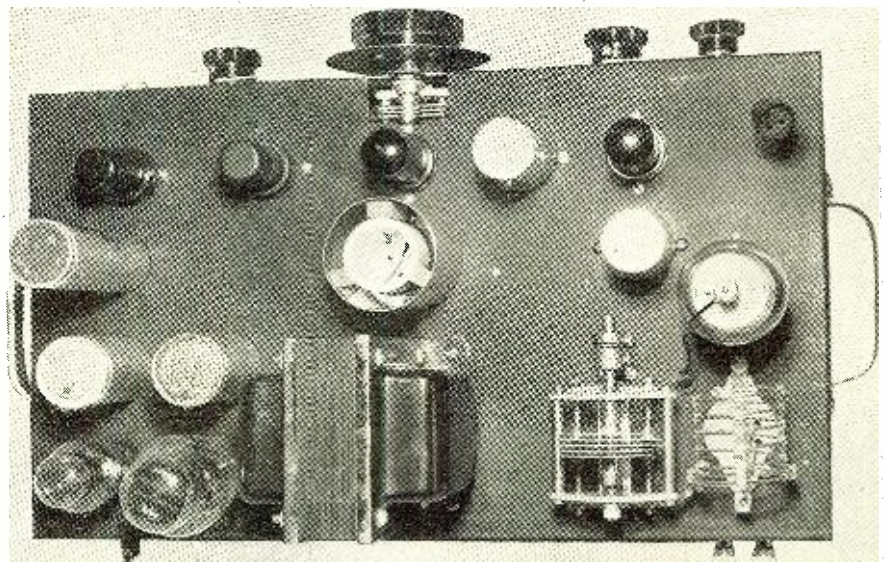

BAND	L ₁	L ₂	L ₃	L ₄
10 meter FM	G2	B	C	10 JEL*
20 meter FM	G1	A	B	20 JEL*
40 meter c.w.	G1	RFC (see text)	A	40 JEL*
80 meter c.w.	G1	RFC (see text)	RFC (see text)	80 JEL*

Coils A, B, and C closewound with #28 d.s.c. wire on Millen #74001 slug-tuned coil forms.

Coil A—32 turns; Coil B—14 turns; Coil C—6 turns

Coils G1 and G2 closewound with #22 enamelled wire on 1 3/8" dia. 4-prong, bakelite or ceramic forms.

Coil G1—18 turns, tapped 3 turns from ground with 100 μfd. APC air padder mounted in form.

Coil G2—7 1/2 turns, tapped 2 turns from ground, last turn spaced out to center band on dial.

* Coils for L₄ are B & W, 75 watt, JEL series, 5-prong, end link.

Table 1. Details on all coils required to cover 80, 40, 20, and 10 meter bands.

air padder in G1 can be adjusted to cover the top half of the 80-meter band if such operation is desired. The above frequency ranges were chosen to spread the 40 and 20-meter bands as much as possible.

The FM circuit should be checked next, using a 40-meter v.f.o. grid coil with the 20-meter coil in the plate circuit. Connect a suitable microphone, set the deviation control about three-fourths on, and tune in the 10-meter harmonic of the oscillator on the receiver. While speaking into the microphone carefully tune on the side of the carrier until the audio is clear. Various settings of the deviation control should be tried and the best point noted for future reference. After the

rig is on the air, other stations can give satisfactory checks for the best point of deviation. For the model shown, the control is used about two-thirds on for close talking into an inexpensive crystal microphone. Although this FM circuit is very simple, it does an excellent job, and all reports have been most satisfactory. Furthermore, there are no exacting adjustments to be made. There was a small frequency shift without modulation that was found to be due, apparently, to variations in the internal capacities of the 6J5. Condenser C₁ was installed, and very effectively swamps out these fluctuations.

The final check to be made is for drift in the v.f.o. In the initial setup

Underneath the chassis. The grounding bus wire and the extension drive for the final condenser are easily identified. A short piece of 300-ohm twin lead is used to transport the r.f. to the output terminals. The adjusting screws for the slug-tuned forms project beneath their respective sockets. The 3-30 μfd. trimmer used for drift compensation is between the 12A6 oscillator tube and the oscillator grid coil. Ceramic or low-loss bakelite sockets are used for all r.f. tubes and coils.

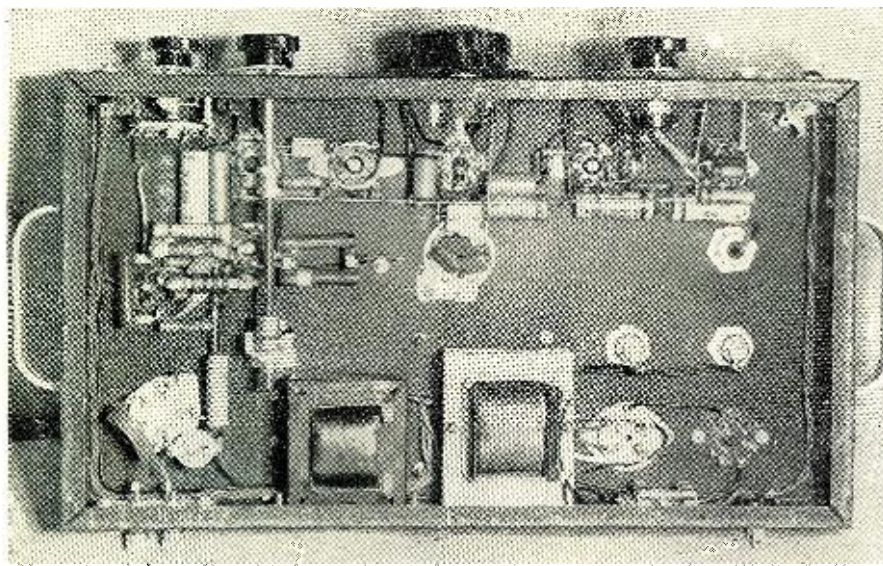

of this rig, a small amount of negative temperature coefficient compensation was installed directly across the v.f.o. grid tank. Drift tests showed the oscillator frequency to be moving higher by an excessive amount. The compensation was reduced by degrees until it was determined that no negative capacity other than C₁ was needed. As a matter of fact, a small amount of upward drift was still present, indicating the need for a very small amount of positive temperature correction. This was secured by wiring the 3-30 μfd. ceramic base trimmer across the v.f.o. grid tank. This condenser is adjusted to provide drift free operation. There is a small amount of drift in the first few minutes of operation from a cold start; however, this is to be expected with a unit where the power supply is located on the same chassis. After a ten-minute warmup run, the v.f.o. will hold zero beat with a crystal oscillator for from thirty minutes to an hour at a time, and over a period of several hours the total drift is well within the audio range. All of these tests were made on 10 meters with the oscillator frequency (and drift) multiplied four times. On 80 and 40-meter c.w., the drift percentage will compare closely with the majority of the better v.f.o.'s on these bands.

The function switch permits spotting the v.f.o. frequency in the receiver and selects between c.w. and FM operation. In the first position, c.w., the cathode circuit of the final amplifier is closed, and the screen circuit of the oscillator is open across the keying jack. Number Two position is for tuning the v.f.o. (for c.w. or FM), and in this position, the final amplifier cathode circuit is open and the oscillator screen circuit is closed, permitting the oscillator to be monitored without putting a signal on the air. The third, or FM, position closes both the final and oscillator circuits, allowing the rig to run normally while being frequency modulated. The "B+" switch may be conveniently used for standby periods when working FM.

Any key click filter that introduces too much lag will produce a chirpy note on c.w. Use only enough filter to reduce clicks to a satisfactory point. Very little should be needed, and an r.f. choke in either or both key leads, at the key itself, should be sufficient.

No trouble has been experienced with the 807 stage in the matter of stability. With the excitation and load removed and the 807 drawing 60 ma. plate current, the final tank condenser can be rotated throughout its range without a flicker of the meter. This is an exacting test for an amplifier.

The rig has been on the air for several weeks feeding a simple two-element beam on ten meters and many satisfactory and enjoyable contacts have been made. The effective use of low power is in a large measure due to the flexibility of v.f.o. control, permitting the operator to select the less heavily occupied frequencies for his use.



International

SHORT-WAVE

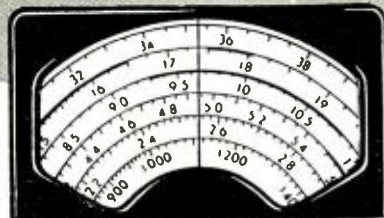

Compiled by **KENNETH R. BOORD**

VENEZUELAN stations have changed all letters, dropping the numerical districts; there also have been some frequency changes, and some new stations have been added. Through the courtesy of Roger Legge, New York, here is a revised list, by channels, calls, locations, and station names:

3.310, YVOG, Trujillo, *Radio Trujillo*—3.330, YVQL, 71 Tigre, *La Voz del Tigre*—3.340, YVMU, Carora, *Radio Carora*—3.360, YVOC, San Cristobal, *Ecos del Torbes*—3.370, YVMI, Maracaibo, *La Voz de la Fe*—3.380, YVQN, Puerto La Cruz, *Ondas del Puerto*—3.400, YVKP, Caracas, *Radio Tropical*—3.410, YVMK, Cabimas, *Radio Cabimas*—3.420, YVOE, Merida, *La Voz de la Sierra*—3.430, YVLI, Maracay, *Radio Maracay*—3.440, YVMC, Maracaibo, *Radio Maracaibo*—3.450, YVQI, Barcelona, *Emisoras Unidas*—3.460, YVLD, Valencia, *Radio Valencia*—3.480, YVLE, Puerto Cabello, *Radio Puerto Cabello*—3.490, YVRA, Maturin, *Radio Monagas*—3.505, YVKX, Caracas, *La Voz de La Patria*—3.515, YVQG, Barcelona, *La Voz de Anzoategui*—3.530, YVKT, Caracas, *Radio Libertador*—3.620, YVLG, Maracay, *Radio Girardot*—4.750, YVMA, Maracaibo, *Ecos del Zulia*—4.760, YVKV, La Guaira, *Emisora Vargas*—4.770, YVMW, Punto Fijo, *Ondas del Caribe*—4.780, YVLA, Valencia, *La Voz de Carabobo*—4.790, YVQC, Ciudad Bolivar, *Ecos del Orinoco*—4.800, YVME, Maracaibo, *Ondas del Lago*—4.810, YVMG, Maracaibo, *Radio Popular*—4.820, YVRC, San Fernando, *La Voz de Apure*—4.830, YVOA, San Cristobal, *La Voz del Tachira*—4.840, YVOI, Valera, *Radio Valera*—4.850, YVMS, Barquisimeto, *Radio Universo*—4.860, YVPA, San Felipe, *Radio Yaracuy*—4.880, YVKF, Caracas, *Ondas Populares*—4.890, YVKB, Caracas, *Radiodifusora Venezuela*—4.900, YVQE, Ciudad Bolivar, *Radio Bolivar*—4.910, YVMM, Coro, *Radio Coro*—4.920, YVKR, Caracas, *Radio Caracas*—4.940, YVMQ, Barquisimeto, *Radio Barquisimeto*—4.960, YVQA, Cumana, *Radio Sucre*—4.990, YVMO, Barquisimeto, *Radiodifusora Occidental*—5.020, YVKO, Caracas, *Radiodifusora Nacional*—5.030, YVKM, Caracas, *Radio*

Continente, and 5.060, YVKD, Caracas, *Radio Cultura*.

* * *

Identification Helps

Radio Indonesia, Makassar, Celebes, Indonesia, announces in Dutch as "Hier is Makassar, *Radio Indonesia*"; in Indonesia, "Disini Makassar, *Radio Indonesia*."

Radio Sofia, Bulgaria, announces in Bulgarian as "Goveri Sofia"; in French, "C'est Sofia qui parle" (literally, "This is Sofia who speaks"), and in English, "This is *Radio Sofia*, calling in the Anglo-American Service of the *Bulgarian Broadcasting System*"; opens with Bulgarian march, and interval is the first four notes of a popular song.

* * *

Leopoldville Data

Here are some further interesting technical notes just received concerning Leopoldville's OTC-2, 9.767.

The Belgian National Broadcasting Service in Leopoldville, Belgian Congo, Africa, uses a 50 kw. transmitter of RCA manufacture. All the high-frequency stages of the transmitter are in duplicate, thus allowing, among other things, for an almost instantaneous change of wavelength. The filaments of all the lamps are fed by alternating current, and the grid and anode voltages are supplied by four rectifiers; thus, all motor generators

Headquarters of Radio Batavia. Batavia, Indonesia (Dutch East Indies), which now has a new 100 kw. s.w. station on the air. Watch for it on 15.15 during the daily English period. 0600-0700 EST.

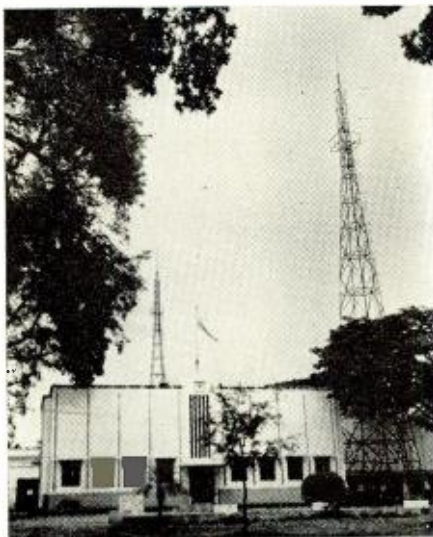

are eliminated. The secondary cooling of the lamps is done by air. The low-frequency stages function by counter-reaction. The transmitter's control system is completely automatic. All switches for relays are gathered at a central desk. The chief characteristics of the transmitter are as follows:

Frequency scale, from 6 to 22 megacycles; stability of frequency, ten parts in 1,000,000; non-linear distortion, less than four per-cent at 1000 cycles, with ninety per-cent modulation; linear distortion, 1.5 db. between 30 and 10,000 cycles with sixty per-cent modulation; ground hum, less than 60 decibels at one hundred per-cent modulation; h.f. harmonics, in conformity with CCIR; power consumed, 135 kw. for an output in the antennae of 50 kw. and average modulation.

The transmitter is used in conjunction with rhombic antennas whose performance does not depend directly on the frequency. To beam broadcasts in several directions simultaneously, these antennas are connected in series. Excellent results have been obtained from this method.

The complete set-up of the Leopoldville station consists of three units—the broadcasting studios and offices, which are in the center of the city; the reception center, about five miles outside; and the transmitting station, about two miles outside. Programs from the studios are sent by land-line to the transmitting station. Relays picked up by the receiving center can either be fed to the studios, to be mixed with the remainder of the programs, or sent direct to the transmitting station.

* * *

BBC Reporting

While the BBC does not verify, it does value reception reports highly. Here is an interesting item from *London Calling*, passed along by Stanley J. X. Worris, N. Y., concerning reports to BBC:

"Reports on reception covering a period of at least one week—and given, if possible, in GMT—are preferred, as the most useful information that is derived from regular listening. But if you are unable to listen to a complete program, reports on conditions over shorter periods are still valuable. A three-figure code has been devised to simplify such reporting.

"The first figure indicates the 'sig-
(Continued on page 101)

(Note: Unless otherwise indicated, all time is expressed in American EST; add 5 hours for GCT. "News" refers to newscasts in the English language. In order to avoid confusion, the 24 hour clock has been used in designating the times of broadcasts. The hours from midnight until noon are shown as 0000 to 1200 while from 1 p.m. to midnight are shown as 1300 to 2400.)

A CATHODE FOLLOWER V.T.V.M.

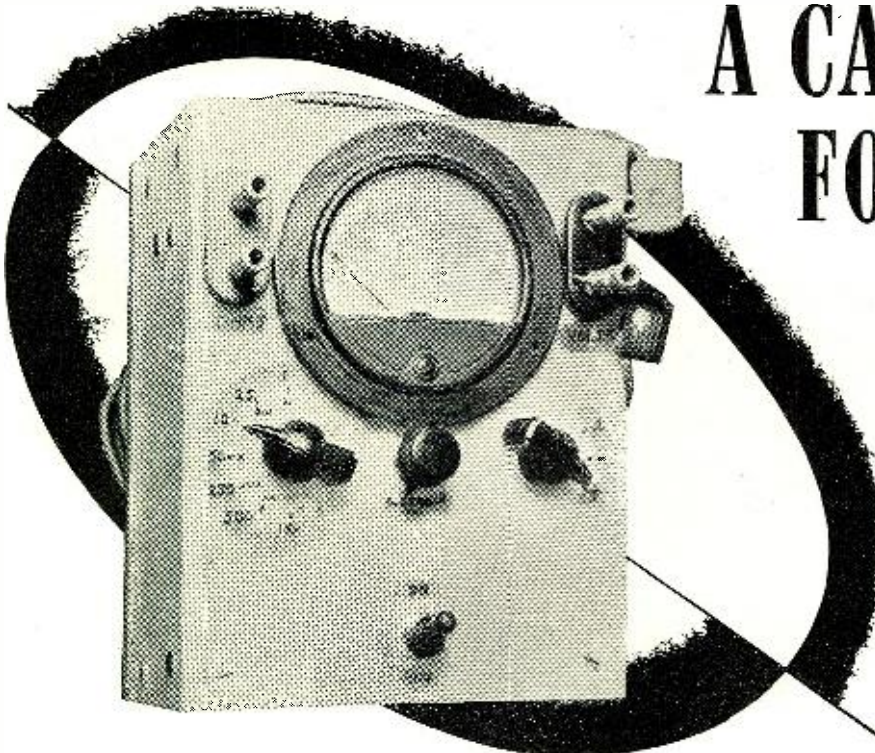

Panel view of home-built unit.

By ERNEST J. SCHULTZ

In addition to the cathode follower v.t.v.m., this unit incorporates resistance ranges from X 1 to X 1 million.

THE present trend in the design of electronic voltmeters is to use a bridge type circuit consisting of two or more tubes with a sensitive microammeter as an indicator. Due to limitations of the usually encountered bridge circuit, it is rare to find a v.t.v.m. of this type with full-scale sensitivities below three volts. Through the use of the simplified cathode follower circuit herein described, it is possible to more than duplicate the performance of the more complicated bridge type v.t.v.m.'s achieving a one-volt full-scale sensitivity without attendant difficulties. Not only is the one-volt sensitivity obtained, but the indicating device used is the cheap, more rugged 0-1 d.c. milliammeter.

The cathode follower, well known for its high input impedance, is ideal in a voltmeter application used for measurements where minimum loading is an essential characteristic. Furthermore, freedom from "zero-set drift" after a warm-up, the same zero set regardless of open or shorted test circuit prods and good linearity are inherent qualities of the cathode follower v.t.v.m. The practical v.t.v.m., as pictured in the accompanying photographs, is built around a triode-connected 35L6 serving as the cathode follower. The plate and filament voltage is supplied by a twenty-four-volt low-current filament transformer. The twenty-four-volt potential is rectified with a selenium rectifier of the type used in a.c.-d.c. receivers to supply the plate voltage. Adequate filtering is realized with a single high-capacity electrolytic across the rectifier output.

The transformer, while not a standard item, is readily available from surplus supply houses as the voltage was quite commonly encountered in service equipment. The smallest physical size to be had is the prime factor to consider in selecting the transformer, as the current demand is extremely modest, and even a 500 ma. transformer is more than adequate. If the constructor desires, an ordinary 6.3 volt 1.2 amp. transformer could be rewound to deliver twenty-four volts. The current drain is so low that more turns of a much finer wire could be

(Continued on page 94)

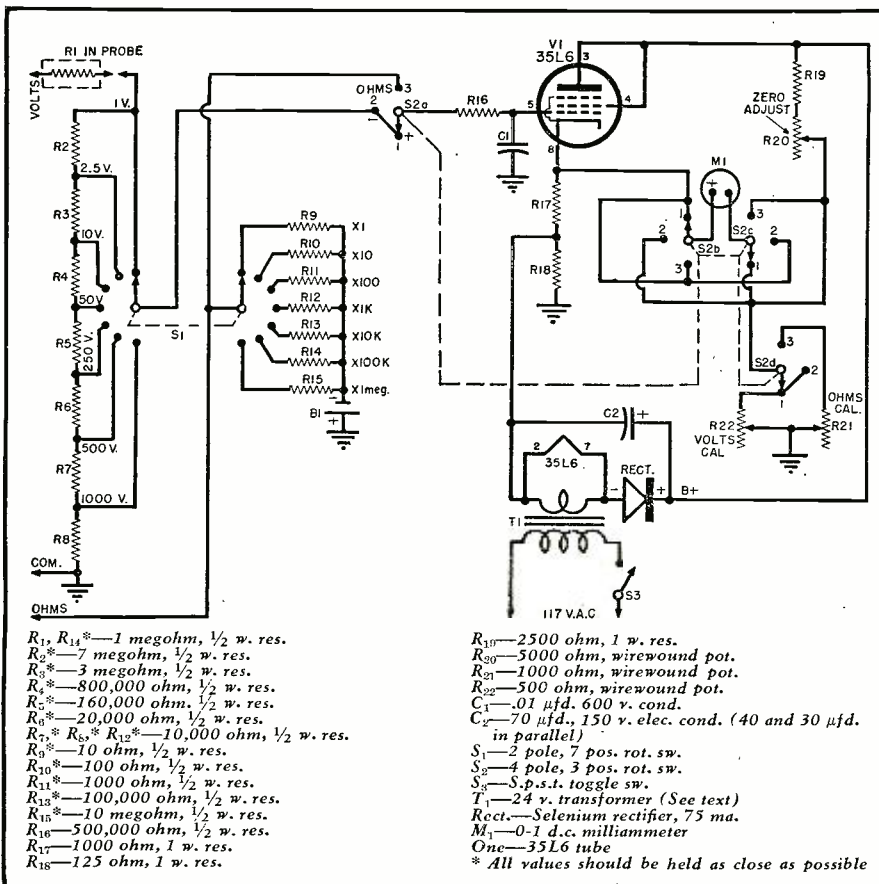

The 35L6 tube is used as a cathode follower in this v.t.v.m.-ohmmeter. The v.t.v.m. circuit as it is shown in diagram can be used only for d.c. voltage measurements.

The Television RECEIVING ANTENNA

By **B. V. K. FRENCH**
Exec. Staff, Howard W. Sams & Co., Inc.

Part I. Practical details on the design and operation of conventional TV antennas—including basic analysis of v.h.f. wave propagation.

THE satisfactory performance of a television receiver is more dependent on the efficiency and placement of the antenna and lead-in than on any other single factor encountered in the installation and maintenance of the set.

Receiving antennas for television are far more critical in performance and play a more important role in the production of satisfactory television reception than do the antennas employed for ordinary sound or FM reception. Sets for AM or FM sound reception are sufficiently sensitive, and the broadcast signal strength is sufficiently great, to render the use of outside antennas unnecessary in most instances.

The design trend of the last few years has been to incorporate the antenna within the receiver cabinet. A loop is normally employed for the broadcast band and a simple half-wave "dipole" or "doublet" for the FM band. Reception with such a simple installation is usually satisfactory except when the receiver is located in a steel building.

It is seldom possible to operate a television receiver without an outside antenna. An exception to this statement would be the case of a receiver operating in a position close to the transmitter, and where reception of only the single station is required.

Many unique factors exist in television wave propagation which are not encountered, to as great a degree, in other forms of broadcasting. A discussion of these factors will assist the television service technician in understanding the nature of the major problems which will be experienced, and in arriving at the best compromise solution under each particular condition.

The elements of the antenna problem which must be considered are:

1. The nature of radiation and propagation of radio waves in the television bands.

2. Horizontal versus vertical polarization of television waves.

3. The wideband nature of the television channel and its relation to the

susceptibility of the system to noise.

4. "Ghost" images due to multiple signal paths caused by the reflection of the signal from buildings, mountains, hills or other obstructions.

5. "Ghost" images due to "mismatch" between the impedance of the transmission line (lead-in) and the antenna or receiver input circuit. (Reflections in the line.)

6. The necessity for special types of antennas to achieve a desired directional reception pattern.

7. "Wideband" antennas to allow reception of stations widely separated in the television frequency spectrum.

8. Problems peculiar to "fringe" reception. (Reception of stations beyond the limits of the "primary service" area.)

Wave Radiation and Propagation

In our study of the nature of the television channel, with its vestigial amplitude modulated video and frequency modulated audio components, we have seen that a channel width of 6 megacycles is required for high definition television. The modulation process requires that the carrier frequency be made at least ten times the top modulating frequency. For this reason, the carrier frequencies of the television transmitters have been assigned in the portion of the radio spectrum above fifty megacycles.

The standard classification of the part of the spectrum between 30 and 300 megacycles is v.h.f. (very high frequencies). The propagation characteristics of v.h.f. waves are considerably different from those of the lower frequencies employed for sound broadcasting. A review of the manner in which radio waves travel from the transmitter to the receiver, as the frequency of the carrier is increased, will be helpful in understanding some of the transmission phenomena which occur in the television bands.

After a radio wave has traveled several wavelengths from the transmitting antenna, it will be found to consist of two components: an electrostatic field and a magnetic field.

These two fields consist of "lines of force" at right angles to each other. The energy in the radio wave is divided equally between these two traveling, alternating fields. Fig. 1 shows a graphical representation of part of the wave front of an electromagnetic wave in space. Since the wave is traveling in all directions from a point source (the transmitting antenna), the lines of Fig. 1 represent a small portion of a spherical surface.

Wave Polarization

The direction of the lines of force of the electrostatic component of the wave defines the direction of polarization. In the graph of Fig. 1, these are the solid horizontal lines, and such a wave is said to be "horizontally" polarized with respect to the earth's surface. If the direction of the electrostatic lines is perpendicular to the earth's surface, the wave is said to be "vertically polarized."

In the v.h.f. portion of the spectrum, utilized for television, the plane of polarization of the transmitted wave is the same as the position of the transmitting antenna with respect to the earth's surface; that is, a vertical antenna produces vertically polarized

Fig. 1. Graphical representation of a horizontally polarized electromagnetic wavefront.

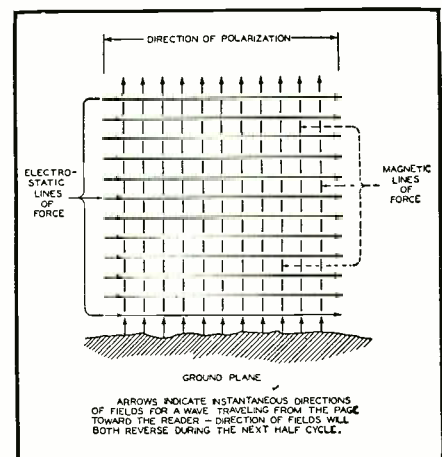

waves, and a horizontal antenna produces horizontally polarized waves. Television broadcasters in the United States have adopted horizontal polarization, and this type is becoming standard for television transmission.

The reasons advanced for the choice of horizontal polarization are:

1. Many types of "man made" interference as well as interference from other radio communication transmitters are vertically polarized, and the horizontal polarization of the receiver antenna helps to reduce interference from these sources.

2. Horizontally polarized waves suffer less loss or "attenuation" when reflected from the earth or passing through the atmosphere.

Wave Paths Between Transmitter and Receiver

Radio waves of different carrier frequencies follow different paths between the transmitter and the receiver. The waves themselves are basically the same and would act alike in free space (beyond the atmosphere of the earth). The effect of the earth's surface, the nature of the earth's atmosphere, and the presence of objects comparable in size to the length of the wave modify the transmission path as the frequency of the wave is changed.

The paths which radio waves follow can be classified generally in two main groups: ground waves and sky waves.

The ground wave group, which is of main interest to us in our consideration of television transmission, can be further subdivided into: a "direct" wave, a "surface" wave, and a "space" wave.

The sky wave, which accounts for long distance reception on the lower frequencies such as the broadcast and short-wave bands, is "bent" back to the earth by ionized "layers" or "strata" in the earth's upper atmosphere. Fig. 2 shows this type of transmission. The ionized "layer," which consists of atoms and molecules of the air (principally nitrogen and oxygen), acts like a mirror at the "virtual" height "X." (See Fig. 2.) In reality the wavefront is steadily bent as it passes into regions of gradually increasing free electron density and emerges toward the earth as though it had been reflected. The amount of bending which a wave will encounter is a function of the wavelength. For each wavelength there exists a critical angle (see (B) of Fig. 2) at which the wave will pass through the "layer" and not return to the earth. Frequencies of more than 30 to 40 megacycles are not returned by the ionosphere, except under unusual sporadic conditions, and therefore this type of wave path cannot be depended upon for television transmission.

Line-of-Sight Transmission

The action of frequencies in the range above approximately 40 megacycles is often termed "quasi-optical" since the waves act in a manner simi-

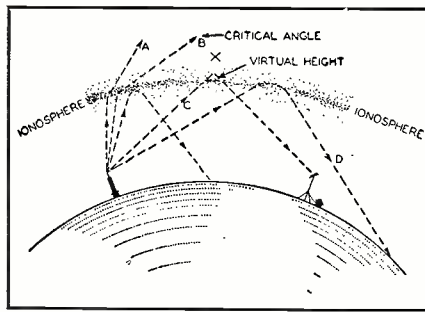

Fig. 2. Bending of radio waves reflected back to the earth from the ionosphere. This occurs at frequencies below 40 mc.

lar to light rays. (Quasi means "as if" and optical means "light" in Latin.) Radio transmitters operating in this frequency range, such as television stations, employ as high an antenna structure as practicability and economics will permit.

The radio carrier waves leaving the antenna act in a manner similar to the rays of light which might be produced if a powerful electric light were to be mounted on the top of the antenna mast. The curvature of the earth would cut off these light waves at the horizon. The horizon distance can be extended by erecting a tower for the observer of the light.

Waves emitted by transmitters in the television bands exhibit this "line-of-sight" action as shown in Fig. 3A. In the case of the radio waves, however, the cut-off at the horizon is not sharply defined. In traveling through the air, the wave is bent or "refracted" slightly toward the earth and the v.h.f. radio horizon is considered to extend some fifteen per-cent beyond the "line-of-sight" or optical horizon. Beyond this radio horizon the strength of the signal decreases very rapidly.

Fig. 3B shows, by means of a "nomograph" chart, the effect of the height of the transmitting and receiving antennas on the optical horizon (shown at X) and the radio path horizon (shown at Y). This chart is calculated for a smooth, spherical earth. If the transmitting and receiving antennas are at different relative heights above sea level, this difference should be taken into account in calculating the radio path horizon. The presence of large intervening objects such as buildings or hills can reduce seriously the signal level and thus the range of satisfactory reception. Fig. 3B indicates the advisability of locating the receiving antenna as high as possible.

Television Channel Wavelengths

In the range of frequencies assigned to television transmission (54 to 88 mc. and 174 to 216 mc.) the length of the electromagnetic wave in space is small when compared with the size of obstructions such as buildings. This accounts for some of the peculiar transmission phenomena encountered, which will be described when we examine the effect of reflections. Another consequence of the short wavelength, on the "credit side of the ledger," is the fact that highly efficient

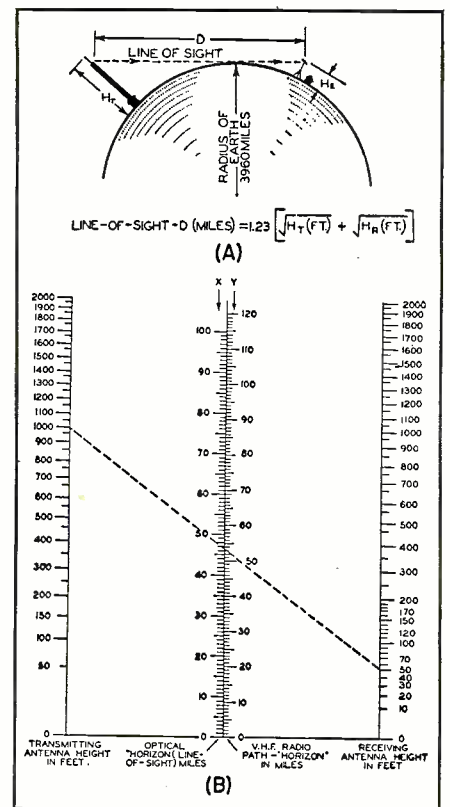

Fig. 3. V.h.f. path length as a function of height of transmitting and receiving antennas. (A) Line-of-sight. (B) Theoretical maximum line-of-sight path chart. The v.h.f. radio path is equal to the optical horizon distance times 1.156. Example: Transmitting antenna, 1000 feet high; receiving antenna, 50 feet high; optical horizon, 46.5 miles—the v.h.f. wave path is then equal to 53.5 miles.

antennas, which are "resonant" to the wavelength and possess directional characteristics, can readily be constructed.

For these reasons, it will be instructive at this time to review some of the fundamental relationships between the frequency of an electromagnetic wave and its wavelength. It will also be valuable for the television service technician to become familiar with the actual wavelengths, in feet, of the television carrier frequencies of stations in his locality, since the wavelength is directly related to the size of the antenna structure required.

All electromagnetic waves (cosmic waves, x-rays, ultraviolet waves, light, infrared and radio waves) travel through space with the same velocity or speed. This velocity has been quite precisely measured as 299,796,000 meters-per-second. For our purposes, this figure can be "rounded off" to 300,000,000 meters, or 186,000 miles-per-second.

The distance in space which an electromagnetic wave travels in one cycle (360° of its sine wave oscillation) is called one wavelength. Fig. 4 shows the relationship of wavelength, velocity and frequency. It will be seen that, when the velocity is expressed in feet-per-second and the carrier frequency in cycles, both numerator and denominator of the fraction can be di-

vided by one million, and the simple expression, 984 divided by the frequency in megacycles, results. The wavelengths encountered in the television bands lie between four and twenty feet.

A handy "rule-of-thumb" which is apparent from Fig. 4 is that the television wave travels approximately 1000 feet in one microsecond (actually 984 feet). This information is of value in determining the effect of reflections of the wave from objects.

Bandwidth and Antenna Problems

We have seen that television requires an extremely wide band to accommodate the video modulation and sound. One of the "axioms" or principles of electrical communication, when employing amplitude modulation, is that the noise susceptibility of a system is proportional to its bandwidth. This situation is aggravated by the fact that automobile ignition systems produce interference which, due to the length of the spark plug wiring, is tuned in the television bands.

Fortunately the radiated interfering field drops rapidly with distance from the car. If the antenna system is relatively high, not sensitive to vertically polarized waves and has a balanced lead-in system, the effects of this, and other types of man made interference, can be reduced. This con-

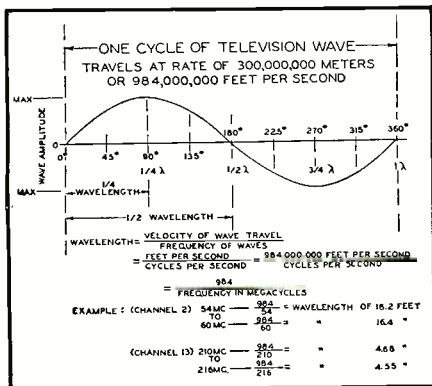

Fig. 4. Relation of carrier frequency to the wavelength of television channels.

consideration is an added reason for the installation of an efficient antenna.

Multiple Path Transmission "Ghosts"

Before considering the television antenna itself in detail, it will be instructive to examine some of the distortions of the picture which are caused by vagaries of the transmission path and to determine their causes. The expedients of antenna design to overcome or alleviate these defects will then be discussed.

Fig. 5A shows a set of conditions which might occur in the residential section of a city. The direct signal arrives at the receiver over Path A (assumed to be 10,000 feet from the transmitter). At a distance of 12,800 feet from the transmitter, an office building acts as a "mirror" and re-

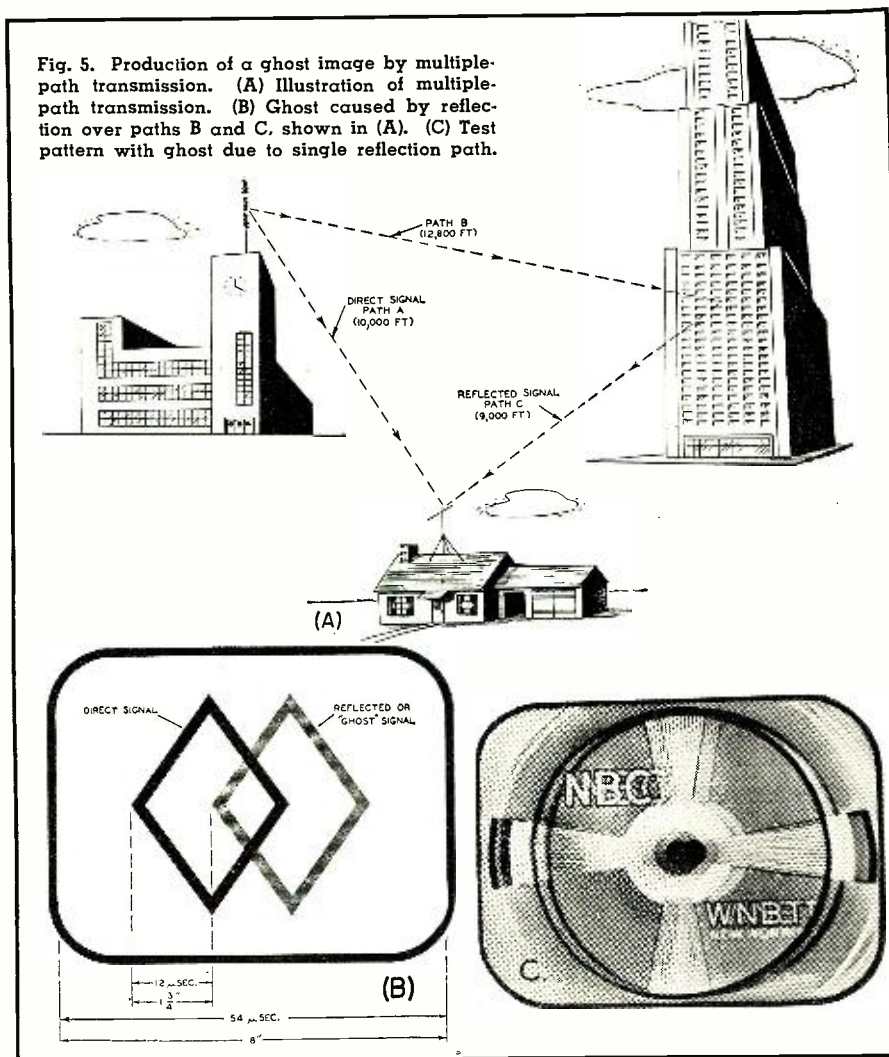

flects the signal to the receiver over Path C (9000 feet). The combined Path B plus C is 21,800 feet. This reflected wave path is 11,800 feet longer than the direct path. We find from the wavelength-frequency relations of Fig. 4 that the wave travels at the rate of 984 feet-per-microsecond. In this instance the reflected wave will arrive 11,800/984 or 12 microseconds later than the direct wave.

Fig. 5 shows the effect of the delayed or "ghost" signal on the picture. An analysis of the horizontal scanning time relations will serve to explain the image displacement. Approximately 54 microseconds elapse during active scan of one line. On a ten-inch tube, the horizontal dimension of the picture is about eight inches. The signal arriving over Paths B plus C requires twelve microseconds more than the direct path, and during this time scanning will have advanced one and three-quarters inches. Thus, a second image, due to the reflected wave, will appear displaced from the main image as shown. In general this "ghost" image will suffer some loss of signal strength due to imperfect reflection and absorption of energy and will therefore be less intense than the image caused by the direct signal.

Fig. 5C shows the appearance of a

"ghost" of the type just discussed, as photographed from a television receiver with the station test pattern as a subject. In the example just discussed and in Figs. 5B and 5C the ghost is caused by a single reflection. In many cases a series of overlapping ghost images will appear due to multiple reflections from a number of buildings or other obstructions. When such multiple ghost images arrive over paths only slightly longer than the direct signal path, the effect on the picture is to "widen" lines and obscure the fine detail. Since this "smears" the picture, it has become known in television slang as a "smear" ghost.

The types of ghost images just discussed are all positive in nature. By this is meant the fact that a black line in the picture will be represented by a black line in the ghost and conversely, white picture elements will be followed by a white ghost. A negative ghost (see Fig. 6) can be caused by reflected signals which arrive at the TV antenna in such phase as to cause partial or complete cancellation of portions of the video modulation envelope. These can be caused by re-radiation of the carrier from metal objects which are of a size comparable to the wavelength of the video carrier

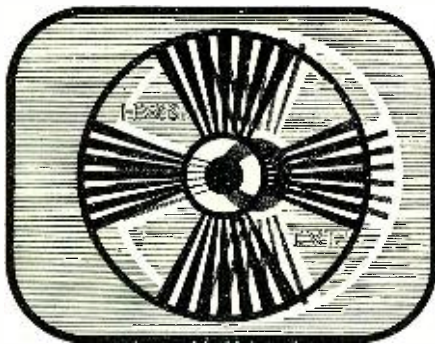

Fig. 6. Negative ghost that is caused by a partial cancellation of the carrier.

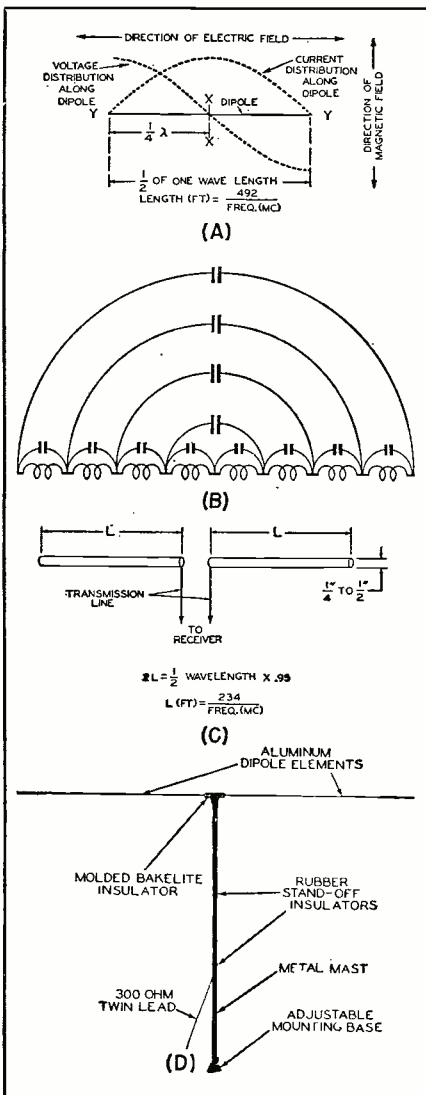

Fig. 7. The half-wave dipole antenna. (A) A theoretical dipole. (A very thin wire isolated in space.) Length equals one-half of carrier wavelength. (B) Electrical circuit equivalent of the dipole. (C) A practical receiving dipole. (D) Commercial form of dipole antenna.

frequency affected. A similar effect can be caused by defects in the video amplifier.

Elimination of ghost images, or their reduction to such a point that they are no longer objectionable, is accomplished by making use of the directional properties of certain types of antennas. The theory and appli-

cation of such antennas will be covered next month in this series.

In certain urban locations the receiving location is shielded by buildings from a direct line-of-sight signal from the transmitter. In this case, one of the reflection paths will often produce a stronger signal than the "shadow" of the direct path. The antenna, in this case, is "beamed" to accept or favor the strongest reflected signal. The dominant reflection is then considered to be a "substitute" primary signal, and the direct path produces a ghost which must be suppressed.

Reflections in the Lead-in Line

The resonant type of antenna employed for television requires a special type of lead-in. This lead-in or transmission line consists of either a "parallel wire" line, a "twisted pair" line, a shielded "twisted pair" line or a "coaxial" (concentric) cable.

The reasons for these special types of lead-ins are twofold: to transfer the maximum amount of energy from the low-impedance type antenna to the first tube input in the receiver, and to restrict signal pickup to the antenna only.

Maximum energy transfer of the intercepted signal from the antenna to the input amplifier of the television receiver requires that the "characteristic impedance" of the line be matched to the impedance of the antenna and the impedance of the receiver input circuit. The various types of lead-in constructions and their application will be covered in greater detail later. At present we will consider the effect of line mismatch in the production of ghost images.

When the impedance of the transmission line is considerably different from that of the antenna or the receiver input, energy will be reflected from the receiver, back to the antenna, and back to the receiver again. This will produce a ghost image when the reflection reaches the receiver. Unless the mismatch is of considerable degree, only one secondary or ghost image will be produced.

In the case of ghost images caused by line mismatch, only a small displacement of the image occurs due to the relatively short length of the transmission line. If the length of the lead-in is less than seventy feet, the ghost will be so close to the main image that the eye cannot distinguish it as a separate image. The horizontal resolution is impaired in this case, and the image appears to be improperly focused.

It is possible to distinguish between a ghost image due to line reflection and one due to reflection by some object. If an assistant rotates the antenna while the service technician watches the image, it will be found that a ghost due to line mismatch will not change. If, on the other hand, the ghost is due to a reflected path it will change in intensity with respect to the main image, due to the directional characteristic of the antenna.

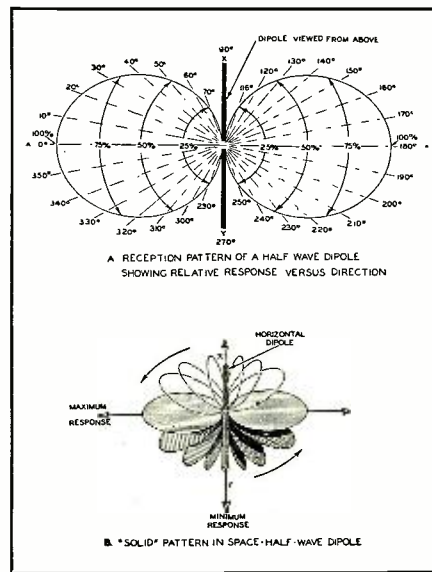

Fig. 8. The reception pattern in space of the basic half-wave dipole antenna.

The Half-Wave Dipole Antenna

Having reviewed the nature of wave propagation and some of the basic phenomena of transmission of television signals, we are prepared to examine the types of antennas which have been developed to cope with the problems encountered.

Since the advent of commercial television in the United States, there has been no single phase of television development which has seen more concentrated activity than the search for types of antennas to meet the requirements. Among the desirable characteristics are: more uniform response or higher pickup and sharper directional pattern. New antenna designs are appearing daily, and the present study will cover basic types and some of the variations which have found widespread use up to this time. The television service technician will undoubtedly find many technical articles on further antenna developments appearing in the radio press from now on.

Practically all types of antennas used for television reception are variations of the basic half-wave dipole

(Continued on page 130)

Fig. 9. The folded dipole. Dimensions (A) and the commercial equivalent (B).

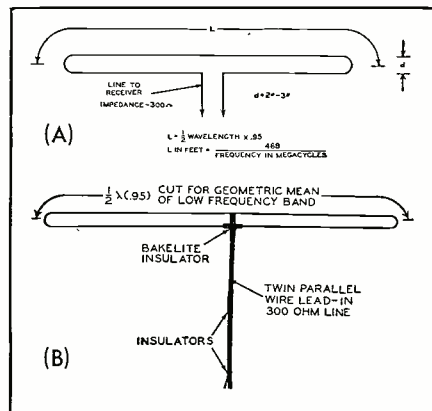

New
hallicrafters
15-in. Custom Installation TV

136 sq. in.
 picture

MODEL T-69

\$259⁵⁰

complete with
 15-in. tube

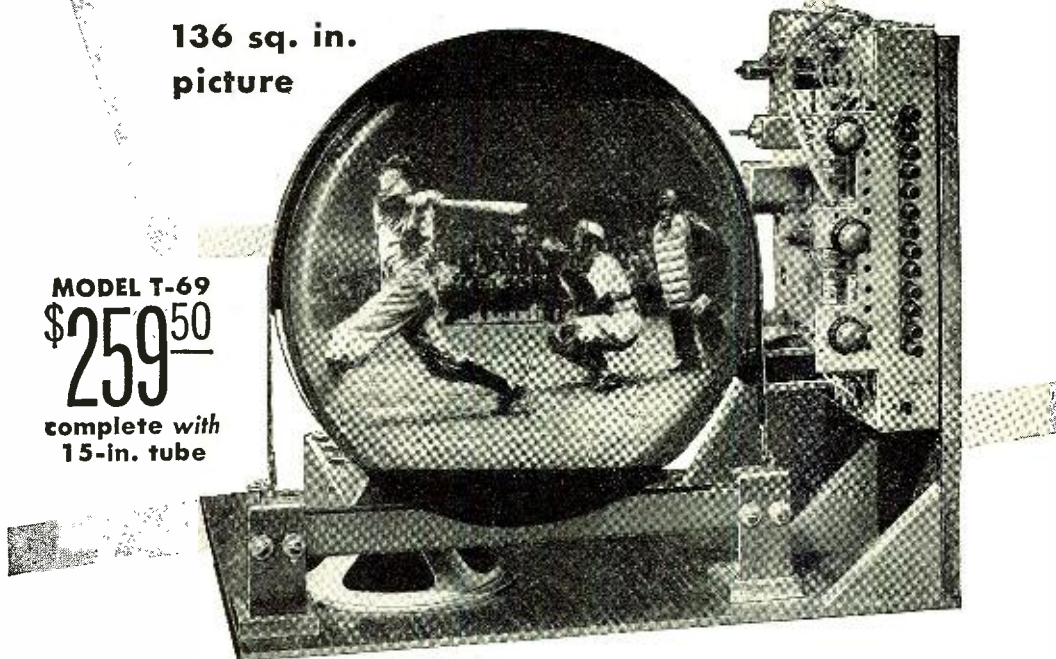

Send for folder of original
 custom-installation designs
 by Hallicrafters.

A new chassis, specially designed for big picture-tube operation. Completely aligned and tested. Regular RMA 90-day guarantee applies to all parts. See your local parts distributor for details.

Other TV Chassis

Model T-64 with 10-inch Tube .. **\$179⁵⁰**

Model T-64 with 12-inch Tube .. **\$199⁵⁰**

the hallicrafters co.

4401 WEST FIFTH AVENUE • CHICAGO 24, ILLINOIS

SOLE HALLICRAFTERS REPRESENTATIVE IN CANADA: ROGERS MAJESTIC LIMITED, TORONTO, MONTREAL

NOW!
BUILD 15 RADIOS \$14⁷⁵
COMPLETE KIT ONLY...

ABSOLUTELY NO KNOWLEDGE OF RADIO NECESSARY
 You Need No Additional Parts
 The **PROGRESSIVE RADIO KIT** is the Only Complete Kit. Operates on 110-120 Volts AC/DC.

Contains everything you need. Instruction book, metal chassis, tubes, condensers, resistors and all other necessary radio parts. The 36-page Instruction Book, written by expert radio instructors and engineers, teaches you to build radios in a professional manner. The circuits are designed to provide excellent performance. Altogether, fifteen circuits are constructed, including 11 receivers, 1 audio amplifier and 3 transmitters.

SPECIAL OFFER—Electrical and Radio Tester sent absolutely **FREE** with each Progressive Radio Kit. Plus **FREE** Membership in the Progressive Radio Club. Entitles you to free expert advice and consultation service with licensed radio technicians. **ORDER YOUR KIT NOW!**

VACUUM TUBE VOLTMETER KIT
 A Professional piece of test equipment you need for FM and TV. Attractive steel case. **\$23.95**
 FREE: Book on Advanced Servicing Techniques.

5" Oscilloscope Kit
AM-FM TELEVISION
 an absolute "must" for today's radio-man. Input Impedance of 1 Meg. and 50 Min. d. Tubes—2-8J7, 2-5Y3, 1-8K4, 1-5BP1. FREE: Book on Cathode Ray Oscilloscope. **\$39.95**

Volt-Ohm-Milliammeter Kit
 simple to construct, inexpensive but accurate. FREE Book on Elementary Radio Servicing. **\$14.95**

SIGNAL TRACER KIT
 an invaluable aid in trouble shooting. FREE: Book on Radio Test Instruments. **\$21.95**

7"-10" TELEVISION KITS
 Factory-built and aligned 13 channel Tuner—18 Tube Kit—7 Tubes. **\$59.50**
 Complete set of tubes, including Cathode Ray Tube. **\$41.58**
 Factory-built and aligned 13 channel Tuner—10" kit, less tubes. **\$82.99**
 Complete set of tubes, including Cathode Ray Tube. **\$55.80**
 Cabinet for 7" or 10" kit. **\$24.50**
 FREE: Television Servicing Notes.

PROGRESSIVE AMPLIFIER KIT

High Fidelity Humless Amplifier complete with five tubes and two selenium rectifiers. FREE: Book on Amplifiers. **\$16.00**

TV SWEEP GENERATOR KIT.....**\$28.95**
 Range—2 Mc.-26 Mc.

SIGNAL GENERATOR KIT.....**\$18.95**
 150 Kc.-34 Mc. Fundamental.
 32 Mc.-100 Mc. Harmonics.

RF SIGNAL TRACER PROBE KIT.....**\$5.50**
 20 cycles—200 Mc.-IN34, N1AL

ECONOMY AMPLIFIER KIT.....**\$5.95**
 simple to build; complete with five tubes. FREE: Book on Amplifiers.

5 TUBE AC-DC SUPERHET KIT.....**\$14.25**
 complete with tubes and cabinet. FREE: Book on Building Receivers.

6 TUBE AC-DC 2-BAND SUPERHET KIT.....**\$17.45**
 complete with tubes and cabinet. FREE: Book on Amateur Radio Building.

7-TUBE AC-DC FM RECEIVER KIT.....**\$29.95**
 complete with tubes and cabinet. FREE: Television and FM Servicing Notes.

4 TUBE SUPERHET PORTABLE KIT.....**\$12.95**
 complete with tubes and cabinet, less batteries. FREE: Book on Unusual Radio Circuits.

Automatic Bike Radio
 Can be mounted on a bicycle, or carried as a personal portable radio. Supplied with all bicycle mounting hardware and telescopic antenna. Anti-theft feature. Less batteries. **\$17.47**

Automatic Car Radio
 6 tubes superhet. Three gang condenser, fits all cars. Easy installation. Mounting brackets included. List price \$39.95. **\$27.97**
 NOW ONLY.....
 Also 5 tube Superhet ONLY..... **\$25.97**

Deuct 2% if full payment accompanies order. C.O.D. orders accepted in U.S.A. Write for further information concerning the above merchandise. Send for our Free catalog.

PROGRESSIVE ELECTRONICS CO.
 Dept. RN-24, 497 Union Avenue
 BROOKLYN 11, NEW YORK

TROOP 510 B. S. A. Starts Ham Program

Scouting and ham radio join forces to their mutual advantage in this training program.

A POSSIBLE new cycle in scouting and certainly a new source of ham operators came into being when Troop 510, Chicago Boy Scouts, launched its Ham Training Course.

From the amateur operator's standpoint, there could come no more enthusiastic group to swell the ham ranks than from these keen, young Americans. From a scouting standpoint, amateur radio operation should indeed be a vital, new part in their program.

The scoutmaster of Troop 510 recognized that scouting, particularly in the metropolitan areas, needs a stimulant—that something out of the ordinary had to be offered the boys in order that they might compete with other organizations offering varied recreations to youth. After a considerable amount of study and research, he decided that ham radio was the one project that offered the type of educational appeal and glamour that would attract and assist in holding boys to the scout movement.

We believe that the scoutmaster has an idea—an idea that will provide that needed spark to scouting—an idea that will bring hundreds of new amateur operators into the fold. For, unquestionably, if the Troop 510 experiment is successful, other farsight-

ed scoutmasters will inaugurate the same program.

Naturally, we will watch this initial experiment with a great deal of interest, for it may well develop into the greatest single source of ham operators. With the cooperation of the scoutmaster, we have arranged to cover the troop's ham program editorially.

Everyone connected with ham radio will undoubtedly watch these program developments with avid interest, as it may prove to be the transfusion that ham radio needs.

Hunting for an Instructor

Finding an instructor willing to take over this group was indeed a tough assignment and an indication of the lethargy that exists among present-day hams. The scoutmaster appealed to several large ham clubs in the Chicago area and found not a single taker. Finally, he secured a list of Chicago hams and started a personal telephone solicitation. After many calls and refusals, he "struck oil."

W9UBT Takes Over

Charles Schram, W9UBT, a former scout and avid ham, thought the project a worthy one and agreed to act as the instructor. Charlie is twenty-four

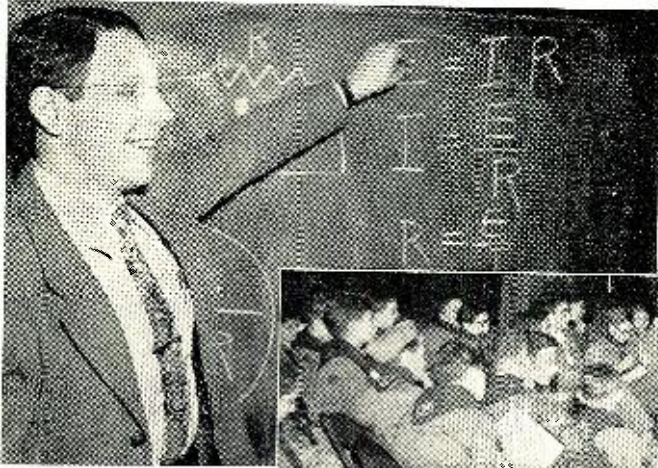

Instruction begins with a thorough grounding in basic theory. Here the instructor is shown driving home some of the finer points in theory and practice of Ohm's law.

A group of students, mostly in full scout uniform, listens attentively as the instructor presents a lecture.



"KEN-RAD TUBES ARE RELIABLE BUSINESS-BUILDERS!"

"To succeed you have to sell reliable merchandise. That's one thing my years in this business have taught me.

"Take Ken-Rad Tubes. I don't mind telling you, I've built a good solid business with these tubes. When I sell Ken-Rad Tubes I know I'm selling dependable tubes that will not let me or the customer down.

"I don't know any other item that's done more to establish my reputation and build my business than Ken-Rad Tubes."

VICTOR A. REITH, Reith's Radio and Television Service, Woonsocket, R.I., insists on Ken-Rad Tubes because he knows—like thousands of other dealers—that Ken-Rad Tubes sell fast and stay sold.



J. H. WORTH, Foreman, Miniature Stem Section, is one of the many supervisors concerned with the comprehensive testing of Ken-Rad Tubes. This testing results in a tube unsurpassed for quality.

"KEN-RAD TUBES HAVE TO BE RELIABLE TO PASS THESE TESTS!"

"There's no tube made that has to undergo more rigid testing than a Ken-Rad Tube.

"It's tested at practically every step in its production.

"For instance, stems are checked every hour in the polariscope (above, left), an instrument used for detecting strain in glass by means of color or line change.

"When the strain pattern is constant, the stems are uniform and one acts like the next in the finished tube.

"Result is a final tube that is more uniform, of better quality.

"Reliable is the word for Ken-Rad Tubes, all right!"



KEN-RAD *Radio Tubes*
 PRODUCT OF GENERAL ELECTRIC COMPANY
 Schenectady 5, New York

THE SERVICEMAN'S TUBE
 . . . backed by profit-making sales aids which your Ken-Rad distributor will be glad to show you. Phone or write him today!

NATIONAL TELEVISION BOOSTER

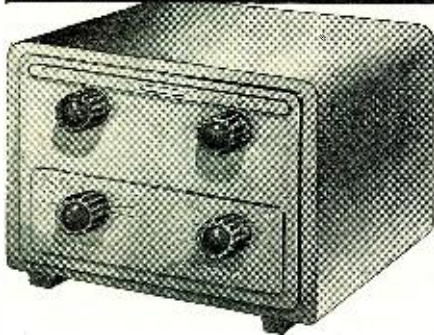

CLEAR BRIGHT PICTURES IN FRINGE AREAS

The new National Television Booster opens up whole new areas to television entertainment . . . makes excellent reception possible far beyond the normal receiving range. Also ideal for use in apartments or other locations where outdoor antennas are either not permitted or not practical. Greatly reduces noise in addition to increasing signal strength.

- A real working RF stage, using separate high-gain 6AK5 tubes for high and low bands.
- Covers all 12 channels.
- Easy to install and operate.
- Fine tuning control assures best possible definition.
- 300 ohm balanced or 72 ohm unbalanced inputs match any antenna.
- Electrostatic shielding.
- Self-contained power supply, 115 volts A.C., 60 cycles, 10 watts.

\$39.95 (Suggested Retail Price)

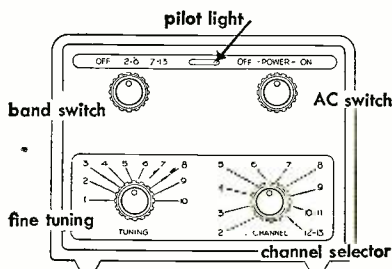

years old and, at present, is a student at the Illinois Institute of Technology. He received his call letters in June of 1941 and his Class A in 1946.

In March, 1943, Charlie joined the Army and was wounded during the Battle of the Bulge. In December, 1945, he received his discharge. He will graduate from IIT in June, and, subsequently, he plans to join the ranks of the benedicts.

Work Begins

On April 4, 1949, forty-five scouts and nine of their fathers attended the first ham class. Of the forty-five, thirty-two were twelve years of age, and the remainder were from thirteen to sixteen years old. The progress of the boys and men in the various age levels will make an interesting study. Instructor Schram devoted the first

evening to orientation, outlining what the course would cover and the instruction methods he would use. He also stated that the class would use as a basic text the series of articles running currently in RADIO & TELEVISION NEWS, titled "The Beginning Amateur," by Robert Hertzberg, W2DJJ.

Component parts of a transmitter, such as tubes, condensers, etc., were passed around in the group, with brief explanations given as to their functions. Schram discussed briefly the plans for the building of a transmitter for permanent installation in the troop room.

The first group of letters from the code was assigned for study at home, and reprints of the first installment of "The Beginning Amateur" were distributed among the scouts for outside reading and study.

-30-

REPLACING 10BP4 TUBES WITH ALUMINUM-BACKED 10FP4

By MATTHEW MANDL

THE 10FP4 picture tube for television receivers has the same socket connections as the standard 10BP4 and will work with the same voltages, but there are some differences which must be observed when replacing one with the other. The 10FP4 has an aluminum coating on the back of the fluorescent material, and this improves contrast and brilliancy. The aluminum coating, however, also acts as an effective trap for ions while allowing the picture forming electrons to pass through. It is for this reason that no ion trapping or beam bending coils are necessary.

In the 10BP4 tubes, both ions and electrons are deflected downward to prevent the ions from reaching the luminescent material on the face of the tube and burning a brown section thereon. Magnets, or beam bending coils, are then placed around the neck of the tube, and the electrons are lifted

upward so that they travel forward and reach the screen. The ions, however, due to their greater mass, are relatively unaffected and are still deflected downward out of harm's way.

When replacing such a tube with the 10FP4 aluminized tube, the ion trap magnets or beam bending coils must be omitted, for electrons and ions within the 10FP4 are not deflected downward as in the 10BP4. Putting an ion trap on the 10FP4 will draw the electrons out of their forward path, and no raster or picture will be visible on the tube face. Ion trap magnet rings can be discarded. Remove the ion trap coils from the tube neck, tape up exposed terminals, and fasten to the chassis. Both the coil and magnet types are normally located between socket and focus coil on the neck of the picture tube.

-30-

Side view of a conventional TV set showing relative position of the ion trap.

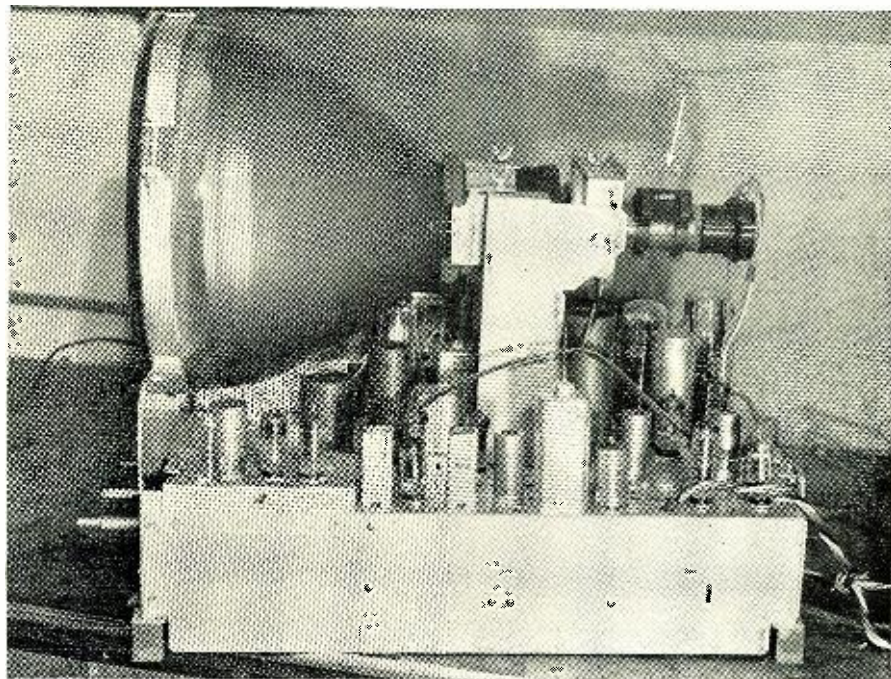



ELECTRONIC BARGAINS for EXPERIMENTERS and HOBBYISTS

ORDER NOW . . . ALL QUANTITIES LIMITED

PE101C BC645 POWER SUPPLY
NO. 273. Complete power supply for BC 645. Operates from 12 or 24 Volts. Supplies both AC and DC required. Shipping Wgt. 13 lbs. Each **\$3.95**

DM 35 12 VOLT DYNAMOTOR
NO. 274. New input 12 Volt at 18.7 Amperes. Supplies 675V at 275 MA or 1/2 above voltage from 6 volts. Excellent for auto use. Shipping Wgt. 11 lbs. Each **\$7.50**

HOME WORKSHOP GRINDER KIT
NO. 230. Easily assembled 110V AC or DC ball bearing fully enclosed motor from Army surplus dynamotor. Purchaser to make simple changes and shaft extensions, detailed instructions and all parts supplied. Motor approximately 5,000 R.P.M. Ideal for tool-post grinder, flexible shaft tool, model drill press, saw. Shipping Weight 6 lbs. **\$3.95**

COLLINS AUTOTUNE CONTROL HEAD
NO. 278. Brand new controls used on the ART/13, 100 Watt, Transmitter. Types 7, 8, 10, and 11 available. Get a spare while available as new cost is over \$22.00 each. Shipping Wgt. 3 lbs. Price any type (mention when ordering). Each **\$4.50**

300 MA SELENIUM RECTIFIERS
NO. 209. Rated 300 MA at 36 Volts, complete with mounting brackets. Shipping Wgt. 1 lb. **3 FOR \$1.00**

1N90 FEED THROUGH INSULATOR
NO. 276. Heavy duty feed through, 2" diameter 4" long, complete with brass hardware and gasket. Shipping Wgt. 2 lbs. **2 FOR \$1.00**

1N86 STRAIN INSULATOR
NO. 277. Husky army type 1 1/4" diameter, 5 1/2" long. Brown porcelain. Shipping Wgt. 4 lbs. **4 FOR \$1.00**

G.E. BC 306 ANTENNA TUNING UNIT
NO. 231. Matches any aerial to 150 Watt transmitter, used on BC 375. Brand new. Add postage for 20 lbs. **\$2.95**

G. E. 1,000 VOLT 350 MA DYNAMOTOR
NO. 213. An ideal dynamotor for mobile operation in taxicabs, police cars, sound systems and amateur stations. Supplies above voltage from 12 Volts or 500V. at 350 MA from 6 Volts. Complete with starting relay, and fuses. New. Our Dynamotor A. Shipping Weight 72 lbs. **\$5.95**

POWER TRANSFORMER Specials
NO. 226. Primary 117V. 60 cycle. Secondaries supply 746 V.C.T at 220 MA, 6.3V. at 4.5 A., and 5V. at 4A. Will handle 13 tube radio receivers. Supply is limited, order early. Shipping Weight 11 lbs. each. **\$3.95 . . . 3 for \$9.95**

T32 TABLE MICROPHONE
NO. 210. One of the Army's best. Built by Kellogg, ideal for factory call system, public address, amateur use. Brand new in original cartons. Add postage for 5 lbs. **\$2.95**

MINIATURE ELECTRIC MOTOR
NO. 211. Tiny Delco motor only 1" x 1 1/4" x 2" 10,000 RPM. Operates from 6 to 24 V. Excellent for models. Add postage for 1 lb. **\$2.95**

OUTPUT TRANSFORMER
NO. 227. Push pull 6V6's to 6-8 ohm voice coil excellent characteristics. **3 for \$1.95**

RCA SATURABLE REACTOR TRANSFORMER
NO. 246. New RCA No. CKV30531 AC current 750 MA DC current 2 Amperes. Rated 1.75 henries. Shipping wgt. 4 lbs. Each **\$1.00**

12.6V POWER TRANSFORMER
NO. 247. New cased 110 V 60 cy. Power Transformer. Supplies 440V Ct. at 60 MA, 6.3V at 2A. and 12.6V at 1 Amp. Excellent for military sets. Shipping Wgt. 6 lbs. Each. **\$1.95**

RCA INPUT TRANSFORMER
NO. 248. Heavy duty RCA No CKV-30529. Input has primaries 600 to 200 and 25 ohms secondary 250,000 ohms C.T. Shipping Wgt. 2 lbs. Each **\$1.00**

FEDERAL POWER TRANSFORMER
NO. 252. New cased 110V 60 cy. Power Transformer. Supplies 480V CT at 50 MA and 6.3 V at 2.1 Amps. A beautiful transformer. Shipping Wgt. 4 lbs. Each **\$1.50**

MILITARY POWER TRANSFORMERS
NO. 229. Convert your military receivers without rewiring the filament. "A" type supplies 500 VCT at 50 MA, 5V. at 2A. and 24V. at 1/2 A. "B" type supplies 500 VCT at 50 MA, 5V. at 2A. and 12V. at 1 Amp. State whether A or B type desired. **\$2.95** Shipping Weight 4 lbs.

WALKIE TALKIE TRANSFORMER
No. 744. Carbon microphone input transformer and output to headphone transformer, all in one case, excellent for building your own. Shipping Wt. 1 lb. **4 for \$1.00**

LOW PASS FILTER UNIT
No. 637. 3000 cycle cutoff consists of 3 inductances and 4 capacitors in network, 500 ohms in and out. Excellent for clipping all frequencies above 3000 cycles. Drawn steel case, shipping Wt. 5 lbs. **\$2.50**

FM PUSH BUTTON TUNER
NO. 224. Brand new ten push button tuning assembly from Army FM receiver. Contains 4 gang 100 MMF silver plated tuning condenser. Add postage for 10 lbs. **\$2.50 EACH**

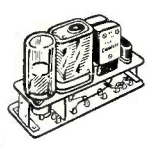

BC 746 TUNING UNIT
NO. 257. Plug in transmitter tuning unit from army Walkie Talkie. Contains antenna and tank coils, tuning condenser, transmitting and receiving crystals. Ideal transmitter foundation. Shipping Wgt. **\$1.00** 1 lb. Each (Same as above except transmitter crystal in 80 meter amateur band \$2.50 each)

T30 THROAT MICROPHONE
NO. 258. Makes excellent contact microphone for musical instrument or vibration pick-up. Shipping Wgt. 1 lb. **\$1.00** each Extension cord with switch for above \$.50 each

BC731 CONTROL BOX
with Weston Model 476 AC Voltmeter
NO. 208. Excellent buy in motor control box. Size 8"x10"x5 1/2". Contains Weston 0-150V. AC 3 1/2" voltmeter, motor starting switch, 28 fuses all 30 Amp 110V. and 8 fuse holders. Fuses and holders alone worth the price. **\$7.95** Shipping Weight 18 lbs.

METER SPECIAL
NO. 237. Brand new DeJur Model 312 0-800 M.A. D.C. Square 3" 0-10 M.A. basic meter with built in shunt. Probably the best buy ever offered in a surplus meter. **\$2.95** Shipping Weight 1 lb.

HEARING AID HEADPHONES
NO. 216. The Army's best - eliminate flat ears and outside noise. Complete with transformer for conversion from low to high impedance. With cord and plug complete. Add postage for 1 lb. **\$1.00**

BC 451 CONTROL BOX
NO. 236. Control box for 274N transmitters. Contains proper c-w voice switch, 4 channel switch, power switch, mike jack and telegraph key. Add postage for 2 lbs. **\$1.95**

100 MA FILTER CHOKE
No. 641. Heavy 1.5 henry choke in drawn steel case, 50 ohm resistance, conservatively rated at 100 MA. Shipping Wt. 1 lb. **50c**

FILAMENT TRANSFORMER
No. 922. 220V. 60 cy. primary supplies 12.6V. at 3.5 Amps, 15.6V at 1 Amp. Supplies 6.3 at 3.5 Amps and 7.8V. at 1. Amp from 110V. Shipping Wt. 8 lbs. **\$1.50**

PANEL METER
Burlington 0-300 VAC Meter
No. 290. Model 32XA 3 1/2" round AC Voltmeter 0-300 VAC full scale. Scale also calibrated 0-600V. Bakelite case. A beautiful meter in original carton. Shipping Wt. **\$3.95**

DRIVER TRANSFORMER
No. 651. Couples 3000 ohm plate to push pull parallel grids hermetically sealed. Ship. Wt. 1 lb. **\$1.00**

OUTPUT and MODULATION TRANSFORMER
No. 745. Companion transformer to above driver. A push pull output, 3000 ohms to 3.2 ohm voice coil, or to 1250 ohms at 80 MA. A high quality cased unit. Shipping Wt. 2 pounds. **\$1.00**

HOW TO ORDER . . . GIVE PART NUMBER AND DESCRIPTION . . . ADD POSTAGE FOR WEIGHT SHOWN. NO ORDERS UNDER \$2.00 . . . WE WILL SHIP C.O.D.

The HEATH COMPANY
... BENTON HARBOR 15, MICHIGAN

It's a Natural

BUILD YOUR OWN

Heathkit SINE AND SQUARE WAVE AUDIO GENERATOR KIT



\$34.50
Nothing
ELSE TO BUY

Experimenters and servicemen working with a square wave for the first time invariably wonder why it was not introduced before. The characteristics of an amplifier can be determined in seconds compared to several hours of tedious plotting using older methods. Stage by stage, amplifier testing is as easy as signal tracing. The low distortion (less than 1%) and linear output (\pm one db.) make this Heathkit equal or superior to factory built equipment selling for three or four times its price. The circuit is the popular RC tuning circuit using a four gang variable condenser. Three ranges 20-200, 200-2,000, 2,000-20,000 cycles are provided by selector switch. Either sine or square waves instantly available at slide switch. All components are of highest quality, cased 110V. 60 cycle power transformer. Mallory F.P. filter condensers, 5 tubes, calibrated 2 color panel, grey crackle aluminum cabinet. The detailed instructions make assembly an interesting and instructive few hours. Shipping Wt., 13 lbs.

New Heathkit TELEVISION ALIGNMENT GENERATOR KIT



\$39.50

Nothing
ELSE TO BUY

Everything you want in a television alignment generator. A wide band sweep generator covering all FM and TV frequencies 0-110 and 165 to 220 Megacycles, a marker indicator covering 19 to 43 Megacycles, AM modulation for RF alignment — variable calibrated sweep width 0-30 Mc. — mechanical driven inductive sweep. Husky 110V. 60 cycle power transformer operated — step type output attenuator with 10,000 to 1 range — high output on all ranges — band switching for each range — vernier driven main calibrated dial with over 45 inches of calibration — vernier driven calibrated indicator marker tuning. Large grey crackle cabinet 16 $\frac{1}{8}$ " x 10 $\frac{3}{8}$ " x 7-3/16". Phase control for single trace adjustment. Uses four high frequency triodes plus 5Y3 rectifier — split stator tuning condensers for greater efficiency and accuracy at high frequencies — this Heathkit is complete and adequate for every alignment need and is supplied with every part — cabinet — calibrated panel — all coils and condensers wound, calibrated and adjusted. Tubes, transformer, test leads — every part with instruction manual for assembly and use. Actually three instruments in one — TV sweep generator — TV AM generator and TV marker indicator. Also covers FM band.

1949 MODEL Heathkit VACUUM TUBE VOLTMETER KIT

Features.

New 200 μ a Meter

24 Ranges

New Accessory H.V. Probe makes Heathkit a kilovoltmeter. (Extra)

New Accessory R.F. Probe extends range to 100 megacycles. (Extra)

A new Model V2 Heathkit VTVM with new 200 microampere meter, four additional ranges — full scale linear ranges on both AC and DC of 0-3V., 10V., 30V., 100V., 300V. and 1,000V. Accessory probe listed elsewhere in ad extends voltage range to 3,000 and 10,000 volts D.C. New model has greater sensitivity, stability and accuracy — still the highest quality features — shatterproof plastic full view meter face — automatic meter protection, push pull electronic voltmeter circuit, linear scales — db. scale — ohmmeter measures 1/10 ohm to 1 billion ohms with internal battery — isolated DC test prod for dynamic measurements — 11 megohm input resistance on DC — AC uses electronic rectification with 6H6 tube. All these features and still the amazing price of only \$24.50. Comes complete with cabinet — panel — three tubes — new Mallory switches — test prods and leads, 1% ceramic divider resistors and all other parts. Complete instruction manual for assembly and use. Better start your laboratory with this precision instrument. Shipping Wt., 8 lbs.



\$24.50

Heathkit RF SIGNAL GENERATOR KIT

\$19.50

Nothing ELSE TO BUY

Every shop needs a good signal generator. The Heathkit fulfills every servicing need, fundamentals from 150 Kc. to 30 megacycles with strong harmonics over 100 megacycles covering the new television and FM bands. 110V. 60 cycle transformer operated power supply. 400 cycle audio available for modulation or audio testing. Uses 6SN7 as RF oscillator and audio amplifier. Complete kit has every part necessary and detailed blueprints and instructions enable the builder to assemble it in a few hours. Large easy to read calibration. Convenient size 9" x 6" x 4 $\frac{3}{4}$ ". Shipping Wt., 4 $\frac{1}{2}$ lbs.

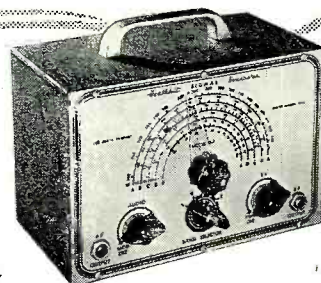

New Heathkit FM TUNER KIT

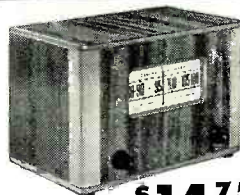

\$14.75
CABINET EXTRA

A truly fine FM Tuner with the coils ready wound, all alignment completed — all that is necessary is wiring and it's ready to play — uses super regenerative circuit — 110V. 60 cycle transformer operated — two gang tuning condenser — slide rule calibrated dial — two tubes — complete instructions including pictorial enable even beginners to build successfully. Shipping Wt., 4 lbs.

Beautiful mahogany cabinet for FM Tuner (shown above) extra \$3.75



The HEATH COMPANY

... BENTON HARBOR 15, MICHIGAN

with **HEATHKITS...**

HAVE THE FUN
Save **THE DIFFERENCE**
WITH HEATHKITS

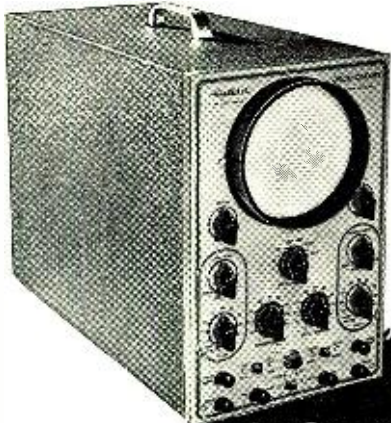

Heathkit 5"
**OSCILLOSCOPE
KIT**

Features

Instant switching to plates or amplifier from front panel.
Sweep generator supplying variable sweep 15 cycles to 30,000 cycles. All controls on front panel.
Cased electrostatically shielded 110V. 60 cycle power transformer. AC test voltage on front panel. External synchronization post on front panel.
Deflection sensitivity .65V. per inch full gain.
Frequency response $\pm 20\%$ from 50 cycles to 50 Kc.
Input impedance 1 Megohm and 50 MMF.

The Heathkit 5" Oscilloscope fulfills every servicing need. The husky cased power transformer supplies 1100 Volts negative and 350 Volts positive. Tubes supplied are two 6SJ7 amplifiers, 884

sweep generator, two 5Y3 rectifiers and 5BP1 CR tube. Grey crackle aluminum cabinet and beautiful grey and maroon panel. Chassis especially designed for easy assembly.

An oscilloscope provides endless sources of experimentation in radio, electronics, medicine and scientific research.

Detailed instructions make assembly fun and instructive. Shipping Wt., 24 lbs. Express only.

Nothing
ELSE
TO BUY

\$39.50

NEW Heathkit
**SIGNAL TRACER AND
UNIVERSAL TEST SPEAKER KIT**



\$19.50

Nothing
ELSE
TO BUY

The popular Heathkit signal tracer has now been combined with a universal test speaker at no increase in price. The same high quality tracer follows signal from antenna to speaker—locates intermittents—defective parts quicker—saves valuable service time—gives greater income per service hour. Works equally well on broadcast—FM or TV receivers. The test speaker has assortment of switching ranges to match push pull or single output impedance. Also test microphones, pickups—PA systems—comes complete—cabinet—110V. 60 cycle power transformer—tubes, test probe, all parts and detailed instructions for assembly and use. Shipping Wt., 8 lbs.

Heathkit

ELECTRONIC SWITCH KIT

DOUBLES THE UTILITY OF ANY SCOPE

\$34.50

Nothing
ELSE TO BUY



An electronic switch used with any oscilloscope provides two separately controllable traces on the screen. Each trace is controlled independently and the position of the traces may be varied. The input and output traces of an amplifier may be observed one beside the other or one directly over the other illustrating perfectly any change occurring in the amplifier. Distortion—phase shift and other defects show up instantly, 110V. 60 cycle transformer operated. Uses 5 tubes (1 6X5, 2 6SN7's, 2 6SJ7's). Has individual gain controls, positioning control and coarse and fine sweeping rate controls. The cabinet and panel match all other Heathkits. Every part supplied including detailed instructions for assembly and use. Shipping Wt., 11 lbs.

Heathkit
CONDENSER CHECKER KIT

\$19.50

Nothing
ELSE
TO BUY



Features

- Bridge type circuit
- Magic eye indicator
- 110 V. transformer operated
- All scales on panel
- Power factor scale
- Measures resistance
- Measures leakage
- Checks paper-mica-electrolytics

Checks all types of condensers, paper-mica-electrolytic-ceramic over a range of .00001 MFD to 1000 MFD. All on readable scales that are read direct from the panel. **NO CHARTS OR MULTIPLIERS NECESSARY.** A condenser checker anyone can read without a college education. A leakage test and polarizing voltage for 20 to 500 volts provided. Measures power factor of electrolytics between 0% and 50%. 110V. 60 cycle transformer operated complete with rectifier and magic eye tubes, cabinet, calibrated panel, test leads and all other parts. Clear detailed instructions for assembly and use. Why guess at the quality and capacity of a condenser when you can know for less than a twenty dollar bill. Shipping Wt., 7 lbs.



The **HEATH COMPANY**

BENTON HARBOR 15, MICHIGAN

Heathkits
ARE COMPLETE

HEATHKITS are QUALITY



Only
\$69.50
Nothing ELSE TO BUY

New Heathkit
IMPEDANCE BRIDGE KIT

A LABORATORY INSTRUMENT NOW WITHIN
THE PRICE RANGE OF ALL

Measures Inductance from 10 microhenries to 100 henries capacitance from .00001 MFD to 1000 MFD. Resistance from .01 ohms to 10 megohms. Dissipation factor from .001 to 1. "Q" from 1 to 1000.

Ideal for schools, laboratories, service shops, serious experimentors.

An impedance bridge for everyone — the most useful instrument of all, which heretofore has been out of the price range of serious experimentors and service shops. Now at the lowest price possible. All highest quality parts. General Radio main calibrated control. General Radio 1000 cycle hummer. Mallory ceramic switches with 60 degree indexing — 200 micro-amp zero center galvanometer — 1/2 of 1% ceramic non-inductive decade resistors. Professional type binding posts with standard 3/4" centers. Beautiful birch cabinet. Directly calibrated "Q" and dissipation factor scales. Ready calibrated capacity and inductance standards of Silver Mica, accurate to 1/2 of 1% and with dissipation factors of less than 30 parts in one million. Provisions on panel for external generator and detector. Measure all your unknowns the way laboratories do — with a bridge for accuracy and speed.

Internal 6 volt battery for resistance and hummer operation. Circuit utilizes Wheatstone, Hay and Maxwell circuits for different measurements. Supplied complete with every quality part — all calibrations completed and instruction manual for assembly and use. Deliveries are limited. Shipping weight, approximately 15 lbs.

Heathkit HIGH FIDELITY
AMPLIFIER KIT

Build this high fidelity amplifier and save two-thirds of the cost. 110V. 60 cy. transformer operated. Push pull output using 1619 tubes (military type 6L6's), two amplifier stages using a dual triode (6SL7), as a phase inverter give this amplifier a linear reproduction equal to amplifiers selling for ten times this price. Every part supplied; punched and formed chassis, transformers (including quality output to 3-8 ohm voice coil), tubes, controls, and complete instructions. Add postage for 20 lbs.



\$14.95

Nothing ELSE TO BUY

12" PM Speakers for above..... \$6.95

Mahogany Speaker Cabinet, 14 1/2" x 14 1/2" x 8"..... \$8.75

New Heathkit
BATTERY ELIMINATOR KIT

Now a bench 6 Volt power supply kit for all auto radio testing. Supplies 5 - 7 1/2 Volts at 10 Amperes continuous or 15 Amperes intermittent. A well filtered rugged power supply uses heavy duty selenium rectifier, choke input filter with 4,000 MFD of electrolytic filter. 0 - 15 Volt meter indicates output. Output variable in eight steps. Excellent for demonstrating auto radios. Ideal for servicing — can be lowered to find sticky vibrators or stepped up to equivalent of generator overload — easily constructed in less than two hours. Complete in every respect. Shipping Wt., 18 lbs.



\$22.50

Nothing ELSE TO BUY

Heathkit 3-TUBE ALL WAVE
RADIO KIT



\$8.75

CABINET EXTRA

An ideal way to learn radio. This kit is complete ready to assemble, with tubes and all other parts. Operates from 110V AC. Simple, clear detailed instructions make this a good radio training course. Covers regular broadcasts and short wave bands. Plug-in coils. Regenerative circuit. Operates loud speaker. Shipping Wt., 3 lbs.

HS30 Headphones per set..... \$1.00
2 1/2" Permanent Magnet Loudspeaker..... 1.95
Mahogany Cabinet..... 2.95



The **HEATH COMPANY**

BENTON HARBOR 15, MICHIGAN

TEST EQUIPMENT

Famous NAMES IN HEATHKITS

- MALLORY
- CENTRALAB
- SYLVANIA
- KENRAD
- GENERAL ELECTRIC
- DEFIANCE
- ALLEN BRADLEY
- PERMOFLUX
- EBY
- CHICAGO TRANSFORMER
- I.R.C.

Heathkit TUBE CHECKER KIT

Features

1. Measures each element individually
2. Has gear driven roller chart
3. Has lever switching for speed
4. Complete range of filament voltages
5. Checks every tube element
6. Uses latest type lever switches
7. Uses beautiful shatterproof full view meter
8. Large size 11" x 14" x 4" complete
9. Checks new 9 pin piniaures

Check the features and you will realize that this Heathkit has all the features you want. Speed — simplicity — beauty — protection against obsolescence. The most modern type of tester — measures each element — beautiful Bad-Good scale, high quality meter — the best of parts — rugged oversize 110V. 60 cycle power transformer — finest of Mallory switches — Centralab controls — quality wood cabinet — complete set of sockets for all type tubes including blank spare for future types — fast action gear driven roller chart uses brass gears to quickly locate and set up any type tube. Simplified switching cuts necessary time to minimum and saves valuable service time. Short and open element check. No matter what arrangement of tube elements, the Heathkit flexible switching arrangement easily handles it. Order your Heathkit Tube Checker today. See for yourself that Heath again saves you 2/3 and yet retains all the quality — this tube checker will pay for itself in a few weeks — better build it now.

Complete with detail instructions — all parts — cabinet — roller chart — ready to wire up and operate. Shipping Wt., 15 lbs.



Only
\$29.50

Nothing
ELSE TO BUY

R. F. CRYSTAL TEST PROBE KIT

No. 309. Kit to assemble. R.F. probe extends VTVM range to 100 Mc. Complete with 1N34 crystal. Ship. Wt., 1 lb.\$6.50



New Heathkit TOOL KIT

Now a complete tool kit to assemble your Heathkit. Consists of Krauter diagonal cutters and pointed nose assembly pliers, Xcelite screwdriver, 60 Watt 110V. soldering iron and supply of solder. Shipping Wt., 2 lbs. Complete kit\$5.95



10,000V. H. V. TEST PROBE KIT

No. 310. Extends range of any 11 megohm VTVM to 3,000 and 10,000 Volt ranges. A necessity for television. Shipping Wt., 1 pound.\$4.50



MAIL THIS
ORDER BLANK

Today



- Enclosed Find Check
- Money Order for _____
- Please Ship C.O.D. Postage enclosed for _____ pounds.

From _____

SHIP VIA
 Parcel Post
 Express
 Freight
 Best Way

QUAN.	DESCRIPTION	PRICE	TOTAL



The HEATH COMPANY

... BENTON HARBOR 15, MICHIGAN

SUMMER SPECIALS METERS

All Brand New — WESTINGHOUSE

- 3" Round 0-1 Mil DC with bad & good colored scale; can be used in tube checker.....
- Additional 0-1 scale provided.....
- 3" Square 7.5V AC.....
- 3" Round & Square 0-15 Mil DC.....
- 3" 0-1 Amp. DC.....

Each
\$3.45

WESTON

- 4½" Round 0-5 Amp. AC with a 0-200 amp scale.....
- 2" Round 0-1.5 Mil.....
- 2" Model 507 0-10 output units. (0-50 microamp movement) in wooden case..
- Without wooden case.....

\$3.95
2.25
4.95
3.95

GENERAL ELECTRIC

- 3" 0-200 Mil DC.....
- 3" Round 0-1 Mil DC.....

\$3.45
3.45

WESTERN ELECTRIC

- 3" Round 100-0-100 Mil DC.....

\$3.45

MISCELLANEOUS

- 3" Round Beede 0-1000 Mil DC.....
- 3" Round Triplet 0-150V AC, 60 cycle.....
- 3" Round Burlington 0-75 amp. AC.....
- Roller Smith portable lab 0-150 Mil DC with handle: 5½x6x3½.....
- Roller Smith portable lab 0-15V Mil DC with handle: 5½x6x3½.....
- 2" Triplet 0-35 Mil DC.....
- 2" Round U.S. gauge 5-0-5 amp DC.....

\$ 1.95
3.45
3.45
19.50
19.50
2.25
.69

RADIO TUBES

Standard Brands—All Brand New

2C34/VT	6H6	726A
224	6J6	801A
2C34	6K6	807
2X2	6SA7	815
3C24	6SH7	837
3C30	6SQ7	843
4B25/	6X5	922
6CF	15B	8012
5BP1	30 Special	1626
5FP7	531	2051
6AK5	717A	7193
6AL5	724A/B	9002
	724B	

\$.59
.79
.59
.66
.29
.59
.59
.79
9.95
1.95
1.95
.79
.79

\$14.95
.39
1.29
2.49
2.49
.69
1.49
1.95
.49
.95
.39
.39

STAND-BY STORAGE BATTERIES



GOULD Storage Battery—a completely covered black hard rubber case, with wing nut terminals on side. It's 6x10x10" high; non-spillable, 12 v. 34 amp. hours, 5 hour rate; weight 40 lbs. when fully charged. Brand New, shipped in original sealed

carton.
Each.....

\$9.95

Battery Acid 1275 Sp. Grav.—Can be used in any storage battery—in hermetically sealed bottles.
36 oz. bottle, .79c. 92 oz. bottle, \$1.95

VIDI-MASTER ANTENNA

Designed by a famous Radio Engineer; works where others fail. Easy to install.

- Model 88 for Channels 7-to-13.....
- Model 74 for Channels 2-to-6.....

\$3.99
\$6.90

Money Back Guarantee

SELSYN MOTORS

50 V. 50/60 cycles. Can be used to turn small beam antenna or as indicators. 3½" diameter x 5½" high. Two can be used in series on 110V. A.C. Brand New.
Per Pair.....

\$4.95



TS-10 Sound power handsets in original export packing. Brand New... Each
2 for.....

\$15.00
\$27.95

BC-223A Transmitter. 2000 to 3000KC without tubes—with one tuning unit. Brand New.....

\$12.95

With extra tuning unit 3000 to 4500KC.....

\$14.95

Prompt Delivery—25% deposit required on C.O.D. order. Shipped F.O.B. New York—Write Dept. RN8

MICHAEL STAHL, INC.

39 VESEY ST.

New York 7, N. Y., WO 4-2882

The Buying Motives (Continued from page 39)

appeal in the sale of a television receiver, unless it is handled something like this:

"Think of it, Mr. Prospect! All you need to do is turn this switch, and you will have at your command drama, news, and sporting events reproduced in your own home, any time you want it. It's almost like being a medieval magician, isn't it?"

4. Reputation and Good Will

This can be a strong motive in the sale of a television receiver. Human nature being what it is, people are much inclined to try to "keep up with the Joneses." More and more, every day, the home that does not have a television receiver is being outclassed. An appeal to this motive would be:

"Yes, Mr. Prospect, over 450 television installations have been made in Suburban Heights, so far, and that figure is increasing at present by over 75 sets a month! There's just no doubt about it, progressive home owners everywhere are realizing that television is an essential part of modern living."

Again, one could say: "There's nothing like a television receiver as a means of entertaining your friends and guests. Wouldn't you really be proud to have this set in your home?"

5. Idealism and Justice

This particular motive would have little direct appeal in the sale of our television receiver, unless it were put something like this:

"Think of the possibilities, Mr. Prospect, just as radio has enabled the great masses of people to hear as well as read the actual words of our great leaders and statesmen, so with television, we can see them as well. It is certainly a great privilege to share in such a step forward, by having a tele-

vision set installed in your own home, isn't it?"

6. Pleasure and Beauty

The appeal of these motives in the sale of a modern television receiver is very great. With the wide variety of programs available and the beauty of modern cabinet and console design, it is not difficult to think how these appeals might be used.

For example: "Yes, Mrs. Prospect, there's no doubt about it, television is the greatest gift of the age to real enjoyment. Think of it, all the pleasure that radio has brought us, plus the gift of sight—movies, dramatic productions, variety shows, on-the-spot news-casts, fashion hints, home hints—a constant source of pleasure and enjoyment."

Or, appealing to beauty: "Notice the beautiful, conservative lines of the console. It will blend with just about any style of furnishings, won't it?"

So, there are the seven buying motives briefly illustrated in relation to the purchase of a television receiver. Naturally, a great deal more could have been said on each of these points, but our purpose has been to show how each of these motives enters into building up the necessary *emotional motive force* to produce buying action.

Naturally, the more strongly we can appeal to these motives in making our sales presentation, the greater will be our total *emotional motive force*, the less will be the *buying resistance*, and the greater will be our chances of obtaining a "Yes" reading on our *sales meter*.

With this in view, every radio dealer will find it well worth while to analyze each of the items he sells and determine how strongly each of the buying motives enters into its sale. With such knowledge as a background, he will then be able to place his selling stress on those motives which have the greatest appeal to the prospect.

—50—

Admiral's newest TV receiver, a 24-tube set with ten-inch picture screen, will be housed in the world's largest single-piece plastic cabinet. Left: The mammoth 2000 ton hydraulic press at Molded Products Corporation, utilizing a 16,000 pound mold to form the cabinet. Center: Removing the completed unit from the press. Right: Dom Siragusa, president of Molded Products Corporation, who worked for a year to achieve the plastic casting, and his brother, Ross Siragusa, president of Admiral Corporation.

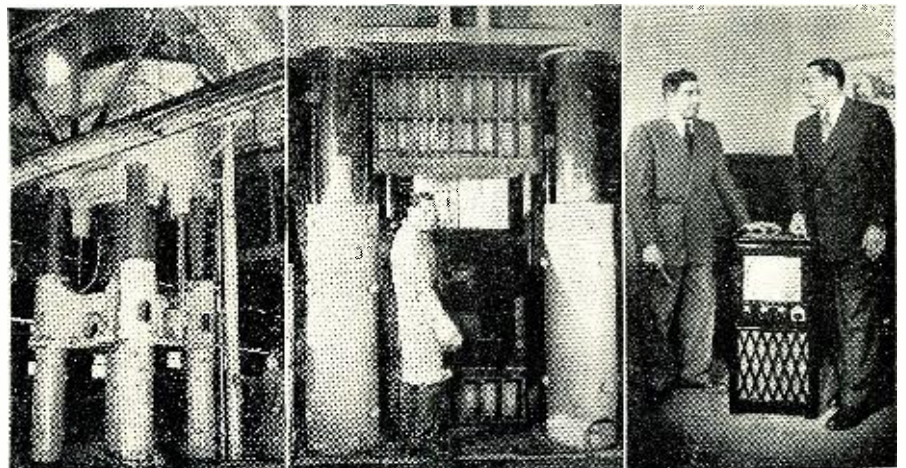

NEW for 1950

MIDWEST

Celebrates its 30th YEAR of FACTORY-TO-YOU Selling with a Sensationally NEW 1950 LINE of

TELEVISION

CONSOLES *and* Complete CHASSIS

New GIANT 16" PICTURE

Here is Television at its finest! . . . brought to you by Midwest, for 30 years a leader in the field of radio and electronics. Immense 151-square-inch screen on new 16" metal-glass tube . . . clear, steady, bright pictures . . . Synchronized sound and picture that a child can tune in perfectly . . . Highest quality FM sound . . . Big 12" Electro-Dynamic Panasonic Speaker. Available in beautiful Television-Radio-Phonograph Consoles, as illustrated, or in complete chassis (not a kit) ready for custom installation in your own cabinet. And you can buy Midwest Television at Low Factory Prices, with Low Down Payment and Long Easy Terms — and on 30 Days Trial! Send for Catalog TODAY!



NEW LOW
Down Payment
Long EASY TERMS

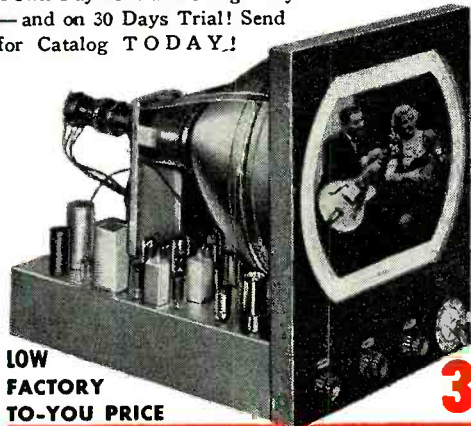

LOW FACTORY TO-YOU PRICE

30 DAYS TRIAL

... also a Magnificent Line of NEW 1950 **MIDWEST RADIOS** featuring the latest Improved FM Circuit and the New 3-SPEED RECORD PLAYER

Powerful new 1950 Series 16 and Series 12 AM-FM Radio in complete chassis. Also beautiful new Console models including the magnificent Symphony Grand Radio-Phonograph with latest FM circuit and new 3-Speed Automatic Record Player. New portable and Table Models also available.

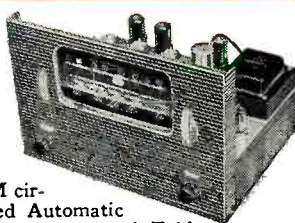
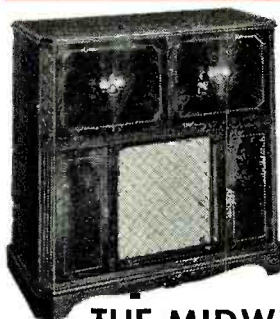

BUY DIRECT FROM THE MIDWEST FACTORY and **SAVE!**

MIDWEST RADIO & TELEVISION CORP.

Dept. X371, 909 Broadway, Cincinnati 2, Ohio

SEND FOR **FREE** 32-Page Full Color CATALOG



Write in Name and Address (Please Print) on Coupon or 1c Postcard.

MIDWEST RADIO & TELEVISION CORP.
Dept. X371, 909 Broadway, Cincinnati 2, Ohio

Please send me your new FREE 1950 Catalog.

NAME _____
ADDRESS _____
CITY _____ ZONE _____ STATE _____

Cent alab Announces the

New KOLORDISK (BC) HI-KAP...



**is Smaller
than a Dime**

Ko ordisk (BC) H Kap

WHAT IT IS! Centralab's amazing new KOLORDISK BC HI-KAP is a versatile, dependable disc-type capacitor — seven times smaller than ordinary capacitors of similar capacity. Just 19/32 of an inch in diameter and .174 inches thick, it's actually smaller than a dime. And you'll like KOLORDISK's sturdy construction as much as its miniature size. The new KOLORDISK BC HI-KAP is made of metallic silver electrodes, bonded to a sturdy disc of tough Ceramic-X, with a tensile strength of 3000 pounds per sq. in. In addition, KOLORDISK's minimum capacity is guaran-

teed to .01 mfd and three other popular lower values. Yes — when you use this reliable new capacitor in your work, you'll agree its positive low internal inductance makes KOLORDISK ideal for TV, AM, FM, HF and AF circuits . . . just the capacitor you need for VFH and UHF applications, too. What's more, with KOLORDISK there's no mistaking capacity values. The complete value is clearly stamped on each capacitor. And, to make recognition simpler, the first digit of each CRL KOLORDISK's capacity is accurately indicated by the capacitor's brown, red or green body color.

WHAT IT DOES FOR YOU! Centralab's new KOLORDISK BC HI-KAP is just what you need to replace obsolete, old-type by-pass or coupling capacitors. Its fine, sturdy Ceramic-X construction gives you exceptional mechanical permanence . . . eliminates the possibility of shorts, opens or intermittent operation. There's no doubt about it — when you use Centralab's KOLORDISK BC HI-KAP, you'll agree it's rugged and efficient. Yes, you'll

find KOLORDISK will give you years of dependable service . . . service that will match the life expectancy of any unit on which it's installed. For all the facts on the KOLORDISK BC HI-KAP — the best capacitor, see your Centralab Distributor. Or write for Bulletin 42-16.

(Note: KOLORDISK BC HI-KAPS are not recommended for resonant or tuning applications.)

Ask Your Distributor for These CRL Parts

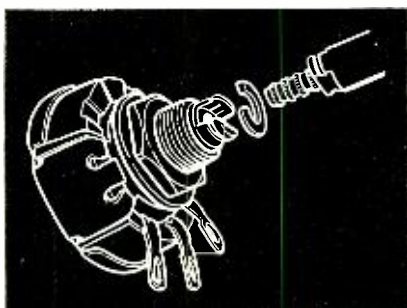

CONTROLS

MODEL "M" for voltage-divider, antenna shunt and "C" bias control, tone control, AF grid control. Model "1" for all miniature applications; rated at 1/10 watt, actually smaller than a dime. MODEL "R", wire wound, for voltage divider, antenna shunt, "C" bias, AF grid or tone control circuits.

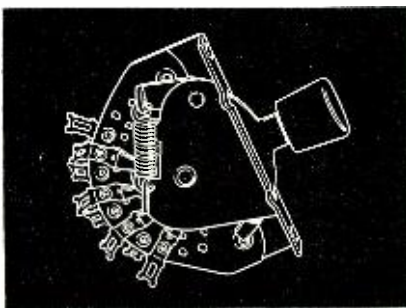

SWITCHES

ROTARY for band change, meter, intercom circuits; made in ceramic and phenolic models. ROTARY SPRING RETURN for meter selection, intercom, phono-radio applications. MEDIUM DUTY for band changing in low power exciter-transmitters and receivers. LEVER ACTION for intercom, speaker, microphone and other applications.

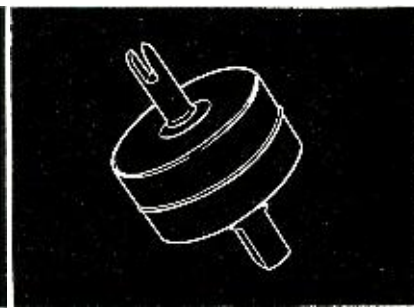

CAPACITORS

TC HI-KAPS for correcting temperature drift in TV, FM, AM, VFO circuits. BC HI-KAPS for by-pass and coupling applications in non-resonant, TV, AM, FM, AF, HF, VHF and UHF circuits. HI-VO-KAPS for TV power supplies. CERAMIC TRIMMERS for padder application in TV, AM, FM and HF circuits.

Centralab

CRL

Division of GLOBE-UNION INC., Milwaukee

To be sure your
calculations are
RIGHT, use



1. Fischer's
**RADIO &
TELEVISION
MATHEMATICS**

Save time and trouble. In this new book you can *quickly* find the solution of any mathematical calculation required in radio or television work, as, for instance, the factors in distortion, television focus control, antennas, etc. Whenever you are "stuck" on a problem, look in this book. Its complete index shows you immediately where to turn for the answer you want.

Over 400 sample problems, completely worked out. All the calculations commonly required in the design, operation or servicing of radio, television and modern industrial electronics are included, arranged under electronic headings where they can be easily found. All formulas, mathematical tables, and a math review are included. A highly useful handbook for anyone working in radio or television and for all those preparing for FCC license exams. \$6.00

Have you got these useful books?

2. **Introduction to Practical Radio**

By **Tucker.** Says one of the thousands of radio men using it: "I have this book and it is money well spent." It explains all radio essentials in the clearest, most practical terms, with hundreds of problems showing specifically how theory is used in the construction and servicing of radio equipment. \$3.00

3. **Principles of Radio for Operators**

By **Atherton.** Using wartime training methods this book teaches radio essentials through hundreds of illustrations and graphic demonstrations, with very simple explanatory text. \$4.00

4. **Introduction to Electronics**

By **Hudson.** Will help you understand the principles and key equipment of television and other modern electronic developments. \$3.30

5. **Public Relations for Retailers**

By **Mahoney & Hession.** The first complete practical guide to modern business techniques that the retailer can profitably use to gain public approval and increase his trade, with examples of successful public relations practices in over 200 stores throughout the country. \$4.50

SEE THEM FREE

The Macmillan Co., 60 Fifth Ave., New York 11
Please send me a copy of each of the books checked by number below. I agree to remit in full or to return the books within ten days without further obligation.

1. 2. 3. 4. 5.

Signed

Address

Testing PRECISION AUDIO EQUIPMENT

*All guess-work is eliminated when final tests
are made in a completely equipped test laboratory.*

By
ART DAVIS

Chief Eng., Cinema Engineering Co.

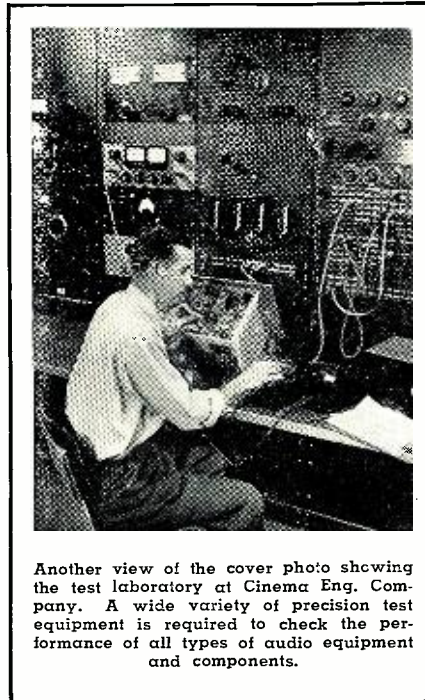

Another view of the cover photo showing the test laboratory at Cinema Eng. Company. A wide variety of precision test equipment is required to check the performance of all types of audio equipment and components.

PPOINT-TO-POINT testing cannot be replaced by any other form of circuit tracing. However, currents and voltages may all be normal, and audio devices still fall short of perfection by a wide margin. The answer to good over-all results is found only in a complete audio testing laboratory.

How precise should your test equipment be? This will be determined by the accuracy of results you desire. If you are planning a laboratory of your own, let's set some practical limits.

Do you want a complete audio test set-up? It will be necessary to provide for coverage of the audio spectrum from 20 to 20,000 cycles. This means several pieces of good test equipment for complete testing.

What volume range do you want to cover? Suppose we set a range of from minus 80 db. to a maximum of 50 watts or plus 39 db. This represents an over-all range of 119 db. A well-equipped laboratory would be able to measure any point in this range to within one tenth of a db. It is not probable that your requirements will be this stringent, but you should strive for a maximum error of one db.

If you are purchasing a commer-

cially made gain measuring set, buy the very best you can afford. If you construct your own, make sure that the design is sound and the quality of all components is as high as possible. One of the normal weaknesses in home-constructed units is the lack of accuracy over a wide range of volume levels.

Any test equipment used should be as free as possible from error, so that the over-all error is not additive. A good audio oscillator is a necessity, preferably one with both sine and square wave output. The output of this oscillator should be continuously variable from zero to maximum, with no leakage. The output control should be accurately calibrated.

A microvolter is useful for obtaining small audio voltages in accurate amounts. A good v.t.v.m. and output meter will be needed for checking over-all gain.

There is a wide choice in the matter of an oscilloscope. Most oscilloscopes will permit a comparison between the input and output signal and give indication of the amount of distortion.

For maximum accuracy in measuring distortion and determining the relative strength of harmonics, a distortion meter is needed.

There are many other pieces of test equipment which will prove useful in audio testing, but quite frequently their purchase will have to be deferred because of financial considerations.

In any event, purchase or build the best equipment possible. It is poor economy to use second-rate equipment, as the accuracy of the over-all results will leave much to be desired.

Amplifiers in test equipment should be the ultimate in design and stability, with an absolute freedom from maintenance problems. A few extra dollars here will pay for themselves many fold.

With wide-range limits, precision apparatus, and proper grounding, you can easily find the answers not revealed by the point-to-point methods of analysis. Electronically, the audio device is observed as if under a microscope.

-50-

RADIO & TELEVISION NEWS

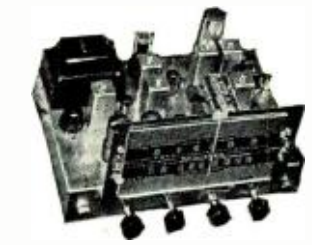

Hallcrafters

MODEL S-56 \$1100 VALUE FM/AM CHASSIS \$59.95

11-TUBE S-56 \$59.95 • PUSH PULL WIDE RANGE AUDIO • AUTOMATIC FREQUENCY CONTROL ON F.M.

Model S-56 Hallcrafters, high fidelity, 11 tube AM-FM radio receiver chassis for broadcast and FM 88 to 108 mc. Automatic frequency control on FM, holds the receiver in perfect tune. Phono connection on rear of chassis. Full range tone control with base boost. Push-pull 6K6 tubes in audio system. Frequency response essentially flat, from 50 to 14,000 CPS. Wide vision accurately calibrated slide rule dial, with pre-selection on broadcast band. Output transformer matches 500 ohm line. 4 antenna terminals; two for AM and two for FM. This is the finest type home radio that we know of today. Better get your order in early. Designed to be used in commercial radios, selling in the \$400.00 to \$600.00 class. The regular dealers net on this chassis is \$110.00. However, a lucky purchase enables us to offer these brand new, factory cartoned S-56 Hallcrafters chassis, complete with tubes and operation instructions, at only \$59.95, less speaker. Speaker matching transformer 500 ohm to voice coil \$2.50 extra. Chassis size 12 3/4" x 10" x 7 3/4". Weight 25 lbs. Brand new factory cartoned. Buy your S-56's with a wide range FM speaker. Pick your combination from the prices listed below and save.

S-56 WITH 12" 21 OZ P.M. \$74.95
 Hallcrafters S-56 chassis with tubes, 500 ohm to speaker matching transformer and our model A-50 super heavy duty 12 inch 21 oz. Alnico V PM speaker (regular \$50.00 list). This gives you the complete radio for custom installations. Shipping weight 38 lbs. Stock No. S-56A50; A-50 Speaker S-56 and transformer all for \$74.95.
 G.I. Dual Speed Changer Stock No. GI-73 \$17.95 extra.

S-56 WITH 12" COAXIAL P.M. \$71.95
 Hallcrafters S-56 chassis with tubes, 500 ohm to speaker matching transformer and our model CR-13X 12 inch coaxial PM wide range speaker. This gives you a complete radio for custom installations. Shipping weight 33 lbs. Stock No. S-56CR13X; CR-13X speaker S-56 and transformer all for \$71.95.
 G.I. Dual Speed Changer Stock No. GI-73 \$17.95 extra.

S-56 WITH 15" JENSEN P.M. \$79.95
 Hallcrafters S-56 chassis with tubes, 500 ohm to speaker matching transformer and model A-15 PM Jensen 15 inch 6 lb. magnet speaker. This gives you a complete radio for custom installations. Shipping weight 47 lbs. Stock No. S-56A15PM; Jensen Speaker S-56 and transformer all for \$79.95.
 G.I. Dual Speed Changer Stock No. GI-73 \$17.95 extra.



CAPEHART CHANGER SCOOP \$9.95

While 500 famous Capehart 2 post automatic record changers last, we offer them to you for only \$9.95. Plays standard 78 RPM records automatically, either 12 1/4" or 10 1/4". These changers are not guaranteed O.K., except they have been removed from new sets, to be replaced with two-speed changers. They may require minor adjustment. This super heavy duty changer with a new type high fidelity, true-timbres, transparent cartridge, with permanent needle. Requires same gain as the G.E. variable reluctance cartridge. Base size 14 1/4 x 14 1/4". Stock No. 71-WL, with connecting instructions. Weight 23 lbs. Net Price \$9.95 each, 2 for \$19.00. Extra tone arm with Astatic MP-1 cartridge and needle \$1.00 extra. Extra tone arm with General Electric MP-10 variable reluctance cartridge, \$2.35 extra.



G.I. DUAL SPEED CHANGER WHEN PURCHASED WITH S-56 OR S-59 \$17.95

General Instrument Dual speed automatic record changer plays 10-12" or 12-10" 33 1/3 or 78 RPM records automatically. Latest model with astatic reversible cartridge and permanent needle. While our stock lasts we offer this changer Stock #GI-73 for only \$17.95 when purchased with S-56 or S-59 Hallcrafters or \$19.95 when purchased by itself. Weight 11 lbs.

NEW WEBSTER CHICAGO CHANGERS
 Model 77-1—2-speed 7" Record Changer. Net... \$16.40
 Model 346-1—3-speed All Sizes Record Changer... \$16.95
 Model 358-1—3-speed All Sizes Record Changer... \$33.95
 Spider to convert 45 RPM Record to standard hole size, 10 for 25c.
 VM Corp. Model 300—O-Matic Changer. Net... \$3.90

NATIONALLY FAMOUS 12" COAXIAL P.M. SPEAKER \$12.95

MODEL CR-13X	MODEL 5-15X	MODEL 15-LS	MODEL 15-KR
12" COAXIAL P.M.	15" COAXIAL P.M.	15" 50 WATT P.M.	15" JUKE BOX
\$12.95	\$24.95	\$16.95	\$9.95

OUTPUT TRANSFORMER HIGH FIDELITY 20-20,000 C.P.S. SCOOP PRICE \$6.95 EACH

6600 OHMS PLATE TO PLATE

Why pay \$20.00 or \$30.00 for an output? Supreme quality and high fidelity output transformer. Designed to match only \$12.95 speaker (2-6L6, 2-6V6, or 2-6AQ5) class AB, to 4-8-15-250 and 5000 ohm with 100% feedback winding. Housed in a compound filled case; 3 1/2 x 4 1/2 x 3". Actual net weight, 8 lbs. If you want the best quality from your audio system, order this transformer. Response essentially flat from 20 to 20,000 cycles. We have tried several high fidelity outputs in our lab and find this to be the best value. Even though our amplifier only puts out 10 or 15 watts, this 34 watt job is what you should have. Connecting instructions are furnished. Stock No. A-403, shipping weight 8 lbs. Net price... \$6.95

DELUXE 12" COAXIAL MODEL CR-13X \$12.95

- RESPONSE 40 TO 17,000 C.P.S.
- FINE CONSTRUCTION
- GREY FINISH

REGULAR \$32.50 LIST

Newly designed by one of America's finest speaker builders. Made for FM and AM high fidelity radios and record players. This speaker is incorporated in radios of the 500 dollar bracket. It has an especially designed 12" 6.5 oz. Alnico V Magnet PM for the low range woofer and a coaxially built in 3" Alnico V tweeter for the extended high range. The high pass filter is concealed under the pot cover. Just hook to any 8 ohm output transformer. Will work in place of any home radio speaker as most speakers have an 8 ohm voice coil, only 2 wires to connect. Will handle 18 Watts peak. Wide range response 40 to 17,000 Cycles. This speaker should sell for \$35.00. Why buy any ordinary speaker when we offer a 12" Coaxial PM for only \$12.95. Shipping weight 8 lbs. Model CR-13X. \$12.95. Two for... \$24.95

15" DELUXE 50-WATT P.M. SPEAKER \$16.95

WITH WIDE RANGE MOLDED CONE

Model 15-LS 15" 2 1/2 oz. Alnico V Magnet PM Speaker. Will take up to 50 watts average or 25 watts peak. Here is a builder of fine speakers. A full 15" 12 1/2 oz. Alnico V magnet speaker of juke box quality. Has standard 8 ohm voice coil. Will take up to 18 watts average or 25 watts peak. Here is a speaker that will bring out those low notes. Latest 1948 production; not line through-outs. Every speaker is guaranteed new and perfect. We may not be able to continue this offer for long, so place your order now. Stock No. 15-KR. INCLUDE POSTAGE. Wt. 10 lbs. A \$35.00 value for only \$9.95

40-Watt CAPEHART Wide Range \$7.95 Output Trans.

Buy for Capehart for this finest combination for capacity all windings interwound to increase high frequency response and decrease capacity losses. High inductance in coils makes for best efficiency at low audio frequency. This high fidelity output transformer is 12" x 4 1/2" and has a net weight of 6 lbs. Made to match push pull 6L6 tubes 5,000 ohm plate to plate. Has 25% feedback winding. 60B below 20 cycles and above 15,000 cycles. Furnished with connecting instructions. Size 2 1/2 x 4 1/2 inch tall. Shipping weight 8 lbs. Stock No. SX-55 net \$7.95.

STANDARD 12" COAXIAL P.M. CN-12X \$10.95

Standard Model 12" Coaxial PM Model CN-12X. Same as model CR-13X except 4.64 oz. Mag. in woofer response 50 to 17,000 CPS. Will handle 12 Watts Output. Shipping weight 7 lbs. Stock No. CN-12X. \$10.95. Two for... \$20.95

15" JUKE BOX P.M. SPEAKER \$9.95

Model 15-KR—Pre-War or Post-War, you never bought a speaker like this for such a scoop price. Made by a nationally known builder of fine speakers. A full 15" 12 1/2 oz. Alnico V magnet speaker of juke box quality. Has standard 8 ohm voice coil. Will take up to 18 watts average or 25 watts peak. Here is a speaker that will bring out those low notes. Latest 1948 production; not line through-outs. Every speaker is guaranteed new and perfect. We may not be able to continue this offer for long, so place your order now. Stock No. 15-KR. INCLUDE POSTAGE. Wt. 10 lbs. A \$35.00 value for only \$9.95

CONSOLE BASS REFLEX SPEAKER BAFFLE \$19.95

6 Cubic Foot Utility Base Reflex Speaker Baffle. Size 32x22x16. Heavy construction with curved pleasing lines. Celotex lining assures non-rattle reproduction. Brown leatherette covered. Chrome front trim. Specify when ordering whether for use with 8" or 10" speaker. Weight 40 lbs. This is an ideal baffle for our deluxe Coaxial model CR-13X. Baffle Stock No. NA-12. Net \$19.95. 10 CR-13X Coaxial PM Speaker and NA-12 Baffle both for \$29.95. You will be pleased with the fine tone of this combination.

Net buys in P.M.s.—With trans.

4" PM 1 Oz. Ain. 5 2500 Ohm Trans.	\$1.49
4" PM 1 Oz. Ain. 5 10M Ohm Trans.	1.49
5" PM 1 Oz. Ain. 5 2500 Ohm Trans.	1.69
5" PM 1 Oz. Ain. 5 10M Ohm Trans.	1.69
5 1/2" PM 1 Oz. Ain. 5 2500 Ohm Trans.	1.89
6" PM 1.5 Oz. Ain. 5 7000 Ohm Trans.	1.99
6" PM 1.5 Oz. Ain. 5 2500 Ohm Trans.	1.99
6" PM 2.15 Oz. Ain. 5 7000 Ohm Trans.	2.49
6" PM 3.16 Oz. Ain. 5 10M Ohm Trans.	2.98

15" "KING COAX" P.M. SPEAKER \$24.95 "IT WOofs as IT TWEETS"

The King Coax. A 2 1/2 oz. 15 inch Alnico V PM speaker with a built-in high frequency tweeter. Will respond to from 40 to 17,000 cycles. This is a ruggedly built speaker with a curvilinear one piece molded cone. Built-in high pass filter. Hook to any 8 ohm output. Built by the maker of our ever popular 12 inch coax model CR-13X. This speaker has a retail list of over \$60.00. We offer you our 5-15X 15 inch coax for only \$24.95. Shipping weight 16 lbs.

50-WATT 12" SUPER HEAVY DUTY P.M. \$14.95

Model A-50—12", 50 watt super heavy duty permanent magnet speaker. Has 1 1/2" 8 ohm super tweeter and one piece molded cone. Heavy half inch machined pot, with bolt secured 21 oz. Alnico V magnet. Frame is of heavy construction with metal pot cover. Finished in silver-grey enamel. This speaker is the best value possible today. Efficiency is two to three times that of ordinary speakers. Especially recommended for all public address systems and high quality home audio systems. Will handle 33 watts with ease and 50 watts peak or short lengths of time. Its retail value is \$30.00. But, by our purchase, we are able to offer it to you for only \$14.95. Do not confuse this speaker with surplus merchandise. This is the latest production. Model A-50. Shipping weight 15 lbs. \$14.95. 2 for... \$29.00

5000 5" P.M. SPEAKERS 89c EACH, 10 FOR \$8.50

5,000 5", 1 oz. Alnico V magnet PM speakers, made by Radio Speaker Co. and Permaflux. All brand new factory cartoned. Every speaker guaranteed perfect. Buy a supply at manufacturers cost. Scoop price 89c each, 10 for \$8.50.

HERE'S THE GREATEST SPEAKER VALUE EVER—3000 TO SELL

10" 450 ohm field speaker, with PP 6K6 output transformer. 8" 450 ohm field speaker, with PP 6K6 output transformer. 6x5" 450 ohm field speaker with PP 6K6 output transformer. All speakers guaranteed. Factory cartoned. Take your pick, \$1.99 each, 10 assorted for \$18.00.

McGEE HAS THE SPEAKERS

Following speakers listed are latest production No-Factory throwouts made by the largest factory who furnish the original equipment to America's biggest Radio Factory. Every speaker guaranteed.

3" PM 1 Oz. Alnico 5 Magnet	\$0.99
4" PM 1 Oz. Alnico 5 Magnet	.99
4" PM 1 1/2 Oz. Alnico 5 Magnet	1.19
5" PM 1 Oz. Alnico 5 Magnet	.99
5" PM 1 1/2 Oz. Alnico 5 Magnet	1.19
6" PM 1 1/2 Oz. Ain. 5 Mag. Square	1.49
6" PM 2.15 Oz. Ain. 5 Mag. Square	1.98
6" PM 3.16 Oz. Ain. 5 Mag. Square	2.49
6 1/2" PM 1.5 Oz. Ain. 5 Mag. Round	1.69
4x6" PM 1.5 Oz. Alnico 5 Magnet	1.49
10" PM 4.64 Oz. Mag.	3.98

6 1/2" OPERADIO P.M. \$1.29

6 1/2" Operadio PM, 1.47 oz. Alnico V magnet. We have 1500 of this beautiful speaker. Buy a load of these at this unheard of price, \$1.29 each, 10 for \$12.00.

McGEE RADIO COMPANY

Prices F.O.B. K.C. Send 25¢ Deposit with Order, Balance C.O.D. With Parcel Post Orders, include Postage

NOW AT OUR NEW AND LARGER QUARTERS
1422 GRAND AVE., KANSAS CITY, MISSOURI

TELEVISION CHASSIS SCOOP AND MANUAL \$5.95



TELEVISION CHASSIS SCOOP \$5.95

Farnsworth Television Chassis Model GV260 partially built up Chassis. Size 12x17. Has 16 Tube sockets and over 150 small parts (Resistor and Ceramic Condensers) no coils or Transformers or tuning unit. Sweep and sync circuits are all partially wired up. This T.V. Chassis is ideal for the student and experimenter. Learn T.V. by building your own set using this chassis to start from. Furnished with a 1948 regular \$3.00 Supreme Publications Television Manual, which has a complete schematic of this chassis as well as 9 pages of service information. If you want to play with Television here is a chance to get started. Farnsworth GV260 partially built up Chassis and 48 Supreme T.V. Manual all for \$5.95. Include postage for 1 lbs. GV260 Chassis only \$2.95.

13-CHANNEL T.V. TUNER SALE PRICE \$9.95



Order This With The Farnsworth T.V. CHASSIS SCOOP

SARKES-TARZIAN, 13 channel tube for Television receiver. This 3 tube front end is wired for 13 channels, including tube sockets. The same TV front end as used by several nationally known manufacturers. Built in fine frequency trimmer. Enclosed with printed schematic diagram. Priced complete with 3 tubes, 6C4 osc., 6AG5 mixer, and 6BF6 RF amplifier. This unit is worth twice our price. All wired, output is to be fed into your video channel. It can be mounted and used with the Farnsworth GV260 chassis, advertised to the left. Weight 2 lbs. Stock No. SK-T3. Net price, Sarkes-Tarzian, 13 channel tuner, with 3 tubes \$9.95.

SAM'S TELEVISION COURSE, \$3.00

Photofact Television Course. Gives you a complete, clear understanding of modern TV principles, operation and practice. Covers cathode ray beam formation and control; beam deflection; sawtooth generators, sync circuits, control functions, receiving antenna circuits, RF input tuning systems, IF systems, A.C. DC restoration, video amplification, contrast, etc. Includes glossary of terms, bibliography. 216 pages; professionally illustrated; sturdy bound, weight 2 lbs., 8 1/2 x 11". Only \$3.00.

TELEVISION ANT. BOOK, \$1.25

Television Antenna guide for design, construction, installation and trouble shooting. The first complete, practical TV antenna guide and easy-to-read instruction manual. Installation profits. Over 192 pages, 124 illustrations. Yours for only \$1.25.

MCGEE'S SPECIAL 10BP4 \$19.95

10 inch T.V. scope tube, 10BP4. Your cost \$19.95. 12 inch T.V. scope tube, 12LP4. Your cost \$33.00. McGee's Special Tubes are fully guaranteed. They will not be branded with our name. They are at the low end, but nevertheless, well within specifications. McGee's own tests fail to show any difference in these and higher priced tubes.

Ward TVH-9 Stacked-Folded Dipoles, with Reflectors for High and Low TV-Bands. Net \$6.49.

100 RADIO TUBES \$29.95

250,000 Tubes for fast sale. Tremendous value. Tubes up to \$3.00 list. 100 Cartoned and branded Hyvac Miniature Tubes for \$29.95. Over a million sold. Guaranteed full replacement. \$1.25 Each in smaller quantities

1R5	12BE6	12AU6	6S7	125H	125T
174	12AT7	12BF6	6AQ5	6A9	6A7
12BA6	35Z4	6AR6	6A08	6BD6	6B7
3A4	35Z5	6BE6	6C4	6BE6	6B6
155	50R5	6AT6	6X4	117Z3	35C5
3V4	12AT7	6A15	6W4	187A	
3Q4	12AU7	6A5	6AG5	6B16	
354	12AX7	6AB7	6AUG	6AT6	
12BA6	12BA7	6A7	6BG6		

Popular GT Tubes, Individually cartoned and branded Hyvacs. \$35.00 per hundred, 39c Each in smaller quantities.

6V6	6X5	6SK7	12S7	125N7	32L7
6SN7	65D7	6SQ7	6J5	12BF7	
6C5	5V3	25L6	65L7	65L7	
12BA6	6K2	70L7	12S17	35Z5	
12A8	5V3	1B4	65F5		
6S8	6K6	12K8	80		
1258	65A7	12A6			

39c each
100 for \$35.00

HYVAC 6A5 AND 6J6 59c EACH

STANDARD BRAND TUBES CARTONED AND UN-CARTONED 49c

OZ4G	1G6	5V4	6F7	6SA7	6T7	7B8	7S7	12F5	12SQ7	26	43
14A	1H6	5Y3	6H6	6SC7	6V6	7C4	7V7	12H6	12SR7	27	45Z5
1A6	1J6	6A3	6J5	6SD7	6X5	7C5	7Y4	12J5	12Z3	30	50B5
11C	1L6	6AB7	6J7	6SE7	6Y5	7C6	7I4	12K6	14B7	32	50
1B5	1R5	6AC7	6K5	6SF7	6Z7	7C7	7J7	12L7	14B6	32	50
1C6	1S5	6AG7	6K6	6SG7	6Z5	7E5	12A6	12SC7	14C7	34	58
1C7	1T4	68H	6K7	6SH7	7A4	7E7	12A8	12SF5	14H7	35	70L7
1D5	1V	6C4	6K8	6SJ7	7A5	7E7	12A7	12SF7	14Q7	35W4	75
1D7	2A5	6C5	6L5	6SK7	7A5	7H7	12A7	12SG7	14R7	35V4	75
1D8	2A6	6L7	6L7	6SL7	7A7	7I7	12B6	12S7	14S7	35W7	75
1F4	2A7	6D6	6N7	6SQ7	7B4	7N7	12B6	12S7	15L5	35Z5	78
1F5	3A4	6D8	6R7	6SR7	7B5	7Q7	12B6	12SL7	25Z5	38	80
1G4	5T4	6F5	6S7	6SS7	7B6	7R7	12C8	12SN7	25Z6	38	80

NAME BRAND 1/2 VOLT LOCALS, ETC.

11L5	11L6	11L7	11L8	11L9	11L10	11L11	11L12
11L13	11L14	11L15	11L16	11L17	11L18	11L19	11L20
11L21	11L22	11L23	11L24	11L25	11L26	11L27	11L28

NATIONAL UNION CLOSE-OUT SALE



ORDER \$100.00 WORTH—TAKE 10% OFF ON N.U. COND.

TYPE "AT" N.U. TUBULAR ELEC. ALUMINUM WITH SEALED ENDS

National Union Type AT Electrolytics. Housed in sealed metal tubes in spun-end cardboard sleeves. Bare wire leads. Standard package of 10 condensers. Save over half. This is your every day need in condensers. One-year guarantee.

National Union Aluminum Tubulars, with paper insulating sleeves. Type AT

10 MFD.	25v..15c	24 MFD.	150v..30c	4 MFD.	450v..20c	20-20	150v..30c
25 MFD.	25v..20c	50 MFD.	150v..35c	8 MFD.	450v..30c	40-20	150v..35c
110 MFD.	25v..40c	80 MFD.	150v..35c	16 MFD.	450v..40c	40-30	150v..50c
8 MFD.	150v..15c	8 X 8	450v..40c	30 MFD.	450v..50c	80-40	150v..60c
16 MFD.	150v..25c	16x16	450v..50c	8x8	150v..20c	20-20	450v..60c

NATIONAL UNION ALUMINUM CAN "TWIST TAB" TYPE TT

National Union Type TT Electrolytic Condensers. Aluminum can P.P. type Twist Tab mounting common negative grounded to can. Individually cartoned in green N.U. boxes. Each condenser supplied with 1 bakelite insulating plate and 1 metal grounding plate. Save over half on these. All sizes and one-year guarantee.

100 MFD	25v..19c	40-20 MFD	150v..35c	40-40	150v..25 MFD	25v..40c
500 MFD	25v..19c	40-40 MFD	150v..40c	40-40-20	MFD	150v..60c
10 MFD	450v..25c	50-50 MFD	150v..60c	40-40-40	MFD	150v..60c
20 MFD	450v..30c	10-10 MFD	450v..40c	80-40	150v..25 MFD	25v..60c
30 MFD	450v..40c	16-16 MFD	450v..45c	10-10	450v..20 MFD	25v..50c
40 MFD	450v..50c	20-20-20	450v..65c	10-10-10	450v..20-25v..70c	
80 MFD	450v..60c	20-20	150v.	10-10-10-10	450v..70c	
		100 MFD	25v..45c			

N.U. THREAD MOUNT ALUMINUM CAN TYPE SC

National Union Type SC-SCN-SCS Upright Aluminum Can Condensers. With pal nut mounting. Flexible insulated leads. Individually cartoned in green N.U. boxes. Save over half on this. One-year guarantee.

4 MFD	450v..25c	8 MFD	600v..60c
8 MFD	450v..30c	16 MFD	600v..80c
16 MFD	450v..40c	8 MFD	600v..80c
40 MFD	450v..50c	8 X 8	450v..50c
4 MFD	600v..35c	16x16	450v..60c
		20x20	450v..70c

100-600V. BY PASSES, \$6.95 MAKE YOUR OWN ASSORTMENT

T .0001. T .00025. T .0005. T .0005. T .001.
T .002. T .005. T .005-5c Each.
T .01. T .05. T .04-5c Each.
T .05-7c Each; T .1-8c Each.
T .25-10/2c Each; T .5-15c Each.

T.V. POWER TRANS. SCOOP PRICE \$2.95

Order This With Your T.V. Scoop Chassis

GV260 Power Transformer
C-94230Z. 135 Mill Tapped 110 Volt primary. Supplies plate voltage and filament for part of Farnsworth T.V. Chassis. 375 V.D.C. 2-3 and 5 filament. Shipping wt. 7 lbs. Scoop price \$2.95.

BIG T.V. POWER TRANS., \$6.95

Power transformer for Television receiver. Stock No. S-176. Fully shielded, flush mounting. Primary 110 volts, 60 cycles. Secondary windings. 730 volts C.T., at 275 mls. 6.3 volts 8 amps, 5 volts 6 amps and 4 volts at 2 amps. Mounting 83334. This transformer is heavy enough for a full TV receiver. Shipping weight 14 lbs. Net price \$6.95. Focus coil, 202D1 as used by RCA. Scoop price \$1.95. Vertical output transformer for TV receiver. Scoop price \$1.95. Ion traps. Scoop price 99c each. Tube socket which leads for 10BP4 and 12LP4 49c each.

R.C.A. COIN RADIOS \$29.95

We have 200 brand new, factory cartoned, RCA coin operated radios. Made to play 1 hour for 25¢. Buy last, at the terrific low price of \$29.95 each.

General Industries Recording in heavy duty plastic case with T.T. 78 RPM. Scoop price \$7.95. Dual speed phono motor with T.T. 78 RPM phono motor with T.T. 78 RPM. Scoop price \$3.95. \$11.00 list, scoop price \$4.95.

\$59.50 VALUE MUSICAL AMP. \$24.95

8 watt Musical Amplifier. 4 tube AC transformer type. Proper gain for all instrument pickups. Housed in leatherette case with built-in 8" speaker. Gain control. Made by large manufacturer, to sell for \$59.50. Stock No. XR-2. Weight 25 lbs. Net Price. \$24.95.

DELCO TUBE SCOOP! 59c Each, 10 for \$5.50

We made a lucky purchase of genuine Delco radio tubes bulk packed, latest production.

125R7gt	50L6gt	125Q7gt
125R7gt	35L6gt	125Q7gt

RECORD PLAYER KITS \$9.95 AND UP

Deluxe Portable Record Player Kit housed in the attractive Record Case. Includes all parts and easy to follow instructions. Has 17" Heavy Duty PM Speaker. 78 RPM Phono Motor. All necessary parts to build a Record Amplifier. Weight 4 lbs. Model CK-1. Net \$9.95.

5-STATION PUSH BUTTON BROADCAST TUNER KIT \$8.95

A compact broadcast AM 5 station push button tuner kit. Designed expressly for use with any of our amplifier kits or any P.A. system. A self powered transformer for 110 AC. Kit with 5 7M-12 universal output (no condenser gang) loop antenna. 456V TR-5 A.V.C. etc. Uses 6BA6-6BE6-6X6-6B6-6B7. Fully guaranteed. Weight 5 lbs. Order this when you buy any of our amplifier kits: TM-4—TM-8—TM-20—TM-12—TM-30 or ME-15R. Kit PP-4 net \$8.95.

AMPLIFIER KITS WITH VARIABLE RELUCTANCE INPUTS \$6.95 UP



TM-4—5 WATT KIT \$6.95	TM-8—8 WATT KIT \$8.95	TM-12—12 WATT KIT \$10.95	TM-20—20 WATT KIT \$15.95
------------------------	------------------------	---------------------------	---------------------------

Kit Model TM-4. 5 Watt Amplifier Kit. Ideal for beginner construction. Has features of higher priced amplifiers. Inputs for phono pick up or mike. Compensation for the G.E. Variable Reluctance pick up. Push-pull output gives good tone quality. Output to 8 ohm Voice Coil. Variable tone control. Input control. Ready punched chassis. This makes a top quality AC-DC Audio amplifier. Priced complete with tubes, diagram and photos. 2-50B5, 2-12AX7, plus selenium rectifier. Weight 3 lbs. Stock No. TM-4, \$6.95. Crystal mike and utility desk stand \$4.95 extra. TM-4 custom wired and tested \$3.00 extra.

Kit Model TM-8. 8 Watt Amplifier Kit for utility use, record playing, or paging. Matched component parts. Has features of higher priced amplifiers. Inputs for phono pick up or mike. Compensation for the G.E. Variable Reluctance pick up. Push-pull output gives good tone quality. Output to 8 ohm Voice Coil. Variable tone control. One control. One control fades from mike to phono. Input compensation for the G.E. Variable Reluctance pick up. Output matches 8 ohm Voice Coil. 75 Mill Power Transformer. Price includes tubes, diagram and photo. Push-pull 6A5 output transformer. Price includes tubes, diagram and photo. 6L6-2-7N7, 2-6L6, 5V4. This kit makes a ready assemble amplifier, or commercial quality and appearance. Kit TM-8 weight 25 lbs. Net, \$19.95.

Which 34 watt wide range high fidelity (20 cps) amplifier. Kit TM-20. 20-20,000 cps) transformer with windings 4-8-16-250-000 ohm add \$5.00.

Kit Model TM-12. 12 Watt Amplifier Kit. Ideal for a high quality record player as a P.A. System or recording amplifier. Matched component parts ready punched chassis. Input control. Push-pull output gives good tone quality. Input compensation for G.E. Variable Reluctance pick up. Output matches 8 ohm Voice Coil. 100 Mill Power Transformer. Complete with tubes, diagram and photos. 2-6V6, 2-12AX7, and rectifier. Variable tone control. Input control. Weight 10 lbs. Net \$10.95. Crystal utility mike and desk stand \$4.95 extra. TM-12 custom wired and tested \$4.00 extra.

Kit Model TM-20. A high quality 20 Watt Audio Amplifier with 135 Mill Power Transformer and push-pull 6L6's. Inputs for mike or phono pickup. Compensation for G.E. Variable Reluctance pick up. Tone and fade controls. Has heavy duty universal output transformer, to match 8 ohm P.M. Speaker. Ready punched chassis. Price includes tubes, diagram and photo. 6L6-2-7N7, 2-4. Frequency response 50 to 9,000 cps. Kit Model TM-20. Weight 20 lbs. Net \$34.95. TM-20 custom wired and tested \$5.00 extra.

SUPER DELUXE 30-WATT AMP. KIT \$19.95

A complete kit of parts to build a 30 watt public address amplifier. Ready punched chassis with cover. 160 mill power transformer for 2.0 watt AC. Inputs for two mikes and crystal or G-E Variable reluctance phono-pick up. Base boost tone control. Input control. Shielded output transformer matches 4 or 8 ohm voice coils. In reverse feed back. Everything furnished including tube sockets. Kit TM-30 weight 25 lbs. Net, \$19.95.

WIDE RANGE 20-20,000 CPS 20-WATT AMP KIT \$24.95

Why pay \$40.00 to \$60.00 to buy parts for a good audio amplifier. Our engineering department designed this Kit to give 20 to 20,000 cps response and have inputs for all variety of microphone. PM tuner or mike and regular crystal pick up cartridge. 3 tone controls, fade control, high fidelity component parts. Transformer matched 4-8-16 Ohm PM Speakers and 250-000 Ohm lines. Push-pull 6V6 tubes. Cuts 15 db wide range audio. This kit is complete with photo, diagram and tubes. 12AX7, 3-6C4-2-6V6, 5V4. Ready punched chassis. Everything furnished. Weight 16 lbs. Kit Model ME-15R. Net \$24.95. Custom wired and tested \$19.00 extra. We recommend our CR-13X 12" Coaxial PM Speaker with this kit \$12.95.

Kit Model ME-34R. Similar to Kit ME-15R except has 2-6L6 tubes in output giving 34 watts audio. Kit ME-34R \$34.95. Weight 25 lbs. Custom wired and tested \$4.00 extra.

BELDON SOLDERING IRON \$1.95

Beldon-100 Watt Soldering Iron for radio set use. Worth \$3.95. Sale Price \$1.95.

McGEE RADIO COMPANY Prices F.O.B. K.C. Send 25% deposit with Order. Balance C.O.D. With Parcel Post Orders. Include Postage. **NOW AT OUR NEW AND LARGER QUARTERS 1422 GRAND AVE., KANSAS CITY, MISSOURI**



TUBE S-59 AM/FM HALLIDRAFTERS-CHASSIS \$32.95

McGEE OFFERS—THIS \$50.00 VALUE CUSTOM CHASSIS—WHILE OUR LIMITED STOCK LASTS.

S-59 8-TUBE FM/AM CHASSIS \$32.95

Model S-59 Hallcrafters, high fidelity, 8 tube FM/AM chassis, for custom installations. Receives broadcast 540 to 1700 KC and FM—88 to 108 Mc. Size 12"x7 1/2"x3". An excellently engineered chassis, with accurately calibrated slide rule dial. Variable tone control and 60 to 14,000 cps, wide range audio. (Push-pull 6K6) 8 ohm output transformer will match most PM speakers. No special output transformer required. Loop antenna built on, for broadcast reception. This is without a doubt, the best radio chassis value we have ever been able to offer. Better rush your order in now. We have them in heavy duty 6X7 PM speaker, for use with the blond console, pictured on the right, \$2.95 extra.

G.E. RFX010 VARIABLE RELUCTANCE CARTRIDGE! \$2.95

The widely publicized and nationally advertised General Electric RFX-010 Variable Reluctance pick-up cartridge for standard 78 RPM records. Permanent sapphire needle. Made to sell to the dealer at \$4.67. A lucky purchase by us enables this low price of only \$2.95. Packed in 18 to a master carton. Better stock up now. Kit to build a G.E. type pre-amplifier with wiring diagram and 6S07 tube. \$2.49 extra.



Astatic MLP-1 99c, 10 for \$9.00

Astatic MLP-1 Cartridge with permanent needle. This model used on many original equipped changers. Priced at below cost of needle. 99c; 10 for \$9.00.

Astatic MLP-2, same as MLP-1, only later model with QT needle. No surface noise. Sale price, \$1.95.

Astatic NJ-Nylon cartridge with permanent, but changeable needle. \$3.29.

Astatic QT 3-M cartridge with silent needle response to 10,000 CPS. Reg. \$8.40 List. Scoop price, \$3.29.

CRYSTAL PICKUPS

Plastic arm with 3 V. cartridge. . . \$1.95
Complete arm with 3 1/2 V. cartridge. . . 2.29
Complete arm with 1 V. cartridge. . . 2.29
L.P. micro-groove arm with needle. . . 3.95

WHY BUY AN ORDINARY RADIO WHEN YOU CAN BUY A HALLIDRAFTERS S-59

S-59 8 tube FM/AM chassis, with tubes. Wt. \$32.95
16 lbs. Net

S-59 8 tube FM/AM chassis, with tubes and regular \$12.95 12" coaxial PM speaker, CR-13X. Wt. 24 lbs. Net \$42.95

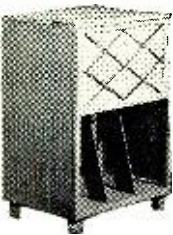

BLOND CABINET \$19.95

Beautiful blond console cabinet. Size 17x21x33 in. high. This cabinet was designed for use on a nationally known \$129.00 radio phone combination. The lower half of the cabinet is divided for record albums. The upper half has a hinged lid which covers the radio and changer compartment. Changer panel is blank, will hold a changer 12x15 1/2 ready cut for the S-59 Hallcrafters or with a blank panel for installing your own record. Shipping weight 40 lbs. Cab. will hold a 6 in. or 6x9 speaker. Stock No. JB-4 with ready cut panel for S-59 Hallcrafters. (Will not hold S-56.) Net \$19.95.

Stock No. JB-5X. Same as above JB-4 except has a blank radio panel. Net \$19.95.

VM-TRI-O-MATIC \$33.21

You are familiar with the popular VM automatic record changer, used by nationally known builders. This new model VM-408 plays 33 1/3, 45 and 78 RPM, records automatically. Intermixes same speed records. Slits off on last. Records on size 13 1/8x16x2 1/4". We think this changer is the answer! VM-408 Tri-O-Matic. Net price \$33.21

War Surplus Clean-Up Sale

Bendix RA-10 Direction Finder. Receiver or as \$7.00 each. Wt. 30 lbs.
R-89 Glide path receiver, with tubes. Good condition. Weight 20 lbs. While they last, \$2.95 each.
Used BC-456 Modulator. with dynamotor. Weight 21 lbs. While they last, \$2.50 each.
AVR-20A Receivers, with tubes (6). Good mechanically but have been wet. Scoop price \$2.95 each.
New Antenna Current meters, used on popular command transmitters. While they last, \$2.00 each.
Radar Transmitter, pulse forming network. Assortment of 3, 1, 3, and 16 micro-second. \$2.50 for each.
I.C.A. Universal AC-DC line cords. \$1.00 value. Special. . . \$1.49
8 L. G.E. AC line cord. . . \$1.49
coated plug. 2.00
10 for 16 G.E. AC line cord and plastic bakelite plug. 1.50
10 for. 1.50

3 Cartridges—95% Off Your Need \$1.79 Each, 10 for \$15.00

Astatic L-40 or equal, with rest clip, replaces the following: L-41, L-75, Webster C-5, E-9, F-3, N-5, or N-7. \$1.79 each; 10 for \$15.00.
Astatic L-70 or equal, with rest clip, replaces the following: L-22, L-26, L-27, L-71, L-75 or Shure, P-88, P-89, W-40, W-59, or Webster 1X6, 1X2, N-4, E-4, etc. \$1.79 each; 10 for \$15.00.
Astatic L-72 or equal, with rest clip. Replaces the following: L-24, L-46, Shure P-89 and Webster. \$1.095 a pair. Put the rest clip on the left side record players and put extra pair in any player. The most unusual crystal built. \$1.79 each; 10 for \$15.00.

WORLD'S BEST MIKE VALUES

33X Crystal Mike with 20 Ft. Cable, worth 1/2 mile. \$10.95
33D Dynamic Mike with 20 Ft. Cable. Scoop Price. 12.95
Top quality Kital mike & stand—recording type. 4.95
Small Plastic Low Loss Mike Cable. 4c Per Foot
Beldon Heavy Duty Mike Cable. 6c Per Ft.; 100 Ft. for \$4.95

BUILD A RADIO WITH MATCHED "DETROLA" PARTS 6-TUBE 2-BAND KIT \$16.95

A complete kit of parts, tubes and ready punched chassis to build a fine 6 tube power transformer type radio chassis. (No cabinet.) We furnish every piece as well as a printed diagram and photograph. Chassis size 14x7 1/2x7. Receives standard broadcast and 6 to 18 MC foreign short wave, 3 gang tuning condenser used on both bands. 90 mil power transformer, 6V6 output tube. Heavy duty 8 inch speaker. Kit is made up of parts intended for use in a high quality Detrola radio. Has full lighted slide rule dial. Everything goes together just like a factory built radio. Priced complete with 6 tubes. Kit model 6-A-C. Weight 16 lbs. net \$16.95.



Kit model CD-B. Same basic design as the above model 6-A-C except it is an 8 tube AC DC circuit with push pull 25L6 tubes in the audio. Weight 15 lbs. Priced complete with tubes net \$16.95.

BUILD THIS 8-TUBE HI FIDELITY RADIO AND AMPLIFIER

- 8-INCH SLIDE RULE DIAL • RECEIVES BROADCAST AND 19 to 49 METERS • PUSH PULL OUTPUT TUBES • BASS BOOST TONE CONTROL
- EVERYTHING FURNISHED • CHASSIS SIZE 9 1/2 x 11 x 8" HIGH • BEST RADIO KIT VALUE IN THE WORLD



Here is something new in radio. A real 15 watt power amplifier with bass and treble controls. Has extra gain stage for crystal or dynamic mikes. And on the same chassis, a standard superhet radio receiver. We furnish all parts, knobs, escutcheon plate and tubes: 6SA7, 6SK7, 6SR7, 6SN7, 6S7, 20 6V6 and 5Y3. No cabinet. Extra care in designing the power supply section assures low hum level, making this unit ideal for recording and hi fi use. We furnish everything as well as schematic diagram and photos of the completed chassis. Weight 26 lbs. Priced complete with tubes. Net \$29.95
CPR-15. Radio-Amp. Kit with 12" PM speaker. With tubes. Net \$37.95
This is our finest kit. Net \$37.95

COMPLETE RADIO KITS \$6.95 UP



Complete Personal Portable Radio Kit Model X-45. Made from genuine Carad factory-matched parts. A complete radio chassis with standard battery operated 4 tube receiver. Small in size 6 1/2x3 1/4x4 1/2". Weight 3 1/2 lbs. 2 Gang tuning condenser. Comes with when lid opens. Rugged metal case with colored plastic front and back. Loop antenna in lid. Furnished with diagram and photos, tubes and 8 1/2 V-Battery. Will go together like a factory unit. Shipping weight 4 lbs. Tube \$X-45. \$12.95. Wired and tested \$17.95.

Complete Mike Broadcaster Kit Model DE-6X. Broadcasts 800 to 1500 KC from either a phonograph pick up or mike. Makes any radio receiver a P.A. system or recording amplifier. Broadcast tone quality. Has feder control from mike to record and back to a regular broadcast stations. Works on 110V AC-DC. Ready punched chassis. Price includes wiring diagram, photos and tubes. 2-35B5, 12SK7, 35W4. Kit Model DE-6X. Weight 4 lbs. Net \$6.95. Crystal Mike and desk stand \$4.95 extra.

Complete Radio Kit Model TF-4. A 4 Tube AC-DC Broadcast TRF Receiver. Ideal for the beginner. 2 Gang Condenser. Ready punched chassis. Alnico V PM Speaker. Airplane Dial. Plastic cabinet. Diagram, photos and special pictorial diagram for beginners. This is the simplest type radio to wire. Price includes every part and tubes. 12SK7, 12SK7, 50B5 and 35W4. Kit Model TF-4. Weight 6 lbs. Net \$6.95.

McGEE RADIO COMPANY

August, 1949

PRICES F.O.B. K.C. Send 25% Deposit with order. Bal. Sent C.O.D. With parcel post orders include postage.

NOW AT OUR NEW AND LARGER QUARTERS 1422 GRAND AVE., KANSAS CITY, MISSOURI

GENERAL ELECTRIC AND WEBSTER VARIABLE RELUCTANCE

New Webster cartridge with removable permanent needle. Response is second to none. Offered with pre-amplifier 6S07 ready wired and tested. A scoop at \$5.95 complete.
Webster M1X3 cartridge only. net. \$4.41
New General Electric V. R. cartridge No. RFX-040, with removable needle. Net \$5.95
General Electric V. R. cartridge RFX-041, for micro-groove records. Net \$5.85
Our 6S07 type pre-amplifier with either RFX-040 or RFX-041 cartridge. Net \$9.35



AUTO RADIO VIBRATORS

Standard size, 4 prong vibrator, made by Standard vibrator factory. Has 4 points. Regular non-synch type. \$1.29, 10 for \$11.95.
8 prong vibrator unit. 1.49
Standard 5 prong vibrator. 1.49
6 prong, reversible sync vibrator. 1.99
7 prong, reversible sync vibrator. 1.99
7 prong, 2 volt G.E. vibrator. 1.99
4 prong, off-set Delco vibrator. 1.49
5 prong vibrator. 1.49
4 prong vibrator for Ford. 1.49

FARNSWORTH CABINET AND CHASSIS \$2.95

Farnsworth model GT-061. We offer you just the 12 inch beautiful plastic cabinet. Chassis pan with 6 octal tubes sockets. Dial bracket and dial glass. This is not a complete kit only the listed parts are furnished. A scoop while they last. Weight 6 lbs. Net \$2.95.

WALNUT ARM CHAIR CABINET \$29.95

This cabinet is OK for S-56 Hallcrafters WILL HOUSE CR-15 KIT. Walnut armchair cabinet. Outside dimensions 24" x 18 1/2" x 13 1/2". 15 1/2" deep and 27" wide. Ample room for high receiver 14" long, 9 inch and 10" deep. Will hold a changer up to 14" square. Will accommodate speaker up to 12". Has record album storage compartment. Hinged lid covers changer compartment. Cabinet AR-15. Net price \$29.95. Crescent Deluxe changer \$14.95 extra. Armchair cabinet. Stock No. AR-26. Has ready cut panel for S-56 Hallcrafters. Net \$29.95

TEST EQUIPMENT KITS

VTVM Kit \$23.95
Vacuum Tube Voltmeter Kit. Eico Model 23-K. Everything included to build a 4 1/2" electronic voltmeter. AC-DC ranges—0.5/10/500/1000 ohms. 2 ohms to 1000 meg ohms in 5 ranges. In a finished metal case. Kit 221-K. Weight 10 lbs. Net price \$23.95.

5 SCOPE KIT \$39.95

5" Scope Kit Eico Model 400-K. Shipping weight 40 lbs. Complete with tubes. You can't tell its appearance from a factory-built job. Kit Model 400-K. Net price \$39.95.

SIGNAL GENERATOR KIT \$19.95

Eico Signal Generator Kit. Model 320-K. Range: 150 kc to 100 mc in 7 bands. Wide vision dial. Weight 12 lbs. Model 320-K. Net price \$19.95.

FM TV SWEEP GEN. KIT \$24.50

FM and Television Sweep Generator Kit. Model A-300-K. 3 bands, 2 to 227 mc. Sweep width 500 kc to 10 mc. Priced complete with 5 tubes, 2-2F8, 2-6D4 and 1-7Y4. Output can be either FM or pure RF. Shipping weight 25 lbs. Net price \$24.50. Model A-300-K only factory wired and ready to work. Net price \$39.50.

TAPE RECORDER 1 HOUR MECHANISM TWIN CHANNELS SPECIAL \$59.95

Our leader tape recorder mechanism—Size 10x11x3 1/2x7-5/16, weight 16 lbs. Tape speed full 7 1/2 feet per second—two sound channels. One hour with 7 1/2 reel, 30 min. with 5 1/2 reel. Bias frequency to erase 50K.C. Twin erase heads, one recording and one erasing. Resistor to 800 ohms. Non-slip and Wow-less drive. Made for high fidelity recording and play-back on tape. Furnished complete with suggested diagram and erase coil. Model TP4-X. Tape mechanism. \$59.95. Recording Tape 7 1/2 Reel. \$2.50.

ST. GEORGE WIRE RECORDER MECHANISM WITH 3-TUBE CONVERTER \$29.95

Less Converter \$22.95

IDEAL FOR USE WITH S-56 OR S-59 Brand new wire Recorder mechanism. Same as those used on the Majestic radio wire recorder. This unit has 78 RPM turntable for recording on wire from standard Webster Recording Wire. Hour on standard Webster Recording Wire. This wire recording mechanism is offered to you at a fraction of the cost. Space required, 9x13x3 1/2" below board. Each unit is furnished with Oscillator Coil and a diagram showing how to wire a 2-Tube Osc. (We furnish special Osc. coil, not small part for Oscillator) and how to wire the wire recorder with radio amplifier. Ready punched for crystal phone pick-up. St. George wire record head with Osc. Coil and Diagram. Stock No. RG-3. Weight 15 lbs. Net \$22.95.
Crystal Pick-up Arm for Playing 78 RPM records. \$2.95 extra.
Webster Recording Wire. 15 Min. \$1.30; 30 Min. \$1.95; 1 Hr. \$3.25. Bullet Stated Sound Crystal Microphone.

WIRE RECORDER CONVERTER \$9.95

With this 3-tube converter you can adapt the St. George Airking, or Webster Chicago wire recorder mechanism to any radio or P. A. system. Only 3 connections necessary. Just plug in to the phono input of your amplifier and change the output tube. AC-Transformer construction. Gain for mike, 3 position switch for quickly changing from record to record. Comes with ready wired and tested with instructions and tube 12AT7 pre-amplifier. 6AQ5 Oscillator. Stock No. 6X4. Weight 10 lbs. Net. \$9.95. When purchased by itself.

ST. GEORGE RECORDER WITH CONVERTER \$29.95

St. George wire recorder mechanism Stock No. G-82 and RG-3. A perfectly combination offer when ordering, both for \$29.95. Why not order one of these for your S-56 Hallcrafters?

WIRE RECORDER AND 18-WATT P.A. SYSTEM SALE PRICE \$89.95

Three years of wire recording experience has led us to the development of this combination wire recorder and public address system. Housed in an attractive portable case with hinged lid on the recorder compartment. Beautiful streamline plastic grill. Storage compartment in back panel for mike and accessories. Size 21x11 1/2x14 1/2. 18 watt HI impedance amplifier with P.P. 6V6 tubes in output stage and separate 6AQ5 eraser circuit. New super erase circuit eliminates all the bugs in wire recording. 12 inch Alnico V P.M. speaker. Extension speaker Jack. Microphone control. Grouped desk stand. St. George wire recorder playback mechanism that has 78 rpm turntable and General Electric variable reluctance pick up. You can record or play phonorecords. Record from mike. The play back quality is tops. Plenty of volume and good fidelity. This is also a top wire recorder. Unit is completely assembled and ready to operate. Furnished with 20 crystal mike tubes. 15 min. 1.30, 30 min. \$1.95 hour \$3.25. Model GE-15 Portable public address system and wire recorder shipping weight 38 lbs. Net \$89.95.

What's New in Radio

WESTON AMMETER-VOLTMETER

To be known as Model 633 Type VA-1, a new a.c. clamp ammeter and voltmeter with five current ranges up to



1000 amperes and three voltage ranges up to 700 volts has been introduced by the *Weston Electrical Instrument Corporation*, 617 Frelinghuysen Avenue, Newark 5, N. J.

This instrument is designed to measure alternating currents and voltages without interrupting electrical service. Current measurements are made simply by placing the heavily insulated, trigger-operated clamping jaw around the conductor. The jaws will accommodate conductors, bare or insulated, up to two inches in diameter.

To prevent shorts when measuring current on bare conductors, the jaws of the clamp meter are insulated with tough rubber sleeves, and operation is simplified by the trigger which can be worked by one hand when making current measurements.

TWIN-LINE CONNECTOR

Grayhill, 1 North Pulaski Road, Chicago 24, Ill., is merchandising a simple twin-line connector for television receivers and accessories. The device is said to promote speed, neatness, and convenience in connecting accessory equipment into the receiver circuit.

By means of this new connector, such accessories as inside and outside antennas, boosters, matching stubs and matching devices, etc., are easily



attached. By permanently attaching one of these connectors to all twin leads involved, any combination of the associated equipment may be had in a matter of seconds.

Installation is comparatively simple. The pin of one-half of the connector

For additional information on any of the items described herein, readers are asked to write direct to the manufacturer. By mentioning RADIO & TELEVISION NEWS, the page, and the issue number, delay will be avoided.

matches the socket of the other half. To attach the wire, the screw holding together the two sections of the molded phenolic housing is removed, and the wires are inserted into the pin connectors.

ELEVEN JENSEN ADDITIONS

Bringing to a total of fifty-three the number of models offered in the standard series of the *Jensen Manufacturing Company*, 6601 S. Laramie Avenue, Chicago 38, Ill., eleven new loudspeakers have been announced by the company.

The company now can provide a speaker size for ninety-nine per-cent of the television and auto receiver replacement needs. The new models include five ovals in the popular 6 by 9 inch size, five 7-inch speakers, and one 5¼ inch model.

THREE NEW TV ANTENNAS

A new development of the *Communication Measurements Laboratory, Inc.*, 120 Greenwich St., New York 6, N. Y., is its new line of Vidi-Master television antennas, Models 73, 74, and 88, all-channel, low-band and high-band, respectively.

Singly or in combination they are

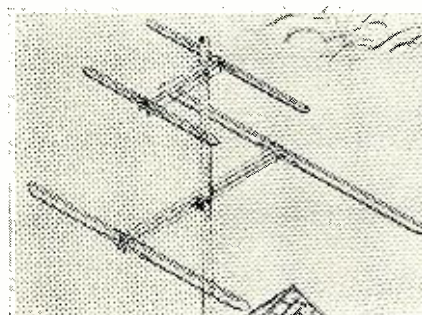

designed to provide ghost-free performance and adequate signal level to the outer fringe of every service area.

Models 73 and 74 are available with or without masts, and the Model 88 is supplied without mast. All have been field tested at various ranges and in the worst possible reception points, to insure the best performance.

NEW SYLVANIA VOLTMETER

Possessing the range and accuracy particularly appropriate for servicing television and high-fidelity audio circuits, an improved vacuum tube voltmeter has been produced by the Radio Division of *Sylvania Electric Products, Inc.*, 500 Fifth Avenue, New York 18, N. Y. The unit may be used to measure a wide range of voltage, current, and resistance values in standard broadcast receivers and many

types of industrial electronic equipment.

This *Sylvania* Polymeter, Type 221 provides an essentially flat response in



voltage measurements at frequencies ranging from 20 cycles to 300 megacycles and useful measurement at frequencies between 300 mc. and 500 mc. Six scales provide ranges for d.c. measurements from 0-3 to 0-1000 volts.

Other features of the Type 221 include shielded r.f. and a.c. probe leads to reduce stray field effects, microphone type panel connectors on test leads to assure firm, trouble-free panel connections, a large meter for good readability, and special zeroing controls for r.f. and a.c. voltage measuring circuits.

FREQUENCY MULTIPLIER

Manufactured as a complete "packaged" unit, including miniature tubes to keep power requirements low, a new all-band frequency multiplier is offered by *Barker & Williamson, Inc.*, 237 Fairfield Ave., Upper Darby, Pa. The unit is designed to simplify developing and constructing proper frequency set-up stages for transmitters.

This frequency multiplier covers 80, 40, 20, 15, 11, and 10-meter bands at the flip of a switch, and according to the manufacturer, it will operate with either v.f.o. or crystal input at an output of not less than 25 watts on all bands.

The size of the instrument is 6¼ by 7 by 9¼ inches, and the panel is of attractive, reverse etched aluminum.

PORTABLE WIRE RECORDER

Audar, Inc., Argos, Indiana, has released its Telvar Model RE-17 portable wire recorder which has the added gain required to obtain full recording volume at distances up to 25 feet from the microphone. More than ample playback volume is also avail-

WARD SMASHES TV ANTENNA INSTALLATION COSTS!

IT COSTS ONLY 6c IN LABOR TO ASSEMBLE WARD'S SENSATIONAL MINUTE MAN ANTENNA

(WP) CLEVELAND, OHIO

The Chief Engineer of the Ward Products Corporation states that the new sensational Minute Man antennas are being made of PERMA-TUBE — a newly perfected non-corroding coated steel tubing, created especially for Ward by the Jones and Laughlin Steel Corp., Pittsburgh, Pa. Independent laboratory tests on over 30 metals commonly used for antennas have proved PERMA-TUBE the best for all weather installations. Aluminum is too weak and other types of coated steel corrodes. Ward is the only manufacturer using PERMA-TUBE in constructing antennas. See your Ward Distributor today.

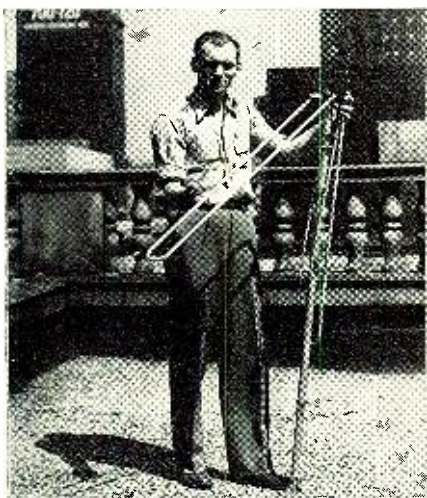

Dick Moss, television engineer, flicks up dipole in assembly operation of Ward Minute Man antennas. (Model TV-46).



A few seconds later and Dick snaps the high frequency dipole into position. It costs but 6c in labor to assemble this Ward Minute Man antenna.

August, 1949

FLASH!

WARD USES PERMA-TUBE IN CONSTRUCTING MINUTE MAN ANTENNAS.

(WP) CLEVELAND, OHIO

The Ward Products Corporation, a Division of the Gabriel Company, disclosed today their new Minute Man line of TV antennas. These 13 antennas, ranging in list prices from \$2.45 to \$49.95 are completely pre-assembled. Where it formerly took two installation men three-quarters of an hour (or approximately \$7.50 in labor) to assemble the ordinary TV antenna, one man can assemble any Ward Minute Man antenna in a few minutes. This is the greatest technical engineering improvement in the antenna field and the Ward engineers are to be congratulated on its achievement. They have spent many months in their laboratory perfecting the many ingenious construction features. See your Ward distributor today.

GREATER INCOMES AND PROFITS REALIZED BY INSTALLING WARD ANTENNAS.

(WP) NEW YORK, N. Y.

Now you can make big money on a standard installation fee. It has been reported that servicemen and retailers are realizing greater profits by installing Ward Minute Man Antennas. The quick 3 minute installation makes the big difference. It means more installations per day and at greater returns. No consumer complaints have been registered by big labor bills. See your Ward distributor today.

**See Your
Ward Distributor
Today**

INTRODUCING WARD'S NEW "MINUTE MAN" TV ANTENNAS

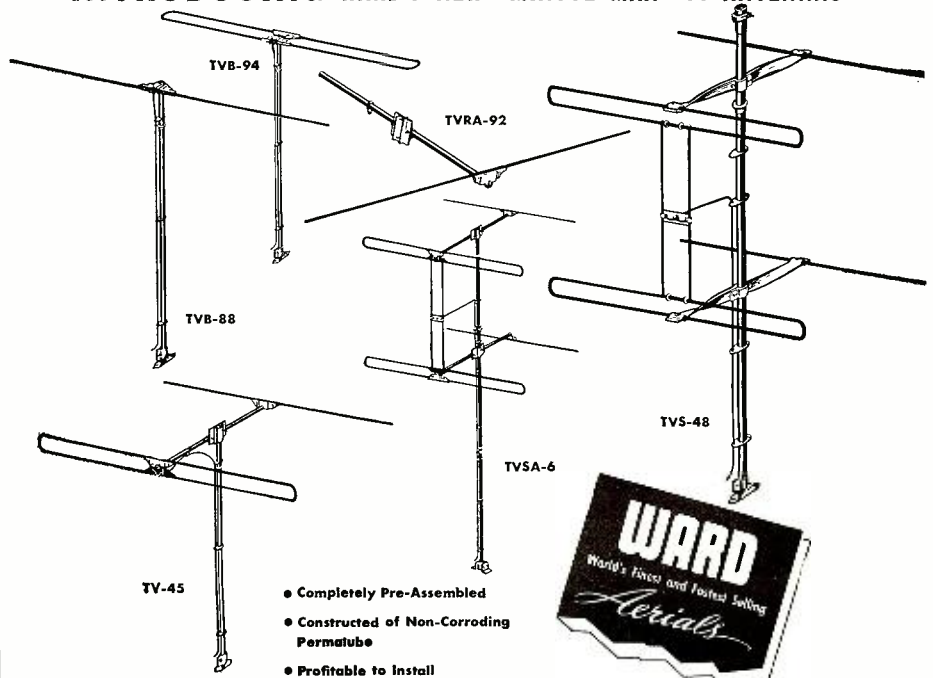

- Completely Pre-Assembled
- Constructed of Non-Corroding Permatube
- Profitable to Install

There are Ward Minute Man Antennas for every purpose and use from any distance from the transmitter. See your distributor today.

perfection
in projection TV

with the

SPELLMAN *Imperial* 3 x 4 feet

OF POWERFUL PROJECTED PICTURE!

Specifically designed for large audiences, this amazing new Spellman Imperial Television Receiver is a *must* for all commercial establishments and institutions. It projects the brightest, sharpest, most brilliant pictures in television today. No dim or fuzzy images . . . can be viewed under any light conditions . . . perfect side angles—truly a triumph in modern projection television achievement.



IMPERIAL MODEL

CHECK THESE EXCLUSIVE SPELLMAN FEATURES:

IDEAL
FOR LARGE
AUDIENCES

- Giant Schmidt Mirror in solid cast housing.
- Exclusive Regulated Power Supply.
- Automatic Cutout Relay for tube protection.
- Remote Control Operation.
- 12-square-feet of brilliant, crystal-clear picture.
- Cabinet—A masterpiece of superb contemporary design.

DISTRIBUTORS and DEALERS being appointed. Don't delay—Wire, Phone, Write today for full information. Take advantage of this new money-maker now!

PIONEERS IN PROJECTION TELEVISION

SPELLMAN TELEVISION CO., INC.

DEPT. A, 130 WEST 24th STREET, NEW YORK 11, N. Y. • AL 5-3680

ONLY VIDI-MASTER TV ANTENNAS HAVE THESE Exclusive—New DESIGN FEATURES!

- The first basic advance in broad-band Antenna design since 1945.
- Two driven, folded dipoles in a phased array provide better overall gain.
- All steel construction for maximum strength and minimum maintenance.
- Copper clad antenna elements for ultimate conductivity and corrosion resistance.
- Variable area principle permits impedance matching to 300 ohm or 72 ohm lines.
- Uni-directional or bi-directional patterns as required.

Complete performance data on VIDI-MASTERS TV ANTENNAS is yours for the asking. If your distributor cannot supply you, write direct.



COMMUNICATION MEASUREMENTS
LABORATORY, INC.

120 GREENWICH ST. • NEW YORK 6, N. Y.
Cable Address: "COMMUNILAB" New York

HIWAY COMPANY

TUBE OF THE MONTH—304TL
Repeated by popular demand!

Brand new, boxed, Ea. 79¢

ORDER 4 for \$2.95 and WE PREPAY SHIPPING!

SCR-274N, ARC-5, ATA/ARA EQUIPMENT

19-55 Mcs. Receiver. New \$14.75
3-6 Mcs. Receiver. Good cond. guar. 4.95
6-9 Mcs. Receiver. Good cond. guar. 5.95
7-9 Mcs. Arc-5 Trans. New but not factory packed 9.95
3-4 Mcs. Arc-5 Trans. Brand new 16.95
(average wt. of above items 13 lbs.)

ANTENNA SWITCHING RELAY: Current indicator is meter with 2 milliamp movement, not linear on D.C. Has best switching relay on the market. With 50 MMFD fixed, 5,000 V. vacuum condenser.

Near new condition \$1.75

NOTE: Order any 2 or more of above items and deduct 10%!

2-IN-1 SPECIAL!!!

BC-458, 4-5.3 Mcs. Transmitter PLUS BC-457, 5.3-7 Mcs. Transmitter, AL80 rack, mounting, plugs. Good condition guaranteed. Wt. 25 lbs. The whole deal . . . \$10.00

BC-221 A.K. FREQUENCY METER

Such excellent condition could pass for brand new! \$85.00

O-150 V.A.C. 3" ROUND G.E. VOLTMETER

Brand new \$4.25

Used, good cond. guar. \$3.35

The Hiway Policy: 25% DEPOSIT WITH ORDER. Remit in full — SAVE C.O.D. CHARGES. SATISFACTION GUARANTEED OR YOUR MONEY BACK!

HIWAY COMPANY

Electronic Division

1304 S. HOOVER ST.

(Just S. of Pico) (Fitzroy 0343)
LOS ANGELES 6, CALIFORNIA

Send for FREE Catalogue!

able with the extremely high gain reproducing amplifier.

High-fidelity recordings possible with the RE-17 put it in the so-called



"professional" class, yet the convenient size of 9 by 14½ by 14½ inches makes it practical for many applications in the home, school, or office.

SUBMINIATURE BALLAST TUBE

The *Amperite Company, Inc.*, 561 Broadway, New York 12, N. Y., has designed a new subminiature ballast tube for equipment where space is at a premium.

No base is required for this new tube, and leads can be soldered directly to those coming from the tube. In addition, this *Amperite* product is not affected by altitude or humidity, and an ambient change of minus 50° to plus 70°C. will produce a current change through the ballast of less than two per-cent. A one hundred per-cent increase in voltage across the tube will produce a current change of less than five per-cent.

Maximum current is 0.9 amps., and the tube can be supplied to dissipate any wattage up to three watts. Size of the flat bulb type is ⅝ by ⅝ inches, and the over-all length is 1½ inches.

BENCH POWER SUPPLY

Having special interest for the radio service trade, a new unit, the 6RS10, has been designed by *P. R. Mallory & Co., Inc.*, 3029 E. Washington St., Indianapolis 6, Ind., which will act as a convenient source of d.c. current



wherever 110-115 volt a.c. current is available.

This power supply is particularly suited for the testing of auto radio sets and has ample power to operate those with electrical tuning mechanisms. It is fully equipped with a 0-20

(Continued on page 96)

RADIO & TELEVISION NEWS

**PERMALLOY SHIELDS
for CATHODE RAY TUBES**



NOW AVAILABLE

1000 KC Crystal.....\$2.97
Socket..... .07

3" Shield..... \$1.47
5" Shield..... 1.97

TUBES!! BRAND NEW! STANDARD BRANDS! NO SECONDS! COMPARE! TUBES!!

1B21.....\$ 2.87	3EP1.....\$ 2.87	305A.....\$12.95	843..... .39	C100D.....\$ 1.95	O1A..... .39	6A6.....\$.89	6U5.....\$.65	19.....\$.98
1B22.....4.57	3EP29.....8.97	307A.....3.95	845W.....4.25	CK507AX.....1.95	1A3......45	6A7......67	6U7G......55	14A......67
1B23.....4.89	3EP7.....1.10	316A......35	851.....15.95	CK1005.....1.95	1A4......97	6A8......79	6V6......97	251B......57
1B24.....4.87	3EP11.....4.97	327A.....3.75	861.....10.95	CK1090.....2.95	1A4P......97	6AB7......79	6V6GT......65	2525......55
1B26.....4.57	4-65A.....14.49	338A.....3.95	861.....10.95	CK1090.....2.95	1A5GT......49	6AC7......77	6X4......59	2526......59
1B27.....4.89	4-125A.....27.45	350A.....1.25	864......49	EF50......47	1A6......79	6AF6G......79	6X5GT......49	26......57
1B29.....3.49	4-250A.....37.45	350B.....1.89	865......98	F123A.....12.95	1A7GT......67	6AG5......79	6Z6G.....1.15	27......47
1B36.....4.59	4AP10.....5.95	353A.....2.95	866A.....1.05	F123A.....14.50	1A8......49	6AH6.....1.29	6Z5Y5G......69	28D7......37
1B38.....37.50	4B24.....3.95	353B.....7.95	866JR.....1.10	F127A.....27.50	1B5.....1.05	6AJ5......79	7A4/XXL......59	30......57
1D24.....5.75	4C35.....29.50	382A.....1.95	869B.....39.50	F128A.....69.50	1B5/25S......67	6AK5......85	7A6......67	31......89
1N21......95	4E27.....12.95	388AS.....3.95	872A.....1.49	F606.....22.50	1C3GT......67	6AK6......69	7A7......57	32......97
1N21B.....1.95	4J32.....97.50	371B......85	874......57	F660.....125.00	1C6......49	6AL5......65	7A87......77	32L7GT......97
1N23.....1.75	5AP1.....3.95	388A.....2.95	876......98	F662A.....450.00	1C7G......89	6AL5......65	7B4......57	33......69
1N23B.....2.25	5AP4.....4.95	393A.....3.85	878......98	FG17.....2.89	1D3GT......97	6AQ6......59	7B6......59	34......69
1N34......85	5EP1.....1.89	394A.....2.85	884.....1.39	FG27A.....9.75	1D7G......95	6AT6......47	7B7......62	35......57
1P24.....2.95	5BP4.....2.85	417A.....14.50	885......97	FG81A.....4.50	1D8GT......95	6AU6......79	7C4......62	35A......67
1S21.....3.95	5CP1.....1.85	434A.....3.50	902P1.....3.85	FG95.....12.95	1F4......75	6AV6......57	7C5......57	35B......65
2A21.....3.89	5OPIA.....9.95	446A.....1.25	905.....3.98	FG105.....10.95	1FG......75	6B3......89	7C7......67	35C......65
2C21......27	5OCP7.....7.95	450TH.....17.95	908.....4.95	FG172.....12.95	1FGT......69	6B4G......89	7E5......67	35C5......65
2C22......19	5C30.....7.95	450TL.....52.50	923......97	FG210.....13.95	1G8GT......69	6B6G......89	7E6......59	35W4......42
2C26......27	5D21.....39.95	501......85	931A.....2.69	GL146.....9.95	1H4G......69	6B7......89	7E7......59	35W4......42
2C34......27	5EP7.....1.35	559......85	931A.....2.69	GL451.....1.95	1H6GT......57	6B8G......47	7E7......59	35W4......42
2C40.....6.59	5GP1.....4.95	575A.....12.95	953B.....29.50	GL562.....85.00	1H6GT......87	6BA6......55	7F7......69	35Y4......57
2C43.....9.97	5J1P1.....11.75	700A/B/C/D.....	954......15	GL697.....69.50	1H6GT......89	6BE8......57	7H7......69	35Z3......57
2C44......67	5JP2.....11.75	701A.....34.50	955......17	HY115......29	1LA......79	6BG8G.....1.59	7N7......67	35Z4......44
2C46.....6.67	5J29.....17.50	702A.....3.65	956......32	HYE1148......29	1LA6......89	6BH6......57	7Q7......59	35Z5......42
2C51.....8.25	5I30.....19.50	702B.....3.95	957......32	KC4.....87.50	1LB4......89	6BJ6......59	7R7......69	37......47
2D21.....1.17	5I1P1.....13.95	703A.....3.95	958A......35	KU610.....9.75	1LC5......79	6C4......25	7W7......89	38......38
2E22.....1.29	5NP1.....4.75	705A.....1.10	959......37	KU610.....9.75	1LC6......57	6C5......47	7X7......67	39/44......27
2E24.....4.87	6C21.....24.75	706CY.....18.75	991......27	ML100.....49.50	1LC6......57	6C6......74	7Y4......67	41......52
2E26.....3.49	6F4.....5.59	707B.....8.75	1603.....2.95	ML101.....139.50	1LDS......79	6C8G......69	7Z4......67	41......57
2J21A.....8.95	6I4.....5.95	708A.....3.95	1613......59	ML21.....69.50	1LGS......89	6D6......47	12A......57	43......57
2J22.....8.95	7HP7.....4.65	713A......95	1614.....1.45	ML502.....149.50	1LH4......69	6D8G......87	12A6......19	45......57
2J26.....7.95	9GP7.....12.50	714A.....12.95	1616......98	REL21.....4.95	1LN6......67	6E5......69	12A7......98	45......57
2J27.....8.95	9J1P1.....3.75	714AY.....3.95	1619......98	REL36......79	1N5GT......59	6F5......47	12AGT......67	45Z3......57
2J30.....32.50	9I1P7.....2.25	715C.....34.95	1624......69	RK21.....4.85	1Q5GT......67	6F6......89	12AHGT......85	45Z5......49
2J31.....9.75	10BP4.....24.85	717A.....1.65	1625......37	RK25.....3.65	1Q5GT......67	6F7......85	12AT6......57	46......69
2J33.....39.50	10Y.....49	723A/B.....24.95	1626......37	RK33......27	1R4......49	6F8G......79	12AU6......67	47......69
2J34.....39.50	12DP7.....13.95	724A/B.....3.95	1629......27	RK34......27	1R5......69	6G6G......69	12AU7......85	50A5......75
2J37.....17.50	12HP7.....13.95	725A.....9.50	1630.....1.98	RK59.....1.95	1S4......59	6H6......47	12BA6......57	50B5......59
2J38.....12.95	15E.....1.95	726A.....6.95	1631.....1.45	RK63.....18.50	1S5......57	6I6......89	12C8......49	50L6......57
2J39.....34.50	15R.....1.95	730A.....10.95	1632.....1.98	RK72.....24.95	1S5......57	6J7......67	12F5GT......67	50V6......57
2J40.....49.50	23D4......29	730TL.....45.00	1633......98	RK72......97	1T5GT......67	6K6GT......49	12H6......35	53......45
2J46.....39.50	24G......47	800.....1.95	1636.....4.75	RK73......79	1U4......59	6K7......57	12I6......57	53......45
2J48.....39.50	30 Spec......35	801A......49	1638......79	RX21.....3.45	1V......57	6K7......57	12I6......57	53......45
2J49.....24.95	45 Spec......29	802.....4.25	1641......69	RX120.....8.95	2A3......69	6K8......69	12K3......79	58......49
2J50.....42.50	75TL.....2.80	803.....4.95	1642......69	RY40.....2.25	2A3......69	6L6.....1.17	12J7......57	59......49
2J53.....42.50	75TL.....2.80	804.....4.95	1645.....1.10	SZ40.....2.27	2A5......69	6L6GA......97	12S2A......57	70L7.....1.17
2J54B.....97.50	100TH.....11.50	805.....3.85	1851......97	V70D.....6.95	2A6......69	6L7......79	12S7......57	71A......67
2J61.....39.50	100TS.....2.35	807.....1.10	1960.....2.95	VR65A.....1.95	2A7......69	6N7......79	12S7......57	71A......67
2J62.....39.50	204A.....57.50	808.....1.39	2050......65	VR75......97	2V3G......89	6N7......79	12S7......57	75......57
2K25.....23.95	205B.....1.75	809.....2.45	2051......67	VR78......67	2X2A......69	6N7......79	12S7......57	75......57
2K28.....32.59	21A......49	810.....1.69	2193......19	W17......29	2X2A......69	6P7......89	12S7......57	75......57
3A2P1.....3.49	215A.....6.65	801B.....1.39	8015.....4.75	VR105......67	3A4......37	6R7......89	12S7......57	75......57
3B22.....2.69	217C.....9.95	812.....2.65	8011......69	VR150......55	3A5......89	6S7......89	12S7......57	75......57
3B23.....4.85	218.....47.50	812H.....6.75	8012.....1.47	VT127.....2.25	3B7......35	6S7......89	12S7......57	75......57
3B24.....1.69	221A.....1.95	813.....6.27	8013A.....1.45	UT111......79	3D6......35	6S7......89	12S7......57	75......57
3B25.....4.87	225.....8.70	814.....2.75	8014A.....22.50	W1468......75	3D6......35	6S7......89	12S7......57	75......57
3B26.....1.47	227A.....2.95	815.....1.39	8020.....1.95	W1530.....49.50	3Q3GT......67	6S7......89	12S7......57	75......57
3B27.....3.85	231D.....1.25	816.....1.05	8025.....3.75	WL331.....7.95	3S4......67	6S7......89	12S7......57	75......57
3BP1.....1.39	249B.....2.49	826......42	9001.....3.75	WL532.....3.50	5R4GY.....1.10	6SH7......37	14A4......87	84/6Z4......67
3C21.....5.95	249C.....1.69	829B.....7.45	9002......34	WL538......69	5T4......89	6S7......89	14A7......87	85......59
3C22.....39.50	250R.....7.45	830B.....3.49	9003......37	WL578.....1.95	5U4G......79	6S7......89	14B6......67	89Y......57
3C23.....2.47	250TH.....18.95	832A.....4.25	9008......37	WL616.....87.50	5V4G......79	6S7......89	14F7......69	117L/M7.....1.17
3C24.....3.24	251A.....18.95	834A.....32.50	9015.....1.95	WL681.....29.15	5W4......79	6S7......89	14F8......69	117L/M7.....1.17
3C30......49	274B.....1.19	834.....5.75	9005.....1.95	WX3245.....49.50	5X4G......57	6S7......89	14F8......69	117L/M7.....1.17
3C31.....1.75	282B.....9.75	836A.....1.95	9006......24	OA2.....1.57	5Y3GT......39	6S7......89	14N7......89	117P7.....1.27
3CP1.....2.67	294A.....4.57	837.....1.25	C5B.....7.95	OA4G......95	5Y4G......49	6S7......89	14N7......89	117P7.....1.27
3CD1A......98	304TH.....3.45	838.....3.45	C6A.....8.45	OB2.....1.75	5Z3......49	6S7......89	14R7......67	117Z3......57
3DP1.....1.97	304TL......99	841......49	C6J.....4.95	OZ4......57	5Z4......79	6T7G......89	15......89	117Z6......75

OIL CONDENSERS
NATIONALLY ADVERTISED BRANDS
All Ratings D. C.

2x.1mf.	600v	\$0.37	1mf.	2000v	\$0.97
.25mf.	600v	.37	2mf.	2000v	1.27
.5mf.	600v	.37	4mf.	2800v	3.77
1mf.	600v	.37	8mf.	2000v	3.47
2mf.	600v	.37	15mf.	2000v	4.97
4mf.	600v	.57	4mf.	2500v	3.97
8mf.	600v	1.07	2mf.	2500v	2.37
10mf.	600v	1.17	1mf.	2500v	1.27
3x.1mf.	1000v	.47	.25mf.	2500v	1.47
.35mf.	1000v	.47	.5mf.	2500v	1.77
1mf.	1000v	.57	.05mf.	3000v	1.97
2mf.	1000v	.67	.25mf.	3000v	2.67
4mf.	1000v	.87	1mf.	3000v	2.87
8mf.	1000v	1.97	12mf.	3000v	6.87
10mf.	1000v	2.07	2mf.	4000v	4.87
15mf.	1000v	2.27	1mf.	5000v	4.97
20mf.	1000v	2.97	1mf.	7000v	2.97
24mf.	1500v	5.27	1mf.	7000v	2.97
.1mf.	1750v	.87	3mf.	4000v	5.37
.1mf.	2000v	.97	2mf.	3000v	3.47
.25mf.	2000v	1.07	2x.1mf.	7000v	3.27
.5mf.	2000v	1.17	.02mf.	2000v	9.97

HIGH CAPACITY CONDENSERS
All Ratings D. C.

2x3500mf.	25v	\$3.47	200mf.	35v	\$ 57
2500mf.	3v	.37	100mf.	50v	.47
3000mf.	25v	2.47	4x10mf.	400v	.87
2x1250mf.	10v	1.27	400mf.	15v	1.97
1000mf.	15v	.97	400mf.	30v	3.27

TRANSFORMERS—115 V. 60 Cy.
HI-VOLTAGE INSULATION

2500v @ 15 ma.	\$4.97
1700v @ 4 ma; 6.3v @ 1A; 2.5v @ 2A.	4.97
1600v @ 4 ma.; 700v CT @ 150 ma.; 6.3v @ 9A.	6.47
525-0-525v @ 60 ma.; 925v @ 10 ma.; 2x5v @ 3A; 6.3v @ 3.6A; 6.3v @ 2A; 6.3v @ 1A.	6.97
500-0-500v @ 25 ma.; 262-0-262v @ 55 ma.; 6.3v @ 1A; 2x5v @ 2A.	4.47
400-315-0-100-315v @ 200 ma.; 2.5v @ 2A; 5v @ 3A; 6.3v @ 9A; 6.3v @ 9A.	5.97
385-0-385-550v @ 200 ma.; 2x4v @ 2A; 5v @ 3A; 3x5.3v @ 6A PRL 110/220.	6.27
340-0-340v @ 300 ma.; 1540v @ 5 ma.	4.97
300-0-300v @ 65 ma.; 2x5v @ 2A; 6.3v @ 2 1/2A; 6.3v @ 1A.	3.47
150-0-150v @ 80 ma.; 150v @ 40 ma.; 6.3v @ 3.5A; 6.3v @ 1	

HARVEY has it NEW
when it's

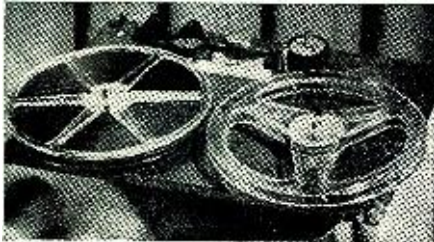

DUOTAPE MAGNETIC RECORDER

PARTS KIT

ANYONE CAN ASSEMBLE THIS KIT with a screwdriver, pliers and a soldering iron. Only a few hours are required to assemble this precision-engineered parts kit. Everything needed to build the tape mechanism is included:

**Erase/Record/Reproduce Head
Tape Reel Take-up Mechanism • Capstan
Pressure Roller and Arm • Driver Motor
Oscillator Coil • Motor Mounting Plate
Motor Switch • Main Support Panel
Flywheel and Bearing • Hardware**

All panels are drilled, difficult sub-assemblies are factory assembled and tested. Easy-to-follow instructions are included.

Playing time is one hour, using dual track on Scotch tape. One-half the width of the tape is recorded in one direction for a half hour, then the reels are reversed and the other half recorded, which also rewinds the first recording ready for playback. Recording speed is 7½ inches per second, response is excellent from 80 to 9000 cycles, with exceptionally low distortion.

Any amplifier may be used, but circuit diagrams, parts list and hints on building a high-fidelity record-playback amplifier are included in the kit. We can supply any or all of the parts for this circuit, or we can furnish you with a high-fidelity amplifier of any standard make.

Uses of the Duotape recorder are limitless. Use it for family recordings, musical instruction, off-the-air recordings, rehearsing speeches, providing synchronized sound for home movies or slides, or for novel party entertainment.

Complete Kit of Parts for
Duotape Magnetic Recorder . . .

\$44⁹⁵

NOTE: All prices are Net, F.O.B. N.Y.C. and are subject to change without notice.

Telephone: **7** LUxemburg 2-1500

HARVEY
RADIO COMPANY INC.
103 West 43rd St., New York 18, N. Y.

AFCA



NEWS

This Association is a patriotic non-profit organization, with chapters in most of the larger cities, dedicated to developing and maintaining efficient personnel, commissioned, enlisted, civilian, for the supply (including design and development), installation, maintenance and operation of communications and electronic equipment for Army, Navy and Air Force and their supporting civilian activities. It publishes a magazine "SIGNALS" at its national headquarters in Washington. Every American interested in any way in communications is eligible and invited to join. Further details may be obtained by addressing the secretary at 1624 Eye St. N. W., Washington 6, D. C.

ROTC Awards

The AFCA medal which is awarded to the outstanding ROTC (Army, Navy, or Air Force) student in the communications course was presented at seventeen colleges at the close of the 1948-49 academic year. The award also includes a special scroll, one year's honorary membership in the Association and a subscription to *Signals*. The recipients were:

Arthur E. LaPorte, Jr., New York University; Terrence S. Meade, State College of Washington; Robert B. Patton, State College of Washington; Louis A. Morton, Massachusetts Institute of Technology; Warren S. Messner, Cornell University; Theodore R. Littlefield, University of Maine; Robert O. Rushing, University of Alabama; Chester R. Richey, Jr., Oklahoma A&M College; Howard D. Akins, Kansas State College; John B. Berry, Jr., Clemson Agricultural College; John W. Main, Michigan State College; Edward L. Shideler, Iowa State College; Leroy L. Williams, Jr., Georgia Institute of Technology; Francis R. Lengfeld, A&M College of Texas; Rex N. Brown, Texas Technological College; Vincent J. Romano, Rutgers University; William M. Mueller, University of California.

West Point Award

This award is made annually to the graduating cadet who stands highest in the study of electricity. This year's winner was Cadet Paul Crowther Dow, Jr., of Massachusetts, who graduated into the Air Force. AFCA President Fred R. Lack made the presentation of the award, consisting of an *Eastman-Kodak* camera, at the review of the corps of cadets at West Point on June 5th.

Annapolis Award

An annual award, similar to the one at West Point, was inaugurated at the Naval Academy this year. Mid-

shipman William Littell Bryan of Clarks Green, Pennsylvania, who stood highest in the electronics course received the award. The presentation was made by Walter R. Evans, AFCA National Director, at a dress parade of the brigade of midshipmen at Annapolis on May 31st.

* * *

AFCA CHAPTER NOTES

Atlanta

The annual spring dinner-meeting of the Atlanta Chapter was held on May 11th at the Officers' Club, Fort McPherson. Col. George W. Goddard, Officer-in-Charge Aerial Photographic Research, was the principal speaker. He was introduced by Maj. Gen. Francis L. Ankenbrandt, Director of Air Force Communications. Col. Goddard demonstrated the tri-dimensional photography show as developed by the Air Force.

New officers for the ensuing year were installed as follows: President—W. H. Mansfield, *Southern Bell T&T Co.*; 1st vice-president—retiring chapter president Dan. A. McKeever of *J. E. Hangar Co.*; 2nd vice-president—Lt. Col. Hugh A. Vest, 3rd Army Communications, Fort McPherson; 3rd vice-president—R. J. Jernigan, Atlanta Signal Depot; 4th vice-president—R. J. Klein, Jr., Georgia Tech; secretary-treasurer—Capt. Dewey Allread, Jr., Fort McPherson.

Augusta-Camp Gordon

Twenty-six members of the newly-formed chapter attended a business meeting at the Camp Gordon Officers' Club on May 18th. The interim officers chosen at the last meeting were unanimously elected to serve for the balance of the year. Lt. Col. Harold F. Osborne of Camp Gordon was added to the slate as 2nd vice-president.

The proposed constitution and by-laws for the chapter were presented and were unanimously approved. Committees were appointed for the following functions: membership, arrangements, financial, armed forces, civilian components, liaison, and publicity.

Baltimore

The Point Breeze plant of the *Western Electric Company* was host to the Baltimore Chapter for its annual dinner meeting on June 8th. One hundred and sixty-five members were present. The guest of honor was Mr. Fred R. Lack, National President of AFCA and vice-president of *Western Electric*. In his address, Mr. Lack explained the vital importance of communications in modern warfare, the part that wire circuits played in

RADIO & TELEVISION NEWS

RADIO TUBES at Lowest Prices!

AM, FM, TV—Tremendous Selection of All Types—ORDER TODAY!

29¢ ea.	35W4 01A 4A6G 6A3 6C4 6F8GT	6SD7GT 10 12A 14X7 39/44 47	50 71A 112A 182B 183 25Z6GT	482B 483 1A4 1A6 1B5	1C6 1C7G 1D5GT 1D7 1D8GT 1F4	1F5G 1G4GT 1G6GT 1H4G 1H6GT 1J6G	29¢ ea.		
35¢ ea.	1R5 1S5	1T4 1U4	3A4 3Q4	354 3V4	5Y3GT 6S8GT	6SS7 26	27 35Z5GT	35¢ ea.	
39¢ ea.	6AC5GT 6AG5 6AK5 6AL5 6AL6 6AQ5 6AT6 6AU6 6A7 6A8G 6A8GT 6B6 6BA6 6BD6 6BE6 6BH6 6BJ6 6C4	6C5 6C8G 6D6 6F5GT 6F6GT 6G6 6H6 6H6GT 6J5 6J5GT 6J6 6J7G 6K6GT 6K7GT 6K8GT 6Q7 6Q7GT 6P5GT	6SA7GT 6SC7GT 6SF5GT 6SG7GT 6SH7 6SJ7GT 6SL7GT 6SK7GT 6SN7GT 6SQ7GT 6SR7 6UG 6U6GT 6U7G 6U7GT 6V6GT 6X4	6X5GT 6Z4 12A8GT 12AT6 12AU6 12AU7 12AX7 12BA7 12BA6 12BE6 12F5GT 12H6 12J5GT 12J7GT 12K7GT 12K8GT 12Q7GT 12S8GT	12SA7GT 12SF5 12SF7 12SG7 12SH7GT 12SJ7 12SJ7GT 12SK7GT 12SN7GT 12SQ7GT 12SR7GT 14X7 2050 2051 24A 24A 30 12AT7 12C8 12J5 12Q7 12SF7 12SG7 14N7 19T8 20	27 30 31 35 35B5 35C5 35Z3 35Z4GT 36 37 38 39 41 42 43 45 46 50A5 50B5	39¢ ea.		
49¢ ea.	1V 1CSGT 2A3 2A5 2A7 2B7 2C34 2E24 5V4 5X4 5Z4 6AC7	6AV6 6B4G 6B8 6C6 6D8 6D8G 6F5 6F8G 6H6 6J7 6K7G 6Q6	6R7 6SF5 6SG7 6SG7GT 6T7G 6T8 6U7 6W7G 6Y6G 6Z7G 7A4 7A7	7B6 7E5 7E6 7E7 7F7 7G7 7H7 7J7 7L7 7N7 7Q7 7S7	7T7 7W7 12A7 12AT7 12C8 12J5 12Q7 12SF7 12SG7 14N7 19T8 20	2050 2051 24A 30 32L7GT 35/51 35L6GT 36 40 50L6GT 56 57	49¢ ea.		
59¢ ea.	1B3 1AD5 1LA6	1LB4 1LC5 1LC6	1LH4 1LN5 2V3G	31F4 6B7 6B8	6B6G 6J8G 6L6G	6L6 6S7G 6U5	12Z3 70L7GT 43	81 117Z6GT	59¢ ea.

5% additional discount for orders of 200 tubes or more assorted.

Less than 25 tubes, 5c per tube extra. Individually boxed—Standard factory guarantee.

OUTPUT TRANSFORMERS

For 50L6, etc. **39¢ ea.**

For 6V6, 6F6, 3Q5, etc. **45¢ ea.**

UNIVERSAL OUTPUT TRANSFORMER SPECIAL:

Up to 12 watts to any speaker... **\$1.10 ea.**

IF TRANSFORMERS

Standard Replacement
Regular size..... **29¢ ea.**
Midget..... **39¢ ea.**

VOLUME CONTROLS

1/2 meg.—switch—long shaft..... **34¢ ea.**
2 meg. for battery sets, DPST switch—long shaft..... **34¢ ea.**

4 PRONG VIBRATORS—VERY BEST BRANDS

Standard replacement—Sensational Value..... **\$129 ea.**

FILTER CONDENSERS

Very best brands. Fresh stock

8 mfd, 450 V.....	ea. 21c	10-10 mfd, 450 V.....	ea. 43c
10 mfd, 450 V.....	ea. 24c	20-20 mfd, 450 V.....	ea. 49c
10 mfd, 450 V with 20-20 mfd, 25 V.....	ea. 29c	15-15 mfd, 150 V.....	ea. 29c
15 mfd, 450 V.....	ea. 29c	20-20 mfd, 150 V.....	ea. 29c
20 mfd, 450 V.....	ea. 39c	30-30 mfd, 150 V.....	ea. 39c
30 mfd, 450 V.....	ea. 49c	40-20 mfd, 150 V.....	ea. 39c
30 mfd, 450 V with 20-20 mfd, 25 V.....	ea. 29c	40-40 mfd, 150 V.....	ea. 39c
		50-30 mfd, 150 V.....	ea. 39c
		50-50 mfd, 150 V.....	ea. 39c
		60-60 mfd, 150 V.....	ea. 39c

Rated accounts—10 days—all others 20% deposit with order, balance COD. Minimum order \$5.00. All shipments FOB Chicago. Prompt attention paid to foreign orders. ORDER TODAY

SPECIAL SALE!

PILOT LIGHTS—100 bulbs **\$4.90**
1 box of 10 bulbs..... **54c**

No. 40 6-8 Volts .15 Amps. No. 46 6-8 Volts .25 Amps.
No. 41 2.5 Volts .50 Amps. No. 47 6-8 Volts .15 Amps.
No. 44 6-8 Volts .25 Amps. No. 51 6-8 Volts .20 Amps.

AUTO ANTENNAS

Snyder TC-3 Top cowl C-30..... **\$1.79 ea.**
an-tenna..... **\$1.99 ea.** Side cowl.

CRYSTAL CARTRIDGE

Standard replacement crystal cartridge..... **\$1.39 ea.**

PICK-UPS Sure, Astatic—wide response. Finest pickups—standard replacement..... **\$2.95 ea.**

6-Ft. LINE CORDS Good Rubber with plug. Underwriters' Approved. 10 for **\$1.25** 10 for **\$1.69**

PUSH-BACK WIRE 100 ft. rolls **39¢ each**

SELENIUM RECTIFIERS

Standard 100 mil..... **69¢ ea.** 75 mil..... **59¢ ea.**

GE VARIABLE RELUCTANCE CARTRIDGE List Price \$9.95 Your Cost..... **\$3.68 ea.**

OCTAL SOCKETS..... **.10 for 49¢**

VARIABLE CONDENSERS Two gang for superb Standard 1/4" shaft..... **69¢**

SPEAKERS

Best quality Alnico 5 PM Speakers.

10 or more Each	Price Each
95¢	\$1.05
2 1/2"	\$1.49
3 1/2"	2.95
4"	4.25
5"	4.95
6"	\$1.49
8"	2.95
10"	4.25
12"	4.95
	\$1.59
	3.25
	4.50
	5.95



BY-PASS CONDENSERS

100 Condensers ass't. in package..... **\$5.49**

.001 mfd. 600 V.....	ea. 6c
.002 mfd. 600 V.....	ea. 6c
.005 mfd. 600 V.....	ea. 6c
.01.....	ea. 7c
.02.....	ea. 7c
.05.....	ea. 8c
.1.....	ea. 9c

400 VOLT BY-PASS CONDENSERS

.2 mfd.....	ea. 9c
.25 mfd.....	ea. 10c
.5 mfd.....	ea. 15c

BUFFER CONDENSERS

.005 mfd. 1600 WV.....	} 15c ea.
.008 mfd. 1600 WV.....	
.01 mfd. 1600 WV.....	

15 mfd, 150 V.....	ea. 21c
16 mfd, 150 V.....	ea. 23c
20 mfd, 150 V.....	ea. 25c
30 mfd, 150 V.....	ea. 29c
40 mfd, 150 V.....	ea. 29c
10 mfd, 25 V.....	ea. 16c
20 mfd, 25 V.....	ea. 16c
25 mfd, 25 V.....	ea. 16c
100 mfd, 25 V.....	ea. 16c
20-16-16 mfd, 350 V Sprague.....	ea. 39c
25-25-150 V-200-10 V.....	ea. 39c

CONDENSERS

PREMIER RADIO TUBE COMPANY, 1812 Winnemac Ave., Chicago 40, Ill.
"Your Tube Source Since 1926"

**TELEVISION
SERVICING at a
PRICE YOU CAN PAY**

R. S. E. 3 inch TELEVISION SCOPE

Features:

**WIDE BAND VER-
TICAL RESPONSE**
FLAT TO 750kc
DOWN 3db
AT 1mc
VOLTAGE GAIN
OF 20 AT 5mc



AR-3

The R.S.E., AR-3 Scope has been built by Armstrong to our rigid specifications. It's a complete unit that embodies standard horizontal amplifier and sweep circuits with normal sensitivity.

The case is 8" high x 5" wide x 14" long, attractively finished in "hammered" opalescent blue enamel. Operates on standard 110 volts—60 cycles—40 watts. Tubes, 3BP1—6AC7—6SJ7—6X5—5Y3—884. Instructions included. Complete specifications upon request. Satisfaction or your money back.

PRICE
\$49⁹⁵
F. O. B.
DETROIT

PUSHBACK WIRE



BELOW MILL PRICES!

2,000,000 feet—tinned copper—all 1st. class, double cotton serve, waxed finish. Available 1,000 foot rolls.

22 gauge (6 colors) \$3.98 roll
20 gauge (6 colors) 4.98 roll
18 gauge (brown only) 6.49 roll



OZ4's (No Limit)

Fresh RK and RCA. Standard commercial grade, not JAN's.

BUY 12 58c
get 1 free EACH

EGG CRATE OF 100 \$4900



**Demand This
Seal of Quality**

ORDER INSTRUCTIONS

Minimum order—\$2.00. 25% deposit with order required for all C.O.D. shipments. Be sure to include sufficient postage—excess will be refunded. Orders received without postage will be shipped express collect. All prices F.O.B. Detroit.

**RADIO SUPPLY &
ENGINEERING CO., Inc.**
89 SELDEN AVE. DETROIT 1, MICH.

World War II as compared with radio, and emphasized the purposes of AFCA. Brig. Gen. S. H. Sherrill, National Executive Director, complimented the Baltimore Chapter on its progress and activities and stressed the need for a vigorous recruiting campaign for more members.

The following were elected to serve as chapter officers for the ensuing year: Mr. F. E. Moran of *Western Union* was re-elected president for a second term; Mr. E. K. Jett, *Baltimore Sunpapers* and former FCC Commissioner, was elected vice-president; Henry W. Williams, *Chesapeake & Potomac Telephone Co.*, was elected secretary; and Lt. Col. H. L. Stecher, USA, was elected treasurer.

Chicago

Action was taken at the reorganization meeting at the Stevens Hotel on May 20th which should return this chapter to an active status comparable to New York and the other large city chapters.

Rear Admiral Earl E. Stone, Chief of Naval Communications and vice-president of AFCA, delivered an interesting address on the Navy's role and the importance of the electronics industry to the services. AFCA President Fred R. Lack followed with a brief talk on the critical world situation and pointed out the objectives of the Association and the need for its expansion and increased influence for military preparedness in the electronics and photography fields. Brig. Gen. S. H. Sherrill, National Executive Director, then outlined procedures followed by other chapters that have been leaders in Association activities and discussed AFCA accomplishments during its three years of existence.

Chapter officers were elected as follows: President—Oliver Read of *RADIO & TELEVISION NEWS*; vice-presidents—J. H. Kellogg of *Kellogg Switchboard & Supply Co.*, R. T. Brengle for radio parts manufacturers, Dwight Brown of *Illinois Bell Telephone Co.*, and John Howland, *Zenith Radio*; secretary-treasurer—Col. R. K. Freid.

Cleveland

The Cleveland Chapter held its annual dinner meeting on May 5th at the Cleveland Engineering Society. Elected to the board of directors were: T. R. Beatty of *National Carbon Co.*; H. C. Endress, *Willard Storage Battery Co.*; T. F. Peterson, *American Steel & Wire Co.*; and L. K. Wildberg, *Radiart Corporation*.

After the presentation of the annual report for 1948-49, the gathering heard Mr. R. J. Kappandaze deliver a talk on "A Glimpse Behind the Iron Curtain."

Kentucky

The May meeting of the Kentucky Chapter took place at the Officers' Club of the Lexington Signal Depot on May 24th and drew a record attendance of 125. The program started with an old fashioned Kentucky bar-

becue, after which Chapter Vice-President Harry Bradshaw introduced T. S. Gary, AFCA National Vice-President who had come down from Chicago for the meeting. Mr. Gary complimented the chapter on its success in winning the "Chapter of the Year" contest and presented the "Chapter of the Year" scroll to Mr. Bradshaw who accepted for the chapter in the absence of President McQuown.

Lt. Col. Caesar F. Fiore of the Armored School at Fort Knox, was the speaker of the evening and gave an illustrated talk on "New Signal Equipment."

New York

The final meeting of the season for the New York Chapter, AFCA's oldest and largest, was held at the Seventh Regiment Armory on June 1st. The program began with two intensely interesting Navy motion pictures—"The Fleet That Came to Stay" and "The Silent Service." Then several MARS certificates were presented by Maj. Gerald S. Morris, OIC, First Army MARS Activities, to hams who had recently qualified for membership in the Military Amateur Radio System. The first certificate was presented to Col. David Talley, veteran amateur radio operator who has done so much for ham activities in the military forces. Mr. George Bailey, President of ARRL, Executive Secretary of IRE, and a Director of AFCA's New York Chapter, made some timely remarks before the presentations.

After dinner, Chapter President George P. Dixon called on the following for informal remarks: Maj. Gen. H. C. Ingles, a director of the Chapter and former Chief Signal Officer and now president of *RCA Communications*; former New York Chapter Presidents C. O. Bickelhaupt of *AT&T* and A. W. Marriner of *IT&T*; Capt. Roy Graham, USN, Communications Officer for the Navy's Eastern Sea Frontier; Col. Robert R. Yeager, Communications Officer for the C. G. Air Defense Command; Warren L. Jacobus, Spanish-American War Signal Corps veteran and an honorary member of AFCA; and Col. Grant Williams, former First Army Signal Officer, now with *IT&T* in Egypt. Brig. Gen. S. H. Sherrill, National Executive Director, who came up from Washington for the meeting, complimented the chapter on being runner-up in the "Chapter of the Year" contest and on its superior leadership.

Sacramento

AFCA's Sacramento Chapter joined with the Sacramento Sections of the Institute of Radio Engineers, American Institute of Electrical Engineers and the Amateur Radio Club in sponsoring a technical meeting on April 18th at the Sierra School Auditorium. The featured speaker was Dr. Cleo Brunetti of Stanford University who delivered a lecture on "Printed Circuits and Miniature Electronics." Dr. Brunetti was well qualified to pre-

THE NEW
MODEL TV-30

TELEVISION SIGNAL GENERATOR

**ENABLES ALIGNMENT OF TELEVISION I.F. and FRONT ENDS
WITHOUT THE USE OF AN OSCILLOSCOPE**

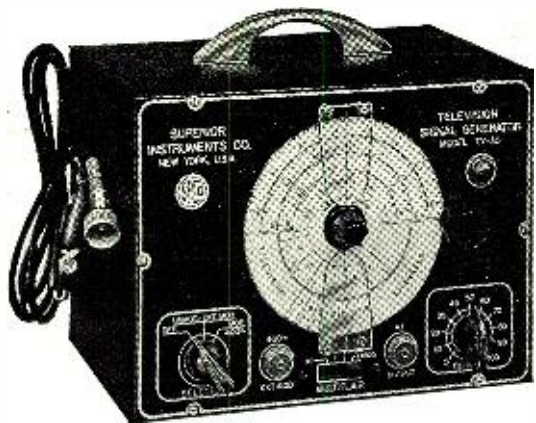

The Model TV-30 represents a radical departure in the design of Television Signal Generators. Unlike the "sweep" type of Generator which requires the use of an Oscilloscope and extensive technical knowledge including pattern interpretation, etc., the TV-30 is a self-contained unit which permits alignment of Television Receivers by the use of exactly the same methods employed in the past to align Broadcast and Short-Wave Receivers.

FEATURES: Built-in modulator may be used to modulate the R.F. Frequency also to localize the cause of trouble in the audio circuits of T.V. Receivers. Double shielding of oscillatory circuit assures stability and reduces radiation to absolute minimum. Provision made for external modulation by A.F. or R.F. source to provide frequency modulation. All I.F. frequencies and 2 to 13 channel frequencies are calibrated direct in Megacycles on the Vernier dial. Markers for the Video and Audio carriers within their respective channels are also calibrated on the dial. Linear calibrations throughout are achieved by the use of a Straight Line Frequency Variable Condenser together with a permeability trimmed coil. Stability assured by cathode follower buffer tube and double shielding of component parts.

SPECIFICATIONS: Frequency Range: 4 Bands—No Switching. 18—32 Mc. 35—65 Mc. 54—98 Mc. 150—250 Mc. Audio Modulating Frequency: 400 cycle (Sine Wave). Attenuator: 4 position, ladder type with constant impedance control for fine adjustment. Tubes Used: 6C4 as Cathode follower and modulated buffer.

6C4 as R.F. Oscillator
6SN7 as Audio Oscillator and power rectifier.

Model TV-30 comes complete with shielded coaxial lead and all operating instructions. Measures 6" x 7" x 9". **\$29.95** NET

THE NEW MODEL 670

SUPER METER



SUPER METER. A Combination VOLT-OHM-MILLIAMMETER plus CAPACITY REACTANCE, INDUCTANCE and DECIBEL MEASUREMENTS.

D.C. VOLTS: 0 to 7.5/15/75/150/750/1500/7500. A.C. VOLTS: 0 to 15/30/150/300/1500/3000 Volts. OUTPUT VOLTS: 0 to 15/30/150/300/1500/3000.

D.C. CURRENT: 0 to 1.5/15/150 ma.; 0 to 1.5 Amps. RESISTANCE: 0 to 500/100,000 ohms. 0 to 10 Megohms. CAPACITY: .001 to .2 Mfd., .1 to 4 Mfd. (Quality test for electrolytics.) REACTANCE: 700 to 27,000 Ohms; 13,000 Ohms to 3 Megohms.

INDUCTANCE: 1.75 to 70 Henrys; 35 to 8,000 Henrys.

DECIBELS: -10 to +18, +10 to +38, +30 to +58.

The model 670 comes housed in a rugged, crackle-finished steel cabinet complete with test leads and operating instructions. Size 5½" x 7½" x 3". **\$28.40** NET

The New Model 770—An Accurate Pocket-Size

VOLT-OHM MILLIAMMETER

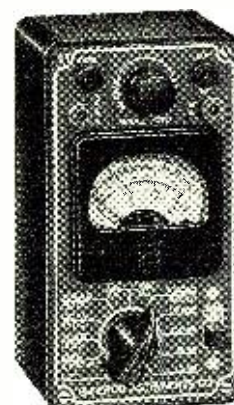

(Sensitivity: 1000 ohms per volt)

Features:

Compact measures 3½" x 5¾" x 2¼". Uses latest design 2% accurate 1 Mil. D'Arsonval type meter. Same zero adjustment holds for both resistance ranges. It is not necessary to readjust when switching from one resistance range to another. This is an important time-saving feature never before included in a V.O.M. in this price range. Housed in round-cornered, molded case. Beautiful black etched panel. Depressed letters filled with permanent white, insures long life even with constant use.

Specifications: 6 A.C. VOLTAGE RANGES: 0-15/30/150/300/1500/3000 volts.

6 D.C. VOLTAGE RANGES: 0-7½/15/75/150/750/1500 volts.

4 D.C. CURRENT RANGES: 0-1½/15/150 Ma. 0-1½ Amps.

2 RESISTANCE RANGES: 0-500 ohms. 0-1 Megohm.

The Model 770 comes complete with self-contained batteries, test leads and all operating instructions. **\$13.90** NET

THE NEW MODEL 247

TUBE TESTER



Check octals, loctals, bantam Jr. peanuts, television miniatures, magic eye, hearing aids, thyratrons, the new type H.F. miniatures, etc.

Features:

- A newly designed element selector switch reduces the possibility of obsolescence to an absolute minimum.

- When checking Diode, Triode and Pentode sections of multi-purpose tubes, sections can be tested individually. A special isolating circuit allows each section to be tested as if it were in a separate envelope.

- The Model 247 provides a super-sensitive method of checking for shorts and leakage up to 5 Megohms between any and all of the terminals.

- One of the most important improvements, we believe, is the fact that the 4-position fast-action snap switches are all numbered in exact accordance with the standard R.M.A. numbering system. Thus, if the element terminating in pin No. 7 of a tube is under test, button No. 7 is used for that test.

Model 247 comes complete with new speed-read chart. Comes housed in handsome hand-rubbed oak cabinet sloped for bench use. A slip-on portable hinged cover is indicated for outside use. Size: 10¼" x 8¾" x 5¾". ONLY **\$29.90** NET

The Model 88—A COMBINATION

SIGNAL GENERATOR AND SIGNAL TRACER

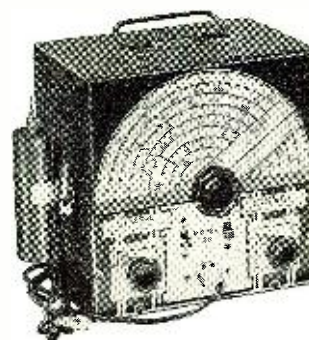

Signal Generator Specifications:

- *Frequency Range: 150 Kilocycles to 50 Megacycles. *The R.F. Signal Frequency is kept completely constant at all output levels. *Modulation is accomplished by Grid-blocking action which is equally effective for alignment of amplitude and frequency modulation as well as for television receivers. *R.F. obtainable separately or modulated by the Audio Frequency.

Signal Tracer Specifications:

- *Uses the new Sylvania 1N34 Germanium crystal Diode which combined with a resistance-capacity network provides a frequency range of 300 cycles to 50 Megacycles.

The Model 88 comes complete with all test leads and operating instructions. ONLY **\$28.85** NET

20% DEPOSIT REQUIRED ON ALL C.O.D. ORDERS

MONEY-BACK GUARANTEE—We believe units offered for sale by mail order should be sold only on a "Money-Back-If-Not-Satisfied" basis. We carefully check on the design, calibration and value of all items advertised by us and unhesitatingly offer all merchandise subject to a return for credit or refund. You, the customer, are the sole judge as to value of the item or items you have purchased.

GENERAL ELECTRONIC DISTRIBUTING CO.

Dept. RN-8, 98 PARK PLACE
NEW YORK 7, N. Y.

You
See



**THESE DISPLAYS
IN FOUR HUNDRED
RADIO PARTS
STORES**

... from coast to coast, and also Honolulu and Anchorage, Alaska, making it easy for you to pick out the "XL" for your microphone and radio equipment.

The XL Series is growing in popularity wherever quality radio equipment is used. Prices are reasonable.

Among the 400 radio parts firms where you may buy "XL" fittings are: Concord Radio, Chicago; Southeast Audio, Jacksonville; Springfield Sound, Springfield, Mass.; Eugene G. Wile, Philadelphia; Carolina Radio Equipment, Raleigh, N. C.; Harrison Equipment, Houston; Satterfield Supply, Madison, Wis.; W. D. Brill, Oakland, Calif.

NEW XL-4 INSERT

4
10-amp.
contacts

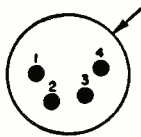

Face
View
Pin Side

Shown in the new XL4-249 — latest edition of the four-page XL Bulletin which lists prices of the XL-3 types as well as the XL-4. The New CEDR-9 will be sent with the XL, if you prefer, so that you may pick out the radio parts store nearest you carrying not only XL plugs but other Cannon Electric fittings.



Address
Department H-228

SINCE 1915

**CANNON
ELECTRIC**

Development Company

Division of Cannon Manufacturing Corp.
3209 HUMBOLDT ST., LOS ANGELES 31, CALIF.

IN CANADA & BRITISH EMPIRE:
CANNON ELECTRIC CO., LTD., TORONTO 13, ONT.

WORLD EXPORT (Excepting British Empire):
FRAZAR & HANSEN, 301 CLAY ST., SAN FRANCISCO

sent this subject. In 1941, he was cited "America's Outstanding Young Electrical Engineer"; in 1945 he received the U. S. Naval Ordnance Development Award and the War Department Certificate for Outstanding Service; and in 1947 he was awarded the "Industrial Oscar" for the contributions printed electric circuits have made to industry.

St. Louis

Chapter members met on April 25th at the Mark Twain Hotel. After dinner, Mr. Harry Walgreen of the Weather Bureau spoke on the art of forecasting the weather and gave the history of the Weather Bureau.

Southern California

The June 9th meeting of the Southern California Chapter took place at the Hollywood American Legion. Mr. Eric Pridonoff, former officer of the State Department with duty in Belgrade during the war, discussed the growth of communism, its current status, and how it might affect the future of the U. S. His talk proved of such vital interest to the audience that it generated a two-hour discussion period at its close.

Washington

Mr. A. K. Mitchell of the *Western Union Telegraph Co.* has been elected President of the Washington Chapter. E. C. Cover of the *Chesapeake & Potomac Telephone Company* was re-elected secretary-treasurer. Vice-presidents to represent the Army, Air Force, Navy, and civilian membership of the chapter were chosen as follows: Army—Brig. Gen. Wesley T. Guest, Chief, ACS Div., OCSigO; Air Force—Maj. Gen. F. L. Ankenbrandt, Director of Air Force Communications; Navy—Col. A. F. Binney, USMC, Dir., Electronics Div., Naval Bureau of Aeronautics; Civilian—Mr. V. B. Bagnall, Div. Plant Supt., *American Telephone & Telegraph Co.* —30—

**AMATEUR SERVICE
RECOGNIZED**

RECENTLY the State of Florida passed a bill to permit the issuance of state vehicle licenses bearing the owners' call letters to any amateurs who apply. This bill was sponsored by State Senator Lloyd F. Boyle, W4IMJ, of Sanford, Florida.

The new law, which became effective July 1st, 1949, provides that any licensed amateur in the State of Florida may obtain license plates bearing his call letters, by the payment of the regular vehicle license fee, plus an additional fee of one dollar.

Provision is being made to register the holders of these special licenses with sheriffs, police, highway patrol, Red Cross, and National Guard. The use of the distinctive license plate will enable the emergency services to locate amateurs quickly in times of emergency or disaster.

The act takes official recognition of the many services rendered by amateurs in furnishing communications in times of emergency.

—30—

A.F. Generator
(Continued from page 40)

is indicated. The power supply consists of a simple selenium rectifier followed by an R-C filter network. The tubes used are type 50B5, with the oscillator tube triode and the amplifier tube pentode connected. The heaters of the two tubes are in series with a 100-ohm resistor, eliminating a filament transformer. Degeneration is obtained in both the oscillator and amplifier circuits by the simple expedient of unbypassed cathode resistors.

The frequency is determined by the inductance of the primary winding of T_1 and the capacity of C_1 which form the resonant circuit of the oscillator. The exact value of stabilizing resistor R_2 must be determined experimentally. The value of this resistor should be as high as possible, consistent with reliable oscillations in order that the best possible stability and purity of waveform may be realized.

The oscillator inductance is usually considered one of the most difficult items to obtain. Surprisingly enough, it is in reality very easily obtained. It is necessary only to modify one of the open mounted midget type of push-pull output transformers to obtain a very satisfactory oscillator inductance, with a coupled output winding. An exploded view of the assembly of the modified transformer is shown in Fig. 1.

The modifications are accomplished as follows:

Carefully remove the core clamp and mounting by bending the legs outward until the core and winding assembly can be removed. The core is built up from "E" and "I" shaped laminations, with alternate combinations reversed so that there is no appreciable air gap in the core structure. With a small screwdriver tip or other

Fig. 3. Suggested modification to provide multiple output frequencies.

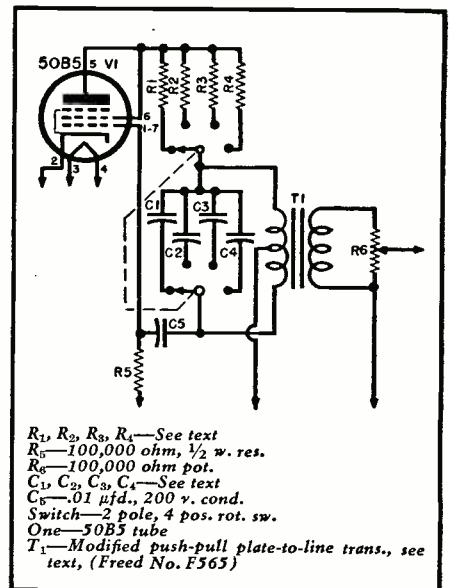

SELENIUM RECTIFIERS

— and —

ELECTRONIC COMPONENTS

THREE PHASE BRIDGE RECTIFIERS

Input	Output
0-126 VAC	0-130* VDC
Type #	Current Price
3B7-4	4 AMP. \$32.95
3B7-6	6 AMP. 48.90
3B7-15	15 AMP. 70.00
Input	Output
0-234VAC	0-250*VDC
Type #	Current Price
3B13-4	4 AMP. \$56.00
3B13-6	6 AMP. 81.50
3B13-15	15 AMP. 120.00

CENTER TAPPED RECTIFIERS

Input	Single Phase	Output
10-0-10VAC		0-8*VDC
Type #	Current	Price
C1-10	10 AMP.	\$6.95
C1-20	20 AMP.	10.95
C1-30	30 AMP.	14.95
C1-40	40 AMP.	17.95
C1-50	50 AMP.	20.95
C1-80	80 AMP.	26.95
C1-120	120 AMP.	34.95

CUSTOM DC POWER SUPPLIES

Built to your specifications.
Fort

- INDUSTRY
- LABORATORIES
- UNIVERSITIES
- GOVERNMENT AGENCIES

We will be pleased to quote on your requirements.

SINGLE PHASE BRIDGE RECTIFIERS

Input	Current	Output
0-18VAC		0-12*VDC
Type #		Price
B1-250	250 MA.	\$0.98
B1-500	500 MA.	1.95
B1-1	1 AMP.	2.49
B1-1X5	1.5 AMP.	2.95
B1-3X5	3.5 AMP.	4.50
B1-5	5 AMP.	5.95
B1-10	10 AMP.	9.95
B1-15	15 AMP.	13.95
B1-20	20 AMP.	15.95
B1-30	30 AMP.	24.95
B1-40	40 AMP.	27.95
B1-50	50 AMP.	32.95
B1-60	60 AMP.	36.95
B1-80	80 AMP.	44.95
Input	Current	Output
0-36VAC		0-26*VDC
Type #		Price
B2-150	150 MA.	\$0.98
B2-250	250 MA.	1.25
B2-300	300 MA.	1.50
B2-450	450 MA.	1.95
B2-1	1 AMP.	3.95
B2-2	2 AMP.	4.95
B2-3X5	3.5 AMP.	6.95
B2-5	5 AMP.	9.95
B2-10	10 AMP.	15.95
B2-15	15 AMP.	24.95
B2-20	20 AMP.	27.95
B2-30	30 AMP.	36.95
B2-40	40 AMP.	44.95
Input	Current	Output
0-54VAC		0-38*VDC
Type #		Price
B3-150	150 MA.	\$1.25
B3-250	250 MA.	1.95
B3-600	600 MA.	3.25
B3-5	5 AMP.	13.95
B3-10	10 AMP.	24.95
Input	Current	Output
0-72VAC		0-50*VDC
Type #		Price
B4-600	600 MA.	\$3.95
B4-3	3 AMP.	14.95
B4-5	5 AMP.	17.95
B4-10	10 AMP.	27.95
Input	Current	Output
0-115VAC		0-90*VDC
Type #		Price
B6-150	150 MA.	\$1.95
B6-250	250 MA.	2.95
B6-600	600 MA.	5.95
B6-750	750 MA.	6.95
B6-1X5	1.5 AMP.	10.95
B6-3X5	3.5 AMP.	18.95
B6-5	5 AMP.	24.95
B6-10	10 AMP.	36.95
B6-15	15 AMP.	54.95
Input	Current	Output
0-234VAC		0-190*VDC
Type #		Price
B13-600	600 MA.	\$12.95
B13-1X5	1.5 AMP.	19.95
B13-3	3 AMP.	35.95
B13-5	5 AMP.	48.95
B13-10	10 AMP.	69.95

RECTIFIER CAPACITORS

CF-13	6000 MFD	10VDC	\$2.49
CF-14	3000 MFD	12VDC	1.69
CF-15	6000 MFD	12VDC	2.95
CF-1	1000 MFD	15VDC	.98
CF-2	2000 MFD	15VDC	1.69
CF-20	2500 MFD	15VDC	1.95
CF-3	1000 MFD	25VDC	1.25
CF-4	2X3500 MFD	25VDC	3.45
CF-5	1500 MFD	30VDC	2.49
CF-6	4000 MFD	30VDC	3.25
CF-7	3000 MFD	35VDC	3.25
CF-8	100 MFD	50VDC	.98
CF-19	500 MFD	50VDC	1.95
CF-16	2000 MFD	50VDC	3.25
CF-9	200 MFD	150VDC	1.69
CF-10	500 MFD	200VDC	3.25
CF-12	125 MFD	350VDC	2.49

RECTIFIER TRANSFORMERS

All Primaries 115VAC 50/60 Cycles

Type #	Volts	Amps.	Price
XF15-12	15	12	\$3.95
TXF36-2	36	2	3.95
TXF36-5	36	5	4.95
TXF36-10	36	10	7.95
TXF36-15	36	15	11.95
TXF36-20	36	20	17.95
XFC17-10	17VCT	10	5.95

All TXF Types are Tapped to Deliver 32, 34, 36 Volts. XFC Type is Tapped to Deliver 15, 16, 17 Volts Center Tapped.

RECTIFIER CHOKES

Type #	Volts	Amps.	Price
HY5	.02 Hy	5	\$3.25

Dimensions: 3 3/4" H x 3" D x 3 1/2" W. Wt. 5 lbs. Fully enclosed.

Type #	Volts	Amps.	Price
HY8X5	.02 Hy	8.5	\$7.95
HY10	.02 Hy	10	9.95
HY12	.02 Hy	12	12.95
HY15	.015 Hy	15	13.95

RECTIFIER MOUNTING BRACKETS

For Types B1 through B6, and Type C1.....\$0.35 per set
For Types B13......70 per set
For Types 3B......1.05 per set

RECTIFIER KIT

6 and 12 VDC at 10 Amps.
This unit will deliver unfiltered direct current for operation of motors, dynamotors, solenoids, electroplating, battery charging and similar equipment.

- The following components are supplied:
- 1 ea. Full Wave Bridge Rectifier
 - 1 pr. Rectifier Mounting Brackets
 - 1 ea. Transformer 115 VAC 50/60 CPS.
 - 3 ea. Silver-Plated Binding Posts
 - 1 ea. 4-Position Tap-Switch
 - 1 ea. Fuse and Fuse Holder
 - 1 ea. Line Cord and Plug
 - 1 ea. Pilot Light Assembly & Bulb

The primary of the transformer is multi-tapped permitting adjustment of the DC output voltages.
Complete with schematic diagram and instructions.....\$15.95

FILTER KITS FOR ABOVE

- 1 section choke input, 10% ripple... \$9.64
- 2 section choke input. 2% ripple... 19.28

SYNCHRO MOTORS

Type 1F Special—KS-5949, L1 Western Electric.
115/90 VAC—400 Cycles.
Price Each.....\$8.00

Write for catalog No. 719 on company letter head.

VACUUM CAPACITORS

Standard Brands	Value	Price
	12 Mmfd. 20 Kv	\$4.95
	50 Mmfd. 20 Kv	4.95
	50 Mmfd. 32 Kv	5.95

SILVER CERAMIC TRIMMERS

820-Z	5-20 Mmfd Zero Temp.	.24c
822-N	5-20 Mmfd Neg. 300	.24c
822-AZ	4.5-25 Mmfd Zero Temp.	.24c
823-AN	20-125 Mmfd Neg. 650	.33c

OIL CONDENSERS

2 Mfd. 200VDC	Bathtub	\$0.20
5 Mfd. 400VDC	Telephone Type	.20
2 V. fd	400VDC Bathtub	.30
2X.1 Mfd	600VDC Bathtub	.39
6 Mfd.	60VDC w/mtg. clamp	.79
10 Mfd	440VAC/1500VDC w/brkts.	1.55
8 Mfd	660VAC/2000VDC w/brkts.	3.50
.15-.15 Mfd	8000VDC Voltage Doubler Type 26F381 w/brkts.	3.95

ATTENTION!!!

INDUSTRIALS, EXPORTERS, SCHOOLS, GOVT. AGENCIES, LABORATORIES

Our engineering staff is at your service to facilitate the application of rectifiers to your specific requirements.

Write for quantity discounts on company letterhead.

VOLTAGE REGULATORS

These solenoid operated carbon pile regulators will stabilize the output of 12-18 VDC power supplies, simply by connecting the coil leads across the output of the rectifier, and the carbon element leads in series with the load. Price each.....\$2.49

D-C POWER SUPPLY FTR 3377-AS

Rating 115 VAC to 115 VDC, .77 Amperes. Operates fans, motors, magnetic chucks, business machines, relays, etc. Descriptive literature available.
Complete, ready to operate.....\$16.50

D-C PANEL METERS

Attractive, rugged, and reasonably priced. Moving vane solenoid type with accuracy within 5%
0-6 Amperes D-C
0-12 Amperes D-C Any range \$2.49 each
0-15 Volts D-C

Minimum order \$3.00. No C.O.D.'s under \$25.00. 25% deposit on C.O.D. Add 10% for Prepaid Parcel Post and Handling. Terms: Net 10 days in the presence of approved credit.

All prices subject to change without notice.
Orders Promptly Filled from Our Stocks
All Prices F.O.B. our NYC Warehouse

OPAD-GREEN COMPANY

71 Warren St.
New York 7, N. Y.

Phone: BEekman 3-7385-6

New! Burlington

ILLUMINATED INSTRUMENTS

EXCELLENT LIGHT DISTRIBUTION affords EASE IN READING. GLARE REDUCED to a minimum by retaining COMPACT DESIGN of front case extension. REFLECTED LIGHT PRINCIPLE permits use of standard METAL DIALS eliminating translucent materials that discolor with age and use. BULB REPLACEMENT FACILITATED by removal of single lamp assembly. Two 3.8 volt STANDARD BULBS are used and connected in series.

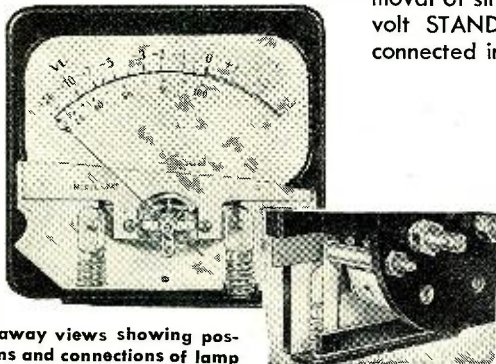

Cutaway views showing positions and connections of lamp assembly.

Available in all ranges 3 1/2" and 4 1/4" rectangular semi-flush models. Write Dept. K19 for complete details. Cutaway views showing positions and connections of lamp assembly.

WRITE DEPT. K-89 FOR COMPLETE DETAILS

BURLINGTON INSTRUMENT COMPANY

BURLINGTON, IOWA

TV TUNER\$5.95

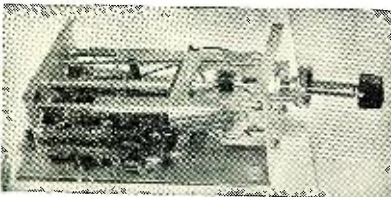

Here is a precision front-end made by well-known mfr. Covers all 13 TV channels with 8 permeability-tuned coils; coarse & fine tuning; IF freq. 21.25 Mc; uses 6AG5 RF, 6AG5 mixer & 6C4 oscillator; completely wired but not tested; with diagram, less tubes, IF coil & trimmer cond. Some coils may need minor repairs, but satisfaction guaranteed. An outstanding value—compares with any \$20 tuner. Hurry for this bargain. 3 3/4 x 2 3/4 x 7; shipping wt. 4 lbs. ONLY \$5.95

In lots of 10, \$5.25; In lots of 100, 4.00 Same as above but with trimmer and perfect coils, each, 9.95

POWER TRANSFORMERS, 115V 60 cycle

40 ma, 350vct; 6.3v @ 1a, 5v @ 3a. \$ 1.45
60 ma, 550vct; 6.3v 5a, 5v 3a; 3 lb. 2.40
70 ma, 710vct; 6.3v 3.5a, 5v 2a; 5 lb. 2.65
90 ma, 700vct; 6.3v 4a, 5v 3a; 6 lb. 3.35
200 ma, 740vct; 2.5vct 5a, 5v 3a, 6.3v 3a, Upright mtg; 10 lbs. 3.95
200 ma, 800vct; 5v 4a, 6.3v 6a; 10 lb. 4.45
200 ma, delivers 600 or 750vDC; 12 lb. 8.95
300 ma, 1500 or 1250 vDC; 38 lbs. 23.10

ODDS-N-ENDS

FL-8 Filter \$ 1.79
Interphone Amplifier BC-347 w/tube 2.95
Control Box BC-266 for above .39
Dial, Collins VFO, 5 ham bands 1.00
PE-157 Vibrator Power supply complete less 2 volt battery, N-1, SPECIAL 11.95
Crystal Kit; incl. 3 40-meter xtals, 2 holders, inst. for grinding .59

All merchandise unused and guaranteed.

FREE SCREWDRIVER

WITH \$10.00 ORDER OR MORE

GET YOUR NAME ON OUR MAILING LIST

Postage extra. Minimum order \$2.00.

TERMS: Net Cash, 25% deposit on C.O.D.'s

ELECTRONIC SUPPLIES

219-R East 1st St. Tulsa 3, Oklahoma

"America's Best Buy"

RADIO TUBES—39c each 100 for \$35.00

GT type. Cartoned and guaranteed.

01A	6A8	6K7	6X5	12SR7	41
1B5/25S	6AQ5	6P5	6U6	12BE6	42
1G4	6AQ6	6S8	12A5	12BF6	35
1H6	6AT6	6SA7	12AT6	12F5	46
1J6	6AU6	6SD7	12AT7	12H6	47
1L4	6BA6	6SF5	12AU6	12J5	50B5
1Q5	6BE6	6SG7	12AU7	12J7	70L7
1R4	6BH7	6SH7	12BA6	12K7	50
1R5	6BG6	6SJ7	12SF7	12K8	117Z3
1S5	6AL5	6SK7	12SH7	12Q7	12A
1T4	6C4	6SL7	12SJ7	12S8	6J7
1U4	6C5	6SN7	12SN7	25Y5	6K8
3A4	6F5	6SQ7	10	32L7	
3Q4	6P6	6SR7	20	37	
3S4	6H6	6SU7	25L6	35W5	
3V4	6J5	6V6	25Z5	39/44	
5Y3	6K6	6X4	25Z6	40	

49c each, 100 for \$45.00

1A5	6AC7	6Y7	27	56	78
2A5	6B5	12AH7	35/51	57	81
2A7	6C6	12SA7	35L6	58	84/6Z4
5U4	6D6	12SK7	32	71A	117F7
6A3	6F8	12SQ7	36	75	
6A6	6Y6	26	50	77	

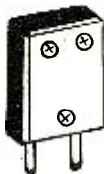

CRYSTALS 98c each

Your frequency plus or minus 10KC

80	Meter, 3500-4000KC
40	Meter, 7000-7300KC for multiplying into
20	Meter, 7300-7425KC
10	Meter, 7300-7425KC
2 1/2	Meter, 8000-8222KC

TOP COWL ANTENNA 98c

4 section. 15" closed, extends to 48". Less lead-in 98c, 10 for \$7.95

Postage extra 20% deposit on C.O.D.

Write for latest bargain list featuring "America's Best Buys."

POTTER RADIO CO.

1314 McGee St., Kansas City 6, Mo.

suitable instrument, remove the "T" laminations from both ends of the core, exercising care not to damage the windings. With the "T" laminations removed, the "E" sections are easily grasped with pliers and removed.

The object is to reassemble the transformer with an open core to greatly reduce the inductance of the windings. Assemble all "E" laminations as shown in (2), Fig. 1. Pile all "T" laminations together and measure the height, width, and length of the pile. Cut a wooden block the exact size of the pile of "T" laminations, then discard the "T" laminations. As they are to be replaced by the wooden block, they are no longer needed.

Carefully insert the "E" laminations in the winding assembly, press the core clamp and mounting down over the laminations, fit the wooden block over the ends of the laminations, and bend the legs of the core clamp back into place around the core lamination and the ends of the wooden block. The core clamp will return to its original shape if the entire assembly is squeezed firmly in a machinists' vise after assembly.

The lower the inductance, the higher the frequency obtainable, and the less iron in the core, the lower the inductance will be. If it is desirable to operate at a higher frequency than is attainable with the transformer modified as described, it will be necessary to remove a part or all of the "E" laminations as well as the "T" laminations.

The oscillator will be a more versatile instrument if provision is made for the selection of any one of several output frequencies. A method of providing this feature is shown schematically in Fig. 3. A standard single section, two pole, four position wafer switch will be convenient for the frequency selector switch. Switches with more positions may be used if more frequencies are desired. The method of adjustment is the same, regardless of the number of frequency selections provided. In each case, the values of C_1 , C_2 , C_3 , etc., are adjusted until the desired output frequency is obtained for that particular switch position. Next the values of R_1 , R_2 , R_3 , etc., are adjusted until the waveform is free from distortion. An oscilloscope provides an easy means of observing the waveform as the value of R_1 is adjusted.

The values of the resistors also have a great influence on the output level. It is therefore possible to obtain a good output waveform and a constant output level for all frequencies by the selection of the proper value of this resistor. As in the case of the condensers, the values of the resistors will be different for each frequency.

The unit described can be operated from either a.c. or d.c. power. Also, as in the case of all a.c.-d.c. equipment, the case or framework should not be connected to any part of the electrical circuit. This does not apply

to the output terminals which are isolated from the rest of the circuit by the transformer primary-secondary insulation.

Other tube combinations may be used if desired, if the heater power is provided in some suitable fashion. A midget filament transformer will permit the use of a twin triode such as a 6SN7, with one section acting as the oscillator and the other as the amplifier. There are many other possibilities, which will be left to the imagination and ingenuity of the individual. Each application may indicate the desirability of certain modifications, but the basic principles described will probably remain unchanged. -30-

ANNOUNCING THE C.A.R.A. PICNIC

THE 1949 picnic and hamfest of the Columbus Amateur Radio Association will be held on Sunday, August 28, at the Maple Shade Picnic Ground. This is an annual affair, and as in the past it will be a basket lunch, with the activities beginning at 10:00 a.m.

Swimming, bingo, games, contests, prizes, and transmitter operation are included in the day's scheduled activities, and there will be supervised games for the children and specially planned entertainment for the ladies.

No reservations are required. Admission is 20 cents for each person, and everyone is invited. Information on location and ways of reaching the picnic ground may be obtained by writing to Harry F. Ream, W8CPA, care of C.A.R.A., P.O. Box 1073, Columbus 16, Ohio. -30-

TELEVISION IN FRANCE

SINCE publishing the item, "European Television Facilities," on page 139 of the May issue, we have received additional details as to the progress being made in television broadcasting in France. A letter direct from Paris from A. V. J. Martin, technical editor of "La Television Francaise," gives us the following details:

France has a 455 line transmitter working three times a day (midday, afternoon, and evening) every day but Tuesday. The high definition transmitter on 819 lines in Paris is actually on the air for tests, and the Lille transmitter (819 lines) will be operating before the end of the year. It will be followed by stations in Lyon, Strasbourg, Caen, etc. An 819 line transmitter has been ordered by the Vatican from a French firm and will be delivered as soon as possible.

The 455 line transmitter has been working for over ten years. Mr. Martin affirms the shortcomings of a medium definition standard, but continues, "Nevertheless, this transmitter will carry on for another ten years, along with the high definition station, so as to give a fair share to 455 line receiver owners."

"We feel certain that a high definition standard such as the new French standard (819 lines) is the only way to obtain a picture of sufficient quality for large size or projection receivers. This opinion is undoubtedly shared by many leading TV engineers in other European countries." -30-

August, 1949

A ready-to-use TV set—NOT A KIT! PLUG IT IN...AND IT WORKS!

COMPLETELY WIRED DIRECT VIEW

19 TUBE CHASSIS FOR 16" TV TUBE

affording giant 145 sq. in. picture television
operating at approx. 14,000 volts

FACTORY ENGINEERED, ALIGNED AND TESTED

STANDARD
RMA
GUARANTEE

\$134⁷⁵ LESS CRT

plus \$1.40 Fed. Tax



PERFECT FOR CUSTOM-BUILT INSTALLATIONS

This compact TV chassis, with licensed RCA circuits, incorporates new improvements that provide excellent reception even in fringe areas... the same receiver is used in combination sets that sell as high as \$795 at retail. It represents unexcelled value!

13 channel tuning, long range reception, 19 tubes (2 rectifiers), high gain audio amplifier, automatic frequency control, new improved daylight viewing, and many other high calibre features found only in high priced sets.

No technical knowledge required to operate... just plug it in to get those sharp, clear images you've always wanted.

BRAND NEW TV TUBES in Sealed Cartons AT LOWEST PRICES

12" CRT	\$36.95
15" CRT	58.75
16" CRT	59.50

Also at low factory prices: high fidelity AM and FM tuners and amplifiers, speakers, record changers and decorator-finish TV or combination cabinets.

For supreme all-around TV performance

CUSTOM-WIRED 630 CHASSIS	} ... for 12" operation (29 tubes) . . .	\$184.75 less CRT
		plus \$2.25 Fed. Tax
}	... for 15" or 16" operation (30 tubes—approx. 14,000 volts)	\$194.75 less CRT
		plus \$2.25 Fed. Tax
Each with highly sensitive no-drift AM and FM TUNERS . . .		\$31.50 additional plus \$1.80 Fed. Tax

WHY PAY MORE? BUY DIRECT FROM THE FACTORY AND SAVE!

Send for our literature and prices — and COMPARE!

Phone and mail orders filled on receipt of certified check or money order for \$25 as deposit . . . balance C.O.D., F.O.B., N.Y.

For free demonstrations, visit our factory showroom

LEHIGH TELEVISION COMPANY

601 West 26th Street, New York 1, N.Y., Dept. I
Telephone: ALgonquin 5-2046

Prices subject to change without notice.

3 GREAT NEW TITONES

meet changing pickup needs!

NOW a full line of Titone's amazing ceramic pick ups—made by famous Sonotone! All with these great basic features: Full frequency (response from 50 to 10,000 cycles.) Bell-like supertone makes new or old players thrilling. Climate-proof, moisture-proof, fungus-proof! Lightest pressure saves needle wear, revives worn records. NO needle talk! NO crystals, magnets, filaments to fail. NO pre-amplifiers. Performs perfectly for years!

3 NEWEST! TITONE MICROGROOVE PICKUP

For all 45 and 33 1/2 rpm players. Highest compliance and 5 to 6 grams needle pressure give minimum wear on record and needle. Aluminum case—1-mil permanent sapphire needle.

Order # W 7530 \$7.95 list

2 NEWER! TITONE 3-MIL PICKUP

New superlight aluminum pickup complements famous original Titone pickup below. 15 grams needle pressure gives unparalleled reproduction, lowest wear!

Order # W 7540 \$7.95 list

1 NEW! ORIGINAL CERAMIC TITONE

Within a few scant months in widest use from coast to coast! Plays at 20 grams needle pressure. Used instead of the newer aluminum Titone above for changers requiring over 15 grams pressure to "flip" records.

Order # 7500 \$7.50 list

NO TONE LIKE TITONE



Call your Jobber or write to SONOTONE, Box 5, Elmsford, N. Y.

MARS

Station of the Month

THIS month we visit K2USA-A2MON, First Army Area Station, located at the "Home of the Signal Corps," Ft. Monmouth, N. J.

Chief operator, M/Sgt. Frank T. Haas, W2WXC, works the bands from 8 a.m. to 5 p.m. and from 6 p.m. to 8 p.m. each weekday. So "give a shout when you hear him on the air."

The boys have the shack all dolled up these days. With white paint, brushes, and a lot of elbow grease, they redecorated the two-room concrete building, trimming the gleaming surfaces with black paint. One room of the shack is the operating room; the other room is used as a meeting place for the Fort Monmouth Radio Club. Frank outlines some rather elaborate plans for further redecoration of the place, but admits, "It'll take some time and maybe some close figuring," to realize his dream shack.

One of the better-equipped stations in the First Army Net, K2USA-A2MON is NCS for New Jersey State Net. Let's look at the big rig. We start off with a full kw. on 20-meter c.w.—a BC-339-J, using a pair of 833's in the final and feeding an 8JK hung between two 40-foot poles. Then comes the 40-meter c.w. rig—800 watts, using a BC-325-B with a pair of 803's in parallel in the final, feeding a three-wire doublet hung between two 60-foot poles.

Next is the 800 watts on 80-meter c.w., which is a BC-447-F, using a pair of 813's in parallel in the final and feeding another three-wire doublet hung up between 80-foot poles. (These boys really go up in the air.)

That old Signal Corps standby, the BC-610, is used, one on 20- and 75-phone, and another on 10-phone. They

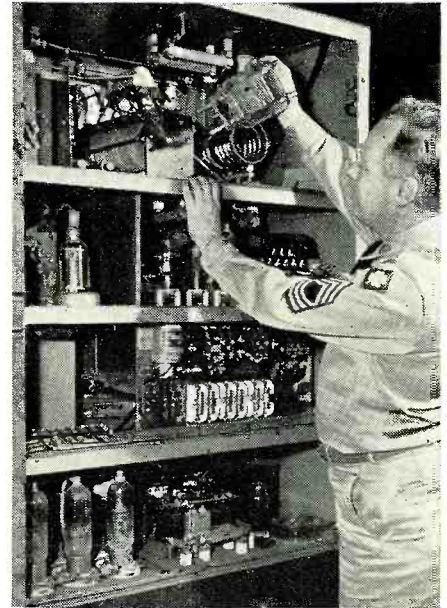

Master Sergeant Frank T. Haas, chief op, replaces an 833, one of a pair, in the BC339.

are rated 500 watts, using a single ended 250TH.

For receivers the boys have a BC-779-B and BC-1004, both Super Pro's, a Hallicrafters "Sky Champion," an SX-28, and an HQ-120.

Receiving antennas at K2USA-A2MON have been pushed into the air atop 45-foot poles in order to get them above surrounding power lines.

Other station equipment includes an oscilloscope frequency generator, frequency meter, multimeters, audio generator, and a Boehme automatic keying head with a Wheatstone perforator.

Home to the Ft. Monmouth hams of K2USA-A2MON is this well-lighted, spacious "shack."

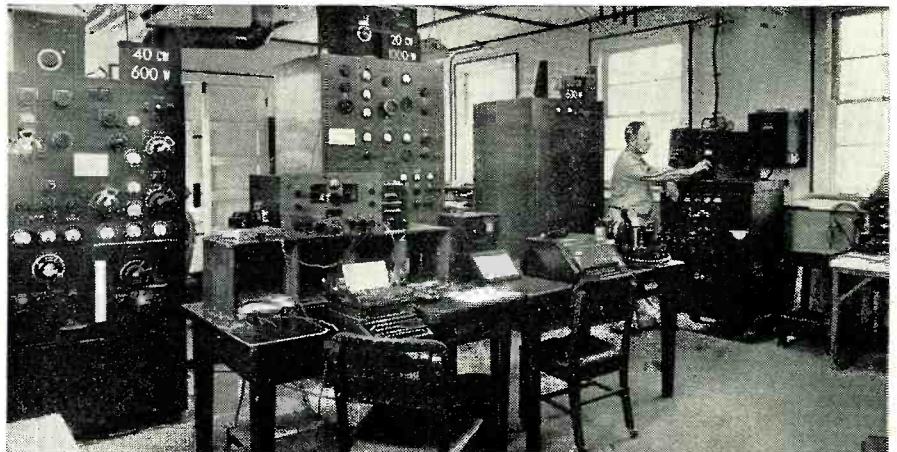

REPLACE USED, INACTIVE TEST & COMMUNICATION EQUIPMENT with new hallicrafters TELEVISION at Tremendous Savings!

Here's HOW!



SENSATIONAL "SURPRISE" TRADE-IN ALLOWANCES ON YOUR USED, FACTORY-BUILT TEST AND COMMUNICATION EQUIPMENT, MAKE IT POSSIBLE FOR YOU TO OWN HALLICRAFTERS TV FOR FAR LESS MONEY! Here's all you have to do: Simply tell us what you have to trade. Indicate your preference for any one of the Hallicrafters TV or Custom Chassis sets illustrated and described. We'll respond with an extra-liberal allowance that's sure to please you. Start right now to enjoy your new Hallicrafters TV set . . . the equipment that steals the show for its brightness, clarity and advanced engineering features.

WIRE, WRITE, PHONE OR USE THE HANDY COUPON DO IT TODAY!



HALLICRAFTERS TV Model 509

Push button tuning on all 12 channels. Dual Focus for larger round pictures with 56 sq. in. rectangular picture or 64 sq. in. full circle picture for dramatic close ups—all at a flick of a front panel switch. Mahogany veneer cabinet. Transparent safety shield. 19 tubes plus 3 rectifiers.

ONLY **\$269⁵⁰**

Complete with ALL TUBES. Shpg. Wt. 105 lbs.

HALLICRAFTERS TV Model T-506

Here's Television at a price, with all the big set features. 12 channel push button tuning. Static free FM sound reception and 23 sq. in. screen. 18 tubes plus 4 rectifiers. Shpg. Wt. 50 lbs. Now ONLY.....

\$149⁵⁰

Formerly sold for \$199.50

HALLICRAFTERS TELEVISION CUSTOM CHASSIS

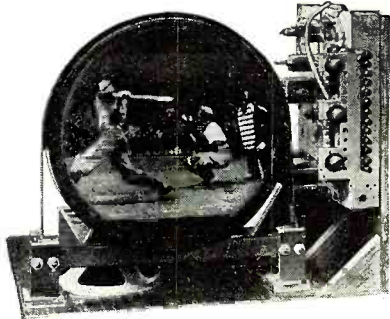

MODEL T-69 15" TV CUSTOM CHASSIS

Now! Big picture television at a price. 130 sq. in. direct view picture. All 12 channel push button tuning. 8" PM speaker. Mounted on reinforced wood frame ready to be slipped into cabinet or opening in wall, etc. Dimensions 19 1/2" high x 23" wide x 24 1/4" deep. Shpg. wt. 80 lbs. Complete with 15AP4 Picture Tube.....

\$259⁵⁰

MODEL T-64

Chassis unit only, of Model T-509. Plan your own TV installation and save money! 95 sq. in. picture with 12" tube; 64 sq. in. picture with 10" tube. Push button tuning on all 12 TV Channels. New DUAL FOCUS Switch for larger, round picture. Factory-wired and tested. Complete with 19 tubes plus 3 rectifiers.

NOW! NEW LOW PRICES ON

T-64 Chassis Complete With 10" Picture Tube... **\$179.50**
Shpg. Wt. 63 lbs.

T-64 Chassis Complete With 12" Picture Tube... **\$199.50**
Shpg. Wt. 66 lbs.

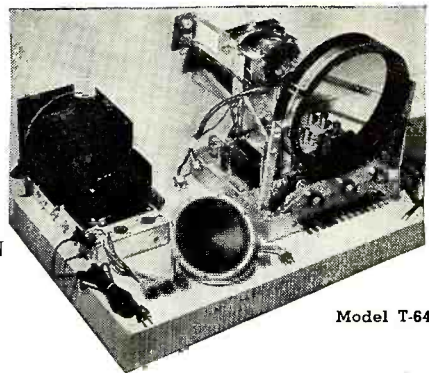

Model T-64

Walter Ashe RADIO CO.
THE HOUSE OF "SURPRISE" TRADE-INS
1125 PINE ST. • ST. LOUIS 1, MO.

ALL PRICES F.O.B. ST. LOUIS

PHONE: **CHestnut 1125**

TIME PAYMENTS AVAILABLE

Walter Ashe Radio Co. R-49-8
Bill DuBord, W0QDF, Mgr., TV and Amateur Div.
1125 Pine St., St. Louis 1, Missouri

Rush bigger-than-ever "Surprise" trade-in allowance on my _____
(describe used equipment)

for Hallicrafters TV _____
(show model of new equipment desired)

Mail me my copy of latest Hallicrafters Catalog.

NAME _____
ADDRESS _____
CITY _____ ZONE _____ STATE _____

Don't miss these
GREAT VALUES
at Mid-America!

GENUINE RCA TV PARTS



- A. MA-2541. Type-204T2 Vertical Output Transformer \$1.85
- B. MA-2552. Electro-Magnetic Ion Trap89
- C. MA-2551. Type-202DL Focus Coil 1.95
- D. MA-3332. Wired socket for 10RP4, 7JP4, 12KP4 and similar tubes31

10% discount on any of the above items when ordered 10 or more at one time.



**VM MODEL 400
Record Changer
MA-3110
only \$14.95**

Plays either 10" or 12" records 78 RPM. Tone arm with high-fidelity Astatic cartridge with permanent "T" needle, shielded cable and connector. Switch for on, off and reject. Complete with line cord and plug for 110-volt AC.

RCA & MAGNAVOX SPEAKERS

MA-2713 12" Dynamic RCA; 1600-ohm field, PP 6V6 output transf. \$3.95 each; \$3.55 each, lots of 4.
MA-2733 12" Dynamic RCA; 1500-ohm field, PP 6V6 output transf. \$3.95 each; \$3.55 each, lots of 4.
MA-2715 8" PM Magnavox; 21 oz. Alnico 3 magnet, \$3.20 each; \$3.00 each, lots of 8.
MA-2720 12" PM Magnavox; 21 oz. Alnico 3 magnet. \$4.29 each; \$4.00 each, lots of 4.

Write for Mid-America
"PARADE OF VALUES"
Money-Saving Bulletin



**TRANSFORMERS
AND CHOKES**

ROCK-BOTTOM PRICES

117-volt Power Transformers

- A. 700 VCT, 200 MA; 5 V, 3 A; 2.5 VCT, 5 A. 4 1/2"x3 3/4"x4", MA-2584 \$2.49
- A. 740 VCT, 200 MA; 5 V, 3 A; 2.5 VCT, 5 A. 6 3/4" x 3 A. 4 1/2"x3 3/4"x4", MA-2582 3.40
- B. 700 VCT, 70 MA; 5 V, 3 A; 6.3 V, 3 A; plus 110 VAC isolation winding. 4 1/2"x3"x2 1/2". MA-2593 1.69

Filter Chokes

- C. 15 hy, 50 MA, 400 ohm DC. 2"x2 1/4"x1 1/4". MA-259649
- C. 6 hy, 100 MA, 65 ohm DC. 2 1/4"x2 1/2"x1 3/4". MA-256779

Output Transformers

- C. 500-ohm line to 6-8 ohm voice coil; 12 watts. 2 1/2"x2 1/2"x1 1/2". MA-252269
- C. PP 6L6 to 2,67, 4, 6 and 8 ohms; 25 watts. 2 1/2"x3"x2 1/4". MA-2564 1.49
- C. Universal; matches any single, push-pull or parallel tubes to 6-8 ohm voice coil; 12 watts. High-fidelity. 2"x1 1/2"x2". MA-1205... .98
- C. Universal; 4 watts. Good for small sets. 1 1/2"x1 1/2"x1 1/2". MA-253269



**METAL CAN
ELECTROLYTIC
CONDENSERS**

Stock No.	MFD	WVDC	Ht.xDia.
MA-50814	10-10-10/20	450/25	3" x 1 3/8"
MA-50871	20-20	450	3" x 1"
MA-50868	30-20	450	3" x 1 3/8"
29c each, 10 of one type for \$2.50			
MA-50896	20/40/40	400/350/250	2 1/2" x 1 3/8"
MA-50801	70-30	150	3" x 1"
MA-443	125	300	3" x 1 3/8"
17c each, 10 of one type for \$1.50			
MA-50819	20-20	150	3" x 1"
MA-508	20/20	400/25	2" x 1 1/2"
MA-50839	30-30/30	350/25	3" x 1 3/8"

WRITE FOR COMPLETE CONDENSER LISTING!

ORDER FROM THIS AD!

All prices f.o.b. Chicago. 25% deposit required on C.O.D. orders, pay balance plus postage on delivery. Send orders to Desk E-89. Minimum order \$2.50.

MID-AMERICA CO. Inc.

2412 S. Michigan Avenue
Chicago 16, Ill.

In any East Coast emergency, K2USA-A2MON would become a focal point in an emergency network of amateur radio stations extending up and down the Atlantic Coast. Working with A2USA at Governors Island, the two would form, in effect, a network with two capable network controls. If either station were put out of operation, the other could continue the operation of emergency nets with a minimum of confusion. -30-

**RADIOPS OFFER
CONTACT AWARDS**

CERTIFICATE awards will be given by the West Park Radiops of Cleveland to any station outside the State of Ohio that can prove at least ten contacts were made with Radiop member stations, after August 15, 1949.

QSL's will not be necessary. All the details needed to establish proof of contact are the calls of the stations worked, the time, date, and band and emission used.

The information on stations worked should be sent to Chairman of Awards Jack Siringer, W8AJW, 2972 Clague Road, Cleveland 16, Ohio. -50-

**WCBC FORCED OFF
THE AIR**

AN INTERESTING experiment in disc jockeying was brought to an end last May when Station WCBC, The Children's Broadcasting Company, after two extremely successful evenings of transmission from studios located in the bedroom of its owner, was forced to suspend operations.

Philip Krause, 14, of Pittsfield, Mass., used a \$7.95 mail order oscillator which he hooked up to the family's 150-foot FM receiving aerial. Thus, he was able to broadcast as far as three miles from his home. The oscillator originally was intended to have a range of only 75 feet.

When Philip's father heard that the FCC has fines ranging up to \$10,000 for unlicensed stations, he regretfully ordered WCBC off the air. During its short span, however, broadcasting records by request and giving a few spot announcements, WCBC received nearly 200 phone calls and many letters. -30-

Philip effected his 2-day coverage of Pittsfield and environs with a \$7.95 oscillator.



Directional TV Array
(Continued from page 29)

proximately the same length as the folded dipole element) and cut two pieces of 300-ohm line half this length for the matching stubs. Connect one end to the dipole element and the other end to the 300-ohm lead-in as shown in Fig. 3B. Support the lines on an insulator at the splice to the mid-point of the supporting mast; be sure to maintain the proper phase relationship between elements and use additional stand-off insulators to keep all the lines from swinging in the wind. Separate the lead-in from the matching stubs as it comes down the mast.

Another simple and satisfactory way of coupling the elements of a stacked array is shown in Fig. 4B. Here the 300-ohm line is connected to the upper dipole, brought down the mast and given a half-turn before being connected to the lower dipole. Support all lines away from the grounded support on stand-off insulators. It is usually impractical and undesirable to stack more than two arrays for the same frequency. About 40% gain over a single array may be secured under ideal conditions, but mismatching often defeats most of this gain and sometimes results in an actual reduction in signal strength. Most signals too weak to come in on a single array are below the noise level. Stacking will often help by increasing the signal-to-noise ratio and by building up the forward gain, which may help to eliminate "snow" and lack of contrast in the picture.

Matching the Antenna

Since the effective impedance of a dipole is reduced by parasitic elements, some form of matching transformer is necessary to insure maximum energy transfer from the antenna to the line. A quarter-wave matching stub, made from a length of 300-ohm line, may be used at the dipole as shown in Fig. 4A. The point where the feeder line connects to the stub must be found experimentally by moving the line along the stub. (Strip the insulation along the stub and attach a couple of alligator clips to the line to make temporary contact until the best point is found; then take another piece of line and make a new stub for a permanent installation.) Match the antenna with set and booster (if used) tuned to a test pattern from the weakest station you plan to receive. If the antenna and line are matched, no matching will be necessary at the receiver if the line and receiver input are the same impedance.

An easy way to match the TV receiver and line is shown in Fig. 4C. This stub consists of a piece of 300-ohm line, with the end shorted, connected across the TV receiver or booster input terminals. Start with a

don't let
others
put
you
out of
the
picture!



Here's How CREI Home Study Training Prepares You NOW For a BETTER Job and a Secure Future in **TELEVISION!**

GET IN and *get ahead* in Television! You can make your own opportunity if you start preparing *now*. No need to tell you how fast Television is expanding—or, of the number of jobs being created. One of industry's leaders predicts: *1 Million Persons in TV within 4 years!* He estimates 12 Million TV sets by 1953—40 Million by 1958.

If your future is in radio, you *must* get in Television. CREI offers the very training you need to go after—and *get*—a good TV job.

CREI can show you the way with convenient spare-time study at home that gives you the up-to-date technical background you *must* have for Television. CREI courses are designed to give you a thorough grounding in basic principles and take you step-by-step through the more advanced subjects of TV and its related fields. It must be remembered that all

new electronic developments have their roots in past techniques. The basic theory of TV finds application in every field—aeronautical radio UHF, wide band operation, etc. are based on TV techniques. Your CREI training becomes important no matter in what direction you are heading. You will find CREI training basic and helpful right from the start. You will learn about and understand such subjects as: Optics, Pulse Techniques, Deflection Circuits; RF, IF, AF and Video Amplifiers; FM; Receiving Antennas; Power Supplies; Cathode Ray, Iconoscope, Image Orthicon and Projection Tubes; UHF Techniques, Television Test Equipment, etc.

Don't wait another day. Television won't wait for you. In all our 22 years of association with professional radiomen we know that the man who acts promptly is the man who succeeds.

VETERANS: CREI TRAINING AVAILABLE UNDER G.I. BILL For Most Veterans July 25, 1951 Is Deadline—ACT NOW!

If you have had professional or amateur radio experience and want to make more money, let us prove to you we have the training you need to qualify for a better radio job. To help us answer intelligently your inquiry—*please state briefly your background of experience, education and present position.*



Capitol Radio Engineering Institute

An Accredited Technical Institute Founded in 1927

Dept. 118-A, 16th and Park Road, N.W., Washington 10, D.C.

Branch Offices: New York (7) 170 Broadway • San Francisco (2) 760 Market St.

August, 1949

MAIL COUPON FOR FREE BOOKLET

CAPITOL RADIO ENGINEERING INSTITUTE

16th & Park Road, N. W., Dept. 118A, Washington 10, D. C.

Gentlemen: Please send your free booklet, "Your Future in the New World of Electronics," together with full details of your home-study training. I am attaching a brief resume of my experience, education and present position.

Check field of greatest interest:

- | | |
|---|---|
| <input type="checkbox"/> BROADCAST RADIO ENGINEERING (AM, FM, TV) | <input type="checkbox"/> PRACTICAL TELEVISION ENGINEERING |
| <input type="checkbox"/> AERONAUTICAL RADIO ENGINEERING | <input type="checkbox"/> TELEVISION, FM & ADVANCED AM SERVICING |
| <input type="checkbox"/> PRACTICAL RADIO ENGINEERING | <input type="checkbox"/> ADVANCED ELECTRONICS COMMUNICATIONS |
| | <input type="checkbox"/> RADIO-ELECTRONICS IN INDUSTRY |

NAME

STREET

CITY ZONE STATE

I AM ENTITLED TO TRAINING UNDER G. I. BILL



SPRAGUE DISC

CERAMIC BYPASS AND COUPLING CAPACITORS

These new ceramic units—no bigger than a dime—find dozens of bypass and coupling uses in both standard and FM as well as television equipment. They have higher self-resonant frequencies than conventional capacitors and fit neatly across miniature tube sockets. They're covered with a tough, protective coating which guards against moisture and heat. Sprague Disc ceramics are available in both single and money-saving dual capacitors.

Use Sprague Disc ceramics whenever circuits call for ultra-compact, bypass or coupling capacitors. Each unit is clearly stamped with capacitance. All capacitors are rated at 1000 v. test, 500 w.v.d.c.

See these remarkable new capacitors at your Sprague distributor today! Write for bulletin M 431.

SPRAGUE PRODUCTS COMPANY

Distributors' Division
of the Sprague Electric Company
NORTH ADAMS, MASS.

piece of line a few inches over a quarter-wavelength long and cut off about an inch at a time until the test pattern shows maximum clarity. Solder the ends together for a permanent installation and cover with tape so that contact with other wires or ground will be avoided when the stub is allowed to drop back of the receiver.

An alternate matching method involves the use of a small ceramic trimmer connected across the antenna input terminals of the TV set or booster (2 to 36 μ fd. ceramic trimmer is suitable). This trimmer may be adjusted to favor either the video or audio as may be needed, and it can be readjusted when tuning other channels. It will be subject to drift and may require readjusting from time to time. An air padder may be used in place of the trimmer if desired.

A matching stub tuned with a metal slug is shown in Fig. 4D. Bend a small piece of sheet aluminum about $\frac{1}{4}$ " wide, cut from an old coil shield, into a small loop which will just slip over the 300-ohm line and slide up and down freely. Tune by moving the slug along the line. It may be fastened in place with a small piece of tape when the best position is found. A matching stub is more stable in operation than the trimmer discussed in the preceding paragraph, but it is not so easy to adjust.

Proper matching is very important if maximum gain from the antenna is to be transferred to the set. Mismatch between set and antenna will often defeat all the extra gain that is to be had from an elaborate array. Practical experience with television installations in marginal areas indicates that proper matching will do more to improve reception than any other one thing. It is more important than the type or height of the antenna, and will often permit reception without a booster in areas where a booster would normally be used with the average antenna installation not properly matched to the TV receiver.

It will be found that an array cut for a lower frequency will be more ef-

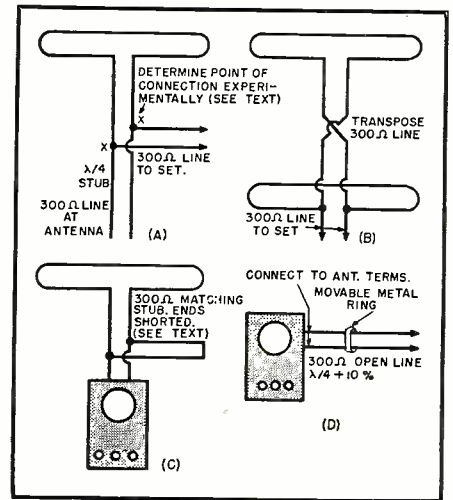
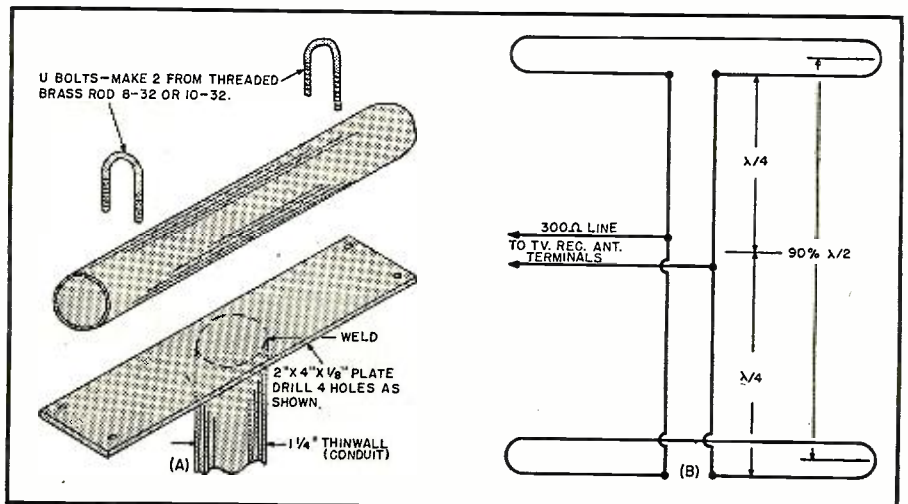

Fig. 4. (A) Scheme for matching 300 ohm line to the array. (B) Simple method of coupling the two elements of a stacked array. (C) A means of matching transmission line to the receiver. (D) Matching stub tuned with a metal slug.

fective in picking up the higher frequencies, within certain limits. For example, suppose we wish to pick up channels 4 and 6 on a single array. If channel 4 is weak, we should choose an array cut for that channel rather than one cut for channel 6. The higher frequency, channel 6, may be picked up on our channel 4 array under conditions where it would be impossible to get the channel 4 station on an array cut for channel 6.

An array cut for channel 5 might seem to be the one to use in picking up channels 4 and 6. This reasoning is not entirely correct, since we might as well get the maximum possible gain from one channel with fair results from the other channel, as to have only fair results from both channels, as might be the case with an antenna cut for an intermediate channel. These conclusions apply to marginal reception where both stations are relatively weak. If one station is stronger, it is usually a good practice to cut the array to favor the weak station, because

Fig. 3. (A) Method of mounting the array on the mast. (B) Method of connecting the dipoles to the transmission line in a two-stack array.





**FILTERS
LINE &
BAND
PASS**

BAND PASS FILTER. Peaked at 700 C.P.S. Band Wdh 650 cy at 20 db. High to High Imped. Cuts out Q.R.M. w/CKT Diag. Price..... **\$1.95**

LINE FILTER. GE 100 Amp. Filter w/2x5Mfd 50V oil cond. Operates on 110VAC DC. Price..... **\$1.98**

1KW LINE FILTER. clean up BCI & TVI. Uses 4-.002Mfd Cond. Easy to Mount..... **\$3.95**

FUSES

Send for Lists of Many Types. Also CKT. Breakers.

XFMR TELEV PWR SUPPLY KITS

BASIC 3" and **5"** T.V. PWR SUPPLY
Trans. 1080V/55Ma, 6.3V/1.2A, 6.3/1.2A, 2-.1 Mfd 2500V 2X2 Tube, Socket 1-10000 ohm Resis. Price..... **\$7.75**

BASIC 5" AND 7" TV PWR SUPPLY
Trans. 2300V/4Ma, 2.5/2A, 2-.1 Mfd 7500V Pyr. 2X2 Tube, Socket, 1-100-000 ohm Resis. **\$9.95**

TV TRANSFORMER

3000V/5Ma. 720V/200 Ma, 6.4V/8.7A, 6.4V/6A, 5V/3A, 1.25/3A Fil & Plate Voltage for 7" & 9" Tube **\$6.95**

TV TRANSFORMER 10,000V/5Ma for 12" Tube. Price..... **\$12.95**

TELEVISION COMPONENTS

DEFLECTION YOKE for 5" to 12" Scope Tube. fully cased **\$4.49**

DEFLECTION Y O K E. Same as above Philco. **\$4.49**

FOCUS COIL for above. W. E. Di64915. **\$4.25**

BLOCKING OSCILLATOR. 15000 cy. Horiz. Ratio 2:1 Freed. **85c**

BLOCKING OSCILLATOR. 9318, 1:1:1, Ratio. **\$1.50**

BLOCKING OSCILLATOR. Turns Ratio 2:1. **\$1.75**

PULSE TRANS. RAY. UX 8092 2.5A P. **\$1.75**

SWEEP CHOICE. 3 Hy. 35 Ma. 250 ohms. Price 2 for. **75c**

Write for Flyers of Other Equipment.

VARIABLE FREQ OSCILLATOR CONDENSER

Precision 2 Sect. Ins. Worm Drive High gear ratio. First Sect 17 Pl. .0025 GAP. 0-150 Mmf. Second Sect 25 Plates .06 GAP. 0-200 Mmf. Precision Trimmer Panel, 51 Adjustments. Price..... **\$4.25**

VARIABLE 7 GANG

Cardwell, Two 200Mmf. One 75Mmf Sect's. Worm Drive Assy and 0-30 Calib Dial 1/4 shaft. 1/8 Lp. Price..... **\$1.95**

VERNIER 3 GANG

Precision Assy used for single dial Control up to 75 watt. 2 single spaced 250Mmf Sect's & Heavy Double Spaced Sect's. 50:1 Ratio. Spring loaded Ceramic Ins. 4". Price..... **\$3.25**

VARIABLE ARC 5

6-9.1Mc Condenser. 90:1 Drive Gear Ratio. 3 Sections. Price..... **\$2.25**

CERAMIC TRIMMER

Stack of 6 Ceramic Trimmers 110-460Mmf. Can be used singly or ganged. Price..... **69c**

Audio EQUIP

UTC OUNCER PL to MULTI grids. 10K to 2-125K ohms Sec..... **\$1.49**

OUNCER PL TO LINE. Pri. 7K to 250 ohms Sec. Price..... **49c**

P.L. to V.C., 7500 to 3 1/2 ohms Sec. **.79c**

OUNCER PL TO H.S. or Line 10K to 4K ohms. Tapped at 250 ohms. 69c

P.L. to H.S. 14,200 ohms to 8000 ohms. **98c**

LINE TO GRID. 600 to 50K ohms. Price..... **\$1.10**

PL TO LINE. 8K to 250 ohms. Price..... **\$1.10**

MIKE OR LINE TO GRID. 100 to 50K ohms. Tapped at 100 ohms. Price..... **\$1.39**

U.T.C. 1:1 RATIO. 50K ohms, 3rd=1db. 50 to 3000 cy Ouncer. **98c**

COMMUNICATIONS EQUIPMENT for your needs COMPANY

ARC 3 COMPLETE AUDIO MODULATION XFMR PKG. T103 Carbon Mike to Grid. Price..... **95c**

T102 615 to PP 6LG GRIDS (Modulation)..... **\$1.15**

T104 MOD. XFMR PP 6LG to 832 or 8298 Plates. \$1.49

COMPLETE KIT OF THREE. **\$2.98**

UNIVERSAL VIBRA-TOR TRANSFORMER 6, 12, 24, 115VDC & 115 & 230vac/50-60 cy 420vct/85MA. 6.3/3A. Price..... \$2.49

COIL 160 watt 200 ct 4 Pin. use w/variable Center Link. Price..... \$1.19

ROTARY BEAM COUPLER
RF Coupler 360° rotation 1 turn coupling link. Plastic case mount on side. Price..... **\$2.95**

TRANSFORMERS AND CHOKES

115V 60 Cy. Input Equip. Conserv. Rated

FILAMENT TRANSFORMERS

5V/6A	\$2.25
2.5VCT/6.5A	3.25
6.3VCT/2A, 6.3VCT/2A	1.85
F5087: 6.3VCT/1A, 6.3VCT/7A	2.75
2x6.3V/1A	1.95
8V/1.5A	2.75
F5123: 6.3VCT/5A, 6.3V/1A	2.25
F5127: 6.3VCT/3.2A, 6.3VCT/1A	2.25
F714: 2.5V/1.75A, 6.5V/8A, 5V/3A, 6.5V/6A	3.95
F714: 2x2.5VCT/6.5A	3.25
6V/2.5A	1.75
6.3VCT/7A, 6.3VCT/5A, 5VCT/6A, 3x6.3V/6.6, 3	3.95
F384A: 6.3V/2.5A, 2x2.5V/7A	3.25
F112: 2x2.5VCT/6.5A, 2.5V/6.5A	4.25

PLATE TRANSFORMERS

P410: 800VCT/40Ma, 760VCT/500Ma	\$6.50
680V/450Ma	4.95
70V/1A	2.25
P413: 510VCT/150Ma, 650VCT/15Ma	3.00
P842: 600VCT/0.166A, 250VCT/0.77A	2.95
P885: 1620VCT/400Ma HV Ins.	11.95
P894: 2x200V/350Ma, 2x20V/.01A	1.95
2x150V/940Ma	4.95
246VCT/830Ma	3.50

COMBINATION TRANSFORMERS

780V/600Ma, 6.3/2	\$3.95
825VCT/150Ma, 5VCT/3	3.95
C11: 2x300V/450Ma, 5V/125Ma, 45V/3.5Ma	4.25
C608: 880VCT/150Ma, 5V/3A, 6.3V/6.25A	4.25
C931: 585VCT/86Ma, 5V/3A, 6.3V/6A	3.95
C055: 525VCT/75Ma, 5V/2A, 6.3/1.8, 10V/2A	4.45
T102: 1080VCT/55Ma, 6.3/1.2, 6.3V/1.2A	5.95
600VCT/155Ma, 6.3VCT/5A, 5VCT/3A	3.95
C899: 2x110VCT/0.1A, 6.3V/1A, 2.5VCT/7A	4.50
6.3VCT/10A, 65V-100V-18VCT-18V-6V-6.3V/1A	5.25
5VCT/3A, 880VCT/040A	2.95
40V/.01A, 6.3/1.25A	1.95
T160: 1120VCT/770Ma, 590VCT/082A HV Ins.	12.50
C579: 24V/900Ma, 770V/0.025, 2.5V/3A HV Ins.	4.25
T378: 2300V/.004A, 2.5/2A HV Ins.	7.95

FILTER CHOKES

25Hy/65Ma \$1.00; 6Hy/150Ma	\$1.50
Swing 15-25Hy/150 Ma \$3.25; 8.5Hy/125Ma	1.50
Dual 7Hy/75Ma, 11Hy/65Ma	1.65
7Hy/140Ma \$1.60; Dual 2Hy/100Ma	.75
Dual 2.5Hy/130Ma \$1.25; .116Hy/150Ma	4.25
.01Hy/2.5A \$1.45; .35Hy/350Ma	7.25
Dual .5Hy/380Ma \$1.00; 5Hy/40Ma	.55
2Hy/200Ma 75c; Dual 120Hy/17Ma	\$1.95
30Hy/20Ma 85c; 5Hy/200Ma	1.45
2,1Hy/200Ma \$1.20; 2x2.2Hy/.55A	9.95
25Hy/75Ma \$1.10; 20Hy/300Ma	7.95

Write for Lists of Many Others.

POWER EQUIPMENT

Fil. Trans. 110V 60 cy. in., 5vct./30A out.	\$9.95
In 110V 60 cy out 6.3vct/20A, 6.3v/1.8A, 6.3v/600MA	\$4.95
In 110V 60 cy out 2x5vct/6.75A, 5vct/13.5A, 3500 Test	\$6.95
In 110V 60 cy out 10vct/13A, 10vct/6.5A, 6.3vct/2A	\$7.95
In 115V 60 cy out 760vct/500MA, 800vct/40MA	\$10.95
In 110V 60 cy out 690vct/400MA	\$6.95
Tapped in. 107 to 127v out 160v to 200v/700MA 12 Taps	\$8.95
In 110V 60 cy out 4V/16A, 2.5V/1.75A	\$1.75
In 110V 60 cy out 1700V/144MA, w/choke 26"x29"x 13" oil immersed.	\$65.00
In 115V 60 cy out 2x5v/5.5A 29kv ins.	\$24.50
In 115V 60 cy out Tapped to give 2750/2470/2240 @ 750 MA 7000v ins.	\$34.50

T.V. Transformer. 7" or 9" scope, 3000v/5MA, 720vct/200Ma, 6.4/8.7A, 6.4/6A, 5/3A, 1.25/3A. Price..... **\$6.95**

WRITE or PHONE DI 9-4124
Att. Mr. Chas. Rosen

RHEOSTATS

5 ohms	250w	\$2.90
50 ohms	25w	.69
250 ohms	25w	.98
1000 ohms	50w	1.10
15000 ohms	4w	.49

TIME DELAY RELAY VACUUM 30 Sec 117y 60 cy Metal Tube 4 Prong, Edison Price..... \$2.25

WHIP ANTENNA
MS49 & MS50 for Mobile or Dipole 74"..... **49c** Set

FLEXIBLE ANTENNA
AN130 33" Whip w/Flexible Neck in 2 sections. Price..... **\$1.75**

YOU'LL SAVE MANY DOLLARS WITH THIS FREE CATALOG AVAILABLE TODAY

HiGain Dyn Mike Xfmr UTC/SuperElec 3wdp 600 CT&400ohms tapped 250 &150 ohms. Fully Shielded Herm Sid..... \$9c
2 for 98c; 10 for \$4.50

COLLINS ART-13 FREQ. MULT. UNIT
2-18 Mc for two 1625 Tubes. Comp Assy less Tubes & Coils w/ckt diag. Price..... **\$8.95**

MICROWAVE TEST EQUIPMENT

TS-117/GP 10 CM WAVEMETER TEST SET. Mfg. "Sperry." 2400-3400 MC. Micrometer Adj. Coaxial Cavity. Freq. Meas. by absorption or transmission method. Mounts Crystal Current Meter & Calib. Chart. **\$145.00**

VSWR AMPLIFIER TS-12/AP. Unit 1 3 stages of Amplif. and Diode Rectifier w/direct VSWR reading on meter. 115 volts 60 cyc. AC operation w/Inst. BK and COT diag. New. **\$235.00**

SLOTTED LINE PROBE and Matched Termination incl'd Accessories TS-12/AP Unit 2 incl UG81/U, CG92/U, CG91/U, CG89/U, UG79/U, CG87/U, MX-158/U, CG88/U, CG90/U, UG80/U plus Tools. **\$135.00**

COMPLETE TS-12/AP UNITS I AND 2..... **\$350.00**

10 CM ECHO BOX CABV 14ABA-1 of OBU-3, 2890 MC to 3170 MCS. direct reading micrometer head. Ring prediction scale plus 9% to minus 9%. Type "N" input. Resonance indicator meter. New and Comp. w/access. Box and 10 CM Directional Coupler. **\$350.00**

3 CM RECEIVER SO-3. Complete with W.G. Mixer Assy (723 A/B) Reg. Fil. Power Supply, 6 Stages IF (6AC7) **\$99.50**

TS-108A/P DUMMY LOAD. **\$85.00**

3 CM. HORN AT-48/UP Model 710. Type "N" input. Hvy. Silver Plated. **\$65.00**

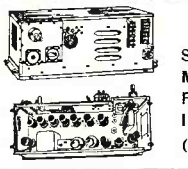

3 CM RECEIVER
SO-3. Complete with W.G. Mixer Assy (723 A/B) Reg. Fil. Power Supply, 6 Stages IF (6AC7)..... **\$99.50**

MARINE RADAR

SO-1 AND SO-8 RADAR SETS. Complete, in Used but Excellent Condition. 10 CM Surface Search using 212E or 2127 Magnetron, 707B Mixer, PPI Indicator, input 115VDC. Used on Merchant Ships throughout the world. FCC Approved. Guaranteed. **\$1250.00**

MAGNETRONS

Tube	Frg. Range	Pk. Pwr. Out	Price
2131	2820-2860 mc.	265 KW.	\$25.00
2121-A	9315-9305 mc.	50 KW.	25.00
2122	3267-3333 mc.	265 KW.	25.00
2126	2992-3019 mc.	275 KW.	25.00
2127	2965-2992 mc.	275 KW.	25.00
2132	2780-2820 mc.	285 KW.	25.00
2137			45.00
2138 Pkg.	3249-3263 mc.	5 KW.	35.00
2130 Pkg.	3267-3333 mc.	87 KW.	100.00
2140	9305-9325 mc.	10 KW.	65.00
2149	9000-9160 mc.	58 KW.	85.00
2134			55.00
2161	3000-3100 mc.	35 KW.	65.00
2162	2914-3010 mc.	35 KW.	65.00
3131	24,000 mc.	50 KW.	55.00
5130			39.50
7144Y			25.00
718DY			25.00
720BY	2800 mc.	1000 KW.	50.00
720CY			50.00
725-A	9345-9405 mc.	50 KW.	25.00
725-B	9345-9405 mc.	50 KW.	25.00
728 A, B, C, D, E, F, G, H, I, J, K, L, M, N, O, P, Q, R, S, T, U, V, W, X, Y, Z			50.00
700 A, B, C, D			50.00
706 A, B, C, D, E, F, G, H, I, J, K, L, M, N, O, P, Q, R, S, T, U, V, W, X, Y, Z			50.00
Klystrons. 723A/B \$12.50; 707B			20.00
417A	\$25.00	2K41	65.00

MAGNETRON MAGNETS

Gauss	Pole Diam.	Spacing	Price
4855	1/4 in.	3/8 in.	\$12.50
5200	1/4 in.	3/8 in.	17.50
1300	1 1/8 in.	1 1/8 in.	12.50
1860	1 1/8 in.	1 1/8 in.	14.50

Electromagnets for magnetrons..... **\$24.50 ea.**

NEW!! CONDENSERS

ELECTROLYTICS

Tubular, Prong Mtg. Lug Term DY or FP Type.		
Mfd.	VOLT	PRICE
30	250	\$ 1.18
30	100	1.70
40	400	1.70
10-10	150	1.70
20-20	25	1.70
20-20	10	1.70
20-10	150	1.70
30-30	25	1.70
40-40	150	1.70
40-20	150	1.70
40/20	150/25	1.70
40/30	150	1.70
10/50/100	350/100/50	1.70
10-10/10	150/25	.18
16	450	.18
20	350	.18
15	250	.18
15	450	.18
10	300	.18
10	450	.18
225	15	.29
20/20	350/25	.29
20/30	450	.25
30/20	350/25	.29
10/50/100	100/50	.29
10-15/20	350/25	.49
15	450	.29
15	450	.29
20	525	.29
50	450	.60
60	750	.60
1000	50	.85
10-10	475	.49

MANY 2-3 SECTION SEND FOR LIST

Minicaps Pigtail

30	450	\$.49
30	300	\$.45
30	350	.48
40	450	.50
40	525	.70
16	350	.35
16	525	.45
16	450	.40
16	100	.24
40	450	.50
20	80	.25
20	450	.40
24	350	.30
8	400	.30
8	150	.15
10	150	.20
10	50	.15
12	450	.30
4	50	.10
4	150	.14
4	250	.20
8	350	.25
10-10	150	.25
20-20	450	.60
50-30	150	.50
50-50	150	.55

Tubulars Screw Mtg. Wire Leads D Type

8	250	\$.25
8-8	450	.50
16	450	.40
20	450	.45
20	450	.50
24	450	.45
12	250	.30
8	600	.60
16	500	.30
16	600	.80
30	450	.50
40	450	.30
240	250	.80
30-30	450	.75

COMMUNICATIONS EQUIPMENT COMPANY

CABLE ADDRESS: COMSUPO
PHONE DIGBY 9-4124
131 LIBERTY ST. DEPT. N.
NEW YORK 7, N. Y.

F M MICROWAVE RADIO SONAR
C.E.C. MONEY BACK GUARANTEE, \$3 MIN. ORDER.
E.O.B. N.Y.C. SEND MONEY ORDER OR CHECK, ONLY SHIPPING CHARGES C.O.D.



Three Astatic UTILITY KITS

To help sell, service, maintain
inventories **FREE**
with your purchase of
ASTATIC CARTRIDGES

• You pay only for the Astatic Cartridges contained—and included in these new kits are only those types you are regularly called upon to furnish. You receive, at no additional cost, important new facilities. Astatic Utility Kit No. 3 is a sturdy, handsome wood cabinet. Inside, individual compartments house 24 boxed and labeled cartridges. Each compartment is also labeled to show what cartridge should be replaced in it. Other compartments hold six Astatic matched needles; pen-size needle pressure scale; an assortment of cartridge mounting screws, needle screws, terminal clips. Inside the lid is a chart showing cartridges which may be replaced by those in the kit. One of the handiest items a serviceman can carry . . . to sell and service 95 percent of cartridge replacement jobs.

Kit No. 2 is a heavy cardboard carton, holding 12 Astatic Cartridges and corresponding replacement charts, and will fill at least 85 percent of all replacement needs. Kit No. 1 contains six cartridges and replacement chart, and will fill a majority of phonograph requirements.



Astatic Crystal Devices
manufactured under
Brush Development Co. patents

TRANSMISSION LINE ACCESSORIES

MOSLEY TRANSMISSION LINE PLUG



For terminating 300 ohm line so that antenna lead-in can be connected or disconnected easily. **NO SOLDER** needed for connections.

CAT. 300-P

MOSLEY TRANSMISSION LINE SOCKET

For 300 ohm line. Will receive CAT. 300-P Plug. **NO SOLDER** needed to connect. Just the thing for extending a lead-in.



CAT. 300-F

MOSLEY BASE-SOCKET

For use with TV and FM receivers so that the receiver can be disconnected and moved for dusting. **NO SOLDER** needed. Lead-in can be shorter. **SOCKET** can be fastened to window frame or base-board.



CAT. 300-SB

FOR SALE AT YOUR JOBBER

MOSLEY ELECTRONIC SPECIALTIES
(WØFQY) 2125 LACKLAND ROAD
OVERLAND (14) MISSOURI.

LOWEST PRICES YET AT GREENWICH SALES!

- MAGNETRON—725A—New—Orig. packing \$9.95
- Each
- Others in stock—Inquiries answered
- A 115VAC-60 CY. SOLENOID—with captive slug-15-25 lbs. pull. Close garage doors—Many experiments. Special 1.50
- 80 KC. Radar Xtal—Cased—New—Boxed 1.10
- HS-15U—8000 ohms. phones—spotless—New—Boxed
- TRANSFORMER—Specials—115V—60 cycle. Pri. cased—Hermetically sealed W.E. Specs. 1.25
- K54J7572—Sec. 750 Volts—220 Ma. 4.50
- KS-8754—Sec. No. 1 1230 Volt 262 Ma No. 2 18 Volt 1.0 5.95
- D-161917—Sec. No. 1 6.3 Volt 3.0A. 2.50
- D-161912—Sec. No. 1 2.5—10. 5 Amps. No. 2 6.3—5.5 Amps. No. 3 6.3—1.0 Amps. 3.50
- Full enclosed—double half shell—115V—60 cycle.
- Sec. No. 1—3000 V RMS-2 Mils; No. 2 —6.3 V—6A
- Sec. No. 3—2.5 V—1.75A—New Small Tv or scope—Reduced 3.75
- Sec. No. 1—600 Volt—75 Mils; No. 2 —6.3V—3.A—No. 3—5.0 V 2.A—New—Small—Special 1.95
- Code practice oscillator—115 V—60 cycle —Small compact chassis—Complete with tube, key. Variable note—Will operate with any phones or small speaker—Complete—Plug in and use—Guaranteed 3.45
- RK 34—Dual Hi-Freq. Transmitting Triode —16 watts—output—New 4 for 1.00
- Cardwell Variable—10 Mmfd—19 plates —1 Gap. X type—New—Boxed—Each 1.00
- Bud Variable—150 Mmfd—27 plates—steatite insul.—Each 75c. 3 for 2.00
- Hammarlund—Insul. APC type—25, 75, or 100 Mmfd. Any 3 for 1.00
- SPECIAL SELENIUM RECTIFIER BUY
- Full wave C.T. 18-0-18. 2 Amps.—New —Only \$.98
- Wide range of selenium stacks at lowest prices—Let us quote
- F.P. Electrolytic—40 Mfd—25 volt—New Shiny Caps—Special closeout 24 for 1.00
- 4 AG Fuse holder—Little fuse Cat No. 442002. List price \$3.00. Special. 3 for 1.00
- Arc-5—Flexible shaft coupling—5" x 3/4" —bushing Dozen 1.00
- Meter-O-100 Microamps—4 1/2" square—Hickock—Guaranteed Each 7.95
- Meter-O-5 Mil. Basic—Blank Scale—2 1/2" square—Guaranteed Each 2.25

GREENWICH SALES CO.
59 Cortland St. New York 7, N. Y.

the stronger one will come in without trouble anyway.

Some constructors may want to know what to expect in the way of reception from a directional array of the type described. It is, of course, impossible to set any hard and fast rules as to what will occur in any given location. The noise level and signal strength will vary greatly for different installations, even though they may be the same airline distance from the transmitter. Suburban locations are usually best because of the lower random noise level. If a fairly good location is available, the constructor should not hesitate to try for reception from any TV station within a 200-mile radius. Reception at maximum distances will be freakish and variable, but signals will come in under favorable weather conditions, and for distances up to 100 miles, reception can be fairly consistent. It is certainly good enough to justify the purchase of a TV receiver.

One or two boosters must be used to pull in the weakest signals. If two are used, tune one of them to the audio and the other to the video signal. Try connecting them in series and also in parallel. Two boosters of different manufacture will often work better than two of the same make when connected together, because the tendency to oscillate is usually less. Shortening or lengthening the lines between the boosters, or between the TV set and a booster, may also help cure oscillation troubles.

Stations less than 100 miles away will come in without boosters whenever weather conditions are favorable. Remember that a change in antenna location may boost signal strength by as much as 100%, so do not hesitate to move the array around on the roof to find the best spot. Height is not too important; usually ten feet above immediately surrounding objects is enough to get a good signal. —30—

SEPARATING SMALL RESISTORS

SMALL sections of corrugated cardboard, of the type used in packing cases, will prove helpful in keeping the small resistors and condensers used in home assembly TV sets separated while working: The cardboard can be bent, standing upright, so as to fit into a box top, and the resistors are slipped into the small corrugated sections. It is easy to locate the desired items when needed by means of their color markings. R. H.

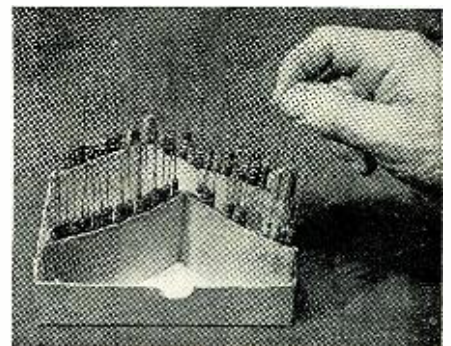

RADIO & TELEVISION NEWS

First Transmitter

(Continued from page 27)

teristics are present, it would be well to first check the regulation of the power supply being used. If necessary the coupling condenser at the grid of the 807 may be reduced to a 50 μ fd. unit to reduce the loading effect of the final on the oscillator. The 100 μ fd. unit presents perhaps the best compromise for optimum results for both crystal and v.f.o. input, especially if the v.f.o. unit is a so-called crystal substitute type with quite low output. If the v.f.o. has more output, there should be practically no change when shifting from crystal to v.f.o.

The antenna may be coupled and loaded up by means of a suitable coupler. The r.f. indicator will now decrease in brilliance, and it may be necessary to increase the coupling by bringing the piece of wire from the bulb into closer proximity to the tank coil. The quality of keying should again be checked because it is possible to load up too heavily. The authors' advice is not to load up too heavily; just as good results will be had, especially if the power supply is not too rugged. The chances are that the change in signal strength at the receiving end will be negligible.

This little rig makes a good "first" transmitter as it is dependable, with no trick circuits involved, thereby eliminating the possibility of off-frequency operation. It is easy to build and get going and has enough power output to produce excellent results. It should appeal also to the established amateur as a good stand-by rig when the larger transmitter is undergoing alterations or as a special-purpose rig for network operations.

-30-

PHONO MOUNTING BOLTS

IT IS important that the bolts holding the phonograph turntable are not adjusted too tightly.

Sometimes mounting cardboard installed for shipment is not removed, thus preventing any freedom of the turntable.

Tightness of mounting bolts as well as any packing left in place can usually be checked by pressing downwards on the table board. A certain amount of "give" or springing effect should be noted. H.L.

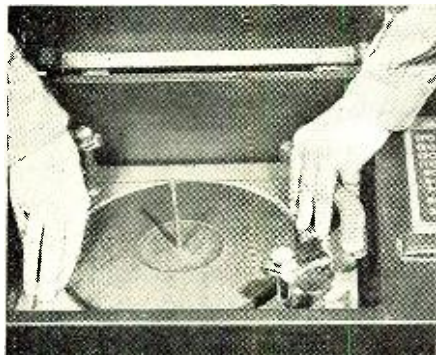

August, 1949

You Build 'em
in
ONE EVENING
but...

THEY LAST A LIFETIME!

EICO INSTRUMENT KITS

HIGH-PRECISION VACUUM TUBE VOLTMETER

Model 221-K

\$23.95

Tops in work bench versatility. 15 different ranges! AC and DC ranges: 0/5/10/100/500/1000 volts. Electronic ohmmeter ranges from 2 ohms to 1000 megohms in 5 steps. New features include Zero Center for TV discriminator alignment. DC input impedance is 26 megohms. Exceptionally accurate. Big 4 1/2" meter cannot burn out. Double triode balanced bridge circuit assures stable, guaranteed performance. Sturdy portable steel case with etched, rubproof panel. 110-130 V. AC 50-60 cycle. Size 9 1/4" x 6" x 5".



FACTORY-WIRED VTVM
Model 221. Same, but completely wired, calibrated, and tested \$49.95

Pocket VOLT-OHM MILLIAMMETER



Model 511-K. A "must" for servicemen! Perfect kit for the beginner. 5 AC ranges to 1000 V; 5 DC ranges to 2500 V; Ohms, to 1 meg.

3" precision meter. New improved Germanium crystal receiver circuit. \$14.95
Model 511 Factory-wired, tested. \$17.95

NEW! MODEL 320-K SIGNAL GENERATOR

\$19.95

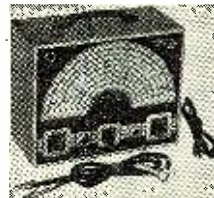

An excellent instrument for service, lab, and school use. Can be used for FM-AM alignment and to provide TV marker frequencies. Highly Stable Hartley oscillator has range of 150 kc to 102 mc with fundamentals to 34 mc. Colpitts audio oscillator supplies pure 400 cycle sine wave voltage for modulation. Audio oscillator voltage can be used for testing distortion in audio equipment, bridge measurements, etc. Handsome etched panel with easy-to-read calibrations. Easily assembled and aligned. Complete with tubes. FACTORY WIRED AND ALIGNED

Model 320. Ready to use. \$29.95

FREE! Write today for colorful new catalog, and name of your nearest jobber. NOTE: Prices do not include shipping charges.

5" 'SCOPE

Model 400-K
\$39.95

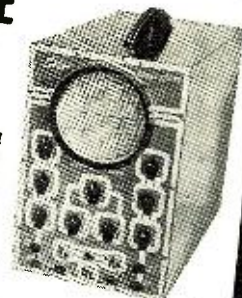

Quality throughout! Laboratory precision scope, for FM, AM, & TV servicing. Deflection sensitivity: .65 volts per inch full gain. Linear sweep with 884 gas triode. Horizontal sweep circuit, 15 to 30,000 cycles. Frequency response of horizontal and vertical amps is from 50 to 50,000 cycles. Provision for external synchronization, test voltage, and intensity modulation. Complete with 2-6SJ7's, 2-5Y3's, 884, and 5B1 CR tube. Graph screen for measurement to peak voltages. Operates on 110 front of handsome 3-color etched, rub-proof panel. Size: 8 1/2" x 17" x 13" high. Shpg. wt. 30 lbs. As with all EICO kits, easy-to-follow Pictorial and Schematic diagrams are included. FACTORY-BUILT OSCILLOSCOPE Model 400. The same high-quality, life-long instrument, but fully wired, assembled, and tested. \$69.95

PENCIL-TYPE HIGH FREQUENCY RF PROBE KITS

Germanium crystal probes for visual RF signal tracing and measurements to over 200 megacycles. 1/2" O.D., 8 1/2" long. Model P-75K. Can be used with EICO Models 221, 113A, or any VTVM! Model P-76K. For Models 400 & 145. \$3.75
Models P75 or P76. Same as above but factory wired and tested. Each. \$7.50



NEW! MULTI-SIGNAL TRACER

Model 145-K. Versatile, high gain--high frequency instrument. Self-contained test speaker permits audible signal tracing of RF, IF, FM, audio, and video circuits. Has provision for visual tracing with VTVM. Response is well over 200 mc. 3-color hammertone panel. 110-125 V. AC Size 10" x 8" x 4 1/4". Comes complete with tubes and diode probe in kit form. \$18.95
FACTORY-BUILT AND TESTED Model 145. Ready to operate. \$28.95

EASY-TO-FOLLOW SCHEMATIC & PICTORIAL DIAGRAMS

come complete with every EICO Instrument Kit.

Each kit fully guaranteed to operate perfectly when assembled according to our instructions!

JOBBERS: Write today for complete literature and discounts.

ELECTRONIC INSTRUMENT CO., INC.
276 Newport Street, Brooklyn 12, N. Y.

Sun Radio's Annual Clearance!

CRYSTALS! All crystals have Army MC harmonic ratings but Sun encloses directions for deriving the correct fundamental frequency in kilocycles.

JUST ARRIVED—NEW FREQUENCY CRYSTALS FOR HAM & GENERAL USE
FT-243 holders, 1/2" pin spacing, fractions omitted

GENERAL USE			HAM USE		
2-6-10-11-20-40 METERS					
6006	6208	7873	5305	5806	5975
6025	6773	7906	5675	5825	6000
6040	6840	7925	5677	5840	6273
6073	6873	7940	5700	5850	6340
6075	6906	7950	5706	5873	6373
6100	6940	7973	5725	5875	6406
6106	6973	7975	5740	5900	6425
6140	7140	8240	5750	5936	6440
6150	7173	8273	5760	5925	6450
6173	7806	8306	5773	5940	6473
6206	7840		5775	5973	6475
					6475
					6506
					7140
					7573
					7606
					7206
					7240
					7306
					7340
					7373
					7406
					8050
					8073
					8100
					8173
					8175
					8340

49c EACH 10 for \$4.50 **99c EACH** 10 for \$9.00

CRYSTALS WITH A MILLION USES

FT241—Fractions Omitted

kc	kc	kc	kc	kc	kc	kc	kc	kc	kc	kc	kc
412	422	433	442	462	477	490	498	504	508	515	519
413	423	434	443	463	478	491	499	505	509	516	522
414	424	435	444	464	481	492	502	506	511	518	523
415	425	436	445	470	483	493	503	507	512		
416	426	437	446	472	484	494					
418	427	438	447	473	485	495					
419	429	440	448	487	496						
420	431	441	451	475	488	497					

49c each

Crystal Frequency Standards	For Crystal Controlled Signal Generators
98.356Kc	FT241—525Kc
Easily altered for 100Kc Standard. Mounted in low loss 3 prong holder.	526.388 533.333 537.500
\$3.89 each	527.777 534.722 538.888
	529.166 536.111
	530.555 99c each
	531.944

I.F. Frequency Standards	200 KC CRYSTALS
450 kc 461.111 99c	Without Holders
451.388 464.815 each	2 1/32" x 2 3/4". Each 69c
452.777 465.277	3 for \$2.00

Assorted Miscellaneous Crystals	For Ham and General Use
Fractions Omitted	Fractions Omitted
370kc 377kc 384kc 387kc	390kc 396kc 403kc 408kc
372 379 386 388	391 397 404 409
374 380 39c	375 381 388 405
375 381 Each	383 389 406 411
376 383 Each	393 400 407
priced at a fraction of the cost of their holders alone.	394 401 79c each
	395 402

CRYSTALS FOR SCR 522	CRYSTALS FOR HAM USE	Crystals from BC 6 10 Spacing—2 Banana Plugs
5910kc 7480	Fit 243 Holder 1/2" Spacing	2045 2305 3302 3500
6370 7580	each	2105 2320 3215 3510
6450 7810	3735 KC... 59c	2125 2360 3270 3580
6610 7930	4190 KC... 59c	2145 2390 3290 3645
7350	5030 KC... 39c	2155 2415 3320 3655
\$1.29 each	5485 KC... 39c	2220 2435 3510 3695
		2250 2442 3520
		2312 383 405
		2328 252 257
		2330 2557 \$1.29 Each

• Payments must accompany order. Enclose 20c for postage and handling. Minimum order—\$2.00 plus postage. Crystals are shipped packed in cloth bags inasmuch as they are shock mounted. All shipments guaranteed.

MONITOR SCOPE UNITS—TS-121/CPN 8—Ideal for building a high quality precision laboratory oscilloscope, contains 115V-60CY power supply, high voltage power supply, C.R. tube shield-condensers, resistors, controls, and almost everything else needed to make this conversion with conversion diagrams, less tubes **\$29.95**

AN/CPN-8 AUTOMATIC TRANSPONDER BEACON—contains the following units—Monitor scope unit, receiver coder unit, transmitter monitor, for 115V-60CY operation, units are mounted in 48"x27"x23" enclosed heavy steel cabinet, complete except less voltage control unit and less tubes **\$149.95**

SHERY AMPLIFIER—with 4 tubes and many parts, with diagram, new **\$3.95**

VHF-NAVY CW TRANSMITTER, 80-105 mc, battery operated, with 2 104 tubes and instruction manual **\$6.95**

BENDIX-100 watt transmitter, 4 6C6's, 4-12SK7's and 3-307's, with complete conversion instructions for operation on 10, 20, 40, 80 meters. LIKE NEW **\$39.95**. Used **\$29.95**

WALKIE-TALKIES, 52-65 mc with spare parts for portable or mobile use. NEW, per pair **\$139.90**

AM/26 INTERCOM AMPLIFIER—with 2Bv dynamotor, 2-12AG 2-12AB tubes and instructions for conversion to HI-FI amplifier. New **\$4.95**

• TERMS: All items F.O.B., Washington, D. C. All orders \$30.00 or less, cash with order. Above \$30.00, 25 per cent with order, balance C.O.D. Foreign orders cash with orders, plus exchange rate.

SUN RADIO
OF WASHINGTON, D. C.
938 F STREET, N. W. WASH 4, D. C.

Cathode Follower v.t.v.m.

(Continued from page 52)

substituted for the regular secondary with facility.

The low twenty-four-volt potential used to light the thirty-five-volt filament and simultaneously supply plate voltage serves the purpose of keeping grid current to an immeasurably small level, even with the high resistance of the voltage divider in the grid return.

The voltage divider was selected to give full-scale readings of 1, 2.5, 10, 50, 250, 500 and 1000 volts; however, as the volt range is basic, any value of voltage above one can be made to read full-scale by changing the divider resistance ratios. As the voltmeter puts no current drain on the measured voltage, the divider taps can be determined on a simple percentage basis; for example, with a total of 10 megohms across 1000 volts and one volt needed for a full-scale reading, the first tap is at 10,000 ohms. The one-megohm isolating resistance in the probe isolates the test lead and meter from the circuit being measured and keeps capacity loading to a relatively small value. The probe resistance need not be considered in divider calculations, as the sensitivity of the meter is adjusted to compensate for it when the range is set at 1.0 volt full-scale with 1.0 volt between the probe and ground. If higher voltages such as those encountered in television are to be measured, it is preferable to make an external divider and safety probe with resistance values based on the same principle.

Two potentiometers are used in the voltmeter proper; one serves as a zero set and the other, as a sensitivity control. The sensitivity control needs only to be adjusted once and, when set, need not be adjusted unless replacing the 35L6. A third potentiometer used in the instrument is a sensitivity control when the v.t.v.m. is

Rear view of v.t.v.m. Test prod retainers are made from ordinary fuse clips.

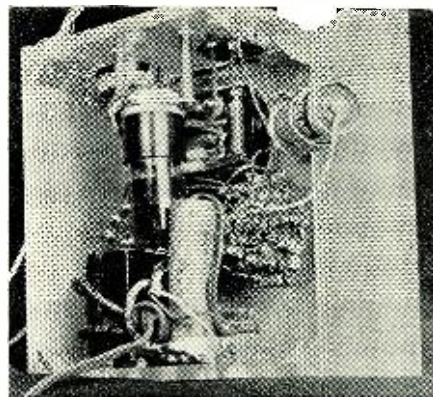
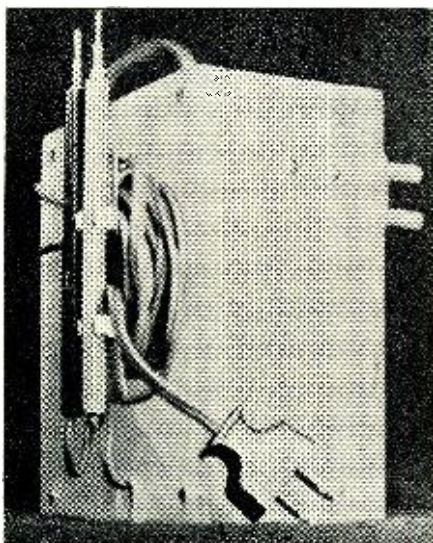

The back and side panels are removed to show mounting of various parts. The voltage divider and ohms multiplier resistors are mounted directly on the range switch. All other resistors are mounted on a small board behind the meter. The voltage and ohms calibration pots are mounted to the top of the case.

used as an ohmmeter. The third control is necessary because a standard flashlight cell is used to supply the potential for measuring resistance; in effect the meter sensitivity is changed to 1.5 volts full scale in this function. A "use" switch serves to reverse the meter when measuring either negative or positive voltages without reversing the test prods. The switch further serves to connect the instrument as an ohmmeter when such a function is desired.

No a.c. ranges were added to the v.t.v.m., but it is a simple matter to construct a probe using a diode and further extend the utility of the instrument to encompass signal tracing and a.c. measurement.

The instrument can be housed in any available casing: metal, wood, etc.; the experimental model shown was built into a plastic box made from 1/4" lucite measuring 3 1/2" x 5 1/4" x 7". The appearance is quite novel, a frosted effect was given to the lucite by rubbing the surface with fine sandpaper. The "frothing" makes the box translucent and makes a convenient surface for marking with india ink.

As the voltmeter operation is linear, the existing calibration curve was used; only the numbers representing voltages were added. However, it was necessary to draw in reference points for resistance readings. This operation is not complex, as one scale serves all resistance measurements, the higher ranges being simply even multiples of the x 1 scale.

When the v.t.v.m. is completed and ready for adjustment, an accurate reference meter capable of reading 1.0 volt plus a 1.5 volt cell and a potentiometer of about 100,000 ohms are all that is needed for calibration.

The potentiometer and reference meter should be connected across the 1.5 volt cell and the potentiometer adjusted to an arbitrary value of, say, 0.5 volts. The v.t.v.m. which has previously been warmed up is set at + volts (with the range switch at 1.0) and adjusted to zero. The test prods

RADIOMEN'S HEADQUARTERS * WORLD WIDE MAIL ORDER SERVICE!!

Highest quality telescoping folded dipole rooftop type antenna with all the features usually expected in such an antenna, including use as dipole and reflector, and in addition a mounting bracket provided so that the antenna can be installed in any window in two minutes or less. Any slight loss in gain because of the reduction from rooftop height is more than compensated by the ability to orient the antenna instantly by opening the window and adjusting for maximum signal strength. Mounting bars can be installed horizontally or vertically in window frame or even between attic rafters, whichever is most convenient. Your cost \$8.65. With high frequency attachment for channels 7 to 13 \$11.00. Either type 10% less in dozen lots.



NO ROOFTOP CLIMBING HERE!



The BUFRAD Model BR8 portable indoor antenna adjusts easily to any channel and any station direction. Triple chrome-plated brass dipoles. Antique finished base with felt pad to prevent scratching furniture. Can also be readily installed attached to ceiling with base up. 300 ohm line furnished. Your cost \$2.95.

Lots of 12 at \$2.50 each.

SOS EMERGENCY TRANSMITTER SOS

This is the famous Gibson Girl Transmitter that saved so many lives during the war. It is used as a distress call transmitter on boats and airplanes. The Gibson Girl is the easiest transmitter in the world to operate. No instruction or experience necessary. No external power supply required for operation. It is merely necessary to turn the crank on the top of the transmitter and power is generated and the distress signal is automatically sent out on the International distress frequency. Brand New Gibson Girl transmitter complete with tubes.....\$9.95

Antenna Kit for Gibson Girl Transmitter. This kit was designed to improve the effectiveness of the Gibson Girl Transmitter by increasing the range several times. The kit includes 300 feet of special antenna wire, two balloons for raising the antenna in calm weather, two hydrogen generators to inflate the balloons, a special box kite for antenna erection in windy weather, and a searchlight, powered by the crank operated generator in the transmitter. Complete kit.....\$9.95

BUFRAD CAR RADIO ANTENNAS

All of our car radio antennas are made of triple plated Admiralty brass tubing, complete with low loss shielded antenna leads and high quality fittings.

SIDE COWL
BR-1, 3 sections, extend to 66". Your price—single units—\$1.75; in lots of 12—\$1.50 ea.

SKYSCRAPER—BR-2 has 4 heavy duty sections that extend 98". This super-aerial must be seen to be fully appreciated. Your price—single units—\$2.50; in lots of 12—\$2.25 ea.

TILT ANGLE—BR-3, may be adjusted to all body contours. 3 sections extend to 66". Single unit price—\$1.75; 12 lot price

1000 CYCLE AUDIO FILTERS

Navy PD52010-1 low pass audio filters as mentioned in the "Peaked Audio" article in June CQ, and designated by the above number, are the exact electrical and physical equivalent of commercial audio filter units selling for \$35.00 wholesale. They are infinitely better than the surplus "Radio Range Filters" being sold for reducing QRM, and at 2 KC cut off resonance, for example, a section filter using PD52010-1 is capable of twice the selectivity available through the use of the Q5-er (the BC453 section of the 274N which has provided the amateur's previous highest standard of interference elimination). EXTRA SPECIAL—NAVY PD52010-1 with diagram—\$5.00.

"RT 1711"

RT1711 Brand New 12 Tube, 110 Volt Receiver-Indicator-Oscilloscope complete with all tubes and power supply. Has telescoping hood over scope tube, which is equipped with a detachable calibrated scale. Has centering and amplitude controls and two video inputs. A natural for television.....\$39.95

FCC AUTHORIZES RADIO for PRIVATE SERVICE!!!!

(The FCC announced that effective June 1, any American over 17 years of age is eligible for a 5 year station permit. In the "Citizens" band, no code test or technical knowledge are necessary.)

GENERAL ELECTRIC 15 TUBE TRANSMITTER-RECEIVER SET

This brand new 15 tube transmitter-receiver was designed for mobile storage-battery powered service. It will operate in the "Citizens" band where no amateur license to transmit is necessary. It's a cinch for any experimenter to connect this unit for 110 VAC operation by following the instructions and diagrams supplied, which cover numerous applications, including television. For those intending to use on car or boat, a new dynamotor, exactly as originally supplied, costs only \$15.00. Don't fail to write for FREE descriptive bulletin. Order our RT-1248 for only \$29.95, or two for \$53.90.

Sensational Value in AC-DC POCKET TESTER

This analyzer, featuring a sensitive repulsion type meter housed in a bakelite case, represents the culmination of 15 years achievement in the instrument field by a large company specializing in electronic test equipment. Specifications of the AC-DC Model Volt-Ohm-Milliammeter: AC—Volts—.25, .50, 1.25, 2.50; DC Volts—.25, .50, 1.25, 2.50, 50, 125, 250; Milliampers AC—0 to 50; DC Milliampers—0 to 50; Ohms Full Scale—100,000; Ohms Center Scale—2400; Capacity—.05 to 15 Mfd. Total Price, prepaid anywhere in the USA—\$7.00. Similar DC Meter, lacking the AC operated ranges of above, \$5.50 prepaid.



"SO" RADAR SET

"SO" RADAR SET complete with 9 tubes including picture tube. This Plan-Position-Indicator Oscilloscope has a section, designed to run from the 110 V. power supply on LST or PT boats. It provides a 5" diameter picture adjustable at will to an 80, 40, 4 or 2 mile circle with the boat at the center, showing location of land, other ships, or any obstruction, so that navigation can be carried out in pitch darkness or densest fog with as much safety as in brightest sunlight. Your cost \$39.95.

RT1655

Only \$11

11 tube crystal receiver that cuts ultra modern wave of tubes into Beautiful chassis Tubes and dia

LINE FILTER

SAVE HOURS OF HARD WORK

Do the job in minutes with a BUFRAD Socket Hole Punch. Cut clean accurate holes for sockets, plugs, connectors, etc. Cutting holes in radio chassis is as simple as cutting butter with a hot knife with a BUFRAD punch. Just insert the punch in the hole and turn with an ordinary wrench. In a minute or less you can complete a job which often takes an hour with the old "drilling, reaming, and filing" method. With BUFRAD punches you can make 13 different sizes of openings from $\frac{1}{16}$ " to $\frac{3}{8}$ " diameter.



$\frac{1}{16}$ " size—\$2.08
 $\frac{1}{8}$ " size—\$2.42
 $\frac{3}{16}$ " size—\$3.10
 $\frac{1}{4}$ " size—\$3.10
 $\frac{5}{16}$ " size—\$3.10
 $\frac{3}{8}$ " size—\$5.95

\$12.95 Order "Bargain D" BIG BARGAINS

1. **SENSATIONAL, FASCINATING, MYSTERIOUS SELSYNS.** Brand new Selsyns made by G. E. Company. Two or more connected together work perfectly on 110V AC. Any rotation of the shaft of one Selsyn and all others connected to it will rotate exactly as many degrees in the same direction, following unerringly as if the units were connected together by shafting instead of wire. This is true whether you twist the shaft of the master unit a fraction of a revolution or many revolutions. Useful in indicating direction of weather vanes, rotating directional antennas, or controlling innumerable operations from a distance. Complete with diagram and instructions. Per Matched pair.....\$4.95

2. **ALUMINUM GEAR BOX 18x8x7** that contains two powerful electric motors and two matched gear trains, 62 gears in all varying in size from $\frac{1}{8}$ " to 4 inches in diameter. This unit is readily converted to rotate a beam antenna or any other similar use.....\$5.00

3. **HOME WORKSHOP AT BARGAIN PRICE.** Accurate and precise 2 speed guaranteed hobby lathe, the essential machine for the home workshop. Sturdy enough for light production work or factory standby service. Supplied with 56" of belt for connecting to any available electric motor or power take-off. Also included in this unbeatable offer are such accessories as a $\frac{1}{2}$ " drill chuck with specially hardened tool steel jaws, a 4" electric furnace high speed grinding wheel, a cotton buffing wheel and a large supply of luffing compound, and a 4" steel wire scratch brush. Your cost \$6.00. Sole export agent. Distributor inquiries invited.

COMPRESSED AIR

INSTANTLY ANYWHERE

Portable Air Compressor. PATENTED unique air intake system increases efficiency tremendously over other compressors so that air output is much greater than that from larger compressors powered by heavier motors. Will deliver approximately 3500 cu. inches of air per minute at maximum pressure of 90 lbs., or will inflate a 90 lb. truck tire in less than one minute. Comes complete with 10 lb. gauge, although finger-tip adjustment allows setting of output pressure at any value, which will automatically be maintained by means of a pressure motor. Useful for spraying paints or lacquers, disinfectants, insecticides, annealing steels, and for natural gas, inflating tires, or brang with natural gas, inflating tires, etc. Price \$14.50 postage prepaid anywhere in the U. S. Efficient, completely adjustable siphon-type spray gun complete with 12 ft. 100 lb. tested hose available for only \$7.75 with pint container, also prepaid.

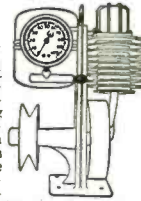

THE BUFRAD SECTIONAL TOWER

This latest addition to the famous line of BUFRAD antenna products makes up to a hundred foot tower from any desired number of ten foot sections of extremely strong welded construction. The sections are shipped assembled and painted, so that erection is a matter of minutes rather than hours. Assembly is one man job, and is accomplished by climbing up the completed portion of the tower with the next 25 lb. section to be installed. Hand and footholds are provided to make the work safe and easy. Cap at top of tower provides bearing surface for rotating, and prevents water from entering tubes. Useful for police, or amateur transmitters, and in addition the tower will provide satisfactory TV reception where otherwise it would be impossible. Ideal for supporting permanent or temporary power lines, wind generators, stadium public address speakers or spotlights for gas stations or parking lots. "B" and "C" sections together cost a total of \$15.75 and total 20 feet. "A" sections, which make up the entire tower except for the top, are each 10 feet long and cost but \$12.75 apiece. Those who wish a mast base will be able to obtain one (not shown above), for only \$6.75. The base is especially useful when erecting the tower on a sloping roof.

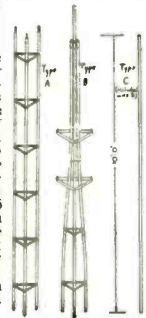

MICROPHONES



Super Special-High quality all chrome bullet shaped CITIZEN TALK MIKE of top-flight nationally known brand—\$5.95. Bullet DYNAMIC MIKE—\$7.00. TALK MIKE with switch on handle—98c. LAPEL MIKE (Specify whether carbon or magnetic) 93c.

RT 1579 With Tubes, Diagram and Parts List Only \$14.95

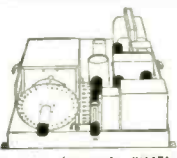

Consists of a three stage (cascade 68J7's and 6F8) output stage high gain, high fidelity amplifier with 60 cycle 110V power supply on the same 13x21x4 1/2" chassis, which is protected by a substantial steel cover over tubes and parts. Made by Western Electric with typical quality components such as a bulky power transformer and oil condensers. This unit is obviously intended to give years of trouble-free service with no more need for repairs than a telephone. Disconnecting one wire each, from the special input and output filters, will result in as high a fidelity amplifier as can be obtained.

"P.M. SPEAKERS"

Latest type PM Speaker in a fully-enclosed finished metal cabinet. This speaker and matching amplifier, complete with receivers, and in addition make perfect intercom remote stations. Our price \$4.50, including output transformer.....\$4.95



SCR-274N COMMAND SET The Greatest Radio Equipment Value in History

A mountain of valuable equipment that includes 3 receivers, covering 130 to 550 KC; 3 to 6 MC; and 6 to 9.1 MC. These receivers use plug-in coils, and consequently can be changed to any frequencies desired without conversion. Also included are two Tuning Control Boxes; 1 Antenna Coupling Box; four 2 V Dynamos (easily converted to 10 V dynamos).

GAIN

49 car radio receivers. We can't give you the price, but we can give you the features that

BARGAINS OF THE MONTH

H.V. TRANSF. 1500-8-1500 volts at 600 ma. Pri. 110/220 v. 50/60 cycles. 8 x 8 1/2 x 7 s.w.t. 78 lbs. Made by Amertran. Only \$19.95

H.V.-H. CURRENT PLATE TRANS.

1500-0-1500 volts at 1.5 amps. Tapped at 1350 and 1250. Pri. 110/220 volts 50/60 cycles in 2 Separate windings. Built to rigid Navy specs by Amertran. Suitable for broadcast transmitters, induction heating, etc. Continuous duty 10 x 10 x 7. s.w.t. 125 lbs. NOW only \$39.50

HIGH CURRENT TRANSF. 820 Volts CT at 775 Ma. Pri. 110/220 Volts 60 cycles. Fully Cased. \$6.95

MALLORY VIBROPACK

6.3 Volt input—output 300 Volt @ 100 ma. Complete only. Each \$8.95

MALLORY TRANSFORMER & 534C Vibrator as used in above. Both for \$5.95

UTC type PA 5000 ohm plate to 500 ohm line and 6 ohm voltage coil. 10 watts. 60 to 10,000 cps ±1 DB. GREAT VALUE. Each \$2.75

THORADSON PLATE TRANSF. 2370 volts CT at 250 MA tapped at 300-0-300 volts, plus 215 volts 55 MA bias winding. 110 volt 60 cy. pri. Fully shielded. Each \$11.95

GENERAL PURPOSE TRANSFORMERS

Ideal for Bias, Filament, Isolation, Stardown, etc. 2 isolated 110v pr. sec. 110v at 900 ma plus 6.3 @ 2 amps. Fully cased. Now \$1.49 ea.

SCOPE TRANSFORMERS

Pri 110V 60 Cy—Hermetically Sealed

2500V @ 12 Ma. 4.95
2300 @ 4 Ma. 2.5 Vits @ 2 Amps. 4.75
1050V @ 20 Ma. 20V 4.5A, 2.5V 5A. 4.75
4500V @ 4 Ma. 8.50

SELSYN MOTORS

115 volts 60 cycles. Large size, high torque. Made by Diehl and Bendix. Ideal for rotating TV beam, etc. Great value at \$6.75 per pair

PANEL METERS—BRAND NEW

2' SIMPSON 0-20 Ma DC (amp scale) \$1.49
2' WESTON 0-1 Ma DC 26 ohms res. 3.50
2' GE 0-1 Ma DC (volt scale) 2.95
2' GE 0-5 Ma DC (amp scale) 1.95
2' WESTINGHOUSE 0-10 Ma DC 2.45
2' GE 0-500 Ma DC 1.95
2' GE 0-10 Volts AC 2.50
2' GE 0-30 Volts DC 1000 ohms/v. 2.50
2' WESTON 0-250 Volts DC 2.50
2' WESTON 150-0-150 Microamps DC 3.49
2' GE 0-30 Amps DC 2.45
2' GE 0-1 Amp RF (Internal Thermo) 2.45
2' WESTON 0-1 Amps RF (Internal Thermo) 2.95
2' WESTINGHOUSE 0-2 Ma DC 3.95
3' WESTERN ELECTRIC 0-80 Ma DC 2.95
3' DEJUR 0-100 Ma DC 2.95
3' GE 0-200 Ma DC 3.95
3' WESTINGHOUSE 0-50 Amps AC 3.95
3' WESTON 0-50 Amps AC 4.95
3' TRIPLETT 0.75 Amps AC 2.95
2' WESTINGHOUSE 0-20 Ma DC 3.95
3' WESTINGHOUSE 0-150 Volts AC 4.50

2" GE 0-200 MICROAMPS

Model DW51 \$4.50 ea.

FILAMENT TRANSFORMERS

110V 60 Cy Pri. Fully Cased.
5 Volt 15 Amp. \$2.75
2.5 Volt 10 Amp. 3.49
2.5 Volt CT 21 Amp. 4.75
6.3 Volt 10 Amp. 1.89

MULTIPLE SECONDARIES

5 1/2 V CT 21A, 7.5V 6A, 7.5V 6A \$4.95
6.3V 21 Amp, 6.3V 2A, 2.5V 2A 3.95
5 Volt 4A, 6.3V, 3A 2.45
2.5V CT 20A, 2.5V CT 20A 6.95
2.5V CT 10A, 10V 3A, 5V 3A 3.95

CHOKO BARGAINS

6 Henry 50 ma 300 ohms. 3 for \$0.99
6 Henry 80 ma 220 ohms. 2 for .99
8 Henry 160 ma 140 ohms. .99
1.5 Henry 250 ma 72 ohms. .59
6 Henry 300 ma 85 ohms. 3.75
4.3 Henry 620 ma 42 ohms. 6.95
Swing. Choke 1.6/12 I Amp/100 ma 15 ohm. 19.95

ODDS AND ENDS BARGAINS

.004 4000 VDC Micacs. 9 for \$0.99
.01 600 VDC Mica Cond. 9 for .99
GE 24V DC Relay. 5 for .99
.02 400 VDC Tubular. 5 for .99
1000 MFD 25 Volt Electrolytic. 2 for .99
25 MFD 25 Volt Elect. Tubular. 6 for .99
JAN 6C4 Tubes, New, Boxed. 4 for .99
.05 600 VDC Oil Tubular. 10 for .99
10 MFM Midjet Variable Cond. 4 for .99
Heineman 5 Amp 110 VAC CKT Breaker. .99
Heineman 25 Amp 110 VAC CKT Breaker. 1.49
2 MFD 250 VAC Oil Cond. 5 for .99
Solar .02 600 VDC Dominoes. 9 for .99
Erie .0005 N7500 Ceramiconics 15 for .99
1X1.2 KV. DC Oil-Condensers. .79
H&H SPST P.B. Switch N.O. 5 for .99
1/40 Amp (25 Ma) Filament. .99

are then connected across the reference meter. Should the v.t.v.m. read high or low, the "volts calibration" potentiometer is adjusted, the prods removed, and the v.t.v.m. re-zeroed. The measurement is then repeated, continuing the process until the v.t.v.m. agrees with the reference meter. When the v.t.v.m. agrees with the reference meter at the calibration point, the voltage can be varied up and down to check the linearity which should be excellent. Higher potentials may then be measured, but the accuracy at higher voltages is merely a function of the divider and if the resistors have been chosen with care, the readings will automatically be correct once the 1.0 volt range is set. The calibration of the ohmmeter section of the meter is carried out as follows.

The "use" switch is turned to ohms, the "range" switch to x 1, then the test prods are shorted. The zero adjustment is then set for zero. When the prods are unshorted, the meter should read full-scale; if not, it will be necessary to adjust the "ohms-calibrate" potentiometer for full scale with prods open. Several interdependent adjustments will have to be made of both the "zero set" and the "ohms calibrate" until shorted prods give zero, and unshorted prods give full-scale respectively. When this condition is achieved, the ohms calibration can be made on the meter scale measuring standard resistors or carefully adjusted rheostats as standards.

As stated previously, the one ohms scale serves for all ranges of the ohmmeter from x 1 to x 1 megohms, and if the scale is carefully made, the accuracy of the higher range is dependent on the resistance multipliers alone. After initial calibration has been made, it will be necessary only to adjust the zero set potentiometer when going from voltage to resistance measurements. The zero set potentiometer will, of course, be used to set the meter at zero on the voltage ranges. On resistance ranges, the "zero set" potentiometer can be adjusted to make the meter read full-scale with the test circuit open, the zero reading with shorted test prods being automatic until the battery deteriorates.

The cathode follower v.t.v.m., because of its basic simplicity and low cost parts, is an ideal answer to the problem of those who have need for an instrument with its capabilities. 30

What's New In Radio

(Continued from page 76)

ampere d.c. ammeter, a 0-10 volt d.c. voltmeter, a self-resetting circuit breaker in the d.c. line, a switch and fuse in the a.c. line, and a six-foot a.c. cord.

The d.c. voltage is variable from 0 to 8 volts, and the unit may be safely operated continuously at 10 amperes and intermittently at 20 amperes. It has a filtered d.c. output with less than 0.9 volts ripple at 6 volt, 10 ampere output.

G-E MARKER GENERATOR

A new unit, the marker generator, Type ST-5A, for television maintenance and development work, has been developed by the Specialty Division

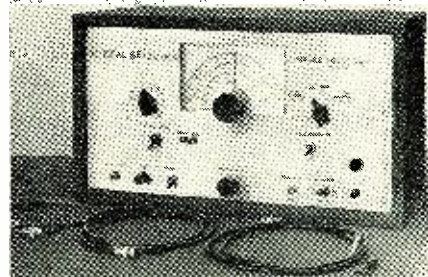

of the General Electric Co., Electronics Park, Syracuse, N. Y.

Designed for television applications where an accurate source of markers is needed, a separate crystal for each TV channel is selectable by a rotary switch, with no tuning required. Picture and audio carrier markers are available simultaneously. Only one dial setting is required for complete receiver alignment, and bandpass and trap circuits can be aligned in one operation.

HYTRON TV TUBES

Shipments of the new line of TV picture tubes made by Hytron Radio & Electronics Corp., Salem, Mass., are being made now to a broadly representative group of TV set manufacturers as well as to Hytron distributors.

Included among the TV receiving types are several tubes especially developed for the low-cost market. Among them are the recently announced 1X2, a miniature high-voltage rectifier, and the 6BQ6GT and 25B-Q6GT, horizontal deflection amplifiers.

TECK-VISION 35 MM. SLIDES

A series of 35 mm. slides on all phases of television and radio has been developed by Teck-Vision Pictures.

It's New

ADC *Yeoman* TRANSFORMER

ADC Adds a New Low-Priced Line of Quality Transformers

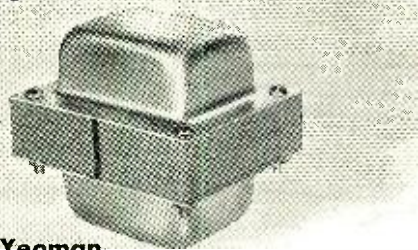

Yeoman Series



Industrial Series

Quality Plus Series



The unvarying high quality of ADC transformers has been recognized through the years. This excellent record for quality results from (1) experience and training in transformer design, (2) modern production methods, (3) the use of only quality materials, and (4) a careful system of production testing in the ADC plant.

NOW! ADC has designed the new Yeoman to bring you high transformer quality at lower prices.

Yeoman Series Incorporates:

- FEATURES OF BOTH THE FAMOUS ADC QUALITY PLUS AND INDUSTRIAL LINES.
- OPEN FRAME CONSTRUCTION, FLEXIBLE LEADS.
- TRANSFORMERS FOR SPECIFIC APPLICATIONS.

For Full Information about ADC's Yeoman, Quality Plus and Industrial transformer series, write for your new ADC catalog today.

Audio Develops the Finest



Audio DEVELOPMENT CO.

2845 13th Avenue South, Minneapolis 7, Minn.

OUTSTANDING VALUES NOW AVAILABLE

CLARK 15 WATT AMPLIFIER KIT



Another popular Clark kit. All first line parts to make an exceptionally fine unit.

- 6 tubes—2—6SQ7, 2—6V6, 1—6SN7, 1—5Y3GT.
- Mike and phono input.
- Separate treble and bass controls.
- Heavy steel chassis and cover.
- Frequency response 30-17000 CPS + 1DB.
- Output impedances 4-8-16-500.
- Hum level 65 DB below rated output. **\$18.95**

Clark 25 Watt Kit. Same features as above, plus 2 mike inputs. Tube lineup 2—6SJ7, 6SC7, 2—6L6, 5Y3. Complete, ready to assemble. **\$24.95**

SPECIAL CLOSE-OUT SALE! MOTOROLA TELEVISION SETS!

Brand new, table models. Beautiful cabinets. 7" Screen. All channels. Complete, ready to operate.....\$89.95

FM and TV Sweep Signal Generator Kit

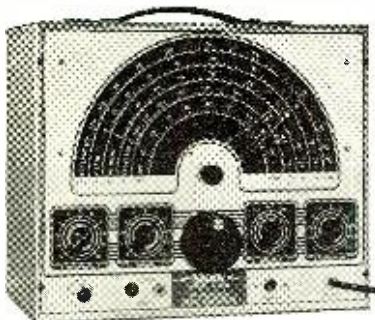

Sweep signal generator kit. Frequency range —3 bands (no bandswitching necessary) 2 to 227 megacycles.

- 2-77 MC
- 40-227 MC
- 151-227 MC
- Calibration and reference scales.
- Dial scale length 23½" total.
- Front panel controls.
- Sweep width 500 KC to approximately 10 MC.
- Phasing control.
- Tuning Vernier control 10 to 1 ratio.
- Selector switch FM—RF—CAL.
- RF output control.
- Power required 105-125 volts, 50-60 cycle, AC 35 watts.
- Power-line filter built in.
- Pilot light indicator.
- Generator output can be used either frequency modulated or pure RF.

Sweep signal generator kit comes complete with 5 tubes, cables, cabinet, circuit and pictorial diagrams, operating instructions. Shipping weight, 25 lbs. 8" x 10" x 12".

Your net cost.....\$24.50

WRITE FOR OUR LATEST CATALOG

Radio Parts Company, 614 RANDOLPH ST., CHICAGO 6, ILL.

NEW-IMPROVED

JERROLD

**The Only TV-FM
Booster With The
AMAZING NEW
BUILT-IN**

MATCH-A-TRAN



MORE TV SALES

You can now step up TV sales in a big way. The new improved Jerrold TV-FM Booster with Match-A-Tran improves reception in critical areas. Helps give sharper, clearer pictures with no loss of definition for longer distances.

THE SECRET OF LONG-DISTANCE RECEPTION

Jerrold TV-FM Booster with Match-A-Tran is the secret of good distance reception. This high gain, tuned-grid, tuned-plate RF amplifier boosts the entire TV 6 megacycle bandwidth from 20 to 30 times and provides complete coverage of FM band.

The Match-A-Tran is a variable step-impedance transformer that provides a perfect match between booster output and TV receiver—any receiver. It makes certain that the entire gain of the booster is delivered into the receiver. Match-A-Tran is an exclusive feature of the Jerrold TV-FM Booster.

See the improved Jerrold TV-FM Booster at your parts-jobber or radio wholesaler. Or, write us for further information.

\$37⁵⁰
List

JERROLD ELECTRONICS CORP.
121 N. BROAD ST. PHILA. 7, PA.

each provided with an instructional guide.

Available for immediate use are slides on waveform analysis, r.f., i.f. alignment, circuit analysis, and flow charts, line drawings, response curves, and photographs on all TV sets and parts.

MOBILE 75-METER ANTENNA

Incorporating a special base-loading coil and a graduated whip, the mobile antenna introduced by *Premax Products*, Niagara Falls, N. Y., is said to show about a six db. gain over more conventional whip types.

The design utilizes a tapering whip, approximately six feet in length, giving a total over-all length of about 88 inches, and provides a gain of great importance to the user, as it is equal to a quadrupling of transmitter power. This greatly increases the effectiveness and range of mobile operations without involving a large expense for equipment.

ALL-ALUMINUM TV ANTENNA

Admiral Corporation, 3800 W. Cortland St., Chicago 47, Ill., announces the development of a "flash-riq" hi-lo, all-aluminum TV antenna which is said to reduce the assembly time from 20 or 30 minutes to 3 minutes or less.

All of the parts are attached to the antenna, which snaps open like an umbrella, and the design enables the structure to withstand 90 mile-per-

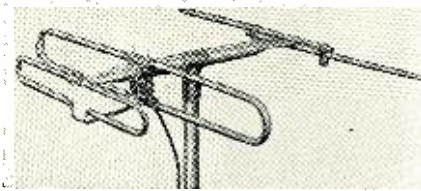

hour gales and ice-loading. The antenna is especially designed to meet any requirement of all TV areas, and there is no necessity of adding high-band adaptors, or a lightning arrestor when the antenna mast is grounded.

SHORTER TV TUBES

A distinguishing feature of the new 16" metal-glass television tube recently developed by *The Rauland Corporation*, 4245 N. Knox Avenue, Chicago 41, Ill., is the shorter length. The use of an external ion magnet is required.

Type 16EP4, which is the identifying model number of this new tube, is 2½ inches shorter than the 16AP4, another tube manufactured by this company. The innovation enables the deflection angle to be increased to 60 degrees. Quantity production of this item was started on July 1.

MICROVOLT SIGNAL GENERATOR

Covering all AM, FM, TV, and mobile frequencies, the Model 292X signal generator announced recently by *Hickok Electrical Instrument Co.*, 10524 Dupont Avenue, Cleveland 8, Ohio, measures both input and output of units under test.

Its major use, according to the manufacturer, will be in the coverage of mobile band frequencies for taxis, police departments, railways, ships, etc.

From 1 to 100,000 microvolts is the modulated and unmodulated output, and the unit may be externally mod-

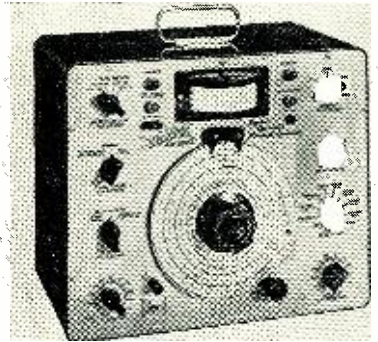

ulated from 15 to 10,000 cycles. A cast aluminum attenuator is provided for minimum signal leakage.

Weight is 29 pounds for the 14 by 16½ by 8 inch unit, enclosed in a blue lacquer finish steel cabinet.

COOL-RUNNING RELAY

Developed for use in equipment where compact size and cool operation is required, a new midjet relay has been announced by *Comar Electric Company*, 3148 N. Washtenaw Ave., Chicago 18, Ill.

It is particularly adapted for use in enclosed units and shielded control panels requiring a small size, efficient relay that must run cool at all times, even under constant duty. The over-all size is only 1½ inches high, 1⅜ inches wide, and 1⅞ inches long.

The unit is available in any combination of switches up to double-pole, double-throw. The standard contacts are of fine silver, rated up to 5 amperes. Power consumption is one to two watts. The mounting is the single-center, stud type, and the relay can be supplied for use on standard voltages up to 110 volts, a.c. or d.c.

REGENCY BOOSTERS

A new addition to the Regency line of signal boosters, Model DB-213, has been produced by *I.D.E.A., Inc.*, 4125 E. 10th St. This is a stable, high-gain,



wideband preamplifier to be used with TV receivers in low signal areas.

Two push-pull, fully neutralized 6J6 triode circuits are utilized in the design, with iron core tuning on both inputs and outputs. Either 72 ohm coax

RADIO & TELEVISION NEWS

or 300 ohm parallel-wire line may be used to connect, and under all conditions, proper impedance match and push-pull performance are maintained.

Tuning TV channels 2 through 13 in two bands, the booster provides a gain of 24 db. on the low channels and 12 db. on the high channels, with a 6 db. improvement in noise factor on all.

A companion model for the low channels (2-6) the Model DB-69 has also just been announced.

OSCILLOSCOPE MODEL 400

The new five-inch oscilloscope, Model 400, announced by *Electronic Instrument Co., Inc.*, 276 Newport St., Brooklyn 12, N. Y., features laboratory precision at a comparatively low cost. The unit is available both as a kit and a fully wired and tested oscilloscope.

Highly recommended for service technicians, schools, laboratories, and factories, the Model 400 scope has a horizontal sweep circuit of 15 to 30,000 c.p.s., and the frequency response of horizontal and vertical amplifiers is 50 c.p.s. to 50 kc. Input impedance of the unit is one megohm and 50 μ fd.

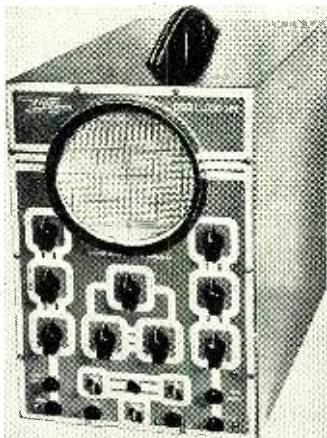

It provides for external synchronization, test voltage, and intensity modulation.

In kit form, the scope (Model 400-K) comes complete with all necessary components, tubes, and diagrams.

"MICRO-SCREEN" PRINTED CIRCUITS

Produced by a new process called "micro-screening," a new line of miniature printed circuits and components offered by the *Glass Products Co.*, 108 N. Dearborn St., Chicago 2, Ill., combines extremely fine spacings, thick conductors, and low cost.

The screening was developed by the manufacturer to improve the resolution of silk screening while retaining the advantage of the heavy deposits obtainable. Micro-screened circuits are produced only in accordance with specifications submitted by customers, and may be had in patterns of any desired size or shape. The lines may be of almost any material, metal, or insulator and can be deposited on any base and readily overlaid with other materials.

Despite its accuracy, micro-screening can produce pieces at rates com-

BEST BUYS—KITS—PARTS—ACCESSORIES LOWEST PRICES

CODE TRAINING SET AN/GSC-T1 \$24.50



We sold out of this equipment at \$49.50 a year ago and now a sharp purchase by our buyer allows us to offer this BRAND NEW Code Training Set complete with power supply, inst. book and spare parts for only \$24.50. The power supply alone is worth the price! Power supply operates from any of the following voltages: ov. dc, 12v dc, 24v dc, 115v. dc, 115v. ac, 230v. ac. Adjustable pitch audio oscillator drives either 'phones or speaker or blinker light for visual training. Set includes also 10 telegraph keys and cords. Heavily shielded and mounted in sturdy Army Trunk. Packed in original wooden boxes. Limited quantity. Subj. to prior sale. \$24.50 ea.

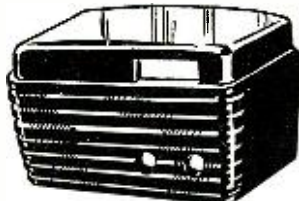

Sturdy modern styled Bakelite Cabinet. List price, \$7.50. A steal at our give-away price. Servicemen, experimenters and hams cannot lose by having one or more of these beautiful, new cabinets on hand. Accommodates 5-6 tube sets, intercomms, etc. 98c ea. or 4 for \$3.00. \$50.00 per C.

HANDSET HANGER

Accommodates all makes and models (W. E. Kellogg, American, etc.) handsets such as TS-9, 11, 13, etc. Fastens to side of desk or on telephone or radio equipment. Felt facing protects handset. Black crackle finish only. \$1.95 ea.

REAL BARGAIN!

HS-16 Headphones

with standard long cord (6 ft.) and adjustable headband. Unquestionably the best buy in surplus phones ever sold. Tested before shipping. Limited quantity. \$1.35 ea. POST-PAID IN U.S.A.

POWER SUPPLY FOR ANY 274-N RECEIVER

Here it is—at last! Just plug it into the rear of your 274-N RECEIVER... any model! Complete kit, and black metal case, with ALL parts and diagrams. Simple and easy to build in a jiffy. Delivers 24 volts plus B voltage. No wiring changes to be made. Designed especially for the 274-N receiver. All necessary parts for conversion of rest of receiver also included. ONLY \$7.95. TUNING KNOB for 274-N Receiver. 59c ea.

FL-8A FILTER

LISTEN ONLY to the Signal You WANT to Hear



Improves ANY receiver! 1020 cps Filter, connects between output of receiver and 'phones or speaker. Hear only ONE signal at a time. Cuts-out interference and background noise. AMAZING PERFORMANCE! Complete with cords, 'phone plug and extension connector. BRAND NEW, made by UTC. War Surplus item. Original cartons. \$2.95 POST-PAID.

WHIP ANTENNA. 4 Sect. Chromed brass. Extends to 23 3/4". For UHF Ant., Beams, etc. 8-32 mtg. ONLY 90c ea.

Telescopic Whip Antennas. BRAND NEW. Extends to 7' in nine sections. Complete with mtg. base. Sealed Cartons. Price \$1.75 ea.

150,000 NEW SURPLUS TUBES JUST ARRIVED! ALL BRAND NEW!

Lots of rare types previously unobtainable! VHF, UHF, SPECIAL PURPOSE TUBES OUR SPECIALTY! UHF AND VHF TRIODES

HY-114B UHF Triode. Ideal for battery port. xmtr. 2 watts output at uhf. 98c ea. or 4 for \$3.00.
708A W.E. Grounded Grid Triode. Unsurpassed for superb high signal to noise ratio at VHF. Tube mounts by bolting silver plated grid ring directly to chassis. ONLY \$1.95 ea. or 4 for \$6.00.
HY-615 UHF Triode. 4.5 w. output. 6.3 v. fil. 98c ea. or 4 for \$3.00.

388A W.E. Transmitting Door Knob. Lots of output at VHF. Carbon Anode for max. plate diss. Small physical size. A steal at \$3.95 ea. or 4 for \$13.95.
826 UHF Triode. Full ratings (86 watts output) up to 250 mc! Get real power on 2 meters with a pair of these tubes. BRAND NEW! Get yours NOW 75c ea. or 4 for \$2.40.

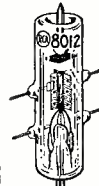

8012 VHF Triode. TANTALUM plate and Tantalum grid! 35 watts output. 40 watts Plate Dissipation. Used as osc. or amp. at full ratings up to 500 MEG! C.T. 6.3v. Filament reduces filament lead inductance. All Brand NEW! Reg. price, \$14.50. A large quantity purchase allows us to reduce the price of this tube to only \$1.50 ea. or 4 for \$5.00.

2C21/1642 Twin triode. Used in RU-16/17 Receivers. Get your spares now at ONLY 95c ea. or 4 for \$3.00.

2C22/7193 Triode. A swell tube for experimental use! Output 4 w. at UHF. Grid and Plate leads out top of envelope. 6.3 v. fil. A real buy at 4 for \$1.00.

2C34/RK34 Twin triode. Full ratings (16 w. output) to 250 mc! 6.3 v. fil. Isol. base. 75c ea. or 4 for \$2.40.

UHF PENTODES AND TETRODES

WE717A PENTODE. Hams know this tube's ability to "soup up" any receiver. Has transconductance of 4,000 and is interchangeable with 6SK7. Low loss base and ultra-short leads. Functions better at high frequencies. ALL BRAND NEW! Orig. cost \$3.75 ea. Your price 98c ea. or 4 for \$3.20.



807 Most versatile ham tube. \$1.12 ea. or 4 for \$3.95.
815 Twin Beam Tetrode. Full ratings (56 watt output) up to 125 mc! Requires only .18 watt grid driving power for full output. Brand new. Only \$2.50 ea. or 4 for \$9.20.

829 Twin Beam Tetrode. Ideal for UHF. Brand new in orig. cartons. \$2.80 ea. or 4 for \$10.80.
829B Twin Beam Tetrode. This well known tube is ideal for application at VHF. Full output (87 watts) up to 200 MEG! BRAND NEW! \$2.95 ea. or 4 for \$13.50.
832 Twin Beam Tetrode. NEW. \$2.50 ea. or 4 for \$8.80.

832A Twin Beam Tetrode. 26 watts output up to 200 MEG! BRAND NEW! ONLY \$3.95 ea.

SPECIAL PURPOSE TUBES

WL532 Transmit-Receive Tube. This is a honey! Used for electronic switching of antennas. Throw away your relay's now. Every ham should own at least one of these tubes at the low price of only \$1.25 ea. or 4 for \$4.00.

1636 VHF Converter Tube. Specially designed to operate with maximum efficiency at UHF. Low Loss throughout. ONLY \$1.95 ea. or 4 for \$6.95.

TRIODES

211 Power Triode. High power audio (260w.) from pair. \$1.00 pair.
805 Power Triode. 150w. plate diss. Full ratings to 30 mc. 215w. output RP; 370w. audio. class B. \$4.25 ea.

819 Power Triode. This tube is a real powerhouse! 375 watts output up to 30 mc! Carbon anode. Grid outside of envelope for max. h.f. efficiency. BRAND NEW! \$5.95 ea. or 4 for \$21.95.
838 Power Triode. 100w. plate diss. Full ratings to 30mc. 130w. output RP; 260w. audio Class B. \$3.50 ea.

RECTIFIERS

2X2 H.V. Rectifier 5.79 ea.
5U4 and 5Z3 Rectifiers39 ea.
C6A Heavy Duty Rectifier. Used in Teletype equip. 7.95 ea.
72 High Voltage Rectifier. 1.25 ea.
704 WE Diode 1.75 ea.

836 H.V. High Vacuum Rectifier. 1.10
872 H.V. Rect. Merc. Vapor. \$1.75 ea. or 2 for 3.25
CK-1005 Easily made into OZ4. 3 for 1.00

CATHODE RAY TUBES

3CP1 3" C.R. Tube. Green Med. Persist. Screen. \$2.95 ea.
3DP1A 3" C.R. Tube. Green Med. Persist. Screen. 14 pin base. For Oscilloscope use. Real Buy at ONLY! 2.50 ea.
3FP1 3" C.R. Tube. Green Med. Persist. Screen. 2.95 ea.

5MP1 5" C.R. Tube. Green Med. Persist. Screen. 2.50 ea.
5NP1 5" C.R. Tube. Green Med. Persist. Screen. 2.50 ea.

CONTROL AND V.R. TUBES

VR105/02 V.R. Tube \$.98 ea.
VR50/02 V.R. Tube90 ea.
991 V.R. Tube, reg. 55-60v.39 ea.
884 Gas Triode 1.25 ea.
2050 Gas Triode33 ea.

TUBE KITS

BC659 Tube Kit. Consists of 14 tubes for famous BC659 portable set. ALL BRAND NEW AND FOR ONLY \$6.50.
Command Receiver Tube Kit. 6 brand new tubes as used in the Command Receivers. All for only \$2.85.
Command Transmitter Tube Kit. 4 brand new tubes as used in the Command Xmt's. All for \$4.85.
RU-16/17 Tube Kit. Contains 6 tubes all brand new and for only \$2.85.
GF 11-12 Tube Kit. Contains 4 tubes. 2-89's and 2-837's. All for ONLY \$2.85.

Here's YOUR CHANCE TO GET the special 20-4 Ampere Regulator tube for the PE-120 Pwr. Supply (for BC659) ONLY 49c ea. Quant. prices on request.
6L6G Nat'l Adv. Brand. NEW. Don't miss these at 79c ea. or 4 for \$3.00.

★ 4-HOUR MAIL-ORDER SERVICE. WE SHIP ANYWHERE.

20% DEPOSIT MUST ACCOMPANY ALL ORDERS, BALANCE C.O.D.

OFFENBACH & REIMUS CO.

372 ELLIS ST. SAN FRANCISCO, CALIF.

'PHONE—ORdway 3-8551



**WE DOOD IT AGAIN!
CUT PRICES LIKE MAD!**

**APN-4 RECEIVER & SCOPE
POWER SUPPLY**

4-switch selected, screw-driver tuned R.F. channels; I.F. freq. 1050 kcs.; band width 45-60 kcs.; R.F. freq. 16-2,000 kcs. Tubes: 2-2Y2, 3-6B4, 4-6SK7, one each of 5U4, 6SU7, 6SA7, 6H6, VR150. Makes fixed tuner for med. freq. police calls or P.A. system. Has electronic controlled B-plus supply; delivers 260 VDC at 150 mills regulated to .01%. Excellent condition.
Complete. Only **\$5.95**

FAMOUS "ARB" RECEIVER

195 to 9,050 Kcs. Controlled by a 4-band selector switch. Features include 6 tubes, 3 micro-volt sensitivity MVC or AVC CW or MCW-sharp or broad tuning for extra sensitivity. 28V dynamotor. Used but in excellent condition. **Special! \$19.95**

"ARB" DUAL CONTROL BOX

Brand new!.....Ea. **\$2.49**

TBY VIBRATOR POWER SUPPLY

4 volt input. 156 volts for plate 3 volts, 1.5 volt, -7½ volts. With polarity switching relay. Has adapter for charging from 6 V. supply. It's terrific for portable battery sets, mobile units and small transmitters. Excellent condition. A \$20.00 value for only **\$8.95**

2 V. WILLARD WET CELL BATTERIES

Excellent for use with TBY Vibrator Power Supply (above). Brand new, individually boxed. Ea. **\$1.49**
Order 2 for only **\$2.75**

ASB-6 TRANSMITTER

500 mcs. xmtr. can be converted for use on citizens' and amateurs' 420 band. 15 watts using pr. of 15-E tubes in push-pull. Has self-excited oscillator.
Complete in near new condition. **\$3.95**

TUBES!!! TUBES!!!

ALL BRAND NEW IN ORIGINAL BOXES!

RX21 MERCURY VAPOR, half-wave rectifier. 11,000 V. peak inverse at 3 amps. Constant output at 1.5 amps. Mounts in standard 5-pin socket. **\$ 1.95**
5BP1..... **1.50**
5BP4..... **1.95**
5CP1..... **1.50**
12DP7 New Low Price!..... **10.95**
211..... **.29**
304TL Special!..... **.75**
316-A (Doorknob tube)..... **.39**
371-A or 371-B..... **.99**
1616..... **.69**
8012..... **.99**

PORTABLE BC-659 TRANSCEIVER

27 to 38.9 Mcs. Crystal controlled, battery operated, power supply 6, 12, or 24 V. Complete (less power supply) with all tubes, 2 crystals, hand sets and antenna.
Used but excel. cond. **\$17.50**

SUPER SPECIAL !!!!!

NEVER BEFORE SO MUCH FOR SO LITTLE!

Approx. 16 (sixteen!) lbs. of radio parts. EACH PACKAGE CONTAINS: transmitter, pots, condenser, crystal, knobs, switches, transformer, choke, insulators, PLUS brand new 10-ft. 3-cond. rubber covered cord. Absolutely no junk, no hardware. All good, useful parts. A \$14.50 value. All of them—yes,
ALL for only **\$3.50**

Send for **FREE CATALOGUE** put out by one of the **GIANT SURPLUS ELECTRONICS** companies in the country. Write today to

COLUMBIA ELECTRONICS SALES

522 South San Pedro Street
LOS ANGELES 13, CALIFORNIA

parable with conventional silk screen printing, and the per-piece price can be kept low even in moderate quantities.

TURNER MICROPHONE

A new model has been added to the line of microphones handled by *The Turner Company*, Cedar Rapids, Iowa, designed for all sound installations

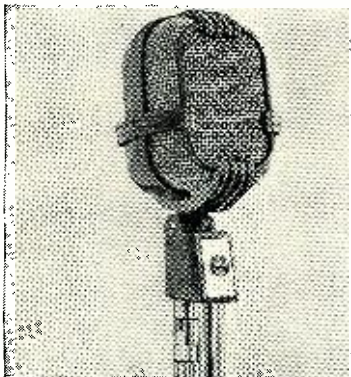

and possessing a smooth, wide-range frequency response and high output level.

This unit, the Model 25D Dynamic,

features Alnico V magnets, an output level of 54 db. below one volt/dyne/sq. cm. at high impedance, and flat response from 50-10,000 cycles.

Another microphone recently added to the company's line is the Model 25X. This is a crystal type, having an effective output of 52 db. below one volt/dyne/sq. cm. This new model has a flat frequency response of from 50 to 9000 cycles.

PORTABLE TVI LOCATOR

The Instrument Division of the *Tobe Deutschmann Corporation*, located at Norwood, Massachusetts, has devised a practical tool for identifying sources of TVI and radio noise. It is also capable of checking any electrical devices which are suspected of causing interference.

Providing four-band coverage, short-wave and broadcast, from 20 kc. to 18 mc., with spot checks at 50 and 150 mc., the instrument measures interference intensity on a dual-scale meter, marked off in graduations of 0 to 100 and in decibels.

To be known as the *Tobe* Model 24 Radio Noise and TVI Locator, the device is portable and self-contained in

AUTOMATIC RELAY OF V.H.F.

At a recent press gathering, the *Chicago, South Shore, and South Bend Railroad*, under the direction of its vice-president and general manager, Charles H. Jones, demonstrated its v.h.f. system, wide-range communications network.

Running from Chicago to South Bend, a distance of 90 miles, the line is completely equipped with the main transmitter located at approximately the center of the run, Michigan City. Besides the main transmitter, there are two unattended relay towers, one at East Chicago, and the other near Carlisle, Ind. Two separate frequencies, 158.43 mc. and 161.37 mc., are used to provide dual-channel operation.

All communications are handled through the relay stations or direct through the main station at Michigan City. Two complete sets of transmitters and receivers are installed at the main transmitter, making it possible for the dispatcher to contact through the relay system, or direct, any remote mobile unit or any of the freight or passenger trains on the line.

With the exception of the remote mobile units, all equipment, including relay towers and main transmitter, was installed by *Bendix Radio*, Division of *Bendix Aviation Corp. Motorola, Inc.*, equipment is used in all mobile units, such as repair trucks, supervisory cars, etc. -30-

This Chicago, South Shore, and South Bend Railroad is completely radio equipped. Communications from any train, repair truck, or supervisory car can be held from one end of the line through relay towers to units at the other end.

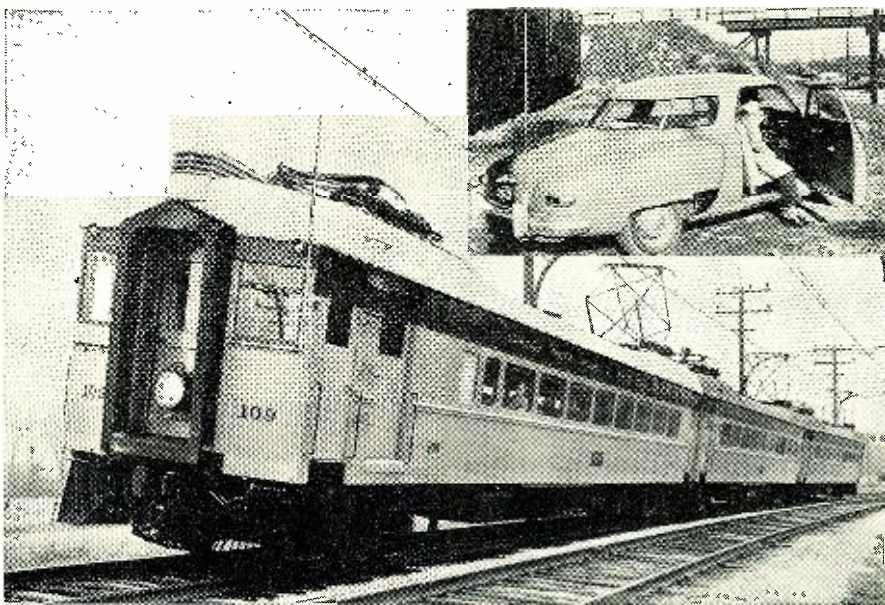

a steel case measuring 11½ X 9½ X 6¾ inches. It is provided with a hinged cover and a strong web carrying strap. With all components, it weighs only 17 pounds. The 39-inch antenna is collapsible, folding to 10½ inches inside the case when not in use.

-50-

International Short-Wave

(Continued from page 51)

nal strength' on the following scale: 0—inaudible; 1—very weak; 2—weak; 3—fairly strong; 4—strong; 5—very strong. The 'magic eye' or other tuning indicator on many receivers gives a useful guide to the strength of signal.

"The second figure indicates the 'strength of interference' (caused by unwanted stations): 0—none; 1—very weak; 2—weak; 3—fairly strong; 4—strong; 5—very strong.

"The third figure indicates the overall value or merit of reception, which depends on the strength of BBC transmissions and degree of interference present: 0—nil, completely unintelligible; 1—very poor, only a few words intelligible; 2—poor, but mainly intelligible; 3—fair, completely intelligible although complete attention necessary; 4—good, completely intelligible and easy to follow; 5—very good, comparable with normal medium-wave reception (a relatively rare experience). Reports should be addressed to the Chief Engineer, BBC, London, W. 1, England."

Example of the way this code works is—505 would be "perfect" reception.

Worris comments: "I like this system because it's the only good replacement to the inadequate 'RST' system borrowed from the hams."

Club Notes

Belgium—QRA of the International SWL Bureau is P.O. Box 38, Bruges, Belgium; this club promotes SWL "card-swapping" as a "means of world friendship."

New Zealand—Donald Trelford is now North American representative for the New Zealand Radio DX League and may be addressed either % Dept. Lands & Forests, Espanola, Ontario, or 41 St. Leonards Cres., Toronto, Ontario, Canada.

U.S.A.—Bill Camp of Short-Wave Listeners' Registry and the International Hobby Registry is compiling a list of SWL's and other hobbyists who are interested in corresponding with hobbyists in other countries; will welcome members from any country in the world; QRA is 1042 Water St., Moosic 7, Pennsylvania, U.S.A.

Last Minute Tips

Beginning in September of this year, *World Radio Handbook* will be issued only once a year. U.S. representative is Ben E. Wilbur, 32 Whittlesey Avenue, East Orange, New Jersey.

Bluman, North Africa, reports to *Radio Australia* that Dhahran, 6.725, Arabia, has been heard calling Cairo,

Egypt, at 2230; two-phone contact followed.

Desouza, Singapore, says the North Shensi (Communist-controlled) Chinese stations on 6.096, 7.500, 9.040, 10.260 have added a new daily transmission 0115-0200. (*Radio Australia*) The Communist-controlled outlets announce that Shanghai is on 11.78 and 900 kcs.; say that the International Radio Station in Shanghai had been destroyed by the Nationalists, but that communications have now been reopened; North Shensi again heard on 7.500, very poor, however; carries *English* 0830 as do the other Communist-controlled outlets. The Communist outlet on 9.76 is no longer being heard. When last heard, the Nationalist-operated outlet at Canton (9.685, approximately) left the air around 0900 with the Chinese National Anthem. (Dilg, Calif.)

"Hanoi, Nambong," 8.640, Fr. Indo-China, heard daily *except* Sundays 0800-0830 with programs in Vietnamese; Sundays at 0800-0845, last 15 minutes being in French; identification in Vietnamese is "Hanoi, Nambong," and in French is "Nambong Radiodiffusion"; identifies every 15 minutes; reception poor in Singapore. "Vietnam," 12.00, heard daily from around 1915-2030 and again 0730-0800; programs in French and Vietnamese. (Desouza, Singapore, via *Radio Australia*)

When the woman announcer signs off the *English* period from the Communist-controlled Chinese outlets, she gives a number of frequencies but never mentions the old Nanking channels of 9.73 and 5.980; however, both 5.980 and 9.730 have been good signals on West Coast lately, while most of the other Communist outlets have been covered for the most part by QRM. (Dilg, Calif.)

Harbin, 7.098, Manchuria, is badly "smeared" but does carry *English* at 0830; readability poor and could not tell if this *English* was same as that carried by the Peiping Network (Communist-controlled). (Dilg, Calif.)

According to prepared verie-card, former PRI-3, 5.995, Brazil, is now PRK-5, 5 kw., using Marconi wireless transmitter with omni-directional antenna; latter explains to a great extent the poor signals, whenever the station can be heard at all. Medium-wave outlet is PRI-3 with 22 kw. Broadcasting hours are 0500-2200. This one is officially listed 5.998, location is Belo Horizonte, Brazil. OAX4V, 5.920, Lima, Peru, in verifying, stated other outlets are OAX4W on 9.360 and m.w. OAX4U on 1.010 kcs. QRA is CIA. *Peruana de Radiodiffusion, S.A., "Radio America, La Voz del Nuevo Mundo,"* Casilla 1192, Lima, Peru.

The Broadcaster, Perth, Western Australia, reports Shiras, Iran, heard in Australia at good strength between 1330-1400 and also during several shorter, irregular transmissions; frequency given 7.960; identifies with bugle call and time pips, followed by station announcement.

Radio Pakistan, 15.27, Dacca, now

FOUND!

the "MISSING LINK" to GOOD TV ANTENNA INSTALLATIONS

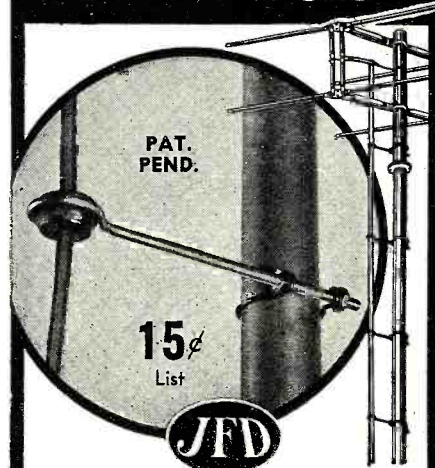

MAST CLAMP LEAD-IN SUPPORTS

Made with POLYETHYLENE

(the ultra-low loss insulation material)

Now you can make any old or new TV installation last longer, look neater, perform better with the unique JFD Mast-Clamp Lead-In Supports. These new Screw Eye Insulators are JFD-engineered to anchor lead-ins firmly in place and assure better TV/FM reception.



TL100-350
1" Clamp with 3/2" Screw Eye for Twin Lead.

15¢ List



RG100-350
1" Clamp with 3/2" Screw Eye for Coaxial Cable.

15¢ List



DTL100-350
1" Clamp with 3/2" Screw Eye for two Twin Leads.

35¢ List



DBR18TL3
3/2" Screw Eye with wood-screw thread, for two Twin Leads.

28¢ List

Mast Clamps are made in all sizes for all applications, individually designed to fit masts from 1/2" to 2" O.D. Screw Eyes range from 3/2" to 12" in length.

JFD MANUFACTURING CO. Inc.

6111 16th Ave. Brooklyn 4, N. Y.

WRITE TODAY for Valuable 4-page Bulletin #DBR

© Copyright 1949 by JFD Mfg. Co. Inc.

FIRST In Television Antennas and Accessories

All rights reserved. No part of above work may be reproduced in any form except by written permission of the manufacturer.

* **A Quality Pair—
Matched for Fine
Reproduction &
Reasonably Priced**

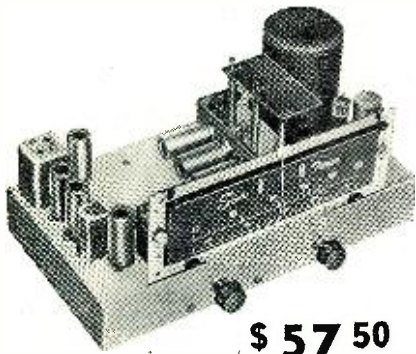

\$ 57 50

* **Sun FM Tuner
with Automatic
Frequency Control**

Just out—this highly compact, newly designed FM Tuner at only **\$57.50** boasts such high quality features as temperature compensation to prevent drift, AFC, 10 miniature tubes including three IF stages, two cascade limiters, Foster-Seely discriminator. 2 microvolt sensitivity guaranteed. IF band width 200 KC at 6DB down. Complete, ready to use, not a kit.

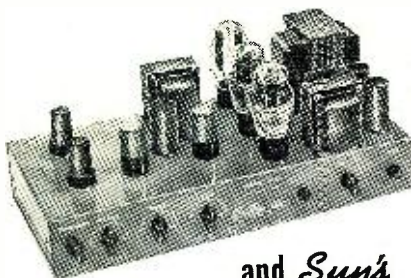

and **Sun's**

* **Great All-Triode
Amplifier Kit \$ 42 50**

From design published by Consumer's Research, Inc., Washington, N. J. A 10 Watt High-Fidelity, 7 Tube Audio Amplifier Kit. Flat frequency response from 20 to 15,000 cycles (± 1 DB). Distortion less than 2.5%. Gain: radio-75DB, phono-97DB. Complete with punched chassis, hardware, wire, all components, clear instructions and diagrams, **\$42.50**.

Laboratory wired and tested, ready to use, **\$69.50**.

Write us now and reserve your free copy of Sun Radio's new booklet, now on the presses, giving the complete story on high-fidelity reproduction and components.

ORDER BY MAIL!

Send full amount with order or 25% on COD's.

SUN RADIO
AND ELECTRONICS COMPANY, INC.
122-124 DUANE STREET
New York 7, N. Y. Barclay 7-1840
2 BLOCKS NORTH OF CHAMBERS ST.

has news 2100-2115, 0110-0120, 0700-0710, 0945-1000. (Sampat, India)

V LX2, 6.130, Perth, Western Australia, noted in California from 0800 to fade-out 0915. (Rosenauer)

SRI, Buenos Aires, Argentina, announces *English* schedule for LRS, 11.88, as 1730-2030; news 1730, 1830, 1930, 2025; the Portuguese period runs 2030-2230. (Worris. N.Y.)

From listening, Paris schedules, in part, appear 1830-1835 in Spanish to Latin America on 9.55; 1845-1900 in *English* to North America on 9.55, 11.70; 1900-2030 in French to Antilles, Guienne, and St. Pierre and Miquelon on 9.56 (relayed by Fort-de-France, Martinique); 1915-1930 in French to Latin America on 9.55; there is slight interference between the two French transmissions 1915-1930. (Worris)

OIX4, 15.19, Helsinki, Finland, is completely inaudible in New York under CKCX at 1925-1935 when is scheduled to carry *English* for North America; however, this outlet comes in well during the Finnish periods 1145-1245, 1600-1700, 2200-0000, and also is good level during the *English* news transmission for North America 0715-0725. At 2200 begins Finnish transmission with *English* announcement, "This is Finland Calling. This is Finland Calling!" But uses no more *English* during the transmission. (Worris, N.Y.)

Readers who have inquired about the ownership and locations of certain "Voice of America" transmitters in the United States will be interested in this data secured by Worris, N.Y.—KNBI and KNBX in Dixon, Calif., are owned by the State Department; KNBA and KNBI (50 kw.) have a common audio system and must carry the same programs although they can operate on different channels with their separate radio frequency systems. KNBX (200 kw.) operates independently. The *National Broadcasting Company* owns WNRA, WNRL, WNRX, and the State Department owns WNRE, WRCA, and WNBI, all at Bound Brook, New Jersey; these six stations are completely independent of each other; they all operate with 50 kw. The *Columbia Broadcasting System* reveals that East Coast transmitters WOOC and WOOW are located at Wayne (near Paterson), New Jersey, while the others—WCBN, WCBX, WCRC, WCDA—are at Brentwood, Long Island, N.Y.

SDB-2, 10.78, has good signal signing on 1900 with chimes and church bells; runs to 2030; DX session on Saturdays 2015. (Bellington, N.Y.) The other Stockholm outlet in parallel, SBT, 15.155, usually is inaudible in this transmission.

Munich, 15.28, Germany, relays *English* programs 1100-1130 and Persian 1130-1200; at other times—1015-1045, 1230-1700, this relay station operates on 11.87. (Worris, N.Y.) The station on 15.28 is now DTSP, used by Vienna at 0845-0915 and by Munich 0945-1000 for contacts with "Voice of America" in New York; this schedule is *weekdays only*. (Fried, Mich.)

KRHO, Honolulu, Hawaii, relay of the "Voice of America," is now on 15.25; KRHK (100 kw.) operates on 17.800. Manila II operates on 15.33 and Manila III, on 11.89. (Worris, N.Y.)

A Brazilian around 15.27 or 15.28 at 1800 announces as "*Radio Nacional*," Rio de Janeiro. (Esquivel, Fla.) PRL-9, 17.850, Rio de Janeiro, heard when tuned 1820; at 1830 announced "*Radio Nacional*" and continued with music. (Ferguson, N.C.)

The "Voice of America" soon will add Arabic and Turkish to its language broadcasts. (Worris, N.Y.)

OZF, 9.52, Copenhagen, Denmark, now has a new feature program called "Our Guest Book," Tuesdays around 2300. (Worris, N.Y.) The daily North American transmission appears now to be only one session on this channel—2200-2330.

A Montevideo, Uruguay, outlet noted on approximately 6.145, very noisy, at 1700; seemed to carry same program as CXA19, 11.835. (Esquivel, Fla.)

Radio Moscow has eliminated several (inaudible) frequencies in the transmissions to North America; current line-up is 1820-1930, 11.88, 11.96, 15.23, 15.31, 15.39; 2030-2215, same, plus 15.41; 11.88 best in New York. (Worris) The 11.63 outlet now has numerous *English* sessions afternoons. (Bellington, N.Y.)

Radio Nacional, PRL-8, 11.72, Rio de Janeiro, definitely now has weekly feature to answer correspondence; is Tuesdays during the (Monday through Friday) 2130-2145 beam to U.S. This transmission is in *English*, of course. (Worris, N.Y.)

"*Emissora Nacional*," 15.16, Lisbon, heard from tuning 1700 to closedown 1800. (Esquivel, Fla.)

According to a Reuters dispatch from Nicosia, Cyprus, the U.S. Government has obtained permission from the Cyprus Government to build a new Department of State radio on the island. *Will this be s.u.?*

A QSL card received from ZQI, 3.48, Kingston, took 100 days; power input given 1.2 kw.; schedule on 4.95 is 1600-1730, on 3.48 is 1930-2200. (Smith, Ala.)

The General Director of the Syrian Posts, Telegraphs & Telephones Dept., Damascus, Syria, verified by letter for report on the 12,000 channel; power given as "temporarily 500 watts"; said, "We transmit Arabic, *English*, and French programs on 6,000, 7,500, and 12,000 at 0000-0100 (Arabic); 0645-0730 (Arabic); 0730-0830 (*English* and French), and 1100-1545 (Arabic)." (Bellington, N.Y.)

The Cuban station heard in Spanish on 9.535 is COCO, Havana, evidently moved from 8.700; uses slogan "*El Periodico del Aire*" which may be a change since is listed on 8.700 as "*Radio America*"; also gives calls CMCK, Havana, and CMHO, Santa Clara (probably m.w.); noted mornings and evenings by Stark, Texas. Is "plenty loud" here in West Virginia now.

Stark says the approximately 11.802 "Radio Cadena," Havana, is giving s.w. call of COBH and m.w. call of CMCH.

Leipzig, 9.728, Germany, opens 2200 *except* Saturdays (it's Sundays) when sign-on seems to be 2300. (Stark, Texas)

WFN, 8.84, Louisville, Kentucky, USA, verified for Bellington, N.Y.; said his was third report received and the most distant; said station is thinking of printing verie cards and wants more reports; also said will use 1 kw. in near future.

From Peddle, Newfoundland, comes word that in verifying, "Emissora Regional," Azores, gave call for both 4.845 and 11.090 as CS9MB, no mention of CSX2; stated summer frequency 7.015 would be put into use soon. Peddle says Sofia, 7.671, Bulgaria, has nice signal 1515-1530 news period; that Dakar's 11.898 channel has improved signal lately, heard 1330-1700; reports transmission from Reykjavik, Iceland, 12.175, at 1115-1145 on Sundays only is only readable irregularly because of heavy CWQRM; that PLF-2, 19.345, Batavia, Indonesia, has French 1230-1300, unusually good signal; that *Radio Luxembourg's* 15.35 outlet is still heard in French daily 0630-0715; and that *Radio Nacional de Espana*, Madrid, is heard daily on 15.610 at 1130-1200 in Spanish.

Desouza, Singapore, is hearing a station on 8.550 in Indian languages around 0930-1000; may be *Radio Jodhpur*, India, moved there for summer. (*Radio Australia.*) Sampat, India, indicated to me some time ago that this move was to be effected.

Here are some F.B. tips received airmail from Pearce, England:

Radio Monte Carlo, Monaco, has definitely been using 6.035, 7.350, and 9.785 at various times; the 7.350 channel not heard for some days when this was compiled. For a while was heard signing on with march 0100 on 7.350 in parallel 9.785; a second period on 7.350 was heard in parallel 9.785 at 0600-0800 and sometimes also on "Sun-

(Continued on page 113)

For The Best in Tape Recorders Look For The TWIN-TRAX® Label



TWIN-TRAX
4-HOUR PLAY



TWIN-TRAX
STANDARD



TWIN-TRAX
PORTABLE

This label identifies the original and only TWIN-TRAX Recorder, manufactured exclusively by Amplifier Corp. of America. It is your assurance that the recorder bearing this label has the professional specifications that have made TWIN-TRAX the "choice of engineers everywhere."

TWIN-TRAX was the first commercially available two-channel tape recorder. Imitators have announced two-channel recorders with similar names and similar external appearances. But it's the performance that counts, not the appearance. And the performance of TWIN-TRAX recorders cannot be duplicated. Our leadership in the tape recording field has been undisputed since we designed the first magnetic recording amplifier in 1936.

Remember, imitative Twin-Track or Two-Track does not mean TWIN-TRAX, because TWIN-TRAX is the registered trade mark of the best in tape recorders, made exclusively by Amplifier Corp. of America. Send today for literature on the exclusive TWIN-TRAX line, and discover why TWIN-TRAX is the recorder engineers are buying.

*Registered Trade Mark.

AMPLIFIER CORP. OF AMERICA

398-2 Broadway

New York 13, N. Y.

PHOTOCON SALES

1060-2 N. ALLEN AVE.

SYCAMORE 4-7156
PASADENA 7, CALIF.

AUGUST SPECIALS—PRICES SLASHED

IN THIS GIANT CLEARANCE SALE OF OUR ELECTRONIC SURPLUS . . . PLEASE WRITE FOR OUR COMPLETE CATALOG . . .

TEST EQUIPMENT

Standard Signal Generator—Model 84, Measurements Corp., 300 to 1000 megacycles, Excellent Condition with Instruction Book	\$750.00
I-193A Test Set for adjusting polarized relays, Western Electric, NEW	125.00
I-200 Calibrator, 115V, 60 cycles, 345 and 621 cps, Western Electric, NEW	39.50
Supreme Model 563—Audio Oscillator	19.50
Test Set, Type 89	19.50
Megger—500V—1000 megohms, Model 1000B, made by Interstate Mfg. Used, NEW	49.50
Model 105S Microwave Signal Generator 375-725 M.C.	79.50
I-222 Signal Generator 150-230 M.C.—8-15 M.C. Used GOOD	39.50
Thermister Bridge, Western Electric	49.50
I-139A Test Set for SCR-522	29.50
TS-34/AP Portable Oscilloscope in case, complete in like new condition with manual, made by Western Electric	150.00
BC-221 Frequency Meter, LIKE NEW, cal. book	69.50
LM-14 Frequency Meter, Excellent Condition, cal. book	69.50
Synchroscope, Designed by Radiation Lab., mfd. by Galvin, Excellent Condition	79.50

SCR-522 EQUIPMENT

SCR-522 Transmitter-Receiver, Good used with tubes	\$ 34.50
SCR-522 Transmitter-Receiver, NEW with tubes	49.50
PLUGS—Set for SCR-522, NEW	3.75
PE-94C-24 volt Dynamotor, NEW	4.50
USED	2.50
PE-98-12 volt Dynamotor, NEW	19.50
BC-602 Control Box, NEW95
BC-631 Jack Box, NEW79
AN-104A Antenna, NEW, Steel	1.95
Copper	2.95
L-139A Test Set for SCR-522	5.00
Radio Set SCR-624C (SCR-522 complete new ground station, packed in six boxes, operates from 110V. AC)	395.00

I-82 Selsyn compass indicator 5" 360 degree dial	\$2.45
Plug to fit either I-82 or I-8165
I-81 Selsyn compass indicator, NEW	3.25

HS-23 HEADSET—BRAND NEW 8,000 ohm with ear pads	\$2.45
HS-33 HEADSET—with ear pads	1.29
HS-30 HEADSET—Complete with matching transformer, 6' cord & PL-55 Plug, NEW	1.95
HS-30 HEADSET, NEW95
DYNAMIC HEADSET AND MIKE—P. O. Mark 11, NEW	1.95
P-16 HEADSET, NEW	1.50
HEADSET EXTENSION CORD—CD-307A with PL-65 and JK-2649
Headset Adapter MC-385D—High to low impedance, NEW35
T-17 Hand Mike, NEW	1.50
T-32 Desk Mike, NEW	3.00
USED	1.95

R-18/ARC-1 TRANSMITTER-RECEIVER in excellent condition, Exceptionally clean, tubes and crystals	\$695.00
T-47A/ART-13 TRANSMITTER with instruction manual, less operating manual, NEW	295.00
Navy Type ART-13—A.T.C. Col. 522 286 with low frequency band, operating manual, very clean	250.00
Keying Relay for ART-13, NEW	5.00
Crystal Unit for ART-13, NEW	14.50
Speech Amplifier for ART-13, NEW	14.50
Modulation Transformer for ART-13	4.50

CD-501 Cable for PE-103-BC654, NEW	\$1.95
RM-29 Remote control unit, ringer, NEW	7.95
SPEAKER—6" P.M. Compartment, 25 watts, 50-6,000 ohms, waterproof, excellent used	8.95

Weston Electrical TACHOMETER METER, Model 545 for use with Model 724 magnet, Speed 0-2,000 R.P.M. Ratio 2:1, BRAND NEW	\$17.50
Weston TACHOMETER GENERATOR, Model 724, Type C, Good Used	16.75

I.F. Transformer—1st, 2nd, or 3rd, from SCR-522, 12,000 K.C. Iron core tuning, can be tuned to television I.F. frequency by removing padder cond. 35c each, 3 for APN-1 ALTIMETER, NEW—COMPLETE	\$1.00
APN-1 Altimeter Indicator—Basic movement 0-1 ma.—5 ma. shunt, 270° dial. An excellent basic movement for selecting your own meters, NEW	1.95
Meter Rectifier, full wave midget Selenium, 10 volts, 30 ma. NEW29

BC-348 Mounting Base, Postpaid	\$2.50
BC-348 Outlet plug, Postpaid80
BC-348 Mounting Base and Outlet Plug, Postpaid	3.00

BC-357J—Beacon Receiver, 75 mc tubes, NEW	\$ 3.45
MN-26C—Bendix Radio Compass 150-1,500 K.C. tubes	17.50
BC-464—TARGET RECEIVER—5 channel remote, battery case, antenna, 68-73 MC, NEW	14.95
INTERPHONE AMPLIFIER—BC-709 Ideal for aircraft, booster for telephone system, etc., NEW	4.50

IDEAL MOBILE POWER SUPPLY

PE-237 Heavy duty vibrator power supply, 6, 12, or 24V. input, 525V., 95 ma.; 105V., 42 ma.; 6.5V., 2 amp; 500 ma.; 1.3V., 450 ma.; small supply 100V., 17 ma.; 1.35-450 ma. with tubes, shock mounted	BRAND NEW \$27.50
INTERPHONE AMPLIFIER—CMX50128A, 12V. 6 watts P.O. T.C.S. equipment—tubes and dynamotor	NEW 58.50
FL-8 Range Filter	NEW 1.50
ANTENNA RELAY UNIT—RE-2/ARC-5, NEW Ant. Current Indicator Meter, Relay, Vacuum Condenser, Excellent Condition	2.95
HANDY-TALKIE Crystal and Coil Sets—3885 K.C. 4,500 K.C. Specify frequency—2 crystals and 2 coils per set	NEW 2.25

400 Cycle INVERTER—G.E. 5D21NH3A Input 27V., 35 amps, Output 115V.-485 V.A. single phase	NEW \$12.50
400 Cycle Inverter—G.E. PE-218 Input 27V., 100 amps, Output 115V., 1,500 V.A. single phase	NEW 29.50
800 Cycle Inverter—PE-206	NEW 5.95
800 Cycle Blower and Motor—1 ph.—6,700 R.P.M.—120V. CAT-2173	1.50
24 V.D.C. Blower and Motor—4700 R.P.M.—1.35 amps—A. G. Redmond Co.	1.95

SOUND POWERED HEAD & CHEST SET, made by Automatic Electric Co.	EACH—NEW \$ 9.95
REACTOR—5 Henries 284 ohms—05 amp Westinghouse Type L	PAIR—NEW .59
SELENIUM RECTIFIER—24 V. @ 350 ma. I.T. & T. 4B3CMI	USED 1.95

TERMS: PRICES f.o.b. PASADENA, unless postpaid. 25% on all C.O.D. orders. Californians add 2½% sales tax.

SAVE \$ ON RADIO SURPLUS

TRANSMITTING FILTER CHOKES
63 Henries, .018 Amp., 930 Ohms.....95c

CONDENSERS

CCA 2 MFD. 1000V (4 3/4" x 3 1/2" x 3 1/2").....\$1.75
CCA 8 MFD. 1000V (7" x 4 1/2" x 3 1/2").....2.25
DUB 1 MFD. 3000V (5" x 7 3/4" x 3 1/2").....2.50
PARADON .125 MFD., 1500V., 2 Amps. @ 39.....1.00
K.C. (5 7/8" x 3 1/2" x 4").....1.00

.00005 MFD. 2500 W. V. D.C. Trans. Mica......35c
MIDGET CABINET—8 1/2" L x 5 7/8" H x 4 1/2" D.
Asst. Colors. Holes for Vol. Control & Var.
Cond. Center Speaker.....69c

Signal Corps Phones—2 M. Ohms (8M Imp.).....\$1.25
2 Ft. Extension Cord (Female Plug).....40c

OIL FILLED FILTER CONDENSERS

1.—MFD—2000V.....95c ea.
1.—MFD—1000 working volts. 4 for.....\$1.00

FAMOUS BRAND RECORD CUTTING HEAD
Size 1 3/8" x 2 7/8" ready to fit your cutting arm or
Bracket. SPECIAL.....\$2.95

TOBE TUBULAR ELECTROLYTICS

20-20 MFD. 150 V.....29c 40-40-20 MFD.....38c
40-40 MFD. 150 V.....37c 150 V.....38c
30-30 MFD. 150 V.....32c

2 1/2" M.H. R.F. CHOKE COIL—27c ea. 5 for \$1.00
3 BAND OVAL DIAL—7 1/2" L x 5 1/2" H.....79c
100 RESISTOR ASST. 1/4-1/2-1 WATT.....95c

Low-Loss Short Wave Variable Condensers 1/4" Shaft Type	3 GANG T.R.F. VARIABLE COND. D.P.D.T. S.E.R.S. .000365 Cap.
5 Plate—20 MMFD.....20c	SLIDE SWITCH.....23c
14 Plate—5-60 MMFD.....27c	TOGGLE SWITCH.....23c
Lock Type Air Trimmer Variable Condensers	2 piece 5-pole Male and Female
3 Plate—12.5 MMFD.....10c	Separable plug.
5 Plate—20 MMFD.....11c	Both with Flex. Cord. A steel at 27
8 Plate—30-35 MMFD.....13c	only. 35c per pr.
10 Plate—40 MMFD.....14c	
14 Plate—56 MMFD.....24c	
20 Plate—80-100 MMFD.....25c	
27 Plate—100-110 MMFD.....35c	

4 PR. WAFER SOCKETS—\$1.49 per C. each.....3c
PHILO 4 MF—300 V—1 3/8" CAN CONDENSER—\$8.00
per C.....29c
W-1-10 W. 1,000 ohm Power Rheostat.....29c
5-6 PRONG WAFER SOCKETS.....\$2.50 per C
100 ASST. SOCKETS—4-5-6-7.....\$1.50 per C
1,000 OHM WIRE WOUND POTENT.....15c
30 HV-FILTER CHOKE SHIELDED.....49c
UNSHIELDED.....39c
100 ERIE—1 WATT—2,000 OHM RESIS.....\$1.15
10 WIRE WOUND RES. KIT—5-50 W. ASST.....49c
2,000 ohm Wire Wound Rheostat.....\$1 per doz.
CARTER WIRE WOUND C.T. VARIABLE 20 OHM
RESISTORS.....\$1.00 per doz.
G. E. TAP-UP VOLTAGE DIVIDER—200 WATT—
230 OHM—MOUNTED ON ASBESTOS BASE—TAPPED
AT 180-205 ohms.....25c
RCA 6 OHM POWER RHEOSTATS.....39c
PHILO AUTO SUPPRESSORS—\$5.00 per C.....7c ea.
GEN. ELEC. WESTINGHOUSE, etc., 60 CYCLE WATT
HOUR METERS.....\$1.10-1.25 volts.
5 Ampere.....\$3.50 10 Amps.....\$4.50

Philco rotary tap tone control.....25c

I. C. A. 30 MH RF choke.....25c

Grind your own crystals—Pure Brazilian Quartz, all sizes and thicknesses—1/2 lb. package.....\$1.00

340—degree dial with 10 push button attachment—
2 1/2" shaft—ideal for Ammitters—Sig. Gen. or Osc.....39c

RCA Band Switches—
3 gang, 3 posit., 3 band.....30c
6 gang, 5 posit., 4-5 band.....40c

Trimmer-Padder Asst.—all isolantite—singles, dual:
triples—100 asst. pieces.....\$2.25

5"—450 ohm AC-DC dynamic.....\$1.35
5" 5M OHM RCA SPEAKER.....1.00

ATTENTION: Prospectors

Explorers for Hidden Treasures!

Do you seek hidden treasures of rare metallic ores? If so, construct a U.S. Army Type of Metallic Mine Detector from these U.S. Army Detectors. Amplifiers that we are offering at a ridiculously low price. Amplifier unit only (less tubes and batteries), with cables, headphone cord and jack (no phones). Complete Army wiring diagram. U.S. Army DETECTOR SET Amplifier Type AN/PRS-1.....\$1.95
No C.O.D.'s. Eveready 45 volt. batteries.....48c
\$1.75 ea., 6 volt A. 73c. 2-1N5 tubes.....95c ea.

TUBES—02A—79c; 53—39c; 2A7—39c; 55—39c;
117L—89c; 27—25c; #15, same as #224—20c;
01A—25c; 31—20c; 85—25c.

DRY ELEC. FILTER COND. ASST. CONTAINS
10 PIECES ALL BRAND NEW 150-450V.....\$1.10
6 ASST. WET ELECTROLYTIC CONDENSERS.....59c

RADIO EXPERIMENTER'S SURPRISE PACKAGE. CON-
TAINS BYPASS & FILTER CONDENSERS, SHORT
WAVE TUNING UNITS, POWER AND AUDIO TRANS-
FORMERS, SOCKETS, RESISTORS, CHASSIS HARD-
WARE, OVER 20 LBS. OF VALUABLE PARTS.....\$4.95

DRILLED CHASSIS FOR 5-6 tubes 7"x10"x1 1/2"
—29c; 5"x10"x1 1/2".....25c

RCA ADJUSTABLE CODE INTERFERENCE WAVE
TRAP 456-475 K.C.....39c

PHONE JACKS—OPEN & CLOSED AUTOMATIC
TYPE.....18c

NATIONAL 5-15-450 VOLT CAN FILTER CON-
DENSER.....39c

ERY SPEAKER VOL. CONTROL 60 OHMS.....25c

SALE—PHONO RECORD ALBUMS—SALE
10"—3 comp.—15c; 4 comp.—20c; 12 comp.—49c
12"—2 comp.—15c; 4 comp.—20c; 12 comp.—69c

JONES 20 TERMINAL BARRIER TYPE STRIP.....95c

BC-654A TRANSMITTER & RECEIVER, Only 10 Sets
Available. SPECIAL.....\$16.00

WESTERN ELEC. TRANSMITTING STEP-DOWN
TRANSFORMER—AC. 190, 210, 230, 250 V. W.E.
20 AMP RETARD CHOKE TO MATCH. Wt. 125 lbs.
ea. Freight Shipments Only. SPECIAL.....\$5.00 ea.

MINIMUM ORDER \$2.00—NO C.O.D.
SHIPMENTS—PLEASE INCLUDE POSTAGE

**NEWARK
SURPLUS MATERIALS CO.**

Dept. JY

324 Plane Street NEWARK 1, N. J.

Manufacturers' Literature

Readers are asked to write directly to the manufacturer for the literature. By mentioning RADIO & TELEVISION NEWS, the issue and page, and enclosing the proper amount, when indicated, delay will be prevented.

AEROVOX RESEARCH WORKER

Once more, after being suspended during the war and for three years thereafter, the *Aerovox* Research Worker is being published again, and will be sent out again on a regular basis, monthly, to subscribers.

Featuring up to the minute tips on radio-electronic technique, it is filled with practical and usable information. Recent issues have contained descriptions of a TV booster amplifier, the transistor or amplifying crystal, video i.f. amplifier design, TV antennas, and other topics of current interest. The material is original and is prepared by outstanding radio-electronic engineers.

A free subscription to the publication may be obtained through the jobber, or those in the manufacturing field may procure it direct from the *Aerovox Corporation*, New Bedford, Mass.

RELAY BOOKLET

Ebert Engineering & Manufacturing Co., 185-09 Jamaica Avenue, Hollis 7, Long Is., N. Y., offers a booklet on its redesigned and improved line of mercury relays, which will be sent in answer to all requests.

Outline drawings, photographs, and technical data are shown in detail in this four-page pamphlet. Tables give the standard coils for specific voltages in a.c. and d.c., and complete operating hints are supplied. All *Ebert* mercury coils are listed under the re-examination service of Underwriters' Laboratories, Inc.

WIREWOUND RESISTOR BULLETIN

New technical data is available in Catalogue Bulletin B-5, offered by the *International Resistance Co.*, 401 N. Broad St., Philadelphia 8, Pa.

The low-wattage wirewound resistors made by *International Resistance Co.* are fully insulated and have good stability in all available ranges. They are small, light in weight, and comparatively inexpensive. The booklet includes tables on standard RMA resistance values, frequency characteristics, and temperature coefficients, besides the table on characteristics of type BW insulated wirewounds.

PREFERRED RATING TABLES

To meet the usual needs of circuit breaker users and give manufacturers and users the benefits of standardization, new tables of preferred ratings for power circuit breakers have just been approved by the American Standards Association. These are a revision of similar schedules issued in 1945.

The schedules are presented in four tables of ratings covering circuit breakers of the indoor oil, indoor oilless types, low oil content type, and outdoor oil and outdoor oilless types. The newer revision has reduced the number of individual ratings, and the result is a net over-all reduction of 43 ratings, from 121 in the 1945 schedules to 78 in the 1949 edition.

The 1949 revision has been printed as a separate document in order to make it available immediately. Copies of the standard, C37.6-1949, are available from the American Standards Association, 70 East Forty-fifth St., New York 17, N. Y., at 35 cents each.

WELLS RELAY CATALOGUE

Specifications, ratings, and prices on a variety of *Wells Sales, Inc.*, relays are conveniently listed in a new four-page catalogue put out by the company.

Included in the publication are many types of miniature switches, dry disc and crystal rectifiers, transmitting tubes and pilot and flashlight bulbs, and these are shown in tables giving the type numbers, sizes, and prices.

The publication is available to all those interested from *Wells Sales, Inc.*, 320 N. La Salle St., Chicago 10, Ill. Specify the new 1949 Relay Catalogue.

VIBRATOR TRANSFORMERS

A four-page, illustrated folder issued by the *Chicago Transformer Division, Essex Wire Corporation*, 3501 Addison Street, Chicago 18, Ill., announces the production of a new line of vibrator transformers. The catalogue gives characteristics and dimensions of the product, together with a replacement guide.

These units make replacements in auto radios faster, easier, and more profitable for service technicians, as they are exact duplicates of the original transformers. They are produced in a wide range of makes and models, permitting installation without extra condensers or resistors, extra holes or chassis alterations.

They may also be used in many other sets where their electrical characteristics are equal to the original, although mountings may differ slightly; base templates are packed with each to handle these replacements.

APPROVED CATALOGUE

Approved Electronic Instrument Corp., 142 Liberty Street, New York 6, N. Y., offers a 12-page illustrated folder, 1949-1950 edition, on its line of TV receivers, field strength meters, sweep signal generators, marker gen-

erators, generator kits, tuners, and amplifiers.

Photographs of the models are given, together with descriptions, prices, coverage, and components; complete specifications are supplied in each instance.

Featured product of the catalogue is the company's 15-inch custom-built television receiver, completely assembled and wired, ready to play. Tube complement, channel ranges, audio output, and complete data on frequencies, contrast, video response, and power consumption are included.

ATLAS SOUND BOOKLET

Magnetic circuits, power driver units, projectors, stands and accessories, and speakers are only part of the company's line described and illustrated in its new catalogue, No. 549, by *Atlas Sound Corporation*, 1449 39th St., Brooklyn 18, N. Y.

Two of the most recent productions by the firm are its super power driver units, four new models, and demountable microphone stands, Models Cs-32 and Cs-33. Complete specifications are given on these products, including prices, power ratings, and sizes.

Other items in the company's line are also amply illustrated and described, and included with the publication is a page giving model number, description, page number, and price of each unit in the 12-page catalogue.

TUBE COMPLEMENT CHART

The commercial engineering department of *Sylvania Electric Products, Inc.*, Emporium, Pa., has compiled a chart on television receivers, which lists the total tube complement, viewing tube type, and number of tubes by type utilized in 110 models, produced by 44 different manufacturers.

Intended for the convenience of radio and television service technicians, the data is arranged in the form of a chart, covering three pages, which are folded and punched for filing in a standard 8½ x 11 binder.

Requests should be addressed to the Advertising Department of the company at the above address.

MALLORY CATALOGUE NO. 549

Ready for distribution to the radio service trade is the No. 549 catalogue, covering the new precision products line put out by *P. R. Mallory & Co., Inc.*, 3029 E. Wash. St., Indianapolis 6, Ind.

One feature of this publication is the grouping together of all listings of the company's parts for TV applications. The items in the TV section also are listed under major classifications throughout.

Among the products described are latest sizes of the metal tubular dry electrolytic and fabricated plate twist prong type condensers; the new a.c. motor starting selector; continuous duty oil impregnated a.c. condensers; the new high-voltage OW types for TV; ceramic condensers; Mallory Midgetrols; and the six-volt bench

August, 1949

Precision Engineered
for *Finest* Equipment

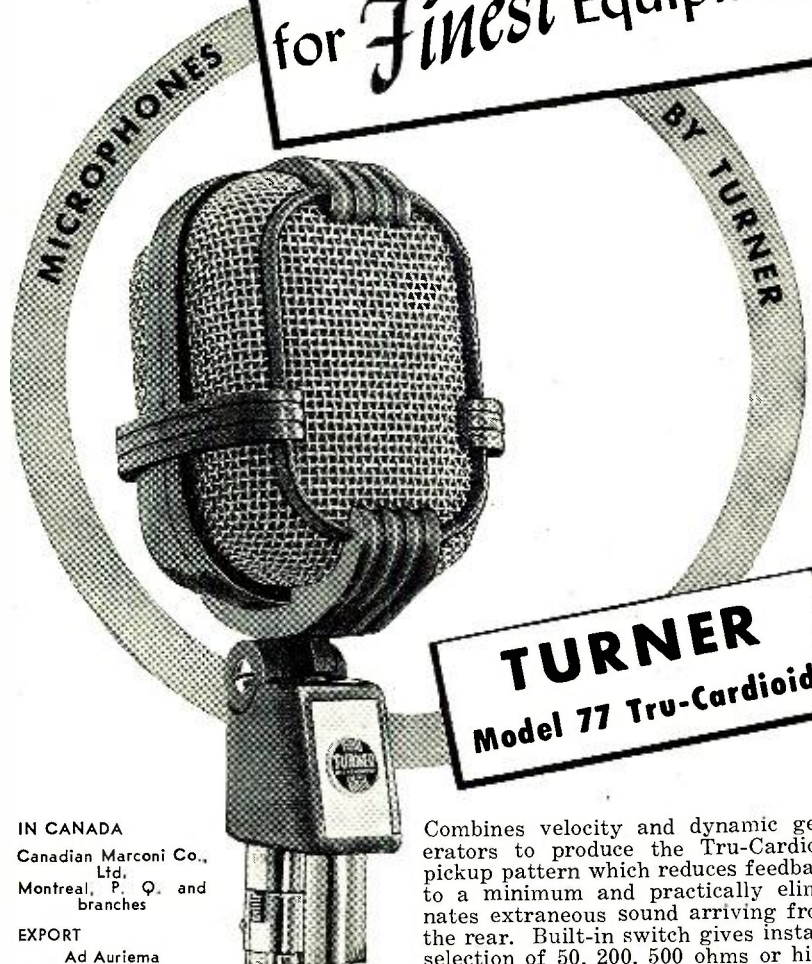

TURNER
Model 77 Tru-Cardioid

IN CANADA
Canadian Marconi Co.,
Ltd.
Montreal, P. Q. and
branches

EXPORT
Ad Auriema
89 Broad Street, New
York City 4, N. Y.

Combines velocity and dynamic generators to produce the Tru-Cardioid pickup pattern which reduces feedback to a minimum and practically eliminates extraneous sound arriving from the rear. Built-in switch gives instant selection of 50, 200, 500 ohms or high impedance output. The Turner Model 77 is recommended for quality recording, public address and broadcast work.

Write for complete details

THE TURNER COMPANY

900—17th Street N.E., Cedar Rapids, Iowa



LICENSED UNDER U. S. PATENTS OF THE AMERICAN TELEPHONE AND TELEGRAPH COMPANY, AND WESTERN ELECTRIC COMPANY, INCORPORATED



RADIO ENGINEERING TELEVISION ELECTRONICS

Thorough training in all phases of radio and electronics, open to high school and junior college graduates. Old established school specializing in radio training exclusively. Modern laboratories and courses. Enrollments limited. Approved veterans training.

VALPARAISO TECHNICAL INSTITUTE
Dept. ED Valparaiso, Ind.

ORIGINAL TWIN-LINE Connectors

TWIN LEAD POLARIZED CONNECTOR FOR STANDARD
300 OHM—FM and TV LINE

LIST
PRICE
90 c
SET

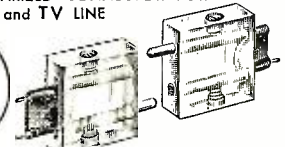

Strip ½ inch of each ribbon—insert in plugs—tighten screws—plug 'em together. Keep TV and FM antenna leads properly polarized no matter how often they are disconnected. Twin polystyrene blocks ¾" x ¾" x ¼".

PRODUCTS ENGINEERING COMPANY
4753 North Broadway, Chicago 40, Illinois



Chassis

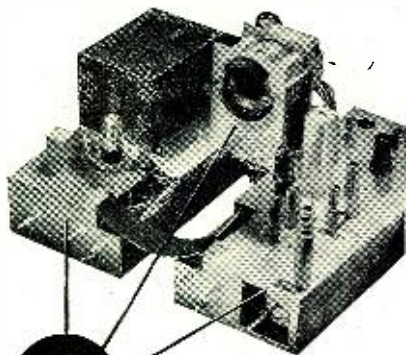

3

UNIT DESIGN

FITS ANY CABINET

The most versatile television chassis yet designed! Three basic units — power supply chassis, RF chassis and deflection yoke assembly — may be placed side by side, one above the other, etc., to conform to any cabinet. Simply plug in the cable connectors. Each unit is soundly engineered and built to famous National standards of performance.

1. Operates 10" or 12" picture tube.
2. Tunes all 12 channels.
3. Wired, pre-tuned and tested — not a kit.
4. RF stage employs tuned grid and plate for maximum gain and optimum band width.
5. Unique 36 mc IF minimizes interference.
6. Fine tuning control covers range of 2-3 mc. for maximum tuning accuracy.
7. Improved intercarrier sound.
8. Magnetic deflection and "fly-back" high voltage supply.
9. 72-ohm unbalanced and 300-ohm balanced inputs.
10. Supplied with two six-inch PM speakers.

\$17950

(less picture tube)



power supply. This listing is only a part of the contents.

Radio service technicians may obtain Catalogue No. 549 from any *Malden* distributor, or from the company.

SELENIUM RECTIFIER HANDBOOK

Many new circuits for TV, home receivers, electrical appliances, industrial, and other equipment, as well as engineering information on miniature selenium rectifiers are included in the "Federal Miniature Selenium Rectifier Handbook."

It contains much interesting and useful information. A description, amply illustrated, is given of the full wave, bridge, half-wave doubler, full-wave doubler, and higher order voltage multiplier circuits. Complete design details are described for each of the 23 types of miniature selenium rectifiers covered.

The last half of the handbook is devoted to uses of the unit; the 38 circuits presented in the publication represent the best of the applications of the item. Schematic diagrams are grouped in accordance with the application, such as television, phonograph, home receivers, etc.

This 48-page manual, priced at 25 cents, is prepared by *Federal Telephone and Radio Corporation*, 900 Passaic Ave., East Newark, New Jersey, and can be obtained either from the company, or from any jobber or distributor.

DU PONT "LUCITE" DATA BOOKLET

A 32-page booklet, illustrated with numerous pictures and drawings, and giving general information about "Lucite" acrylic resin cast sheeting, has been issued by *E. I. du Pont de Nemours & Company*, Wilmington 98, Delaware.

A section of the publication is de-

voted to some of the many applications of this plastic.

The section of the booklet which should be of special interest to craftsmen is the one giving suggestions on handling and fabricating.

It concludes with a summary of types, forms, and sizes of the plastic sheeting, and an inquiry form is included for use in connection with problems where technical advice may be sought.

PYROFERRIC IRON CORES

The iron cores used in coils to increase the permeability of the unit and to vary the inductance are a specialty of the *Pyroferic Company*, 621 E. 216th St., New York 67, N. Y., and the company has just issued an 8-page booklet on its new line.

Illustrations, photographs, and specifications on standard and insulated cores, cup cores, threaded cores, and sleeve and washer cores are given in the catalogue. A chart and a listing of the *Pyroferic* powders in general use are included.

"AN" DESK CHART

The desk-size Army-Navy connector specifications chart (AN-C-591) just issued by the Catalogue Dept. of *Connon Electric Development Company*, 3209 Humboldt St., Los Angeles 31, California, contains the latest insert arrangements. These are shown in detail at half scale for use by aircraft, radio, communications engineers, designers, maintenance men, and purchasing agents.

Measuring 17 by 22 inches in size, it has 203 insert-layouts and many additional positions, with latest service voltages, alternate insert positions, etc. A full-scale 38 by 50 inch chart is also available, and copies of either or both are free on request. —30—

The sun helmets worn by these bathers are actually "radio hats," made by American Merri-Lei Corp., Brooklyn, N. Y. The antenna is the hoop-like affair on the crown, and the two tubes can also be seen on the top front, one on either side of the white knob, which is the tuning control. Leading from the hat is a four-foot battery cord, ending in a three-prong plug. A replaceable "A" battery and a 22½ v. "B" battery make up the pack. Head size can be adjusted to fit by means of a band inside, making it possible for the receiver earphone to rest snugly over one ear, either side.

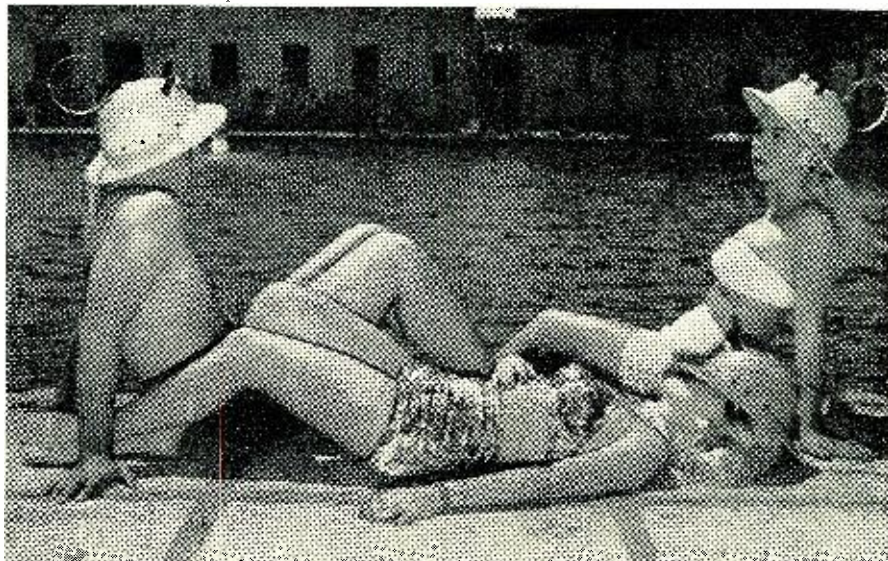

Portable Transmitter

(Continued from page 35)

tion, in order to resonate its inductance with the capacity and inductance of the line connecting it to the antenna, and thus provide a non-reactive link between the antenna and the transmitter for maximum radiation efficiency. After all these precautions and considerations have been taken care of, the results are rather gratifying. The three-tube transmitter shown in the photographs requires a total power input (allowing for a one-tube modulator not shown) of 8 watts and develops 1.5 watts into a load at 150 mc. This is close to twenty per cent efficient. The actual power requirements are 6.0 volts at .33 amperes and 135 volts at 55 mils, and these requirements can be met by ordinary portable batteries and give surprisingly long life. If used for emergency contacts, where short, brief transmissions are the rule, the actual battery life could easily be extended to several days. It is well to keep in mind that there is no standby current when tubes of this type are being used. The filaments as well as the high voltage are switched off together, and all battery drain stops.

The construction is quite simple, as shown in the photographs. The chassis is made of sheet copper and is 2" wide, 1½" deep, and 6" long. One side and the bottom are left open to make assembling and wiring easy. A bottom cover and one side are put on afterward to complete the shielding and provide ample strength and rigidity.

All components mount either on the socket lugs or on the coil terminals. This makes for neat appearance and stable operation as well as simple construction and easy duplication. A single shield is fitted down over the center of the final amplifier socket, and ordinary miniature tube shields complete the shielding above decks. The shield on the tripler is very necessary, unless it is desired to build a complete shield

SURPLUS GEAR

TV Builders! Hams! Servicemen!

NOW YOU CAN SAVE

TWO WAYS

AT R & M RADIO

STANDARD EQUIPMENT AND PARTS

Save on equipment! Save on parts! Our stocks are as complete as they come: all ham gear, receivers, transmitters, all types of resistors, condensers, transformers and tubes; test equipment for the builder and experimenter.

WRITE for monthly specials, bulletins, and special price lists. All equipment F.O.B. 25% deposit or save C.O.D. charges by remitting in full.

ORIGINAL LAZY Q FIVER

FOR PERFECT SINGLE SIGNAL RECEPTION

Says Jan. QST (p. 40, Tech. Topics): "... (BC-453A) will perk up that old broadband superhet of yours and make it cut through the QRM and pull out the desired signal like nothing you ever saw or heard." BC-455 is easily adapted to 10 and 20 meter reception as well as it works on 40 meters. Then all you need is one BC-454 to cover 75 meters and you cover most of the Ham bands. Order yours today!

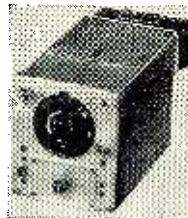

BC-453 (Lazy Q Fiver) **\$16.95** BC-454 (75 meters) **\$9.95** BC-455 (10 and 20 meters) **\$9.95**

APN-4 RCVR SCOPE POWER SUPPLY

Has power supply for 5-inch scope; electronic controlled low v. supply; delivers 260 vdc., 150 mils; reg. to .01%. With 13 tubes.

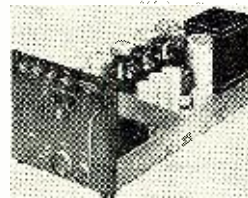

\$8.95

HEAD PHONES

69c Used

\$3.50

Brand New



TELEVISION & STANDARD RECEIVING TUBES

50% OFF

Unconditional guarantee. Write for special TUBE listing.

RACKS & MOUNTS SCR-274

Dual Trans. Rack FT226 and mount **\$3.50**
Triple Receiver Rack FT220 and mount **\$3.50**
BC348 Rec. Rack, Mount and Plug **\$2.00**

PLUGS PLUGS

Any plug for the SCR-274-N
75c ea., 2 for \$1.00

SPECIAL! \$8.00 value for a BUCK!

No more rusting!
OIL LUBRICATING PRESERVATIVE, SPECIAL

Specifications AX5-777

This oil was such a great bargain that we couldn't afford to pass it up, even though it is out of our line. It's the same oil that you pay 50c for, in a tiny bottle, for oiling your guns, fishing reels, tools, etc. It is an effective rust preventative.

Postpaid anywhere in continental U.S.A.

ONE QUART FOR

\$1.00



R & M RADIO COMPANY

2701 WILSON BLVD. DEPT. RN-89 ARLINGTON, VIRGINIA

MECHANIC'S VEST POCKET REFERENCE BOOK

by E. PHELPS AND J. WOLFE

Valuable tables, formulas and diagrams never before published in book form with simple instructions for practical use.

Price \$1.50

At Your Bookstore or Direct from
ZIFF-DAVIS PUBLISHING COMPANY
185 N. Wabash Ave. Chicago 1, Ill.

AUDIO ENGINEERING SCHOOL

A practical Audio engineering course in Sound Fundamentals; DISC, FILM and MAGNETIC Recording; Transmission Measurements; Monitoring and Mixing. Laboratories contain Transmission Sets, Oscillators, Harmonic Analyzer, Distortion Sets, Intermodulation Analyzer and other equipment; Recording Studio assembling Broadcast, Motion Picture and Commercial Sound Recording; H. M. TREMAINE, Pres.-Director. Approved for Veterans and Foreign visas.

HOLLYWOOD SOUND INSTITUTE, Inc.
1040-N North Kenmore, Hollywood 27, Calif.

FACTORY TO USER

ALL CHANNEL TV AND FM ANTENNA

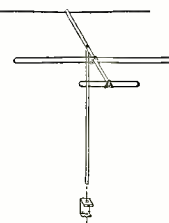

Broad Band Response
High Gain on
All Channels

\$6.95 POST PAID

User Net Price

Mounting Bracket
Optional—\$1.00 Addt.

Assembly completed by fastening three screws and one nut. Simple instructions supplied.

Aluminum elements—plastic insulators, insure excellent all weather reception.

J. M. WEAVER CO.
267 Kings Road Madison, N. J.

Sensational NEW LOW PRICE on Guaranteed Quality Tubes



1A5GT	3Q4	6AU6	6J5	6SL7	12AU7	12SL7	35W4	53
1A7	3Q5	6BA6	6J6	6SN7	12AX7	12SN7	35Z5	58
1H5	3S4	6BA7	6J7GT	6SQ7	12BA6	12SQ7	38	70L7
1L4	3V4	6BE6	6K5GT	6SU7	12BA7	19T8	41	75
1N5	5U4	6BF6	6K6GT	6T8	12BE6	25L6	42	76
1P5	5Y3	6BG6	6K7GT	6Y6	12F5	25Z6	43	77
1Q5	6A7	6BH6	6P5	6W4	12J7	26	45	78
1R5	6A8GT	6BJ6	6Q7	6X4	12K7	27	45Z5	80
1S5	6AC5	6C4	6S8	6X5	12S8	32L7	46	82
1T4	6AG5	6C6	6SA7	12A8	12SA7GT	35	47	84
1T5	6AK5	6D6	6SD7	12AL5	12SF5	35B5	50B5	85
1U4	6AL5	6F5GT	6SF5	12AT6	12S7	35C5	50C5	117Z3
1U5	6AQ5	6F6GT	6SJ7	12AT7	12SK7	35L6	50L6	117Z6
2A5	6AT6	6H6GT	6SK7	12AU6				

\$27.50 PER 100 ASSORTED

Any Tube Above 32c Each.
35c Handling Charge On Orders Under 100 Tubes.

All Orders Filled Promptly. All Tubes Individually Boxed.

Order NOW... this offer limited to stocks on hand... HURRY!

ALL ORDERS SHIPPED C.O.D.

OWL RADIO TUBE COMPANY

32 BEECHER STREET • NEWARK 2, N. J.



CODE SENDING RECEIVING SPEED



Free Book

HIGH SPEED
WITHOUT NERVOUS TENSION

REVEALING BOOK shows how "crack" operators develop high speed and proficiency. Learn code for Amateur or Commercial Radiotelegraph License, or improve your sending and receiving with the Candler System which develops radiotelegraph experts and code champions.

CANDLER SYSTEM Box 928, Dept. 2-J, Denver, Colorado

YOU MUST SEE CANADA by CECIL CARNES

Canada—coast to coast—as seen by Cecil Carnes, world traveler, adventurer, story-teller extraordinary. Canada offers a warm welcome to travelers and here is the book no visitor should be without. Price \$2.75. At Your Bookstore or Direct from

ZIFF-DAVIS PUBLISHING COMPANY
185 N. Wabash Ave., Chicago 1, Ill.

RADIO ENGINEERING!

COMPLETE Radio Engineering Course. B.S. degree. Courses also in Civil, Elec., Mech., Chem., Aeronautical Engineering, Bus. Admin., Acc., Sec., Science. Visitors welcome. See beautiful campus, well equipped laboratories. Graduates successful. 66th year. Enter Sept., Jan., March, June. Write for catalog.

TRI-STATE COLLEGE
1689 College Ave. Angola, Indiana

The plate current will suddenly drop, showing that oscillation has started. Continue turning the screw in, and the plate current should reduce a small amount and then suddenly jump up again, showing that oscillation has stopped. Back the slug out again until plate current drops and leave it at about halfway between the two points where the oscillator drops out. Switch the plate supply on and off a few times to be sure that it will restart easily at this point. If it fails to restart easily, move the slug in or out a bit and recheck again. A point will be found where operation is stable and reliable, and the oscillator adjusting slug should be locked at this point.

Tuning the doubler is done in the usual manner, adjusting the slug in the plate of the doubler and watching for a dip in doubler plate current, or by reading current in series with the tripler grid resistor. Grid current will be about .3 to .4 mils and can be read on a 0-1 milliammeter. After tuning the doubler, the tripler plate is tuned, placing the 0-1 milliammeter in the grid of the final. Grid current should be .5 to .6 mils before applying high voltage to the final. At this point, we check the neutralization as pointed out above in the usual manner by tuning the final plate through resonance and watching for a change in grid mils. It will be found that this grid dip can be reduced to an imperceptible amount by adding the feedback wire as described and spending a few minutes adjusting it.

Obviously, this transmitter is incomplete without a modulator of some sort. It could be modulated by keying the high voltage for straight c.w. transmissions, or a high-frequency buzzer could be used to interrupt the final. Most likely, however, it will be voice-modulated, and for this, the audio output tube of the accompanying receiver can be used. Its filament will be in series with that of the final, so that no increase in filament power will be required. The only requirement is 8 to 10 mils of high-voltage power, plus a microphone of the dynamic type.

Know Your "Pigtail" ABC's



Accurate... Better Constructed LECTROHM WIRE-WOUND RESISTORS

Here are the fixed resistors that you can count on every time—Lectrohm Wire-Wound Resistors. They are space wound on low loss ceramic cores with resistance wire that has a low temperature coefficient. High temperature vitreous enamel coating in the 5 and 10 watt sizes (others up to 25 watt) means constantly safe heat dissipation. Resistances up to 50,000 ohms. Insist on Lectrohm—for the BEST in Resistors.

LECTROHM
INCORPORATED

5907 Archer Avenue, Chicago 38, Illinois
Division of National Lock Washer Co., Newark, N. J.

"Midar"

(Continued from page 30)

undergo "paralysis" and "receiver recovery time."

4. It is capable of responding to any minimum distance, right up to the equipment itself.

5. Its maximum range is comparable to that possible with the average power, rather than the peaked pulse power, of any conventional radar. Using larger tubes in a "midar" unit, suitably energized, will increase the range. It is primarily intended to do what conventional radars cannot do, namely, function in the blanked-out minimum ranges common to every pulsed radar, and so it can function with small conventional tubes.

A basic "midar" set consists of a small single unit using two conventional tubes. It detects the relative change of position of reflecting bodies by means of a steady emission of electromagnetic waves. Fig. 2 shows the principles of operation.

The unit consists of an r.f. amplifier (11) utilizing one or more stages of r.f. amplification. It is constructed of tubes and parts conventional for any frequency or power selected. The last stage of this amplifier feeds the transmitting antenna (12). This antenna may be any type of radiating device, directional or non-directional, depending on whether an indication of precise direction is required. No master oscillator is provided at the input of the first r.f. stage, which is coupled directly to the receiving antenna (13). Space coupling exists between the transmitting antenna (12) and the receiving antenna (13). These antennas are separated by a fraction of a wavelength and are attached to the same instrument. Sustained oscillation takes place because part of the radiated power (14) is picked up by the receiving antenna (13), amplified by the amplifier (11), and radiated again. The frequency of the oscillation is the common frequency of all the coupling circuits.

The entire circuit functions as a feedback oscillator, where the feedback takes place between the last and the first stages, through the space coupling existing between the antennas and the surrounding objects. The strength of the oscillation depends upon the distance between the antennas and the presence of the interposing bodies (15) which reflect back to the receiving antenna (13) another part of the transmitted power. The resulting phase of the arriving waves actually controls the strength of the oscillation in accordance with the number of phase reversals that occur in the amplifiers. If no reflecting bodies are present within the range of the device, the strength of the oscillation depends only upon the distance between the antennas and, therefore, upon the phase with which the radi-

For Dependable Trouble-Free TV Servicing

REPLACE WITH STANCOR EXACT DUPLICATE TELEVISION TRANSFORMERS

Eliminate callbacks and dissatisfied customers—get a bigger share of the profitable television service business with Stancor *Exact Duplicate* Replacement Transformers. These units are *exact* physical and electrical duplicates of original equipment used in popular receivers—they're precisely what is needed for "new set" performance!

Don't take a chance with replacements that are "almost exact"; use Stancor *Exact Duplicate* Replacement Transformers. Representative types listed below.



HORIZONTAL DEFLECTION OUTPUT AND HV TRANSFORMER
Stancor Part No. A-8117. *Exact duplicate of RCA type 211T1.* For use with direct viewing kinescopes such as RCA types 7DP4 and 10BP4.

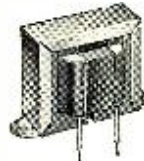

FILTER CHOKE
Stancor Part No. C-2326. *Exact duplicate of filter choke used in RCA models 630TS, 630TCS and 8TS30 receivers.*



PLATE AND FILAMENT TRANSFORMER
Stancor Part No. P-8157. *Exact duplicate of Motorola part No. 25C484095 used in models VK106, VT105 and VT107.*



HORIZONTAL BLOCKING-OSCILLATOR TRANSFORMER
Stancor Part No. A-8120. *Exact duplicate of RCA type 208T1.* Generates 15,750 cps. pulse required to drive grids of horizontal discharge tubes.

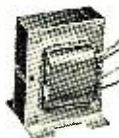

VERTICAL DEFLECTION OUTPUT TRANSFORMER
Stancor Part No. A-8115. *Exact duplicate of RCA type 204T2.* Used with kinescopes such as types 10BP4, 7DP4 and 5TP4.

SEE YOUR STANCOR distributor or write for Catalog DD337, listing complete specifications and prices of Stancor Television Components.



JUST PUBLISHED! Write for the New Stancor Transformer Catalog listing over 400 replacement transformers, reactors and related components for radio and television.

STANDARD TRANSFORMER CORPORATION
ELSTON, KEDZIE & ADDISON • CHICAGO 18, ILLINOIS

Make Your Career RADIO and TV

In no other industry does the future hold brighter financial promise and security than in AM and FM Radio, Television. These fields need and want men trained as announcers, script writers, disc jockeys, and radio technicians. It will pay you to investigate the Don Martin School of Radio Arts, established in 1937. Complete day and night classes in the latest equipment and a staff of 30 nationally known instructors. Over 97% of the combination men graduates are placed on jobs immediately through the free placement service. Approved for veterans. **FREE**—Write for Free Booklet "Your Future in Radio."

DON MARTIN SCHOOL OF RADIO ARTS
1655 No. Cherokee, Hollywood, Calif., HUdson 23281



RUNNING TIME METERS

Cramer timer with Vender counter in hours and 1/10 hours to 9999.9. 110v. 60 cycles. **\$2.95!!**

G. E. TRANSFORMERS
110 V. 60 Cy. AC

850 V cT 6.3 V @ 5A, 6.3 V @ 3A, 5 V @ 3A. Conservatively rated @ 148 Mil, tested @ 250 mil and will handle more. **\$2.95**
A steal at.....

G. E. 12 HENRY CHOKE

Made as companion to above, only..... **\$1.95**
Many other items. 25% cash with order. Bal. C.O.D.

EMMONS RADIO SUPPLY

405 - 10th ST. OAKLAND, CALIF.
Phone TWinoaks 3-9103

RADAR, COMMUNICATIONS AND SONAR TECHNICIANS W-A-N-T-E-D For Overseas Assignments

Technical Qualifications:

1. At least 3 years practical experience in installation and maintenance.
2. Navy veterans ETM 1/c or higher
3. Army veterans TECH/SGT or higher.

Personal Qualifications:

1. Age, over 22—must pass physical examination.
2. Ability to assume responsibility.
3. Must stand thorough character investigation.
4. Willing to go overseas for 1 year.

Base pay, Bonus, Living Allowance, Vacation add-up to \$7,000.00 per year Permanent connection with company possible

Apply by Writing to
**D-4, P.O. Box 3575,
Philadelphia 22, Pa.**

Men qualified in RADAR, COMMUNICATIONS or SONAR give complete history. Interview will be arranged for successful applicants.

LEARN

Radio-Television Electricity

OR
IN THE GREAT SHOPS OF
COYNE

COYNE 50th ANNIVERSARY

**TRAIN QUICKLY!
OLDEST, BEST EQUIPPED
SCHOOL OF ITS KIND IN U.S.
2 Opportunity Fields**

Come to the Great Shops of COYNE in Chicago during our 50th Anniversary Year! Get quick, practical training in RADIO-TELEVISION or ELECTRICITY. G. I. Approved. Finance plan for non-veterans. Mail Coupon Today for complete details.

NOT "HOME-STUDY" COURSES!
You learn on real, full-size equipment, not by mail. Finest staff of trained instructors to help you get ready quickly for a better job, a fine future.

FREE BOOKS Clip coupon for big illustrated Coyne book on either ELECTRICITY or RADIO-TELEVISION. Both books sent FREE if you wish. No obligation; no salesman will call. Act NOW!

B. W. COOKE, Pres.
COYNE Electrical & Radio School, Dept. C9-85 H
500 S. Paulina Street, Chicago 12, Illinois

Send FREE BOOK and full details on:

RADIO-TELEVISION ELECTRICITY

NAME.....

ADDRESS.....

CITY..... STATE.....

ated waves arrive at the receiving antenna. It may be adjusted by changing this distance.

If this strength is kept at a proper value, the arrival of a new reflecting body within the range of the device or the change of the position of the already present body will increase or decrease the oscillation strength by changing the total phasing of the received waves. By adjusting the spacing between the antennas, the original oscillation may be kept very weak until a new target comes in the range of the device and rephases the waves at the receiving antenna.

The oscillation strength will vary from a maximum to a minimum and vice versa as the target moves through successive quarter-wavelength distant positions. Since every half-wavelength separation completely inverts the phase, the input and output antennas can be so spaced that they are almost, although not completely, opposite or out-of-phase. Consequently, only enough energy need be maintained to keep the circuit alive between the two antennas and to provide the minimum energy for target reflection or change of conditions. It will therefore create minimum interference during those times when no targets are being detected. It is also incapable of being received over a longer range than that over which it can itself detect another object. This is an advantage over radar which can interfere as a one-way signal to receivers several times farther away than the distance over which it can itself detect an object. The other appurtenances shown in Fig. 2 are necessary for calibrated range indications if a cathode-ray oscilloscope is employed. For amateur use, a plate milliammeter in the r.f. amplifier stage can be used as an indicator without providing Items 16, 17 and 18 shown in Fig. 2.

Fig. 3 shows the complete circuit diagram and parts list for a basic "midar" equipment as successfully used for short-range detection and alarm purposes. It has detected vehicles and personnel passing by outside a window, people coming up a flight of stairs, workmen directly underneath the room in which it was located, or even the movement or change of placement of anything within the same room. In the diagram, two type 6V6 tubes are employed (V_1 and V_2). A single tuned circuit constitutes the coupling circuit between the output of the first tube and the input of the second tube. This tuned circuit is made with a resonant quarter-wavelength of lecher wires (31 and 32) shorted by the large condenser C_3 (.1 μ f) at the voltage nodal point (33). As shown by the alignment of the arrows (34), the total length of the resonant sections comprise also the connections in the tubes and the length of the electrodes. The power developed by tube V_1 , when excited at the same frequency of the coupling resonant circuit (31-32), sustains an amplified oscillation in the circuit itself. This oscillation, which appears directly at the grid of tube V_2 , drives the second stage. The output power largely exceeds the losses in the plate circuit and is radiated by the dipole (37) which is the same as Item 12 in Fig. 2.

Tuning of the plate circuit is accomplished by means of the sliding sleeve (35) which is the terminal part of the coaxial feeder (36). The receiving dipole (38), comparable with Item 13 in Fig. 2 is inductively coupled through the coax (39) and the loop (310) to the grid input circuit of the first tube, V_1 . This circuit is constituted by a single wire (311) grounded at its voltage nodal point by means of the slider (312).

The grid input circuit (311) of tube

Fig. 3. Wiring diagram of two-tube "midar" unit illustrated on page 30.

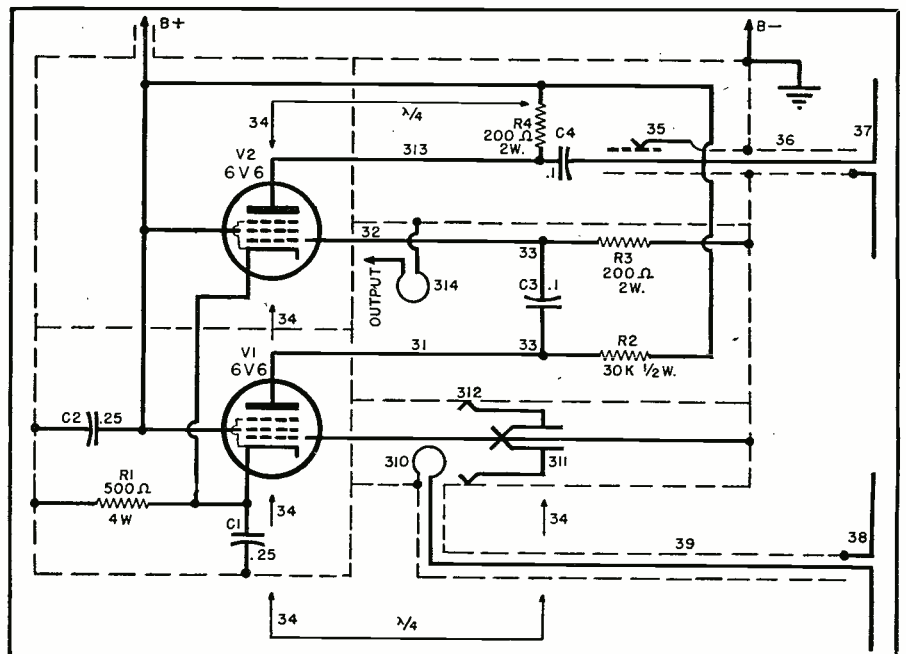

V, the coupling circuit (31-32), and plate output circuit (313) are separated by a complete and careful system of shields in order to prevent coupling other than the space coupling between the dipoles (37 and 38). Chassis currents and the common power supply always provide a small coupling which in any case can sustain the oscillation. The tubes may be energized at the approximate voltages recommended by the tube manufacturer for such type.

A small loop (314) is inductively coupled to the resonating circuit (31-32) and provides the excitation of the detector (Item 16 in Fig. 2). This detector may be of any type capable of functioning on the frequency employed. The loop (314) is coupled to the circuit (31-32), i.e., before the last stage and not to the circuit (313). This is necessary because this stage is blanked out if ranging is required from the device, while it is necessary that the detector functions also when the last stage is inoperative during the blanking period.

The device comprises essentially a two-tube r.f. amplifier without the need for a separate oscillator and receiver.

The reader may adapt this basic circuit for a large choice of detection or indication. It may even be connected to the complete indicating system of a radar without using the basic radar transmitter and receiver portions. It is possible to construct a one-tube version of reduced sensitivity. One such version constructed by the same inventors as the heart of a portable blind man's radar, or "midar," utilized a single 6SK7 tube with a single wire comprising the tuned grid circuit and another single wire comprising the tuned plate circuit. It must undergo further development and test before publication.

The initial two-tube model shown in Fig. 1 was successfully operated at a frequency of about 300 megacycles during the war. It may be used on any frequency affording convenient antenna dimensions and spacing between antennas consistent with satisfactory tube availability and operation in that part of the radio spectrum.

"REPS" PLAN FALL MEETING

THE Heart of America Manufacturer-Jobber Conference, conducted annually in the fall by the Missouri Valley Chapter of "The Representatives," will be held in Kansas City, Missouri, on September 26, 27, and 28.

At the May meeting, "The Representatives" completed the preliminary plans, and invitations were mailed by the members to the officials of the factories they represent, asking them to set aside the above dates.

From a modest beginning four years ago, the fall event has become increasingly popular each year, so that now both the jobbers and manufacturers look forward to it with keen interest, giving it a top billing on their calendar of industry events.

August, 1949

SEE LEO FIRST... for HALLICRAFTERS!

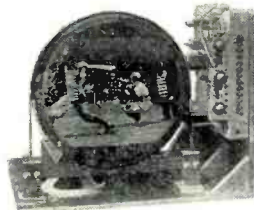

T-69 15 INCH TV CHASSIS

Now you can have big-picture television at a reasonable price! Brilliant 130 sq. inch picture on direct-view tube. All channel push-button tuning provides instant station selection. Has 300 ohm twin-wire lead for any standard antenna. 8 inch P.M. speaker. Operates on 105-125 volts 60 cycle, AC. 19 tubes, picture tube and 3 rectifiers. Ready for custom installation.

\$259.50



SAVINGS ON BRAND NEW MODELS TV RECEIVERS

No. 511—16" TV Remote Control	\$395.00
No. 512—12 1/2" TV Console	\$299.50
No. 513—10" TV Table Model	\$199.50
No. 514—7" TV Portable (Built in antenna)	\$149.50
No. 515—15" TV Console in cabinet	\$399.50
No. 509—10" TV Receiver in cabinet	\$269.50
No. T-64—10" Custom TV Chassis with CR tube	\$179.50
No. T-64—12" Complete with 12" CR tube	\$199.50

SENSATIONAL NEW LOW PRICES

SX-43—less speaker	\$159.50
S-40A	\$ 79.95
S-53	\$ 69.95

20% DOWN — E-Z PAYMENTS

S-72 PORTABLE



Hallicrafters new versatile, extra-sensitive, all-wave portable receiver. Covers standard broadcast band and 3 CW bands—540 KC to 30.5 MC. Operates from built-in antennas—loop for broadcast and 27 inch whip for short-wave. Includes eight tubes and rectifier. Operates on 105-125 volts DC or 60 cycle AC or battery. Sturdily built — covered with handsome brown leatherette with brass plated hardware. 14 inches wide—12 1/4 inches high—7 1/4" deep.

\$79.95 (batteries not included).



GIANT RADIO REFERENCE MAP

Just right for your control room wall. Approximately 28" x 42". Contains time zones, amateur zones, leading short-wave stations, monitoring stations. Mail Coupon Today and **25c**

FREE

The most complete Ham Catalog ever assembled. Send for your copy today!



WORLD RADIO LABORATORIES R-8

744 West Broadway
Council Bluffs, Iowa

Please send me:

- New Catalog
 Radio Map
 List of Used Equipment

- T-69 TV Chassis
 S-72 Portable Radio
 New Model No. _____

Name _____
Address _____
City _____ State _____



RADIO COURSES

Preparatory Mathematics, Broadcast, Marine Operating, Servicing, Aeronautical, Television, Frequency Modulation, Radar.

Classes forming for Fall term Oct. 1.
Entrance examination Sept. 19
Veteran Training, Literature

COMMERCIAL RADIO INSTITUTE

(Founded 1920)
38 W. Biddle St. Baltimore 1, Md.

GEIGER COUNTER TUBES

Plateau 900-1050 volts (approx.)

COMPLETE—Encased in metal probe only \$15 postpaid in U.S.A.

FREE: INSTRUCTIONS FOR BUILDING YOUR OWN GEIGER COUNTER

RADIO Specialists CO.

417 W. 12th Ave., Denver 4, Colorado

THE "ALL PURPOSE" TELEVISION KIT

10" 12 1/2" 16" TUBES

\$89.50

LESS TUBES

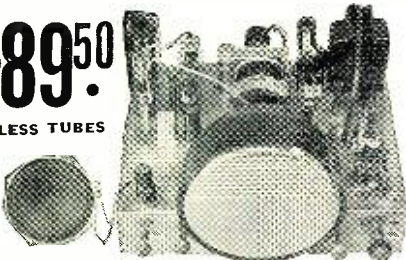

COMPLETE WITH ALL TUBES

10" KIT - - - - \$139.50
 12 1/2" KIT - - - - \$159.50
 16" KIT - - - - \$189.50

FEATURING

- Latest Type of Circuits
 - AGC—Automatic Gain Control
 - Picture and Sound Automatically Locked
 - Sound Cannot Drift
 - Non-Microphonic
 - Stagger Tuned I.F. for Max. Gain and Ease of Alignment
 - 12 Channel Tuner
 - Electromagnetic Focus and Deflection
 - Automatic Stabilized Synchro-Lock Circuit Holds Picture Steady
 - Voltage Regulated Circuit for Stability
- Large clarified stage by stage pictures and schematics to insure ease of construction. Guaranteed to work. Money Back Guarantee—Buy it, inspect it, if you don't think it's the best buy on the market—return unused within 5 days and your money will be refunded. All prices F.O.B. New York. 20% deposit with order. IMMEDIATE DELIVERY

SOVEREIGN TELEVISION CO.
 5508 New Utrecht Ave.
 Bklyn 19, N. Y.

FREE

HOW TO GET THE MOST FROM YOUR RADIO

"KNOW-HOW"

Learn all about a new, simplified way of fixing radios. Nothing complex to learn, no calculating. Used by beginners and experts. Send for FREE manual, "THE INSIDE STORY," today. 28 pages—illustrated—easy to read! Shows how obsolete methods prevent full use of your real ability. Explains use of NEW techniques. You owe it to yourself and your future to "get out in front" in your work.



SEND COUPON OR PENNY POSTCARD FOR FREE MANUAL TODAY!

FEILER ENGINEERING CO., Dept. 8H9
 945 George St., Chicago 14, Illinois
 Please RUSH my FREE copy of "The Inside Story"

Name

Address

City Zone State

Crystal Tuner

(Continued from page 31)

nor any other really high-fidelity receiver can separate stations operating closer than this, for such bandwidth is needed for high program quality transmission.

In aligning the tuner, the really ideal instruments for the job are a bandsweeping signal generator used in conjunction with an oscilloscope. In lieu of such aids, however, a 250 μfd . condenser should be connected to the antenna post of the tuner, and the lead from a regular signal generator connected to it. The signal generator should share a common ground with the tuner. A 20-watt resistor of a value equal to one of the higher (250- or 500-ohm) output impedances provided by the amplifier is placed across the voice coil terminals in place of the speaker. The output meter, in our case a model 260 Simpson set to the 2.5 volt a.c. scale, is placed across this resistor. With the tuner connected to the amplifier input (at least 50 to 80 decibels gain should be available) the gain control is advanced to about one eighth its full scale setting. Any noise or hum within the amplifier will cause the meter to read. The voltage indicated should be noted as being the "base line" or reference level for subsequent readings.

The modulated signal generator is now tuned to approximately 900 kc. and the tuning condenser of the tuner rocked back and forth to find the signal. Once such a point has been found, the output attenuator of the signal generator should be adjusted until the output meter reads just full scale on the peak response of the signal. Adjust trimmers C_{1a} and C_{1b} until, upon

tuning through the signal, two slight peaks or rises are noticed on each side of the signal generator's frequency. These peaks should be made equal to each other by careful adjustment of the trimmers; this is the proper alignment. The antenna may now be connected and the speaker replaced for an actual air check.

If no signal generator is available, the tuner may still be aligned, at the expense of a little sleep, by waiting until the hour most broadcast stations end their regular programs. It will be found usually that several return to the air in the early morning hours, emitting a steady tone-modulated signal for transmitter adjustments. With such signals available it is then a simple matter to follow the procedure outlined above.

If it is found impossible to make the two slight peaks each side of the center frequency equal in magnitude, the bottom plate of the chassis should be removed and the wires leading from the "grid" connection of each J. W. Miller r.f. coil slowly moved with an insulated probe. It will usually be found that this has an appreciable effect upon the magnitude of the first or second peak. The lead found to have the major effect should be bent away or nearer to the metal chassis and the trimmers adjusted until the two peaks are matched.

So called "monkey chatter" may be noticed when listening to one or more stations in a given locality due to interchannel interference. This effect may also take the form of a very high-pitched ringing sound. If this interference is objectionable, T_1 should be added to the circuit. This filter is an iron core, parallel-tuned circuit, which should be tuned while listening to a signal until the "chatter" is eliminated.

-30-

Fig. 1. Schematic diagram of the low-cost bandpass crystal tuner.

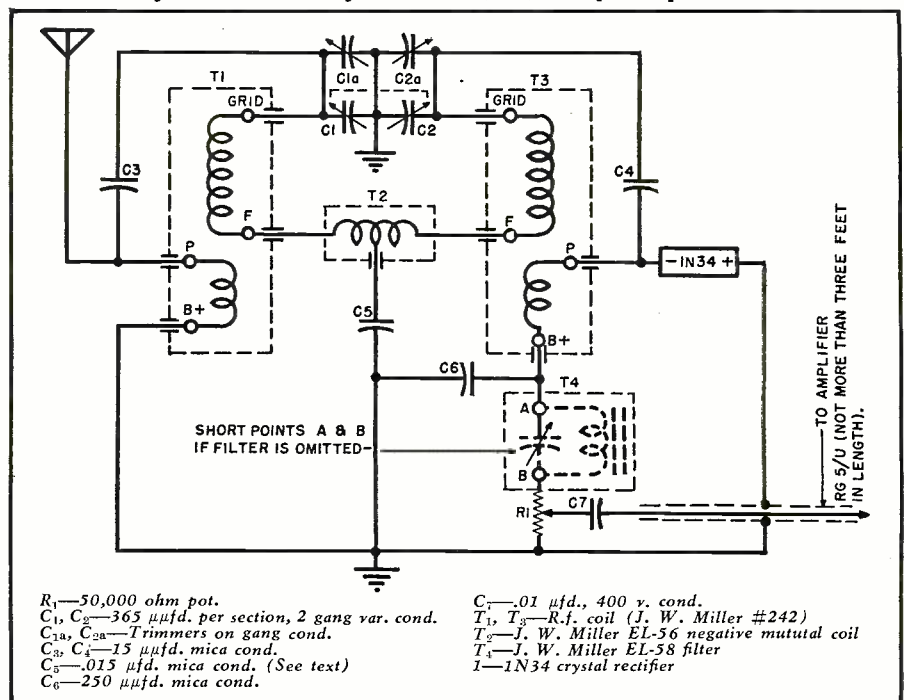

International Short-Wave
(Continued from page 103)

day afternoons." Noted 1245-1715 on 7.350 and 6.035; news in French 0100, 1330. Noted more recently 0200 on 6.035 and 9.785.

Magyar Radio (call *Radio Kossuth Budapest*, m.w. station), 6.247, 9.820, Budapest, Hungary, broadcasts from 0800 to 1745; *English* news 1720; French 1710; announces *only* m.w. channel of 549.5 metres. Verified by letter; said experimental broadcasts with power of 400 watts on these channels since April 1; *new* 100 kw. transmitter under construction near Budapest and will be completed and put into operation April 15, 1950; also from July 15 the present station was to have increased power to 2 kw.; present schedule listed 0800-1740 relaying *Radio Kossuth*, 549.5 m., *Radio Pitofi*, 288.5 metres (these are 135 kw. and 50 kw., respectively).

Radio Ankara, TAQ, 15.195, Ankara, Turkey, now carries the *English* periods to Britain on Mondays, Thursdays, and the Sunday Mailbag program, all at 1530-1600. But the daily news 1345 is still over TAP, 9.465. EPB, 15.100, Teheran, Iran, news still 1400; French 1410 and then from 1420 to 1500 sign-off has recorded music (usually dance numbers); signs on 1330 in this transmission.

Helsinki, Finland, noted on 17.800, around 1330, same program as 6.120, news in Finnish 1500.

Baden-Baden, Germany, noted on 6.321 around 0045; news in German 0100, in French 0130.

Kol-Isreal, 6.817, Tel-Aviv, Israel, news in *English* now at 1400; Haifa, 8.170, relayed news from Tel-Aviv at that time; now heard in parallel on approximately 9.010.

"The Radio Broadcasting Station of the Army Corps," 6.745, Larissa, Greece, has extended schedule; heard in *English* 1530- or 1535-1555 sign-off; announces *English* is on Fridays, Sundays, Tuesdays.

United Nations Radio, 6.672, Geneva, Switzerland, heard daily with UN news 1330.

Sendergruppe Rot-Weiss-Rot, 9.565, Austria, noted with news in German 0100, and heard at other times in England.

Damascus, Syria, still gives news 1400 on 12.00; French 1410.

KZCA, 9.535, Salzburg, "Blue Danube Network," moved from 7.22, is scheduled 0000-1800.

A letter from Studio Controllor, Forces Broadcasting Service, Lakatamia, Cyprus, says series of test transmissions given on Saturdays 1700-1900 on 7.22 are now ended; impossible to count all reports received but those from Sweden out-numbered all others in ratio of 10-1.

CQM-4, Bissau, Portuguese Guinea, sent card by registered mail for report on 6.998 outlet; schedule given 1630-1800.

At the time this was compiled, *Ra-*

Our 27th Year

GRID DIP METER
LYSCO "DIPMASTER"

3 Mc to 150 Mc frequency range; calibrated dial. Ideal for Signal generator, 3.4 to 500 Mc range phone monitor, F.S. meter, or absorption wavemeter. Complete power supply and tubes. Really a good buy at **\$33.50**

CONVERTERS

Mobile or Fixed. RF Gain control. Simple installation. Size 2" x 6" x 5"

Model 210—
27 to 50 Mc-10 meters... **\$25.50**
Model 202—
144 to 148 Mc-2 meters... **25.50**
3 tubes for converter... **3.49**

TRANSMITTERS

Mobile or Emergency, 8 watt output crystal control, push to talk. Power requirements 6.3V. at 2 Amp; 350V. at 110 Ma. without dynamotor.

Model 129—
27 to 29.7 Mc (10 meters)... **\$23.95**
Model 175—
3750 to 4000 Kc (75 meters)... **23.95**
3 tubes for transmitter... **4.98**
Noise Limiter—Model NXL—adjustable threshold control. Power 6.3V—150 Ma. 100V. 6Ma. D.C. **\$4.50**
6AL5 tube... **1.11**

CHOKES

SMOOTHING TYPE	SWINGING TYPE	PRICE EACH
Hy	Hy	MA Price
C-80 10	C-87 4-10	150 \$3.09
C-81 10	C-88 4-16	200 \$3.82
C-82 10	C-89 4-16	250 \$5.29
C-83 8	C-93 4-14	300 \$5.59

All above 3000 Volts Insulation

TRANSFORMER SPECIAL

870 volt CT @ 250Ma with 80V bias tap
5 volts @ 3 amps
2 1/2 volts CT @ 10 amps
2 1/2 volts @ 3 amps
6.3 volts @ 1.5 amps
115V. 60 cycle primary

SELSYN MOTORS

115 V.A.C. 60 cycle #C-78248. Can be used to turn small antennas or as indicators. Size 3 1/2" x 5 1/2". Price per pair... **\$6.95**

RAYTHEON VOLTAGE STABILIZERS

Positive Stabilization ± 1/2%
Input 95-130 volts, 60 cycles single phase; output 115 volts stabilized to ± 1/2% *Output 6.0 or 7.5 volts stabilized ± 1/2%

Catalog	Output Net	Cap. wt.	Net	Type	Sec. Rms.	DC	Price
VR-6110	15	4	\$15.00	P 57	660-660†	500	250
VR-6101*	30	5	\$17.00		550-550	400	125
VR-6111	30	5	\$17.00	P 58	1080-1080	1000*	150
VR-6112	60	8	\$24.00		500-500	400	225
VR-6113	120	14	\$31.00	P 59	900-900	750	300
VR-6114	250	25	\$48.00	P 67	1450-1450	1200	300
VR-6115	500	45	\$75.00	P 68	1175-1175	1000	300
VR-6116	1000	92	\$125.00		2100-2100	1750	300

FILAMENT TRANSFORMERS

Type 940 2.5VCT @ 10 Amps	7500V Ins	\$2.79
Type 040 5 VCT @ 3 Amps	2500V Ins	\$2.06
Type 941 5 VCT @ 6 Amps	2500V Ins	\$3.38
Type 943 5 VCT @ 20 Amps	2500V Ins	\$5.29
Type 946 6.3VCT @ 3 Amps	2500V Ins	\$1.91
Type 947 6.3VCT @ 6 Amps	2500V Ins	\$2.79
Type 948 6.3VCT @ 10 Amps	2500V Ins	\$3.67
Type 960 7.5VCT @ 4 Amps	2500V Ins	\$2.35
Type 143 7.5VCT @ 8 Amps	2500V Ins	\$4.12
Type 146 10 VCT @ 10 Amps	3000V Ins	\$4.99
Type 961 Dual 6.3VCT @ 3 Amps	2500V Ins	\$3.38
Type 041 5VCT @ 2 Amps	2500V Ins	\$3.38
6.3VCT @ 3.6 Amps		



LEEDS
The Name of RADIO

BIAS TRANSFORMER TYPE KS8779

Completely shielded. Insulator Terminals. Primary: 115 Volts 60 cycle @ 500 Ma. Secondaries
180 V. @ 20 Ma.
300 V. @ 20 Ma.
6.3 V. @ 1.2 amps.
5.1 V. @ 7 amps. C.T.

Special **95c**

STEEL CHASSIS 16 GAUGE

4 x 17 x 3 Black Crackle	\$1.05
4 x 17 x 3 Cadmium	1.17
10 x 14 x 3 Black Crackle	1.44
11 x 17 x 3 Black Crackle	1.94
13 x 17 x 3 Black Crackle	2.35
13 x 17 x 4 Black Crackle	2.70

Complete stock of steel & aluminum chassis & panels on hand.

ALUMINUM CHASSIS—

Heavy Duty	Price
7 x 7 x 2	94c
7 x 9 x 2	\$1.06
5 x 10 x 3	\$1.08
7 x 11 x 2	\$1.15
7 x 13 x 2	\$1.23
10 x 17 x 3	\$1.88

ISOLATION TRANSFORMERS

All 117 Volts to 117 Volts 60 Cy.
40 watts \$3.60 P-98, 100 watts \$9.30 P-97, 80 watts \$5.10 P-99, 250 watts \$17.70

ITEMS YOU MAY BE LOOKING FOR

Multiple Contact Telephone Type Relay No. A2-2—
Windings 125 ohms. Each... **\$.29**
No. A1—
Single winding 12,500 ohms... **.49**
Heineman 5 amp. circuit breaker... **.95**
Sockets for 813, 829... **.73**
1/4 watt Neons bayonet base... **.20**
Sockets for 882... **.49**
6 Gang 3 position Isolantite Deck Switch... **.69**
2x2/879 Rectifiers... **.49**
3BP1 Cathode Ray Tubes... **1.45**
3C24 Triode... **1.39**
10 for... **3.50**

GREENLEE PUNCHES—
Cuts to 1/8" thick metal.

1/2"	\$1.94
5/8"	\$1.94
1"	\$2.12
1 1/8"	\$2.25
1-3/16"	\$2.75
1 1/2"	\$2.88

We carry a complete line of all sizes of punches up to 3 1/2" diameter.

SUPERIOR POWERSTATS

Smooth, efficient voltage control. 0 to 135V. output from 115V. AC line.

Type 20 (illustrated) 3 amps... **\$12.50**
116 for table mtg 7.5 amps... **23.00**
116U for panel mtg 7.5 amps... **19.00**
1126 15 amps... **46.00**
1156 45 amps... **118.00**

Also available for 230 volt input. Write for descriptive literature.

RELAYS CS DIFFERENTIAL

ates 220-250 Volts. 8000 pivoted normally open. Oper. V.A.C. Controls rated 2 amps. 110 ohms each coil. contacts bridge type circuits where limited or current or power is available **88c**

GENERAL ELECTRIC PYRANOL CONDENSER

1 Mfd 15000 V.D.C. Brand New. Shipping Weight 35 lbs. A terrific value **\$10.95**

PLATE TRANSFORMERS

For Small Transmitters. DC Voltage Ratings are Approx. Values Obtained at Output of a 2 section Choke Input Filter. Using Mercury Vapor Rectifier Tubes Pri. is for 115 V. 60 cy.

EASY TO LEARN CODE

It is easy to learn or increase speed with an Instructograph Code Teacher. Affords the quickest and most practical method yet developed. For beginners or advanced students. Available tapes from beginner's alphabet to crucial messages on all subjects. Speed range 5 to 40 WPM. Always ready—no QRM.

ENDORSED BY THOUSANDS!

The Instructograph Code Teacher literally takes the place of an operator-instructor and enables anyone to learn and master code without further assistance. Thousands of successful operators have "acquired the code" with the Instructograph System. Write today for convenient rental and purchase plans.

INSTRUCTOGRAPH COMPANY
4711 SHERIDAN ROAD, CHICAGO 40, ILLINOIS

LEARN TELEVISION

ELECTRONICS RADIO

Modern Completely Equipped Laboratories

DAY AND EVENING CLASSES

G.I. Approved—Veterans Receive Subsistence

ENROLL NOW!

ELECTRONICS INSTITUTE, INC.
21 Henry, Detroit 1, Mich.

August, 1949

113

www.americanradiohistory.com

PARTS CARNIVAL

CONDENSERS

SPEAKERS

VIBRATORS

CHANGERS

AUTO RADIO REPLACEMENT VIBRATORS

Type	Mallory	Radiart	Each
V1	294	5300	\$1.19
V43	854	5331	.69
V49	505P	5320P	.69
V71	249	5406	.89
V66	246	5411	.89
V5	245	5409	.89
V6	296	5306	.69

LIMITED QUANTITIES—ACT NOW

P. M. Speakers P. M.

ALL BRAND NEW—NO SECONDS

3" P.M. 1 oz. Alnico V. Mag.	\$0.89
4" P.M. 1 oz. Alnico V. Mag.	.99
5" P.M. 1 oz. Alnico V. Mag.	1.10
5½" P.M. 1½ oz. Alnico V. Mag.	1.49
6" P.M. 1½ oz. Alnico V. Mag.	1.69
8" P.M. 2.15 oz. Alnico V. Mag.	2.45
8" P.M. 21 oz. Alnico 3 Mag.	3.65
6"x9" P.M. 2.15 oz. Alnico V. Mag.	2.45
10" P.M. 4.7 oz. Alnico V. Mag.	3.65
12" P.M. 21 oz. Alnico 3 Mag.	4.95

SEEBURG Model 1 Record Changer

Finest 2-post record changer on market. Will play 12" and 10" or 10" and 12" records. Base size 14" square. Automatic shut-off after last record. Best Astatic Cartridge and Permanent Needle. A big bargain for only..... **\$17.95**

SEEBURG DS101 Record Changer on Base
Handles 10- or 12-inch records. Smooth, quiet action. Lightweight pickup arm with astatic Q-type cartridge and permanent needle—the right combination for high-fidelity reproduction. Handsome formed walnut-finish wood base 12½"x14½". Complete with shielded cable and plug for connection to radio or amplifier, and line cord and plug for 110-V 60-cycle operation. Regular \$44.25. **\$17.95**
Now only.....

STANDARD BRANDS CONDENSERS

Bi-Pass 600V Tubular Pigtail Types

.001.....6c each	.02.....6c each
.005.....6c each	.05.....7c each
.006.....6c each	1.....8c each

(Deduct 10% in lots of 100—may be assorted)

Tubular Electrolytics

	Each	10 for
20-20 MFD—150V.....	39c	\$3.50
50-30 MFD—150V.....	58c	5.00
40-40 MFD—150V.....	48c	4.20
35-30 MFD—150V.....	45c	4.00
8-8 MFD—450V.....	58c	5.40
20-20 MFD—450V.....	79c	7.50

F. P. CONDENSERS

We have a limited quantity of F. P. Condensers in single, dual and triple sections, in various capacities and voltages. Large variety but small quantities of each. We offer them 10 assorted for \$2.00. An excellent value for the Serviceman.

ORDER FROM THIS AD!

Select what you need from the big values listed here—and send your order now! Quantities are limited.—Send 25% deposit with order. We ship C.O.D. for balance, all advertised items F.O.B. Chicago. When remitting in full, include sufficient postage—overages refunded. GET YOUR NAME ON OUR MAILING LIST. We carry complete stock PA equipment—BOGAN, MASCO Amplifiers—Shure, Turner Mikes—University Speakers, etc.

Write for complete list TODAY!

NATION WIDE RADIO
(The Serviceman's Supply House)
572 W. Randolph Street
CHICAGO 6, ILLINOIS

dio Australia reported the "Forces Broadcasting Service in the Middle East" had been heard testing on 7.220; this may be a new one located on Malta.

OZH, 15.165, Copenhagen, Denmark, noted recently from tuning shortly after 2000 to closing around 2105 with Danish National Anthem; was not parallel 9.52; read news in Spanish and then gave station announcement in both Spanish and Danish at close-down; signal improved when Oslo's 15.17 left air 2100. (Fargo, Ga.) This may be a new transmission to Latin America.

At present, the Chinese Communist stations give English news program and discussions at 2130 Shanghai time (0830 EST) for usually 20 minutes; announce as the Peiping-Nanking Broadcasting System, and give frequencies of 14.02, 6.096, 10.28, 9.740, and 7.50. Heard in Hawaii also on 5.980 with good signals, also on 6.07, fair level, loud carrier hum; approximately 7.48 very weak, usually inaudible; 9.73 very good, and approximately 10.30 is good level; all with 0830 newscast; quality of the Nanking station is very poor, also Peiping. (Fellers, Hawaii.)

Blüman, North Africa, reports "Israeli Forces Broadcasting Station," 4X4EA, is on 6.725, verifies reports addressed to Station 4X4EA, A.P.O. No. 150, Tel-Aviv, Israel. Blüman says Kol-Israel, 6.820 and 8.170, has published a new schedule of 2245-0100, 0300-0645, 0830-1500; news 0600, 1400; another transmitter is being tested on 11.840 in the mornings" and on 11.62 in the "evenings," relaying Kol-Israel. (Swedish DX broadcast.)

A transmitter reported earlier as

testing under call sign "Radio Peloponesus," Greece, now opens 0000 with roll of drums and the Greek National Anthem; however, fades out after 0230 but is heard reopening 1100 with a Greek marching song; closes down around 1600; frequency is approximately 7.050; location seems to be Nauplia. Another Greek station so far unidentified can be heard on 7.040 opening 0000. The Greek Communist Radio can be heard on approximately 9.665 at 0700-0730 and on approximately 6.500 at 1200-1415; generally adjusts frequency during transmission in order to escape QRM. (Swedish DX broadcast)

Airmail tips just in from Dorothy Sanderson, Australia, include BED9, 7.22, Formosa, noted 0645 with Chinese news, then music; Radio Kuala Lumpur, 6.025, noted with news 0630 yet; Srinagar, Kashmir, heard on 4.856, at 0745 with native program; Bangkok heard on 6.010 in parallel 11.650 around 0600, news yet 0615. Radio Ceylon noted on 21.62 at 0430; DZH5, 9.69, Manila, noted 0445 with sponsored program; DZH4, 6.000, heard 0515 with music, good signal. PLB-4, 10.36, Batavia, Indonesia, noted 0630 with musical program and Dutch news, announcing as "Batavia II." Radio Hue, 7.21, Fr. Indo-China, heard 0630 with French news, then music, relayed from Saigon, while Radio Dalat has recently been logged on 6.18 at 0700 with French news, then music, chimes and gong. KZCA, 9.535, Salzburg, Austria, heard in Australia 0100 with news in German, followed by music. ORL3A, 9.55, Prague, Czechoslovakia, noted 1645 with news. Cape Town, 5.88, South Africa, heard 1630 in Australia.

Fifteen foreign engineers, representing twelve organizations in Canada, Latin America, and Europe, were among the many TV engineers who attended the recent seventh Television Technical Training Program at the RCA Victor plant in Camden, New Jersey. Here, John H. Roe, TV development engineer (second from right), demonstrates a TV studio camera for (l. to r.) W. Obermuller, RCA, Brazil; V. Montes, CMQ, Havana, Cuba; Antonio Zamarano, Humara Y Lastra S. en C., Havana, Cuba; Dr. Edoardo Cristofaro, RAL Italy; and Luigi Sponzilli, RAL Italy.



Bangkok, 6.01, Siam, fair signal 0600 in California, news 0615; signs off just after 0630; cannot find parallel in 25-m. band (11.65 or 11.715). (Balbi) Other last-minute tips from Balbi include a Chinese station on about 11.815 heard after 0345 and still on 0700; not parallel 9.73 or 10.26; might be Shanghai as Balbi found 11.78 channel (supposed to be used by Shanghai), clear at 0630. *Radio Sario*, Menado, Celebes, Indonesia, at time this was compiled seemed to have "wandered" again from its 9.72 channel up to about 9.76. Balbi says Hankow, 11.492, appears off, and that he no longer was hearing Canton, 11.65. The 6.075 outlet at Petropvlosk, U.S.S.R., signs on now 0223, strong to 0330 sign-off. CR7BJ, 9.65, not noted lately 0000-0100 (Portuguese), and CR7BE, 11.76 (*English*) has been only fair lately at that time. Balbi has heard *Radio Ceylon*, 21.62, from 0500 on, weak to fair; 15.12 is strong. Says SBT, 15.155, Stockholm, signs on 0015 (*except Saturdays*), fair to good signal in California.

LRS-1, 9.455, Buenos Aires, heard 0538 with fine signal, Spanish news. CXA-19, 11.835, Montevideo, Uruguay, noted 1705 in Spanish and then announced in *English*, continued in Spanish and music. ZPA-3, 11.85, Asuncion, Paraguay, heard from tuning 1910 to leaving them 2100 when they had announced "Reporte Esso"; all-Spanish; fair level. *Radio Pakistan*, 15.27, Dacca, heard 0700 with news. Manila heard on 17.764 at 0810 relaying news for "Voice of America"; at 0810 announced from U.S.A. and then from Manila; gave frequencies as 11.890 and 920 kc.; continued with language broadcast. (Ferguson, N.C.)

Lytle, Ontario, Canada, has received this data on CBC transmitters at Montreal. The stations are at Vercheres (35 miles east of Montreal, Quebec) and include two s.w. transmitters; one is 200 watts and the other, 7.5 kw. Frequencies allotted and which vary according to the seasons are CBFW, 6.09; CBFY, 9.52; CBFX, 9.61; CBFO, 9.63; CBFY, 11.705; CBFL, 11.72; CBFA, 11.76; CBLX, 15.09, and CBFZ, 15.19. At present using CBLX at 0600-1845; CBFO at 1900-2300, and CBFW at 0600-2300. Programs are *English* at 0600-1000 and French at 1100-2300. Both transmitters are RCA units. The 7.5 kw. one has a frequency range of 6-22 mc. and antenna is rhombic type of 100 ft. height; frequency range of the 200 watt station is 1.5-14.4, antenna is a doublet, 100 ft. high.

A Soviet station is heard on about 9.380 mornings with same program as Khabarovsk, 5.950; good signal on West Coast. (Dilg, Calif.)

Radio Australia has replaced 15.210 with 15.320 for transmissions beginning 2158, 0915.

The Fr. Indo-China station on approximately 7.210 is *Radio Hue*, P.O. Box 65, Hue, N.N., Fr. Indo-China; schedule believed daily 1800-2000, 2200-0100, 0500-1030. Some relays

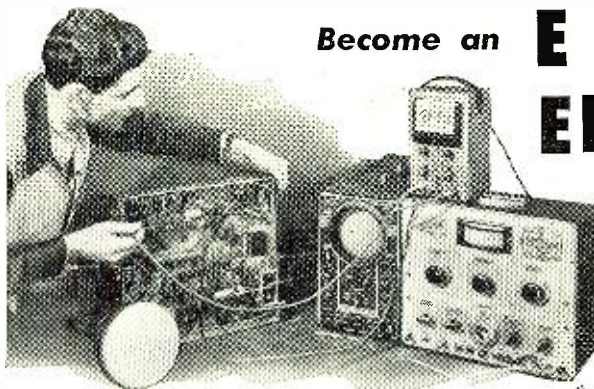

Become an ELECTRICAL ENGINEER

MAJOR IN ELECTRONICS



B. S. Degree . . . in 36 months

Make one of the most important decisions of your life—today! Capitalize on your electronic interests—decide to become an **Electrical Engineer**. Choose, also, to save a valuable year by earning your Bachelor of Science Degree here in 36 months of intensive study.

This 46-year-old, non-profit Technical Institute offers a world-famous course in **Electrical Engineering with a major in Electronics**. You follow an industry-guided program which is constantly attuned to current developments. It presents a solid background in the basic sciences . . . Chemistry, Physics, Mathematics, Economics and Electrical Engineering subjects . . . plus 19 technical specialty courses in Engineering Electronics, including four courses in Electronic Design.

Practical, military or academic training will be evaluated for advanced credit.

ELECTRONIC TECHNICIAN

At the end of the first year of study of the Electrical Engineering course, the student is qualified as an Electronic Technician.

RADIO-TELEVISION TECHNICIAN

To young men interested specifically in **radio and television**—prepare here for a career in television—the field which business leaders predict will be among America's top ten industries by 1951. In 18 months you become a Radio-Television Technician, ready for positions in receiver and transmitter testing, servicing, sales, supervision and production. Because of this school's **concentric curriculum**, the Bachelor of Science degree in Electrical Engineering (Electronics major) may be earned in 24 additional months.

* * *

A SPECIAL PREPARATORY PROGRAM is offered for men lacking high school diplomas.

TRAIN in modern, well-equipped laboratories, shops and classrooms. Faculty of 85 specialists—over 1500 students and 30,000 graduates.



FALL TERM OPENS OCT. 3

Electrical Engineering	36 months
Electronics Major	
Electronic Technician	12 months
Radio-Television Technician	18 months

MILWAUKEE SCHOOL of ENGINEERING

Founded 1903 by Oscar Werwath

Send Coupon for free 48-page Pictorial Bulletin, "Your Career," and 110-page Catalog.

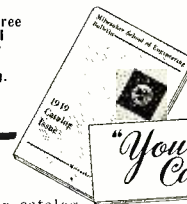

MILWAUKEE SCHOOL OF ENGINEERING

Dept. RN-849, N. Broadway and E. State, Milwaukee, Wis.

Without obligation send me the Bulletin, "Your Career," and your catalog.

I am interested in _____ course.

NAME..... AGE.....

ADDRESS

CITY..... STATE..... Veteran of World War II

AUTOMATIC M-90 AUTO RADIO



- Six Tube Superheterodyne
- Three Gang Condenser
- Powerful, Long-Distance Reception
- Fits All Cars, Easy Installation
- Mounting Brackets Included
- 6 Tube model M90
- 5 Tube model X50

Net \$29.97

Net \$29.97

Net \$24.36

MAIL US YOUR ORDERS

All orders filled within 24 hours. Illustrated parts list on request. Sylvania and Cunningham tubes 50% off list

Bill Sutton's

Wholesale Electronics
Fort Worth, Texas

Fifth at Commerce

FREE TELEVISION CATALOG FREE

OF

ALL T-V COMPONENTS EQUIPMENT • PARTS • KITS CABINETS • ANTENNAS, ETC.

WRITE Dept. 100

ARROW ELECTRONICS

INCORPORATED
82 CORTLANDT ST., NEW YORK 7, N. Y.

NEW TELEKITS

NOW

59⁵⁰

Jobbers: Write for Confidential Price Information

NEW TELEKITS
10-B \$82.99
7-B \$59.50

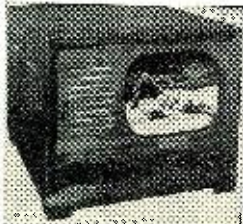

Sparkling new Telekit 10-B has 52-inch screen. Brand new compact lay-out has video tube mounted on chassis. Big illustrated easy-to-follow instruction book guides you step by step through easy assembly. No special knowledge of television is required. All you need is a soldering iron, pliers, and screw driver. 10-B kit can be used with 12 1/2, 15, 16 inch tubes. Telekit 10-B, \$82.99. Tube kit, including 10BP4 and all other tubes, \$55.80. 10-B Telekit cabinet \$15.95 to \$24.50. Telekit Guarantee includes free factory service.

Write for catalog listing 10-B and 7-B Telekits. New 7-B Telekit for 7-inch tube, \$59.50. Tube kit, including 7JP4, \$39.58. 7-B cabinet, \$15.95 to \$24.50.



Note simple clean lay-out for easy assembly of new Telekit 10-B. Features 2 sound I. F. stages, a new pre-built, pre-aligned tuner that includes a stage of R. F. for distance reception. Easy-to-adjust horizontal lock circuits. Beautiful new model cabinets for 7-B and 10-B are heavily constructed of hand rubbed walnut.

13 CHANNEL TUNER \$19.95



NEW 13 CHANNEL TUNER is a small compact unit with stage of R.F. Tunes all TV and 2FM channels. Made to conform with Telekit or any other TV set having video I.F. of 25.75 Mc. Complete with tubes, pre-wired, pre-aligned; only three connections to make. See your jobber, or write to us for information. Your cost, \$19.95.

Write for catalog of Telekit antennas, boosters, television kits tuners, television parts and tubes.

TELEKIT

ELECTRO-TECHNICAL INDUSTRIES
1432 NORTH BROAD STREET PHILADELPHIA 7, PA.

seem to be taken from Saigon. (*Radio Australia*)

Moscow appears to use 15.14 now in parallel 15.34 and others to Asia and the Far East (*English*) 0700-0800.

Radio Norway, Oslo, has a transmission to South American Waters now 1800-1900 on LLG, 9.61; LKQ, 11.735, and LKQ, 15.17. North American beam remains 2000-2100 on same channels. Frequent *English* announcements noted in both periods. (Worris, N.Y.)

In order to establish and increase cooperation among s.w. radio clubs throughout the world. *Radio Sweden* is preparing a "catalogue" covering all clubs; desires information on name of club, postal address, number of members, house organ, and so on. Information should be sent to DX Editor, *Radio Sweden*, Stockholm, Sweden. (Swedish DX broadcast)

Radio Tananarive, Madagascar, still heard on 9.695 in parallel with approximately 6.07 opening 2230; identification is easy, "*Ici Radio Tananarive*," following "*La Marseillaise*"; news in French 2300. (Fellers, Hawaii)

Some time ago ZNP-19, Amman, Trans-Jordan, of Cable Wireless, was heard testing around 19.140; had recordings of dance music 0915-0930; good signal in New York. (Osterman)

* * *

Acknowledgement

Thanks for the F.B. reports which have come in lately despite relatively poor reception conditions. Best of DX to all! K.R.B.

Spot Radio News

(Continued from page 14)

sideration the propagation studies of the *ad hoc* committee, which were recently submitted to the Commission. The industry will be given thirty days to study the proposals, and offer comments and alternate suggestions at a meeting two weeks later. This meeting will be followed by an oral argument session, after which the FCC will probe the mass of testimony and try to arrive at a decision.

Although many praised the long-awaited definite statement of the FCC explaining its plan for TV, there were others who severely criticized the move as premature. Commissioner Frieda B. Hennock was one of the most outspoken of the dissenters, declaring that the action was too hasty. She said: "I am keenly aware of the intense interest in the progress of television shared by members of the public generally, and especially the families contemplating purchase of a television set, by manufacturers and by station licensees. But I am aware also of the many problems that exist as to the future status of black-and-white television, color TV, both in the present and proposed bands, and the multitude of other questions which must be solved to insure the finest development of this great new art for as many people as possible. I feel strong-

ly that these questions must be carefully deliberated and thoughtfully answered . . . by the orderly conduct of rule-making proceedings. We are now in the midst of such proceedings, in which all interested persons are being offered a full opportunity to participate, present their views, and offer technical information. . . . I feel that we must patiently continue to move forward in this orderly manner."

Members of the RMA also found that the announcement could have a serious effect on current business and thus prepared a clarifying statement emphasizing that TV sets purchased today would continue to receive TV casts and provide service for the life of the receiver. Agreeing with the FCC that the existing twelve channels are not sufficient for a nationwide program and, thus, the ultra-high channels are required, the RMA release went on to state that present sets could be adapted to receive the higher frequency stations with "simple and inexpensive converters." Covering the delicate subject of color, which was also mentioned in the FCC report, RMA pointed out that the . . . "industry has been and still is engaged in research on the various proposed systems of color TV which are still in the laboratory stage. When and if one of these systems is accepted by the FCC and the industry as standard, it must be thoroughly field tested and proven under practical broadcasting conditions. The industry is in accord with the policy expressed by the FCC that any future color system must be capable of being received on present sets with only minor modifications."

Others viewed the FCC announcement as a confirmation of the facts cited during the recent engineering hearings and sessions, with the ultra-highs becoming available not only for the smaller communities which the present allocation schedule cannot accommodate, but also for those areas which, unfortunately, fall into the interference path and thus must resort to high-band stations. Fortunately, at present, the latter condition does not prevail in too many cities with operating stations and too large a receiver audience. Color, also probed at these hearings, is still believed to be in the early experimental stages, and many predict that it will not become available commercially for entertainment purposes before at least 1956.

THE VIRTUES OF FM are being debated once again, with the boys at the FM Association playing a hammering role.

William E. Ware, president of the association, who has sparked the new cycle, declared that . . . "FM is the only expandable product remaining on the radio market for the next year or so."

Ware pointed out that FM coverage is far beyond that of most AM stations, especially at night. Neither is it plagued by conditions suffered by AM broadcasting, he continued, such

WHERE TO BUY IT.....
WHOLESALE RADIO
of Baltimore

Unbeatable T. V. Reception

For the strongest, sharpest, brightest picture possible in any location.

Snyder Lazy XX T.V. ANTENNA

Quick to install
Just unfold,
tighten and erect.

Extremely hi-gain. Recommended for fringe areas. Easily stacked conical lazy X type. All channels plus FM. Over-all height 11 ft. erected. Complete with 3 masting mast sections, guy wire anchors. Stand-off pole, insulators and adjustable mounting base. Completely preassembled. Order Model TX-2.

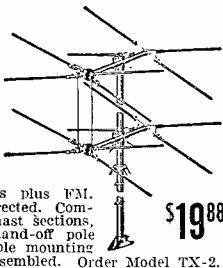

\$19.88

Low Cost, High Quality, Instruments

New Jackson Tube Tester



Includes the famous dynamic testing method, first used by Jackson. Provides tube tests under actual use conditions. Tests over 700 types including T.V. rectifiers and sweep tubes. Built-in roll chart. Shorts and noise tests. Combination push-button, rotary switch element and voltage selection. Order Jackson Challenger Model 103.

\$49.50

New Jackson Oscilloscope—CRO-1.....\$195
New Jackson TV-FM Sweep Generator—TVG-1.....\$220

Lowest Prices On Quality Gudeman

Tubular Type ELECTROLYTIC CONDENSERS

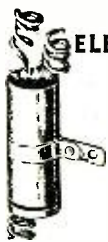

25 mfd—25 v.	25c
20 mfd—150 v.	24c
40 mfd—150 v.	33c
20—20—150 v.	39c
40—20—150 v.	48c
50—30—150 v.	54c
40—20—150 v.—20—25 v.	65c
50—30—150 v.—20—25 v.	72c
50—30—150 v.—200—25 v.	85c
80—40—20—150 v.—20—25 v.	90c
8 mfd—450 v.	23c
16 mfd—450 v.	36c
20 mfd—450 v.	49c

Other Sizes Proportionately Low Priced!

Save Time and Do a Better Job with LYNN LIGHTNING Solderless Terminals



Clear, plastic kit includes a complete assortment of the most popular Solderless Terminals, insulation tubing, and Crimping Tool. The Ideal Kit For—

- Automotive Mechanics
- Electrical Repairmen
- Maintenance Men
- Garage Owners
- Fleet Operators
- Service Shops

No. 2090
Service Kit \$7.95

No. 1900
CRIMPING TOOL
Cuts wire . . .
strips wire . . .
crimps terminals.
Sold separately. \$2.95

Extra Terminals
Available in Popular
Dollar Packs



ATR "A" BATTERY ELIMINATORS

Specially designed for testing and operating auto radios and P.C. electrical apparatus on A.C. lines 105-125 v. 50-60 cycles. Std. model 610 ELIP. Rated output 6 v.

10 amps.	\$32.40
Heavy Duty model 620-c ELIP. 6 v. 18 amps, 12 v.	\$49.80
9 amps.	

WRITE FOR FREE MONTHLY "FYI" BULLETIN
Phone Mulberry 2134

Address orders to Dept. QR-84

WHOLESALE
RADIO PARTS CO., Inc.
311 W. Baltimore St.
BALTIMORE 1, MD.

ence-free channels to handle any foreseeable expansion in the use of radio in the future. The report stated that the original allocation of sixty frequencies was based on an estimate that thirty usable frequencies would be necessary to handle main line communications of the thirty-two yards operating in Chicago. Yet, the FCC explanation discloses, more than three years after the allocation, only seven roads were using radio for such operations.

Continuing its blistering criticism of the railroads, the Commission urged that the roads re-evaluate their requirements, make a full investigation of systems engineering on a coordinated basis of operation, if necessary, and study a functional use of frequencies, as is done in the aviation and marine services, to determine the best method of utilizing the spectrum space allocated. The Commission said it felt that the more than two megacycles of space provided (nearly 25 per-cent of the entire band) was ample to permit the present establishment of an extensive and efficient system of train communications.

ONE OF THE MOST AMBITIOUS European FM broadcast programs is now under way in the American and British zones of Germany.

According to a report from the International Broadcasting Union, Geneva, plans call for the construction of fifty-six stations in the American zone, using powers of 250 watts and

one, three, and ten kilowatts. Receivers with sensitivities of 100 microvolts have been suggested. To expedite the development and production of these receivers, a receiver-design contest has been set up, with substantial awards offered.

The rules cite that receivers must be built from German materials or such components, accessories, and raw products as may become available in Germany in the near future. Some of the electrical requirements of the receivers are: FM frequency coverage between 87.5 and 100 mc., audio frequency time constant of 75 microseconds, and standard band coverage between 525 and 1620 kc. A reward is also being offered for a converter which will permit the reception of FM signals.

The set and converter-contest jury will be composed of a representative of the broadcasters from each of the three Western zones and the technical directors of the Radio Engineering Institute of Bad Homburg and NWDR, the FM station in Hanover, which went on the air in March of this year.

Industry experts here and abroad will be keen observers during this unusual contest which may not only produce the important equipment required, but reveal the type of talent now available on the continent; it will indicate, too, the technological progress which has been achieved in the Western zones of Germany, a point of vital interest to the world at large. . . . L. W.

RCA celebrated the production of its one-millionth television picture tube recently with a broadcast of the event which was relayed to video audiences in twelve cities. Besides the eye-witness report of the actual manufacture of the kinescope, viewers saw the first reported demonstration in which electron scanning beams in home TV sets were slowed down to show how the picture is painted on the face of the tube. Here, the one-millionth tube is lifted off the production line by Darlene Currant, plant employee, as Ben Grauer (center) reports for NBC's television network and D. Y. Smith (left) manager of the Lancaster, Pa., plant, looks on.



TV Interference

(Continued from page 33)

field strength meter similar to the *Transvision* Model FSM-1, which tunes the television channels, will give precise information on all signals in the affected spectrum. In the absence of specific information, start with traps covering the 27 to 30 megacycle region, followed by ones covering 50 to 60, 14 to 15, and 144 to 148 megacycles. Usually series-resonant ones from each side of the line to ground are more effective, but sometimes the parallel types are better, and at other times, both types are necessary. Shielding the traps in aluminum or copper boxes is desirable to prevent re-radiation of the trapped signals.

Signal Boosters or Preselectors

Signal boosters attack the interference in two ways, by amplifying the desired signal and, at the same time, attenuating the undesired ones. While almost any booster will amplify the television signals, not all of them are equally effective in eliminating off-channel interference.

Shielding

All of the boosters and traps made will not help when the interference is picked up directly by a receiver component, usually in the intermediate frequency channels. The cure for this is shielding. A thorough job is generally impractical, but an aluminum or copper bottom plate for the receiver chassis, or a lining of fine mesh copper screening for the inside of the cabinet may be helpful.

Special Conditions and Conclusions

Occasionally, a transmitter harmonic will fall into an unassigned television channel and block out the channels on either side. Although this is basically a transmitter fault, it may be easier to suppress the harmonic at the receiver with traps at the transmitter. In fact, it may be the only effective way.

That interference can usually be eliminated may be seen by the fact that many amateurs operate television receivers in their homes while the transmitters are working and are not bothered with interference. It is only fair to say, however, that not every case can be cured, but where television signals of adequate strength are available, a definite improvement can be expected. A method of attack that has not been described, is to retune the sound traps in the television receiver to different frequencies. This may reduce interference, but it usually degrades the picture as well.

Do not hesitate to ask the amateur to test with you, because he is probably more interested in eliminating interference from his transmitter than anyone. While we here emphasize amateur interference, any devices

A WIDE RANGE
HIGH QUALITY

...
INSTRUMENT



the new improved
ESPEY 511 AM-FM RADIO

- Here is a fine radio, in chassis form, to please the most discriminating music lovers.
- Easy to install in any console cabinet old or new, the Espey 511 AM-FM radio chassis embodies the latest engineering refinements for lasting high quality and enjoyment at a price that defies competition.
- Features, 12 tubes plus rectifier and tuning indicator; drift compensated circuit for high frequency stability; tuned RF on AM and FM, high fidelity push-pull audio; 13 watts power output; wide range 12" PM speaker; smooth flywheel tuning; phono input provision; separate AM and FM antennas.

Other models available including 25 watt output.

Write Dept. KD for your free catalog.

Makers of fine radios since 1928.

ESPEY MANUFACTURING COMPANY, INC.

528 EAST 72nd STREET, NEW YORK 21, N. Y.

TEL BUtterfield 8-2300

NEVER AGAIN

BRAND NEW—Genuine

WESTERN ELECTRIC
DRIVER UNIT with REFLEX PROJECTOR

Way Below Manufacturer's Cost



\$19.95

F.O.B. N.Y.C. 4 For \$75.00

WILL HANDLE UP TO 50 WATT WITH NO DISTORTION

MANUEL KLEIN

A Blast-Proof, Blare-Proof Reflex Speaker with a Projector especially designed for use with the famous WESTERN ELECTRIC DRIVER UNIT. Heavy gauge metal construction throughout, including the main trumpet section, gives you peak performance without blaring or blasting. Excellent for Industrial Purposes, Call Systems, Concessions — Ball Parks — Schools — and P. A. Work.

25% DEPOSIT WITH ORDER, BALANCE C.O.D.
74 CORTLANDT ST.
NEW YORK 7, NEW YORK
PHONE BEekman 3-9530 or REctor 2-6668

Get set for UHF

ULTRA HIGH FREQUENCY



CONVERTER

NOW AVAILABLE!

Be First...

Service men! Dealers! Engineers! Amateurs! Servicemen! Schools! Get set for important testing! Ultra-High-Frequency TV days are just ahead! Be ready for Conversion! Every TV set in your community is a prospect—NOW—for modernization to UHF reception. Go after this lucrative market TODAY—with the AERCO UHF CONVERTER! It's a triumph of engineering—the forerunner of the millions of converters to be manufactured and installed! Highest rated materials, finest quality construction. Thoroughly pre-tested and pre-aligned, ready for operation. No conversion necessary to the television receiver. Just attach to your present television antenna post. The converter does the rest.

Order yours NOW at our introductory LOW PRICE

only \$49⁵⁰

Complete with full technical data

AERCO SALES CO.,
540 Bushwick Ave., Brooklyn 6, N.Y.

ORDER BY MAIL

AERCO SALES CO.,
540 Bushwick Ave., Brooklyn 6, N. Y.
Gentlemen: Please ship.....Aerco UHF Converters @ \$49.50 ea. I am enclosing check
..... money order
Send C.O.D. I am enclosing \$5.00 deposit

Name.....

Address.....

City.....Zone.....State.....

emitting energy in the high-frequency spectrum, including government, aviation, or police radio stations, taxicab or FM broadcast stations, diathermy machines, and even the oscillators in FM and other television receivers can and do cause television interference. Much of it, however, can be eliminated by methods similar to those just described.

-30-

Carrier Communications

(Continued from page 25)

the means employed to achieve this include "choking," "trapping," and "bypassing."

Chokes and wave traps provide a means of guiding the carrier current along certain desired line channels and eliminating it entirely from others. Condensers allow the signal to be routed around oil circuit breakers or line type voltage regulators whose coils may offer enough impedance to the signal to cause attenuation.

Any electrical branch circuit or tap whose electrical length approaches one-quarter wavelength, or odd multiple thereof, will act as a short circuit to carrier current signals. These taps must be electrically lengthened by the insertion of choke coils in the lines, or, possibly by changing the transmitter frequency providing that by so doing new one-quarter wave taps are not set up.

There are various types of chokes called "isolating" chokes, which are inserted in the phase wire and act to prevent the carrier current from entering a line where it obviously is not desired.

An isolating choke is a large inductance capable of handling higher load currents and maximum fault currents. It may also take the form of a parallel resonant circuit. These traps, more often used in the higher voltage trans-

mission line circuits, are usually referred to as "bird cages."

"Tap" chokes are not quite as effective as isolating chokes in limiting carrier current and will not handle as large load or fault currents.

"Transmission" chokes allow some carrier current to pass through them and provide the means of electrically lengthening lines or taps.

The maximum load and fault currents in the power system must be known at all points where chokes are to be installed. The location of quarter-wave taps and points of high attenuation are best determined by field tests. The long line taps hardly ever require choke installations as they absorb enough energy in themselves and thus have small wave reflection. It is sometimes necessary to break up loop feeds by installing chokes at one point to prevent cancellation of signals. This cancellation occurs when circuits have parallel paths but one circuit is longer by one-half wavelength or 180 degrees.

Power lines must not be constructed and left unterminated as severe wave reflections result from open or short-circuited lines. Service transformers satisfactorily terminate the power lines at carrier frequencies, under normal working conditions.

Conclusion

The cost of two-way power line carrier systems is comparable to that of space radio systems for the same number of units.

Maintenance problems are not as great on carrier systems as those encountered in space radio.

Carrier current systems are being used for applications other than communications. Remote control of large power loads, such as hot water heaters, telemetering and measuring the power loads at remote points of the system, and remote switching are just a few of the present-day applications of carrier current systems. -30-

Fig. 8. Side view of the mobile transmitter-receiver chassis.

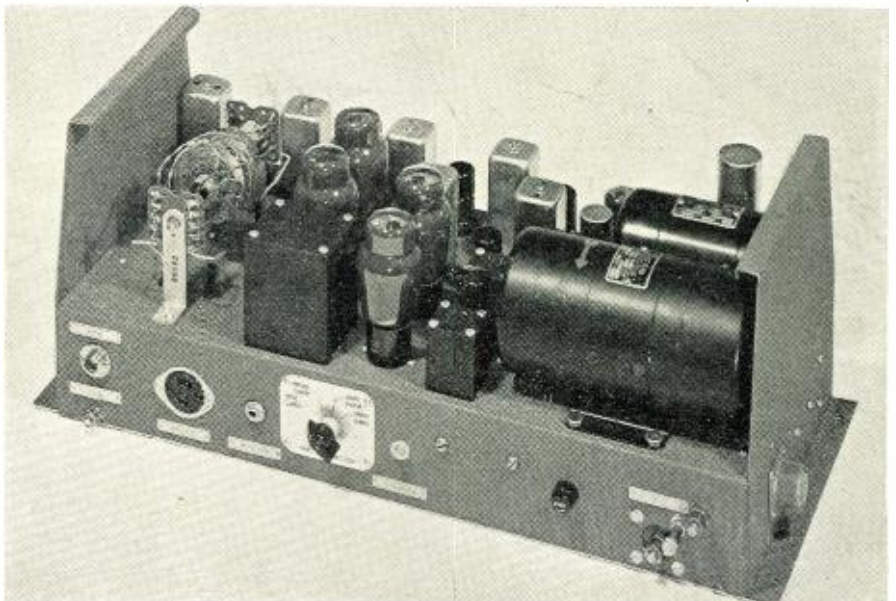

Mac's Service Shop

(Continued from page 36)

"Among other things, yes; and the big advantage of the mechanical fingers, as it is called, is that it is flexible. You can really work into some tight places, because it will curve around corners. It is surprising how small an object you can pick up with the gadget. With a test-lead attached, it also makes a good emergency connector for biting through paint or enamel.

"Speaking of attaching test-leads brings us to this little combination of Fahnestock and battery clips. As you know, we have a dozen or so of these things made up; and they are handy for a host of things. For example, the leads of a resistor or condenser can be slipped into the Fahnestock clips, and the part can be temporarily clipped into a circuit with the battery clips. Or you can use them on the ends of test-leads for attaching a meter to a suspected portion of a circuit when 'sweating out' an intermittent. The battery clips make dandy little clamps for holding the rim of a recemented speaker cone in place while it dries. Put one on the end of a test-lead, put a needle in the jaws of the battery clip, and you have a good emergency needlepoint test probe."

"What's the purpose of those long-handled tweezers?"

"Those 'long-handled tweezers' are surgical clamps, used to clamp arteries during an operation. Surgeons are darned good mechanics and know how to make and use good tools. Those gadgets are a natural for working in tight places. Their long handles and short jaws give them an altogether different 'feel' from needle-nose pliers; and it is surprising how tightly you can hold an object with them. Another feature is that they can be locked in the closed position. When you have a delicate job of soldering, you will appreciate how firmly a couple of those hemostats will hold the work for you."

"I suppose you use that hypodermic needle to give the old sets a 'shot in the arm,'" Barney offered.

"Well, not exactly," Mac said with a grin. "I got the thing after I saw a model railroad fan using one to oil his miniature locomotive. The big advantage is that it allows you to put exactly the amount of liquid you want precisely where you want it. Oiling dial cord pulleys without getting oil on the cord is one example. Putting a little acetone on a cemented speaker spider to soften it up so the voice coil can be moved over to where it belongs is another. It also is a dandy for shooting carbon-tet into a noisy volume control when the customer does not want to pay for a new one."

"And is that curved, out-size needle for closing the incision, Dr. McGregor?" Barney asked.

"No, that curved piece of piano wire with an 'eye' formed in one end is for

BUY COMET OUTSTANDING VALUES!

CODE EQUIPMENT

Tape Puller and Rewinder BOHME 4-F-FIL.	\$44.95
Tape Puller BOHME 11P.	39.95
Tape Bridge BOHME 4-5.	5.95
Tape Stand McElroy TS-915	1.45
Practice Tape—1 Hour Tape on 16MM Motion Picture Film Reel 400'	.75
Tape Reel McElroy "Cum-apt" Metal 16MM 400' Capacitance	.50
Signal Ink Recorder SR900 with Amplifier and Leveler SL900 Record Perfect Block Signal at Speeds above 200 Words per minute	35.95

AIRCRAFT EQUIPMENT

MN-26V Radio Compass Receiver 150-325KC. 325-695KC. 3.4-7.0 MCS, 28 Volt, Bendix, New	\$34.50
Impact Switch SPST Nor. Open, Operates upon application of 100 in horizontal plane, Kiddo, New	2.50
BK-22E Relay, New	4.50
T-21A Indicator, New	4.75
J-65 Indicator, New	4.75
BC-733D Receiver—Orig. Box, New	14.95

TUBES

2C4A	\$.65	20B1	\$.40
2X2A	.55	9001	.35
2X2/879	.35	9002	.35
3C24	.50	9003	.35
3C24	.35	9004	.35
3E29	3.35	3BP1	1.35
10Y	.30	3CP1	1.95
21A	1.45	3P4	2.45
15R	.75	3EP7	1.00
45 SPEC.	.35	CEO-72	1.30
803	1.45	3P4	2.45
450 TH	18.25	HY-69	2.10
713A	1.25	VT-127A	2.35
805	3.85	2A3	.85
807	1.00	3A4	.65
8145	1.45	30P4	2.45
826	.45	6AJ5	.85
872A	1.45	6HG	.35
803	1.45	3P4	2.45
CK1005	.25	12A6	.15
1616	.85	6Y6GT	.80
1629	.25	3Z5	.45

CAPACITORS

BATH TUB

4 MFD	50 VDC	\$.35	\$.30
4 MFD	100 VDC	.40	.35
3X.1 MFD	400 VDC	.25	.20
2X.25 MFD	400 VDC	.19	.15
.03 MFD	600 VDC	.20	.15
.25 MFD	600 VDC	.20	.15
.5 MFD	600 VDC	.30	.25
1 MFD	600 VDC	.30	.25
2 MFD	600 VDC	.45	.40

OIL FILLED AND G.E. PYRANOL

2 MFD	600 VDC	\$.35	\$.30
4 MFD	600 VDC	.60	.50
6 MFD	600 VDC	.65	.60
8 MFD	600 VDC	1.00	.90
10 MFD	600 VDC	1.10	1.00
4 MFD	700 VDC	.65	.60
2 MFD	1000 VDC	.55	.50
5 MFD	2000 VDC	2.00	1.70
.25 MFD	3000 VDC	1.95	1.65
.5 MFD	3000 VDC	2.00	1.75
.008 MFD	15000 VDC	6.95	6.50
.045 MFD	16000 VDC	3.95	3.50
8X10 MFD	90 V 60 cy	4.50	4.25

PAPER

8-8 MFD	600 VDC	Each	Ten
Tonp Filtermic		\$1.00	\$.90
3X8 MFD	600 VDC	1.45	1.25
8-84 MFD	650 VDC	1.45	1.25
160-160 MFD	150 VDC	1.25	1.00

ELECTROLYTIC

2500 MFD	3 VDC	\$.25	\$.20
150 MFD	25 VDC	.20	.15
150 MFD	50 VDC	.25	.20
500 MFD	200 VDC	1.00	.90

F-3 SANGAMO X-MITTING CAPACITY AMPS

007	12	5000	\$2.60
006	11	6000	4.10
002	7.5	8000	3.95
003	10	8000	4.70
004	10	8000	5.25
005	11	8000	5.65

TIME DELAY SWITCHES

3 Sec. and 90 Sec. Each SPDT Motor 120VAC	\$2.95
Cramer, Each	1.25
1 Minute 115VAC 60 cy Enc. In Waterproof Metal Case	2.95
3 Micro Switches Make Contact at 40-41-42 Sec. Time Delay	4.00
110VAC 60 cy Motor	4.00

DE ION LINE STARTER

DPST 115V 60 c. Westinghouse Type DN Size O, Class 15-825-0, NEW.....\$3.25

POTENTIOMETERS

Cat. No.	OHMS	WATTS	TAPER	BUSHING	SHAFT	PRICE	
WIREWOUND						EA. TEN	
003P5	5,000	2	LINEAR	3/16"	1 1/2"	WIRT \$0.25 \$0.20	
003B1	10,000	2	LINEAR	1/2"	3/8"	CHIC.TEL. .30 .25	
036B2	1,000	3	LINEAR	3/8"	7/8"	TREFF .25 .20	
02-885	15	25	LINEAR	3/8"	1 1/2"	DEUR .45 .40	
OHMITE	20	25	LINEAR	3/8"	1 1/2"	OHMITE .45 .40	
207B2	25	25	LINEAR	3/8"	1 1/2"	DEUR .50 .40	
048B1	50	25	LINEAR	3/8"	1 1/2"	IRC .55 .50	
N2017	100	25	LINEAR	3/8"	1 1/2"	OHMITE .55 .50	
OHMITE	500	25	LINEAR	3/8"	1 1/2"	DEUR .70 .65	
155B1	15,000	25	LINEAR	3/8"	1 1/2"	DEUR .85 .70	
105	20,000	25	LINEAR	3/8"	1 1/2"	OHMITE 1.10 .95	
OHMITE	300	50	LINEAR	3/8"	1 1/2"	DEUR 1.10 .95	
024	10,000	50	LINEAR	3/8"	1 1/2"	DEUR 1.50 1.25	
IRC	15	75	LINEAR	1/2"	1 1/2"	IRC 1.50 1.25	
OHMITE	750	150	LINEAR/ Knob	1/2"	1 1/2"	OHMITE 2.45 2.10	
HELIPOT CARBON	20,000	05%	5	LINEAR	1/2"	1 1/2"	GIBBS 4.50 4.00
101	500	2	LINEAR	1/2"	1 1/2"	AB .25 .20	
084	10,000	2	LINEAR	1/2"	1 1/2"	SD AB .25 .20	
134B1	20,000	2	LINEAR	1/2"	1 1/2"	SD AB .25 .20	
120B1	25,000	2	LINEAR	1/2"	1 1/2"	SD AB .25 .20	
125B1	50,000	2	LINEAR	1/2"	1 1/2"	SD AB .25 .20	
086	100,000	2	LINEAR	1/2"	1 1/2"	SD AB .25 .20	
151B2	200,000/200,000	2	LINEAR	3/8"	1"	SD AB .35 .30	

TERMS: Mail orders promptly filled—all prices F.O.B. Boston, Mass. Send M.O. or check. Shipping charges sent C.O.D. Minimum order \$5.00. 25% deposit required with all orders.

SEND FOR OUR CATALOGUE NOW!

COMET

22 Washington St.
Beacon 2-7863

ELECTRONIC SALES CO.

Brighton 35, Mass.

Inquiries from Dealers, Schools and Industrial Firms Invited

LOGARITHMS AND SLIDE RULE FOR PRACTICAL USE

by E. W. BANHAGEL

A practical, easy-to-understand volume on logarithms and slide rule from the elemental stages through the most advanced techniques. A college course condensed into easy reading. **\$2.50**

AT YOUR BOOKSTORE OR DIRECT FROM
ZIFF-DAVIS PUBLISHING COMPANY, 185 N. WABASH AVE., CHICAGO 1, ILLINOIS

LEARN RADIO!

PREPARE FOR A GOOD JOB!

BROADCAST ENGINEER
COMMERCIAL OPERATOR (CODE)
RADIO SERVICEMAN

Television Servicing

(Approved for Veterans)
SEND FOR FREE LITERATURE

BALTIMORE TECHNICAL INSTITUTE
1425 EUTAW PLACE, BALT. 17, MD.

RADIO Surplus Buys

G & H WAR SURPLUS CATALOG

—that is jam-packed with values galore for the factory, home, workshop, farm and outdoors! New, used and reconditioned items priced amazingly low!

10¢ Today!

C & H SALES CO.
1850-R8 East Colorado St., Pasadena 8, Calif.

SUMMER SPECIALS

6v. **DYNAMOTOR**. Output 190v. at 70 MA. 9 amp. drain; second winding gives 350 to 250v. at 50 to 100 MA, 10 to 15 amp. drain. Complete instructions. **NEW \$3.25**

FLASH! EXCLUSIVE!

WE KNEW IT WAS COMING! WE HAVE IT! Special custommade modulation-driver xformer for amazing rig Page 50 June **RADIO NEWS**. Full class A, not class B substitute. Good up to and including KW. 2500 rms insulation. Yes, you can rebuild your rig. **ONLY \$7.95...A REAL SCOOP WE'RE PROUD OF**

THE HOTTEST 10-METER SPECIALS!

BC-923 RECR. 4 chan. auto or manual tuning. 27-38.9 MC, AM or FM. Self cont. spkr. Double super-ckt. Contains xtal cal. het-type freq. meter, check points every 100 and 1000 kcs. Instructions for rewinding 3 of 4 chans. for full coverage 27-150 MC. and AC power. Exlnt. used, checked and guar. OK before shipping. **WITH 12 V DYNAMOTOR, \$27.50. LESS DYNAMOTOR...\$24.50**

BC-924 XMTR. Mates with BC-923. 30w. FM. 4 chan. Schematic. **W/DYNMTR \$27.50. L/DYNMTR \$24.50.**

RA-34 Rectifier for BC-375-E, BC-191, input 115 or 230v. 60 cy., filtered outputs 1000v. 350 MA and 12v 3.2 A; plus 12v. 14.5 A AC.

FIXED OUTPUTS, NO METERS \$59.50

VARIABLE OUTPUTS, WITH METERS \$85.00

TUNING UNITS for BC-375. Exlnt used. **\$1.95**

BC-306 Antenna Loading Units. **98c**

MAST SECTIONS. 38 1/4" long. Screw together. Extend as long as you like. **Each 35c**

RG-7/U 95 ohm cable. New. **Fl. 5 1/2c**

FLASH!

COMPLETE ADF INSTALLATION, SCR-269-G or AN/ARN-7 with MG-149. Exlnt used **\$69.50**

SCR-625 Metallic mine detector with BA-38 battery. Brand new, export packed. **\$39.50**

BD-71 6 trunk switchboard. New, complete **\$17.50**

W110B 2 cond. field wire. New, mile. **\$22.50**

SPECIAL! Hi-fi 15 w. triode output tube #10. .21c

DU-1 LOOP. 12/24v. .195-1.6 mc. Easily extended thru 2.8 mc. 2 stage pre-amp. Makes unidirectional direction finder of any recr. **NEW \$27.50**

HI-FI BULKHEAD SPKR. Phenolic cone. In weather-proof baffle, extra heavy PM. w/universal xformer. handles 25W. EXLNT USED. **\$14.95**

CATHODE RAY TUBE SPECIALS

7BP7 ea **\$3.95** **3EP1/1806P1** ea **\$3.75**

5CP1, 5PB4 ea **2.75** **3FP7, 3HP7** ea **0.98**

5GP1/5BP1XXX ea **1.75** **3DP1** ea **0.98**

5FP7 ea **1.29**

ASB-7 INDICATOR. Exc. foundation for test scope Contains 5BP1 and many smaller tubes. With schematic. EXLNT USED. **\$12.95**

SERVICEMEN'S SPECIALS

FRESH STOCK! SET MFR'S DISTRESS!

No. 20 stranded tinned copper push back wire. 18 50-ft. rolls, each roll diff. color. **\$7.95**

6" HVY-DUTY PM GE spkrs. New. Special. **\$1.89**

FP CONDENSER ASSORTMENT. All good items, includes: (4x20 @ 450v) (40, 30, 20 @ 450v) (30, 20, 20 @ 450v, 20 @ 25v) (30 @ 350v) (2 x 20 @ 300v) (20 @ 450v, 25 @ 25v) (100 @ 50v) (20 @ 25v). **25 assorted \$14.95**

TUBULARS. 100 asst. .01 & .05 @ 600v. **\$5.95**

COMMAND XMTR SUPER SPECIAL!

BC-457 (4-5.3 mc) or EC-458 (5.3-7 mc.) Used, as is condition. **\$2.95**

Please remit with order. Calif. buyers add sales tax.

G. L. ELECTRONICS

1260 S. Alvarado St., Los Angeles 6, Cal.

SCHEMATICS—CONVERSIONS FOR SURPLUS GEAR

PARTIAL LIST:

ARC-4 schematic, parts, cabling. **\$1.00**

Another **\$2.00** for 2-meter AC conversion with all specs, tune-up, color-coded wiring diagrams.

BC-375-E original schematic, tuning units, complete parts list, values, characteristics, circuit functions, plate and ant. currents. **\$2.00**

BC-645 original and conversion. **\$1.00**

ARC-5 schematics, all units. **\$2.00**

SCR-522-A, AM, and C schematics, parts lists with circuit functions, explanation of differences, chart for xtal selection. **\$2.00**

Please remit with order. We pay postage. Send stamped addressed envelope for comprehensive list, cross-indexed for BC and SCR. Add 25c for chart explaining code used in Army-Navy nomenclature.

R. E. GOODHEART **345 1/2 N. PALM DRIVE**

BEVERLY HILLS, CALIF.

stringing dial cords. After fumbling around for years trying to coax the end of a limp dial cord through holes and around corners, I finally made that flexible needle, and it makes the job twice as easy. What's more, it can also be used to thread a replacement wire back along the identical path the original wire followed—something that is hard to do with just the easily bent wire itself. It is often important, especially in TV circuits, that the original wire-dress be followed exactly."

"Now those next items are something I recognize," Barney announced proudly. "Them there are end-wrenches!"

"You're a bright boy—and you speak beautiful English!" Mac exclaimed fondly. "It is really surprising how many radio shops will have every kind of socket wrench you can imagine, but not a single end-wrench; yet, when it comes to moving speaker-cone spiders, or loosening a nut in a really tight place, those little end-wrenches are right there. You do not need them often, but when you do need them, nothing else will take their place."

"By golly, if I did not know better, I'd say that next thing was a bottle of the stuff Margie puts on her fingernails."

"And you would be right for the second time in one day—which sets some kind of a record!" Mac exclaimed. "I have six of those little bottles of what was originally clear fingernail polish; but I have added coloring matter—inks and cake coloring—so that now we have red, blue, green, yellow, white, and black colors. The little brush attached to the top is used to put a tiny spot of appropriate color on or near a lug before a wire is unsoldered from a coil, volume control, or socket. The stuff dries almost at once, and its use surely is an improve-

ment over drawing a wiring diagram before removing a coil with several connections. It also is a help for marking unmarked loop antenna and speaker connections."

"I've seen you use that last gadget so often that I was here a month before I was sure it was not a sixth finger," Barney remarked.

"I do use it a lot," Mac said with a chuckle. "In the first place, it is an ideal alignment screwdriver. It is small enough to go through any i.f. shield can port; the metal nib is not as wide as the lucite rod, which avoids shorting out 'hot' trimmer screws; the rod is long enough to reach trimmers intended to be adjusted through ports in the chassis or the back of the set; the insulation is good enough to avoid causing hum when adjusting the secondary of the output i.f. transformer—"

"Okay! Okay! So I'm convinced it is the ideal alignment screwdriver!" Barney broke in; "but what else can it do? Cook? Wash the dishes? What's that sheep's crook doing on the other end?"

"That piece of metal, which by no stretch of the imagination resembles a shepherd's crook, is intended to be used to pull or push wires, condenser leads, socket lugs, and so on," Mac explained, "and, because of its small size, it is fine for the job. You can work it into almost any spot without danger of causing a short, and you can sort out just the one lead you want to move."

"Don't you have some more time-savers?" Barney asked hopefully, with a furtive glance at the clock.

"Lots of them," Mac replied with a knowing grin, "but they will keep. Right here is where we start spending time—on the bench. Grab yourself a radio and the soldering iron, Glamour Boy!"

-50-

Located atop a mountain six miles from Johnstown, Pa., Station WJAC is one of the few radio stations in the country with a radiant heating installation. The new FM transmitter remains comfortable amid the wildest mountain storms, thanks to the heating system embedded in the concrete floor, which employs about 2 1/2 tons of wrought iron pipe coils. Hot water is circulated through the pipes, converting the entire floor of the building into a heating panel that maintains constant comfort.

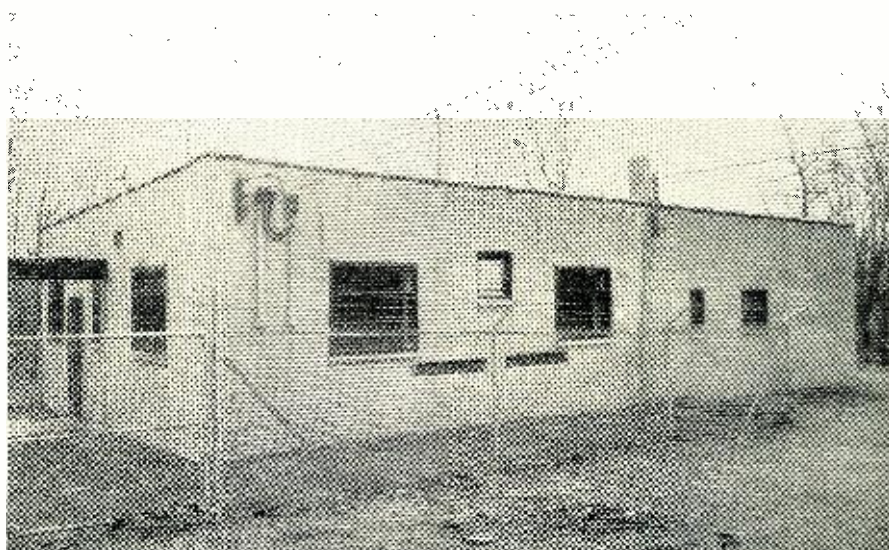

Technical BOOKS

"RADIO LISTENING IN AMERICA" by Paul F. Lazarsfeld and Patricia R. Kendall. Published by Prentice-Hall, Inc., New York. 178 pages. Price \$2.50.

This book is a complete report of a public poll and will serve as an indicator of the current trends in radio listening and perhaps as a yardstick for new standards of program planning and quality.

The report is based on two nationwide surveys conducted by the National Opinion Research Center at the University of Chicago. Beginning with a combined study of radio entertainment and book and magazine reading, it cites documentary evidence to show that there is a close relationship between reading tastes, movie going, and radio listening habits.

Radio fans' likes and dislikes differ widely in terms of social and economic status, education, age, sex, and urban or rural residence. The answers received are tabulated and then interpreted to reveal their true significance. The listening public's appraisal of radio uncovers some interesting facts. For instance, only nine per-cent condemn the oft-maligned daytime serials, whereas the theoretically popular mystery and crime programs are thought to be harmful by fifteen per-cent of all listeners.

Advertising is a matter on which the listeners have decided opinions. Indifference to the commercials is general, and fifty-seven per-cent are willing to tolerate them, while only nine per-cent would abolish them. Observations included in the appendix on singing commercials in particular should be quite revealing to broadcasters, program directors, and the listeners themselves.

"AUTOMATIC RECORD CHANGER SERVICE MANUAL, Vol. 2" by Sams Staff. Published by Howard W. Sams & Co., Inc., Indianapolis 1, Ind. 400 pages. Price \$6.75.

Volume 2 of the "Record Changer Manual," first published in 1947, continues with a complete coverage of automatic record changers and wire and tape recorders, with no duplication of contents. All of the newer designs and innovations in record changer mechanisms are included.

In the volume are diagrams for forty-six changers. Information on each of these is divided into at least four pages, beginning with some general information on the model. The section then enters on detailed descriptions of the parts, showing the placement of the components by large diagrams; the adjustment and mechanical operation directions next are given, together with check charts and a parts list. Pictures, several of them on every type of changer, are

August, 1949

TUBES! NATIONALLY ADVERTISED BRANDS TUBES!

RCA — Kenrad — Sylvania — Tung-Sol — National Union — Raytheon — Philco — Hytron
All new tubes. 100% guaranteed. Individually boxed.

TYPE	PRICE	TYPE	PRICE
0A4G	\$.09	5T4	\$.40
01A	.50	5U4	.54
02A	.80	5V4G	.85
1A3	.80	5W4	.96
1A4P	1.40	5X4G	.65
1A5GT	.65	5Y3GT	.45
1A6	1.15	5Y4G	.54
1F5GT	.72	5Z3	.96
1B4P	1.40	5Z4	.96
1B5/25S	1.15	6A3	.96
1C5GT	.80	6A4/LA	1.15
1C6	1.15	6A6	.96
1C7	1.15	6A7	.72
1D5GP	1.40	6B2T	.72
1D7G	1.15	6AB7	1.15
1D8GP	1.40	6AC7	.96
1E5GP	1.40	6AD7G	1.15
1E7GT	1.40	6AF6G	.96
1F4	.96	6AG5	1.25
1F5G	.96	6AG7	1.15
1G4	.96	6AK5	1.25
1G6GT	.96	6AL5	1.25
1H4G	.80	6AL7	.96
1H5GT	.80	6AQ7	.80
1H6	1.15	6AT6	.54
1L4	.72	6B4G	.96
1LA4	.96	6B7	1.15
1LA6	.96	6B8G	1.15
1LB4	.96	6B8G	1.15
1LC5	.96	6C6	.50
1LD5	.96	6C8G	1.15
1LG5	.96	6D6	.80
1LE3	.96	6E5	.80
1LH4	.96	6E5	.80
1LN5	.96	6F3GT	.60
1N5GT	.72	6F6	.72
1P5GT	.96	6F6G	1.15
1Q5GT	.96	6G7	1.15
1R4	.96	6F8G	.96
1R5	.72	6G6G	.96
1S4	.85	6J5GT	.54
1S5	.65	6J6	1.25
1T4	.72	6J7	.72
1T5GT	.96	6A6GT	.54
1V	.80	6K8	.85
2A3	1.15	6L5G	.96
2A4G	1.15	6L6	1.25
2A5	.80	6L6GA	1.15
2A6	.96	6L7	1.15
2B7	.96	6N7	.85
2X2	1.15	6P5GT	.80
3A4	.72	6Q7	.72
3B7/1291	.96	6R7	.96
3D6/1299	.96	6S7	.96
304	.80	6S8G	.85
3Q5GT	.85	6SA7GT	.60
3S4	.72	6SB7-Y	.85
5R4GY	1.40	6SC7	.72
		6SD7GT	1.15

SPECIAL! SAVE!
26-27-76-77-78
6K7-6C5-6H6GT
49c EACH
10 FOR \$4.49
EACH OR
100 ASSORTED \$39
ONLY

6SF5	\$.072	6Y7G	\$.15
6SF7	.72	6Z7G	1.40
6SG7	.72	6Z5G	.80
6SH7	.80	7A4	.72
6SJ7	.80	7A5	.72
6SK7GT	.80	7A6	.72
6SL7GT	.85	7A7	.72
6SN7GT	.80	7A8	.72
6SQ7	.80	7B4	.72
6SR7	.65	7B5	.72
6SS7	.65	7B6	.72
6ST7	.96	7B7	.72
6SV7	1.15	7B8	.72
6T7G	1.15	7C5	.72
6U5	.72	7C6	.72
6U6	.65	7C7	.72
6U7	.65	7E6	.72
6V6	1.15	7E7	.80
6V6B7	.72	7F7	.80
6V7G	.96	7F8	.96
6X5GT	.54	7G7	.96
6Y6G	.85	7H7	.72
		7H7	.96

TERMS: 25% with Order
—Balance C.O.D.—F.O.B.
Chicago. Prices Subject
to Change Without Notice.
Minimum Order \$2.00.

TYPE	PRICE	TYPE	PRICE
7L7	\$.80	31	\$.96
7N7	.80	32	1.15
7O7	.72	32L7GT	1.15
7V7	.96	33	1.15
7W7	.96	34	1.15
7X7	.96	35	.72
		35A5	.72
		35B5	.72
		35L6GT	.66
		35W4	.45
		35Y4	.65
		35Z4	.65
		35Z4GT	.45
		35Z5GT	.96
		36	.96
		37	.65
		38	.80
		39/44	.96
		40	.80
		41	.60
		42	.60
		43	.60
		44	.60
		45	.60
		45Z3	.65
		45Z3GT	.65
		46	.96
		46Z5	.96
		47	.85
		48	1.40
		49	1.40
		50A5	.80
		50B5	.72
		50L6GT	.80
		50X6	.80
		50Y6GT	.65
		51	.96
		52	.65
		53	.65
		54	.65
		55	.72
		56	1.40
		57	.72
		58	.60
		59	.96
		60	.45
		61	.96
		62	.72
		63	.60
		64	.96
		65	.96
		66	.96
		67	.96
		68	.96
		69	.96
		70	.96
		71	.96
		72	.96
		73	.96
		74	.96
		75	.96
		76	.96
		77	.96
		78	.96
		79	.96
		80	.96
		81	.96
		82	.96
		83	.96
		84	.96
		85	.96
		86	.96
		87	.96
		88	.96
		89	.96
		90	.96
		91	.96
		92	.96
		93	.96
		94	.96
		95	.96
		96	.96
		97	.96
		98	.96
		99	.96
		100	.96

FRANKLIN-ELLIS CO. 1313 West Randolph Street Dept. RN-8 Chicago 7, Illinois

MECHANIC'S VEST POCKET REFERENCE BOOK
by E. PHELPS AND J. WOLFE
Valuable tables, formulas and diagrams never before published in book form with simple instructions for practical use.
Price \$1.50
At Your Bookstore or Direct from
ZIFF-DAVIS PUBLISHING COMPANY
185 N. Wabash Ave., Chicago 1, Ill.

Mass. Radio School
273 Huntington Ave., Boston 15, Mass.
Offers Training Courses for Radio Technician (Pre-Television) and Licensed Radio Operator (All Types) including maintenance and operation of General Electronic Equipment. Over 20,000 Alumni and 30 years radio-training EXPERIENCE. Courses approved for Training for Veterans.
Send for Catalog
Licensed by Commonwealth of Mass.
Department of Education

CONICAL TV RECORD BREAKER

Matches any ohm wire. All channels 1 to 13. No booster required. Lightweight — approx. 7 lbs. Immediate delivery.

\$15 with Mast

LIST \$37.95
8V-TV
YOUR COST \$14.00
COMPLETE WITH CENTER MAST
SINGLE STACK
\$7.95 4V-TV WITH MAST
LIST \$18.95
YOUR COST \$7.00
4V-TV WITH MAST
NO JOBBERS
ORDER DIRECT
20% DEPOSIT
ON ALL C.O.D. ORDERS

8V-TV

Users report up to 300 miles reception.

RAYTRON—441 Summit—Toledo, Ohio

REJECT INTERFERENCE ON TV-FM-AM!



NEW MEISSNER WAVE-TRAPPERS

AVAILABLE IN 5 MODELS



6 to 13 mc, 13 to 27 mc
27 to 54 mc, 54 to 108 mc
108 to 216 mc

You can now attenuate interfering signals on fundamental or harmonic frequencies with these new, highly efficient tunable wave traps. Several may be connected in series if interference exists on more than one frequency. Efficient with any balanced or unbalanced line from 50 to 400 ohms impedance. **\$5.00** List Price



NEW MEISSNER LINE FILTERS

(Grounded & Shielded)
Reject interference

from electric shavers, electric fans, food mixers, vacuum cleaners, etc. 300 watt rating. **\$6.50** List Price

See Them At Your Dealers

MEISSNER MFG. DIVISION
Maguire Ind., Inc.
Mt. Carmel, Illinois

THEY'RE GOING FAST!!!

—PORTABLE DC AMMETER 0-15 AMPS—EFFICIENT—ACCURATE! COMPLETE WITH INSTRUCTIONS FOR EASY CONVERSION TO A MULTI-TESTER!!—(AC & DC VOLTS, Resistance & Milliamps) .3 1/4" mirror scale; knife-edge pointer. Perfect as is for testing: Electrical Appliances; Battery Charging; Motor Work; Automotive, Industrial & Medical Eqp. with 36" test leads & black crackle hinged lid metal case.

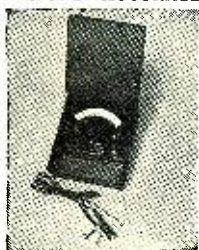

BRAND NEW!
Shpg. wt. 8 lbs.
THOUSANDS SOLD AT TWICE
THE PRICE OF ONLY

3.95

BIRTCHEER TUBE CLAMPS—No. 926B—ea. 9c.....15 for \$1.00

110V. AC INDUCTION MOTORS. 1750 RPM. fract. HP. For Phono, Fans, Displays, etc. 2 3/4" O.D. x 2" deep. Shpg. wt. 2 lbs. ... ONLY 1.29

SCR-511 TECHNICAL MANUAL including PB-157 Power Supply. 173 pp.; 50 illust. & diagrams75

FREQUENCY METER MANUAL (TS-173)25
R-89/ARN-5A SCHEMATICS25
SPECIAL!—TUNING UNIT TU-17A (BC-223)—Perfect condition for replacement & a "GOLD MINE" of fine parts: Switches, Capacitors, Variometer, 19 Jacks, etc., etc. Black crackle case 1 1/2"x9 1/2"x3 1/2". Less crystal. Shpg. wt. 8 lbs. ... SPECIAL

ANTENNA MAST SECTIONS—MS-49, 50, 51, 53, or 54. Shpg. wt. 2 lbs. ea.—ea. 39c. 3 for \$1.00

HIGH FIDELITY CRYSTAL MICROPHONES!! Made for world famous hearing aid mfr. Sensitive hi-impedance diaphragm type. Small size (1 1/2" O.D., 3/4" deep) ideal for REGULAR LAPEL or CONTACT MIKE. Rubber shock-mtd. frame, less hous- 98c

Lightweight aluminum housing.15c

Factory Speaker Repairs Since 1927!
Write for Latest Free Bargain Bulletins!
Min. order \$2.00. 20% Deposit Req. on all C.O.D.s.
Please add sufficient postage—excess refunded.

EOTONE

RADIO CO.
65 Dey Street,
New York 7, N. Y.

clear, very well done, and presented with each of the separate parts numbered, keying it to the list at the end of that particular section.

Besides the operational and mechanical data, the new volume contains an indexing and cross-reference section embracing all of the post-war changers and combinations.

Service technicians and others having occasion to work with record changer equipment and wire and tape recorders will find this new Sams Photofact volume an up-to-date guide in the solving of technical problems.

* * *

"THE MIRACLE OF TELEVISION" by Luther S. H. Gable, Ph.D. Published by *Wilcox & Follett Co.*, Chicago. 150 pages. Price \$2.50.

This is a "story" of the development of television, told in simple, easy-to-understand terms, so that the most scientifically unschooled may become acquainted with the basic principles and workings of the medium.

It is an excellent preparation for the study of science and is perhaps of most value as an inducement to young people to enter the fields of science and electronics.

Apart from its apparent purpose of instruction for the young, it should prove interesting to any layman who, though possessing no background of science, is interested in learning something of the operations and future possibilities of television.

* * *

"TV-FM ANTENNA INSTALLATION" by Ira Kamen and Lewis Winner. Published by *Bryan Davis Publishing Co., Inc.*, New York. 104 pages. Price \$2.00.

One of the most important factors in good FM and TV reception is the installation of the proper antenna, and the maintenance and servicing job done subsequently. This publication is a handbook for the dealer, the service technician, or the dealer-service-man. Every possible type of antenna installation is covered, including high-frequency installations, types of antennas required for fringe-area reception, twelve-channel coverage, and master antenna systems.

Information to be found under these major classifications covers ham interference, rhombic installations, coaxial cables, pre-testing, application of parabolic antennas, and discussions of a hundred other individual problems to be encountered in this work.

Besides the study of these technical problems, the manual devotes an entire opening chapter to the proper tools required for best results. The last two sections of the book provide helpful suggestions on good business practices for the dealer-service technician, including distributor-dealer agreements, cancellation clauses, and service policies, as well as "tricks of the trade" short-cuts and suggestions which could be culled only from a long experience in the servicing and antenna installation fields.

Television Receivers

(Continued from page 44)

circuit is shown in Fig. 9. The first triode, V_1 , is a normal voltage amplifier. Its output is the complete video signal and is applied to the grid of V_2 with the sync peaks in the positive direction. In the input circuit of this tube, a diode, V_2 , is connected from grid to ground. This diode has -14 volts applied to its plate terminal and will not conduct until the 14 volts is neutralized by a signal which is at least 14 volts above zero reference level (ground). When this does occur, the diode conducts, effectively preventing the signal at the grid from rising any further. The grid of V_3 is biased by the same -14 volts, preventing the tube from conducting until part of this voltage has been neutralized. The video detail voltage variations of the incoming signal are unable to overcome this negative bias and thus the video detail voltage up to approximately the blanking level is removed. Only the sync pulses, which extend in the positive direction, are able to force V_3 to conduct, and produce positive pulses in the cathode circuit which are then fed through appropriate filters to the vertical and horizontal blocking oscillators.

Serving as a sync leveler is V_2 , which tends to provide a constant pulse output. Due to the amplification accorded by V_1 , the sync pulses of all normal signals reaching V_3 extend more than 14 volts above the zero reference axis. Hence, all sync pulses drive the diode into conduction preventing further rise of the pulse beyond 14 volts and leveling off the tips of all sync pulses. For signals too weak to develop sufficient voltage at the output of V_1 to drive V_2 into conduction, leveling does not occur, and the sync amplitude variations reach the sweep oscillators, impairing sync control. This circuit is found in some *RCA* and *U.S. Television* receivers.

A sync separation circuit which is sometimes used, although not frequently, consists of a triode with the grid connected to "B+." See Fig. 11. One end of a 1-megohm grid resistor is returned to "B+," making the grid positive and resulting in a flow of grid current. When the grid is made positive and grid current flows, the grid-to-cathode impedance decreases to relatively low values. Essentially,

Fig. 11. Diagram of a sync clipping circuit using a positive biased tube.

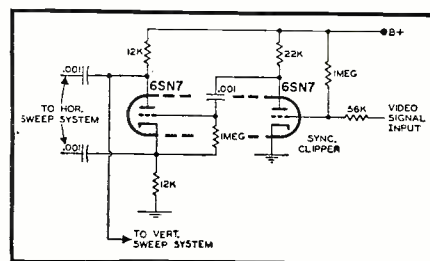

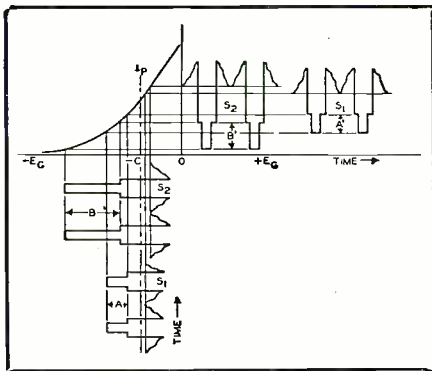

Fig. 12. The action of V_2 in Fig. 10 in stabilizing the sync pulse output of V_1 .

then, we have a voltage divider network connected between "B+" and ground, with the 1-megohm resistor forming one resistor in this network and the considerably smaller grid-to-cathode resistance forming the other resistor. Since the 1-megohm resistor is considerably greater than the grid-to-cathode impedance, most of the "B+" voltage will appear across the 1-megohm resistance and only 1 to 2 volts will actually be present between grid and cathode. When a video signal with the sync pulses in the negative direction is applied to this tube, here is what happens. For the positive portions of the signal, the grid-to-cathode impedance changes in such a manner that the grid potential does not become more positive. Thus, the positive portions of the applied signal are effectively suppressed. During the negative portions of the signal (the sync pulses here), the grid voltage decreases, and the plate current is varied accordingly. Thus, the negative sync pulses are passed by the tube and appear in the plate circuit.

In the circuit of Fig. 11, the pulses are then applied to a phase inverter which feeds a vertical multivibrator and the control tube of an a.f.c. system for the horizontal sweep oscillator.

Pentode Sync Separators

To obtain clean-cut sync separation, sharp cut-off pentodes are usually more satisfactory than either triodes or diodes. The circuit of Fig. 10 was shown in part in the previous section dealing with d.c. restorers. It was shown there that the diode d.c. restorer circuit (V_1) delivered 14 times more sync voltage to V_2 than video detail signal. However, an appreciable amount of video signal still remains and so further clipping is necessary. Note that while the diode may be labeled as a sync separator in commercial diagrams, this is not strictly so. Complete pulse separation is achieved by the following three-stage system containing a sync amplifier, a sync separator, and a second sync amplifier or limiter. Let us analyze each in turn.

The first sync amplifier is a 6SK7 pentode which has a remote cut-off characteristic. The signal received from the d.c. restorer network has a



ACORN

• SPEEDY SERVICE—GREATER BUYS
• HEADQUARTERS FOR TOP VALUES
IN BRAND NEW MERCHANDISE

★ BARGAINS IN SPEAKERS

- 8" Magnavox PM 22 cc. Alnico III Magnet, 8 watts output. A Terrific Value. **\$2.99**
- 10" FM Jensen, "Standard Series" P10T St. 119. An excellent speaker for good quality radio sets or PA systems. Output undistorted 8 watts. Voice coil imp. 6-8 ohms. Wt. 7 lbs. **\$4.49**
- 12" high fidelity extended range 50-10,000 Cy. Jensen PM 12SH, Alnico V Magnet, 6-8 ohm voice coil, 9 watts output. Wt. 12 lbs. **\$8.45**
- List \$18.00
- 12" Coaxial JRP-40 Jensen high fidelity, tweeter woofer. Built-in network. Frequency range 30-12,000 C.P.S. Voice coil imp. 6-8 ohms. 12 watt undistorted output. Shipping wt. 15 lbs. List \$30.00 **\$16.50**

★ AUDIO TRANSFORMERS

- Stancor output transformer, 6L6 d.p. parallel 30 watts output. Voice coil tapped @ 4-8-13-500 ohms imp. Upright mount. **\$2.69**
- Stancor inter-stage transformer, p.p. plate to d.p. grids. Upright mount. **\$1.39**

★ MEISSNER PLASTIC IF TRANSFORMERS—456 KC.

- 39c ea.; 3 for \$1
- Ouncer Transformer—c.t. plates to low, high pri. 6 terminals. 59c ea.; 4 for \$2
- 500 Ohm line to 8 Ohm voice coil. 39c ea.; 4 for \$1.35
- 501.6 Output Transformer, 8 Ohm V.C. 39c ea.; 4 for \$1.35

★ TUNING CONDENSERS

- 3 Gang Push Button—420 MMFD per sec. 2 inch shaft, with trimmers. \$1.19 ea.; 4 for \$4
- 3 Gang 530 MMFD with 3 inch drum. 89c ea.; 4 for \$3
- 4 Gang FM Tuning Condenser, 3-30 MMFD per sec. Ceramic insulation. 1 inch shaft. \$1.79 ea.; 3 for \$4.75

★ TV COMPONENTS

RCA PART NO.	EACH
204L-1	Filter Choke \$.12
203L-1	Peaking Coil26
203L-2	Peaking Coil26
203L-4	Peaking Coil26
201R-3	Horiz. line control43
201R-5	16" Horiz. line control48
201R-1	10" Horiz. width control43
201R-4	16" Horiz. width control 4.45
211T-3	Horiz. output transformer. 5.60
211T-5	16" Horiz. output transf. 2.95
204T-2	Vert. output transformer. 1.55
208T-2	Vert. blocking transf. 6.54
2D2	Focus coil 12.74
4x2	Coil Kit, complete 34.50
RCA Front End, complete aligned. 5.79	
RCA Blank chassis, punched. 4.65	
Universal mounting brackets (12" to 16" tube)	

★ FP CONDENSERS—STANDARD BRANDS



SINGLE SECTION			TRIPLE SECTION		
Cap.	Volt.	Each	Cap.	Volt.	Each
2,000	15	\$.75	90-90-20	200-200-50	5.89
1,000	25	.74	30-15-10	350-300-25	.59
10	450	.34	10-10-20	350-350-25	.21
20	450	.39	30-15-10	350-300-30	.69
20	475	.47	15-10-10	400-400-35	.62
30	450	.49	15-10-10	350-350-25	.64
DUAL SECTION			40-40-20	400-300-25	.89
40-20	25	\$.39	10-10-20	450-450-25	.68
80-80	25	.49	15-15-10	430-400-35	.73
20-20	250	.54	30-10-10	450-450-35	.79
40-40	250	.79	30-30-10	450-450-25	1.19
10-40	300-25	.49	60-20-20	450-450-40	.89
90-10	350	.69	QUADRUPLE SECTION		
40-20	450	.79	80-30-100-40	150-150-25-25	\$.79
40-40	450	1.09	40-40-20-200	150-150-50-10	.79
20-20	450	.49	40-50-20-20	300-250-250-25	.79
50-20	450	1.19	10-20-30-20	350-300-25-25	.89
			40-20-10-40	300-300-300-250	.99
			20-20-20-20	450-450-450-450	1.29
			20-20-20-20	475-475-475-450	1.34

PHONE WORTH 4-3270

ACORN ELECTRONICS CORP.

76 Vesey St., Dept. N-8, New York 7, N. Y.

TERMS: 20% cash with order, Balance C.O.D. unless rated. All prices F.O.B. our warehouse in New York City. No orders under \$2.50.

WHY ROTATE TV ANTENNAS

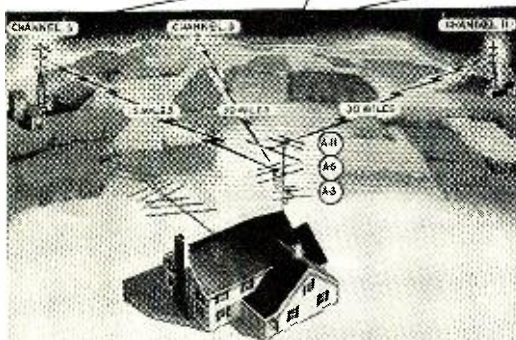

With a Workshop TV antenna system you have an array specifically designed for each channel in your area, permanently oriented for maximum signal strength.

- Channels are selected instantaneously.
- High gain response on each channel.
- No mechanical breakdown.

REMEMBER . . . your pictures are only as good as your antenna system.

Send for the new Workshop TV Catalog (No. 49)

THE WORKSHOP ASSOCIATES, Inc.

Specialists in High-Frequency Antennas

62 MEDHAM STREET, NEWTON HIGHLANDS 61, MASSACHUSETTS

Earn the big pay of
an expert radioman.

This Self-study
**BASIC
RADIO
COURSE**
trains you at home



- EXPLAINS** the principles of operation of vacuum tubes, their basic circuits and other essentials of radio
- PROVIDES** the electrical background you must have
- FILLS IN** the radio and electrical mathematics you need, taking you in easy steps from simple fractions to logarithms

● Let this self-study course prepare you right at home for a successful future in the RADIO field. It contains all the information you need . . . radio—electrical—mathematical—to handle all types of radio sets, test equipment and electronic devices. Explains everything from time delay circuits to the most recent advances in the field . . . mechanical and wire recording sound systems—frequency modulation—multiunit and multielectrode tubes, etc.

A 3-Way Set!

Even as you learn the fundamentals of radio work you absorb the practical electricity and electrical theory you need. And as you go along the set fills in the mathematics you must know . . . gives you the essentials of algebra, geometry, trigonometry.

This basic course includes . . .
ESSENTIALS OF RADIO by Morris Slurzberg and William Osterheld
ELECTRICAL ESSENTIALS OF RADIO by M. Slurzberg and W. Osterheld
MATHEMATICS ESSENTIAL TO ELECTRICITY AND RADIO by Nelson Gooke and Joseph Orleans
Over 1000 illustrations!
1953 pages!
29 appendices!

McGraw-Hill Book Co., 330 W. 42 St., NYC 18
Send me your 3-volume course in BASIC RADIO for 10 days' examination on approval. In 10 days I will send \$4.95 and \$3.00 a month until I have paid \$13.95 or return the books postpaid.

Name.....
Address.....
City.....Zone.....State.....
Company.....
Position..... RN-8 19
Books sent on approval in U. S. and Canada only

SIGNAL GENERATOR KIT

EICO MODEL 320K

\$19.95

Complete

Build your own signal generator. Eico kit comes complete with all parts and easy-to-follow instructions. Hartly oscillator range of 150 Kc to 100 Mc; Co-pitts audio oscillator gives pure 400 cycle sine wave voltage. Perfect for aligning standard broadcast receivers. In kit form, complete, \$19.95. Fully assembled, factory wired and tested, \$29.95.

Write for **FREE Broadcaster newspaper**

10% CASH WITH ORDERS

Phone LO 3-9255

509 Arch Street, Philadelphia 6, Penna.
Sixth & Orange Sts., Wilmington, Del.
6205 Market St. W., Phila., Pa.

polarity such that the sync pulses are in the negative direction. This tends to drive the tube toward plate current cut-off. With a weak signal, such as S_1 in Fig. 12, the sync pulse operates over the relatively high-gain portion of the curve. With large signals, such as S_2 , the sync pulse extends into the curved or low-gain portion of the tube characteristic. The result is a more constant sync pulse output. Noise pulses are also suppressed by this action, improving the sync-to-noise ratio.

The sync separator stage, V_3 , clips the signal just above the blanking level and removes all of the video portion of the signal. This is accomplished by using the sync pulses of the signal to drive the grid of V_3 positive, establishing a negative grid-leak bias. Although some fixed bias is applied to this stage, it is considerably smaller than the grid-leak bias and serves mainly to prevent noise peaks from operating the sweep oscillators when no sync signal is reaching the sync separator. The 6SH7 tube used in this stage has a sharp cut-off characteristic.

The sync pulses reaching the grid of the second sync amplifier are negative in polarity and must be inverted before they can be applied to the sweep oscillators. These pulses are sufficiently strong to drive V_4 into cut-off, clipping the signal. The result is a square-topped wave. Through the use of this fairly elaborate network, a constant sync pulse output is obtained with peak-to-peak video signal varia-

tions of from 6 to 60 volts on the grid of the picture tube. Systems which utilize fewer stages of sync separation are more sensitive to signal strength variation and the stability of their synchronizing circuits diminishes rapidly with lowering of the signal strength. The following receivers use this method of sync separation: *Fada*; *RCA 630TS*, *641TV*, *648PTK*, *8TS30*, *741PCS*; *DeWald*; *Motorola VK101*; *Hoffman Radio*; *Scott Radio*; *Stromberg-Carlson*.

Admiral television receivers employ a slightly modified version of the foregoing circuit in order to adapt it to their method of automatic frequency control. The sync amplifier and the sync separator are essentially the same as the preceding circuit. The third tube, instead of being a second sync amplifier, merely serves as a cathode follower and phase inverter. It functions as a cathode follower for the pulses fed to the vertical multivibrator and as a phase inverter for the pulses fed to the horizontal automatic frequency control tube. The latter stage requires pulses of equal amplitude but opposite phase.

In *Philco* television receivers, the composite video signal is taken from the screen-grid of the first video-frequency amplifier and fed to a pentode sync separator. The output of this stage then goes to individual vertical and horizontal sync amplifiers which, in turn, feed the signals to their respective sweep oscillators.

Fig. 13A is a final illustration of a

Fig. 13. (A) Pentode sync separator as used in Tele-Tone and Hallicrafters television receivers. (B) Characteristic of the 6AU6 sync separator circuit. (C) Clipping operation with either black or white picture signals.

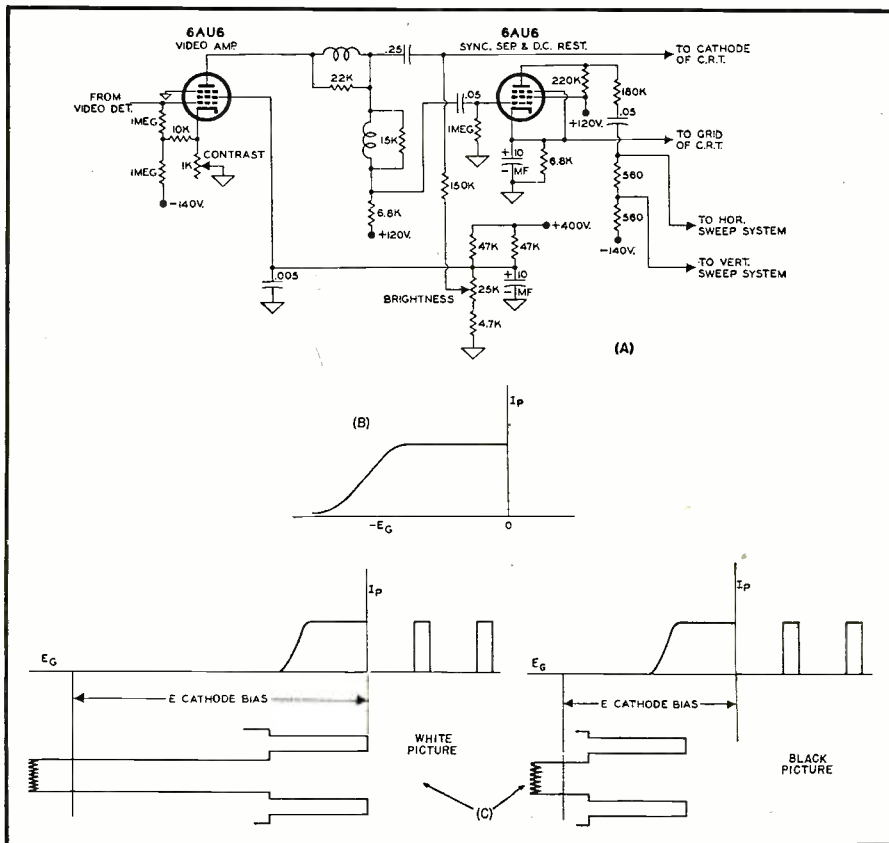

pentode sync separator. The tube, a sharp cut-off 6AU6 pentode, clips the sync from the composite signal and produces a d.c. restoration voltage across its cathode bias resistor. The tube contains a large load resistor in its plate circuit and a relatively large resistor in its cathode leg. The result of this combination, particularly the large plate resistor, is to produce a characteristic such as shown in Fig. 13B. The cathode bias produced will vary with the average amplitude of the applied signal and will be great enough to place all video detail information beyond cut-off, permitting only the sync pulses to appear in the plate circuit. See Fig. 13C. The pulses are sufficiently strong, with normal signals, to extend into the flat portion of the curve. Thus, sync clipping at either end is obtained. Due to the rather large amplitude of the output pulses, a voltage divider network is connected to the plate load resistor with the sync pulses tapped off at appropriate points and then fed to the horizontal and vertical oscillators through filter networks. *Tele-Tone* and *Hallcrafters* television sets use this system.

(To be continued)

TV HINT

BY C. F. BACHMAN

MYSTERIOUS whistling or humming sounds, apparently coming down the chimney, have puzzled some owners of television sets. This is especially true in cases where the antenna mast has been strapped to the chimney for support.

These noises are caused by molecular air turbulence on the lee side of the antenna rods. If the frequency of this turbulence approximates the natural frequency of the rods they will vibrate violently.

The cure for the whistle is simpler than its explanation: fill the antenna rods with sawdust.

-30-



There's a CINAUDAGRAPH SPEAKER FOR EVERY PURPOSE!



CINAUDAGRAPH builds speakers with three objectives in mind:

1. To offer you the World's Most Complete Line—currently 105 standard models, 2" to 15".
2. To supply you with any specialized unit you require—quickly and economically.
3. To insure flawless performance in every application.

When you buy speakers, always specify
**CINAUDAGRAPH . . . and be sure you're
getting the best!**



DIVISION OF AIREON MFG. CORP.

SALES OFFICE and FACTORY 1401 FAIRFAX TRAFFICWAY KANSAS CITY, KANSAS

CANADIAN OFFICE: Charles W. Pointon, Queen at Bay St., Toronto, Ont.
EXPORT OFFICE: 13 E. 40th St., New York, N. Y. Cable ARLAB.

MP-22 MAST BASE



Mounting with spring action and mounting bracket insulated at top to receive MS-53 Mast Section, as listed below. Mast Base MP-22 only. **\$2.95**

MAST SECTIONS: For above MP-22 Base, tubular steel, copper coated, painted—in 3 foot sections. Bottom Section MS-53 can be used to make any length. MS-52-51-50-49 for taper. Screw-in type. Any section—Price..... **50c Ea.**

BLOWER—110 Volt 60 cycle. 4" intake 2" outlet. Approx. 100 cu. ft. dis. Motor size 3" x 3"—1750 RPM. NEW Motor ONLY..... **\$6.95**

GN-15 GENERATOR only—Used..... **\$5.00**
LIG and SEAT ASSEMBLY for Hand Generators..... **2.75**
CRANKS for Hand Generators..... **.75 Ea.**

DYNAMOTORS and INVERTERS

Input	Output	Stock No.	Price
12 V DC	220 V 105 MA	D 402	\$3.95
12/24 V DC	440 V 200 MA and 220 V 100 MA	D 104	9.95
24 V DC	400 Cycle Inverter	MG-149F	14.95
13/26 V DC	1/2 BC-645	PE 101	2.95
12/24 V DC	500 V 50 MA	D 0515	2.95
28 V DC	F/Comm. Receivers	DM 32	1.95
14 V DC	230 V 100 MA	DM 20	3.95
9 V DC	450 V 60 MA	D 9450	3.95

MISCELLANEOUS

TU-17 or 25 for BC-223—Price: NEW	\$4.50
Coaxial Cable—125 OHM cotton covered—50 Ft.	1.00
Coaxial Cable—72 OHM Rubber covered—8 Ft.	.50
Cable—4 conductor. Rubber covered, shielded—50 Ft.	2.00
Wire—Heavy duty 2 cond. Rubber covered #14 stranded. 20 Ft.	1.00
Wire—2 Cond. Rubber covered Tires #16. Per Ft.	.06
BC-645 A Transceiver	14.95
AC-Meter 150 Volt 400 Cycle 2"	3.95
Cable for BC-223 w/PL-150 each end.	1.75
Plugs for BC-375—PL-64 or PL-59.	.55
Cable for BC-375 w/PL-61 each end.	1.75
Cable for TCS EQ/65F7, 65F10, or 65F13. Ea.	2.95
Autosyn RPM Indicator. 2500's.	4.95
Autosyn Fuel Pressure Indicator.	4.95
Plugs for LP-21 Loop, PL-112 or PL-108.	1.00
FL-8 Filter 1200 CFS.	1.75
BC-1023 Marker Beacon Rec. with tubes.	3.79
BC-301 Marker Beacon Rec. less tube.	1.95
BB-54 2 Volt Dry Cell Battery	1.50
BC-778 Gibson Girl Receiver—Only	4.95
CD-385 Cord for LP-21 Loop.	1.50

Available: MARK 11 219 Sets and Accessories!
Address DEPT. RN • Minimum Order \$2.00 • Prices F.O.B., Lima • 25% Deposit on C.O.D. Orders

AUGUST SPECIALS:

FT-237 MOUNTING BASE for BC-604 and 603's, and for BC-684 and 683's. Prices: **\$9.95**
USED: \$7.00 NEW: **\$9.95**
PI AIRCRAFT GENERATOR 200 amp. 28 Volt. NEW..... **\$30.00**

SELSYN TRANSMITTER & INDICATOR SYSTEM—Ideal as radio beam position indicator for Ham, Television, or Commercial use. Complete with 3 inch 1-82 Indicator, Autosyn Trans., 12 Volt 60 cycle Transformer, and wiring instructions.

Price NEW..... **\$7.95**
PL-118 PLUG I/I-82. \$1.00 Autosyn Trans. **\$2.95**
SELSYN 211G1—WITH CAPS—Can be used as position indicator for antennas—110 Volt 60 cycle, with instructions. Normally operates from 57.5 Volts 400 cycle. Price per pair: **\$3.00**. Price Caps only..... **\$0.50 Ea.**

SELSYN No. C-76248—115 Volt AC 60 cycle. Size V 3 3/4" x 5 1/2". Can be used to turn small antennas or for position indicator systems. Per Pair..... **\$5.95**

TRANSFORMERS—110 Volt 60 Cycle Primaries:
Sec. 12 V. 1 amp. **\$1.50**
Sec. 24 V. 1 amp. **1.95**
Sec. 24 V. .5 amp. **1.50**
Sec. 36 VAC 2.5 amp. **2.95**
Sec. 14-14 or 28 Volt—7 1/2 or 15 amp. **4.95**

COMMAND RECEIVER AND TRANSMITTER SETS AND ACCESSORIES

BC-454 3 to 6 MC. USED.....	\$5.95
BC-455 6 to 9.1 MC. USED.....	6.95
DYN-6V. Can be used for Comm. Rec #0515.	2.95
TRANSFORMER NH-109 for Comm. Rec. Input 115 VAC 60 cycle; output 250-0-250 VAC at 60 MA. 24 VAC at .6 amps; 6.3 VAC at .6 amps. NEW.....	3.00
TRIPLE REC. RACK—black.....	1.50
TUNING CRANK or Knob.....	1.65
CONTROL BOX BC-450.....	1.95
CONTROL BOX BC-451.....	1.95
BC-458 5.3 to 7 MC. NEW. \$8.95 ; USED.....	5.95
T-18 ARC. 5 2.1 to 3 MC. Like New.....	8.95
T/20 4 to 5.3 MC. NEW. \$9.95 ; USED.....	6.95
BC-456 MODULATOR—Like New.....	2.50
DUAL TRANSMITTER RACK—New.....	1.50
TRANSFORMER NH-108 for Comm. Trans. Input 115 VAC 60 cycle; output 600-0-600 VAC at 250 MA. 12 VAC at 3 amps; 12 VAC at 3 amps and 5 VAC at 3 amps. NEW.....	6.90
BC-442 Antenna Relay Box w/cond. New.....	2.95

AC POWER SUPPLY AND SPEAKER

Completely wired power supply and speaker with volume control C.W. and on-and-off switch, housed in metal cabinet. For Command receivers with connections to plug into receiver and 110 Volt 60 cycle line. Voltage output: 250 V. 60 MA., 6.3 V. .6 amp and 24 V. .6 amp. Price: Completely wired..... **\$14.95**
Kit of Parts..... **9.95**

FAIR RADIO SALES

132 SOUTH MAIN ST.
LIMA, OHIO

Miller
 BUILDERS OF QUALITY RADIO INDUCTANCES SINCE 1924
**THE SENSATIONAL
 NEW MILLER BAND-PASS TRF
 TUNER USING A GERMANIUM DIODE
 DETECTOR**

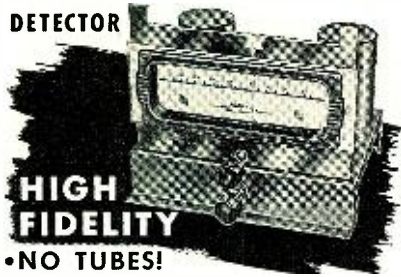

**HIGH
 FIDELITY**

- NO TUBES!
 - NO POWER SUPPLY! • NO HUM!
- A SIMPLE 2 TUNED CIRCUIT NEGATIVE MUTUAL COUPLED BAND PASS TUNER
- EASY TO ASSEMBLE & WIRE!

In spite of its simplicity, low cost; #585 kit is not a toy — it is a carefully designed High Fidelity Broadcast band tuner. Use it with your amplifier and speaker system for truly high quality reception.

The audio output of the tuner is proportional to the input signal and will vary from .05V to .5V for stations within a 20-25 mile radius when used with a good antenna of from 75 to 100 feet in length. A good antenna is absolutely essential to the proper operation of the #585 tuner.

The net price of the Miller #585 TRF Tuner kit, including chassis, dial, and tuning condenser, is only \$11.40. The additional parts required make it possible to build the complete tuner at a net cost of less than \$15.00.

Order yours now — ask for the new MILLER — Cat. No. 585 Crystal Detector Tuner — Net \$11.40



SEE YOUR LOCAL RADIO PARTS SUPPLIER FOR THE MILLER #585 KIT AND OTHER MILLER PRODUCTS — INCLUDING THE COILS USED IN THE HIGH FIDELITY TUNER IN THIS ISSUE.

J. W. MILLER COMPANY
 5917 S. MAIN ST. LOS ANGELES, CALIF.

RADIO TEST INSTRUMENTS

By **RUFUS P. TURNER**
 Consulting Engineer, Radio & Television News

This well-illustrated and practical manual shows how to build, how to properly calibrate, how to use dozens of different types of radio and electronic testing devices.

**Covers Fully All These
 Test Instruments**

Multipliers, Resistors, Multi-Range Voltmeters and Ammeters, Ohmmeters, Ultra High-Resistance Megohmmeters, Vacuum Tube Voltmeters, Impedance Meters, Capacitor Checkers, Resonant Inductometers, Precision Resistance Bridge, Oscilloscopes, R.F. Test Oscillators, and others.

\$4.50; Use Convenient Coupon with Full Return Privilege

ZIFF-DAVIS • CHICAGO

ZIFF-DAVIS PUBLISHING COMPANY
 185 North Wabash Avenue, Chicago 1, Illinois

I am enclosing \$4.50 (check or money order) for which please send one copy of RADIO TEST INSTRUMENTS. I understand that I may return book within five days for full refund if I am not entirely satisfied.

Name

Address

City..... Zone.....

State

RN 849

LETTERS

from our readers

YOUNG 'UNS, HERE'S A PAL

I TAKE great pleasure in reading what you have to say about the radio amateurs in your magazine. Keep it up. As I enjoy very much reading what some your readers have sent in, feel free to print all or part of my letter.

"My call is WØFHA, and although I am 28 myself, I think there should be more younger hams, say high-school age. For one reason, the 80 c.w. band is always dead until evening, and if a few high-school-age hams would work the band, they would find it much easier to start off with, because of the absence of QRM.

"I have a low-power outfit, and for a while I would work it in the daytime on 40 c.w. or late at night on 80 c.w. or 40 c.w. I had tried a few times to work it from 5 p.m. to 9 p.m. but with no success, until I had a stroke of luck one night that started me to operating in all kinds of QRM, and now I almost enjoy it because of the many more stations I can reach.

"Lots of times, I like to work with new amateurs, sending CQ very slowly; I for one welcome them on the air. Although my speed is 20 w.p.m., I will hold it down to give the newcomer a break. There would be some happier new hams if some experts would slow down and give them a chance.

"It might also encourage youngsters if they knew others their own age are operating, and perhaps printing a few pictures would help, just so they would know that ham radio is not all 'old timers.'

"Maybe now that the 160 phone band has been restored in part, some code instruction can be offered. I myself am not on 160 phone yet, but I plan to be in the near future."

George L. Davenport, WØFHA
 R. F. D. 3, Box 10
 Chadron, Nebraska

Certainly if you catch them young, they're yours, as the saying goes. And the objective of the ham contest and our Beginning Amateur series is just that.

EASY DOES IT

I AM an old-timer, starting with custom-built radios in 1924 (\$350 up). Before this time I worked in a phone factory to develop a phone system to replace railway telegraph. Soon, wherever possible, in commerce phone replaced telegraph.

"Hams starting with code graduated to phone, but the examination requirements still stress code speed above all else. I have been tempted to join the ranks of hams but cannot see the reason for putting code speed

above the many other desirable qualities a ham may have, especially as relating to phone or video.

"I believe the art would be better served by having an alternative examination for the phone ham, requiring only a knowledge of code (no speed), with the rest based on radio and phone transmission. This would attract men of advanced training and ability to cooperate in the advancement of communications."

R. Benson Hall
 6431 Euclid Avenue
 Hammond, Indiana

The code test is only one of the examination elements required for an amateur license. There are moves for both higher and lower code speeds.

* * *

JERK? NOT THIS HAM

HERE is a suggestion to be taken as you judge its value.

"Why not publish a list of hams who are willing to offer assistance to others wishing to secure a ticket. I believe this would help spread the gospel of amateur radio and induce new blood in our ranks.

"If so desired, add the weary old jerk's call, QTH, handle, etc., to such a list."

(The Weary Old Jerk)
 George E. Wilson W6WOJ
 1086 Aileen St.
 Oakland, California

George, if all hams were like you, we wouldn't even need a contest.

We have seized on your name, and herewith offer it, both as an example of the right attitude for a ham, and as a helpful offer extended the neophytes.

* * *

so first you must pass the code test. Why is a code test required? Because the FCC has never washed this old requirement from its books.

"After all is said and done, it adds up to the fact that older, substantial citizens who would be a credit to the ranks never do become hams."

John Ryan

We hope it is not generally true that the code test keeps many older phone-enthusiasts from joining the ranks of licensed amateurs. If it is, perhaps they could learn to consider the code test just a small hurdle to be taken, so they can become hams; then they may operate their phone station to their hearts' content.

* * *

A LETTER FROM N.R.I.

I AM a ham (call letters W9DER). Amateur radio is a great American hobby. It stimulates interest in the whole field of radio, among other things. The pleasure one gets from making radio contacts cannot be expressed in words, and age or physical handicap does not prevent one from getting a license to practice this great hobby.

"I notice from the May issue of RADIO & TELEVISION NEWS that one of your students, Mr. Charles Apon, is in Ward 84, Vaughan Hospital, Hines, Ill. In a letter to the editor of RADIO & TELEVISION NEWS, Mr. Apon said that he would like to have some help in getting his ham ticket. I have just written him a letter offering him my services. I will be happy to help him out."

Mr. Elhart F. Nelsen,
16 N. Kildare Ave.
Chicago, Illinois

This letter was forwarded to us from the National Radio Institute Alumni Association, and Mr. L. L. Moore, Executive Secretary, adds the following comment: "We are proud of graduates such as Mr. Nelsen, who show the true fraternal spirit," to which we might add that all amateurs should be proud of a fellow ham like Elhart Nelsen.

* * *

DODO BIRD?

YOUR articles in the May issue, pages 8 and 44, mean two things: young people find the code no longer essential as a means of communication, and those interested will have the facilities available through bands allotted citizens. There was a time when use of code was essential in governmental operations, but because of the recognition of the International code throughout the world, it afforded no secrecy.

"Considering the progress made, radio becomes a carrier method only, and the key is as dead as the proverbial dodo bird. Use and knowledge of key and code may be a hobby and a pleasure to some, but no specific value accrues, excepting secrecy from those unfamiliar with it.

"It seems, therefore, that the requirement of the ability to send and receive code is a detriment to the de-

Invitation to a new kind of Reception!

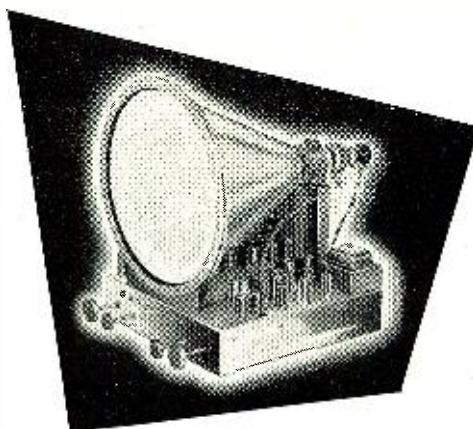

It's here—the sensational new Craftsman Television, with qualities of reception years ahead of its time! Every feature is engineered with one thought . . . outstanding big picture performance. Watch unbelievable sensitivity in action way out on the fringes. See it—and you'll believe it!

CHASSIS FOR 16" CRT — 27 TUBES PLUS RECTIFIER

The Craftsman RC-100 Chassis is designed for any 16" kinescope. Ample sweep voltage for "giant circle" operation—even with short (60° deflection) tube. Over 13 KV for extra brilliance and definition. Flexible bracket permits mounting tube in any position. Remarkable new auto. gain control is keyed—completely eliminates disturbance by aircraft, windblown transmission lines. Perfect interlace with automatic phase control of

both vertical and horizontal synchronization. 500-ohm cathode follower audio output connects with your audio system, preserves high fidelity of FM—and you don't pay for minimum-performance audio. Easily accommodates UHF channels. Secondary controls in front, under nameplate, for convenience. See Craftsman TV at your distributor's, or write for information, Dept. B-1.

THE RADIO **craftsmen** INCORPORATED

1617 S. MICHIGAN AVE., CHICAGO 5, ILL.

WAR SURPLUS SPECIAL SALE!

VHF TRANSCEIVER

Ideal substitute for SCR-522, freq. range 140-144 mc. crystal controlled, 10 watts. The receiver section has two individual IF sections, feeding a common 3 stage 10 mc. IF amplifier. Both RF sections may be operated simultaneously or either one individually. The receiver unit has 13 tubes. The transmitter is of straight forward design. Transmitter unit has 7 tubes, one #832 as final modulated by a pair of 6L6 and push-pull. Complete unit in case with tubes, crystals and diagram, less dynamotor. Used, excellent condition. **\$14.95**

New Phantom Antenna for above unit, 3 lamps in parallel with sockets complete for.....**95c**

RECEIVER-AMPLIFIER

Contains the following circuits: Blocking oscillator, C.R.T. gate circuit, Azimuth and vertical sweep circuit. 5 stage 30 Mc. IF strip with AFC circuit. Tube complement: 6-6SN7GT, 2-6V6GT, 6-6AG7, 2-6L6GT, 8-6AC7, 2-6HG6, 1-2050, 1-884. Used, excellent condition. **\$14.95**

POWER SUPPLY for above unit complete with the following tubes: 3-5U4G, 5-VR105, 1-2X2, 1-6X5G, 1-6AC7, 1-6Y6. Used, excellent condition. **\$9.95**

VERTICAL ANTENNA

1/2 wave vertical dipole antenna, complete with 36 inch whip, 36 inch skirt, 7 ft. aluminum pole, mounting brackets and 8 ft. of coaxial cable with PL-259 plug.....New **\$12.95**

ALTIMETER TRANSCEIVER RT-3/ARN-1

Frequency 418-462 mc. FM with 14 tubes including 3-12SJ7, 4-12SH7, 2-12H6, 1-VR150, 2-955, 2-9004, 24 V. Dynamotor, used, in working condition. **\$4.95**

BRAND NEW TUBES

304 TL	ea.	\$0.90
	Four for	3.00
5BP1	ea.	1.95
5BP4	ea.	2.95
4AP10	ea.	1.95

TERMS: All shipments FOB Chicago or Los Angeles, unless specified. 20% Deposit required on all orders. Minimum order accepted—\$3.00. California and Illinois residents, please add regular sales tax to your remittance.

ARROW SALES, Inc., Dept. N

No. Side Branch: 1802 N. Humboldt Blvd.
Chicago 47, Illinois

SCR-283 40-80 METER XMITTER

New equipment: Transmitter-Modulator and coil sets to cover 2.5-7.7 mc. Transmitter tubes 2 No. 10 special and 2 No. 45 special receiver (less the receiver coil sets), receiver tubes 1-37, 1-38, 4-39/44, shock mounts, dynamotor, antenna switching relay, receiver control box, transmitter control box, charts, dials, and instruction book. Ideal substitute for BC-696 & BC-459. What a sweet buy! Only. **\$9.95**

FREE!

Jack Box with volume control, 3 separate mike and phone circuits with each SCR-283.

BC-620 TRANSMITTER-RECEIVER UNIT

FM transmitter-receiver, crystal controlled, two channels, freq. range 20-27.9 mc. 13 tubes, dual meter for testing filament and plate circuits. Used, good. **\$9.95**

PE-97, POWER SUPPLY

6-12 V less tube and vibrator—Used, excellent condition with mounting rack to hold or to mount BC-620 and PE-97. **\$3.69**

MOBILE INSTALLATION KIT

of BC-650 or BC-620
Consists of TS-13, MP-48; 4 section whip antenna; insulators, 2 maintenance manuals. NEW. **\$12.95**

CONDENSERS

2 MFD. 4000 V. Pyranol.	ea.	\$2.95
4 for		\$10.00
2 MFD. 5000 V. C-D Type	ea.	3.95
6 for		\$20.00
.25 MFD. 15,000 V.	ea.	5.95

SMASH VALUES IN COMMAND EQUIPMENT

BC-453	Exc.	\$3.95	Exc.	\$12.95
BC-454	Exc.	6.95	NEW	6.95
BC-455	Exc.	7.95	NEW	7.95
BC-456	Exc.	2.95	NEW	7.95
BC-458	Exc.	9.95	NEW	9.95
BC-459	Exc.	9.95	NEW	9.95
BC-696	Exc.	14.95	NEW	14.95

BC-709 INTERPHONE AMPLIFIER

Complete with 2 T-30 mikes, 2CD-508 switches, 2 CD-307 cords, and 2 HS-30 headsets—Ideal unit for aircraft, boats and shop installations. Manual included. New (less batteries) **\$7.95**

NEW CATALOG

Listing Many Surplus Values. Write for Your FREE Copy Today!

Main Office: 1712-14 S. Michigan Ave.
Chicago 5, Ill.

West Coast Branch: 1260 S. Alvarado
Los Angeles, Calif.

FACTORY TO YOU

DIRECT!

THE NEW

Certified TELEVISION KIT

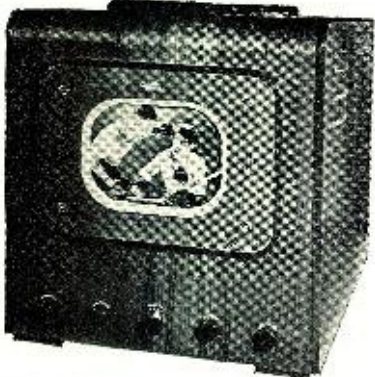

7" KIT..\$49⁵⁰
\$84⁵⁰ WITH TUBES
LESS TUBES

This kit can be used with 10" electrostatic tube without any changes

Money Back Guarantee—Buy it, inspect it, if you don't think it's the best buy on the market—return unused within five days and your money will be refunded

All prices F.O.B. New York. 20% deposit with order
IMMEDIATE DELIVERY

Certified TELEVISION
LABORATORIES

5507 — 13th AVE. BKLYN. 19, N. Y.



JOBS IN TELEVISION

YOUNG MEN 16 TO 60

There is a job opening for every qualified trained Television Technician.

WE CAN TRAIN YOU
FREE EMPLOYMENT SERVICE

Visit Our Modern Laboratories and Class Rooms
Approved Under G.I. Bill of Rights

AMERICAN RADIO INSTITUTE

New York, N. Y.
2010 Broadway

Syracuse, N. Y.
131 Shonnard St.

Mt. Vernon, N. Y.
174 Gramatan Ave.

Buffalo, N. Y.
640 Main St.

"Teaching Radio Since 1935"

velopment of experimenters in the radio communications and electronics field and is unnecessarily restrictive on the training and experimental progress of the novice.

"Outside of the permission to transmit, nothing is involved in a ham license. Anyone may now make or buy a receiver for any band, and circuits or schematics are available by the thousands. If the radio industry wishes to thrive on hams' and experimenters' business, and if the government wants men familiar with radio and electronics, removal of the code requirement will do far more than the \$10,000.00 prize offered by RADIO & TELEVISION NEWS.

"Why should there be key pounders in radio? Sounds a little ridiculous, does it not? Airplanes are controlled by voice, railroads by telephone, and radio and communications companies use typing machines.

"Allow the beginner on the air with speech, and he will learn the languages necessary to communicate. If he really has the ambition to be a ham, he surely will want to know who he is hamming with and what it is all about.

"Give interested persons a sensible break, and you will have plenty of hams, probably more than the government will care to police. The days of 'the fist' are gone."

R. V. Prucha
Lorain, Ohio

We're surprised to find (judging from letters received) how many people believe the code unnecessary. It's hard to tell, though, how the FCC looks at the problem. They probably don't feel that code is outmoded. —50—

RMA PLANS FUTURE TOWN MEETINGS

AT THE recent meeting of the RMA "Town Meeting" Committee, held at the Hotel Roosevelt, New York City, the future schedule of RMA activities in behalf of radio and television service technicians was up for consideration.

During 1948 and the early part of this year, six RMA sponsored "Town Meetings" have been held. Among the problems discussed for future programs was the question of preparing short films for television broadcast, which would give TV set owners elemental information on receiver care. It was thought that, thus, many "nuisance" calls for service technicians would be eliminated.

Heading the committee as chairman was Robert C. Sprague, pres., *Sprague Electric Co.* Other members are: Benjamin Abrams, *Emerson Radio & Phonograph Corp.*; A. T. Alexander, *Motorola, Inc.*; W. R. G. Baker, *General Electric*; H. C. Bonfig, *Zenith Radio Corp.*; Leonard F. Cramer, *Allen B. DuMont Laboratories, Inc.*; Harry A. Ehle, *International Resistance Co.*; J. B. Elliott, *RCA Victor Division*; G. M. Gardner, *Wells-Gardner & Co.*; Larry F. Hardy, *Philco Corp.*; H. L. Hoffman, *Hoffman Radio Corp.*; J. J. Kahn, *Standard Transformer Corp.*; Stanley H. Manson, *Stromberg-Carlson Co.*; Leslie F. Muter, *The Muter Co.*; and A. D. Plamondon, Jr., *The Indiana Steel Products Co.* —50—

The TV Antenna (Continued from page 56)

or "Hertzian double." An understanding of the action of this "resonant" type will help in the study of more complicated "arrays." The basic nature of the half-wave doublet is indicated by the fact that it is used by the industry as a standard against which the efficiency of other types is compared.

Fig. 7A shows the concept of a half-wave dipole in space. If such an antenna is made of very small wire and could be far removed from the influence of the earth, its resonant electrical length would be equal to its physical length. This length in turn would be one-half of the wavelength of the electromagnetic wave in space.

Although Fig. 1 shows the electric and magnetic fields as fixed uniform lines, it is to be understood that both of these fields are varying in intensity at a sine wave rate. Thus, a varying magnetic field will induce alternating electron currents in the dipole wire, and a wave of current will pass down the dipole to its end. At the end, reflection will occur and a "standing" wave will build up along the wire having the voltage and current distributions shown in Fig. 7A. Since the length of the theoretical dipole of Fig. 7A is exactly equal to one wave in space, the build-up of voltage along the wire and the current through it will reach a resonant condition similar to that found in a parallel tuned circuit. Actually, the dipole may be considered as such a tuned circuit, but in this case the inductance is "distributed" along the length of the wire and the capacitance consists of many elements across the individual small inductances. This electrically tuned circuit equivalent is shown in Fig. 7B.

The foregoing discussion has been concerned with a hypothetical or theoretical dipole which could never exist in actuality since it requires that the dipole wire be infinitely small in diameter compared with its length, and that the dipole is positioned at a distance so far from surrounding objects, including the earth itself, that no influence of such objects exists. In practice, the dipole must be erected within a few wavelengths of ground and must be physically large enough in diameter to be self-supporting. Both of these requirements cause the velocity of wave travel in the practical dipole to be less than the speed of electromagnetic waves in free space.

While the actual length of the dipole, for resonance, will vary slightly depending upon the proximity of other objects, it has been found that a good average figure for the reduction in length, due to the proximity effect, is 5%. Or, in other words, the half-wavelength value obtained from the formulas of Fig. 4 should be multiplied by .95 to find the length of the required dipole for any given fre-

quency. A practical dipole formula is found in Fig. 7C, and a commercial dipole antenna for installation on a roof is illustrated by the Fig. 7D.

The dipole produces the greatest current when it is parallel to the electric field of the wavefront. In other words, a line drawn from the receiving location to the transmitter should be at right angles or perpendicular to the length dimension of the dipole. As the dipole is rotated with respect to the distant transmitter, its response varies in the manner shown in Fig. 8A. A curve of this type is known as a "polar" response diagram. The relative response at different angles away from the "normal" or maximum response position, is determined by taking the ratio of the length of the radius at any point to the maximum radius, or line A-A.

The response curve of Fig. 8A represents a cross section taken in the plane of the antenna. The response to waves arriving from the sky or reflected from the ground at any angle is determined by the solid figure obtained by rotating curve 8A around the axis X-Y as shown in Fig. 8B. This solid figure is seen to be "doughnut shaped."

It is also seen from the reception pattern (Fig. 8A) that the simple dipole is "bi-directional," and will receive equally well from the front or rear, but it shows practically no response at right angles or in line with the length of the dipole. This directional characteristic is of value when it is desired to discriminate against spurious reflection objects which would produce ghosts in the television picture. The simple dipole is a satisfactory television receiving antenna in locations in which the signal strength is high, only one station (or stations close to each other in frequency assignment) is to be received, and in which the multiple reflection or ghost problem is not severe.

The impedance of the simple half-wave dipole at its center is approximately 72 ohms and, for maximum energy transfer, the lead-in or transmission line should have a characteristic impedance of this value. Such value of impedance is rather low and is best suited to the coaxial type transmission line. It is found that the mismatch of the antenna to the transmission line can vary as much as two to one without serious loss in the signal and without the production of disturbing ghosts, provided the line is appropriately matched to the receiver input. This means that transmission

Nothing Finer!

CHICAGO FEATHERWEIGHT MULTI-TESTERS

Highest Quality—Chicago "Featherweight" Multi-testers are made with the precision of a fine watch. Strict tolerances provide accuracies far above commercial standards—readings are absolutely dependable.

Most Compact—Chicago "Featherweights" are the smallest multi-testers in the world. They are truly pocket-size instruments, weighing only a few ounces . . . a pleasure to use in or out of the shop.

Lowest Cost—Chicago "Featherweights" guarantee more real usefulness and dependability at considerably lower cost. There is nothing like a "Featherweight" for standing up under hard daily use. They are built to "take it."



Chicago "Featherweights"

Model 450A

Volt-Ohm Milliammeter for DC
Volts 0-5/10/50/500/1000 Mils 0-1
Ohms Full Scale 5000/50,000/500,000
Ohms Center Scale 30/300/3000
Net price \$10.90

Model 451A

Volt-Ohmmeter for AC and DC
Volts DC 0-10/50/100/500/1000
Volts AC & Output 0-10/50/100/500/1000
Ohms Full Scale 500,000
Ohms Center Scale 7200
Net price \$14.90

Model 452A

High Sensitivity DC Volt-Ohmmeter
Volts 0-10/50/100/500/1000 10,000 Ohms per Volt
Ohms Full Scale 2000/20,000/200,000/2,000,000
Ohms Center Scale 30/300/3000/30,000

Net price \$14.90

There is a Chicago Multi-Tester for every purpose

Write for our complete catalog

Chicago

CHICAGO INDUSTRIAL INSTRUMENT CO., 536 W. ELM ST. CHICAGO 10, ILL.

For Clearer Television!



TV-FM ANTENNA ROTATOR

- Sharper Pictures
- Wider Range
- Peak Reception!

This antenna rotator turns your TV antenna instantly as needed "aims" it at the station—keeps image clear—overcomes In multi-station and fringe areas station you couldn't get before—activity and range!

Introducing the new SHORE DIAMOND ANTENNA

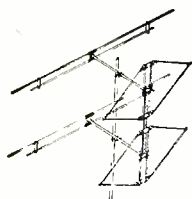

- ★ Stacked array offers high DB gain on both bands.
- ★ High signal to noise ratio.
- ★ Channels 2 to 13 plus FM.
- ★ For use with 72, 150 or 300 ohm transmission line.
- ★ U-Bolt clamp provided to facilitate proper spacing and independent orientation of each bay.
- ★ No loose ends to become victims of adverse weather conditions.

Fast assembly—easy to mount.

Net weight—8½ lbs.

Shipping weight—9½ lbs.

No. RW102 (single diamond)

\$16.90 list

No. RW104 (as illustrated with ¼ wave transformer) . . . \$33.80 list

Write for Details

SHORE ENGINEERING, Inc.

Box 325

Long Branch, N. J.

SAVE

at **RADIONIC** the
House of Radio and Television Buys

BIG
61 sq. in.
T.V. Set
\$169⁹⁵

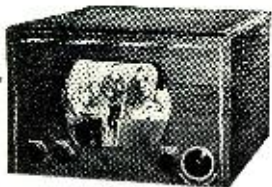

21 tubes incl. 10" picture tube. RCA lic.
Nationally Known Name. TERMS: 20%
dep.; Bal. C.O.D.; F.O.B. Warehouse.

**RADIONIC EQUIPMENT
COMPANY**

Tribune Theater Entrance

1703 Nassau Street :: New York 7, N. Y.
WOrth 2-0421 :: Open daily 9 to 6--Saturday 9-5

FREE! MAIL TODAY!

station on Channel Three (video carrier frequency 61.25 mc.), and a station on Channel Six (video carrier frequency 83.25 mc.) are to be received with approximately equal antenna response, the dipole should be made the correct length for the geometric mean of these frequencies, i.e.:

$\sqrt{61.25 \text{ mc.} \times 83.25 \text{ mc.}} = 71.4 \text{ mc.}$
Each dipole section would thus be 234 divided by 71.4, or 3.28 feet long (3 feet - 3-3/8 inches).

The Folded Dipole

If two half-wave dipoles are placed closely parallel to one another with their ends connected, the received currents will be "in-phase." The effect of the reaction of one dipole upon the other is to increase the impedance at the center of either dipole from 72 ohms to approximately 300 ohms. Fig. 9A shows such a folded dipole with the formula for calculating the required dimensions. The folded dipole possesses several advantages over the simple single half-wave dipole:

1. Its higher impedance provides an ideal match for the popular polyethylene insulated parallel, or twin-lead, flat strip, transmission line. The most popular type of this lead-in has a characteristic impedance of 300 ohms, and the majority of television receivers are designed to match a 300 ohm transmission line.

2. The folded dipole is receptive to a wider frequency band than the simple half-wave dipole but possesses the same directional pattern.

3. Because of its design, it has a more rigid structure and will withstand greater wind pressure. Fig. 9B shows a commercial form of such a folded dipole.

If greater directional selectivity or more signal pickup is required, the pattern of the simple dipole and its response can both be improved by the use of additional elements known as "reflectors and directors." The use of these elements, in more complicated antenna structures or "arrays," will be covered in detail in next month's issue.

(EDITOR'S NOTE: Material contained in this article has been taken from Chapter 12 of the Howard W. Sams & Co., Inc., book, "PHOTOFACT Television Course.")

(To be concluded next month)

Microgrooves (Continued from page 37)

the L-P attachment, while entirely satisfactory for home use, is not suited for radio station application where high fidelity is required.

Since the average transcription turntables used by most radio stations are of extremely high quality, with heavily weighted turntables and powerful, flutter-free motors, it was decided to try the regular turntable equipment, simply adding the requisite arm and pickup unit. The engineer should realize that because of the extremely critical stylus-to-groove compliance involved in microgrooves and the shallow groove-depth, flutter must be reduced to an absolute minimum. Even moderate ripple is unpleasant to the ear, while heavy flutter will actually cause the stylus to vibrate out of the groove and mis-track inasmuch as stylus pressure is only one-fifth of an ounce. However, no turntable operating within NAB standards will present a problem along this line.

What pickup to use? That question involves the price and availability of the unit. The low-priced, variable-reluctance type has been found entirely satisfactory (we used a *General Electric* unit at WGPC), and its low price makes replacement comparatively economical. Any good arm may be employed, but it should be capable of tracking at the requisite one-fifth-ounce stylus pressure. Theoretically the offset-head or tangent-corrected type is preferable, but experimentation has proved there is very little difference between that and the straight-arm models. At WGPC, a Livingston arm was used. (See Fig. 1, showing *RCA* turntable adapted for L-P records.)

With the mechanical considerations successfully solved, the remaining problems were purely electrical. The variable-reluctance pickup, with its wide-range and comparatively flat response, still requires equalization to conform with L-P recording characteristics. To attain this, we fed the output of the pickup directly into the conventional *G-E* preamplifier circuit. This gave us a flat response curve as far as the reluctance cartridge was concerned, but since L-P records have a characteristic curve of their own, further equalization was necessary. This was accomplished through a unique tone-control circuit—a modification of the *Thordarson* dual tone

The preamplifier and tone control unit were constructed on a small chassis which can be mounted in the speech console, turntable unit, or elsewhere, provided it is kept clear of any hum-producing source such as phonomotors or transformers. The output of this unit will match either 50- or 500-ohm speech inputs, but if it is fed directly into a microphone input, an attenuating pad will be necessary between the preamplifier and the mike input. Once this attenuating pad is set, no further adjustment will be necessary.

The tone control unit is remarkably flexible and allows for individual difference in L-P records, both as to treble and bass response, entirely separate and without interaction between lows and highs. With the treble control in normal position and the bass at full boost, a curve is obtained which is very pleasant to the ears of the average listener. Actually, the treble and bass can be varied through approximately ten db.—more than enough to compensate for any recording curve.

Just a word about the programming of microgroove records. The first cut on an L-P record is preceded by a series of lead-in grooves. The actual music begins two full turns (approximately four seconds, at 33 1/3 r.p.m.) from the last lead-in groove. This same rule applies to the leadgroove between separate bands on the L-P disc. Therefore, the engineer has a convenient, visible means of cueing long-playing records. It is recommended that the motor switch be used in starting *without* slipping the record on the turntable, as is customary with shellac pressings. Dust and scratching will adversely affect L-P records, particularly on felt-covered turntables. Needless to say, the tables must be maintained perfectly level.

As stated before, this method of putting microgrooves on the air is the result of extensive experimentation. No other system tried gave quite the flexibility of tone compensation that this one offers. At station WGPC, even uncritical listeners noticed the difference between conventional records and microgroove discs. Indeed, no radio station is completely modern without at least one turntable for L-P.

-30-

NEW YORK HAMS NOTE

AMATEUR radio operators living in the vicinity of New York City are invited to investigate the positions open at the 42nd Signal Company, New York National Guard. Openings are in the Radio Operations, Radio Maintenance, and Radio Relay sections of the Guard company.

Amateurs who are veterans and who can qualify may enter the company with their old ratings.

The company meets at the Jamaica Armory, 169th Street, Jamaica, New York, every Monday night from 8 to 10 p. m. For information, contact Lt. Henry Lichtenberger, W2AEX, at the armory any Monday night.

-30-

TRADE-INS ARE MY BUSINESS! TELL ME WHAT YOU HAVE AND WHAT YOU'D LIKE TO HAVE. WE CAN MAKE A DEAL!

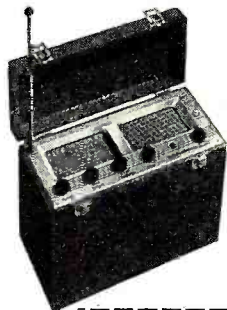

HOW ABOUT THIS NEW S-72 HALLICRAFTERS ALL-WAVE PORTABLE

Super powered. Maximum efficiency on AC, DC or battery. Covers standard broadcast band and 3 short-wave bands—540 KC to 30.5 Mc. 8 tubes plus rectifier. Handsome brown leatherette cabinet with brass plated hardware. Less batteries. Only \$79.95.

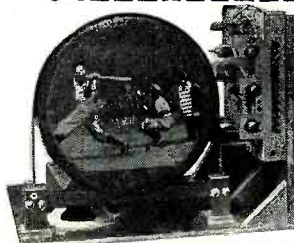

T-69 NEW HALLICRAFTERS 15" TV CHASSIS FOR CUSTOM INSTALLATIONS

Complete with picture tube. Needs only cabinet or mounting place in your wall. Brilliantly lighted. All channel push-button tuning. 8 inch P.M. Speaker included. 19 1/2" x 23" x 21". Here's a custom installation at a real saving in price. Only \$259.50.

Nobody can beat Bob Henry on a trade-in! (I make the deals myself.) Nobody can beat Bob Henry's world's lowest credit terms! (Because I handle it myself.)

Bob Henry gives you immediate delivery on practically anything in the amateur or communications receiver line. (I carry the world's biggest stock.) Bob Henry gives YOU FREE ten-day trial and FREE 90-day service!

These are just some of the reasons why Bob Henry sells more receivers than anyone in the world! EVERYTHING has some trade-in value. Write me what you have and what you want. We can do business!

BOB HENRY W0ARA
COMPLETE STOCK OF ALL HALLICRAFTERS RECEIVERS AND TRANSMITTERS

Write for catalog prices, time sale information



Butler 2, Missouri

HENRY RADIO STORES

11240 Olympic Blvd
LOS ANGELES 25
CALIF.

"WORLD'S LARGEST DISTRIBUTORS OF SHORT WAVE RECEIVERS"

The PENN Teletower... NEW 3-WAYS!

- (1) NEW Low Price
- (2) NEW Ease of Erection
- (3) NEW Extended Field of Reception

RETAILERS

Grab at Low Price of
Less Than Dollar per Foot!

Everyone's known for a long time that a tripod-type tower provides the best support for antenna. But until now, "only the rich could afford it." Today, Penn prices the tripod within reach of the solid bulk—not just the thin cream—of television's market.

INSTALLERS

Go For Ease of Erection!

So foolproof—so safe—is the Penn Teletower that just two men zip it up fast without use of rigging hoists. Exclusive pilot hole provides automatic alignment.

HAMS

Enthusiastic About Reception!

Ingenious Teletower sectional construction makes it easy to gain height... rise above interference.

WHOLESALE: Write for details about Penn's profitable line—distributed entirely through jobbers.

PENN Teletower...

Manufactured by PENN BOILER and BURNER MFG. CORP.
Makers of Penn Packaged Heat ESTABLISHED SINCE 1932

CLOSE OUT SALE



RM-29A TELEPHONES

Reduced
to only **\$7.95**
each
2 for \$14.95

Complete
with handset
and 4 1/2 volt
"C" battery



Stock No. B-588H

Two or more of these units make an excellent private telephone system. Require only two wires connecting the two or more units. No external power required. Every unit has been completely reconditioned and tested and is guaranteed to be in excellent condition, ready to operate. Shipping weight - 16 lb.

Only a limited quantity in stock. Don't delay! This may be your last opportunity to take advantage of this outstanding surplus buy.

Outdoor Telephone-Intercom 3-CONDUCTOR CABLE

at less than 1¢ per foot

Stock No. C-561H

525 FOOT ROLLS

Only **\$4.95** per roll



Each conductor consists of four #28 steel strands for extra strength and three #28 copper strands for extra conductivity and flexibility. Rubber insulation with two-ply waterproofed braid covering around each conductor. Net wt. 20 lbs. A wonderful buy for any telephone or inter-communication use requiring 2 or 3 conductor cable. Shipping weight - 20 lb.

Anticipate your needs on this wire!

Lay in a stock now. You will never again be able to duplicate this value.

TERMS -- cash with order, or 20% deposit - balance C.O.D.

Prices are net, F.O.B. Dayton, Ohio

SREPCO, Inc.

STANDARD RADIO & ELECTRONIC PRODUCTS

135 E. Second St. - DAYTON 2, OHIO - Tel. FULTON 2174

Good enough... to frame!

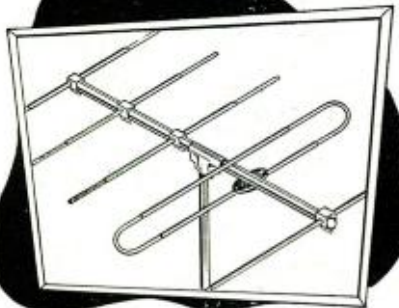

Model 300EA for Channels 2-6 adjustable
Model 520TVA for Channels 7-13 non-adjustable

The Elincor 5 Element Beams have been expressly designed for narrow beam reception. These Elincor 5 element arrays have proved themselves in wireless telephone communication, in remote broadcast pickup, in airplane beams and in fringe area television reception.

Having a forward gain of 12 db and a front-to-back ratio of 30 db, they are particularly advantageous in reducing QRM and interference from other stations. The use of a folded dipole gives these antennas much wider response. These antennas will bring in signals where boosters have failed and have given good results in a 140-mile range.

ELINCOR ASSURES BETTER RECEPTION

Send for
Free "49" catalog



ELECTRONIC INDICATOR CORP.
53 WYCKOFF STREET BROOKLYN, N. Y.

Classified

Rate 20c per word. Minimum 10 words

RADIO ENGINEERING

SPECIAL instrument panels made for Custom Constructors, Designers. Complete Service. Gilpin, Box 638, Rte. 4, Mt. Clemens, Mich.

RADIO Engineering Broadcasting, Aviation and Police Radio. Servicing, Marine Operating and Electronics taught thoroughly. Expenses low. Write for catalog. Valparaiso Technical Institute. Dept. N., Valparaiso, Ind.

SALE

AIRCRAFT Radio Business. Nice service business. Good stock of transmitters, receivers, accessories and parts. Distributorships of several nationally known lines and dealership of top television line. Also available Aeronca Chief aircraft equipped with aerial sound. McRadio Sales & Service, P. O. Box 2811 or Phone 24961, Little Rock, Ark.

PHOTOFLASH Ignition Transformer; 15KV peak, reg. \$4.50; special \$1.95. Modelectric Products, Asbury Park, N. J.

WIRE Recorder. Webster 80. Cost \$150. Sell \$100. J. Pitcairn, Amberson Pl., Pittsburgh, Pa.

BATTERY Tester; 1 1/2-3V. Dry-cells and 2V. wet-cells. Reg. \$14.95; closeout \$4.95. Money-back guarantee. Modelectric Products, Asbury Park, N. J.

BC-312-D and BC-223-AX new. Make offer one or both. E. L. Robberson, 334 Main St., Port Washington, N. Y.

AMP. ACA-100 ADC. Guaranteed, 25 W. Johnston, Box 193, Nogales, Ariz.

GRILL Cloth, Celanese, light and dark pieces. 1000 square inches for \$1 bill. Write for list of lowest priced national brand parts in nation. Bursma Radio, Route 5, Grand Rapids, Mich.

BARGAINS: New and reconditioned Hallcrafters, National, Collins, Hammarlund, RME, Meissner, other receivers, tuner, television receivers, transmitters, amplifiers, speakers, etc. Lowest wholesale prices. Terms. Shipped on trial. Liberal trade-in allowances. Write. Henry Radio, Butler, Mo., and 11240 W Olympic, Los Angeles, Calif

BARGAIN Hunting? Radio Servicemen write. Sensational catalog. Henshaw Radio Supply, 3619 Troost, Kansas City 3, Mo.

RADIO Diagrams under seven tubes 30c, over six tubes 60c. Television Diagrams \$1.00, with service data, \$2.00. State manufacturer and model number. Kramer's Radio Service, 36 Columbus Ave., New York 23, N. Y.

HEARING Aids. Zeniths, others. All used but working. Make miniature transmitters or receivers. Complete with cords, ear piece, \$20 ea. Shelby Instrument, 321 W. 7th, Long Beach, Calif.

RADIOS, record players, tubes, parts; send for free list. Mr. Morillo, Mike's Radio Service, 173 E. 101st St., New York 29, N. Y.

LOWEST Prices Radio Tubes, parts. Bargain lists, 3c. Potter, 1314 McGee, Kansas City 6, Mo.

ALUMINUM tubing, etc. Beams for Amateurs, TV, FM. Write for lists. Willard Radcliff, Fostoria, Ohio.

COAXIAL Cable. 100 feet \$3.00; sample 10c. Harry H. Van Dick, Box 236, Little Falls, N. J.

300 SETS; wireless sets, Canadian, 19 MK and 11. Export packed. 193 wireless sets, American, B-19, in crates, 108 wireless sets, Canadian 19 MK, 11 basic stations, in crates. Export packed sets are complete with antennas and spare tubes; American sets are less antennas and spare tubes; basic Canadian sets are repacked with 1 set of antennas. FOB Canada, \$32. Amco Brass, 428 Broome St., N. Y.

CODE Tapes. Radiotelegraph Practice Tapes for school and individual use. Wide selection for Beginners, Advanced and FCC code preparation. Fits most phototube keyers. \$2.50 each, postpaid. For Tape list, write: Ultradyne Electronics, Oswego, Ore.

SUPREME Audolyzer #562. Just factory checked, still in carton. Best offer. Nels M. Berge, Dolliver, Iowa.

BAUSCH and Lomb f1.9 Television Projection Lens, new \$85.00. J. Floam, 2201 Bryant, Baltimore, Md.

WRITE Dept. RN18 for our free wholesale list of Radio parts & accessories. R. C. Radio Parts & Distributing Co., 731 Central Ave., Kansas City 6, Kan.

HOTTEST surplus list in the country. Electronics-Hydraulics. Aircraft-Gadgets. Dick Rose, Everett, Wash.

TOGGLE Switches, new H & H arrow 3 amp DPDT, ball handle, stem length 1/2", 4 for \$1.00, 9 for \$2.00. Rectifier capacitors, surplus Aerovox, 2000 mfd 35 VDC \$2.50 each. All items postpaid in U.S. Kissel Electric Products, 431-N, Sherman, Galion, Ohio.

CLOSING out sale, used equipment, while they last. SX-42 complete with Speaker, \$200.00. Rek-O-Kut recording Amps, \$100.00. Thordason Power Pack parts 3120-2500/300 Mills CT, complete chokes and filters, \$50.00. Cash only. Box 443, Crookston, Minn.

SPECIAL parts made to your spec. Very reasonable. Leo J. Vince, W8FYA, 2805 E. 117th St., Cleveland 20, Ohio.

RADIO Parts 9c up! Tubes low as 29c. Speakers 89c up. Condensers 9c to 99c. Vibrators 99c. Loop Ants., 19c 500m Vol. Cont. w.s.w. 29c. No junk. No surplus. Free list. Paramount Co., 4406 York Blvd., Los Angeles 41, Calif.

COMPLETE sixteen-inch recording equipment, reasonable. E. Bernash, 46 Hillside Ave., Woodlawn, Buffalo 19, N. Y.

PHOTOFLASH Tubes Sylvania R4330 brand new, \$10.00. Quantities of ten, \$8.00. Iavarone, 1218 Leland Ave., Bronx 60, N. Y.

WANTED

TECHNICOLOR chromosec telescope kit. A. Porterfield, 41 Winnebago, Tuckahoe 7, N. Y.

MAGAZINES--Modern Electronics and Popular Electricity 1909. J. Landa, 157 Leverett, Boston 14, Mass.

HELP WANTED

INSTRUCTORS in Electronics and Radio. Prefer former Navy Radio Technician instructors willing to locate in the Detroit, Mich., area. Write to Box 452, % Radio & Television News, 185 N. Wabash Ave., Chicago 1, Ill.

PATENT ATTORNEYS

LANCASTER, Allwine & Rommel. Registered Patent Attorneys. Patent practice before U.S. Patent office. Validity and infringement investigations and opinions. Booklet and form "Evidence of Conception" forwarded upon request. Suite 414, 815 15th St., N.W. Washington 5, D.C.

HERMAN Lewis Gordon, Registered Patent Attorney. Patent Investigations and Opinions. Warner Building, Washington, D. C.

CORRESPONDENCE COURSE

AMATEUR radio licenses. Complete code and theory preparation for passing amateur radio examinations. Home study courses. American Radio Institute, 101 West 63rd St., New York 23, N. Y.

USED Correspondence courses and books bought, sold, rented and exchanged. Catalog free. Leo Mountain, Pisgah, Alabama.

MISCELLANEOUS

TELEVISION and Radio Service Charts simplifies locating troubles, 50c each. Satisfaction guaranteed. Louis Harper, P. O. Box 8, Castleton Corners, Staten Island 14, N. Y.

"RADIOBUILDER," 3 issues 25c. Sample free. Laboratories, 578-H, San Carlos, Calif.

LET Wife and Kids play Crypto-Game while you DX. 20c postpaid. The Crypto-Game Co., Enid, Okla.

EMBOSSED Business Cards 1,000, \$3.45 postpaid. Spada Enterprises, 10D Lexington, Wethersfield 9, Conn.

27 YEARS of experience Radio Repairing. Simplified system. No calculations. No formulas. Total price \$2.00 postpaid or C.O.D. Moneyback guarantee. Ross Radio, 14615 Grandriver, Detroit 27, Mich.

RADIO Service shop going out of business. Complete set of test equipment for sale, cheap. Herbert W. Gordon, 12 Sunnyside Ave., Wellesley 81, Mass.

QSL-SWL cards. Samples. W1HJI, Box 32, Manchester, N. H.

FOR Sale: Radio Shop, Service Station and Grill with 2 completely furnished apartments, located 16 miles south of Atlanta, Ga., on U. S. Highway 41. Must sell because of ill health. For full information write Carl's Radio & Television Service, Jonesboro, Ga.

RADIO & TELEVISION NEWS

ANSWERS to FCC Supplement Four Radio-telegraph questions; and Element One complete. \$1. A. A. McKenzie, 245 Poplar Ave., Fairmount, Hackensack, N. J.

INFINITELY variable voltage transformer operates from home lighting current. Steps voltage up or down. Vary speed of motors, dim lights, do radio test work. Copyright data \$1.00. PeJay Engineering, P.O. Box 1172, Oakland 4, Calif.

RADIOMEN, Servicemen, Beginners. Make more money, easily, quickly. \$250 weekly possible. We show you how. Information free. Merit Products, 216-32R 132 Ave., Springfield Gardens 13, N. Y.

SPEAKER RECONING

THE NATION'S FASTEST SERVICE
INFRARED DRYING

By actual count, over 90% of our recone jobs are on their way back to the sender in less than 24 hours after receipt.

2½ in. \$1.40	6¾ in. \$1.65	13¼ in. \$4.00
3½ in. 1.40	7 in. 1.95	15 in. 4.00
4 in. 1.40	7½ in. 1.95	18 in. 7.50
4½ in. 1.40	8 in. 2.20	2x3 in. 1.50
5 in. 1.50	10 in. 2.70	4x6 in. 1.90
5½ in. 1.50	11 in. 3.00	5x7 in. 2.20
6 in. 1.65	12 in. 3.00	6x9 in. 2.50

Satisfaction Guaranteed

All speakers sound tested at full audio rating before shipment. Send us a trial shipment and we believe that you will become another of our regular customers. Avoid C.O.D. Fees by prepaying the amount of your shipment according to the above schedule.

ARROW RECONING

125 East First St.

Duluth 2, Minn.

PORTABLE POWER SUPPLY

(Low drain)

AVA-126A, RCA mfg., for mobile, boats, planes. In grey crackle steel box 5" 6½" 7" — wt. 10-lbs. Operates from 6 or 12 V. DC source and delivers 320 V. DC at 110 Ma. with taps for rcvr. and transmitter. OZ4GT rectifier, 3 built-in relays, complete filters, 2 vibrators (6 and 12 V.), mtg. accessories. **NEW**..... **\$14.95**

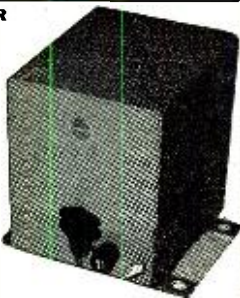

RECEIVER—AVR-20A, RCA mfg., manual tuning, CW and phone, and two xtal positions. Freq: 2300-6700 Kcs., but overlaps into 40 Mtrs. All you need is 6 volts "A" and small "B" supply, or use companion AVA-126A above. Size 5½" x 6½" x 6" — wt. 6-lbs. All tubes, data **\$15.50**

PORTABLE FOLDING WHIP ANTENNA—AN-131A famous "Throw Out" folds into 8 interconnected lengths 17" long. When thrown out measures 10'6". Threaded base for mounting. **\$1.65**

COMMUNICATION DEVICES CO.
2331 TWELFTH AVENUE NEW YORK 27, N. Y.
Cable: Communidev Tel: AD-4-9277

GREYLOCK

RADIO TUBE BARGAINS!
GT. Glass and Miniature Types

1R5	6AT6	12SA7	} 34½¢ ea. in 100 lots
1S5	6BA6	12SJ7GT	
174	6BE6	12SK7	
1U4	6SA7GT	12SQ7	
3Q4	6SJ7GT	25Z6GT	
354	6SK7GT	25L6GT	
3V4	6SQ7GT		

SPECIAL OFFER! All above types may be purchased in lots of 100 assorted, at \$34.50 per 100. Also available in smaller quantities at 39¢ each.

6AK5 49¢ ea. 6BG6 69¢
6AQ5 123-8016 69¢
6J6 2E24 \$1.89

TERMS: Net C.O.D., F.O.B. NYC. MINIMUM ORDER \$5.00.

Write for Bargain Catalog N-8
Greylock Electronics Supply Co.
30 Church Street New York 7, N. Y.

ELECTRONIC EXHIBIT NEAR SELL-OUT

AUGUST 30 and 31, and September 1 are the dates set for the Fifth Annual Pacific Electronic Exhibit to convene during San Francisco's 1949 Gold Rush Centennial. In conjunction with this exhibition, the 1949 Western Regional Convention of IRE will be held at the same time, and the two-way conference will feature the introduction of many new products and developments.

All exhibits will be on the Civic Auditorium's large floor. Among the firms participating this year in the Pacific Electronic show are the Audio Development Co.; Boonton Radio Corp.; DeMornay Budd Co.; Drake Electric Works; General Radio Co.; Hallicrafters Co.; James Knight Co.; The National Company; National Union Tube Co.; Ohmite Mfg. Co.; Radio Receptor Co.; Sangamo Electric Co.; Simpson Electric Co.; Sorensen & Company; Sprague Electric Products Co.; Telex, Inc.; Sylvania Electric Products Co.; Webster-Chicago Corp.; and Westinghouse Electric Corp.

Because of the fact that a larger-than-usual number of Far Western firms have ordered space, spokesmen for the Association announce that only a handful of vacancies remains, and the exhibition bids fair to be a huge success. —50—

WOW-TV 1949 SCHOLARSHIP AWARD

NAVY veteran Thomas G. Smith of Sioux City, Iowa, a student at Creighton University, was presented recently with a television scholarship by Secretary of the Navy Francis P. Matthews, acting in his capacity as general counsel and vice-president of the board of directors of Radio Station WOW, Inc.

The scholarship pays tuition for the senior year and was presented to Smith for his work in the television production experiments WOW-TV has conducted on the Creighton campus the past two years. It will enable him to spend more time on his television work.

Winners of the scholarship must show promise of becoming assets to the television industry, and professional students are eligible provided they demonstrate real interest and are willing to devote time to extra-curricular television work. —50—

ERRATUM

In the article, "A Super-Modulated, Low-Power Phone Transmitter," under Performance, page 99 of the June issue, the readings given for plate current on jacks J₅ and J₆ should be transposed.

PHOTO CREDITS

Page	Credit
30	DeMornay Budd, Inc.
38, 39 (right)	Admiral Corporation
39 (left), 114, 118	Radio Corporation of America
41	General Electric Co.
56 (Fig. 7D, 9B)	Ward Products Corp.
66	Molded Products Corp.
86	U. S. Army
88	Weld Cox—Berkshire Evening Eagle
100	Chicago, South Shore & South Bend R. R.
106	Acme
122	A. M. Byers Company

SNAP!

YOUR ANTENNA IS
ASSEMBLED

THE OAK RIDGE 6
FM and TV ANTENNAS

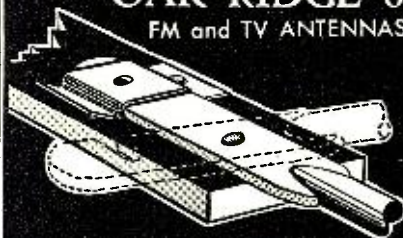

FEATURING THE AMAZING
SNAP-LOCK®

®Pat. Pending

- Revolutionary four-second assembly.
- Just snap it out and it's fully assembled.
- Extremely rugged—½ inch aluminum elements.
- Completely pre-assembled—No loose hardware.
- We manufacture a full line of quality FM and TV antennas, including Hi-Lo's, Conicals, In-lines, Vee's, Stacked Arrays.
- Ask your local jobber for a demonstration. Inquiries invited.

OAK RIDGE ANTENNAS

239 East 127th Street, New York 35, N. Y.
Manufacturing Division of Video Television, Inc.

SAVE MONEY BRAND NEW GUARANTEED GENERAL ELECTRIC SELSYN

Type 2J1G1

Will operate from 110 volts, 60 cycle by using a resistor or a condenser in series. Size is 2¼" in diameter x 4¾" long. Ideal for beam antenna position indicator.



Price **\$2.75**
per pair — removed from new equipment



HAYDEN TIMING
MOTORS
Type 45629R

110 volts, 60 cycle, 2.2 watts, 1/240 R.P.M.

Price **\$3.00**
ea. net, new

Type 36938-2

110 volts, 60 cycle, 2.2 watts, ½ R.P.M.

Price **\$3.00**
ea. net, new

Type 33669-2

110 volts, 60 cycle, 2 watt, ⅓ R.P.M.

Price **\$3.00**
ea. net, new

4 R.P.M. with break
110 volts, 60 cycles
3.2 watts.

Price **\$4.00**
ea. net, new

INSTRUMENT ASSOCIATES
147-57 41st Ave., Flushing, N. Y.
INdependence 3-1919

Portable TRI-TUBE Antenna MASTS TELEVISION FM-AMATEUR COMMERCIAL



LOW COST
•
LIGHT
•
QUICK
•
EASY

Most section is triangular in construction using 1" ID steel tubing with proper bracing, all electric welding. Lower unit is 20 ft. long hinged on frame with locking device. Levelling device compensates for position of vehicle on any test location. Upper unit is a smaller triangle and telescopes into lower unit on rollers, which allow smoother operation. Cable and drum provided with pin assembly for safety and locking into any height. Antenna mast can be set up by two men in a few moments... NO GUYS - NO WRENCHES - NO BOLTS All bolts have T handles. Demountable by removing two bolts in four minutes. Aluminum painted ready to mount.

- 250 BASIC UNIT COMPLETE 50 ft., 10 ft. pole
- 251 SAME AS 250-ORIENTATION AT ANY HEIGHT
- 252 SAME AS 251, WITH ANTENNA HEIGHT 70 FEET

A. A. PETERS
TRI-TUBE MASTS
231 N. 7th Allentown Pa.
SHIPPED F O B ALLENTOWN, PA.
\$295 and up

CREI Prepares Young Men for Professional Careers with Industry-Recognized Training in a minimum of time

RADIO-ELECTRONICS-TELEVISION ENGINEERING

GRADUATES of the Capitol Radio Engineering Institute residence school are preferred by industry because of their *training and ability*. This recognition is the reason that CREI men quickly find good jobs in radio-electronics-television engineering and technical fields.

With 22 years of practical teaching experience in these highly technical fields, CREI offers an outstanding faculty, modern and complete laboratories, shops and equipment.

New students are accepted twice monthly and each may advance as rapidly as he is capable. The basic course with one specialized course requires an average of 20 months to complete, depending on the ability of the individual student.

CREI is recognized as one of the country's leading technical institutes. Its work is of college level. It prepares the young man for a good job in industry in a minimum of time.



Approved for Veterans' Training

CAPITOL RADIO ENGINEERING INSTITUTE

An Accredited Technical Institute Founded in 1927

MAIL COUPON FOR FREE CATALOG
Capitol Radio Engineering Institute, Dept. 138A
16th and Park Rd., N. W., Washington 10, D. C.
Please send me your residence school catalog and details.
(If interested in Home Study check below)

Name Age.....
Street
City Zone..... State.....
 I am entitled to training under G.I. Bill. Send information on Home Study Courses.

INDEX OF Advertisers

AUGUST 1949

While every precaution is taken to insure accuracy, we cannot guarantee against the possibility of an occasional change or omission in the preparation of this index.

ADVERTISERS	PAGE	ADVERTISERS	PAGE
Acorn Electronics Corp.	125	Leetrolm, Incorporated	108
Aerco Sales Co.	120	Leeds Radio Co.	113
Alliance Manufacturing Company.	131	Lehigh Television Company.	85
Allied Radio Corp.	9	Leotone Radio Co.	124
Almo	126	MaeMillan Co., The.	70
American Radio Institute.	130	Mallory & Co., Inc., P. R.	4th Cover
Amplifier Corp. of America.	103	Martin School of Radio Arts, Don.	109
Arrow Electronics	115	Mass. Radio School.	123
Arrow Reconing	135	Meissner Mfg., Division Maguire Ind., Inc.	124
Arrow Sales, Inc.	129	Mid-America Co., Inc.	88
Ashe Radio Co., Walter.	18, 87	Midwest Radio & Television Corp.	67
Astastic Corporation, The.	92	Miller, J. W.	128
Audio Development Co.	97	Milwaukee School of Engineering.	115
Baltimore Technical Institute.	121	Mosley Electronic Specialties.	92
Bell Telephone Laboratories.	10	McGee Radio Company.	71, 72, 73
Bliss Electrical School.	117	McGraw-Hill Book Co.	126
Buffalo Radio Supply.	95	Nation Wide Radio.	114
Burlington Instrument Company.	84	National Company, Inc.	60, 106
C & H Sales Co.	121	National Radio Institute.	3
Candler System	108	National Schools	13
Cannon Electric Development Company.	82	Newark Surplus Materials Co.	104
Capitol Radio Engineering Institute.	89, 136	Oak Ridge Antennas.	135
Centralab, Division of Globe-Union, Inc.	68, 69	Offenbach & Reimus Co.	99
Certified Television Laboratories.	117, 130	Olin Industries, Inc.	11
Chicago Industrial Instrument Co.	131	Opad-Green Company	83
Cinaudagraph Speakers, Division of Aircor Mfg Corp.	127	Owl Radio Tube Company	108
Cinex, Inc.	14	Peak Electronics Co.	96
Clear-Vac Co.	70	Penn Boiler & Burner Mfg. Corp.	133
Cleveland Institute of Radio Electronics	5	Photocon Sales	103
Columbia Electronics Sales.	100	Potter Radio Co.	84
Comet Electronic Sales Co.	121	Premier Radio Tube Company.	79
Commercial Radio Institute.	111	Products Engineering	105
Communication Devices Co.	135	Progressive Electronics Co.	58
Communications Equipment Company.	91	Pyramid Electric Company.	16
Communication Measurements Laboratory, Inc.	76	Quad Electrical Supply, Inc.	18
Cornell-Dubilier Electric Corp.	3rd Cover	RCA Institutes, Inc.	14
Coyne Electrical & Radio School.	110	R & M Radio Company.	107
DeForest-Sanabria Corporation	17	Radio Craftsmen Incorporated, The.	129
DeForest's Training, Inc.	7	Radio Ham Shack, Inc.	77
Electro-Technical Industries	116	Radio Parts Company	97
Electronic Indicator Corp.	134	Radio Specialists Co.	111
Electronic Instrument Co., Inc.	93	Radio Supply & Engineering Co., Inc.	80
Electronic Supplies	84	Radionic Equipment Co.	132
Electronics Institute, Inc.	113	Raytheon Manufacturing Company.	18
Emmons Radio Supply.	109	Raytron	123
Espey Manufacturing Company, Inc.	119	Sams & Co., Inc., Howard W.	19
Fair Radio Sales.	127	Senco Radio, Inc.	117
Feiler Engineering Co.	112	Shore Engineering, Inc.	132
Franklin-Ellis Co.	123	Sonotone	86
G. L. Electronics	122	Sovereign Television Co.	112
General Electric Company.	22, 59	Spellman Television Co., Inc.	76
General Electronic Distributing Co.	81	Sprague Products Company.	90
General Test Equipment.	14	Stahl, Inc., Michael.	66
Goodheart, R. E.	122	Standard Radio & Electronic Products.	134
Greenwilt Sales Co.	92	Standard Transformer Corporation.	109
Greylock Electronics Supply Co.	135	Sun Radio and Electronics Co., Inc.	102
Hallcrafters Co., The.	57	Sun Radio of Washington, D. C.	94
Harvey Radio Company, Inc.	78	Supreme Publications	21
Heath Company, The.	61, 62, 63, 64, 65	Sutton's Wholesale Electronics, Bill.	115
Henry Radio Stores.	133	Sylvania Electric Products, Inc.	15
Hiway Company	76	TAB	137
Hollywood Sound Institute, Inc.	107	Thordarson Electric Manufacturing Division Maguire Industries, Inc.	14
Hytron Radio and Electronics Corp.	2nd Cover	Transvision, Inc.	20
Indiana Technical College.	18	Tri-State College	108
Instant Tool Corporation.	12	Tri-Tube Masts	136
Instructograph Company	113	Turner Company, The.	105
Instrument Associates	135	Valparaiso Technical Institute.	105
International Resistance Co.	6	Ward Products Corporation.	75
JFD Manufacturing Co., Inc.	101	Weaver Company, J. M.	107
Jerrold Electronics Corp.	98	Weller Manufacturing Company.	8
Klein, Manuel	119	Wells Sales, Inc.	138
		Wholesale Radio Parts Co., Inc.	118
		Workshop Associates, Inc., The.	125
		World Radio Laboratories, Incorporated.	111
		Ziff-Davis Publishing Company.	107, 108, 117, 123

Within the Industry
(Continued from page 18)

as an assistant buyer of radios in the Chicago headquarters, was given the position of buyer of console and console-combination radios.

SYLVANIA ELECTRIC PRODUCTS, INC., has recently formed a Canadian subsidiary to manufacture fluorescent lamps and other lighting equipment. The new company, to be known as *Sylvania Electric (Canada) Ltd.*, has leased a plant in the Province of Quebec, the building being reconditioned by the city to the company's specifications.

Officers of the new company are F. J. Healy, president; R. H. Bishop, vice-president; William O'Keefe, secretary; and M. F. Balcom, treasurer. Mr. O'Keefe, general foreman at the *Sylvania Danvers, Mass.*, plant, will manage the new firm, while J. C. Hicks, formerly Kansas City, Mo., division manager, has been appointed sales manager.

BOB HOPE, as chairman of the *Quality Electric Television Corporation* of Los Angeles, is now the new distributor of *Du Mont* television sets in Southern California. Hope, already well-known as a radio and motion picture comedian, declared he had been interested in the industrial side of television for some time. . . . **SID LUCKMAN** will head the *New World Distributors, Inc.*, 540 N. La Salle St., Chicago, which has been named official distributor for *Du Mont* TV receivers in the Chicago area. Luckman is the former All-American football star, and later Chicago Bears pro. . . . Sales manager of the distributor division of *National Union Radio Corporation* has been announced as **EMIL J. MAGINOT**. One of the real old timers in radio, Mr. Maginot has been with *National Union* eight years. . . . Operating out of the company's Chicago office at 20 North Wacker Drive, **EDWARD G. BRIERTY** has been appointed equipment sales representative for the radio division of *Sylvania Electric Products, Inc.* . . . **CHARLES F. "BUD" FOUTS** has been appointed to the staff of M. F. Gillern, *Cannon Electric Development Company* specialty sales manager, and will be responsible for selling such items as signal systems, special lights, etc. . . . Widely known in the electric clock and synchronous motor and timer fields, **RUSSELL T. WOODWARD** has been appointed manager of marketing of *Telechron, Inc.* . . . It was recently announced that **MILTON J. STREHLE** will be the new assistant sales manager of replacement tubes for the Tube Division of the *General Electric Company*, Electronics Park, Syracuse, N. Y. . . . **LEONARD C. WELLING**, well known in the radio and television field, has joined the *Jewel Radio and Television Corp.*, New York, as general sales manager.

**SUMMER SPECIALS—NO BALLYHOO
JUST A CARLOAD OF BARGAINS!!**



CIRCULAR Slide Rule Equipped with 2 1/2" Radius LAMINATED Print Keeps Muds, Stubs, Cubes, Roots, LogDecScale, Data Case \$9c Six For \$5.

RCA UNIV. Output Transformer 10 Watt—Up to 10,000 cys. Matches ANY Voice Coil 3 to 10 or 15ohms to ANY Load & Tube Imp. Price \$0.39 & 1024 Ohms. \$1.39

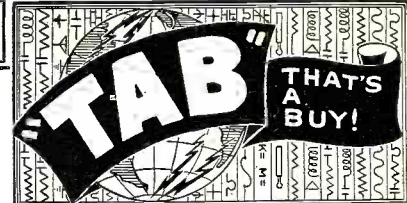

TUBES... AND GUARANTEED

0A4G \$ 1.05	3V4 \$.69	6SL7GT \$.55	35L6GT \$.63
OZ4 \$.87	4B27/201 \$ 2.49	6SN7GT \$.55	35W4 \$.45
1A3 \$.59	4C33 \$ 81.00	6SQ7GT \$.47	35Y4 \$.70
1A5T \$ 1.70	4C35 \$ 22.95	6ST5GT \$.70	30Z5GT \$.45
1A6 \$ 1.26	4J42/700A \$ 29.95	6S8T \$.63	36 \$.63
1B2/8016 \$.81	4J47 \$ 45.00	6T7G \$ 1.19	38 \$.44
1B21/471A \$ 2.95	4L42 \$ 45.00	6U5/6G5 \$.72	41 \$.58
1B24 \$ 2.89	5C30/CSB \$ 9.95	6U6GT \$.69	43 \$.63
1C5 \$.86	5D21 \$ 24.95	6U7G \$.70	4S/VT52 \$.30
1C7G \$ 1.26	5E4 \$.95	6V6 \$.58	46 \$.48
1D5GP \$ 1.25	5F4 \$.95	6V8 \$ 1.17	48 \$ 1.20
1E3/1007 \$ 1.38	5G4G \$.96	6V9 \$ 1.42	49 \$ 1.49
1E7G \$ 1.17	5Y3GT \$.38	6X4 \$.49	50B5 \$.54
1F4G \$ 1.05	5Z3 \$.81	6X5GT \$.55	50L6 \$ 1.63
1F6V \$.98	6A4 \$ 1.29	6Z7G \$ 1.23	73/RK73 \$ 1.67
1G4GT \$ 1.05	6A9 \$.98	7A4 \$.70	75 \$.56
1G6GT \$.98	6A9 \$ 1.29	7A6 \$.69	77 \$.47
1H5 \$.87	6A9 \$ 1.29	7A8 \$.69	77 \$.47
1H5G \$.65	6AB7/1853 \$.84	7AG7 \$.85	78 \$.85
1H6G \$ 1.27	6AB7 \$ 1.02	7B5 \$.75	78 \$.85
1L4 \$.69	6AC7 \$.81	7C4/1205A \$.38	82 \$.98
1L4AGT \$ 1.05	6AG3 \$.81	7C6 \$.69	83V \$ 1.05
1L4B \$ 1.05	6AG3 \$ 1.27	7E5/1201 \$.89	84/6Z4 \$.65
1L6C \$.85	6A15 \$.85	7E6 \$.85	205B/VT2 \$ 1.98
1L6BGT \$.95	6A15 \$.85	7E9 \$.85	211S/VT4 \$.95
1L7 \$ 1.18	6A15 \$.85	7F7 \$.85	250TH \$ 19.44
1L8 \$.75	6A15 \$.85	7G7 \$ 1.83	250TH \$ 19.44
1L8S \$.69	6A15 \$.85	7N7 \$.85	804TH \$.95
1NSGT \$.69	6A15 \$.85	7Q7 \$ 1.04	804TH \$.95
1P24 \$.85	6A15 \$.85	7Y4 \$.69	327A \$ 2.90
1Q5GT \$.96	6A15 \$.85	80 \$.69	350B \$ 1.89
1R4/1294 \$ 1.09	6A15 \$.85	80 \$.69	350B \$ 1.89
1S5 \$.54	6A15 \$.85	80 \$.69	350B \$ 1.89
1T4 \$.54	6A15 \$.85	80 \$.69	350B \$ 1.89
1U4 \$.69	6A15 \$.85	80 \$.69	350B \$ 1.89
2A5 \$.86	6A15 \$.85	80 \$.69	350B \$ 1.89
2A6 \$ 1.05	6A15 \$.85	80 \$.69	350B \$ 1.89
2B7 \$.85	6A15 \$.85	80 \$.69	350B \$ 1.89
2B22/6L59 \$.73	6A15 \$.85	80 \$.69	350B \$ 1.89
2C18/3012 \$.25	6A15 \$.85	80 \$.69	350B \$ 1.89
2C26 \$.85	6A15 \$.85	80 \$.69	350B \$ 1.89
2C34/RK34 \$.55	6A15 \$.85	80 \$.69	350B \$ 1.89
2C36 \$.85	6A15 \$.85	80 \$.69	350B \$ 1.89
2C40 \$ 9.98	6A15 \$.85	80 \$.69	350B \$ 1.89
2C43/464A \$ 8.98	6A15 \$.85	80 \$.69	350B \$ 1.89
2C44 \$ 9.98	6A15 \$.85	80 \$.69	350B \$ 1.89
2D21 \$.98	6A15 \$.85	80 \$.69	350B \$ 1.89
2D25 \$.86	6A15 \$.85	80 \$.69	350B \$ 1.89
2E25/HY65 \$ 2.98	6A15 \$.85	80 \$.69	350B \$ 1.89
2J21/725 \$ 1.98	6A15 \$.85	80 \$.69	350B \$ 1.89
2J21A \$ 34.95	6A15 \$.85	80 \$.69	350B \$ 1.89
2J26 \$ 8.89	6A15 \$.85	80 \$.69	350B \$ 1.89
2J31 \$ 14.50	6A15 \$.85	80 \$.69	350B \$ 1.89
2J34 \$ 23.98	6A15 \$.85	80 \$.69	350B \$ 1.89
2J38 \$ 39.95	6A15 \$.85	80 \$.69	350B \$ 1.89
2J48 \$ 45.00	6A15 \$.85	80 \$.69	350B \$ 1.89
2J50 \$ 55.00	6A15 \$.85	80 \$.69	350B \$ 1.89
2J61 \$ 39.95	6A15 \$.85	80 \$.69	350B \$ 1.89
2J62 \$ 39.95	6A15 \$.85	80 \$.69	350B \$ 1.89
2K28 \$ 24.89	6A15 \$.85	80 \$.69	350B \$ 1.89
2K29 \$ 24.95	6A15 \$.85	80 \$.69	350B \$ 1.89
2X30 \$ 4.98	6A15 \$.85	80 \$.69	350B \$ 1.89
2X2 \$.49	6A15 \$.85	80 \$.69	350B \$ 1.89
3A4 \$.38	6A15 \$.85	80 \$.69	350B \$ 1.89
3A5 \$ 1.20	6A15 \$.85	80 \$.69	350B \$ 1.89
3B7/1291 \$ 1.85	6A15 \$.85	80 \$.69	350B \$ 1.89
3B24 \$ 1.85	6A15 \$.85	80 \$.69	350B \$ 1.89
3B25 \$ 4.95	6A15 \$.85	80 \$.69	350B \$ 1.89
3C23 \$ 2.48	6A15 \$.85	80 \$.69	350B \$ 1.89
3C28/1C1B \$ 1.47	6A15 \$.85	80 \$.69	350B \$ 1.89
3D6/1299 \$.85	6A15 \$.85	80 \$.69	350B \$ 1.89
3D22 \$ 7.49	6A15 \$.85	80 \$.69	350B \$ 1.89
3Q4 \$.54	6A15 \$.85	80 \$.69	350B \$ 1.89
3S4 \$.79	6A15 \$.85	80 \$.69	350B \$ 1.89

837 \$ 2.35	VR150 \$.55
838 \$ 2.75	WL460 \$ 11.98
843 \$.59	WL468 \$ 8.98
845 \$ 4.75	WL531 \$ 1.95
850 \$ 16.95	WL619 \$ 20.00
860 \$ 1.62	WL632A \$ 8.98
861 \$ 10.27	WTU5 \$ 2.49
864 \$.95	2AP1A \$ 4.98
865 \$.95	3BP1 \$ 2.98
866A \$.95	3BP2 \$ 2.98
866J \$ 1.00	3CP1 \$ 2.79
868/PJ23 \$ 1.90	3DP1 \$ 1.62
874 \$ 2.43	3DP2 \$ 1.49
876 \$ 1.49	3FP1 \$ 3.49
877 \$.36	3HP1 \$ 6.95
878 \$ 2.23	3HP2 \$ 4.98
884/6Q4G \$ 1.26	3HP10 \$ 5.98
885 \$.95	5BP1 \$ 1.95
903 \$ 4.85	5BP2 \$ 1.95
905 \$ 1.19	5CP1 \$ 2.98
923 \$.85	5CP7 \$ 12.95
924 \$.89	5DP1 \$ 1.26
931A \$ 3.95	5HP1 \$ 4.95
934 \$.18	5HP2 \$ 4.95
956 \$.13	5LP1 \$ 11.00
956 \$.13	5LP5 \$ 14.00
957 \$.25	5LP6 \$ 2.95
957 \$.25	7HP7 \$ 5.95
968 Submin \$ 4.98	9GP7 \$ 13.98
969 Submin \$ 5.98	9LP6 \$ 19.98
1049 \$ 59.95	12DP7 \$ 12.49
1603 \$ 3.98	12GP7 \$ 12.80
1609 \$ 5.95	12LP4 \$ 5.49
1676/6P6X \$ 1.50	912 \$ 79.95
1614 \$ 1.35	16AP4 \$ 59.98
1816 \$ 1.35	
1822 \$.49	BALLAST \$ 4.49
1822 \$.49	10-B \$.49
1822 \$.49	11-B \$.49
1822 \$.49	12-B \$.49
1822 \$.49	13-B \$.49
1822 \$.49	14-B \$.49
1822 \$.49	15-B \$.49
1822 \$.49	16-B \$.49
1822 \$.49	17-B \$.49
1822 \$.49	18-B \$.49
1822 \$.49	19-B \$.49
1822 \$.49	20-B \$.49
1822 \$.49	21-B \$.49
1822 \$.49	22-B \$.49
1822 \$.49	23-B \$.49
1822 \$.49	24-B \$.49
1822 \$.49	25-B \$.49
1822 \$.49	26-B \$.49
1822 \$.49	27-B \$.49
1822 \$.49	28-B \$.49
1822 \$.49	29-B \$.49
1822 \$.49	30-B \$.49
1822 \$.49	31-B \$.49
1822 \$.49	32-B \$.49
1822 \$.49	33-B \$.49
1822 \$.49	34-B \$.49
1822 \$.49	35-B \$.49
1822 \$.49	36-B \$.49
1822 \$.49	37-B \$.49
1822 \$.49	38-B \$.49
1822 \$.49	39-B \$.49
1822 \$.49	40-B \$.49
1822 \$.49	41-B \$.49
1822 \$.49	42-B \$.49
1822 \$.49	43-B \$.49
1822 \$.49	44-B \$.49
1822 \$.49	45-B \$.49
1822 \$.49	46-B \$.49
1822 \$.49	47-B \$.49
1822 \$.49	48-B \$.49
1822 \$.49	49-B \$.49
1822 \$.49	50-B \$.49
1822 \$.49	51-B \$.49
1822 \$.49	52-B \$.49
1822 \$.49	53-B \$.49
1822 \$.49	54-B \$.49
1822 \$.49	55-B \$.49
1822 \$.49	56-B \$.49
1822 \$.49	57-B \$.49
1822 \$.49	58-B \$.49
1822 \$.49	59-B \$.49
1822 \$.49	60-B \$.49
1822 \$.49	61-B \$.49
1822 \$.49	62-B \$.49
1822 \$.49	63-B \$.49
1822 \$.49	64-B \$.49
1822 \$.49	65-B \$.49
1822 \$.49	66-B \$.49
1822 \$.49	67-B \$.49
1822 \$.49	68-B \$.49
1822 \$.49	69-B \$.49
1822 \$.49	70-B \$.49
1822 \$.49	71-B \$.49
1822 \$.49	72-B \$.49
1822 \$.49	73-B \$.49
1822 \$.49	74-B \$.49
1822 \$.49	75-B \$.49
1822 \$.49	76-B \$.49
1822 \$.49	77-B \$.49
1822 \$.49	78-B \$.49
1822 \$.49	79-B \$.49
1822 \$.49	80-B \$.49
1822 \$.49	81-B \$.49
1822 \$.49	82-B \$.49
1822 \$.49	83-B \$.49
1822 \$.49	84-B \$.49
1822 \$.49	85-B \$.49
1822 \$.49	86-B \$.49
1822 \$.49	87-B \$.49
1822 \$.49	88-B \$.49
1822 \$.49	89-B \$.49
1822 \$.49	90-B \$.49
1822 \$.49	91-B \$.49
1822 \$.49	92-B \$.49
1822 \$.49	93-B \$.49
1822 \$.49	94-B \$.49
1822 \$.49	95-B \$.49
1822 \$.49	96-B \$.49
1822 \$.49	97-B \$.49
1822 \$.49	98-B \$.49
1822 \$.49	99-B \$.49
1822 \$.49	100-B \$.49

CONDENSER SPECIALS!!

OIL 5m/600vwbkcts \$.98
0.1 m/500vdc \$.49
OIL 2 m/330 vac/1000 dc \$.89
CD \$.89
OIL 0.25m/1500vdcGE \$.29
VACUUM 50mm/7500v/GE \$.98
CERAM 50mm Button \$.10
MICA 0.1m/600vTobu \$.98
ELC 30-1-10m/250V \$.59
Elec 15m/300vSprague \$.79
Elec 50m/350vPPSprague \$.98
Elec 30-1-10m/250V \$.59
Elec 40m/250v&20m/25v \$.98
Elec 10m/450v&2x20m/25v \$.98
FP \$.20
Tubular Paper .009 m/600 \$.98
Tubular Paper .05 m/150 \$.98
Tubular Paper .05 m/600 \$.98
Tubular Paper .1 m/150 \$.98
v \$.25 \$.98

PRECISION RESISTOR SPECIALS!!

Acry Vol 1 to 1/10 of One Percent
OHMS 179 673 1518 9902
.425 182 684 1646 10430
.271 371 10936
1.33 311.5 697 1818 11690
6.25 389 711 2141 17977
10.35 413 1272 3530
11.25 426.8 806 2463 20441
13.52 427 854 3163 22990
51.78 452 899 3384 45860
63.8 478 1017 3509 57063
74 518 946 4314 58333
105.7 633 1067 4444 116667
107 641 1162 4717 130938
147.5 657 1488 8094
Any Size Above 25c; 10; 53.98
MEG OHMS \$2.855 \$3.673 \$4.239 \$5.11
11 55 1.2 85 \$2.55c 10 \$4.85
RHEOSTAT 20ohm/50W&knob 69c

RHEOSTATS 25Watt IRC & Ohmited Slotted Shrt 350.

500 1500A 500Ohms \$ 1.98
ANTENNA UHF 12"/30cm AT1/APN2, AT5/ARR1 Usable Cht&Ham BandConn Term Insld SWVCont w/pt gask. Uprng & h'wareMOBILE nte NEW 49c, 3/51; w/PL59, add 29c; ANT AN 130B 2/Whip \$9.88
ANT AN30 Telescope Whip 12" to 9' NEW O'seas Pkg. \$1.49; 2/52.49
ANTMS49-52 12 1/2ft \$ 2.49
ANT MS49-36 16ft \$ 2.69
ANTMS49-26 2-53 52 1/2ft \$ 5.98
ANT AN191

- TRANSMITTING
- RECEIVING
- INDUSTRIAL
- SPECIAL PURPOSE

TUBES

*Guaranteed
by*
WELLS

**IMMEDIATE DELIVERY
AT LOWEST PRICES IN
OUR HISTORY**

Check this list for exceptional values in magnetrons, cathode ray tubes, voltage regulators, transmitting tubes—also neon, pilot and flashlight bulbs. These are brand new, standard make tubes. Order enough for future needs directly from this ad or through your local parts jobber.

01A.....\$0.45	6SF5......65	VT-127A..... 2.95	714AY...... 9.95	878...... 2.15
1B22..... 4.35	6EG7......70	VR-150......55	RK715B..... 7.95	930...... 2.20
1N21 Xtal Diode.. .65	6SH7......40	VT-158......9.85	717A...... .90	954...... .50
1N21B Xtal Diode .80	6SJ7/GT......65	FG-172.....29.50	721A...... 3.95	955...... .55
1N23 Xtal Diode.. .80	6SK7/GT......65	205B...... 1.95	724A...... 4.65	956...... .55
1N23A Xtal Diode .85	6SL7/GT......65	211 (VT-4-C).... .65	724B...... 4.25	957...... .55
1N27 Xtal Diode.. .85	6SN7/GT......80	215A...... 1.95	725A.....19.95	991 (NE-16)......30
1R4/1294......65	6SQ7/GT......60	231D...... 1.30	726A.....19.95	1005...... .35
1R5...... .95	7A4......65	282B......4.25	730A.....11.95	1148...... .40
1S5...... .95	7A7......65	304TH......5.95	801...... .60	1201...... .75
1S21...... 1.10	7C4/1203......40	304TL...... 1.75	801A...... .75	1616...... 1.25
1T4...... .95	7C7......65	307A......4.25	803...... 6.95	1619...... .55
2C26...... .35	7E6......65	316A...... .75	804...... 9.95	1624...... 1.25
2C26A...... .45	7F7......75	350B...... 2.55	805...... 5.45	1625...... .45
2C34...... .55	7H7......75	371B...... .85	808...... 1.75	1626...... .45
2J21A.....11.45	7N7......75	388A...... 4.95	809...... 2.75	1629...... .45
2J22...... 9.85	7Q7......65	417A.....19.95	810...... 7.95	1635...... .95
2J26...... 8.45	10Y/VT-25A......40	434A...... 7.45	811...... 2.35	2051...... .95
2J27.....14.45	10Y/VT-25......45	446A...... 1.55	813...... 7.85	7193...... .35
2J31...... 9.95	12A6......25	450TH.....19.95	814...... 3.75	8011...... 2.55
2J32.....14.85	12K8......65	GL-471A......2.75	815...... 2.85	8012...... 4.25
2J33.....19.95	12SF7......70	527......11.25	826...... .49	8020...... 3.35
2J37.....13.85	12SH7......40	WL-530.....17.50	829...... 3.25	8025...... 7.50
2J38.....12.95	12SK7......60	WL-531.....17.50	830B...... 3.95	9001...... .70
2J48.....14.95	12SL7/GT......70	532A/1B32......3.55	837...... 1.75	9002...... .45
2X2/879......65	12SR7......40	GL-559...... 3.75	838...... 3.25	9003...... .65
3A4...... .35	12x825 2 amp. Tungar..... 2.25	KU-610...... 7.45	841...... .55	9004...... .45
3A5...... 1.05	13-4 Ballast......35	HY-615...... 1.20	843...... .55	9006...... .45
3AP1 CRT...... 3.85	15R...... 1.40	700B...... 9.95	851.....39.50	
3B22...... 2.95	FG-17...... 2.85	700C...... 9.95	WL-860...... 2.55	
3B24...... 1.75	REL-21...... 3.25	700D...... 9.95	861.....32.50	
3BP1 CRT...... 3.75	23D4 Ballast......45	702A...... 2.95	864...... .55	
3CP1-S1...... 1.95	25Z6/GT......55	703A...... 4.85	865...... 2.55	
3C24/24G...... .47	28D7......40	705A...... 2.65	866A...... 1.30	
3D6/1299......65	30/VT-67 (For Walkie Talkies)......75	707A.....19.50	869.....26.50	
3FP7 CRT...... 2.95	33/VT-33 (For Walkie Talkies)......75	707B.....23.25	869B.....28.95	
3HP7 CRT...... 2.95	RK-34......45	710A...... 2.15	872A...... 2.45	
3GP1 CRT...... 3.75	34......35	713A...... 1.55	874...... 2.15	
3O5...... .90	39/44......35			
REL-5.....17.95	45 Spec......55			
5AP1 CRT...... 3.95	46......60			
5BP1 CRT...... 2.95	EF50/VT250......45			
5CP1 CRT...... 3.85	CEQ 72...... 1.50			
5GP1 CRT...... 6.55	72/3B24...... 1.75			
5J23.....14.25	VR-75......90			
5J29.....14.25	LB-17 C......55			
5Y3G......40	LB-58A......55			
6A6......90	LB-57A......65			
6AB7......95	VR-78......65			
6AC7......90	80......45			
6AK6......80	FG-81-A...... 3.95			
6B7......95	83......85			
6BE6......65	83V......95			
6C4......45	89Y......40			
6C6......75	VR-90......70			
6C21.....19.75	VR-92......65			
6D6......60	100R...... 3.25			
6E5......70	FG-105...... 9.95			
6H6......50	VR-105......85			
6J5/GT......50	VU-111......65			
6J6......90	117Z3......55			
6N7/GT......80	VT-127 English......25			
6R7G......80				

NEON BULBS FOR RADIO USE

NE-2.....\$0.06
NE-15......06
NE-16......24
NE-20......06
NE-21......24
NE-48......24
NE-51......06

PILOT AND FLASHLIGHT BULBS

Stock No.	Mazda No.	Volts	Watts	Bulb	Base	Price
350-40	64	6-8	3CP	G-6	DC Bay	\$0.07
350-31	57	12-16	1.5CP	G-4½	Min. Bay	.08
350-42	Spec.	12	6	E-6	Cand. Ser.	.13
350-20	1446	12	.2 amp.	G-3½	Min. Ser.	.07
350-14	49	2	.06	T-3¼	Min. Bay	.06
350-15	356	120	3	E-6	Can. Bay	.11
348-22	72/3B24	6	.5 amp.	B-3½	Min. Flang	.05
350-19	VR-75	120	500W	T-20	Med. Pf	1.45
LB-17 C	LB-17 C	24	.035 A	T-2	Tel. Base	.18
LB-58A	LB-58A	110	7W	C-7	Cand. Ser.	.17
LB-57A	53	12-16V	1 CP		Min. Bay	.07
LB-100A	Airplane Headlight	24V	239W	A-19	Med. Pf	.38
LB-101	323	3	(Aircraft)	T-1½	953	.21
LB-101A	L31-60	115V	250W	T-20	Med. Pf	.40
LB-102	1195	12-16	.50 CP	RP-11	DC Bay	.14
LB-102A	CC-13	110V	100W	T-8	DC Pf	.33
LB-102B	1491	2.4	.8 amp.		DC Bay	.14
LB-102C	3D2	28	(Airplane type)		DC Bay	.11
LB-101	313	28	.17 amp.	T-3½	Min. Bay	.14
LB-105	1816	13V	33A		Min. Bay	.12
LB-106	12A	12	.09-11	T-2	Tel. Base	.18
LB-107	24-A2 WE	24	.75 .105	T-2	Tel. Base	.18
LB-108	S-14 Argon	105	2½ Watt		Med. Ser.	.22
LB-109	S	Telephone Type	Neon	T-2		.17
350-18	1477	24	17	T-3	Min. Ser.	.16

10% DISCOUNT ON ORDERS OF \$100.00 OR OVER

Manufacturers: We carry thousands of electronic parts in stock. Send us your requests for quotation.

Distributors: Our standard jobber arrangement applies. Order directly from this ad.

320 N. LA SALLE ST., DEPT. R-8, CHICAGO 10, ILL.



This sign belongs on your door...



not on the Vibrators you use

Customers "call again" for two reasons: they are either pleased with your service or displeased. Because the workings of an auto radio are quite intricate, no car owner can figure out for himself just who is at fault when a vibrator kicks up.

Nevertheless, call backs on installations are costly affairs to you—both in time and reputation. The parts you choose must be as dependable as your own service. So stick with a name you know you can trust:

CORNELL-DUBILIER

Here's why C-D Vibrators are **reliable,** **quiet and** **last longer**



1. Exclusive C-D pole piece design and armature weight result in a perfectly-balanced unit with less vibration, minimum mechanical hum and maximum life.



2. Exclusive C-D base mounting results in a full floating unit.



3. New stack design utilizing pure india ruby mica will take peak voltages of even 4,200 volts with no damage to vibrator.



5. C-D designed electronic micro-metric equipment removes guesswork in contact point setting and assures consistent high quality.



4. Unit completely enclosed in new, exclusive C-D super-soft, pure sponge rubber floating sock. Eliminates usual difficulties found in other vibrators.



For the best in Vibrators insist on C-D's. Now at your local C-D distributor. Or write for full details to Cornell-Dubilier Electric Corporation, Dept RN-39, South Plainfield, N. J. Other plants in New Bedford, Worcester and Brookline, Mass.; Providence, R. I.; Indianapolis, Ind., and Cleveland, Ohio.

For your nearest C-D distributor, consult your local Classified Telephone Directory.



Reg. U. S. Pat. Off.

A GREAT NAME IN CAPACITORS - A GREAT NAME IN VIBRATORS

Quiet as a **MOUSE**!



The Mallory Midgetrol

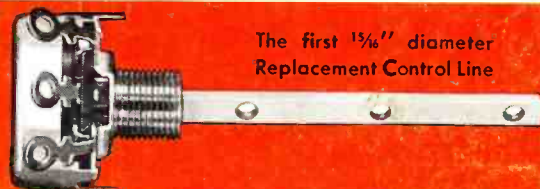

The first $\frac{1}{16}$ " diameter Replacement Control Line

Quietest by actual test!—that's the Mallory Midgetrol. Tests made on the ultra-sensitive sound testing meters built for the Navy prove that its noise level in radio applications is so low as to be totally inaudible.

Low noise level, long life, accurate resistance values and smooth, uniform tapers—all the things you want in a volume control—you get from the Mallory Midgetrol!

LOOK WHAT THE MALLORY MIDGETROL OFFERS:

WIDER APPLICATION—The small size allows you to service portables, auto radios and small AC-DC receivers requiring $\frac{15}{16}$ " controls.

SIMPLER INSTALLATION—The new and unique flat shaft design of the Mallory Midgetrol saves installation time with *all* types of knobs.

LESS INVENTORY—Electrical characteristics allow you to use the Mallory Midgetrol to replace $\frac{1}{8}$ " as well as $\frac{15}{16}$ " controls. Since no special shafts are required, you carry fewer controls in stock.

NEW SIZE
NEW DESIGN

NEW SHAFT
NEW EXTENSION

NEW SWITCH
NEW ELEMENT
NEW TWO-POINT SUSPENSION

NEW CONTACT
NEW TERMINAL

See your Mallory Distributor for this new standard in carbon controls

P. R. MALLORY & CO. Inc.
MALLORY

CAPACITORS . . . CONTROLS . . . VIBRATORS . . .
SWITCHES . . . RESISTORS . . . RECTIFIERS . . .
VIBRAPACK* POWER SUPPLIES . . . FILTERS

*Reg. U. S. Pat. Off.

APPROVED PRECISION PRODUCTS

P. R. MALLORY & CO., Inc., INDIANAPOLIS 6, INDIANA