

# RADIO & TELEVISION NEWS

MAY  
1949  
35¢

## WKY's FM-AM MOBILE UNIT

Page 53



# SHOOTING



## High output efficiency is one reason why **MALLORY VIBRATORS** **are so popular!**

**H**igh output efficiency! That's one of the vital reasons why more Mallory Vibrators are in use today than all other makes combined.

You get maximum efficiency from a Mallory Vibrator because its related parts are carefully

matched. Every part is carefully balanced with its counterpart by an exclusive Mallory method.

All working parts of Mallory Vibrators are Mallory-designed and Mallory-made. For Mallory focuses on Vibrator design an unusual combination of engineering talent and resources in electronics, electrochemistry and metallurgy.

The result is not only *high output efficiency* from Mallory Vibrators, but *long life* and *dependable starting*. No wonder more Mallory Vibrators are used in original equipment than all other makes combined. No wonder they make the best replacements. See your Mallory Distributor.

### **Mallory "2448" Vibrator Deal**

This deal gives you a handsome storage and display cabinet for your stock of vibrators, together with a selection of vibrators and buffer capacitors that will answer 75% of your requirements.



You pay only the service man's net price for the six vibrators and twelve buffer capacitors. There is no charge for the attractive, convenient cabinet. Your Mallory distributor has them in stock for immediate delivery.

*More Mallory Vibrators are used in original equipment than all other makes combined*

P. R. MALLORY & CO. Inc.  
**MALLORY**

CAPACITORS • CONTROLS • VIBRATORS • SWITCHES • RESISTORS  
• RECTIFIERS • VIBRAPACK\* POWER SUPPLIES • FILTERS

\*Reg. U. S. Pat. Off.

**APPROVED PRECISION PRODUCTS**

**P. R. MALLORY & CO., Inc., INDIANAPOLIS 6, INDIANA**

# LEARN RADIO

## BY PRACTICING IN SPARE TIME

As part of my Course I send you the speaker, tubes, chassis, transformer, loop antenna, etc., to build this modern, powerful Radio Receiver! In addition, I send you parts to build many other real Radio circuits, like the Signal Generator, Radio Tester and Superheterodyne Receiver pictured below. You use this material to get practical Radio experience and to make EXTRA money fixing neighbors' Radios in spare time. Mail coupon below for complete information!

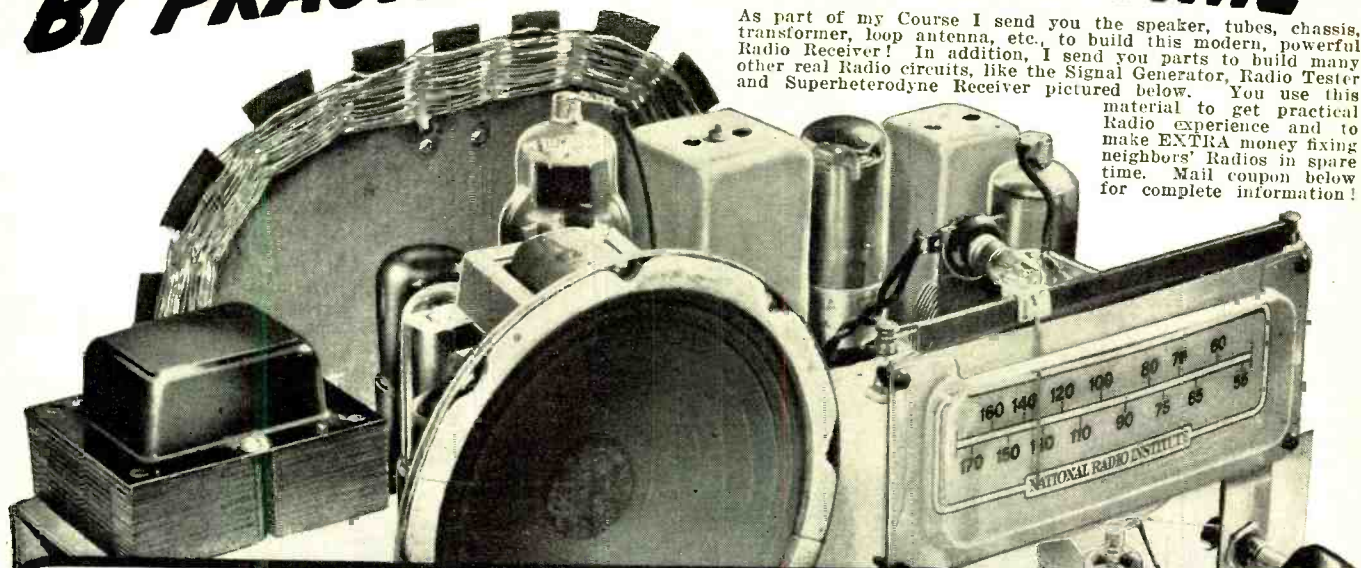

**I SEND YOU BIG KITS OF PARTS**  
**You Build and Experiment**  
**With this MODERN RADIO**  
**AND MANY OTHER CIRCUITS**



J. E. SMITH, President  
National Radio Institute

### I TRAINED THESE MEN



Makes \$60 A Week Plus Bonus  
 "I am Radio Serviceman for The Adams Appliance Co. Am now getting \$60 a week, plus bonus and overtime."—W. A. ANGEL, Blythesville, Arkansas.



Knew Nothing About Radio  
 "I knew nothing about Radio when I enrolled. I am doing spare time work. I have more than paid for my Course and about \$200 worth of equipment."—RAYMOND HOLT CAMP, Vandalia, Illinois.

Want a good-pay job in the fast-growing RADIO-TELEVISION Industry? Want a money-making Radio-Television shop of your own? Here's your opportunity. I've trained hundreds of men to be Radio Technicians... MEN WITH NO PREVIOUS EXPERIENCE. My tested and proved train-at-home method makes learning easy. You learn Radio-Television principles from illustrated lessons. You get practical experience building, testing, experimenting with MANY KITS OF PARTS I send. All equipment yours to keep.

### Make EXTRA MONEY in Spare Time

The day you enroll, I start sending SPECIAL BOOKLETS that show you how to make EXTRA MONEY fixing neighbors' Radios in spare time. From here it's a short step to your own shop, or a good-pay Radio-Television servicing job. Or get into Police, Aviation, Marine Radio, Broadcasting, Radio Manufactur-

ing or Public Address work. And think of getting in on the ground floor of the booming Television Industry. Trained men are already in demand... new stations are going on the air, manufacturers are building over 100,000 sets a month, more and more homes are getting sets. The man who prepares now will reap rich rewards.

### See What N. R. I. Can Do For You

Act now! Send for my DOUBLE FREE OFFER. Coupon entitles you to actual lesson, "GETTING ACQUAINTED WITH RECEIVER SERVICING," absolutely free. Over 80 pictures and diagrams! You also get my 64-page book, "HOW TO BE A SUCCESS IN RADIO AND TELEVISION-ELECTRONICS." Tells more about YOUR opportunities, details of my Course, how quickly, easily you can get started. Send coupon in envelope or paste on penny postal. J. E. SMITH, President, Dept. 9ER, National Radio Institute, Pioneer Home Study Radio School, Washington 9, D. C.

## VETERANS

You can get this training without cost under G. I. Bill.

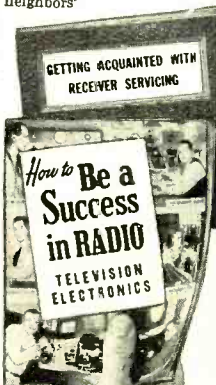

MY COURSE INCLUDES **TELEVISION**

## Good for Both—FREE

MR. J. E. SMITH, President, Dept. 9ER  
National Radio Institute, Washington 9, D. C.

Mail me FREE Sample Lesson and 64-page book. (No salesman will call. Please write plainly.)

Name.....  
 Address.....  
 City..... Zone..... State.....

Check if Veteran

Editor  
**OLIVER READ, W9ETI**

Managing Editor  
**WM. A. STOCKLIN**

Technical Editor  
**H. S. RENNE, EX-W8PTS**

Associate Editor  
**RAY FRANK, W9JU**

Contributing Editor  
**R. HERTZBERG, W2DJJ**

Staff Artist  
**R. S. KUPJACK**

—

Advertising Manager  
**L. L. OSTEN**

Midwest Adv. Manager  
**JOHN A. RONAN, JR.**

—

Art Director  
**HERMAN R. BOLLIN**

# RADIO & TELEVISION NEWS

First in  
radio-television-electronics

Average Paid Circulation over 181,000

Radio News Trade Mark Reg. U.S. Pat. Office No. 378427

MAY, 1949

## CONTENTS

Television Set Shipments by Areas.....	22
Dqn Lee's New \$3,000,000 Studios.....	Walter W. Carruthers 35
How to Eliminate Auto Radio Static.....	M. C. Anderson 38
A Booster For Your FM Receiver.....	Peter G. Sulzer, W3HFW 40
A Novel Plate-Dip Oscillator.....	E. J. Schultz, W2MUU 42
The Beginning Amateur, Part 4.....	Robert Hertzberg, W2DJJ 44
Directory of Television Receiver Manufacturers.....	46
Television Projection Systems.....	M. S. Kay 47
The Electric Eye in Advertising.....	A. Edelman 50
Mac's Radio Service Shop.....	John T. Frye 52
Broadcasting Station on Wheels.....	53
A Briefcase Ham Portable.....	E. Campaine, W3KWP, and M. F. Judkins, W3AC 54
A Dual-Purpose Frequency Meter—V.F.O.....	G. L. Countryman, W3HH-W1RVK 56
Build Your Own 10.7 mc. Discriminator Transformer.....	Joseph C. Michalowicz 59
The Tubeless Grid-Dip Adapter.....	Douglas H. Carpenter 60
Regenerative Short-Wave Receiver in Miniature.....	Robert H. Hawkins 62
Modern Television Receivers, Part 14.....	Milton S. Kiver 64
\$10,000.00 New Ham Contest.....	67
A TV Antenna Location-And-Orientation Indicator.....	Fred Marco 68
Elimination of Reflections on Video Lines.....	C. A. Meyer and R. G. Middleton 70
EM Data for Surplus Tubes.....	74
Tentative Program of Events, 1949 Radio Parts And Electronic Equipment Shows, Inc. ....	79
Do You Know?.....	David Scott 80
Eyestrain—A New Video Hazard.....	W. S. Stewart 84
Assignments of Booth Space In The 1949 Radio Parts And Electronic Equipment Conference And Show.....	96
How to Prepare Your Article for Publication.....	C. C. Erhardt, W2HNU 122
Navy Men Open New "Ham" Station at Pearl Harbor.....	146

## DEPARTMENTS

For the Record .....The Editor	8	Technical Books .....	107
Spot Radio News.....	14	Manufacturers' Literature.....	114
Within the Industry.....	26	Letters from Our Readers.....	126
Short-Wave .....K. R. Boord	58	New TV Receivers.....	132
What's New in Radio.....	88	MARS .....	138

AFCA News ..... 172

COPYRIGHT 1949

ZIFF-DAVIS PUBLISHING COMPANY  
185 North Wabash Ave., Chicago 1, Ill.  
VOLUME 41 • NUMBER 5



Member  
Audit Bureau of  
Circulations

RADIO & TELEVISION NEWS is published monthly by the Ziff-Davis Publishing Company, 185 N. Wabash Ave., Chicago 1, Ill. Subscription Rates: In U. S. and Canada \$4.00 (12 issues), single copies 35 cents; in Mexico, South and Central America, and U. S. Possessions, \$4.00 (12 issues); in British Empire, \$5.00 (12 issues)—all other foreign countries \$5.00 (12 issues). Subscribers should allow at least 2 weeks for change of address. All communications about subscriptions should be addressed to: Director of Circulation, 185 N. Wabash Ave., Chicago 1, Ill. Entered as second class matter July 21, 1948, at the Post Office, Chicago, Illinois, under the Act of March 3, 1879. Entered as second class matter at the Post Office Dept., Ottawa, Canada. Contributors should retain a copy of contributions and include return postage. Accepted material is subject to whatever revisions and by-line changes that are necessary. Payment made at our current rates, covers all authors', contributors' or contestants' rights, title, and interest in and to accepted material, including photographs and drawings.

RADIO & TELEVISION NEWS



COVER PHOTO: Custombuilt bus-studio on a WKY remote broadcast, complete with AM-FM receiving and transmitting antennas. (Photo courtesy A. Y. Owen, Staff Photographer, Oklahoman and Times)

Chairman of the Board and Publisher  
**WILLIAM B. ZIFF**

President  
**B. G. DAVIS**

Secretary-Treasurer  
**ARTHUR T. PULLEN**

Vice-Presidents

**MICHAEL H. FROELICH**  
Dir. Eastern Div.

**H. J. MORGANROTH**  
Production Director

**H. G. STRONG**  
Circulation Director

### BRANCH OFFICES

NEW YORK (1)  
Empire State Bldg., W1 7-0400

LOS ANGELES (14)  
815 S. Hill St., TUCKER 9213  
Manager, WILLIAM L. PINNEY

TORONTO  
21 King Street, East

ASSOCIATED WITH  
Ziff-Davis, Ltd., Gropians Bldg.  
Western Gate, London, England



I can train you to pass your FCC License Exams in a few short weeks if you've had any practical radio experience—amateur, Army, Navy, radio servicing, or other. My time-proven plan can help put you, too, on the road to success.

Let me send you FREE the entire story

Just fill out the coupon and mail it. I will send you, free of charge, a copy of "How to Pass FCC License Exams," plus a sample FCC-type Exam, and the amazing new booklet, "Money Making FCC License Information."

EDW. H. GUILFORD,  
Vice President

# How to Pass FCC Commercial Radio Operator License Exams

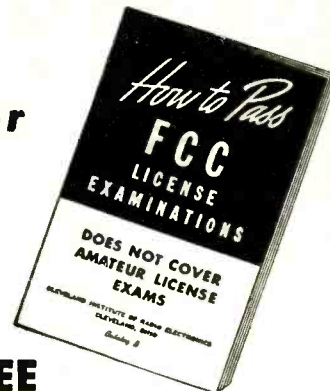

**FREE**

Tells where to apply for and take FCC examinations, location of examining offices, scope of knowledge required, approved way to prepare for FCC examinations, positive method of checking your knowledge before taking the examinations.

## Get your FCC ticket in a FEW SHORT WEEKS

IT'S EASY IF YOU USE CIRE SIMPLIFIED TRAINING AND COACHING METHODS AT HOME IN YOUR SPARE TIME

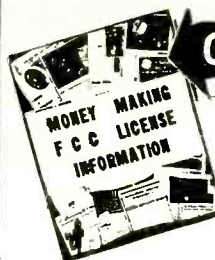

### Get This Amazing New Booklet

1. TELLS OF THOUSANDS OF BRAND-NEW, BETTER-PAYING RADIO JOBS NOW OPEN TO FCC LICENSE HOLDERS.
2. TELLS HOW YOU WILL BENEFIT BY HOLDING AN FCC COMMERCIAL LICENSE.
3. TELLS HOW YOU CAN GET YOUR FCC COMMERCIAL RADIO OPERATOR LICENSE IN A FEW SHORT WEEKS—EASILY AND QUICKLY, BY USING CIRE SIMPLIFIED TRAINING AND COACHING AT HOME IN YOUR SPARE TIME.
4. TELLS OF HUNDREDS OF OUR SUCCESSFUL STUDENTS WHO NOW HAVE LICENSES AND NEW, BETTER-PAYING JOBS.
5. TELLS HOW WE PREPARE YOU TO PASS NOW THE NEW FCC COMMERCIAL LICENSE EXAMINATIONS, WHICH INCLUDE FM AND TELEVISION.

Get your license easily and quickly and be ready for the \$3000 to \$7500 jobs that are open to ticket holders. CIRE training is the only planned course of coaching and training that leads directly to an FCC license. Your FCC ticket is recognized in all radio fields as proof of your technical ability. Employers often give preference to license holders, even though a license is not required for the job. Hold an FCC "ticket" and the job is yours!

### Look what these students say

"I now hold ticket Number P-10-3787, and holding the license has helped me to obtain the type of job I've always dreamed of having. Yes, thanks to CIRE, I am now working for CAA as Radio Maintenance Technician, at a far better salary than I've ever had before. I am deeply grateful."—Student No. 3319N12.

"I was issued license P-2-11188 on November 4. The next day I was signed on board a tanker as Radio Operator-Purser. Besides radio operating, I handle the payrolls, etc., which is all over-time and brings my monthly pay up to between \$400 and \$650."—Student No. 2355N12.

## Get ALL THREE FREE

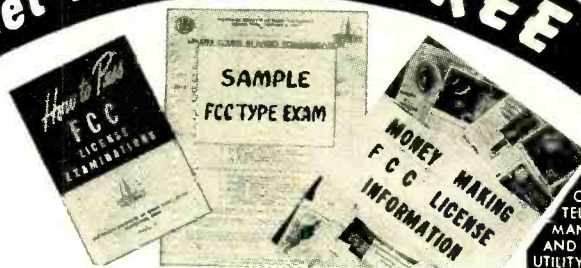

6. TELLS HOW WE GUARANTEE TO TRAIN AND COACH YOU UNTIL YOU GET YOUR LICENSE.
7. TELLS HOW WE HELP YOU TO GET A BETTER-PAYING, LICENSED JOB, WITH OUR FREE AND EXCLUSIVE SERVICE, WHICH PREPARES YOUR EMPLOYMENT APPLICATION FOR MAILING TO HUNDREDS OF EMPLOYERS, INCLUDING FM, AM AND TELEVISION BROADCAST STATIONS, RADIO MANUFACTURERS, POLICE RADIO STATIONS, AND RADIO-EQUIPPED TAXI, BUS AND PUBLIC UTILITY COMPANIES.

## Don't Waste Valuable Time MAIL COUPON TODAY!

Don't put off getting this valuable information. Good jobs in radio need men like you. You can earn higher income, have a bank account, enjoy vacations, and have easier and better living. But you must have your FCC License. Hurry! Fill out the coupon right now and mail it. There is no obligation. You owe it to yourself to get the full story NOW.

CLEVELAND INSTITUTE OF RADIO ELECTRONICS  
Desk RN-5 4900 Euclid Bldg., Cleveland 3, Ohio  
Address to Desk No. to Avoid Delay  
APPROVED FOR VETERAN TRAINING UNDER THE  
"G.I. BILL OF RIGHTS"

CLEVELAND INSTITUTE OF RADIO ELECTRONICS  
Desk RN-5 4900 Euclid Bldg., Cleveland 3, Ohio  
Address to Desk No. to Avoid Delay

I want to know how I can get my FCC ticket in a few short weeks. Send me your FREE booklet "How to Pass FCC License Examinations" (does not cover exams for Amateur License) as well as a sample FCC-type exam and the amazing new booklet "Money Making FCC License Information."

NAME.....

ADDRESS.....

CITY..... ZONE..... STATE.....

Veterans check for enrollment information under G.I. Bill.  
NO OBLIGATION—NO SALESMEN.

**ANNOUNCING...**  
**"Three-Sixty" Hypex**  
**PROJECTORS**



**MODEL VR-11 "THREE-SIXTY" HYPEX**  
 (above) 15 WATTS; 280 CPS CUT-OFF.  
**MODEL VR-241 "THREE-SIXTY" HYPEX**  
 (at right) 25 WATTS; 140 CPS CUT-OFF.

**T**WO new Hypex\* Projectors—designed for 360-degree sound dispersal—are now available. With sound distributed horizontally in all directions, these new models are intended for installations where coverage of relatively large areas and suspension from the ceiling are desired. Like all Hypex Projectors, these radial units incorporate the famous Hypex formula† which results in improved acoustic performance.

By the addition of the two radials to the four previously announced Hypex units illustrated below, the Hypex line now includes a model for every "sound" need, indoors or outdoors.

**Jensen**  
*Hypex*

**JENSEN MANUFACTURING COMPANY**

Division of the Muter Company  
 6617 SOUTH LARAMIE AVENUE, CHICAGO 38, ILLINOIS

In Canada: COPPER WIRE PRODUCTS, LTD., 351 CARLAW AVENUE, TORONTO

\*Trade Mark Registered †Patent 2,338,262

Write for Data Sheet 143



**MODEL VH-24 HYPEX**  
 25 WATTS; 110 CPS CUT-OFF



**MODEL VH-20 HYPEX**  
 25 WATTS; 140 CPS CUT-OFF



**MODEL VH-15 HYPEX**  
 15 WATTS; 180 CPS CUT-OFF



**MODEL VH-91 HYPEX**  
 15 WATTS; 300 CPS CUT-OFF

*See how we may help you*  
get started toward a

profitable, exciting future in

# TELEVISION RADIO-ELECTRONICS

Get the facts about our  
**GREATEST OFFER IN 17 YEARS**

Here's your big chance to get started toward **FASCINATING WORK** . . . **GOOD MONEY** . . . a **THRILLING FUTURE!** Mail the coupon today. See how **YOU** may prepare to tie in your future with a field that includes one of America's fastest-growing new industries—**Television**. You'll find out, too, about the many other thrilling opportunities in **FM Radio** . . . **Aviation and Broadcast Radio** . . . **2-Way Taxi, Truck and Police Radio** . . . **Industrial Electronics** . . . even the chance to start your own profitable **Television-Radio Sales and Service** business. And to top it all, you'll see that you don't need to know a thing about this subject at present—that **NOW** you can get the very training and starting help you need by means of our **GREATEST OFFER IN 17 YEARS**.

Send for **FREE** information

See **HOW**—in your own home—DeForest's Training, Inc., now brings you one of today's most complete combinations of major home training aids. You (1) **Learn-by-Reading** from well-illustrated lessons. (2) **Learn-by-Seeing** from D.T.I.'s exclusive instructive Home Movies. (3) **Set up your own HOME LABORATORY** where you **Learn-by-Doing** from 16 shipments of Radio-Electronic parts which you use and **KEEP** to work over 300 instructive, fascinating projects. This includes building the valuable 6 tube "Superhet" **RADIO**, commercial-type **OSCILLOSCOPE**, **R-F SIGNAL GENERATOR**, and Jewel-Bearing **MULTI-METER**, pictured at the right.

You may use this test equipment to help you earn real money—both in your spare time and later when working full time in the field. Get complete facts. Mail coupon today!

### EMPLOYMENT SERVICE

When you complete your training, our effective Employment Service is available to you without extra cost—a grand aid to help you get started.

OSCILLOSCOPE

MULTI-METER

R-F SIGNAL GENERATOR

6-TUBE RECEIVER

**YOU BUILD and KEEP THIS EQUIPMENT TO WORK OVER 300 HOME EXPERIMENTS**



### MODERN CHICAGO LABORATORIES

Train quickly, using a wide variety of commercial equipment. D. T. I.'s new laboratories are among the finest of their kind. Ample instructors . . . every major training advantage. Write for details.

### You also use HOME MOVIES

. . . a D. T. I. Exclusive! D. T. I., alone, includes the use of today's most effective training aids . . . **MOVIES** . . . to help you learn important fundamentals faster, easier at home. What an advantage to see electrons on the march, and other fascinating "hidden action"—a remarkable home training advantage that speeds your progress.

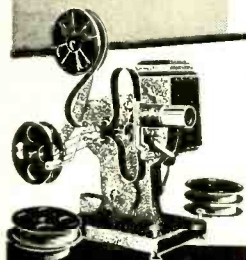

**DeFOREST'S TRAINING, INC.**  
CHICAGO 14, ILLINOIS

Affiliated with the DeVry Corporation, Builders of Electronic and Movie Equipment

**MAIL THIS OPPORTUNITY COUPON NOW!**

DeForest's Training, Inc.  
2533 N. Ashland Ave., Dept. RM-F5  
Chicago 14, Illinois

Without obligation, send me complete facts showing how I may make my start in Television-Radio-Electronics.

Name . . . . . Age . . . . .

Street . . . . . Apt. . . . .

City . . . . . Zone . . . . . State . . . . .



**IN JUST  
5 SECONDS!**

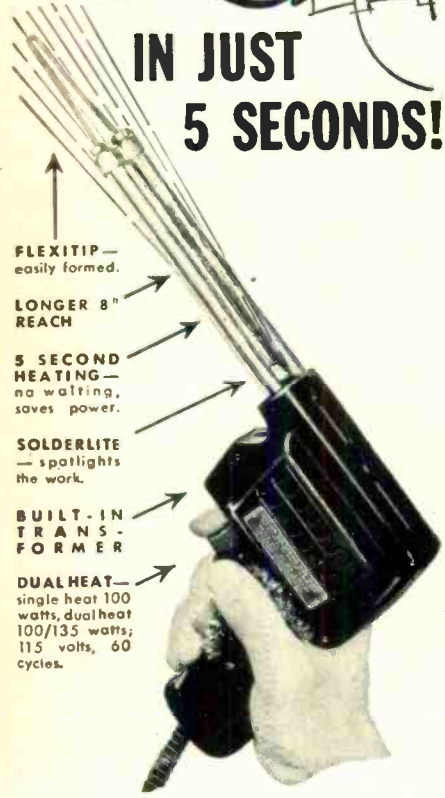

- ↑ FLEXITIP — easily formed.
- ↑ LONGER 8" REACH
- ↑ 5 SECOND HEATING — no waiting, saves power.
- ↑ SOLDERLITE — spotlights the work.
- ↑ BUILT-IN TRANSFORMER
- ↑ DUAL HEAT — single heat 100 watts, dual heat 100/135 watts; 115 volts, 60 cycles.

Pull the trigger switch, make contact, and you solder. Then release the trigger and off goes the heat—automatically. No wasted time. No wasted current. No need to unplug the gun between jobs. The Weller Gun's Flexitip heats only when in use—saves hours and dollars. Your Weller Gun will pay for itself in a few months.

Solderlite, extra length, and the easily shaped Flexitip mean real soldering ease. And because the transformer is built in—not separate—the Weller Gun is a complete, self-contained unit, compact, convenient.

For laboratory and maintenance work, we recommend the efficient 8" model—DX-8 with dual heat; or 4" types S-107 single heat and D-207 dual heat. Order from your distributor or write for bulletin direct.



Be sure to get your copy — SOLDERING TIPS, the new Weller Handy Guide to easier, faster soldering—20 pages fully illustrated. Price 10c at your distributor's.

**WELLER**  
MANUFACTURING COMPANY  
810 Packer Street • Easton, Pa.

# For the RECORD.

BY THE EDITOR



**I**F YOU, OM were to pick up a newspaper and read such a headline, you would be shocked as never before. You wouldn't believe that such a thing could ever happen to your hobby in a country of free speech and enterprise.

But it CAN happen unless you and I are willing to pitch in and do something about it. Strong words? We think not!

Let's quit kidding ourselves about the future security of our hobby. We, as hams, have always had a good "offensive" team. We have helped our country in times of stress, performed yeoman service when disaster came upon us and considered ourselves to be quite alert and aggressive in matters that are technical and communicationswise.

A strong offense is f.b.—but suppose the other teams have an equal or better offense. Someone's going to eventually lose his punch unless he is blessed with a good "defense."

### Building a Defense

Amateur radio's defense depends upon its ability to train new hams and to make replacements as the going gets tougher. It needs the vitality of youth, as well as the wisdom of the coach, if it is to combat the increasing pressure brought to bear by new radio, television, and other services.

We have been told in Washington, for example, that unless we hams occupy and make use of our higher frequencies, they will be assigned to services having greater interest and need for their use.

If we believe that there is strength in numbers, then let's increase our strength by encouraging new hams to

join our team. It is the surest way to bolster our defense—in fact the ONLY way.

Too many of us hams are prone to "let George do it." We received a very discouraging report from a scoutmaster in one of our larger cities, telling how he approached the members of a ham club (about 200) for an instructor to teach an enthusiastic group of 50 scouts and 12 of their dads, who sincerely wanted to become hams. In spite of the incentive provided by our \$10,000.00 contest, not one amateur present even offered a suggestion—let alone a volunteer to take over 62 prospects who were ready and eager to start their course of instruction.

If this case is typical of the attitude of the American amateur, we hams had better look to our laurels and correct our thinking before it is too late!

### Contest Extended to March, 1950

Realization that many trainees and their instructors will be away on vacations during the Summer months and necessarily miss several weeks' study for their licenses prompted us to extend the closing date of our \$10,000.00 contest to midnight, March 1, 1950, and to extend Club entries until midnight, April 31, 1949.

In addition, we are adding an alternate choice of U.S. Savings Bonds instead of amateur equipment to the winners, both individuals and clubs, of our \$10,000.00 contest.

There it is fellows—your opportunity to build a strong "defense" and a greater security for your hobby, as well as to gain financial rewards for your efforts. Are YOU going to pitch in? . . . . . O. R.

**RADIO & TELEVISION NEWS**



# it's ALLIED for hallicrafters!

hallicrafters  
Model T-64  
Television Chassis  
with exclusive  
"DUAL-FOCUS"  
feature

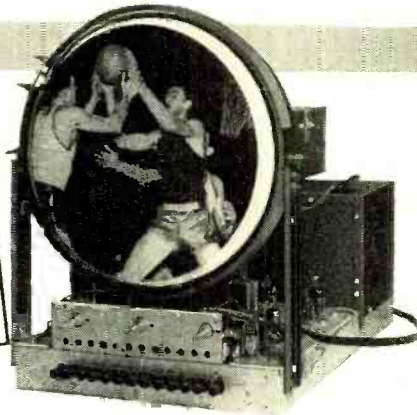

Tops for custom installations at low cost—a factory-built direct-view chassis for 10 or 12-inch tubes. With exclusive new Dual-Focus switch—10" tube gives you choice of big 64 sq. in. telescopic view for dramatic closeups, or large 56 sq. in. full-range view. Either way, you get a sharp picture, with fine stability and superb contrast. Features: 12 channel push-button tuning; RF amplifier; 3 IF amplifiers; 2 video amplifiers; improved sync circuits; AGC; static-free FM audio system. Complete with power supply, speaker and 15 tubes, plus 3 rectifiers. Less picture tube (you can use either 10" or 12" size). For 105-125 volts, 50-60 cycles AC. Shpg. wt., 60 lbs.

97-875. Hallicrafters T-64 Television Chassis. Only... \$169.95  
\$33.99 down, \$12.01 monthly for 12 months.

6-780. 10BP4 10" picture tube. Shpg. wt., 20 lbs. NET... \$34.00

7-211. 12LP4 12" picture tube. Shpg. wt., 25 lbs. NET... \$60.00

97-885. Bracket to permit use of 12" tube with chassis. NET... \$8.50

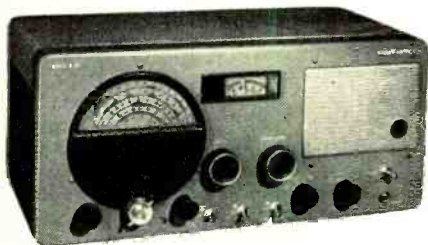

## hallicrafters S-40A and S-52 All-Wave Receivers

Popularly-priced Hallicrafters communications receivers, packed with advanced features. Cover 550 kc to 43 mc in 4 bands. Highlights include: full electrical bandspread; inertia flywheel tuning; calibrated main dial; automatic noise limiter; adjustable pitch BFO; standby switch; code-phone switch; headphone jack; shock-mounted speakers; separate sensitivity and volume controls; 3-position tone control. All tubes included. In handsome all-steel cabinet, 18½"x9"x11". Shpg. wt., 32 lbs.

97-546. S-40A, for 105-125 v., 50-60 cy. AC.

97-588. S-52, for 117 volts AC or DC.

YOUR NET PRICE, EITHER MODEL, ONLY... \$99.50  
\$19.90 down, \$7.63 monthly for 12 months

# FREE

Send for  
Your Copy  
of the  
180-Page

## ALLIED Catalog

### Radio's Leading Buying Guide

Get the Radio Buying Guide that's used by thousands of expert servicemen, engineers, amateurs, soundmen, builders and experimenters. Get every buying advantage at ALLIED: widest selection of equipment at money-saving low prices—speedy, expert shipment—personal attention—complete satisfaction on every order. Get your ALLIED Catalog today—use handy coupon below!



## hallicrafters S-38 the Super-Value Receiver

The all-star, all-wave value that amazes even the experts. Covers 4 full wave bands, continuous range from 540 kc

to 32 mc. Features: full electrical bandspread; Noise Limiter; Band Selector; BFO pitch; Voice-Code switch; Speaker-headphones switch; Standby-receive switch; latest PM speaker. In handsome furniture-steel cabinet; 12x7x8" Complete with all tubes. For 105-125 v., 25-60 cy. AC, or 105-125 v. DC. Shpg. wt., 15 lbs.

97-564. Model S-38 Receiver. Only... \$39.95

### ALLIED STOCKS ALL HALLICRAFTERS MODELS

Hallicrafters SX-42 (less speaker) .....	\$275.00
Hallicrafters SX-62 (less speaker) .....	269.50
Hallicrafters SX-43 (less speaker) .....	189.50
Hallicrafters S-51 (complete) .....	149.50
Hallicrafters S-53 (complete) .....	89.50
Hallicrafters HT-17 Transmitter .....	39.50
Hallicrafters HT-18 Oscillator .....	110.00

All Prices Net F.O.B. Chicago

Radio's Leading  
Buying Guide...

# FREE



ALLIED RADIO CORP., Dept. 1-E-9  
833 W. Jackson Blvd., Chicago 7, Illinois

- Send FREE 180-page ALLIED Catalog  
 Enter order for Hallicrafters Model.....  
Enclosed \$.....  Full Payment  
 Part Payment (Bal. C.O.D.)  
 Send ALLIED Easy Payment details and order blank

Name.....

Address.....

City..... Zone..... State.....

Everything  
in Radio  
and Electronics

# ★ ALLIED RADIO

# CHICAGO

The Name  
that Makes NEWS  
in TRANSFORMERS



## TELEVISION TRANSFORMERS

to fit today's leading TV circuits

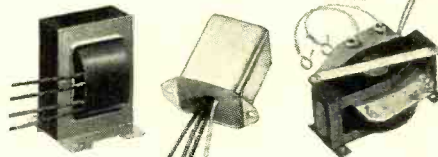

A complete catalog line, made by CHICAGO—the largest single manufacturer of original equipment TV transformers. Included are power, vertical blocking oscillator, and both vertical and horizontal scanning output transformers in a range of designs that are exact duplicates of units used in the leading TV sets.

## POWER TRANSFORMERS

A Complete Line  
in 2 alternate  
"Sealed in Steel"  
Mountings



Exclusive features like these make this the "Engineer's Line": Plate and filament voltages to fit today's most-used tubes; in two mountings—with solder lugs or 10" leads; one series for condenser input, another for reactor input use; exactly matching reactor for each power transformer. Get complete catalog now.

## HIGH Q CHOKES

for Dynamic  
Noise Suppression  
Circuits



Two efficient filter reactors, inductance values .8 and 2.4 henrys respectively, are designed for noise suppression circuits, but can be used in any tuned circuit requiring the given inductances. Inductance values are accurate within  $\pm 5\%$  with up to 15 ma. d-c. Minimum Q of 20. Mounted in identical drawn steel cases  $1\frac{1}{16}'' \times 2\frac{3}{8}'' \times 1\frac{1}{16}''$ . Write for descriptive sheet including diagram of simplified dynamic circuit.

## FULL FREQUENCY RANGE AUDIO TRANSFORMERS

within  $\pm \frac{1}{2}$  db.  
typical response  
30 to 15,000 cycles



For uniformly low distortion, for response curves that are truly flat over the full frequency range, use these CHICAGO input and output units. Get the facts on the BO-6 (P-P 6L6's to 6/8 or 16/20-ohm speaker), the BO-7 (600/150-ohm line to 6/8 or 16/20-ohm speaker), and other CHICAGO full frequency units—they're tops in transformers.

## ISOLATION TRANSFORMERS

for safer,  
more efficient  
servicing



For isolating chassis ground from line ground and eliminating the shock hazard (important on "hot" TV sets). Dual purpose: where line is under/over voltage, sec. supplies 115 v.; with 115-volt line, sec. supplies 125/115/105 volts (high/low volts help find doubtful tube, etc.). Three sizes: 50, 150, or 250-VA. to cover full range of servicing needs.

## MODULATION TRANSFORMER

for  
Ham and  
Commercial  
Transmitters



A Modulation Transformer ideally suited for use in ham and commercial speech transmitters. Will deliver 250 watts of Class B audio power from P-P 203A's, 211's, 805's, 75TL's, etc. to a Class C load with response variations not exceeding  $\pm 1$  db. over the speech range, 200-3,500 cycles. Primary impedances, 9000/6700 ohms; secondary impedances, 8000/6000/4000 ohms. A matching driver transformer is available.

## REPLACEMENT TRANSFORMERS

Premium  
Quality  
Yet They  
Cost No More

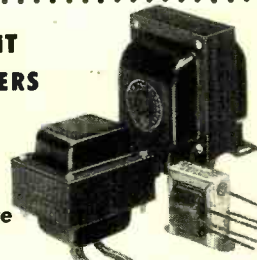

The new CHICAGO Replacement Line provides servicemen with a wide range of standard ratings that fit the most frequent power and audio transformer requirements. These units, backed by CHICAGO'S 20 years of manufacturing experience represent the finest quality attainable through engineering ingenuity and precision manufacture—yet they cost no more.

**NOW—IN PHOTOFAC!**

CHICAGO Replacement Transformers for AM, FM and Television Receivers are now listed in Howard W. Sams Photofact Folders for Servicemen.

Write for complete CHICAGO Transformer Catalogs

# CHICAGO TRANSFORMER

DIVISION OF ESSEX WIRE CORPORATION

3501 ADDISON STREET • CHICAGO 18, ILLINOIS



RADIO & TELEVISION NEWS



*The very picture of profit...*

**by the greatest name in radio**

● RCA and *only* RCA, can offer you this preferred line of related products for greater sales volume throughout the year.

You benefit by handling RCA Tubes, Batteries, TV Components, Speakers, Parts and Accessories . . . because you can get them all from *one* dependable source of supply . . . because the RCA monogram on

any product gives it immediate customer acceptance. Also, you'll save time and give greater customer satisfaction with the outstanding new line of RCA Test Equipment in your service shop.

**See us at the  
CHICAGO PARTS SHOW  
Hotel Stevens, May 17-20**



**ALWAYS KEEP IN TOUCH WITH YOUR RCA DISTRIBUTOR  
RADIO CORPORATION of AMERICA  
HARRISON, N. J.**

# TRANSVISION TV KITS

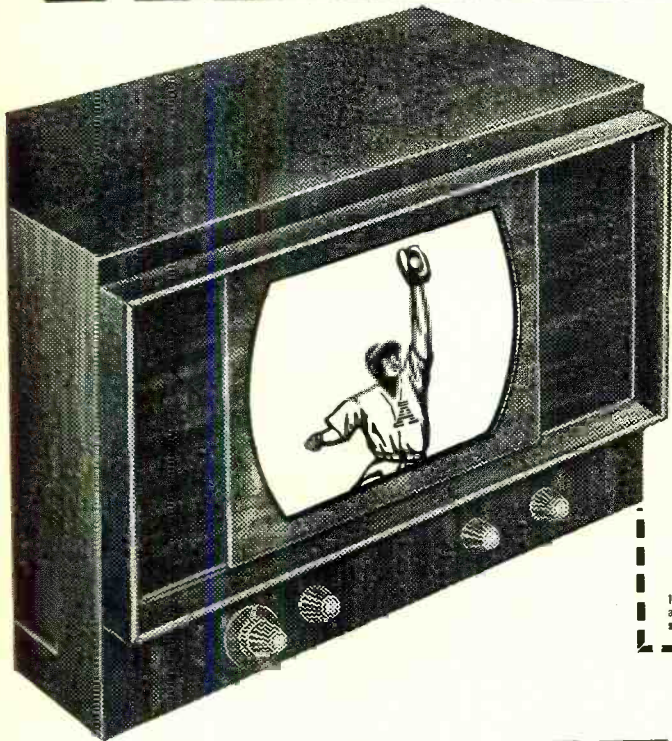

## Special Offer— MODEL 12A-TV KIT with 12 1/2" PICTURE TUBE

REMARKABLE VALUE!

**\$239<sup>00</sup>**

less cabinet\*

Here's what you get:

- FAMOUS TRANSVISION TELEVISION KIT, giving the finest television money can buy.

- 12 1/2" DIRECT-VIEW PICTURE TUBE

- FREE ANTENNA: INDOOR or OUTDOOR type, with lead-in wire. Either antenna gives ideal reception on all channels. Landlord's permission NOT required for indoor type.

- NO INSTALLATION COST. You can install assembled kit yourself in about an hour.

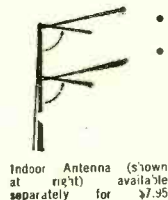

Indoor Antenna (shown at right) available separately for \$7.95



MODEL 12CL TV-FM KIT

## 200 Sq. In. PICTURE TV-FM KIT MODEL 12CL

Has DuMont Inputuner

IMAGE IS EQUAL to that of a 20" tube—even sharper and clearer—visible from all angles.

EQUIVALENT OF \$1000 SETS! Price of the new Transvision 12CL electromagnetic kit includes these outstanding features:

- 12 1/2" picture tube with special fitted built-in All-Angle Lens and color kit.
- DuMont TV-FM Inputuner
- Streamlined Cabinet and Roto-Table

Includes Cabinet, Lens, Table, Indoor or Outdoor Antenna, 63 ft. of Lead-In Wire.

**\$399**

## TRANSVISION Model 15A TV KIT

This high-quality Transvision TV Kit has a 15" picture tube. In all other respects it is the same as the 12A shown above.

**\$299** Less Cabinet\*

\*CHOICE of BEAUTIFUL CABINETS from \$29

For example, a "Modular" Console Cabinet which can be easily assembled in about an hour, costs \$29.

### ASSEMBLE Your Own CABINETS

Transvision's "MODULAR" Cabinets come in knock-down, unpainted units, offering an unlimited range of combinations, including even a bar. Finish them off to suit your taste and need.

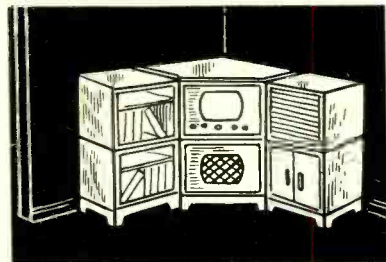

Corner piece, shown above, has room for TV, Phono, Record Storage, and open Book Case. COMPLETE \$84.00. For other units and prices, write for "Modular" Catalog.

## FREE: 162 PAGE TV COURSE

... with purchase of any Transvision TV Kit... You don't need this course to assemble a Transvision Kit, because the job is easy enough and our instruction sheet is simple and clear. BUT, if you want a good introduction to television fundamentals as a basis for further study, the Transvision Television Home-Study Course is ideal. Remember, you pay nothing extra for this course.

All Transvision Prices are fair traded; subject to change without notice. Prices 5% higher west of the Mississippi.

TRANSVISION, INC., Dept. RN, NEW ROCHELLE, N. Y.

For FREE 20-page TV BOOKLET and CATALOG SHEETS, SEE YOUR TRANSVISION OUTLET!

NEW YORK, N. Y.  
TRANSVISION OF MANHATTAN  
75 Church St.

BROOKLYN, N. Y.  
TRANSVISION OF BROOKLYN  
485 Coney Island Ave.

LONG ISLAND, N. Y.  
TRANSVISION OF LONG ISLAND  
40-14 Greenpoint Ave.  
Long Island City, N. Y.

NEWARK, N. J.  
TRANSVISION OF NEW JERSEY  
601 Broad St.

PHILADELPHIA, PA.  
TRANSVISION OF PHILADELPHIA  
235 North Broad St.

BOSTON, MASS.  
TRANSVISION OF NEW ENGLAND  
1306 Boylston St.

WASHINGTON, D. C.  
STAR RADIO  
409 11th St., N. W.

CHICAGO, ILL.  
TRANSVISION OF CHICAGO  
1002 South Michigan Ave.

SYRACUSE, N. Y.  
TRANSVISION OF SYRACUSE  
517 Butternut St.

MIAMI, FLA.  
TRANSVISION OF FLORIDA  
10 Northeast Third Ave.

DALLAS, TEX.  
TRANSVISION OF TEXAS  
700 Commerce St.

HOLLYWOOD, CALIF.  
TRANSVISION OF CALIFORNIA  
8572 Santa Monica Blvd.

SAN FRANCISCO, CALIF.  
TRANSVISION OF CALIFORNIA  
3471 California St.

CANADA  
TRANSVISION OF CANADA  
465 Church St.  
Toronto, Ontario

# TRANSVISION TV INSTRUMENTS



## ELIMINATE the VARIABLES in Television Installation with the TRANSVISION FIELD STRENGTH METER

Improves Installations!!  
Saves 1/2 the Work!!

Has numerous features and advantages, including—(1) Measures actual picture signal strength . . . (2) Permits actual picture signal measurements without the use of a complete television set . . . (3) Antenna orientation can be done exactly . . . (4) Measures losses or gain of various antenna and lead-in combinations . . . (5) Useful for checking receiver re-radiation (local oscillator) . . . (6) **12 CHANNEL SELECTOR** . . . (7) Amplitudes of interfering signals can be checked . . . (8) Weighs only 5 lbs. . . (9) **Individually calibrated** . . . (10) Housed in attractive metal carrying case . . . (11) Initial cost of this unit is covered after only 3 or 4 installations . . . (12) Operates on 110V, 60 Cycles, A.C.  
Model FSM-1, with tubes . . . Net \$99.50



## NEW LOW PRICE TRANSVISION ALL-CHANNEL TELEVISION BOOSTER CONTINUOUS TUNING

To assure television reception in weak signal areas, or areas which are out of range of certain broadcasting stations, Transvision engineers have designed this new booster. It increases signal strength on all television channels. Tunes all television channels continuously. Can be used with any type of television receiver. Unusually high gain in upper television channels.

Model B-1 . . . List \$32.50

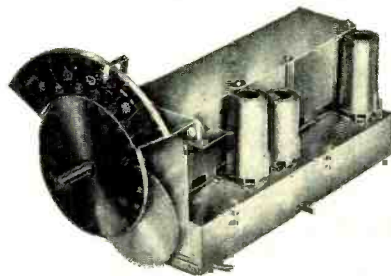

## DuMont TV-FM INPUTUNER

The finest TV-FM Tuner on the market today! Distributed exclusively by Transvision.

- Covers all 12 channels, entire FM Range.
- Continuously tunes from 44 to 216 mc without a break. Requires no band switching for tuning from channel to channel.
- Complete with tubes and escutcheon.

Model IT-1 . . . \$59.95

## TRANSVISION ALL-ANGLE LENSES for ALL TV SETS

Give picture sizes up to 150 sq. in. **Exclusive patented feature makes image visible from wide angle.** Lenses come with adapter for installation on ANY 7" or 10" picture tube, and with color kits. **All-Angle Lens for 7" tubes (gives 75 sq. in. picture) \$25.95**  
**All-Angle Lens for 10" tubes (gives 150 sq. in. picture) \$37.50**  
For 12 1/2" tubes . . . \$49.50



**GET INTO the TV BUSINESS In a BIG WAY with the TRANSVISION DEALER PLAN**  
WRITE FOR FOLDER D-1

IF YOU ARE NOT NEAR A TRANSVISION OUTLET . . .

**USE THIS COUPON**

MAIL TO: TRANSVISION, INC., NEW ROCHELLE, N. Y.

Please ship the following Transvision Products THROUGH YOUR NEAREST LOCAL OUTLET:- RN-5

I am enclosing 10% DEPOSIT in the amount of \$ . . . balance C.O.D.

I want to get into the Television Business. Send me details of your Dealer Plan.

Name . . . . . City & Zone . . . . .

(please print) Address . . . . . State . . . . .

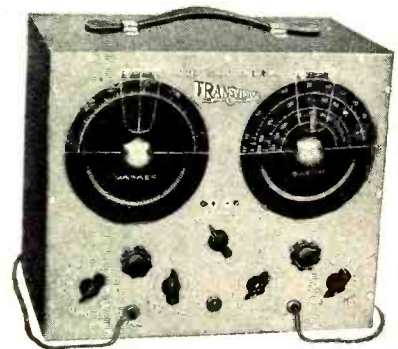

## TELEVISION and FM SWEEP SIGNAL GENERATOR

Complete frequency coverage from 0-227 MC with no band switching. . . Sweep width from 0-12 MC completely variable. . . Accurately calibrated built-in marker generator.

**OUTSTANDING FEATURES:** (1) Frequency range from 0-227 MC . . . (2) Dial calibrated in frequency . . . (3) Sweep width from 0-12 MC completely variable . . . (4) Self-contained markers readable directly on the dial to .5% or better. (No external generator required to provide the marker signals) . . . (5) Crystal controlled output makes possible any crystal controlled frequency from 5-230 MC . . . (6) Plenty of voltage output—permits stage-by-stage alignment . . . (7) Output impedance 5-125 ohms . . . (8) Directly calibrated markers, 20-30 MC for trap, sound and video IF alignment . . . (9) RF for alignment of traps for IF channels when a DC voltmeter is used as the indicating medium . . . (10) Unmodulated RF signal to provide marker pips simultaneously with the main variable oscillator . . . (11) Markers can be controlled as to output strength in the pip oscillator . . . (12) Power supply completely shielded and filtered to prevent leakage . . . (13) All active tubes are the new modern miniature type . . . (14) Phasing control incorporated in the generator . . . (15) Operates on 110V, 60 Cycles, A.C.

Model SG . . . . . Net \$99.50

## REMOTE CONTROL UNIT KIT OPERATES ANY TELEVISION SET from a DISTANCE up to 30 feet.



Model TRCU Remote Control Unit Kit with 25-ft. cable . . . \$69.00  
Also available without cabinet . . . 65.00

# MERIT

## news

**MERIT out in front again  
for sound equipment!  
with  
New OUTDOOR TYPE  
Universal Line  
TRANSFORMERS**

To couple various line impedances to a voice coil. Universal mounting bracket. Features: Universal mounting (may be bolted or clamped to speaker bracket); Weathersealed to withstand outdoor conditions at moderate cost; Encased in one-piece drawn metal can; Potted to resist moisture absorption; Terminal board mounted inside can.

Put the Merit Outdoor Type Transformers in Your Stock Today



**MERIT  
OUTDOOR TYPE  
UNIVERSAL LINE  
TRANSFORMER  
MOUNTING JO**

Type No.	List Price	Ohms Impedance	
		Primary	Sec.
A-4040	\$ 8.75	250-500-1000-1500-2000	4-8-16
A-4041	9.75	250-500-1000-1500-2000	4-8-16
A-4042	13.75	250-500-1000-1500-2000	4-8-16
A-4043	9.75	45-50	4-8

Type No.	Watts	Mounting Center Case	Dimensions		
			H	W	D
A-4040J	8	2 1/4 x 3 3/4	4 1/4	4 7/8	3 3/4
A-4041	12	2 1/4 x 3 3/4	4 1/4	4 7/8	3 3/4
A-4042	25	2 1/4 x 3 3/4	4 1/4	4 7/8	3 3/4
A-4043	12	2 1/4 x 3 3/4	4 1/4	4 7/8	3 3/4

**NOW READY—Merit's new catalog No. 4911 incorporating all TV Replacements in the regular line. Be sure to get your copy.**

**JOBBER! See Merit's exhibit at the 1949 Radio Show, Stevens Hotel, Chicago, Booth No. 150.**

**PRODUCTS OF MERIT**



**ANNIVERSARY 25 MERIT**  
COIL & TRANSFORMER CORP.  
4437 NORTH CLARK ST., CHICAGO 40, ILL.

**MERIT**  
Since 1924  
FINE RADIO PARTS

# Spot Radio News

★ Presenting latest information on the Radio Industry.

By RADIO & TELEVISION NEWS'  
WASHINGTON EDITOR

**WASHINGTON**, once again, has become a technological arena with the very-high and ultra-high TV bands as the featured performers.

Since December, when the famous propagation hearings were held and the subsequent Ad Hoc committee was formed to resolve the divergencies of opinion, industry and government experts have been sparring and marking time until all the possible variables in the allocation problem could be evaluated and a decision formulated. The volumes of statistical information which had to be studied made it difficult to arrive at an immediate satisfactory conclusion, and as a result, armchair specialists became busy and began to arrive at diverse opinions, which were far from complimentary not only to the government bodies but those from industry who were striving to solve an extremely difficult situation, all of which tended to alarm Mr. and Mrs. Public.

Actually the committee has reached a statistical approach, which involves relating the median tropospheric fields to the 4/3 earth's radius value up to distances of about 90 miles. At larger distances, where but few measurements are available and where the median value is in general below the recorder noise level, a single curve was developed which provided the best fit to the measured levels of intensities for one per-cent of the time, irrespective of the frequency and of the height of the transmitting antenna. Measured ratios of the one per-cent and ten per-cent levels, which showed systematic frequency effects, were applied to the one per-cent curve to produce curves of the levels exceeded for ten per-cent of the time for a sequence of frequencies. Families of curves for several antenna heights and frequencies, showing the continuous variation with distance of the field intensities to be expected for various percentages of the time, were produced by a system of smooth transition between the distance ranges involved in the foregoing two approaches.

Now these data are being probed for application to the present standards. The information at this stage has been conclusive enough for FCC Chairman Wayne Coy to state, and most emphatically, that the existing very-high channels will be available for a long, long time, the freeze will be undoubt-

edly lifted during the first weeks of the summer and some ultra-high stations will probably be operating in the early months of next year. The ultra-high stations, operating on the same channels, are expected to be about 200 to 225 miles apart, Coy stated.

Senator Edwin C. Johnson of Colorado, chairman of the Interstate Commerce Committee and father of the 50-kilowatt AM bill now being debated in Congress, entered the ultra-high battle by writing a letter to FCC Chairman Coy asking that the Commission and the TV industry take steps to protect the public against depreciation of their investments in television receivers when the higher frequencies come into use. As a result of this correspondence, one manufacturer decided to enter the dispute and indicate in advertisements, which appeared nationally, that his equipment could accommodate the higher bands without major alterations. Others in the industry voiced the opinions that present channels will not be obsolete, basing their remarks on FCC Chairman Coy's assurances, and, therefore, the sets now being sold will continue to receive all stations now on the air or soon to be authorized. These manufacturers also emphasized that conversion of most current receivers for the ultra-highs would offer no particularly difficult technical problems and in most cases will not prove prohibitively expensive, as several in Washington and industry indicated.

Two schools of thought did enter into the experienced experts' probe as to the immediate and future use of the ultra-high bands. In one set of views, expressed at the recent IRE national meeting at the Hotel Commodore in New York City, David B. Smith, vice president in charge of research and engineering at Philco, said that the ultra-highs are unlikely for several years and when they do come will not obsolete present TV receivers. Smith based his conclusions on an investigation made by Joseph Fisher of the Philco research division, who presented his report at the IRE meeting. According to the Fisher tests, which were made at sixty locations in the area of Washington, at distances of from one-and-a-half to twenty-three miles from the NBC experimental transmitter in the Wardman Park Hotel operating in the 504 to 510-mega-

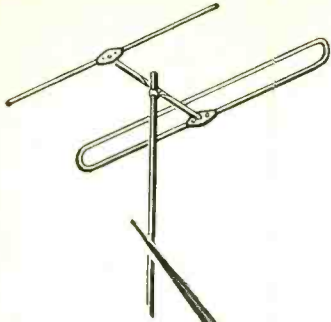

**PERFECT MATCH**  
**between Antenna and Receiver!**  
**AT ALL TIMES**

**INTELIN TV-59**  
**Shielded Lead-In Line**  
**for 72-Ohm Input Impedance**  
**Television Sets**

**HIGH QUALITY AT LOW COST**

Here's the finest lead-in available, at such low cost, for television receivers of 72-Ohm input impedance.

Intelin TV-59 offers a perfect match in impedance—and keeps that characteristic continuously despite the effects of weather and abrasion. This highly desirable *stability*—together with effective shielding—provide maximum signal-to-noise ratio . . . clear and steady television reception.

Federal—America's leading manufacturer of solid dielectric coaxial cables—gave Intelin TV-59 all of the important electrical and physical characteristics of its Intelin RG-59/U—considered the ultimate in 72-Ohm coax lines. And through Federal engineering, manufacturing and testing techniques Intelin TV-59 is now made available to you at a considerable saving in price. For full information, write to Department D-959.

from *Federal*—  
**America's Leading**  
**Manufacturer of**  
**Solid Dielectric**  
**Coaxial Cables**

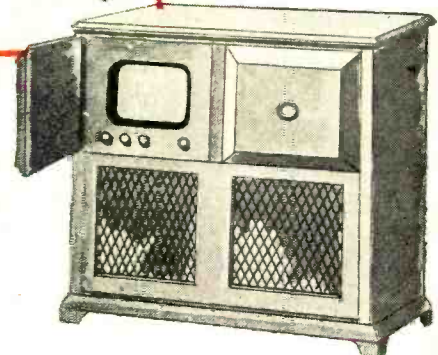

*Federal Telephone and Radio Corporation*

KEEPING FEDERAL YEARS AHEAD... is IT&T's world-wide research and engineering organization, of which the Federal Telecommunication Laboratories, Nutley, N. J., is a unit.

SELENIUM and INTELIN DIVISION, 900 Passaic Ave., East Newark, New Jersey

In Canada: Federal Electric Manufacturing Company, Ltd., Montreal, P. Q.  
 Export Distributors: International Standard Electric Corp. 67 Broad St., N. Y.

# PLUG IT IN... AND IT WORKS!

## Completely wired 29 TUBE CHASSIS FOR 12½" TV TUBE

Factory engineered, aligned and tested in accordance with most modern electronic methods

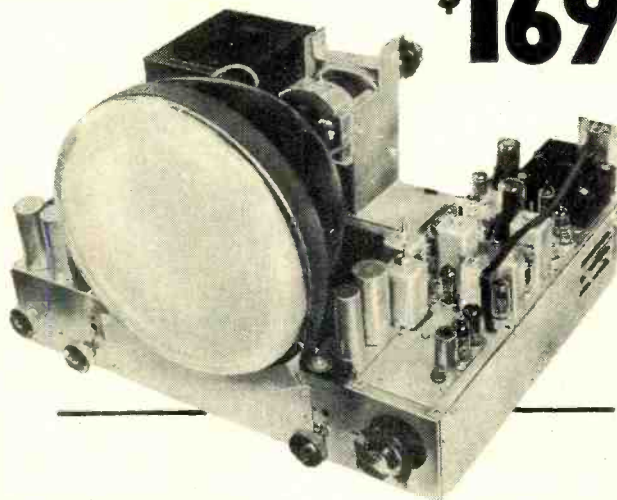

# \$169<sup>50</sup>

WIRED CHASSIS WITH 12½" CRT . . . . . \$229.50  
CHASSIS WIRED FOR 15" OPERATION (LESS CRT) . . . . . \$179.50

### NOTHING ELSE TO BUY OR BUILD!

This extraordinary direct view chassis, with licensed RCA circuits represents the utmost in TV value . . . The foundation of a \$900 retail value combination, it features large 84" picture screen, 29 tubes including 3 rectifiers, 13 channel tuning, long range reception, front focus control, high gain audio amplifier, automatic frequency control, and many other high-quality construction and operation advantages.

Comes with Schematics and full instructions.

**EVEN A LAYMAN CAN INSTALL IT.**

Standard RMA Guarantee on tube and chassis.

### BUY DIRECT FROM FACTORY AND SAVE!

Phone and Mail Orders filled on receipt of \$25 deposit . . . FOB N. Y.

Call in person at our factory showroom for free demonstrations and instruction

## LEHIGH TELEVISION COMPANY

601 West 26th Street, New York 1, N. Y. Dept. D

Telephone: ALgonquin 5-2046

Prices subject to change without notice.

cycle channel, power requirements in the ultra-highs will have to be much higher than on the lower channels to achieve comparable coverage, probably four to five times more powerful. It was also found that the shadowing effect caused by obstructions such as hills, buildings, and trees is much greater in the higher bands, thus requiring added height for the antenna system. The report then went on to reveal that at least three years or longer would be required before transmitters with the required high powers could be built.

According to Fisher it was found possible to receive satisfactory signals on the ultra-highs with a simple three-tube converter and a standard television model. During the tests three types of receiving antennas were used and mounted on a station wagon. These were a half-wave dipole, four-element Yagi and eight-element array with a screen reflector, each of which at one time or another was extended to a height of thirty-five feet. The antennas were connected to the input of the converter by means of a double shielded 93-ohm coaxial transmission line. The converter used a tuned coaxial input circuit feeding into a 1N21C crystal. The i.f. frequency of the converter was 54 to 60 megacycles.

In addition to the 500-megacycle tests in Washington, propagation measurements were made in the Philadelphia area, using a 20-kilowatt, 3300-megacycle one-microsecond pulse transmitter with a directional transmitting antenna.

In a contrary opinion and IRE report, Dr. Thomas T. Goldsmith, director of research for *Du Mont*, declared that ultra-high transmitters could be made available probably within a year. Goldsmith did agree with Fisher and Smith as to the successful use of converters and the fact that obsolescence of the present receivers would not be a factor, when the ultra-highs were authorized.

The implication that the ultra-highs may not be too far in the offing was also expressed in an *RCA* engineering report, which revealed the development of a method of combining transmitting tubes in groups or clusters, which could materially increase the power of television stations operating anywhere from 300 to 3000 megacycles. Describing the method at the IRE meeting, G. H. Brown, W. C. Morrison, W. L. Behrend and J. G. Reddick of the *RCA* labs, said that two tubes, or two complete transmitters, are teamed through a special network called a duplexer, which permits the combined outputs of the tubes to be fed into the same antenna, thereby doubling the effective power output, without narrowing the width of the band transmitter. It was stated that a transmitter with four output stages, combined with three duplexers, had been built. With the four stages operating at 850 megacycles, the final output of the transmitter was found to be four times the power obtained from a sin-

(Continued on page 152)



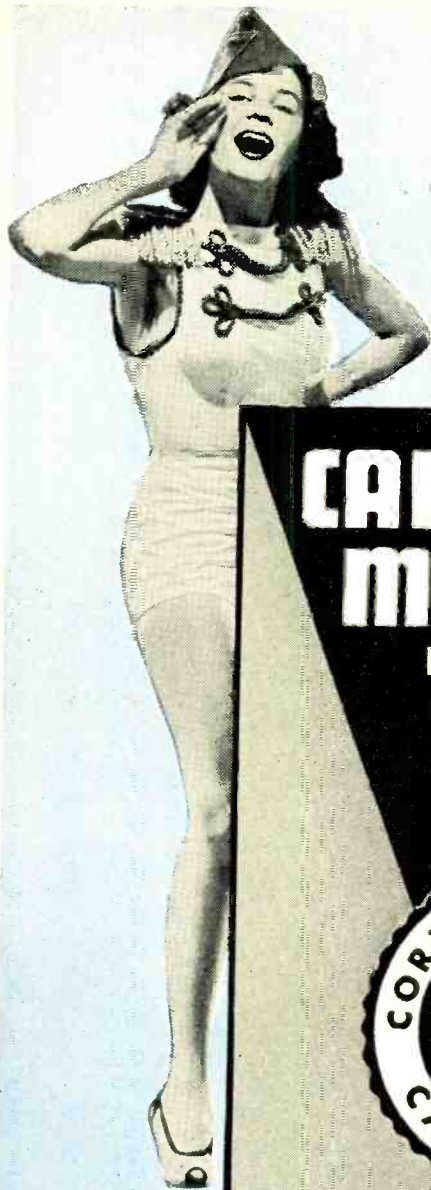

# LAST CALL!

50¢



**More than 30,000 Copies  
Now in Circulation!**

Got four bits burning a hole in your pocket? Dig for it fast, brother, and shoot it thisaway for the best service book bargain you'll ever see again. It's a big, fat-with-info volume that you need every day like vitamins for quick, accurate servicing of radios with C-D capacitors. We say you'll save 1,000 hours per annum of hot-footing it around for a whatsis that goes into a thingama-circuit. You'll save lots more — on shoe leather, frazzled nerves, yelping customers and cold cash. So fill in the coupon and mail it now for your copy of this last edition of the C-D Capacitor Manual for Radio Servicing.

**LIMITED QUANTITY!**

- complete tables on A to Z radio brands with C-D replacement numbers
- simplified color code of wire leads
- sharp schematics of bypass and filter circuits
- full descriptions of C-D capacitor replacements
- 352 pages, including memorandum pages, with a semi-stiff cover—pierced through for hanging reference

*Cornell-Dubilier Electric Corporation, South Plainfield, New Jersey. Other large plants in New Bedford, Worcester, and Brookline, Mass.; Indianapolis, Ind., and Providence, R. I.*



1910

1949

Reg. U.S. Pat. Off.

## CORNELL-DUBILIER

world's leading manufacturer of

CAPACITORS

AUTO VIBRATORS • TV and FM ANTENNAS  
POWER CONVERTERS

CORNELL-DUBILIER ELECTRIC CORP., Dept. RN 59  
South Plainfield, New Jersey

RUSH my copy of the C-D Capacitor Manual of Radio Servicing at your super-bargain price of only 50c each.

Quantity .....  Stamps  Cash (50c pc. only)

Name .....

Shop or Occupation .....

Address .....

City ..... Zone ..... State .....

# DUAL FOCUS Steals The Show with TWO Pictures Instead of ONE

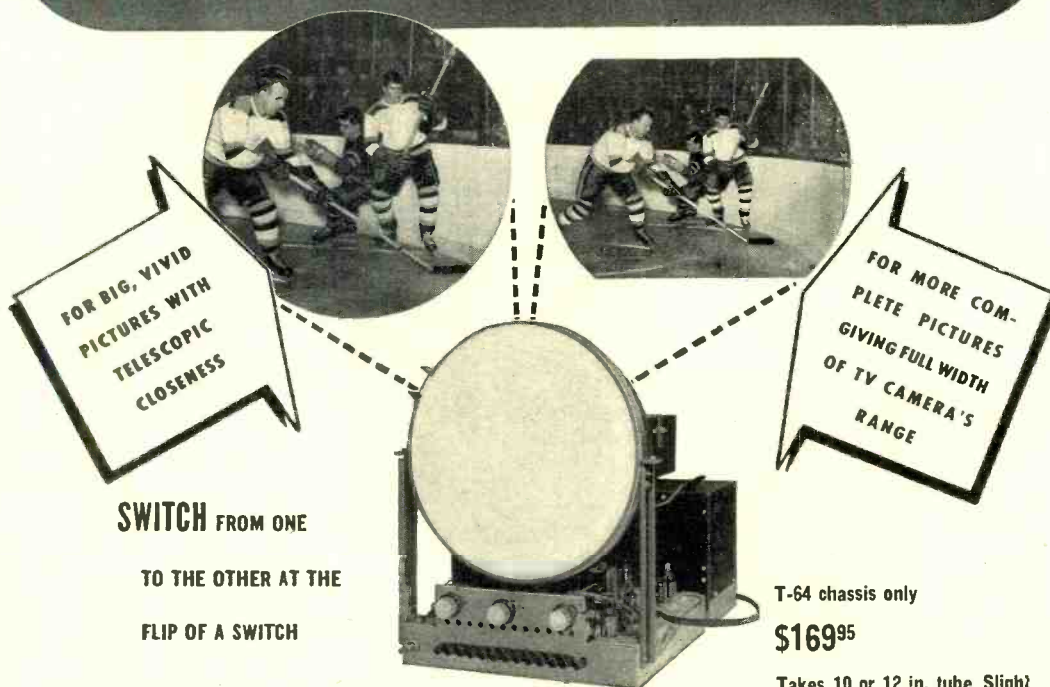

## WHY YOU NEED BOTH PICTURES

For complete enjoyment of circular-picture television, you need both the circular picture and the rectangular picture. The larger picture is truly a joy to behold, *but*—it clips off the sides of the normal picture. It works like a telescope; it concentrates on a smaller area and magnifies it. You see *less*, but what you do see appears *bigger* and *closer*. However, if reading material is flashed on the screen, the circular view may not cover the full width of the lines. Then, of course, with Hallicrafters, you merely flip the switch back to the rectangular picture.

### HALLICRAFTERS IS EXPANDED BOTH WAYS

In going from the rectangular to the circular picture, both height and width are blown up together to maintain normal proportions. This avoids the excessive distortion by vertical elongation as seen on early model sets with circular pictures.

**the hallicrafters co**

4401 W. Fifth Ave., Chicago 24, Ill.

See the latest Hallicrafters equipment  
in our Booth 153 at the Radio Parts  
Show in Chicago May 17-20.

MANUFACTURERS OF PRECISION RADIO & TELEVISION EQUIPMENT

# The Success Story of Bill Smith... OR YOU!



Mails coupon to National Schools in Los Angeles, and receives Free Lesson and book of information about Radio, Television and Electronics training.



Enrolls... studies in spare time. Finds personal attention from instructors, interesting material and practical equipment, all increase his interest.



Builds actual units as part of Course. Earns money doing spare time repair and installation work.



Completes Course and receives Diploma... is now a qualified Radio, Television and Electronics Technician.



Applies for—and GETS—a good pay, full time job in industry. Finds that employers know National Schools and like to hire their graduates.



Or he opens own profitable Service Shop, with valuable counsel and aid from National Schools. Now for real happiness and success!



## GET INTO RADIO, TELEVISION and ELECTRONICS by NATIONAL SCHOOLS SHOP METHOD HOME TRAINING

### THIS PRACTICAL, TECHNICAL RESIDENT TRADE SCHOOL TRAINS YOU AT HOME FOR BIG RADIO OPPORTUNITIES!

Never in history has such rapid progress been made as in the great Radio, Television and Electronics Industry today! This exciting, fast-moving development means new and greater opportunities for the trained, skilled man—for you—in Television and Radio Broadcasting, Installing, Servicing; in Frequency Modulation; in Applied Electronics in many industries; in a business of your own!

**National Home Training is Practical**  
Your National Schools Course fully covers basic, advanced and specialized instruction in all phases, including basic radio principles, receivers, am-

plifier systems, transmitters, television, aviation radio, electronics. You get complete instruction material, including shop manual, tube manual, job sheets, radio dictionary, special laboratory experiment lessons, experimental equipment. You receive complete, modern television lesson texts.

Your Home Study is supervised by our staff of highly trained instructors who daily teach our resident students here. Let the Free Books shown below tell you more about National Home Training. Use coupon today!

**APPROVED FOR VETERANS**

#### You Build This Superheterodyne Receiver With Parts We Send

You receive complete standard equipment, including latest type High-Mu Tubes, for building various experimental and test units. You progress step by step until you build a complete Superheterodyne Receiver. It is yours to use and keep.

#### Professional Multitester Included!

This portable instrument (see right) enables you to perform many practical tests, make delicate adjustments and do service work. Complete with test leads.

You receive a series of special laboratory experiment lessons to guide your practical exercises with your equipment. These lessons have been prepared with a special technique of illustrating radio principles by numerous easy-to-understand examples.

Both Resident and Home Study Courses Offered

Send Coupon Today for These Two Valuable Free Books

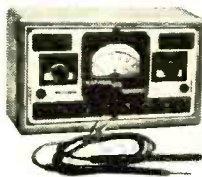

### NATIONAL SCHOOLS

LOS ANGELES 37, CALIF. • EST. 1905



### FIND OUT NOW... MAIL COUPON TODAY

National Schools, Dept. 5-RTNR (Mail in envelope 4000 South Figueroa Street Los Angeles 37, California or paste on postcard)

Mail me FREE the book, "Your Future in Radio," and a sample lesson of your course.

NAME..... AGE.....

ADDRESS.....

CITY..... ZONE..... STATE.....

Check here if veteran of World War II

# YOU BE THE JUDGE!

➡ See for yourself why BC "Hi-Kap" Capacitors, feature for feature . . . are your best buy for **QUALITY!**

➡ See for yourself why BC "Hi-Kap" Capacitors, feature for feature . . . are your best buy for **PRICE!**



◀ SEE THIS DISPLAY AT YOUR CENTRALAB DISTRIBUTOR

SEE THESE "HI-KAP" VALUES AND PRICES ➡

PART NUMBER	VALUE (MFD)	LIST PRICE*
D6-100	.00001	\$1.25*
D6-150	.000015	1.25*
D6-250	.000025	1.25*
D6-400	.00004	1.25*
D6-500	.00005	1.25*
D6-101	.0001	1.25*
D6-151	.00015	1.25*
D6-201	.0002	1.25*
D6-251	.00025	1.25*
D6-301	.0003	1.25*
D6-401	.0004	1.25*
D6-501	.0005	1.25*
D6-751	.00075	1.25*
D6-102	.001	1.25*
D6-152	.0015	1.25*
D6-202	.002	1.25*
D6-252	.0025	1.25*
D6-502	.005	1.50*
D6-752	.0075	1.50*
D6-103	.01	1.50*

\*Per Envelope of 5  
Rating: 600 WVDC — 1000 V. flash tested. Individually color coded, inspected and insulated.

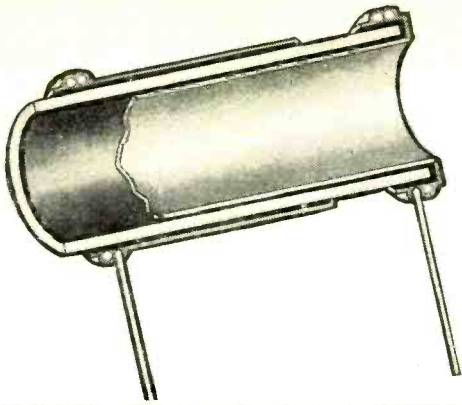

➔ *Never before has the dependability, permanence and convenience of ceramic by-pass and coupling capacitors been offered to Radio Service Dealers at a favorable price!*

"HI-KAP" FEATURES	DESCRIPTION			ADVANTAGES
1. Impervious to moisture	Ceramic-X is non-hygroscopic. Moisture absorption is .007% or less.			No deterioration, no shorting. Longer life even under the most adverse conditions.
2. Low mass weight	Av. Wt.	Dimensions	Values	For unit size and weight, Centralab BC "Hi-Kaps", made with Ceramic-X, are the only capacitors on the market which provide these voltage ratings.
3. Small size	.029 oz.	D—.315" L—.540"	.00005— .00025 mfd.	
4. High capacity	.044 oz.	D—.315" L—.830"	.0005 mfd.	
5. Special insulation	.050 oz.	D—.340" L—1"	.000750— .005 mfd.	
6. Convenient side leads	Rating: 600 WVDC — 1000 VDC flash test.			Prevents any possibility of shorting to adjacent leads, chassis or components.
7. Low power factor	Wax impregnated, lacquered, dipped in special phenolic resin, cured and wax impregnated.			Permit rapid, close-coupled connections. No tricky bending or fitting required.
8. High leakage resistance	Heavy #22 gauge tinned copper.			More efficient circuit operation, fewer failures.
9. Maximum dependability	Initial — .6%. After 100 hours, 95% humidity test — 3.0%.			Long life, more efficient performance.
10. Factory tested	Initial — 5000 megohms. After humidity — 500 megohms.			Will not short or become intermittent.
10. Factory tested	One-piece construction. Leads soldered directly to electrodes.			Your guarantee to your customers of reliable service and performance.
10. Factory tested	For your protection, all units 100% factory tested before packaging and shipping.			Your guarantee to your customers of reliable service and performance.

➔ *See your Centralab Distributor for complete information on this new line of ceramic by-pass and coupling capacitors, or write direct to*

# Centralab

**DIVISION OF GLOBE-UNION INC., MILWAUKEE, WIS.**

# Announcing 2 SENSATIONAL NEW INDOOR ANTENNAS By WARD

## WARDS NEW TVI-49

Ward's portable TVI-49 will give excellent reception on all channels—orients easily in all directions. Chrome plated brass dipoles. The TVI-49 is sturdily constructed and weighted perfectly—it will not tip over—List \$6.95

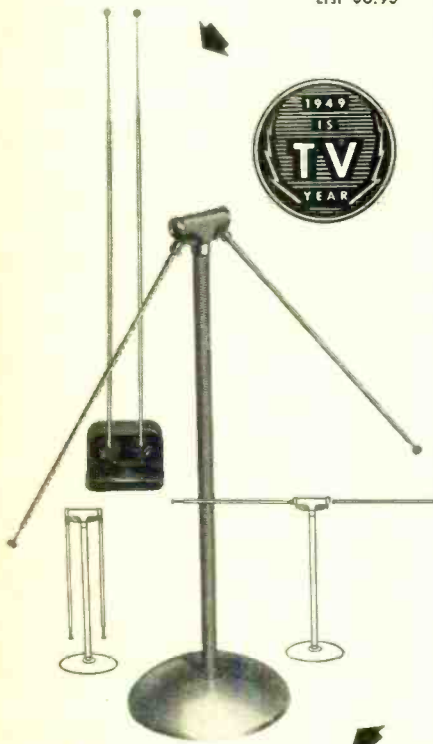

## WARDS NEW TVI-43

The TVI-43 brings in all channels precisely and brilliantly. Most attractive — chrome plated brass telescopic dipoles, satin beige brown finish—blends perfectly with the most exacting interior. List \$17.95

See any leading parts distributors or write for catalog today.



**WARD PRODUCTS CORPORATION**  
1523 E. 45TH ST., CLEVELAND 3, OHIO  
DIVISION OF THE GABRIEL CO.

# TELEVISION SET SHIPMENTS BY AREAS

Television Broadcast Service Area	Accumulative (1947 & 1948)	Television Broadcast Service Area	Accumulative (1947 & 1948)
<b>ALABAMA</b>		Paterson	1,864
Birmingham	23	Ruamecde	13
<b>ARKANSAS</b>		Trenton	5,101
Little Rock	19	Newark-Trenton	2,155
Other Cities	42	Cities not stated	6,579
<b>CALIFORNIA</b>		Other Cities	5,128
Fresno	11	<b>NEW MEXICO</b>	
Los Angeles	75,250	Albuquerque	246
Long Beach	554	<b>NEW YORK</b>	
Oakland	60	Albany	11,933
Santa Barbara	201	Binghamton	53
San Diego	536	Buffalo	8,687
San Francisco	11,665	Long Island	9,986
Other Cities	1,157	Middletown	153
<b>COLORADO</b>		Newburgh	34
Denver	37	New Rochelle	110
<b>CONNECTICUT</b>		New York City	256,873
Bridgeport	2,039	Poughkeepsie	813
Hartford	11,492	Rochester	65
New Britain	144	Schenectady	491
New Haven	2,012	Syracuse	1,734
Waterbury	117	Tarrytown	33
Other Cities	688	Utica	66
Cities not stated	580	Westchester	1,486
<b>DELAWARE</b>		Other Cities	683
Wilmington	2,724	Cities not stated	729
Other Cities	7	<b>NORTH CAROLINA</b>	
<b>DISTRICT OF COLUMBIA</b>		Charlotte	219
	30,338	Other Cities	12
<b>FLORIDA</b>		<b>NORTH DAKOTA</b>	
Miami	789		1
Tampa	44	<b>OHIO</b>	
Cities not stated	54	Akron	1,565
<b>GEORGIA</b>		Canton	186
Atlanta	4,455	Cincinnati	9,617
Other Cities	376	Cleveland	19,462
<b>ILLINOIS</b>		Columbus	22
Chicago	72,345	Dayton	1,763
Moline	26	Toledo	5,349
Peoria	365	Youngstown	142
Rockford	82	Other Cities	843
Rock Island	20	<b>OKLAHOMA</b>	
Sterling	37	Oklahoma City	18
Tuscola	16	Other Cities	10
Other Cities	733	<b>OREGON</b>	
<b>INDIANA</b>		Portland	125
Gary	2,261	Other Cities	9
Fort Wayne	47	<b>PENNSYLVANIA</b>	
Hammond	214	Allentown	2,147
Indianapolis	423	Easton	46
South Bend	1,429	Harrisburg	303
Cities not stated	160	Erie	201
Other Cities	206	Harrisburg	103
<b>IOWA</b>		Hazeltine	285
Madison	42	Lancaster	98,369
Other Cities	6	Philadelphia	5,652
<b>KANSAS</b>		Pittsburgh	144
	9	Pottsville	1,449
<b>KENTUCKY</b>		Reading	119
Louisville	2,897	Sunbury	31
Other Cities	57	Williamsport	838
Cities not stated	165	Other Cities	
<b>LOUISIANA</b>		<b>RHODE ISLAND</b>	
New Orleans	3,970	Providence	3,266
Other Cities	13	Other Cities	1,115
<b>MAINE</b>		<b>TENNESSEE</b>	
	14	Chattanooga	15
<b>MARYLAND</b>		Knoxville	19
Baltimore	27,885	Memphis	3,057
Other Cities	375	Nashville	40
<b>MASSACHUSETTS</b>		Other Cities	30
Boston	29,095	<b>TEXAS</b>	
Cambridge	3,797	Dallas	3,982
Springfield	159	El Paso	163
Taunton	48	Fort Worth	2,093
Worcester	994	Houston	2,047
Other Cities	265	Other Cities	249
Cities not stated	321	Cities not stated	175
<b>MICHIGAN</b>		<b>UTAH</b>	
Detroit	25,942	Salt Lake City	977
Grand Rapids	148	Cities not stated	24
Pontiac	24	<b>VERMONT</b>	
Other Cities	222		3
<b>MINNESOTA</b>		<b>VIRGINIA</b>	
Minneapolis-St. Paul	6,223	Alexandria	15
Other Cities	13	Norfolk	286
<b>MISSISSIPPI</b>		Richmond	2,846
	30	Other Cities	173
<b>MISSOURI</b>		<b>WASHINGTON</b>	
Kansas City	502	Seattle	4,450
St. Louis	15,849	Tacoma	47
Other Cities	76	Other Cities	72
<b>NEBRASKA</b>		<b>WEST VIRGINIA</b>	
	31	Clarksburg	41
<b>NEW HAMPSHIRE</b>		Wheeling	97
Manchester	309	Other Cities	29
Other Cities	46	<b>WISCONSIN</b>	
<b>NEW JERSEY</b>		Madison	96
Atlantic City	1,109	Milwaukee	12,859
Camden	11	Other Cities	80
Irvington	587	<b>AREAS NOT DETERMINED</b>	29,037
Jersey City	286		
Newark	87,459	<b>TOTAL SHIPMENTS</b>	964,206
New Brunswick	21		

*Editor's Note: The figures herein are presented through the courtesy of the Radio Manufacturers' Association (RMA). In view of the fact that not all television set manufacturers are members of RMA, add approximately 10 per cent to all of the figures above. Admiral Radio Corporation for one, and all kit manufacturers, do not belong to RMA, and their production of sets accounts for at least 10 per-cent additional.*

**HOWARD W. SAMS** *presents*  
**the authoritative new book**

*by* **OLIVER READ** *Editor, RADIO & Television NEWS*

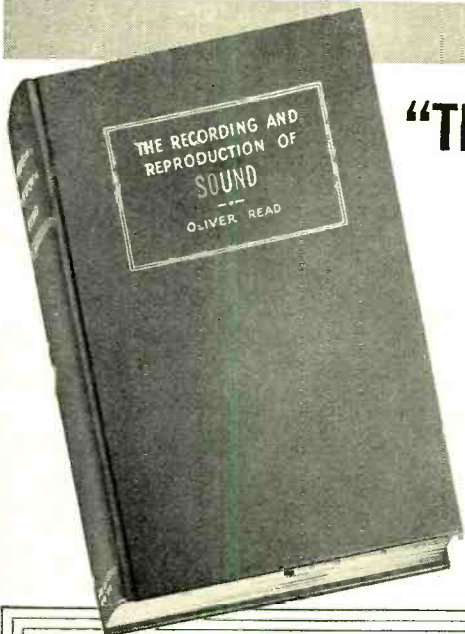

**“The Recording and Reproduction of SOUND”**

**The first complete reference book that gives  
the right answers on all phases of Sound**

Now you can own the book thousands have asked for—the book they got a taste of in the representative chapters which ran in RADIO & TELEVISION NEWS during 1948. Now brought up to the minute—*complete*—the one-volume answer to the great demand for a reliable, understandable, full discussion of the theory and methods used in the recording and reproduction of Sound. Absolutely essential to everyone interested in any or all phases of Sound—for a complete, unbiased explanation that gives you a thorough understanding of the entire subject.

**Absolutely Invaluable References**

**A PARTIAL LIST OF CONTENTS:**

- Behavior of Sound Waves—History of Sound.
- Basic Recording Methods: Film, Disc, Wire, Tape, etc. Magnetic and Crystal cutters. Magnetic recording methods on wire, tape and coated materials. Magnetic tape recorders.
- Microphones—Types and applications.
- Pickups—Types and applications. Phono pickup tracking error.
- Stylis—Selection and use.
- Microgroove and LP records.
- The Decibel simplified.
- Loudspeakers and enclosures. Dividing networks.
- Amplifiers—complete analysis of types and applications. Dynamic noise suppression. Tone controls, equalizers, and attenuators. Performance and testing of amplifiers.

**PLUS HUNDREDS OF OTHER SUBJECTS—  
A “MUST” FOR EVERYONE INTERESTED IN THE  
RECORDING AND REPRODUCTION OF SOUND!**

**304 PAGES  
180 ILLUSTRATIONS  
6 x 9”, CLOTH BINDING** **ONLY \$5.00**

**HOWARD W. SAMS & CO., INC.**  
INDIANAPOLIS 1, INDIANA

**Have the Answers to Questions Like These**

Do you know how to select the proper recorder for your purposes? Do you know how to get the most out of your recorder? Can you select the proper amplifier for a given application? Want to know how to test amplifier performance? Which to use—crystal or magnetic pickup? Do you know how to utilize inverse feedback, expanders and compressors? The answers to these and hundreds of other vital questions are given authoritatively by Oliver Read. His easy-to-understand treatment takes the mystery out of the subject; his facts are based largely on actual laboratory experience. No other single volume brings you this vast wealth of reliable information. This book belongs in your library!

**PUBLICATION DATE: MAY 15**

**ORDER YOUR COPY TODAY!**

**HOWARD W. SAMS & CO., INC.**  
955 N. Rural St., Indianapolis 1, Ind.

- Send me Oliver Read’s “Recording and Reproduction of Sound.” \$5 per copy.
- Check Enclosed  Ship C.O.D.

Name .....

Address .....

City ..... Zone ..... State .....

**Autographed  
copies  
for the  
first 250  
purchasers!**

# TWO NEW TV TESTERS

SEE THEM AT OUR BOOTH  
No. 118. R.M.A. PARTS SHOW  
CHICAGO MAY 17 TO 20

MODEL 665

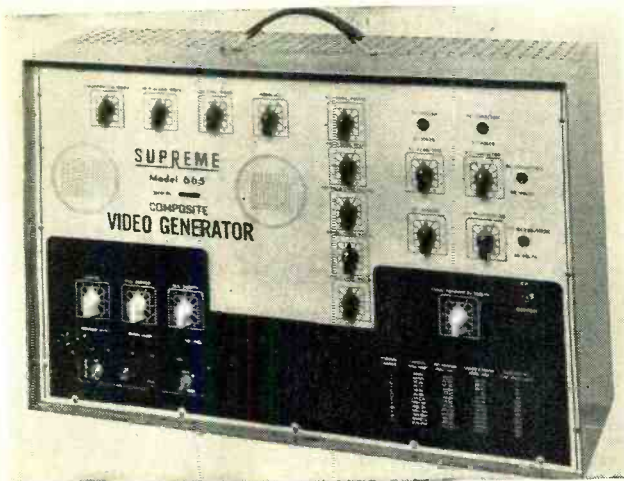

## COMPOSITE VIDEO GENERATOR

- INSTALLATION AND REPAIR WITHOUT STATION TEST PATTERN OPERATION.
- PROVIDES COMPLETE COMPOSITE VIDEO SIGNAL.
- PROVIDES BOTH HORIZONTAL AND VERTICAL SYNC AND BLANKING PULSES—SAME AS TV STATION OPERATION.
- PROVIDES DOT MODULATION FOR ADJUSTMENT OF HORIZONTAL AND VERTICAL LINEARITY AND HOLD CIRCUITS—ADJUSTMENT OF DEFLECTION YOKE AND FOCUS COILS.

MODEL 660

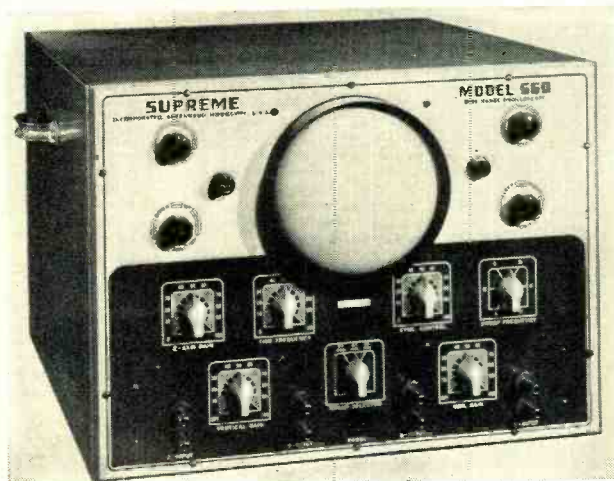

## TELEVISION OSCILLOSCOPE

- EXTRA SENSITIVE AMPLIFIERS. FIVE TIMES AVERAGE SENSITIVITY.
- WIDE BAND AMPLIFIERS. 10 CYCLE TO 5 MEGACYCLES.
- Z AXIS AMPLIFIER. PROVIDES AMPLE SIGNAL FOR GRID MODULATION OF CATHODE RAY TUBE.
- WIDE RANGE SWEEP GENERATOR FOR TIME BASE. UP TO 150,000 CYCLES.

The Model 665 Composite Video Generator and the Model 660 Television Oscilloscope provide a pair of testers whereby "Signal Tracing" in television sync separation, sweep circuits, and video amplifiers can be made without frequency distortion. SEE THIS NEW TEST SYSTEM.

**ANOTHER 1ST!**  
**BY SUPREME**

**SUPREME**  
**INCORPORATED**



You'll Satisfy More Customers With



Flat Cell "B" Batteries . . .

The Only Radio Batteries Whose Cells Are

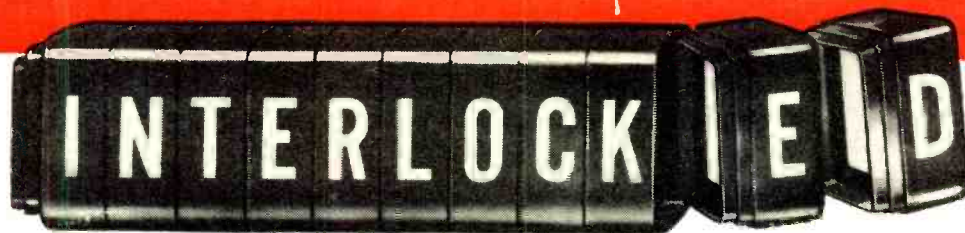

**LOOK WHAT IT MEANS** Each cell holds more power-producing chemicals with no waste space.

Triple sealing, under fixed pressure, insures against power leakage.

Up to 91% fewer soldered connections greatly reduce battery "hum" or failure—give longer life.

We guarantee these . . . the ONLY radio batteries with INTERLOCKED flat cells . . . to give more listening hours, and clearer reception under normal conditions.

IT'S EXCLUSIVE WITH OLIN!



**SEE HOW IT'S DONE** Note in the magnified view showing the enlarged cut-away section how each cell is INTERLOCKED . . . Patented U. S. Pat. No. 2416576.

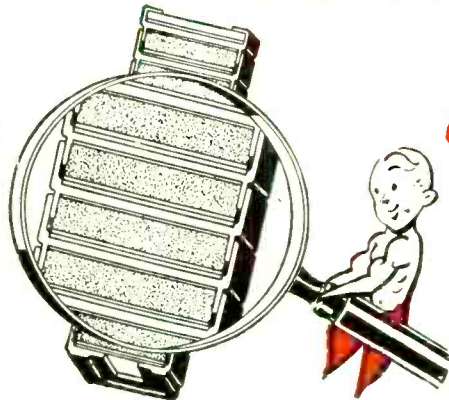

**CHECK THE PRINCIPLE** Interlock your fingers. Then even a strong man would have difficulty pulling your hands apart. This is simple proof of the power of *interlocking* . . . the same principle which is used to make OLIN "B" flat cell batteries the strongest and therefore the longest lasting radio batteries . . . the ONLY batteries that have triple-sealed, equally-strong INTERLOCKED flat cells instead of cells bound together with paper tapes or the other type wrappings found in ordinary batteries.



Available Only In The

**WINCHESTER** and **BOND** Lines

of OLIN INDUSTRIES, INC., Electrical Division, New Haven 4, Connecticut

**FAST SHIPMENTS FROM FIVE STOCK WAREHOUSES**

Houston, Texas . . . . . East Alton, Illinois . . . . . Chicago, Illinois  
San Francisco, California . . . . . Los Angeles, California

MR. RETAILER: Order From Your Wholesaler's Salesman Today To Be Ready For The Vacation Selling Season!

Choose  
**PYRAMID**  
 ELECTROLYTICS  
 for  
 Top performance  
 at 85°c



Pyramid Type 85TM Capacitors are now in volume production for leading TV-receiver manufacturers throughout the U.S.A. and Canada.



**PYRAMID**  
 CAPACITORS

**PYRAMID ELECTRIC COMPANY**

155 Oxford Street  
 Paterson, N. J., U.S.A.

TELEGRAMS: WUX Paterson, N. J.  
 CABLE ADDRESS: Pyramidusa

# Within the INDUSTRY

**HOFFMAN RADIO CORPORATION**, during a luncheon meeting held recently in its main plant, honored Max Balcom, president of the Radio Manufacturers Association. Some 32 members of the West Coast Electronic Manufacturers Association were in attendance.

Mr. Balcom, also vice-president of *Sylvania Electric Products, Inc.*, was welcomed by H. Leslie Hoffman, president of *Hoffman Radio*. Principal speaker at the luncheon, the RMA head expressed confidence regarding the growing future of the television industry, with particular emphasis on the West Coast TV picture. He stressed the fact that television must be sold for what it really is—a medium of entertainment for bringing home and family together. He also stated that the East needs the cross-continent coaxial cable link as much as the West, as it will make available outstanding Western talent.

The meeting closed with a get-together of the Electronics group, founded by Mr. Hoffman, its first president.

\* \* \*

**JOHN HOLLISTER POTTS** of New York City, president of *Radio Magazines, Inc.*, died March 16, at the age of 56.

Mr. Potts was a descendant of John Potts, founder of Pottstown, Pa. He was born in Chicago and graduated from the University of Chicago, with a degree in electrical engineering. During his career, he worked with the *Radio Corporation of America*, the *Sperry Gyroscope Company*, and other firms in engineering capacities. He also served *John F. Rider Publishers, Inc.*, and was technical editor of *RADIO NEWS*.

\* \* \*

**CHARLES K. HOOPER** is the new advisory engineer for the Electronics and x-ray division of the *Westinghouse Electric Corporation*, Baltimore, Maryland.



A graduate of the University of Maine, Mr. Hooper has been associated with *Westinghouse* for the past sixteen years, where he was concerned with the design and application of motors, generators, and other forms of rotating electric power equipment. More recently he has been engaged in the application and design of power supplies and controls for use in the electronics industry.

\* \* \*

**REMINGTON RADIO CORPORATION**, White Plains, New York, has acquired

an additional 16,000 square feet of space to further its plans to substantially increase present production.

The space is located in White Plains, in a building apart from the present operations and will serve the company by providing more room for the cabinet department. One section, however, will be turned over to assembly.

The *Remington Radio Corporation* is the manufacturer of Rembrandt Television receivers.

\* \* \*

**ROBERT D. ESSIG**, a graduate of the University of Michigan, is currently an engineer in the Broadcast Engineering Department of the *Collins Radio Company*.



Mr. Essig joined the *Collins* organization in 1947 following a period when he was an en-

gineer for the University of Michigan Broadcasting Service. Prior to that he had served as assistant technical supervisor for the American Forces Network of broadcast stations while with the occupation forces in Germany.

An associate member of the IRE, Mr. Essig is also a member of the Armed Forces Communications Association, and a 1st Lieutenant in the Signal Corps Reserve.

\* \* \*

**JOHN B. WALT**, who has been in sales promotion work in the Chicago area since 1937, has been appointed assistant advertising manager of *Admiral Corporation*, it was announced by the advertising director, **SEYMOUR MINTZ**. **DORMAN D. ISRAEL**, executive vice-president of *Emerson Radio & Phonograph Corporation*, was made a Fellow of the American Institute of Electrical Engineers, at a recent meeting of the engineering organization. *Frederick Hart & Company, Inc.*, manufacturer of electronics equipment, has acquired a new vice-president in the election of **JAMES F. BREHM** to that office. At a meeting held in February, the board of directors of *Lear, Incorporated*, elected **D. W. HAVEN** as treasurer; at present, Mr. **HAVEN** is controller and will retain his duties in that capacity. The appointment of **W. WESLEY BALLARD** to the post of director of publicity and advertising, communications division, has been announced by *Motorola, Inc.* The new assistant advertising manager of the *Philco Corporation* is **EDWARD B. BALLEY**, who will serve as executive assistant to **JOHN F. GILLIGAN**, advertising manager. **WILLIAM E. NEILL** will be the sales engineer of the television

**RADIO & TELEVISION NEWS**

## IN A RADIO SET

*how small  
can you get?*

### Sylvania's four tiny new tubes hold the answer

The miniature radio set shown here is an example of what can be done through the use of Sylvania's new subminiature tubes.

These specially designed and engineered T-3 subminiatures are battery-type receiving tubes perfect for very small radios or amplifiers. Short tube leads provided in conventional pin arrangement permit these tubes to be plugged into appropriate subminiature sockets. They can be operated over a wide range of battery voltages. Low current requirements result in battery economy.

*Send for complete ratings and characteristics.  
Sylvania Electric Products Inc., Advertising  
Dept., R-1005, 500 Fifth Ave., New York 18, N. Y.*

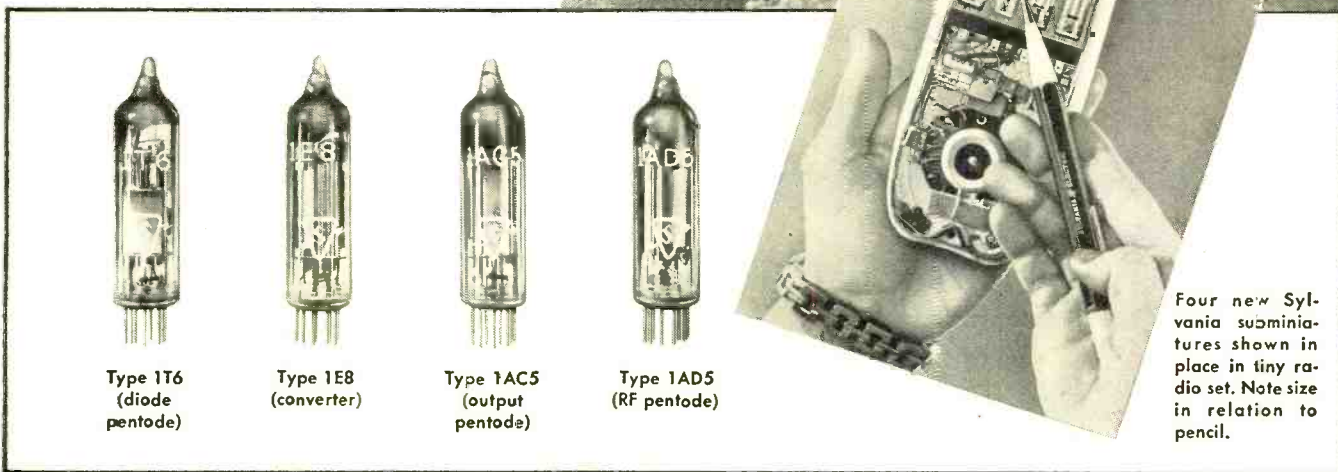

Type 1T6  
(diode  
pentode)

Type 1E8  
(converter)

Type 1AC5  
(output  
pentode)

Type 1AD5  
(RF pentode)

Four new Sylvania subminiatures shown in place in tiny radio set. Note size in relation to pencil.

# SYLVANIA ELECTRIC

**the ultimate  
IN DELUXE PERFORMANCE  
with ESPEY  
AUDIO AMPLIFIER  
POWER SUPPLY  
DE LUXE TUNER**

**MODEL 514 AMPLIFIER**      **MODEL 513 TUNER**

**NEW!  
CUSTOM BUILT  
AM-FM Quality CHASSIS**

**Here is exquisite high fidelity in chassis form that will grace the finest cabinet.**

**The 513 De Luxe Tuner is easy to install in any console cabinet, old or new and embodies the latest engineering refinements for lasting high quality at a price that defies competition.**

The Espey 513 Tuner employs 10 tubes plus tuning indicator in a super heterodyne circuit and features a drift compensated circuit for high frequency stability, tuned RF on AM and FM plus phono input provision, and separate AM and FM antennas.

**Model 514 De Luxe Power Supply-Audio Amplifier** is designed specifically to work in conjunction with Model 513 Tuner, and is also used wherever a high quality audio amplifier is required.

With an output of 25 watts, Model 514 features a parallel push pull output circuit, self balance phase inverter system, extended range high fidelity response, and inverse feedback circuit.

*Write Dept. KD for your free catalog.*

**ESPEY** *Makers of fine radios since 1928.*  
**MANUFACTURING COMPANY INC.**

528 EAST 72nd STREET, NEW YORK 21, N. Y. • TEL. BUtterfield 8-2300

and microwave engineering department of *Raytheon Manufacturing Company*, Waltham, Mass., bringing sixteen years' experience in radio broadcasting and VHF radio communications to that capacity. *Technical Appliance Corporation*, manufacturers of *Taco* radio and TV antennas, has announced that its new chief engineer will be **KENDRICK H. LIPPITT**, formerly associated with George C. Davis, broadcast radio consultant in Washington, D. C.

\* \* \*

**RALPH V. LITTLE, JR.**, is presently supervisor of *RCA's* Theater Television Engineering Group and is now active in the development of theater TV equipment by the direct projection and intermediate film processes and the development of equipment for making television recordings on 16 mm. film.



Mr. Little, a graduate of Pennsylvania State College with a degree of Electrical Engineering, joined *RCA* in 1933 and was assigned to the testing of transmitter and television equipment. He was transferred to the Television Engineering staff in 1939, and while with this group contributed to the development of portable television equipment.

\* \* \*

**CHET JORDON** and **MAX LIEBMAN** have been appointed district sales managers in the respective territories of lower Manhattan and Queens County, New York, to handle the *Air King* line of radio and television receivers. **WALTER T. MORELAND** will succeed **WILLIAM E. SKINNER** as *Arvin* district manager for Texas and the southwest territory, following Mr. Skinner's appointment as manager of *Arvin Distributors*, the company's new factory branch operation in Chicago. **ROWLAND R. GUILDFORD** is the new assistant sales manager of the *Allen B. Du Mont Laboratories, Inc.*, television receiver division, and will work closely with **VICTOR E. OLSON**, sales manager, in the direction of *Du Mont* receiver sales policies. *Garod Electronics Corporation* announces the following territorial distributors for its line of "Tele-Zoom" receivers: **GENERAL DISTRIBUTORS**, Wheeling, West Virginia; **THE HARGIS COMPANY**, Austin, Texas; **MONITOR DISTRIBUTING CO.**, East Providence, R. I.; **SILK-WORTH DISTRIBUTORS, INC.**, Ypsilanti, Michigan; and **W. E. TITUS WHOLESALE CO.**, Oklahoma City 2, Oklahoma. Recent *Emerson Radio & Phonograph Corporation* appointments include **STANLEY M. ABRAMS** as the new sales manager of the television division, **HAROLD E. KARLSRUHER** as head of the home radio division, **ARTHUR N. GROSSBERG**, assistant sales promotion manager, and **GERALD LIGHT** as assistant to the vice-president in charge of sales.

-30-

**RADIO & TELEVISION NEWS**

**HI-MU TRIODE OSCILLATOR 100TH AMPLIFIER MODULATOR**

Made by nationally known mfr. Can't reveal mfr's name, you know it. Each tube is BRAND NEW. R.M.A. GUARANTEE, individually boxed.

**\$7.95** each      Two for **\$15.50**

Please send check or M.O. with order. Add postage.

If you are a user of this tube, believe me, this is a real buy. Put them away for future use—it's like money in the bank! With our personal guarantee.

**XTALS 500 KC STANDARDS**  
2 pin mount, brand new. Price, each \$1.50

**McCONNELL'S**      3834 Germantown Ave., Phila., Penna. RA5-6033

**F I M A M O U T H**



"Madame X" was the code name, during research and development, for an entirely new system of recorded music . . . perfected by RCA.

## *The remarkable background of "Madame X"*

Now the identity of "Madame X," the *unknown* in a long search for tone perfection, has been revealed. From this quest emerges a completely integrated record-playing system—records and automatic player—the first to be entirely free of distortion to the trained musical ear . . .

The research began 11 years ago at RCA Laboratories. First, basic factors were determined—minimum diameters, at different speeds, of the groove spiral in the record—beyond which distortion would occur; size of stylus to be used;

desired length of playing time. From these came the mathematical answer to the record's *speed*—45 turns a minute—and to the record's size, only 6 $\frac{3}{4}$  inches in diameter.

With this speed and size, engineers could guarantee 5 $\frac{1}{2}$  minutes of distortion-free performance, and the finest quality record in RCA Victor history!

The record itself is non-breakable vinyl plastic, wafer-thin. *Yet it plays as long as a conventional 12-inch record.* The new RCA Victor automatic record changer accommodates up to 10 of the new records—1 hour and 40 minutes of

playing time—and can be attached to almost any radio, phonograph, or television combination.

Not only records are free of surface noise and distortion—the record player eliminates faulty operation, noise, and cumbersome size. Records are changed quickly, quietly . . . RCA Victor will continue to supply 78 rpm instruments and records.

This far-reaching advance is one of hundreds which have grown from RCA research. Such leadership adds *value beyond price* to any product or service of RCA and RCA Victor.



**RADIO CORPORATION of AMERICA**

*World Leader in Radio — First in Television*

# "This OHMITE Resistor Cabinet Saves You Time and Money!"

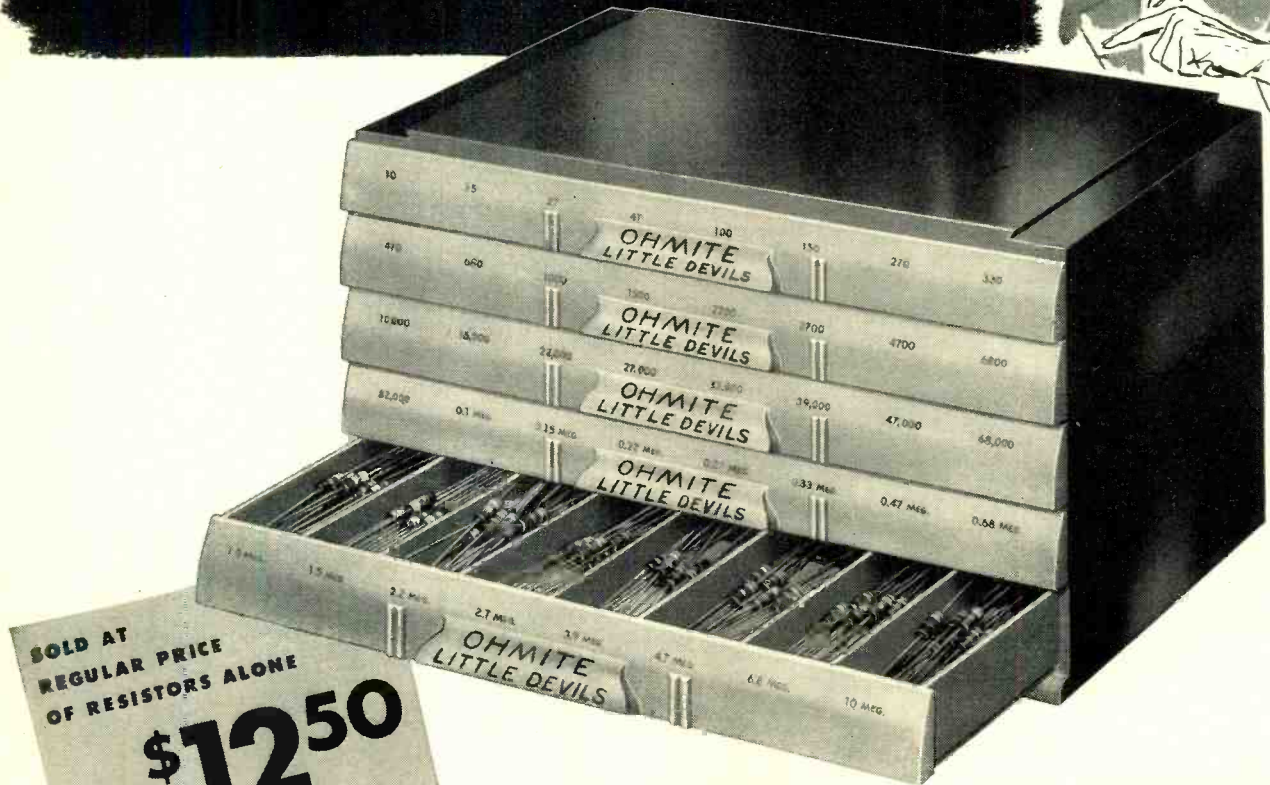

SOLD AT  
REGULAR PRICE  
OF RESISTORS ALONE  
**\$12.50**  
1/2-WATT  
ASSORTMENT  
NO CHARGE FOR CABINET

SEE YOUR  
DISTRIBUTOR

## HANDY, NEW ALL-PLASTIC CABINET WITH A SELECTED ASSORTMENT OF 125 "LITTLE DEVIL" RESISTORS

Molded of solid plastic, this rugged compact cabinet—9"x4 3/4"x5 1/4"—has 40 compartments factory packed with the "Little Devils" (from 10 ohms to 10 megohms) most frequently used. You find the *right* resistor...*fast*. Check inventory at a glance. And pay nothing extra for it—only regular price of resistors.

SOLID-MOLDED  
POTENTIOMETER \*  
RUGGED • RELIABLE

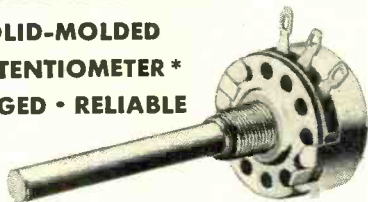

Built to last, this Type AB potentiometer has a heat-treated, solid-molded resistance element—not just a film. Unaffected by heat, cold and moisture. Has a 2-watt rating, good safety factor.

OHMITE MFG. CO. 4884 Flournoy St., Chicago 44, Ill.

Write for Catalog 21

## INDIVIDUALLY-MARKED "LITTLE DEVIL" COMPOSITION RESISTORS\*



Both color coded and individually marked for quick, sure identification, these sealed and insulated resistors are available in Standard RMA values. 1/2, 1, and 2 watts. Tol. ±10% and ±5%.

\* So that two exceptionally high-quality products will be universally obtainable, Ohmite Manufacturing Company, in co-operation with the Allen-Bradley Company, has arranged for the Type AB (Allen-Bradley Type J) control and Little Devil Molded Composition Resistors (Allen-Bradley Types EB, GB, and HB) to be available from stock at Ohmite distributors.

Be Right with **OHMITE**

RHEOSTATS • RESISTORS • TAP SWITCHES • CHOKES • ATTENUATORS



**Belden**  
CHICAGO  
WIRES CORDS

100 FT.  
8401  
SINGLE CONDUCTOR  
MICROPHONE CABLE  
MADE IN U.S.A.

8411

8401

8422

8410

8412

8423

8424

**MORE  
HOURS  
OF  
SERVICE  
•  
MICROPHONE  
CABLES**

*Every Type for Every Service*

**Belden**  
*Radio WIRE*

# THE EAR IS OUR CUSTOMER

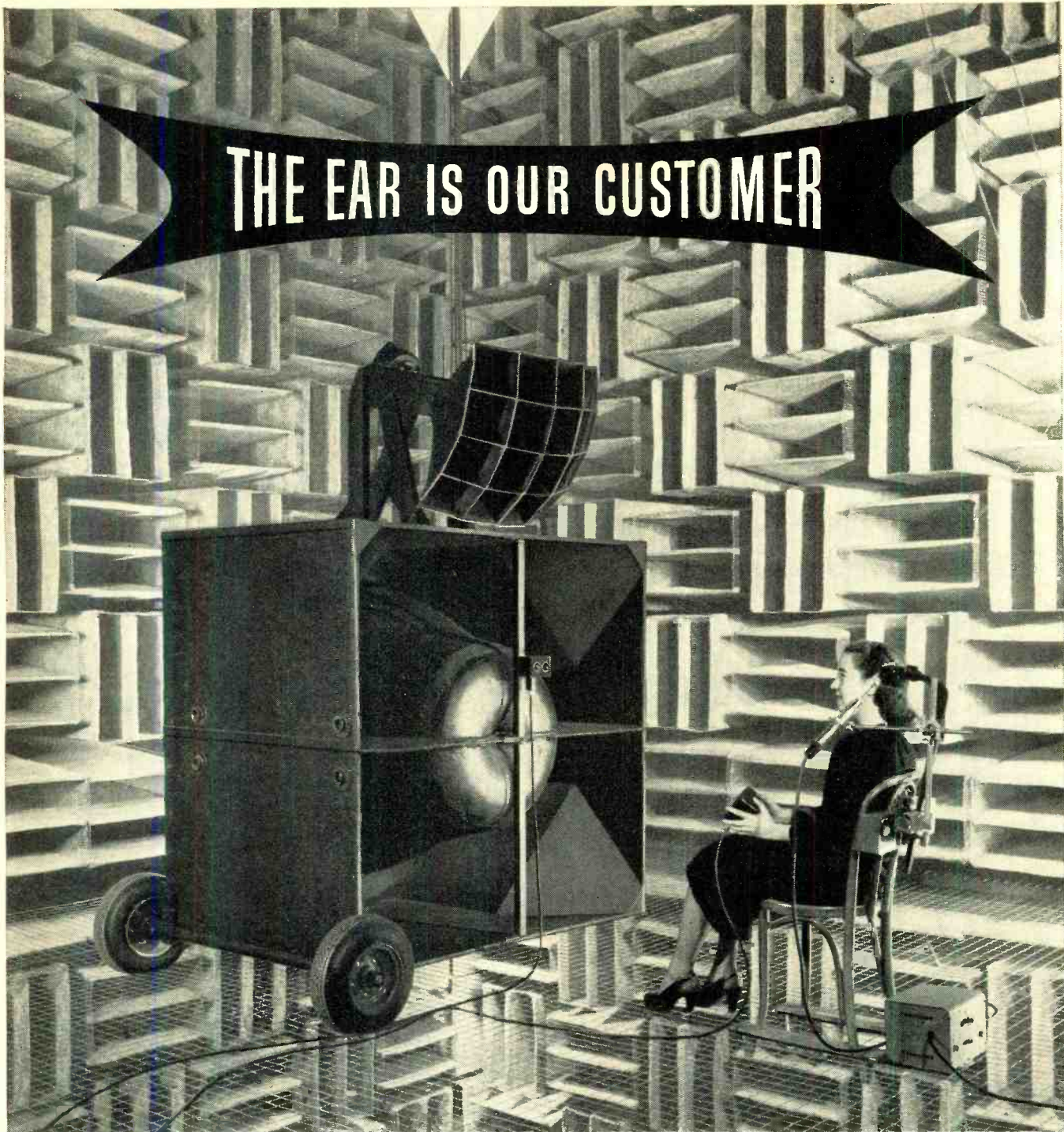

What happens when you hear? What happens *inside* your ear when sound waves come in from a telephone conversation?

Bell Telephone Laboratories scientists have developed special apparatus to help answer these questions, for the telephone system is designed to meet the ear's requirements for good listening.

In the test pictured above, the young lady sits before loudspeakers in a soundproofed room with a small hollow tube, reaching just inside the ear canal. Sounds differing slightly in frequency and intensity come from a loudspeaker. The subject seeks to tell one from another, recording her judgment electrically by pressing a switch.

Meanwhile, the same sound waves pass down the hollow tube to a condenser microphone, and a record is made of the exact sound intensities she identified. Results help reveal the sound levels you can hear clearly and without strain—the sounds your telephone must be designed to carry.

Scientists at Bell Telephone Laboratories make hundreds of tests in this manner. It's just one part of the work which goes on year after year at the Laboratories to help keep Bell System telephone service the finest on earth.

## BELL TELEPHONE LABORATORIES

*Exploring and inventing, devising and perfecting, for continued improvements and economies in telephone service.*



**RADIO & TELEVISION NEWS**



IN RADIO AND TELEVISION TUBE SALES



1949 IS A  
G-E YEAR!

**Biggest news of the year:  
General Electric's TV-service course!**  
**Jampacked with profit possibilities for  
you and other tube dealers to whom tele-  
vision—the miracle market—offers peak rewards.**

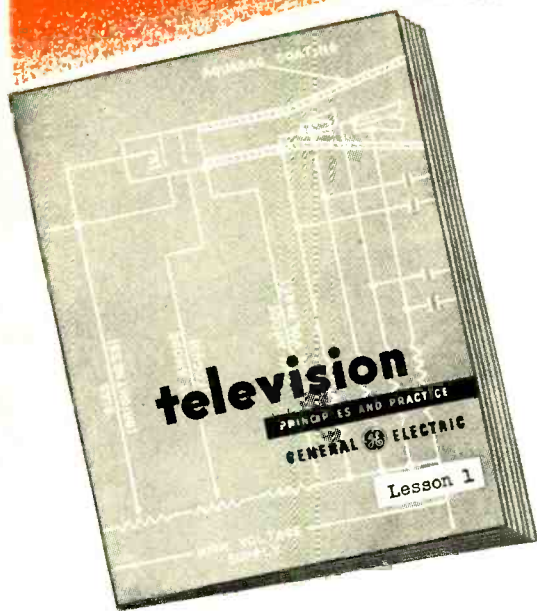

It's all here, in this book and those that follow—the basic theory of television; how TV receivers operate; the tubes and other components; how to install and repair sets of various types to their owners' satisfaction and your profit. Each lesson of the series is a clear, straightforward explanation of some one phase of television . . . *plus* a searching list of questions for you to answer after study.

Mail your answers, and a reply will reach you soon afterwards, grading you on your knowledge of the subject. This is an organized, hard-hitting correspondence course. You'll work hard to learn—but the hours you devote to General Electric's TV-service course will pay off in the sale of tubes, parts, and service to owners with real money to spend.

See your G-E tube distributor for the details! He's ready *now* to start you along this thruway to profits. It's one more step in General Electric's 1949 campaign to help you help yourself to prosperity and an assured business future. *Electronics Department, General Electric Company, Schenectady 5, New York.*

*You can put your confidence in—*

**GENERAL  ELECTRIC**

THEY'RE  
HERE



FOR  
FLASHLIGHTS



SHORTPROOF



LONGER  
ACTIVE  
LIFE

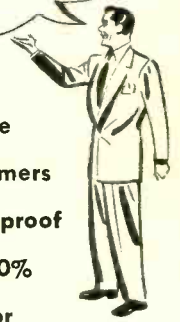

THE NEW "Plastic Clad"  
**PHILCO**  
RADIO "A"  
**BATTERIES**  
INCREASE THE LIFE OF YOUR FLASHLIGHT

Here, from Philco, is the flashlight battery customers will cheer for. It's shortproof . . . and packed with 20% more active material for extra long life that keeps buyers coming back for more.



**NEW COUNTER DISPENSER**

Turns stock fast! They sell on sight, in this compact eye catching dispenser. Place it up front and cash in on this big news in flashlight batteries. Has testing bulb. Fits in minimum space.

GET READY FOR THE NO. 3  
PHILCO ACCESSORY  
"GOLD RUSH" PROMOTION



SEE YOUR  
PHILCO  
DISTRIBUTOR

RADIO & TELEVISION NEWS

# Don Lee's New \$3,000,000 STUDIOS



By  
**WALTER W. CARRUTHERS**

Chief Eng., Studio Div.,  
Don Lee Broadcasting System

*The "Electronic Brain" is one of the many unique features of Mutual Don Lee network broadcasting headquarters in heart of Hollywood's radio center.*



Shown above is Mutual Don Lee's new three-million-dollar broadcasting building. Insert shows one of the four radio-television studios. Each studio is painted in 19 colors, running through the spectrum from a lemon-yellow to a deep blue-green.

**A** NEW building has gone up in Hollywood. . . the new home for the West Coast operations of the Mutual and Don Lee Broadcasting Systems, one of the most complete installations of its kind ever to be erected. The growth of Mutual and Don Lee required repeated expansion of the program production and studio facilities in use at the Hollywood headquarters. When the requirements became clear, however, it was decided to make a complete break with the past and design a new network center from the ground up, with new equipment designed specifically to provide the most efficient facilities for both existing and future needs. Description of the three-million-dollar, block-square building divides naturally into two parts: studio complement and acoustic design and program control equipment.

The studio designing program started in 1943 by Willet H. Brown, vice-president and general manager of the Don Lee Broadcasting System, and Walter W. Carruthers, called for four

auditorium sound stages—each 115 feet by 65 feet—four spacious dramatic studios and six smaller commentary and announce booth type studios. Each was studied individually for a particular type of radio program and was built as a separate and completely isolated cement structure. Claude Beelman, architect, tied the eight individual buildings into one four-story structure with general and executive offices, lounges, dressing and conference rooms, and work areas for the many network departments.

In contemplating the design of the new Mutual Don Lee Broadcasting Studios, several problems had to be considered.

Since radio programs usually fall into three general categories—musical and variety, dramatic, and commentary and announcement—each had a

specialized requirement which needed consideration in studio design. To use the space requirements of the musical studios as an example, a certain room size is demanded consistent with a certain type of music. Since we usually hear orchestras in halls bearing certain relationships in size to that of the orchestras, there is an emotional satisfaction when this effect is reproduced. The quality of the reverberation of a large room is successfully simulated at the present time only in rooms of commensurate size. Another way to think of this relationship is as "space effect," an audible perspective to the ear, as "depth" in a picture is perspective to the eye.

In order to facilitate picturing an actual orchestra, the direct sound must reach the ear surrounded by the indirect reflections or reverberation

character of the natural surroundings. Lack of this effect lessens our ability to mentally orient an orchestra with its component parts separated in space, resulting in an underestimation of the size of the orchestra and a diminished sense of the number of instruments playing each part.

Although the number of instruments may be increased in a studio of insufficient volume, the impression of added orchestral size is not proportional; however, where the number of instruments is small compared to the volume normally associated with the group, it is possible, with proper pickup, to create the effect of numbers in excess of those actually employed.

Much has been published on the problem of optimum reverberation characteristic for each type of studio. In order to correlate objective data with the subjective, or "sound," as interpreted by management, producer, artist, engineer, etc., first-hand information was required.

In the growing art of broadcasting, the optimum reverberation characteristic for a given room size has been controversial as with most things dealing with the aesthetic. Programs emanating from certain music halls and studios seemed to score a un-

nimity of opinion as to sound excellence. Equipment capable of producing tones and graphically recording the time of sound decay was moved into these favored places and the resulting curves were compared. There was an unmistakable similarity about all of them. An average of these measurements was taken as the optimum reverberation characteristic. The studio which had a sound characteristic closest to the selected standard was chosen as the place to produce a series of programs, so that a more careful study could be made in listening tests.

Aside from the quantitative aspect, other, more subtle, factors were considered, among them, the shape of each studio. To minimize sound and mechanical transmission, each studio was basically designed within an isolated 8 inch concrete enclosure dimensioned to a ratio of 2:3:5. To minimize standing modes, the inner walls of wooden construction were angled to avoid parallel surfaces. The ceiling was angled with respect to the floor. As a compromise between sound diffusion and the retention of room character, the walls and ceiling were alternately treated with different areas of convex and flat surfaces. For acoustic amplification, the auditorium stages

were shaped to form a gigantic orchestra shell.

In the sound treatment calculation another acoustic factor considered was the use of wood. All areas not otherwise employed were used to expose wooden panels in an effort to gain tonal enrichment by sympathetic vibration. For producing aperiodic irregularities in the reverberation decay characteristic, the sound absorbent materials were randomly placed yet the architectural beauty and symmetry were preserved.

The next problem was to design an auditorium which would conform to the optimum sound characteristic. In earlier building history, such an undertaking would be difficult. Today, with the science of acoustical engineering, it is possible to calculate the sound treatment for a given volume enclosure so that the desired reverberation characteristic can be obtained. The audible spectrum was divided into three regions—high, middle, and low frequencies. Each group was studied separately and given a different type of treatment in an effort to gain the desired results.

Low-frequency reverberation is usually excessive in rooms because materials normally found there do not absorb the lower tones as rapidly as higher tones. Through use of diaphragmatic areas, control can be exercised in the dissipation of low frequency sound. A "polycylindrical diffuser" is a form which has been used as a low-frequency reverberation control element. It is constructed with a thin sheet of veneer wood bent over a convex form. The wood is at a tension and by virtue of the ribs which are spaced at random, many diaphragms are created which vibrate at different frequencies. The multiplicity effect in the vibrating diaphragms causes an evenness in the attenuation of the low frequency reverberation.

The absorption of middle frequency sound is controlled by the amount of exposed area of such common materials found in the auditorium as upholstered seats, carpeting, drapes and wall treatment. Each material has a different coefficient of absorption, and all surfaces in the room must be taken into account.

High frequencies are usually absorbed to a greater degree by the same material affecting the mid-band frequencies and to further exaggerate the condition, sound travel through the air acts as high frequency absorption. To help compensate for this natural attenuation the convex surface was painted with hard enamel so that while it was acting as a low frequency control it could be highly reflective in maintaining high frequency persistence.

In the Don Lee studios the construction schedule was so arranged that sound measurements could be made as each type of material was added. There was a two-fold purpose in this procedure: (1) The acoustic measure-

Engineer Doc Bennett works on the relays behind the master control unit. The board, which cost \$300,000, is one of the largest control systems in the country.

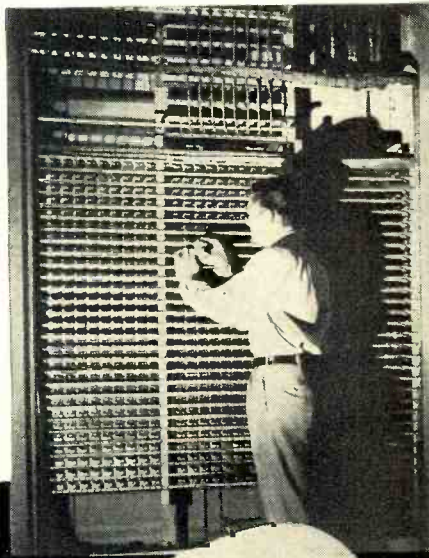

Earl Grant (left, standing), Don Lee Engineer; D. P. Loye, Technical Construction Superintendent for Western Electric; J. Garafalo, Western Electric Engineer; and Walter Carruthers, Chief Engineer, Studio Division, Don Lee, make sound measurements during construction of one of the large auditoriums.



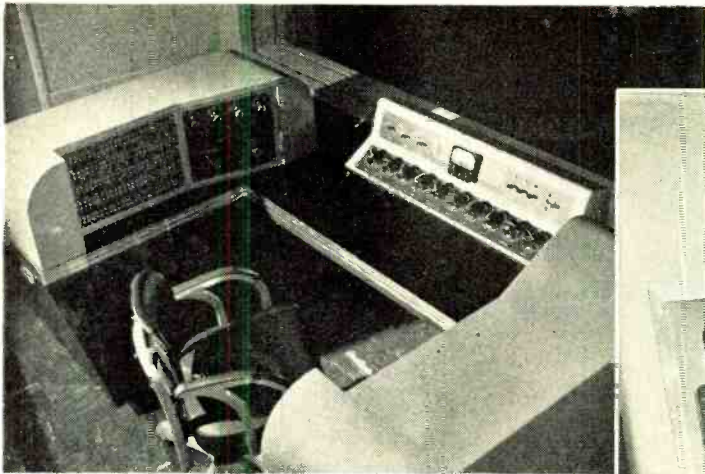

Custom-built speech input console. Mutual Don Lee's new Hollywood headquarters include four large auditorium studios, each 170,000 cubic feet in volume and seating 350 people. All of these four studios have Western Electric control consoles located in the control booths which are at left of the stages.

A close-up of the control panel shows the numerous meters and controls necessary to serve the eleven studios and five different network lines radiating from this network center.

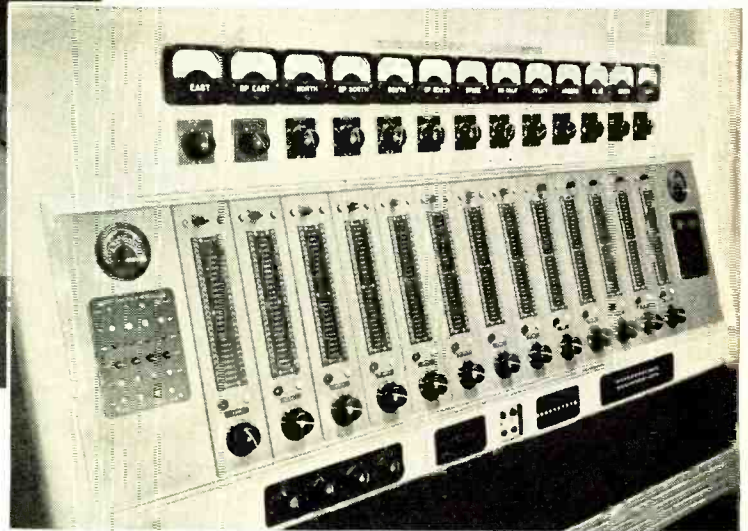

ments gave a family of related curves, each of which allowed a check on predictions as calculated for that stage of the building program. If, at that time, curve measures were indicated, it was simple to make them while that part of the construction crew was still on the job. (2) From an academic point of view the calculation of the sound absorption coefficient of each type of construction and material was made possible which would greatly facilitate the building program in the future by virtue of such information being compiled and available. Fig. 1 shows a typical family of curves resulting from measurements made during the course of construction. Here, for the first time, a building was constructed to the optimum reverberation characteristic indicated by the curves as they approach the dotted line representing the optimum.

It has been the usual practice for network centers to expand facilities on an add-a-unit basis in which the new would supplant the old as it became obsolete. The new \$3,000,000 Mutual Don Lee Broadcasting System plant is different in that with the move to the new quarters there was a complete break away from the old. There was very little, if any, transfer of equipment. Fortunately, the change had been anticipated for sufficient time to allow research and development with the exacting standards and demands imposed by modern AM, FM and television broadcasting.

In considering the studio control desk and master control room equipment, the engineering and developmental services of *Western Electric* were called upon to pose problems and needs and to share the vast experience and engineering background acquired through many years in the field of telephone communication.

The present master control equipment is the result of a vast amount of collective study over a period of years. In the early days of the net-

work, the switching was done by patch cords in which the line from the originating studios was manually patched into the telephone lines. The "patch-up-bridging bus-system" of program distribution proved inadequate as it became common for a number of programs to stop and others to start at the same time, and there grew a need for a coordinating center in program switching. Relays were substituted for patch cords. A system of pre-set selection followed, allowing the operator to anticipate forthcoming programs rather than act under the pressure of time.

With the rapid advance in the D. L. B. S. network activities, the installation became overloaded and obsolete. In 1934 a master control switching panel was set up using *Western Electric* locking 92 type keys to activate the relays. One hundred and forty-four program switching possibilities

were represented by 144 keys. There were twelve incoming and twelve outgoing lines.

In 1940 a move to the Melrose Ave. location gave rise to a larger and more complex master control system. The switching panel was expanded to a 17x20 board with 340 possible connections. For presetting, 92 type keys were replaced with rotary switches at the bottoms of the strips of green and red lights. Above each strip was located a volume indicator. It was then only necessary to rotate the switch until a green light stopped opposite the desired switch to be made. Then by push button a red light would be lit opposite the green showing the switch had been completed.

In 1948 a system was evolved which was a far cry from the early days of patch and cord switching. *Western Electric* engineers were invited to sur-

(Continued on page 156)

Over-all view of master control panel. Built by Western Electric, this master control incorporates a switching system for over 800 possible program combinations and requires 821 relays, 49 amplifiers, 850 indicator lamps, 2500 jacks and 13 volume indicators. This entire system can be controlled by only one man.

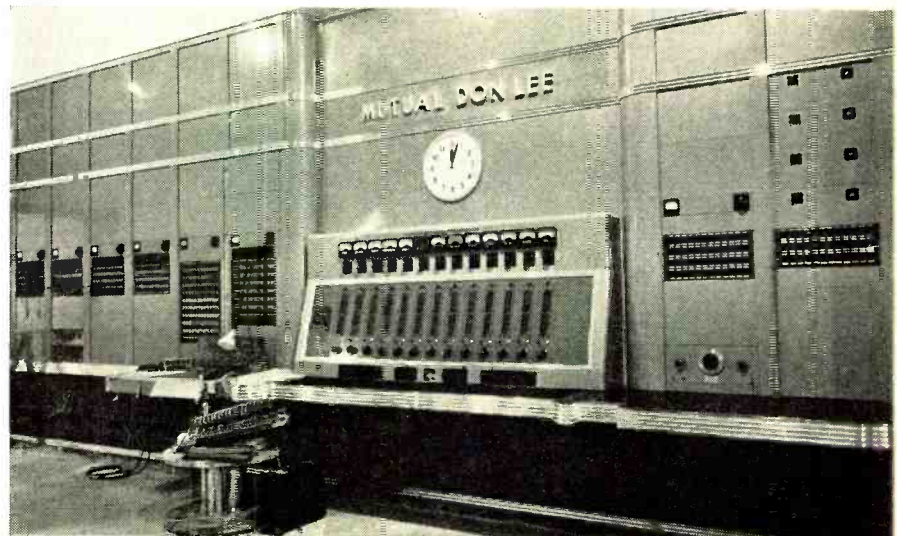

# How To Eliminate

# AUTO RADIO STATIC

By

M. C. ANDERSON

*Locate that baffling source of static noise by means of these to-the-point suggestions.*

**T**HERE is nothing mystifying about radio static to most amateurs, and the average radio fan, up against a static problem, would start a systematic check to eliminate the noise. Put the radio in an automobile, however, and we have to contend with the ignition and other units with which the radio man may not be familiar. Anyone can improve auto radio reception and eliminate annoying static noises by a few simple tests which require no special equipment whatsoever.

One way to eliminate noises, of course, is to remove the radio from the noise source, provided the cause is external. In autos, however, this is seldom possible, since mounting space is at a premium. The radio must generally be mounted right in the midst of a whole group of static-producing units. In spite of this, it is usually a comparatively simple matter to eliminate noise from the auto radio by checking it at its source.

**Location.** Though the choice of mounting locations for the auto radio is likely to be small, an attempt should be made to locate the radio as far from the ignition coil as possible. Generally speaking, a position at the extreme upper-right side of the dash is best for most installations; however, often some other location must be chosen because of interference with the heater or other equipment. In any case, make certain that the radio is well grounded to the dash through the mounting bolts by thoroughly cleaning the metal before tightening down the nuts.

**Ignition system.** The ignition system is commonly thought to be the worst static producer on the automobile, probably because of the high voltages used to jump the

spark gap. Actually, if the ignition system is in good condition it may give much less static trouble than other often unsuspected parts, such as the tires.

If the motor does not run evenly or shows other signs of ignition system trouble, chances are that the system will be a noise-producer. In this case, the system should be thoroughly checked.

Ignition system noise, if present, is usually easy enough to distinguish from other static noises. Tracking down the source of the leak may not be so easy. Begin by checking and regapping the spark plugs to the manufacturer's specifications. Plugs which have worn over the specified gap clearance will be likely to cause radio noise. Noise suppressors may be mounted on top of the spark plugs if subsequent tests indicate that they are necessary. These should be mounted in a horizontal position, or parallel to the head of the engine, as shown, if possible. Make certain that the suppressors are not near any wires, fuel or oil lines, or the like, which might pick up radiation and carry it to the radio. A good test to run on these suppressors after installation is to check continuity from the distributor cap to the spark plug with a battery light. An open circuit will cause arcing and radio static.

While the distributor is open, check the condition of the breaker points. Burned or pitted points will cause radio noise and should be replaced rather than filed. Point clearance should also be checked and correctly set at this time, or you may have your local garage do the job for you on a distributor test machine. Check the condition of the distributor rotor and distributor cap contact points. They should be clean and bright. If the points are pitted or burned, replace the rotor or distributor cap, or both. The rotor point to distributor cap contact clearance is also important and must not be excessive, or the resultant arcing will be heard in the radio. A gap of over .005" is likely to cause trouble here, and should be decreased either by installing a new rotor, or building up the old one by adding solder to the end of the electrode. Take care, however, that the point is not lengthened enough to strike the cap electrodes causing breakage. A suppressor may be used at the center lead of the distributor also, and should be placed here in preference to the cable outlet at the ignition coil.

If all these check-points are carefully inspected and cared for, and the ignition noise still persists in the radio, it is likely that the static is being transmitted to the radio by parts outside the ignition system. The choice may be narrowed somewhat by disconnecting the antenna from the set. If the noise persists, it is being transmitted through the frame of the car, but if it subsides, it is being picked up from the antenna. If the trouble lies in the antenna, check the lead-in for proper shielding and make certain that the lead-in shield is well grounded. No part of the antenna system itself must touch the car.

If the noise does not decrease when the antenna is dis-

Poor ground connections on cables and rods which pass through the firewall may be quickly located by shorting them to the wall.



connected, showing that it is being picked up from the chassis, check the ground connections on the radio, engine, and on all rods or lines passing through the dash. A file is a handy tool to use when checking grounds, since the teeth bite into the metal and give a good contact on painted or greasy surfaces. Check the speedometer cable, choke and throttle rods, oil lines, etc., by grounding them to the dash with the file. If the noise decreases, ground the offending part with a short length of copper braid well-soldered to both the rod and the dash of the car. Do this at the dash itself, using a length of braid just long enough to allow free movement of the control. Wires entirely outside of the ignition system sometimes pick up and transmit ignition noises. Check to see if any low-voltage wires (such as the generator leads) run through the same housing with the ignition wiring. If so, remove them and reroute the wires away from the ignition system. In extreme cases, it may be necessary to slide a flexible woven wire shielding over such wires to prevent radio interference. Check all wiring connections, such as those at the generator, ammeter, oil pressure gauge, etc., to make certain that they are tight. When making these tests, the radio should be tuned off-station for maximum sensitivity and the volume turned full on. Then, any variation in the noise level will be most apparent, since the static noise will be at its peak.

**Generator.** Generator noise may usually be eliminated by a condenser shunted across the cutout. Mount the condenser under one of the cutout mounting screws and attach the lead to the generator side of the cutout.

Clean the commutator with fine sandpaper and see that the brushes are making good contact. Brushes which have worn short will give poor contact due to low spring tension and should be replaced to prevent arcing and radio interference. Be sure to properly seat in the new brushes by running a strip of fine sandpaper about the commutator, rough side out, and drawing it back and forth to cut the brushes to the contour of the commutator.

In some cases, a second condenser may be necessary, connected across the generator armature terminal to a good ground on the generator housing.

Generator noise may be identified as a howl or whine in the receiver which will begin when the motor is speeded up sufficiently to operate the cutout and cause the ammeter to register charge. This may be further verified by speeding up the engine and then shutting it off. The noise, if it is being caused by the generator, will persist, dropping off as the generator loses speed and the engine finally comes to a stop.

**Tires.** Considerable trouble has been experienced with radio noise caused by static electricity generated by the tires, and especially so in the case of synthetic rubber tires. Tire noise is usually heard as an almost continuous roar in the radio. The noise will be heard only when the car is on the road and in motion, and the radio may work perfectly while the car is standing still, even with the engine running.

(Continued on page 125)

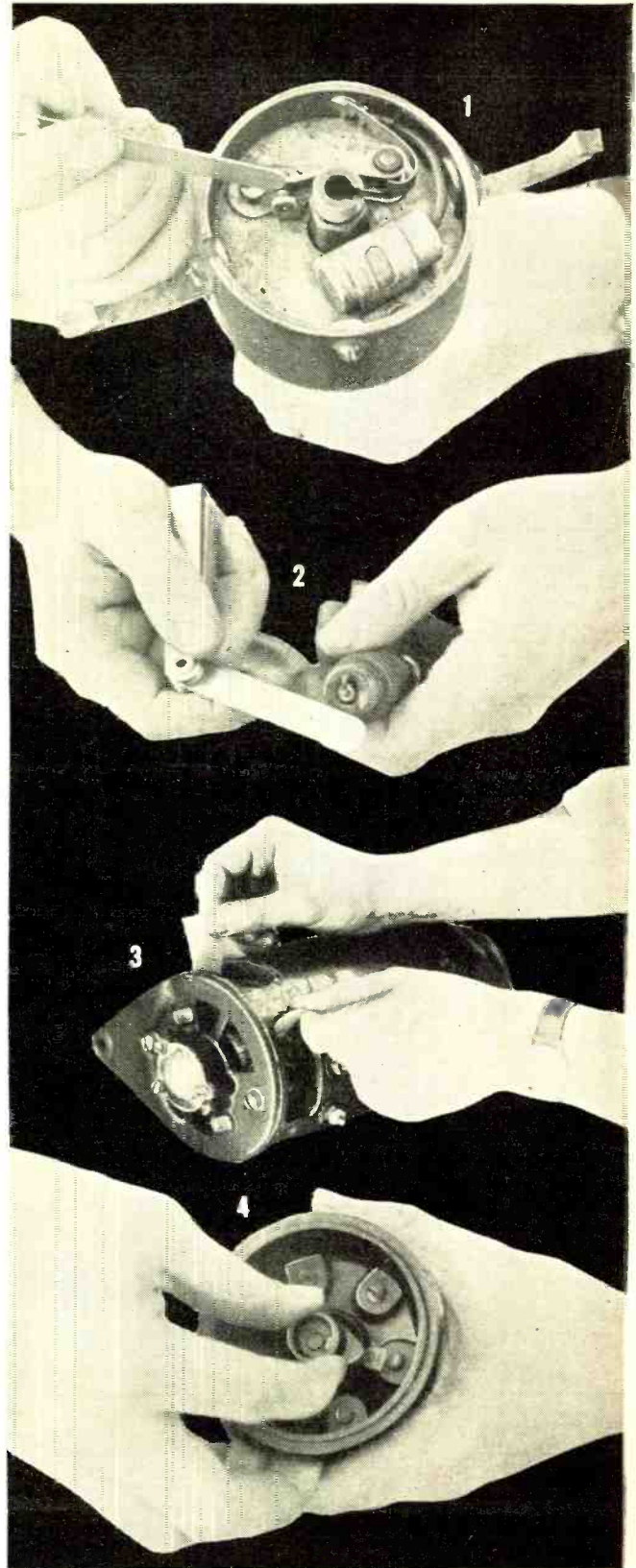

↑ (1) It's important to check on the distributor point clearance as well as the condition of the points themselves. (2) Spark plug gaps, if incorrect, can increase radio static noise. (3) If generator noise is heard in the radio, it may be necessary to sea in the brushes with sandpaper. (4) Distributor rotor to electrode clearance is important to good reception; watch for pitted contacts.

← Spark plug noise suppressors are of two types. The kind that is mounted parallel to the engine head (arrow) reduces the chances of transferring the noise to other wiring points.

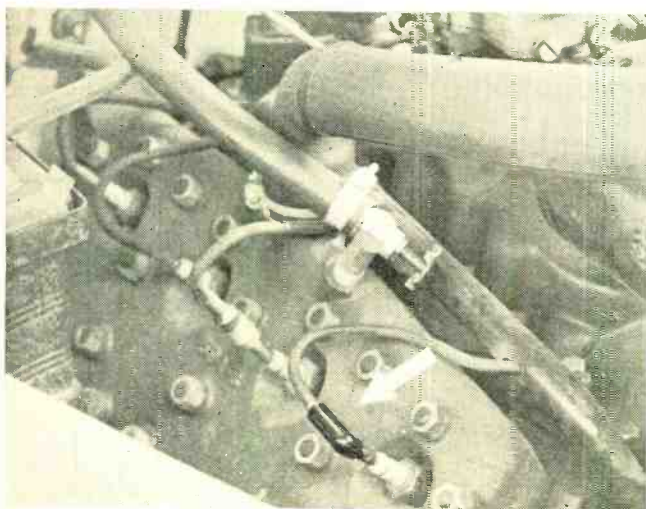

**By adding this pre-amplifier to your present receiver, better reception is obtained from remote FM stations.**

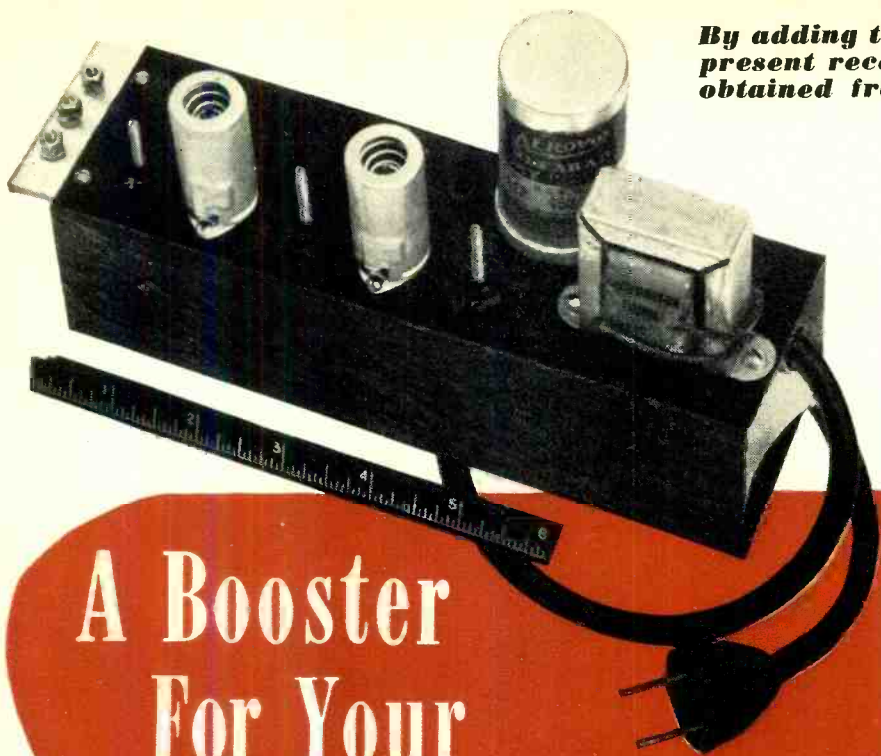

Fig. 1. Top view of the home-built pre-amplifier. Although designed specifically for the FM band, this booster, with modified coils, can be made to cover TV and the 10, 6, and 2-meter amateur bands.

# A Booster For Your FM RECEIVER

By

**PETER G. SULZER, W3HFV**  
Engineering Experiment Station,  
The Pennsylvania State College

**T**HE writer happens to be in a very poor location for FM reception. There are no local stations, and the antenna cannot be mounted on a high tower because of building restrictions. Measurement of the receiver sensitivity showed that it was not all that it might be. This unhappy situation led to a study of the limitations of receiver sensitivity, which resulted in the design of the preamplifier to be described.

At first glance it might appear that, in the absence of atmospheric or man-made noise, any number of amplifier stages might be added ahead of a receiver to increase its sensitivity. However, this is not so for two reasons. The first is that the amplifiers themselves contribute noise—*tube noise*. The second, and much more fundamental reason, is that the antenna itself contributes some noise as a result of thermal radiation from its surroundings. Since the objects around the antenna, including the earth and sun, are hot, they radiate heat. Some of this is picked up by the antenna, and appears as a random voltage at its terminals. It turns out that the magnitude of the voltage depends upon the resistance presented by the antenna.

In fact, the antenna can be replaced by an equal resistance, and the same noise voltage will be obtained, provided the resistance is maintained at the same temperature as the objects around the antenna. It is this noise voltage, *Johnson Noise*, which places a limit on the amount of amplification that can be placed ahead of the receiver. Even if the amplifiers themselves were perfect, the receiver could be made to overload on Johnson noise alone with sufficient amplification.

Obviously, it is desirable to make the receiver as sensitive as possible. This involves, then, not only sufficient amplification, but also low-noise amplifiers. The noisiness of an amplifier is expressed in terms of "noise figure," which is the ratio of the total noise output of the amplifier to the output that would result from Johnson noise alone. A perfectly noise-free amplifier would then have a noise figure of 1. All amplifiers do contribute some noise, and consequently have noise figures greater than 1.

Tubes contain many sources of noise. The basic one, however, results from the fact that electrons are discrete charges of electricity. Therefore, every time an electron passes the grid, a small voltage is induced in it, which is amplified and heard as noise. Another source of noise is encountered in pentode tubes, or in any tube with positive grids which draw current. Since the

current must divide between the positive grid and plate, this division takes place in a random manner. The result is, again, more noise. Other noise sources, such as gas and hum, are not important here because of the high frequencies involved.

## Preamplifier

It appears, then, that a triode tube, which does not have a positive grid, is best for the preamplifier. Unfortunately, as is well known, neutralization is required. Although the triode could have been used as a grounded-grid amplifier without neutralization, it has been the writer's experience that a better noise figure can be obtained with the ordinary, neutralized connection. A fair amount of gain is required to override the receiver noise. Calculations showed that, in this case, two stages would be necessary for a band width of 15 megacycles, which is required to cover most of the FM band.

Figs. 1 and 3 are photographs of the preamplifier, which was constructed on a narrow chassis-base to permit placement inside an S-55 receiver. Fig. 2 is the schematic diagram showing two stages, with  $V_1$  connected as a triode for low noise and  $V_2$  connected as a pentode for high gain.

The coils,  $L_1$ ,  $L_3$ , and  $L_4$ , are slug-tuned without any additional capacity, for maximum bandwidth. Loading resistors  $R_1$ ,  $R_3$ , and  $R_6$  are used to obtain still broader tuned circuits. The second stage,  $V_2$ , is a conventional pentode amplifier, with link coupling to the receiver. It will be noted in the parts list that all bypassing is done with button-type silver-mica condensers. Although these condensers are fairly expensive (even on surplus) it was felt that they should be used because they permit very low-inductance connections. It is possible that small, tubular ceramicons might be substituted with only a small sacrifice in performance.

The first stage,  $V_1$ , has the screen-grid and plate tied together to obtain a triode connection. As mentioned above, neutralization is necessary, which is accomplished by means of  $L_2$ . This coil "tunes-out" the grid-to-plate capacity, resulting in a high imped-

**RADIO & TELEVISION NEWS**



ance, which prevents feedback and oscillation. The antenna is link-coupled, the number of turns having been adjusted for optimum noise figure with a 300-ohm feeder. A center-tap is brought out so that the FM antenna can also be used on the broadcast-band without affecting its FM performance.

The power supply is novel in that two filament transformers are used "back to back" to obtain the required voltages. Filament transformer  $T_1$ , which is connected to the a.c. line, provides heater voltage for the tubes, and drives  $T_2$ , which gives about 90 volts a.c. for the rectifier plate supply. In this way, it was possible to use two very compact transformers and a single selenium rectifier. The preamplifier could be operated with an a.c.-d.c. power supply, eliminating the transformers, but it was considered undesirable in this case. It is possible that the receiver itself could supply the power, since the requirement is only 6.3 volts at 0.35 amperes and 75 volts at 20 milliamperes.

### Construction

Figs. 1 and 3 show the parts layout used. This should be closely followed for best results. It is necessary that the three coils,  $L_1$ ,  $L_3$ , and  $L_4$ , be mounted at one side of the chassis-base rather than in the center, to decrease the coupling between them. The selenium rectifier can be mounted under the chassis-base because the heat dissipated is very small with a current of only 20 milliamperes.

When wiring,  $C_1$  and  $C_2$  should be returned to one of the screws mounting the socket of  $V_1$ .  $C_8$  should be returned to the other screw on the same socket. In the same manner,  $C_4$  and  $C_5$  should be returned to one of the screws mounting the socket of  $V_2$ .

The tuning coils  $L_1$ ,  $L_3$ , and  $L_4$  were wound on surplus slug-tuned forms. If these are not available, National XR-50 forms will do very well. When mounting  $L_3$ , the neutralizing coil, it should be placed at right-angles to  $L_1$  and  $L_4$ .

### Adjustment

After the wiring is finished, the grid of  $V_1$  should be grounded to prevent oscillation, and the power should be turned on. The plate supply should be approximately 75 volts, while the drops across  $R_2$  and  $R_4$  should be about 1 volt, indicating cathode currents of 10 milliamperes in each tube.

If everything is satisfactory, the link of  $L_4$  can be connected to the receiver through a short piece of twisted-pair. If long leads are necessary, 300-ohm twin-lead should be used. With the receiver set at 100 megacycles, a very noticeable peak should occur in the noise as  $L_4$  is tuned through its range. Both  $L_3$  and  $L_4$  should be set for maximum noise output at the middle of the FM band.

It is next necessary to neutralize  $V_1$ . This can be accomplished by ungrounding the grid, and disconnecting  $R_5$  at the connection  $C_2$ - $R_5$ . If a signal generator is available, it should be

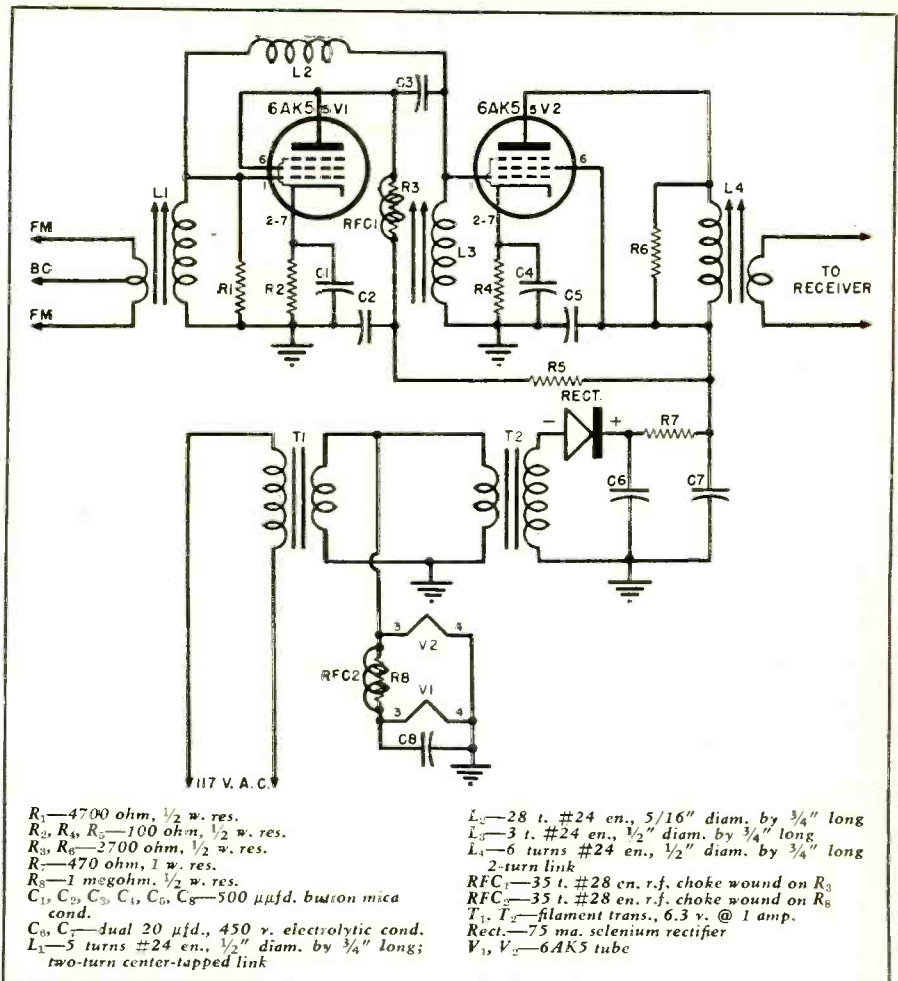

Fig. 2. Complete schematic diagram of the self-contained two-tube FM booster.

connected to the antenna terminals and tuned to the receiver frequency. If not, the antenna should be connected, and a strong station near the center of the band tuned in. It is necessary to vary the inductance of  $L_2$  to check for neutralization. This can best be accomplished by means of a tuning stick, which has a copper slug on one end and a piece of powdered iron on the other. As one end or the other of the tuning stick is inserted in  $L_2$ , a sudden dip will be noted in the receiver output. The dip is the desired condition, since there is then no coupling from grid to plate, or vice-versa. If it is necessary to insert the copper slug to obtain a dip, the inductance is too high, and the coil should be spread out, or should have turns removed. The re-

verse applies, of course, if the iron slug produces a dip. When the proper adjustment is obtained, a dip will be obtained without the insertion of either slug, and inserting either slug will make the signal stronger. At this point the coil should be coated with coil dope.

The antenna can then be connected, and plate voltage can be restored to  $V_1$  by reconnecting  $R_5$ .  $L_1$  should then be tuned for maximum noise at the band center. The FM receiver can then be tuned through the entire band. There should be no sharp peaks of noise at any one frequency, since these would indicate regeneration or oscillation. If there are, the adjustment of  $L_2$  can be checked.

(Continued on page 131)

Fig. 3. Under-chassis view of pre-amplifier shows relative placement of components.

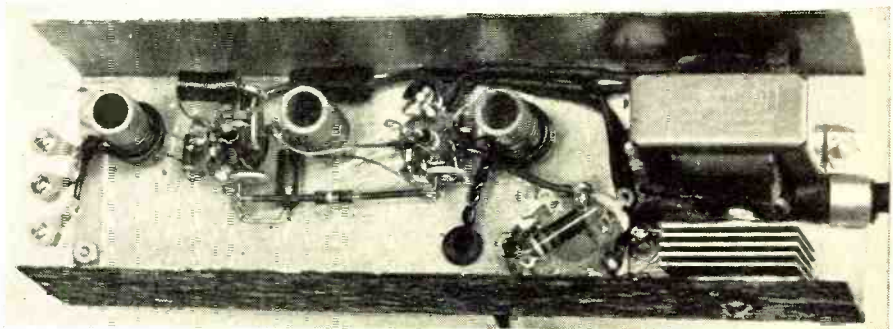

# A Novel Plate-Dip OSCILLATOR

By E. J. SCHULTZ, W2MUU



Plate dip oscillator being used to adjust a two-meter converter to frequency before the power is applied.

***This instrument can be used to measure resonant frequency of circuits, as a signal generator, and as a field strength meter, harmonic checker, etc.***

**M**OST amateurs and experimenters are familiar with the versatile instrument known as the grid dip meter. In short, a grid dip meter is an oscillator with a meter connected in its grid return indicating oscillator grid current. The current is relative to the strength of oscillation and if the oscillator circuit is loaded, the meter will register a decrease proportionate to the load. The meter, therefore, can indicate the resonant frequency of a tuned circuit by coupling the oscillator to the circuit in question and varying the frequency of the grid dip meter until a pronounced dip occurs. Conversely a trap or other tuned tank to be adjusted to a given frequency can be set by leaving the instrument frequency constant and tuning the unknown circuit to resonance as indicated by the grid dip.

The instrument herein described performs in essentially the same manner, with the exception that the dipping meter is placed in the plate circuit instead of the grid. In the conventional oscillator circuit normally employed in instruments of this type, the plate current increases with load and the change is relatively small as compared with the grid. However, the oscillator diagrammed in Fig. 1 is un-

conventional to say the least, the plate current vastly *decreasing* with small loading. Using a 6J6 twin triode, the oscillator is the negative resistance type of excellent stability. It is a war-born device which, in circuitry, is similar to a multivibrator. The particular circuit was chosen as it eliminates the need for coils with feedback windings and taps or a clumsy split-stator condenser as used in a Colpitts oscillator. Furthermore, the oscillator output is nearly constant over its useful range, only falling off slightly at the low frequency end of the highest band. Continuous coverage from 3 to 160 megacycles is obtained in 7 ranges with useful bandspread as each range covers slightly less than 2 to 1. Seven plug-in coils are used to change frequency. A reduction in the amount necessary for coverage of the range could be achieved by employing a larger tuning condenser with an attendant loss in bandspread.

The instrument was built in two parts, the oscillator and its components in one box and a power supply and compartment for the coils in the other. It was considered desirable to connect the units together with a cable from the oscillator terminated in a terminal strip on the power supply, as it might

be necessary to operate from battery power in the field.

The oscillator is built around a *Hammarlund* Mc-50-S condenser, the tube socket being mounted on a bracket on the rear of the condenser for short connections. Any similar condenser may be used, but the double bearing type is preferable and straightline frequency construction, while not essential, is highly desirable for uniform dial calibration.

The  $\frac{3}{4}$ " poly coil forms employed were mounted on strips of polystyrene provided with pins from discarded octal tubes, spaced  $\frac{1}{2}$ ", so as to plug into a crystal socket. If the regular miniature coil forms with prongs are available, they are to be preferred, as they eliminate the need for making the previously mentioned polystyrene strip plugs.

A double-pole switch, labeled "det.-osc." in the schematic, removes plate voltage from one of the triodes and simultaneously increases the cathode bias, making the input triode a plate detector. The plate detector is a much more sensitive device than a diode as is provided by the usual grid dip meter in a non-oscillating condition, and the instrument can be used as a tuned vacuum tube voltmeter because the plate current will increase sharply when the instrument is loosely coupled to an r.f. source and tuned to resonance. A jack is provided for earphones (any type except crystal earphones may be used) and the instrument serves as a phone monitor in the detector position of the switch and as a c.w. monitor with the switch set to oscillate. A dry cell is connected across the meter and, in conjunction with a potentiometer, provides a variable bucking voltage to enable zero or full scale adjustment without varying the

instrument's sensitivity which would occur if a variable shunt across the meter was used. In "osc." position the potentiometer is adjusted to give full scale reading, resonance of an external circuit is indicated by a dip. When used as a detector the meter is set to zero and the current increases when the instrument is resonated with an r.f. source. The potentiometer is equipped with a switch to remove the bucking voltage from the meter when the instrument is not in use. The one-mil. meter employed in the model proved inadequate as the dip obtained when a resonant circuit was approached drove the meter off-scale in a negative direction. A shunt was therefore employed to slightly desensitize the instrument. If a 2- or 3-mil. meter is used, the shunt will not be necessary. An NE-51 neon bulb mounted on the oscillator serves the dual function of a pilot light and a voltage regulator maintaining the voltage fairly constant at about 105 volts.

These tubes vary widely, however, in their operating voltage, and it might be better to use a VR-150 in its stead. The filament transformer is used in the conventional way, while the output transformer is connected backwards. The secondary tap, giving sufficient output voltage across the primary to cause the neon tube to ignite, is selected by experiment. Very probably the proper tap will be the 4, the 8, or the 15.

The primary of the output transformer connected between ground and a selenium rectifier with an R-C filter completes the power supply. The two boxes housing the oscillator and the power supply are identical with the exception that a piece of polystyrene was used on the end of the oscillator housing instead of aluminum and one side of the power supply was cut and fitted with miniature 10 cent hinges, forming a door, and providing access to the coil compartment. The boxes measuring 3" x 4" x 5 1/2" were both made from 3/16" aluminum and were bent without the aid of a brake by using pieces of angle iron in a vise. Commercially available metal boxes can, of course, be used, but the ones available hereabouts are not wide enough to take a 2" meter on the side.

(Left) Side view of instrument showing dial detail, layout of meter, switch, neon bulb, and jack. The penlight cell indicates comparative size. (Center) End view showing polystyrene endpiece. (Right) Over-all view of power supply unit. A separate coil compartment, shown with the door open, is incorporated. A three-wire cable supplies power to the instrument.

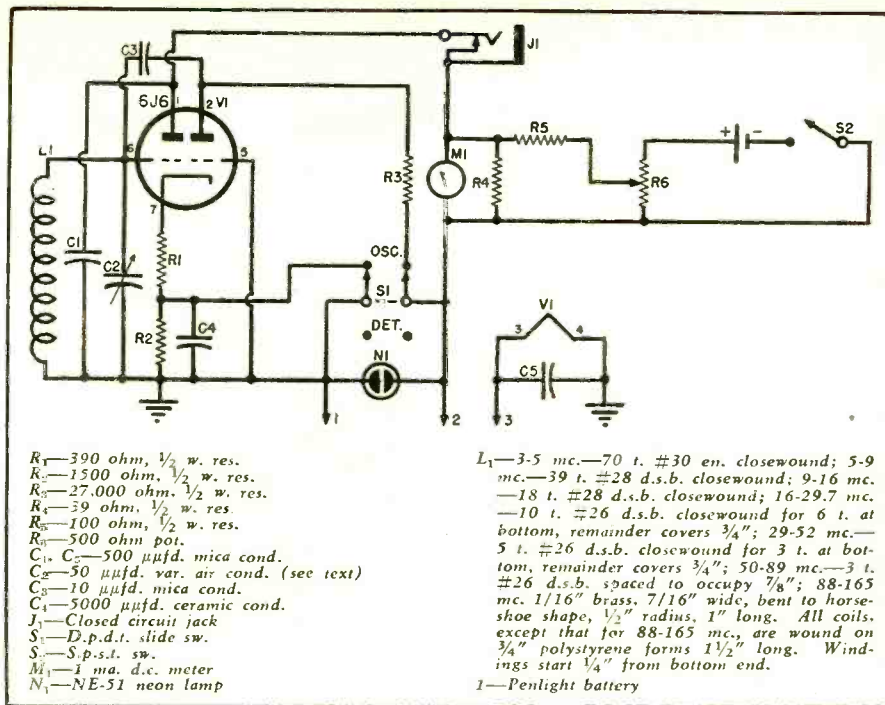

Fig. 1. Circuit diagram of the novel plate dip oscillator unit.

However, by using one of the new miniature 1" meters or by changing the layout, they could, no doubt, be employed.

The dial pointer is made of a piece of 1/4" Plexiglas screwed to a conventional bakelite finger grip knob drilled and tapped for the purpose. The dial is made of a small piece of double-weight Bristol board purchased from the local art supply shop. It has a semi-gloss surface and readily accepts ink without preparation or blotting. Calibration was made by drilling small, evenly-spaced holes in the pointer and inserting a needle through the holes at appropriate points on the dial scale, later inking the points in. The dial scale is fastened to the instrument with rubber cement or Duco.

Calibration can be made, of course, using a number of methods, the method selected depending upon the equipment available and accuracy required by the individual's requirements. Calibration adequate for general purposes can be made using communications

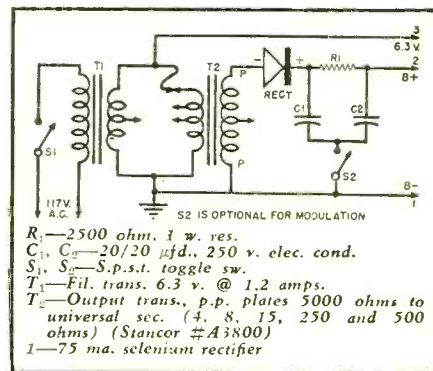
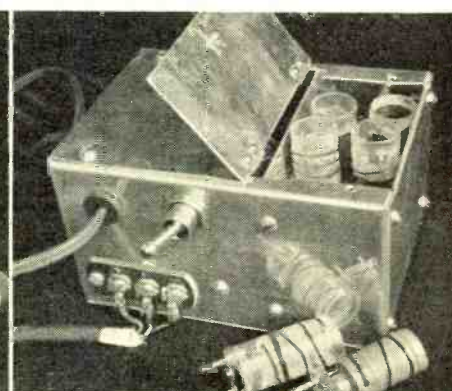
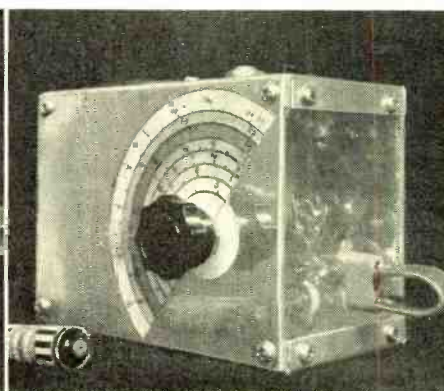
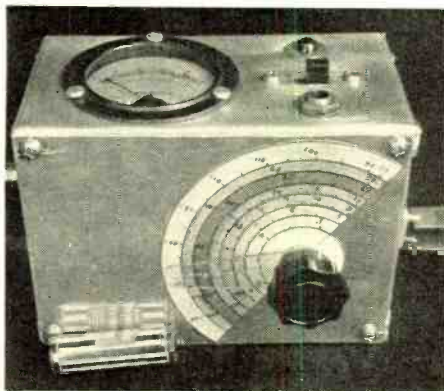

Fig. 2. Circuit diagram of power supply used in conjunction with plate dip oscillator. The center taps on the secondaries of both transformers are not used.

receivers for the low ranges and absorption meters or Lecher wires on the high bands. The instrument's accuracy is dependent on the accuracy of the calibration source and the care of the calibrator. For greatest accuracy  
 (Continued on page 130)



The receiving test. Here is where you worry a bit. Confidentially, this "ham" got through all right and is now operating as W1RWV.



# The BEGINNING AMATEUR

By  
**ROBERT HERTZBERG,**  
W2DJJ

**Part 4. The FCC tests for ham licenses are like any other exam. They're easy—if you're prepared.**

**T**HREE tall young men, wearing the white-and-blue sweaters of a large Brooklyn high school, hovered in front of a door marked *Federal Communications Commission—Radio Operator Examinations* in a building at 641 Washington Street, New York. They were whispering to themselves and quite evidently were undecided about going in.

"Gee, I don't think I'm up to it, now that we're here," said one of them, as he eyed the door nervously.

"We came this far," said another, "so let's make a stab at it. What can we lose?"

The three brushed their hair back with quick waves of their hands and piled through the door as one. You'd think they were being called on the carpet to answer for some serious infraction of school rules, instead of merely making an entirely voluntary trip for the purpose of obtaining radio amateur operator and station licenses . . . "ham tickets." Behind the fateful door they found a large room, with a couple of desks in the center. Still fidgety, they approached and in unison mumbled something that sounded remotely like, "We'd like to take the ham license test."

The FCC engineer smiled at them in a most friendly manner and said, "Sure, boys. I'll give you the application forms to fill out."

As he turned around to a filing cabinet he whispered to me, "Scared stiff, aren't they? No reason for it, either; we're here to help 'em."

Turning again to the three he continued, "Now, boys, just make yourselves comfortable at one of those tables and fill out these forms carefully. Relax and take your time. If you have any questions, just ask me."

Breathing more easily, the three young men took the forms to a table, sat down, unbuttoned their sweaters, and began to regain some of the color in their cheeks. Still whispering, one of them remarked to no one in particular,

"Hey, that guy's all right."

The FCC Form 610 they were given was headed *Application for Amateur Operator and/or Station License*. Each applicant filled in his pedigree: name, address, place and date of birth, etc., and repeated some of the information on a separate little card. The whole operation took five minutes. They carried the forms back to the FCC man, who examined them quickly with a practiced eye.

"These look OK," he said. "The first part of the exam is the code receiving test." He hesitated a moment as he saw the boys going pale again. "How about taking a dry run, boys? Just listen for a few minutes to get an idea as to how the stuff sounds."

Grateful beyond expression, the applicants followed the examiner into an adjacent room that had a familiar air to it. It was fitted with about two dozen of those little wooden desks found in schools everywhere. On each was a pair of earphones, a key and an inkwell and pen. The boys put on the

phones and listened intently as precise, machine-made dots and dashes filled their ears.

At the automatic tape transmitter used for the code tests, the FCC engineer adjusted the speed control knob a bit.

"The prescribed speed for the test is thirteen words per minute, plain text," he said to me. "The 'plain text' consists of understandable words, but the whole transmission doesn't necessarily make sense as a series of words and sentences. Numbers and 'Q' signals are thrown in at random, and the applicant must copy what he hears. Wait a minute; I'll get those boys started."

He went back into the examination room, handed each young man a couple of sheets of blank paper and said, "The next run will be for the record. Write clearly. The tape will be on for five minutes. If you copy any one minute's section without error, you pass. Take it easy. Good luck."

With a reassuring smile he returned to the tape machine and flipped it on. Their noses almost touching the paper, the boys wiggled their pencils furiously as the transmission got under way.

"This is the most important part of the test," continued the FCC man. "If an applicant flunks at this point, he's through. He can come back after thirty days and try again. How many times can he try? As often as he wants, just so he waits thirty days in between. We've had a couple of people who made six attempts before they passed, but that's unusual."

"My best suggestion for prospective hams is that they practice thoroughly and become proficient at fifteen words per minute or more before they attempt the exam. Too many of 'em rush right down after they hit thirteen. Surroundings here are different than at home, and almost everyone suffers from a little 'buck fever'. Another thing: our thirteen words per

**RADIO & TELEVISION NEWS**

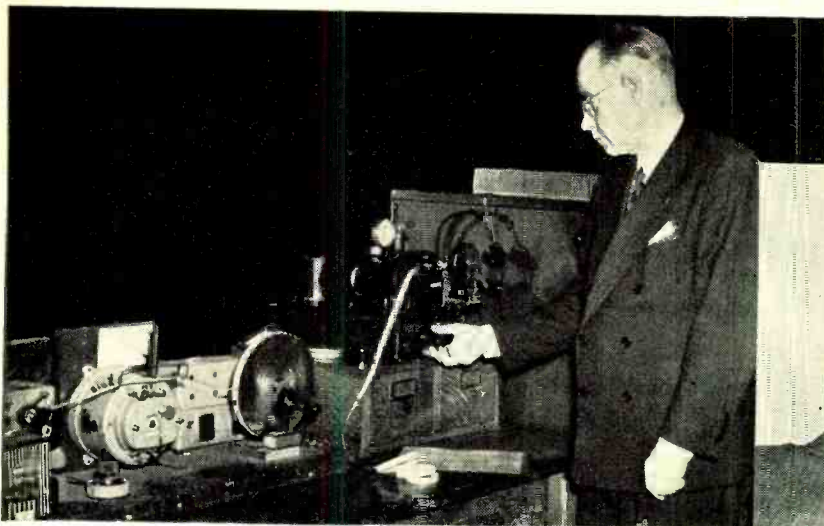

← FCC Engineer Walter J. Howell adjusts the speed of the automatic code transmitter in the examining room of the FCC. Like so many other FCC men, Walter himself is a ham, holding the call W2II. He is a real old-timer, having obtained his license back in 1913.

→ Sending may seem a little better than receiving to the applicant. Here a potential licensee attempts to prove he knows his code, while FCC examiner Charles Finkleman, standing, lends a critical ear to the neophyte's dots and dashes.



← Your receiving test is checked, while you stand by nervously. If your code, receiving and sending tests have been found to be okay, the next step is a written examination.

↓ The examination room. Here a group of applicants takes the written test, which lasts from an hour to an hour and a half. Then you await results!

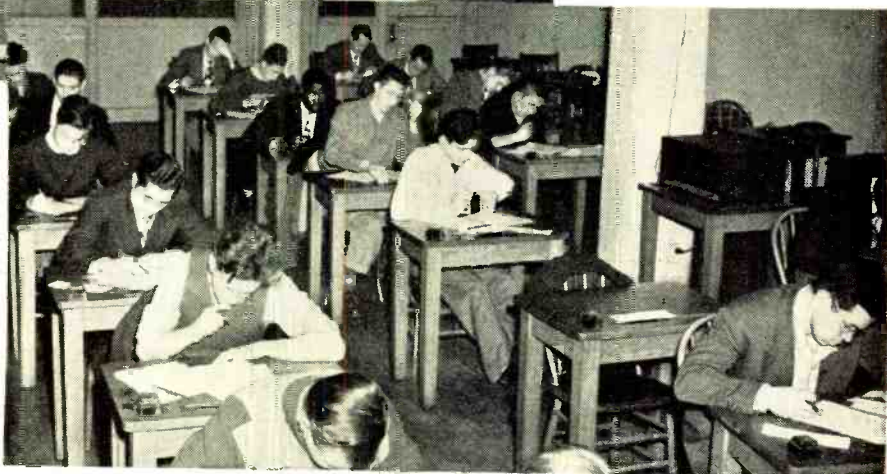

minute rate is really thirteen words per minute; no more, no less. When an applicant remarks that the test sounded too fast we just laugh."

At the end of the five-minute run, the FCC examiner immediately took the papers from the young men, before they had a chance to go over their "copy." He checked the results and in a few minutes announced that they had all passed.

"Now let me hear you send" he said. The group returned to the exam room, and the examiner listened with a pair of phones as each boy transmitted a sentence or two. "All OK, all OK. Now you get the written part. I'll give each of you a packet. Read the instructions on the envelope and go to work. You can take all afternoon if you want."

The packet contained five double pages of questions of the multiple-choice type. About thirty are devoted to technical topics and the rest to the rules and regulations. Several of them require the applicant to draw schematic diagrams. Most of the questions are pretty easy for anyone who has

read any of the standard ham license manuals. A typical question might read like this:

*The unit of resistance is the*

1. Volt
2. Ohm
3. Cycle
4. Centimeter
5. Ampere.

*Answer:—*

For the answer, the applicant merely writes in the appropriate number.

"Many people concentrate on learn-

ing the receiver and forget that they have to know how to transmit too," said the FCC man as the boys busied themselves with their papers. "We get quite a lot of applicants who sail right through the receiving part and then flunk out on sending."

The rest of the license procedure is simple. After the would-be ham finishes his written test, it is collected by the examiner, who, oddly enough,

*(Continued on page 108)*

# DIRECTORY OF TELEVISION RECEIVER MANUFACTURERS

- Admiral Corporation  
3800 W. Cortland St.  
Chicago 47, Ill.
- Airadio, Inc.  
Melrose Ave. & Barry Pl.  
Stamford, Conn.
- Air King Products Co., Inc.  
170 53rd St.  
Brooklyn 32, N. Y.
- Andrea Radio Corp.  
27-01 Bridge Plaza N.  
Long Island City 1, N. Y.
- Ansley Radio & Television, Inc.  
41 St. Joes Ave.  
Trenton, N. J.
- Approved Electronic Instrument Corp.  
142 Liberty St.  
New York 6, N. Y.
- Arcturus Radio & Television Corp.  
19 Nesbitt St.  
Newark, N. J.
- Atlas Coil Winder, Inc.  
392 State St.  
Stamford, Conn.
- Atlas Radio & Television, Inc.  
26 Journal Square  
Jersey City 6, N. J.
- Audar, Inc.  
Walnut & Maple Sts.  
Argos, Ind.
- Automatic Radio Mfg. Co.  
122 Brookline Ave.  
Boston 15, Mass.
- Bace Television Corp.  
Green & Leuning Sts.  
S. Hackensack, N. J.
- Bell Radio Co.  
125 E. 46th St.  
New York 17, N. Y.
- Bell Television, Inc.  
147 West 42nd St.  
New York 18, N. Y.
- Belmont Radio Corp.  
5921 W. Dickens Ave.  
Chicago 39, Ill.
- Bendix Radio  
Division of Bendix Aviation Corp.  
Baltimore 4, Md.
- Bowen & Co., Inc.  
4712 Bethesda Ave.  
Bethesda, Md.
- Bowers Radio & Television Co.  
44 S. 6th St.  
Reading, Pa.
- Brite-Ray Television Co.  
7 Clinton St.  
Brooklyn, N. Y.
- Brunswick Radio & Television, Div.  
Radio & Television, Inc.  
244 Madison Ave.  
New York 16, N. Y.
- Cage Projects, Inc.  
393 Grove St.  
Upper Montclair, N. J.
- Certified Television Laboratories  
5507 13th Ave.  
Brooklyn 19, N. Y.
- Cleerue Television Corp.  
81 Willoughby St.  
Brooklyn 1, N. Y.
- Colonial Radio Corp.  
254 Rano St.  
Buffalo 7, N. Y.
- Colonial Television Corp.  
780 E. 137th St.  
Bronx 54, N. Y.
- Columbia Radio & Television Co.  
85 Tompkins St.  
Staten Island 4, N. Y.
- Columbia Television Co.  
601 E. Tremont Ave.  
New York 57, N. Y.
- Cornell Television, Inc.  
385 Flatbush Ave., Ext.  
Brooklyn 1, N. Y.
- Coronet Radio & Television Corp.  
500 W. 52nd St.  
New York 19, N. Y.
- Cortley Television Co.  
15 W. 27th St.  
New York 1, N. Y.
- Cosmo Electronics Corp.  
675 Hudson St.  
New York 14, N. Y.
- Crosley Div., AVCO Mfg. Corp.  
1329 Arlington St.  
Cincinnati 25, Ohio
- DeWald Radio Mfg. Corp.  
35-15 37th Ave.  
Long Island City, N. Y.
- Du Mont Laboratories Inc., Allen B.  
2 Main Ave. 515 Madison Ave.  
Passaic, N. J. New York, N. Y.
- Duval Radio & Television Corp.  
423 Grove St.  
Jersey City 2, N. J.
- Electronic Creations Co., Inc.  
367 Greenwich St.  
New York 13, N. Y.
- Electro Technical Industries  
1432 N. Broad St.  
Philadelphia 21, Pa.
- Emerson Radio & Phonograph Corp.  
111 Eighth Ave.  
New York 11, N. Y.
- Espey Mfg. Co.  
528 E. 72nd St.  
New York 21, N. Y.
- Fada Radio & Electric Co.  
525 Main St.  
Belleville, N. J.
- Farnsworth Television & Radio Corp.  
3700 State St.  
Fort Wayne 1, Ind.
- Federal Telephone & Radio Corp.  
100 Kingsland Rd.  
Clifton, N. J.
- Federal Television Corp.  
210 E. 9th St.  
New York 3, N. Y.
- Fisher Radio Corp.  
41 E. 47th St.  
New York 17, N. Y.
- Fiske Products, Inc.  
12 Maple Ave.  
Mt. Kisco, N. Y.
- Free Radio Corp.  
200 Hudson St.  
New York 13, N. Y.
- Garod Electronics Corp.  
70 Washington St.  
Brooklyn 1, N. Y.
- General Electric Co.  
Electronics Park  
Syracuse 1, N. Y.
- Gilfillan Bros., Inc.  
1815 Venice Blvd.  
Los Angeles 6, California
- Globe Electronics, Inc.  
225 W. 17th St.  
New York 11, N. Y.
- Gott Radio Mfg. Co.  
6517 West Blvd.  
Inglewood, Calif.
- The Hallicrafters Co.  
4401 W. 5th Ave.  
Chicago 24, Ill.
- Hoffman Radio Corp.  
3761 S. Hill St.  
Los Angeles 7, Calif.
- Hollywood Electronics  
7460 Melrose Ave.  
Los Angeles, Calif.
- Howard Radio Co.  
1735 Belmont Ave.  
Chicago 13, Ill.
- Industrial Television, Inc.  
359 Lexington Ave.  
Clifton, N. J.
- International Television Corp.  
745 5th Ave.  
New York 22, N. Y.
- Jamaica Radio Television Mfg. Co.  
148-18 Jamaica Ave.  
Jamaica 2, N. Y.
- Jewel Radio Corp.  
583 Ave. of Americas  
New York 11, N. Y.
- Kinsey Radio Mfg. Co.  
5807 Oak St.  
Omaha 6, Nebr.
- LaMagna Mfg. Co., Inc.  
51 Clinton Pl.  
E. Rutherford, N. J.
- Lytle & Canon  
4721 N. Kedzie  
Chicago 25, Ill.
- Magnavision Co.  
3605 Kingsbridge Ave.  
Bronx 63, N. Y.
- Magnavision, Inc.  
1546 2nd Ave.  
New York 28, N. Y.
- The Magnavox Co.  
2131 Beuter Road  
Fort Wayne 4, Ind.
- Maguire Industries, Inc.  
936 N. Michigan Ave.  
Chicago 11, Ill.
- Majestic Radio & Television Corp.  
900 N. State St.  
Elgin, Ill.
- Major Television Co.  
2500 David Stott Building  
Detroit 26, Michigan
- Mars Television, Inc.  
29-05 40th Road  
Long Island City 1, N. Y.
- Midwest Radio & Television Corp.  
909 Broadway  
Cincinnati 2, Ohio
- Motorola, Inc.  
4545 Augusta Blvd.  
Chicago 51, Ill.
- MP Concert Installations  
Fairheld 10, Conn.
- Multiple Television Mfg. Co.  
987 Hegeman Ave.  
Brooklyn 8, N. Y.
- Nalpak Products, Inc.  
352 E. 32nd St.  
New York 16, N. Y.
- National Co., Inc.  
61 Sherman St.  
Malden 48, Mass.
- National Polytronics, Inc.  
2430 Atlantic Ave.  
Brooklyn, N. Y.
- New England Television Co.  
544 E. 6th St.  
New York 9, N. Y.
- Nielsen Television Corp.  
Newtown Ave. at Crawford Rd.  
Norwalk, Conn.
- Nobell Mfg. Co.  
517 W. 47th St.  
New York 19, N. Y.
- Noblitt-Sparks Industries, Inc.  
Columbus, Indiana
- North American Philips Co., Inc.  
100 E. 42nd St.  
New York 17, N. Y.
- Olympic Radio & Television, Inc.  
3401-19 38th Ave.  
Long Island City, New York
- Orthon Corp.  
196 Albion Ave.  
Paterson 2, N. J.
- Packard-Bell Co.  
3443 Wilshire Blvd.  
Los Angeles 5, Calif.
- Philco Corp.  
Tioga & C Sts.  
Philadelphia 34, Pa.
- Philharmonic Radio Corp.  
119 W. 57th St.  
New York 19, N. Y.
- Pilot Radio Corp.  
37-06 36th St.  
Long Island City 1, N. Y.
- Pioneer Television Co., Inc.  
282 W. 25th St.  
New York 1, N. Y.
- Radio Corp. of America  
RCA Victor Div.  
Camden, N. J.
- Radio Craftsmen, Inc.  
1341 S. Michigan Blvd.  
Chicago, Ill.
- Regal Electronics Corp.  
603 W. 130 St.  
New York 27, N. Y.
- Remington Radio Corp.  
80 Main St.  
White Plains, N. Y.
- Remler Co., Ltd.  
2101 Bryant St.  
San Francisco 10, Calif.
- RGH Mfg. Corp.  
365 Canal St.  
New York 13, N. Y.
- Royal Television & Radio Corp.  
81 Willoughby St.  
Brooklyn, N. Y.
- Scott Radio Laboratories  
4541 Ravenswood Ave.  
Chicago 40, Illinois
- Sentinel Radio Corp.  
2100 Dempster St.  
Evanston, Ill.
- Shevers, Inc., Harold  
33 West 46th St.  
New York 19, N. Y.
- Sightmaster Corp.  
385 North Ave. 220 5th Ave.  
New Rochelle, N. Y. New York 1, N. Y.
- Slate & Co.  
2533 Webster Ave.  
Bronx 58, N. Y.
- Smucker & Co., Inc., A. F.  
338 E. 23rd St.  
New York 10, N. Y.
- Sonora Radio & Television Corp.  
325 N. Hoyne Ave.  
Chicago 12, Ill.
- Sparks Withington Co., The  
2400 E. Michigan Ave.  
Jackson, Michigan
- Standard Radio & Television  
209 Main St.  
Fort Lee, N. J.
- Starrett Television Mfg. Corp.  
601 W. 26th St.  
New York, N. Y.
- Stewart-Warner Corp.  
1826 Diversey Parkway  
Chicago 14, Ill.
- Stromberg-Carlson Co.  
100 Carlson Rd.  
Rochester 3, N. Y.
- Symphonic Radio & Television Corp.  
230 S. Spring St.  
Los Angeles 12, California
- Tech-Master Products Co.  
123 Pince St.  
New York 12, N. Y.
- Telecraft Corp.  
2 W. 15th St.  
New York 11, N. Y.
- Tele King Television Corp.  
601 W. 26th St.  
New York 1, N. Y.
- Telegrip Radio Co.  
1901 S. Washienaw Ave.  
Chicago 8, Ill.
- Teleonic Corp. of America  
212 Concord St. 2 Prince St.  
Brooklyn, N. Y. Brooklyn, N. Y.
- Tele-Tone Radio Corp.  
540 W. 58th St.  
New York 19, N. Y.
- Television Assembly Co.  
540 Bushwick Ave.  
Brooklyn 6, N. Y.
- Television Development Labs., Inc.  
232 W. 64th St.  
New York 23, N. Y.
- Television Industries  
Brooklyn, N. Y.
- Television Laboratories, Inc.  
542 N. Parkside Ave.  
Chicago 44, Ill.
- Televista Corp. of America  
114 E. 16th St.  
New York 3, N. Y.
- Televue Corp. of America  
339 Laurel Ave.  
Lakewood, N. J.
- Telcor Corp.  
351 Madison Ave.  
New York 21, N. Y.
- Telindustries Inc.  
4921 Exposition Blvd.  
Los Angeles, Calif.
- Templetone Radio Mfg. Corp.  
New London, Conn.
- Tradio, Inc.  
1001 First Ave.  
Asbury Park, N. J.
- Transvision, Inc.  
460 North Ave.  
New Rochelle, N. Y.
- U. S. Television Mfg. Corp.  
3 W. 61st St.  
New York 23, N. Y.
- Universal Television Co., Inc.  
147 Montague St.  
Brooklyn 2, N. Y.
- Video Corporation of America  
229 W. 28th St.  
New York 1, N. Y.
- Vid-craft Corp.  
New York, N. Y.
- Watterson Radio Mfg. Corp.  
2700 Swiss Ave.  
Dallas 1, Texas
- Wells-Gardner & Co.  
2701 N. Kildare Ave.  
Chicago 39, Ill.
- Westinghouse Electric Corp.  
1354 Susquehanna Ave.  
Sunbury, Pa.
- Wilcox Gay Corp.  
Charlotte, Michigan
- Zenith Radio Corp.  
6001 Dickens Ave.  
Chicago 39, Ill.

# Television PROJECTION SYSTEMS



RCA's Model 648 PTK large-screen television receiver which gives a 15" x 20" picture.

By M. S. KAY

**Current developments in projection TV makes possible large images from relatively compact television sets.**

**T**HE desire for relatively large television pictures is a natural one. One immediate advantage is the ability to view the screen for long consecutive periods without fatigue. Secondly, a greater number of persons can more comfortably view a large area than say a 7- or 10-inch screen. This is particularly desirable in sets installed in public places, such as auditoriums, taverns, theaters, and retail establishments.

Large images can be obtained in two ways: by using cathode-ray tubes having large viewing surfaces, or by projection. In the first method, practical considerations limit the screen to diameters of 20 inches. A tube having a diameter of 20 inches possesses a large physical volume, is awkward to manipulate, and expensive.

Difficulties with these tubes are encountered at all points. In manufacture, the machines required for evacuating and sealing must be considerable in size. This either results in a limited production or a large capital investment. The large bulk of the tube increases the storage and transportation costs to an amount far beyond a proportionate value for a smaller tube. Finally, in the home, the cabinet, which is no minor item in the final pricing of the set, must likewise be large. Because of these difficulties, tubes with screens greater than 20 inches have not been commercially attempted. Sets using viewing tubes with 12, 15, or 20-inch screens are readily available, however.

The other approach to large screen television is by projection and to date

two general systems have been employed. In one method, the image is formed on the screen of a small cathode-ray tube and then enlarged, using several projection lenses similar to those employed in motion-picture equipment. The chief disadvantage of this method is its low efficiency. Specially treated lenses, having a large aperture and good transmission of light, deliver to the viewing screen only about 6 per-cent of the light available on the screen of the cathode-ray tube. Consequently, even with intense images developed on the cathode-ray screen, the final image is bound to be dim and difficult to see.

As an illustration, consider the 5-inch projection tube, with its image of 3" x 4". The total area here is 12 square inches. If the image is enlarged to fill a screen 15 x 20 inches, the total area becomes 300 square inches, and the light which was originally concentrated in an area of 12 square inches is now spread out to cover an area of 300 square inches. The brightness is thereby reduced by the ratio of 300/12 or 25 to 1. This is, of course, assuming 100 per-cent transmission. If now we take into ac-

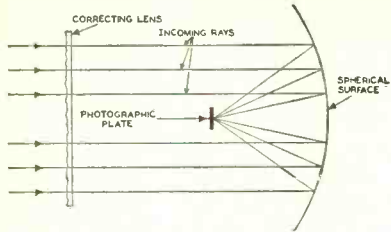

Fig. 1. Original Schmidt optical system as designed for astronomical telescopes.

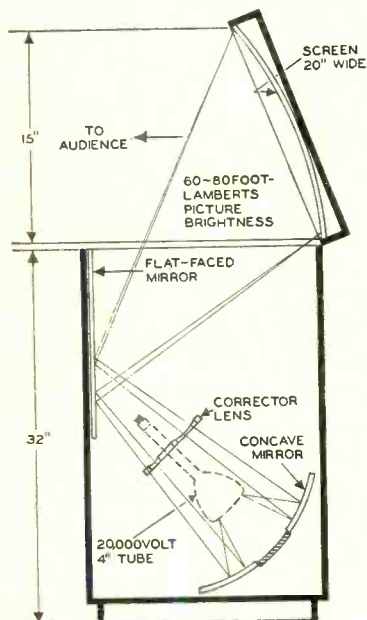

Fig. 3. The Philco projection system.

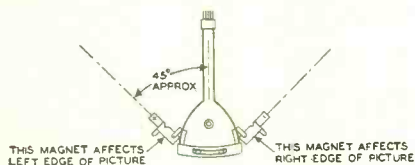

Fig. 6. The visual effect of improper adjustment of the fixed magnets of Fig. 5.

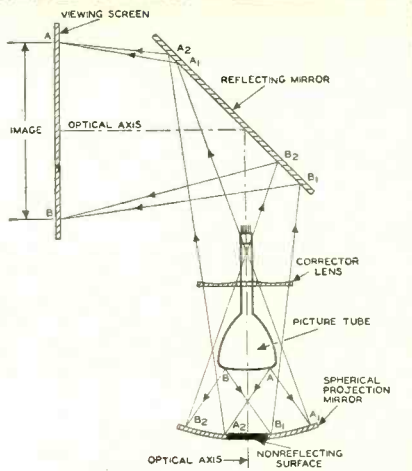
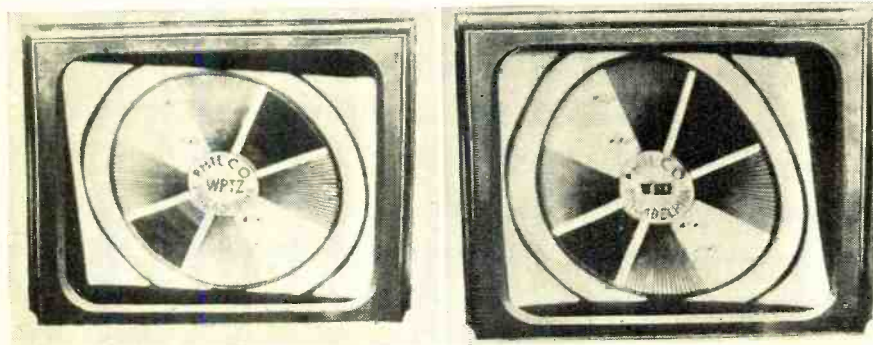

Fig. 2. The Schmidt system as adapted by G.E. and RCA for their television sets.

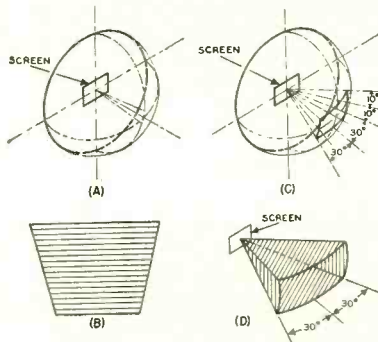

Fig. 4. (A) A non-directional screen will produce equal illumination at all equidistant points throughout a hemisphere. (B) A trapezoid. (C and D) The directional characteristics of Philco viewing screen.

Fig. 5. To produce a trapezoidal image on the CRT face, the magnets are attached to the tube as indicated in the drawing.

count that the over-all efficiency is only 6 per-cent, then the brightness is decreased by a factor of approximately 400 to 1 rather than 25 to 1.

Increasing the brightness of the image developed on the tube screen would be one partial solution to this problem, but the cost involved can readily place the equipment in the same expensive class as large cathode-

ray tubes. A second approach to the problem, and one which appears to have greater possibilities, is to increase the efficiency of the lens system.

The first attempt in this direction was tried with the same lenses mentioned above and several difficulties were immediately encountered. In order to capture as much light as possible being emitted from the screen, the

projection lens should be as large as possible. However, as the lens becomes larger, the number of distortions or "aberrations" multiply. (There are principally six aberrations that must be corrected; namely, chromatic aberration, spherical aberration, coma, astigmatism, curvature of field, and distortion.) To correct for these aberrations in a fairly satisfactory manner, we require several lens elements, say possibly three. However, in a wide angle system, more than three lens elements should be used. As more elements are added, the cost of the system rises. The greater the number of lenses in a system, the greater the total loss of light at the intersecting surfaces and the lower the over-all efficiency. Finally, with large lenses, the elimination of some aberrations is accompanied by a greater accentuation in others.

This was the impasse that faced television engineers until the adaptation of the Schmidt reflective optical system to television. Schmidt, an instrument maker at the Hamburg Germany Observatory, invented his optical system in 1931. The system, originally designed for astronomical telescopes, was built around a large spherical reflecting surface or mirror. See Fig. 1. Use of this type of reflecting surface offered several immediate advantages:

1. Mirrors are completely free of chromatic aberrations.

2. Under comparable designs of focal distance and diameter, a spherical mirror has a spherical aberration one-eighth that of a single lens. The need for correction is still present, but the problem is now considerably simplified.

3. By placing a small aperture or opening at the center of curvature of a spherical mirror, all of the monochromatic aberrations (except spherical aberration) are eliminated.

We are thus left with essentially two problems to solve. One is spherical aberration and the other is curvature of the field. The latter is quite simply resolved by curving the screen of the projection tube to suit the curvature of the mirror. To eliminate spherical aberration, a special correcting lens is employed. The correcting lens introduces into the beam an amount of spherical aberration which is equal to that introduced by the mirror, but is opposite in sign. As a result, the two neutralize each other, effectively removing the last great defect of the spherical mirror. With this lens in place, we have an optical system possessing an efficiency of 25 per-cent with magnification of 5. Compare this to the meager 6 per-cent obtainable using a refractive lens system.

For use in television receivers, there are several modifications of the original Schmidt lens system as designed for astronomical use. In *RCA* and *G.E.* projection receivers, the optical mirror is mounted at the bottom of the cabinet with its axis vertical, project-



ing the image straight up and onto a flat mirror inclined at 45 degrees to the beam of light and throwing the image on a translucent screen. See Fig. 2. The throw or distance between the correcting lens and the viewing screen will depend upon the diameter of the correcting lens and the spherical mirror. To increase the size of the projected image, the distance or throw must increase, necessitating large cabinets, a larger mirror, and a larger correcting lens. Eventually the optical system becomes awkward and bulky. A compromise is thus necessary between the size of the final image and the cost and size of the set. For each different throw or magnification, we require a different correcting lens. This, it will be noted, differs from a refractive lens system where the size of the projected image can be increased merely by changing the position of the lenses and the screen.

In *Philco* projection television receivers the arrangement of the optical system components is slightly different as shown in Fig. 3. The distance between the corrector lens and the screen is  $33\frac{1}{2}$  inches and variations of plus or minus 10 per-cent are permissible without leading to any serious deterioration of image quality. Each of the reflecting plane mirrors in all these optical systems are front-surfaced mirrors to prevent ghosts which would occur from reflections at the surface of the glass of a rear-surfaced mirror.

The translucent screen upon which the final image is projected has, in itself, directional properties which concentrate the incoming beam in certain desired directions. If the screen was a perfect diffuser of light, it would produce illumination which was equally visible all over the room. Graphically this could be shown as indicated in Fig. 4A. At all points throughout a hemisphere, whose center coincides with the screen, equal illumination would be received from the screen. Since many of the extreme angles of this hemisphere are never (or very seldom) used for viewing, due to foreshortening, it is advantageous to concentrate the light that would normally go to these points toward those angles that are most used for viewing. To achieve this, the translucent screen is made directional in the vertical and horizontal directions. Not only does this cause the final image to be brighter than it would be using the perfect diffuser screen, but it also presents the added advantage of greatly reducing the susceptibility of the screen to any stray light from lamps located in the viewing room.

In the *Philco* projection receiver, the screen is designed to have a viewing sector which extends  $60^\circ$  horizontally and  $20^\circ$  vertically. See Fig. 4B. To achieve this directivity, the screen contains a large number of vertical grooves, random shaped. These vertical grooves are responsible for the horizontal directivity of the screen. To achieve the  $20^\circ$  vertical directivity,

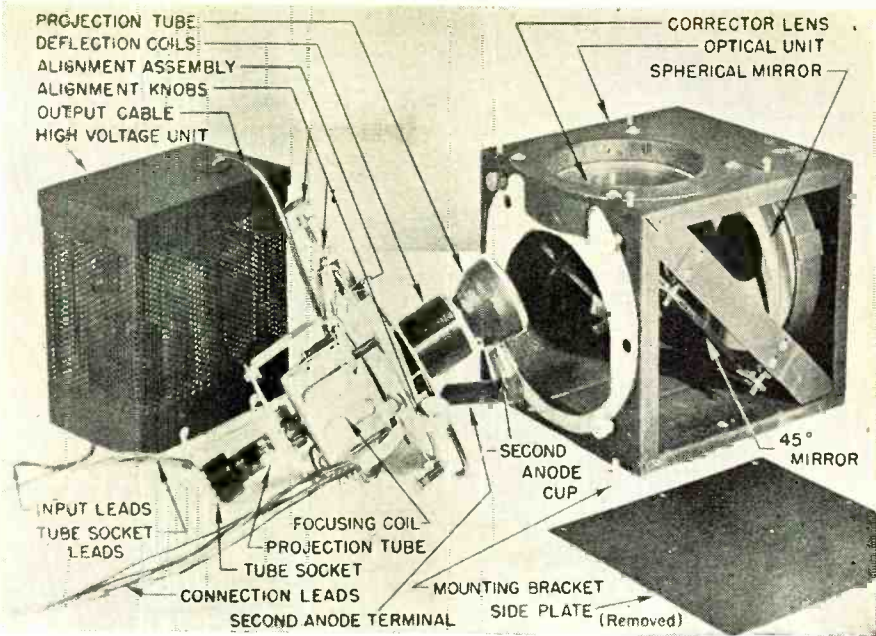

Fig. 7. The entire assembly, including the special power supply, as used in the North American Philips projection television system.

the screen surface is made concave. See Fig. 3. The screen, in addition to its directional properties, also possesses a great many minute or lenticular elements, each of which redistributes or diffuses the light reaching it uniformly throughout the desired sector. The over-all brightness of this screen is about 50 foot-lamberts.

Since the optical system is mounted at an angle and projects on the screen at an angle, a rectangular image projected from the face of the picture tube would appear on the screen as a trapezoid (the image would have sloping sides with the top larger than the bottom). See Fig. 4B. On the other hand, by projecting a trapezoidal image from the tube, we obtain a rectangular image on the screen. This latter method is the one used in the *Philco* system.

Formation of the trapezoid pattern is achieved by applying a magnetic field at right angles to the electron beam. To produce this magnetic field, two oppositely polarized permanent magnets are mounted opposite each other on the end of the projection tube. See Fig. 5. An iron pole piece, curved to fit the sides of the tube, is attached to each magnet and is used to produce a strong field for deflecting the electron beam upward near the tube face. The oppositely polarized ends of the magnets farthest from the tube face cause a lesser and downward deflection of the beam before it is deflected upward. The result is the same as that which would be produced if the face of the tube were tilted inward; the distance the beam travels to the bottom of the image is reduced and the distance to the top is increased. This creates the desired trapezoidal pattern. The magnets are adjusted for the proper keystone pattern by moving them toward (parallel to the

(Continued on page 150)

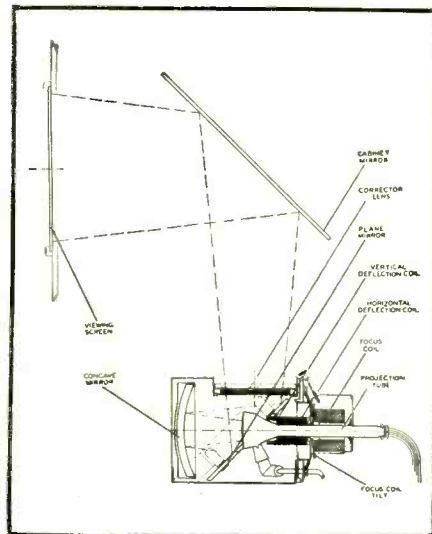
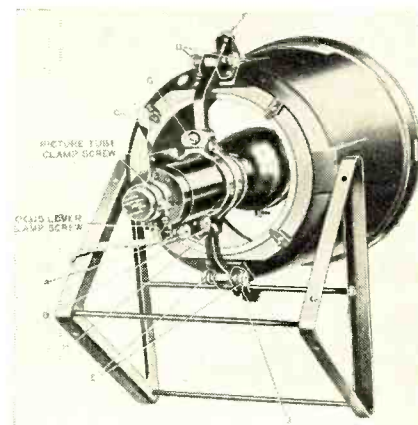
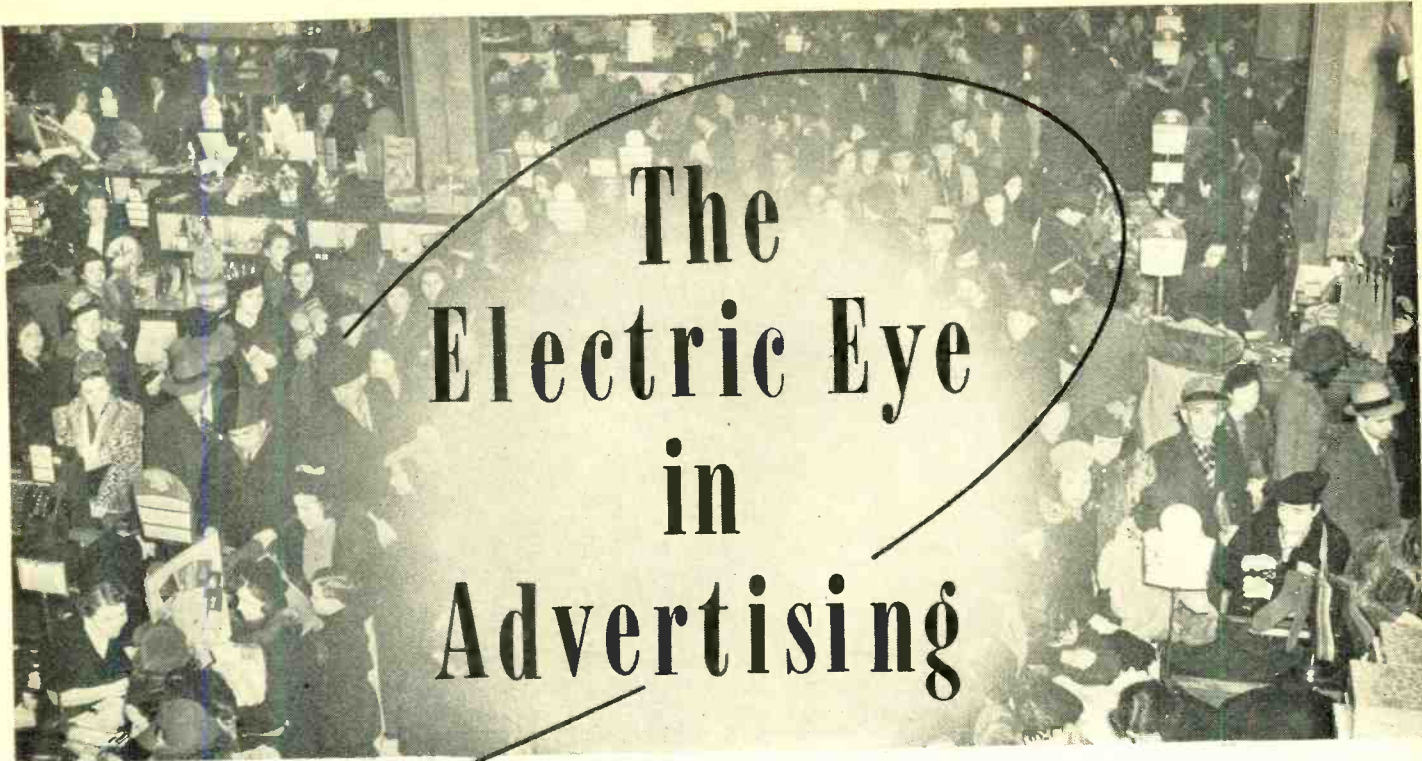

Fig. 8. The various components of the optical unit of the Philips projection set.



Fig. 9. The "optical barrel" in *Philco* and *RCA* receivers. The points lettered A through H are physical positioning adjustments.





# The Electric Eye in Advertising

By  
A. EDELMAN

***A real sales promoter—the “electric eye” incorporated in novel gadgets will attract the interest of potential customers.***

**M**OST of our collective electrically-disposed brains are so engrossed with radio, recordings, television, and other forms of communications electronics that we tend to overlook the amazingly varied jobs handled by the workaday electric eye relay, or photorelay. I would like to tell you about some of those jobs, and how my friend Xavier made them his source of income.

When I first met Xavier he was a thin, thoughtful, seedy-looking soldering-iron mechanic not long out of the Army and its unfailing three squares daily. He entered my office to borrow a photorelay, a man with small resources, a wife in prospect, and big ideas. Now, months later, he has invited me to bring you readers along on a visit in the neighborhood, to see how he has applied the electric eye to good use in advertising.

Following Xavier's instructions, we arrive at the Roebuck Hurn department store at dusk, just in time to see their big neon signs light up, more or less at the same time. Xavier has told me how he placed photorelays in some of the upper story windows, pointed towards the sky; and how, when the sky darkens sufficiently, these relays turn the signs on. Each photorelay operates one or two neon signs.

I remember vividly the trouble he had with the first of these units; he

had placed it right near the sign it was to control, but inside the window. When it became dark that first day, the sign went on, and its light reached into the phototube, so that the phototube promptly turned off the sign. This went on quite merrily, until the contactor overheated, and someone called the store electrician. After that, the electrician had to be pacified with the gift of one of our photorelay kits for his high school age son. The sign control was adjusted by making sure that the sign could not shine into the phototube, and also by putting in a time-delay circuit so that it would take ten or fifteen seconds to turn the sign either on or off. That was to fool the clerks who started showing their friends how they could turn the sign on by placing their hands over the electric eye light entrance. By permission, I am passing along the circuit details to you, on the chance you may want to use it sometime. It's all in the diagram of Fig. 1 and the explanation below the diagram.

Well, now we are at the store, and there are the show-windows with all their displays. Xavier asked me to watch out for the second window, and to walk by after it was cleared of people, so that we could see just what happens. We do that, and notice the spotlight shining at us, and the phototube box near it picking up the light reflected from our clothes. Xavier ex-

plained to me sometime back how a disturbance to the amount of reflected light entering the phototube was amplified as an a.c. signal, and how this caused a relay to operate. This circuit, with its voltage regulators, high gain amplifier, bandpass filter, resistance-capacity coupling, and time-delay arrangements, is too complicated to explain here, so I won't try. But it certainly does work fine, because as we pass by, the window seems to come to life. A fast-flashing lamp somewhere in the window dazzles, and cannot be ignored; it is almost hypnotic. We go to the window, of course, and are able to see how Xavier laid out all of the electrical stuff without taking any room away from the pajamas and blankets. Judging by the crowds that follow us, a lot of people are going to know all about those pajamas soon.

That fast-flashing lamp, by the way, is another piece of photorelay work, and is something like the sign control that didn't work correctly, which I just described. The photorelay controls the big lamp, and when the lamp goes on, the light from it reaches into the phototube, and causes the relay in there to turn the lamp off. When the lamp is off, the darkness at the phototube causes it to switch on again. The effect is better when the lamp does not switch on and off too fast, and so the phototube is adjusted to require

**RADIO & TELEVISION NEWS**

the maximum amount of light that the lamp can give it. This means that the lamp has to come up to full brightness each time, before it can switch off. Also, a slow carbon lamp is used to shine into the phototube, while the main light in the window is obtained from tungsten lamps. That slows the relay operation down some more. As for the photorelay itself, almost all of the circuits in my new book\* will do, because the circuit is not a bit critical, as long as no part of it, like the relay contacts, has been overloaded.

We enter the doorway of the store. There is a "bong" to announce us, and a salesman smiles us officiously into the furniture department. That was the door signal Xavier fussed with for days. You might suppose a simple beam of light across the entranceway was an easy job; but it so happens that the sun and daylight enter those big show windows strongly part of the day, so that the phototube was never sure to be darkened by the shadow of a person entering, to cut off a weak little beam of light across the entrance. Xavier fixed that, after he found out what the difficulty was, by protecting the phototube against daylight as much as he could, and then by using a resistance-capacity coupled circuit to make sure that different amounts of daylight that got in anyway would not change the bias in his amplifier tubes. His circuit is so good that it is all covered in Fig. 3.

We get rid of the salesman fast merely by telling him that we are not buying anything today, and start walking down a long aisle lined with furniture. A showcase up ahead suddenly lights up like a Christmas tree, and a display near it begins to turn around and around. That's because Xavier ambushed us again with an electric eye, and now we can't help but see the new clocks and radios. This time it's the same circuit as the door signal electric eye, except that instead of a chime tone, the relay started off a timing motor, which had to make one full turn before it could stop. While it turned, the lights were on in the showcase, and the display motor turned around and around.

We don't stay long here, and after we leave, the display goes to sleep again, saving wear, tear, and electricity. The boss of this store must be a real pennypincher to have Xavier work it out that way.

Now we are at phonograph records, and there is a crowd of people around a sign that says "Talk over the Light Beam—Free." There are two reflectors, one at each end of the space, and a man at one end is talking to a lady at the other, using telephones. The small boy in the middle is up to something—he lifts that umbrella into the light beam and annoys the talkers by cutting them off. Perhaps we should tell Xavier to raise the reflectors; but then, maybe not, because after all, the

\* Edelman, A.: "Electric Eye Circuits and Relays in Theory and Practice." Photobell Company, 116 Nassau, New York 7, N. Y.

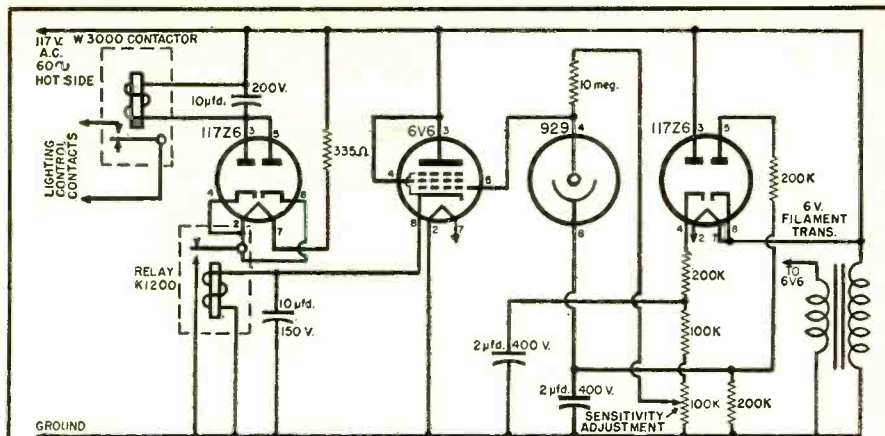

Fig. 1. This photoelectric sign lighting control circuit is one that you will use in several different forms so it is well worth the time and effort to build it soundly. A 6-volt transformer is used for heating the 6V6 amplifier tube cathode, and a 117Z6 dual rectifier for furnishing both a plus-to-ground and a minus-to-ground voltage for the grid circuit of the 6V6. A phototube, an amplifier tube with a relay in its cathode circuit, a time delay tube (another 117Z6), and a contactor complete the circuit.

The two voltages for the grid circuit are well filtered, and furnish enough voltage to bias the phototube so that it will work sensitively. If you do not have a Type 1P24 phototube, then any vacuum-type, such as the 929, will do. Be sure not to use electrolytic condensers for filtering the grid circuit voltages; the impedances here are high and when the electrolytics change their leakage, as they do continuously, the voltages will be disturbed. The phototube and the 10 megohm resistor divide the voltages obtained from the 117Z6 and, when the phototube is dark, takes most of the voltage for itself. This raises the grid of the 6V6 and the cathode has to follow the grid, so the relay gets the voltage. By putting the relay in the cathode circuit, instead of in the plate circuit, there is a high negative feedback, no amplification of voltage, but lots of current amplification and stability of adjustment.

You might have noticed that raw a.c. is used on the plate of the 6V6. This doesn't matter because nothing happens when the plate is negative. The tube merely operates during about half of each a.c. cycle, which is just as good as operating all the time, and there is less work for you in building it.

When the relay operates and stays in an operating condition for awhile, it heats up the 117Z6 time delay tube, which is just a rectifier, and this slowly pulls over the contactor to turn on the lights. In the same way, when the relay releases the next morning, the 117Z6 lets go after a delay and slowly opens the contactor.

Be sure to adjust the relay so that it has a fairly wide margin between "operate" current and "release" current, as this prevents any chattering of the relay contacts. Also be sure that the lamps or signs that are on the relay contacts do not shine into the phototube, unless you want to build a slow oscillator.

people are laughing, having fun, and buying records.

That light-beam job is just like a crystal microphone preamplifier. The phototube is in series with a 5 megohm resistor, and with a 90 volt battery, and the resistor is coupled through a condenser into a standard audio amplifier. The output is coupled to a ¼ watt neon lamp through a trans-

former, and with some d.c. bias to make sure that the lamp doesn't extinguish. It's not a bit difficult, if you fuss with it a little, and don't try to put the reflectors too far apart. The quality of the voice will not be very good, of course, unless you know about frequency range, and pick over the circuit with your oscillograph to

(Continued on page 148)

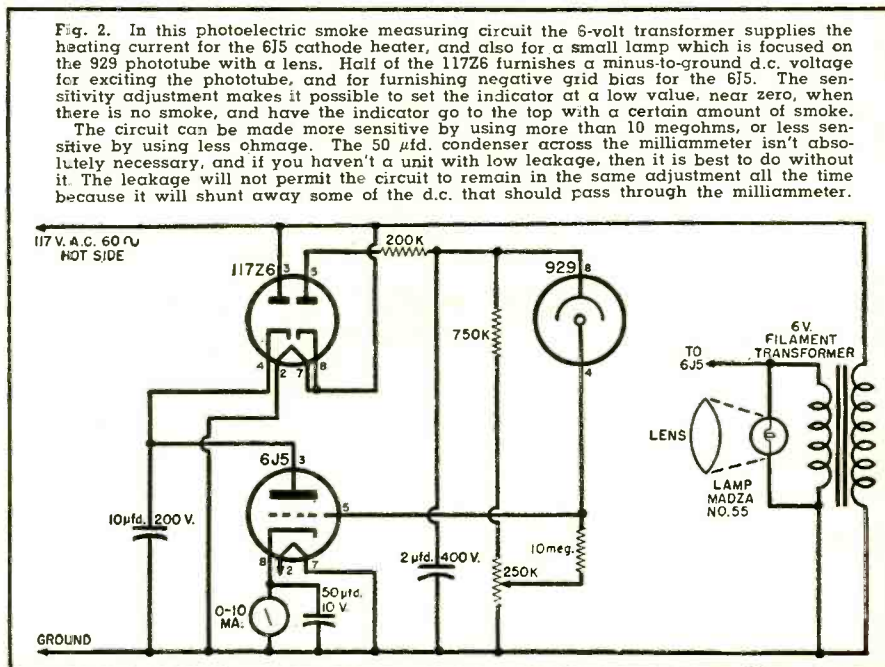
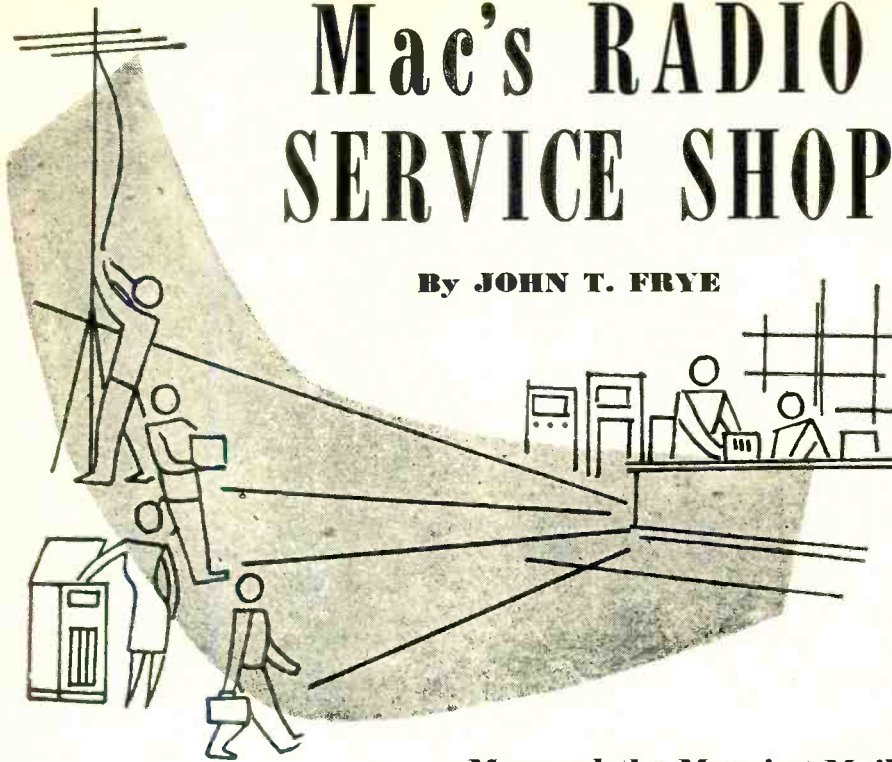

Fig. 2. In this photoelectric smoke measuring circuit the 6-volt transformer supplies the heating current for the 6J5 cathode heater, and also for a small lamp which is focused on the 929 phototube with a lens. Half of the 117Z6 furnishes a minus-to-ground d.c. voltage for exciting the phototube, and for furnishing negative grid bias for the 6J5. The sensitivity adjustment makes it possible to set the indicator at a low value, near zero, when there is no smoke, and have the indicator go to the top with a certain amount of smoke.

The circuit can be made more sensitive by using more than 10 megohms, or less sensitive by using less ohmage. The 50 μfd. condenser across the milliammeter isn't absolutely necessary, and if you haven't a unit with low leakage, then it is best to do without it. The leakage will not permit the circuit to remain in the same adjustment all the time because it will shunt away some of the d.c. that should pass through the milliammeter.

# Mac's RADIO SERVICE SHOP

By JOHN T. FRYE



## Mac and the Morning Mail

**B**ARNEY was busy at the service bench putting a new volume control in an a.c.-d.c. midget, while behind him the boss-man himself was making some adjustments on a TV console. The bright May-morning sunshine flooding through the big plate glass windows of the front room seemed to dim the usual brilliance of the fluorescent-lighted service department.

What Mac was really doing was adjusting the ion-trap on the neck of the 10BP4 picture tube, and to do this he was making use of his latest "invention." This invention—which Barney had solemnly dubbed the *Reflectomagnovisor*—was nothing more than one of those swivel-mounted, reversible shaving mirrors with a plain mirror on one side and a magnifying mirror on the other, mounted on a folding music stand. The mirror was mounted in place of the original music rack, so it could be adjusted to any height and turned and tilted through any angle. This portable device permitted Mac to stand behind a TV set and to see a reflection of the pattern on the face of the tube while making the adjustments usually controlled from the rear of the set. He could have his choice of a wide-angle, undistorted view of the whole tube face or a highly-magnified reflection of a particular portion of that screen—a selection that came in very handy when working with the *linearity*, *drive*, and *focus* controls.

As Mac decided that he had the trap at the exact spot and in the best possible position on the neck of the tube for maximum brilliance of the raster, Miss Perkins brought in the morning mail and thumped it down on top of the receiver.

"For once," she remarked acidly,

"you actually have a first-class letter or so in that mess."

Miss Perkins had a very low opinion of the flood of catalogs, circulars, technical bulletins, and advertising postcards that made up the bulk of the radio shop mail. Mac sat down on the end of the service bench and began to gouge open the envelopes with the long slender blade of a dialknob screwdriver.

"Hey, Red," he said as he waved the first letter about, "do you remember my telling you about those 35Z5's, 35Z3's, etc., that develop a funny condition so that the smallest jar will cause them to make a noise? Well, I wrote to this tube manufacturer and asked if he could tell me why they did this. He said to send him some samples of the noisy tubes, and I did. In this letter he says that an inspection reveals that under certain conditions some of these tubes develop a condition wherein they actually generate r.f. pulses when they are jarred ever so slightly. These pulses are picked up by the antenna and are amplified by the set. He remarks—as we found out, too—that the noise is worse in those sets in which a built-in loop is quite near the rectifier. He suggests that putting a shield around the rectifier tube will help reduce the noise."

"Do we start shielding those noisy tubes or do we continue to replace them as we have been doing?" Barney wanted to know.

"I think that in most cases we will continue replacing the tubes," Mac said after a little reflection. "A 35Z5 usually has a short life anyway, and if we cut off its ventilation by putting a shield around it, the set would probably be back in a few days with a burned-out rectifier; then we would

have to put in the new tube that we might just as well have put in in the first place."

Having made this decision, Mac laid aside the letter and butchered open another envelope with his screwdriver. "Well, well," he muttered as he glanced over the page, "we seem to have hit the jackpot today. This letter takes up another of our problems. I have always wondered exactly what happens to those electrolytic condensers that become noisy without developing either an open or a shorted condition. You know—the ones that make a static-like noise until you bridge a good condenser across them; and then the noise stops, only to start up again a few minutes later.

"Well, I saved up a few of these that we had taken out of sets and sent them in to this condenser manufacturer. Some were his; others were of competitive makes. This letter says that the chief engineer of the company inspected the condensers and found that in every case there were very small variations in the contact resistance of the leads. In certain critical circuits, these variations would cause noise. He goes on to say that these variable resistances, tiny though they were, have now been eliminated in their own products."

"What do you suppose he means by 'certain critical circuits?'" Barney wanted to know.

"I think he means circuits in which an abrupt change of voltage, even though it is slight, would produce a sort of r.f. pulse. We know that the noise is of an r.f. nature, for when one of these noisy sets is playing on the bench, you can pick up the noise on other sets operating nearby; moreover, when the volume control is turned down so that an r.f. signal cannot be detected and fed through into the audio amplifier, the noise disappears. Possibly the little abrupt changes of voltage due to the variations in the contact resistance pulse-modulates the oscillator in the set and produces a noise in much the same way that a keyed oscillator or r.f. amplifier produces key clicks."

Barney nodded sagely in agreement with this and went on with his work while Mac continued reading still a third letter.

"Hey, Mac," Barney suddenly interrupted, "what's the idea of this coil of insulated wire wrapped around this .2  $\mu$ fd. condenser? The circuit diagram shows the coil and condenser in series between the 'B-minus' point and the chassis, and then there's a quarter-meg resistor across the whole works."

"What does it look like?" Mac asked quizzically.

"It looks like a series-tuned circuit," Barney said cautiously.

"And by a happy coincidence, that's exactly what it is!" Mac said.

"Well, come on!" Barney said impatiently. "Tell me more! What's a tuned circuit doing in that out-of-the-way place? Why use it instead of the usual condenser-and-resistor combina-

(Continued on page 158)

RADIO & TELEVISION NEWS

# Broadcasting Station on Wheels



**When a news story breaks in Oklahoma, WKY is on the spot with instant coverage—thanks to a complete and unique studio which travels to the story locale.**

**C**OMplete communication facilities for use in emergencies, and as a showpiece for more normal remote broadcasts are housed in the custombuilt "broadcasting station on wheels" now roaming the plains of Oklahoma for WKY, the NBC affiliate in Oklahoma City.

A study of special events programming in Oklahoma by P. A. Sugg, station manager, revealed the need of more versatile facilities for such work. As a result, a new and completely equipped remote studio was created. The 29 passenger bus was custom-built by *Flexible Company* at their Loudonville, Ohio plant, following specifications carefully detailed by the WKY engineering department.

Immediately behind the driver are seats for announcers, engineers, and others on special assignment. The center section contains the control room where all equipment a studio requires is shock mounted, enabling the unit to operate while in motion.

Included in the control room are four AM-FM cue and talkback receivers, a 150 watt AM transmitter and two turntables with recorders adjustable to bus position, plus record storage and seating space.

The back third of the unit is a maroon and gray appointed studio, sound treated and large enough to accommodate nine people. There are two Pullman-type tables for broadcasting, four microphone outlets and seats for five across the back.

The luggage compartment contains a 2 kw. gasoline power plant, a 50 w. public address system, a *Bell* telephone transmitter and receiver and an FM police receiver.

Sound power phones are used for communication within the unit and a *Bell* highway telephone provides com-

munication with established circuits throughout the state of Oklahoma.

This equipment has already proved its value. For example, the remote studio was parked on the campus of the University of Oklahoma, 20 miles south of Oklahoma City recently, where a program was scheduled for that afternoon. Word of a disastrous fire at Woodward, 150 miles northwest of Oklahoma City, was relayed to the vehicle by the *Bell* highway telephone. Plans were quickly changed, the remote studio pulled out for Woodward, further instructions were given by telephone as the vehicle sped along the highways, and in less than three hours an eye-witness broadcast was on the air from Woodward.

A railed platform atop the remote

studio provides an unobstructed view for on-the-scene broadcasts. AM-FM transmitting and receiving antennas are also located along the top of the vehicle.

Power outlets, microphone and telephone line inputs were installed outside the unit, along the body frame supports.

Accessories such as fog lights, siren, spotlights and public address speakers add the final touch.

Jack Lovell, chief engineer, Gene Lyons, field supervisor, Ed Callahan, engineering supervisor, and Bob Hayward, engineer, worked steadily for nearly two months making the installations that make the remote studio one of the finest in America.

-50-

View of mobile control room showing transcription tables, console, highway-type telephone, sound power phone, speakers, AM and FM receivers, and AM transmitter.

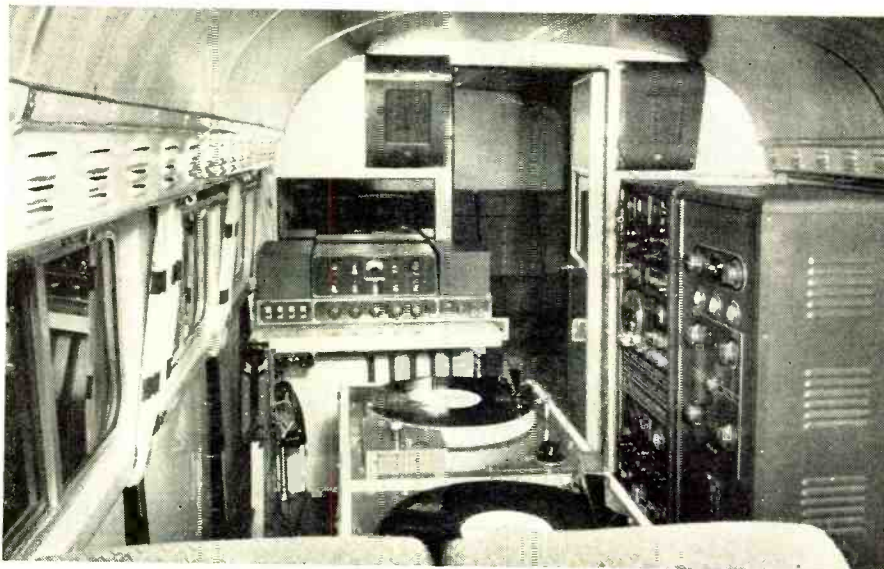

# A Briefcase HAM PORTABLE

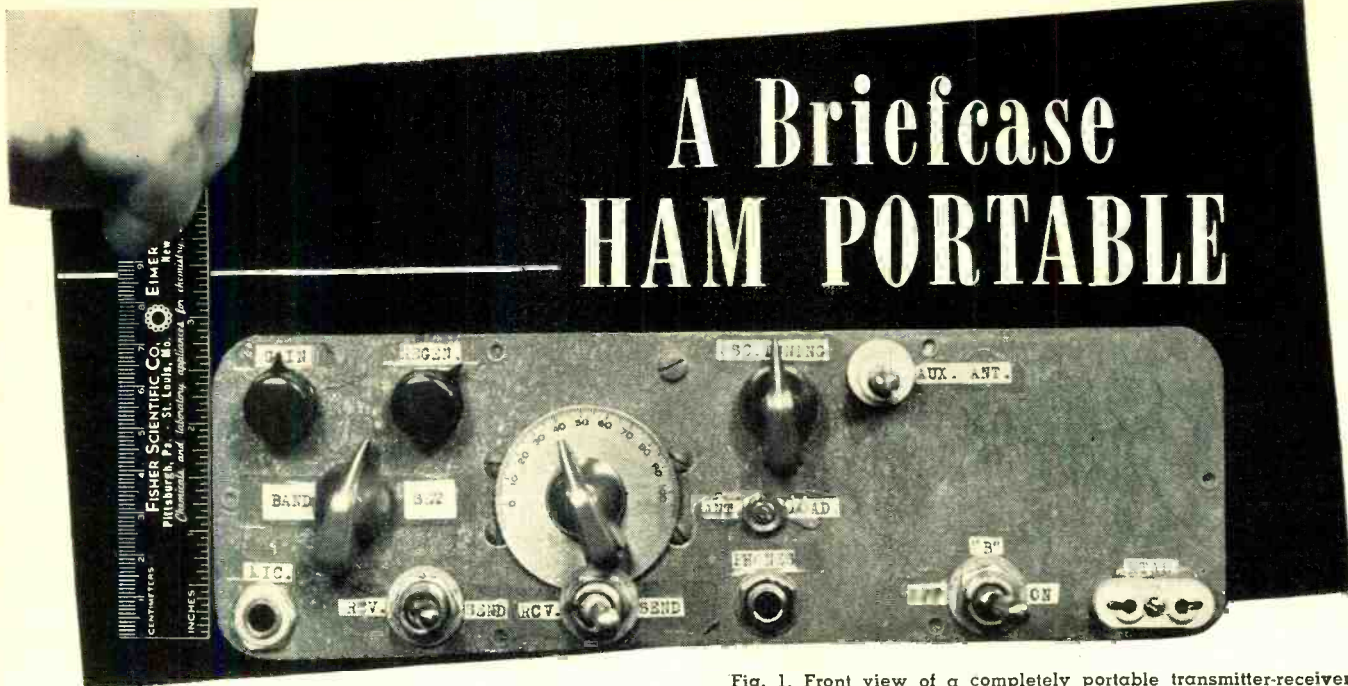

Fig. 1. Front view of a completely portable transmitter-receiver which provides either phone or c.w. operation in the lower bands.

By E. CAMPAINE, W3KWP and M. F. JUDKINS, W3AC

***A standard briefcase or the glove compartment of a car will readily hold this tiny ham "station."***

**B**RIEFCASE ham portable, portable mobile, vacation portable—call it what you will but this little combination transmitter-receiver represents the ultimate in compactness for two-way communication on both phone and c.w. for the low frequencies.

The urge to build some type of battery-operated equipment was fulfilled when surplus gear began to flood the market. The vital parts used in the construction of the rig are all from surplus items—parts that might have otherwise been discarded. Fig. 6 is a front view of the complete station including headphones, microphone, key, loading coil, and antenna. Fig. 5 is the rear view of the unit showing the

meter, key jack, and modulator-c.w. switch.

### Portability Without a Truck

This equipment is really portable and readily fits a standard briefcase or the glove compartment of the average car. Fig. 1 is a front view of the cabinet. The ruler clearly indicates that the over-all height of the unit is scarcely three inches!

Many articles have been written about the so-called "vest pocket" transmitter but usually a bushel basket is required to hold the rest of the paraphernalia that normally goes to make up the complete station, i.e., the receiver, antenna, batteries, etc. The auxiliary equipment used with this

station includes a throw-out antenna, which when folded is less than 16 inches long and when jointed ten feet, six inches; an antenna loading coil, headphones, a key, a microphone, and a plug-in meter. Everything else is housed inside the case—even the batteries.

### The Circuit

Fig. 4 shows the circuit as it finally evolved. It is a compromise between the ultimate in compactness and efficiency yet it provides absolute minimum "A" and "B" battery drain. Alternatives could have provided an r.f. stage ahead of the detector and a Pierce oscillator power amplifier transmitter but both "A" and "B" current drain would have been doubled.

### Receiver Details

The receiver is conventional and uses a 1T4 amplifier tube as a regenerative detector impedance-coupled to the 1S4 audio. Bias for the 1S4 amplifier tube is provided by three penlight cells which are cemented to the under-

Fig. 2. Top view of the transmitter-receiver unit showing the location of the coils, battery, and other top-chassis parts.

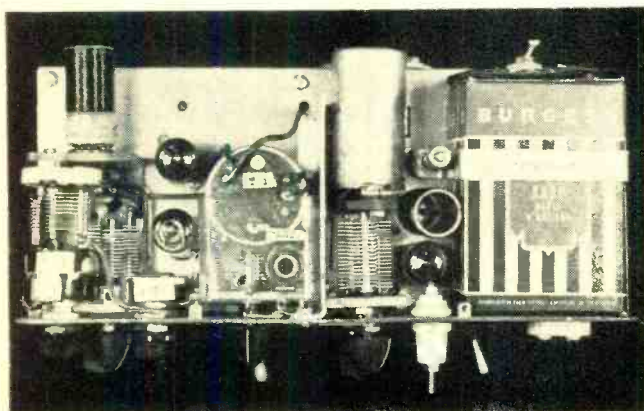
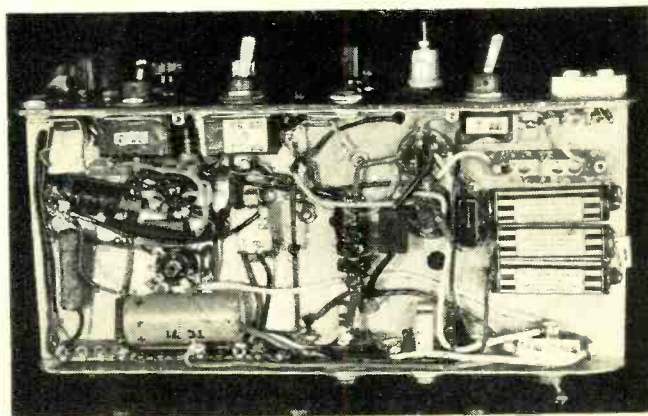

Fig. 3. Under chassis view of portable. Note that although the set is compact there is no undue crowding of the components.



side of the chassis. Since no current is drawn by these batteries their life can be considered that of shelf-life batteries. When using phone the 1T4 detector becomes the speech amplifier by switching the microphone into its grid circuit, and the 1S4 audio tube choke-modulates the screen grid of the 1S4 oscillator tube. The output transformer was salvaged from a surplus BC 453A. It serves as an output transformer when receiving, while the primary alone is used as the modulation choke. Because the headphones remain in the circuit at all times, complete monitoring of voice transmissions is possible.

As can be seen in Fig. 1, the 140  $\mu\text{f}$ d. bandset condenser,  $C_3$ , is mounted on the left side of the front panel, the gain control,  $R_5$ , is in the upper left-hand corner, and to the right of gain control is the regeneration control,  $R_1$ . The plug-in coils,  $L_1, L_2$ , which can be changed with the shield in place, and the antenna series condenser,  $C_1$ , are mounted on a piece of lucite, bent into an angle and bolted to the chassis, as shown in Fig. 2. The 1T4 detector appears directly behind the regeneration control in Fig. 2 and farther back is the 1S4 audio tube. The output transformer,  $T_1$ , is mounted to the right and is in the center of the chassis. Visible through the lucite angle bracket used to mount the antenna jack,  $J_3$ , is the bandsread tuning condenser,  $C_4$ . A vertical aluminum shield, bolted to the chassis and the front panel, separate the receiver and the transmitter.

### The Transmitter

The transmitter is nothing more than a 1S4 crystal oscillator with a small feedback condenser to help some of your sluggish crystals perk up and take notice. The plate circuit is metered by a 0-25 ma. meter, through a closed-circuit jack,  $J_5$ . The assumption that a simple pi-coupler will load any length of wire or anything from a wet string to a bed spring proved to be untenable. Designed to load the throw-out surplus antenna, this pi-coupler in conjunction with a loading coil can't miss, and no one can deny the reliability of the low impedance link when working the rig on the home antenna.

(Continued on page 120)

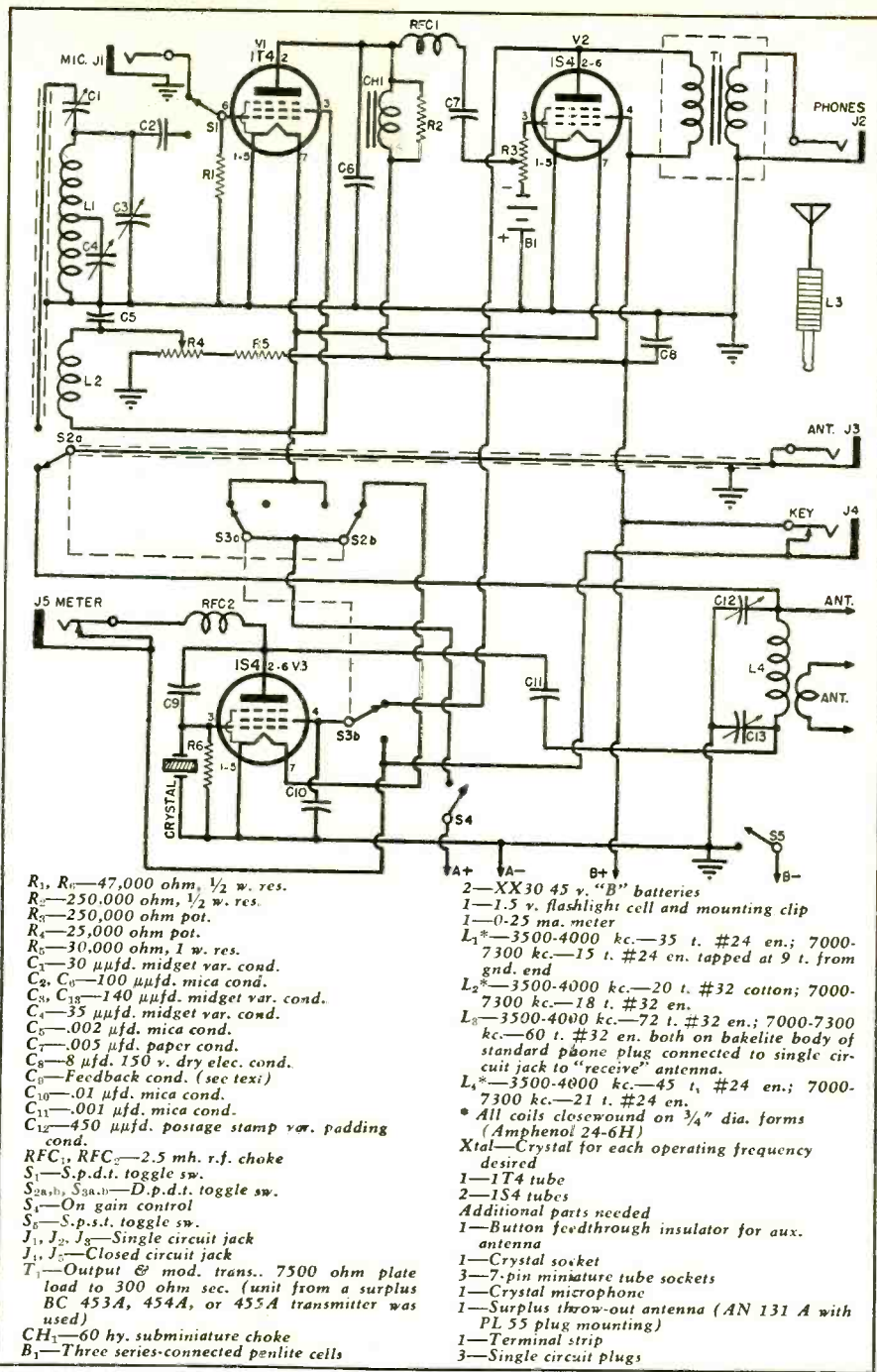

Fig. 4. Schematic diagram and parts list for the portable transmitter-receiver.

Fig. 5. Back view of unit showing plug-in milliammeter in place and the operating key inserted in the proper circuit jack,  $J_5$ .

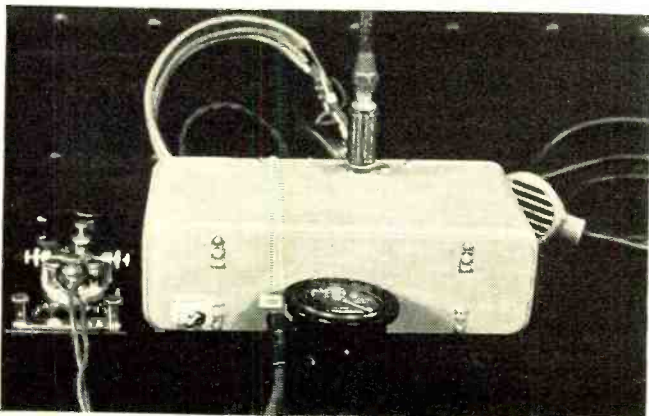
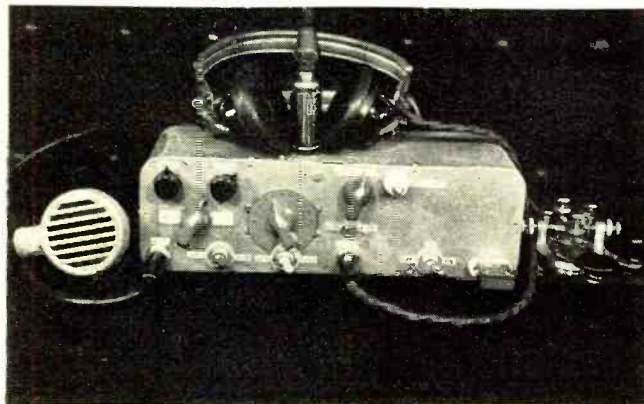
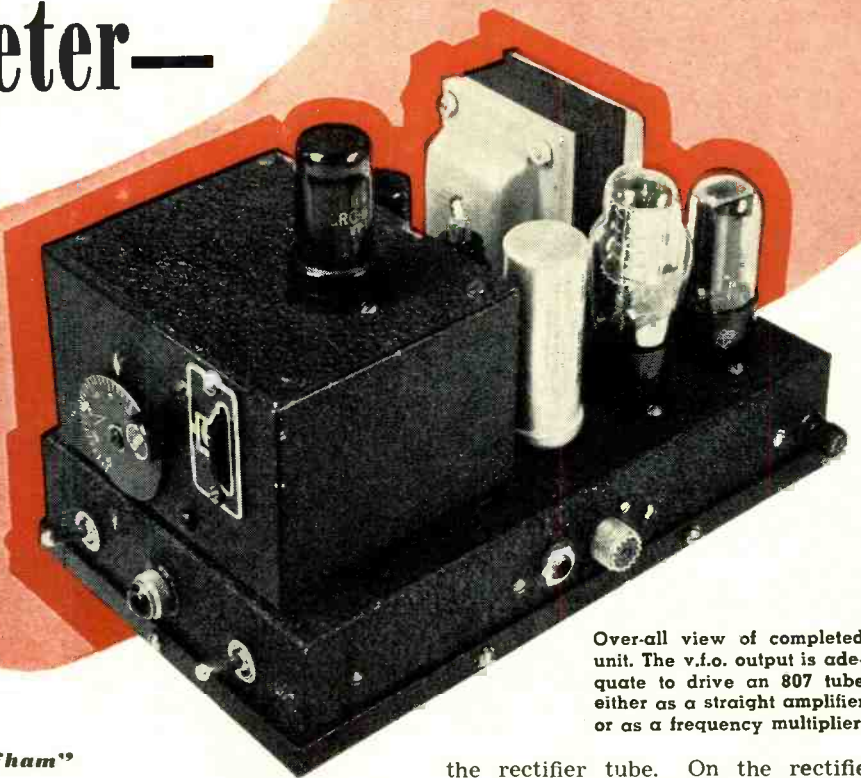

Fig. 6. Front view of unit with all of the operating accessories, headphones, mike, key, and throw-out antenna, assembled.



# A Dual-Purpose Frequency Meter— V.F.O.

By  
**G. L. COUNTRYMAN,**  
W3HH, WIRVK  
Commander, USN, Electronics Officer  
Boston Naval Shipyard



Over-all view of completed unit. The v.f.o. output is adequate to drive an 807 tube either as a straight amplifier or as a frequency multiplier.

**Complete construction details for a "ham" unit that can be used either as a v.f.o. to drive a transmitter or as a frequency meter for both receiver and transmitter frequency measurements.**

**T**HE basic unit to be described is similar to a v.f.o. designed by Don Mix about two years ago and written up in the 1948 *ARRL Handbook*. The main differences are the substitution of a mixer tube for one isolation stage, minor changes in the electron coupled oscillator components, and some refinements such as the inclusion of a dial that will read direct to 2500 divisions.

Provision is made for coaxial connection to the transmitter when the unit is used as a v.f.o., and for r.f. input and headphone output for the direct checking of a transmitter frequency or for monitor uses.

The v.f.o. output is adequate to drive an 807 tube either as a straight amplifier or as a frequency multiplier. No provision has been made for keying the unit so one or more of the following stages must be keyed, preferably in the cathode. A convenient switch in the center tap of the high voltage winding on the transformer cuts the v.f.o. on or off as desired.

Referring to the photographs, the dial on the 3" x 4" x 5" ECO box can be read directly to 2500 dial divisions in 180 degrees rotation. These dials sell new for around \$7.00 but are included with BC375E tuning units which currently retail on the surplus market for around \$1.25. The dial

shown was removed from one of the used surplus tuning units.

The left hand switch is in the a.c. line and the right hand switch is in the center tap of the high voltage winding of the power transformer. Between the switches is a 6.3 volt pilot light connected to the filament winding of the power transformer. The bulb is removable from the front of the chassis. A two-terminal strip (Millen No. 37302) is on the rear of the chassis for attaching the a.c. line cord, and on the right hand side of the chassis are the phone jack, the coaxial output terminal, and a binding post mounted on insulated grommets for coupling r.f. input, if necessary, in connection with the use of the unit as a frequency meter. A two or three-foot length of wire attached to this binding post provides sufficient input for checking even a low power transmitter, and insures adequate headphone volume.

Behind the ECO box are, left to right, the 6F6 isolation stage, the 6L7 mixer tube and an octal base plug-in 20-20  $\mu$ f. filter condenser obtained at surplus for 35 cents. The 6SK7 ECO tube is mounted on top of the ECO box where its heat will not affect the frequency or stability of the oscillator. Behind the filter condenser is the VR105 regulator tube and at the rear,

the rectifier tube. On the rectifier tube socket, pins 3 and 4, pins 5 and 6, and pins 2 and 7 are connected together. This arrangement permits the use of any of the octal base rectifier tubes. The power transformer occupies the left hand rear corner of the chassis.

## The ECO

The ECO itself is contained in a *Parmetal* 3" x 4" x 5" utility box and the wiring diagram is self-explanatory. The coil,  $L_1$ , was picked up at surplus for a dime. It is marked "L-205" and is about 1½" long. Two threaded holes in one end permit fastening to the side of the ECO box. The coil consists of 24¼ turns of No. 20 tinned copper wire, wound on a threaded ceramic form ¾" in diameter with the individual windings spaced approximately the diameter of the wire and is tapped 3¼ turns from one end.

The tuning condenser,  $C_1$ , is mounted on the rear of the box and an insulated shaft is coupled to the rear extension of the condenser shaft then, in turn, coupled to the dial. Incidentally, the dial must be mounted first, and the holes laid out with great care, as the dial will just exactly fit within the three-inch dimension of the box. As the panel from which the surplus dial was removed is thicker than the side of the ECO box, it is necessary to use washers with the three screws which secure the dial. After the dial is installed, the hole on the opposite side of the box for the condenser mounting may be made, being careful to locate

**RADIO & TELEVISION NEWS**



it so that the condenser shaft and the dial coupling will be perfectly centered. If that is not done, the dial will bind and not turn free. Care must also be exercised not to damage or even scratch the worm gear in the dial, as any defect will cause the dial to bind at that point and not operate smoothly.

Considerable experimenting was done with the various fixed capacities and the proper temperature coefficients required to insure continuous stable operation. The arrangement finally adopted has no appreciable frequency drift thirty seconds after the filaments are turned on, and no changes in calibration have been noted over a period of several months, checking against an accurate frequency meter with an accuracy of .003%. The ECO is considerably more stable than the Navy type LM or its Army equivalent BC221, which maintain an accuracy of .01%. For this reason, no additional variable compensating condenser was found necessary, although it had originally been planned to add a small capacity trimmer condenser across the main tuning condenser for screwdriver adjustment from the side of the ECO box. Due to the excellent stability which was obtained, it was also considered unnecessary to incorporate a 100 kc. crystal and associated circuit in the unit.

The range from 3500 to 4000 kc. is well centered, covering from 230 to 2126 on the dial. This represents 996 direct reading dial divisions for the 80-meter band which anyone will agree should be sufficient. Harmonics for either v.f.o. or frequency measuring purposes are usable to at least 30 megacycles, but have not been checked above that point.

One of the tests used in connection with temperature compensation was to fasten a lighted cigarette to a wooden dowel and hold the hot end of the cigarette adjacent to various components within the ECO box, after zero beating the ECO output with another frequency meter, or the station receiver. With the component values as given, it was impossible to obtain any perceptible frequency drift after allowing the ECO to warm up for thirty seconds. Coupling the v.f.o. to the transmitter does not affect the frequency, and in fact direct shorting of the coaxial output terminal makes no change in the pitch of the note that can be detected by ear. Apparently one isolation stage is entirely adequate.

The ECO section should be wired except for  $C_3$ , a 6SK7 tube inserted in the socket and 6.3 filament volts placed between the filament lead and the box. Next a 45 volt "B" battery or other high-voltage source should be connected between the HV lead and the box (ground). This procedure is necessary for determining the condenser to be used for  $C_3$  as described below, and the signal may be picked up on the station receiver as precise calibration is unnecessary.

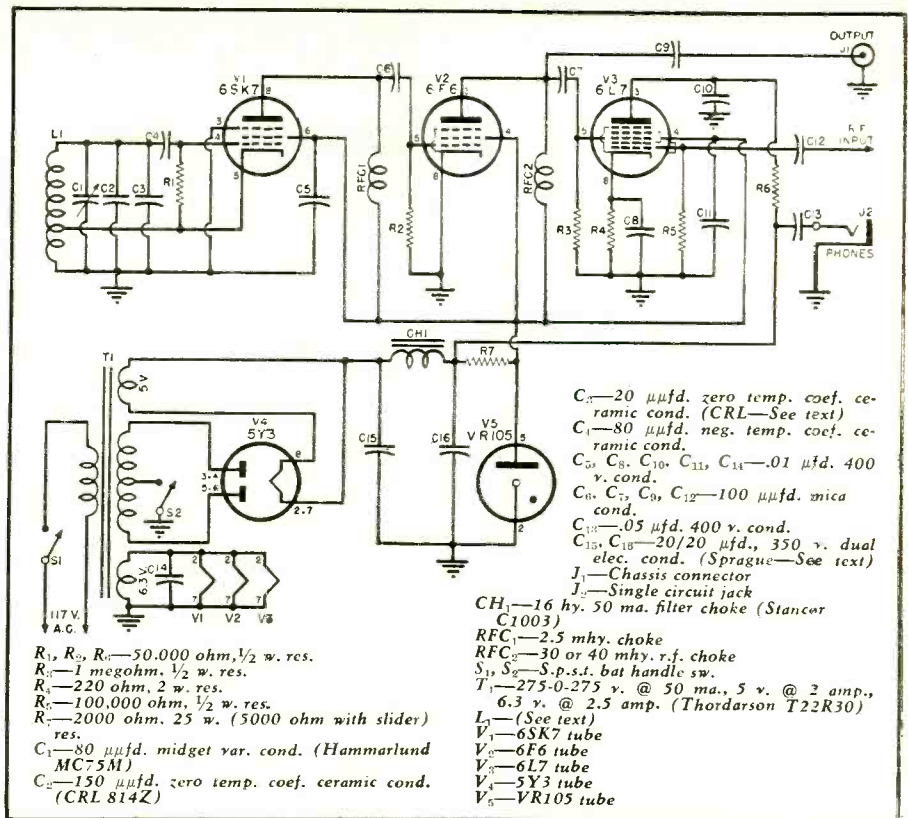
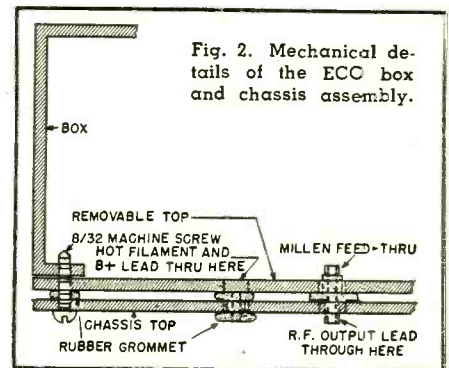

Fig. 1. Complete schematic diagram of dual-purpose frequency meter-v.f.o.

The wiring diagram shows  $C_3$  as 20  $\mu$ fd. The CRL ceramic tube zero temperature coefficient condensers are supposed to have a capacity tolerance of  $\pm .5 \mu$ fd. in the low values and  $\pm 2\frac{1}{2}$  per-cent in the higher values. Actually one marked 175  $\mu$ fd. was closer to 195  $\mu$ fd. For centering the band, since no trimmer condenser is used, it is necessary to determine the condenser to be used for  $C_3$  experimentally before the ECO box is put in place on the chassis. In one case, a condenser marked 20  $\mu$ fd. centered

(Continued on page 118)



Top view of the home-built unit. Although it does not appear so in the photograph, the 3x4x5 inch ECO box is centered on the chassis.

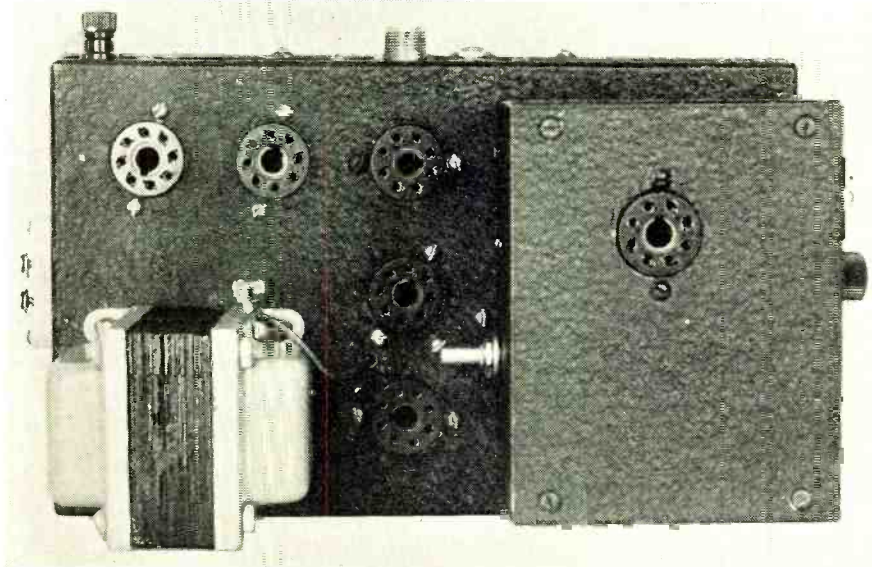



# International SHORT-WAVE

Compiled by **KENNETH R. BOORD**

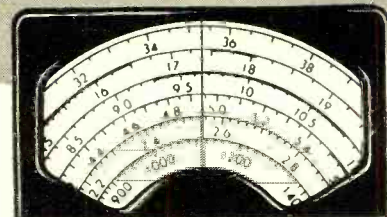

**W**E ARE pleased to dedicate the May *ISW Department* to radio in the new Dominion of Pakistan.

At present, *Radio Pakistan* has transmitters operating in four of its principal cities—Karachi (national capital), Dacca, Lahore, and Peshawar.

In Karachi there are two m.w. stations—one of low power and one of fairly high output. The low-powered transmitter operates on 1,452 kcs., power unknown; the high-powered one is on 825 kcs. with 10 kw. Presently inactive is 850 kcs. which serves as an alternate for 825 kcs. Karachi's short-wave outlet is listed officially on 6.075 with a power of 250 watts. It radiates the network programs of *Radio Pakistan* originating in Karachi. The alternate short-wave channel is 6.120 (inactive).

Dacca's m.w. outlet is on 1,167 kcs. with 5 kw. power. The present s.w. channel in use is 15.270 with 7.5 kw. power; alternate s.w. frequencies of 11.890, 4.950, and 3.460 are now inactive. The Dacca short-wave station relays the 1,167 m.w. transmitter as well as a few network programs direct from Karachi (chiefly the *English* news).

Lahore is operating currently on m.w. only, on 1,086 kcs., 5 kw.; it re-

lays network programs from Karachi as well as originating regional programs from its own studios.

Peshawar, like Karachi, has one low-power and one high-power m.w. transmitter, on 1,500 kcs. and 629 kcs., with 250 watts and 10 kw., respectively; relays network programs and also originates its own regional broadcasts.

In addition, *Radio Pakistan* has a number of m.w. and s.w. stations under construction. These include:

**KARACHI**—A 7.5 kw. station is under construction with assignment to 3.450 and 4.935; a 20- and a 100-kw. transmitter are "reported" to be under construction, but no frequency assignments have been announced.

**PESHAWAR**—A 7.5 kw. transmitter is under construction for assignment to 3.320 and 4.790.

**LAHORE**—A 7.5 kw. job is under construction for assignment to 3.355 and 4.818.

**MULTAN**—A 7.5 kw. station is under construction for assignment to 3.385 and 4.910; a 5 kw. transmitter, to be assigned to 600 kcs.

Other m.w. outlets, either projected

(Note: Unless otherwise indicated, all time is expressed in American EST; add 5 hours for GCT. "News" refers to newscasts in the English language. In order to avoid confusion, the 24 hour clock has been used in designating the times of broadcasts. The hours from midnight until noon are shown as 0000 to 1200 while from 1 p.m. to midnight are shown as 1300 to 2400.)

or under construction, include Hyderabad (Sind), 910 kcs., 5 kw.; Bannu, 950 kcs., 1 kw.; Quetta, 1,040 kcs., 10 kw.; Gutrat, 1,055 kcs., 1 kw.; Sialkot, 1,195 kcs., 1 kw.; Sylhet, 1,200 kcs., 1 kw.; Jessore, 1,250 kcs., 1 kw.; Bhawalpur, 580 kcs., 1 kw.; Lyallpur, 675 kcs., 1 kw.; Montgomery, 715 kcs., 1 kw.; Sukkur, 780 kcs., 1 kw.; Chittagong, 795 kcs., 5 kw., and Sheikheura, 825 kcs., 1 kw.

Owner of all the stations is the Pakistan Government with headquarters in Karachi, Sind.

Incidentally, in Lahore, Karachi, and Peshawar the dominant language is Urdu, while for Dacca it is chiefly Bengali.

The most commonly-heard short-wave outlet from Pakistan is *Radio Pakistan*, Dacca, on 15.270, which first started operations on 11.890. It moved to 15.270 on February 13, presumably to escape severe QRM from the "*Voice of America in Manila*" on 11.890.

Dacca's schedule appears to be daily at 2030-2200, 0100-0130, 0140-0230, 0600-1130; news has been heard at 2130, 0730, 1030. Since the day the transmitter moved from 11.890 to 15.270, I have found the 19-m. channel best here in West Virginia around 0730 when news is presented. I have heard location and frequency announced at 0745 just preceding "tonight's announcements" (in *English*). The station usually can be heard here also at 2130 with the news, but in the evening it is much weaker and often has CWQRM. Mornings it is in the clear and normally is quite readable to around 1030 news time when a powerful carrier causes interference. (I believe the QRM is caused by the carrier of WCBN, New York City, during its "warm-up" period at 1030-1115. During that time, *Radio Pakistan, Dacca*, is partly readable here.)

An Indian correspondent tells me that the s.w. transmitter at Dacca was constructed in seven weeks by three engineers and four assistants.

I have not yet received current schedules of other Pakistan stations but I believe they are similar to that of Dacca.

Pearce, England, has received a letter from *Radio Pakistan* in Karachi, stating that its transmitter there is still working on 6.070 (officially listed 6.075), and that the transmissions heard late in 1948 on 6.210 were not from *Radio Pakistan*.

(Continued on page 140)

This attractive and well-equipped Listening Post is that of Jack F. Gardener, Jacksonville, Florida. Jack is American representative of the ISW Club, London.

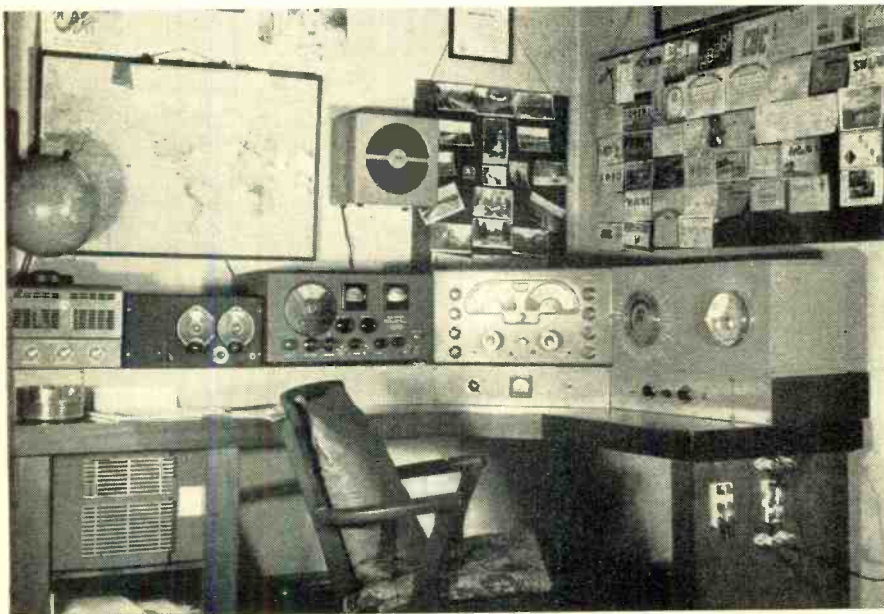

# Build Your Own 10.7 mc. DISCRIMINATOR TRANSFORMER

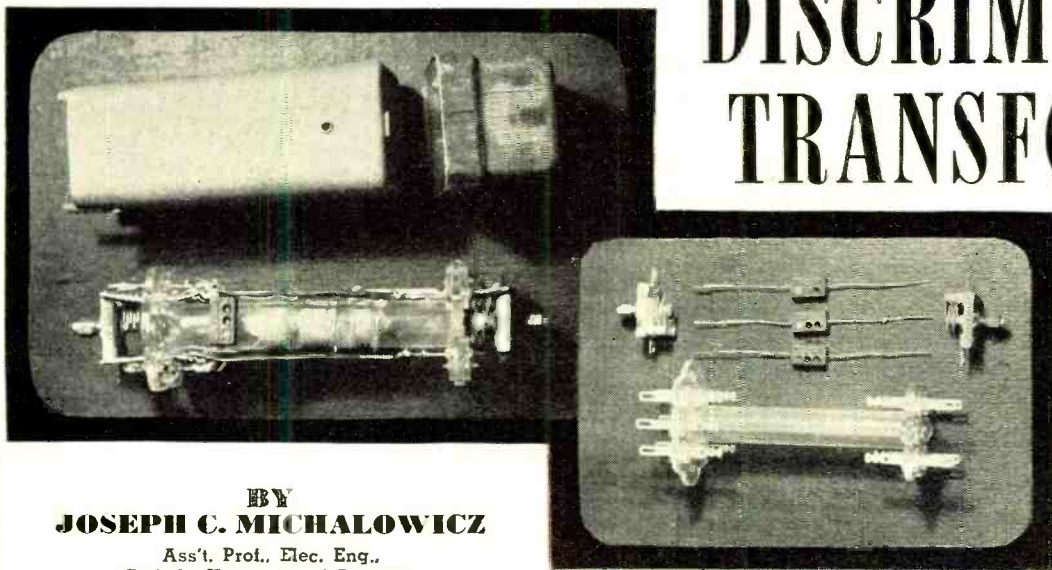

Fig. 1. Parts required to construct discriminator transformer. Photograph shows the fixed and tuning condensers, coil form, shield can, and the completed assembly.

BY  
**JOSEPH C. MICHALOWICZ**

Ass't. Prof., Elec. Eng.,  
Catholic University of America

**"Learn by doing"—it is not a difficult task  
to build your own discriminator transformer.**

**S**INCE frequency modulated signals are time axis modulations which are in quadrature with amplitude modulations, customary types of demodulators used in amplitude-modulated receivers cannot be used for separating the intelligence from the modulated carrier current. In the high-frequency and intermediate-frequency networks of an FM receiver, the circuits are very similar to those employed in the customary superheterodyne type of AM receivers, with the principal exception that the networks must accommodate a broader frequency spectrum. (See "New Band FM Receiver," p. 51, RADIO NEWS, April, 1948.) But the second detector in an FM receiver functions much differently from the detector in an AM receiver, it being a special circuit, called a discriminator, that must change the frequency modulation into a variable amplitude signal. It is the most important part of the FM receiver and should be designed and built with much care. It is worthy to note that not only does the discriminator circuit perform its primary function of demodulating the FM signal, but eliminates certain types of static. When a certain abrupt interference enters the i.f. stages of the receiver, a series of spectrum amplitudes of similar polarity, acting simultaneously and symmetrically with respect to the mid-frequency, is produced. Since inputs to a discriminator, consisting of equal simultaneous positive voltages displaced from the mid-frequency, produce zero output voltage, the inter-

ference is virtually eliminated in the audio stages of the receiver.

The basic type of discriminator is the balanced discriminator circuit shown in Fig. 2. The 6SH7 tube is the last limiter stage of the receiver and produces a voltage drop across the inductance  $L_1$  which is the primary of the double-tuned transformer  $L_1-L_2$ . This transformer is tuned to the i.f. frequency of the receiver,  $F_c$ . The secondary of the transformer is center-tapped and the output is supplied through two diode rectifiers to the resistive loads  $R_3$  and  $R_4$ . The voltage drops across these two load resistors are in opposition, and if the signal supplied to the discriminator is equally divided between the two diodes, the

voltage drop across "a"-c" will be zero.

The resultant voltages  $E_1$  and  $E_2$ , applied to the two diodes, have two components: one supplied through the condenser  $C_3$ , and the other inductively through the transformer  $L_1-L_2$ . If the input signal is exactly at the i.f. frequency, these two components are displaced by  $90^\circ$  and the resultant voltages  $E_1$  and  $E_2$  have the same magnitude, thus causing a zero voltage drop across "a"-c." However, should the frequency of the incoming signal deviate in one way or another from the resonant frequency of the discriminator transformer, the displacement angle between the two component voltages will in one case increase and in the other decrease, thus causing a difference in the magnitudes of the resultant voltages supplied to the diodes. This in turn will cause different voltage drops to occur

(Continued on page 143)

Fig. 2. Wiring diagram of the discriminator transformer and its associated circuit.

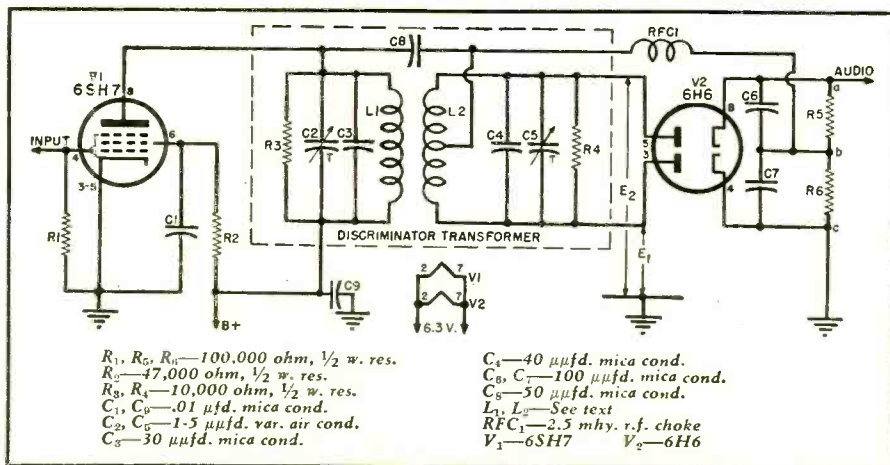

# The Tubeless GRID-DIP Adapter



Fig. 1. Over-all view of grid-dip adapter unit. Close-up view of probe assembly is also shown.

By **DOUGLAS H. CARPENTER**  
Chief Eng., McMurdo Silver Co., Inc.

***This novel unit converts any signal generator or test oscillator to a direct-reading resonance indicator.***

**T**HE complex problems encountered by the modern service technician are far removed from those he was required to solve even a few years ago. There has been a gradual transition in servicing technique that identifies itself with the addition of several new and radically different instruments in every progressive radio shop. The new fields of FM and television impose problems that have no counterpart in the average serviceman's experience. The conglomeration of separate instruments required to perform all necessary measurements on present-day equipment represents a considerable initial investment, and is time-consuming from the standpoint that several are needed to analyze even a "run of the mill" service job. Although the unit to be described is designed primarily for the service technician, it has wide application in laboratory, production-testing, and amateur work.

One technique has always been endorsed by technical authorities, and the application of this principle has been followed to the present day. This principle is that of using the signal itself as the medium of determining circuit function. With the advent of high frequency transmission (FM and TV), such a method is no longer practical. Measuring apparatus invariably adds undesired elements to the circuit under test. When dealing with an

amplifier that may be detuned by 2  $\mu\mu\text{fd.}$ , the foregoing statement is certainly justified.

Means, therefore, must be devised to circumvent this inadequacy and allow quick, sure checking of this specialized apparatus. The method to be described is ideal, as it allows measurements without direct mechanical coupling. It permits measurement of all but oscillator frequencies, without the circuit's being energized. It makes possible laboratory caliber comparisons in a simple direct-reading form, eliminating tedious, time-consuming figuration. Every practical frequency range is covered, the only limitation being that of the coupling signal source.

As the heading denotes, the instrument under discussion is primarily a resonance indicator of markedly advanced design. Because of the unit's broad application, it is believed that this article should prove of value to every reader, whether engineer, technician, serviceman, or amateur.

Over a period of time, several authors have described and advocated the use of a grid-dip meter. Essentially, the grid-dip meter is nothing more than an oscillator whose grid current can be changed by coupling an external load to the oscillating tank circuit. The amount of loading depends on the degree of coupling and the  $Q$  of the external circuit. If we

had an i.f. transformer that was tuned to 455 kc., for example, we could check its actual resonance by coupling the grid-dip meter coil field close to this transformer. As the grid-dip oscillator was tuned to the exact frequency of the specimen under test, a pronounced dip would be observed. This is clearly accounted for by the loading effect of the external circuit upon an oscillator, which is inherently a source of extremely poor regulation. By utilizing several coils, it is possible to cover a certain frequency range and determine the resonant frequencies of all tuned circuits, whether they are energized or not. Band-switching is impossible, because of the physical size of the unit. As the higher frequencies are employed, full-scale deflections are difficult to attain, because of the ratio of oscillator efficiency. The physical size of the calibrated dial must be small because of the necessary miniature size of the total unit.

It is this author's opinion that the very valuable grid-dip oscillator never achieved popularity throughout the service profession because of several shortcomings listed above, and also because of its necessary physical size. There is no other single instrument that can perform as many diversified measurements as the grid-dip meter, nor is there a combination of instruments that can perform such measurements as quickly.

The Model 915 "Tubeless Grid-Dip Adapter," in conjunction with a sig-

**RADIO & TELEVISION NEWS**

nal generator, duplicates all of the functions of the old grid-dip meter, and does this without undesired complications. The sensitivity is much higher than that of the grid-dip type, thereby allowing greatly expanded utility. It also permits measurement without oscillator detuning.

As the title indicates, this unit is an adapter and is intended to be used with any signal generator or test oscillator. The output of the generator is connected to the adapter by attachment to a screw terminal located in the instrument back plate. If the generator is on and one of the three coils is plugged into the test probe, a full scale meter reading will be observed. The degree of meter deflection is controlled by the output attenuator of the generator itself. The three coils provided cover the continuous range of 100 kc. through 300 mc. The only frequency limitation is that of the companion generator. Since there is usually a large second, third, and fourth harmonic content in the output of any generator on its highest frequency range, the usefulness is proportionally extended.

We have described a little companion unit that multiplies the value of any standard signal generator that the serviceman now has. At this point, it might be appropriate to outline a typical application.

A timely example might be that of an over-all check of a television receiver. With the generator connected to the adapter, plug in the probe coil covering the receiver i.f. range. Switch the generator to the proper range. Adjust the generator output for a comfortable meter deflection. Place the probe close to the last i.f. coil, and tune the generator until a pronounced dip is observed. Tuning the generator either side of the point of greatest dip will allow direct reading of the i.f. selectivity response. This is directly read from the generator dial. In this case, and in all operations, the tolerance, or frequency accuracy, is that of the generator, which is an extreme advantage over former types. The probe is now moved, by the same method, successively to each i.f. transformer, and similar evaluations are made. The r.f. section now can be checked by the same system. During these operations, the television set does not have to be turned on. If it should appear necessary to check the oscillator, the set is turned on and a headset plugged into the jack provided on the unit. When the signal generator is tuned to the same or a submultiple frequency of the TV oscillator, a loud squeal will be heard in the phones. Simultaneously, the meter will kick downward. For r.f. measurement, the proper coil must, of course, be used. Generators having restricted fundamental ranges but usable harmonics work just as well as more expensive types for this application.

It would be impossible to describe all applications of this test unit in the

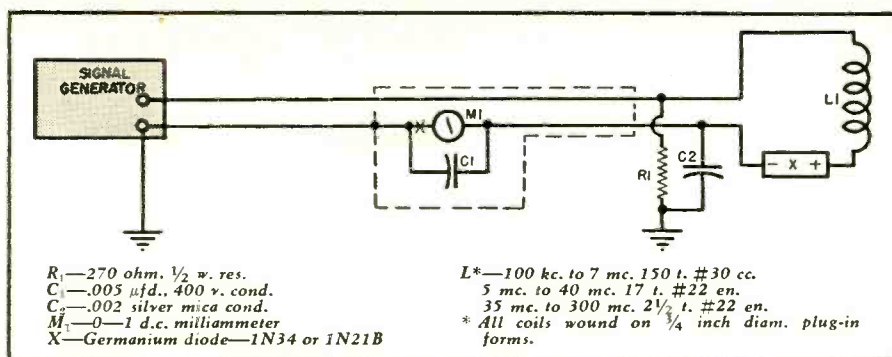

Fig. 2. Complete schematic diagram. Unit covers 100 kc. through 300 mc. A closed circuit jack is inserted at point (X) if audio indications are desired.

allotted space. Under the following basic classifications have been itemized several of the more important functions that this instrument is capable of performing.

#### Resonance Indicator

This function is about the most important from an over-all use standpoint. The circuit under measurement does not have to be energized for this type of checking. The adapter unit is utilized as a grid-dip meter, and is coupled to the companion signal generator. Coupling the appropriate probe coil, inductively, to the circuit or specimen under test will permit direct reading resonance indications. Such indication is, of course, the pronounced meter dip as the generator is tuned through the proper frequency. Under this heading would be such measurements as i.f., r.f. alignment, and general checking. Transmitter tuning would be another application. In design work, all tuned circuits can be carefully evaluated and preset. Production checking of coils and tuned circuits in sub-assemblies is also made much faster. Antenna resonance may be quickly determined. Relative  $Q$  of individual components by comparison is also possible. The photograph below shows a technician using the

unit in conjunction with a standard signal generator to make a quick check of a television i.f. strip. Since this adapter will respond only to the proper resonance point, no misleading effects can exist.

#### Energized Detector

A phone jack is provided so that both audio and visual indications are possible when using the test instrument as an energized detector. The external circuit to be tested may be an oscillator of any type, operating in the aforementioned range of 100 kc. to 300 mc. With the unit connected to the signal generator, plug a headset in the jack provided. When the signal generator is tuned to the fundamental or harmonic frequency of the oscillator, a loud squeal will be heard in the phones. Such a measurement is valuable, as it allows pin-point accuracy when zero beat is reached. To determine where the oscillator should be working, the dip method previously described may be employed prior to this check. Oscillator tracking, output, etc., may be easily analyzed. The probe coil, in this case, may be very loosely coupled to the circuit under test. A complete TV oscillator section may be very quickly set by this meth-

(Continued on page 112)

Serviceman illustrates how the grid-dip adapter unit is used in conjunction with a signal generator to check resonant frequency of a television tuned circuit.

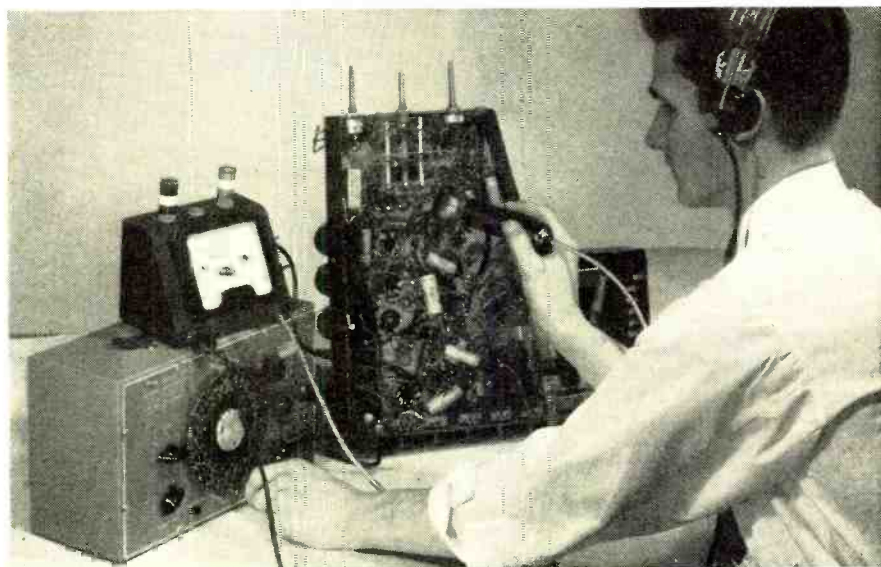

# Regenerative SHORT- WAVE RECEIVER in Miniature

By **ROBERT H. HAWKINS**  
Instructor, Purdue University

**Build this low-cost receiver and make DX-ing a pleasure. It covers 5.5 to 18 megacycle band.**

**A** MINIATURE short-wave receiver that would give fine performance was the objective when this unit was designed, and it has more than fulfilled all expectations.

The use of a separate receiver for covering the 5.5 to 18 megacycle band of frequencies was prompted by the need of really great sensitivity and selectivity to cover the 20-meter amateur band. Most two-band home receivers will cover this band of frequencies, but without the sensitivity found in this regenerative receiver. Regeneration was chosen to give the extreme sensitivity desired, and a stage of tuned radio frequency amplification ahead of the regenerative detector gives excellent selectivity. No electrical band-spread arrangement is employed on this unit and hence the entire 20-meter amateur band is covered in about 4 dial divisions. However, this receiver has a vernier dial and little trouble has been experienced in separating the many amateur stations on this band. A 6C4 triode audio amplifier drives the 6AK6 power amplifier to give plenty of gain for loudspeaker operation on most stations. The audio quality is good and the BBC Symphony from London has been received with excellent quality. It is a fortunate fact that the higher-frequency bands are relatively static-free; thus one of the advantages of frequency modulation,

freedom from static, is approximated in this receiver. For extremely weak signals, a phone jack is supplied, but the author has found little need for it. Amateur stations as far distant as Jerusalem, Palestine, have been received with amazing clarity.

The small size of the receiver makes it an attractive addition to any home. Miniature tubes are used throughout giving excellent performance and filling the small space requirement. Referring to Fig. 1, a photograph of the receiver, the loudspeaker can be seen at the left end of the front panel with the phone jack below it. The bar knob farthest left is the audio gain control with the regeneration control at its right. The vernier-type dial for main tuning is mounted in the center of the panel. The r.f. stage is gang-tuned with the regenerative detector to make for ease of tuning. It was expected that some difficulty would be encountered in trying to make such a combination track over the entire range of frequencies when this unit was first constructed. However, a slight revamping of the number of turns added to the oscillator coil has made for good tracking. The oscillator coil used was a standard Stanwyck S-231 and 12 turns of #22 enameled wire were added as shown in the detail drawing (Fig. 5). Two solder terminals are added between those al-

ternals—plate, "B plus," grid, oscillator tap, and ground. It is suggested that a coating of wax be added after the new winding and terminals are completed. The antenna coil (Stanwyck S-410) is used with no changes and is so placed as to give extremely short leads. The 6AU6 r.f. amplifier not only increases the selectivity of the receiver, but prevents any excessive radiation from the antenna.

To begin construction of this receiver, it is suggested that the following steps be followed. First, study the photographs and circuit diagram until thoroughly familiar with the use and placement of each part. Looking at Fig. 4, the top view of the receiver, let us identify the components. The power transformer is at the upper-left corner of the chassis with the 6X4 rectifier tube and electrolytic filter condenser directly behind it. The two-gang main tuning condenser is in the center of the chassis with the filter choke behind it. Starting at the antenna binding post and working towards the front panel, we find the antenna coil, 6AU6 r.f. amplifier, oscillator coil, 6AU6 regenerative detector, in that order. Starting at the panel in the next row, we find the 6C4 audio amplifier, 6AK6 power amplifier, and audio output transformer. The output leads of the transformer are connected to a Jones terminal strip and thence to the voice coil of the loudspeaker. The parts list should be checked against the photographs to make certain that no parts are omitted or misplaced. Second, lay out a full-size template of the chassis and front panel and then fasten with

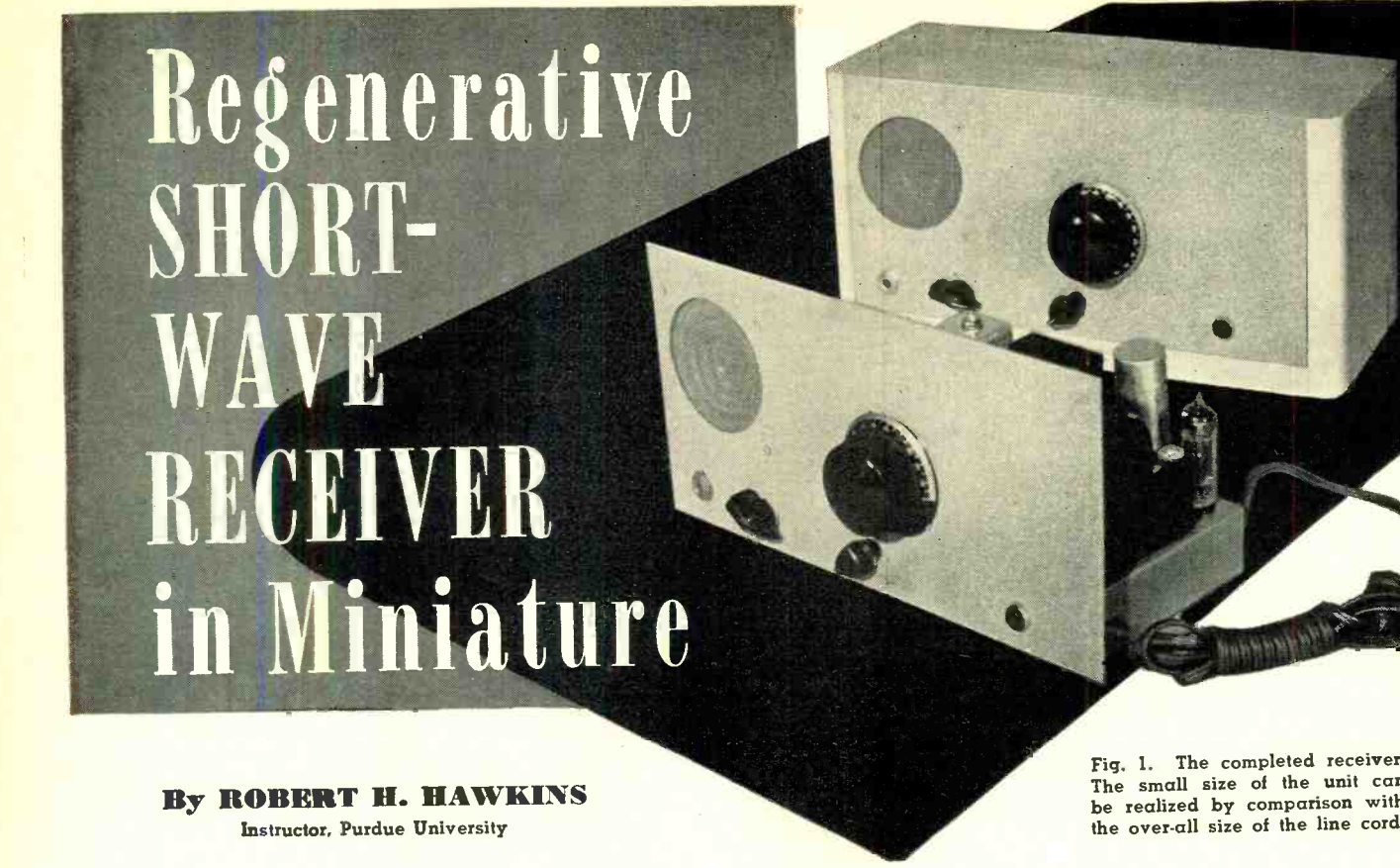

Fig. 1. The completed receiver. The small size of the unit can be realized by comparison with the over-all size of the line cord.

"Scotch" tape to chassis and panel for center punching and drilling. Leave the templates on the parts while drilling as it prevents errors in hole sizes which could ruin the chassis. As long as the templates are correct, then the chassis and panel will be correctly drilled. Third, mount all parts before attempting any wiring and make certain that the tube sockets are mounted so as to give the shortest possible leads. The antenna and oscillator coils should also be mounted to give short leads without any crossovers inside the shield can. A suggestion that will ease the job of wiring is that of removing the 0.5 megohm potentiometer and switch until the regenerative detector is wired. After the wiring on that particular tube socket is completed, the potentiometer can be placed in position.

The wiring job on the receiver can be simplified by duplicating the wiring shown in the bottom view photograph of the receiver. In Fig. 3, the bottom view, a paper condenser can be seen mounted on the outside of the left end of the chassis. This condenser is  $C_{11}$  which connects to the phone jack. Start with the leads coming out of the secondary of the power transformer and commence wiring the power supply. It will be noted that several insulated solder terminals are placed in the chassis to make for ease of connecting the different circuits. Solder the 6.3 volt filament leads to pins 3 and 4 of every tube, then place all the paper condensers in their proper positions. The resistors and mica condensers are placed in position last, but of course, follow the suggestion of wiring the regenerative detector completely before placing the 0.5 megohm regeneration control in its proper place on the chassis.

In selecting parts for the receiver, remember that a good deal of effort will be spent in constructing it, and a faulty component can cause all sorts of difficulties. Using quality components will be a good insurance of long life and good operation. The main tuning dial used in the original unit was removed from a war surplus tuning unit TU-5B and was slightly revamped. A National Velvet-Vernier dial will fill the bill exactly for this

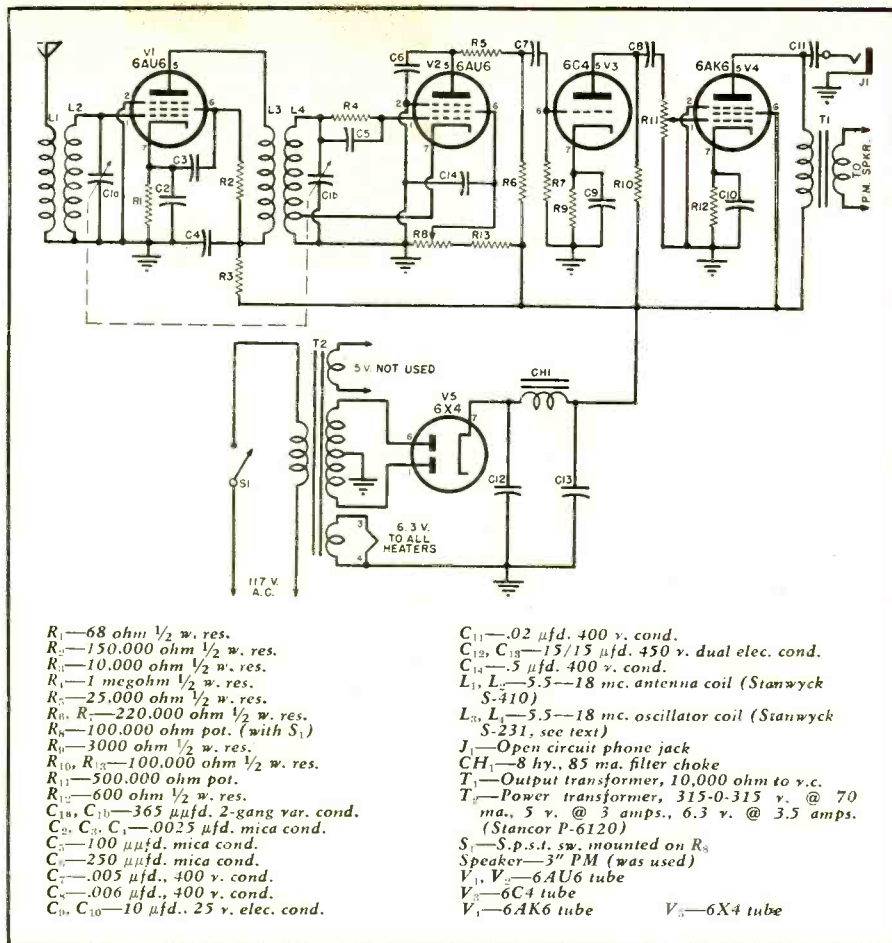

Fig. 2. Complete schematic diagram of the a.c. operated regenerative receiver.

receiver if one is available; however, the entire tuning unit mentioned above can be purchased on war surplus for about \$3.00. The crackle finish shown on the front panel was sprayed on in two coats and baked in an oven. It might be suggested that those having some woodworking experience could easily build a cabinet that would harmonize with period furniture.

Alignment and test of the receiver can be completed in a short time using a standard signal generator and an output meter. Simply inject a signal of 5.5 megacycles into the antenna binding post and adjust the permeability-tuned antenna coil and oscilla-

tor coil until maximum signal is indicated at the speaker terminals by the output meter. Then set the signal generator at 18 megacycles, tune the receiver to the high-frequency end of the dial and make any minor adjustments necessary to again give maximum signal indication.

The original unit locates the 20-meter amateur band at about 70 on the 0-100 dial scale. Regeneration control is smooth and the gain control is usually set about half way towards maximum position. A few pointers on how to tune a regenerative receiver may be in order. After the set has

(Continued on page 106)

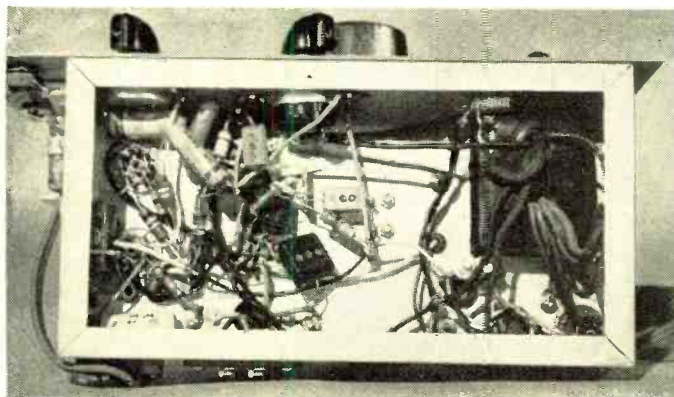

Fig. 3. Bottom view of receiver showing under-chassis components. An exact duplication of parts layout is not necessary.

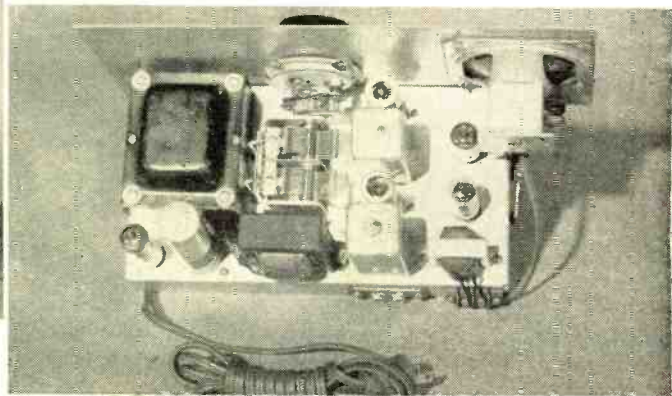

Fig. 4. Top view of receiver showing correct placement of components. Vernier dial used was a revamped surplus unit.



# Modern TELEVISION RECEIVERS

By  
**MILTON S. KIVER**

**Part 14. A complete analysis of the design and operation of Intercarrier TV sound systems.**

**T**O THIS point we have been studying what might conveniently be called the conventional television receiver. In this receiver, shown in Fig. 1, the audio and video signals, after passage through a mixer, are reduced to their i.f. values. At some point after the mixer and before the video second detector, the sound i.f. signal is removed from the video i.f. system and fed to a separate set of i.f. amplifiers which are peaked to the sound i.f. value. After two or three i.f. stages, the audio signal is fed to an FM detector where it is converted to audio frequencies. This is then followed by one or more stages of audio amplification after which the signal is

powerful enough to drive a loudspeaker. Once the two signals have been separated, every precaution is taken in the video system to prevent any sound voltage from reaching the video detector and the subsequent cathode-ray tube. Usually these precautions consist of one or more trap circuits distributed throughout the video system following the point of signal separation.

While this system will operate successfully when properly designed, it does possess several disadvantages when cost becomes an important design factor. Thus, one of the most important stages in the television receiver, the local oscillator, is also one

Present-day television receivers that are designed around an Intercarrier sound system. There are many other TV receivers on the market today that employ the same system.

of its weakest points. We know that the sound i.f. value is the difference between the frequency of the local oscillator and the frequency-modulated sound carrier. If the frequency of the local oscillator should drift, either during the warm-up period when the set is first turned on, or during the operation of the receiver, then the difference frequency produced as a result of the mixing in the mixer will change, too. Thus, consider the case of a television receiver tuned to channel 3 and designed for a sound i.f. of 21.25 mc. On channel 3, the audio carrier frequency is 65.75 mc. and since the oscillator frequency is above this by an amount equal to the sound i.f., the oscillator frequency will be 65.75 mc. plus 21.25 mc., or 87.00 mc. The sound carrier is frequency-modulated, and the modulation shifts the audio carrier frequency plus and minus 25 kc. In other words, the total audio signal for channel 3 can be expressed as 65.75 mc. plus or minus 25 kc.

In the sound i.f. system (including the input discriminator coil), the band pass is about 200-300 kc., although generally the discriminator response is linear only for about 150 kc. If the local oscillator should drift by as little as 75 kc., it is possible for the sound i.f. signal to shift to a non-linear portion of the discriminator characteristic, thereby causing audio distortion. Now, a drift in frequency of 75 kc., with the oscillator functioning at 87 mc., represents a change of less than .09%; at 200 mc., the same frequency drift represents a change of .03%. Using ordinary components, combined with the station selector rotary switches, it can hardly be expected that the local oscillator will not drift more than this during warm-up and even during subsequent operation. It is due to this very situation that oscillators are provided with *fine-tuning* controls which, extended to the front panel, permit the observer to correct



for oscillator drift. While such controls remedy the drifting temporarily, it is annoying to have to use this control several times during each set operation. Furthermore, the oscillator frequency is extremely sensitive to tube capacitance and it is not uncommon to find that the oscillator frequency is altered sufficiently by a tube change to require a complete realignment of the oscillator circuit. Finally, in time, the resistive and capacitive components themselves will change sufficiently in value, even without a tube change, to also require a complete realignment.

The local oscillator is the source of other annoyances. Any inadequate filtering of the "B+" voltage used by the local oscillator will cause the oscillator frequency to vary at a 60-cycle or 120-cycle rate. This results in phase and frequency modulation of the local oscillator, which passes through the sound i.f. system and FM detector and appears as an audible hum. The only remedy for this is complete filtering of the power supply. We also obtain phase and frequency modulation when acoustic feedback from the speaker causes oscillator coils, condensers, and tube elements to vibrate. Vibrations of the cores in permeability or slug-tuned coils or the plates in a condenser can be a difficult annoyance to eliminate.

Solutions to all of the foregoing problems are not unknown, but they usually involve sufficient additional expense to make them unattractive in today's competitive market. Manufacturers are constantly on the alert for methods of decreasing the cost of television receivers and the recently devised Intercarrier television sound system appears to offer economic advantages, as well as the elimination of the effects of oscillator drift.

### Basic Principles of Intercarrier System

In sets employing the Intercarrier system, the sequence of stages follows the form shown in Fig. 2. A quick comparison of this illustration with that of Fig. 1 reveals that separation of the audio and video signals does not occur until both signals have passed through the video second detector and the video-frequency amplifiers. Thus, at first glance, every precaution which was previously taken to insure that the sound voltage did not reach the cathode-ray tube is now seemingly ignored. Another fact which appears contrary to previous principles is the passage of the FM signal through the AM video detector where the possibility of slope detection exists. We thus appear to have here an unworkable combination used as the basis for the Intercarrier system.

From the block diagram, Fig. 2, it is seen that the audio and video signals are received by the r.f. stages of the receiver, lowered in frequency at the mixer by beating with the local oscillator voltage, and then both passed

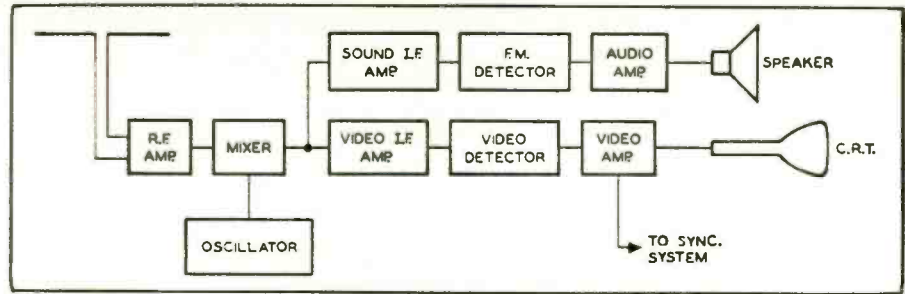

Fig. 1. Block diagram of a conventional television receiver.

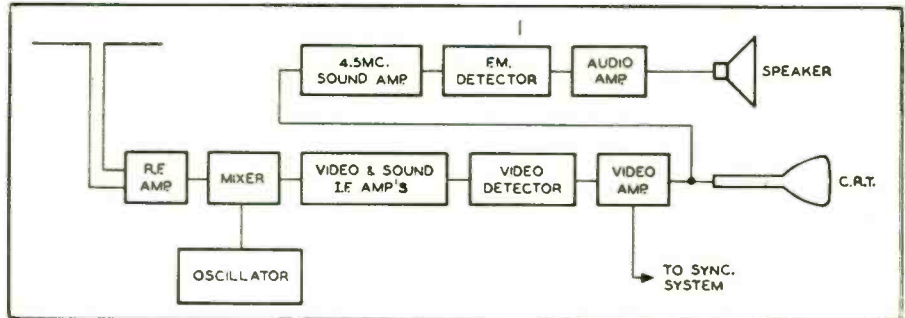

Fig. 2. Block diagram of an Intercarrier TV receiver.

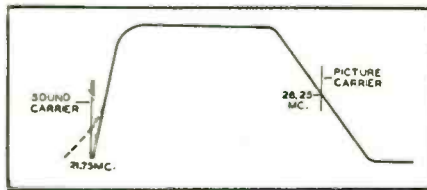

Fig. 3. The solid line represents the desired i.f. response of conventional TV receivers. The dotted line shows the modification required for sets operating on the Intercarrier system. With this change the response becomes more symmetrical.

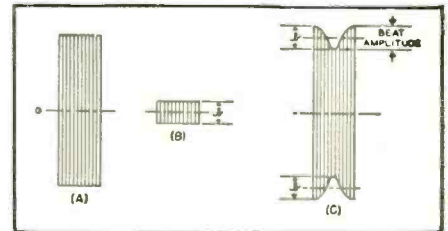

Fig. 4. When two signals beat together, the resultant voltage will contain a beat frequency equal to the frequency difference of the two signals.

together through a common video i.f. system.

The carrier i.f. values after passage through the mixer are the same as they would be using the conventional system of Fig. 1. The intermediate frequencies assigned to each carrier are functions only of the local oscillator setting and to this point in the receiver both systems are identical. The first departure appears in the i.f. system. The video i.f. response characteristic for a conventional receiver is indicated by the solid line in Fig. 3. To adapt

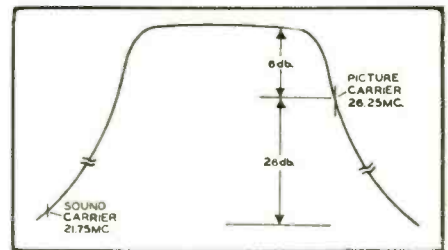
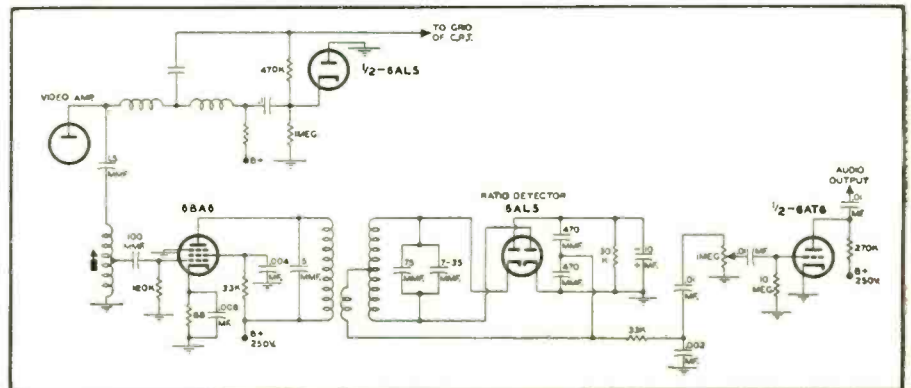
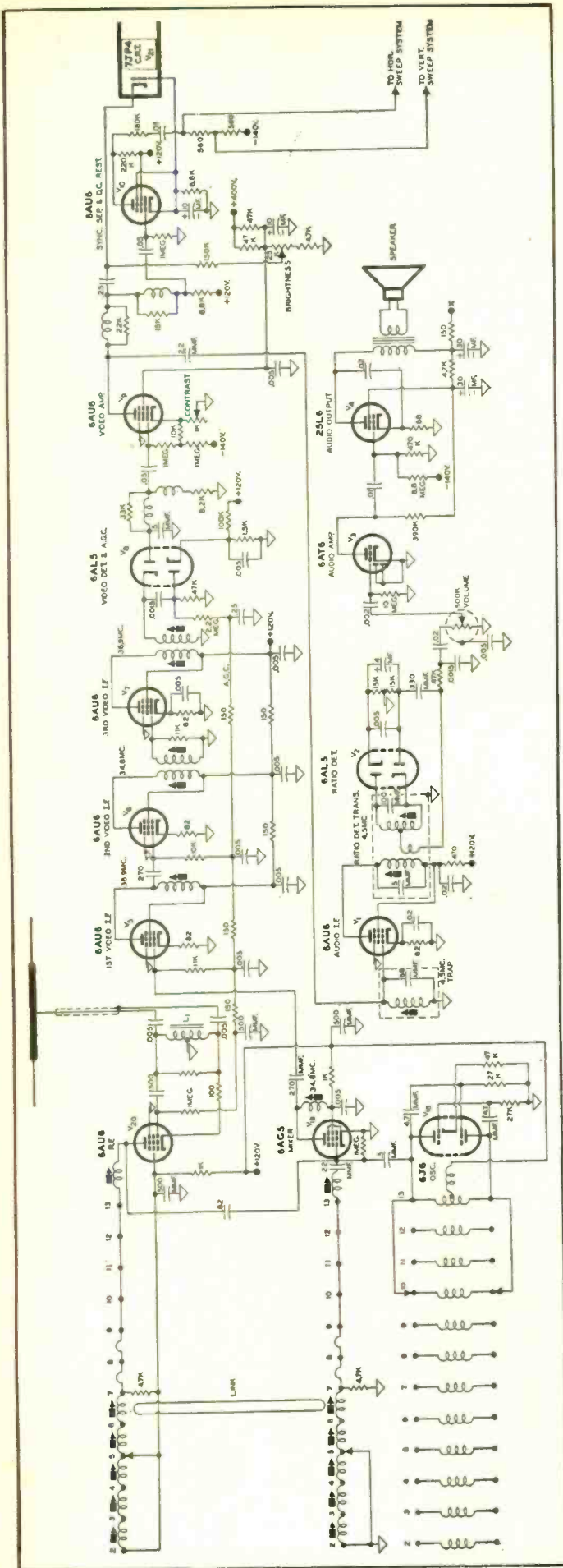

Fig. 5. The i.f. response curve recommended for television receivers employing the Intercarrier system.

Fig. 6. A series resonant trap connected from plate to ground is used to remove the 4.5 mc. voltage from the video system and feed it to the audio system.





this response for the Intercarrier sound system, it must be widened to include the sound i.f. signal, as indicated by the dotted line. However, instead of providing the sound carrier with as much amplification as the video signal receives, we provide it with considerably less amplification, and it is specifically because the sound carrier receives this lesser amount of amplification that the system is able to function. This is important, for if the level of the sound carrier is not kept considerably below the level of the video signal, the latter signal becomes completely unusable.

To understand why the sound carrier level must be considerably below the video signal level, let us look ahead in Fig. 2 to the video detector. The video and sound i.f. signals reach this point in the Intercarrier system after passage through the i.f. system. Now, a detector (such as used ordinarily for the video second detector) operates basically in the same manner as the previous mixer. In both, a mixing process occurs. Thus, in the mixer stage (which has long been known as the first detector), the local oscillator voltage beats with the incoming signal or signals to produce the i.f. signal. At the video second detector, a beating or mixing takes place between the video and sound i.f. carriers with the result that a 4.5 mc. beat note is produced. In this case we could consider the video carrier as being equivalent to the local oscillator and the audio carrier as the incoming signal. The result of the mixing is a 4.5 mc. beat note. In addition to the beat note, we also obtain all of the 0-4 mc. video frequencies from the video carrier.

The reason for keeping the level of the sound carrier low can now be given. Consider the two carriers shown in Fig. 4, A and B. Assume the larger one to be the video carrier and the smaller one to be the audio carrier. If these two signals are mixed together, a ripple will be produced in the resultant wave, Fig. 4C, which will have a frequency equal to the difference between the carrier frequencies. In this case this is 4.5 mc. As long as the amplitudes of the two carriers differ considerably, the amplitude of the 4.5 mc. beat note will remain small and unaffected by any amplitude modulation contained in the video carrier. Here is one of the pivotal points in the Intercarrier television sound system. *By maintaining the sound carrier small in comparison to the video signal, we obtain a 4.5 mc. beat note which contains only the frequency modulation of the original sound r.f. carrier and practically none of the video modulation.*

The sound carrier is continually shifting back and forth between the limits of plus and minus 25 kc. In the mixing process in the video second detector this frequency modulation is imparted by the sound i.f. carrier to the 4.5 mc. beat note. The 4.5 mc. signal represents the difference between the video and sound i.f. carriers. The frequency of the video carrier is fixed, but the frequency of the sound carrier continually shifts back and forth. This changes the value of the beat note. Thus, while we speak of 4.5 mc. as the beat note, we actually mean a beat note with a center frequency of 4.5 mc., but which shifts back and forth about this value to the limits of plus and minus 25 kc. This frequency shifting, remember, represents the sound intelligence of the television broadcast.

Now let us see how the foregoing is employed to make the Intercarrier television sound system workable. When the video carrier (with its amplitude modulation) and the audio carrier are received at the receiver, they have substantially the same amplitude. (The FCC regulations state that the power of the sound carrier be 50 to 150 percent of the power of the video carrier when transmitting synchronizing pulses. However, most stations transmit equal sound and maximum amplitude video carriers.) After passage through the mixer stage, the two signals are converted to their i.f. values and are ready to pass through the i.f. system. If we are to keep the degree of amplitude modulation of the beat note signal to a minimum, it is desirable to keep the level of the sound carrier at least 26 db. below the peak video carrier level at the

(Continued on page 100)

Fig. 7. A portion of the Tele-Tone 7-inch television receiver, which operates on the Intercarrier principle.

# HAMS —

You Still Have Time To Enter The ...

## **RADIO & TELEVISION NEWS**

# \$10,000 00

## **NEW HAM CONTEST**

★ **Closing date extended to March 1, 1950**

★ **Choice of U.S. Savings Bonds or Amateur Radio Equipment**

**I**N ANSWER to many requests and in recognition of the fact that much valuable training time is lost during the vacation period, the judges have decided to advance the closing date of the contest to March 1, 1950. Original closing date was December 31, 1949.

The issuing of new licenses and call letters by the FCC following the successful passing of the amateur radio license examinations sometimes takes as long as six weeks. The new closing date, therefore, will allow sufficient time for this processing to all those passing their exams prior to January 1, 1950, or even later. The two months following should find all new licensees, trained during the contest period, in possession of their coveted tickets. The contestant (trainer) will then have sufficient time to send us the dates and call letters shown on the new licenses of those trained during the contest period.

Contestants will, on or before March 1, 1950, send us the call letters and issuance dates of licenses of the new hams trained by themselves during the contest. These will be checked by the judges from the FCC lists sent to the

publishers of the Radio Amateur Callbook as of March 1, 1950.

U. S. Savings Bonds, if preferred by winners, will be awarded instead of equipment.

Don't underestimate your chance to win. Early entries are mostly from small towns and cities. Hams in our large metropolitan centers are getting off to a slow start. There's plenty of opportunity and time to "hit the jackpot!"

We know that we are all going to win additional prestige and security for our hobby.

That's worth much more than we hams can buy at any price.

How about *you* OM? Can Amateur Radio count on *you* to do your share?

Send in your entry NOW! Don't wait. Remember the new ham can give credit only to one individual or club as his trainer. It's to your advantage as a contestant to list your trainee on your entry blank promptly and send it in.

## **Remember "Amateur Radio Needs New Blood"**

# A TV ANTENNA ORIENTATION

By **FRED MARCO**  
Consulting Engineer

***This novel yet simple test instrument permits a service technician to install a TV antenna without additional help.***

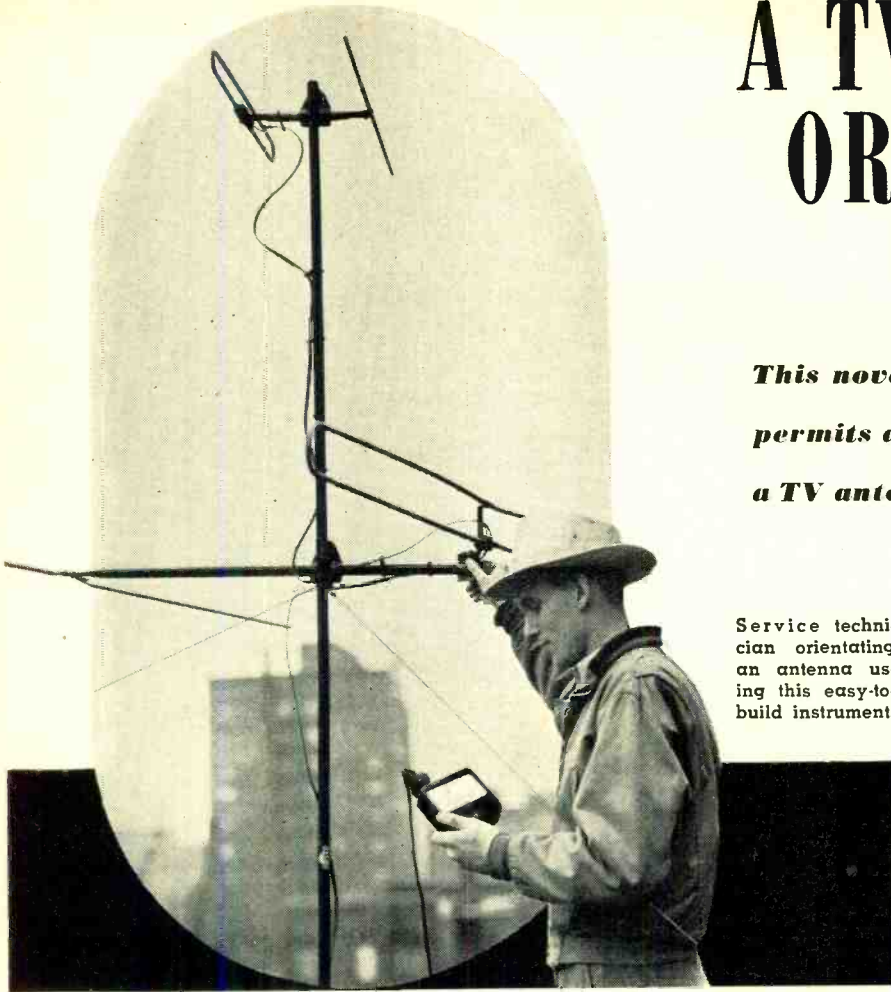

Service technician orientating an antenna using this easy-to-build instrument.

**T**HE proper location and orientation of the TV receiving antenna has always been a major problem to the installation men and service organizations engaged in this type of work. Placing the receiver itself in a room location pleasing to the critical housewife, running the transmission line to the roof, and instructing the customer in the proper operation of the controls is a relatively simple and straightforward procedure, but getting the antenna in the best roof spot and orienting it for the maximum input to the receiver, with a minimum of "ghosts," has been a job requiring good judgment, much tinkering, and a lot of luck.

It has been almost impossible for one man, working alone, to effect the best compromise, unless possessed with infinite patience, lots of time, and energy enough to repeatedly run back and forth from the roof to the receiver, to actually see on the screen the result of a few feet movement or a few degrees rotation of the antenna. Although TV engineers and servicemen have been known to get their necks out pretty far, no one yet has achieved the ostrich-like length necessary to stand on the roof, rotate the antenna, and at the same time, watch the TV screen image.

In order to do a good job in a minimum amount of time, standard pro-

cedure among the better installation houses has been to send *two* men on a job, one of whom stays at the receiver and relays instructions to the roof man, by intercommunicating phones or by sheer lung power. While this method undoubtedly works to a reasonable degree, it is wasteful of manpower and time and also leaves a good deal to the judgment of the downstairs operator.

Now, if the man on the roof could see for himself the result of his adjustments, the maximum effect could be achieved in the minimum time, with complete assurance of peak performance. Since it would be a bit awkward to carry the receiver itself up to the roof, the logical method is the use of an indication device, small, light in weight, easy to read, and low in cost, which can be connected to the receiver and carried to the roof, and which visually interprets the quantity that mainly interests us, the brightness of the received image.

The instrument to be described does exactly this and is known as the *Simpson TV Antenna Compass*.

## **How To Use It**

Actual use of the equipment is simple and straightforward. On a new installation, the receiver is first connected, turned on, and allowed to warm up thoroughly. Meanwhile the

transmission line is installed and the antenna set up temporarily in what appears a likely roof location, and oriented approximately to the direction of the transmitting station. Now, returning to the receiver, the two test clips associated with the junction box are connected to the set. One of these clips is conventional and furnishes the ground return, being merely connected to the chassis at a convenient point. The other clip, the "high" side, is of a special alligator type, having a needle point associated with the jaws in such a manner that the point pierces the insulation of any wire to which it may be attached, thus furnishing contact without the necessity of scraping insulation or finding an exposed terminal. This "high" clip must be attached to the modulated electrode of the picture tube, which in most receivers is the control grid. Some receiver designs put the control grid at ground (r.f.), and drive the cathode. In these cases the "high" clip should be connected to the cathode. The proper lead is readily apparent to the serviceman by inspection of the wiring diagram of the particular receiver being used. See Fig. 1A and Fig. 1B. Since all TV receivers must allow the base of the picture tube to float, the socket is wired to the chassis with flexible, insulated leads, and, therefore, this connection can always be easily made. It may not even be necessary to remove the metallic safety screen on the back of the receiver, since this high lead is usually long enough and has enough slack to be fished through the ventilation holes in the back, thus allowing the inch or so necessary for connection.

Now, with the two clips of the probe properly connected, the meter is plugged into the short extension fitting on the other end of the probe, and a station tuned in. If the receiver has a fine tuning control, this should be adjusted in the conventional manner, and then the contrast (video gain) control, adjusted for approximately half-scale meter reading. The meter itself has a "Hi-Lo" switch to reduce its sen-

**RADIO & TELEVISION NEWS**

antenna and receiver. Usually, in one channel, the antenna will practically match the line, although a mismatch exists in all other channels. Accordingly, a switching test might lead to the erroneous conclusion that a multi-path ghost is present, when, as a matter of fact, line reflection is taking place. Reference to the chart, however, will answer the question conclusively.

The displacement of a ghost image on a kinescope screen depends on the horizontal sweep width and upon the time delay between desired and undesired signals. This time delay has a definite relation to line length in the case of mismatch reflection, and a definite relation to path-length difference in the case of multi-path reception. In the case of line mismatch, the duration of the delay also depends upon the type of line used.

Because a multi-path ghost is considerably more displaced than a mismatch ghost (unless an unusually long line is used), differentiation is possible upon this basis. Furthermore, when a mismatch ghost is present, its displacement on the kinescope screen will check closely with the value found from Fig. 1 with respect to horizontal sweep width, type of line, and line length.

To use this chart, adjust the horizontal sweep width to correspond with the nearest value given in Fig. 1; measure the amount of displacement (leading edge of main image to leading edge of first ghost); and determine or estimate the length of the antenna transmission line. Find the displacement (D) on the vertical axis of Fig. 1 and the line length (L) on the horizontal axis. If the intersection of these two coordinates is approximately on the diagonal for the sweep width and type of transmission line used, then one may reasonably assume that the ghost is caused by a mismatch.

Let us take the following example: A displacement of 0.15 inch is observed on a 10BP4 10-inch kinescope; the sweep width is 8 inches; approximately 325 feet of RG-58/U coaxial cable connects the receiver to the antenna. Since L and D nearly intersect on the RG-58/U line for a 10-inch tube, the conclusion is drawn that the ghost is caused by mismatch. If the line is short and displacement of the ghost image is very small, it may not be possible to measure this displacement on the screen. The effect in this case is that of "fuzziness" or loss of definition and detail.

### Matching Considerations

Representative impedances for both receiver and line are shown in Table 1. It is evident that mismatch difficulties may arise from installation of unsuitable lines, changing receivers, or mixing balanced and unbalanced systems. Television receivers have either balanced or unbalanced input systems, as diagrammed in Fig. 3. The unbalanced input system requires a coaxial line for proper operation; the balanced

(A)	
TYPE OF LINE	CHARACTERISTIC IMPEDANCE
Twin Lead	300, 150, 75 ohms
Coaxial RG-8/U, RG-58/U	53 ohms
Coaxial RG-11/U	75 ohms
Twisted Pair	Large Variation

(B)		
Receiver	Input Circuit Impedance	Type of Input
Admiral	300 ohms	Balanced
Andrea VII2	72 ohms	Unbalanced
Belmont	300 ohms	Balanced
Bendix	300 ohms	Balanced
Consolidated	72 ohms	Balanced
Crosley 9-408	300 ohms	Balanced
Crosley 9-407 M	72 ohms	Unbalanced
Du Mont	72 ohms	Unbalanced
Emerson	300 ohms	Balanced
Feda	300 ohms	Balanced
Farnsworth	300 ohms	Balanced
Gerod	200 ohms	Balanced
G-E 802	300 ohms	Unbalanced
G-E 810	300 ohms	Balanced
Hallcrafters	300 ohms	Balanced
Industrial TV, Inc.	72 ohms	Unbalanced
Magnavox	300 ohms	Balanced
Motorola	300 ohms	Balanced
National	300 ohms	Balanced
Philco	300 ohms	Balanced
Pilot TV37	300 ohms	Balanced
RCA	300 ohms	Balanced
Scott	72-75 ohms	Unbalanced
Stewart-Warner	300 ohms	Balanced
Stromberg-Carlson	72 ohms	Unbalanced
Tele-Tone	300 ohms	Balanced
U. S. TV Mfg. Co.	100 ohms	Balanced
Westinghouse	300 ohms	Balanced

Table 1. (A) Characteristic impedance of several types of television transmission lines. (B) Characteristics of television receiver input circuits.

input requires a twin line (shielded or unshielded). A pair of coaxial lines, or a shielded balanced line provides a shielded balanced input. A twin-lead

line provides an unshielded and balanced input.

Receivers with balanced input systems should be operated from bal-

Fig. 1. Chart may be used to determine whether ghost images appearing on television screens are caused by multi-path reception or by line mismatch.

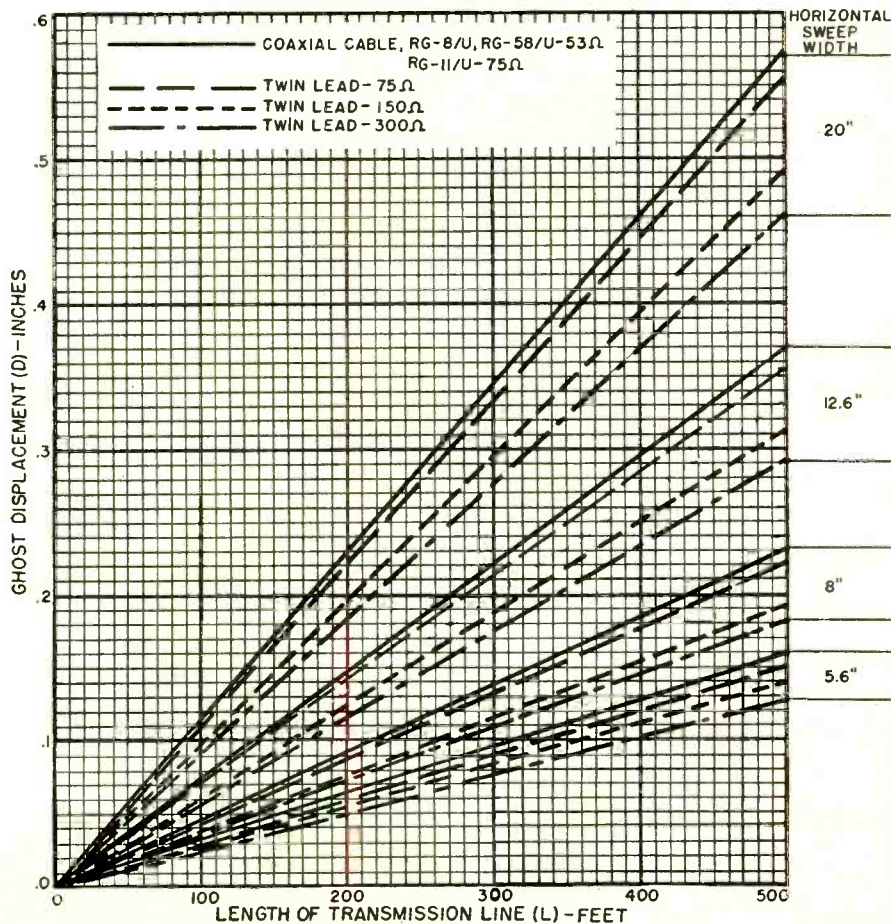

RECEIVER IMPEDANCE (OHMS)	LINE IMPEDANCE (OHMS)				
	53	75	106	150	300
72	$R_1 = 36$ $R_2 = 100$		$R_1 = 62$ $R_2 = 130$	$R_1 = 110$ $R_2 = 100$	$R_1 = 270$ $R_2 = 82$
100	$R_1 = 68$ $R_2 = 75$	$R_1 = 47$ $R_2 = 150$		$R_1 = 91$ $R_2 = 180$	$R_1 = 240$ $R_2 = 130$
150	$R_1 = 120$ $R_2 = 68$	$R_1 = 100$ $R_2 = 100$	$R_1 = 82$ $R_2 = 200$		$R_1 = 220$ $R_2 = 220$
300	$R_1 = 270$ $R_2 = 56$	$R_1 = 270$ $R_2 = 82$	$R_1 = 240$ $R_2 = 130$	$R_1 = 220$ $R_2 = 220$	

All resistance values are in ohms.

(Pad resistances given in nearest five per-cent RMA preferred values.)

Example: A 300-ohm twin line is to be matched to a 75-ohm balanced receiver.

From table,  $R_1 = 270$  ohms,  $R_2 = 82$  ohms,  $\frac{1}{2}R_1 = 135$  ohms.

Pad arrangement is obtained from Fig. 2A.

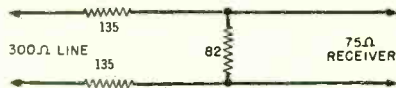

Table 2. Various pad arrangements required when antenna-receiver mismatch occurs.

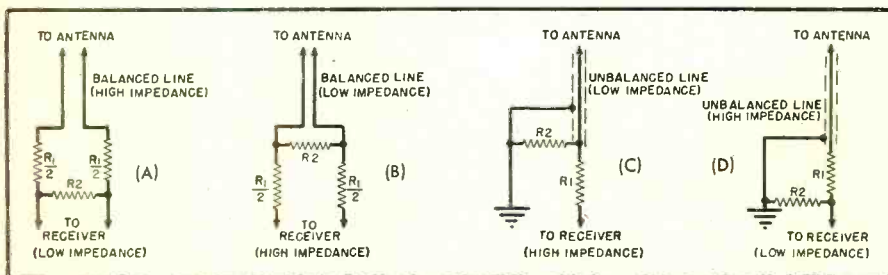

Fig. 2. Pad arrangements for balanced and unbalanced systems.

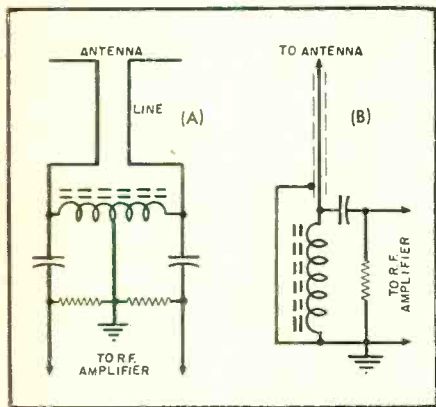
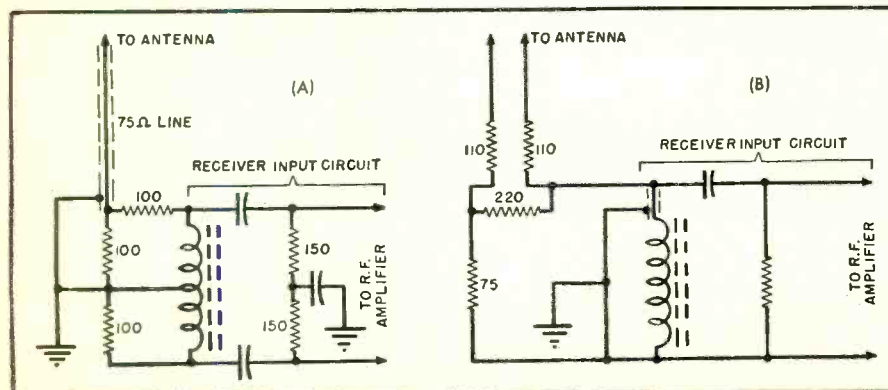

Fig. 3. Conventional balanced input circuit (A) and unbalanced circuit (B).

Fig. 4. (A) An unbalanced line matched to a balanced receiver input circuit. (B) A balanced line matched to an unbalanced receiver input circuit.



anced lines; receivers with unbalanced inputs should be operated from unbalanced (single coaxial) lines. If line-balance converters to operate over the TV band are not conveniently available, it will be necessary to make use of expedients when a balanced receiver is operated from an unbalanced line, or an unbalanced receiver is operated from a balanced line. These expedients are discussed in more detail at a later point.

#### Padding the Line

When a mismatch ghost exists, it can be eliminated by matching the line impedance to the impedance of the receiver input circuit. Matching is accomplished by the insertion of a suitable carbon resistor pad between

the line and the receiver input terminals. At television frequencies, both the line impedance and the receiver impedance are resistive for all practical purposes. Accordingly, simple resistive pads serve the purpose and maintain a practical match over all television channels. An unavoidable power loss, however, is the price which must be paid for ghost-free reception, when pads are used. If this insertion loss cannot be tolerated because of low signal level, the only remaining solution is to install a new transmission line which has the same characteristic impedance as the receiver. In many cases, however, the insertion loss of the pad can be tolerated.

To obtain proper impedance relations with minimum insertion loss, L-type pads are recommended. In the case of receivers with balanced input circuits, half the total series resistance (see Fig. 2) is placed in each side of the line. For receivers with unbalanced input circuits the total series resistance is placed in the "hot" side of the line.

The question is sometimes asked why both series and shunt resistors are used to make up a pad. The answer is that two conditions are to be met: the line should "see" its own impedance when looking into the pad-plus-receiver, and the receiver should "see" its own impedance when looking into the pad-plus-line. The reason for the first condition has been explained above. If the receiver does not "see" its own impedance, the input circuit may be disturbed with corresponding impairment of performance.

When a pad is designed, reference should be made to Fig. 2 to determine the required circuit. The series resistance is placed in the high-impedance side of the system. In addition, the total series resistance is placed in the "hot" side of an unbalanced line, but in a balanced line, half the total series resistance is placed across the low-impedance side of the system.

Next, the values of  $R_1$  and  $R_2$  are determined. If the impedances of both the line and receiver are known, the resistance values can be found from Table 2. If the impedances are unknown, the values may be found by experiment. To determine the values of  $R_1$  and  $R_2$  experimentally, two (or three) potentiometers having at least 300 ohms of resistance are hooked up into the required pad circuit. Only carbon-type potentiometers should be used because wirewound elements have excessive inductance. The settings of the potentiometers are varied until the ghost disappears. Adjustment of the contrast control may be required to maintain satisfactory picture brightness. The values of potentiometer resistance are then measured with an ohmmeter, and the nearest values of small fixed carbon resistors are made up into a pad and permanently installed.

Inspection of Table 2 shows that  
(Continued on page 98)

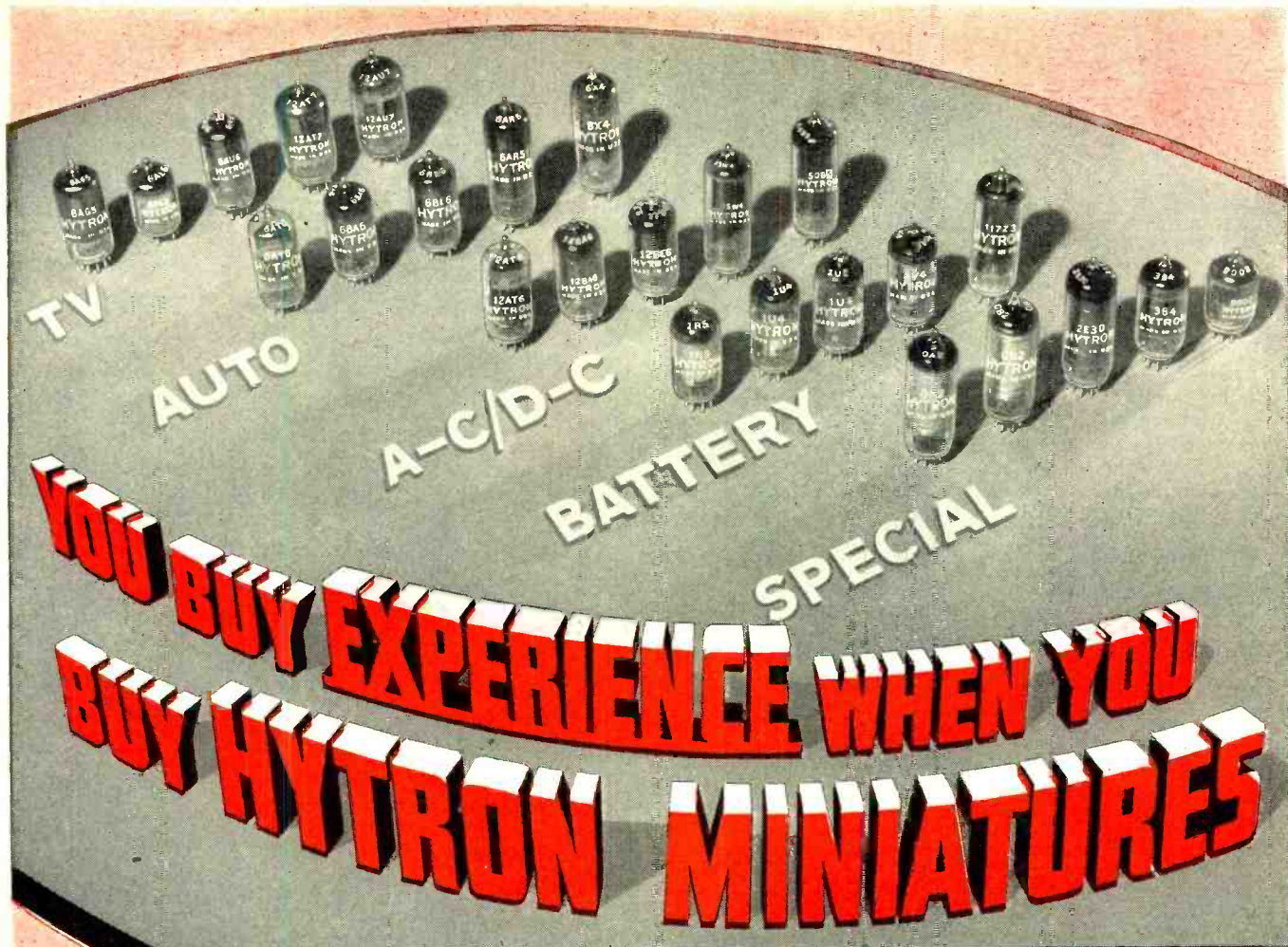

AS YOU CAN READILY IMAGINE, these little fellows are tough to make—and make right—because they are so darned tiny. A heck of a lot of *experience* is a must.

Hytron has it. First to telescope standard glass tubes to Bantam GT size. First to originate the subminiature. First to make even subminiatures tinier. First to build the smallest subminiature used in the wartime proximity fuse.

With this background in making 'em *small*, Hytron manufactured millions of wartime miniatures like the 6AK5, 9001, 9002. Quite naturally, it began to originate miniatures too. Some of the more famous: 6AR5, OB2, 2E30. Hytron also originated the first and only Reference Guide (now in its third edition) for *all* miniatures, regardless of make.

Yes, when you buy Hytron miniatures, you buy the most valuable advantage any manufacturer can offer you. *Experience*.

SPECIALISTS IN RADIO RECEIVING TUBES SINCE 1921



**HYTRON**  
RADIO AND ELECTRONICS CORP.



MAIN OFFICE: SALEM, MASSACHUSETTS

keeping up  
with radio



## THE ONLY BOOKS of THEIR KIND



### SURPLUS RADIO CONVERSION MANUAL IN TWO VOLUMES

Here is a set of reference data which has become standard for the most commonly used items of surplus electronic equipment. All conversions are practical and yield a useful item of equipment; all have been proven by testing on several units. Listed below are the many worthwhile items included in these helpful, unusual reference books.

#### VOLUME I

BC-221 Frequency Meter  
BC-342 Receiver  
BC-312 Receiver  
BC-34R Receiver  
BC-112 Oscilloscope as a test scope or as a television receiver  
BC-645 420-Mc. Transmitter/Receiver  
BC-453A Series Receivers  
BC-157A Series Transmitters  
SCR-522 144-Mc. Transmitter/Receiver  
TBY Transceiver with Xtal Control  
PE-103A Dynamo/or  
BC-1068A V-h-f Receiver  
Electronics Surplus Index  
Cross Index of VT-Number tubes

#### VOLUME II

ARC-5 and BC-454 Rcvrs for 28-Mc.  
ARC-5 and BC-157 Tx for 28-Mc. Mobile  
ART-13 and ATC Transmitter  
Surplus Beam Rotating Mechanisms  
Selenium-Rectifier Power Units  
Hi-Fi Tuner from BC-946B Rcvr  
ARC-5 V-h-f Transmitter  
GO-9 and TBW Transmitters  
9-Watt Amplifier from AM-26  
TA-12B and TA-12C Transmitters  
AVT-112A Transmitter for Aircraft  
BC-375 and BC-191 Transmitters  
Model LM Frequency Meter  
Primary Power Requirements Chart  
ARB Receiver Diagram Only

**\$2.50** FOR EITHER VOLUME AT YOUR DEALER—On mail orders from us, \$2.60 postpaid.

### ANTENNA MANUAL



The only practical, comprehensive book on antennas. 300 pages of down-to-earth help on antenna, feed line, radiation and propagation for all frequencies up to 1000 Mc. including FM and TV. Plain language; no need to brush up on math. A necessity for everyone interested in transmission or reception.

**\$3.50** AT YOUR DEALER—On mail orders from us, \$3.60 postpaid. Add tax in Cal. Foreign, \$3.75

### RADIO HANDBOOK

11th Edition



Radio's outstanding practical text, with the greatest array of radio equipment. All tested in our own shop in actual use. Transmitters—all bands, powers up to 1 kw.; antennas and lines; arrays; conversions of surplus; beam-tetrode amplifiers; FM; new v-f-o's; extensive tube tables. BIGGER THAN EVER BEFORE!

**\$3.00** AT YOUR DEALER—On mail orders from us, \$3.25 postpaid. Add tax in Cal. Foreign, \$3.50

### WORLD'S RADIO TUBES

(Radio Tube Vade Mecum)



The only book of its kind in the world. 12 languages with more than 10,000 tubes listed. The most complete set of tube data in existence. Many carefully prepared charts. Tube characteristic data of U.S., British, French, Czech, German, Swiss, Australian, Italian, Russian, Japanese, Scandinavian and all other available types... all in one book!

**\$3.00** AT YOUR DEALER—On mail orders from us, \$3.10 postpaid. Add tax in Cal. Foreign, \$3.25

# EM DATA for Surplus Tubes

Useful efficiency-modulation (EM) information on twenty popular war surplus transmitting tubes.

**T**HE reasonable price of surplus high-power tubes and high-voltage power supply parts has resurrected a certain amount of amateur interest in efficiency-modulated final amplifiers. Efficiency-modulated stages allow a lot of r.f. power to be modulated with a small amount of audio. The three EM systems of interest to the ham are the class B linear r.f. amplifier, class C grid-modulated amplifier, and cathode-modulated amplifier.

The efficiency of class B linear amplifiers and of class C grid-modulated stages is about 30%; that of cathode-modulated amplifiers about 55%. This means that the class B linear and the class C grid-modulated finals will give about 300 watts output with the legal input of 1 kw., while the cathode-modulated final will give about 550 watts output for 1 kw. input. So far, so good. That's all right, we say, because surplus tubes and equipment are cheap and we make a big saving on modulation equipment. Furthermore, the decibels difference between a 550 watt cathode-modulated-carrier and a 750 watt plate-modulated carrier hardly is worth the higher cost of plate modulation. But the picture is not as rosy as it appears at first glance—and plate dissipation

of the tube is the fly in the ointment.

Plate dissipation puts a limit on the maximum amount of power we can put into the EM final. We cannot just dump 1000 watts into a tube rated to take that much input, and then take out 300 watts of r.f. unless the plate dissipation rating is high enough to "take" the remaining 700 watts difference. In the case of a cathode-modulated final running at 1 kw. input, the plate must dissipate the 445 watts difference!

There is a certain maximum amount of power which any tube will handle safely in an efficiency-modulated amplifier without exceeding the plate dissipation. And we should not exceed that input value. What we can do with a surplus tube in an EM final depends, therefore, upon the plate dissipation of the tube.

For the convenience of the reader, the accompanying table has been prepared to show the highest EM input power and corresponding output power for 20 of the most suitable surplus tubes. No tube has been included in this list if its dissipation figure is lower than 100 watts. The wattages in the table are for single tubes. Twice as much input and output can be expected with two tubes in push-pull or parallel.

Highest EM input power and corresponding output power for twenty popular tubes.

TUBE TYPE	CLASS C GRID MOD. or CLASS B LINEAR		CATHODE MOD.	
	Input	Output	Input	Output
100TH	150	50	333	183
VT127A	150	50	333	183
204A	375	125	555	305
211	150	50	333	183
250TH	375	125	555	305
250TL				
304TH				
304TL	450	150	666	366
450TH	675	225	1000	555
527	450	150	666	366
805	187	62.2	278	154
806	337	112	500	275
810	225	75	334	184
813	150	50	333	183
822	300	100	445	245
833A	675	225	1000	555
838	150	50	333	183
845	150	50	333	183
852	150	50	333	183
860	150	50	333	183

Editors and Engineers  
LIMITED

1302 KENWOOD ROAD, SANTA BARBARA, CALIFORNIA





# Heathkit TEST



Heathkit engineer measuring frequency response and distortion of Heathkit Oscilloscope using Hewlett Packard Audio Generator and Distortion Analyzer.

## 1949 MODEL Heathkit VACUUM TUBE VOLTMETER KIT



**\$24.50**

Comes complete with cabinet — panel — three tubes — new Mallory switches — test prods and leads, 1% ceramic divider resistors and all other parts. Complete instruction manual for assembly and use. Better start your laboratory with this precision instrument. Ship. Wt., 8 lbs.

### Features

- New 200 ua Meter. 24 Ranges.
- New Accessory H.V. Probe makes Heathkit a kilovoltmeter. (Extra)
- New Accessory RF Probe extends range to 100 megacycles. (Extra)

A new Model V-2 Heathkit VTVM with new 200 microampere meter, four additional ranges — full scale linear ranges on both AC and DC of 0.3 V., 10 V., 30 V., 100 V., 300 V. and 1,000 V. Accessory probe listed elsewhere in ad extends voltage range to 3,000 and 10,000 volts D.C. New model has greater sensitivity, stability and accuracy — still the highest quality features — shatterproof plastic full view meter face — automatic meter protection, push pull electronic voltmeter circuit, linear scales — db. scale — ohmmeter measures 1/10 ohm to 1 billion ohms with internal battery — isolated DC test prod for dynamic measurements — 11 megohm input resistance on DC — AC uses electronic rectification with 6H6 tube. All these features and still the amazing price of only \$24.50.

## Heathkit RF SIGNAL GENERATOR KIT

**\$19.50**

Nothing  
ELSE TO BUY

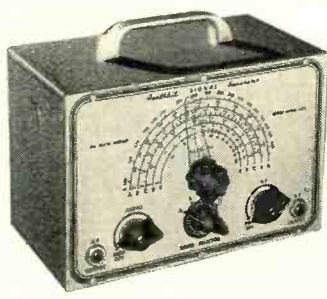

Every shop needs a good signal generator. The Heathkit fulfills every servicing need, fundamentals from 150 Kc. to 30 megacycles with strong harmonics over 100 megacycles covering the new television and FM bands. 110 V. 60 cycle transformer operated power supply. 400 cycle audio available for modulation or audio testing. Uses 6SN7 as RF oscillator and audio amplifier. Complete kit has every part necessary and detailed blueprints and instructions enable the builder to assemble it in a few hours. Large easy to read calibration. Convenient size 9" x 6" x 4 3/4". Shipping Wt., 4 1/2 lbs.

## Heathkit 5" OSCILLOSCOPE KIT

### Features

- Instant switching to plates or amplifier from front panel.
- Sweep generator supplying variable sweep 15 cycles to 30,000 cycles.
- All controls on front panel.
- Cased electrostatically shielded 110 V. 60 cycle power transformer.
- AC test voltage on front panel.
- External synchronization post on front panel.
- Deflection sensitivity .65 V. per inch full gain.
- Frequency response  $\pm$  20% from 50 cycles to 50 Kc.
- Input impedance 1 Megohm and 50 MMF.

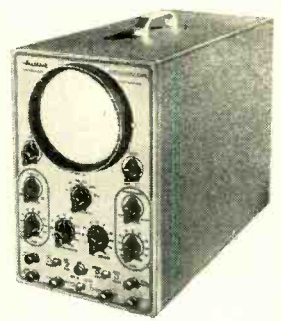

The Heathkit 5" Oscilloscope fulfills every servicing need. The husky cased power transformer supplies 1100 Volts negative and 350 Volts positive. Tubes supplied are two 6SJ7 amplifiers, 884 sweep generator, two 5Y3 rectifiers, and 5BPI CR tube. Grey crackle aluminum cabinet and beautiful grey and maroon panel. Chassis especially designed for easy assembly.

An oscilloscope provides endless sources of experimentation in radio, electronics, medicine and scientific research. Detailed instructions make assembly fun and instructive. Shipping Wt., 24 lbs. Express only.

**\$39.50**

Nothing  
ELSE TO BUY

## New Heathkit SIGNAL TRACER AND UNIVERSAL TEST SPEAKER KIT

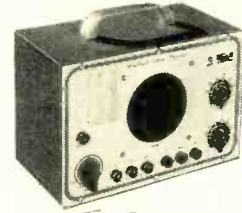

**\$19.50**

Nothing  
ELSE TO BUY

The popular Heathkit signal tracer has now been combined with a universal test speaker at no increase in price. The same high quality tracer follows signal from antenna to speaker — locates intermittents — defective parts quicker — saves valuable service time — gives greater income per service hour. Works equally well on broadcast — FM or TV receivers. The test speaker has assortment of switching ranges to match push pull or single output impedance. Also tests microphones, pickups — PA systems — comes complete — cabinet — 110 V. 60 cycle power transformer — tubes, test probe, all parts and detailed instructions for assembly and use. Shipping Wt., 8 lbs.

## Heathkit ELECTRONIC SWITCH KIT

DOUBLES THE UTILITY OF ANY SCOPE

An electronic switch used with any oscilloscope provides two separately controllable traces on the screen. Each trace is controlled independently and the position of the traces may be varied. The input and output traces of an amplifier may be observed one beside the other or one directly over the other illustrating perfectly any change occurring in the amplifier. Distortion — phase shift and other defects show up instantly, 110 Volt 60 cycle transformer operated. Uses 5 tubes (1 6X5, 2 6SN7's, 2 6SJ7's). Has individual gain controls, positioning control, and coarse and fine sweeping rate controls. The cabinet and panel match all other Heathkits. Every part supplied including detailed instructions for assembly and use. Shipping Wt., 11 lbs.



**\$34.50**

## Heathkit 3-TUBE ALL WAVE RADIO KIT



**\$8.75**

An ideal way to learn radio. This kit is complete ready to assemble, with tubes and all other parts. Operates from 110 V. AC. Simple, clear detailed instructions make this a good radio training course. Covers regular broadcasts and short wave bands. Plug-in coils. Regenerative circuit. Operates loud speaker. Shipping Wt., 3 lbs.

HS30 Headphones per set.....	\$1.00
2 1/2" Permanent Magnet Loudspeaker.....	1.95
Mahogany Cabinet.....	2.95

# EQUIPMENT must be good!



MATCHED TO THE HIGHEST PRECISION STANDARDS...



## New Heathkit TELEVISION ALIGNMENT GENERATOR KIT

Everything you want in a television alignment generator. A wide band sweep generator covering all FM and TV frequencies — a marker indicator — AM modulation for RF alignment — variable calibrated sweep width 0.30 Mc. — mechanical driven inductive sweep. Husky 110 V. 60 cycle power transformer operated — step type output attenuator with 10,000 to 1 range — high output on all ranges — band switching for each range — vernier driven main calibrated dial with over 45 inches of calibrations — vernier driven calibrated indicator marker tuning. Large grey crackle cabinet 16-1/8" x 10-5/8" x 7-3/16". Phase control for single trace adjustment. Uses our high frequency triodes plus 5Y5 rectifier — split stator tuning condensers for greater efficiency and accuracy at high frequencies — this Heathkit is complete and adequate for every alignment need and is supplied with every part — cabinet — calibrated panel — all coils and condensers wound, calibrated and adjusted. Tubes, transformer, test leads — every part with instruction manual for assembly and use. Actually three instruments in one — TV sweep generator — TV AM generator and TV marker indicator. Also covers FM band. Deliveries start early in March. Order early.

**\$39.50**

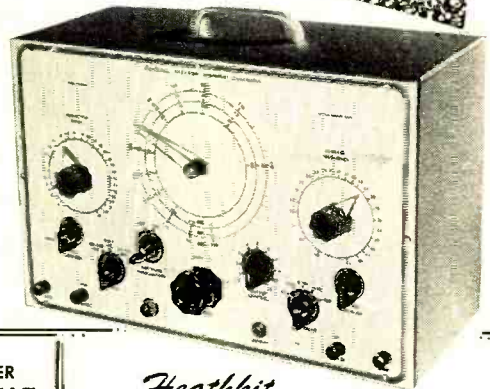

## Heathkit SINE AND SQUARE WAVE AUDIO GENERATOR KIT



**\$34.50**  
*Nothing ELSE TO BUY*

Experimenters and servicemen working with a square wave for the first time invariably wonder why it was not introduced before. The characteristics of an amplifier can be determined in seconds compared to several hours of tedious plotting using older methods. Stage by stage, amplifier testing is as easy as signal tracing. The low distortion (less than 1%) and linear output ( $\pm$  one db.) make this Heathkit equal or superior to factory built equipment selling for three or four times its price. The circuit is the popular RC tuning circuit; using a four gang variable condenser. Three ranges 20-200, 200-2,000, 2,000-20,000 cycles are provided by selector switch. Either sine or square waves instantly available at slide switch. All components are of highest quality, cased 110 V. 60 cycle power transformer, Mallory F.P. filter condensers, 5 tubes, calibrated 2 color panel, grey crackle aluminum cabinet. The detailed instructions make assembly an interesting and instructive few hours. Shipping Wt., 13 lbs.

## 110 V. A.C. MILITARY RECEIVER POWER SUPPLY KIT



**\$5.95**

Ideal way to convert military sets. 110 V. 60 cy. transformer operated. Supplies 24 volts for filament — no wiring changes inside radio. Also supplies 250 V. D.C. plate voltage at 50-60 MA. Connections direct to dynamotor input. Complete with all parts and detailed instructions. Ship. Wt., 6 pounds.

## 110 V. A.C. TRANSMITTER POWER SUPPLY KIT

For BC-645, 223, 522, 274N's, etc. Ideal for powering military transmitters. Supplies 500 to 600 volts at 150 to 200 MA plate, 6.3 C.T. at 4 Amps., 6.3 at 4 Amps., and 12 V. at 4 Amps. Can be combined to supply 3-6-9-12 or 24 volts at 4 amperes. Kit supplied complete with husky 110 V. 60 cycle power transformer, 5U4 rectifier, oil filled condensers, cased choke, punched chassis, and all other parts, including detailed instructions. Complete — nothing else to buy. Shipping Wt., 22 lbs.



**\$14.50**

## Heathkit CONDENSER CHECKER KIT

**\$19.50**  
*Nothing ELSE TO BUY*

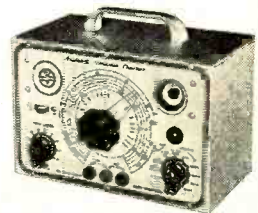

### Features

- Bridge type circuit
- Magic eye indicator
- 110 V transformer operated
- All scales on panel
- Power factor scale
- Measures resistance
- Measures leakage
- Checks paper-mica-electrolytics

Checks all types of condensers, paper-mica-electrolytic-ceramic over a range of .00001 MFD to 1000 MFD. All on readable scales that are read direct from the panel. NO CHARTS OR MULTIPLIERS NECESSARY. A condenser checker anyone can read without a college education. A leakage test and polarizing voltage for 20 to 500 volts provided. Measures power factor of electrolytics between 0% and 50%. 110 V. 60 cycle transformer operated complete with rectifier and magic eye tubes, cabinet, calibrated panel, test leads and all other parts. Clear detailed instructions for assembly and use. Why guess at the quality and capacity of a condenser when you can know for less than a twenty dollar bill. Shipping Wt., 7 lbs.



The **HEATH COMPANY**

... BENTON HARBOR 15, MICHIGAN



# ELECTRONIC BARGAINS for EXPERIMENTERS and HOBBYISTS

ORDER NOW . . . ALL QUANTITIES LIMITED



**PE101C BC645 POWER SUPPLY**  
NO. 273. Complete power supply for BC 645. Operates from 12 or 24 Volts. Supplies both AC and DC required. Shipping Wgt. 13 lbs. Each **\$3.95**

**DM 35 12 VOLT DYNAMOTOR**  
NO. 274. New input 12 Volt at 18.7 Amperes. Supplies 675V at 275 MA or 1/2 above voltage from 6 volts. Excellent for auto use. Shipping Wgt. 11 lbs. Each **\$7.50**

**HOME WORKSHOP GRINDER KIT**  
NO. 230. Easily assembled 110V AC or DC ball bearing fully enclosed motor from Army surplus dynamotor. Purchaser to make simple changes and shaft extensions, detailed instructions and all parts supplied. Motor approximately 5,000 R.P.M. Ideal for tool-post grinder, flexible shaft tool, model drill press, saw. Shipping Weight 6 lbs. **\$3.95**

**COLLINS AUTOTUNE CONTROL HEAD**  
NO. 278. Brand new controls used on the ART/13, 100 Watt, Transmitter. Types 7, 8, 10, and 11 available. Get a spare while available as new cost is over \$22.00 each. Shipping Wgt. 3 lbs. Price any type (mention when ordering). Each **\$4.50**

**300 MA SELENIUM RECTIFIERS**  
NO. 209. Rated 300 MA at 36 Volts, complete with mounting brackets. Shipping Wgt. 1 lb. **3 FOR \$1.00**

**1N90 FEED THROUGH INSULATOR**  
NO. 276. Heavy duty feed through, 2" diameter 4" long, complete with brass hardware and gasket. Shipping Wgt. 2 lbs. **2 FOR \$1.00**

**1N86 STRAIN INSULATOR**  
NO. 277. Husky army type 1 1/4" diameter, 5 1/4" long. Brown porcelain. Shipping Wgt. 4 lbs. **4 FOR \$1.00**

**G.E. BC 306 ANTENNA TUNING UNIT**  
NO. 231. Matches any aerial to 150 Watt transmitter, used on BC 375. Brand new. Add postage for 20 lbs. **\$2.95**

**G. E. 1,000 VOLT 350 MA DYNAMOTOR**  
NO. 213. An ideal dynamotor for mobile operation in taxicabs, police cars, sound systems and amateur stations. Supplies above voltage from 12 Volts or 500V. at 350 MA from 6 Volts. Complete with starting relay, and fuses. New. Our Dynamotor A. Shipping Weight 72 lbs. **\$5.95**

**POWER TRANSFORMER Specials**  
NO. 226. Primary 117V. 60 cycle. Secondaries supply 746 V. CT at 220 MA, 6.3V. at 4.5 A., and 5V. at 4A. Will handle 13 tube radio receivers. Supply is limited, order early. Shipping Weight 11 lbs. each. **\$3.95 . . . 3 for \$9.95**

**T32 TABLE MICROPHONE**  
NO. 210. One of the Army's best. Built by Kellogg, ideal for factory call system, public address, amateur use. Brand new in original cartons. Add postage for 5 lbs. **\$2.95**

**MINIATURE ELECTRIC MOTOR**  
NO. 211. Tiny Delco motor only 1" x 1 1/4" x 2" 10,000 RPM. Operates from 6 to 24 V. Excellent for models. Add postage for 1 lb. **\$2.95**

**OUTPUT TRANSFORMER**  
NO. 227. Push pull 6V6's to 6-8 ohm voice coil excellent characteristics. **3 for \$1.95**

**RCA SATURABLE REACTOR TRANSFORMER**  
NO. 246. New RCA No. CKV30531 AC current 750 MA DC current 2 Amperes. Rated 1.75 henries. Shipping wgt. 4 lbs. Each **\$1.00**

**12.6V POWER TRANSFORMER**  
NO. 247. New cased 110 V 60 cy. Power Transformer. Supplies 440V Ct. at 60 MA, 6.3V at 2A., and 12.6V at 1 Amp. Excellent for military sets. Shipping Wgt. 6 lbs. Each. **\$1.95**

**RCA INPUT TRANSFORMER**  
NO. 248. Heavy duty RCA No CKV-30529. Input has primaries 600 to 200 and 25 ohms secondary 250,000 ohms C.T. Shipping Wgt. 2 lbs. Each **\$1.00**

**FEDERAL POWER TRANSFORMER**  
NO. 252. New cased 110V 60 cy. Power Transformer. Supplies 480V CT at 50 MA and 6.3 V at 2.1 Amps. A beautiful transformer. Shipping Wgt. 4 lbs. Each. **\$1.50**

**MILITARY POWER TRANSFORMERS**  
NO. 229. Convert your military receivers without rewiring the filament. "A" type supplies 500 VCT at 50 MA, 5V. at 2A. and 24V. at 1/2 A. "B" type supplies 500 VCT at 50 MA, 5V. at 2A. and 12V. at 1 Amp. State whether A or B type desired. **\$2.95** Shipping Weight 4 lbs.

**WALKIE TALKIE TRANSFORMER**  
No. 744. Carbon microphone input transformer and output to headphone transformer, all in one case, excellent for building your own. Shipping Wt. 1 lb. **4 for \$1.00**

**LOW PASS FILTER UNIT**  
No. 637. 3000 cycle cutoff consists of 3 inductances and 4 capacitors in network, 500 ohms in and out. Excellent for clipping all frequencies above 3000 cycles. Drawn steel case, shipping Wt. 5 lbs. **\$2.50**

**FM PUSH BUTTON TUNER**  
NO. 224. Brand new ten push button tuning assembly from Army FM receiver. Contains 4 gang 100 MMF silver plated tuning condenser. Add postage for 10 lbs. **\$2.50 EACH**

**BC 746 TUNING UNIT**  
NO. 257. Plug in transmitter tuning unit from army Walkie Talkie. Contains antenna and tank coils, tuning condenser, transmitting and receiving crystals. Ideal transmitter foundation. Shipping Wgt. **\$1.00** 1 lb. Each (Same as above except transmitter crystal in 80 meter amateur band \$2.50 each)

**T30 THROAT MICROPHONE**  
NO. 258. Makes excellent contact microphone for musical instrument or vibration pick-up. Shipping Wgt. 1 lb. **\$1.00 each** Extension cord with switch for above **\$.50 each**

**BC731 CONTROL BOX**  
with Weston Model 476 AC Voltmeter  
NO. 208. Excellent buy in motor control box. Size 8"x10"x5 1/2". Contains Weston 0-150V. AC 3 1/2" voltmeter, motor starting switch, 28 fuses all 30 Amp 110V. and 8 fuse holders. Fuses and holders alone worth the price. Shipping Weight 18 lbs. **\$7.95**

**METER SPECIAL**  
NO. 237. Brand new DeJur Model 312 0-800 M.A. D.C. Square 3" 0-10 M.A. basic meter with built in shunt. Probably the best buy ever offered in a surplus meter. **\$2.95** Shipping Weight 1 lb.

**HEARING AID HEADPHONES**  
NO. 216. The Army's best - eliminate flat ears and outside noise. Complete with transformer for conversion from low to high impedance. With cord and plug complete. Add postage for 1 lb. **\$1.00**

**BC 451 CONTROL BOX**  
NO. 236. Control box for 274N transmitters. Contains proper cv-voice switch, 4 channel switch, power switch, mike jack and telegraph key. Add postage for 2 lbs. **\$1.95**

**100 MA FILTER CHOKE**  
No. 641. Heavy 1.5 henry choke in drawn steel case, 50 ohm resistance, conservatively rated at 100 MA. Shipping Wt. 1 lb. **50c**

**FILAMENT TRANSFORMER**  
No. 922. 220V. 60 cy. primary supplies 12.6V. at 3.5 Amps, 15.6V at 1 Amp. Supplies 6.3 at 3.5 Amps and 7.8V. at 1. Amp from 110V. Shipping Wt. 8 lbs. **\$1.50**

**PANEL METER**  
Burlington O-300 VAC Meter  
No. 290. Model 32XA 3 1/2" round AC Voltmeter 0-300 VAC full scale. Scale also calibrated 0-600V. Bakelite case. A beautiful meter in original carton. Shipping Wt. **\$3.95**

**DRIVER TRANSFORMER**  
No. 651. Couples 3000 ohm plate to push pull parallel grids hermetically sealed. Ship. Wt. 1 lb. **\$1.00**

**OUTPUT and MODULATION TRANSFORMER**  
No. 745. Companion transformer to above driver. A push pull output, 3000 ohms to 3.2 ohm voice coil, or to 1250 ohms at 80 MA. A high quality cased unit. Shipping Wt. 2 pounds. **\$1.00**

**HOW TO ORDER . . . GIVE PART NUMBER AND DESCRIPTION . . . ADD POSTAGE FOR WEIGHT SHOWN. NO ORDERS UNDER \$2.00 . . . WE WILL SHIP C.O.D.**



mismatch condition must exist at both ends. To obtain a mismatch ghost, a mismatch condition must exist at both

The chart is further useful because it shows that a mismatch ghost can be received at the time, the chart usually suffices to distinguish between ghost reception and those caused by line mismatch.

If a reflecting surface is so situated that multi-path reception could be expected from all stations, the switching test will be inconclusive. In such a case, or if only one television station can be received at the time, the chart shown in Fig. 1 usually suffices to distinguish between ghost reception and those caused by multi-path reception and those caused by line mismatch.

Determination of Source of Ghost

When ghosts are observed on the kinescope screen, it becomes necessary at the outset to distinguish between displaced images caused by multi-path reception, and those caused by line mismatch. These two types of ghosts can frequently be distinguished by switching the television receiver from one station to another. If ghosts are observed on one channel, but not on the other channels, multi-path reception is indicated.

This article is primarily concerned with the elimination of the second type of ghost: that caused by a mismatch between the transmission line and the receiver input circuit. It should be observed that while a line can be practically matched to a receiver for operation on all television channels, it is not possible to match a line to an antenna over a wide band of frequencies. Hence, a match is sought only at the receiver input terminals. Fortunately, a match at this point suffices for satisfactory, ghost-free reception.

Mismatch arises in practice from several situations. In the case of older installations, consideration may not have been given to matching requirements, and a line may have been used which has a widely different impedance from the impedance of the receiver input circuit. When an old television receiver is traded in on a new receiver, the customer usually fails to consider possible differences in receiver input systems. In some cases, coaxial lines are installed on the assumption that they will help minimize severe noise pickup at street level; but, since coaxial lines have a considerably lower characteristic impedance than that of many standard receivers, a mismatch may be encountered. In other cases, the line is selected to "match" the antenna impedance instead of the receiver impedance. This selection, however, is based upon incorrect conceptions and frequently leads to reflections along the line.

**TV ghosts are usually considered the result of signal reflections—but there are other factors that can bring about identical ghost images.**

A third type of ghost can result from impaired receiver operation when the video intermediate-frequency amplifier or video amplifier is improperly adjusted. This type of ghost, however, is infrequent. The first type can be minimized or eliminated, in many cases, by suitable orientation and positioning of a directional antenna. In poor receiving locations, however, it may be impossible to attenuate this type of ghost signal to a level where it is unobjectionable. No other method as yet is commercially available which can eliminate ghosts in such situations.

A second type of ghost is caused by a mismatch of the television line to the receiver input circuit. When the impedances of the line and the receiver input circuit differ, not all of the available signal energy is delivered to the receiver. Instead, a portion of the incoming energy is reflected from the receiver back up the line to the antenna. This diverted energy is usually

re-reflected from the antenna terminals back down the line to the receiver, where it causes a displaced secondary image or ghost. When the mismatch between the receiver and the line is very bad, several ghosts can be observed because the signal "bounces" back and forth several times along the transmission line between the antenna and the receiver.

From several causes. One type of ghost is caused by reception of two or more signals from the same transmitting station. The desired signal travels, in most cases, by direct line-of-sight, while the undesired signal is reflected and delayed along its course. Reflection can take place from buildings, cliffs, suspension bridges, or other large structures, man-made or natural. The reflected signal is delayed with respect to the line-of-sight signal because it travels a longer path, and thereby causes a displaced or ghost image on the television screen.

A second type of ghost is caused by a mismatch of the television line to the receiver input circuit. When the impedances of the line and the receiver input circuit differ, not all of the available signal energy is delivered to the receiver. Instead, a portion of the incoming energy is reflected from the receiver back up the line to the antenna. This diverted energy is usually

re-reflected from the antenna terminals back down the line to the receiver, where it causes a displaced secondary image or ghost. When the mismatch between the receiver and the line is very bad, several ghosts can be observed because the signal "bounces" back and forth several times along the transmission line between the antenna and the receiver.

From several causes. One type of ghost is caused by reception of two or more signals from the same transmitting station. The desired signal travels, in most cases, by direct line-of-sight, while the undesired signal is reflected and delayed along its course. Reflection can take place from buildings, cliffs, suspension bridges, or other large structures, man-made or natural. The reflected signal is delayed with respect to the line-of-sight signal because it travels a longer path, and thereby causes a displaced or ghost image on the television screen.

A second type of ghost is caused by a mismatch of the television line to the receiver input circuit. When the impedances of the line and the receiver input circuit differ, not all of the available signal energy is delivered to the receiver. Instead, a portion of the incoming energy is reflected from the receiver back up the line to the antenna. This diverted energy is usually

re-reflected from the antenna terminals back down the line to the receiver, where it causes a displaced secondary image or ghost. When the mismatch between the receiver and the line is very bad, several ghosts can be observed because the signal "bounces" back and forth several times along the transmission line between the antenna and the receiver.

From several causes. One type of ghost is caused by reception of two or more signals from the same transmitting station. The desired signal travels, in most cases, by direct line-of-sight, while the undesired signal is reflected and delayed along its course. Reflection can take place from buildings, cliffs, suspension bridges, or other large structures, man-made or natural. The reflected signal is delayed with respect to the line-of-sight signal because it travels a longer path, and thereby causes a displaced or ghost image on the television screen.

A second type of ghost is caused by a mismatch of the television line to the receiver input circuit. When the impedances of the line and the receiver input circuit differ, not all of the available signal energy is delivered to the receiver. Instead, a portion of the incoming energy is reflected from the receiver back up the line to the antenna. This diverted energy is usually

re-reflected from the antenna terminals back down the line to the receiver, where it causes a displaced secondary image or ghost. When the mismatch between the receiver and the line is very bad, several ghosts can be observed because the signal "bounces" back and forth several times along the transmission line between the antenna and the receiver.

From several causes. One type of ghost is caused by reception of two or more signals from the same transmitting station. The desired signal travels, in most cases, by direct line-of-sight, while the undesired signal is reflected and delayed along its course. Reflection can take place from buildings, cliffs, suspension bridges, or other large structures, man-made or natural. The reflected signal is delayed with respect to the line-of-sight signal because it travels a longer path, and thereby causes a displaced or ghost image on the television screen.

A second type of ghost is caused by a mismatch of the television line to the receiver input circuit. When the impedances of the line and the receiver input circuit differ, not all of the available signal energy is delivered to the receiver. Instead, a portion of the incoming energy is reflected from the receiver back up the line to the antenna. This diverted energy is usually

re-reflected from the antenna terminals back down the line to the receiver, where it causes a displaced secondary image or ghost. When the mismatch between the receiver and the line is very bad, several ghosts can be observed because the signal "bounces" back and forth several times along the transmission line between the antenna and the receiver.

From several causes. One type of ghost is caused by reception of two or more signals from the same transmitting station. The desired signal travels, in most cases, by direct line-of-sight, while the undesired signal is reflected and delayed along its course. Reflection can take place from buildings, cliffs, suspension bridges, or other large structures, man-made or natural. The reflected signal is delayed with respect to the line-of-sight signal because it travels a longer path, and thereby causes a displaced or ghost image on the television screen.

A second type of ghost is caused by a mismatch of the television line to the receiver input circuit. When the impedances of the line and the receiver input circuit differ, not all of the available signal energy is delivered to the receiver. Instead, a portion of the incoming energy is reflected from the receiver back up the line to the antenna. This diverted energy is usually

re-reflected from the antenna terminals back down the line to the receiver, where it causes a displaced secondary image or ghost. When the mismatch between the receiver and the line is very bad, several ghosts can be observed because the signal "bounces" back and forth several times along the transmission line between the antenna and the receiver.

From several causes. One type of ghost is caused by reception of two or more signals from the same transmitting station. The desired signal travels, in most cases, by direct line-of-sight, while the undesired signal is reflected and delayed along its course. Reflection can take place from buildings, cliffs, suspension bridges, or other large structures, man-made or natural. The reflected signal is delayed with respect to the line-of-sight signal because it travels a longer path, and thereby causes a displaced or ghost image on the television screen.

A second type of ghost is caused by a mismatch of the television line to the receiver input circuit. When the impedances of the line and the receiver input circuit differ, not all of the available signal energy is delivered to the receiver. Instead, a portion of the incoming energy is reflected from the receiver back up the line to the antenna. This diverted energy is usually

re-reflected from the antenna terminals back down the line to the receiver, where it causes a displaced secondary image or ghost. When the mismatch between the receiver and the line is very bad, several ghosts can be observed because the signal "bounces" back and forth several times along the transmission line between the antenna and the receiver.

From several causes. One type of ghost is caused by reception of two or more signals from the same transmitting station. The desired signal travels, in most cases, by direct line-of-sight, while the undesired signal is reflected and delayed along its course. Reflection can take place from buildings, cliffs, suspension bridges, or other large structures, man-made or natural. The reflected signal is delayed with respect to the line-of-sight signal because it travels a longer path, and thereby causes a displaced or ghost image on the television screen.

A second type of ghost is caused by a mismatch of the television line to the receiver input circuit. When the impedances of the line and the receiver input circuit differ, not all of the available signal energy is delivered to the receiver. Instead, a portion of the incoming energy is reflected from the receiver back up the line to the antenna. This diverted energy is usually

# Elimination of Reflections on Video Lines

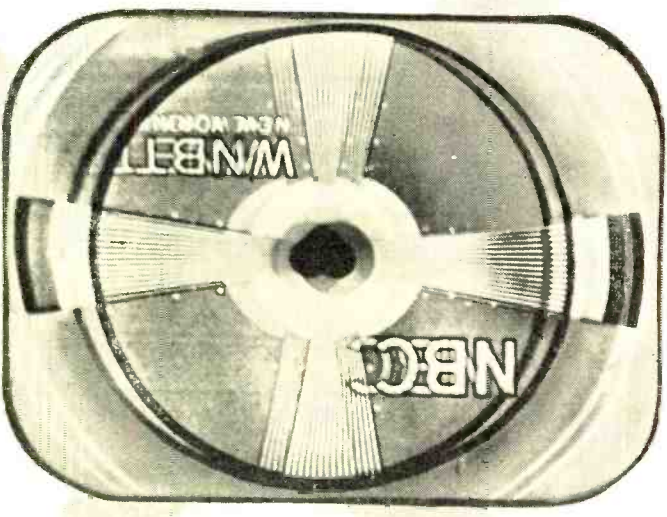

Typical ghost as seen on kinescope screen. This can be caused by multi-path reception, or line mismatch, or improper receiver adjustment.

By C. A. MEYER and R. G. MIDDLETON  
Tube Dept., Radio Corporation of America

receiver and re-checking. If this is the instrument, when returning to the give an even higher scale reading on when tuned in at the receiver, will really found that all other stations, be the weakest station, it will be gen- the antenna for what was assumed to With this optimum adjustment of moments.

ment of the antenna takes only a few of the argument. The actual adjust- guess-work and personal judgment out orientation can be found, taking all curately the best antenna position and It is surprising how quickly and ac- ceiver to reduce the gain is avoided. sitivity of the meter, a trip to the re- "Lo" position, thus reducing the sen- By snapping the "Hi-Lo" switch to the off-scale when a "hot" spot is found. a poor one, the meter may actually go of the antenna turns out to have been If the original temporary situation simple as that!

screen image brightness. It's just as the receiver and, therefore, maximum includes with the maximum input to assurance that this maximum also co- mum scale indication, with complete ferent directions and rotated for maxi- tenna can be moved a few feet in dif- With the meter on the roof, the an- from the antenna lead-in.

than to keep the cord a few feet away. No precautions need be observed other and, therefore, it need not be special. is no a.c. or r.f. in the extension line current at low d.c. potential. There lead carries only a small amount of can be used for this purpose, since the socket, any ordinary extension cord standard 115 volt household plug and things on the probe and meter are it did at the receiver. Since the fit- plugged in, and will read the same as the extension cord, the meter is again with the meter and the other end of is substituted. Proceeding to the roof, long enough to reach to the antenna, of ordinary two-wire extension cord, ter itself is disconnected, and a length Leaving the probe connected, the me- capable of later duplication, if desired, and tuning, in order to be relative and receiver operating at constant gain adjustments must be made with the drift slightly. Therefore, all antenna warm-up, the meter reading will also the receiver is still "drifting," due to control and also will vary somewhat will vary with the setting of the gain their input to the receiver may be various stations, a relative idea of ing maximum meter readings between this is seldom necessary. By compar- procedure can be repeated, although taneous choice of the test channel, the found not to be the case, due to er-

sitivity if necessary, and this should preliminary adjustments. The chan- nel selected should be that of the sta- tion expected to be weakest and most critical at the receiving location. It will be noted that the meter reading will vary with the setting of the gain had, although this is not necessarily a direct indication of their field strength, since the antenna itself (and the re- ceiver), may be working more effec- tively on one channel than on another. A ready means of comparing various antenna designs is also available by

# LOCATION-AND-INDICATOR

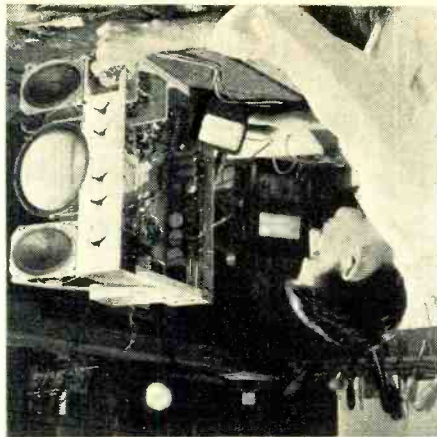

The peaking of r.f. and oscillator sections in a TV receiver can be done on the bench, using this easy-to-build test unit.

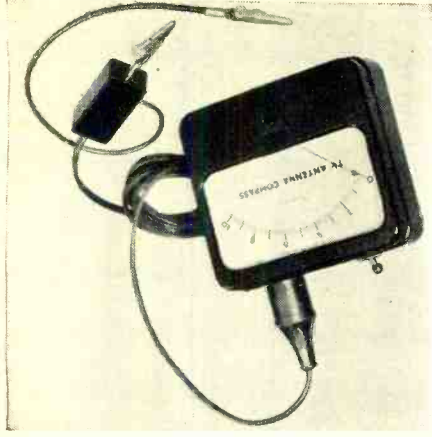

The TV antenna compass and probe assembly. This is all the equipment necessary to orientate your TV antenna.

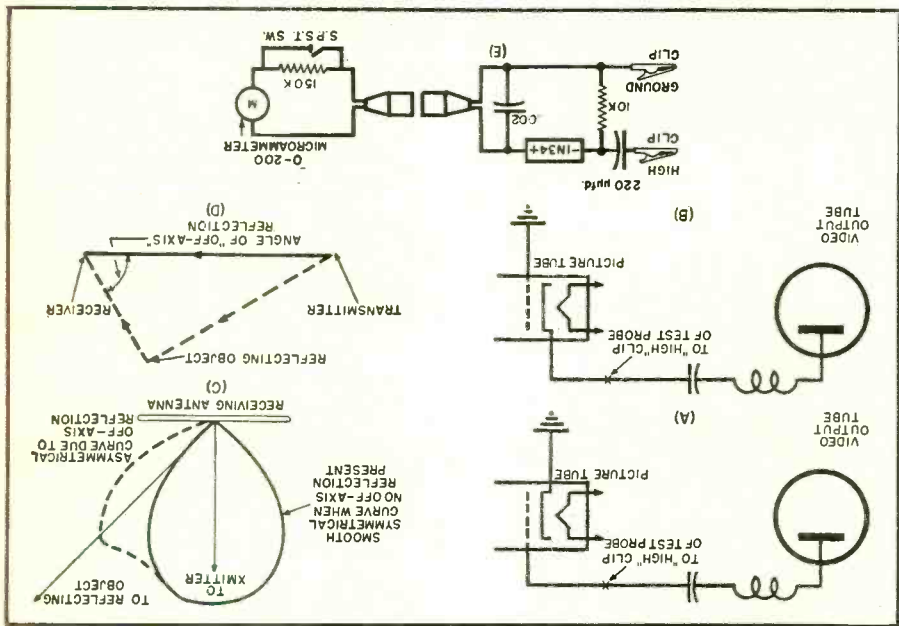

Fig. 1. (A) Illustrating where the "high" clip terminal of test probe is connected in a typical grid drive TV receiver, such as the Crosley 9-408. (B) "High" clip. Leaving the probe connected, the meter itself is disconnected, and a length of ordinary two-wire extension cord, is substituted. Proceeding to the roof, long enough to reach to the antenna, the extension cord, the meter is again plugged in, and will read the same as it did at the receiver. Since the fit- tings on the probe and meter are standard 115 volt household plug and socket, any ordinary extension cord can be used for this purpose, since the lead carries only a small amount of current at low d.c. potential. There is no a.c. or r.f. in the extension line and, therefore, it need not be special. No precautions need be observed other than to keep the cord a few feet away from the antenna lead-in.

the use of this instrument, since an actual meter-reading comparison can be made, rather than trusting to personal opinion.

All of the above assumes a constant transmitted signal from the station and a constant gain in the receiver itself. Therefore, it is important that any actual quantitative work be done only while a test pattern is being received, since varying picture content will naturally give varying meter readings. (The meter reading is proportional to the picture modulation and not to the video carrier.) Also, changing the setting of the gain control or abnormal drifting of the receiver will give non-comparable indications. The reasons for this are quite obvious.

It should also be mentioned that if the receiver has automatic gain control (a.g.c.) in the video channel, this (Continued on page 136)

## TENTATIVE PROGRAM OF EVENTS

# 1949 RADIO PARTS AND ELECTRONIC EQUIPMENT SHOWS, INC.

### SUNDAY, MAY 15th

9:00 a.m. Exhibition Hall open for erection of displays  
Sales meetings should be held on this day and prior days

### MONDAY, MAY 16th—"ASSOCIATIONS' MEETING DAY"

9:00 a.m. Exhibition Hall open for erection of displays  
10:00 a.m. National Electronic Distributors Association—General Meeting  
10:30 a.m. "The Representatives" of Radio Parts Mfrs., Inc.—General Meeting  
12:00 Noon "Canadian Luncheon"—Radio Parts Sales Managers Ass'n. of Canada  
12:30 p.m. "The Representatives" of Radio Parts Mfrs., Inc.—Luncheon  
2:00 p.m. Sales Managers Club, Eastern Division, Ass'n. of Electronic Parts & Equipment Mfrs., and West Coast Electronic Mfrs. Ass'n.—Joint Meeting  
2:30 p.m. "The Representatives" of Radio Parts Mfrs., Inc.—Delegates Meeting  
3:30 p.m. Radio Parts & Electronic Equipment Shows, Inc.—Annual Meeting of Member-Exhibitors and General Members  
6:30 p.m. "Old Timers" Cocktail Party

### TUESDAY, MAY 17th—"NEDA DAY" (Exclusive)

10:00 a.m. Exhibition Hall opens for exhibiting manufacturers, booth attendants sales representatives and members of Nat'l. Electronic Distributors Ass'n.  
10:00 a.m. Display rooms on fifth and sixth floors open to all distributors, manufacturers and sales representatives  
6:00 p.m. Exhibition Hall and Display rooms close

### WEDNESDAY, MAY 18th

10:00 a.m. Display rooms on fifth and sixth floors open to all distributors, manufacturers and sales representatives  
10:00 a.m. Exhibition Hall opens  
10:00 a.m. to 1:00 p.m. Attendance confined to exhibiting manufacturers, their booth attendants, sales representatives and members of NEDA  
1:00 p.m. to 3:00 p.m. Attendance confined to exhibiting manufacturers, their booth attendants, sales representatives and all distributors  
3:00 p.m. to 6:00 p.m. Attendance confined to exhibiting manufacturers, their booth attendants, sales representatives, all distributors, industrial manufacturers, government agencies, their purchasing agents and engineers  
6:00 p.m. Exhibition Hall and Display rooms close

### THURSDAY, MAY 19th

10:00 a.m. Display rooms on fifth and sixth floors open to all distributors, manufacturers and sales representatives  
10:00 a.m. Exhibition Hall opens  
10:00 a.m. to 1:00 p.m. Attendance confined to exhibiting manufacturers, their booth attendants, sales representatives and members of NEDA  
1:00 p.m. to 3:00 p.m. Attendance confined to exhibiting manufacturers, their booth attendants, sales representatives and all distributors  
3:00 p.m. to 6:00 p.m. Attendance confined to exhibiting manufacturers, their booth attendants, sales representatives, all distributors, industrial manufacturers, government agencies, their purchasing agents and engineers  
6:00 p.m. Exhibition Hall and Display rooms close  
7:00 p.m. Dinner—RMA's "Silver Anniversary" Banquet, Grand Ballroom, Stevens

### FRIDAY, MAY 20th

10:00 a.m. Display rooms on fifth and sixth floors open to all distributors, manufacturers and sales representatives  
10:00 a.m. Exhibition Hall opens  
10:00 a.m. to 1:00 p.m. Attendance confined to exhibiting manufacturers, their booth attendants, sales representatives and members of NEDA  
1:00 p.m. to 3:00 p.m. Attendance confined to exhibiting manufacturers, their booth attendants, sales representatives and all distributors  
3:00 p.m. to 6:00 p.m. Attendance confined to exhibiting manufacturers, their booth attendants, sales representatives, all distributors, industrial manufacturers, government agencies, their purchasing agents and engineers  
6:00 p.m. Exhibition Hall and Display rooms close  
1949 Radio Parts & Electronic Equipment Conference & Show ends

## JUST PUBLISHED!

# Complete, practical data on MAGNETIC RECORDING



BY S. J. BEGUN

Chief Engineer, The Brush  
Development Co.

300 pages, 6x9, 130 illus—  
\$5.00

Here at last is the "low down" on one of the fastest growing electronic developments in all of its design, engineering, and experimental phases. MAGNETIC RECORDING acquaints you with every detail of modern equipment, brings you the latest information on applications ranging from home entertainment to movies, broadcasting, professional and amateur radio and special uses such as military speech scrambling.

*All about the theory, types, and makes of recorders, their applications and performance measurement*

1. Short History of Magnetic Recording
2. Acoustic Factors
3. Magnetism
4. Theory of Magnetic Recording
5. Components of a Magnetic Recording System
6. Magnetic Recording Equipment
7. Applications of Magnetic Recording
8. Instrumentation and Magnetic Recording Measurements
9. The Magnetic Phonograph
10. Helpful Glossary of Magnetic Recording Terms

### IT PAYS TO STUDY THE NEW DEVELOPMENTS!

Acoustic and magnetic factors are carefully explained. A-C and D-C biasing methods, distortion factors, reproducing heads, drive mechanisms and the various recording media and methods of recording, reproducing, and erasing are discussed in detail. Particularly valuable are a complete outline of recording devices and how they are used; a helpful study of instruments for determining recording performance; and a clear discussion of magnetic versus other recording methods. More than 130 diagrams and illustrations make things easily understandable. Use coupon for 10 days' free trial.

## Cash in on a know how of FREQUENCY

# MODULATION

FUNDAMENTALS — APPARATUS  
—SERVICING

BY NATHAN MARCHAND

448 pages, 6x9, over 300 illustrations, Price \$5.00

FM in high-fidelity reception—in all kinds of mobile communication systems—and now in television—is a must subject for every opportunity-minded serviceman. This book covers it fully—theory and circuits; transmitters, receivers, antennas; testing and servicing. "Will undoubtedly become a bible with every service man."—SERVICE Magazine.



*It takes more  
than ordinary  
radio training  
to handle FM!  
This big book  
shows you how!*

## 10 DAYS' TRIAL

Dept. RN-59, Murray Hill Books, Inc.,  
232 Madison Avenue, New York 16, N. Y.

Send me books checked below for 10 days' examination on approval. In 10 days, I will either pay for the books plus a few cents postage or return them postpaid. (Postage paid on cash orders; same return privilege. Books sent on approval in U. S. only.)

- Begun, MAGNETIC RECORDING, \$5.00 (Outside U.S. \$5.50 postpaid.)
- Marchand, FREQUENCY MODULATION \$5.00 (Outside U.S. \$5.50 postpaid.)

Name.....  
Address.....  
City, Zone, State.....

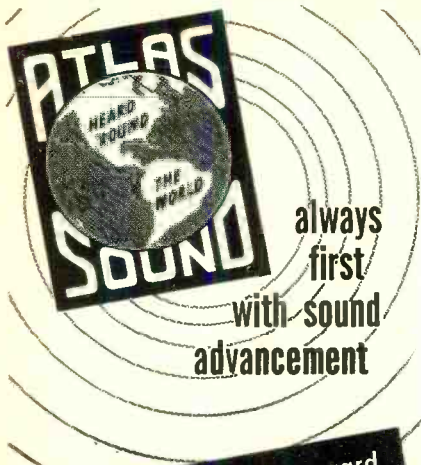

Truly — a great step forward  
**ATLAS D. R. Projectors**  
 are tops in Performance



non resonant  
 sturdy compact  
 uniform response  
 storm proof demountable

featuring the new "ALNICO V-PLUS"

super power  
 driver units

with Atlas-Super  
 Efficient Alnico  
 V-Plus  
 Magnetic Circuit

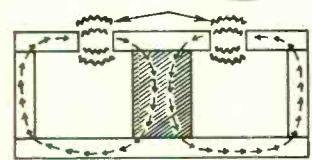

New "Alnico V-Plus" magnetic circuit completely shielded construction.

Cross section illustration indicating the advantages of "Alnico V-Plus" super efficient magnetic assembly over the old type external ring magnets of conventional alloy, shaded portions of sketch indicate magnetic material "Alnico V-Plus" offers an energy content per unit volume three times as great as any magnet used before!

Traditional ATLAS Quality and Fidelity to Precision are incorporated in all these new developments.



**ATLAS Sound Corporation**  
 1447—39th St., Bkn. 18, N. Y.

# DO YOU KNOW?

By **DAVID SCOTT**

54. What may be the result of variations in the velocity of the electron stream?

A. Variations in the velocity of the electron stream will cause defocusing. Since electrostatic deflection depends on the square of the electron velocity, whereas magnetic deflection depends only on the first power, this source of defocusing is more serious when electrostatic deflection is used.

55. What may be the result of the ion spot?

A. The result is a dark spot in the center of the reproduced picture.

56. In what type of deflection is the ion spot most troublesome?

A. In magnetic deflection the ion spot is quite apparent and eventually this continual bombardment of heavy ions on one spot will burn that portion of the screen. This is due to the fact that in magnetic deflection the deflection is inversely proportional to the square root of the mass of the particles. Since the ions have a mass of 1800 to 500,000 times that of the electron mass there is a correspondingly smaller deflection and they cluster in the center.

57. Define a saw-tooth waveform.

A. A saw-tooth waveform is one in which the deflection voltage or current increases linearly with time and decreases rapidly to its initial value.

58. What is the keystone effect?

A. In the iconoscope there is a 30 degree angle of the beam to the plate. Due to the difference in distance resulting from this angle from the top to the bottom of the plate by the scanning beam, an unequal amplitude of scanning results giving rise to a pattern keystone in shape.

59. Draw a simple schematic diagram illustrating and explaining methods of producing saw-tooth waves of voltage.

A. All methods used in television to produce saw-tooth waves are

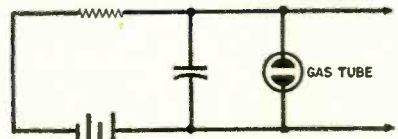

based on the slow charge of a condenser followed by its rapid discharge. A simple circuit for achieving this, though not used practically, is as follows: A tube with two electrodes immersed in gas at low

pressure is connected across the terminals of a condenser. As the voltage across the condenser increases, the gas tube remains non-conducting until a critical voltage is reached. Then the gas tube suddenly becomes conductive and discharges the condenser resulting in a saw-tooth wave. In order to exercise some control over the tube action a three element tube, gassy or hard, is used. The control grid is used to carry a synchronizing impulse which discharges the tube at a fixed rate.

60. Draw a simple schematic diagram illustrating and explaining methods of producing saw-tooth waves of current.

A. Saw-tooth waves from a condenser alone cannot be used to pro-

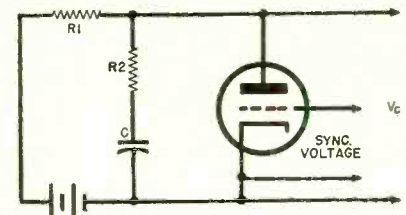

vide saw-tooth waves of current necessary in magnetic deflection. This is because the deflecting coils possess inductance and resistance. Hence, a current passing through them becomes distorted. Therefore a pre-distorted voltage must be applied to the coils to produce a saw-tooth wave of current. This "pre-distortion" is accomplished by placing a resistor in series with the condenser as shown in the diagram.

61. What are some of the necessary design qualities of voltage waveform amplifiers?

A. Voltage waveform amplifiers must be flat up to ten times the scanning frequency, i.e.,  $60 \times 10 = 600$  c.p.s in the vertical amplifier and  $15,750 \times 10 = 157,500$  c.p.s in the horizontal amplifier. The angular phase displacement of the sine wave components must be proportional to the frequency, and both deflecting plates must be symmetrically disposed with respect to the second anode to keep the field between the plates as uniform as possible.

62. What are the three important types of impulse generators?

A. Three important types of impulse generators are:

1. Dynatron
2. Multivibrator
3. Blocking oscillator.

(To be continued)



# YOUR DOLLAR BUYS MORE AT MCGEE RADIO COMPANY

"COMPLETE AUDIO AMPLIFIER KIT AS LOW AS \$6.95"

**12-WATT AMP. KIT, \$10.95**  
Gain—V.P. Pick-Up  
**KIT MODEL TM-12.** 12 watt amplifier kit. Ideal for high quality record player or public address or recording amplifier. Blasted component parts, ready punched chassis pan. One control fader, from phono to microphone. Gain enough for crystal or dynamic microphone. 100 mill power transformer for 110 volt AC 60 cycle operation. Priced complete with tubes—2-4V6, 12X7, 6X17 and rectifier. Diagrams and photos furnished. Weight 8 lbs. Kit TM-12. Net \$10.95.

**8-Watt AC Amplifier Kit \$8.95 WITH PUSH PULL 6A05**  
A complete kit of parts to build a 8 Watt Power Transformer type Audio Amplifier for 110 Volt AC operation. Inputs for mike and phono pickup crystal or variable reluctance type. Variable tone and fader control. Output transformer matches 4 to 8 Ohm speaker. Ready punched chassis similar in appearance to Model TM-12 shown above. Price includes easy to follow diagram and photos. Includes 12X7, 6X17, and 5Y3. This amplifier will make a fine audio system. Remember this is not any ordinary AC-DC Amp. but an AC job with 75 Mill Power Transformer. Kit Model TM-8, weight 10 lbs. Net \$8.95. Crystal Mike & Desk Stand \$4.95 extra. 12 inch Alnico V PM Speaker \$4.95 extra.

**5-WATT AMP. KIT \$6.95 PUSH PULL 50B5**  
A complete kit of parts to build a 5 Watt Audio Amplifier for 110 Volt AC operation. Inputs for mike and any phono pickup crystal or variable reluctance. Output transformer matches 4 to 8 Ohm voice coil. Has tone and fader controls. This is a complete kit with ready punched chassis and easy to follow diagram. Includes 12X7, 6X17, and 5Y3. Selection rectifier. Offered at the usual price of a similar type. Kit Model TM-4, weight 8 lbs. Net \$6.95. Crystal Mike and Desk Stand \$4.95 extra. 12 inch PM Speaker \$4.95 extra.

**GAROD DELUXE 5-Tube Kit \$12.95**  
This is our latest and finest AC-DC radio kit. Receives Broadcast, 540 and 1620 KC. Has full length illuminated slide rule dial. Choice of Ivory or Walnut plastic cabinet. Full high efficiency 2 gang superhet circuit, with loop antenna. Ready punched chassis, full 5" PM speaker. Every part fits. Everything furnished including tubes—12A7, 14A7, 12SQ7, 6X23 and 50L6. Diagram photos and instructions are furnished. Stock No. 1290. Kit model XA-49. Net \$12.95.

**WALNUT ARM CHAIR CABINET \$29.95**  
**WILL WOOD CRP-15 KIT.** Beautifully made walnut arched cabinet. Outside dimensions—18 1/2" x 16 1/2" deep and 27" wide. Ample room for radio receiver 12" long, 10" high, and 10" deep. Will hold a changer up to 14" square. Will accommodate speaker up to 12". Has record album storage compartment. Hinged lid covers changer compartment. Cabinet AR-15. Net price \$29.95. Crescent Deluxe Changer \$14.95 extra. Cabinet in blonde finish. Net price \$34.95.

A few items of war surplus are still available.  
Brand new 458 5.3 to 7.1 MC trns. \$5.95  
Used BC 458 transmitters with tubes 2.95  
Used 458 modulators with tubes 2.95  
New BC 743D localizer rec. with tubes 6.95  
ARC-4 trans. rec. 144MC used with tubes and dynamotor 12.95  
200 KC crystal calibration for Collins autotune less tubes and crystal. 1.00  
BC 1035A Marker Beacon Rec. tubes. 2.95

**R.C.A. COIN RADIOS \$34.95**  
Brand New RCA 6-Tube Coin Operated Radio. The popular model of which thousands are now in use. 25c Coin Slot set for 1 hour play. Sample order \$39.95. Lots of 10 \$33.95. Phone Victor 9045 for quantity prices.

**PHILCO MIKE SCOOP**  
Philco Mike same as Electrovoice 630 Dynamic High Z. 20 Ft. Cable. Regular, \$39.50. Scoop price, \$14.95. 3 for \$41.95.  
Philco Mike same as Electrovoice 51 Velocity. High Z. 20 Ft. Cable. \$40.00 list. Price, \$14.95. 3 for \$41.95.  
Philco Mike same as Electrovoice 126 Carbone Dynamic High Z. 20 Ft. Cable. \$39.50 list. Scoop price, \$24.95.

**RADIO TUBE SCOOP!**  
Service men attention. Here is a chance to buy the best of money can buy. 6 GT types. Designed to replace either metals or st. New internal construction makes metal tubes obsolete. All tubes dated by a maker whose name you will know.  
128A7 ..... 69c 100 for \$59.00  
128A7 ..... 69c 100 for \$59.00  
128Q7 ..... 59c 100 for \$55.00  
351B ..... 69c 100 for \$59.00  
501C ..... 69c 100 for \$59.00  
352A ..... 49c 100 for \$45.50  
All are MGRS type bulk packed 100 to a carton.

**20-WATT AMP. KIT \$15.95 HAS-P.P. 6L6**  
A complete kit of parts to build a high quality 20 Watt Audio Amplifier with full AC operation. Inputs for 110 Volt Public Address Amplifier. Inputs for mike and either crystal or variable reluctance pick ups. Tone and fader controls. Has heavy duty Universal Output transformer to match any speaker. 4-8-10-250 and 500 ohms. Ready punched chassis. Includes 6L6, 2-6X17, 2-7N7, 2-6Y3, 5Y3. Speaker recommended Model CR-13X \$12.95 extra.

**SUPER DELUXE 30-WATT AMP. KIT \$19.95**  
A complete kit of parts to build a full 30 Watt Public Address Amplifier. Ready punched chassis with cover. 100 Mill Power Transformer for 110 Volt AC operation. Inputs for 110 Volt Public Address Amplifier or Variable Reluctance Phono Pick up. Tone Control. Has heavy duty output transformer to match any speaker. 4-8-10-250 and 500 Ohms. Inverse Feed Back. Everything furnished including easy to follow diagram and tubes 6X17, 2-7N7, 2-6Y3, 5Y3. This makes a ready saleable amplifier of commercial quality. Kit Model TM-30, weight 25 lbs. Net \$19.95. With HI-Pot. Output Trans. \$5.00 Extra.

**McGee's Theatre Quality AMPLIFIER KIT \$34.95**  
Our sales and engineering department, realizing that not every one can afford a \$100.00 audio amplifier, has designed a Theatre quality 15 watt True-Fidelity Amplifier Kit. Response essentially flat, from 20 to 15,000 cycles. It contains every part, tubes and ready punched chassis. Has input for a crystal or dynamic microphone and gain and tone compensation for the new G.E. Variable Reluctance pickup, as well as the conventional metal pickups. A 4 step tone switch for tone equalization. This kit has a 34 watt Merit high fidelity, wax impregnated output transformer with 4, 8, 16 and 500 ohm taps. The chassis is of heavy treated metal, ready punched; approximately 5x11 inches. The quality of all parts is second to none. Priced complete with tubes as follows: 12A7, 2-6X4, 2-6X3, 5Y3. This is the best amplifier kit we know how to produce and we have made thousands. Kit Model ME-15R. Wt. 16 lbs. Net Price \$34.95. \$63.00 Extra. (Pictured above Amp.).  
Altec 15" Coaxial Speaker Model 003B. \$63.00 Extra.  
Kit Model ME-34R. Similar to Model ME-15R except has push-pull 6L6. Giving up to 34 Watts of Audio. Weight 25 lbs.

**GAROD PERSONAL RADIO KIT \$14.95**  
Size 6 1/2 x 3 1/4 x 4 1/4—Weight 3 1/2 Lbs. Simple Assembly and Wiring Instructions  
This kit is ready for immediate delivery. The same nationally known factory that manufactures tens of thousands of radio sets line producing this radio kit for us. Every part, from the cabinet down to the last resistor, is matched. The chassis is ready punched; all you do is mount the tubes and wires. The radio will assemble into a beautiful personal radio for you. Just the same as it does for the factory. We furnish you a diagram, photograph of the completed chassis and full assembly instructions so that those with a minimum knowledge of radio may wire this kit. The beautiful case is made of metal with plastic hinged lid and snap-on back. The lucite face of the receiver has an inlaid zoid design. The circuit is the conventional two gang superhet type with 455 KC. Receptor, 18S converter, A.V.C., 17A amplifier and 354 power amplifier. Alnico V PM speaker. The loop antenna is built in the lid. Radio comes on automatically when lid opens. Operates on self-contained batteries. Includes a 67 1/2 volt "B" battery and fresh cell (Not AC-DC). Nothing else to buy.  
Kit Model X-45. Price \$14.95. Includes Postage for 6 lbs. Scoop Model X-45 Personal Portable Kit Wired and Tested With Batteries. Net \$17.95.

**BUILD THIS 8-TUBE HI FIDELITY RADIO AND AMPLIFIER**  
• 8-INCH SLIDE RULE DIAL • RECEIVES BROADCAST AND 19 TO 49 METERS • PUSH PULL OUTPUT TUBES • BASS BOOST TONE CONTROL • EVERYTHING FURNISHED • CHASSIS SIZE 9 1/2 x 11 x 8" HIGH • BEST RADIO KIT VALUE IN THE WORLD  
Here is something new in radio. A real 15 watt power amplifier with bass and treble controls. Has extra gain stage for crystal or dynamic mikes. And on the same chassis, a standard superhet radio receiver. We furnish all parts, knobs, escutcheon plate and tubes—12A7, 6X17, 6X27, two 4V6 and 5Y3. Everything comes together in a complete design. The power supply section assures low hum level, making this unit ideal for recording as well as P.A. use. We furnish everything as well as schematic diagram and photos of the completed chassis. Weight 26 lbs. Net \$37.95.  
PRK-24. Radio-Amp. Kit with 12" P.M. speaker. With tubes..... Net \$29.95  
CPR-15. Exactly the same kit as the PRK-24 kit, except it is furnished with a 12" Cinnaudagram wide range speaker. (Has built-in high frequency tweeter.) This is our finest kit..... Net \$37.95

**BUILD A RADIO WITH MATCHED "DETROLA" PARTS 6-TUBE 2-BAND KIT \$16.95**  
A complete kit of parts, tubes and ready punched chassis to build a fine 6 tube power transformer type radio chassis. (No cabinet.) We furnish every piece as well as a printed diagram and photograph. Chassis size 14x7 1/2x7. Receives standard broadcast and 6 to 18 MC foreign short wave. 3 gang tuning condenser used on both bands. 90 mill power transformer. 6V6 output tube. Heavy duty 8 inch speaker. This kit is made up of parts intended for use in a high quality Detrola radio. Has full lighted slide rule dial. Everything comes together just like a factory built radio. Priced complete with 6 tubes. Kit Model 6-AC. Weight 16 lbs. Net \$16.95.  
Kit model CD-8. Same basic design as the above model 6-AC except it is an 8 tube AC DC circuit with push pull 25L6 tubes in the audio. Weight 15 lbs. Priced complete with tubes net \$16.95.  
If you desire, we will sell just the chassis pan, slide rule dial, IF coils, RF and Ant coils and band switch for the model 6-AC kit. You supply all other parts. \$6.95. Diagram furnished. Stock No. B-14. Weight 7 lbs..... Net \$6.95

**COILS, IF'S—LOOPS**  
Universal slug tuned RF or ant coil for broadcast band..... 5 for \$1.49  
3 or 4 wire 456 ohm. coil..... 15c  
Matched sets of 456 IF coils, per set..... 98c  
Either input or outputs..... 49c  
Small Medium or large loops..... 39c  
Matched set. 2 gang cond. loop..... 59c  
ant. osc. coil and 2 IF special..... 1.29  
Pee Wee 456 IF input or output..... 39c

**DELUXE 5-TUBE AC-DC KIT LEADER \$9.95**  
Made from Detrola Components  
A full size 5-tube superhet radio kit housed in a 14-inch wood cabinet with full plastic front. Includes lighted slide rule dial. Incorporates a standard 2 gang superhet circuit. Loop antenna, ready punched chassis, etc. This is another one of our line production radio kits. Every part is furnished including tubes, 12BA6, 12BF6, 12AT6, 50B5 and 35W4. Diagrams, photos and instructions are included. 5" dynamic speaker. Receives broadcast 550 to 1650 kc. Weight 9 lbs. Kit Model TF-6C. Net \$9.95.

**4-TUBE T.R.F. KIT BARGAIN SPECIAL \$6.95**  
4 tube AC-DC, TRF radio kit. Ideal for students and beginners. Every part furnished to build this kit, including tubes, diagram and photos. Has inlaid pick speaker and plastic cabinet with airplane dial. Receives broadcast 550 to 1650 kc. This is the easiest type of radio to build. Kit Model TF-4. Weight 6 lbs. Net \$6.95.

**7-TUBE PHONO AMP. \$7.95**  
4 Tube Phono Amplifier with 6", 3 1/2 Oz. Alnico V PM Speaker. Tubes—12X7, 6X25, 6Y3, 6X4, 12SQ7, and 35L6. Tone and Volume Controls. Small thin chassis. Made for a retail mail order house. Plenty of power. Offered at a price less than production cost. Stock No. 5R-4. Weight 7 lbs. Net \$7.95.

**1948 MODEL—MIKE-BROAD-CASTER KIT—ONLY \$6.95**  
4-TUBES  
Broadcasts 800 to 1500 from either a phono-graph pick-up or a crystal or dyna mic mike. Makes any radio receiver a P.A. system, record player or recording amplifier. Broadcast quality. Has fader control from mike to record, simulating a regular broadcast station. This is a beautiful radio model. Has 540 and 1620 KC. and 35W4. Priced with tubes and wiring diagram. Works on 110 volts AC-DC Crystal Rectifier. Net \$6.95 extra. Complete Kit Model DE-4 truly a deluxe mike-phono oscillator. Weight 4 lbs.

**\$59.50 VALUE MUSICAL AMP. \$24.95**  
8 Watt Musical Amplifier. 4 tube AC transformer type. Proper Gain for all instrument pickups. Housed in leatherette case with built-in speaker and tone controls. Made by a large manufacturer, to sell for \$59.50. Stock No. XA-3. Weight 24 lbs. Net Price \$24.95.

**SCOOP SALE ON RADIO CHASSIS: 6 TUBES, 3-WAY \$14.95**  
Chassis Model 819-A. A deluxe broadcast 3-way: 110 volt AC or DC or battery pack radio chassis, complete with 6 tubes, 6" slide rule dial and 6" PM speaker. Size 12x8x7 inches. Made by a manufacturer for a top mail order house. Has tuned IF stage; giving high sensitivity and selectivity. A \$25.00 value for only \$14.95.

**5-TUBE BATTERY CHASSIS \$10.95**  
Chassis Model 801. A broadcast 5 tube straight battery operated chassis. Requires 6 1/2 volt A and 90 volts B. Similar in appearance to the model 819 pictured above. Size 12x3 1/2x7 1/2 inch slide rule dial. 3 tuned stages RF stage. Tubes 1L6, 1L6C, 1L6S, 1L6A, 1L6D5. Made for silvertone. Price includes chassis, tubes, a 6 inch PM speaker. Net \$10.95.  
**6-TUBE AC-DC CHASSIS \$10.95**  
Model 802. A broadcast 6 tube AC-DC receiver made for silvertone. Size 5 1/2x5 1/2x10". 5 inch slide rule dial. 2 gang tuning cond. Tone control and 6 inch speaker. Similar to picture above. Ideal for utility use. Tubes 7H7, 14Q7, 7B7, 7C6, 50A5 and 351A. Chassis \$10.95. Net \$10.95. Weight 13 lbs. Scoop price \$10.95.  
**5-TUBE AC-DC CHASSIS \$9.95**  
5-Tube AC-DC chassis similar to the 6 tube set above. With tubes and 6 inch speaker. Receives standard broadcast. Weight 10 lbs. Net \$9.95.  
Chassis Model 825. A 9 tube transformer type AC chassis made for silvertone. Broadcast and FM. 88 to 108 MC. Size 11x8x8". 10 inch speaker. A ruggedly built receiver. With tubes, tubes 7H7, 7C6, 7C7, 7C5, 72A, 7N7, 7A8. An ideal chassis to replace those old model chassis. Weight 30 lbs. Chassis, tubes and speaker, Model 825, net \$34.95.

**8-TUBE WIRE RECORDER REC. CHASSIS \$35.95**  
Model 814 Chassis made for silvertone. 8 tubes. 12B0, 14Q7, 14A7, 7C7, 2-50A5, 2-35Y4. 3 inch slide rule dial. Chassis size 14x8 1/2x7. 2 gang cond. receives standard broadcast. Tone control. Power trans. is mounted on small separate chassis to keep hum out of wire recording. Input on chassis for mike and phono pick up. Built in osc. circuit for use with any wire recording mechanism. This chassis is from the famous silvertone radio wire recorder. Price includes chassis, tubes and 10 inch speaker. Weight 25 lbs. Model 814. Net \$34.95.

## McGEE RADIO COMPANY

May, 1949

Order from This Ad. With Full Remittance Include Postage or May Be Sent Express Collect.

SEND 25% DEPOSIT — BALANCE C.O.D. 1225 MCGEE ST., KANSAS CITY, MISSOURI



SALE! NATIONAL UNION

ORDER \$100.00 WORTH OF N.U. COND.—TAKE 10% OFF
100.00 FOR SALE AT OVER 1/2 SAVING. PLENTY OF EACH SIZE.

We bought the entire stock of National Union Electrolytics, Tubular By-passes, and Sav-A-Shaft Volume Controls. Stock up now while pickings are good. All National Union Condensers offered by us are late 1948 production by a Number One builder of Electrolytics. Guaranteed by us for a period of one year. You must be satisfied with the merchandise we ship you. Order \$100.00 worth of these N. U. Condensers and take 10% off of price.

TYPE "AT" N.U. TUBULAR ELEC. ALUMINUM WITH SEALED ENDS

National Union Type AT Electrolytics. Housed in sealed metal tubes in spun-ent cardboard package of 10 condensers. Save over half. This is your every day need in condensers. One-Year Guarantee.

Table listing various AT electrolytic models and their prices, including AT 1 MF, AT 25 MF, AT 100 MF, AT 5 MF, AT 10 MF, AT 25 MF, AT 50 MF, AT 100 MF, AT 4 MF, AT 8 MF, AT 12 MF, AT 16 MF, AT 20 MF, AT 24 MF, AT 30 MF, AT 40 MF, AT 50 MF, AT 80 MF, AT 8 MF, AT 16 MF, AT 20 MF, AT 24 MF, AT 30 MF, AT 40 MF, AT 50 MF, AT 80 MF.

TYPE "CT" ELECTROLYTICS DUAL TUBULAR BANKS

National Union Type CT Cardboard tubular with wax seal and mounting strap. Flexible leads. Individually cartoned in green N.U. boxes. A hot red value at over 1/2 saving. One-year guarantee.

Table listing various CT electrolytic models and their prices, including CT 16-16 MF, CT 20-20 MF, CT 30-30 MF, CT 40-40 MF, CT 50-50 MF, CT 80-80 MF, CT 20-20 MF, CT 30-30 MF, CT 40-40 MF, CT 50-50 MF, CT 80-80 MF.

N.U. THREAD MOUNT ALUMINUM CAN TYPE SC

National Union Type SC-SCNS Upright Aluminum Can Condensers. With pat mounting. Flexible insulated leads. Individually cartoned in green N.U. boxes. Save over half on this. One-year guarantee.

Table listing various SC electrolytic models and their prices, including SC 4 MF, SC 8 MF, SC 12 MF, SC 16 MF, SC 20 MF, SC 24 MF, SC 30 MF, SC 40 MF, SC 50 MF, SC 80 MF, SC 8 MF, SC 16 MF, SC 20 MF, SC 24 MF, SC 30 MF, SC 40 MF, SC 50 MF, SC 80 MF.

N.U. 600-VOLT TUB. BY-PASSES

National Union attractive green paper 600 Volt Tubular Condensers. Super sealed, wax filled, rigid tinted leads. Save 2% on these. All 1-year guaranteed. Order 100 assorted. You pick size, for \$6.95.

Table listing various 600-volt tubular by-passes and their prices, including T.001 MF, T.002 MF, T.006 MF, T.03 MF, T.04 MF, T.25 MF, T.50 MF, T.100 MF, T.200 MF, T.500 MF, T.1000 MF.

SCN-DUAL-COMMON NEG.

Table listing various SCN dual-common negative electrolytic models and their prices, including SCN 8-8 MF, SCN 8-16 MF, SCN 16-16 MF, SCN 20-20 MF, SCN 30-30 MF, SCN 40-40 MF, SCN 50-50 MF, SCN 80-80 MF, SCS 8-8 MF, SCS 8-16 MF, SCS 16-16 MF, SCS 20-20 MF, SCS 30-30 MF, SCS 40-40 MF, SCS 50-50 MF, SCS 80-80 MF.

NATIONAL UNION ALUMINUM CAN "TWIST TAB" TYPE TT

National Union Type TT Electrolytic Condensers. Aluminum can F.P. type Twist Tab mounting common negative grounded to can. Individually cartoned in green N.U. boxes. Each condenser supplied with 10 gauge insulating wire and 1 metal grounding plate. Save over half on these. All sizes and one-year guarantee.

Table listing various TT electrolytic models and their prices, including TT 100 MF, TT 25 MF, TT 50 MF, TT 10 MF, TT 25 MF, TT 50 MF, TT 100 MF, TT 40 MF, TT 50 MF, TT 20 MF, TT 25 MF, TT 30 MF, TT 40 MF, TT 50 MF, TT 100 MF, TT 10 MF, TT 25 MF, TT 50 MF, TT 100 MF, TT 40 MF, TT 50 MF, TT 20 MF, TT 25 MF, TT 30 MF, TT 40 MF, TT 50 MF, TT 100 MF.

100 N.U. SAV-A-SHAFT \$29.95

National Union Sav-A-Shaft Volume Controls. A regular \$1.25 list item all individually cartoned with instructions. Every size Control is equipped with an off-on switch which may be used by pulling small tab. These Controls are handy as most of you radio service men know. For replacement merely say off old Volume Control Shaft and drive into the National Union Sav-A-Shaft coupling. Pick the sizes you want at these dollar saving prices or just order one hundred, as we assort them for only \$29.95.

Table listing various Sav-A-Shaft volume control models and their prices, including NU 5M-A, NU 10M-B, NU 25M-A, NU 50M-B, NU 100M-B, NU 250M-TX, NU 500M-TX, NU 1 MEG-TX, NU 2 MEG-TX, NU 500M-CB, 100 National Union Controls \$29.95.

CRYSTAL CARTRIDGES

WE HAVE 'EM, \$1.39 AND UP EVERY XTAL GUARANTEED

Table listing various crystal cartridge models and their prices, including Astatic MLP-1, Astatic MLP-2, Astatic N-1, Astatic QT, Astatic T-1, Webster M-1, GE Variable Reluctance Cartridge RPX-010, GE RPX-041.

SAVE 1/2 ON THESE "NAME BRAND" COND.

100 N.U. SAV-A-SHAFT \$29.95

ELECTROLYTICS UPRIGHT ALUMINUM CANS

Table listing various electrolytic upright aluminum can models and their prices, including RS213, RS215, RS223, RS262.

ELECTROLYTICS EVERY DAY REPLACEMENTS

Table listing various electrolytic replacement models and their prices, including TCS45, TCS47, TCS48, TCS52, TCS55, TCS71, TCS74.

CRESCENT DELUXE CHANGER ONLY \$14.95

Model 400A Crescent Deluxe 78 RPM Automatic Changer with shure cartridge. Shuts off on last record. Base size 11x2x13 1/2. Deep in a room finish. Weight 1 1/2 lbs. Scoop price. \$14.95. Acro 78 RPM Automatic Changer with Q.T. Cartridge and permanent needle. Base size 12x13 1/2. Scoop price \$12.95. \$24.95. Vm-800 78 RPM Automatic Changer. Base size 13 1/2x14 1/2. A wonderful buy at \$12.95. Two for \$24.95. Fansworth 78 RPM 2-Post Automatic Changer with new variable reluctance cartridge. Net \$19.95. Vm-400 78 RPM Automatic Changer. Inter-terms 10" and 12" records. Price required 12x13 1/2. A Scoop at only \$19.95. Triple Post 78 RPM Seeburg Automatic Changer. Super construction. Inter-terms 10" and 12" records. Base size 14x21 1/2. Price \$12.95. Popular Detroit Changer. \$12.95. General Instrument 78 RPM Automatic Changer. A fine small changer. Base size 10 1/2x12 1/2. Net \$14.95. Leatherette made to fit bases for any of the above changers. \$1.95 each.

UNIVERSAL OUTPUTS. 75c

4 Watt Single Plate Universal. 75c. 4 Watt P. P. Plate Universal. 75c. 8 Watt P. P. Plate Universal. 75c. 12 Watt P. P. Plate Universal. \$1.25. 100 Assorted 1/2, 1/4, and 1 Watt Resistors. All in plastic and coded. Low Ohm to 10 Meg. 100 for \$1.49. ICA UNIVERSAL AC-DC LINE CORD \$0.59. 8 Foot G. E. Plastic AC Cord. 10 for 2.00. 6 1/2 Foot G. E. Plastic AC Cords. 10 for 1.50. 50 Mill AC-DC Chokes. .39. Small Plastic Mike Cable. 4c Per Ft. Beldin Mike Cable. Best quality. 6c Per Ft.

BELDON 100 WATT IRON. \$1.95

Radio Shack. Soldering Iron. \$4.00 Value Net. \$1.95. G.I. RM-4. \$5.95

General Industries RM-4 heavy duty phono motor with T. 78 RPM. Scoop price. \$5.95. Deluxe quality 78 RPM phono motor with T. 78 RPM. Dual speed phono motor 3 3/4 x 7 3/4. Reg. \$11.00 list. Scoop price. \$4.95. REPLACEMENT MOTOR. \$1.29. Scoop price. \$1.29. Webber "56". \$19.95. Brand new Webster 56 Record Changers with Crystal Cartridge of Norman output voltage. These new changers but have been removed from new models. A replacement with dual speed models. A regular \$26.66 dealers' net item offered for only \$19.95. Webster 56 Changer with Caltron V.R. Cartridge. (Use same preamp as G. E.) only 50¢ to sell at \$22.95.

Nationally Famous 600 Volt Tubulars

All latest production 600 volt tubulars Branded by their makers as type T.P. Each in smaller quantities. .04, .06, .02, .004, .006, .008.

Table listing various 600-volt tubular models and their prices, including 1600 volt rated for the tough job or auto buffers. .002, .02, .04, .05, 15c each; 10 for \$1.29.

Solar Wet Electrolytics

Genuine Solar Screw Mounting Wet Electrolytics. Late 1948 production. Use Solar wets when you want a filter for those tough jobs. 8 mfd. 500 Volt wet. Solar. \$0.87. 16 mfd. 500 Volt wet. Solar. 1.23. 8 mfd. 800 Volt wet. Solar. 1.32. 16 mfd. 600 Volt wet. Solar. 1.80.

PHILCO \$9.95

Regular \$26.50 list Philco High Imp. Dynamic Mike and Cable. Same as Electrovoice Model 605. Net \$9.95. 33x Crystal Mike with 20 Ft. of Cable. Net \$10.95. 33D High Frequency Dynamic Mike with 20 Ft. of Cable. Net \$12.95. Crystal Recording Mike with Desk Stand \$4.95.

\$26.95

15 Inch P.M. 6 Lb. Mag. Jensen \$26.95. A 15 PM. A fine 15 Inch Permanent Magnet Speaker. Heralded by some connoisseurs of fine musical reproduction as the world's finest speaker. Brand new original cartons. 6 Pound Alnico 3 Magnet. 1 1/2 inch 8 Ohm Voice Coil. One piece molded cone made by Jensen. A regular \$55.00 list price for only \$26.95. Two for \$50.00. Weight 22 lbs.

McGEE RADIO COMPANY

Order from This Ad—With Full Remittance Include Postage or May Be Sent Express Collect. SEND 25% DEPOSIT—BALANCE SENT C.O.D. 1225 MCGEE ST., KANSAS CITY, MISSOURI

# NOW...

## ONE MAN ALONE



### CAN ORIENT A TV ANTENNA QUICKER and BETTER!



with the New  
**SIMPSON**  
TV  
*Antenna Compass*

Simpson Model 351 is a ruggedly built pocket size meter which connects to the video input of the cathode ray tube in a television receiver. By an extension cord it is carried to the antenna site. With a test pattern tuned in on the area's weakest station, the antenna is simply rotated for maximum deflection of the TV Antenna Compass! Identifies ghosts, too. Much more accurate than the old-fashioned method—and *one man does it in one-third the time two men used to take!* Dealer's net price only \$16.35. Your Parts Jobber has them NOW.



**SIMPSON ELECTRIC COMPANY**  
5200-18 WEST KINZIE STREET  
CHICAGO 44, ILLINOIS  
In Canada:  
Bach-Simpson Ltd., London, Ontario

# EYESTRAIN—A New Video Hazard

By **W. S. STEWART**  
TV Ed., "International Photographer"

**TV manufacturers must help eliminate this very real threat to television's entertainment role.**

**A** MOUNTING number of television fans are finding that their favorite entertainment medium is causing them considerable grief in the form of eyestrain.

One factor contributing to this situation is the viewing of television screens in totally darkened rooms. This practice puts a severe strain on even normal eyes. Many optometrists recently have pointed out that alternate shifting of the eyes between a relatively bright television screen and an adjacent area of total darkness places an abnormal load upon the light accommodating mechanism of the eye.

One of the foremost reasons for dark room television viewing is the poor judgment used in cabinet design by many of the television manufacturers.

Too many TV cabinets employ highly reflective materials to mask the television screen.

Materials such as highly polished wood and brass, chrome and plastic trim and excessively large areas of polished plate glass surrounding the picture area provide sources of intense specular reflections from even subdued room lights or window light.

Some television cabinet designs are so poor that distracting specular reflections from the picture tube light itself are bounced into the observers' eyes from the picture area masking material. The latter situation is especially bad when the picture frame has an inside bevel.

Thus, the predominating tendency of television set owners to view their TV in total darkness is encouraged by the fallacies of picture-masking techniques on the part of the television manufacturers.

It may not be true, but the evidence seems to point to a professional, obstinate, and incongruous jealousy between the radio-television and motion picture industries.

The motion picture industry and allied photographic and visual arts professions have spent upwards of fifty years in the study of picture viewing.

The gamut from pure scientific research to empirically derived formulas, painstakingly developed over an extended period, has determined

physiological and psychological medians and standards of practice which are difficult to refute with respect to picture viewing.

These decades of study have indicated that a dark, matte surface surrounding pictures of the transmitted-light type provides the optimum viewing condition.

It is difficult to comprehend upon what premise the TV manufacturers, relatively inexperienced in the visual aspects of communication, proceed to decorate picture-area borders with shining gingerbread of brass, chrome, and glittering plastic.

Some specular reflection is unavoidable due to the smooth glass surfaces of the cathode-ray tube face and the shatter-proof protective glass plate covering the picture area.

Thus, since the necessary materials involved in the actual presentation of the picture to the viewer are inherently reflective it seems to be extremely poor practice to aggravate the dilemma by masking the picture area with additional highly reflective materials.

In view of the fact that many of the spurious reflections from ambient light sources can be eliminated by obvious cabinet design treatments, it seems that some effort should be made in the direction of excluding the built-in reflections from the polished surfaces of the cathode-ray tube face and its protective glass plate.

A variation on one of the coated-lens techniques, as applied to plane glass surfaces, might lead to a solution of the problem. Another solution might be found in some type of very light etching of the glass surfaces involved to reduce the unwanted reflections without intolerable loss of contrast range and definition.

Many suitable materials, from both a decorative and utilitarian standpoint, could be given matte finishes to offer practically non-reflective surfaces for masking the picture area of the television receiver.

The gain in consumer viewing comfort would constitute a definite contribution to the television art and at the same time eliminate a point of sales resistance which may eventually assume major proportions.

—30—

**RADIO & TELEVISION NEWS**



Look at these  
**SENSATIONAL  
LOW PRICES**

# Complete MATCHED High

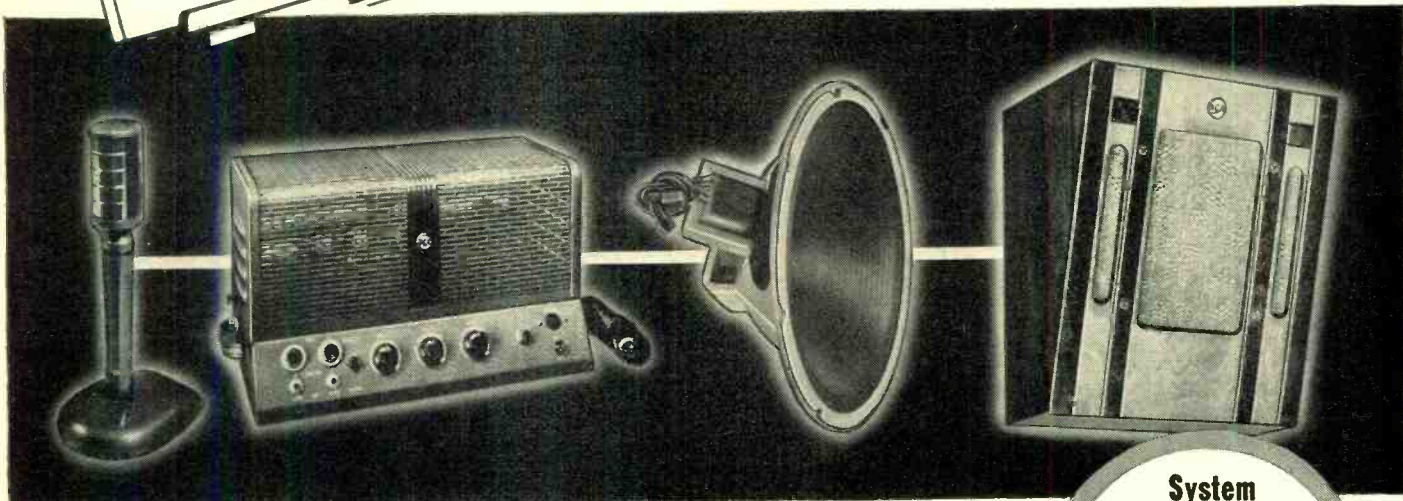

## RCA 25-WATT SYSTEM, UNEXCELLED VALUE

This complete, ready-to-operate, matched sound system surpasses any sound system you could buy at this sensational low price.

**AMPLIFIER:** High gain, wide range, low-distortion, 25-watt amplifier with inverse feedback. 2 high impedance microphone inputs—high and low impedance phono inputs—speech music switch and tone control—complete with tubes.

**MICROPHONE:** De luxe dynamic high im-

pedance microphone—modern, rugged, lightweight, with 15-ft. cable and matching base.

**SPEAKER:** 12-inch PM speaker with 6.8 ounce Alnico V magnet and multi-tap line matching transformer.

**BAFFLE:** Attractively styled, sloping front, walnut finish, wood baffle.

**EXTRA SPEAKERS AND BAFFLES:** Available at comparably low prices.

System  
P-525-12W  
**\$99<sup>50</sup>\***  
Suggested list price.

## RCA HIGH QUALITY COMPLETE SOUND SYSTEM WITH 4 SPEAKERS

An ideal sound system for general applications—uses same 25-watt amplifier and microphone described in system P-525-12W—with 4 high efficiency 6-inch PM speakers with multi-tap

line matching transformers and beautiful molded fibre, sloping front baffles. Compare this unparalleled equipment value.

System P-525-6F4  
**\$119.50\***  
Suggested list price.

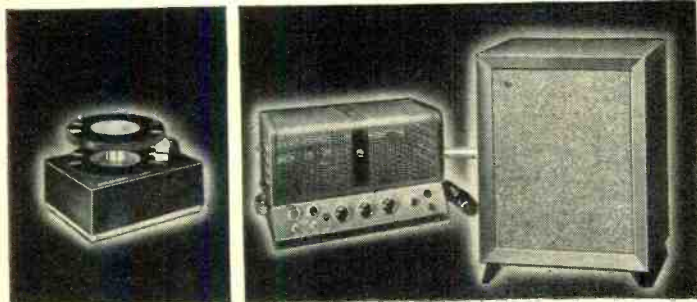

## RCA DE LUXE MUSIC REPRODUCING SYSTEM

This system using the 25-watt amplifier described in System P-525-12W and a handsome modern console reproducer may be used with the sensational new RCA 45 rpm Record Player—or other turntable—or FM tuner to provide a superb music reproducing system. Console Cabinet is 22" wide, 25" high, 12"

deep available in blonde or walnut finish. The new RCA 45 rpm record player (pictured above) using the new 7-inch distortion free records is ideal for use with any of these sound systems.

System P25-10C  
**\$139.50\***  
Suggested list price.  
Less Record Player

All prices shown are suggested list prices subject to normal dealer discounts

\*Prices do not apply outside the continental U.S.A.



Ask Your nearest  
**RCA SOUND PRODUCTS  
DISTRIBUTOR** for  
**FREE Catalog**

84 pages of sound products—microphones, amplifiers, speakers, recorders, portable P.A. and other profitable items.

**RADIO & TELEVISION NEWS**

# Quality Sound Systems by **RCA**...

Contact Your nearest **RCA SOUND PRODUCTS DISTRIBUTOR**  
**For these Advertised and other Matched  
 Sound Systems and Accessories**

**MAKE THE RCA SOUND PRODUCTS DISTRIBUTOR IN YOUR AREA Your Sound Headquarters**

**ALABAMA**  
 Nelson Radio & Supply Co.  
 451 St. Louis Street, Mobile  
 Radio Service Company  
 1907 5th Ave., North, Birmingham

**ARIZONA**  
 Culver's  
 231 N. First Avenue, Phoenix

**CALIFORNIA**  
 Jack C. Arbuckle  
 2330 Kern Street, Fresno  
 Jack C. Arbuckle  
 523 E. 19th Street, Bakersfield  
 C. O. Davey Company  
 90 Tehama Street, San Francisco  
 Foster-Barker Company  
 408 W. 4th Street, Santa Ana  
 Otto K. Olesen Company  
 1534 Cahuenga Blvd., Hollywood 28  
 San Diego Theatre Supply  
 1030 Twentieth Street, San Diego

**COLORADO**  
 McCormick Radio & Sound  
 614 Road Avenue, Grand Junction  
 Niles Phonograph & Radio Co.  
 505-07 14th Street, Denver

**CONNECTICUT**  
 Radio & Appliance Distributors, Inc.  
 673 Connecticut Blvd., East Hartford

**FLORIDA**  
 Hill Sound Systems  
 1609 Altan Road, Miami Beach  
 Pogue Radio & Sound Company  
 1603 Grand Central Avenue, Tampa  
 Southern Hardware & Bicycle Co.  
 2336 Liberty Street, Jacksonville

**GEORGIA**  
 Yancey Co., Inc.  
 340 W. Peachtree St., N. W., Atlanta

**ILLINOIS**  
 Edward H. Gordon  
 LeClair Hotel, Moline  
 Klaus Radio & Electric Co.  
 707 Main Street, Peoria  
 RCA Victor Distributing Corp.  
 1257 S. Wabash, Chicago 5

**INDIANA**  
 Commercial Sound & Radio Co.  
 528 E. Colfax Avenue, South Bend 17

**INDIANA Cont'd.**  
 Ohio Valley Sound Service  
 11 N. W. Riverside Drive, Evansville  
 Van Sickle Radio Supply Co.  
 34 W. Ohio Street, Indianapolis

**IOWA**  
 Radio Trade Supply Co.  
 1224 Grand Avenue, Des Moines  
 Radio Trade Supply  
 434 W. 2nd Street, Ottumwa

**KENTUCKY**  
 Ewald Distributing Co., Inc.  
 309 S. 9th Street, Louisville

**LOUISIANA**  
 Electrical Supply Co.  
 201 Magazine Street, New Orleans 8

**MAINE**  
 Henry D. Burrage  
 494 Four Street, Portland

**MARYLAND**  
 The Electronics Co.  
 502 E. North Avenue, Baltimore

**MASSACHUSETTS**  
 Boston, Massachusetts—To be announced  
 Write: RCA Sound Products Section  
 Camden, N. J.

**MICHIGAN**  
 RCA Victor Distributing Corp.  
 7400 Intervale Avenue, Detroit 7

**MINNESOTA**  
 Lew Bonn Co.  
 1211 LaSalle Avenue, Minneapolis  
 Lew Bonn Co.  
 228 E. Superior Street, Duluth

**MISSOURI**  
 Interstate Supply Co.  
 10th & Walnut Streets, St. Louis 2  
 RCA Victor Distributing Corp.  
 2113-15 Broadway, Kansas City 8

**MONTANA**  
 Northwestern Auto Supply Co.  
 420 Broadway, Billings

**NEBRASKA**  
 Sound Engineering Co.  
 2755 Farnam Street, Omaha 2

**NEW JERSEY**  
 Commercial Radio-Sound Corp.  
 North Jersey Sales & Service  
 1060 Broad Street, Newark 2

**NEW YORK**  
 Commercial Radio-Sound Corp.  
 570 Lexington Avenue, New York 22  
 Commercial Radio-Sound Corp.  
 50 State Street, Albany

**NEW YORK Cont'd.**  
 F. M. Scund Equipment Corp.  
 136 Delaware Avenue, Buffalo 2  
 Morris Distributing Co.  
 412 S. Clinton Street, Syracuse 2  
 Morris Distributing Co.  
 195 Water Street, Binghamton

**NORTH CAROLINA**  
 Freck Radio & Supply Co.  
 38-40 Baltimore Avenue, Asheville  
 Southeastern Radio Supply Co.  
 411-415 Hillsboro Street, Raleigh  
 Southern Radio Corp.  
 1201 W. Morehead Street, Charlotte

**NORTH DAKOTA**  
 Fargo, North Dakota—To be announced  
 Write: RCA Sound Products Section  
 Camden, New Jersey

**OHIO**  
 Gustav-Hirsch Organization  
 310 W. Broad Street, Columbus  
 Music Systems, Inc.  
 2600 Euclid Avenue, Cleveland 15  
 Music Systems, Inc.  
 1312 Jackson Avenue, Toledo 2  
 Midwest Sound Equipment Division  
 (Gustav-Hirsch Organization)  
 1638 Central Parkway, Cincinnati  
 Youngstown, Ohio  
 Write: Hamburg Brothers  
 305 Fenn Avenue, Pittsburgh 22, Pa.

**OKLAHOMA**  
 Atomic Sound Engineering Co.  
 312 N. W. Second St., Oklahoma City  
 Ridley's, Inc.  
 214 E. 10th Street, Tulsa

**OREGON**  
 Harper-Meggee, Inc.  
 1506 N. W. Irving Street, Portland 8

**PENNSYLVANIA**  
 Hamburg Brothers  
 305 Penn Avenue, Pittsburgh 22  
 Erie, Pennsylvania  
 Write: Hamburg Brothers  
 305 Penn Avenue, Pittsburgh 22  
 Raymond Rosen Engineering Products, Inc.  
 32nd and Walnut Streets, Philadelphia  
 Harrisburg, Pennsylvania  
 Write: Raymond Rosen  
 Engineering Products, Inc.  
 32nd and Walnut Streets, Philadelphia

**SOUTH CAROLINA**  
 Radio Laboratories  
 215 King Street, Charleston 5

**SOUTH DAKOTA**  
 Warren Radio Supply  
 115 S. Indiana Ave., Box 478, Sioux Falls

**TENNESSEE**  
 Curle Radio Supply & Sound Service  
 825 Cherry Street, Chattanooga  
 Hahn Electronics Supply Corp.  
 350 E. Scott Street, Knoxville  
 McGregor's, Inc.  
 1071 Union Avenue, Memphis 3  
 Radio & Appliance Corp.  
 4 Cummins Station, Nashville

**TEXAS**  
 Carver Sound & Equipment Co.  
 1408 S. Akard Street, Dallas 1  
 Midland Specialty Co.  
 425 W. San Antonio Street, El Paso  
 R. & R. Supply Co.  
 704 Main Street, Box 329, Lubbock  
 Sound Sales & Engineering Co.  
 1614 Fannin Street, Houston  
 Southwest Radio-Sound Equip. Co.  
 635 S. Flores Street, San Antonio  
 Western Sound Equipment Co.  
 1601 N. Ballinger St., Ft. Worth

**UTAH**  
 Western Sound & Equipment Co.  
 142 E. First St., South, Salt Lake City

**VIRGINIA**  
 L. C. Hartman  
 P. O. Box 329, Roanoke  
 Radio Supply Co.  
 711 Granby Street, Norfolk  
 Radio Supply Co.  
 3302 W. Broad Street, Richmond 21

**WASHINGTON**  
 Harper-Meggee, Inc.  
 960 Republican Street, Seattle 9  
 Harper-Meggee, Inc.  
 N. 734 Division Street, Spokane 8

**WEST VIRGINIA**  
 Crichton Engineering Co.  
 203 Payne Building, Charleston 25  
 Hamburg Brothers  
 1407 Main Street, Wheeling

**WISCONSIN**  
 Taylor Electric Co.  
 112 N. Broadway, Milwaukee

**WASHINGTON, D. C.**  
 American Amplifier & Television Corp.  
 1111 Nineteenth Street, N. W.



If you are interested in qualifying as a distributor or dealer,  
 please write to RCA Victor Division, Sound Products Group, Camden, N. J.



**SOUND PRODUCTS**  
**RADIO CORPORATION of AMERICA**  
 ENGINEERING PRODUCTS DEPARTMENT, CAMDEN, N. J.

In Canada: RCA VICTOR Company Limited, Montreal

# What's New in Radio

## AUTOMATIC RESONATOR

Lewis E. Babcock & Co., 62 Basswood Ave., Providence 8, Rhode Island, has announced a small, inexpensive automatic resonating device, designed



to tune to resonance in succession, any desired number of grid and plate tank circuits. The unit will resonate the antenna tuning circuit, the final plate tank, and all the tuned circuits back to the first exciter stage plate tank in any transmitter.

The device can be incorporated in a transmitter by merely adding the motors, and running the connections from it to the resonator unit. The system is non-critical as to operating frequency and uses no special tuned circuits of its own, no selsyns, and imposes no limitations on the efficiency of the equipment with which it is employed.

Further information can be obtained by writing Lewis E. Babcock & Co., at the Rhode Island address.

## INSULATED CHOKES

Especially engineered for television and FM receiver requirements, the new line of fully insulated chokes announced by *International Resistance Company* are said to be relatively inexpensive. The firm believes the additional savings over so-called more conventional types are made possible because of the molded phenolic housing, which not only provides complete protection against high humidity, but



reduces assembly loss by affording protection from abrasion and physical damage.

These new chokes come in two sizes, Types CLA and CL-1. There is a wide range of size and characteristic combinations available. Resistance is low enough to enable their use as filament

chokes for moderately high-power tubes.

Samples for testing as well as comprehensive catalogue data may be obtained by writing *International Resistance Company*, 491 N. Broad Street, Philadelphia 8, Penn.

## ASTATIC CRYSTAL CARTRIDGE

The LQD crystal cartridge produced by the *Astatic Corporation*, Conneaut, Ohio, uses two separate, independent needles, one with one-mil tip radius to play the new long-playing records, the other with three-mil tip radius for standard recordings.

These double-needle, turnover type pickup cartridges use the Astatic "Q" and "Q-33" needles available for some time. A gentle pry with a penknife or small screwdriver lifts either of these special needles from its snap-in position in the cartridge, without removing the cartridge from the tone arm. Gentle pressure with the tip of a knife blade clicks the new needle into place. Removing or replacing one needle does not disturb the other.

Top reproduction quality also is claimed for the LQD, with excellent frequency response, particularly at low frequencies. A relatively high

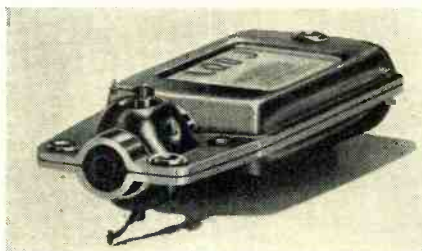

vertical and lateral compliance of the Q needle design is said to provide appreciable reduction in needle talk.

The LQD cartridge has a stamped aluminum housing. The output voltages are 1.2 at 1000 cycles with 78 r.p.m. audio-tone test record; .75 with 33 1/2 r.p.m. Columbia 281 test record; and .5 with 33 1/2 r.p.m. Columbia 103 test record. Recommended needle pressures are 15 grams for 78 r.p.m. and six to eight grams 33 1/2 r.p.m.

Write to *Astatic Corporation*, at Conneaut, Ohio, for more complete information.

## STREAMLINED MULTITESTER

A new, streamlined version of the Model 447 manufactured by *Radio City Products Co.*, 152 W. 25th St., New York, N. Y., has been announced, with no increase in price scheduled for the improved unit.

This Model 447A Multitester is lighter in weight because of a magnesium panel and a new battery arrangement. The panel is attractively

finished in hammertone grey with white markings to correspond to the other instruments in the line. The ohmmeter circuit has been simplified so as to have the same over-all coverage with only one unit cell and an improved battery holder.

Provision is made for extending the ohmmeter range to 10 megohms by using an external battery, and a gold-plated copper oxide rectifier with ex-

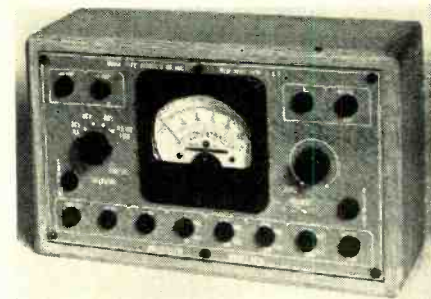

cellent current density characteristics gives improved performance for the measurement of a.c. and output voltages.

## NEW MINIATURE CABINET LINE

Recent additions to the regular line of *Bud* sheet metal products include cabinets, boxes, amplifier foundations, and aluminum chassis for equipment using miniature tubes.

*Bud Radio, Inc.*, now offers over 200 different sheet metal housings fabricated from steel and aluminum for radio and electronic equipment. Most of these are available for immediate delivery.

Estimates and manufacturing details are furnished upon receipt of engineering drawings. For complete information write to *Bud Radio, Inc.*, 2118 East 55th Street, Cleveland, Ohio.

## "THE MEGALIGNER"

A marking device which covers the frequency range of 19 to 49 mc., including all present and proposed i.f. bands, has been introduced by the *Kay Electric Company*, Pine Brook, N. J.

This new instrument, designated "The Megaligner," has a self-con-



tained power supply and provides a tunable c.w. signal which may be used as a signal source or with "The Mega-

**RADIO & TELEVISION NEWS**



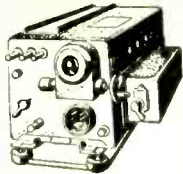

GREAT BUY!

RU-16 receiver with 3 plug-in coil drawers... Price with tubes, plug and simple conv. diag. \$5.95 ea.

Box with plug. NEW. \$2.50 ea. Power Supply Kit for above Receiver. All parts and diag. included. \$9.45.

RU-16-17 Tube Kit. 2-77's, 3-78's, 1-1642 tubes. ORIG. CARTONS. ONLY \$2.85 ea.

LIMITED QUANTITY ITEMS

BC-342 Receiver. Used, but in good cond. Tested before shipping. \$79.50 ea.

ARN-5A 11 tube Glide Path Superhet. NEW. 3:32 to 3:35 mc. Complete with tubes. Sealed cartons. Tubes alone worth the price of only \$10.95 ea.

Telescopic Whip Antennas. BRAND NEW. Extends to 7' in nine sections. Complete with mtg. base. Sealed Cartons. Price \$1.75 ea.

Push Button Tuning Unit. A Mechanical tuning mechanism which is adaptable to any tuner. 10 Chrome Plated Push Buttons operate tuning condenser. A Real Buy at \$1.95 ea.

Desk type Telephone Mike. Mfgd. by Strom, Carlson and Kellogg. With p. to t. sw. ONLY \$2.95.

COMBINATION OFFER. This month only. 70 ma. Power Xfmr., 70 ma. Choke, Dual Smfd. 450v. Filter, 5Y3GT tube and socket, 275v. @ 70ma., 4.3v. @ 3a. output. All items NEW. ONLY \$4.95 for lot.

SCOPI! Here's a BUY. 10" P.M. Speaker with good sized Alnico 5 magnet. Large 1" voice coil. Sturdy construction throughout. Handles 10 watts. Reg. Price \$11.50. Your cost \$4.60 ea.

WHIP ANTENNA. 4 Sect. Chromed brass. Extends to 23 3/4". For UHF Ant., Beams, etc. 8-32 mtg. ONLY 90c ea.

CONDENSER TESTER



One of our best sellers! Useful, versatile laboratory item... Checks condenser leakage and continuity up to 8-megs. Will test any paper, electrolytic, mica or oil condenser from 50-puf. to 50-mfd.

REAL BARGAIN!



HS-16 Headphones with standard long cord (6 ft.) and adjustable headband. Unquestionably the best buy in surplus phones ever sold.

POWER SUPPLY FOR ANY 274-N RECEIVER



Here it is—at last! Just plug it into the rear of your 274-N RECEIVER... any model! Complete kit, and black metal case, with ALL parts and diagrams.

parts for conversion of rest of receiver also included. ONLY \$7.95. TUNING KNOB for 274-N Receiver. 59c ea.

SIGMA HERMETICALLY SEALED 7000 OHM SPDT RELAYS!



Operates on 1 ma. current change. This relay requires no maintenance as all moving parts and contacts are in a VACUUM! Contact ratings, 1 amp.

KURMAN #1901 SPDT SENSITIVE RELAY

1700 ohm fast acting coil closes on 2 ma. 2 amp. 5/32" silv. cont. Mtd. on thick Mycalex base 2 3/4" x 3/8". BRAND NEW. \$1.50 ea. or 10 for \$12.50.



BC-221 Frequency Meter. Range 125KC to 20,000 KC. We have been fortunate to purchase another small lot of BC-221 Frequency Meters.

BC-221 Power Supply Kit. Includes chassis, transformer, rectifier, all parts and diagram \$5.85 ea.

BC-221 Modulation Kit. Converts any BC-221 for modulation. All parts and diagram included. ONLY \$2.80

BC-221 Set Spare Tubes. ONLY \$1.29.

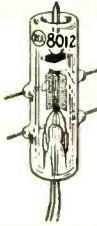

VHF SURPLUS TUBES

FILAMENTS TESTED BEFORE SHIPMENT! ALL BRAND NEW!



829 UHF Triode. Full ratings (86 watts output) up to 250 mc! Get real power on 2 meters with a pair of these tubes. BRAND NEW! Get yours NOW \$5.00 ea. or 4 for \$20.00.

WE717A PENTODE. Hams know this tube's ability to 'soup up' an receiver. Has transconductance of 4,000 and is interchangeable with 6SK7.

829 Twin Beam Tetrode. Ideal for UHF. Brand new in orig. cartons. \$2.80 ea. or 4 for \$11.00.

829B Twin Beam Tetrode. This well known tube is ideal for application at VHF. Full output (87 watts) up to 200 MEG! BRAND NEW! \$3.95 ea. or 4 for \$13.50.

832 Twin Beam Tetrode. NEW. \$2.50 ea. or 4 for \$8.80.

832A Twin Beam Tetrode. 26 watts output up to 200 MEG! BRAND NEW! ONLY \$3.95 ea.

807 Beam Tetrode. One of the most popular tubes for r.f. application. Brand new. \$1.12 ea. or 4 for \$3.95.

810 Power Triode. This tube is a real powerhouse! 575 watts output up to 30 mc! Carbon anode. Grid outside of envelope for max. h.f. efficiency. BRAND NEW! Only \$5.95 ea. or 4 for \$21.95.

815 Twin Beam Tetrode. Full ratings (56 watts output) up to 125 mc! Requires only .18 watt grid driving power for full output. Brand new. Only \$2.50 ea. or 4 for \$9.20.

836 H.V. Rectifier tube. Similar characteristics to 866. Interchangeable. Don't miss this BUY! 2 for \$11.10.

872 Rectifiers. New. \$1.75 ea. or 2 for \$3.25.

5U4G and 5Z3 tubes. New. \$1.39 ea.

6AB7, 6AC7 tubes. New. \$1.79 ea.

6L6G Nat'l Adv. Brand. NEW. Don't miss these at 79c ea. or 4 for \$3.00.

CK-1005 Rectifier. Cut off pin #8 and you have an OZ4. Several different experimental circuits inc. with each order. Price 3 for \$1.00 Postpaid.

NEED 866 TUBES?

Then you'll be interested in our large shipment of NEW 836 tubes, just received. Same base connections and very similar ratings to 866.

5-VOLT, 60-AMP. XFMR.

110v. 60 cyc. pri. Ideal for 304TL, VT-127A, etc. NEW. Mfgd. by Kenyon. Limited quant. \$5.95.

2 1/2-VOLT, 10-AMP. XFMR

110v. 60 cyc. pri. 13,000 v. ins. For 836 and 866 rectifiers. NEW. Mfgd. by Kenyon. BUY. \$4.95 ea.

COLLINS MODULATION XFMR

Handles 2,000 watts audio power. BRAND NEW. Pri. imped. 12,000 ohms. Sec. 4,000 ohms. Freq. resp. +/- db. to 5,000 c.p.s.

COAX FITTINGS

UG/21U Straight plug. 25c ea. CQA 49470 Chassis recept. for UG/21U. 25c ea.

UG/29U Straight Union. Fits UG/21U. 15c ea.

UG/27U Rt. angle adaptor plug. 30c ea.

British type snap-on coax plug and socket combination 10H/701 plug and 10H/528 recept. Set 25c ea.

83-1 SPN/PL-259A Std. Coax. Cable plug. 49c ea.

83-1R/50-239 Chassis recept. for above 79c ea.

RM-53 REMOTE CONTROL BOX

Two way telephone conversation can be routed over a transmitter and receiver output transferred to a telephone line with this handy remote control box. ONLY \$2.50 ea.

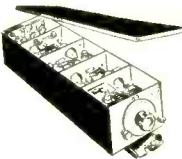

R-1/ARR-1 Homing Receiver

Read excellent article in Jan. RADIO NEWS how to convert this receiver to high freq. converter to use with your present receiver.

★ 4-HOUR MAIL-ORDER SERVICE. WE SHIP ANYWHERE.

20% DEPOSIT MUST ACCOMPANY ALL ORDERS, BALANCE C.O.D.

OFFENBACH & REIMUS CO.

372 ELLIS ST. SAN FRANCISCO, CALIF.

AMERTRAN TRANSTAT VOLTAGE REGULATOR

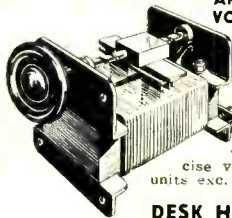

Here's a real value! Spiral screw type brush adjustment with handwheel. Extremely heavy brushes. 2.17 max. amps. Voltage range 110-128 volts. 115v. 60 cycle fixed winding. Useful for precise voltage adjustments.

DESK HANDSET HANGER

Designed to fit all type handsets equipped with butterfly switch such as TS-9, 11, 13, etc. Circuit opening switch operates when handset is returned into place.



HANDSET HANGER

Accommodates all makes and models (W. E. Kellogg, American, etc.) handsets such as TS-9, 11, 13, etc. Fastens to side of desk or on telephone or radio equipment. Felt facing protects handset. Black crackle finish only. \$1.95 ea.

TS-10 SOUND POWERED HANDSETS

These are what you have been waiting for! All BRAND NEW. Made by W.E. RCA and Automatic Elect. Requires no batteries or transformers, of course!



RM-29A TELEPHONE

These famous telephones now available in limited quantity. Contains magneto ringer system for calling.

EE-89A TELEPHONE REPEATER

Here's a REAL BUY. In a 700 cc transmission and extends talking range of EE-8 and RM29-A telephones. Only 2 wire lines used.

ONLY \$9.95 ea. Limited quantity.

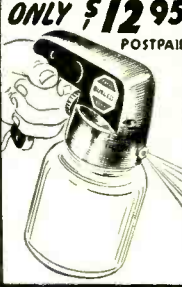

Brand new ELECTRIC PAINT SPRAYER

Just plug it into any 110v. AC outlet and spray! No compressor or other bulky equipment needed.

# On the Warpath against capacitor troubles...

**The SANGAMO**  
*Pathfinder*



**TYPE 30**  
**Molded Tubular**

This molded capacitor is used extensively by television manufacturers. They find it easier to tie into their production lines because the especially designed, flexible leads are trouble-free... they resist breakage and they can't pull out! There is no wax to run when heat is applied. The thermo-setting plastic case is molded with less heat...less pressure...the element is not distorted in fabrication. This means greater dependability—no "hot spots." Try this stable, rugged, long-lived paper-tubular—you'll like it!

**The SANGAMO**  
*Chieftain*



**TYPE MT**  
**Dry Electrolytic**

The Chieftain is tiny, but durable! Meticulous care in manufacture protects against source contamination and assures corrosion-free elements. These capacitors have heavy insulating sleeves that are wax impregnated—not dipped. Positive electrodes are formed of rugged, etched-foil aluminum plate which insures longer life, greater dependability.

Small in size, with bare copper leads, the Chieftain is easy to mount—ideal for replacements—anywhere! Bulletin 825 gives complete information.

\* \* \*

**See your Jobber—if he can't supply you, write us direct.**

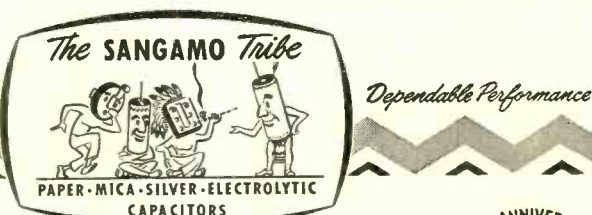

SC494

**SANGAMO ELECTRIC COMPANY** ——— 

SPRINGFIELD, ILLINOIS

IN CANADA: SANGAMO COMPANY LIMITED, LEASIDE, ONTARIO

Sweep" to produce a tunable "birdie" type marker on an oscilloscope display. In addition, when used with "The Mega-Sweep," a tunable "pip" type marker may be connected directly to the vertical amplifier of the display oscilloscope, if desired, which does not overload the receiver or disappear in traps.

The two markers have independent amplitude controls, and the accuracy of the instrument is 5 per-cent of full scale. "The Megaligner" is priced at \$150.00, F.O.B. Factory.

**MOBILE DX CONVERTER**

The *Gonset Company* recently announced that it has in production a compact short-wave converter to permit reception on an ordinary auto radio.

The converter derives power from the set and uses the regular auto

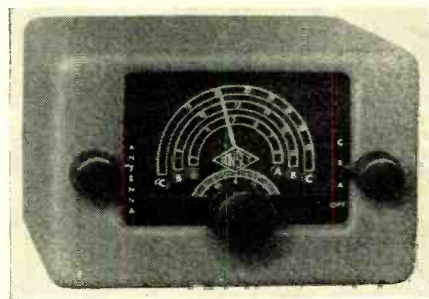

antenna; normal or short-wave reception can be obtained if desired. By means of a bandswitch, it covers all frequencies between 3 and 30 megacycles, and short-wave signals can be brought in from all over the world with good volume. The work of connecting the converter is simple and takes but a few minutes.

Further details on this Model 3-30 may be obtained by writing to the *Gonset Company*, 72 E. Tujunga Ave., Burbank, Calif.

**FIXED-FREQUENCY TUNERS**

Of the three fixed-frequency FM tuners recently announced by *Browning Laboratories, Inc.*, Winchester, Mass., Model RP-25 combines most of the features of the others and, besides, permits turning the audio "on" or "off" as required.

In common with the *Browning* Model RP-23, it is crystal controlled and



adapted to relay reception, storecasting installations, or monitoring purposes. As in the Model RP-24, it also contains relay circuits that operate on tones of from 15 to 20 kilocycles received from the transmitter and which select in sequence two preset audio volume levels that may be man-

**AMSCO'S MAY SPECIALS**

**67 LEFT PHOTO-CELL AMPLIFIER**



110 V. 60 cy. Drawer type. Has milliammeter on front panel. Complete with tubes — 6V6, 6J7, 45, 80 and VR105.

**\$995**

**PARABOLIC REFLECTORS**

15" spun aluminum. Alzak fin. for 1200 Mc. Up.....Per pair **\$3.00**

Available **1949 CATALOG** Write Today

**AMERICAN SALES CO.**  
1811 W. 47th St. Chicago 9, Ill.

**GET YOUR COPY NOW!**

**LOUD-SPEAKERS**



by G. A. Briggs Here's the WHY and HOW of good reproduction explained in simple, non-technical language. Saves money, avoids pitfalls for layman and enthusiast. A remarkable book highly praised by authorities.

Send Only **\$1.50** Postpaid

British Industries Corp., Dept. H  
315 Broadway, New York 7, N. Y.

**SRO**

**has a  
new meaning  
now!**

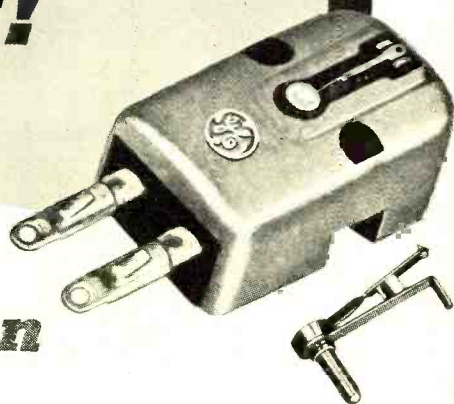

**Stylus Replacement Often**

WHEN the big attraction hit town they hung the "Standing Room Only" sign—it meant overflow business.

It still means that, but the big attraction now drawing overflow business for distributors and dealers is the G-E Variable Reluctance Cartridge with the Replaceable Stylus.

Why? Because record fans who know their records best wanted the finest reproduction possible. The G-E Variable Reluctance Cartridge gave them just that. To secure peak performance they often replaced the cartridge when the stylus was only slightly worn.

Now, with the Replaceable Stylus, cartridge replacement is no longer necessary. In four easy steps the cartridge can be removed from the tone arm, the stylus changed and listening pleasure increased.

Economy is the big feature but this redesigned cartridge has many other advantages. Smaller in size, it can be adapted to many

more tone arms. Higher lateral compliance provides more faithful tracking, hence better fidelity. Frequent stylus replacement reduces record wear and adds hours of top listening pleasure. Needle talk and needle scratch are negligible, giving cleaner, finer reproduction.

Best of all, the cartridge is available for either the new LP records with 1 mil stylus or for conventional records with the 3 mil stylus.

Now for the *Big Extra* to step up sales! A neat dispensing unit for the counter with two cartridges and six styli recessed in a gold-flocked panel to catch the eye. The entire unit is finished in an attractive blue and has a compartment in the rear for additional stock. It is a silent salesman that keeps selling. See your distributor right away for details.

For complete information on Variable Reluctance Cartridges and Replaceable Styli write to: *General Electric Company, Electronics Park, Syracuse, New York.*



The counter sized dispensing unit for greater sales—7½" long, 5½" wide, 4¾" high at the back.

*You can put your confidence in—*

**GENERAL  ELECTRIC**

# SPRAGUE PHENOLIC-MOLDED TELECAP\* TUBULARS



**THE MOST  
TRULY  
DEPENDABLE  
PAPER  
TUBULAR  
CAPACITORS  
EVER OFFERED  
TO THE  
SERVICE  
PROFESSION**

- Extra Dependability at No Extra Cost
- Withstand Heat and Humidity, Shock and Vibration
- High Insulation Resistance
- High Dielectric Strength
- Unequalled for Sizzling AC-DC Midgets, or "Hot" TV and Auto Sets.

See Your Jobber Today!

**SPRAGUE PRODUCTS CO.**  
North Adams, Mass.

\*Trademark

ually adjusted from zero to full output.

Model RP-25's two relay operations are controlled by transmitted tones of different frequency and are, therefore, independent. As in the RP-24, the relay circuits are preset to operate at 15, 17½, or 20 kilocycles, as specified by the customer.

All of the models are rack panel style, finished in black leatherette, and can be supplied with steel cabinet if desired.

For further information, address the company at 742-750 Main Street, Winchester, Mass.

#### NEW TELEVISION CAPACITORS

Distributors of the *Sprague Products Company*, North Adams, Mass., have been supplied with complete lines of the company's television replacement electrolytic capacitors, engineered especially for the tougher applications.

These new type TVA and TVL "Twistlock" electrolytics are designed to stand up under the extremely high temperatures, high ripple currents, and high surge voltages encountered in television receivers.

Complete descriptions of these capacitors is given in the *Sprague* bulletin M-429, available upon a postcard request, and the listing includes 93 separate ratings comprising the units most needed by teleservicemen. Address inquiries to *Sprague Products Company*, North Adams, Mass.

#### PRE-ALIGNED KIT

Believing that pre-alignment of the vital channels is the only satisfactory method of kit assembly, the *Philmore Manufacturing Company, Inc.*, has designed its TV kit with tuner, video, and sound channels completely wired and fully aligned.

Among the features *Philmore* has provided are complete 12-channel tun-

ing, daylight viewing, built-in extra power for video up to 16 inches, PM speaker with choke, and the mounting of all components to the chassis. A licensee of *RCA*, the company reports also that the kit circuit is very similar to the well-known *RCA* 630TS and 830TS.

Also available are the *Philmore* custombuilt television receivers, supplied

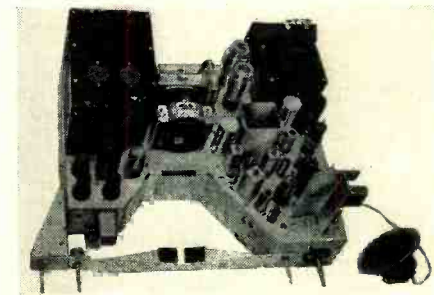

without cabinets, completely wired and assembled ready to play. These can be installed in any piece of furniture, and the customer has a choice of any picture size from 10 to 16 inches.

For further details, write the *Philmore Manufacturing Company, Inc.*, 113 University Place, New York 3, N. Y.

#### DIRECT-VIEW TV KITS

From now on, the direct-view television receivers made by the *Television Assembly Co.*, 540 Bushwick Ave., Brooklyn, N. Y., will be delivered with all of the major components mounted.

These changes were announced the first part of April by the *Sneider Television Corporation*, which operates *Television Assembly Co.*, as well as *Television Industries Co.*, as subsidiaries.

This innovation by *Television Assembly Co.*, which makes television kits for direct-view tubes from 10" up

## BLUEGRASS BUYS

from

### RADIO EQUIPMENT COMPANY

Dept. LD, 480 SKAIN AVE., LEXINGTON, KENTUCKY

Standard type variable condensers, size 1¼ x 1½ x 1¾, ½" shaft. Lots of uses. 120 mmfd—19c . . . 140 mmfd—24c . . . 170 mmfd—34c. One of each value 69c. Buy several for your parts box!

**24V Transformers**—Tapped at 4V. Primary 110V-60 cy. Rated 4 amp. Just the thing for operating your surplus equipment and a real low price. Only \$2.49.

Some real bargains in slightly used Genuine Stancor transformers, etc. Used for Army School demonstration and training but clean and good as new. Order before our stock is exhausted and save. Look at the list price—then at our price.

**Stancor A-3808 Modulation Transformer.** Primary 3,800/3,300 C.T. Sec. 10,000/7,500/5,000/4,500. List \$13.25.

Our Price Is \$2.95

**Stancor C-1721 Choke.** 8.5 Hy at 200 Mil. 3000 V. Ins. List \$6.30.

Our Price Is \$1.69

**Stancor A-4404 Driver.** P.P. Plates 3,000 to 5,000 to P.P. Grid. List \$7.30.

Our Price Is \$1.89

**Stancor P-1325 Power Transformer.** Pri. 115V-60Cy. Sec. 700V 100 Mil. C.T., 2.5V-4 amp. C.T., 5V-3 Amp., 6.3V-4 Amp. C.T. List \$8.00.

Our Price Is \$2.69

**SAVE  
and Be  
SAFE!**

**Buy Surplus & Standard Equipment  
with money-back guarantee at**

**R & M  
RADIO**

**EXTRA TUNING UNITS**

**\$2.50 each, FOB, Kingman, Ariz., or Arlington, Va.**

Types in stock: TU 5-7-8-9-10-26.  
Typical components: 2 vernier dials; 1 var. cap., 20-135 mmf.; 1 var. cap., 20-156 mmf.; 1 var. cap., 8-26 mmf.—neutralizing; 1 .00003-2000V cap., CD—Mica; 3 .00009-3000V cap., CO—Mica; 2 .0001-3000V cap., CO—Mica; 3 .0001-3000V cap., CO—Mica; 2 4-position ceramic band switches; 2 RF chokes; 1 tank coil—ceramic form with tapped ant. coupling coil; 1 tank coil—ceramic form; 1 parasitic suppressor; 2 ceramic flex. couplings; plus banana jacks, stand-off insulators.

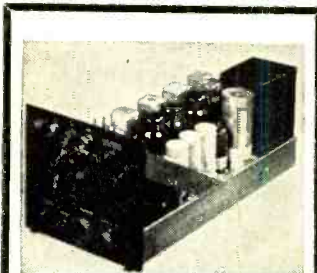

**APN-4 RCVR—'SCOPE  
POWER SUPPLY**

4 switch-selected screw-driver tuned RF channels; IF freq. 1050 kc, band-width 45-60 kc; RF freq. 16 2000 kc. Tubes: (2) 2Y2, (3) 6B4, (4) 6SK7, (1) ea. 5U4, 6SU7, 6SA7, 6HG, VR150. Makes fixed tuner for med. freq. police calls or PA system. Has power supply for 5" scope, with 400 cycle trans. Electronic-controlled low v. supply; delivers 260 vdc, 150 mils reg. to .01%. Power supply alone worth **\$8.95** more than price.



**Buy it for conversion! Buy it to cannibalize!  
Buy it to get on the air! It's the war-proved, versatile**

- Complete with**
- tuning unit (TU-6)
  - antenna loading unit
  - dynamotor
  - set of plugs
  - all tubes
  - wiring diagram and conversion data free

**BC-375-E**

Quantity Limited

**19.95**

FOB KINGMAN, ARIZ.

Complete conversion diagram included. Xmtr. designed to operate from 200 kc to 12 mc (less BC band). Equipped with antenna tuning unit BC-306-A—variometer and tap switch. Dynamotor (PE-73-C) complete with relay, fuses and filter.

**INTER-COM**

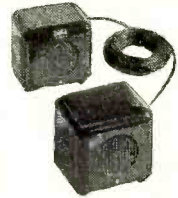

**Factory  
Close-Out!**

**Brand New and Priced  
for Quick Clearance!**

Limited Quantity **\$14.95**

(List price \$34.95)

Price includes master station, one remote, and 50' of wire. Rig it up as a "baby-sitter" with pick-up at baby's crib. Useful in office, or for instant contact with basement, garage, attic, kitchen. Simple to install—just plug it in to 110 v. AC or DC socket.

**TRANSFORMERS**

For converting SCR-274-N to 115 Volts AC.

No. 1 Power Transformer. Pri—115v 60 cycle; sec—500 CT .06 Amp. 24v 1/2 amp.  
Price only **\$3.90**

No. 2 Filament Transformer. Pri—115v 60 cycle; Sec. 1—14v 7 1/2 amp.; sec. 2 14v 7 1/2 amp. Series 28v 7 1/2 amp. Parallel 14v 15 amp.  
Price only **\$4.50**

No. 3 Filament XMFR. Pri—115v 60 cycle; Sec. 24v 2 amps.  
Price only **\$2.25**

**Speakers—Brand New  
Permanent Magnet**

4" **\$1.60**  
5" **1.85**  
12" Jensen in Metal Case **14.50**  
10% discount, purchase of 2 or more

**Heavy Duty  
Transmitting Chokes**

8 HY—500 MA—5000 V INS.  
Price each **\$8.95**

**Condensers—Fixed**

.05 Mfd. 600 Volts	\$0.15
10 Mfd. 350 Volts	.69
15 Mfd. 150 Volts	.60
16 x 16 450 Volts	1.20
20 250 Volts	.69
40 150 Volts	.75
50 150 Volts	.69
150 25 Volts	.54
200 10 Volts	.45
8 x 8 Can. Electrolytic	1.50

**Tubes (New, in Original Cartons).**  
For the SCR-274-N Command Set & Others.

12A6	69c	OD8- VF150	75c
12SR7	69c	12SA7	69c
12K8	69c	77	59c
12SK7	69c	78	59c
12SF7	69c	89	59c
1625	89c	38322	\$1.19
1626	79c	12J5-GT	69c
1629	89c		

**ALL EQUIPMENT F.O.B.**

• SAVE C.O.D. CHARGES and speed your order by remitting in full or 25% deposit. Please don't send money for postage, we ship "transportation charges collect." These prices supersede all previous prices. Write every month for BARGAIN BULLETIN.

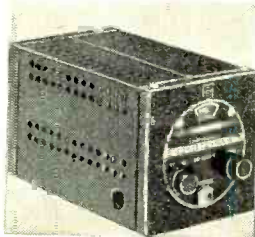

**BC 1206, LAZY Q FIVER  
SINGLE SIGNAL  
RECEPTION **\$9.95****

The littlest BIG BUY ever offered! A BC-1206 Satchell Carlson receiver will take the place of BC-453 (Lazy Q Fiver). We think it's even better. Here's why: Smaller—4" x 4" x 6 1/2"; weighs only 3 lb. 14 oz. Less current drain, .75 amps at 24 v. DC. IF freq. 135 kc. A conventional superhet circuit is employed and is arranged so that AVC will prevent overloading on strong signals.

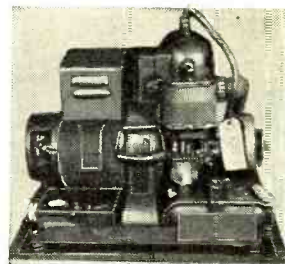

**The Famous PUTT-PUTT  
Gasoline Generator (HRU-28)**

28 - 32  
Volts D.C. **\$74.50**  
ONLY

Single cylinder, 2-cycle gasoline engine with generator that is rated at 2,000 watts direct current, 70 amps. Has unlimited use around a farm; useful as field day power supply. More literature upon request.

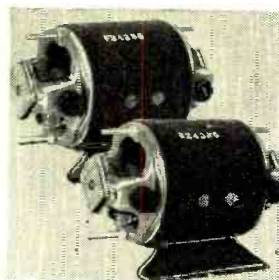

**DUAL POWER SUPPLY**

SAVE YOUR BATTERY **\$4.95**  
Both for \$8.95 each

Use our dual dynamotors by wiring them in series and use one on receivers and both in transmitter. High voltage output 600 volts at 48 watts. Low voltage 300 volts at 24 watts.

**R & M RADIO COMPANY**

2701 WILSON BLVD. DEPT. RN-59 ARLINGTON, VIRGINIA

# ...Help end spark plug INTERFERENCE



Spark Plugs are miniature broadcasting stations, send signals that interfere with radio reception, distort television. The New Auto-Lite "Resistor" Spark Plug reduces this interference.

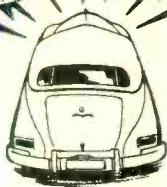

## Recommend NEW AUTO-LITE Resistor SPARK PLUG

### Here's How It Works to End Interference

The "Resistor" acts to dampen the spark plug radio signal to an acceptable level\* while still delivering the full high voltage discharge required to ignite the fuel.

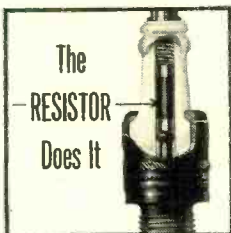

Auto-Lite Ignition Engineers, working with leading automotive manufacturers, have developed the new Auto-Lite "Resistor" Spark Plug with this built-in resistor that reduces spark plug interference.\* Remember, the "Resistor" also helps deliver smoother idling, improved economy, longer electrode life. Dealers are being supplied as rapidly as possible. Write for Booklet M-1186 for full information.

THE ELECTRIC AUTO-LITE COMPANY  
Toronto, Ontario Toledo 1, Ohio

\*Under 35mv/m from 540 k.c. to 150 m.c. at 50 ft.

Tune In "Suspense," Thursdays, 9:00 P. M., E. T., CBS

to 20" as well as a projection television receiver with a 520" screen, will leave only 13 tubes to be wired. The change involves the pre-wired i.f. picture and sound strip, named the "Vivideo" feature, and the front ends.

#### NEW PHONOMOTOR UNITS

Many customers will find the new Alliance Dual-Speed 33 $\frac{1}{2}$ -45 r.p.m. phonomotor unit very economical for the new LP records.

This unit, together with a new single-play 45 r.p.m. record player, intended expressly for the newer records, will be made available in individual boxes to the radio-phonograph distributors. Although the Dual-Speed player assembly is primarily intended as a single player, the mechanism, consisting of motor and turntable, can also be adapted to changers.

The Alliance Manufacturing Company, Alliance, Ohio, started mass production of both models around March 1, and it expects a large volume of business from many consumers who will want to replace older-style players with the new assemblies.

#### MINIATURE LAMPS

Packaged in the familiar red, black, and white colors, a well-rounded line of miniature lamps has been an-



nounced by the RCA Tube Department, Camden, New Jersey.

These were planned to give the radio service dealer a wide assortment of lamps to take care of everyday replacement needs, and to fill practically every radio panel and flashlight need.

The line includes sixteen different types for radio panel and miscellaneous replacement use, and eight types for flashlight replacement purposes, and is available from RCA tube and parts distributors.

#### FIELD STRENGTH METER

The Transvision Model FSM-1 field strength meter which has been designed to facilitate television installations consists of a compact, high-gain receiver with a calibrated meter to indicate signal level. Each unit is individually calibrated. The instrument comes complete with self-contained power supply for operation at 120 volts, 60 cycles.

This compact, portable service instrument includes among other features a 13 channel selector. It measures actual picture signal strength besides losses or gain of various antenna and lead-in combinations. It is useful

for checking receiver reradiation; amplitudes of interfering signals can also be checked.

For further information write to

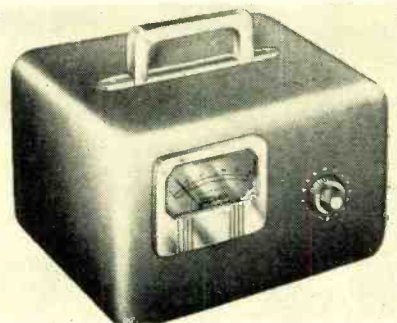

Transvision, Inc., New Rochelle, New York.

#### ALL-RECORD PHONOGRAPH

Arthur Ansley Manufacturing Company of Doylestown, Pennsylvania, announces the production of a portable phonograph that will play all types of records, both 33 $\frac{1}{2}$  and 45 r.p.m., as well as the standard 78 r.p.m. discs.

The unit is housed in a compact, luggage-type case 13 $\frac{1}{2}$  by 16 by 7 $\frac{1}{4}$  inches. It features a turntable with two spindle diameters, one for the standard and Columbia long-playing records, and one for the new RCA types.

#### INDOOR ANTENNA

The TVI-43 indoor antenna made available by the Ward Products Corporation is said to bring in all stations in metropolitan multi-station areas, precisely and brilliantly.

It is an attractive item, blending with most interiors, with chrome plated brass telescopic dipoles, and satin beige finish. Engineered and weighted so that it will not tip over, it will extend to a full 7 feet 9 inches, but can be stored without difficulty.

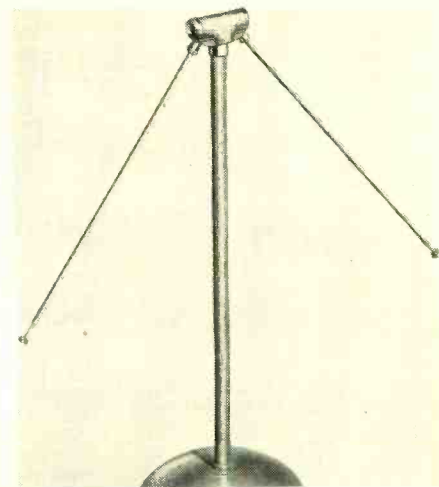

Further information on the TVI-43 will be supplied by the company, a division of the Gabriel Co. Address Ward Products Corporation, 1523 East 45th St., Cleveland 3, Ohio.

-50-

RADIO & TELEVISION NEWS

**NOW  
SAME WEEK DELIVERY!**

# RADIO TUBES

**34<sup>1</sup>/<sub>2</sub>¢**  
ea.

**YOUR CHOICE**

**34<sup>1</sup>/<sub>2</sub>¢**  
ea.

**LARGEST TUBE STOCK IN THE COUNTRY AT ROCK BOTTOM PRICES. Cartoned and Guaranteed . . . 39c ea. in smaller quantities.**

in lots of 100 or more

in lots of 100 or more

**FREE!**

Cornell-Dubilier, Mallory, Aerovox, Sprague, Solar, Filter Condensers—ten fast moving filters FREE with each 100 tubes.

Popular GT Miniature and Loctal Tubes. All individually cartoned and guaranteed best quality. Available at this low price and may be assorted. **THE FIRST REAL SCOOP FOR THE SERVICE DEALER.**

7Y4	5Y3GT	6K6GT	12A7	25L6GT	47
7Z4	5Y4G	6K7GT	12AT6	25Z5	50
7B6	5Z3	6P5GT	12AU6	25Z6GT	50B5
7E6	6A7	6Q7	12C8	26	50L6GT
7C4	6AC5GT	6Q6GT	12BA6	27	56
14X7	6A3	6R7	12BE6	30	57
1B4	6A8GT	6SA7GT	12F5	31	58
1C4	6AJ5	6SC7GT	12H6	32L7GT	70L7GT
1L4	6AQ6	6SD7GT	12J5GT	35	71A
1P5	6AT6	6SF5GT	12J7GT	35/51	75
1R5	6B6	6SF7	12K7GT	35B5	76
1S4	6B7	6SG7GT	12K8G	35C5	78
1S5	6BA6	6SH7	12Q7GT	35L6GT	81
1T4	6BE6	6SJ7GT	12SA7GT	35W4	83
1U4	6C4	6SK7GT	12SH7GT	35Z5GT	84/6Z4
1V	6C5GT	6SL7GT	12SG7	37	75
2A3	6C6	6SQ7GT	12SJ7GT	37A	112A
2A5	6C8G	6SR7GT	12SK7GT	38	89
2A7	6D6	6U7GT	12SN7GT	39	117Z3
2B7	6F5G	6V6GT	12SQ7GT	39/44	182B
3A4	6F6GT	6X4	12SR7	40	183
3Q4	6F8G	6X5GT	12SR7GT	41	482B
3S4	6G6	6Y6G	20	42	483
5U4G	6H6GT	10	2050	43	
5V4	6J5GT	12A8GT	2051	44	
5X4G	6J7GT	12A6	24A	46	

## TELEVISION and FM TUBES

**SPECIAL 49¢** each in 100 lots assorted 54c ea. in smaller quantities.

1B3	6AL5	6S8GT	12AT7
2C34	6AQ5	6SN7GT	12AX7
2E24	6AU6	6SS7	12BA7
4A6G	6BD6	6T8	12S8
6J6	6BG6G	6W7G	19T8
6AG5	6BH6	6Z7G	
6AK5	6BJ6	12AU7	

## CRITICAL TUBES 54c

**Sensational Low Price** each in 100 lots assorted. 59c ea. in smaller quantities.

0Z4	1LC6	7A4	7Q7
1AD5	1LH4	7A7	7S7
1A5GT	1LN5	7E5	7W7
1A7GT	1NSGT	7F7	7X7
1G4GT	1Q5GT	7G7	117L7GT
1H5GT	2V3G	7H7	117P7GT
1J6G	3LF4	7J7	117Z6GT
1LA6	6U5	7N7	35Z4GT

**IMPORTANT—100 lot prices also apply to mixed assortments of 34<sup>1</sup>/<sub>2</sub>c and 49c and 54c tubes. IF YOU WISH, tear out this page and send it in. Just write in quantities desired. Please print name and address plainly.**

**5 TUBE Super AC-DC KIT**



Packed complete including tubes, plastic cabinet, all parts and the easiest, best instructions ever printed. Students, hobbyists, experimenters, hams—build your own radio, each **\$11.95**

Quantity prices upon request.

**PM SPEAKERS**

Nationally advertised brands—**GUARANTEED—best quality**

5" Alnico 5 Magnet.

4"	Lots of 10, ea.	95c
4"	Lots of 10, ea.	95c
3"	Lots of 10, ea.	95c
3"	Individual price	ea. 99c
6"	Lots of 10, ea.	\$1.45
6"	Individual price	ea. 1.59
8"	with output transformer	ea. 3.65
10"		ea. 4.25
12"		ea. 4.95



**BY-PASS CONDENSERS**

7c each      Lots of 100 (assorted) **\$5.95**

.001 mfd, 600V.—	ea. 7c
.002	ea. 7c
.005	ea. 7c
.01	ea. 7c
.02	ea. 7c
.05	ea. 8c
.1	ea. 9c



**FILTER CONDENSERS**

Highest Quality Standard Brands, All Fresh Stock Electrolytic.

60-60 mfd, 150V	ea. 47c
(Small size, low price, use in place of 60-40, 50-30, 50-50, 40-40, 30-30, etc.)	



**STOCK UP AT THESE PRICES**

20-20 mfd, 150V	ea. 39c	8 mfd, 450V	ea. 24c
30-30 mfd, 150V	ea. 47c	8-8 mfd, 450V	ea. 43c
40-40 mfd, 150V	ea. 49c	10-10 mfd, 450V	ea. 43c
50-50 mfd, 150V	ea. 49c	20-20 mfd, 450V	ea. 39c
20 mfd, 150V	ea. 25c	25 mfd, 25V	ea. 17c
40 mfd, 150V	ea. 29c	100 mfd, 25V	ea. 17c

**OUTPUT TRANSFORMERS**

For: 50L6, 50B5, 50A5, 50C6, 32L7, 70L7, 26A7, 6W6, 2B3, 70A7, 1276, 6A5, 6B4, 25C6, 7C5, 2A3, 6A3, 6Y6, 25B6, 25L6, 6L6 each **39c**

For: 6V6, 6F6, 3Q5, 42, 41, 43, 45, 50, 71A, 12A5, 25A6, 25A7, 6N7, 6A6, 25N6, 25B5, 117L7, 117M7, 117N7, 117P7, 35A5, 6AH5, 6AL6 ea. **49c**



**IF TRANSFORMERS**

Standard replacement. **45c**  
Each  
Standard replacement. **45c**  
Midget

**VOLUME CONTROLS**

500,000 ohms with switch and long shaft—best brands **35c**  
ea.  
2 MEG. with switch and long shaft **35c**  
ea.

**MISCELLANEOUS BUYS!**

Crystal Cartridge  
Standard replacement crystal cartridge. ea. \$1.49

6-Ft. Line Cords  
Good rubber with plug . . . 10 for 1.25

Push-Back Wire  
100-ft. rolls . . . per roll 49c

4-Prong Vibrators. ea. \$1.25

Selenium Rectifiers  
Standard 100 mil . . . ea. 69c

**UNIVERSAL OUTPUT TRANSFORMER SPECIAL—Up to 12 watts to almost any speaker . . . 99c ea.**

All Merchandise is Brand New and nationally advertised brands.—Minimum order \$5.00; all shipments F.O.B. Chicago . . . **ORDER TODAY!** 20% additional on small orders outside continental United States. *Low Price Catalog sent with first order.*

**CLEAR-VAC CO. 5036 RAVENSWOOD AVE. CHICAGO, ILLINOIS**  
"Clear heads order from CLEAR-VAC"





**MONEY BACK GUARANTEE** — We believe units offered for sale by mail order should be sold only on a "Money-Back-If-Not-Satisfied" basis. We carefully check the design, calibration and value of all items advertised by us and unhesitatingly offer all merchandise subject to a return for credit or refund. You, the customer, are the sole judge as to value of the item or items you have purchased.

## BUILD YOUR OWN OSCILLOSCOPE and V.T.V.M. and SAVE!!

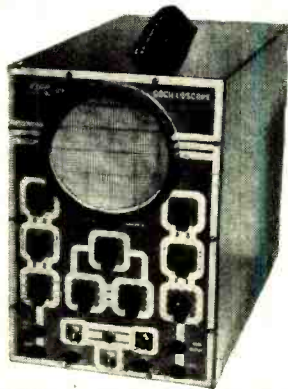

### 5" OSCILLOSCOPE KIT

Indispensable for AM, FM, and TELEVISION. Horizontal sweep circuit 15 to 30,000 cycles. All controls on front panel. Linear sweep with 884 gas triode. Graph screen for measuring peak to peak voltage. Frequency response of horizontal and vertical amplifiers from 50 cycles to 50 Kc. Input impedance 1 megohm and 50 mmfd. Etched panel for long life. Tube complement: 2—6SJ7, 2—5Y3, 1—884, 1—58PI. Provision for external synchronization, test voltage and intensity modulation. Deflection sensitivity: 30 volts per inch full gain. Detailed instructions and pictorial diagrams included. Operates from 105/130 V.A.C. 50/60 cy. Nothing else to buy!

**\$39<sup>95</sup>**

### VACUUM TUBE VOLTMETER KIT

**THE MOST USEFUL TOOL ON THE RADIO BENCH!**

D.C. and A.C. ranges 0-5, 10, 100, 500 and 1000 volts. Ohm-meter ranges from .2 ohms to 1,000 megohms in steps of Rx1, Rx10, Rx1000, Rx10,000 and Rx1 megohm. Db scale from -20 to +55. Db in 5 ranges. Diode A.C. rectifier. Large rugged 4 1/2" meter with all A.C. and D.C. readings on one simple scale. 1% accuracy. Complete tubes and test prods. Nothing else to buy!

**\$23<sup>95</sup>**



### THE NEW MODEL 670

## SUPER METER



**SUPER METER. A Combination VOLT-OHM-MILLIAMMETER plus CAPACITY REACTANCE, INDUCTANCE and DECIBEL MEASUREMENTS.**

**D.C. VOLTS:** 0 to 7.5/15/75/150/750/1500/7500. **A.C. VOLTS:** 0 to 15/30/150/300/1500/3000 Volts. **OUTPUT VOLTS:** 0 to 15/30/150/300/1500/3000. **D.C. CURRENT:** 0 to 1.5/15/150 ma.; 0 to 1.5 Amps. **RESISTANCE:** 0 to 500/100,000 ohms, 0 to 10 Megohms. **CAPACITY:** .001 to .2 Mfd., .1 to 4 Mfd. (Quality test for electrolytics.) **REACTANCE:** 700 to 27,000 Ohms; 13,000 Ohms to 3 Megohms.

**INDUCTANCE:** 1.75 to 70 Henries; 85 to 8,000 Henries.

**DECIBELS:** -10 to +15, +10 to +88, +30 to +58.

The model 670 comes housed in a rugged, crackle-finished steel cabinet complete with test leads and operating instructions. Size 5 1/2" x 7 1/2" x 3".

**\$28<sup>40</sup>** NET

### The New Model 770—An Accurate Pocket-Size

## VOLT-OHM MILLIAMMETER



(Sensitivity: 1000 ohms per volt)

**Features:**

Compact measures 3 1/4" x 5 7/8" x 2 1/4". Uses latest design 2% accurate 1 Mil. D'Arsonval type meter. Same zero adjustment holds for both resistance ranges. It is not necessary to readjust when switching from one resistance range to another. This is an important time-saving feature never before included in a V.O.M. in this price range. Housed in round-cornered, molded case. Beautiful black etched panel. Depressed letters filled with permanent white, insures long life even with constant use.

**Specifications: 6 A.C. VOLTAGE RANGES:** 0-15/30/150/300/1500/3000 volts.

**6 D.C. VOLTAGE RANGES:** 0-7 1/2/15/75/150/750/1500 volts

**4 DC. CURRENT RANGES:** 0-1 1/2/15/150 Ma. 0-1 1/2 Amps.

**2 RESISTANCE RANGES:** 0-800 ohms. 0-1 Megohm.

The Model 770 comes complete with self-contained batteries, test leads and all operating instructions.

**\$13<sup>90</sup>** NET

### THE NEW MODEL 777

## 20,000 OHMS PER VOLT!! TUBE & SET TESTER

**Tube Tester Specifications:**

★ Tests all tubes including New Miniatures, etc. Also Pilot Lights.  
★ Tests by the well-established emission method for tube quality, directly read on the scale of the meter. ★ New type line voltage.

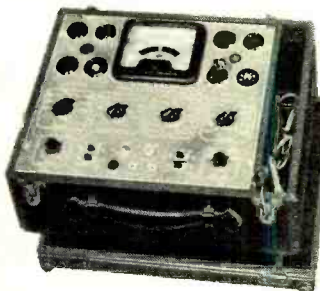

**V.O.M. Specifications:**  
**D.C. VOLTS:** (at 20,000 Ohms Per Volt), 0 to 7.5/15/75/150/750/1,500 Volts.

**A.C. VOLTS:** (At 10,000 Ohms Per Volt), 0 to 15/30/150/300/1,500/3,000 Volts.

**D.C. CURRENT:** 0 to 1.5/15/150 Ma. 0 to 1.5 Amperes.

**RESISTANCE:** 0 to 5,000/50,000/500,000 Ohms, 0 to 50 Megohms.

Model 777 operates on 90-120 volts 60 cycles AC. Housed in beautiful hand-rubbed cabinet. Complete with test leads, tubes, charts and detailed operating instructions. Size 13" x 12 1/2" x 6".

**\$59<sup>95</sup>** NET

### The Model 88—A COMBINATION

## SIGNAL GENERATOR AND SIGNAL TRACER

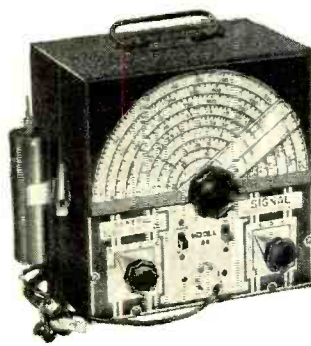

**Signal Generator Specifications:**

\*Frequency Range: 150 Kilocycles to 50 Megacycles. \*The R.F. Signal Frequency is kept completely constant at all output levels. \*Modulation is accomplished by Grid-blocking action which is equally effective for alignment of amplitude and frequency modulation as well as for television receivers. \*R.F. obtainable separately or modulated by the Audio Frequency.

**Signal Tracer Specifications:**

\*Uses the new Sylvania 1N34 Germanium crystal Diode which combined with a resistance-capacity network provides a frequency range of 300 cycles to 50 Megacycles. The Model 88 comes complete with all test leads and operating instructions. ONLY.....

**\$28<sup>85</sup>** NET

20% DEPOSIT REQUIRED ON ALL C.O.D. ORDERS

**GENERAL ELECTRONIC DISTRIBUTING CO. DEPT. RN-5, 98 PARK PLACE NEW YORK 7, N. Y.**



Model 260 in all-bakelite roll top carrying case

There are more  
**Simpson 260**  
 high sensitivity  
 Volt-Ohm-Milliammeters  
 in use today  
 than all others  
 combined!  
 —your Parts Jobber  
 can tell you why

**RANGES at 20,000 ohms per volt DC,  
 1000 ohms per volt AC VOLTS:**

AC & DC—2.5, 10, 50, 250, 1,000, 5,000

**DC CURRENT:**

10, 100, 500, MA—10 AMP—100 MICRO AMP

**OHMS:**

0-2,000 (12 center), 0-200,000 (1200 center),  
 0-20 MEGOHMS (120,000 ohms center)

**DECIBELS:**

(5 ranges) —10 to +52 DB



**SIMPSON  
 ELECTRIC  
 COMPANY**

5200-5218 W. KINZIE ST., CHICAGO 44, ILL.  
 IN CANADA: BACH-SIMPSON, LTD., LONDON, ONT.

## Ghost Elimination

(Continued from page 72)

each potentiometer must be adjusted to some particular value to obtain a proper match. That is, one potentiometer cannot be changed to compensate for the incorrect adjustment of another potentiometer.

Unless the relative magnitudes of receiver and line impedances are known, it is quite possible that the potentiometer pad will be tried the "wrong way" on the first trial, and no match will be found. In this case, the pad should be reversed and a match sought with the new connections.

If it is found impossible to eliminate the ghost with the variable pad, a defective transmission line is indicated. For example, there may be a break or short in one side of the line. Such defects can usually be detected by a visual or ohmmeter check.

### Balanced Input, Unbalanced Line

When it is desired to operate a receiver with balanced input circuit from an unbalanced line, the input circuit may be arranged as shown in Fig. 4A. As an example, a 300-ohm balanced input circuit is shown in combination with a 75-ohm unbalanced line. One half of the input circuit is shunted with a 150-ohm resistor. This 150-ohm dummy load provides correct loading for the unenergized half of the input. The other half of the input circuit is energized from the line through a pad designed to match 75 ohms to 150 ohms. The values for both resistances in this pad (as found in Fig. 4A) are 100 ohms.

### Unbalanced Input, Balanced Line

When it is desired to operate a receiver with an unbalanced input circuit from a balanced line, it is possible to use the arrangement shown in Fig. 4B. In this diagram, a 300-ohm balanced line is shown properly matched to a 75-ohm receiver. It will be ob-

served that a 75-ohm dummy load is provided to maintain line balance to ground, thus preserving the antenna and line characteristics.

The receiver and dummy load together present a 150-ohm resistance to the 300-ohm line. Consequently, a pad which utilizes two 110-ohm resistors and one 220-ohm resistor is required to match the 300-ohm line to the input system. The pad indicated in Table 2 for matching a 300-ohm impedance to a 150-ohm impedance is comprised of two 220-ohm resistors. Because the line is balanced, however, the 220-ohm series resistance is split into two 110-ohm sections, with one section in each side of the line.

It should be noted that the noise-rejection feature claimed for a balanced line is lost in the circuit of Fig. 4B, because the receiver is energized from only one side of the line. Moreover, the matching losses are doubled when a dummy load is used. Thus, in the circuits given in Fig. 4A and Fig. 4B, the operating losses are about 12 db. This figure, however, is only about 6 db. more than the power loss encountered if a pad were not used. In strong-signal areas, satisfactory ghost-free reception can be obtained with these matching systems. In weak-signal areas, however, it may be necessary to forego these expedients and replace the transmission line with a line having characteristics which match the receiver.

It is interesting to compare the power loss due to mismatch with the power loss caused by the insertion of a matching pad. Such a comparison is given in Table 3. It can be seen from this tabulation that the power loss due to the addition of the pad for ghost-free reception is between 4 and 6 db. Except in critical areas of low signal strength, this loss is not troublesome. In critical areas, however, it is apparent that replacing the transmission line with one that matches the receiver may not only result in ghost-free reception, but in a signal increase of as much as 13 db.

Table 3. Power losses in typical unmatched and matched systems.

RECEIVER IMPEDANCE (OHMS)	LINE IMPEDANCE (OHMS)				
	53	75	106	150	300
72	$L_p = 5$		$L_p = 6$	$L_p = 8$	$L_p = 12$
	$L_m = 0.3$		$L_m = 0.6$	$L_m = 2.1$	$L_m = 6.9$
	$L_o = 4.7$		$L_o = 5.4$	$L_o = 5.9$	$L_o = 5.1$
100	$L_p = 7$	$L_p = 5$		$L_p = 6$	$L_p = 10$
	$L_m = 1.7$	$L_m = 0.4$		$L_m = 0.7$	$L_m = 4.5$
	$L_o = 5.3$	$L_o = 4.6$		$L_o = 5.3$	$L_o = 5.5$
150	$L_p = 10$	$L_p = 8$	$L_p = 5$		$L_p = 8$
	$L_m = 4$	$L_m = 1.9$	$L_m = 0.5$		$L_m = 1.9$
	$L_o = 6$	$L_o = 6.1$	$L_o = 4.5$		$L_o = 6.1$
300	$L_p = 13$	$L_p = 11$	$L_p = 10$	$L_p = 8$	
	$L_m = 9$	$L_m = 6.5$	$L_m = 4$	$L_m = 1.9$	
	$L_o = 4$	$L_o = 4.5$	$L_o = 6$	$L_o = 6.1$	

$L_p$  Power loss due to insertion of pads in db.

$L_m$  Loss due to mismatch in db.

$L_o$  Additional operating loss under matched (ghost-free) conditions in db.



# LOOK at these BIG VALUES!

## True Fidelity AM-FM Phono Amp

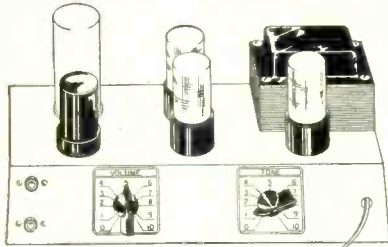

You'll enjoy every minute of listening pleasure with this high-quality low-cost amplifier. Plenty of big-set features at a price you can afford. Big room volume with hum-free output rated at 10 watts undistorted to any 6-8 ohm speaker. Input is dual purpose 6SC7 phase-inverter shock-mounted to reduce possible microphonics; push-pull 6V6 output; 5Y3GT rectifier. Input jacks for both high and medium impedances. Complete, compact unit measures only 9 1/2"x5"x5"; metal chassis finished in attractive brown wrinkle enamel. Wide-range tone and volume controls on front panel. Complete with tubes and line cord, ready for immediate operation on 115-volt, 60-cycle line. Greatest value ever offered at this low price.

**\$17.95**  
complete

### SEEBURG Model L Record Changer

Finest 2-post record changer on market. Will play 12" and 10" or 10" and 12" records. Base size 14" square. Automatic shut-off after last record. Best Astatic Cartridge and Permanent Needle.

**\$17.95**  
A big bargain for only

### Dual Speed RECORD CHANGERS

This changer has the finest dual-speed mechanism made. Plays both new LP and older standard records and CHANGES THEM TOO! Adjustable cartridge with finest permanent needles. Base measures 12"x13". Priced right at

**\$29.25**  
**33.91**

Deluxe model of above on 14" square base.

WRITE FOR COMPLETE DESCRIPTIVE FOLDER ON THE ABOVE CHANGERS!

### SPEAKER VALUES!

8" Magnavox, 21 oz., Alnico 3 magnet..... \$3.95  
12" Magnavox, 21 oz., Alnico 3 magnet..... 5.95  
for use with above amplifier

Save **\$26.30** on  
this SEEBURG  
RECORD CHANGER



Model DS-101 handles 10-inch or 12-inch records. Smooth, quiet action. Lightweight pickup arm with Astatic Q-type cartridge and permanent needle—the right combination for high-fidelity reproduction. Handsome formed walnut-finish wood base 12 1/2"x14 1/2". Complete with shielded cable and plug for connector to radio or amplifier, and line cord and plug for 110-V 60-cycle operation. Regular \$44.25

**\$17.95**

### SAVE MONEY on PARTS KITS!

- (1) 100 asstd. mica condensers: pigtail and lug types. .000005 to .01 mfd. .... **\$1.95**
- (2) 40 asstd. push-on knobs for knurled shafts. Red, green, walnut, ivory.... **\$1.29**
- (3) 25 asstd. 5, 10 and 20 watt vitreous enameled resistors. Values up to 25,000 ohms. No two alike..... **\$1.69**
- (4) 100 asstd. 1/2-1-2 watt carbon resistors. All RMA color-coded. Most popular values..... **\$1.49**

ORDER BY KIT NUMBER!

### STROMBERG-CARLSON FM-ANTENNA

Folded Dipole Aerial for both FM and TV. Complete with 60 ft. of 300-ohm line. **\$4.95** EA.  
Covers both FM bands. Mounts anywhere, vertically or horizontally. Seamless, heat-treated, all aluminum.

### ORDER FROM THIS AD!

Select what you need from the big values listed here—and send your order now! Quantities are limited. Send 25% deposit with order. We ship C.O.D. for balance, all advertised items F.O.B. Chicago. When remitting in full, include sufficient postage—overage refunded. GET YOUR NAME ON OUR MAILING LIST. We carry complete stock PA equipment—BOGAN, MASCO Amplifiers—Shure, Turner Mikes—University Speakers, etc. Write for complete list.

**NATION WIDE RADIO**  
(The Serviceman's Supply House)  
**572 W. Randolph Street**  
**CHICAGO 6, ILLINOIS**

## Television Receivers

(Continued from page 66)

second detector. This means that the amplitude of the sound carrier should be reduced to about 5 per-cent of the maximum picture carrier amplitude. In order to achieve this, the i.f. system through which both signals pass is designed to have the response characteristic shown in Fig. 5. At the frequency of the sound i.f. carrier, the response curve is 26 db. down from the video carrier frequency point.

After passage through the i.f. system, the signals are fed to the video detector, where the i.f. frequencies are removed, leaving only the video frequencies, which extend from 0 to 4.0 mc. and the 4.5 mc. beat note that is produced when the two carriers beat against each other.

At the output of the video second detector, the complete signal, including the 4.5 mc. voltage, is usually passed through the video-frequency amplifiers. The sound signal, it must be remembered, was reduced considerably in the i.f. system and thus requires a corresponding increase in amplification following the video second detector in order to bring it back to a usable value. Even after passage through the video-frequency amplifiers, its average level seldom exceeds one or two volts. Thus, what is done is to transfer this voltage out of the video system into an audio i.f. amplifier, tuned to 4.5 mc., and after one stage of amplification, apply it to an FM detector for conversion into audio frequencies. Thereafter, one or two audio amplifiers bring the signal to the desired strength for normal operation of a loudspeaker.

We might pause and note here that the actual number of stages devoted exclusively to the sound signal is less in the Intercarrier system than in conventionally designed sets. This usually means a savings of two to three stages.

One way to remove the 4.5 mc. voltage from the video system is to employ a series resonant trap, connected from the plate of the final video-frequency amplifier to ground. See Fig. 6. The voltage developed across the coil is amplified by a 6BA6 4.5 mc. amplifier and then made available to the FM detector. Through the use of a series resonant circuit, essentially all of the 4.5 mc. voltage is removed from the video path and thereby does not reach the cathode-ray tube. The 6BA6 operates as a limiter and serves to present a fairly constant output when widely varying signals are applied to its input. This is desirable, especially if some form of tuning control is provided, otherwise the set user might attempt to tune for loudest sound, which would seriously distort the picture.

We are now in a position to appreciate fully the reasons for the reduction in sound carrier prior to the video second detector. First, if the video and

# ATTENTION MOBILE HAMS

THE OUTSTANDING MOBILE SIGNALS USE MOTOROLA MOBILE EQUIPMENT—BACKED BY YEARS OF COMMUNICATION EQUIPMENT EXPERIENCE—THE WORLD'S LARGEST PRODUCER OF 2-WAY MOBILE EQUIPMENT.

A mobile transmitter with a double feature FM or AM at a flip of the switch, the MOTOROLA FMT-30-DMS (27-30mc.) operation, 30 watts r.f. output complete with control head, microphone, cables and mounting hardware ready to install..... **\$130.00**

MOTOROLA P-69-13-ARS receiver with special noise limiter for use with any converter having 1500-3000 k.c. output, i.f. frequency locked by crystal controlled oscillator for stability, designed for near trunk mounting complete with control head, cables and mounting hardware ready to install..... **\$60.00**

For further information write to:

## MOTOROLA INC.

Amateur Sales Dept. R&TN-Ma  
1327 W. Washington Blvd.  
Chicago 7, Illinois  
Attention Harry Harrington W9LLX  
Telephone Taylor 9-2200 Ext. 161

# TUBES

Type	Price
10Y.....	\$ .55
211.....	.85
250TH.....	21.30
304TL.....	1.10
450TH.....	22.75
450TL.....	36.50
803.....	4.50
805.....	3.80
807.....	1.14
808.....	2.80
810.....	5.50
836.....	.95
861.....	27.50

Subject to prior sale

## FRENCH-VAN BREEMS, INC.

405 Lexington Avenue  
New York 17, New York  
Oregon 9-3650

audio carriers are comparable in strength when they reach the video second detector, the resultant 4.5 mc. beat note will contain a considerable amount of amplitude modulation. Also, the amount of this amplitude modulation will vary as the modulation of the video carrier changes. Since no FM detector now in practical use is able to completely remove or ignore amplitude modulation in an FM signal, the audio output will be distorted to an extent dependent upon the amount of amplitude modulation present in the signal. Even the use of a limiter prior to the detector does not altogether alleviate this trouble. With the amplitude of the sound carrier equal to about 5 per-cent of the video carrier, the 4.5 mc. beat note amplitude remains substantially constant as the level of the video carrier varies between 15 to 100 per-cent of its peak value.

Another consideration in conjunction with the use of comparable audio and video carriers is the manner in which the audio voltage can affect the picture. The sound carrier, it is known, is frequency modulated and one way to convert an FM signal into an audio voltage is by means of slope detection. Now, if the sound signal receives 26 db. less amplification than the video signal in the i.f. system, it will be quite small and even if 30 per-cent of this signal suffers slope detection at the video second detector, the interference from this source will be approximately 33 db. below the video signal and generally unnoticeable. However, if the audio signal is large at the detector, then even 10 per-cent slope detection will produce enough audio voltage to develop horizontal bars across the screen. It will probably be found that with a large audio signal, more than 10 per-cent slope detection occurs, further aggravating the situation.

If the 4.5 mc. signal itself reaches the control grid of the cathode-ray tube, a fine line pattern will appear on the screen. This will occur if the audio signal is strong at the video detector output and does not receive the proper amount of attenuation. However, if the audio signal is reduced by the 26 db. specified above, then its effect, after the shunting effect of the series resonant pick-off circuit, will be so small as to be negligible.

Thus, we see from the foregoing why it is mandatory for the video car-

Fig. 8. The i.f. response curve of the Tele-Tone 7" receiver diagrammed in Fig. 7.

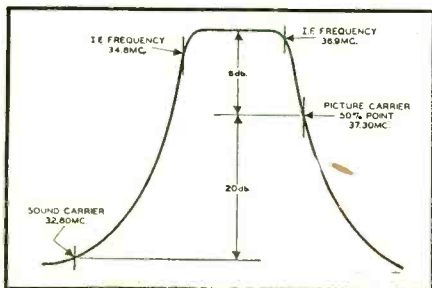

# New Headset from TELEX . . .

## NO PRESSURE ON THE EARS

Here's a really new headset: TELEX TWINSET! Sweaty, tiresome "ear-cups" are gone forever! Signal may be piped directly into the ear so that *nothing touches the ear* at all! Matched in-phase magnetic receivers banish listening fatigue—listen for hours in complete comfort with this high-fidelity, 1.6 ounce headset.

An all purpose headset, the unique TELEX TWINSET, is designed for your hearing comfort and exacting headset demands. Obtainable from your favorite parts jobber, or, write Dept. 10, Telex Inc., Telex Park, Minneapolis, Minnesota.

### SPECIFICATIONS:

**Sensitivity**—101 decibels above .000204 dynes per sq. cm. for 10 microwatts input  
**Impedances**—1000 ohms and 64 ohms  
**Construction**—Weight: 1.6 oz.  
 Tenite plastic and bright nickel construction, with head-band of Z-Nickel steel wire encased in plastic. Single 5-foot cord plugs into either receiver. Sealed, rustproof diaphragms.

*Special Cord with built in miniature Volume Control also available*

## NEW TELEX TWINSET

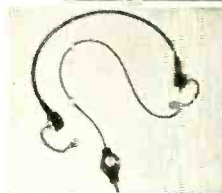

**TELEX, Telex Park, Minneapolis, Minnesota**

Manufacturers of Telex Monoset\* • Telex Pillow Speaker • Telex Precision Hearing Aids



**TYPE "O"**

Type "O" Series—shown at right is the 03-11 Plug, with three 30-amp. contacts, fits certain quality types, notably Western Electric.

**TYPE "P"**

Type "P" Series—P3-CG-12S Plug shown at right, is standard with most broadcast stations and used with RCA and other equipment. . . 7 interchangeable inserts.

**TYPE "XL"**

Type "XL" Series—XL-3-11 Plug shown at right, is standard on certain RCA, Electro-Voice and Turner microphones. Two inserts: XL-3, XL-4.

Used on many types of sound and communication equipment in addition to microphone, Cannon Plugs are recognized by engineers, sound men and hams as the quality fittings in the field. Over a period of years various improvements have been made in insulating materials, shell design, material and clamp construction.

Available through many parts jobbers in the U. S. A. . . In Louisville: Peerless Electronic Equipment Co. In Flint: Shand Radio Specialties. In Syracuse: Morris Dist. Co. In Toledo: Warren Radio. In Norfolk: Radio Supply Co.

Bulletin PO-248 covers all the engineering data on the above 3 series; RJC-2 the prices; CED-8 Sheet lists jobbers. For copies address Department E-228.

SINCE 1915

**CANNON**  
**ELECTRIC**

*Development Company*

3209 HUMBOLDT ST., LOS ANGELES 31, CALIF.  
IN CANADA—CANNON ELECTRIC CO., LTD.

rier to be considerably stronger than the audio carrier, at the video detector, if the Inter-carrier system is to function properly. It also explains why the presence of the sound signal, even as far as the last video-frequency amplifier, does not materially affect the image on the screen.

In receivers employing the conventional system, it has recently become common practice to insert a 4.5 mc. trap in the grid or plate circuits of the first video-frequency amplifier following the video second detector. This is done to prevent any 4.5 mc. voltage, which may be generated in the video detector from reaching the cathode-ray tube. In the mass production of many television receivers, the sound carrier may not receive the full attenuation required to suppress it completely. Hence this additional precaution.

To see how the Inter-carrier system is applied commercially, let us analyze a receiver operating on this principle.

**Tele-Tone Television Receivers**

The Tele-Tone 7" receiver diagram is shown in Fig. 7. The front end of the receiver contains a 6AU6 r.f. amplifier, a 6AG5 mixer, and a 6J6 push-pull oscillator. Examining this section of the receiver briefly, we find that the antenna signal is fed between the grid and cathode of the r.f. amplifier in a balanced arrangement, against ground, so as to properly terminate a 300-ohm transmission line. The input circuit is untuned, the input coil,  $L_1$ , serving as part of a high-pass filter designed to permit all the television signal frequencies to pass but to attenuate extraneous signals at the i.f. frequency. For strong local signals, an attenuator pad is provided (not shown) to prevent overloading of the amplifiers with resultant distortion to the image and sound.

The plate circuit of the r.f. stage is tuned by what is, electrically speaking, a single tapped inductance. Mechanically, this coil takes the form of several individual coils which are cut in or out of the plate circuit by the rotary 12-position band switch.

The 6J6 oscillator is a push-pull arrangement with the coil for channel 2 (the present first channel) permanently in the circuit. For the remaining channels, 3—13, a second coil is placed in parallel with this coil, reducing the oscillator frequency to the proper value. Each coil is tuned by brass slugs accessible from the front panel. The output from the r.f. amplifier and the oscillator are condenser fed to the grid of the 6AG5 mixer tube. Additional transfer of energy by means of a single turn of link coupling is provided between the r.f. amplifier and the mixer for the upper channels.

The oscillator, in this receiver, operates above the incoming audio and video carriers on all channels. In Inter-carrier sets this need not be true as we will see in a later set. The video carrier i.f. is 37.3 mc. and the sound carrier i.f. is 32.8 mc.

**Canadian Surplus Values**

**BENDIX TRANSMITTER TA-12**

Four separate E.C.O. with matching output channels . . . 100 WATTS . . . \$45.00  
Brand new with tubes. . . . . \$45.00  
Power Supply Modulator MP-28BA input 24 V. DC to Dynamotor . . . . . \$10.50  
Remote Control MT51-C . . . . . \$ 4.50  
Antenna Loading Unit MT53-C . . . . . \$ 5.00

**HOOK-UP WIRE—ass't colors**

#18 B&S Flameseal flexible Lacquered Braid on 1000 ft. Spools. . . . . \$8.75/M  
#20 B&S Flameseal flexible Lacquered Braid on 1000 ft. Skeins. . . . . \$5.50/M  
#22 B&S Flameseal flexible Lacquered Braid on 1000 ft. Skeins. . . . . \$4.50/M

**METERS**

0-5 Mills D.C. 2 1/2" Square—SANGAMO-WESTON \$1.95  
0-5 Mills D.C. 2 1/2" Round—STARK . . . . . \$2.50  
0-5 Mills D.C. 2 1/2" Round—SPARTON . . . . . \$2.50  
0-5 Mills D.C. 2 1/2" Round—SIMPSON . . . . . \$4.00  
0-5 Amps R.F. 2 1/2" Round—SPARTON . . . . . \$3.50  
0-300 Mills D.C. 3" Round—BENDIX—MT-31-C. . . \$3.50  
0-300 Mills D.C. 2 1/2" Round—SPARTON . . . . . \$3.50  
0-2.5 Amps R.F. 2 1/2" Square—WESTON . . . . . \$1.95

**CO-AXIAL CABLE**

RG8U—52 OHMS. Per ft. . . . . 8c

**TUBES! TUBES!**

**ALL BRAND NEW**

2X2 . . . . . \$ .40	6V6 . . . . . \$1.10
3BX . . . . . 8.75	12C8 . . . . . .65
5Y4G . . . . . .75	12SK7 . . . . . .65
6AG5 . . . . . .99	12SN7G . . . . . .60
6B8 . . . . . 1.30	EF50 . . . . . .40
6C5 . . . . . .75	VR150 . . . . . .65
6F6 . . . . . .99	304TH . . . . . 7.25
6H6 . . . . . .50	807 . . . . . .99
6J5 . . . . . .50	813 . . . . . 7.50
6K6G . . . . . .60	816 . . . . . .99
6K7 . . . . . .65	878A . . . . . 2.50
6K7G . . . . . .65	884 . . . . . 1.50
6K8 . . . . . .95	E1148 . . . . . .40
6L7 . . . . . .95	1616 . . . . . 1.25
6N7 . . . . . .95	1619 . . . . . .50
6R7 . . . . . .80	7193 . . . . . .30
6SH7 . . . . . .30	9002 . . . . . .50
6SK7 . . . . . .80	9003 . . . . . .50

CERAMICONS . . . . . 20c ea.  
5-10-30-35-1000 MMFD

NEGATIVE TEMP. COEF. . . . . 20c ea.  
4-20-80-200 MMFD

MICA, postage stamp . . . . . assortment of 50, new . . . . . \$2.50  
MICA, transmitting . . . . . assorted values, ea. . . . . \$ .25  
CERAMIC AIR TRIMMERS . . . . . assorted values, ea. . . . . \$ .25

TERMS: Prices F.O.B. Montreal. 15% discount on orders over \$10.00. Send 25% deposit with order, balance C.O.D.

**THE RADIO CENTRE**

62 Craig St. W. Montreal, Canada  
Mailing address, P.O. Box 6, Station H, Montreal

**GEIGER COUNTERS**

**MONITOR YOUR AREA FOR RADIOACTIVITY**

Read cumulative register once a day to warn against foreign radioactivity or local contamination. Also check relationship of cosmic radiation to sunspots and radio and natural electrical disturbances.

**MODEL 1: LABORATORY OR STATION INSTRUMENT**

110 V AC quantitative instrument with precision 4% plateau Beta counter and register . . . . . \$125.00  
FOB SWARTHMORE

MODEL 2: 5.5 POUND PORTABLE FOB . . . . . \$100.00

SELF QUENCHING GEIGER TUBES  
Gamma \$15; Beta \$30; 3mg/cm<sup>2</sup> \$40

**COSMIC COUNTERS**

112 Cornell Ave. Swarthmore, Pa.

# Surplus CLEARANCE Sale!

## DYNAMOTOR D-2



D-2 Converts to 110 V AC in ten minutes, diagram included, contains integral gear box having four  $\frac{1}{4}$ " drive shafts turning simultaneously at the following speeds:  
 4000 RPM—Grinders, buffers, flexible shaft tools, etc.  
 150 RPM—Wrapping fishing rods, slow speed tools.  
 25 RPM—Dev. tray rocker for photo darkroom.  
 5 RPM—Turning barbecue spits. Adv. Disp. Beams. A  
 Thousand Other Uses Around the Work Shop. **\$7.95 ONLY**

## DYNAMOTOR D-1

D-1 Converts to 110 V AC in ten minutes, diagram included, has shaft with squirrel cage blower, also gear reducer with 2 shafts and pulleys at the other end. 1001 uses. **\$4.95 NEW**

## RM-29 PORTABLE FIELD TELEPHONE

An ideal portable field telephone. Complete in a rugged steel case for years of wear. Ringer circuit and TS-13 handset. No leather case to deteriorate. Compact 5"x6"x9"—also used as remote control on SCR-284. Simple two wire operation. 15 miles distance and upwards. Can be used for television installation, intercom system, construction companies outside and inside work, etc. Light weight, 13 lbs. Excellent condition.



SPECIAL LOW PRICE EACH. **\$9.95 2 for \$18.95**

### BC-727 INDICATOR BOX

With two red jewel pilot light assemblies. It's a steal! Each **29c**

### HEADSETS!

HS-23 High Impedance, HS-33 Low Impedance, Army Air Force Type, cord and plug. Used **98c**  
 New **\$1.59**

### MIKE ADAPTER

M-299 for SCR-522 permits use of carbon mike in place of magnetic. New Each **\$1.50**

### BC-733 D

A 10-tube superhet receiver for lateral blind landing guidance (CAA type certificate) TC-1045. Excellent condition 108-110 MC. Tube complement: 1—12SQ7; 2—12SR7; 1—12A6; 1—12AH7GT; 2—12SG7; 3—717A—tubes alone worth more than this low price. **\$5.95**  
 SCHEMATIC FURNISHED Each **\$5.95**

### AN/CRW-2 V.H.F. RECEIVER

6 tubes: 3—6SL7, 1—6SN7, 1—6SG7, 1—6J5. Dynamotor, plug-in coils and sensitive relays. This was one of the Army's "Secret" V.H.F. remote control receivers. Operating at about 110 MC. A thousand and one uses. **\$5.95**  
 Like new in a metal case. Each **\$5.95**

### COMPLETE BEAM ROTATOR ASSEMBLY LP-21A AND I-82A

A large 5' indicator I-82A, brand new and an LP-21 loop (removed from aircraft). A complete perfect beam rotator system with indicator. Loop is low impedance—contains selsyn transmitter, etc. **\$7.95**  
 Loop alone... \$5.95 Indicator alone... \$4.25

### WAFER SWITCHES

10 assorted, rotary, gang. Removed from equipment. ALL 10 for **\$1.00**

### LIP MIKE & CORD SET

MC-419 lip mike with cord CD-318 or CD-508, with PL-68, JK-48 and switch. New **\$1.59**

### HOOK-UP WIRE

Approx. 400 ft. assorted gauges and colors—about 2 to 4 ft. length. **98c**

### CORD CD-605

A two foot cord with a PL-55 plug; with low to high impedance transformer for your headset. **39c**

### CORD CD-370 & 307

A ten foot and six foot head set extension cord with PL-55 plug on one end and a jack on the other. NEW. Six foot **59c**  
 Ten foot **79c**

### ANTENNA LOADING UNIT

MC 432 contains 2 pole, 5 position rotary switch with silver ceramic variable condensers, and coils for matching VHF transmitter to AN 109 antenna with 50 ohm line. Useful parts. New Each **\$1.39**

### TOGGLE SWITCH

S.P.D.T. luminous tip bat handle. NEW. 4 for **\$1.00**

### SLIDE SWITCH

S.P.D.T. designed for portables, etc. 10 for **\$1.00**

**MINIMUM ORDER \$2.00. ALL PRICES FOB CHICAGO. 20% Deposit required on all COD orders. Prices subject to change without notice.**

### AUTOMATIC RECORD CHANGER

Play 10" or 12" records. Special purchase Stewart-Warner Stroboscopic. Each only **\$16.95**

### WALKIE TALKIE

BC-222. Operates over considerable distance. 28-52 MC. Complete with battery—ready to use. Excellent condition. Each **\$34.95**

### TRACEOMETER HICKOK

Ideal for the radio service man. Design for accurate general testing (signal generating, signal tracing, etc.). Good condition. Each **\$79.95**

### RELAYS

24 V. { S.P.S.T. 4 for **\$1.00**  
 { D.P.S.T.

### MODULATOR UNIT

BC 456. Each **\$7.95**

### ANTENNA RELAY UNIT

BC 442 010 RF Amp. Meter, change-over unit with mounting FT-229, for use with Command Set Transmitter. Brand New. Each **\$1.95**

SCR 610 F. M. TRANSCEIVER. Each **\$47.95**

### BC-433G

15-tube superhet radio compass receiver 200 to 1750 Kc; CW-tone-voice. Like new. Similar to R5/ARN7. Only **\$24.95**

### GIBSON GIRL

Emergency transmitter balloon, kit, generator, case, etc. New **\$15.95**

### BC 457 TRANSMITTER

4-5.3 MC. Can be converted to 80 meters with slight modification. Ea. **\$9.95**

### BC 459

40 meter Command transmitter. Used, excellent condition. **\$14.95**

BC 458 TRANSMITTER. **\$9.95**  
 5-7 MC.

PULSE AND SWEEP GENERATOR. Each **\$72.95**

### MALLORY SWITCH

6 Pole 3 position single deck wafer switch. Each **39c**

BC-221A FREQUENCY METER. **\$79.95**

### TU 10B

Tuning unit for BC-375... a terrific parts value with a metal case. Brand New. See page 24 Nov. Radio Craft for conversion to 10 meter final. Only **\$2.95**

### BC-306

Antenna loading unit for BC-375. Excellent condition. Another parts value. Each **\$1.50**

### RU-18 AND RU-19

Receiver transmitter with all parts, spares and coils. Excellent Condition. **\$59.95**

## TUBES

1625 ... 3 for	\$1.10	5BP1 Scope tubes	@ \$2.50
6V6 ...	@ .49	5EP4 Scope tubes	@ 3.45
3D6 ...	@ .49		
35Z5 ...	@ .59		

### BC-1296

Beacon Receiver 200 to 400 K.C.'s 28V plate and filament. Easily converted to broadcast band by adjusting of slug and tuned coils. Each **\$7.45**

### T-17 D MIKE

The desirable single button carbon mike. With press the button to talk switch, 4' cord and PL-68 plug, mike cover. Features non-echo effect. New **\$2.49**

### FILAMENT TRANSFORMERS

Fully shielded Pri. 100 V. Sec. (#1 winding 10.2 V @ 5 A. C. T.; #2 winding 10.2 V @ 10 A. C. T.) Secondary winding can be connected in series to supply 25 V. with a line Voltage of 115 Volts—60 Cyc. New Each **\$3.75**

### CD-604 CORD

With 8000 Ohm xfmr for HS-30 Headset. New **59c**

### 30 FT. CABLE

CO-213 7 Conductor cable with outside shield. Length of 30 ft. **98c**

### INVERTERS

#### PE 109 D

12 V. Input for radio compass 115 V. 400 cycle output. Used, good condition. Each **\$29.50**

#### PE 218

Input 25-28 VDC—92 amp. output 115 V. 350-500 cycles. 1500 Volt amp. Used, **\$23.95**

#### PE 206

Input 28 VDC—38 amps. Output 80 V. 800 cycles, 500 Volt amps. Used. **\$8.95**

### MAST SECTION

MS-51 Mast section. New **50c**

## PLUGS and CONNECTORS

**YOUR CHOICE for only each 49c**

For the SCR-522... PLQ-167, PL-172  
 For the BC-348... PLQ-103  
 For the BC-733... PLQ-254  
 For 269-F Radio Compass Inverter, PL-3108-22-48  
 For the SCR-274-N  
 ... PL-147, 148, 151, 152, 153, 154A, 156, 258  
 For the BC-375... PL-59—PL-61—PL-64  
 For the ART-13... U-8U, U-10U, U-16U  
 For the ARC-1... U-15U, U-16U  
 MC-203A coupling Coax. Fittings—  
 PL-259A (83-1SP)-UG-21U-UG-22U  
 PL-164 M-359 U-11/U  
 AN-3108-28-19P  
 AN-3108-128 } Combination Male and  
 AN-3100-128-33 } Female  
 PL-63 SO-44 PL-62  
 PL-56 SO-86

**NECORP ELECTRONICS** Division of NATIONAL EQUIPMENT & SUPPLY CO., INC.  
 2635 W. Grand Ave., Dept. R Phone EVerglade 4-5870 Chicago 12, Illinois

# VEE-D-X introduces

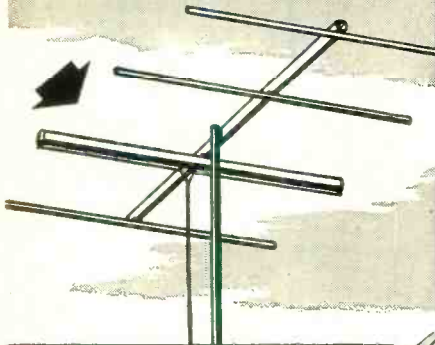

## The Sensational NEW YAGI Array

HIGH GAIN AT LOW COST

Here is an antenna which is the most sensational single channel performer yet to be manufactured. VEE-D-X engineers have attained astonishing results in producing an array combining every desirable characteristic necessary for optimum performance.

- Four element beam cut especially for each particular channel.
- High forward gain and sharply directional.
- Stepped-up driven element affords an excellent match to 300 ohm transmission line.

List Price as low as **\$14<sup>95</sup>**

## NEW Versatile All Angle Mount

Here is a rugged, low cost antenna mount which keeps installation costs to a minimum and yet affords you all the advantages of a high cost installation.

- Particularly suited for mounting on side of house near a window for manual rotation of antenna.
- Swivel joint facilitates raising and lowering of antenna.
- Accommodates all popular size masts up to 1-3/8" O.D.

List Price **\$7<sup>50</sup>**

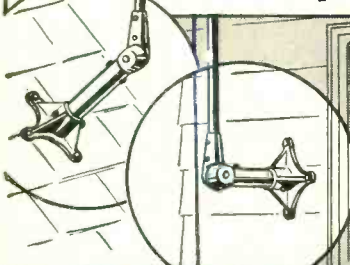

## VEE-D-X means video distance

LaPOINTE-PLASCOMOLD CORP., Unionville, Conn.

Gentlemen: Send me new literature and prices on the complete line of VEE-D-X television accessories.

Name \_\_\_\_\_

Company \_\_\_\_\_

Street \_\_\_\_\_

City \_\_\_\_\_ Zone \_\_\_\_\_ State \_\_\_\_\_

The i.f. system contains 3 stages, two of which employ transformer coupling and the third impedance coupling. Each i.f. transformer has only one adjustment, a powdered iron slug accessible from the top of the chassis. The i.f. string is stagger-tuned to two frequencies, 34.8 mc. and 36.9 mc., resulting in the over-all response characteristic shown in Fig. 8. The curve is fairly flat-topped and the amplification accorded the sound carrier is 20 db. less than that received by the video carrier frequency. (The previous 26 db. figure specified would be a more desirable value. However, in commercial sets values from 18 to 26 db. will be found. With the smaller figure we obtain a larger sound voltage at the pick-off point and this can be used to advantage in designing the audio system. On the other hand, there are the pitfalls previously described when the sound carrier level approaches closer to the video signal amplitude.)

The video second detector is an AM half-wave rectifier, incorporating high-frequency compensation in order to maintain the circuit response for the high video frequencies and the 4.5 mc. beat frequency. The signals are amplified by one stage of video frequency amplification after which the sound carrier is tapped off the plate of the video amplifier by a 4.5 mc. trap and fed through a 4.5 mc. sound i.f. amplifier to a ratio detector, and then to the sound amplifier, audio output, and speaker. The coupling network between the plate of the video amplifier and the cathode-ray tube will pass most of the video frequencies but attenuate any of the 4.5 mc. voltage that may attempt to pass through. From the output circuit of this same video amplifier, a portion of the signal is

also fed to a sync separator and d.c. restorer tube. Sync systems in Inter-carrier television receivers are similar to the sync networks in conventional television receivers. The use of an Inter-carrier sound system does not affect this portion of a television receiver.

A word about the 4.5 mc. take-off trap in the plate circuit of  $V_0$ , the video amplifier. At first glance the trap appears to be a parallel resonant circuit. However, the 2.2  $\mu\text{fd.}$  condenser, in conjunction with the coil and 68  $\mu\text{fd.}$  condenser across the coil, form a series resonant circuit at 4.5 mc. The 68  $\mu\text{fd.}$  condenser neutralizes enough of the inductance of the coil to which it is connected so that what inductance remains can resonate with the 2.2  $\mu\text{fd.}$  series condenser at 4.5 mc. The operation here is identical with the series resonant traps used in the video i.f. systems of some conventional television receivers. This was previously described in detail.

The Tele-Tone receiver uses an a.g.c. circuit controlling the r.f. and the first two i.f. stages. The a.g.c. voltage is developed by a separate diode section of the 6AL5; the other section of this tube is the video detector. It is important to remember, when aligning the i.f. system, that the sound carrier marker appears at a point which is roughly 20 db. down from the level of the video carrier. Furthermore, the video carrier should be 50 per cent down (i.e. 6 db.) from the maximum amplitude of the response characteristic. Other receivers employing a similar circuit design are the *Sentinel* models 400-TV and 450-TVM receivers, the *National* model NC-TV7 receiver, and the *Hallcrafters* models T-54 and T-505.

(To be continued)

The radio service business is booming in the Tanganyika Territory as this picture will prove. H. S. Bharj of Moshi sent along this photo showing a friend of his catching up on his repair work on a Sunday. Because of a power failure that Sunday he had to do his soldering with a non-electric iron. The test equipment is British-made.







**LARGEST SURPLUS STOCK  
in the COUNTRY  
at the LOWEST PRICES!**

**BRAND NEW TUBES**

304 TL	ea.	\$ .90
Four for		3.00
5 RP1	ea.	1.95
5 RP4	ea.	2.95

**SMASH VALUES IN COMMAND EQUIPMENT**

BC-453	EXC.	\$3.95	EXC.	\$12.95
BC-454	EXC.		NEW	4.95
BC-455	EXC.		NEW	7.95
BC-456	EXC.		NEW	2.95
BC-457	EXC.		NEW	6.95
BC-458	EXC.		NEW	7.95
BC-459	EXC.		NEW	9.95
BC-696	EXC.		NEW	14.95

**CONDENSER**

2 MFD. 4000V. Pyranol.	ea.	\$2.95
4 for		\$10.00

**VHF TRANSCEIVER**

Ideal substitute for SCR-522, freq. range 140-144 mc, crystal controlled, 10 watts. The receiver section has two individual RF sections, feeding a common 3 stage 10mc IF amplifier. Both RF sections may be operated simultaneously, or either one individually. The receiver unit has 13 tubes. The transmitter is of straight forward design. Transmitter unit has 7 tubes, one #832 as final modulated by a pair of 6L6s and push-pull. Complete unit in case with tubes, crystals and diagram less dynamotor.

**EXCELLENT CONDITION..... \$14.95**

New Phantom Antenna for above unit, 8 lamps in parallel with sockets, complete for.....95c

**APN-1 RADIO ALTIMETER**

Complete 420 mc transmitter-receiver unit, complete with all plugs, indicators. BRAND NEW. FOB Chicago only. **\$34.50**

**ALTIMETER TRANSCEIVER RT-7/APN-1**

Frequency 418-462 mc, FM with 14 tubes including 3-12N7, 4-12NH7, 2-12H6, 1-VR150, 2-955, 2-9004, 24v Dynamotor, used. In working condition. **\$7.95**

**P-89/ARN-5A**

Slide path receiver. Crystal control of local oscillator, 332-335MC, complete with relays, 7-6A5, 12SR7, 2-12SN7, 1-2BD7 and 3 xtals: 6497 KC, 6522 KC, 6547 KC, 90 cye. band pass and 150 cye. band pass filters, excellent for making an intermodulation checker. Beautiful cabinet and chassis as foundation for many interesting experimental and construction projects. Broad pass band on 20.7 MC. IF's ideal for television. Schematic furnished. Used, excellent. Only **\$6.45**

New..... **\$12.95**

**BC-733-D**

New..... **\$9.95**  
Used..... **3.95**

**POWER YOUR RIG FROM AC**

RA34 RECTIFIER. Makes a ground kmtr of BC-191, the 12v version of BC-375-E. Convert BC-375-E to 12v by changing heater link switches and tube connections. Power it with RA34. Input 105-125 or 210-250 V 60 cye. Outputs: for plates, 1000v filtered dc at 350 ma; for relay and mike, 12v filtered dc at 2.4 A; for heaters, 12v ac at 14.25 A. With technical manual. Used, excellent condition. FOB Los Angeles only. **\$59.75**

With meters and adjustable hi-voltage output..... **\$85.00**

**EE-8 ARMY FIELD TELEPHONE**

Sturdy, highest quality telephone at less than price of a better-class toy. With ringer. Requires only two flashlight batteries for each phone and two wires between each phone. Excellent condition. Used, Each..... **\$7.95**

**BC-659 TRANSMITTER-RECEIVER UNIT**

FM transmitter-receiver, crystal controlled, two channels, freq. range 27-38.9 mc, 13 tubes 2 crystals. NEW..... **\$16.95**

**BC-620 TRANSMITTER-RECEIVER UNIT**

FM transmitter-receiver, crystal controlled, two channels, freq. range 20-27.9 mcr 13 tubes, dual meter for testing filament and plate circuits. Used, good..... **\$9.95**

**MOBILE INSTALLATION KIT  
for BC-659 or BC-620**

Consists of TS-13, MP-48; 4 section whip antenna insulators. 2 maintenance manuals. NEW..... **\$12.95**

**BC-604 20-28 FM TRANSMITTER**

For 11 and 15 meters; can be operated on 10 meters by use of proper xtals; 10 channel pushbutton xtal controlled with all tubes, meter, schematic, case and covers; less crystals. Used, excellent, with dynamotor..... **\$10.95**  
F.O.B. Chicago Only

**BC-684 27.0-38.9 FM TRANSMITTER**

Same as above except for freq. range. New. FOB Chicago only..... **\$24.95**

**SPECIAL!**

**WESTINGHOUSE TRANSMITTER BC-122**

Freq. range 325 to 800 Kc; in portable field case; 3 meters plus excellent parts (less tubes)—An Excellent Buy—BRAND NEW \$7.95 ea.

All shipments FOB Chicago or Los Angeles unless specified. 20% Deposit required on all orders. Minimum order accepted—\$5.00. California and Illinois residents, please add regular sales tax to your remittance.

**ARROW SALES, INC., DEPT. N**

Main Office: 1712-14 S. Michigan Ave.  
Chicago 5, Illinois  
North Side Branch: 1802 N. Humboldt Blvd.  
Chicago, Illinois  
West Coast Branch: 1260 S. Alvarado  
Los Angeles, Calif.

**Regenerative Receiver**

(Continued from page 63)

warmed up, turn the audio gain control to about the half-way position and then commence turning the regeneration control towards maximum position until a rushing noise or squeal is heard on the loudspeaker. The squeal would indicate that the set was tuned to exactly the same frequency as the carrier of some station. A slight decrease in regeneration control will remove the squeal and allow the station to be heard. Slight adjustment of the

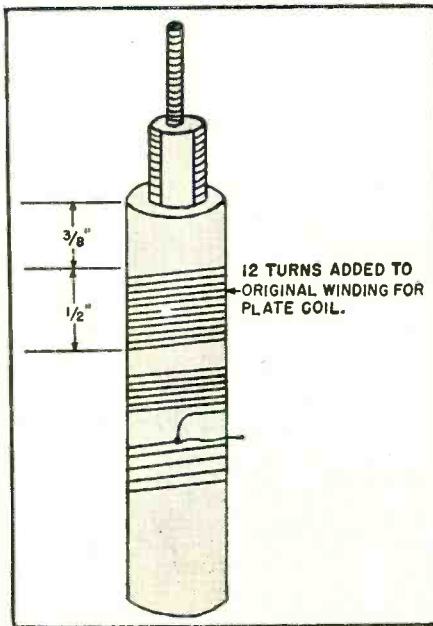

12 TURNS ADDED TO ORIGINAL WINDING FOR PLATE COIL.

Fig. 5. Mechanical details of oscillator coil. Twelve turns are added, as shown above, to a Stanwyck S-231 coil.

main tuning dial may be in order to get best reception. For reception of C.W. or Morse code signals, it will be necessary to set the regeneration control higher so that the squeal or chirping noise of the C.W. may be heard at all times. A little experience in adjusting this unit will allow the reception of many foreign broadcast stations, and local and foreign amateurs.



"My, My. It does show a swinging choke!"

**"TEST-AID" means  
FIRST AID**



for  
Television  
Radio  
F-M

One of the most useful instruments ever devised, for radio servicemen! Checks opens, shorts, faulty resistors or condensers, serves as output meter, continuity check. Substitutes 11 different values of capacitance, resistance, with set in operation. Indispensable for TV servicing — portable, compact, lightweight, **\$19.95** net now only...

**PHAS-TROL**

**\$3.95**  
NET



Phases Antenna to Television Receiver Gives Sharper Clearer Pictures Improves many Indoor Antenna Installations

Literature on both of these 1949 "Best Sellers" available on request to

**Custom Craft MANUFACTURING CO.**

256 EAST 98th ST. BROOKLYN 12, N. Y.

Sensational NEW 1949

# MIDWEST RADIOS with

## DUAL-SPEED RECORD PLAYER

EASY TERMS

Powerful 5 Wave Band Series **16** AM-FM CHASSIS

SEPARATE CHASSIS OR COMPLETE CONSOLES AVAILABLE

### SYMPHONY GRAND

AM-FM RADIO-PHONOGRAPH

A magnificent musical instrument that offers the new Dual-Speed Phonograph which plays and changes, automatically, both the new LP (long playing) records as well as Standard records. Uses the powerful Series 16 AM-FM Radio Chassis. Offers Flash-O-Matic Volume and Band Indication, TELEVISION Audio Switch-Over, Giant 14 1/2" Panasonic Speaker, Color-Ray Tuning, No-Drift FM. Other beautiful console and table models available with Series 16, 12 or 8 chassis.

Buy Direct From **FACTORY and SAVE**

**30 DAYS TRIAL**

...also the **NEW** **MIDWEST TELEVISION** with **BIG 75 Square-Inch Picture** Write for **FREE Folder**

Write in Name and Address (Please Print) on Coupon or to Postcard.

**MIDWEST RADIO & TELEVISION CORP.**  
Dept. T3710-909 Broadway, Cincinnati 2, Ohio

Please send RADIO Catalog  
 Please send TELEVISION Folder

NAME \_\_\_\_\_  
ADDRESS \_\_\_\_\_  
CITY \_\_\_\_\_ ZONE \_\_\_\_\_ STATE \_\_\_\_\_

**SEND THIS COUPON TODAY**

## Technical BOOKS

**"RADAR PRIMER"** by J. L. Hornung. Published by *McGraw-Hill Book Company, Inc.*, New York. 213 pages. Price \$3.50.

Although most persons probably think of radar only in terms of a military "weapon," in reality this warborn device is today filling many highly important civilian roles.

It is for this new segment of the population whose work deals with the various phases of radar that this book has been written. While the author has carefully adhered to the "primer" type of presentation and has avoided the use of technical terminology wherever possible, he doesn't "talk down" to his readers.

The book is divided into eight chapters which cover the fundamentals of radar, determining distance and direction, "electrons paint a picture," the basic parts of a radar set, radar at work, long distance navigation, microwaves and pulses, and the history of radar.

Airline employees and shipping line personnel will find this book of particular value because of the special emphasis placed on radar applications in these fields.

\* \* \*

**"THE RECORDING AND REPRODUCTION OF SOUND"** by Oliver Read. Published by *Howard W. Sams & Co.*, 2924 E. Washington St., Indianapolis, Ind. 304 pages. Price \$5.00.

The author has analyzed and appraised the host of circuits, equipment, accessories, and philosophies that have been developed about this extensive subject. An avid enthusiast on high fidelity recording and reproduction and a critical experimenter in all phases of the art, Mr. Read presents his material with the authority born of practical experience in his own laboratory, with all types of record-playback equipment. Noted for his easy-to-read style in rendering technical information, his presentation of all phases of this subject is accomplished with unusual clarity. Evolving his subject from a complete history of sound and the behavior of sound waves, the author fully covers all basic media for making recordings with a detached analysis of their respective merits. Auxiliary equipment is fully covered and amply illustrated in the text.

The handbook provides excellent coverage of acoustical systems for the reproduction of sound and a complete analysis of the various types of amplifiers, together with their individual applications.

\* \* \*

**"COYNE ELECTRICAL TROUBLE SHOOTING MANUAL"** by The Coyne Staff. Published by *Coyne Electrical Radio School*, Chicago. 626 pages. Price \$6.95.

May, 1949

# ALL THIS!

...in the **IMPROVED**

**E-V** *Cardyne*

**CARDIOID DYNAMIC  
MICROPHONE**



**It Means: Better Performance!  
Finer Quality! Greater Value!**

Recessed Impedance Selector  
Dual-Type External Shock Mount  
Non-metallic Acoustalloy Diaphragm  
Built-in Cannon XL-3 Connector  
E-V Mechanophase\* Cardioid  
High Output Level  
—50 db, Model 731 —53 db, Model 726  
Smooth Wide Range Response  
30—12,000 cps, Model 731  
40—10,000 cps, Model 726  
Enclosed Magnetic Assembly  
With or Without "On-Off" Switch  
Wider Stand Mounting Stud  
Highest Purity Cast Case  
Satin Chromium Finish

Model 731. Broadcast Cardyne II  
List Price..... \$80.00

Model 726. Cardyne I. With MC-3  
connector and without external  
shock mount. List Price. \$59.50

Try the Cardyne now! Send for Bulletin No. 139

**ELECTRO-VOICE, INC., BUCHANAN, MICH.**

Export: 13 East 40th St., New York 16, U.S.A.

Cables: Arlab

NO FINER CHOICE THAN

*Electro-Voice*

\*Patent Pend.

# NEW TELEKITS

NOW

**59<sup>50</sup>**

**Jobbers: Write for Information**

**NEW TELEKITS**  
10-B \$99.50  
7-B \$59.50



Sparkling new Telekit 10-B has 52-inch screen. Brand new compact lay-out has video tube mounted on chassis. Big illustrated easy-to-follow instruction book guides you step by step through easy assembly. No special knowledge of television is required. All you need is a soldering iron, pliers, and screw driver. Telekit 10-B, \$99.50. Tube kit, including 10BP4 and all other tubes, \$59.50. 10-B Telekit cabinet \$24.50. Telekit Guarantee includes free factory service.

Write for catalog listing 10-B and 7-B Telekits. New 7-B Telekit for 7-inch tube, \$59.50. Tube kit, including 7JP4, \$42.08. 7-B cabinet, \$24.50.

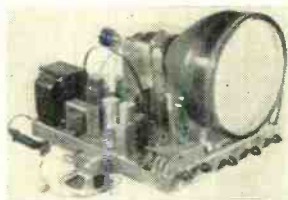

Note simple clean lay-out for easy assembly of new Telekit 10-B. Features 2 sound I. F. stages, a new pre-built, pre-aligned tuner that includes a stage of R. F. for distance reception. Easy-to-adjust horizontal lock circuits. Beautiful new model cabinets for 7-B and 10-B are heavily constructed of hand rubbed walnut.

**13 CHANNEL TUNER**  
**\$19.95**



**NEW 13 CHANNEL TUNER** is a small compact unit with stage of R.F. Made to conform with Telekit or any other TV set having video I.F. of 25.75 Mc. Complete with tubes, pre-wired, pre-aligned; only three connections to make. See your jobber, or write to us for information. Your cost, \$19.95.

Write for catalog of Telekit antennas, boosters, television kits, tuners, television parts and tubes.

# TELEKIT

**ELECTRO-TECHNICAL INDUSTRIES**  
1432 NORTH BROAD STREET PHILADELPHIA 7, PA.

Almost the entire 626 pages of this manual are devoted to wiring diagrams of equipment which the average industrial technician is likely to encounter in his work. The manual is divided into six main sections dealing with basic electricity, transformers, motors, controls, generators and converters, and electronics. These sections are further divided into divisions and applications.

According to the plan worked out by the authors, an electrician confronted by the problem of repairing a two-step magnetic controller for a d.c. motor would first consult the "subject matter" section of the "subject and application guide." After determining that the work falls into the "controls" classification, the user then breaks down the subject still further by selecting the subject "d.c. motors" under the main "control" classification. The "d.c. motors" category is subdivided and the user would select "magnetic, multi-step" as the application pertinent to the problem at hand.

Men whose daily work involves the repair, maintenance, and installation of all types of industrial electronic equipment will find this manual a help in cutting servicing time. -30-

## Beginning Amateur

(Continued from page 45)

doesn't even read it. Instead, he gives the application form back to the applicant and tells him to have it notarized. (One or more notaries can always be found in or near a Federal building.) All the papers are then for-

warded to Washington for grading. Notification of passing takes the form of the actual amateur license, with call letters marked on it. Failure brings only a form letter of regret. The usual wait for a license is about a month; for the less welcome notice, a couple of weeks. You cannot ask for specific call letters; you have to take what comes along.

The brand-new ham is eligible only for licenses of the Class B and Class C type. These involve the identical examination, but the difference lies in the manner of giving it. If you live within 125 miles of an FCC office or a point at which amateur tests are held periodically, you must appear in person and be checked by an FCC engineer, as described. If you live more than 125 miles from an examining point, you can obtain all the papers by mail from the nearest FCC office. You must arrange with a licensed operator to give you a code test and to certify that you answered the written part of the examination in his presence, without assistance. The government puts you on your honor in this deal! If you move into an area served by an FCC office less than 125 miles away, you must appear for an official re-examination within four months.

Class B and C licenses permit the holders to operate c. w. on any amateur band and phone above 27,160 kilocycles. The Class A license allows, in addition, the privilege of working phone in the so-called "20- and 75-meter" bands. Only hams with a minimum of one year's experience can apply for this license, which boasts a much stiffer examination than the

FCC offices where complete information on obtaining amateur licenses may be obtained.

## RADIO DISTRICTS

Radio district	Address of the inspector in charge Federal Comm. Comm.	Territory within district	
		States, etc.	Counties
1	Seventh Floor Customhouse, Boston 9, Mass.	Connecticut ..... Maine ..... Massachusetts ..... New Hampshire ..... Rhode Island ..... Vermont .....	All counties. Do. Do. Do. Do. Do.
2	748 Federal Bldg., 641 Washington St., New York 14, N. Y.	New Jersey .....  New York .....	Bergen, Essex, Hudson, Hunterdon, Mercer, Middlesex, Monmouth, Morris, Passaic, Somerset, Sussex, Union and Warren. Albany, Bronx, Columbia, Delaware, Dutchess, Green, Kings, Nassau, New York, Orange, Putnam, Queens, Rensselaer, Richmond, Rockland, Schenectady, Suffolk, Sullivan, Ulster and Westchester.
3	Room 1200, New United States Customhouse, 2d and Chestnut Sts., Philadelphia 6, Pa.	Delaware ..... New Jersey ..... Pennsylvania .....	Newcastle. Atlantic, Burlington, Camden, Cape May, Cumberland, Gloucester, Ocean, and Salem. Adams, Berks, Bucks, Carbon, Chester, Cumberland, Dauphin, Delaware, Lancaster, Lebanon, Lehigh, Monroe, Montgomery, Northampton, Perry, Philadelphia, Schuylkill, and York.
4	508 Old Town Bank Bldg., Gay St. and Falsway, Baltimore 2, Md.	Delaware ..... District of Columbia ..... Maryland ..... Virginia .....	Kent and Sussex. All. All counties. Arlington, Clark, Fairfax, Fauquier, Frederick, Loudoun, Page, Prince William, Rappahannock, Shenandoah, and Warren.
5	Room 402, New Post Office Bldg., Norfolk 10, Va.	North Carolina ..... Virginia .....	All except district 6. Do.
6	411 Federal Annex, Atlanta 3, Ga.	Alabama ..... Georgia ..... North Carolina .....	All except district 8. All counties. Ashe, Avery, Buncombe, Burke, Caldwell, Cherokee, Clay, Cleveland, Graham, Haywood, Henderson, Jackson, McDowell, Macon, Madison, Mitchell, Polk, Rutherford, Swain, Transylvania, Watauga, and Yancey.
	Suboffice, Post Office Box 77, 214-218 Post Office Bldg., Savannah, Ga.	South Carolina ..... Tennessee .....	All counties. Do.

(Continued on page 110)



# TITONE

**Now! A \$10 SALE**

**for every record-player in your area!**

LIST PRICE \$7.50

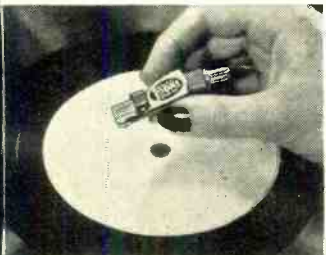

**SELL NEW TITONE PICKUP to every customer!**

Here's a way to quick profit from every player owner who visits your shop! Have your salesman "plug" it on every service call! First basic pickup advance in over 10 years—the original piezoelectric ceramic pickup, made by SONOTONE, famous makers of hearing aids and miniature tubes!

- SELLS ITSELF IN A 2-TO-5-MINUTE CALL! Fits all tone arms. Let all your customers hear TITONE. They'll say "SOLD!" because—
- TRANSCRIPTION TONE QUALITY! Full frequency to 10,000 cycles! Real high fidelity! Bell-like supertone makes even old players thrilling!
- SURE-FIRE IN HUMID CLIMATES! Utterly unaffected by climate, moisture, fungus! Booms sales, wins back customers.
- DOUBLES RECORD LIFE AND PLEASURE! Gives "ordinary" records sparkling quality—revives worn favorites. Will play down to 1/2 normal pressure. NO "needle talk"!
- RUGGED! PERMANENT! No crystals, magnets, filaments to fail! No pre-amplifiers. Ceramic TITONE performs perfectly for years!

**NO TONE LIKE TITONE**

**CALL YOUR JOBBER—**  
or write now to  
SONOTONE, Box T-7 Elmsford, N. Y.

**picks up profit NOW!**

## RADIO DISTRICTS (Continued from page 108)

Radio district	Address of the inspector in charge Federal Comm. Comm.	Territory within district	
		States, etc.	Counties
7	Post Office Box 150, 312 Federal Bldg., Miami 1, Fla. Suboffice, 409-410 Post Office Bldg., Tampa 2, Fla.	Florida	All except district 8.
8	400 Audubon Bldg., New Orleans 16, La.	Alabama Arkansas Florida Louisiana Mississippi Texas	Baldwin and Mobile. All counties. Escambia. All counties. Do. City of Texarkana only. Arkansas, Brazoria, Brooks, Calhoun, Cameron, Chambers, Fort Bend, Galveston, Goliad, Harris, Hidalgo, Jackson, Jefferson, Jim Wells, Kennedy, Kleberg, Matagorda, Nueces, Refugio, San Patricio, Victoria, Wharton, and Wilsey.
9	404 Post Office Bldg., Galveston, Tex.	New Mexico Oklahoma Texas	All counties. Do. All except district 9 and the city of Texarkana.
10	Post Office Box 5238, 500 U. S. Terminal Annex, Dallas 2, Tex.	Arizona California	All counties Imperial, Inyo, Kern, Los Angeles, Orange, Riverside, San Bernardino, San Diego, San Luis Obispo, Santa Barbara, and Ventura.
11	539 U. S. Post Office and Courthouse Bldg., Temple and Spring Sts., Los Angeles 12, Calif.	Nevada	Clarke.
12	Suboffice, 307 U. S. Customhouse and Courthouse Bldg., Union and "F" Sts., San Diego 1, Calif.	California Nevada	All except district 11. All except Clarke.
13	328 Customhouse, San Francisco 26, Calif.	Idaho Oregon Washington	All except district 14. All counties. Wahkiakum, Cowlitz, Clark, Skamania, and Klickiatt.
14	805 Terminal Sales Bldg., Portland 5, Oreg.	Idaho Montana Washington	Benawah, Bonner, Boundary, Clearwater, Idaho, Kootenai, Latah, Lewis, Nez Perce, Shoshone. All counties. All except district 13.
15	504 Customhouse, Denver 2, Colo.	Colorado Utah Wyoming	All counties. Do. Do.
16	208 Uptown Post Office and Federal Courts Bldg., 5th and Washington Sts., St. Paul 2, Minn.	Minnesota Michigan	Do. Alger, Baraga, Chippewa, Delta, Dickinson, Gogebic, Houghton, Iron, Keweenaw, Luce, Mackinac, Marquette, Menominee, Ontonagon, and Schoolcraft.
17	809 U. S. Court House, Kansas City 6, Mo.	North Dakota South Dakota Wisconsin	All counties. Do. All except district 18.
18	246 U. S. Court House, Chicago 4, Ill.	Iowa Kansas Missouri Nebraska Illinois Indiana Iowa	All counties. Do. Do. Do. Do. Do. Allamakee, Buchanan, Cedar, Clayton, Clinton, Delaware, Des Moines, Dubuque, Fayette, Henry, Jackson, Johnson, Jones, Lee, Linn, Louisa, Muscatine, Scott, Washington, and Winnebago.
19	1029 New Federal Bldg., Detroit 26, Mich.	Wisconsin	Columbia, Crawford, Dane, Dodge, Grant, Green, Iowa, Jefferson, Kenosha, Lafayette, Milwaukee, Ozaukee, Racine, Richland, Rock, Sauk, Waubesa, Washington, and Waukesha.
20	Suboffice, 541 Old Post Office Bldg., Cleveland 14, Ohio.	Kentucky Michigan Ohio West Virginia	All counties. All except district 16. All counties. Do.
21	328 Federal Bldg., Buffalo 3, N. Y.	New York Pennsylvania Territory of Hawaii Guam Midway Wake American Samoa Puerto Rico Virgin Islands	All except district 2. All except district 3.
22	609 Stangenwald Bldg., Honolulu 1, Territory of Hawaii	Alaska	
23	Post Office Box 2987, 322-323 Federal Bldg., San Juan 13, Puerto Rico. Post Office Box 1421, 7-8 Shattuck Bldg., Juneau, Alaska.		

others. Also, you must appear in person for the Class A test, regardless of where you live.

One of the things not generally known about the licensing procedure is that an applicant can take the test in person at any FCC office giving it, regardless of where he lives. For instance, your permanent home might be Illinois, but you are attending school in New Haven. If you should happen to be in Boston or New York or Washington during a school vacation period, you can march into the FCC offices there and take your exam. These three big offices hold "open house" Monday through Friday, from about 9 a. m. to 5 p. m. At other offices the tests are given less frequently; two or three times a week at

some, once a year at others. It pays to inquire beforehand.

And talking of paying. Never in the history of government control of radio, dating back to 1912, has there been a fee attached to the ham ticket. You do have to pay out a quarter to the notary public, but that's a private matter.

The FCC has twenty-three district offices, whose locations are given in the accompanying table. When you think you're ready for the ham test, write, phone or visit the one nearest you and ask about the license schedule. If you write, type or print your name and address clearly. Then practice the code some more, brush up on the theory, put an extra quarter in your shoe, and get going! (To be continued)

# New 1949 Diagram Manual Added to Supreme Publications

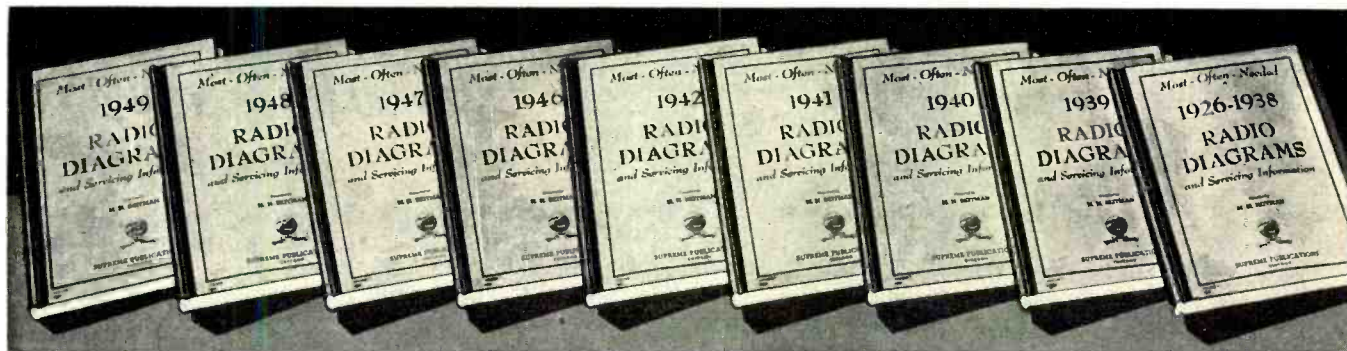

## NEW MANUAL COVERS ALL POPULAR 1949 SETS

Use this new manual to repair quickly all modern 1949 radio receivers. In this big, single volume, you have clearly printed, large schematic diagrams, needed alignment data, replacement parts lists, voltage values, and information on stage gain, location of trimmers, and dial stringing for almost all recently released sets. A worthy companion to the 8 previous volumes used by over 123,000 shrewd radio servicemen. Like the previous volumes illustrated above, it sells at a give-away price and gives you a whole year of radio diagrams for a couple of dollars total cost — nothing else to buy the rest of the year, nothing else to pay. Giant size: 8½ x 11 inches. Includes complete index. Manual style binding. Available at your jobber, **\$2.50** or send coupon, price only...

### Models Made by:

R.C.A., Zenith, Philco, Sears, Fada, Emerson, Belmont, Detrola Radio, Majestic, United Motors, Westinghouse, Admiral, Arvin, Stewart-Warner, Delco, Stromberg-Carlson, Western Auto, Wards, Sparton, Crosley, Motorola, Gamble, G.E., and many others.

## AMAZING BARGAIN IN SERVICE DATA

Here is your low-priced, money-saving source of radio diagrams and service information for all popular sets. Above is a photograph of these giant-size manuals — available to servicemen at only \$2 for most volumes. Let these easy-to-use manuals guide you to quick fault-finding and simplified repair of any radio. Eliminate guesswork, cut hour-wasting jobs to pleasant moments. For 16 years, radiomen expected and received remarkable values in Supreme Publications service manuals. Yes, these manuals are still only \$2 each, and only \$2.50 for the new 1949 manual and the extra large 1926-38 volume. Biggest bargain in service manuals. Only a publisher who sold over a million manuals can offer such values based on tremendous volume-sales. Sold by all radio jobbers. No-risk examination granted to servicemen.



Compiled by M. N. Beitman, radio engineer, teacher, author & serviceman.

## FIND ALL RADIO FAULTS DOUBLE-QUICK

You can speed-up and simplify radio repairs with Supreme Publications manuals. Service all radios faster, better, easier, save time and money, use these most-often-needed diagram manuals to get ahead, earn more per hour. These manuals cover every popular radio of all makes, from old timers to new 1949 sets. Clearly printed circuits, parts lists, alignment data, and helpful service hints are the facts you need to be more expert in radio servicing. Save hours each day, every day, begin to earn more by making repairs in minutes instead of hours. Let these inexpensive manuals give you needed diagrams for 80% of all sets. These manuals pay for themselves with time saved on a couple of jobs, after that you use them FREE. There are nine volumes in all as illustrated above. Each manual is 8½ x 11 inches, sturdy manual style binding, average manual has 194 pages of diagrams and practical service data. Use coupon below to order on trial.

## SENSATIONAL LOW PRICES

Be money ahead with SUPREME manuals. For the amazing bargain price (only \$2 for most volumes) you can be certain of having in your shop and on the job, needed diagrams and other essential repair data on 4 out of 5 sets you will ever service. There is no need to spend large sums for bulky, space-wasting manuals of other publishers, or to buy additional drawings every few weeks; be wise, use SUPREME Manuals to get the most in diagrams for the smallest cost. Check manuals wanted below.

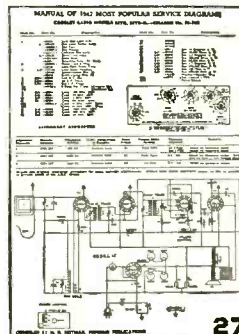

Giant page size is 8½x11 inches

## RADIO SERVICING COURSE-BOOK



Here is your practical radio course of 22 easy-to-follow lessons. Review fundamentals, learn new servicing tricks, all about signal tracing, use of oscilloscope, recording, test equipment P.A., and T-V. Just like a \$100 correspondence course. Covers every topic of radio servicing. With self testing questions and index. Large size: 8½ x 11 in. Order by mail or see course-manual at **\$2.50** your radio jobber, price only.....

## New 1948 T-V Manual

New, giant volume of television factory data covers every popular make. Gives description of circuits, pages of test patterns, response curves, alignment facts, oscilloscope waveforms, voltage charts, service hints, many diagrams in the form of double-spread blueprints, test points, everything to bring you up to date and make you expert in all T-V repairs. Large, sturdy 8½"x11" manual style binding, flexible covers, **\$3** price only.....

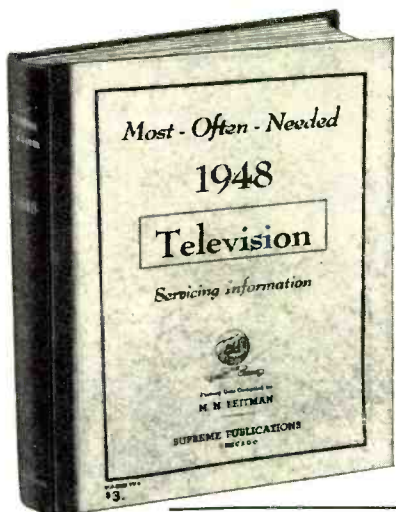

## F.M. and Television Manual (1947)

Manual of instructions for trouble-shooting, repairing, and alignment of all popular 1947 F.M. and Television sets. Covers every popular make; includes AM-FM combinations, F.M. tuners, and all types of T-V receivers. This is the material you need to adjust and fix any modern F.M. and T-V set. Data on 192 large pages, 8½x11". Sturdy, manual style binding. At your jobber or by mail; your price, only..... **\$2**

# Supreme Publications

Available at the Better Radio Jobbers Everywhere

May, 1949

## NO-RISK TRIAL ORDER COUPON

SUPREME PUBLICATIONS, 3727 W. 13th St., Chicago 23, ILL.

Ship the following manuals: (Satisfaction guaranteed or money back)

- |   |              |   |  |  |
|---|--------------|---|--|--|
| <input type="checkbox"/> 1949 Manual, only \$2.50 | } <b>\$2</b> | <input type="checkbox"/> Radio Servicing Course-Book.....\$2.50 |  |  |
| <input type="checkbox"/> 1948                     |              | } <b>PRICED AT ONLY</b>   | <input type="checkbox"/> New 1948 Television Servicing Manual 3.00 |  |
| <input type="checkbox"/> 1947                     |              |   | } <b>EACH</b>  | <input type="checkbox"/> 1947 F.M. and Television Manual.... 2.00    |
| <input type="checkbox"/> 1946                     |              |   |  | <input type="checkbox"/> I am enclosing \$..... send postfree.       |
| <input type="checkbox"/> 1942                     |              |   |  | <input type="checkbox"/> Send C.O.D. I am enclosing \$..... deposit. |
| <input type="checkbox"/> 1941                     |              |   |  |  |
| <input type="checkbox"/> 1940                     |              |   |  |  |
| <input type="checkbox"/> 1939                     |              |   |  |  |
| <input type="checkbox"/> 1926-1938 Manual \$2.50  |              |   |  |  |

Name: .....  
Address: .....

**You Can't Match these  
MID-AMERICA Values!**

**ELECTRIC MOTOR SCOOP!**

**115-volt 60-cycles**

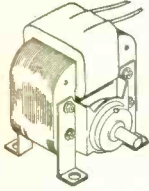

Get this motor and make the handiest tool on your workbench! Attach a flexible shaft and you're all set for grinding, sanding and buffing operations. Great for model-makers, 1/20 h.p. motor turns at 2900 RPM—does the job in half the time! 3/4" shaft, 3/4" long, 3 1/4" x 2 3/4" x 3 3/4" high; weighs only 3 3/4 lbs. May be used for many motor applications.

**\$3.95**

**THIS MONTH'S SPECIALS**

- Brand New Throat Microphone.....19c
- Lever Action Switch with Knob (3-pos. 2-SP3P and 1-SPST; spring return).....29c
- 8" PM Speaker, 50L6 Transformer.....\$3.95
- Brand New BC-366 Jack Box.....19c
- 6-volt AC-DC Motor; 1/4" shaft; app. 3" long, 2 1/2" dia. Used, sold as is.....98c

**PLATE LOAD RELAY**

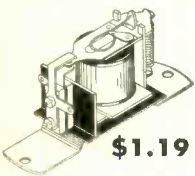

6000-ohm coil, SPST normally open contacts. Extra sensitive and used for many applications. 1 1/2" high 1 1/4" wide, on 1 1/2" mts. ctrs. **\$1.19**  
MA-1903..... **\$1.19**

**METAL CAN ELECTROLYTICS**

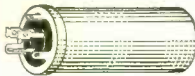

- MA-50868 30-20 mfd. 450 VDC.....39c
- MA-50866 15/15 mfd. 450/350 VDC.....39c
- MA-50865 30-15/15/10 mfd. 450/350/25 VDC.....39c
- MA-50871 20-20 mfd. 450V.....39c

**Silver Mica Button Condensers**

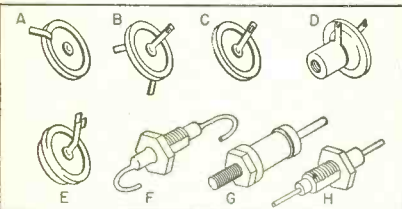

**\$7.50 per 100 (all one type)**

- |                     |                      |
|---------------------|----------------------|
| MA-3536 (G) 20 mmf  | MA-3505 (C) 360 mmf  |
| MA-3501 (D) 30 mmf  | MA-3509 (A) 500 mmf  |
| MA-3531 (F) 55 mmf  | MA-3506 (B) 500 mmf  |
| MA-3503 (A) 75 mmf  | MA-3510 (C) 500 mmf  |
| MA-3532 (H) 75 mmf  | MA-3502 (D) 500 mmf  |
| MA-3504 (A) 200 mmf | MA-3507 (E) 500 mmf  |
| MA-3519 (F) 250 mmf | MA-3518 (A) 2000 mmf |

**No. 18-2-conductor Wire & Drum**

Used for running 110-volt AC lines, extension speakers, etc. Full 175 feet of highest quality wire with tough, weather-resistant insulation. Complete with handy drum for spooling wire for storage. **\$2.39**  
Limited quantity

**BRAND NEW METERS**

Dejur Model 310 meter for all-around ham and test applications. 10 ma DC basic movement, 3/4" diameter frame; 3/4" body, 1 1/2" deep. Stock up on these while they last. MA-2036 **\$1.95** each

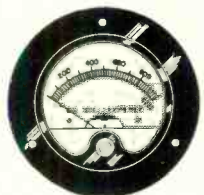

**ORDER FROM THIS AD!**

Send 25% deposit with order. Pay balance plus postage on delivery. Get your name on Mid-America's select mailing list and get first crack at latest, greatest values in radio parts, electronic equipment, tubes, etc. Send orders to Desk E-59. Minimum order \$2.50.

**MID-AMERICA CO. Inc.**

**2412 S. Michigan Avenue  
Chicago 16, Ill.**

**Grid Dip Adapter**

(Continued from page 61)

od, without the use of additional equipment.

We have made reference to the probe and probe coils throughout the preceding text. The photograph of Fig. 1 shows the internal construction of this unit, component placement, and the socket mounting layer construction. The whole unit is mounted inside the small convenient tubular can. This permits measurement in the tightest places without any difficulty.

**Energy Indicator**

Another important application of 915 is that of a non-oscillating detector. In this case, the back plate terminals are shorted across, to provide a d.c. return for the rectifier. Under this heading may be listed the important functions of absorption-type frequency meter, field strength meter, and monitor, to mention only a few. The coupling in this case is the same as previously mentioned. The meter will read upward as we are taking energy from the specimen circuit. With an external calibration chart, it is possible to use this instrument as a db. meter for receiver or fixed line work. This, again, represents just a few of the many different applications that may be performed when using it in the de-energized condition.

**Measurement of Capacitance and Inductance**

The value of any capacitance, within practical limits, may be quickly determined. Model 915 is again connected to the companion signal generator, as in the dip application. To make capacitance measurements properly, it is necessary to have a good high-value, variable condenser with an associated calibration scale. This scale should indicate the actual capacitance change vs. degrees rotation. In parallel with the condenser should be an air-wound coil. Determine first the resonance of this combination circuit with the variable condenser at maximum setting. Leave 915 loosely coupled to the circuit coil and shunt the specimen condenser across the variable condenser. Retune the variable condenser until resonance is again indicated by the 915 meter. The value of the unknown condenser is the difference between the two readings on the calibrated scale. For example, if the circuit was resonant at some frequency with a maximum setting of 500  $\mu$ fd., and could be re-resonated (after the specimen had been added) at a setting of 430  $\mu$ fd., the unknown value would be 70  $\mu$ fd. A similar method may be utilized to determine, by a series additive system, the exact value of inductors. These units may be constructed if desired. The value of either type of measurement is directly related to the tolerance of the calibration scale.

**SOLDER BETTER with Soldetron**

Tr. Mark Reg., Pat. Pend.

**For LIGHT or HEAVY WORK  
Heats Rapidly from Cold Start**



- LIGHTWEIGHT.
- FINGERTIP CONTROL. No Fatigue.
- Though it weighs only 3 ozs. "Soldetron" can do the job of a 200 watt iron.
- Ideal for precision work in "hard-to-reach" places.
- Interchangeable tip-heads; no cleaning or filing.
- Retains heat with switch off up to 1 minute.
- COOL GRIP bakelite handle, cork covering. Comfortable.



Operates on 110-V. A.C., 50-60 cycles, through transformer supplied with iron, or 6-8 volt A.C. or D.C. without transformer (from an automobile battery). Price: with transformer and 1 tiphead, \$13.95 5% higher west of Miss.; fair traded.

Ask your distributor, or write to:

**TRANSVISION, INC.**

Dept. RN, NEW ROCHELLE, N. Y.  
In Calif: 8572 Santa Monica Blvd., Hollywood 46

WITH PRACTICAL

BUILD YOUR CAREER

SPECIALIZE



**You can become a Radio and Television Technician now!**

A million new jobs—almost 4,000 a week—will be created in the television industry during the next five years according to estimates of industry leaders.

- Now you can get complete practical, technical training in the MSOE laboratories.
- Prepares you for any of the following careers:
  - Television Serviceman
  - Broadcast Operator
  - Radio Serviceman
  - Police, Taxi-Cab and Railroad
  - Radio and Television Retailer
  - Transmitter Operator
  - Supervisor in Radio and Television Assembly
  - Police, Taxi-Cab and Railroad
  - Radio and Television Receiver Serviceman
  - Radio and Television Tester

- OTHER COURSES AVAILABLE
- SERVICE Heating and Air Conditioning
- 6 to 12 Months
- Electricity
- Welding
- Refrigeration, 3 Years
- Heating
- TECHNICAL Bachelor of Engineering
- 1 to 2 Years
- Electrotechnics
- Radio and Television
- Electronics
- Refrigeration
- Science Degree
- Major in Electronics or Power

**MILWAUKEE SCHOOL OF ENGINEERING**

MILWAUKEE SCHOOL OF ENGINEERING, N. Broadway and E. State, Milwaukee, Wis. Dept. RN-549

Without obligation, send me free booklet "Career Building" and more details on course in Radio and Television or.....course.

Name ..... Age.....  
Address .....  
City ..... State.....



A separate associated unit is available to perform these measurements exactly. This unit is Model 917, and consists of a capacitance and inductance standard. Both standards are accurately calibrated and completely variable throughout all practical ranges.

The preceding discussion has outlined some of the application merits of a new and very unique instrument. To the engineer, technician, and production worker, it represents a quick solution to many design and testing problems. To the serviceman, it is a means of aligning and checking all receivers rapidly. The amateur reader has probably realized that his v.f.o. is the signal generator described, and may be used as a coupling source for transmitter alignment, parasitic and oscillator checking, etc. It is our opinion that once you have used an instrument of this type, you will find it indispensable. -30-

### TISA PLANS CAMPAIGN

At a special meeting of the Television Installation and Service Association (TISA) of Chicago, a program was drawn up which is designed to promote the betterment of the professional serviceman.

Specific goals outlined were the establishment of adequate technical standards, installation and service rates, advanced training of personnel, owner education, and better relations with the industry.

The officers of the TISA, Frank J. Moch, president; Irving Kaluzna, vice-president; Fred Levine, secretary; and Philip Bann, treasurer, hope to hear from other units regarding mutual problems. Questions should be addressed to the association offices at 3125 West 59th Street, Chicago 29, Illinois. -30-

### VISUAL CODE COURSE

Recently, Mr. Otto H. Luther of New Preston, Connecticut, designed a rather novel system for learning the Morse code alphabet. This method enables the student to associate the code symbols with the already familiar appearance of the letter, by means of superimposing the dots and dashes on the letters themselves in an amusing and colorful way.

For instance, the letter "I" is represented by a diagram of two bulls eyes with large red-dot centers. Under this appears the memory key word "EYES." Obviously, two dots stand for the letter "I," and you don't easily forget it.

According to Mr. Luther, a commercial artist, who sells it, this color chart system will shorten code learning time drastically, and it is not unusual for a student to master it in an hour. -30-

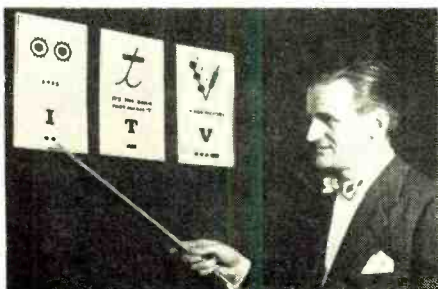

May, 1949

McMurdo  
**SILVER**

IS FIRST AGAIN!



## NEW! TUBELESS GRID DIP ADAPTER

**THIS OUTSTANDING ELECTRONIC INVENTION** brings to the engineer, serviceman and amateur a single accurate means of determining circuit function. The utility of any signal generator, test oscillator or v.f.o. is expanded many times. Allows direct measurement of all tuned circuits: r.f., i.f., etc., simply and quickly without the receiver being turned on. Checks all oscillators: antenna systems: transmitters: trap circuits: without mechanical coupling. Determines the value of all coils and condensers. Requires no power supply or tubes: two simple connections permit quick attachment to any signal generator you are using. Covers the continuous frequency range from 100 kc. through 300 mc. by use of the three calibrated plug-in coils provided. Equipped with a phone jack for easy aural identification of oscillator frequencies. Model 915 has no equal as a field strength monitor or grid dip oscillator. Handsomely styled, complete with compact probe and plug-in coils, **\$34.95<sup>NET</sup>**

**MODEL 906 FM-AM SIGNAL GENERATOR** This advanced type signal generator stands out as today's greatest electronic value. Continuous coverage from 90 kc. through 210 mc. Accuracy  $\pm 1\%$ . Less than  $\frac{1}{2}$  microvolt including strays to over 1 volt metered output. AM modulation adjustable from 0-100%. FM sweep from 0-1200 kc. Complete with all accessories **\$116.50** at a low net price of only



**MODEL 911 TV-FM SWEEP GENERATOR** Here is an all-in-one TV service center. Continuous range of 2 thru 226 mc. Output from 0- $\frac{1}{2}$  volt. 1 and 5 mc. precision crystal markers insure pin-point setting of TV i.f. band width, and trap circuits. Phased 60 cycle sine and 120 cycle saw-tooth voltages for direct scope control. Sweep from 0-10 mc. An outstanding buy at only **\$78.50**



Look to **McMURDO SILVER** for the **NEWEST** in FM-TV Service Equipment  
SEE US AT BOOTH 41 AT THE CHICAGO SHOW

Send for Catalog  
See these and other  
McMurdo Silver  
LCETI instruments at  
your favorite jobber.

OVER 37 YEARS OF RADIO ENGINEERING ACHIEVEMENT

*McMurdo Silver Co., Inc.*

EXECUTIVE OFFICES: 1240 MAIN ST., HARTFORD 3, CONN.  
FACTORY OFFICE: 1249 MAIN ST., HARTFORD 3, CONN.

**WHERE TO BUY IT . . .**  
**WHOLESALE RADIO**  
of Baltimore

**NEW LOW PRICED T.V. KIT**

Philmore Model U-30-A

Circuit Design of  
R.C.A. 630 T.S.

Now only

**\$159**

Less picture tube  
and cabinet



With Philmore's Famous Step-by-Step Instructions Complete with 29 tubes and all mounting hardware. Factory pre-wired and aligned front end. All sockets are assembled to chassis.  
Cabinet for R.C.A. 630 T.S. . . . . \$33.75

**UNBEATABLE METER BUY!**

An Accurate Pocket Size

**VOLT OHM MILLIAMMETER**  
**SUPERIOR MODEL 770**



(Sensitivity—1000 ohms per volt)  
Complete with self-contained batteries, test leads and all operating instructions.

**\$13.90**

- 6 A.C. VOLTAGE RANGES:  
0-15/30/150/300/1500 3000 Volts
- 6 D.C. VOLTAGE RANGES:  
0-7.5 15 75/150/750/1500 Volts
- 4 D.C. CURRENT RANGES:  
0-1.515/150 ma. 0-1.5 amps.
- 2 RESISTANCE RANGES:  
0-500 ohms 0-1 megohm

COMPACT  
Measures 3 1/8" x 5 7/8" x 2 1/4"

**G.E. GERMANIUM DIODE IN48**

- Welded Contact
- Self Healing
- Molded Plastic Case



Eliminates hum. 10,000 hrs. average life. Shown in actual size. Write today for complete specifications.

**\$1.35**

**JFD Super Beam, All Channel**

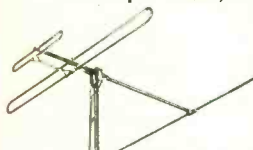

**T.V. & FM**  
**ANTENNA**

**\$8.65**

\$8.10 each  
In lots of six or more

Matches input of nearly all T.V. sets. Unidirectional pattern over both bands eliminates "Ghosts" caused by multipath signals. Complete with 5 ft. mast and mounting bracket less lead-in. Order model TA150.

STACKING BARS, set of 2. . . .98c

300 OHM TWIN LEAD \$1.95—100 ft. \$13.75—1000 ft.

**ALLIANCE "Tenna-Rotor"**

A perfect rotator for Television or Amateur Antenna. Order model ATR.

**\$39.95**

With Remote Control Box

List Flat, rubber covered, 4 conductor connecting cable for Alliance motor. . . . . net 4c per ft.

**OIL FILLED CONDENSER**

10 MFD **95c**  
600 V.



WRITE DEPT. QR 76 TODAY FOR OUR FREE MONTHLY "FYI" BULLETIN  
Phone Mulberry 2134

**WHOLESALE RADIO PARTS CO., Inc.**  
311 W. Baltimore St.  
**BALTIMORE 1, MD.**

# Manufacturers' Literature

Readers are asked to write directly to the manufacturer for the literature. By mentioning RADIO & TELEVISION NEWS, the issue and page, and enclosing the proper amount, when indicated, delay will be prevented.

**CONVERTER CATALOGUE**

The complete line of Carter converters is presented in a new catalogue which is designed to furnish complete information in great detail to those who buy, sell, use, or service the company's products. The literature is presented in a convenient form, best suited to the needs of engineering and purchasing departments.

The bulletin consists of 16 illustrated pages on the entire range of available input and output voltages, including the recently perfected designs to be used in conjunction with television operations, as well as those for recording, sound projection, and mobile communications applications.

Also included is a Carter Selector Chart, augmented to include new television and recording equipment for which these converters are adapted. The chart shows at a glance the correct converter required to operate each popular make and model. A complete list of sales representatives is also supplied, and a convenient index is included.

Inquiries for the "Converter Catalog No. 349" should be addressed to Carter Motor Company, 2644 N. Maplewood Avenue, Chicago, Illinois.

**TV ANTENNA BOOKLET**

An eight-page catalogue recently put out by the Workshop Associates, Inc., 66 Needham Street, Newton Highlands 61, Mass., amply illustrates the company's line of television antennas, mounts, etc.

Sections are devoted to the Workshop high-gain antennas, masts, and mounts, as well as high-gain arrays, transmission line, connectors, transformers, and typical antenna arrangements. Complete specifications are given for the products, together with prices. Television reception problems are covered, and the suggestions should be welcomed by the servicemen who must experience them.

This catalogue, Number 49, is obtainable free of charge by writing to the Workshop Associates, Inc., in Massachusetts.

**STANDARD TERMINOLOGY**

Recent scientific developments in ultrasonics, recordings, underwater sound, acoustical instruments, and shock and vibrations are reflected in the Proposed American Standard Acoustical Terminology, being published for a period of trial study before its final approval. The American Standards Association has made every effort to keep the definitions consistent with those in standards relating to neighboring fields, and each term is as completely defined as possible.

The committee working on the terminology took into consideration such recent developments as the wide-spread use of the term "supersonic" for speeds higher than the velocity of sound following its use in this sense during the war. As a result, the term "ultrasonic" has been defined as indicating sounds having frequencies beyond the upper pitch limit. Studies of underwater sound phenomena also showed the need for a broader definition of "reverberation" as the types of reflections from boundaries under water differ from those received in a room.

Workers in theoretical and applied acoustics and all others interested are invited to send comments on the proposed terms to the committee in charge not later than September 30, 1949. Address Messrs. E. Dietze or C. F. Wiesbusch, Bell Telephone Laboratories, Inc., Murray Hill, N. Jersey. Copies of the standard, Z24A, can be obtained from the American Standards Association, 70 East 45th Street, New York 17, N. Y., at \$1.00 each.

**BROADCAST MICROPHONES**

Electro-Voice, Inc., Buchanan, Michigan, has developed two new ultra-wide-range, high-fidelity microphones (Models 645 and 650) designed for the FM and AM broadcast services and has released a new bulletin, Number 144, giving all necessary data on these models.

The bulletin explains the various performance and construction features, with detailed specifications, and is illustrated with photographs and sketches.

A copy may be obtained by writing to the company at Buchanan, Michigan.

**SOLDERING TECHNIQUES**

The 28-page technical manual entitled "Solder and Soldering Technique," published by the Kester Solder Company, contains an analysis of the properties and application of soft solder alloys and soldering fluxes.

Contents include the general nature of soldering, its application, the melting points and properties of solder and solder alloys, and information on how to utilize the company's technical and industrial service.

Write the Kester Solder Company, Technical Department, 4201 Wrightwood Avenue, Chicago 39, Illinois, for free copies of this manual.

**GAUGE HANDBOOK**

A combination catalogue, price list, textbook, and reference manual has been announced by The Sheffield Corporation of Dayton 1, Ohio. It is an

**RADIO & TELEVISION NEWS**



**HALLICRAFTERS TV**  
Model 509

The latest addition to the Hallicrafters TV line. Push button tuning on all 12 channels. Dual Focus for larger round pictures with 56 sq. in. rectangular picture or 64 sq. in. full circle picture for dramatic close ups—all at a flick of a front panel switch. Mahogany veneer cabinet. Transparent safety shield. 19 tubes plus 3 rectifiers.

**\$269<sup>50</sup>**

Complete with ALL TUBES. Shpg. Wt. 105 lbs.

**Walter Ashe SCORES AGAIN!!!**  
offers **AMAZING BARGAINS** on  
**hallicrafters TELEVISION**

**MADE POSSIBLE BY "SURPRISE" TRADE-IN ALLOWANCES ON YOUR USED TEST AND COMMUNICATION EQUIPMENT**

Right on the eve of an exciting new season of summer sports events, Walter Ashe makes it possible for you to own Hallicrafters TV equipment at tremendous savings! So don't delay. Get your trade-in deal working today. Phone, wire, write or use the handy coupon.



Model T-506

Here's Television at a price, with all the big set features. 12 channel push button tuning. Static free FM sound reception and 23 sq. in. screen. 18 tubes plus 4 rectifiers. Shpg. Wt. 50 lbs. **Now ONLY \$149<sup>50</sup>**

Formerly sold for \$199.50

Model T-64 Chassis unit only of Model 509. Completely wired and tested, but less picture tube. Only

**\$169<sup>95</sup>**

All Prices F.O.B. St. Louis

Phone: CHestnut 1125

"Surprise" Trade-Ins available on used, factory-built equipment toward purchase of any item in our complete Hallicrafters line. Latest Hallicrafters catalog free on request.

**Walter Ashe**  
**RADIO CO.**

THE HOUSE OF "SURPRISE" TRADE-INS  
1125 PINE ST. • ST. LOUIS 1, MO.

Walter Ashe Radio Co. F-49-5 α  
Bill Dubord, W 0 QDF, Mgr., Amateur Div.,  
1125 Pine St., St. Louis 1, Missouri

Rush bigger than-ever "Surprise" trade-in allowance on my \_\_\_\_\_ for Hallicrafters TV  
(describe used equipment)

\_\_\_\_\_ (show model of new equipment desired)

Mail me my copy of latest Hallicrafters Catalog.

NAME \_\_\_\_\_  
ADDRESS \_\_\_\_\_  
CITY \_\_\_\_\_ ZONE \_\_\_\_\_ STATE \_\_\_\_\_

**For GREATER Earnings... LEARN RADIO-ELECTRONICS**

This fast-growing science of RADIO, TELEVISION, RADAR and ELECTRONICS, offers tremendous opportunities, and in no industry is RADIO-ELECTRONICS more important than in aviation. A skilled technician who *knows* the modern application of electronic devices, as used in the aircraft industry, is always in demand . . . not only in aviation, but in many other industries. Many large organizations call on Spartan regularly for graduates. Often, students are hired months before graduation.

Don't confuse the RADIO-ELECTRONICS course offered by SPARTAN with other courses, offered anywhere! As a graduate from this famous school you will know the application to industrial control devices; to the search for petroleum; and the important uses of radar, television and other electronic equipment.

SPARTAN offers two complete and thorough courses. You will work on the most modern and complete equipment. You will build equipment. You may join the SPARTAN "Ham" Club. Either course prepares you for Federal Communication Commission license tests — first class radio telephone, second class radio telegraph, or class "B" radio amateur.

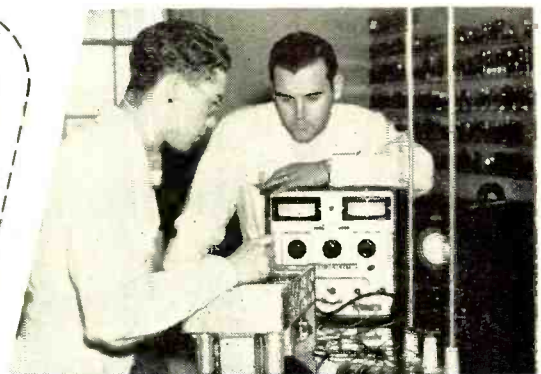

SPARTAN'S 21 years of teaching civilian and army personnel is your assurance of receiving the best possible training in the least possible time. You'll not need MORE than Spartan training — you cannot afford to take LESS.

**BIG CATALOG — Free**

NAME \_\_\_\_\_ AGE \_\_\_\_\_

ADDRESS \_\_\_\_\_

CITY \_\_\_\_\_ STATE \_\_\_\_\_

Dept. RN-59

G. I. APPROVED — Write TODAY for Complete Information

**SPARTAN**

SCHOOL OF RADIO AND ELECTRONICS



SCHOOL OF AERONAUTICS  
MAXWELL W. BALFOUR, DIRECTOR

COLLEGE OF ENGINEERING  
ADDRESS-DEPT. RN-59

TULSA, OKLAHOMA



Visit ATR Booth 82 Radio Parts Show—May 16th, Chicago

## STANDARD AND HEAVY DUTY INVERTERS



### For Inverting D. C. to A. C.

Specially Designed for operating A. C. Radios, Television Sets, Amplifiers, Address Systems, and Radio Test Equipment from D. C. Voltages in Vehicles, Ships, Trains, Planes and in D. C. Districts.

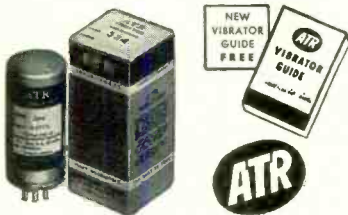

### AUTO RADIO VIBRATORS

A Complete Line of Vibrators . . .

Designed for Use in Standard Vibrator-Operated Auto Radio Receivers. Built with Precision Construction, featuring Ceramic Stack Spacers for Longer Lasting Life.

NEW MODELS ✓ NEW DESIGNS ✓  
NEW LITERATURE ✓

ATR "A" Battery Eliminator, DC-AC Inverters, Auto Radio Vibrators.

See your jobber or write factory

**AMERICAN TELEVISION & RADIO CO.**  
Quality Products Since 1931  
SAINT PAUL 1, MINNESOTA-U.S.A.

illustrated bulletin of factual information for the buyers and users of precision gauges and includes prices, complete specifications, diagrams, and tables.

This 116-page catalogue is among the first to present information and prices on gauges conforming to the new, unified screw thread system recently agreed upon by the English speaking countries using the inch as a standard of measurement.

Sheffield representatives throughout the United States and Canada have been given a supply to distribute to their customers, and copies may be had free of charge by any user of gauges by writing to *The Sheffield Corporation*, Dayton 1, Ohio, on business stationery.

### BI-MONTHLY "TECHNI-TALK"

The Tube Division of the *General Electric Company* has announced a new magazine called "Techni-Talk," which is designed to keep servicemen and dealers abreast of the latest developments in radio and television and to assist them with technical problems encountered in the field.

This bi-monthly illustrated publication features in the first issue (February-March) the beginning of a group of articles on the installation and servicing of television receivers. This issue also carried an article on the volt-ohm-milliammeter, the first of a series to help the serviceman get the most out of a minimum of test equipment.

"Techni-Talk" is distributed to the dealer or serviceman without cost but is obtainable only through *General Electric* or *Ken-Rad* distributors and not direct from the company.

### PRINTED CIRCUITS

"Here is the Story," a booklet issued by *Microcircuits Company*, describes briefly their printed circuits and lists a number of branches of electronics in which these have been utilized.

The catalogue also illustrates the *Microcircuits Company* line of conducting, resistance, and magnetic paints, and the uses to which the paints may be put by repairmen, amateurs, engineers, designers, teachers, operators, and students. Also given are the order numbers, current prices, and pertinent technical data on each product.

The bulletin may be obtained without charge by writing to *Microcircuits Company*, New Buffalo, Michigan.

### SERVICING YEARBOOK

*Philco Corporation* has published a yearbook containing servicing information on its 1946 and 1947 home radios and radio phonographs. This book, available to dealers and independent servicemen, provides in one volume information previously contained in separate radio manuals, together with many additions.

The yearbook explains the *Philco* trouble-shooting procedure, showing alignment procedures, base views, schematic diagrams, circuit descrip-

**BUY IN BULK! SAVE IN BULK!**  
Now You Can Have Approximately

# 200 LBS. OF COSTLY RADIO PARTS

Special Gov't Surplus Ass'tm't **\$25.00**  
FOR ONLY

### SEND ONLY \$5 DEPOSIT!

We ship C.O.D. (Balance \$20 Freight Collect) subject to your inspection and approval at freight station. If not delighted, have agent return to us collect and we will refund your deposit immediately. Your only cost will have been freight one way.

The parts in this assortment undoubtedly cost the government many hundreds of dollars. We have passed this tremendous saving on to schools, colleges and other institutions. Now it's **FIRST COME FIRST SERVED!** . . . so act **FAST**.

### HOW DO WE DO IT?

We buy carloads of these items. Inventorying, itemizing and grouping only multiplies cost to you. So we divide them into choice assortments we know you want and make this sensational offer. Order Now!

This offer good East of the Mississippi only.

**ABELL DISTRIBUTING CO., Dept. N-5**  
5 E. Biddle Street Baltimore 1, Md.

**INTERESTED IN TELEVISION?  
INTERESTED IN SURPLUS BUYS?  
WRITE FOR OUR LATEST CATALOG!**



**Radiosonde Transmitters  
AN/AMQ-1D**

An excellent value for the amateur experimenter. This is the unit which is sent into the sky by balloon and automatically transmits back information as to the changing temperature, humidity, barometric pressure, etc.

### Consists of the following:

- 1—Miniature Battery Transmitter complete with a 3A5 tube.
- 1—Miniature sensitive relay-SPDT. 100 ohm coil operates from 3 Volt battery.
- 1—Temperature sensitive resistance element.
- 1—Humidity sensitive strip.
- 1—Barometer coupled to a selector switch.
- 1—Pressure, temperature, humidity chart.

The entire unit is encased in the original packing and is brand new.

While they last—only **\$4.95**

**Television Transformer.** Pri. 115 Volts 60 Cycles. Sec. 2500 Volts @ 2 ma. 6.3 Volts @ .6A. 2.5 Volts @ 1.75A . . . . . **PRICE \$3.85**

**Magnet Wire** on small spools 1/8-1/4 lb. in sizes No. 22 through No. 44. **Price per spool 25c**

### Radio Noise Filter

**Model NFRD—If it doesn't work, send it back!!**

We absolutely guarantee that our Model NFRD will eliminate all line noises when properly connected to radios, television sets, short wave sets, motors, electric shavers, refrigerators, vibrators, oil burners, transmitters, and all other sources of interference. This unit will carry up to 12 amperes at 1 1/4 KW of power and may be used right at the source of interference or at the radio. Small size only 3" x 1 1/2" x 7/8". Very low price only **each \$1.95**

Write for Latest Catalog R-5 Listing Thousands of Relays, Resistors, Condensers, Switches, Etc.

**EDLIE ELECTRONICS, INC.**

Telephone Digby 9-3143  
154 Greenwich Street New York 6, N. Y.

**RADIO & TELEVISION NEWS**



# Hot Radio Values At Sun Radio

## 2-6 MC PB RECEIVERS

6 Tubes (3—1T4, 1—1R5, 1—1S5, 1—3S4) 2-6 MC in 4 bands. Sold as pictured including 4" speaker and Schematic. Easily converted to broadcast with instructions furnished. Has RF Stage and audio output stage to dual speaker. Used but guaranteed operative.

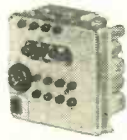

**\$9.95**

### GRAB BAG... only \$7.95

**\$50 Value Over 8 lbs.** The greatest value your dollar ever bought. Resistors, Condensers, Sockets, Ballast Tubes, Rheostats, Pots, Knobs Transformers.

- POWER TRANS.**—650V-CT-70MA, 6.3V-3A, 5V-2A., Also 115V Isolation winding on secondary. PRI—115V-60CY \$ 1.25
- POWER TRANS.**—745 VCT—145 MA, 5V-3A, 6.3V-5A—PRI-115V-60CY... 4.95
- Base for Record Changer**—with 3 tube AMP & 5" SPKR. mounted..... 7.95
- BASE ONLY**—Less AMP & SPKR..... 2.95
- WESTON**—2-Range D.C. Milliammeter —0-150—1500 MA Laboratory Standard—with Leather carrying case... Brand New—Value... \$125.00 ONLY 24.95
- COILS**—3-circuit with Vario coupler—BC Band..... 0.75
- OSCILLOSCOPE**—2 inoh—Waterman —Reg. \$66.50..... ONLY 44.50
- TWEETER**—Atlas HF-1—In Cabinet with Crossover Network. Reg. List Price \$100.00..... ONLY 39.95
- 12GP7**—Cathode Ray Tube—Electrostatic..... 14.00
- REINER**—451 Laboratory VTVM. Reg. \$150.00..... ONLY 100.00
- VO-M-GE-Unimeter UM3**—2000 OHMS per volt. Reg. \$28.50... ONLY 19.95
- VO-M GE Unimeter YMW**—1A—20,000 per volt. Reg. \$39.50..... ONLY 29.50
- AUDIO OSCILLATOR**—YG-A. 4-Reg. \$49.50..... ONLY 29.50
- WESTERN ELECTRIC**—3B24A Tubes 1.95
- TRANSCRIPTION TURNTABLE**—16"—Dual Speed Famous make. Reg. \$125.00..... ONLY 99.50
- TRANSCRIPTION ARM R.M.C.**—16" Broadcast Type—Magnetic with Equalizer. Reg. Price \$136.50, ONLY 99.50
- GE-YYWI**—HI-voltage multiplier for 20,000 OHM per volt meters to 10 KV... 9.95
- JACKSON**—multitester No. 642—20,000 OHMS per volt. Reg. \$59.95... ONLY 39.95
- GONSET**—20 meter converter. Reg. \$39.95..... ONLY 29.95
- GONSET** 6 meter converter. Reg. \$39.95 ONLY 29.95

**TERMS** All items F.O.B. Washington, D. C. All orders \$30.00 or less, cash with order. Above \$30.00, 25 per cent with order, balance C. O. D. Foreign orders cash with orders, plus exchange rate.

**SUN RADIO**  
OF WASHINGTON, D. C.  
938 F STREET, N. W. WASH. 4. D. C.

## Frequency Meter—V.F.O.

(Continued from page 57)

the band perfectly, but when another condenser, also marked 20  $\mu\text{fd.}$ , was substituted it was necessary to parallel it with a condenser marked 10  $\mu\text{fd.}$  to bring the band where it was desired. It is suggested that for C<sub>3</sub>, three CRL CC20Z condensers in values of 2  $\mu\text{fd.}$ , 5  $\mu\text{fd.}$ , 10  $\mu\text{fd.}$  and one CRL CC25Z 20  $\mu\text{fd.}$  condenser be purchased and by cut and try methods, using the condensers in parallel, adjust the band exactly where it is desired. Of course, if a 15 or 25  $\mu\text{fd.}$  variable air trimmer condenser is used, the band can be centered after the unit is assembled. The disadvantage in the use of a trimmer adjustable from the outside is that there is always the possibility that it may be inadvertently changed.

The chassis is aluminum, 10" x 6" x 2", with welded corners, and a shallow tray also with welded corners and 1/2" deep was made in which the chassis just fits. This provides complete shielding. The tray is fastened to the chassis with six 6/32 screws, the chassis being threaded to receive them. Four rubber feet fastened to the bottom of the tray assist in eliminating vibration and possible scratching of your desk top.

Two holes are drilled in the removable bottom of the ECO box, both 1/4" in diameter. The r.f. output lead from the ECO passes through one hole in which a *Millen* feed-through has been inserted. The positive high voltage lead and the hot filament lead go through the other hole. A rubber grommet is inserted in the matching hole in the chassis top through which these voltage leads pass. The four screw holes in the box are tapped to take 8/32 bolts. The box is then assembled on the chassis by inverting it and securing with 8/32 bolts passed upward through the chassis and the

box top as shown in Fig. 2. The rubber grommets provide additional shock mounting.

All wiring in the ECO box is made self-supporting and extremely rigid. Ceramic pillar stand-offs 3/4" high are used to support the r.f. output and high voltage leads. Every nut in the entire unit has been lock-washer. This all adds up to increased stability. Under the chassis a small piece of aluminum was bent and placed as a shield between the 6F6 isolation stage and the 6L7 mixer tube as shown in the photographs. It was found better to use grid 3 (terminal 5) of the 6L7 to receive the output from the 6F6 isolation stage, and use grid 1 (cap) for r.f. input, than to reverse these grids.

As originally mentioned, this unit may be used both for transmitter frequency control and as an accurate heterodyne frequency meter for use with either your transmitter or your receiver. With a short pickup wire attached to the binding post and either headphones or a small PM speaker plugged into the phone jack it makes an excellent monitor for keying or note checking. It also functions as a monitor for your phone transmitter as due to the large band spread, zero-beating the carrier poses no problem.

At WIRBK, the transmitter with which this unit is used as a v.f.o. normally uses a 6L6 crystal oscillator in the usual series fed tetrode circuit. A coaxial terminal is connected in parallel with the crystal socket and a length of RG12/U connects the two units together when v.f.o. rather than crystal operation is desired. Obviously it is necessary to remove the crystal when using v.f.o., and to detach the RG12/U cable when using crystal control.

Some amateurs may have built up a Don Mix v.f.o. and later replaced it with a commercial model. In that case, the v.f.o. may be easily modified for use as a heterodyne frequency meter and thus retain its utility in the ham shack.

—30—

Under-chassis view of home-built, dual-purpose frequency meter—v.f.o.

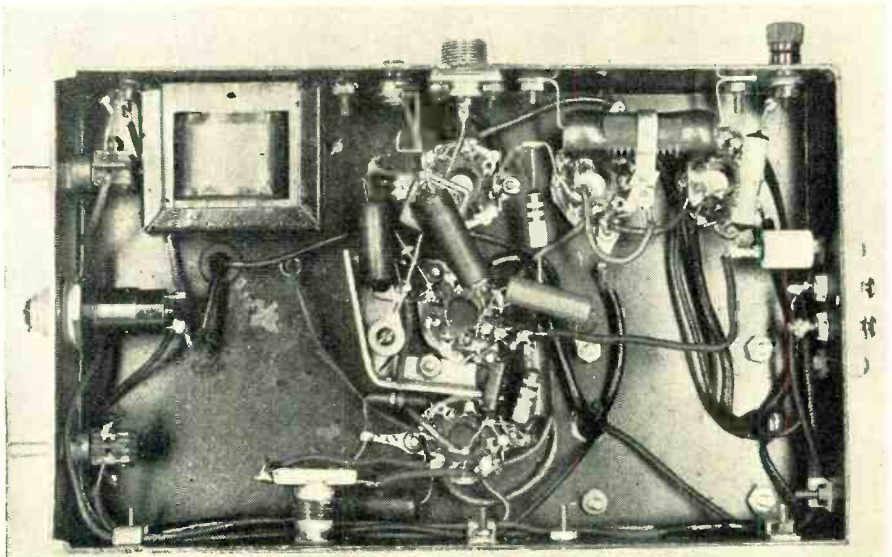

# NEW *Rauland* High-Fidelity 1825 Phono Amplifier TOPS FOR CUSTOM INSTALLATIONS



U/L  
LISTED

**EXCLUSIVE!**  
Detachable  
Remote  
Preamplifier

Preamp is detachable; mounts in any position to meet mechanical requirements of any custom installation. Compact; only 2 3/8 x 2 3/8 x 1 1/2". Unlimited flexibility for custom-built installations.

- 5-Position Frequency Cut-Off**
- Boost Type Tone Controls**
- Dual Volume Controls**
- Dual Input Selector**
- Plug-In Equalizer**

+ 1 DB, 40 TO 20,000 CPS  
25 WATTS OUTPUT (5% harmonic distortion)

AVAILABLE AT YOUR REGULAR SUPPLIER, OR WRITE FOR DETAILS

*Electronics is our business*

**SOUND EQUIPMENT** **INTER-COMMUNICATION**

RAULAND-BORG CORPORATION • 3523-G ADDISON ST., CHICAGO 18, ILL.



## YOU CAN PUT ALL YOUR EGGS IN THE QUAM BASKET...

In spite of the old adage, you'll find it pays to specify Quam Adjust-A-Cone Speakers for all your replacement jobs.

The Quam Line is complete, there's a speaker for every standard receiver. Quam Speakers are listed in the Radio Industry Red Book for your convenience.

Quam Speakers are built by a reliable organization that has been manufacturing quality speakers for over a quarter century.

Customer Good Will is important in your business—you can be sure of building it when you install Quam Speakers. Their fine performance and trouble-free service reflect to your credit!

It pays to replace with Quam!



MAIL THIS  
COUPON FOR  
FREE CATALOG

QUAM-NICHOLS CO.  
522 E. 33rd Place  
Chicago 16, Illinois  
Please send QUAM Catalog.

Name .....  
Address .....  
City ..... State .....

May, 1949

# AMPHENOL TV ANTENNA

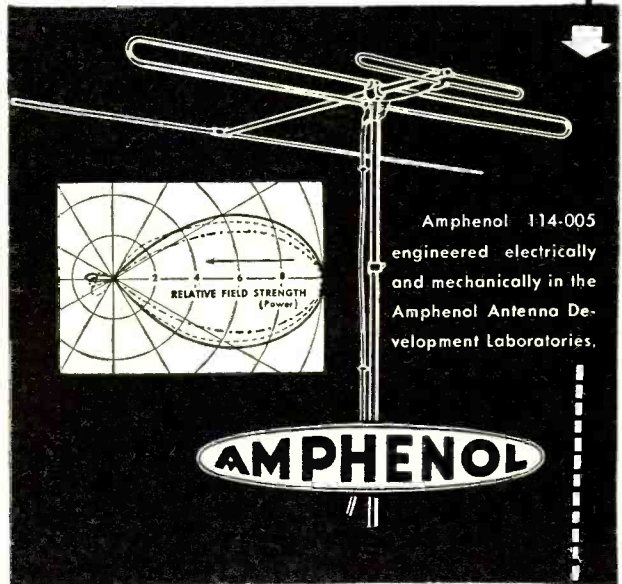

Amphenol 114-005  
engineered electrically  
and mechanically in the  
Amphenol Antenna De-  
velopment Laboratories.

Streamlined and scientifically engineered for best reception and optimum gain, the Amphenol 114-005 Television Antenna incorporates two broadbanded folded dipoles and a low band reflector, with a common transmission line. Top performance is provided over all channels in both the high and low bands.

The radiation patterns as diagrammed are substantially unidirectional and maintain high front-to-back and front-to-side ratios over both bands.

The 114-005 is ideal for use with rotators.



### MORE SIGNAL STRENGTH BRIGHTER PICTURES

Standard Amphenol TV Antenna in stacked array (Model 114-301 or 114-302) provides additional high-gain for fringe areas. Each bay of the antenna may also be individually oriented in areas requiring reception from different directions.

*Amphenol Engineering News, containing latest developments in electronics, will be sent to you on your request.*



**AMERICAN PHENOLIC CORPORATION**  
1830 SO. 54TH AVENUE • CHICAGO 50, ILLINOIS

119



# There's A CINAUDAGRAPH SPEAKER

for Every Purpose

CHOOSE FROM  
**83**  
DIFFERENT MODELS

From dainty dictaphone to television cinaxial... Cinaudagraph Speakers do the job better, longer, and more economically.

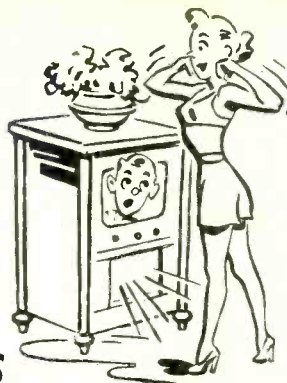

### MICROPHONE TYPES

P2A1	2"	.68-oz. Alnico V	3.2 ohm VC	\$3.65 List
P2C1	2"	1.47-oz. Alnico V	3.2 ohm VC	4.25 List
(45 ohm VC available on special order)				

### TELEVISION SPEAKERS

F46B60	4"x6"	60 ohm field	3.2 ohm VC	\$ 5.00 List
F46B100	4"x6"	100 ohm field	3.2 ohm VC	5.00 List
F5B60	5"	60 ohm field	3.2 ohm VC	4.55 List
P8JHF1	8"	6.8 oz. Alnico V	8 ohm VC	13.50 List
P12JHF1	12"	6.8 oz. Alnico V	8 ohm VC	17.00 List
CIN-12A	12"	Cinaxial with 3" H.F. speaker, 8 ohm input		27.50 List
CIN-15B	15"	Cinaxial with 5" H.F. speaker, 8 ohm input		47.50 List
CIN-15C	15"	Cinaxial with 5" H.F. speaker, 8 ohm input		62.50 List

### FREE

Illustrated Cinaudagraph Catalog. WRITE TO: Dept. 150P, CINAUDAGRAPH SPEAKERS, 1401 Fairfax Trafficway, Kansas City, Kansas.

World's Finest,  
Most Complete Line



DIVISION OF AIREON MFG. CORP.

SALES OFFICE and FACTORY 1401 FAIRFAX TRAFFICWAY KANSAS CITY, KANSAS

CANADIAN OFFICE: Charles W. Pointon, Queen at Bay St., Toronto, Ont.  
EXPORT OFFICE: 13 E. 40th St., New York, N. Y. Cable ARLAB

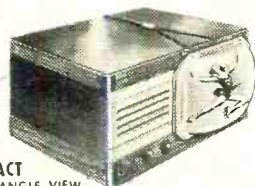

CONTACT  
GIVES WIDE ANGLE VIEW



DE LUXE  
WITH ADJUSTABLE BRACKET

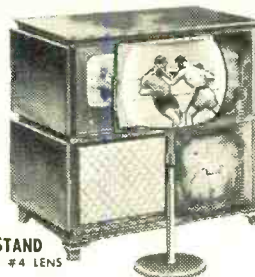

FLOOR STAND  
FOR #3 AND #4 LENS

Distributor territories still available

## An ENLARGING LENS for television by OPTI-GEM inc.

manufacturer of precision optical elements... this lens is developed by an optical manufacturer who made lenses and prisms to exacting government specifications

Opti-Gem lenses are low-priced and top quality. They come in a full range of sizes from \$9.95 for the 3" Pilot, to \$37.95 for the 16" picture tube. All sizes are available in clear, blue and smoke.

- OPTI-GEM lenses retail for
- \* 1 for the 7" screen.....from \$11.95
  - \* 2 for the 10" screen.....from 16.95
  - \* 3 for the 10" or 12" screen....from 24.95
  - \* 4 for the 10" 12" or 16" screen..from 39.95

- OPTI-GEM filters control glare
- \* 7" .....\$1.00 list 12" ..... 2.98 list
  - 10" ..... 1.98 list 15" ..... 3.50 list

Sold through leading stores  
Write or phone for nearest dealer

# OPTI-GEM inc.

LENSES AND FILTERS FOR ALL SIZE TELEVISION SCREENS

320 EAST 39th STREET, NEW YORK 16, N. Y. MURRAY HILL 3-1126

### Briefcase Portable

(Continued from page 55)

Figs. 1 and 2 show the panel and chassis layouts respectively. The 140  $\mu\mu\text{fd}$ . oscillator tuning condenser,  $C_{13}$ , is mounted on the front panel just to the right of the aluminum shield. Directly behind  $C_{13}$  is the 1.5 volt flashlight cell supported in a spring clip which affords easy replacement of the "A" source without removing the case. The antenna loading condenser,  $C_{12}$ , hidden in the top view by  $C_{13}$  (Fig. 2), can be seen mounted on the front panel in Fig. 1. Referring again to Fig. 2, the auxiliary antenna feedthrough insulator is just to the right of  $C_{13}$ . Directly behind the feedthrough is the oscillator tube followed by the oscillator final tank coil. The two XX30 45 volt "B" batteries, which neatly fill the remaining chassis space, are bolted in place by an aluminum strap.

Referring to the bottom view, Fig. 3, along the front panel from left to right are the microphone jack,  $J_1$ ,  $S_1$  which switches the microphone into the grid circuit of the 1T4, and the d.p.d.t. switch  $S_{2a}$ ,  $S_{2b}$ .  $S_{2b}$  changes the "A" battery from the receiver to the transmitter while  $S_{2a}$  is the antenna changeover switch. Next in line is the headphone jack  $J_2$ , the "B" negative switch  $S_5$ , and the crystal socket.

$RFC_1$  is located just back of the microphone jack and  $S_1$ . To the right of the 1T4 socket,  $CH_1$ , the impedance choke, is mounted by the same screws which hold the output transformer,  $T_1$ , on top of the chassis. To the right is  $RFC_2$  and  $C_{10}$ , the screen grid bypass condenser. Next is the final tank coil socket and directly in front is the 1S4 oscillator tube socket. Below the crystal socket is the feedback condenser,  $C_9$ , a fixed neutralizing condenser, which was salvaged from an SCR-274 N command transmitter. The plates are squeezed together to increase the capacity to the required value. To the left of the "C" penlite cells is the blocking condenser,  $C_{11}$ . From the left to right, along the back drop of the chassis, can be seen the 8  $\mu\text{fd}$ . electrolytic,  $C_8$ , which is the feedback bypassing condenser, mounted on the terminal strip. The 1S4 audio tube socket is directly in front of  $C_8$ . Next is the closed-circuit meter jack,  $J_3$ , and the key jack,  $J_4$ .  $S_{3a}$ ,  $S_{3b}$ , the modulator-c.w. changeover switch is mounted near the right hand end of the chassis.

Housing the unit was solved by salvaging the cabinet shield and base plate from the BC 456 modulator unit. This housing measures 3 x 4 1/4 x 9 3/4 inches over-all. The chassis was cut from the modulator base plate.

The unit is assembled by attaching the chassis to the panel with washers and nuts on the front panel switches. The cabinet is fastened with the screws and square rivet-head nuts originally used in the salvaged unit.

Adjustment and operation is by means of the front panel controls

RADIO & TELEVISION NEWS



shown in Fig. 6 and the switch on the back of the case shown in Fig. 5.

To adjust the receiver the filaments are lighted by turning the gain control switch clockwise. The plate voltage is then switched on and the regeneration control is advanced until a hiss is heard in the headphones. If no hiss is heard, there is probably insufficient feedback from the tickler coil,  $L_2$ . Some 1T4 tubes oscillate with difficulty and  $L_2$  may require more turns. The oscillator tube should oscillate with approximately 30 volts on the screen grid. The receiver is set in the band by adjusting the bandset condenser,  $C_3$ , and securing a beat note in the home receiver. Receiver tuning is then performed with the bandspread condenser,  $C_1$ .

Adjusting the transmitter for c.w. operation is simple. Plug in the throw-out antenna and its loading coil, the meter, crystal, and key. Throw the "receive-send" changeover switch to the "send" position. With the key closed rotate the antenna tuning condenser to resonance as indicated by minimum dip on the meter. The antenna loading condenser is then turned clockwise with a screwdriver to the maximum increase in plate current. For best keying characteristics this increase, with the throw-out antenna, will be about 8 to 10 milliamperes. Check for resonance by readjusting the oscillator tuning condenser.

For phone operation, change the crystal to the desired phone frequency. Plug in the microphone and throw switch  $S_{2a}$  and  $S_{2b}$  to the "send" position. Remove the key to furnish plate voltage to the oscillator. Switch  $S_{3a}$  and  $S_{3b}$  is thrown to the "modulation" position and is left this way.

The regeneration control is fully advanced and the gain control then controls the modulation percentage. Further transmitter adjustments are the same as those described for c.w. operation.

The range of phone operation in open terrain, using the throw-out antenna, is about 5 miles, but c.w. stations hundreds of miles distant have been worked with a center-fed doublet home antenna. —30—

### SUPPORT MINIATURES

WHEN the new miniature tubes are removed from the radio while tests or repairs are being made, some means of protecting these small tubes is needed.

A block of wood may have a number of holes—about three-fourths inch in diameter—drilled as shown to accommodate these tubes. The block shown is about 14 inches in length, 3½ inches wide, and 2 inches thick. The holes are around one inch in depth. . . H.L.

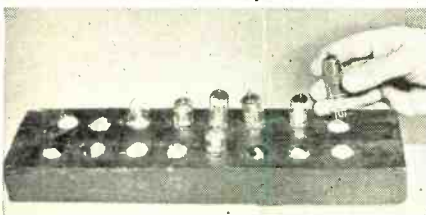

## — THE BEST IN ELECTRONIC SURPLUS —



### AMAZING "SNOOPERSCOPE" TUBE

An Infra-Red Image Converter Tube made in Britain that enabled combat men to see in the dark and through camouflage. Type CR1-143. No scanning or amplifiers necessary! Uses only infra-red light source and simple high-voltage supply which can be easily built from toy ignition transformer and rectifier tube. An optical system for long-range work or where magnification of image is desired, can be made from toy telescope. Shows image in greenish-white

color on 1¼" screen. Has wonderful possibilities for darkroom work, fog penetration devices, night photography, etc. With technical data and diagrams. All NEW, individually boxed tubes.

PRICE, EACH ..... \$8.00  
TWO, FOR ..... \$15.00

### BAUSCH & LOMB SNOOPERSCOPE LENS UNIT



This lens unit will absolutely give clearer, sharper images when placed in front of the Infra-Red Tube described above. Increases range and permits use of less infra-red light. If you have had trouble in getting desired results from the tube, this lens unit is guaranteed to be the answer. Speed F 2.1, f.l. 3.5 inches. Originally designed for IP25 tube, but works even better with above British tube. With construction details for making infra-red image receiver.

PRICE, EACH ..... \$12.00



### FREQUENCY METER TS-69/AP

Frequency range 350 mc to 3,000 mc. Ideal for labs, schools, or for hams experimenting with eqpt. for civilian phone band. Black-crackle finished metal case, dim.: 6"x6"x22" contains variable length coax resonating cavity with crystal rectifiers and 0-200 microammeter. Veeder-Root counter and calibration charts insure extreme precision. Telescopic antenna, and coax line probe, with metal carrying case for entire equipment. With instruction sheet. NEW equipment.

COMPLETE, EACH \$42.50



### 32 VDC to 110 AC CONVERTER

Mfd. by Kato Engineering, for marine or farm installation. Rotary type, compact and ruggedly built for continuous duty. Rubber shock mounting on filter case, with complete input and output filtering. Output—110 volts, 60 cycles AC, 225 KVA, but, will operate efficiently on loads up to 300 watts. NEW units only.

PRICE, EACH ..... \$39.95  
Quantities, 10 or more, Each ..... \$32.00

### EXTRA SPECIALS!!

1100 Lbs. No. 18 DCC Magnet Wire, per lb. (lot price) ..... 37½¢  
1,600 mfd. 15W.V.D.C., approx. 10,000, lot price, Each ..... 20¢  
Adlake Time Delay Relays, type 902-72-1, 220V, 50/60 cycles, normally open, EACH ..... \$4.95  
Same as above, but type 1040-65-1, 110 Volts, Each ..... \$3.45  
General Electric Model 5AM78AB47 (Amplidyne) Motor Generator set. Motor 3HP, 440V, 3 phase. Output 250V, 2120 at 3 amps, and 60V, DC at 12.5 amps. Excellent amplification, EACH ..... \$80.00

### RADIO TRANSMITTERS, MODULATORS, AND POWER SUPPLIES

Immediate Delivery from Stock

2.5 KW Press Wireless, Model 2.5 consisting of 2 sections, one—the 2.5 KW P.A. with power supply, second section containing exciter-driver stages with crystal-controlled oscillator (with oven for constant temperature control). Emission A1. Freq. range 2 to 23 mc. Operates from 220 V.A.C. Excellent condition. WRITE FOR PRICE.

2 KW Power Amplifier, Press Wireless, as described above power amplifier section and power supply only. When used with above complete installation provides additional, instant change-over frequency of operation. Also, ideal as a spare PA and power supply for above. WRITE FOR PRICE.

NORTHERN RADIO—Ship to shore transmitter-receivers, 5 channels, crystal controlled, 65W, output, 100 V, at V. DC 1.5 to 5.8 Mcs. With tubes, Each ..... \$250.00

HALSTEAD MODEL 101FA Transmitters—A3, 25W, output 200-400 KC, 110 V, 60 C, operation, Condition N 2, EACH ..... \$100.00

BC—319-A Transmitter, CW only 300 watts output, Freq. range 4.0 to 13.4 mc. Operates from 110-220 volts, 60 cycles AC. Excellent condition. Less tubes, PRICE EACH \$300.00

LINK FM Transmitter Receiver, 70-100 mc. Model 1498 DC, 50 watts output, wall style cabinet containing transmitter, receiver and 14 V.D.C. power supply, handset. Dim.: 34" x 21" x 11". NEW CONDITION. Complete with tubes, crystals, special telescopic antenna, instruction book, PRICE EACH ..... \$600.00

RADIO TRANSMITTER BC-339, CW only, 1 KW output, Freq. range 4.0 to 26.5 mc. Six crystal positions also M.O. four intermediate stages and two 833s final. Operates on 220 volts 50/60 cycles. Reconditioned. Complete with power supply and one set operating tubes, PRICE ..... \$2100.00

MODEL SVC100L/110 TRANSMITTER, Output A1, 150-watts, A2-A3-50 W. Mfd. by Phillips, Freq. 2 to 20 mc., with 6 pretuned channels. Operates from 90-260 volts 50/60 cy. A.C. COMPLETE, with tubes, ..... \$450.00

BC-1100 (RC-263), 75W, A1, 50W, A2, 4 channel dial selection of channel, 1.5-10 mc. 110-260V 25-60c. AC, with remote control, New, EACH ..... \$575.00

Supreme ship-to-shore transmitter receiver, 110W output, 9 channel, 2-3 mc., crystal controlled, for 110V, 60c. A.C. Condition N-2. Complete with tubes and microphone, EACH ..... \$600.00

NOTICE: Prices quoted above do not include crating or packing. Price for packing will be quoted upon specification as to whether export or domestic packing is desired.

DC TO AC MOTOR GENERATORS, All types, 115 and 230 V. DC and 0.5 KVA to 7.5 KVA output; prominent makes. ALL NEW. WRITE FOR LOW PRICES.

All Material Subject to Prior Sale.

Minimum Order \$5.00, 25% Deposit—Balance C.O.D., F.O.B. New York City.

## TELEMARINE COMMUNICATIONS COMPANY

PHONE—LONGacre 4-4490

280 NINTH AVE., N. Y. 1, N. Y.

# FOUND!

the "MISSING LINK" to  
**GOOD TV ANTENNA  
INSTALLATIONS**

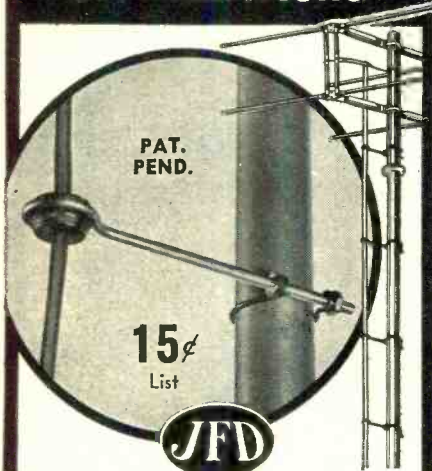

## MAST CLAMP LEAD-IN SUPPORTS

Made with **POLYETHYLENE**  
(the ultra-low loss insulation material)

Now you can make any old or new TV installation last longer, look neater, perform better with the unique JFD Mast-Clamp Lead-In Supports. These new Screw Eye Insulators are JFD-engineered to anchor lead-ins firmly in place and assure better TV/FM reception.



Mast Clamps are made in all sizes for all applications, individually designed to fit masts from 1/2" to 2" O.D. Screw Eyes range from 3/2" to 12" in length.

Visit JFD Booth 117  
at Chicago Radio Trade Show

**JFD MANUFACTURING CO. (INC.)**

6111 16th Ave. Brooklyn 4, N. Y.

WRITE TODAY  
for Valuable 4-page Bulletin #DBR

© Copyright 1949 by JFD Mfg. Co. Inc.

FIRST In Television Antennas and Accessories

All rights reserved. No part of above work may be reproduced in any form except by written permission of the manufacturer.

# How to Prepare Your Article for Publication

*Important rules to follow when submitting  
that manuscript—the editors will like it.*

By

**C. C. ERHARDT, W2HNJ**

**H**OW many of you have felt impelled to submit a write-up on your favorite brain child only to let it slide with the thought—"Aw heck, they wouldn't publish any of the messy stuff I write." Well, brother, maybe they wouldn't; but on the other hand, maybe they would if you went about it properly.

As in any other field of endeavor, there are certain rules which must be observed in order to obtain satisfactory results. It is the purpose of this article to outline those rules and to make some suggestions for the aid of the embryo writer.

The important point to consider before doing any writing is this: Is your idea of genuine interest to the radio public? Does it contain fresh, unique features? If, for example, you were considering sending in a constructional article on "How To Build A Super-Duper Receiver," it would be a good idea to look through your back issues and make sure that the reader hasn't already been deluged with super-duper receivers. However, if you feel that you have something that is really good then it's up to you to make it into first class material for publication.

For the purpose of discussion, an article may be considered as consisting of three parts: 1. Manuscript. 2. Photographs. 3. Diagrams and sketches. Let's take them in that order.

A manuscript, of course, is the text or written portion of an article. Let me emphasize one thing right now. Don't ever submit a manuscript written in longhand! Whether it means hiring a public stenographer or swiping Cousin Effie's portable, make sure that your completed manuscript is typewritten.

Don't try to write in too flowery a style. Short, simple sentences are usually best. Avoid use of overworked phrases such as "due to the fact." It's much easier to say "because." Another dilly that crops up in radio articles and makes editors pull out their hair is—"the circuit is conventional in most respects." If your circuit is conventional don't say anything. Try to avoid having too many of your paragraphs begin with the word "the." This is a habit most beginning writers fall into as it is the easiest way to open a paragraph.

Remember, you are not competing for the Pulitzer Prize. Don't worry too much about spelling or grammatical structure. If they are too atrocious the editorial staff will fix 'em up. What they are mostly interested in is the message you are trying to convey.

When typing your final version of the text be sure to use double spacing and use only one side of the paper. Paragraphs should be separated by at least three spaces. Leave wide margins all around—about two inches on top and at least an inch and a half on the other three sides. This will allow the editor sufficient room to make notations and changes directly on your copy. Number each page and put your name and address in the upper right-hand corner. When you are finished, make up a title page. This consists of a first page bearing nothing but the title of the article, your name, a one or two-sentence inking of what the story is about, and the total number of words in the text. Don't get lazy and forget that *total*, and space the wording on the page so it is reasonably attractive. The more work you can save the editor, the more favorable his response to your article is apt to be.

Although some types of writing, such as this one, can get along very nicely without photographs, in constructional and descriptive types of articles they are very important. Photographs can make or break an article. Many an excellent piece of work has been relegated to the waste paper basket because of the poor quality of the photographs. Some types of photos, such as an outdoor shot of an antenna, can be achieved quite satisfactorily by an amateur photographer. However, for fine detail jobs, such as the underside view of a chassis, it is best to have the work done by an industrial photographer specializing in this sort of thing. They will retouch the pictures for you, masking out blemishes and highlighting fine detail with the result that you get a really excellent photograph. Do not write on the backs of photographs; use gummed labels for your captions. Your name and address should also be included.

If your article is of the type that describes apparatus or equipment of a commercial nature, don't overlook the

**RADIO & TELEVISION NEWS**

### FREQUENCY METERS

LM frequency meter, excellent condition, less manual	\$29.50
LM 2 frequency meter, excellent condition, with manual	49.50
LM 7 frequency meter, excellent condition, with manual	79.50
LM 13 frequency meter, excellent condition, with manual	79.50

MINE DETECTOR—SCR-625-A Used for locating metal, underground pipes, kold, etc. NEW with manuals \$74.50  
USED—excellent condition 45.00

BC-348 RECEIVER, 21 volt input, Brand new	\$115.00
FT-167 FEDERAL TRANSMITTER, 29" x 19" x 7 1/2". Brand new with 12" desk. Uses 4—6L6's and 2—813 tubes.	197.50
BC-375E TRANSMITTER. New—complete with tubes, 7 tuning units, antenna tuning unit, dynamotor and plugs.	57.50

TORPEDO CAMERA ASSESSOR, Mark II—manufactured by Abrams Instrument Company for U.S. Navy. Contains velocity triangle assembly, 10 x magnifier, computer, target travel templates, and viewing box. All parts are in 4 1/2" x 14 1/2" x 16" finished wooden instrument case. New \$7.95  
10 x—double lense magnifier. Precision type 2.95  
Viewing box—4" x 9 1/2" x 1 1/8" with lights and flashed opal glass cover—110 A.C. 2.95  
Wooden Instrument Case with velocity triangle and templates. 3.95

FL-8 Range Filter, New \$1.50  
Antenna Relay Unit—RE-2/ARC-5 Weston Antenna Current Indicator Meter, Relay, Vacuum Condenser, Excellent condition. 2.95  
Handy-Talkie Crystal and coil sets—3885 K.C. to 5500 K.C.—Specify frequency—2 Crystals and 2 Coils per set. NEW \$2.25

I-82—Selsyn compass indicator, 5" 660 degree dial	\$2.95
Plugs will fit I-82, I-81	.70
I-81—Selsyn compass indicator. NEW	3.25

WESTON Electrical Tachometer meter Model 545 for use with Model 724 Magneto. Speed 0-2000 R.P.M., Ratio 2:1. NEW \$19.50  
WESTON Tachometer Generator, Model 724, Type C. Good Used. 18.50  
1st, 2nd or 3rd I.F. Transformer from SCR 522, 12,000 kc.—Iron Core Tuning, can be tuned to television I.F. freq. by removing padding cond. 35c ea. 3 for 1.00

APN-1 ALTIMETER INDICATOR—Basic movement 0-1 ma., 5 ma. shunt, 270° scale. An excellent basic movement for constructing your own meters. NEW \$1.95  
METER RECTIFIER, full wave midjet Selenium, 10 volts, 30 ma. NEW .29

### MAY SPECIALS

6" P.M. COMPARTMENT SPEAKER, 25 watts, 50 6,000 ohms. Waterproof. Used Excellent \$8.95

#### SCR 522 EQUIPMENT

NEW TRANSMITTER-RECEIVER Complete with tubes, PE-94C Dynamotor, AN-104 Antenna, BC-602B Control Box, set of plugs.	\$59.50
PLUGS—Set for SCR 522	4.00
BC-631B—Jack Box	.79
RC-629B—Jack Box	.79
PE-94C—Dynamotor for SCR 522. NEW \$4.95. USED	2.95
AN-104 Antenna STEEL. NEW \$1.95. COPPER	2.95
BC-602—Control Box. NEW	1.00

HS-23 Headset—Brand New with ear pads	\$2.95
HS-30 Headset—Complete with matching transformer, 6 ft. cord, and PL 55 Plug.	1.95
BRAND NEW	.95
HS-30 Headset. NEW	.49
Extension cord, CD-307A—New with PL 55 and JK 26	.35
Headset Adapter MC-385D—High to low impedance	1.95
Dynamic Headset and Mike—P.O. Mark II.	.75
T-17 HAND MIKE. NEW \$1.50. USED	1.95
T-32 DESK MIKE. NEW \$3.50. USED	1.95

#### IDEAL MOBILE POWER SUPPLY

PE 237—Heavy duty vibrator power supply, 6, 12, or 24 v. input. 525 v., 95 ma.; 105 v., 42 ma.; 6.5 v., 2 amp.; 6 v., 500 ma.; 1.3 v., 450 ma.; small supply 100 v., 17 ma.; 1.35-450 ma. with tubes, shock mounted. BRAND NEW \$29.50

BC-1306 SMALL COMPACT TRANSMITTER—3800-6500 kc., 2E22, less cover. Can be used with PE 237, GN 58. NEW \$9.95

EE-8 TELEPHONE FIELD SETS with handset & ringer. Good used \$9.00 ea. \$16.00 pr.

400 CYCLE INVERTERS—ALL BRAND NEW  
General Electric, 5D21NH3A Input 27 v., 35 amps. Output 115 v. 485VA, single phase \$12.50  
General Electric, PE-218D Input 27 v., 100 amps. Output 115 v. 1500VA, single phase 20.00

#### PHOTOCON SALES

1060-2 North Allen Avenue Pasadena 7, Calif.  
TERMS: f.o.b. Pasadena, unless postpaid.  
25% on all C.O.D. orders.  
Californians add 2 1/2% sales tax.

### TUBE SPECIALS

1A5 \$0.55	WL.	316A \$0.79
5U4G .55	530 \$19.50	707B 9.50
6A6 .89	VR150 .90	726A 7.50
6B8G 1.05	E1148 .90	801 .85
6K7G .60	VT.	803 3.95
6K8G .90	127A 2.95	807 1.25
6L6G .90	2X2 .75	837 1.50
6SL7GT .89	5BP1. 1.95	872A 1.00
6SN7 .55	5BP4. 2.50	1616 1.00
6X5CT. .55	5CP1. 2.50	1625 .35
12A6 .25	75TL. 2.50	1630. 2.95
1E7E 1.25	211. .50	849 39.50
3B24 .69	249C. 1.75	304TL .89
212E Amperex	891 Amperex	6 amp. Tungar 2.95
NEW 29.00	NEW 100.00	

GIBSON GIRL, SCR 578B Transmitter for sending distress signals from boats. Transmitter complete with balloon, hydrogen generator, kite and installation manuals. NEW. Export packed \$19.50  
NEW. Domestic packed 17.50  
Transmitter only, tubes 5.95

BC 348—MOUNTING BASE, Postpaid	\$2.50
BC 348—OUTLET PLUG, Postpaid	.80
BC 348—MOUNTING BASE and OUTLET PLUG, Postpaid	3.00

BC 357 J—BEACON RECEIVER, 75 mc., tubes. NEW	\$ 3.45
MN 26C—RADIO COMPASS RECEIVER, tubes 150-1500 kc.	17.50
BC 464—TARGET RECEIVER, 5 channel remote control, battery case and ant. 68-73MC. NEW	14.95
INTERPHONE AMPLIFIER—BC 709: Ideal for Aircraft, booster for telephones, etc. NEW	4.50

PE-206A—New 800 cycle Inverter \$5.95

CRANK for 274N Receivers	\$6.00
CD-501A CABLE for PE 103A-BC654A.	\$1.95
FRAME MOUNTING BC654A-103A	4.95
RM-29 REMOTE CONTROL UNIT, RINGER NEW	8.75

BC 375 TRANSMITTER ONLY, used, less tubes \$9.50  
INTERPHONE AMPLIFIER—CMN60128A, 12 v., 6 watts output P.O. TCS equipment with tubes and dynamotor. NEW 8.50

TRANSFORMER: 5 v. at 190 amperes; 115 v., 60 cycle input. USED \$12.95  
200-0-200 at 50 ma.; 6.3 v., 3 amps, output, 115 volt, 60 cycle input. NEW 2.50  
100 watt Class B modulation transformer P.O. BC 375. NEW 2.95  
PEERLESS HQ-200 line matching transformer, 50/125/200/500 ohms. NEW 1.80

# THE FINEST PRODUCTS OF

# Audio Engineering

## AMPLIFIERS

### ADC AMPLIFIER—TYPE 71

- 8 Watt (69.3V rms across 600 Ohms).
- ± 1/2 db 40-15,000 cps.
- Measured response (1 KC = 0).
- 8 Watts 1/2 db 40 cps. Flat @ 20 KC. 20db Down 1/4 db 18 cps. Flat @ 20 KC. 40db Down 1/2 db 20 cps. Flat @ 20 KC.
- Input for full power output—Zero VU.
- Max. Noise Level—77db below full output.
- Gain Control Range—35 db.
- Distortion measurement at 8 Watts: Av. tubes, 1%; picked tubes, .76%.
- Apparent source impedance (looking back into amplifier) 500 Ohms for 600 Ohm load.

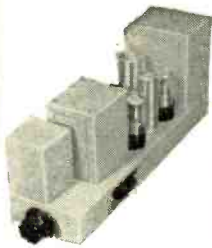

## JACKS



## PLUGS



## PATCH CORDS



## AUDIO TRANSFORMERS

### QUALITY PLUS SERIES

- ± 1/2 db 30-15,000 cps, all types.
- Low transmission loss.
- Excellent longitudinal balance.
- Top or bottom mounting.
- Silver plated terminals.
- High permeability mu-metal shielding.
- Highest grade insulation materials.



### INDUSTRIAL SERIES

- Dependable at lower cost.
- ± 1/2 db from 50 to 10,000 cps.
- Minimum insertion loss.
- Same construction, insulation and impregnation as Quality Plus series.

FOR DEPENDABLE Amplifiers, Transformers or components of all descriptions used in radio or television look to ADC.

Our catalog carries complete details on all available products. If you don't have your ADC catalog, Write TODAY!

SPECIFICATIONS engineered and quotations made for research laboratory and product design to fit your needs.



## Audio DEVELOPMENT CO

2845 13th AVE. SOUTH • MINNEAPOLIS 7, MINN.

*Audio Develops the Finest*

**PROGRESSIVE**  
**NOW! BUILD 15 RADIOS \$14.75**  
 COMPLETE KIT ONLY...  
**ABSOLUTELY NO KNOWLEDGE OF RADIO NECESSARY**

**You Need No Additional Parts**

The **PROGRESSIVE RADIO KIT** is the Only Complete Kit—Operates on 110-120 Volts AC/DC

Contains everything you need. Instruction book, metal chassis, tubes, condensers, resistors and all other necessary radio parts. The 36-page Instruction Book written by expert radio instructors and engineers teaches you to build radios in a professional manner. The circuits are designed to provide excellent performance. Altogether, fifteen circuits are constructed, including 11 receivers, 1 audio amplifier and 3 transmitters.

**SPECIAL OFFER**

Electrical and Radio Tester sent absolutely FREE with each Progressive Radio Kit. Plus FREE Membership in the Progressive Radio Club. Entitles you to free expert advice and consultation service with licensed radio technicians. ORDER YOUR KIT NOW!

**BUILD KITS !!  
 SAVE !! LEARN !!**

- VACUUM TUBE VOLTMETER KIT.....\$23.95  
a professional piece of test equipment you need for FM and TV. FREE: Book on Advanced Servicing Techniques.
- 5" OSCILLOSCOPE KIT.....\$39.95  
an absolute "must" for today's radioman. FREE: Book on Cathode Ray Oscilloscope.
- VOLT-OHM-MILLIAMMETER KIT.....\$14.95  
simple to construct, inexpensive but accurate \$14.95. FREE: Book on Elementary Radio Servicing.
- SIGNAL TRACER KIT.....\$21.95  
an invaluable aid in trouble-shooting. FREE: Book on Radio Test Instruments.
- HIGH FIDELITY HUMLESS AMPLIFIER KIT.....\$16.00  
attractive aluminum chassis, complete with five tubes and two selenium rectifiers. FREE: Book on Amplifiers.
- ECONOMY AMPLIFIER KIT.....\$5.95  
simple to build, complete with five tubes. FREE: Book on Amplifiers.
- 7" TELEVISION KIT.....\$59.50  
complete tube kit.....\$39.58  
FREE: Television Servicing Notes.
- 10" TELEVISION KIT.....\$99.50  
complete tube kit.....\$57.30  
FREE: Television Servicing Notes.
- 10" TELEVISION SUB-ASSEMBLY KIT.....\$229.50  
sub assemblies factory-wired, complete with tubes; FREE: Television Servicing Notes.
- 12" TELEVISION SUB-ASSEMBLY KIT.....\$259.50  
sub assemblies factory-wired, complete with tubes; FREE: Television Servicing Notes.
- 15" TELEVISION SUB-ASSEMBLY KIT.....\$349.50  
sub assemblies factory-wired, complete with tubes; FREE: Television Servicing Notes.
- 5 TUBE AC-DC SUPERHET KIT.....\$14.25  
complete with tubes and cabinet. FREE: Book on Building Receivers.
- 6 TUBE AC-DC 2-BAND SUPERHET KIT.....\$17.45  
complete with tubes and cabinet. FREE: Book on Amateur Radio Building.
- 7-TUBE AC-DC FM RECEIVER KIT.....\$29.95  
complete with tubes and cabinet. FREE: Television and FM Servicing Notes.
- 4 TUBE SUPERHET PORTABLE KIT.....\$12.95  
complete with tubes and cabinet; less batteries. FREE: Book on Unusual Radio Circuits.
- LP RECORD PLAYER KIT.....\$20.95  
complete with motor, pick-up, permanent needle, amplifier, tubes, speaker, cabinet. FREE: Book on Radio Questions and Answers.

**AUTOMATIC**

- Car Radio Model M-90 (Universal Mounting).....\$ 27.97
- Car Radio Model M-92-C (Built-in Battery charger).....34.97
- Bike Radio (anti-theft feature).....17.47
- Tom Thumb "Ruddy" Portable (3-way plus battery charger).....27.97
- 7" Table Model Television Receiver.....149.65

**RMS**

- All-Channel Video Booster (excellent for fringe areas).....\$22.75
- All-Channel Television and FM Antenna (2 folded dipoles, 2 reflectors).....15.00

**EICO**

- V.T.V.M.....\$49.95
- 5" Oscilloscope.....69.95
- Multimeter.....17.95

**RADIO CRAFTSMAN**

- FM/AM Tuner.....\$110.00
- Model RC 8.....\$110.00
- Amplifier Model RC 2.....39.00

**ESPEY**

- FM/AM Chassis Model 7B1 (11 tube receiver).....\$84.00
- FM/AM Chassis Model 511 (14 tube receiver).....98.00

**VM**

- Long Playing Dual Speed Record Changer Model 400.....\$33.90

**FEILER**

- Pocket Stethoscope Model TS 5.....\$28.95
- Cathode Ray Stethoscope Model TS7 (less phones and probe).....89.95
- Stethoscope Probe (complete with 6C4 tube).....8.25

**H. H. SCOTT**

- Dynamic Noise Suppressor Type 110 A.....\$49.50

**FERRITT**

- FM-TV Sweep Generator (20 MC sweep width).....\$164.95

**All Merchandise Shipped F.O.B. New York**

Deduct 2% if full payment accompanies order. 25% deposit required on COD orders.

Write for further information concerning the above merchandise. Send for our Free catalog.

**PROGRESSIVE ELECTRONICS CO.**

Dept. RN-21, 497 Union Avenue  
 BROOKLYN 11, NEW YORK

possibility of securing your photographs from the manufacturer. Most manufacturers are glad to cooperate in this respect because of the free publicity they receive.

Liberal use should be made of diagrams and sketches if your writing requires them. Although the point you are trying to bring out might be quite clear to you, remember that the reader is not a mind reader. Anything that requires further clarification should be illustrated by photograph, sketch, or both. It is a good idea to have someone read over your manuscript to see whether everything is understandable to them. Diagrams, of course, should have all components clearly numbered, followed by a list of the parts, the "Parts List." Diagrams and sketches may be made in pencil as they will have to be redrawn by the staff artist. A transparent drawing ruler will come in very handy for this purpose. Get the kind shaped like a triangle with circular cutouts. They are swell for tube symbols, etc.

After you have gone over the completed article several times and are satisfied that it is as nearly perfect as you can make it, you are now ready to submit it for publication. Now, I bet you were going to fold up those nice typewritten sheets and put them in an ordinary envelope for mailing. Don't do it! In editorial work, everything must be kept flat. Put your sheets in a large brown envelope with stiff cardboard on both sides to prevent bending. If photographs are included, use an envelope of sufficient size to include the whole works. A couple of pieces of "Scotch" tape around the outer edges of the cardboard will hold everything intact. Gummed address stickers are very convenient to use on these envelopes. They may be obtained for a few cents at any stationery store. If you want to have your material back in the event of a reject, include a self-addressed envelope with sufficient postage.

Be sure to send everything by first class mail. Good luck to you!

*Editors note: Not all publications pay for manuscripts accepted, especially those affiliated with societies or fraternal organizations. The publishers of RADIO AND TELEVISION NEWS, however, pay upon acceptance for all material of a non-publicity character at better than average rates.*

-50-

**PAGE FINDER**

By MELVIN W. DOAN

**WHEN** working on a radio bench with a paper-bound book, it is always a problem to me to keep the book opened to the proper page, or read the book after the transformers, etc. which were put on the book to keep it open were in place.

I made a small flat stick, about 12x 1/2x1/4 inches, slotted at each end. I then



inserted a stout rubber band across the stick. By slipping the book under the band the pages can be read easily. Pages can be turned by raising the rubber band slightly.

-50-

**FOR THAT "FRINGE" AREA**

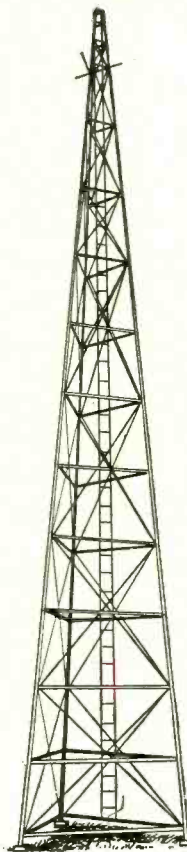

**A Better Picture and a Good Profit, Too!** with

**CHAMPION**

Television Towers

**Guyed Towers**  
45', 65', 85'

**Self-Supporting Towers**  
40', 53', 67', 80'

Make Your Television Sales Stick

**Use Champion Steel Towers**  
Strong—and Easy to Erect

Sold Through Dealers and Jobbers  
Write for Literature

In answering please state whether you are a jobber, dealer, ham, serviceman or in communications.

Look us up at the Stevens Hotel during Parts Jobber Show.

**Norman M. Sewell, Inc.**  
Susquehanna Ave.  
at Derstine  
LANSDALE, PA.



**YOU'LL SAVE MANY DOLLARS WITH THIS BIG 180 PAGE FREE CATALOG**

**TELEVISION, ELECTRONIC PARTS, HIGH FIDELITY RADIO, HAM GEAR, PUBLIC ADDRESS EQUIPMENT, PARTS AND WORKSHOP TOOLS**

A penny postcard will bring you the 1949 Lafayette-Concord catalog. It's a bargain guide that means big savings to you. There are pages and pages of the finest equipment at amazing low prices. Use it to order everything you need, and pocket the difference. Helps you save both time and money. You'll like shopping from this mammoth book of bargains.

Write for your copy today. It's free!

**LAFAYETTE-CONCORD**

World's largest radio supply organization

- LAFAYETTE-CONCORD, Dept. RE-9
- 100 Sixth Avenue, New York 13
- 901 West Jackson Blvd., Chicago 7
- 265 Peachtree Street, Atlanta 3
- Please rush free catalog No. 89

**FREE!**

Name.....  
 Address.....  
 City..... Zone..... State.....

**RUSH THIS COUPON FOR FREE CATALOG**

## Auto Radio Static

(Continued from page 39)

Usually tire noise will be eliminated by a slight application of the brakes while driving, allowing the static electricity to pass off the wheels to the frame of the car. Wheel noise will change with the weather and road surface, being most persistent in dry weather and on hard-surfaced roads. Most wheel noise is caused from static electricity built up on the front tires by friction with the road surface and continuously discharging. The remedy is simply to provide a good ground path for the static discharge. The front wheels are not attached to the axle, but run on bearings which are greased, thereby providing an extremely poor ground at times. A coil spring inserted between the axle end and the hub cap will provide a constant ground and eliminate any discharge.

Since the rear wheels are usually well-grounded to the rear axle and drive shaft, static troubles here are infrequent. Need for noise suppressors here may be checked by disengaging the clutch while on the highway. If the noise increases, spring static grounds should be installed on the rear wheels also. While testing for tire noise, have the radio tuned between stations and the volume full on for maximum sensitivity.

Wheel noise may be further identified by kicking the car out of gear while driving and shutting off the engine. If the noise is caused by wheel static it will be heard continuously in the speaker. Antennas which mount under the car tend to pick up tire noise more easily than those which mount on the side or top of the body.

Tire noise may be further reduced by grounding the tire to the rim of the wheel by driving a round-head wood screw into the bead to make contact between the bead wire and the wheel rim. A conductive powder, now on the market, will also be found helpful in keeping down tire noise. Dust it inside the tire and on the inner tube before assembly.

**Miscellaneous.** On some installations it will be necessary to install condensers across the oil pressure gauge, ignition switch (at the battery terminal), starter switch, starter motor and possibly other electrical parts.

Not all of these anti-static precautions will be necessary on each individual automobile; however, it is difficult to say just what steps will be necessary in any individual case. Cars of the same year and model will often react in the same way, and a quick inspection of the radio installation in a car similar to yours may be of help in running down the source of interference.

When properly installed, a modern car radio should give as clear and noise-free reception as the set in your living-room.

# Choice of 626 Tubular Resistor Values IN STOCK

## Hundreds of other Stock Types, sizes and values!



### Always Available for Quick Needs

More Ward Leonard Wire Wound Resistors have been produced and used over more years than any other make. Among these are the great number of *Vitrohm* stock units always quickly available to you... for a wide variety of needs. So remember... for *result-engineered* quality—for *time-proved* performance—for *prompt delivery*... choose Vitrohm resistors right from stock, at your W-L Distributor.

Radio and Electronic Distributor Division  
**WARD LEONARD ELECTRIC CO.**  
53-N West Jackson Blvd., Chicago 4, U.S.A.



Send now for handy Stock-Unit Catalog D-130

# WARD LEONARD

RESISTORS • RHEOSTATS • RELAYS • CONTROL DEVICES

WHERE BASIC DESIGNS ARE RESULT-ENGINEERED FOR YOU

### TUNING UNITS from BC-375

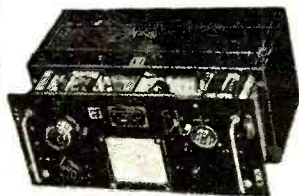

T.U.-5-6-7-8-9-10-26  
with Covers used in  
VERY GOOD CONDITION

\$1.49  
ea.

AT-49/ApR4 RADAR ANT.  
New radar dome type antenna  
with mounting base and con-  
nection in original carton.

\$2.39  
ea.



Control Box from SCR-522  
BC-602-A

69¢  
each  
New



We Have Hundreds of Surplus Radio Items  
"Send Us Your Inquiries"  
Do Not Include Postage. We Will Send Postage Collect

7201 E. Marginal Way  
SEATTLE 8, WASH.

"STERNOFF'S HAM SHACK"

Phone: LAnder 8100

# HARVEY HAS THE TOPS

## COLLINS 32V-1 TRANSMITTER



Desk Transmitter, 150 watts cw., 120 watts phone. Band switching, gang tuning. Built-in Collins VFO covers 10, 11, 15, 20, 40 and 80 meter bands. Completely self-contained with built-in power supply. Shipping weight 133 lbs. **\$475.00**

## NEW 1949 TECHMASTER TV KIT



Exactly the same as the RCA 630TS chassis, complete kit of parts, including pre-wired and aligned RCA front end, punched chassis, with all major components and sockets mounted, as shown, all RCA tubes including kine, complete manual with service notes, all RCA. New, simplified point-to-point instructions. (Free circuit and parts list on request.) **\$198.50**  
 Shpg. Wt. 85 lbs. ....  
 Kit as above but less 10BP4 tube..... **\$168.50**  
 Shipping Weight 55 lbs. ....  
 12-inch kine tube..... **69.75**  
 15-inch kine tube..... **89.50**

Available from stock.

## FM TRANSLATOR

### General Electric Model XFM-1



Post-war version of the old G.E. J.F.M.-90 Translator which was used and enjoyed by tens of thousands of discriminating radio listeners. Covers 88-108 mc range, dial 12 inches long, uses guillotine tuning for highest efficiency, high stability. Designed for export, has power inputs for 110 to 250 volts, 50/60 cy. In attractive natural walnut cabinet—10 3/4" high x 15 3/4" wide x 11 3/4" deep, complete with 8 tubes. Tropic-proof construction. Quantity limited.

**Special Price . . . . . \$49.50**

NOTE: All prices are Net, F.O.B. N.Y.C. and are subject to change without notice.

Telephone: **hrc** Luxemburg 2-1500

# HARVEY

## RADIO COMPANY INC.

103 West 43rd St., New York 18, N. Y.

# LETTERS

from our readers

### BETTER TELEVISION PROMOTION!

**I**N regard to your article on TV promotion in the January issue of RADIO & TELEVISION NEWS, there is one important point that was not brought out, namely, the *sound*.

"In Los Angeles, and I believe in other parts of the country, a radio shop, or furniture store will have a very nice, expensive, well-engineered television set in the window, correctly operating; but it is behind the glass window of the store itself, so that the speaker, or speakers of the set that have been matched to the unit cannot be heard by the crowd outside. In place of the correct speaker system, they will have probably a 4, 5, or 6-inch speaker in a metal case stuck on the wall outside the window, and this in most cases is so badly mismatched, all you can hear is 'very poor audio.'

"Good audio, along with a clear picture are two of the best selling points that television has. I believe that poor audio has been one of the biggest setbacks that television promotion has to overcome. This not a gripe, but just a hint for better TV promotion."

A. N. Swiggett  
 897 West Vernon Avenue  
 Los Angeles 37, California

*A good suggestion that will undoubtedly be seriously considered by many dealers.*

\* \* \*

### BRITISH "CLAM UP" ON SCHEMATICS

**I** FEEL that I must write and let you know how much I enjoy reading my one and only copy of RADIO NEWS, dated January 1947.

"I've searched our bookstalls for other copies, but apparently I'm always too late, or just unfortunate; they're just unprocurable.

"The bold manner in which you publish the manufacturers' technical circuits simply stuns me, because our radio manufacturers are like clams with their circuits, nor have we a radio magazine anything like your RADIO NEWS.

"During the war, I had the great pleasure of working with the U. S. Signal Corps in Northern Ireland, South England, France, and Burma—a fine bunch of fellows I'll probably never meet again; they were the absolute tops on their jobs.

"Should this meet the eye of any of those fellows who spent a few months in Lisburn, N. I., teaching us their speedy and snappy methods of communication, I shall certainly be glad to hear from them. They taught the 55th Signals something, believe you me. Such pleasant memories, although the days were hard, are too difficult to for-

get. Well, here's hoping I catch up to another RADIO NEWS. More power to your elbow!"

Ernest Chadwick  
 (Ex/Sgt. Sig. Corps)  
 26 Smollett St.  
 Bootle, Liverpool 20, England

*It is indeed gratifying to find appreciation of this sort, but it is regrettable that it must flourish in the midst of such scarcity.*

### NEWS FROM THE NORTH WOODS

**I** HAVE just received the February issue of your magazine and enjoy it very much. Each issue is looked forward to with so much enthusiasm that it has become an event of importance each month.

"It is in regard to the contest for amateur radio you are sponsoring that I am writing this letter. This contest is open only to licensed hams who already have the necessary equipment, and who, for the most part, are residing in thickly populated areas. The publishers, unfortunately, like all others who are promoting amateur radio, have given no thought to the large numbers of would-be amateurs who, like myself, live in the remote and unsettled wilds of our North American continent.

"Do you not agree that the furtherance of amateur radio would be serving at its best in these remote districts and thereby provide a complete unbroken link in the country, rather than continue to have them congregate in groups in the larger centers?"

"There are numerous draw-backs to the prospective amateur in places like mine (there are thousands of them). The main one is a lack of electrical power. Battery power is, for the most part, out of the question, due to the need for recharging, and the long distances to the nearest facilities for this. The expense of lighting plants and radio equipment is another. It is not easy to purchase any article when every penny must be seriously accounted for.

"I do not want you to take this letter as criticism, as it is intended merely to bring to your attention a class of people who are always barred by circumstances from most events of importance.

"I am very interested in radio and have been planning an amateur station in this district for some time now, but am held back by the same circumstances listed above.

"The town of Quesnel, where I live, is located in the northern part of British Columbia and is now gripped in the middle of a severe winter. I live

**RADIO & TELEVISION NEWS**

*short-wave  
in your car!*

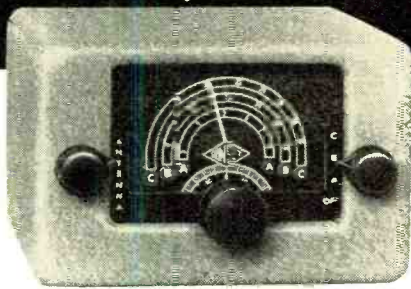

**GONSET "3-30" CONVERTER**

attaches to your automobile radio  
continuous coverage, 3 to 30 mc.  
four working (r. f.) tubes.

extremely compact.  
bandsread dial.

**\$39.95 net**

see your dealer



**GONSET CO.**  
BURBANK, CALIF.



FOR  
**TELEVISION TESTING  
AND SERVICING**



Advanced  
practical  
engineering  
gives you



**NET PRICE \$12750**

Combines the two essential instruments needed in television testing—alignment—service. A complete oscilloscope and a complete sweep generator that can be used independently. Tee Vee 90 combines two units for compactness and portability—meticulously engineered in advanced design and construction. Oscilloscope also has its own variable linear sweep. Sinusoidal sweep with phasing control for use with internal RF sweep generator when testing band pass characteristics. Synchronization provision for either internal positive, external or line frequency. External jack provided for trace blanking. Requires 10 volts of negative pulse to blank a normal intensity level trace. Independent sweep generator has a center frequency range of 1.5 to 45 megacycles giving a choice of any IF frequency desired. The band width can be varied continuously from 0.5 KC to 7 MC. Attenuation of RF is continuously variable from 0 to 500 millivolts and the output is applied through low loss coaxial cable. Traveling detector probe is included for observing signal at any point of the RF circuit under test. 105-130 volts 50-60 cycles. Weight 25 lbs. Size 14 x 18 x 12 1/2 inches. Finished in attractive hammer-tone grey. Supplied complete with tubes, probe, coaxial output cable and operating instructions ready to operate.

Buy it at Your Local Jobber—Write for Catalogue 2N

**RADIO CITY PRODUCTS CO., INC.**

152 WEST 25th ST  NEW YORK 1, N. Y.

**OUTSTANDING VALUES NOW AVAILABLE**

**RA 233 DUAL-SPEED  
RECORD PLAYER**



The finest in record reproduction. Complete in attractive carrying case. Featuring ASTATIC LP playing arm with micro-groove pick-up. Standard playing arm with L70 cartridge. Two-speed, silent running motor. 33 1/3 RPM and 78 RPM. 3-tube amplifier. 5" PM speaker.

**ONLY \$22.95**

**SUPER 25 WATT HI-FI  
AMPLIFIER KIT**

Including all parts, schematic and layout diagrams, enabling you to easily build this fine, deluxe amplifier.

**FEATURES:**

- Ready punched chassis
- Multi-impedance output transformer 2-4-8-16-500 ohms for use with any PM speaker
- 2 mike inputs, 1 phono input
- Push pull phase inverter driver for low hum and distortion
- Separate bass and treble control
- 110-120 volt AC operation, on fuse UL approved line cord
- 6 tubes: 2-6SJ7, 6SC7, 2-6L6G, 5Y3
- Attractive, well-constructed steel chassis and cover. Baked hammerloid finish
- Indirect lighted panel



Nowhere can an amplifier of comparable features be had for twice the price. This amplifier, designed from the famous Clark Amplifier, will fill 90% of all sound uses.

**\$22.95 COMPLETE WITH TUBES**

**CROWE HEADS for AUTOMOBILE RADIOS—1940 thru 1949**

<b>Under 1940—Universal Underdash</b>	
Mounting Dials. Dealers' Price.....	<b>\$4.41</b>
Tuning Units 706-T1 up thru 720-T1.	
Dealers' Price.....	<b>2.03</b>
Tuning Units with switch 706-T2 up thru 720-T2. Dealers' Price.....	<b>2.80</b>
Volume control units 700-V1. Dealers' Price.....	<b>.88</b>

Volume control units with switch. 700-V2.	
Dealers' Price.....	<b>\$2.12</b>
Cable kits to fit Delco-Arvin-Philco.	
Dealers' Price.....	<b>2.09</b>
Motorola Cables. Dealers' Price.....	<b>2.80</b>
When ordering, specify Make, and Model of car and make and model of radio.	

Complete dial kit consists of "Head, Tuning Unit, and Volume Control Unit."  
We carry a complete line of all auto radio equipment and accessories.

6" Square type Auto Speaker. 4 ohm field. Replacement for all auto radios.  
Each..... **\$1.95**  
Lots of 10..... **16.50**

**WRITE FOR OUR LATEST CATALOG**

**Radio Parts Company, 614 RANDOLPH ST., CHICAGO 6, ILL.**

# TELEVISION SERVICING at a PRICE YOU CAN PAY

## R. S. E. 3 inch TELEVISION SCOPE

- Features:**
- WIDE BAND VERTICAL RESPONSE
  - FLAT TO 750kc
  - DOWN 3db AT 1mc
  - VOLTAGE GAIN OF 20 AT 5mc



AR-3

The R.S.E., AR-3 Scope has been built by Armstrong to our rigid specifications. It's a complete unit that embodies standard horizontal amplifier and sweep circuits with normal sensitivity.

The case is 8" high x 5" wide x 14" long, attractively finished in "hammered" opalescent blue enamel. Operates on standard 110 volts—60 cycles—40 watts. Tubes, 3BP1—6AC7—6SJ7—6X5—5Y3—884. Instructions included. Complete specifications upon request. Satisfaction or your money back.

PRICE **\$49.95**  
F. O. B. DETROIT

### PUSHBACK WIRE



**BELOW MILL PRICES!**  
2,000,000 feet—tinned copper—all 1st. class, double cotton serve, waxed finish. Available 1,000 foot rolls.

22 gauge (6 colors) \$3.98 roll  
20 gauge (6 colors) 4.98 roll  
18 gauge (brown only) 6.49 roll

### MIDGET I. F. TRANSFORMERS



Original List \$2.10  
At discounts up to 86%

400-500 Kc range  
1 1/4" square, 3" high  
hi-gain iron core.

INPUT—A826  
OUTPUT—A827

Specify Type

Matched Pair	Dozen	Egg Crate of 100
69c	\$3.95	\$29.00

### ORDER INSTRUCTIONS

Minimum order—\$2.00. 25% deposit with order required for all C.O.D. shipments. Be sure to include sufficient postage—excess will be refunded. Orders received without postage will be shipped express collect. All prices F.O.B. Detroit.

**RADIO SUPPLY & ENGINEERING CO., Inc.**  
89 SELDEN AVE. DETROIT 1, MICH.

some distance from this town, but just the same, I went in expressly to get the current issue of RADIO & TELEVISION NEWS. I might add that it was 32 degrees below zero. I wonder if any of your large city hams would walk 14 miles in like weather for their copies? "Thanking you for a good magazine." . . . . . J.H.S.

*Fourteen miles in 32 degrees sub-zero temperature for a copy of RADIO & TELEVISION NEWS. That is a record! It's obvious that lots of our big city hams do not realize the little effort they expend in keeping up their hobby.*

### HERE'S A LIKELY RECRUIT

"I'D like to help someone win that \$1500 ham station. I'm not an amateur, but I want to be one, and I'm writing to you for help.

"When in the Army, I began taking the National Radio Institute course and had about a third of it completed when I was discharged. I cashed my war bonds for a Hallicrafters SX-28A and began learning code. Later I entered Purdue to study electrical engineering, but had an accident in which I broke my neck, and I've been paralyzed from the chest down since.

"I've been in the hospital since. I tried to go on with my radio, but gave up because I could no longer hold tools or equipment. Then all of a sudden, I asked myself why couldn't I go on and get my license anyway? Of course, a lot of the fun comes from building

and experimenting, but I could buy a transmitter and learn the theory well enough to pass the test. I started the NRI course all over again and bought a Hallicrafters SX-42. (Now I hope I can sell the SX-28A to pay for it.)

"Well, that's my story. I probably can't take more than 6 or 8 w.p.m. now, but when I saw the contest announcement I decided to write in the hope that you could tell me how I can get a little help with my theory. No matter how many times I read them over, I still don't understand certain things.

"I'll be very glad to have somebody help me qualify for that priceless ticket, so that at the same time I could help him get some of those prizes."

Charles Apon  
Ward 84, Vaughan Hospital  
Hines, Illinois

*Enthusiasm like this would certainly help the cause of ham radio, and there must be an interested, already established amateur able to devote some spare time to helping Charles over the hurdles.*

### RADIO & TELEVISION NEWS CERTAINLY GETS AROUND

"I READ your February issue of RADIO & TELEVISION NEWS with much interest. This is the first American radio magazine I have seen and read.

"While it is at the moment not possible to buy this fine magazine in Germany, I would like to ask your read-

## ARE YOU RECTIFIER-WISE? WIN A VALUABLE PRIZE

With your Circuit Designs Using Federal's Miniature Selenium Rectifiers

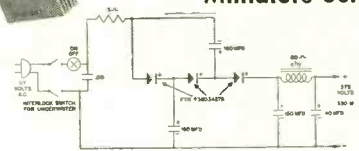

Here is your opportunity to convert your circuit ingenuity into a useful and valuable prize. Federal, the originator of the Miniature Selenium Rectifier, is interested in your ideas on the use of this revolutionary circuit element.

A multitude of circuits have been built around the outstanding characteristics of Federal's complete line of Miniature Selenium Rectifiers—audio amplifiers, home radios, television receivers, 'ham' transmitters, FM adapters, phonograph amplifiers and many other electrical and electronic circuits. They all capitalize on the long life, high current capacity, instantaneous starting and great efficiency of these rectifiers. This compact, lightweight television power supply is typical.

These are but a few applications. The uses of these Miniature Rectifiers are almost unlimited. Get your idea down on paper and send it in today. It may be a prize winner!

### FIVE MONTHLY PRIZES AND A GRAND PRIZE



The five monthly winners will each receive, FREE, a Federal FTR-1342-AS Selenium Rectifier Power Supply-Battery Charger. This compact unit, with its 6-volt, 6-ampere DC output, has many uses in home and shop. It comes equipped with a handy under-dash mounting socket for automobile battery charging.

The grand prize, a Federal FTR-3246-B5 Radio Service Power Supply, is invaluable as a source of heavy duty, filtered DC power. Its 6-volt, 10-ampere DC output will handle auto radio testing and many other test and permanent power requirements. List price \$74.50.



MAIL YOUR ENTRY TO: MINIATURE RECTIFIER CONTEST  
*Federal Telephone and Radio Corporation*

SELENIUM INTELIN DIV. • 900 PASSAIC AVENUE • EAST NEWARK, NEW JERSEY



ers if any of them would be willing to exchange their American magazines for German publications. I would also be very happy to exchange questions pertaining to all phases of radio. We could correspond in English or German.

"I do hope you can help me. I send my thanks to you, and congratulations on such a fine magazine."

Gebhard Auerswald, Engineer  
282 Bahnhofstrasse  
Lispenshausen b/Bebra  
U. S. Zone, Germany

Here is a chance for some of you hams and radio enthusiasts to correspond with someone who really knows European radio. Undoubtedly, a lot of good would be realized by such an exchange of information. How about dropping Engineer Auerswald a line and comparing notes on your respective problems?

-30-

### HAM CLUB FIELD DAY

THE radio ham clubs of Arizona are sponsoring a statewide Field Day contest in which amateur stations outside of the State of Arizona and in the United States are invited to participate. A certificate of award will be presented to stations outside of Arizona submitting the highest score in their call areas.

Two points will be counted for each Arizona station contacted between 2 p.m. and 12 midnight, MST, on May 14, and 7 a.m. and 3 p.m., MST, on May 15 using either c.w. or phone. The same station may be worked for full credit on different bands, and the total score is multiplied by the number of Arizona Field Day stations worked. Arizona stations operating at home locations count two points also, but may not be used as multipliers.

To enter the contest, watch for W7 stations calling "CQ Arizona" or call "CQ Arizona." Scores should be mailed not later than June 1, 1949, to SCM Gladden Elliott, 39 North Melwood, Tucson, Arizona.

-30-

### HAM RADIO GOES SCIENTIFIC

DR. PAUL H. KIRKPATRICK, Stanford University x-ray expert now on sabbatical leave and spending a semester at Bowdoin College as visiting professor of physics, is making use of short-wave radio to supervise research work at Stanford on the x-ray microscope he invented.

Albert V. Baez, Stanford research assistant in physics, who is continuing the development work in Dr. Kirkpatrick's absence, speaks from amateur station WIKJU, operated by Melvin Goodwin at his home at 875 La Pera Avenue, Palo Alto. Dr. Kirkpatrick speaks from the home of Murray Litchfield, operating radio station W6WLL from a house close to the Bowdoin campus.

The hour-long, cross-country confabs are held every Monday at 2:00 p.m. (CST), or 5:00 (EST). Melvin Goodwin, who suggested the ingenious conferences, says the contacts have been very successful and that reception on the 10-meter bands has been so clear that not a word has been missed.

-30-

May, 1949

You Build 'em  
in  
ONE EVENING  
but...

THEY LAST A LIFETIME!

## EICO INSTRUMENT KITS

### HIGH-PRECISION VACUUM TUBE VOLTMETER

Model 221-K  
**\$23.95**

Tops in workbench versatility. 15 different ranges! AC and DC ranges: 0.5/10/100/500/1000 volts. Electronic ohmmeter ranges from 2 ohms to 1000 megohms in 5 steps. New features include Zero Center for TV discriminator alignment. DC input impedance is 26 megohms. Exceptionally accurate, big 4 1/2" meter cannot burn out. Double triode balanced bridge circuit assures stable, guaranteed performance. Sturdy portable steel case with etched, rub-proof panel. 110-130 V. AC 50-60 cycle. Size 9 7/16" x 6" x 5".

**FACTORY-WIRED VTVM**  
Model 221. Same, but completely wired, calibrated, and tested..... **\$49.95**

### Pocket VOLT-OHM MILLIAMETER

**\$14.95**

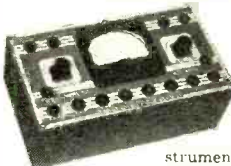

Model 511-K. A "MUST" FOR EVERY SERVICEMAN! This small, handy instrument is used by every Radio-TV repairman a thousand times a day. New, improved circuit employs Germanium crystal rectifier. Large, 3" meter, attractive etched panel. Ranges: DC—0.5/50/250/2500 volts. AC—0.1/10/100/500/1000 volts. DC Ma.—0.1/10. DC Amps—1/10. Ohmmeter—0/500/100,000 ohms/0/1 meg. DB meter: —8 to +55 db. A PERFECT KIT FOR THE BEGINNER BECAUSE IT'S SO EASY TO ASSEMBLE.

**WIRED AND TESTED**  
Model 511. Factory-built, ready to use. For sturdy, life-long service..... **\$17.95**

### 5" SCOPE

Model 400-K  
**\$39.95**



Quality throughout! Laboratory precision scope for FM, AM, & TV servicing. Deflection sensitivity: .30 volts per inch full gain. Linear sweep with 884 gas triode. Horizontal sweep circuit, 15 to 30,000 cycles. Frequency response of horizontal and vertical amps is from 50 to 50,000 cycles. Provision for external synchronization, test voltage, and intensity modulation. Complete with 2—6SJ7's, 2—5Y3's, 884, and 8B1 CR tube. Graph screen for measurement to 130 volts AC, 50-60 cycles. Operates on 110 front of handsome 3-color etched, rub-proof panel. Size: 8 1/2" x 17" x 13" high. Shpg. wt. 40 lbs. As with all EICO kits, easy-to-follow Pictorial and Schematic diagrams are included. **FACTORY-BUILT OSCILLOSCOPE** Model 400. The same high-quality, life-long instrument, but fully wired, assembled, and tested..... **\$69.95**

### PENCIL-TYPE HIGH FREQUENCY RF PROBE KITS

Germanium crystal probes for visual RF signal tracing and measurements to over 200 megacycles. 1/2" O.D., 6 1/2" long. Model P-75K. Can be used with EICO Models 221, 113A, or any VTVM! **\$3.75** Model P-76K. For Model 400 scope. Models P75 or P76. Same as above but factory wired and tested. Each... **\$7.50**

### EASY-TO-FOLLOW SCHEMATIC & PICTORIAL DIAGRAMS

come complete with every EICO Instrument kit. Each kit fully guaranteed to operate perfectly when assembled according to our instructions!

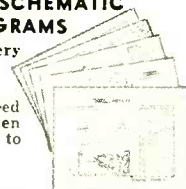

SCHOOLS: Special Discounts To Quantity Users.

**ELECTRONIC INSTRUMENT CO., INC.**  
276 Newport Street, Brooklyn 12, N. Y.

### RADIO ENGINEERING I

DEGREE IN 27 MONTHS

COMPLETE Radio Engineering Course. Bachelor of Science Degree. Courses also in Civil, Electrical, Mechanical, Chemical, Aeronautical Engineering, Business Administration, Accounting, Secretarial, Science. Graduates successful. 66th year. Enter June, Sept., Jan., March. Write for catalog.

**TRI-STATE COLLEGE**

1659 College Ave.  
Angola, Indiana

### ONLY FILMGRAPH

Records: Interviews, Conferences, Dictation, Telephone Conversations, AUTOMATICALLY, CONTINUOUSLY and PERMANENTLY at less than 3 per hour.

**MILES REPRODUCER CO., INC.**  
812 Broadway, N. Y. 3, Dept. RN-5

### GOVERNMENT SURPLUS! WORLD'S LOWEST PRICE

### PHOTO FLASH EQUIPMENT



COMES COMPLETE WITH 4 EDGERTON FLASH TUBES & REFLECTORS

EASY TO CONVERT INTO A 2-WAY PHOTO FLASH UNIT OPERATES ON 110V. AC & 12V. BATTERY

Brand new at a fraction of original cost. Contains finest component parts available. All necessary parts and complete instructions included. After conversion, works on 110V AC or 12V battery by a flick of a switch. **\$68.** WRITE FOR MORE DETAILED INFORMATION. IMMEDIATE DELIVERY COMPLETE. **CINEX, INC., 165 W. 46th St., N. Y. 19, N. Y., Dept. RN-5**

## The ULTIMATE in BEAMS

the new *universal*  
**JOHNSON ROTOMATIC**

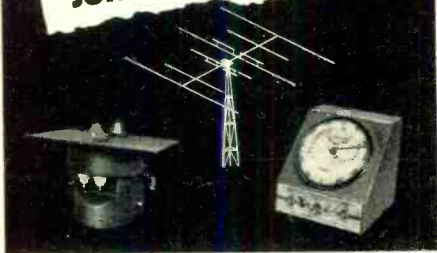

### With New Unidirectional Phased Array, All Elements Driven or Parasitic Arrays

Every desirable feature has been incorporated in the new JOHNSON Rotomatic plus the new JOHNSON Phased Array, a symmetrical unidirectional beam employing driven elements, which is easy to tune—performs beautifully.

### Dual Band Operation

DeLuxe Models of the parasitic or phased arrays are available for two band operation, employing two separate sets of elements but only one transmission line.

### New JOHNSON Parasitic Array

When you see it you will realize it's in a class by itself! New, unique design allows an infinite variety of element lengths and spacing. Perfect impedance matching on two bands—any impedance from 50 to 600 ohms—coaxial or open wire line.

### New Rotator and Direction Indicator

The new Rotomatic Rotator was designed for those who want the very finest. The heavy duty drive unit will take rain, sleet and high winds in its stride—will turn on the coldest mornings. Rotation is instantly reversible, 360° at 1 1/4 RPM. Motor control and antenna relay switch are contained in the selsyn indicator case.

The elements, rotator, direction indicator, etc. may all be purchased separately.

Write for folder fully describing the "NEW JOHNSON ROTOMATIC" or see it at your jobber.



**JOHNSON**

E. F. JOHNSON CO. WASECA, MINN.

## Plate Dip Unit (Continued from page 43)

in measurements, the search coil should be coupled as loosely as possible to the circuit under test.

A further word about the dial. After marking the calibration points with India ink, the dial was treated with an oil coloring. The oil colors were purchased from a photograph shop in the form of a beginner's hand coloring set for about a dollar. The little kit contains 8 shades in an amount suitable for coloring literally hundreds of dials and perhaps some pictures, too. The colors are applied with a tiny wad of cotton around the end of a toothpick and no talent is required to make a very presentable dial with a different color for each band. If you are not satisfied at first, you can remove a part or the whole thing with a solution included in the kit and start over again. After several days, the whole dial can be given several coats of lacquer and the job is made permanent. To identify coils with the proper dial calibration, a dot of color is put on the inside of the coil forms. This type of coloring system is, of course, adaptable to the commercial home-calibrated dials made by *Bud, Millen, and National*.

To try and mention all the possible uses of an instrument such as this plate dip meter is a gargantuan task as the applications are limited only by the ingenuity of the user. However, a few of the primary functions can be here summarized: The resonant frequency of circuits can be measured or adjusted to desired range without requiring any energy in the circuit itself, hence a transmitter can be tuned without the power turned on and a trap can be similarly adjusted. Antenna resonance can be found by coupling the search coil to the end of the antenna or the feed system.

As a signal generator, set the dial to the frequency desired and align your equipment. If modulation is a must, connect a switch in the negative return of the filter condenser; this will cause the oscillator to be modulated at the supply frequency.

In the non-oscillating condition, the meter will read upward when reso-

Interior view of unit. Note short, heavy lead from tuning condenser to coil socket, and bracket mounting of tube socket on condenser. Control is "full scale-zero adjust." A penlight cell provides bucking current.

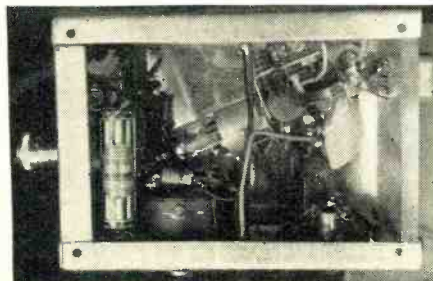

## Easier Antenna Installations



Star Expansion Bolts make it easy to fasten TV equipment to brick, stone, concrete or any other type of masonry. Help you to position antenna masts, cables and lines in the best possible manner... assure greater satisfaction; reduce service calls. There's a Star fastening for every masonry job. See your jobber or write for details.

**★ STAR EXPANSION BOLT CO. INC.**

147 Cedar Street, New York 6, N. Y.

## SENSATIONAL! NEW! SOUND POWERED TELEPHONE HANDSET



- No Batteries Needed
- No Power Supply Needed
- HIGH FIDELITY SPEECH TRANSMISSION

Ideal for emergency or convenience applications. Operates up to 25 miles with No. 16 twisted wire; up to 15 miles with No. 19. And no auxiliary power is needed. Also operates over single wire with ground return. As many as 12 handsets can be operated in communications systems for group conversation. Explosion proof. No fire hazard. No spark is generated. Guaranteed one year by Wheeler Insulated Wire Co. (Div. of Sperry Co.). Shipping weight 3 pounds. Immediate delivery. **\$9.95**  
Order Now . . . . .

### GIBSON GIRL SALE!

**NYLON PARACHUTE** Bright yellow. Supports 40 pounds. With Nylon shrouds. . . . . \$4.95  
**4" DIAMETER PURE RUBBER BALLOON** Vacuum packed with Hydrogen generator, inflation tube and instructions. . . . . \$3.49  
**BOX KITE—LARGE** 17" x 17" x 36" Dural tubing, feather weight. Snaps together in a jiffy. Adjustable for wind. Instructions included. . . . . \$2.95  
**ANTENNA WIRE** 300' spool. Use in conjunction with kite or balloon for super antenna. High tensile strength. . . . . \$1.95  
**WATERPROOF SIGNAL LAMP** With cord. Will float in water with no injury. Spare lamp included. . . . . \$1.00  
**FAMOUS GIBSON GIRL XMITTER** 500 kc. CW or modulated signals. Automatic keyer. Self powered hand generator. Water proof case. Made with latest design practices. Good ideas, good parts. Power supply furnished. Can be used for emergency field station by simple conversion. Manual included. . . . . \$8.95  
**THE WHOLE WORKS! A \$28.00 VALUE** With two balloons and two spools of wire (Bag included at no charge) . . . . . Only \$18.95

**ABELL DISTRIBUTING CO., Dept. N6**  
5 E. Biddle St. Baltimore 2, Md.

**RADIO & TELEVISION NEWS**

nated to an r.f. source and can be used as a sensitive field strength meter, an absorption frequency meter, a harmonic checker, a parasitic hunter, a sensitive neutralizing indicator, and, of course, a phone monitor.

Still other applications of this handy gadget can be found and once a "build-it-yourself" ham or experimenter has one, he won't part with it for love or money.

-30-

### FM Booster

(Continued from page 41)

It was found that the use of the preamplifier resulted in a great improvement in receiver sensitivity. Stations that were barely audible in the background noise were brought up to a point where very little noise was noticed, while the total number of stations logged was more than doubled.

As a most convincing demonstration of the performance of the preamplifier, the antenna can be replaced with a 300-ohm, 1/2 watt carbon resistor. A certain amount of noise, which appears as a smooth, rushing sound, will be noticed at the receiver output. If the thermal energy of the resistor is increased by raising its temperature, the Johnson noise will appear as an increase in the receiver output. If a lighted match is held under the resistor for a few seconds, the noise may increase to a point where it is practically deafening. Before you build the preamplifier, make this test with the receiver alone!

### Other Applications

Although the booster described was intended particularly for the FM band, it can be used on the 10, 6, and 2-meter amateur bands merely by changing  $L_1$ ,  $L_2$ ,  $L_3$ , and  $L_4$ . Also, with suitable coils it should perform well ahead of a television receiver. The band width is sufficient to cover two adjacent channels. In making these changes, it will be necessary to determine coils  $L_1$ ,  $L_2$ ,  $L_3$ , and  $L_4$  experimentally.

-30-



## Our 26th Year

# LEEDS

The Home of RADIO

### PLATE TRANSFORMERS

For Small Transmitters. DC Voltage Ratings are Approx. Values Obtained at Output of a 2 section Choke input Filter. Using Mercury Vapor Rectifier Tubes. Pri. is for 115 V. 60 cy.

Type No.	Sec. Rms. Volts	DC Sec. Volts	MA	H. 4%	W. 3 1/2"	D. 4 3/8"	Price Each
P 57	660-660†	500	250	4 3/8"	3 1/2"	4 3/8"	\$ 6.76
P 58	550-550	400	150	4 3/8"	3 1/2"	4 3/8"	8.23
P 59	1080-1080	1000*	125	4 3/8"	3 1/2"	5 1/8"	7.94
P 67	500-500	400	150	4 3/8"	3 1/2"	4 3/8"	19.84
P 68	900-900	750	225	4 3/8"	3 1/2"	4 3/8"	24.99
	800-800	600	150	4 3/8"	3 1/2"	4 3/8"	
	1450-1450	1200	300	5 3/4"	6 1/8"	4 3/8"	
	1175-1175	1000	300	5 3/4"	6 1/8"	4 3/8"	
	2100-2100	1750	300	5 3/4"	6 1/8"	4 3/8"	
	1800-1800	1500	300	5 3/4"	6 1/8"	4 3/8"	

\* For dual operation with simultaneous use of both sec ratings.  
† Has 40-volt bias tap.

### SCOPE & TELEVISION TRANSFORMERS & CHOKES

2500V. RMS @ 5 Ma D.C.-6.3V. @ 3 amps tapped at 2.5V. @ 3 amps; 2.5V. @ 2 amps; Type P-3171 \$6.76  
1700V. RMS @ 2 Ma D.C.-6.3V. @ 9 amps tapped at 2.5V. @ 2 amps; 2.5V. @ 2 amps; Type P-3170 \$5.14

2 Hys @ 250 Ma D.C. 50 ohms \$1.62  
Type C-2991  
2 Hys @ 200 Ma D.C. 50 ohms \$1.92  
Type C-2974

VERTICAL BLOCKING OSC. turns ratio pri. to sec. 1:4.2  
Unshielded type A-3000 \$1.18  
Shielded type A-4000 1.62

HORIZONTAL BLOCKING OSC. turns ratio pri. to sec. 2:1  
Unshielded type A-3002 \$1.32  
Shielded type A-4002 1.76

VERTICAL OUTPUT turns ratio pri. to sec. 10:1  
Unshielded type A-3035 \$3.09

### SUPERIOR POWERSTATS

Smooth, efficient voltage control. 0 to 135V. output from 115V. AC line.

Type 20 (illustrated) 3 amps	\$12.50
116 for table mtg 7.5 amps	23.00
116U for panel mtg 7.5 amps	19.00
1126 15 amps	46.00
1156 45 amps	118.00

Also available for 230 volt input. Write for descriptive literature.

### STEEL CHASSIS

Size	Material	Price
7 x 7 x 2	Black Crackle	94c
7 x 9 x 2	Black Crackle	\$1.06
5 x 10 x 3	Black Crackle	\$1.00
7 x 11 x 2	Black Crackle	\$1.15
7 x 13 x 2	Black Crackle	\$1.23
10 x 17 x 3	Black Crackle	\$1.88

### ALUMINUM CHASSIS

Size	Material	Price
7 x 7 x 2	Black Crackle	94c
7 x 9 x 2	Black Crackle	\$1.06
5 x 10 x 3	Black Crackle	\$1.00
7 x 11 x 2	Black Crackle	\$1.15
7 x 13 x 2	Black Crackle	\$1.23
10 x 17 x 3	Black Crackle	\$1.88

### CHOKES

TYPE	Hy	MA	Price		
C-80	10	C-87	4-16	150	\$3.09
C-81	10	C-88	4-16	200	\$3.82
C-82	10	C-89	4-16	250	\$5.29
C-83	8	C-90	3-14	300	\$5.59

All above 3000 Volts Insulation

### RAYTHEON VOLTAGE STABILIZERS

Positive Stabilization ±1/2%  
Input 95-130 volts, 60 cycles single phase; output 115 volts stabilized to ±1/2%. \*Output 6.0 or 7.5 volts stabilized ±1/2%.

Catalog No.	Output	Net Price
VR-6110	15	\$15.00
VR-6101*	30	\$17.00
VR-6111	30	\$17.00
VR-6112	60	\$24.00
VR-6113	120	\$31.00
VR-6114	250	\$48.00
VR-6115	500	\$75.00
VR-6116	1000	\$125.00

### FILAMENT TRANSFORMERS

Type 940 2.5VCT @ 10 Amps. 7500V Ins.	\$2.79
Type 040 5 VCT @ 3 Amps. 2500V Ins.	\$2.06
Type 941 5 VCT @ 3 Amps. 2500V Ins.	\$3.38
Type 943 5 VCT @ 20 Amps. 2500V Ins.	\$5.29
Type 946 6.3VCT @ 3 Amps. 2500V Ins.	\$1.91
Type 947 6.3VCT @ 6 Amps. 2500V Ins.	\$2.79
Type 948 6.3VCT @ 10 Amps. 2500V Ins.	\$3.67
Type 960 7.5VCT @ 8 Amps. 2500V Ins.	\$2.35
Type 143 7.5VCT @ 10 Amps. 3000V Ins.	\$4.12
Type 146 10 VCT @ 8 Amps. 2500V Ins.	\$4.99
Type 961 Dual 6.3VCT @ 3 Amps. 2500V Ins.	\$3.38
Type 041 5VCT @ 3 Amps. 2500V Ins.	\$3.38
Type 041 6.3VCT @ 3.6 Amps.	

### GRID DIP METER

LYSCO "DIPMASTER"  
3Mc to 150Mc freq. range; calibrated dial, band switching (no coils to plug-in). Complete power supply and tubes. A really good buy

**\$33.50**

### ISOLANTITE Sockets for 832's or 829's

ISOLANTITE Sockets for octal tubes  
SEALITE Sockets for 813 and other large 7 pin tubes  
3C24 Triode Each 39c, 10 for \$3.50

### OIL FILLED BATHTUBS

Special 19c Each \$10.00 per 100. All 600VDC in following sizes: .05 Mfd., .1 Mfd., 2x.1 Mfd., 3x.1 Mfd., .01x.3 Mfd.

### ISOLATION TRANSFORMERS

All 117 Volts to 117 Volts 60 Cy.

P-96, 40 watts	\$3.60	P-98, 100 watts	\$9.30
P-97, 80 watts	\$5.10	P-99, 250 watts	\$17.70

### TRANSFORMER SPECIAL

870 volt CT @ 250Ma with 80V bias tap  
5 volts @ 3 amps  
2 1/2 volts CT @ 10 amps  
2 1/2 volts @ 3 amps  
6.3 volts @ 1.5 amps  
115V. 60 cycle primary

**\$5.88**

If not rated 25% with order, balance C.O.D. All prices F.O.B. our warehouse New York. No order under \$2.00 We ship to any part of the globe.

## LEEDS RADIO CO.

75 Vesey Street Dept. RN 5  
COrtlandt 7-2612 New York City 7

## Electronic TUBES

# RECEIVING TUBES

STANDARD CARTONS NO BULK—NO GYPS

### 50—10—10% DISCOUNT

WRITE TODAY FOR YOUR PREFERRED CUSTOMER ORDER BLANK

POSTPAID ANYWHERE IN U.S.A.  
GUARANTEED ONE YEAR

Write **CENTRAL ELECTRONIC SUPPLY CO., INC.**  
203 W. 4th STREET OWENSBORO, KENTUCKY

**AT WARREN** ★  
 DISTRIBUTORS  
 3089 WASHINGTON ST.  
 BOSTON 19, MASSACHUSETTS

*For Immediate Delivery*

**DE WALD HIGH DEFINITION TELEVISION**



No. CT-104  
**\$39995**  
 List  
 12 1/2" Screen

Direct View model with complete channel coverage. Excellent performance even in fringe areas.

Beautifully designed console cabinet of fine walnut or mahogany veneer takes minimum floor space. 22 tubes (including 2 rectifiers and damper). Range 44-88, 174-216 MC. Size: 38 1/2"x20"x21".



No. CT-102  
 10" Screen  
**\$29995**  
 List

High Definition Table Model with 10" screen. Thrilling performance. 22 tubes (including 2 rectifiers and damper). Tuning range 44-88, 174-216 MC. Beautifully designed hand-rubbed cabinet in mahogany or walnut veneer. Dimensions: 20"x14"x20".

**ALSO AVAILABLE:** DeWald No. CT-101 with 16" tube providing 145 square inches of picture. A masterpiece of performance.

List..... **\$49995**

**GENUINE POLARIZED FILTER LENSES**  
 Individually packed

7".....List, \$ 6.50.....Our price **\$2.29** each  
 10".....List, 10.00.....Our price **\$3.98** each

**DEALERS: USE COUPON**

**MAIL TODAY**  
 Warren Distributors  
 3089 Washington St.  
 Boston 19, Mass.

**FOR BIG NEW TELEVISION CATALOG & NET PRICES**

Please rush me your BIG NEW CATALOG illustrating outstanding values in TELEVISION, RADIOS AND SUPPLIES.

Name.....

Firm.....

Address.....

City.....State.....

132

# NEW TV RECEIVERS on the Market

## ALL-MIRROR TV SET

The all-mirror television receiver, named the Pandora 15, produced by *Sightmaster Corp.*, 20 E. 35th St., New York, N. Y., has safety glass mirror for sides, and the exclusive feature of "Sightmirror" on the viewing side.

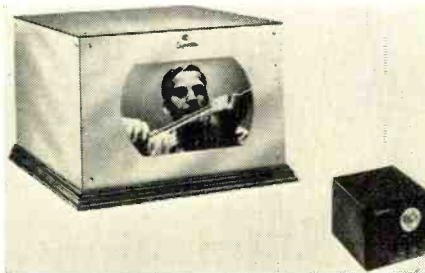

This 15-inch glass tube set is listed at \$675.00.

The Sightmirror principle is aimed at providing an attractive front on the receiver when it is not in use. The mirror eliminates the unattractive dead space, and when the set is in use, the television picture comes through as a soft filtered picture. So that no knobs are necessary, it is tuned in by a remote control unit that can be operated from an armchair.

This new model will be distributed nation-wide through the organization sales system.

## FOUR-WAY TV COMBINATION

The *Sparton* Radio-Television Division of *The Sparks-Withington Company*, Jackson, Michigan, recently introduced among its new line of television models a TV console in mahogany finish, priced at \$399.95, east of the Rockies.

This new console, Model 4916, has a



ten-inch screen with 54-inch picture, automatic brightness control, 28-tube chassis, and a choice of mirror-view or direct-view screen. In common with

the other models, this console has a dual-purpose, single-arm, two-speed record changer, for playing standard records at 78 r.p.m. and long playing records at 33 1/2 r.p.m. automatically.

In the first of a number of showings, these combinations were unveiled to *Sparton* dealers of the Detroit area and it was hoped to bring them to all major television markets soon.

## 17-TUBE LOW-PRICED TV SETS

Model 807, part of the new line of table television receivers coming from *General Electric's* Electronics Park, Syracuse, N. Y., is mounted in a compact blond oak cabinet, at the list price (eastern) of \$289.95. It uses a simplified circuit design, necessitating only 17 tubes and three rectifiers in addition to the 10-inch picture tube.

Three table models, 805, 806, and 807 comprise this new line, along with Model 809, a contemporary console in



mahogany finish. All of the sets, with the exception of 805, listing at \$239.95, will have "Daylight" television tubes, said to produce pictures 80 per-cent brighter than other tubes operating under the same conditions.

All of these new receivers are pretuned to the 12 television broadcast channels and are equipped with the *G-E* automatic clarifier, a stabilization circuit intended to reduce the interference caused by passing automobiles or unfiltered electrical appliances.

## "GUEST TELEVISION" SYSTEM

The system designed and manufactured by *Industrial Television, Inc.*, 359 Lexington Avenue, Clifton, N. J., was scheduled to be installed in the Loudon - Knickerbocker Hall sanitarium in Amityville, New York, according to a recent announcement.

This so-called "guest television" system incorporates many features necessary in an institution of this type. All of the tuning will be done at the central control unit. The individual picture units use a 15-inch picture tube and have absolutely no operating con-

**RADIO & TELEVISION NEWS**

trols. Shatterproof plexiglass covers the picture tube.

The receivers are to be installed in the recreation rooms of the various sanitarium buildings with provision to expand the system to the sanitarium theater.

#### VIDEO LARGE-SCREEN TV

One of the new features of the *Video Corporation of America* line of low-priced receivers is the inclusion of a circuit, the "plakron compensator,"

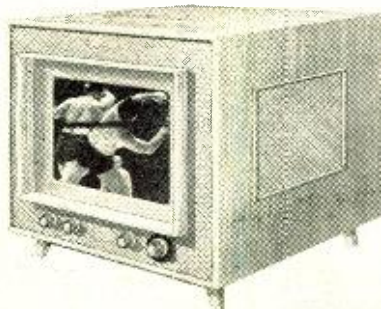

which produces a high-fidelity picture in much the same way that a tone control increases the tonal range in a radio receiver.

One of these models, priced at \$459.00, is a new 135 square inch, direct-view table receiver, scheduled for dealer delivery. Others include a 91 square inch table model at \$359.00 and a 91 square inch console at \$379.00. In addition, there is a 135 square inch console with sliding door and hidden controls that turn the receiver into a handsome furniture piece, priced at \$499.00.

According to the manufacturer, *Video Corporation of America*, 229 West 28th Street, New York City, particular attention was paid to the development of these models, to make them trouble free in performance. All heat producing components that tend to deteriorate parts have been eliminated.

#### CROSELY TV-AM-FM CONSOLE

The *Crosley* so-called "complete-entertainment" television - radio - phonograph consoles include the blond oak Model 9-414B, in the functional lines

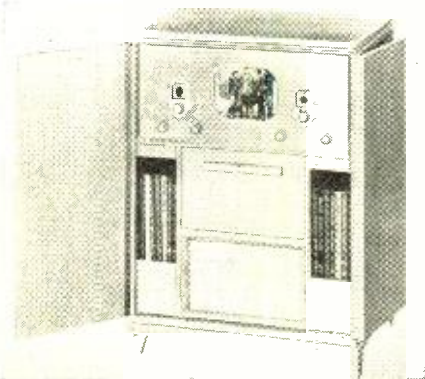

and smart finish of the modern motif, at \$529.95.

The new line provides *Crosley* spectator television reception with the 10-inch direct-view picture tube, both

# ANNOUNCING

## A STRIKING NEW MICROPHONE BY TURNER

### THE TURNER MODEL 25X-25D CRYSTAL OR DYNAMIC

New . . . all new from its precision engineered crystal and dynamic circuits to its specially designed case. The Turner 25X-25D combines quality performance, convenience, and style with world famous Turner *dependability*. Features include Alnico V magnets, high quality moisture sealed crystals, smooth, wide range response to voice and music pickups, 90° tilting head for semi- or non-directional operation, 20 ft. removable quick-change cable set, mechanical-shock proof interior mounting, and high quality construction throughout. Finished in attractive two-tone umber gray with chrome plated grill.

The new Turner 25X-25D may be mounted on desk stand as illustrated or used with any standard floor stand. It is recommended for call system, public address, recording, amateur communications and general-purpose sound work.

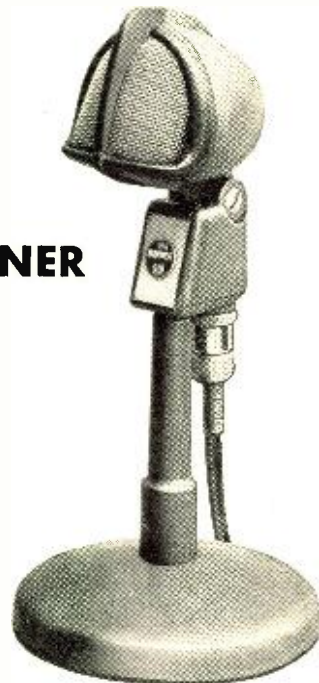

#### GENERAL SPECIFICATIONS

##### MODEL 25X CRYSTAL

Response: Substantially flat from

50 to 9,000 c.p.s.

Level: 52 db below 1 volt/dyne/sq.cm.

##### MODEL 25D DYNAMIC

Response: Substantially flat from 50 to 10,000 c.p.s. Level: 54 db below 1 volt/dyne/sq. cm. at high impedance. 30, 200, and 500 ohms—wired for balanced line.

High impedance—wired single ended.



#### THE TURNER COMPANY

900 17th Street N.E.

Cedar Rapids, Iowa



Licensed under U. S. patents of the American Telephone and Telegraph Company, and Western Electric Company, Incorporated. Crystals licensed under patents of the Brush Development Company.

#### PEN-OSCIL-LITE

Extremely convenient test oscillator for all radio servicing; alignment • Small as a pen • Self powered • Range from 700 cycles audio to over 600 megacycles u.h.f. • Output from zero to 125 v. • Low in cost • Used by Signal Corps • Write for information.

GENERAL TEST EQUIPMENT  
38 Argyle Buffalo 9, N. Y.

"HEATHKITS ARE THE BEST KITS"  
Write For Catalog

**The HEATH COMPANY**  
BENTON HARBOR 15, MICHIGAN



#### RADIO ENGINEERING TELEVISION ELECTRONICS

Thorough training in all phases of radio and electronics, open to high school and junior college graduates. Old established school specializing in Radio training exclusively. Modern laboratories and courses. Enrollments limited. Approved veteran training.

VALPARAISO TECHNICAL INSTITUTE  
Dept. RD Valparaiso, Ind.

frequency modulation and standard broadcast reception, and an automatic phonograph with two-speed player and the *Crosley* jewel-tone system. In addition, there are record library storage spaces on either side of the record playing compartment. The consoles have full-length panel doors which can be closed to put them in complete harmony with the room settings when the instrument are not in use.

The *Crosley Division, Avco Manufacturing Corporation*, 1329 Arlington St., Cincinnati 3, Ohio, will be happy to supply further information on these sets.

#### NEW FREED-EISEMANN TV MODELS

All of the television receivers manufactured by the *Freed Radio Corporation*, 200 Hudson Street, New York 13, N. Y., use the 16-inch metal tube. In a recent demonstration, a specially-invited group of retailers from the East saw four new consoles, which marked *Freed Radio Corporation's* entrance into the television market.

These *Freed-Eisemann* models are housed in period design cabinets with a high eye level, permitting strain-free viewing from any part of the room, without a disorderly rearrangement of furniture directly in front of the receiver.

According to Arthur Freed, president of *Freed Radio Corporation*, the company's entire engineering and production efforts would be devoted to television models with the 16-inch

metal tube. The consoles are available in *Sheraton, Chinese Chippendale, Regency, and Chippendale* styles, and the retail prices range from \$625 to \$1295.

#### LIFE-SIZE TV

A new life-size television projection system, featuring an optical barrel which is suspended from a convenient ceiling mounting, has been announced by the *RCA Engineering Products Department*, Camden, New Jersey.

The system is especially adaptable



for use in night clubs, hospitals, taverns, clubs, hotels, industrial plant recreation, and lunch rooms. The ceiling mounting lends itself to built-in applications in harmony with a room's

decorations, and the space-saving aspect of the installation is also a major feature.

The optical barrel is connected to the control console by a 40-foot cable. In use, the barrel is focused on a screen up to 6 by 8 feet in size, of either the front or rear-projection type.

The system (TLS-87) has a 30-watt amplifier, with microphone and phonograph inputs provided so that the unit can be used as a public address system when television programs are not on the air.

#### FIRST UST CONSOLETTA

The first 15-inch television-radio consolette to be produced by *United States Television Mfg. Corp.*, 3 West 61st Street, New York 23, N. Y., features a Zetka 15-inch glass viewing tube with a flat face to provide more picture space. The tube has an ion trap which is designed to eliminate ion stain, an eye disturber which sometimes occurs in tubes without this feature.

A full consolette, this model does not require the use of any supporting furniture, and has, besides large-screen television, FM radio reception. It is priced at \$625, which the manufacturer feels is comparable to 16-inch metal-tube table models at the \$500 level, since these do not have FM radio, and the consumer must have a supporting table.

A producer of television sets since

# Here it is... RADIO & TELEVISION NEWS MAGAZINE LIBRARY

- An ingenious, custom-built storage file—made of high quality Kraft fibre board—printed and constructed to look like a Buckram bound book.
- Free date label stickers—supplied in strips for your convenience in typing.
- Convenient Reference Index form, printed on back (for recording location of selected articles, wiring diagrams, etc.)
- Magazine copies are inserted vertically between spring-like flaps which prevent issues from leaning and curling. As copies are added, flaps fold over to sides; hold magazines firmly.

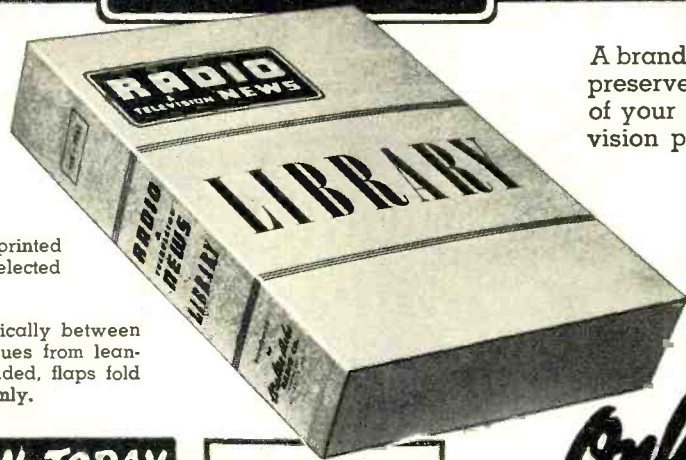

A brand new, grand new way to preserve every treasured issue of your favorite radio and television publication.

NOW AVAILABLE FOR IMMEDIATE DELIVERY

(use coupon below)

Only **50¢** per set of 2

Holds 12 complete issues (6 in each) (Plus 15c to cover pkg. & pstg. anywhere in U. S.)

### MAIL THIS COUPON TODAY

Walter Ashe Radio Co. R-49-5 b  
Bill Dubord, WØQDF, Mgr., Amateur Div.,  
1125 Pine St., St. Louis 1, Missouri

- Rush my order for \_\_\_\_\_ sets Radio & Television News Library @ 50c per set of 2 (holds 12 issues) plus 15c for pkg. & pstg.
- Remittance for \$\_\_\_\_\_ is enclosed.
- Send my Free copy of your Big, New 1949 Catalog of Radio, Electronics & Television.

NAME \_\_\_\_\_  
ADDRESS \_\_\_\_\_  
CITY \_\_\_\_\_ ZONE \_\_\_\_\_ STATE \_\_\_\_\_

**FREE!**

Big, new 1949 Catalog of Radio, Electronics and Television. The treasure chest of values. Order your copy today!

**Walter Ashe**  
**RADIO CO.**  
1125 PINE ST. • ST. LOUIS 1, MO.

pre-war days, *United States Television Mfg. Corp.* will distribute its models on a national scale. Other *UST* models range from 10-inch table models to large-screen projection TV sets for public places.

**THEATER TELEVISION**

Television on a life-size 6 by 8 foot screen is a major attraction at Walter Reade's *New Majestic Theater* in Perth Amboy, New Jersey. The theater reopened recently upon the completion of a \$150,000 remodeling program that included installation of the video lounge.

This special 40 by 25 foot lounge was installed as an additional patron service. There is no charge for admission to it—the patron may see both the theater's screen attraction and the television while in the theater.

The set used is the new *RCA TLS-86*, housed in a portable wheeled cabinet. From a spot 14 feet away from the center of the screen, it throws a picture 6 by 8 feet in size. It replaces a 20-inch tube television set installed nearly two years ago and at that time the largest available.

According to Walter Reade executives, the present television picture is the largest ever presented publicly in New Jersey, and the biggest direct video pictures ever unveiled for regular daily viewing.

**HOFFMAN 16" COMBINATION**

The *Hoffman Radio Corporation*, 3761 S. Hill St., Los Angeles, California, announces that a new combination radio-phonograph and television receiver has been released, which features the new 16" metal tube.

In cabinet style, the set, Model 902, is a twin of the company's Model 900, but the new combination's 16" metal tube presents a particularly clear,



crisp, and bright image to the viewer, according to the manufacturer. This is especially true when used in conjunction with the Easy-Vision Lens.

Other features of the Model 902 include a 12" acoustically treated speaker, plus such regular *Hoffman* TV features as an automatic picture synchronizer which locks the picture in focus electrically. It is housed in a blond oak cabinet, 37 by 40 by 21 inches.

**BUILD YOUR OWN SMALL PARTS STORAGE CABINETS TO FIT YOUR SPACE AND NEED**

**ALL STEEL CONSTRUCTION**

- Assemble quickly
- Units rigidly interlock
- Smooth drawer operation
- Durable green finish

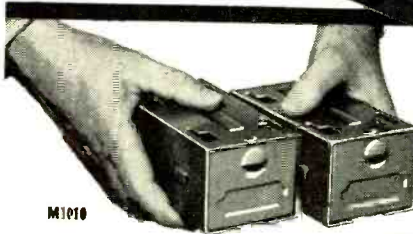
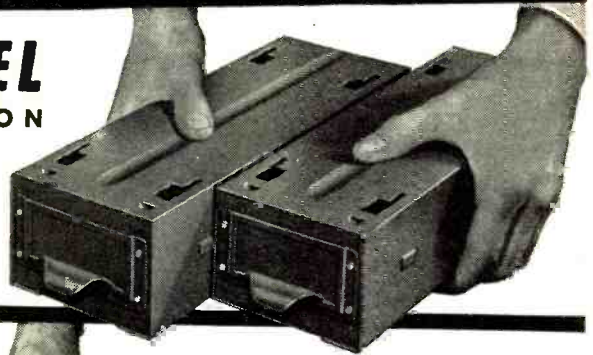

M1010

**TWO CONVENIENT SIZES—LOW PRICE**

M1010 (small drawer unit)—5" front to back, 2 7/8" wide, 2 1/4" deep—40c each. Accommodates 3 drawer dividers—2 for 5c—Part No. M1011.

M1212 (large drawer unit)—11 1/2" front to back, 3 1/2" wide, 3" deep—\$1.29 each. Accommodates 5 drawer dividers—5c each—Part No. M1213.

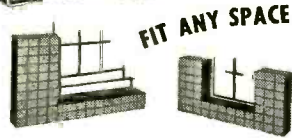

**FIT ANY SPACE**



Jobbers—some excellent territories still open—present jobbers say it's one of the fastest moving items carried.

Makes ideal package or merchandiser for small parts. Available retail through radio shop—or write direct for nearest supplier.

**THE CINCINNATI VENTILATING CO. INCORPORATED**  
COVINGTON, KENTUCKY

**EVERY SERVICEMAN CAN afford SUPERIOR TEST EQUIPMENT**

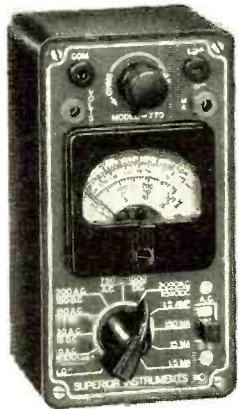

**THE NEW MODEL 770 — AN ACCURATE POCKET-SIZE VOLT-OHM-MILLIAMMETER**

(Sensitivity: 1000 ohms per volt)

- Compact—measures 3 1/2" x 5 3/8" x 2 1/4".
- Uses latest design 2% accurate 1 Mil. D'Arsonval type meter.
- Same zero adjustment holds for both resistance ranges. It is not necessary to readjust when switching from one resistance range to another. This is an important time-saving feature never before included in a V.O.M. in this price range.
- Housed in round-cornered, rounded case.
- Beautiful black etched panel. Deep etched letters filled with permanent white, insures long life even with constant use.

Specifications: 6 A.C. VOLTAGE RANGES: 0-15/30/150/300/1500/3000 volts. 6 D.C. VOLTAGE RANGES: 0-7 1/2/15/75/150/750/1500 volts. 4 D.C. CURRENT RANGES: 0-1 1/2/15/150 Ma. 0-1 1/2 Amps. 2 RESISTANCE RANGES: 0-500 ohms, 0-1 Megohm.

The Model 770 comes complete with self-contained batteries, test leads and all operating instructions. **13.90 NET**

We manufacture a complete line of radio test equipment  
Write Dept. RN5 for FREE catalog to you!

MFD. BY



**SUPERIOR INSTRUMENTS CO.**

227 Fulton Street

New York 7, N. Y.

**at your regular jobber**

# Sensational New universal clamp

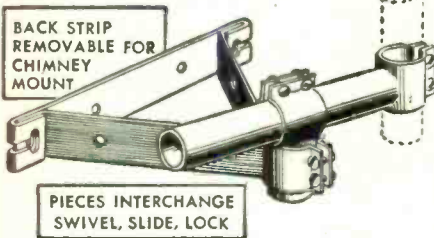

BACK STRIP REMOVABLE FOR CHIMNEY MOUNT

PIECES INTERCHANGE SWIVEL, SLIDE, LOCK

## Licks EVERY antenna mounting problem!

**\$4.95**

NET

UNIMAC is an installer's dream come true! This one unit completes your kit. UNIMAC mounts anywhere, in any position, handles all 1 to 1 1/4" masts, and swings them free and clear to perfect, upright position. NO GUY WIRES REQUIRED.

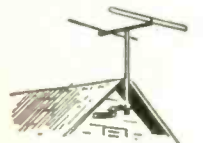

Clears overhanging eaves on gables... masts need not be bent... mount fastens directly to house without extension blocks. NO GUY WIRES.

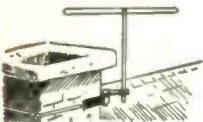

Clears lips on chimneys... choice of lag screw or strap mounting provided on part... NO GUY WIRES.

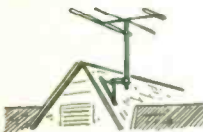

Base mounts easily on pitched surfaces... full adjustment for erecting mast and orienting antenna. NO GUY WIRES.

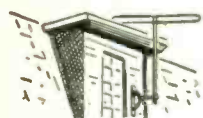

Mounts on horizontal or vertical window sash... swings antenna clear of obstructions. NO GUY WIRES.

UNIMAC is constructed of heavy steel throughout, with all joints welded, eliminating part failures. Sturdy, clean-cut appearance pleases customers, increases business. ONE-MAN CREWS NOW PRACTICAL.

*There's no call back when you use Unimac*



MARVIN RADIO-TELEVISION  
Buckeye at East 89th St., Cleveland 4, Ohio

- Enclosed find \$5.10 (\$4.95 plus postage) for one sample.
- Enclosed \$..... for..... boxes of UNIMACS at \$29.70 per box of 6.

Name.....

Address.....

## TV Antenna Compass

(Continued from page 69)

should be temporarily disabled during any measurements. This is easily done by following the directions of the manufacturer for service or alignment of the video channel. Since such a receiver having a.g.c. would automatically attempt to adjust its gain to compensate for a weaker or stronger signal, any antenna adjustments, with or without the use of the Simpson antenna compass, to be at all informing, would have to be done with such a.g.c. disabled.

One of the first questions to come to the mind of the reader is—"How can it possibly show ghosts?" Well, it will, provided the ghost is of the type about which anything can be done by orientation or location of the antenna. It is not generally realized that there are actually at least three types of ghosts (displaced images) which appear on the TV screen. While a thorough discussion of this subject is beyond the scope of this article, the problem may briefly be stated as follows.

First, there is the ghost due to mismatch of the impedance of the antenna, the transmission line, and/or the receiver input circuit. The reflections, due to this mismatch, coursing back and forth along the transmission line, cause a slight time delay in the impulses supplied to the picture tube. With any reasonable length of line, and not too bad a mismatch, this time delay is usually so slight that actual multiple images do not appear, but a general loss of horizontal definition may result, giving the effect of poor focus and a lack of crispness to the image. Obviously, no change in orientation of the antenna will cure this; the solution lies in a good match. This is by no means an easy job when all-channel operation is considered. There is a lot of room for development work on TV receiving antennas.

The second type of ghost originates near the transmitting station. Reflections which are caused by objects located relatively near the transmitter arrive at the receiving site from nearly the same direction as that of the prime wave, but delayed in time. This time delay causes the displaced image. Now, with any practical receiving antenna, the horizontal directivity is so broad that the antenna is unable to discriminate between waves arriving from directions displaced by only a few degrees. Again, obviously, no practical change in location or orientation of the receiving antenna can cure this trouble. This is a real problem, and it does not appear that it can be solved at the receiving site but is rather one for the transmitter engineers. The selective removal of a few large office buildings would undoubtedly help matters, but appears a bit impractical.

The third type of ghost, (and this is the one that we can do something

about), originates from reflections relatively near the receiver and sufficiently off-axis from the prime wave so that the acceptance pattern of the receiving antenna can discriminate against it. Fig. 1D shows how this time delay due to longer path, and directional difference due to reflector location, originates. Now, assuming that the source of such a reflection is displaced at least twenty degrees or so from the path of the direct wave, we can, by rotating the antenna somewhat to the opposite side of the peak, reduce the ghost to negligible proportions without reducing the prime wave too greatly. Such adjustments must always be a compromise between allowable diminution of the prime wave in relation to the strength and direction of the ghost.

Now, if we know the direction from whence the ghost arrives, we can much more rapidly and intelligently discriminate against it. It is gratifying to see how well the use of the meter shows up this direction, and, therefore, the direction to which the antenna should be turned to nullify it. By slowly rotating the antenna while watching the meter pointer, if no directionally displaced ghosts are present, the curve will be a smooth one, rising to a peak and falling off uniformly on the opposite side. This, of course, assumes that the antenna itself has a smooth acceptance pattern. Now, as shown in Fig. 1C, if the movement of the pointer is non-uniform, falling off more slowly on one side of the peak than on the other, or actually showing a smaller sub-peak, off-axis reflection is present, and the remedy is obvious. Simply rotate the antenna to the side of the peak away from the ghost direction, and you have done all that the present state of the art permits.

The design of this instrument is the outgrowth of a good deal of antenna measurement work done by the writer during the past few months. The comparison of various types of indoor and outdoor TV antennas here in Des Plaines, about twenty miles from our group of four Chicago TV stations, necessitated the use of some sort of indicating instrument. While the setting up of a signal generator and a simple field-strength indicator would be obvious, it seemed simpler (and cheaper) to use the TV transmitters as the generators and the TV receiver itself as the amplifier. There are many places in the receiver circuit where an indicating instrument could be connected for comparative purposes, such as a VTVM across the video channel or a milliammeter/microammeter in series with the video diode load or the a.g.c. load. All such measurements are, of course, merely comparative and are not quantitative, but if the gain of the amplifier (receiver) remains constant, and comparisons are made rapidly enough so that wave propagation conditions do not materially change, and if the power output and picture modulation of the trans-





## WALKIE-TALKIE!

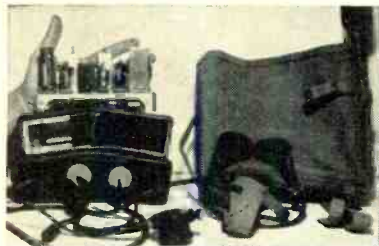

Navy Model "M" series, 2.3 mc to 4.5 mc crystal controlled reo-transmitter. Ideal for hams, forest service, foreign, etc. Uses 7 peanut tubes and ordinary dry batteries that fit into same case. Weight less batteries, 6 lbs. With all tubes, mike, headset, antenna, bag, diagram and 2 crystals. LIKE NEW, 2 for \$58.00, Each.....\$29.95

**20 to 28 MC FM RECEIVER BC-603** for 11 meters; can be tuned to 10 meters with slight modification; superhet, BFO, squelch; 10 push-buttons and manual tuning. Makes 10 meter converter or IF strip for 88-108 MC wide-band FM; with all tubes, speaker, case, diagram. **FREE CONVERSION INSTRUCTIONS.**



UNUSED.....\$19.95  
USED, Excellent.....17.95  
Used, Good.....14.95

**DYNAMOTOR DM-34**, 12 V input for above.....\$3.00



**20 to 28 MC FM TRANSMITTER BC-604** for 11 & 15 meters; can be operated on 10 meters by use of proper crystal; 10 channel; with all tubes, meter, diagram, case and covers; less xtals and drawer.

USED, Excellent w/dyn.....\$19.95  
USED, Good, w/dyn.....15.95  
USED, Good, w/o dyn.....12.95

**BC-684 TRANSMITTER 27 to 38.9 MC**; 30 watt 10 channel (as above); with covers, tubes, meter, diagram; less crystals and drawer.  
U-1 with dynamotor \$34.95 Without dyn. \$32.95  
U-2 with dynamotor 29.95 Without dyn. 27.95

**PLUG**, Cannon female fits into any of above FM sets. Does away with Mounting FT-237. N-1.....\$2.45

**BC-659 and BC-620 ACCESSORIES. VIBRATOR POWER SUPPLY PE-120**, operates from 6, 12 or 24 volts depending on vibrator. With 12 or 24 v. vibrator, battery cable & plug. **UNUSED \$12.95**  
U-2.....\$9.95 Fair.....7.95  
Crystals for any channel 20 to 27.9 or 27 to 38.9 mc. each.....1.00  
Battery Case CS-79 w/plug, U-2.....1.95  
Handset TS-13 w/plug, NEW \$5.95, U-1.....3.95  
Diagram, BC-659 or BC-620......65  
Antenna, Sectional type fits MP-48, 9 ft. U-1.....1.95

**VIBRATOR POWER SUPPLY PE-157** operates from 2v wet cell (not included) which fits inside. Output: 1.4v @ 500 ma & 125v at 50 ma or 1.4v at 350 ma & 60v at 15 ma. Case 6"x6"x11 1/2" contains 4" speaker, vibrators, ximrs, diagram, etc. **BRAND NEW \$12.95**  
Mounting Rack.....1.95



### BARGAINS

**ANTENNA SWITCH, 3PDT**, extra heavy duty knife. Porc. stand-offs on base 7"x8"x3/4". Wt. 6 lbs. **BRAND NEW**. Per doz. \$12.00. Each \$1.19  
**PHONO-MOTOR & 9" TURNTABLE**, 115 vac, 78 rpm rim drive. NEW, orig. cartons.....\$2.89  
**TUNING UNIT TU-26**, 200-500 kc used in BC375. Has 13 hi-voltage mica & 1 var. condenser, 2 vernier dials, 2 variometers, etc. N-1.....\$2.95  
**VIBRATOR**, Rauland or Vokar JV-0014; "heart of PE237" for SCR 694. Six, 12 or 24 volt input. 2 1/2"x2 1/2"x5 1/2". **BRAND NEW**, original cartons, each.....\$4.95

N-1, new; U-1, used, excel; U-2, used, good

**TERMS** Postage extra. Please, minimum order \$2.00. Net Cash, 25% deposit on C.O.D.'s. **FREE LIST.**

**ELECTRONIC SUPPLIES**

219-R East 1st St. Tulsa 3, Okla.

# MARS

# Station of the Month

**H** EADQUARTERS, Airways and Air Communications Service, a support organization of the Military Air Transport Service, station K3FMC was named "MARS Station of the Month" by Major Rawleigh H. Ralls, Chief, MARS, Air Force.

The station is too new to have a long list of accomplishments to display, but the speed with which it was put on the air, its traffic handling activities, and its consistency of operation are indicative that the NCS for Headquarters AACCS will merit this recognition in its continued operation.

Master Sergeant Arthur R. "Mac" McKinnis, W4QOC, as chief op, puts in a full day pounding brass with an occasional break to put through a 10-meter schedule to DL4 or W5 land for a personal QSO for some member of MATS staff or their families.

C.w. operation occupies 99 per-cent of the time and the ultimate ambition is to be the lead station in the "Brass Pounders League" every month. At the moment K3FMC has entered the Eastern Shuttle Net on 7120 kc. at 1030 every morning. In addition to making deliveries in the Washington, D. C., area, Mac has a message box at Headquarters building, and this is generating a bit of traffic.

Organization of world-wide nets covering the far-flung outposts of Air-

ways and Air Communications Systems is waiting only on the clarification of call signs for MARS stations outside the ZI.

The station layout consists of an HT-4 (ancient vintage BC 610), a BC 610-E, and a home-grown peanut whistle for 40-meter operation exclusively. The HT-4 has been modified for 10-meters and is v.f.o. through the courtesy of T/Sgt. Leonard Finkle, ex-KL7FY, who built it out of surplus Navy gear. The 610-E is used for 20 and 80-meter operation in most part and is resorted to on 40 meters only when things are especially rough.

The pet transmitter is the one that Mac put together in the fall of 1945 using a BC 375 and one of its tuning units for chassis and cabinet. The v.f.o. uses a 6G6G oscillator and a 6V6 isolation stage. A VR-150 is used for voltage regulation. The transmitter proper uses a 6V6 doubler, a 6V6 buffer, which is keyed in the cathode, into an 807 with about 60 watts input. Mac feels the same way about shooting squirrels with a shotgun that he does about using more than 100 watts on 40-meter c.w.

The receiver complement consists of two SX 28s, two Super-Pros, a BC 342 and an Echophone.

Antennas really sprout from the shack. A 3-element close spaced,

Lt. James B. Bartlett (K3FMC), trustee, and Lt. (j.g.) Richard F. Thorpe observing message handling at K3FMC. L. to R.: M/Sgt. Alois M. Palenchar (W40WG) shown completing radio telephone contact; M/Sgt. Arthur R. McKinnis (W4QOC) copying traffic from W2MRL; Lts. Bartlett and Thorpe. Sgt. McKinnis is a non-commissioned officer in charge of K3FMC, Airways and Air Communications Service's amateur radio station.

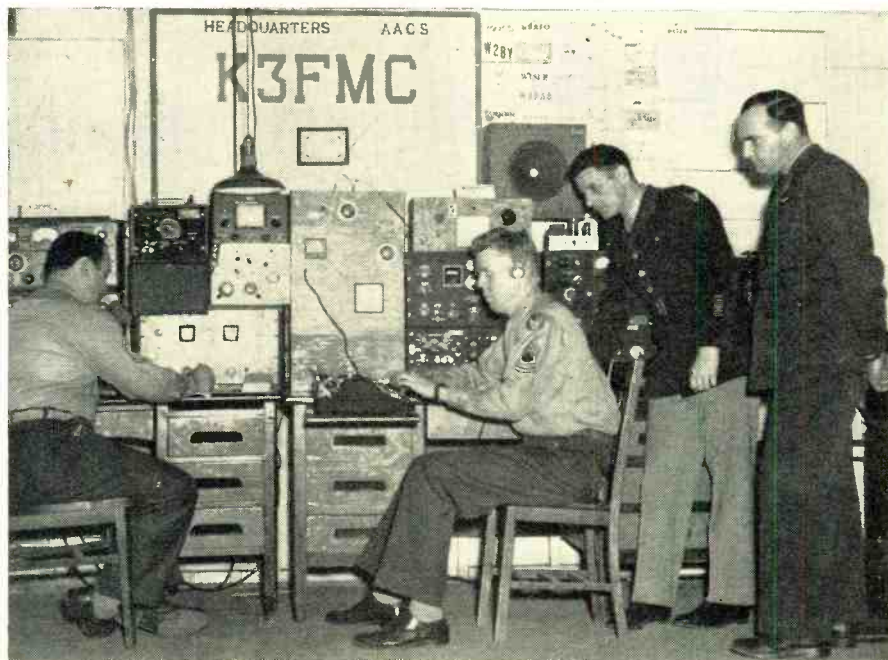

which is rotated by hand, is fed with a 600-ohm open wire line and is delta matched into the driven element because the owner of same did not want it cut in two. There is a 10-meter and 20-meter doublet, each fed with coax, an end fed 40-meter full wave, and a center fed Zepp cut for 80 meters that works well on all bands.

Unification of the services is exemplified in the operation of K3FMC with Lt. (j.g.) Richard F. Thorpe, W3PHB, at the key or on the horn, evenings and week ends. Lt. Thorpe is an instrument flying instructor at Anacostia Naval Air Station during the day.

Master Sergeant Alois Palenchar, W4OWG, as second op, spends as much time as his duties will permit, sometimes indulging in two-band operation or giving the first op a break. His ear is always cocked for VK2's since his XYL hails from Melbourne.

Lt. James B. Bartlett is station trustee for K3FMC and has also been appointed as MARS director for Headquarters, Airways and Air Communications Service.

The majority of the 200 odd QSO's per month are traffic handling or rag chews with DX holding only a small allure. The Gang at K3FMC say QRU? and are always happy to QSP.

-30-

## EUROPEAN TELEVISION FACILITIES

A RECENT London news item reports that only one country on the Continent (excluding Britain) can boast of television service at present. France is operating a 425 line transmission from the Eiffel Tower in Paris, and two additional French stations, operating with 819 lines, are being proposed. It will be a year or more before these are ready, however, and for the time being, no other Continental country has ordered any TV transmitting equipment, nor have any of them decided on the number of lines they will use. . . . K.B.

## ANNUAL S. T. E. N. CONVENTION

THE ANNUAL convention of the South Texas Emergency Net, largest emergency net in the world, will be held in Cuero, Texas, again this year, May 28 and 29. This is a real hamfest with emphasis on emergency and net operation. Attendance last year numbered between 400 and 500, and all OM's, XYL's, and others interested are invited to this year's celebration.

On both days, there will be entertainment as well as technical information, interspersed with lively contests and prize drawings. On Saturday, May 28, there will be a special mobile contest on the way to the convention, beginning at 7:00 a.m., in which as many stations as possible will be worked.

Besides the regular program, it has been arranged to have the FCC inspector present, and those who want to take their amateur license exams may do so on Saturday.

Contact B. B. Thorn, W5CIX, Cuero, Texas, for information, or tickets to the convention, which are \$2.50 each.

-30-

May, 1949

# SEE LEO FIRST . . . for HALLICRAFTERS!



**T-64 TV CHASSIS**  
For 10" or 12" tube  
Big picture TV at a small-set price. Factory wired, aligned, and tested . . . backed by RMA 90-day warranty. With speaker and all tubes except CR tube. Hallicrafters new Dual-Focus switch gives instantaneous selection of either 56 or 64 square inch picture on 10" tube.

**\$169.95**  
**DOWN PAYMENT \$33.95**

<b>10" TUBE</b>	<b>12" TUBE</b>	<b>CONVERSION BRACKET FOR 12" TUBE</b>
<b>\$34.50</b>	<b>\$66.00</b>	<b>\$8.50</b>



**LEO I. MEYERSON WØGFG**  
CU ON 10-20 & 75 METERS

**COMPLETE LINE OF HALLICRAFTERS**  
(DOWN PAYMENT 20%)

TV-509 (Television) . . . \$269.50	SX-42 (Receiver) . . . \$275.00
S-40A (Receiver) . . . 99.50	S-53 (Receiver) . . . 89.50
SX-43 (Receiver) . . . 189.50	SX-62 (Receiver) . . . 269.50
R-42 (Speaker) . . . . . \$34.50	

**IT'S EASY TO BUY FROM WRL!**  
Best E-Z Payment Plan in the country—We finance our own paper—no red tape! ONLY 20% DOWN—liberal trade-in on your present equipment. Deal with WRL—The World's Most Personalized Radio Supply House.



**S-38 RECEIVER**  
Overall frequency range from 540 KC to 32 MC in four bands. Main tuning dial calibrated with precision accuracy. Separate electrical bandspread dial. CW pitch control adjustable from front panel, automatic noise limiter, self-contained PM dynamic speaker. 105-125 volt AC/DC.

For the first time **NEW LOW PRICE** **\$39.95** Down Payment \$7.99

**SPECIAL SALE**—Brand new guaranteed 160 Meter Crystals in FT-243 Holders— Each **98c**  
Frequency range 1800 to 2000  
**WRITE FOR OUR BIG LIST OF SPECIALS!**

**World Radio Laboratories**  
INCORPORATED  
COUNCIL BLUFFS, IOWA

**WRITE - WIRE PHONE 7795**



**GIANT RADIO REFERENCE MAP**  
Just right for your control room wall. Approximately 28" x 42". Contains time zones, amateur zones, leading short-wave stations, monitoring stations. Mail Coupon Today and **25c**

**FREE**  
The most complete Ham Catalog ever assembled. Send for your copy today!



**TELEVISION RECEIVER—\$1.00**  
Complete instructions for building your own television receiver. 16 pages—11" x 17" of pictures, pictorial diagrams, clarified schematics, 17" x 22" complete schematic diagram and chassis layout. Also booklet of alignment instructions, voltage and resistance tables and trouble-shooting hints. —All for \$1.00.

**CERTIFIED TELEVISION LABORATORIES**  
5507-13th Ave., Brooklyn 19, N. Y.

**AUDIO ENGINEERING SCHOOL**  
A practical Audio engineering course in Sound Fundamentals: FILM and MAGNETIC Recording; Transmission Measurements; Monitoring and Mixing. Laboratories contain Transmission Sets, Oscillators, Harmonic Analyzer, Distortion Sets, Intermodulation Analyzer and other equipment. Recording Studio assimilating Broadcast, Motion Picture and Commercial Sound Recording. H. M. TREMAINE, Pres.-Director. Approved for Veterans and Foreign visas.

**HOLLYWOOD SOUND INSTITUTE, Inc.**  
1040-N North Kenmore, Hollywood 27, Calif.

**WORLD RADIO LABORATORIES**  
744 West Broadway  
Council Bluffs, Iowa R-5

Please send me:  
 Radio Map  
 New Catalog  
 List Of Used Equipment  
 Send Free Halli-crafter catalog

Name .....

Address .....

City..... State.....

**BARGAINS**

KEY Code Practice TAC J-38 New.....	\$ .49
TRANSFORMER—Kenyon Trans. Co. Primary 110 v. 60 cy. Sec. 5v @ 60 amp. C.T.....	4.49
CATHODE RAY TUBE—5CP.....	1.35
RADAR JAMMING TRANSMITTER AN/APT-2 Range 500-700 meg. 10 Tubes. New.....	9.49
RADAR RECEIVERS—BC-738D 10 Tubes 108-110 meg. New. With crystals.....	4.49
DYNAMOTORS—101-C Input 13/26 v. 12.6/6.3 amp. DC Output 400v. @ .135 Amp., 800v., .020 Amp. AC. Output 9v., 1.12 amp.....	2.95
METER—Weston or Westinghouse 0-150 v. AC, 2 inch panel mount.....	2.95
TUNING UNIT (1st It. F.) 2C4/2A1/7T.....	.95
CONDENSER—5 gang Navy RBA L481, silver plated, No. 1, 251 mmf; 2, 253; 3, 253; 4, 250 and 5, 252 mmf.....	2.49

All C.O.D. orders to be accompanied by 25% deposit. Orders without postage will be shipped express collect. F.O.B. Berwyn, Md.

**R. & T. ELECTRONICS COMPANY, INC.**  
9723 Baltimore Blvd. Berwyn, Md.  
Phone Tower 5384

## BRAND NEW NAVY EQUIPMENT

BG

115V  
60 cycle  
470 Mgc  
Xmtr  
493 Mgc  
Rcvr  
with  
Power  
Supplies



BUILT  
LIKE  
A  
BATTLE-  
SHIP

Less Tubes -72<sup>00</sup>

## MOBILE COMPANION UNIT ABA-1

470 Mgc. 493 Mgc. 12 or 24V. DC Input.

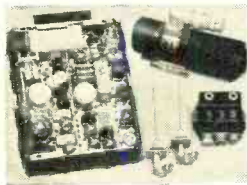

Furnished with tubes, all connectors, control box and antennas.

### FREE CONVERSION INSTRUCTIONS

All for only \$22<sup>50</sup>

Medium Impedance USED

Headphones Guaranteed.....50c

NAVY YJ-Racon

175 & 515 Mgc

Operates from 115 V 60 Cycle

Including 20' Mast

and Antennas NEW.....\$71<sup>50</sup>

### Butterfly Tuner NEW

2½" diameter .....\$1.25

5" diameter ..... 2.25

### Tubes

211 \$ .50 2k28 \$ 5.00 6SJ7 \$ .50

807 1.00 5R4G .75 6AC7 .90

2J22 12.00 C6J 10.00 931A 3.50

100 83-ISP Connectors.....\$25.00

100 83-IAP Connectors ..... 15.00

3" Weston 301 30V DC.....\$3.00

2" GE 30V DC..... 2.25

Kentucky's SURPLUS Home

## ELECTRONIC SERVICE CO.

119 S. 6th St.

Louisville, Ky.

## International Short-Wave

(Continued from page 58)

According to Nattugglan, Sweden, reports to Karachi should be addressed to Z. A. Bokhart, Esq., Controller of Broadcasting, *Radio Pakistan*, Mohammed Ali Jinnah Road, Karachi, Pakistan. The Swedish publication reports the 6.070 outlet is heard in Sweden 2130-2210, with news at start.

*Radio Australia* reports that the Dacca station is eager to receive reception reports, especially from distant points, and that the QRA is simply *Radio Pakistan*, Dacca, East Bengal, Pakistan.

Finally, here are a few brief background notes on Pakistan that may add to your enjoyment of its radio broadcasts:

The new Dominion of Pakistan comprises two zones a thousand miles apart, embracing portions of a number of predominantly Moslem provinces in the northwest and northeast corners of India and a number of Princely (native) States. The zones are connected by sea, air, and radio-telephone links. The area is approximately 361,000 square miles, and the population is upwards of 70 million. Pakistan consists of four provinces—East Bengal, capital Dacca; North West Frontier province, capital Peshawar; West Punjab, capital Lahore; and Sind, capital Karachi.

Karachi, the nation's capital, is a seaport and is an important airline junction as well, having the largest airport in all Asia. It is the seat of the Sind University.

The national flag of Pakistan is green and white; the white portion, which is one quarter of the flag, stands for the non-Moslem minorities; on the green part appears a white crescent and heraldic star.

As you probably know, Pakistan is essentially agricultural, chief crops being jute, cotton, wheat, and rice; in fact, the Dominion is the largest producer of jute fiber in the world. Tea and oil seeds are exported in quantity. A geological survey—now under way—has already revealed the existence of rich deposits of oil, coal, sulphur, salt, lime, chromite, asbestos, antimony, steatite, and gypsum.

Eastern Bengal was over-run by the Moslems at the end of the 12th century. It is a land of rivers, tributaries of the Ganges and the Brahmaputra. These serve as highways, and bring down the alluvial soil which makes it one of the most fertile countries in the world. It has a good seaport in Chittagong. Its products include tea, indigo, jute, timber, and many kinds of grain.

Pakistan was accepted as the 57th member of the *United Nations* on September 30, 1947.

As we take our leave of radio in the new Dominion of Pakistan, it is with a feeling that already the Dominion is

## Magnify Your Profits!

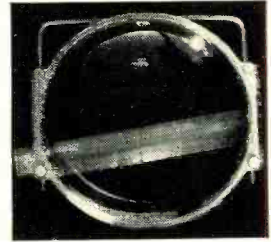

Buy direct from one of the largest Manufacturers of magnifiers for Television sets.

Our freeblown magnifier lens gives undistorted magnification at a wide angle. Available in clear or light blue. With universal bracket providing adjustment up or down—in or out. Fits any set on the market.

Standard lens with bracket for 10" tube, retails for... **23.95**

Standard lens with bracket for 7" tube, retails for... **19.95**

Both sizes available at slightly less with metal strap hangers designed for particular sets.

Regular dealer discounts of 50% on orders for two or more units.

Inquiries invited from Distributors.

## Crosdale & deAngelis Inc.

LENS DEPT.  
LENNI MILLS, PA.

# FREE

send today for this big book of values in



**TELEVISION**  
RADIO, ELECTRONIC,  
INDUSTRIAL, SOUND &  
AMATEUR EQUIPMENT

NEW 1949

## NEWARK CATALOG

20,000 items including everything in STANDARD BRAND equipment! 148 pages packed with pictures, charts, and vital information!

**KITS! SETS! PARTS! ACCESSORIES!**

No matter how tiny the part, how tremendous the system... it's listed in this mammoth catalog... the one easy, satisfactory way to always get top-performing, top-value equipment! The most complete essential reference book for pros, hams, lobbyists, novices, oldtimers... anyone, everyone interested in TV, radio and sound equipment!

24-HR. MAIL SERVICE • ONE YEAR TO PAY

**3 GREAT STORES!** Uptown at 115 West 45th Street and Downtown at 212 Fulton Street in NEW YORK  
323 West Madison Street in the heart of CHICAGO



MAIL COUPON TODAY

Newark Electric Co.  
242 W. 55th St., NYC

Dept. e- Please send FREE Newark Catalog to:

NAME \_\_\_\_\_

ADDRESS \_\_\_\_\_

CITY \_\_\_\_\_ STATE \_\_\_\_\_

RADIO & TELEVISION NEWS

well under way with its program for providing radio facilities—both for domestic and foreign consumption. Our hearty congratulations and best wishes for the future go this month to *Radio Pakistan!*

**Verification Data**

QRA for Tashkent is Radio Taschkent Broadcasting Commity, Taschkent, USSR. (Nattugglan, Sweden)

COCQ may be addressed in care of CMQ Network, Inc., Radio Center, Havana, Cuba. (Bachman, Pa.)

Here are a few current QRA's from Sidney Pearce, England—Foreign Broadcast Section, Radio Indonesia, Koningsplein Zuid 17, Batavia C., Java, D.E.I.; Forces Broadcasting Station, Station Commander, No. 4, Cyprus M.E.L.F. 3; JJOY, Grecian District, Office of the District Engineer, Corps of Engineers, Athens, Greece; VUM, Station Director, No. 15, Marshall Road, Egmore, Madras, India; Emissora Nacional, Rua do Quelhas, Lisbon, Portugal.

*Radio Hong Kong*, Hong Kong Broadcasting Studios, Hong Kong, has written Gaynor, Calif., thanking him for his reception report; stated "It was very welcome, as we don't often get a report from America. I'm afraid that we don't send out verification cards—we are a Government department, and the expenditure has not yet been approved. However, we enclose a schedule of our times of transmission, etc." The letter was signed by D. Keith Hardy, Program Secretary.

Address for XGT-2 series is Chinese Govt. Radio Admin., Sasson House, Tienchil Road, Shanghai, China. (Gaynor, Calif.)

**Club Notes**

*Sweden—Nattugglan*, "Night Owl," house organ of the Scandinavian DX-Club, is available to overseas club members for 20 IRC's for a whole year, 10 IRC's for a half year; QRA is Box 563, Jonkoping 2, Sweden. President of this fine organization is Karl-Ake Bergstrom; editor of *Nattugglan* is Viggo Bengtsson.

*United States—Walt Morgan*, Pa., informs me that the World-Wide DX Society has merged with the Dial Spinner's Club under the latter's name. Publishes a monthly bulletin.

**This Month's Schedules**

(NOTE: Some stations are now changing to Summer Time, in which cases schedules may be one hour earlier than listed herein.—K.R.B.)

*Albania—Nattugglan*, Sweden, lists Scutari on 8.220 at 2330-0100, 1300-1630, says at 1300-1400 has own program, but after 1400 relays ZAA, Tirana. It lists *Radio Korce* on 6.280 with weekday schedule of 0045-0200, 0530-1200, and Sundays 0630-0715, 1145-1505.

ZAA, 7.852, Tirana, heard in Newfoundland 1500-1630; *English* 1515-1530. (Peddle)

*Algeria—Radio Algiers*, 9.570, heard well lately in Arabic before 1445-1530 and French from 1530 to sign-off 1800.

May, 1949

# YOUR BEST VALUE

## IS IRC POWER WIRE WOUNDS

By any comparison, IRC is your biggest value in Power Wire Wound Resistors. Examine the *extra* features you get with these dependable IRC heavy duty resistors.

The exclusive moisture-proof coating is designed to the known scientific principle that a dark, coarse surface dissipates more heat more rapidly than a smooth, shiny surface. This means better performance.

For easier installation, IRC provides both lead and lug on the same terminal. Lugs may be clipped for space saving in crowded chassis, and heavy tin dipping assures easy soldering. Resistor ends are clean and free of coating—permitting easy vertical mounting with tie-bolts. Bracket mountings are available for larger power wire wound types. Clear identification of type and range on every IRC Power Wire Wound is permanent . . . for easy, accurate replacement.

And here's a feature that should not be taken for granted—IRC Power Wire Wounds *handle full rated power*. No derating is required at high ranges.

When you buy power wire wound resistors, always ask your distributor for IRC—most for your money by any comparison. International Resistance Co., 401 N. Broad Street, Philadelphia 8, Pa. *In Canada:* International Resistance Co., Ltd., Toronto, Licensee.

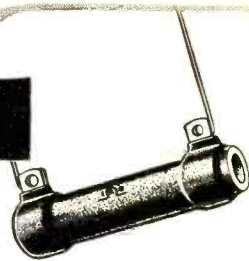

**COMPARE THE COATING**  
dark and rough for rapid heat dissipation.

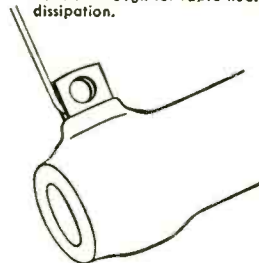

**COMPARE THE TERMINALS**  
both lead and lug on same heavily tinned terminal.

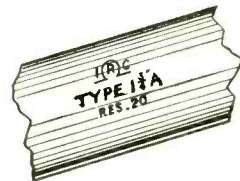

**COMPARE IDENTIFICATION**  
permanent marking shows type, size and resistance—will not fade.

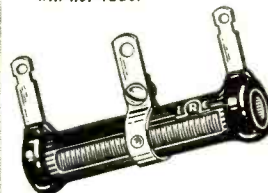

**COMPARE PERFORMANCE**  
IRC PWW's handle full rated power—no derating required at high ranges.

### INTERNATIONAL RESISTANCE CO.

Wherever the Circuit Says ~~~



fixed and adjustable types in wide range of ratings, sizes and terminal types.



**RADIO and TELEVISION**

Thorough Training in All Technical Phases  
APPROVED FOR VETERANS

WEEKLY RATES      DAYS—EVENINGS

RCA GRADUATES ARE IN DEMAND  
For Free Catalog write Dept. RN-49  
RCA INSTITUTES, Inc.

A Service of Radio Corporation of America  
350 West 4th St., New York 14, N. Y.

**FREE**

Send name and address for our free catalogue, chock-full of standard brand radio and TV sets, parts and equipment at rock bottom bargain prices.

COMMERCIAL RADIO, Dept. N  
36 Brattle St.      Boston 8, Mass.

**FL-8 FILTER**

ONLY to the Signal You WANT to Hear



Improves ANY receiver! 1020 cps Filter, connects between output of receiver and phones or speaker. Hear only ONE signal at a time. Cuts out interference and background noise. AMAZING PERFORMANCE! BRAND NEW War Surplus item. Add 40c for postage. Cash with order. **\$1.79**

ESEGE SALES CO.  
1306 Bond St., Los Angeles 15, Calif.

**NOW FOR GREATER TELEVISION ENJOYMENT**

# Tele-Turn

**A UNIQUE TURNTABLE FOR ALL TABLE TOP TELEVISION SETS**



No more strained eyes or strained necks. No more shifting of your furniture. Now everyone can enjoy your television set at once.



No Fuss—No Botler; Simply Place the Tele-Turn Centrally Under Your Television Receiver. With a Feather-touch Turn You Can Gently Turn Your Set in Any Direction. Tele-Turn Will Hold the Largest and Heaviest Sets.



The Bottom of the Turntable Is Fitted with Heavy Rubber Suction Cups; No Slipping or Marring of Furniture.

# Tele-Turn

This unique television turntable was created by popular demand. It allows your television set to be seen from any point in the room by any number of people at the same time and without strained necks or strained eyes. It is made of heavy gauge steel. The top plate is felt covered and so constructed that you get ventilation for the bottom of your television set. Tele-Turn is also adaptable for use under heavy ham equipment.

Send for your Tele-Turn today, only... **\$7.95**  
F.O.B. Chicago

**DEALER INQUIRIES INVITED**

Manufactured by

**KRENCO MFG. INC.**

231 South La Salle St., Chicago 4, Illinois

(Hagen, Ala.) Heard testing on 11.836 at 1145-1230. (Swedish DX)

*Anglo-Egyptian Sudan*—Omdurman is still heard on approximately 9.750 during Arabic session 1400-1430; call of "Huna Omdurman" is clear and distinct. (Pearce, England) Other British listeners report this channel audible in England 1130-1300, 1400-1430. Only English is Fridays 1230-1300. (Swedish DX)

*Angola*—CR6RL, 8.090, Luanda, heard 1330-1600 sign-off, same for CR6RA, 9.470. (Peddle, Newfoundland)

*Argentina*—LRS, 9.315, Buenos Aires, heard 1730-2100; LRU, 15.290, heard 1515-1600. (Peddle, Newfoundland) LRY-1, 9.545, heard 0515 with Spanish news. (Alfred, Ontario)

*Australia*—Recent schedule alterations of *Radio Australia* effected these current listings—at 0900-0945, VLA6, 15.200, to N. Asia, British Isles and Europe, while VLC11, 15.21, is used to S. Asia, British Isles and Europe; 0900-1000, VLB3, 11.76, to S. Asia, British Isles and Europe, and same time, VLG3, 11.71, to same areas. At 1000-1115, VLA6, 15.20, to North America (West Coast), VLC3, 11.76, to same area, VLG3, 11.71, to S. Asia; at 1015-1115, VLB9, 9.615, to Africa. At 1500-1655, VLC (dependent on BBC monitoring report for clear channel, may be one of 15.16, 15.21, or 15.22), to British Isles and Europe; 1710-1815, VLC9, 17.84, to South America; other schedules remain as previously listed. (Hutchins)

Graham Hutchins, DX Editor of *Radio Australia*, has airmailed me complete current schedules of the Inland Short-Wave Service of the Australian

Broadcasting Commission. *Melbourne*—VLG6, 15.23, Sunday through Friday 1500-1700, Saturday 1545-1700; VLR2, 6.15, Sunday through Friday 1500-1715, Saturday 1545-1715, Monday through Friday 0345-0830, Saturday 0345-0900, and Sunday 0230-0830; VLR, 9.54, Sunday through Friday 1730-0330 (next day), and Saturday 1730-0215 (next day); VLH4, 11.88, Sunday through Friday 1500-1815, Saturday 1545-1815; VLH5, 15.23, daily 1830-0315 (next day); VLH3, 9.58, Sunday through Friday 0328-0830, Saturday 0328-0900. *Sydney*—VLI2, 6.09, Sunday through Friday 1500-1745, Saturday 1545-1730, Sunday through Friday 0330-0830, Saturday 0330-0900; VLI3, 9.50, Sunday through Friday 1800-0315 (next day), and Saturday 1745-0315 (next day). *Brisbane*—VLQ3, 9.66, Sunday through Thursday 1500-0830 (next day), Friday 1500-0900 (next day), and Saturday 1545-0830 (next day). *Perth*—VLW3, 11.83, daily 1930-0300 (next day); VLW5, 9.61, Sunday through Friday 1700-2115, Saturday 1745-2115, and Sunday through Friday 0515-1030, Saturdays 0515-1100.

*Port Moresby (Br. New Guinea)*—VLT5, 7.28, Sunday through Thursday 1545-1900, Friday 1545-1730, Saturday 1645-2000, Monday through Friday 0315-0730, Saturday 0315-0800, Sunday 0315-0700; VLT7, 9.52, Sunday through Friday 2100-2300, Saturday 2100-0300 (next day), Monday through Friday 0030-0300, and Sunday 0100-0300.

VLI3, 9.50, Sydney, N.S.W., heard in California after XEWW, Mexico City, leaves this channel 0100; is best 0230. (Balbi)

(Continued on page 159)

## LEAD-IN FASTENING TO TELEVISION ANTENNA

By MATTHEW MANDL

THE place where the twin-lead or coaxial cable fastens to the terminal posts of the antenna should never be the means of support for the weight of the transmission line. When the line is not pulled tight, the combined weight of the lead-in and the constant flexing the connection receives during windy days, will break the connection.

Even if it is desired to run the lead-in well away from the supporting mast in order to minimize losses, an extra fastening should be made eight or ten inches below the antenna to support the lead-in weight and prevent flexing of the lead-in at the terminal joints. This may be accomplished by use of the metal stand-off insulator with the polystyrene insert as shown in Fig. 1.

A hole is drilled through the supporting mast so that the insulator can be bolted on. If the insulator end is of the wood screw type, a slightly smaller drill can be used so that the insulator will partially make its own thread as it is turned into place. With the twin-lead type, a pair of pliers can be used to press the loop tightly around the insert. This forces the slot closed and holds the twin-lead rigidly. A thin hole can also be punched exactly in the center of the twin-lead insulation, one above the stand-off insulator, and one below.

Thin string can then be pulled through the holes and tied around the insulator to prevent movement of the twin lead through the slot.

With the coaxial-type line, a stand-off insulator made for the coaxial is used. Two pieces of size 14 wire are looped around the coaxial above and below the insulator, and twisted tightly so that the line cannot shift down and exert a strain on the terminals at the antenna. Inasmuch as the outer conductor of the coaxial is at ground potential and covered with insulation, the twisted wire around it will not alter its characteristics.

—30—

Fig. 1.

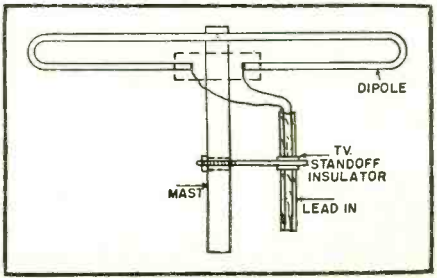



# Best By Comparison!

## THE MEISSNER 8C FM RECEPTOR

**New Ceramic Components Assure  
Even Finer Performance**



This outstanding receptor now offers even finer performance, truer tone, more stability—the result of new design changes and the exclusive use, wherever possible, of ceramic components.

Designed for simple connection to present AM radio receivers, the 8C instantly converts them to standard AM or thrilling, static-free, high fidelity FM reception.

It is also excellent for use with Phono Amplifiers, or with Public Address Systems.

### Compare These Features:

- **AUDIO FIDELITY:** Flat within plus or minus 2 db. from 50 to 15,000 CPS.
- **SENSITIVITY:** 40 microvolts.
- **AUDIO OUTPUT:** 3 volts R. M. S. at minimum usable signal input, 30% modulation. For greater signal inputs, output voltages as high as 15 volts R. M. S. obtained without distortion.
- **AMPLIFIER REQUIREMENTS:** Any high quality audio power amplifier may be used which has high impedance input and which will produce full output with 10 volts R.M.S. audio input.

See and hear the new 8C Receptor at your Meissner Jobber.

# MEISSNER

MEISSNER MANUFACTURING DIVISION  
Maguire Industries, Inc., Mt. Carmel, Illinois

## Now \*DYNAMIC NOISE SUPPRESSION

with your present Radio-Phonograph or Amplifier on both Standard and Long-Playing Records.



Reduces *scratch* and *rumble* without fixed loss of "highs" or "lows".  
Add realism to your music reproduction by these 2 simple steps.

1. Plug in the "Little Wonder" \*Dynamic Noise Suppressor between your pickup and amplifier.
2. Plug in the socket adapter to the power-tube socket.

The "Little Wonder" (Type 110-A) realizes the full capabilities of your present equipment; remote control mounts anywhere; high-and-low-frequency noise suppression; two inductor type high-frequency gate circuit; two separate control rectifiers; compact — 7 x 3 3/4 x 4 3/4 inches. For full specifications write for bulletin 549 RN-1.

\*Licensed under U. S. and foreign patents pending and issued.

**HERMON SCOTT  
HOSMER INCORPORATED**  
"PACKAGED ENGINEERING"  
385 PUTNAM AVE • CAMBRIDGE 39 MASS

## TV LENS FILTERS — SAVE \$\$

**REDUCE GLARE & EYESTRAIN**  
IMPROVE PICTURE QUALITY! Heavy blue tinted acetate, EASILY ATTACHED—A MUST for complete TV enjoyment.  
For 7" tubes... \$ .75 For 15" tubes... \$ 1.89  
For 10" tubes... \$ .89 For 20" tubes... \$ 3.39  
For 12" tubes... \$ 1.39



## HEARING AID AMPLIFIER ASSEMBLY

(Sonotone Vacuum Tube type). Make a real VEST POCKET RADIO or AMPLIFIER, adding only small tuner & speaker or phone. Ready-wired miniature components including 2 controls, output trans, choke, switch, resistors, condensers, etc. Overall only 2 1/2" x 5" — WEIGHS ONLY 3 1/2 ozs! Less tubes & case. COMPLETE WITH DIAGRAMS FOR 2 or 3 TUBE SETS... NOW ONLY \$249

GENERATOR VOLTAGE REGULATOR (GE)—Navy type GBD-1-A-18). Contains valuable 24 stepped contact 24V adj. relay; asstd. resistors, plugs, sockets, shock mounts, etc. Shpg. wt. 4 lbs. \$1.49  
A STEAL AT... SELENIUM RECTIFIERS—F.W. bridge. 18V. AC input @ 1/2 amp. cont. 5/8" x 3 1/4" . . . . . 98c  
1/2 Wave. 54V. AC input @ 1 amp. 1 3/4" x 1 1/2" —ea. 69c; 4 for . . . . . \$2.49

## "KIT OF THE YEAR"

**LEOTONE'S JUMBO RADIO PARTS KIT "NEVER A BETTER BUY—MOST FOR MY MONEY"**  
says Radioman James E. Riley of West Chester, Pa. That's what they're all saying about this gigantic assortment of new & dismantled Radio & Electronic parts—17 FULL POUNDS OF COILS, SOCKETS, WIRE, SPEAKER ACCESSORIES, TRANSFORMERS, RESISTORS, CHASSIS. ALL THESE (shpg. wt. 21 lbs.) AND MUCH MORE FOR ONLY... \$249

## CABINET DRAW SLIDES

FOR CONSOLE CHANGERS, RECORDERS, TRANSMITTER RACKS, DRAWERS OF EVERY TYPE. Sturdy steel & aluminum ball-bearing action. Shpg. wt. 3 lbs.  
9" extension (13" overall) . . . . . \$1.89 pair  
11" extension (15" overall) . . . . . 1.98 pair  
12 1/2" extension (16 1/2" overall) . . . . . 2.19 pair  
Hvy. duty, all-steel. 12 1/2" / 16 1/2" . . . . . 2.75 pair

## HERE IT IS BRAND NEW!

**ARMY FIELD WIRE (W-110)**  
All-purpose twisted pair for Radio, Telephone or Bell Wiring. Impregnated cotton & rubber. 7 strand steel & copper. Available only in coils, 300 to 450 ft. Specify min./max. length desired. Shpg. wt. 4 lbs./100 ft. WHILE IT LASTS! 1/2c per ft.

Mtn. order \$2.00—20% Deposit on all C.O.D.'s. Please add sufficient postage—excess refunded.  
**LEOTONE RADIO CO.**  
65 Dey Street  
New York 7, N. Y.

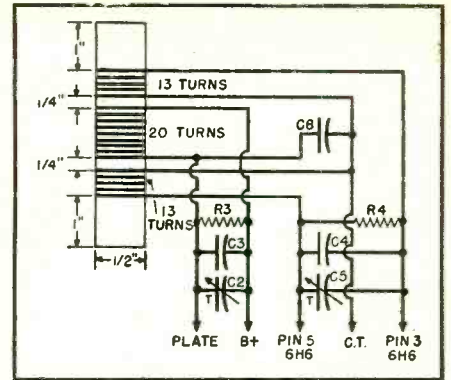
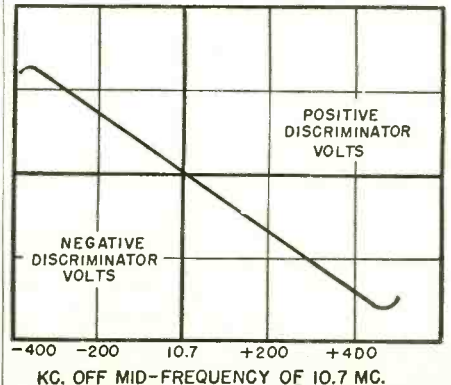

Fig. 4. Winding specifications and wiring details of the discriminator transformer.

used. Since it is desirable to use variable air condensers for better stability, this requirement limits the tuning range since it is also well to make these tuning condensers as small as is physically possible so that they can be made an integral part of the discriminator transformer assembly. However, the condensers used in this transformer, though small physically and capacitively, have ample tuning range to adjust the resonant conditions of the transformer properly.

The winding data is given in Fig. 4. The primary winding consists of 20 turns of #29 double nylon covered copper wire (#29 D.C.C. may be used as well) close wound. The secondary consists of two windings of 13 turns of #29 D.N.C. close wound, one winding being displaced 1/4 inch above and the other displaced 1/4 inch below the secondary winding. All windings are wound in the same direction, with the common center tap ends of the secondary winding placed closest to the primary winding. The fixed capacitance of the primary circuit is 30  $\mu\text{fd}$ ; while that of the secondary circuit is 40  $\mu\text{fd}$ . Midget micamolds were used to conserve space. The variable tuning condensers are Underwood silver-plated 1.5  $\mu\text{fd}$ . variable air condensers, that of the primary being placed at the bottom of the transformer form and that of the secondary at the top of the form. The windings are held in place by applying a thin coat of liquid polystyrene coil dope. The 10,000 ohm damping resistors and the 50  $\mu\text{fd}$ .

Fig. 5. Discriminator characteristic.



RADIO & TELEVISION NEWS



coupling condenser are mounted within the transformer shield.

The frequency discriminator characteristic curve is shown in Fig. 5. The data for such a curve may be obtained by means of an unmodulated variable frequency oscillator, a vacuum tube voltmeter and a discriminator circuit as shown in Fig. 1. The data for the characteristic shown in Fig. 5 was actually obtained by using a Model 900 Vomax and a surplus Signal Corps signal generator I-222-A. Using such equipment with an input of 0.05 volts the maximum discriminator output voltage was about  $\pm$  one volt. In order to have a correctly operating discriminator, the characteristic curve shown in Fig. 5 should be obtained. The i.f. frequency of 10.7 mc. should be applied to the grid of the last limiter stage and the output of the discriminator measured across the diode load resistors (points "a"- "c" in Fig. 2) by means of a vacuum tube voltmeter. There should be a zero voltage output when the input frequency is exactly 10.7 mc. As the input frequency at constant voltage is varied positively and negatively with respect to the center frequency of 10.7 mc. the output voltage should vary linearly as shown by the characteristic in Fig. 5. If the output voltage is not zero at 10.7 mc. then the transformer secondary tuning condenser,  $C_s$ , should be adjusted until this condition is met. The linearity of the characteristic is adjusted by means of the transformer primary tuning condenser,  $C_p$ .

## DUST IN PROJECTION TELEVISION RECEIVERS

BY MATTHEW MANDL

TELEVISION receivers using the direct projection method or the modified Schmidt system, are prone to gather a considerable amount of dust on lenses and picture tube faces, with the result that brilliancy is reduced to a considerable degree. Unless the entire unit is hermetically sealed, dust will get through the various small crevices and holes in the projection system housing. The television serviceman is usually surprised when he inspects such sets after a half year's use, to find how much dust has actually accumulated within the "barrel" which houses the spherical mirror, the tube, and correcting lens.

When projection sets are serviced, a complete check should be made of all glass or mirrored surfaces involving the projection system. A successive accumulation of dust on all the components of the system all add up to produce a marked reduction in picture brilliancy. The corrector lens, the reflecting mirror, the face of the projection tube, the viewing screen, or any other part that has to do with the projected function of the picture, should be first dusted off with a soft, dry cloth so that the abrasive characteristics of the dust will not injure the highly mirrored or polished surfaces. A chamois, soaked in warm water and wrung nearly dry should then be used to clean the surfaces thoroughly.

-30-

May, 1949



**HEAR AND TRY** **BEFORE YOU BUY**

Visit Sun Radio's sensational 1000 ft. "Self-Service" Sound & Television Studio.

# FOR SOUND IT'S SUN RADIO

(on Duane Street)  
Hours: 9 A.M. to 6 P.M.  
Saturdays, 9 A.M. to 4 P.M.

**TUNERS:** Meissner 8C, FM Tuner \$38.33  
Meissner 6L, FM, Chassis \$34.33  
Howard 482, FM Tuner \$35.90  
Espey 512, FM-AM \$80.51  
Radio Craftsmen, FM-AM \$110.00  
Browning RV-10, FM \$87.71

## SUN RADIO 10 W. HI-FI AMPLIFIER KIT!

From design published by Consumers Research, Inc. of Washington, N. J.

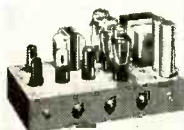

Build this high-quality all-triode, self-biased, High-Fidelity amplifier for much less than you'd expect to pay! Kit composed and chassis punched in accordance with the design published by Consumers Research, Inc., of Washington, N. J., in Special Bulletin 31. Compare these specifications!

- Freq. Response: 20-15,000 c.p.s.  $\pm$  1 db
- Built-in preamplifier and equalizer for use with magnetic cartridges.
- Individual bass & treble electronic tone control circuits.
- Hum level is 60-70 db below rated output at radio input.
- Distortion: less than 2.5% at 10 watts; 2.5% at mid-frequencies at 11.8 watts.
- Gain: radio, 75 db; phono, 97 db; magnetic pickup, 117 db.
- Tubes: 6SC7, 6J5, 2-6SN7, 2-6B4G, 5U4G.
- Complete with all 7 RCA tubes, components, punched chassis, hardware, etc., and easy step-by-step instructions. Great buy! Order now!

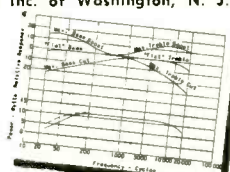

**FREQUENCY RESPONSE CHART**  
Lower curve shows power output. (2 1/2% distortion, solid line; 5% distortion, broken line.)

Triode Kit, Model CR-10, complete ..... **\$42.50**  
Laboratory-wired and tested ..... \$69.50

## NEW WEBSTER 3-SPEED CHANGER

Terrific! Plays standard (78 rpm), LP (33-1/3), and RCA (45) records. Beautiful tonal quality. Uses plug-in heads for use with Variable Reluctance cartridges of any make. Automatically correct stylus pressure. Instantaneous changeover to 45 rpm. Complete with 2 plug-in heads, 45 rpm spindle adaptor, hardware, and template.



Less cartridges, your cost ..... **\$25.95**

## "TWIN-TILT" MAGNETIC CARTRIDGE WITH 2 STYLI!

Electro-Voice. 2 sapphire tips (for 78 rpm and LP) on one cartridge. Perfect for converting Webster 256-1 and other changers from xtal to High-Fidelity Variable Reluctance pickup. Both styli replaceable. Use with any preamplifier or EV #503 transistor. FREE—for limited time: 45 rpm adaptor, with purchase of "Twin-Tilt"

Your cost ..... **\$7.64**

SUN RADIO & ELECTRONICS CO. Inc.  
122-124 Duane Street  
New York 7, N. Y.

Please put me on your Special Mailing List for all bargain flyers and bulletins.

NAME .....  
ADDRESS .....  
CITY .....  
ZONE ..... STATE .....

## SPEAKER VALUES!

GE 1201D, 12", cone type ..... \$17.35  
Altec 400B, 8", diacone ..... \$18.00  
Altec 600B, 12", cone type ..... \$45.00  
Stephens P22-FR, 12", co-spiral ..... \$41.16  
Jensen JRP-40, 12", co-axial ..... \$19.60  
University 4401 tweeter ..... \$11.76  
Univ. 4407 tweeter adaptor, with #4401 tweeter, mounting cowl, etc., (shown) \$14.70

## HUNDREDS OF CARTRIDGES IN STOCK:

GE SPX-040, .003 stylus, VR cartridge ..... \$5.82  
GE SPX-041, .001 stylus, VR cartridge ..... \$5.82  
Astatic MI-2M, .003, magnetic cart. .... \$4.41  
Astatic MI-2M-33, .001 magnetic cart. .... \$4.41  
Pickering R-150, replaceable stylus cart. .... \$9.90  
Styli for above, .002, .0025, .003, each ..... \$2.40

## GOODSELL NOISE-SUPPRESSION FILTER

A sharp cut-off filter for use with magnetic pickups. Install in a few seconds. You quickly choose a maximum high frequency range for any given record to minimize noise without serious loss of music signal. Get it at Sun Radio.

Your cost ..... **\$7.50**

4-HOUR MAIL ORDER SERVICE! 25% DEPOSIT.

# SUN RADIO

AND ELECTRONICS COMPANY, INC.

122-124 DUANE STREET

New York 7, N. Y. BArlay 7-1840

2 BLOCKS NORTH OF CHAMBERS ST.



## RADIO COURSES

Preparatory Mathematics, Broadcast, Marine Operating, Servicing, Aeronautical, Television, Frequency Modulation, Radar.

Classes forming for Summer term June 1.  
Entrance examination May 16  
Veteran Training, Literature

### COMMERCIAL RADIO INSTITUTE

(Founded 1920)  
38 W. Biddle St. Baltimore 1, Md.

## TELEPHONES

Now — Deluxe quality telephones incorporating latest improvements in design and technique. No scrap parts — but real honest to goodness first class material and finest workmanship. Lowered costs due to increased volume make possible this special low price.



**DESK MODEL**  
**\$17.95 PAIR**

either type shown complete with wire, power supply and instructions.

Ready to Hook Up  
Anyone Can Install  
25% deposit required  
on C.O.D. orders

**DUNN-WRIGHT ELECTRIC CO.**  
667 6th Avenue  
Brooklyn, N. Y.

**WALL MODEL**



**HERE IT IS!  
JUST PUBLISHED!**

**TELEVISION  
ANTENNA  
INSTALLATION**



**For Those  
Who Want  
to Know  
How**

**A PRACTICAL BOOK THAT  
SHOWS YOU STEP BY STEP**

Proper antenna installation can do as much for a television receiver as 2 R.F. amplifiers or a special booster. And unless you get the signal into your set, even the most expensive receiver will function poorly. TELEVISION ANTENNA INSTALLATION covers every phase of installing a television antenna showing how to get the most out of every installation. Every step is clearly and simply explained so that any radio man can do the job right the first time. NO PREVIOUS EXPERIENCE NEEDED.

**WORK FASTER, MAKE MORE MONEY  
ELIMINATE EXPENSIVE RECALLS**

Here is the practical approach. Full information is given on how to choose the best antenna, how to find the right location, what mounting brackets to use, which transmission line is best, and even what tools to have. Nothing is left to your imagination. This is a book designed for the man who will do the job.

**ORDER NOW . . . LIMITED PRINTING  
OVER 100 PAGES . . . \$1.50  
MORE THAN 100 ILLUSTRATIONS**

**10-DAY MONEY-BACK GUARANTEE**

**Consolidated Publications,  
55 East Washington Street,  
Chicago 2, Illinois**

- Enclosed find (check) (money order) for \$..... or,  
 Send C.O.D. (no C.O.D.'s outside U.S.A.) and I will pay postman this amount plus a few cents postage. In either event, I may return books within 10 days for complete refund of my remittance.

Name .....  
Address .....  
City ..... (Zone No.) .....  
State ..... RN-2

# Navy Men Open New "HAM" Station at Pearl Harbor

**O**NLY fifteen days after construction was started on the all-Navy "ham" station, KH6TX, at Pearl Harbor, it went on the air for the first time, September 30, 1948.

Under the guidance of Commander Ashton B. Jones, Jr., USN, of Sugar Creek, Mo., and James W. Armstrong, chief electronic technician, USN, of Windham, Ohio, the officers and men worked in their leisure hours to construct one of the most powerful amateur stations in the Hawaiian Islands. They gathered surplus and surveyed radio parts from sources in the Hono-

lulu area, and utilized the highly specialized Navy course in constructing and operating this popular hobby of amateur communications.

King-How-6-Tare-Xray, operating at the legal power limit of 1000 watts, is licensed in the name of Commander Jones, fleet maintenance electronics officer. Of the men at the Maintenance Unit, four are licensed operators, including Commander Jones and Chief Armstrong. The others are studying the International Morse Code in preparation for their "ham" licenses.

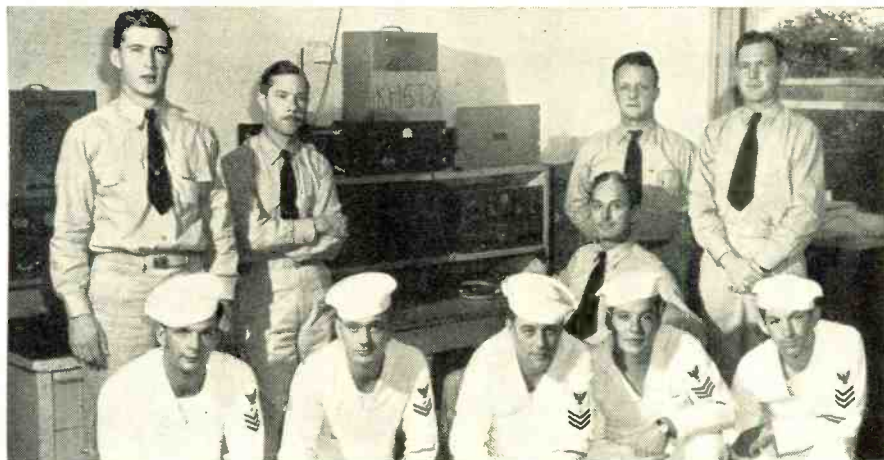

Officers and men of the Fleet Electronic Maintenance Unit at Pearl Harbor. These Navy electronic specialists combined their talents and leisure hours in constructing KH6TX in less than fifteen days from non-operative parts of surplus and surveyed equipment. Commander Ashton B. Jones, Jr., USN, is shown, seated, second row.

This quonset hut is the home of King-How-6-Tare-Xray, at Pearl Harbor, one of the most powerful "ham" stations in the Hawaiian Islands. The three-element rotary beam is seen in the foreground attached to the roof of the quonset hut. The other antenna, a long wire, is shown in the background, mounted on a tripod.

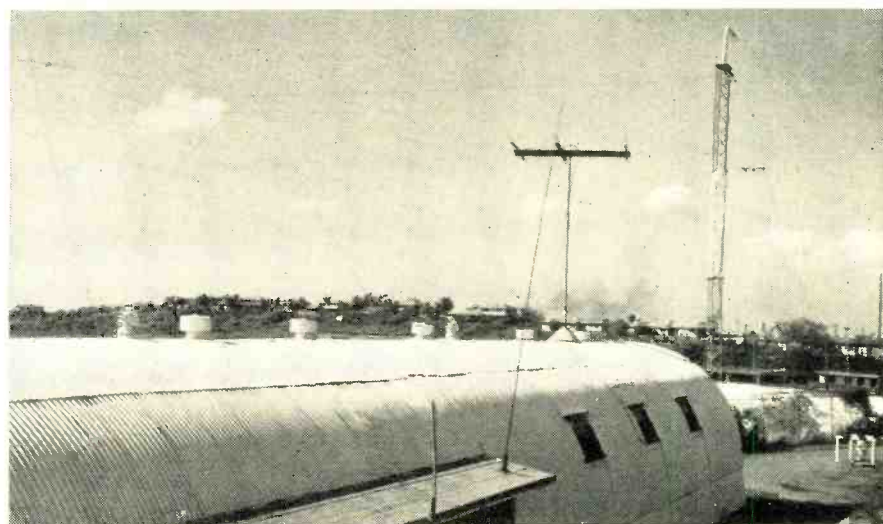

Chief Armstrong reported that there is no other outfit in Hawaii more powerful than KH6TX. It tries to deliver messages anywhere in the world and to arrange radio-telephone contacts between the members of the Armed Forces in that area and their families and friends back home. One bluejacket at Pearl Harbor talks regularly with his wife in Wichita, Kansas.

The so-called "home-constructed" station was made from parts that were in non-operating condition. The Navy technicians modified some parts and repaired others in forming their station, constructing two transmitters and a three-element rotary beam antenna.

Working on the 10, 20, and 40-meter bands, KH6TX, Pearl Harbor, now carries on conversations with Japan, Australia, New Zealand, the United States, Canada, and the many "hams" in the vast Trust Territory of the Pacific Islands.

### "REPS" GOPHER CHAPTER SELECTS NEW OFFICERS

THE GOPHER chapter of "The Representatives" of Radio Parts Manufacturers, in one of their recent monthly dinner pow-wows in Minneapolis, elected Jack Heimann as the new president, Fred B. Hill, vice-president, and Al Warner as secretary-treasurer.

Delegates to the "Reps" annual meeting, to be held in connection with the radio parts show in Chicago during May, were also selected. Fred Hill, a member of the Industry Relations Committee of the national group, will be delegate chairman, with Al Warner and Mel Foster supporting him. Alternates are Merrill Franklin, Herb Richardson, and Marvin Kirkeby.

The Gopher group gets together in the well-known "Hucksters" room at "Harry's Cafe" in Minneapolis on the third Monday of each month to hash over mutual problems and cooperative promotion. The Gopher motor caravan "Radio Trade Tour" last Fall was so successful that a similar program is in prospect for late this year.

Sun Radio's Burt Zimet, manager of the Sun's Test Equipment Center, is shown instructing a serviceman in the proper use of a new television signal generator at one of the fully-equipped test benches. The Center at 122-124 Duane St., New York, N. Y., displays all of the latest types of testing devices, and these are at the disposal of servicemen and dealers, who are urged to come in and try before they buy.

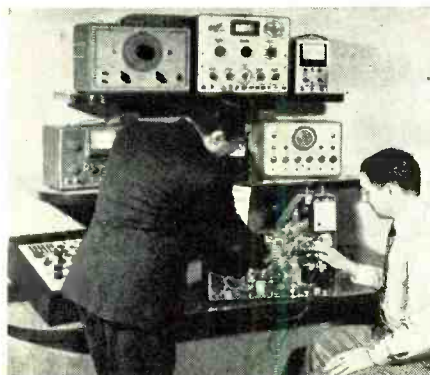

May, 1949

## TREMENDOUS TELEVISION VALUES AT FEDERATED



### Federated Antenna Towers

Get your antenna up high, and watch signal strength climb. Excellent for fringe area TV installations, hams, etc. All welded construction, with patented supports. Lightweight, but rigid and rugged to withstand severest conditions. It is a universal antenna mount. Can be used with any rotator unit. (Less antenna.)

E190 (Illustrated)—20 ft. tower, 10' adj. pole in cap. Total height, 28 ft. **\$24.00**  
 C103—10' top section with 10' adj. pole and cap. **\$19.79**  
 M102—10' center section **\$14.29**  
 B101—Base section **5.88**  
 1250 ft. pkg. of 6 strand #20 guy wire. **\$3.50**  
 1250 ft. pkg. of deluxe heavy duty, cushion center guy wire. **\$5.40**

### ICA "WASP" ANTENNA

An attractive, decorative, tabletop TV antenna. Dipoles are fixed in a swivel base for "peaking" each channel. Permits horizontal and vertical orienting, and length adjustment for desired channel tuning. Comes complete with length of 300 ohm line, equipped with plugs for insertion into jacks on TV antenna. Only. **\$4.17**



### Federated Wave Trap

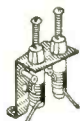

Reduces interference from FM stations. Stabilizes picture. Connects to antenna terminals on TV set. Use with any set. Terrific value. Order now. **\$1.95**

### Federated Glare Filter



Reduces glare and eyestrain, improves contrast. Available in smoke or blue—specify.  
 7" tape adhesive **52c**  
 10" tape adhesive **66c**  
 10" suction cups **77c**  
 12" tape adhesive **\$1.15**  
 12 suction cups **\$1.27**

### 18-DRAWER EQUIPTO



### STEEL SHOP CABINETS

Remarkably useful assembly, contains 18 drawers, each with 4 removable adjustable compartments. Olive green baked enamel finish. Width 34", height 13 3/4", depth 12". Cabinets may be stacked or used individually. **\$26.50**  
 YOUR COST **\$14.50**

MAIL ORDERS TO N. Y. OFFICE DEPT. 28-H

Please include 25% Deposit with order. Balance C.O.D. Minimum C.O.D. order: **\$5.00**

Federated INCORPORATED CABLE FEDERPURCH

NEW YORK CITY

80 PARK PLACE  
 Dlgby 9-3050

ALLENTOWN, PA.

1115 HAMILTON ST.  
 Allentown 3-7441

DEALER INQUIRIES INVITED

### TELREX ANTENNAS

Outstanding new conical design produces better picture definition. Because of non-varying center impedance, the transmission line is terminated correctly on all frequencies, thus eliminating standing waves and ghosts, noise, etc. High front-to-back ratio. High gain on all 12 channels. Supplied less mast. Rapid installation. Model 4X-TV—Double-stacked **\$42.50**  
 Model 2X-TV—Single unit **\$20.50**  
 12 ft. Dural Mast. each **4.80**

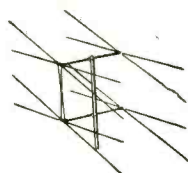

### ALLIANCE "TENNA-ROTOR"

Rotates your antenna 365°, "beaming" your antenna for best reception. Operates in any weather, as rotor is water-tight. Makes pictures clearer and sharper, signals stronger. Reduces noise. Easily attached to any type of antenna. "Arm-Chair" control with attractive plastic control box which plugs into house circuit. Equipped with Automatic **\$39.95**  
 Stop **\$39.95**  
 4 cond. cable for above. per ft. 4c



### G.I. TV TUNER

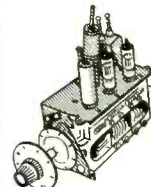

All channel continuous tuning front end that will improve results on any TV kit or set. Uses 3-6J6's in newly-designed capacitively-tuned circuit. Dimensions: 7" H x 3 1/4" W x 6 1/4" D. Shaft extends 2 1/2". Extremely stable, high gain. Net **\$27.50**  
 Cost.

### GET TELEMATCH FOR BETTER TV

Made by Stancor, Telematch eliminates antenna impedance mismatch. Immediately minimizes ghosts, reduces interference, etc. Startling results with indoor antennas. Your cost. **\$9.50**



### SENSATIONAL NEW WAFER THIN Magnifier Lens



Wide-angle, FLAT lens. No bulk, no oil. Extremely light weight. Excellent, distortionless enlarger. Conventional adj. bracket. 9"x12" clear **\$22.95** 12"x16" clear **\$29.95**  
 9"x12" filtered **\$25.95** 12"x16" filtered **\$32.95**

### LAST MINUTE SPECIALS

2 volt Willard storage battery **\$1.25**  
 2 volt vibrator **49c**  
 150 ma. pwr. xformer, 6 V tubes **\$3.39**  
 115 ma. pwr. xformer, 6 V tubes **\$2.95**

## GREYLOCK RADIO TUBE BARGAINS!

GT, Glass and Miniature Types

IR5	3Q4	12SA7GT	} <b>39c</b> each
IS5	3V4	12SK7GT	
IT4	6AT6	12SQ7GT	
IU4	6BA6	(and many others)	
IS4	6BE6		

SPECIAL OFFER! All above types may be purchased in lots of 100 assorted, at \$35 per 100.

6AK5	6BG6G	} <b>89c</b> ea.
6AG5	1B3-8016	
6J6		

All tubes in individual cartons

TERMS: Net C.O.D., F.O.B. NYC. MINIMUM ORDER \$5.00.

Write for Bargain Catalog N-5

Greylock Electronics Supply Co.  
 30 Church Street New York 7, N. Y.

## EASY TO LEARN CODE

It is easy to learn or increase speed with an Instructograph Code Teacher. Affords the quickest and most practical method yet developed. For beginners or advanced students. Available tapes from beginner's alphabet to typical messages on all subjects. Speed range 5 to 40 WPM. Always ready—no QRM.



ENDORSED BY THOUSANDS!

The Instructograph Code Teacher literally takes the place of an operator-instructor and enables anyone to learn and master code without further assistance. Thousands of successful operators have "acquired the code" with the Instructograph System. Write today for convenient rental and purchase plans.

## INSTRUCTOGRAPH COMPANY

4711 SHERIDAN ROAD, CHICAGO 40, ILLINOIS

# BUILD YOUR OWN WITH RADIO KITS!

Complete Kits Plus Detailed Instructions Are Your Guarantee of Perfect Equipment!

## SWEEP GENERATOR



Assemble this kit now and be ready for FM and TV servicing! 5 tube circuit. Covers 2 Mc. to 22.6 Mc. 110 V AC. Supplies RF or FM. Variable sweep width 0 to 10 Mc. Large to build!

dial. Variable phasing control. Easy to build! Ask for KIT MODEL SW5..... **\$22.95**

## SIGNAL GENERATOR

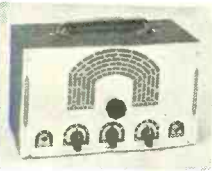

This useful signal generator is a necessity for every servicing need. 150Kc. to 30 mega cycles on fundamentals. Can be extended to cover over a 100 megacycle range on strong harmonics. 110V AC power supply. 400 cycle oscillation may be used internally for modulating the signal or externally for audio testing purposes. Ask for KIT MODEL SG2, only..... **\$18.95**

## VACUUM TUBE VOLTMETER



- 6SN7 bridge type voltmeter circuit.
- 0-500 microamps DC 41/2 square meter.

11 megohms DC, 6.5 megohms AC input resistance. 0.1 ohms to 1000 megohms in 5 ranges. Linear AC-DC volts 0-1000 volts; 5 scales. 6H6 balanced linear diode AC rectifier. 1% precision resistor. The perfect instrument for signal tracing and dynamic testing. Ask for KIT MODEL V12, only..... **\$23.95**

HIGH FREQUENCY PROBE for FM and TV work, for use with voltmeter, only..... **\$6.00**

## Three-Way PORTABLE RECEIVER



5-Tube Superhet

What a swell way to learn by doing! You'll be making a fine radio for portable battery operation and AC-DC house use. Smartly designed leatherette case with modern grille and slide-rule dial. 5" Alnico V speaker. Complete with extra low current drain tubes for long battery life—1R5, 1S5, 1T4, 3Q4, 11Z3. A terrific buy! Ask for KIT MODEL 3W10A, complete with tubes, only..... **\$16.95**

## Sensational High Fidelity "CONCERTO" AMPLIFIER with Cathode Follower Output



If you know a Rood amp, you know the "Concerto" is for you. It gives you separate fingertip control of treble and extreme base registers with a frequency range of 30 to 1500 cycles. Plus 8 watts of undistorted output for maximum volume if necessary. Plus an eight tube circuit of advanced design including 1-6SN7, 1-6SC7, 4-6SH7, 1-6AS7, 1-5Y4. The Concerto Amplifier "has what it takes" to fit perfectly into most any set-up. For a superb, easy-to-assemble amplifier, ask for KIT MODEL "CONCERTO," only..... **\$37.95**

ALL KITS SOLD LESS SOLDER AND WIRE If Kits Are Not Available at Your Local Supplier, Write to Us Giving Supplier's Name.

FREE — Send for Free Catalog P for full details on all Radio Kits.

# RADIO KITS COMPANY

120 Cedar Street New York 6, N. Y.

## "Electric Eye"

(Continued from page 51)

remove the hum and patch up the distortion.

Well, Xavier is not in sight, so we go on to see more of his work. The electrical department is next, and there is a salesman holding a match and lifting it up to a dark electric lamp in a socket, just as though it were a candle that needed lighting. When the match reaches the lamp, it lights. Then the salesman takes down his hand and blows out the match, while the ladies near him point and seem much amused. After some talk, he reaches up again, waves his handkerchief at the lamp, and it goes out. This one is easy to figure out, because anyone can see the box right next to the lamp, with a hole in it; and of course the photorelay is right inside the phototube, it turned the lamp on.

After that, the lamp kept illuminating the phototube, so that it stayed on. This is also just like the sign control, except that the relay contacts are connected up in the opposite way—the open side of the relay instead of the closed side. When the salesman put his handkerchief there, between the lamp and the phototube, he covered the phototube opening momentarily, and that darkened the phototube, turning off the lamp. After that, there wasn't enough light to get the lamp on again, so it stayed off. This circuit is so easy that I haven't bothered to copy it down.

Next is the drug department, and there is a big sign which says "Individually prescribed face powder to fit your face." We watch the lady place her cheek to the small hole in the machine, and how the clerk turns in the first filter, takes a reading, then turns in the next filter, takes another reading, and so on. Then, the clerk compounds a special face powder with ingredients to neutralize the unwanted

Fig. 3. This photoelectric door signal circuit has a sensitivity that will surprise you. The transformer heats the cathodes of both tubes, lights the lamp, and may also be used to furnish 6 volts for a chime. You might notice that the 6V6 heater-to-cathode voltage is the full-line voltage which is more than is recommended for the tube. If that bothers you, then just use another transformer for the 6V6 but I know that it will not give you any trouble because the rating was probably set low to prevent hum pick-up in audio and radio circuits. Xavier reports he has never had any trouble with heater-to-cathode breakdowns here.

The 6SQ7 tube is used as two tubes, as a rectifier to furnish filtered d.c. for the phototube and grid circuit, and as a high gain voltage amplifier. The .05  $\mu$ fd., 600 volt condenser pulls electrons from the 6SQ7 diode plates during half of each cycle, and these electrons leak back through the 750,000 ohm resistor and the 250,000 ohm sensitivity control, to make a well-filtered minus-to-ground d.c. supply, good for phototube, and grid bias requirements. Of course, if you don't care about the saving of a tube, you can replace the 6SQ7 with a 6J5, and put a 1V rectifier in where the .05  $\mu$ fd. condenser is in the circuit.

The high negative voltage, about 100 volts, is applied to the 922 phototube in series with a really large resistor, 50 megohms. The voltage divides more or less equally between them, according to how much light is on the phototube. A .05  $\mu$ fd. condenser couples the mid-point between these two to the control grid of the triode voltage amplifier, and controls it. The second 50 megohm resistor is a grid leak and controls the grid bias of the 6SQ7. If the 6SQ7 is a gassy tube with grid current the circuit won't work, so be sure to use a good tube. Also, if the .05  $\mu$ fd. coupling condenser is at all leaky, the grid will be drawn too negative. Use a new, well-waxed, low-leakage condenser and be sure not to let it get overheated from your soldering iron.

This grid circuit will let the control grid settle down to a constant bias as long as the phototube is illuminated constantly. However, if the phototube is darkened suddenly, the current through it stops, the grid gets a kick in the positive direction, and because of the high megohm resistors, this kick will last a few seconds. The plate current through the 6SQ7 rises to a high value and the 1  $\mu$ fd. condenser in the plate circuit charges. This makes the control grid of the next tube, the 6V6, go more negative with respect to its own cathode, which is just right for shutting off plate current. The 6V6 had plate current because its plate is "plus" half the time. This tube operates half of each cycle, just as the 6SQ7 operates half of each cycle, but the two of them work on alternate half cycles, not together. Doing it this way saves a high voltage transformer, and has the effect of another plate supply.

Be sure to put the condenser across the relay coil in its proper polarity, with the plus side to ground, not in the usual way. A small paper tubular is entirely satisfactory and does the job of taking the buzz out of the relay. The relay contacts are normally held closed, and released when someone walks through the beam of light. If you want to reverse this, it can be done easily—just interchange the 922 phototube and its 50 megohm series resistor. Be careful not to reverse the polarity of the phototube or it won't respond at all.

This two-stage circuit is so sensitive that the 1 candlepower lamp with a 1" diameter lens in front of it can work the photocell over 20 feet away, and even if different amounts of daylight get into the photocell during the course of the day, the amplifier will not be biased improperly but will respond as it should.

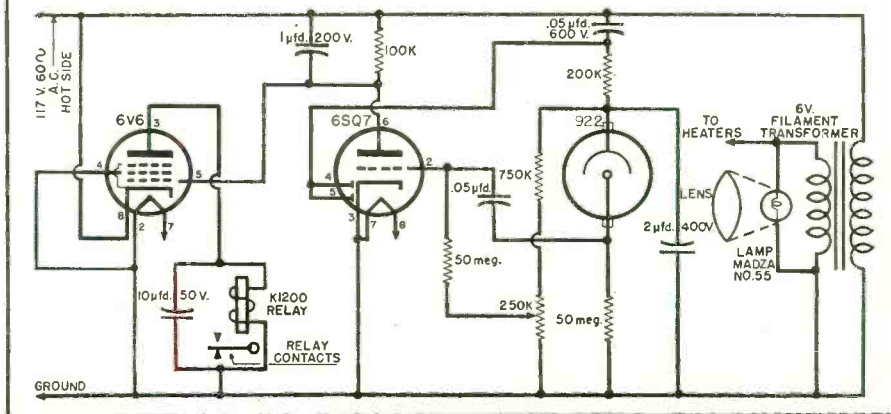

shades. That is quite an idea, and the ladies seem to like it a lot, because they keep coming back for more of that expensive powder, especially the ladies that can't boast about their complexion.

This "Cosmetigraph" uses a very simple circuit, just a photocell of the self-generating kind connected to a microammeter, just as you have in your exposure meter that you use in taking pictures. The real work in it lies in the mechanical parts, getting the light to shine onto the skin without "specular" reflection effects, and collecting the light efficiently and accurately.

Now we come to the tobacco counter, really crowded and with everybody smoking away real hard. Over to the left there is a lot of coming and going, and people seem to be waiting a turn. We elbow over, and see what the attraction is—a big glass tube. That must be the smoke measuring outfit Xavier just completed, with a millimeter to show how much smoke is in the tube. The big man presses a button, and a fan blows out the old smoke in the tube. He exhales gently into the tube, and the indicator goes way down. Now comes a thin chap with a pipe. He doesn't do as well, and there is much comment and discussion about lung size, black smoke, and light smoke. This setup is shown in Fig. 2.

Just then, Xavier himself comes along with a pencil and a pad. He is glad to see us, but we are late, and now there isn't much time. At this hour he must check over the figures on the inter-departmental counting machines which measure the volume of traffic today in the underwear department. It seems that the boss thinks this is a good way to compare the "Planet" advertising with that in the "Clarion."

So off he went, a happy, busy man. He is stouter and more prosperous looking now. Probably his clothes are made to order.

-30-

### KEEP EQUIPMENT INTACT

AN ORDINARY lunch box serves as a suitable container for soldering irons of the late models, iron support, solder, tape, and other needed equipment.

The assembled outfit may be kept at the work bench where it is easily picked up for use away from the shop.  
H. L.

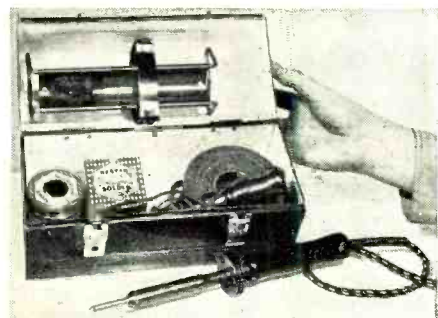

May, 1949

## SAVE! ELECTRONIC EXPEDITERS SAVE!

### TUBES!!! Receiving, Special Purpose, and Transmitting JAN and Commercial.

Bulk and Boxed		Bulk and Boxed		Bulk and Boxed	
1A5GT. \$0.70	5PB4. \$4.00	7C1. \$0.35	45. \$0.50	615. \$12.00	872A. \$2.50
1AB5. .50	5CP1. 4.50	7F7. .90	50B5. .75	715B. 7.95	875. 6.00
1B26. 3.00	5FP7. 3.75	7H7. .75	70L7. 1.50	703A. 4.50	908. 4.50
1LC6. .95	5Z3. .70	7N7. .90	77. .60	707B. 19.00	954. .50
1LD5. .95	6AK5. 1.50	9GP7. 12.50	78. .60	713A. 2.00	956. .50
1LN5. .95	6B8. .80	10Y. .65	80. 1.50	714A. 15.00	957. .50
1N5GT. .80	6C4. .35	12A6GT. .39	105P. .80	717A. .75	1616. .70
1R4. .70	6C5. .60	12C8. .60	11L7GT. 1.50	729CV. 12.00	1619. .50
2C34. 1.00	6E5. .85	12CP7. 12.50	123A. 3.00	735A. 18.50	1625. .50
2J21. 29.00	6F5. .65	12H6. .40	205B. 3.50	800. 2.95	1629. .65
2J22. 20.00	6J5GT. .85	12HP7. 14.50	211. .95	801. 1.50	1630. .75
2J40. 29.00	6I6. .50	12K7GT. .75	224. .75	803. 9.95	1641. .75
2J61. 29.00	6K7. .65	12K8. .90	250TL. 18.95	815. 2.95	1619. 4.95
2J62. 29.00	6S7. .65	12L5GT. .35	304TH. 6.50	826. .80	2051. .90
2J49. 22.00	68C7. .70	12S8GT. .70	305A. 10.00	837. .80	7193. .30
3B7. .35	68F7. .85	12SH7. .50	316A. 2.95	841. .79	8012. 4.95
3B24. 2.00	68H7. .85	12SN7. .80	353A. 4.00	843. .79	9002. .50
3C31. 1.75	68J7GT. .70	12SR7. .60	371B. 2.50	851. 59.50	9003. .50
3HP7. 2.00	68J7. .70	14A7. .85	388A. 5.50	864. .69	GT434. 7.00
3Q4. .80	68L7GT. .95	14B6. .85	150TH. 24.00	865. 2.00	VR150. .80
3Q5GT. .95	68L7. .95	14C7. .85	52. 15.00	866A. 1.25	VT67. .60
3B2P1. 4.00	68U7GT. .80	23D4. .89	530. 25.00	869B. 25.00	VT127A. 4.50
5B5P1. 2.95	7A7. .70	39A4. .40	531. 20.00		

### AUDIO and FILTER CHOKES

Stock No.	Induct. Hy.	MA	DC Ohms	Test Volts	Case Dimensions	Description	Fig.	Price
143	3/12	150-90	80 215	2000	5 1/2 x 2 3/4 x 3 1/4	Dual Filter	D	\$1.90
146	5.3	60	475	2400	2 3/4 x 1 3/4 x 1 3/4	Filter	I	0.90
147	6	70	180	1000	2 3/4 x 1 3/4 x 1 3/4	Filter	A	1.95
148	6	150	100	1500	3 x 3 x 2 3/4	Filter	I	0.90
149	7	60	350	2500	2 1/2 x 2 1/4 x 1 1/2	Filter	A	1.40
150	8	100	200	2500	2 1/2 x 2 1/4 x 1 1/2	Filter	I	0.90
154	12	100	510	2500	3 1/2 x 2 3/4 x 2 3/4	Filter	B	1.50
155	12	120	450	1500	1 1/2 x 2 x 1 1/4	Mfg Centers 3/4" Audio Choke	C	1.15

### OIL-FILLED CAPACITORS

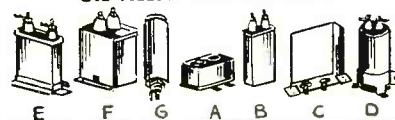

Stk No.	Cap. MFD.	Work Volts	Manufacturer	Type No.	Fig.	Price Each
100	1	600 DC	C-D	TJU6010	E	\$0.39
101	4	600 DC	C-D	TDF6040	G	0.90
102	4	600 DC	Micamold		E	1.15
103	4	600 DC	C-D	TLA6040	G	1.40
104	5	220 AC	FAST	18858-10	A	1.35
105	8	600 DC	C-D	48830-15	C	1.25
106	1-8	600 DC	C-D	48830-15	C	1.25
107	2	1000 DC	Gudeman	7612	B	0.85
108	2	1000 DC	Utilities		B	0.85
109	2	1000 DC	C-D	TLA10020	G	1.15
110	4	1000 DC	C-D	TQ10040	D	1.35
111	4	1000 DC	Aerovox	1005	D	1.35
112	12	1000 DC	TOBE	TR810012	E	2.25
113	6	1500 DC	TOBE	TR81506	E	2.25
114	1	2000 DC	C-D	TJU20001	E	0.75
115	1	2000 DC	GE	25F615	B	1.35
116	1	2000 DC	Solar	XLMJW20-1	E	1.35
117	1	2000 DC	C-D	TJ20010G	E	1.35
118	1	2000 DC	C-D	TJU20010	E	1.50
119	1	2000 DC	Gudeman	XLMJW20-2	B	1.35
120	2	2000 DC	Gudeman	7631	B	2.85
121	2	2000 DC	Solar	7630	B	3.85
122	2	2000 DC	C-D		B	3.10
123	2	2500 DC	Aerovox	2509	E	3.60
124	4	3000 DC	GE	23F44	F	6.95

### POWER TRANSFORMERS 115V 60 CY. PRIMARIES

Stock No.	H.V. MA.	H.V. CT.	Rect. Volt	Amps	Filament Volts	Price Each
130	70	600V	5V	2A	6.3V 1.85A	\$2.25
131	100	670V	5V	3A	6.3V 2.8 A	3.00
132	100	700V	5V	2A	6.3V 2.5 A	3.00
133	125	700V	5V	2A	6.3V 4.1 A	3.15
134	190	780V	5V	3A	6.3V 5.0 A	4.50

TERMS: Merchandise Subject to Prior Sale. Prices Subject to Change: Min. Order \$5.00. 20% Dep. with Orders. Balance C.O.D. All Prices F.O.B. Chicago, Ill. QUANTITY PRICES ON REQUEST.

## ELECTRONIC EXPEDITERS INC.

333 NORTH MICHIGAN AVE. CHICAGO 1, ILLINOIS STATE 2-5615

## WANTED!

Men and Women to Fill  
**TOP RADIO JOBS**  
in AM—FM—Television

If you are looking for a career with a future, why not join the hundreds of graduates from the Don Martin School of Radio Arts now successfully employed in the radio industry. The demand is great for qualified radio personnel in AM-FM-Television. Train now to be an announcer, script writer, disk jockey, newscaster, or radio technician. Complete day and night classes... the latest equipment. Free placement service. Approved for veterans. Write for free booklet.

**Don Martin School of Radio Arts**  
1655 North Cherokee St. Hollywood 28, Calif.

## 4 SPEED MOTORS



ONLY  
**\$8.95**  
Plus \$1.00 for packing and shipping  
Calif. please add 20c for sales tax

Approx. 11" long  
1/20th Horsepower 115 V 60 cycle AC motors with integral gear box having four 1/4" drive shafts turning simultaneously at the following speeds:  
4000 RPM—(4) indexers, buffers, flexible shaft tools, etc.  
150 RPM—Wrapping fishing rods, slow speed tools, 25 RPM—Dev. tray rocker for photo darkroom.  
5 RPM—Turning barbecue spits, Adv. Disp. Beams.  
A Thousand Other Uses Around the Work Shop

MONEY BACK GUARANTEE  
Pulleys, Mandrels, Belts, Etc., Available.  
**TROUP ENGINEERING CO.**  
2221 B Grand Avenue Long Beach 4, Calif.



**TRANSMITTERS—ARC-5 & ATA**

Lenny is shedding bitter tears at the ridiculously low price. But Buck says: "Let 'em have it!" So here it is:

4-5.3 Mcs. **\$2.99** ea. 5.3-7 Mcs.

Complete with tubes and crystals in good condition. Get 'em while they last!

**FAMOUS "ARB" RECEIVER**

195 to 9,050 Kcs. Controlled by a 4-band selector switch. Features include 6 tubes, 3 micro-volt sensitivity MVC or AVC CW or MCW—sharp or broad tuning for extra sensitivity. 28V dynamotor. Used but in excellent condition. **Special! \$19.95**

**ARC-4 Transceiver**

This is the Navy VHF unit. Conversion dope supplied makes it the hottest 2-meter transceiver. 144-148 Mcs. With tubes, dynamotor and crystals. Used but in excellent condition. Ea. **\$17.49**  
 Rack, extra. **\$3.50**  
 Brand new. Ea.

**BC 746 TUNING UNITS**

Complete with FT type 243 crystals, coils and condensers. All numbers from 1 to 71 such as:  
 No. 3—3995 to 4450 Kc  
 No. 8—3525 to 3980 Kc  
 No. 10—3735 to 4190 Kc  
 Ea. **79c**  
 Only

**FAMOUS PORTABLE BC-659 TRANSCEIVER**

Excellent for outdoor use! 27 to 38.9 Mcs., crystal controlled. Ideal for hams, police, park service, etc. Battery operated, power supply 6, 12 or 24 volt with proper vibrator. Complete (less power supply) with all tubes, 2 crystals, hand sets and antenna. Used, excel. **\$17.50**

**POWER SUPPLY**

PE-120 or PE-117. 6, 12, or 24 volts. Used, but in good condition. **\$9.95**

**HEADSET EXTENSION CORD**

CD 307 with PL-55 Plug JK 26 jack. Length, 6 ft. Used but good condition. **Special! 29c**

**TUBES—ALL NEW AND BOXED**

- 211.....29c
  - 371A.....99c
  - 371B.....99c
  - 1616.....69c
  - 803.....\$4.95
  - 5CP1.....\$1.50
  - 5FP7.....\$1.50
  - 12DP7.....\$13.95
- Special:** Brand new tube puller, **19c** boxed.

**SOS GIBSON GIRL BALLOONS**

New individually packed in vacuum cans.—Expands to diam. of 4 ft. **\$1.95**

**COLLAPSIBLE MOBILE ANTENNA**

7 ft., telescopic, brass anodized. Boxed, brand new. Ea. **\$1.95**

Send for our **NEW FREE Catalogue!**

These prices are good for Month of **MAY** only!

All prices F.O.B. Los Angeles. 25% deposit with order. Balance C.O.D. Minimum order \$2.00.

Come in and see the **LARGEST** supply of surplus in the **BIGGEST** electronics warehouse on the West Coast!

**COLUMBIA ELECTRONICS**

522-524 South San Pedro Street  
 LOS ANGELES 13, CALIFORNIA

**Projection Television**

(Continued from page 49)

tube neck) or away from the tube (at right angles to the tube neck). The visual effects of improper positioning of the magnets are shown in Fig. 6.

In the *RCA* and *G.E.* projection receivers the additional bar magnets are not required because the translucent screen is not slanted and because it is perpendicular to the axis of the optical system. Hence, a rectangular image on the projection tube face appears as a rectangle on the screen. The translucent screen used in these sets is composed of two lucite sheets with a partial diffusing layer between them. The back sheet has a fresnel lens molded into its rear surface. The front sheet has vertical ribs molded into its outer surface. The fresnel lens functions to concentrate the light into a narrow viewing angle. The vertical ribs act to increase the horizontal viewing angle above that obtained with a flat surface. The diffusing layer eliminates interference patterns between the fresnel lens and the vertical ribs. The screen and lens combination give a gain of approximately five over that which would be obtained from a ground glass screen.

In the *RCA* and *Philco* receivers, the projection tube, the spherical mirror, and the correcting lens are all mounted in what is known as an "optical barrel." See Fig. 9. The spherical mirror is mounted in the bottom of the optical barrel and held against a knife edge by three sets of springs. The spring pressure is strong enough to hold the mirror securely against the knife edges, but not sufficient to distort the spherical mirror.

The 5TP4 is held in a retaining ring within the optical barrel, the face of which is approximately one-half way between the correction lens and the mirror. The tube is adjusted to posi-

tion by controls on the side of the optical barrel. Optical focusing is accomplished by moving the picture tube up and down vertically. Other adjustments are needed to secure proper centering of the picture tube on the optical axis of the mirror. The correction lens is held in the ring on top of the barrel and secured by three spring fingers.

Another variation of the Schmidt optical system as adopted for television is that devised by *North American Philips*. The system, known by the tradename of "Protelgram," is an adaptation of the "folded" Schmidt system and occupies only half the space of a conventional arrangement. Since the light path is folded, it is possible to mount the projection tube with its optical system within a small metal box, thereby producing a compact and dustproof arrangement. The actual metal case measures only 8½" x 8½" x 9". It contains three optical elements: (1) a 6" spherical mirror, (2) an aspherical corrector lens, and (3) a special plane mirror to "fold" the light beam. See Fig. 8. These three elements form an optical triangle within the optical unit and are adjusted at the factory. They remain in adjustment under normal use. The optical unit is dustproof, with only the upper face of the corrector lens being exposed. It can be dusted with an ordinary cloth without scratching. The light emitted from the tube face is gathered by the spherical mirror, reflected to the plane mirror and then projected upwards through the corrector lens. At the center of the plane mirror there is a hole large enough to permit the projection tube face to be inserted through it. Behind the mirror ample room is provided for the deflection and focusing coils of the tube, plus whatever tube supports are required. There is no interference from the coils and the neck of the tube, since these are behind the plane mirror.

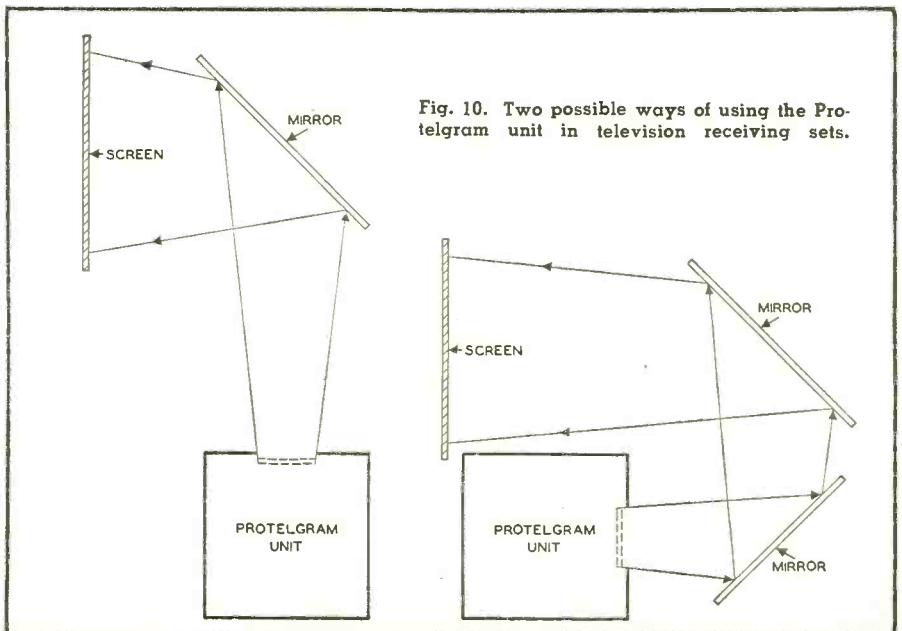

Fig. 10. Two possible ways of using the Protelgram unit in television receiving sets.

A throw distance of 31" from the corrector lens to the viewing screen is required to produce an image 12" x 16". Extending behind the tube face and for 7½" beyond the 9" dimension of the optical unit is the alignment assembly. This carries the tube and socket, focus, horizontal and vertical deflection coils and aligns the tube optically by means of three screws, which can be locked to insure good mechanical stability. Horizontal and vertical deflection coils are inside the optical unit; the focusing coil is outside. The tube is firmly seated in the plastic coil forms for the deflection coils, which are designed so that linear current will produce linear deflection over the full picture area.

A special small-size cathode-ray projection tube (3NP4) was designed for this unit. The tube screen diameter is 2.5 inches from which is obtained a 1.4 x 1.86 inch picture. 2.5 inches appears to be the smallest practical size from which an enlarged image can be obtained. The tube uses magnetic deflection, magnetic focusing and 25,000 volts for acceleration. The spot diameter at the tube face is 0.003 inches and this permits 450 line resolution to be obtained. The high-voltage anode terminal consists of a button in a glass cup sealed to the cone of the tube. The glass cup lengthens the external leakage path from the high-voltage contact to the coils thereby minimizing any tendency for arc-over to occur. The outside of the cone and part of the neck are covered with a conductive coating that can be grounded. This outer coating, together with the conductive coating inside the tube, forms a 300 µfd. condenser which can be utilized for filtering of the high voltage. The neck of tube is quite narrow and, in conjunction with a deflection angle of only 40 degrees, permits full deflection to be achieved using only as much deflection current as ordinarily supplied to a 10BP4 direct-viewing tube operating at 9 kv.

A 25 kv. second anode is needed for the 3NP4 with better than average stability. Since existing types of high-voltage power supplies were found to be unsatisfactory, a new, compact unit was designed having low weight, small size, great stability and no r.f. radiation. See Fig. 7.

The flexibility of this particular design is illustrated by two possible arrangements, Fig. 10. In the left-hand illustration, the beam emerging from the corrector lens is folded once more by a second mirror tilted 45-degrees. For an even more compact arrangement, the beam can be folded twice after leaving the "Protelgram" unit.

For future projection television receivers, the immediate objectives are: greater light intensity on the viewing screen, better contrast, and increase in horizontal and vertical viewing angles.

Projection television, while presenting more problems must, nonetheless, keep pace with direct view receivers.

**FIRST AGAIN** with the finest!

**WALCO**  
**TELE-VUE-LENS®**

Patented: U.S. Pat. Off. 2449886

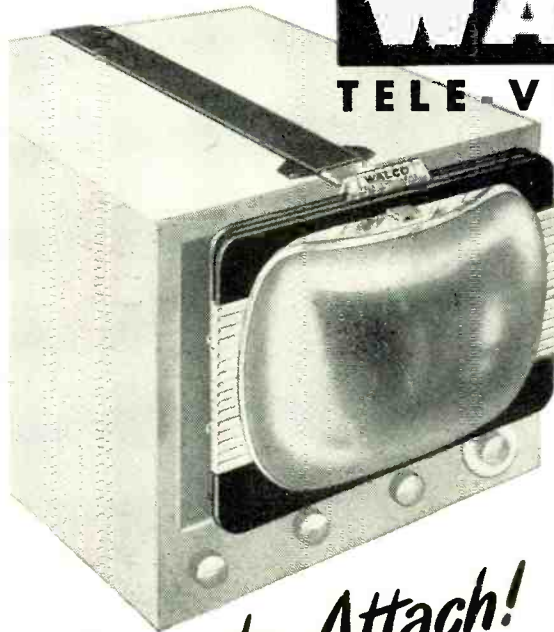

*Easy to Attach!*  
*... no screws! no bolts!*

Fits all television cabinets, table or console models. Felt-lined for cabinet protection. Easy adjustments. Available in following sizes: for 7" tube, 7-10" tube, 10-12" tube.

**ADJUSTABLE**  
VERTICALLY-HORIZONTALLY

BUILT IN  
FILTER ADAPTER  
WITH REMOVABLE  
GLARE CONTROL  
FILTER

STYLED TO ENHANCE  
TELEVISION SET  
APPEARANCE

NO WONDER discriminating television set owners prefer WALCO by overwhelming majority! WALCO is the leader in style, quality and value. Here is a wonderful new WALCO television enlarging lens that actually IMPROVES the appearance of television cabinets. It's styled in keeping with the newest designs and developments. Insist on WALCO and be sure of the finest.

**DISTRIBUTORS! REPRESENTATIVES!**

A few good territories are available. Write for interesting arrangement to...

**WALCO SALES CO.**

60 Franklin St., East Orange, N. J.

**AUTOMATIC M-90 AUTO RADIO**

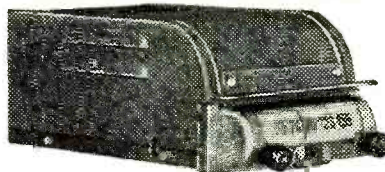

- Six Tube Superheterodyne
  - Three Gang Condenser
  - Powerful, Long-Distance Reception
  - Fits All Cars, Easy Installation
  - Mounting Brackets Included.
- Net **\$29.97**

**MAIL US YOUR ORDERS**

All orders filled within 24 hours.  
Illustrated parts list on request  
sylvania and Cunningham tubes 50% off list

*Bill Sutton's*  
Fifth at Commerce

Wholesale  
Electronics  
Fort Worth, Texas

**WAR SURPLUS BARGAINS**

Gigantic mail sale electronic-radio-electrical apparatus. Sale ends midnight June 1st. Amazing values. Opportunity for home experimenters, laboratories, schools, etc., to get fine new, or new condition guaranteed, equipment at fraction of original cost. We pay freight or postage. Typical items are listed below.

3000-watt, 115-volt, 60-c Power Plants	\$299.50
Wheatstone Bridges (0 to 11, 110 ohms)	\$9.50
Weston Air Port Photo-light Control Units	29.90
Weston Model 689-1F Industrial Ohmmeter and case	12.90
W. E. Desk or wall C.B. Telephones and ringer (complete)	4.99
RCA (5" 3" and 2") Cathode Ray Tubes	3.55
RCA Light burglar alarm kit. Consists of rectifier, photo cell, thyatron, relay, sockets, etc.	4.49
Drill press 31" polishing-grinding shaft and stone	1.29

Other items include gas engines, chromofux elements, radar altimeters, tubes, transformers, etc. Order from ad or send card for bargain catalog. Satisfaction guaranteed. Our reference-National Bank of Commerce.

**LECO ENGINEERING CO.**  
BOX 908 RTN-5 LINCOLN, NEBRASKA

# TRANSVISION

## "Flip-Up" TV ANTENNA

... the revolutionary **PRE-ASSEMBLED, PRE-WIRED TV ANTENNA** that gives Superior Performance on ALL CHANNELS—yet **COSTS YOU ONLY 1/2** the price of equivalent antennas!

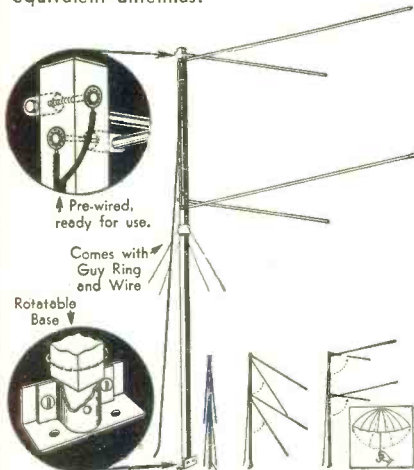

- **PRE-ASSEMBLED**, ready for use. Just "flip-up" (like an umbrella) and install.
- **PRE-WIRED**—just connect your lead-in to the two terminals.
- **RECEIVES ALL CHANNELS.**
- **ALL-DIRECTIONAL**; can be oriented for the weakest station in an area with assurance that all other channels will be brought in equally well.
- **EXTREMELY SENSITIVE.** Unusual high gain on upper channels. Ideal for fringe areas.

• **PRICE: \$9.95 LIST**

Completely assembled with rotatable base, 7-ft. mast, guy ring and guy wire.  
Additional 7-ft. masts, to build antenna up to 19 ft., at small extra cost.  
All prices fair traded . . . All prices 5% higher west of the Mississippi River.  
See your local Transvision Outlet, or mail this coupon TODAY to:

**TRANSVISION, INC.** DEPT. R.N.  
NEW ROCHELLE, N. Y.

Please ship **THROUGH YOUR NEAREST LOCAL OUTLET:** RN-5

( ) "FLIP-UP" ANTENNAS  
I am enclosing 10% DEPOSIT in the amount of \$.....; balance C.O.D.  
( ) Send me details of your DEALER PLAN

Name.....  
please print

Street.....

City and Zone..... State.....

## Spot Radio News (Continued from page 16)

gle stage. The RCA specialists emphasized that their system should not be cited as a means of obtaining higher power from many small tubes, but rather as a means of increasing transmitter output when existing tubes have been improved so that they could handle more power.

Another approach to the high-power problem was demonstrated at a special engineering-press meeting by Westinghouse at their Lansdowne, Maryland, plant. In this method, described as a *Symmetron* power amplifier, tubes are operated in parallel and symmetrically inserted into coaxial tanks (cathode and plate). Each tube, therefore, sees the same electrical and mechanical configuration for all operating frequencies. Thus the design lends itself to multiple tube operation. Two to ten tubes or more may be operated in parallel without affecting the circuit symmetry. This type of circuit is associated with simplified wide-range tuning, a 50-kilowatt tank requiring only three adjustable tuning controls, cathode tuning (shorting bar), plate tuning (shorting bar), and output coupling (condenser). These controls are motor driven and tune through the complete FM band of 88 to 108 megacycles without mechanical adjustment of the tank, which is in contrast to the conventional FM grounded-grid, push-pull amplifiers, using two-wire transmission line tanks, where even at lower power levels, up to nine adjustable controls are required.

Using the present types of tubes, the *Symmetron* system was said to provide powers of 75 kw. in the standard FM band; 25 kw. in the 54 to 88 mc. TV band; 10 kw. in the 174 to 216 mc. TV band, and for black and white or color TV, one to two kilowatts in the 500-1000 mc. spectrum. Westinghouse engineers declared that these power levels were from one to one-and-one-half times greater than those available with current equipment designed to operate on the ultra-highs.

Ultra-high telecast studies are continuing at a merry pace, too, with NBC and the Washington consulting engineering firm of McNary and Wrathall preparing four setups for tests. NBC has asked the FCC for permission to install a 846-854 mc. transmitter, using a rated visual power of 100 watts and a peak carrier power of 400 watts, at their Princeton labs and another ultra-high unit, operating on 529 mc., installed in the vicinity of Bridgeport, Conn., which is expected to have an effective radiated power of between 15 and 20 kilowatts. The other two experimental stations are being planned for Scranton, Pa., and Pawtucket, R. I., with a frequency of 515 mc. used for a pulse-modulated visual signal having a power of 5 kilowatts. Slotted cylindrical transmission antennas with power gains of ten

## \$URPLU\$ BARGAIN\$

### FM REC. BC 603

For 10 and 11 meters. 20 to 30 MC superhet. BFO, squelch; 10 push-buttons and manual tuning. Makes fine wide-band IF strip for 88-108 MC FM with converter. Includes 10 tubes, speaker, case, and diagram. 12 volt. Used. Good. \$12.95

R4-ARR-2 Receiver. See RADIO NEWS, P. 112, Jan. 1949 issue. Used, good. \$10.95

Radio Transmitter & Receiver APS 13, 410-420 mc., light weight, fully enclosed; 30 mc. I.F. Complete with 17 tubes, including 5-6J6; 9/6AG5; 2/2D21; 1/XR105. Brand new with manual. \$17.95  
APS 13 Racks, New. \$1.00  
Handy Talkie Batteries. Good condition. BA-37 1.00  
BA-38 1.00

### COMMAND REC.

Used. Good.  
BC453-1.9-550 KC .....\$12.95  
BC454-3.6-MC ..... 5.95  
BC455-6.9-1-MC ..... 6.95  
6 1/2' CONTROL CABLE for above command sets.....\$1.00

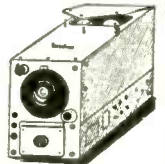

APN 1. Used, good. \$ 7.95  
BC 684 Transmitter. Used, good. 12.95

### Climbing Equipment



Safety belt, leather. Good used. \$2.95 ea.  
Pole Climbers, and straps. Good used. \$1.95 pr.

### R-5/ARN-7 COMPASS RECEIVER

Includes broadcast band. Freq. 100-1750 kc. in 4 bands. 5-gang tuning capacitor. 15 tubes: 4-6K7, 1-6L7, 1-6J5, 2-6B8, 2-6F6, 1-6N7, 1-6SC7, 2-2051, 1-5Z4. Like new. \$17.50 ea.

Send 25% with Order, Balance C.O.D.  
All Equipment F.O.B.

## C & H SALES CO.

1850-B East Colorado St., Pasadena 8, Calif.

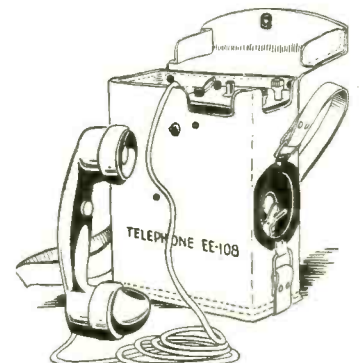

### TELEPHONE EE 108

A highly efficient telephone communication system requiring no batteries or current. Has sound powered handset, generator and crank for signaling. Talking range 9 to 12 miles. Comes in fine, sturdy leather case with adjustable carrying straps. Is 9 1/2" x 7 3/4" x 3 1/2". Weighs 9 1/2 lbs. All brand new. Can be used on Ships, Athletic Fields, Farms, Plantations, Oil Fields, etc. Send check or money order. Our price, F.O.B., N. Y. each. \$17.95

### EASTERN RADIO SALES

150 Broadway New York 7, N. Y.

## → TUBES ←

FACTORY SEALED CARTONS, ANY ASSORTMENT—25 for \$9.95; 50 for \$18.00; 100 for \$35.00.

1R5	3S4	12SA7GT	35W4
1S5	3V4	12SJ7GT	35Z5GT
1T4	12AT6	12SK7GT	50B5
1U4	12BA6	12SQ7GT	50L6GT
3Q4	12BE6	Each	35B5 117Z3

ASSORTED BULK-PACK LOTS—25 for \$8.75—50 for \$17.00—100 for \$33.00.

The following tubes at 49¢ each  
6AG5 6AU6 6T8  
6AK5 6F8C 12AU7  
6AL5 6SN7GT 19T8

MANY OTHER TUBE TYPES AVAILABLE. SEND FOR FREE LIST.

Complete stock of replacement parts available for the RCA 630TS TV Receiver.

Send for our parts Bargain list.

**HALLMARK ELECTRONIC CORPORATION**

592 Communipaw Ave.

Jersey City 4, New Jersey Bergen 4-6365



are expected to be used. WQAN will conduct the Scranton tests and WCFI, the Providence studies. It is believed that about \$10,000 will be spent for each experiment.

**TRENDS IN MINIATURIZATION** in industry and the military were accentuated at the IRE national convention exhibits at the Grand Central Palace, New York City. The U. S. Navy displayed a complete receiver, formerly requiring 12,160 cubic inches, compressed into a volume of 3,150 cubic inches, with no efficiency lost in the transfer. A ten-tube receiver, weighing but one pound and sealed in a plastic case, three inches by six inches by one inch thick, was also on view. An answer to every serviceman's prayer, a test kit with all of the basic tools in a container less than a foot long, was also shown by the Navy. Containing fountain-pen like instruments serving as voltmeters, ohm-meters, soldering irons, vacuum-tube testers, signal generators and tracers, plus other test essentials, the kit weighs about twenty-five pounds and is ten by ten by nine inches in size.

Describing this *dream kit*, E. J. Nucci of the Navy Bureau of Ships, said that the kits are being expanded a few inches and increased in weight about two pounds to include a 'scope, to provide maintenance and service for practically every type of first-aid problem.

**THE AVERAGE LISTENER** prefers the full frequency range in speech and music, and not a restricted frequency range, Harry F. Olson of RCA Labs, said at the IRE meeting during a talk on the reproduction of sound.

Analyzing this and other related factors, Olson disclosed that there are six physical aspects of a musical tone: frequency, fundamental frequency, overtone structure, duration, growth and decay, and vibrato. He said that an examination of these physical aspects shows that speech and music are exceedingly complex, and since sound-reproducing systems involve all manner of mechanical vibrating elements, one would expect deviations from true fidelity of reproduction. However, Olson continued, it is truly remarkable and fortunate that tremendous deviations from true reproduction may be made and we may still retain a system which is acceptable by the average listener.

Olson pointed out that there are seven types of defects which must be considered in order to reproduce the physical characteristics of a musical tone, and which should not be present in a distortion-free system: amplitude distortion, nonlinear distortion, phase distortion, transient distortion, noise, directional pattern of reproducers, and seven conditions of deviations (single channel system, special distribution, acoustics of two rooms—the pickup studio and listening room, limited dynamic range, microphone placement and balance, difference in

May, 1949

## NEW TRANSFORMERS And CHOKES

### ALL FOLLOWING TRANSFORMERS 115 V.A.C. 60 CYCLE INPUT

OUTPUT: 750-0-750 V.A.C. (600 V.D.C. after choke input filter at 250 MA.). Includes 6.3 V.A.C. winding at 5 amps and 5.0 V.A.C. winding at 4 amps. NH-106 ..... **\$7.95**  
OUTPUT: 600-0-600 V.A.C. at 250 MA. 12 V.A.C. at 3 amps; 12 V.A.C. at 3 amps and 5 V.A.C. at 3 amps. Designed for Army surplus transmitters. NH-108 ..... **\$6.90**  
OUTPUT: 250-0-250 V.A.C. at 60 MA. 24 V.A.C. at .6 amps; 6.3 V.A.C. at .6 amps. Designed for Army surplus Receivers. NH-109 ..... **\$3.00**  
OUTPUT: 6.3 V.A.C. at 6 amps. NH-110 ..... **\$2.25**  
OUTPUT: 24 V.A.C. at 2 amps. NH-111 ..... **\$2.25**

### CHOKES:

NH-115—8 Henries at 500 MA. filter choke, 5,000 volt insulation ..... **\$8.67**  
NH-116—5-20 Henries 500 MA. swinging choke, 5,000 volt insulation ..... **\$8.37**  
NH-117—8 Henries at 700 MA. filter choke, 7,500 volt insulation ..... **\$12.90**  
NH-118—5-20 Henries at 700 MA. swinging choke, 7,500 volt insulation ..... **\$12.45**  
ALL ABOVE ITEMS BRAND NEW—NOT SURPLUS!

### WRITE FOR COMPLETE LIST OF HIGH VOLTAGE TRANSFORMERS AND CHOKES

#### INVERTER MG-149F



Input 24 Volt DC; Output 26 Volt DC, 250 VA 400 cycle, or 115 V. 400 cycle 500 VA. Appear to be unused; are re-finished and tested. Price..... **\$14.95**

#### AC POWER SUPPLY AND SPEAKER

Completely wired power supply and speaker with volume control C.W. and on & off switch, housed in metal cabinet. For command receivers with connections to plug into receiver and 110 Volt 60 cycle line. Voltage output: 250 V. 60 MA., 6.3 V. and 24 V. Price: Completely wired..... **\$14.95**  
Kit of Parts..... **9.95**

**SELSYN 21IG1**—Can be used as position indicator for antennas; 110 Volt 60 cycle, with instructions. Normally operates from 57.3 Volts 400 cycle. Price per Pair, **\$3.00**  
**SELSYN # C-78248**—115 Volt AC 80 cycle. Size V 3 3/4" x 5 1/2". Can be used to turn small antennas or for position indicator systems. Price per Pair, **\$5.95**



#### SELSYN TRANSMITTER AND INDICATOR SYSTEM

Ideal as radio beam position indicator for Ham, Television, or Commercial use. Complete with five inch 1-32 Indicator, Autosyn Trans., 12 Volt 60 cycle Transformer, and wiring instructions. Price—New..... **\$9.95**

### MISCELLANEOUS

BC-1206 C Rec. 200-400 KC. DET. 6 tube set. **\$6.95**  
BC-1206 Rec. 200-400 KC. S&C 5 tube set. **6.95**  
TU-17 or 25 for BC-223—Price: New..... **4.50**  
TU-5, 8, or 10 f/BC-375 w/case—New..... **3.95**  
Cable for BC-223 w/PL-150 each end..... **1.75**  
Cable for BC-375 w/PL-61 each end..... **1.75**  
Cable for TCS EQ/65F7, 65F10, or 65F13..... **2.95**  
Plug for I-32 Indicator PL-118..... **1.00**  
Plug for LP-21 Loop, PL-112 or PL-108..... **1.00**  
FL-8 Filter 1200 CPS..... **1.95**  
BC-1023 Marker Beacon Rec. with tubes..... **3.79**  
RC-301 Marker Beacon Rec. Less tube..... **1.95**  
RB-54 2 Volt Dry Cell Battery..... **1.50**  
BC-773 Gibson Girl Receiver—Only..... **4.95**  
CD-365 Cord for LP-21 Loop..... **1.50**  
GN-45 Generator..... **6.95**  
Circuit Breaker—115 V. 60 cycle 12 amp..... **1.75**  
Circuit Breaker—24 VDC 30 amp..... **1.00**

ADDRESS DEPT. RN • ALL PRICES ARE F.O.B. LIMA, OHIO • 25% DEPOSIT ON COD ORDERS

## ANTENNAS FOR ALL USES

### TELESCOPING ANTENNA WITH

Base Insulator: Four section, steel, extends 6'2" to 23'6". Diameter taper from 1 1/4" to 3/4". Each section fitted with adjustable locking clamp. Can be adjusted to length required for freq. Brown glazed base insulator and stand off. (Illustrated at left.) Price... **\$12.95**

### WHIP ANTENNA FOR MOBILE AND STATIONARY USE

MP-48 Mast Base Mounting with heavy vertical Coil Spring. Insulated at top to receive Mast Section MS-53. Mast Base only ..... **\$2.95**



### MAST SECTIONS

For above MP-48, tubular steel, copper coated, painted—in 3 foot sections. Bottom section MS-53 can be used to make any length. MS-52-51-50-49 for taper. Screw-in type. Any Section. Price ..... **50c Ea.**

WHIP STEEL—24 ft. two piece. Bottom section 4 ft. long. Taper 3/4" to 1/2". Bottom Sec. threaded 1/2". Price. **\$2.50**

TELESCOPING STEEL ANTENNA—3 Sections, 94" long. Telescoped 40". Size: 3/4" to 1/2". Price..... **\$1.75**

ANTENNA ROTATOR—Ideal reversible motor for rotating all types of antennas at the top. Weighs only 4 1/2 lbs. Size: 7 1/2" L. less shaft. Gear box and Mtg.: 1 1/2" x 3 1/2". Motor size: 5" L x 2 1/4" D. Shaft size: 3/8" x 1 1/2" threaded. Operates from 24 V. DC, 2 amps. 4.5 RPM or 36 V.A.C. Torque: 70 lbs. per inch. Price..... **\$9.95**  
TRANSFORMER for above item..... **2.95**

### TRANSFORMERS—110 Volt 60 Cycle Primaries:

Sec. 12 V. 1 amp. .... **\$1.50**  
Sec. 24 V. 1 amp. .... **1.95**  
Sec. 24 V. .5 amp. .... **2.95**  
Sec. 36 VAC 2.5 amp. .... **2.95**  
Sec. 14-14 or 28 Volt—7 1/2 or 15 amp. .... **4.95**

HIGH TORQUE MOTOR for Antenna Rotation—3/4 RPM; operates on 110 Volt 60 cycle with 10 MFD condenser; normally 110 Volt 400 cycle, reversible. Instructions included. Size: 4 1/2" x 4". Price: **\$2.95**. 10 MFD Cond. only **\$1.00**. Reversing Switch @ **35c**

### MOTORS

6 or 12 Volt AC-DC Heavy Duty reversible motor with 3/8" x 3/8" shaft. Price: NEW..... **\$2.95**  
6 Volt AC-DC Motor—ideal for auto fans, models, etc. Shaft 3/8" x 3/8". Used—Tested..... **1.50**

### DYNAMOTORS

INPUT	OUTPUT	STOCK NO.	PRICE
12 V DC	220 V 100 MA	D 402	\$3.95
12 V DC	440 V 200 MA	D 401	7.95
12/24 V DC	440 V 200 MA and 220 V 100 MA	D 104	9.95
12/24 V DC	F/No. 19 MARK I	P/S #3	9.50
13/26 V DC	F/BC-645	PE 101	2.95
12/24 V DC	500 V 50 MA	D 051	3.95
24 V DC	F/Comm. Receivers	DM 32	1.95
14 V DC	230 V 100 MA	DM 20	3.95
9 V DC	450 V. 60 MA with Blower	D 9450	3.95

### COMMAND RECEIVERS

BC-454. 3 to 6 MC. USED..... **\$5.95**  
BC-455. 6 to 9.1 MC. USED..... **6.95**  
DYN-64. Can be used for Comm. Rec. # 0515 TRANSFORMER NH-109 for Comm. Rec. 110 V..... **3.00**  
TRIPLE REC. RACK—black..... **1.50**  
TUNING CRANK or Knob..... **.65**  
BC-442 Antenna Relay Box w/cond. New..... **2.95**  
Less Cond..... **1.95**

### COMMAND TRANSMITTERS

BC-458. 5.3 to 7 MC. NEW: **\$8.95**. USED: **\$5.95**  
T/20 ARC-5. 4 to 5.3 MC. NEW: **\$9.95**. USED: **6.95**  
BC-456 MODULATOR—like New..... **2.50**  
DUAL TRANSMITTER RACK—New..... **1.50**  
TRANSFORMER NH-108 for Comm. Trans..... **6.90**

# FAIR RADIO SALES

132 SOUTH MAIN ST. LIMA, OHIO

## WANTED

**TELEPHONE CARRIER EQUIPMENT** (Western Electric) types C, CF-1, CF-3, CF-4, CF-5, H, H-1.

**TELEGRAPH CARRIER EQUIPMENT** (Western Electric) X-61822A, CF-2, CF-6, 40AC1.

**TELETYPEWRITERS**—All Models.

**TELEPHONE SWITCHBOARDS**—Manual and automatic.

**RADIO TELEPHONE LINKS**—AN/TRC-1, AN/TRC-3, AN/TRC-4, T-14/TRC-1 Transmitters, R-19/TRC-1 Receivers, Antennas.

Box 484, % RADIO & TELEVISION NEWS 185 N. Wabash Ave. Chicago 1, Ill.

## Booklets by A. C. Shaney

Written by a foremost Audio design engineer—

### Yours almost as a gift!

Elements of Magnetic Tape Recording and 999 Applications ..... 25c  
Direct-Coupled FM-AM Amplifier Manual ..... 25c  
20 Steps to Perfect Amplification ..... 3c in postage

### Thousands Sold!

Famous Twin-Trax Instruction Book! Practically a course in tape recording, 30 diagrams, illustrations.

**\$2.50** (Price may be applied against future purchase of chassis.)



## AMPLIFIER CORP. OF AMERICA

398-2 Broadway New York 13, N. Y.

## WE FOUND THESE RECEIVERS IN

# WAR SURPLUS



OUR ENGINEERS CHECKED THEM AND SAID:  
"This is the hottest little receiver on the market at any price. Does everything the BC-348 will do, and then some."

**WE PURCHASED ALL AVAILABLE—LESS THAN 400 COMPLETE BRAND NEW SETS**

It's the **FAMOUS BENDIX RA-10 RECEIVER**. An 8-tube superhet. Tunes 150 to 1100 kc. and 2 to 10 mc. Tunes from remote control. Comes complete with tubes, built-in dynamotor, plugs, control box, and flexible tuning shaft. Ready to operate. **BRAND NEW**, as received

from factory. Available for 12-volt or 24-volt operation. A \$500 set for... \$69.95  
**CONVERSION KIT for converting RA-10 to 110 volt AC.** Complete with all parts, hardware, schematic, and simple instructions. \$ 7.95

**BC-375E 100 watt GE TRANSMITTER.** Complete with 24-volt dynamotor, antenna tuning unit, TU-5 tuning unit (1500 to 3000 kc), all tubes and plugs. **BRAND NEW EQUIPMENT**, ready to operate... \$44.95  
(Also available for 12-volt operation. Specify BC-191. Same price.)

"Expertly built powerful little transmitters. At these prices, **COMPLETE AND BRAND NEW**, they're a steal," said our chief engineer.

**One of the boys from the lab took a look at these items and remarked "Clean merchandise. No 'What is it's' here. Honest to goodness values, all."**

BC-221 FREQ. METER, LIKE NEW.....	\$69.95	PE-103 DYNAMOTOR, 6 or 12 v. input; 500 v. out. NEW.....	\$19.95
RM-29 TELEPHONE BOX, complete with bell and ringer, NEW.....	\$ 7.95	EXCELLENT, USED.....	\$10.95
TS-13 HANDSET, complete with cord and plug, NEW.....	\$ 3.95	J-48 TRANSMITTER KEY in weather-proof metal case, with cord and plug, NEW.....	\$ 7.95
(2-RM-29's and 2-TS-13's make the finest two-way telephone system. All for.....	\$19.95)	T-17 MICROPHONES, NEW.....	\$ 1.95
HS-25 HEADSET (2000 ohms). Complete with cord and plug, NEW.....	\$ 2.45	25 ft. WHIP ANTENNAS (8-36" sections), complete with insulator mtg. base, NEW.....	\$ 7.95
R-14 SPARE EARPHONE for HS-25, NEW.....	\$ .45	BD-77 DYNAMOTOR, 12 v. input, 1000 out. NEW.....	\$ 5.95
MR-9F CONTROL BOX, EXCELLENT, USED.....	\$ 5.95	CD-307 EXT. CORD, NEW.....	\$ 7.75
LEAD THRU INSULATOR, 4 1/2" heavy duty.....	\$ .15	CD-307 EXT. CORD, NEW.....	\$ 5.95
CD-501 CABLE with plugs, NEW.....	\$ 2.50		

**ORDER \$15 WORTH AND GET FREE A HANDY STEEL CARRYING CASE FOR TUBES & PARTS**  
\$5 Min. Order. 25% with order. Balance C.O.D. Include Postage  
**EVERY ITEM GUARANTEED AS ADVERTISED OR YOUR MONEY BACK**

## ACOUSTICRAFT CORP.

Manufacturers of "TINY TOONER" pocket and wrist radios.

2144 So. Kedzie Avenue

Chicago 23, Illinois

## SCHEMATICS—CONVERSIONS FOR SURPLUS GEAR

### NEW

PE-117 conversion, supply 12 V AC and 180 V B plus for mobile command receivers or ARB from 6 V battery. Supply 24 V AC and 180 V B plus from 12 V DC boat or aircraft battery.....	\$1.00
BC-348 alignment. Specify model.....	\$1.00
BC-348 schematic with parts list and AC conversion. Specify model.....	\$1.00
AN/ARC-4 mobile ham conversion, 2 meters.....	\$2.00
SCR-522-A, AM, and C with parts lists, explanation of differences, and chart for crystal frequencies.....	\$2.00
ARB (CRV46151): Step-by-step conversion, with original schematic and alignment chart.....	\$2.00
For old customers who already have schematic.....	\$1.00
ARB (CRV-46151), Complete schematic, simplified schematic (both with control boxes), and IF and RF alignment chart.....	\$1.00
ASB-7; Indicator, transmitter, receiver, schematics with voltage inputs. Specify which unit. Each.....	\$1.00
GP-6, GP-7, TCE-2 schematic.....	\$1.00
BC-645, original and conversion, fixed or mobile. Includes PE-101-C.....	\$1.00
BC-375-E step-by-step conversion to AC, with power pack.....	\$1.00
BC-375-E original schematic plus tuning units plus complete parts list with values and characteristics plus plate current information.....	\$2.00
SCR-274-N receivers, BC-453, 4, 5: Conversion of front plug to local control adapter. AC power. Alignment. Parts location. Voltage and resistance readings. Interconnections. Large clear sheet.....	\$2.00
MN-26 operation and maintenance manual, 145 pages.....	\$5.00
AN/ARC-5 schematics: very large sheet, includes VHF receiver and transmitter.....	\$2.00
SCR-274-N Transmitter schematics, including modulator, rack, and control box.....	\$1.00
RU-16/GF-11 equipment schematic.....	\$2.00
RU-17/GF-12 equipment schematic.....	\$2.00

## SCHEMATICS: \$100

Each  
ARN-7 BC-433-G BC-733-D ART-13A  
APN-1 APN-9 SCR-625 APT-2 BC-1206-C  
R-89/ARN-5A RA-10  
No. 19 MARK II Sender-receiver

Please remit With Order. We Pay Postage. Send 25c and stamped addressed envelope for comprehensive list, cross-indexed for BC and SCR. Includes chart explaining code used in Army-Navy nomenclature.

R. E. GOODHEART  
345 1/2 N. PALM DRIVE  
BEVERLY HILLS, CALIF.

## PREMAX

### Why the Adjustable "V" Antenna Is Best for TV

Premax Adjustable V Dipole Antennas permit the proper vertical or horizontal adjustment of the elements to prevent, as generally happens with horizontal type dipoles, the combining of a "direct" with a "reflected" signal which results in a cancellation of both signals and poor reception.

The Premax V can be adjusted to the proper vertical or horizontal position to make the two signals combine in phase, thereby increasing rather than reducing the received signal.

Another Premax feature is that, properly mounted, it permits a sufficient signal energy at the antenna terminals to minimize the importance of the otherwise difficult task of perfect impedance matching.

Service men, installing the Premax V, find it insures optimum reception of signals from ALL of the TV stations within the line of sight.

Premax V is a low-cost antenna, easy to install and profitable to the service man. Send for details.

## PREMAX PRODUCTS

DIVISION CHISHOLM-RYDER CO., INC.

4909 Highland Ave., Niagara Falls, N. Y.

level of the original and reproduced sound, and volume effects of rooms).

**INTERFERENCE** from auto ignition and electrical equipment, a serious problem in reception and particularly television, is receiving legal attention in Great Britain with a Wireless Telegraphy Bill, which would make it mandatory to equip all units which may radiate electromagnetic energy with suppressors.

Discussing this move during an interview in New York City, Dr. R. L. Smith-Rose, director of research of the department of scientific and industrial research, London, and formerly vice president of the IRE, said that the bill would undoubtedly pass and guarantee interference-free reception. According to Dr. Smith-Rose, all manufacturers of accessories or automobiles which might radiate will have to secure an approved certificate, indicating that tests have been made to assure radiation-free performance.

In a query covering the 405-625-819 line debate now raging across the continent, Dr. Smith-Rose said that the British industry has not changed its opinion as to the virtues of the 405-line method, since it was believed that this standard was the most efficient in relation to cost and ether space occupied. The 625-line system, which seems to be favored by those in Sweden and Germany as well as Belgium and Switzerland, and the 819-line system popular in France, is not practical for Great Britain, according to Dr. Smith-Rose. The 625-line system, which has been developed by Philips of Eindhoven, and uses a 6-mc. bandwidth with two-to-one interlacing, does have many interesting possibilities according to other continental experts who were interviewed during their recent attendance at a series of lectures on television in this country.

**FORMER PRESIDENT HERBERT HOOVER** was honored at a recent luncheon of the Radio Executives Club at the Hotel Roosevelt, New York City, for his pioneering work in radio legislation and control while Secretary of Commerce and as President.

As tokens of esteem, the club presented Mr. Hoover with the original microphone that he used on January 15, 1921, at the European Relief dinner in the Duquesne Club, Pittsburgh, when he spoke over KDKA, and the microphone used at the White House while he was president.

A galaxy of outstanding technical, administrative, and entertainment personalities joined in the tribute, including Laurence Tibbett of the Metropolitan Opera; David Sarnoff, RCA Chairman of the Board; Walter Evans, president of Westinghouse Electric broadcasting division; Frank Stanton, CBS prexy; Wayne Coy, FCC Chairman; Norman Luker, North American Director of BBC; Ted Streibert, WOR prexy; Allan Hoover, son of Mr. Hoover; A. D. Willard, executive vice president of NAB; Ted Husing, fa-

mous sports announcer; Carl Haverlin, president of the club; and Frank M. Russell, vice president of NBC in Washington, D. C.

**THE EXTENSIVE PREPARATIONS** required for that epic inaugural TV network program a few months ago were disclosed recently in a special report.

According to this review, more than 550 long-line telephone experts were trained for the event, who for two months prior to the telecast were engaged in lining up and testing the coaxial links. The tests, which involved many changes and adjustments, went on continuously right up until the program was scheduled to go on the air.

The *Illinois Bell Telephone* number two toll building in Chicago was the key center for much of the activity. For into the 157-foot basement vault of the building was placed the Chicago-Cleveland-New York and Chicago-St.-Louis coaxial cables. Although this building and its equipment were designed to handle telephone conversations, the center was established to provide a headquarters to monitor and switch television programs.

The report showed that 540 amplifiers had to be installed along the routes and an additional system of 250 amplifiers were required for the television terminals in the telephone buildings in each city of the network.

Today, the network, still in the improvement stages, but providing excellent services, links fourteen cities and 30 stations and serves one-fourth of the nation's population, a remarkable record of engineering progress.

L. W.

Queen-Dona (CQ) Grace Burbage, Humboldt College co-ed, was chosen to reign over the all-male student body of California State Polytechnic College at the annual Poly Royal celebration April 29 and 30. Miss Burbage shown seated at the controls of the college short-wave station, sent invitations to all hams to inspect the college's radio and electronics facilities during the two-day celebration on the San Luis Obispo campus. This is a regular, extra-curricular activity of the student body, planned, managed, and directed by the student leaders and is recognized nationally as a pioneer and model of vocational education of the college level.



May, 1949

## CONVERT DIRECT - VIEW TELEVISION TO

# LARGE SCREEN PROJECTION TELEVISION!

Any electro-magnetic deflection TV set can be converted! All you need are 3 basic components: lens, tube and power supply.

### 30 KV RF POWER SUPPLY



Dimensions: Length 14", Width 11", Height 11 1/4"

New Improved unit of exceptional regulation. Has a focus control pot built in for use with 5TP4 Tube. Voltage variable from 27 to 30 KV. Supply utilizes 6 tubes.

Net price, including DC Power Supply.....\$99.50

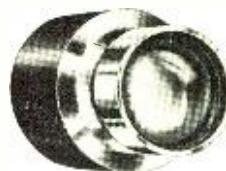

### SPELLMAN F1.9 PROJECTION TV LENS

Dimensions: Length 7", Diameter 4 1/4"

F1.9 EF.5 in. (127.0 mm.) This lens incorporates in barrel a corrective lens for use with a 5TP4 projection tube. It is easily removable for use with flat type tubes. Lens can be utilized to project picture sizes from several inches to 7 x 9 feet.

Complete with mounting ring. Machined slotted Mounting Ring available for hand focusing adjustment. Has 4 holes for easy mounting on plate. \$8.00 extra.

Only \$90



### 5TP4 PROJECTION KINESCOPE TUBE

Features a metal backed white fluorescent screen having high brightness and contrast.

Net Price.....\$67.50



### HIGH VOLTAGE METER 0 TO 30 KV

A precision-made instrument with range from 0 to 30 KV. Has 4" scale and only draws 20 microamps. Bakelite meter panel housed in solid oak cabinet. Meter has jack connector for convenient connection to oscilloscope in checking voltage

wave forms. Net price.....\$67.50

Send for Free Complete Technical Details

### HIGH VOLTAGE COILS

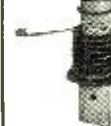

5 KV.....\$ 3.25  
10 KV..... 7.75  
15 KV..... 7.75  
25 KV..... 35.00  
30 KV..... 35.00

FILAMENT TRANSFORMER FOR 1B3 Rectifier Tube.....90c

### HIGH VOLTAGE TELEVISION CAPACITORS

#### SPECIFICATIONS: JEFFERS TYPE SKC CAPACITORS

Type	Capacity	Operating Voltage	Net Price
SKC 10-10	1000 mmfd	10,000	.45 ea.
10-20	500 "	20,000	.84 ea.
10-30	300 "	30,000	2.10 ea.
SKC 20-10	1600 mmfd	10,000	2.52 ea.
20-20	1200 "	20,000	3.36 ea.
20-30	600 "	30,000	4.17 ea.
SKC 30-10	3200 mmfd	10,000	4.17 ea.
30-20	2500 "	20,000	5.01 ea.
30-30	1200 "	30,000	5.85 ea.

### NEW REAR PROJECTION PLASTIC TELEVISION SCREENS

The screen surface consists of a conglomerate arrangement of microscopic plastic crystals that "Pin Point" the projected image providing unexcelled angular viewing with a minimum loss of projected light. It is estimated that there is a loss of approximately 10% of light viewing the image at 45 degrees off center.

Light transmission percentages are controlled to obtain the maximum efficiency of the television optical projection system.

Net price of Rear Projection Screen, per sq. foot \$3.00

Include 25% Deposit With Order, Balance C.O.D.

## SPELLMAN TELEVISION CO., INC.

DEPT. A, 130 WEST 24th STREET, NEW YORK 11, N. Y. • AL 5-3680



### HOW TO GET THE MOST FROM YOUR RADIO "KNOW-HOW"

Learn all about a new, simplified way of fixing radios. Nothing complex to learn, no calculating. Used by beginners and experts. Send for FREE manual, "THE INSIDE STORY," today. 28 pages—illustrated—easy to read! Shows how obsolete methods prevent full use of your real ability. Explains use of NEW techniques. You owe it to yourself and your future to "get out in front" in your work.



SEND COUPON OR PENNY POSTCARD FOR FREE MANUAL TODAY!

FEILER ENGINEERING CO., Dept. 5H9  
945 George St., Chicago 14, Illinois  
Please RUSH my FREE copy of "The Inside Story"

Name.....  
Address.....  
City..... Zone..... State.....

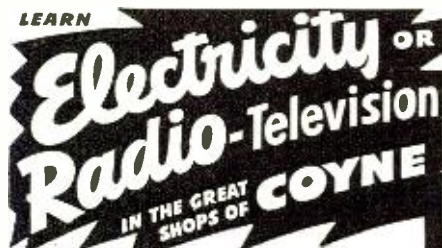

### LEARN Electricity OR Radio-Television IN THE GREAT SHOPS OF COYNE

TRAIN QUICKLY! OLDEST, BEST EQUIPPED SCHOOL OF ITS KIND IN U.S. 2 Opportunity Fields

Come to the Great Shops of COYNE in Chicago during our 50th Anniversary Year! Get quick, practical training in RADIO-TELEVISION or ELECTRICITY. G. I. Approved. Finance plan for non-veterans. Mail Coupon Today for complete details.

NOT "HOME-STUDY" COURSES! You learn on real, full-size equipment, not by mail. Finest staff of trained instructors to help you get ready quickly for a better job, a fine future.

FREE BOOKS Clip coupon for big illustrated Coyne book on either ELECTRICITY or RADIO-TELEVISION. Both books sent FREE if you wish. No obligation; no salesman will call. Act NOW!

B. W. COOKE, Pres.  
COYNE Electrical & Radio School, Dept. 59-85H  
500 S. Paulina Street, Chicago 12, Illinois  
Send FREE BOOK and full details on:  
 ELECTRICITY  RADIO-TELEVISION  
NAME.....  
ADDRESS.....  
CITY..... STATE.....

# SURPLUS BARGAINS

## REC. & TRANS.

BC 454 (new) 3 to 6 mc.  
BC 457 or ARC5, 4 to 5, 80 mc.  
(slightly used) with  
schematic. **\$895**



Both for

BC 459, 7 to 9.1 mc. (new)	\$14.95
T20 ARC 5, 4 to 5.3 mc.	11.95
T22 ARC 5, 7 to 8.1 mc.	11.95
BC 459 7-9.1 mc. (used)	9.95
T22/ARC-5 7-9.1 mc. (new)	12.95
(Used)	5.95
T20/ARC-5 4-5.3 (used)	4.95
274-N Type Trans. 2-1-3 mc. (used)	5.95
BC 453 190-550 kc. (used)	9.95
BC 454 3-6 mc. (new)	5.95
(Used)	3.95
BC 455 6-9.1 mc. (used)	5.95
274-N Type Receiver 1.5-3 mc. (new)	15.95
(Used)	9.95
12 volt Dynamotor (can be used for above)	7.95
ARB Recvr 190-9.05 mc. continuous (exc. for marine) (used)	19.95
ARN-7/BC 433 Recvr 150-1750 mc. continuous (used)	14.95
ASB/7 Indicator Unit with Tubes (exc. basic unit for 5" scope) (used)	14.95

## SELSYN XMITTER & INDICATOR



Ideal as Radio beam position  
Indicator for Ham, Television  
or commercial use. **\$495**  
Complete with I-82...

Spare set of Tubes for Command Recvr or  
Trans. Specify which set. **\$ 1.29**  
Dynamotor 6 volts DC-300 volts DC 85 ma. **4.95**  
PE-103 Dynamotor 6-12 volts DC-500 volts  
DC 160 ma. (new, complete with base) **14.95**  
(New, without base) **7.95**

## SCR-522 TRANS. & REC.

Like New **\$39.50**  
BC 375 Tuning Unit. New **2.45**  
FILAMENT TRANSFORMERS-110 volt 60 cycle  
primary.

12-24 volt at 2 amp	\$ 2.95
5-24-30 volt at 20 amp	3.95
6.3 volt at 6 amp.-5 volt at 3 amp.- 33 volt at 150 ma.	1.95

## PLATE TRANSFORMERS-115 volt 60 cycle primary.

3200 volts NO CENTER TAP-NEW.	
Two (2) used SINGLE PHASE FULL WAVE RECTIFIER CIRCUIT 2900 volts WITH 300 ma. LOAD <b>8.95</b>	
2 for <b>15.95</b>	
540 C.T. @ 150 ma.	
5 volts @ 3 amp.	
6.3 volt @ 6 amp.	3.95
880 C.T. @ 150 ma.	
6.3 volt @ 4.5 amp.	
1.7 volt @ 5 amp.	4.95

## HEINEMAN CIRCUIT BREAKERS

120 volts @ 10 amperes	.89
120 volts @ 20 amperes	1.95
120 volts @ 30 amperes	2.49

## TRANSMITTING AND RECEIVING TUBES

2K2	\$ .79	6L6	\$1.25	959	\$ .59
5Z3	.79	717A	.69	VR150	.79
757L	3.95	861	12.95	304TL	.90
832A	3.95	958	.89	6AJ5	.89
6L6C	.89	9AC7	.89	4E27	12.95
801A	.49	807	.89	829	3.95
866A	1.39	810	4.95	6SC7	.89
954	.59	6AK5	.89	803	4.95
6SN7	.89	VT127A	2.95	1616	.89
617	.79	860	4.95	872	1.98
813	7.95	6SH7	.89		

## CATHODE RAY TUBES

3BP1	\$2.49	5GP1	\$2.95	5HP4	\$3.95
5BP1	2.95	5BP4	2.95	5FP7	3.95

FL-8 Audio Filter (new)  
Add 40c for postage. **\$1.79**

DC Ammeter 60-0-60 (new) **.97**

## CHOKES FOR MEDIUM POWER "B" PLUS SUPPLIES

6 henries @ 150 ma.	\$1.49
10 henries @ 150 ma.	2.19
10 henries @ 200 ma.	3.19

## FILTER CONDENSERS OIL FILLED

2 mfd. @ 600 volts, 3 for	\$ .49
10 mfd. @ 600 volts, 3 for	1.19
1 mfd. @ 1000 volts, 3 for	.49
5 mfd. @ 2000 volts, 3 for	3.49
2 mfd. @ 2500 volts, 3 for	2.39
1 mfd. @ 3600 volts, 3 for	2.95
1 mfd. @ 4000 volts, 3 for	3.49
2 mfd. @ 4000 volts, 3 for	4.95
3 mfd. @ 4000 volts, 3 for	5.45
2 mfd. @ 5000 volts, 3 for	5.95

Remittance with Order. Minimum Order \$2.50.  
Orders F.O.B. Los Angeles, Calif.

Prices Subject to Change without Notice.

## ESEGE SALES CO. LTD.

Distributors of Surplus Radio and Electronic Parts  
1306 Bond Street at Pico  
Los Angeles 15, Calif.

## LEARN

# TELEVISION

## ELECTRONICS RADIO

Modern Completely Equipped  
Laboratories

## DAY AND EVENING CLASSES

G.I. Approved—Veterans Receive  
Subsistence

ENROLL NOW!

## ELECTRONICS INSTITUTE, INC.

21 Henry, Detroit 1, Mich.

## Don Lee Studios

(Continued from page 37)

vey the traffic problem and equipment needs of the expanding network. The outgrowth of many round table discussions was master control equipment with a switching system of over 800 possible program combinations requiring 821 relays, 49 amplifiers, 850 indicator lamps, 2500 jacks, and 13 volume indicators. The equipment contains facilities for handling 12 studios, 3 announce booths, 4 recording channels, 4 simultaneous remote programs, 96 remote connections, 7 incoming networks, 10 outgoing networks, and equipment for special facilities. Despite the complexity, there are tell-tale indicators, automatic features, and convenient control arrangements to permit its entire supervision by only one man.

In regard to the automatic features, it is normal to allow 20 seconds after cue for fill to the network before switching, permitting the master control operator only 10 seconds to perform his many functions. He now can press *Delay Master* buttons on cue, which will automatically switch the network 20 seconds later, leaving him free for other duties. The equipment has its own dust-free air conditioning system.

A mixing console which would incorporate facilities necessary to the needs of radio production had been planned for several years. Many schematics were drawn and revised. It was desired to have the greatest amount of flexibility and facilities for fulfilling the demands of all types of programs, but unfortunately the mixing console became excessively complicated. Often it has been said that an engineer's job is one of making the best compromise and here a compromise was necessary.

With this in mind, less frequently used special effect equipment was deleted with the idea of housing such equipment in a separate cabinet so that it could be wheeled to the side of any console when the occasion demanded. The desk circuits were treated to gain maximum flexibility through the use of jack bays. The eight channel mixer, operationally speaking, was simplified by keys, which, by choice of the technician, split the board into channel groupings controllable by sub-masters. On certain types of programs this greatly facilitates mixing. For example: the multi-microphone pickup of an orchestra, controlled by one hand, can be balanced against the instrumental solos or vocal microphones controlled by the other hand. The sound microphones can be balanced against the cast microphone in the dramatic programs.

Through the continual exchange of ideas with *Western Electric Company*, there emerged a control desk which in one year of trial installation has proven very satisfactory. The readily accessible plug-in amplifiers have made the occasional service requirements very simple.

The equipment installed in the KHJ network and FM announce booths is to provide for fading into or out of programs, giving identification and spot announcements, playing transcribed commercial spots or recorded fills in case of program failure, and cueing and monitoring necessary to the operation. The Don Lee Broadcasting System production department and announcing staff studied the possible layout of equipment fulfilling these needs with the intention of improving the ease and accuracy of operation. The number of controls appearing on the equipment was held to a minimum to avoid confusion and the placement was based on frequency of use. Much consideration was given to the slope

Fig. 1. A typical family of curves resulting from reverberation tests made during the course of construction. Here, for the first time, a building was constructed to the optimum reverberation characteristic as indicated by the curves.

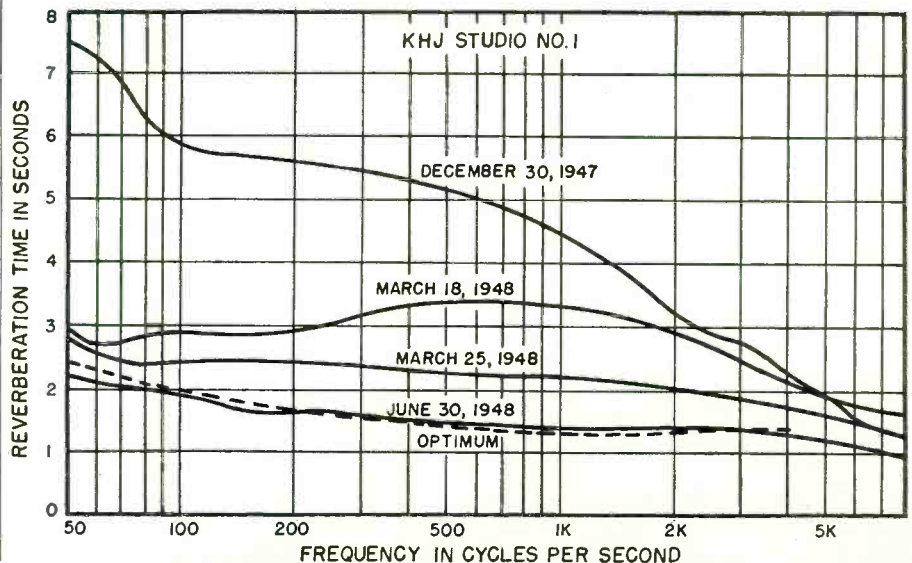

of the control panel and location of the volume indicator to further facilitate operation. It was decided that a control desk similar in shape to that developed for the small studios would be ideal with circuit and control modification for use in the announce booths.

A need existed for control room equipment associated with the small studios used in commentary and round table discussion types of programs, preparation and playback of delayed broadcasts with facility for cut-in announcements, and assembly of record shows with the announcer (disc jockey) working in the control room or in the studio with a technician at the controls.

The design philosophy was that of simplicity, ease of operation, and dependability. With an intent to minimize operational errors resulting from poorly placed and excessive numbers of controls and switches, a careful study was made to determine the most frequently used controls and the most convenient location for each with the least hazard to smooth operation. The aim was to satisfy program production demands with the minimum number of controls in order to facilitate fast and accurate operation. To insure greater dependability, each part was studied as a potential trouble maker. For ease of operation, two turntables were built into one side of the desk, and a third was placed in a separate cabinet on the other side of the operator as optional equipment. Moreover, the physical shape and color of the control desk were worked out with *Western Electric* engineers to give eye appeal and modern design rather than just the "technical look."

Mutual Don Lee is convinced that the care and effort expended in the design and construction of this network center have produced the ideal home for its operations in Hollywood. The acoustic characteristics of the studios add measurably to the quality of the broadcasts. The provisions in the building for technical services and the careful planning of the layout for storage, for entrance and exit of the public, and for the managerial functions of the networks are of great value, and finally, the audio system brings simplicity and efficiency to program production and dispatching.



"But all I said was that her battered old chassis was sprung and bulged where it shouldn't."

May, 1949

## SEE THE BACK COVER

Since RADIO NEWS covers are printed far in advance of the balance of the publication, certain changes have taken place after our announcement on the back cover was printed. These are as follows:



All Major Components are Already Mounted on Chassis including prewired "VIVIDeo" I.F. strip (Pat. Pend.) and prewired front end. Only 13 tubes remain to be wired.

**FREE!..** Complete comprehensive Service Data on the T.A.C. exclusive "VIVIDeo" 13-tube Picture and Sound I.F. Strip (Pat. Pend.). Contains all information needed to thoroughly understand and service this unique high-gain I.F. Strip which features 5 1/2 stages of Cathode-Coupled Grounded-Grid Video I.F. amplification. For high gain, sensitivity, stability, "VIVIDeo" can't be beat! Write for FREE booklet SB-1 or ask your local jobber for it. Booklet SB-1 also included with each T.A.C. Direct-View Assembly.

### NEW LOW PRICES!

**T.A.C. STANDARD MODELS** 29 RCA tubes, plus RCA or DuMont C.R. Tube. Prewired "VIVIDeo" 13-tube Picture and Sound I.F. Strip with 5 1/2 stages of Picture Amplification. Prewired All-Channel Front End with Fine Tuning. RCA 5x7 Oval Heavy Duty PM Speaker. Delivered complete with ALL MAJOR COMPONENTS MOUNTED. PLUS New Comprehensive SUPER-SIMPLIFIED DATA for Wiring and Servicing.

Model M101S—Complete (less C.R. Tube) **\$169.50** Dealer's Net\*  
 Model F101S—Complete with 10" RCA C.R. Tube **\$203.50** Dealer's Net\*  
 Model F121S—Complete with 12" DuMont C.R. Tube **\$231.25** Dealer's Net\*  
 Model F151S—Complete with 15" DuMont C.R. Tube **\$314.50** Dealer's Net\*

**T.A.C. CHAMPION MODELS.** Identical extra-value features as above except Standard Tuner replaced by DuMont Inputuner for Continuous Tuning of ALL FM RADIO AND TV CHANNELS.

Model M101C—Complete (less C.R. Tube) **\$209.50** Dealer's Net\*  
 Model F101C—Complete with 10" RCA C.R. Tube **\$243.75** Dealer's Net\*  
 Model F121C—Complete with 12" DuMont C.R. Tube **\$271.40** Dealer's Net\*  
 Model F151C—Complete with 15" DuMont C.R. Tube **\$357.35** Dealer's Net\*  
 Model F201C—Complete with 20" DuMont C.R. Tube **\$566.75** Dealer's Net\*

ALL T. A. C. 15" and 20" Assemblies contain 30 RCA tubes, plus DuMont C.R. tube, RCA 12" Heavy Duty PM Speaker, and all features mentioned above PLUS Prewired 14KV High Voltage Doubler Power Supply.

★ Write for Catalog on our Complete Line of TV Replacement Components!

540 BUSHWICK AVE., BROOKLYN 6, N. Y.

\*Prices 5% Higher West of the Mississippi

Prices subject to change without notice.



## SEE THE BACK COVER

# STAY ON THE AIR ...WHEN POWER FAILS

When storms, floods or breakdowns interrupt electric service to your station and force you off the air, you lose listeners... you lose income... you lose the opportunity to give vital service to your community. These losses can be prevented by installing a dependable Onan Standby Electric Plant.

Always on guard against commercial power failures, Onan Plants equipped with Line Transfer Controls automatically take over the job of supplying electricity during emergencies. Upkeep costs are negligible. Only periodic servicing and inspection are required.

Range—1000 to 35,000  
Watts A.C.

SEND COUPON BELOW  
FOR STANDBY FOLDER

Station WJPG, Green Bay, Wisc. is  
protected by Onan Standby Power



**ONAN  
ELECTRIC  
PLANTS**

**D. W. ONAN & SONS INC.**

4799 Royalston Ave. Minneapolis 5, Minn.

Please send me your Standby Folder.

NAME \_\_\_\_\_  
 ADDRESS \_\_\_\_\_  
 CITY \_\_\_\_\_ STATE \_\_\_\_\_



157

# MAKE YOUR OWN BIG PICTURE TELEVISION!

ALMOST

# 7 SQUARE FEET OF PICTURE!



## with INTERNATIONAL'S PROVEN PROJECTION ASSEMBLIES

The following units when assembled produce a complete projection unit for pictures from 15" x 20" to 3' x 4'.

PK-36 (Projection video chassis).....	\$180
LK-36 (Projection low voltage power supply) .	76
HK-36 (Projection high voltage power supply) 55	
CK-36 (Projection Schmidt optical assembly) 294	
Complete .....	TOTAL \$605
PBK-36 (Optical barrel assembly) only.....	\$98

Prices on mirror and screen upon request

### SPECIAL SENSATIONAL PRICE!

RCA 630TS type chassis.....\$165.50  
The tried and true chassis adaptable for use with 10", 12", 12½", 15" and 16" tubes.  
Send check with order or 25% deposit on C.O.D.'s.  
Prices quoted F.O.B. factory.

Dealer prices quoted upon request.

## INTERNATIONAL TELEVISION CORPORATION

238 William Street  
New York 7, N. Y.

## RADIO ENGINEERING DEGREE IN 27 MONTHS

Intensive, specialized course, including strong basis in mathematics and electrical engineering, advanced Radio Theory and Design, Modern laboratory, Low tuition. Self-help opportunities. Also 27-month courses in Aeronautical, Chemical, Civil, Electrical and Mechanical Engineering. Gov't approved for G.I.'s. Enter June, Sept., Dec., March. Catalogue. **INDIANA TECHNICAL COLLEGE**  
959 E. Washington Blvd., Fort Wayne 2, Indiana

### COUPON-OF-THE-MONTH

TUBES—STD. BRAND 5Y3 GT.....	3 for \$0.99
TUBES—STD. BRAND 12SQ7 or 12AT6.....	2 for .99
VOL. CONTROLS—STD. BR. .5 Meg. W. SW.....	3 for .99
CONDENSERS—40-40 Mfd. 150V.....	2 for .99
CONDENSERS—20-20 Mfd. 150V.....	2 for .99
LOOP ANTENNA—III GAIN (5"x8").....	3 for .99
I.F. COILS 455 KC (1½"x2½").....	3 for .99
OSC. COILS 455 KC (for 12SA7).....	4 for .99
BY PASS COND. KIT—18 Ass'd.....	.99
DIAL CORD KIT—100 Ft. Ass'd. & 8 Springs.....	.99
GRILLE CLOTH—6 Ass'd. 6"x8" & 10 Knobs.....	.99
COMBINATION KIT—All Above Items—Only.....	10.00

WITH THIS COUPON—ORDER AT ONCE

Write for Monthly Coupons and Bulletin

RADIO DISTRIBUTING CO., PASADENA 18, CAL.

## Mae's Service Shop

(Continued from page 52)

tion that ordinarily separates the line from the chassis? What's the resonant frequency?"

"Let's see if you can figure it out for yourself," Mac suggested. "First, what's the chief characteristic of a series-tuned circuit?"

"A very low impedance at the resonant frequency," Barney said promptly; "so I suppose that this circuit is for the purpose of furnishing a very low impedance path between the chassis and 'B-minus' at one particular frequency."

"So far, so good!" Mac encouraged. "And what particular frequency is it that we want to be sure is tied down so that it cannot go wandering around through the receiver and cause us more trouble?"

"The i.f. frequency?" Barney guessed.

"That's right. Because of the high gain of the i.f. amplifier, it is essential that the i.f. signal stick strictly to the path intended for it. The series-tuned circuit is usually mounted physically near the cathode return of the i.f. amplifier, and so it serves to prevent degeneration at the i.f. frequency as well as to prevent oscillation. In short, you might say that the series-tuned

circuit is employed as a particularly effective bypass."

"It is rather funny that you should ask about that at just this time, though," Mac continued, "for this letter I am holding contains a descriptive bulletin on the *Sprague* line of resonant condensers that were designed to contain in a single compact unit that tuned circuit you have there. These condensers, which come in .05, .1, and .2  $\mu$ fd. values, have *built-in* inductance so that they resonate at 455 kilocycles. At this frequency, the impedance of a typical .2  $\mu$ fd. unit is less than a quarter of an ohm."

"If a fellow had to replace one of those resonant condensers, he ought to use an exact duplicate, right?"

"Right!" Mac said. "For if he doesn't, he is likely to have oscillation trouble."

"Do they look any different from ordinary condensers?"

"Well, the ones that bear the *Sprague* name come in yellow tubes and are marked 'resonant' for identification. The other day, though, I ran across one of the units that was in a slate-gray tube and just had the word 'special' stamped on it."

Barney shook his head sadly. "It is not enough that we have resistors that look like condensers and condensers that look like resistors. Now we gotta have tuned circuits that look like condensers yet!"

—30—

## A USEFUL SWITCHING CIRCUIT

By JACK D. GALLAGHER, W5HZB

AN ARTICLE by the writer which appeared in *Radio & Television News*, June 1948, entitled "Another Method of Power Supply Control" presented a simple solution to the problem of turning the plate voltage on last and off first by three switches. For reference, the switching arrangement is shown in Fig. 1A.

Removing  $S_3$  of Fig. 1A will provide a method of "plates on last, off first" for  $T_1$  and  $T_2$ . Suppose, however, that these same features could be accomplished with just one toggle switch instead of two. Or, if all three transformers were to be used, it would still simplify matters if two toggle switches would serve the purpose of three.

The diagram of Fig. 1B will serve the purpose quite well. The relay is connected in a lock-up circuit by throwing  $S_1$  to the right. Since only a momentary connection is needed to turn on the filaments,  $S_1$  can be a 3-position switch with a momentary action on one side. By switching  $S_1$  to the left, primary voltage can be applied to  $T_2$ . If  $S_1$  were switched to the left at first, nothing would happen since the primary of  $T_2$  is open through the relay contacts. If for some reason  $S_1$  is to the left and the relay coil goes open,  $T_2$  is turned off as well as  $T_1$ , both simultaneously. If the plate voltage is left on ( $S_1$  to the left) accidentally, the push-button will turn off both voltages.

$S_2$  in Fig. 1B controls  $T_3$ , if it is used. Since the filament voltage must be applied before either  $T_2$  or  $T_3$  will operate, there is no possibility of turn-

ing the plate voltage on first, or off last. If both  $S_1$  and  $S_2$  were "on" ( $T_2$  and  $T_3$  operating), all voltages would be turned off when the push-button was opened and nothing could be turned on first except the filament transformer  $T_1$ .

—30—

Fig. 1

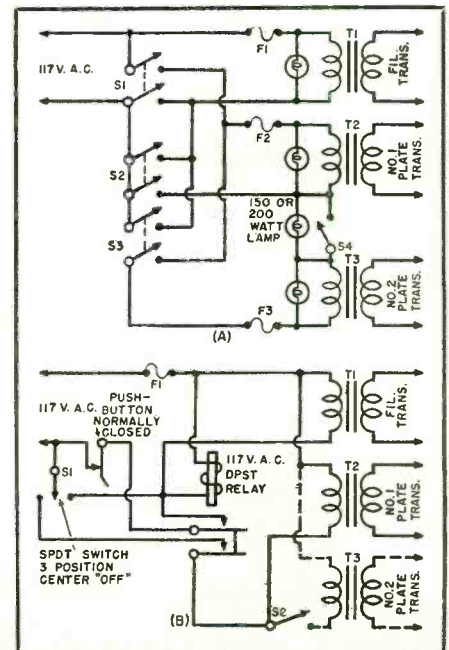

## International Short-Wave

(Continued from page 142)

**Azores**—CSX2, 4.845, Ponta Delgada, heard 1715-1900; CS9MB, 11.090, heard 1415-1500. (Peddle, Newfoundland)

**Barbados**—VPR-9, 15.035, heard recently calling VRR-4 at 0740; heard another day 0745 contacting same station. (Ferguson, N. C.)

**Belgium**—Brussels, 17.845, heard recently calling ABC, New York, at 1730. (Beck, N. Y.) ORG, 19.230, heard to LSMS at 1300. (Peddle, Newfoundland)

**Bermuda**—ZFD-2, 10.390, works WNB; ZNX-2, 20.715, works London, and ZNU-4, 10.150, works WNB; all located at St. Georges. (Peddle, Newfoundland)

**Brazil**—Radio Jornal do Comercio, Recife, confirmed report via registered airmail QSL card. Transmitter is Marconi SWB 10, input 15 to 20 kw. high-level plate modulation. Antennas are 258 degree Beverage array for 19-, 25-, 31-, and 49-meters. Input at time of report was 15.18 kw. Stations, frequencies, and schedules listed PRL-6, 780 kcs., 0600-2100; ZYK-2, 15.145, 0600-1400; ZYK-3, 9.565, 0600-1200, 1400-2100; ZYK-2, 6.085, 1600-2100; advised that ZYK-3 also operates at times on 11.825 but is subject to heavy QRM there. (Rosenauer, Calif.)

What appears to be PYZ-2, *Emissora do Distrito Federal*, Rio de Janeiro, on 9.220, is heard 1800 or 1815 to 1830 sign-off. (McPheeters, La.) Also heard in Texas by Stark.

**British Guiana**—ZFY, about 5.985, Georgetown, heard in New York at 2000 and signing off 2045 with "God Save the King." (Weisberg) Relays BBC news 1800. (Ferguson, N. C.) Good level early mornings, also.

**British Honduras**—Ferguson, N. C., says ZIK-2, 10.598, Belize, seems to be back on old schedule as has heard it opening several times lately 1332 with news; was heard one day 1250 calling VQNA at 1331, had news which ended 1343, then called VQNA again; fair signal.

**Bulgaria**—Radio Sofia, 7.671, is still broadcasting 2250-0300; no English noted; improved signal recently. (Hagen, Ala.) Has setting-up exercises 2320, Eastern music 2330, news in Bulgarian 0000, then music (this time mostly marches of Slovak type). (Beck, N. Y.) Is heard in Newfoundland 1650-1700 with news. (Peddle)

**Cameroon**—"Ici Radio Douala," 9.160, signs on 1300 with march, then gives call "Allo, Allo, Ici Radio Douala"; programs feature much recorded music. (Pearce, England) On Sundays appears to run 1430-1600. (Peddle, Newfoundland)

**Canada**—VE9AI, 9.54, Edmonton, Alberta, has news 0000. On West Coast, says Dilg, Calif., can be heard at weak level mornings after *Radio Australia* leaves the channel 0845.

**Cape Verde Island**—DeMeyer, Mich.,

# For Clearer Television!



## alliance TENNA · ROTOR

TV-FM ANTENNA ROTATOR

- Sharper Pictures
- Wider Range
- Peak Reception!

This antenna rotator turns your TV antenna instantly as needed—"aims" it at the station—keeps image clear—overcomes interference and distortion! In multi-station and fringe areas Tenna-Rotor brings in that station you couldn't get before—increases selectivity, directivity and range!

Weather-proof enclosed electric rotor unit, (size 7" x 8") fits antenna mast—is quick and easy to install—self-lubricated for long life! Smart, plastic remote-control case plugs into 110-volt house circuit. Price \$39.95. (Slightly higher west of Rockies.) Complete assembly, rotor and control case, weighs 12 lbs. End your "fixed position" antenna worries—ask your dealer or service shop!

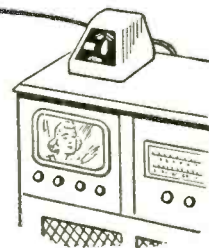

**ALLIANCE MANUFACTURING COMPANY • ALLIANCE, OHIO**

Export Department; 401 Broadway, New York, N. Y., U. S. A.



**What Receiver Would You Like to Have?  
What Do You Have to Trade-In?  
I Will Make You the Best Deal!**

Nobody can beat Bob Henry on a trade-in! (I make the deals myself.) Nobody can beat Bob Henry's world's lowest credit terms! (I finance the thing myself.)

Bob Henry gives you immediate delivery on practically anything in the amateur or communications receiver line. (I carry the world's biggest stock.) Bob Henry gives YOU FREE ten-day trial and FREE 90-day service! (I don't want you to buy anything you don't want.)

These are just some of the reasons why Bob Henry sells more receivers than anyone in the world! EVERYTHING has some trade-in value. Write me what you have and what you want. We can do business!

*Bob Henry*  
WOPARA

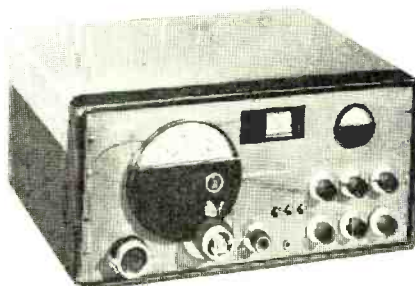

**SX-42** Greatest continuous frequency coverage of any communications receiver—from 540 kc. to 110 Mc. One superb unit with 6 bands; AM, FM, CW. Finest performance obtainable. **\$275.00**

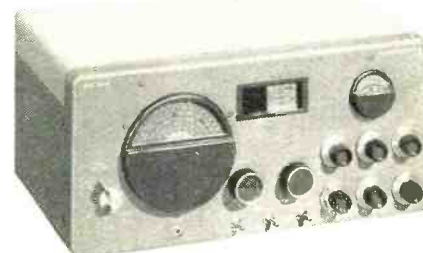

**SX-43** All essential ham frequencies from 540 kc. to 108 Mc. In the band of 44 to 55 Mc, wide band FM or narrow band AM, just right for narrow band FM reception is provided. **\$189.50**

**COMPLETE STOCK OF ALL HALLICRAFTERS RECEIVERS AND TRANSMITTERS**

Write for catalog, prices, time sale information

Butler 2, Missouri

## HENRY RADIO STORES

11240 Olympic Blvd.  
LOS ANGELES 25  
CALIF.

WORLD'S LARGEST DISTRIBUTORS OF SHORT WAVE RECEIVERS

LICK low signal strength with a HIGH GAIN QUALITY

# Dielectric Duoband Antenna

The DIELECTRIC DUOBAND, Model D (illustrated) — just one of the complete line of DIELECTRIC antennas— is designed to give excellent results on all channels, in low signal strength areas.

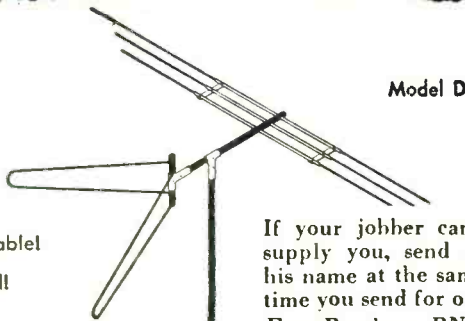

Model D

- Durable!
- Easily installed!
- No interfering high frequency unit needed. One DUOBAND — one lead . . . that's all you need!

If your jobber can't supply you, send us his name at the same time you send for our Free Brochure RN-1, which illustrates field patterns!

**Dielectric PRODUCTS CO., Inc.**  
125 Virginia Ave., Jersey City 5, N. J.



SEND FOR FREE BROCHURE RN-1

has received verification (making his 208th country verified!) from *Radio Clube De Cabo Verde*, Praia CR4AA, heard on 5.910 some months ago; sent a beautiful card, gave frequency 6.024 and schedule of 1350-1500; however, Pearce, England, lately heard this station to 1700 on approximately 5.895 through bad CWQRM; DeMeyer heard it on 5.910 at 1600-1700. Swedish sources list this one with only 100 watts.

*Ceylon*—*Radio Ceylon* was recently heard at 1100 on 15.12 and 17.73 (not 17.77). (Balbi, Calif.) Has BBC news relay 1100 and some days is readable here in East on 15.12. The Sunday transmission to the British Isles is best in East now on the 16-m. outlet, since 15.12 at that time suffers severe QRM; time 1130-1330.

*China*—Nanking's former XGOA, 9.730, no longer giving call, still heard in California 0900 with usual news. (Dilg) This outlet is fair level in West Virginia early mornings, but usually has interference from around 0625. Balbi, Calif., recently heard the 9.730 channel 0500-0730, all native, strong level, but says there is no sign of the 5.985 outlet now.

A Communist-controlled outlet on approximately 7.500 was recently heard by Dilg, Calif., with *English* starting shortly before 0900; may be old XNCR.

GDX-AREN, house organ of Goteborgs DX-Klubb, Sweden, reports "*Shanghai Broadcasting Station*" heard 0900-1000 sign-off on 11.705. (I am anxious for full details on current frequency and schedule of former XORA, Shanghai.—K.R.B.)

BCAF, 8.995, is believed to be old XGAF, Nanking Air Force, moved from 7.102. (Dilg, Calif.)

According to data received directly from the station, *Radio Hong Kong* has two m.w. transmitters of 2 kw. and one s.w. transmitter (ZBW-3) of 2.5 kw.; frequencies are ZBW, 645 kcs., transmitting the *English* Program 2330-0100, 0500-1015; ZEK, 640 kcs., transmitting the Chinese Program same hours; ZBW-3, 9.52, carrying the *English* and Chinese Programs of ZBW and ZEK at same hours listed for m.w. outlets. But on Sundays, the *English* Program starts 2 hours earlier, that is at 2130, and Chinese Program begins Sundays one-half hour earlier, that is 2300 (Ghurkali Program). The s.w. outlet, 9.52, is shared between *English* and Chinese Programs. News scheduled 0015; BBC's, GOS relay of world news and news analysis 0600; BBC's GOS relay of "*Radio Newsreel*" 0900. Summer time schedule listed *English* 2200-2330 (Sundays) and other days 2230-2330, 0530-0630, 0715-0915, and Chinese at 2330-0000, 0400-0530, 0630-0715. (Gaynor, Calif.)

YGYA, 7.990, heard 0530 with relay of XNCR in Chinese news, music. (Sanderson, Australia)

Desouza, Singapore, says North Shensi New China Station is heard on 9.000 from 0430 to 0900; no call-sign heard; has news 0845 to closedown at

**RADIO & TELEVISION NEWS**



Assembled for your convenience  
**Facts, standards practices, data**  
for the whole field  
of radio engineering

## Radio Engineering Library

RADIO specialists of the McGraw-Hill publications selected the books for this library as those

giving the most complete, dependable coverage of facts needed by engineers whose special fields are grounded on radio fundamentals. They cover circuit phenomena, tube theory, networks, measurements, and other subjects . . . give specialized treatment of all fields of practical design and application.

- ★ Special Low Price
- ★ Bought singly, the five volumes would cost \$30. Under this offer you save \$2.50
- ★ Pay in easy installments

**FREE 10 Day Trial!**

### Library includes:

1. Fundamentals of Vacuum Tubes—Eastman
2. Radio Engineering—Ierman
3. Communication Engineering—Everitt
4. High-Frequency Measurements—Hund
5. Radio Engineering Handbook—Henney

3559 pages!

2558 illustrations!

McGraw-Hill Book Co., 330 W. 42nd St., N.Y.C. 18  
Send me Radio Engineering Library, 5 vols., for 10 days' examination on approval. In 10 days I will send \$2.50, plus few cents postage, and \$5.00 monthly till \$27.50 is paid, or return books postpaid.

Name .....

Address .....

City..... Zone..... State.....

Company .....

Position..... RN-5-49

## THE "ALL PURPOSE" TELEVISION KIT

10" 12 1/2" 15"  
TUBES



## FEATURING

- Latest Type of Circuits
- AGC—Automatic Gain Control
- Picture and Sound Automatically Locked
- Sound Cannot Drift
- Non-Microphonic
- Stagger Tuned I.F. for Max. Gain and Ease of Alignment
- 12 Channel Tuner
- Electromagnetic Focus and Deflection
- Automatic Stabilized Synchro—Lock Circuit Holds Picture Steady
- 21 Tubes Including CR Tube

Large clarified stage by stage pictures and schematics to insure ease of construction. Guaranteed to work.

Money Back Guarantee—Buy it, inspect it, if you don't think it's the best buy on the market—return unused within 5 days and your money will be refunded.

All prices F.O.B. New York. 20% deposit with order. IMMEDIATE DELIVERY

**SOVEREIGN TELEVISION CO.**  
5508 New Utrecht Ave.  
Bklyn 19, N. Y.



*Some Prefer a Portable*

*Others Prefer a Standard*

*But ALL Prefer*  
**TWIN-TRAX\***  
*"The Tape Recorder the Engineers are Buying"*

When it comes to high fidelity sound equipment, it's the specifications that count with engineers. And that's why they're buying Twin-Trax—the popular-priced tape recorder with professional specifications. Extended frequency response, wide dynamic range, low hum level, easy operation, trouble-free performance! And two tracks means twice the playing time on standard tape reels, with tape costs cut in half—a saving you don't have to be an engineer to appreciate.

Write today for technical literature and professional factory discounts. \*Trademark

**AMPLIFIER CORP. OF AMERICA**  
398-2 Broadway New York 13, N. Y.

**"America's Best Buy"**

**RADIO TUBES—39c each  
100 for \$35.00**

GT type. Cartoned and guaranteed.				
01A	6A8	6K6	6X4	2526 39 44
1B5/25S	6AK5	6K7	6N5	12BR7 40
1G4	6AU6	6I5	6I6	12BE6 41
1H6	6AQ6	6S8	12A8	12BI6 42
1J6	6AT6	6SA7	12AT6	12F5 38
114	6AI6	6SD7	12A17	12H6 46
1Q5	6BA6	6SF5	12AU6	12J5 47
1R4	6BE6	6SG7	12AU7	12J7 50B5
1R5	6BH6	6SH7	12BA6	12K7 70L7
1S5	6BO6	6SJ7	12SH7	12K8 80
1T4	6AL5	6SK7	12SH7	12Q7 117Z3
1U4	6C4	6SL7	12SJ7	12S8 12A
3A4	6CS	6SN7	12SN7	25Y5 6J7
3Q4	6F5	6SQ7	10	32L7 6K8
3S4	6F6	6SR7	20	37 7AF7
3V4	6I6	6SU7	25L6	35V5
5Y3	6J5	6V6	25Z5	35Z5

**49c each, 100 for \$45.00**

1A5	6AC7	12AH7	35L6	58	83V
2A5	6B8	12SA7	32	71A	84 6Z4
2A7	6C6	12SK7	36	75	117L7
5U4	6D6	12SQ7	50L6	77	117P7
5Z3	6F8	26	50	78	
6A3	6Y6	27	56	81	
6A6	6Y7	35/51	57	83	

**COMBINATION SIGNAL TRACER AND SIGNAL GENERATOR \$29.95**

The SIGNALYZER provides the following items of test equipment: Signal Generator, all frequency Audio, R.F. Signal Tracer, Audible output or meter, Test Amplifier, Test Speaker, Output Meter.

**3 WATT AMPLIFIER \$14.95**  
Two tubes 12S J7-117L7  
2 inputs for microphone, instrument or phonograph pickup, 8" P.M. speaker. Mounted in a portable steel case.

Postage extra 20% deposit on C.O.D.  
Write for latest bargain list featuring "America's Best Buys."  
**POTTER RADIO CO.**  
1314 McGee St., Kansas City 6, Mo.

which time identifies; reception very poor. (Radio Australia)

Colombia—HJCX, 6,020, Bogota, has returned to the air; was off for a while following revolution in that country. (Beck, N. Y.) HJBB, 4,815, Radio Cutata, heard 0500-2200. HJGF, 4,845, Bucaramanga, signs off 2230 giving sign-on as 1300. (McPheeters, La.) HJKJ, 6,160, good signal, identifies in Spanish 1900. (Hankins, Pa.) Bogota, 11.68 (measured 11.682.5) fair signal 2015-2120; HJCT, measured 6.199, Bogota, good level 2300-2310 sign-off.

Cuba—CMQ Network (which operates COCQ, 8,700), recently acquired two new announcers, Alberto Gandero and Francisco Forcade, both of whom have been for several years on the NBC staff in New York. CMQ Network won the 1948 Cuban radio awards for the best dramatic program (El Derecho de Nacer), the best actor and actress, the best comedian, the best announcer, the best news commentator, and the best program of service to the Republic of Cuba. (Bachman, Pa.)

Cyprus—Sharq-al-Adna, 6,135, 6,170, 9,650, all good 2255 sign-on; 6,135, 6,170 fade out around 0015 but 9,650 is heard with fair to good level to sign-off 0130. (Beck, N. Y.) The 6,790 channel is scheduled in parallel. Latter is heard in Newfoundland by Peddle at 1400-1445.

Forces Broadcasting Service, Kakatamia, 7,220, continues to test Saturdays 1700-1900, answers listeners' reports that day 1800-1815, and asks for reports "from anywhere." (Pearce, England)

Czechoslovakia—Hagen, Ala., says "The only time I have been able to receive Prague is on 11.760 between Melbourne's transmissions—at 1115-1200, that is—broadcasting news in various languages." At the time this was compiled, the daily North American transmission 1850-2000 was on 9,550, excellent at start but soon

A regular, valuable contributor to ISW is D. W. McPheeters, Louisiana, who relaxes here as he tunes his National Receiver. Mac, who is a member of the Romance Language Department at Louisiana State University, is quite handy in translating material for your ISW editor.



**SAVE \$ ON RADIO SURPLUS**

**TRANSMITTING FILTER CHOKES**  
63 Henries, .018 Amp., 930 Ohms. . . . 95c

**CONDENSERS**  
CCA 2 MFD. 1000V (4 3/4"x3 1/2"x3 1/2") . . . \$1.75  
CCA 8 MFD. 1000V (7"x8"x4 3/4") . . . 2.25  
DUB 1 MFD. 3000V (5"x7 3/4"x2 1/2") . . . 2.50  
PARADOX 125 MFD. 1500V, 2 Amps. @ 39 K.C. (5 7/8"x5 1/2"x4") . . . 1.00  
00005 MFD. 2500 V. D.C. Trans. Mica. . . . 35c  
MIDGET CABINET—8 1/4" L x 5 7/8" H x 4 1/4" D. Asst. Colors. Holes for Vol. Control & Var. Cond. Centre Speaker . . . 69c  
Signal Corps Phones—2 M. Ohms (8M Imp.). . . \$1.25  
2 Ft. Extension Cord (Female Plug). . . 40c

**OIL FILLED FILTER CONDENSERS**  
1.—MFD—2000 volts. . . . 95c ea.  
1.—MFD—1000 working volts, 4 for. . . \$1.00

**FAMOUS BRAND RECORD CUTTING HEAD**  
Size 1 3/8"x2 3/8" ready to fit your cutting arm or bracket. SPECIAL . . . \$2.95

**TOBE TUBULAR ELECTROLYTICS**  
20-20 MFD. 150 V. . . 29c 40-40 MFD. . . 29c  
40-40 MFD. 150 V. . . 37c 150 V . . . 38c  
30-30 MFD. 150 V. . . 32c

2 1/2 M.H. R.F. CHOKE COIL—27c ea. 5 for \$1.00  
3 BAND OVAL DIAL—7 1/2" L x 5 1/2" H. . . . 79c  
1/20 RESISTOR ASST. 1/4-1/2-1 WATT . . . . 95c

Low-Loss Short Wave Variable Condensers	3 GANG T.R.F. VARIABLE COND. D.E.N.S.E.R.S. .000365 Cap. 95c
1/4" Shaft Type	
5 Plate—20 MMFD. . . . . 20c	
14 Plate—55-60 MMFD. . . . 27c	
Lock Type Air Trimmer Variable Condensers	
3 Plate—12-15 MMFD. . . . 10c	
5 Plate—20 MMFD. . . . . 13c	
8 Plate—30-35 MMFD. . . . 13c	
10 Plate—40 MMFD. . . . . 14c	
14 Plate—56 MMFD. . . . . 14c	
20 Plate—80-100 MMFD. . . 25c	
27 Plate—100-110 MMFD. . . 35c	

2 piece 5-pole Male and Female Separable Plug. Both with Flexible Cord. A steal at 35c only, 35c per pr.

4 PR. WAFER SOCKETS—\$1.49 per C. each. . . 3c  
PHILCO 4 MF—300 V—1 1/8" CAN CONDENSER. . . \$8.00  
100 OHM WIRE WOUND POT. 2 PIECE. . . 10c each  
W.L.—10 W. 1,000 ohm Power Rheostat . . . 29c  
5-6 PRONG WAFER SOCKETS . . . \$2.50 per C.  
100 OHM WIRE WOUND POTENTIAL . . . \$3.50 per C.  
1,000 OHM WIRE WOUND POTENTIAL . . . 15c  
30 HY-FILTER CHOKE SHIELDED . . . 49c  
UNSHIELDED . . . 39c  
100 ERLENMEYER 2,000 OHM RESIS. . . \$1.15  
10 WIRE WOUND RES. KIT—5-50 W. ASST. . . 49c  
2 METER RF CHOKES . . . 7c  
PHONO PICK-UP REST. RUBBER—1 Hole MTG. . . 6c  
2,000 ohm Wire Wound Rheostats . . . \$1 per doz.  
RCA-VICTOR NEEDLE CUPS—2 PIECE. . . 10c ea.  
CARTER WIRE WOUND C.T. VARIABLE 20 OHM RESISTORS . . . \$1.00 per doz.  
G. TAPPED VOLTAGE DIVIDER—200 WATT  
230 OHM MOUNTED ON ASBESTOS BASE-TAPPED AT 180-205 ohms. . . 25c  
RCA 6 OHM POWER RHEOSTATS . . . 39c  
PHILCO AUTO SUPPRESSOR . . . 7c ea.  
GEN. ELEC. WESTINGHOUSE, etc., 60 CYCLE WATT HOUR METERS, slightly used, perfect condition, same as used in your home, 10/25 volts. 3 Ampere. . . \$3.50 10 Amperes. . . \$4.50  
Philco rotary tap tone control . . . 25c  
I. C. A. 30 MH RF choke . . . 25c  
Grind your own crystals—Pure Brazilian Quartz, all sizes and thicknesses—1/2 lb. packages . . . \$2.00  
340—degree dial with 10 push button attachment—1/4" shaft—ideal for Xmitters—Sig. Gen. or Osc. 39c  
RCA Band Switches—  
3 gang, 3 posit., 3 band. . . . . 30c  
6 gang, 5 posit., 4-5 band. . . . . 40c  
Trimmer-Padder Asst.—all isolantite—singles, dual, triodes—100 unit, pieces. . . . \$2.25  
5"—450 ohm AC-DC dynamic. . . \$1.35  
5" 5M OHM RCA SPEAKER . . . 1.00

**ATTENTION: Prospectors**  
Explorers for Hidden Treasure!  
Do you seek hidden treasures of rare metallic ores? If so, construct a U.S. Army Type of Metallic Mine Detector from these U.S. Army Mine Detector Amplifiers that we are offering at a ridiculously low price. Amplifier unit only (tests tubes and batteries), with cables, headphones, cord and jack (no phones), complete Army wiring diagram, U.S. Army DETECTOR SET Amplifier Type AN/PRS-1 . . . \$1.95  
N.C.O.D. Eveready 45 volt batteries . . . \$8.20  
51.75 ea., 6 volt A. 73c. 2-1N5 tubes. . . 95c ea.  
TUBES—0Z4—79c; 53—39c; 2A7—39c; 55—39c; 117L7—89c; 27—25c; 35, same as #224—20c; 01A—25c; 31—20c; 85—25c.

DRY ELEC. FILTER COND. ASST. CONTAINS  
10 PIECES ALL BRAND NEW 150-450V. . . \$1.10  
6 ASST. WET ELECTROLYTIC CONDENSERS . . . 59c

RADIO EXPERIMENTER'S SURPRISE PACKAGE—CONTAINS BYPASS & FILTER CONDENSERS, SHORT WAVE TUNING UNITS, POWER AND AUDIO TRANSFORMERS, SOCKETS, RESISTORS, CHASSIS HARDWARE, OVER 20 LBS. OF VALUABLE PARTS. \$4.95

DRILLED CHASSIS FOR 5-6 tubes 7"x10"x1 1/8" . . . 29c; 5"x10"x1 1/8" . . . 29c  
RCA ADJUSTABLE CODE INTERFERENCE WAVE TRAP 456-475 K.C. . . . 39c  
PHONE JACKS—OPEN & CLOSED AUTOMATIC TYPE . . . 18c  
NATIONAL 5-15-450 VOLT CAN FILTER CONDENSER . . . 39c  
FRY SPEAKER VOL. CONTROL—60 OHMS . . . 25c  
SALE—PHONO RECORD ALBUMS—SALE  
10 3 comp.—15c; 4 comp.—20c; 12 comp.—49c  
12 3 comp.—15c; 4 comp.—20c; 12 comp.—65c

ALFRED NEWMAN PHONO RECORD ALBUM  
Three Records—Hit Melodies. "I Only Have Eyes for You." "Lovely to Look At." "Someone to Watch Over Me." "They Didn't Believe Me." "Foggy Day." "Long Ago and Far Away." . . . Special Sale \$1.19  
Reg. Price \$3.95.

MINIMUM ORDER \$2.00—NO C.O.D.  
SHIPMENTS—PLEASE INCLUDE POSTAGE  
**NEWARK**  
**SURPLUS MATERIALS CO.**  
Dept. 1  
324 Plane Street NEWARK 1, N. J.

**DRILL PRESS OWNERS!**  
Get This Transformer as a  
**SPOT WELDER \$18.95**



Attaches to your drill press to make a Professional SPOT WELDER! Superior quality NEW war surplus. Orig. Gov't cost over \$160. Free copy of picture instruction book with each transformer. Positive uniform welding up to 18 ga. Cont. rating Pri: 105 to 125 V. Sec: 5.1 V at 190 amps. 35 kv insl. Shipping weight approx. 100 lbs.

**COMPLETE PICTURE INSTRUCTIONS AND PLANS**, alone (including information about new Supreme Spot Welder Kit) **10c**

**PE-101-C DYNAMOTOR**  
for your MOBILE RIG  
12 or 24 V Input



**3 OUTPUTS \$4.95 BRAND NEW**  
AS SHOWN!

- 1) 400 V at .135 amps. d.c.
- 2) 800 V at .020 amps. d.c.
- 3) 9 V at 1.12 amps. a.c.—80 cycles

And if you are not in the market for one of the finest, most dependable MOBILE POWER sources, we furnish FREE with each unit data for making a fine d.c. POWER SUPPLY which will give you 12/24 V at 12.6/6.3 amps. NO CONVERSION REQUIRED.

Complete with gear box as designed **\$6.95** for use with BC-645 (not shown) **\$1.35 ea.** for mailing charge.\*

**DY-9/ARC-1** or **DY-10/ARC-4X** **\$13.95** either  
24 V Input 12/24 V Input  
Slightly used. Add \$1.35 ea. for mailing charge.\*

**Hermetically Sealed POWER TRANSFORMER**  
Primary: **\$2.95**  
117 V—60 cycles Brand New!  
Sec: New!  
1) 1100 V—C.T.—75 ma  
2) 5 V at 3 amps  
3) 6.3 V at 1.2 amps  
Conservative Army rating. Good for high overload. Add 95 cents each for mailing charge.\*

**Synchronous (Self-Rectifying) VIBRATOR**  
Hermetically Sealed  
Good for 100 milliamperes. Does not require rectifier tube. Fits standard octal tube socket. Orig. Gov. price over \$5.  
**12 Volt Model... 99c**  
6 Volt Model... \$1.29  
Add 25c ea. for mailing charge.\*

**RL-42-B ANTENNAREEL**  
Brand New! With Bobbin. **\$4.25**  
The Perfect Beam Rotator. Add \$1.00 ea. for mailing charge.\*

**SHOCK MOUNT BASE**  
for BC-348  
New! Fits all models. Add 45c ea. for mailing charge.\* **\$1.65**

**5BP4 Bk. & White Picture TUBE**  
**\$2.95** Add 60c ea. for mailing charge.\*

**250R HI POWER TRANS. TUBE**  
Add 60c ea. for mailing charge.\* **\$4.95**

**TELEVISION & SCOPE TRANSFORMER**  
Brand New. Fully Guaranteed. Sec. tapped to supply either 2200 or 3300 V D.C. Also has 2.5 V insulated winding for 2x2 rectifier. Small size 2 1/2" x 2 1/2" x 2 1/2". NOT SURPLUS. BUT ESPECIALLY MANUFACTURED FOR US. Add 60c each for mailing charge.\* **\$4.95**

**ORDER DIRECT FROM THIS AD.** No order less than \$2.50, please. Send check or M.O. Add mailing charges as shown. \*Charges include postage, handling, insurance and tax. Heavy materials or large orders shipped fast freight collect. Satisfaction Guaranteed or Money Refunded.

**ELECTRONIC SALES CO. Dept. RN-1**  
3923 VAN BUREN, CULVER CITY, CALIFORNIA

**CODE SENDING SPEED**  
**CODE RECEIVING SPEED**



**Free Book**

**HIGH SPEED WITHOUT NERVOUS TENSION**

REVEALING BOOK shows how "crack" operators develop high speed and proficiency. Learn code for Amateur or Commercial Radiotelegraph License, or improve your sending and receiving with the Candler System which develops radiotelegraph experts and code champions.

**CANDLER SYSTEM** Box 928, Dept. 2-E, Denver, Colorado

**TALK ANYWHERE INSTANTLY TO ANYONE!**  
JUST PUSH BUTTONS AND TALK TO OR FROM DIFFERENT PLACES! Not a phone-loud room, volume—NO ELECTRIC "PLUG-INS" OR TUBES NEEDED! Six or hang up! SIMPLE and QUICK TO HOOK UP. For HOMES, OFFICES, STORES, FARMS, etc. Guaranteed satisfaction. Write for as low as FREE details today! Dealers and agents wanted. **\$9.97** each



MIDWAY CO., RN-5, Kearney, Nebr.

QRM'd by Paris; last 20 minutes is a relay from Bratislava; news 1900. *Radio Australia* reports the 11.840 channel has been heard in Australia around 0045, closed down 0103.

**Denmark**—OZF, 9.52, Copenhagen, often heard with news 2230, good signal. (Ferguson, N. C.) According to announcement, uses 15.165 on Tues., Thurs., Sat. 0500-0600 to Far East. (Huse, Washington) It is believed this is the new 50 kw. transmitter which is used other times on 9.52.

**Dominican Republic**—HI2A, Santiago, checked recently on 9.682, signing on 1450 with announcements in Spanish. (Ferguson, N. C.)

**Ecuador**—Clayton Howard, engineer at HCJB, Quito, informs that operations have been expanded on the 16-meter channel. Is now on the air daily except Mondays on 17.890 with 10 kw. and beamed to Europe 1200-1545 (Sundays begins 1130). The station desires reports from European listeners, and believes reception in Europe will "pick up" as summer comes on.

**Finland**—Helsinki, 15.19, still has news daily 0715 but now suffers terrific QRM from AIR, Delhi, same channel. Balbi, Calif., says the 2200-0000 transmission is heard with excellent strength. Fargo, Georgia, reports this one at excellent level 1145-1245, all-Finnish.

**France**—European Service of Paris on 7.280 signs off 1600. Paris heard 1515-1645 on 9.680, 11.845 to French East and Equatorial Africa. (Beck, N. Y.) The 15.350 channel heard in French from tuning 1130 to sign-off 1213, good signal. (Ferguson, N. C.)

**French Equatorial Africa**—Radio Brazzaville, 9.440, 9.984, 11.972, is scheduled 0000-0230, 0500-0745, 1100-1700, 1705-1825, 1830-2000; sometimes 6.024 is in parallel as at 0000-0230 and 1705-1825 periods; 17.840 is in parallel except at 1600-2000. In recent DX session, Leopoldville gave call letters of Brazzaville as FZ1 (not FZI). (Beck, N. Y.)

**French Indo-China**—Radio Saigon, 11.78, heard with news 1830, announces next news for 1930. (Pearce, England) The 1830 period is heard here in West Virginia, but soon is buried in QRM. Balbi, Calif., reports 6.10 and 7.21 in parallel with Saigon's 6.165 to 1030 sign-off.

Sanderson, Australia, still lists Phnompenh on 12.36 at 0530 with Chinese news at dictation speed, then music; she gives Radio Dalat on 6.18 at 0700 with news in French, fair signal, and Saigon on 7.21 at 0545 with news in French.

**French Morocco**—Radio Maroc, 6.005, Rabat, heard 0150-0215 fade-out in Ontario with Arabic program. (Alfred) Heard in Arabic 1530-1600, in French 1600-1630. (Peddle, Newfoundland) Has news in French 0300.

**French West Africa**—Radio Dakar, 11.898, heard well from 1315 to 1700 sign-off after headline news in French; Saturday and Sunday is heard to 1800. (Pearce, England) Heard in Newfoundland 1330-1700. Dakar is

**TUBES! TUBES! TUBES!**  
NATIONALLY ADVERTISED BRANDS  
BRAND NEW! BRAND NEW!

TYPE	PRICE	TYPE	PRICE	TYPE	PRICE
024	\$.55	6SK7GT	\$.45	6A4G5	\$.79
1A7GT	.69	6SL7GT	.79	6AT6	.69
1B3GT	1.49	6SN7GT	.69	6A4G6	.69
1D5GP	1.29	6SQ7GT	.45	6BA6	.69
1D7G	1.19	6SH7	.39	6B6GG	1.89
1H5GT	.69	6SS7	.59	6C4	.29
1L6	.99	6ST7	.79	6D6	.49
1LD5	.99	6U5/6G5	.59	6F6GT	.49
1LN5	.69	6V6	.69	6G6G	.95
1N5GT	.69	6X5	.69	6H6	.49
1R5	.69	6Y6G	.79	6J5GT	.49
1S4	.69	7A8	.79	6I6	.89
1S5	.59	12A6	.29	6L6GA	1.09
1T4	.59	12AT6	.49	6SA7GT	.45
3Q4	.59	12BA6	.59	6SD7GT	.45
3Q5GT	.59	12BE6	.59	35A5	.55
354	.59	12J5	.49	35L6	.55
5T4	.89	12K8Y	.89	35W4	.45
5U4	.59	12SA7	.55	35Y4	.49
5V4	.89	12SJ7	.55	35Z3	.69
5X4	.49	12SK7	.49	35Z5	.40
5Y3GT	.39	12SQ7	.49	39/44	.39
6A6	.89	14A7	.55	50A5	.55
6A7	.69	14B6	.55	50B5	.55
6AC7	.79	14Q7	.55	50L6	.56
6AD7G	.99	25L6	.59	57	.39
6AG5	.89	25Z5	.49	76	.39
6AK6	.89	25Z6	.49	80	.42
6AL5	.79	31	.39	117Z6	.69

Write for Complete New Catalog  
Minimum order \$3.00  
All Prices F.O.B. N.Y.C.  
On C.O.D. Orders 25% Deposit

**THE ROSE COMPANY**  
98 Park Place, Dept. N, New York 7, N. Y.

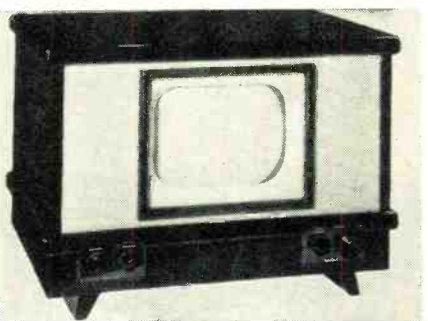

**MASTERPIECES**  
in CABINETRY

Television cabinets specially engineered for 630TS models using 12" or 12 1/2" picture tube (illustrated above). Exclusively designed cabinets available for TRANSVISION 12" and 15" models—all tuners. Also 12" and 15" TELEVISION ASSEMBLY in Standard and Champion models. Modern and period consoles available for all custom installations. Various finishes. Write for particulars.

**TEL-CRAFT COMPANY**  
108 Havemeyer St. Brooklyn 11, N. Y.

**PROP PITCH MOTORS**

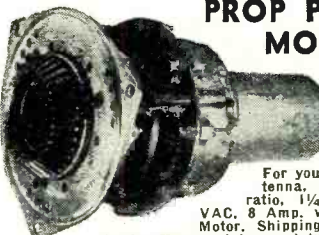

**\$11.95**

For your beam antenna, 7000 to 1 ratio, 1/4 RPM, 2 1/2 VAC, 8 Amp. with 1/2 HP Motor. Shipping Wt. 70 lbs.

Cutler-Hammond heavy duty contactors Z 6041H30B 12VDC S.P.S.T. \$50.40

**I.F. TRANSFORMERS**

- 100kc, 1100kc, 2.1 output, 2.1 interstage, \$4.50-50 min., 57 mm., 14 plate ceramic trimmer condensers 4/1.00
- 30 AMP DC full scale 1/2 meter, scale not calibrated, good for battery chargers, New 2/1.00
- P.L. 6B Plugs with 4 ft. cord, 15c ea. 8/1.00
- Shocks Mounts 3/4 or 2 1/2 size, 25/1.00
- Assorted hardware, ALL SMALL P.C.S. 3 1/2/1.00
- Assorted Selector wafer switches, 6/1.00
- 14 Pt. Amphenol connectors, Complete (male & female), 2/1.00
- 12000 Ohm precision W. W. resistor 20%, 12/1.00
- Acro snap micro switches, normally closed, 4/1.00
- Resistor assortment, all color coded, 150/1.00
- Condenser assortment 400 & 800 V., 25/1.00
- Dual control box B C 493-A, Ea. 1.00
- Current Transformers 10 to 1 ratio, 2/1.00
- 24 VDC Series motors, reversible, good for intermediate duty on 110 A.C., 85/3 Ea. or 2/1.50
- Minimum order \$2.00, Ohio buyers add 3% Sales Tax.

**WESTERN SALES CO.**  
1218 Prospect Ave. Cleveland, Ohio  
Ph. Main 1052

heard on 15.405 some days phoning Paris 1015. (Peddle)

*Germany*—Leipzig, 9.728, heard opening 2258. (Stark, Texas)

DTFC, 15.105, Munich, heard point-to-point and with relay to "Voice of America" in New York 1030-1100, good signal. (Sutton, Ohio)

Stuttgart recently heard 0845 on 6.030, moved from 6.180; has news in German 1145. (Pearce, England) Sweden confirms this change in frequency. (Swedish DX)

*Gold Coast*—Kumlin, Sweden, has heard ZOY, 4.915, Accra, at 1235-1302 with program of native songs, then news in *English* (1800), announced, and then signed with national anthem; QSL card received.

*Greece*—Hagen, Ala., says Athens, 9.605, runs to 0315 on Sunday with all-religious program; some days signs on 0000, others 0030. Beck, N. Y., comments that now has fine modulation but that there still is a slight hum on the channel. Reports from various points in East indicate improved signal from *Radio Athens*, 15.345, in daily period to North America 1730-1830, news at start.

Pearce, England, reports "*Hona Larissa Radio Fonicos Strathmos*" on 6.740 daily to closedown with march 1430; asks for reports to The Greek Democratic Army Broadcasting Station, Larissa, Greece; heard signing on 1100; has some Arabic, some Western programs. Nattugglan, Sweden, comments that announces in French and *English*. Heard by Peddle, Newfoundland, 1230-1500. (Closedown may be irregular in view of above reports.)

*Holland*—PCJ, 21.48, heard opening in Dutch 0943 and closing down 1031 with Dutch National Anthem, good level. (Ferguson, N. C.)

Eddie Startz of PCJ informs me that by this time the new 40 kw. transmitter should be in operation; station is on a field near the small town of Lopik close to city of Utrecht where one of the Home Service transmitters is located.

Current schedule for the "*Happy Station Programs*" is—to East and Near East, Sundays and Wednesdays 1030-1200, 17.77, 15.22, 6.02; to Africa and South America, Sundays and Wednesdays 1600-1730, 11.73, 9.59, 6.02; to North America, Sundays and Wednesdays 2200-2330, 11.73, 9.59, 6.02; to Pacific, Australia, New Zealand (also heard in Asia), Tuesdays 0330-0500, 21.48, 17.77, 15.22, 6.02. Reports will be welcomed by PCJ at P. O. Box 137, Hilversum, Netherlands.

*India*—Delhi, 15.79, has recently been good level here in West Virginia late mornings to closedown 1230; has last news 1215.

On Saturdays there is a program of request musical selections at 1000-1030 on 9.590 and other AIR channels in use at that time. (Rosenauer, Calif.)

*Indonesia*—*Radio Indonesia*, 19.345, Batavia, is heard well now 1100-1300 (may sign off 1230 some days); 15.150 is in parallel although some times is buried by BBC on an adjacent channel. (Fuller, R. I.) I note that on the

May, 1949

ALTEC  
LANSING

gives you more  
QUALITY  
VALUE  
CHOICE



400B  
DIA-CONE  
8"



600B  
DIA-CONE  
12"



603B  
DIA-CONE  
15"



604B DUPLEX  
AND NETWORK

Wherever highest quality sound reproduction is essential, the Altec Lansing speaker line is inevitably first choice.

**604B DUPLEX**—Industry's first choice for professional monitoring, meeting all requirements for a full, two-way speaker unsurpassed by any unit at any price.

**603B MULTICELL DIA-CONE**—A 15-inch speaker which meets the need for an economical, high quality speaker having the advantages of a two-way multicellular speaker system. Ideally suited for wide angle public address coverage.

**600B DIA-CONE**—A highly efficient, 12-inch low cost unit meeting the need for faithful reproduction of sound from radios and music systems.

**400B DIA-CONE**—An outstanding 8-inch speaker with exceptionally high quality, high efficiency and high power.

Compare these with any other speakers on the market.

write for  
illustrated  
brochure



1161 North Vine St., Hollywood 38, Calif.  
161 Sixth Ave., New York 13, N. Y.



## Television's Great New DISAPPEARING ACT!

The CRAFTSMEN  
**SLIDE-RULE\***  
ANTENNA

NOW YOU SEE IT . . .

With calibrated dipole arms extended, the amazing new Slide-Rule antenna gives you instant, precision tuning of all TV channels and FM. One simple operation! Works on any TV set.



ONLY  
**\$9.95**

No other antenna gives you  
**ALL THESE FEATURES**

• **INSTANT CHANNEL TUNING.** Dipole arm is calibrated with all TV channel numbers, plus entire FM band. Simply extend one metal loop to desired channel position. Other arm extends automatically. Slide-rule accuracy!

• **FOLDED DIPOLE DESIGN.** Never before on a portable antenna! Rugged, efficient folded dipole gives sharper, better performance — with 20 per cent less dipole length!

• **PERFECT RECEIVER MATCH.** Eliminates "ghosts," inter-channel interference, etc., due to mismatching. Ample lead is 300-ohm, twin-line type — correctly matches antenna and receiver!

• **FULLY RETRACTING ARMS.** Push button control silently retracts dipole into attractive walnut hammertone housing. Only 4½" x 2½" when closed! Felt bottom protects furniture.

NOW YOU DON'T!

What compactness! With the click of a button, antenna arms disappear smoothly, silently into a case so small it would fit in your pocket! No unsightly indoor antenna. No expensive rooftop installation.

\*Patent Pending

Sold by leading distributors

For information, write dept. A

The **RADIO CRAFTSMEN** Inc.

1341 S. MICHIGAN AVE., CHICAGO 5, ILL.

# F R E E!

For BEST BUYS and  
LOWEST PRICES in

RADIO & TELEVISION  
PARTS—SETS—ACCESSORIES

Get Radionic's  
Bargain Bulletins

**TUBES** RCA • GE • SYLVANIA  
HYTRON • RAYTHEON  
NATIONAL UNION • TUNG-SOL • KEN-RAD

Individually Boxed Standard RMA Guarantee  
5Y3GT, 45c; 6F6GT, 55c; 6SN7GT, 90c; 12SQ7GT,  
70c; 25L6GT, 70c; 25Z5, 60c; 35L6GT, 65c; 35Z5GT,  
49c; 50L6GT, 65c; 25Z6GT, 60c.

## CAVITY RESONATOR

FOR THE UHF BUGS



Here's the best bet yet in UHF gear! A portable test oscillator designed for the Navy. Gold-plated cavity resonator provides freq. range of 234 to 258 mcs. Includes 2-955's. Ready to go. Plenty of room in the battery compartment to house a small modulator and power supply. OR... Rip out the parts and you have a handy 1 1/8" aluminum cabinet (no holes) with handle. Dzus fasteners. 9 1/2" x 6 1/2" x 6 3/4". **\$3.25** (in lots of 3, \$2.95 each)

## RADIONIC EQUIPMENT COMPANY

Tribune Theater Entrance

170-J Nassau Street, Worth 2-0421 New York 7, N. Y.  
Open Daily 9-6 • Saturday 9-5

RADIONIC EQUIPMENT COMPANY, Dept. 55

170-J Nassau St., New York 7, N. Y.

Please rush free copy of latest bulletin of radio and television bargains in parts, tubes, sets and accessories.

NAME .....

ADDRESS .....

CITY ..... STATE .....

## WALMAR'S MAY SPECIALS!!

### TRANSFORMERS—115v. AC 50-60 Cyc.

Hi Volt. plate, Sec. 4000v. @ 0022 amp. DC	\$6.25
Plate—Sec. 1330v. (CT) .17 amp. DC	3.75
Plate—Sec. 800v. (CT) .270 amp. DC	3.75
Plate—Sec. #1, 680v. (CT) @ 225 MA. Sec.	3.75
#2, 1540v. @ 20 MA	3.50
Plate—Sec. 750v. (CT) 22 amp.	6.25
Fila. Hi Volt. Sec. #1, 6.3v. 2.0 amp. 4800v.	2.75
DC. Sec. #2, 2.5v. 1.75A. 5700v. DC	6.25
Fila. 6.3v. @ 8 amp.	2.75
Fila. Sec. #1, 6.8v. 10A. Sec. #2, 6.5v. 6A.	3.25
Sec. #3, 5.0v. 3A. Sec. #4, 5.0v. 3A.	
Hi Volt. Sec. #1, 6.3v. 13A. Sec. #2, 6.3v. 3A.	4.25
Sec. #3, 7.0 v. 14A. Sec. #4, 5.0v. 6A. Sec.	
#5, 5.0 v. 3A	

### CHOKES

10 hy. 250 MA DC	\$2.75	15 hy. 25 MA DC	\$2.15
7 hy. 270 MA DC	2.75	5 hy. 100 MA DC	1.95

### G. E. METERS—3" ROUND—TYPE DO-41

0-1.0 RFamp. w/t.c.	3.65	0-50 MA DC	3.85
0-1.0 DC MA	3.85	0-20 KV 1 ML.MVT	3.75

### CONDENSERS—PYRANOL-OIL FILLED

.25 mfd 3000v. DCW	1.25	2 mfd 600v DCW	.45
.5 mfd 2000v. DCW	.75	4 mfd 600v DCW	.60
.1 mfd 7500v. DCW	1.75	10 mfd 600v. DCW	1.15
1 mfd 2000v. DCW	1.05	10 mfd 1000v. DCW	1.75
8 mfd 2000v. DCW	3.85		

### TUBES—GUARANTEED!!!

2x2/879	.55	705A	2.55
GL-1641	.95	SCOPE 12GP7	
836	1.00	Original Cartons.	14.75

COPPER OXIDE RECTIFIER 50v. 0.5 amp. 1.25  
Heineman 10 amp. DP circuit breakers 1.95

## WALMAR DISTRIBUTING CO.

3002 Virginia Ave. • Baltimore 15, Md.

19.345 outlet there are frequent announcements in both Dutch and English. Recently, the Batavia outlet on approximately 11.000 has been fairly good here in West Virginia for the 0600-0700 English period; 15.150 is in dual.

Pearce, England, has heard *Radio Indonesia*, 15.150, Batavia, at 1800 with clock striking; often has North American recordings from 1800, and has been heard from 1745 after sign-off of US station on that channel.

Balbi, Calif., recently noted an Indonesian on 9.78, signed off 1000; believes might be *Radio Sario* moved from 9.72.

*Radio Indonesia*, 9.550, Makassar, heard recently on West Coast 0900-1000 sign-off, good level, musical program, announcements in Dutch. (Rosenauer)

Rosenauer, Calif., flashes that he has recently been hearing a new Indonesian on approximately 11.110, first heard 0900-1000 sign-off with good signal; program was music; at close clock strikes eleven and station then signs off with Bing Crosby's recording of "Just a Prayer Away"; another day was heard 0600-0700 with announcements in Indonesian and Dutch.

YDH-2, 11.034, Semarang, heard 0800-0830. (Alfred, Ontario)

Iran—Nattugglan, Sweden, reports Khoramabad on 6.845 at 1130-1230 on two days of the week (probably Monday and Thursday). A recent Swedish DX session from Stockholm said the Regional Broadcasting Station for the province of Fars at a place called Shiras is transmitting on 7.960 Mondays and Thursdays 1130-1200; heard in Sweden.

EQC, 9.680, Teheran, heard around 2330; all-Persian. (McKay, Fla.) I checked this channel and found a station opening there 2330; seemed to

have news in Persian 0000; rather strong signal.

Teheran, 15.100, is usually good level in daily 1340 newscast.

Israel—In verifying for DeMyer, Mich., Kol-Israel, Tel Aviv, listed frequency of 6.820 scheduled 2345-0100, 0430-0715, 1015-1530, news 0700, 1500. DeMyer hears this one well from 0000.

Italy—Rome still has English session 2015-2055 with news 2015, good on both 9.630, 11.810. (Beck, N. Y.) Heard on 9.630 at 1510 in foreign language; at 1515 announced program of Arabic; at 1544 announced in English and gave news, ending English period 1630, continued in Italian. Heard on 11.810 closing program for Latin America 1935 and leaving air. (Ferguson, N. C.)

Jamaica—ZQI, 3.480, Kingston, heard 2100-2200. (Puddle, Newfoundland)

Japan—Tokyo, 9.505, heard 0545, fair signal. (Alfred, Ontario)

Here are current Japanese calls, frequencies, and schedules as received airmail from Howard H. Boyle, Tokyo, Chief Engineer with AFRS.

1st Network—JKH, 7.257.5, Yamata, 5 kw., 1525-0900; JKI, 4.910, Nazaki, 5 kw., 1555-1715, 0255-0900; JKI-2, 9.655, Nazaki, 5 kw., 1725-0245.

2nd Network—JKJ, 7.285, Nazaki, 5 kw., 1625-1800, 0255-0900; JKM, 4.930, Kawachi, 5 kw., 0255-0900; JKM-2, 9.695, Kawachi, 5 kw., 1625-1800.

Repatriates—JBD, 9.505, Kawachi, 7.5 kw., 0255-0900; JBD-2, 9.560, Kawachi, 5 kw., 0455-0900; JBD-3, 15.225, Kawachi, 7.5 kw., 1730-0245; JBD-4, 15.235, Kawachi, 5 kw., 1750-0245.

AFRS—JKK, 6.015, Nazaki, 5 kw., 1615-0907; JKL, 4.860, Yamata, 5 kw., 0355-0907; JKL-2, 9.605, Yamata, 5 kw., 1615-0345.

Korea—HLKA, 7.935, Seoul, often is R6-7 at 1630 with English lesson, presumably for Koreans.

## FUSING HORIZONTAL OUTPUT CIRCUIT IN TV RECEIVERS

By MATTHEW MANDL

A COMMON trouble in television receivers having tubes larger than 7 inches has been the failure of the 6BG6 horizontal output tube. The high potential pulses present on the plate of this tube, due to the fly-back process of the high-voltage power supply, do much to produce ionization and cause the tube to go gassy more quickly than if it were used in other services. Once the tube goes gassy, excessive current flows through it, and this in turn will cause over-heating of the horizontal output transformer.

Most present-day sets have this circuit fused to prevent damage to the output transformer. A number of television receivers manufactured during the past several years, however, have no fuse in this circuit, and, in consequence, ionization of the 6BG6 will burn out the horizontal transformer if the receiver is not shut off in time.

When a television receiver is brought in for repair, this circuit should be checked and a fuse inserted if none has been included by the manufacturer. A .25 ampere fuse is sufficient to open the circuit when excessive current

flows through the tube. A No. 44 pilot bulb can also be used, since this has a rating of .25 amperes. A No. 47 bulb will also prove satisfactory and will usually glow dimly when the set is turned on.

The fuse can be inserted in several places in the circuit, though the easiest is probably the cathode circuit. The lead going directly to the cathode can be unsoldered, and the fuse inserted as shown in Fig. 1.

Fig. 1.

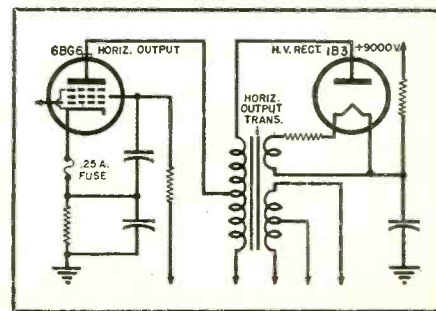

**Lebanon**—Radio Beirut, about 8.020, heard in New York 0045 with news, not sure of language being used. (Belington, N. Y.)

**Luxembourg**—Radio Luxembourg, 15.350, heard 0715 with sponsored program in French. (Ward, England) Is fairly good level in America, appears to end transmission 0835.

**Malaya**—Stark, Texas, recently heard Radio Malaya, Singapore, 4.825, identified 0800 (in English). A station he recently heard on 7.220 (in English) 0730 also appears to be Radio Malaya. Balbi, Calif., flashes that the 7.220 channel is strong on West Coast to 1030 sign-off, relays Blue Network. Also heard by Dilg, Calif.

**Radio Malaya**, Kuala Lumpur, is back on 6.025; heard on West Coast 0900-1045 fade-out, best 0900-1000; is in the clear now. (Rosenauer) If it is still audible in East during May, best time to try for it would probably be 0630 when usually has news. ISWC, London, lists call ZGE.

**Manchuria**—Harbin, approx. 7.099, now has news 0840 instead of 0800; Harbin announces frequencies of 7.100 and 3.500 on s.w. in addition to 2 m.w. outlets. (Dilg, Calif.)

**Martinique**—Hagen, Ala., says Fort-de-France, 9.700, can be heard well between transmissions of WLWS, Cincinnati, that is at 1800-1900, in French. Heard in North Carolina by Ferguson early as 1740.

**Mauritius**—Nattugglan, Sweden, says Mauritius is heard on 40.87 metres (approx. 7.340) to 1215 when signs off with "God Save the King."

**Monaco**—Radio Monte Carlo seems regular now at 1400-1500 on 9.495. (Peddle, Newfoundland) Swedish sources say the m.w. outlet has been changed to 959 kcs., and that the s.w. transmitters on 6.035 and 9.494 both operate with 25 kw. power. (Swedish DX)

**Mozambique**—CR7BE, Lourenco Marques, recently appeared back on 9.715 from 9.708. (Stark, Texas) Still later has been heard both 0000-0100 and 0900-1100 on approximately 9.750. Rosenauer, California, informs me that this channel (he lists it approximately 9.745) is heard 1045-1100 sign-off with fine signal; at 1100 asks listeners to tune to 60- or 85-meter band as the 31-meter channel closes down then; however, some days at least the 9.745 one runs late as 1105. In the 0000-0100 transmission, the frequency appears to me to be 9.750, fine level, English announcements.

**New Caledonia**—Radio Noumea, 6.000, can be heard after Rabat leaves 6.005 at 0300 until after 0500 when fades out; announces at 0500 as "La Voix de la France" and has all-French program. (Hagen, Ala.)

Rosenauer, Calif., has received a letter from Le Directeur du Cabinet du Gouverneur General, Directeur du Service de l'Information, Noumea, "La Voix de la France dans le Pacifique," Noumea, New Caledonia, in answer to airmail letter requesting confirmation of the change in fre-

## ILLINOIS CONDENSER

Presents

### A Greatly Expanded Line

Customer acceptance—proven by 15 years of high quality production — has made Illinois condensers one of the fastest sellers in the field.

They are reliable, even in the most humid climates . . . they are long lived under brutal heat conditions . . . they are manufactured under the strictest quality control methods in the industry . . . they are backed by a one year guarantee!

#### From Radio To Television

There is an Illinois condenser to meet every modern need . . . original application to replacement. An expanded line has been developed to serve the entire electronic field—from radio to television.

A new and greatly expanded ILLINOIS CONDENSER catalog is now off press. Write for your free copy today!



**NEW CATALOG NOW AVAILABLE**



**ILLINOIS CONDENSER CO.**

1616 NORTH THROOP STREET • CHICAGO 22, ILL.

## SHOOTS TROUBLE FASTER!

MAKES MORE MONEY FOR YOU ON JOB OR AT SERVICE BENCH!



PRICE \$9.95

at distributor or postpaid, direct. Sorry, no C.O.D.'s. Ohioans add 3% State Sales Tax

## Signalette

### MULTI-FREQUENCY GENERATOR

In radio service work, time means money. Locate trouble faster, handle a much greater volume of work with the SIGNALLETTE. As a trouble shooting tool, SIGNALLETTE has no equal. Merely plug in any 110 V. AC-DC line, start at speaker end of circuit and trace back, stage by stage, listening in set's speaker. Generates RF, IF and AUDIO Frequencies, 2500 cycles to 20 Megacycles. Also used for Checks on Sensitivity, Gain, Peaking, Shielding, Tube testing. Wt. 13 oz. Fits pocket or tool kit. See at your dist. or order direct.

**Clippard**

Instrument Laboratory, Inc.

DEPT. N, 1125 BANK STREET CINCINNATI 14, OHIO

QUALIFIED JOBBERS WRITE, WIRE FOR DETAILS.

In line with our policy of recommending the most for the least to the amateur, serviceman and hobbyist, we are presenting the following items:

#### EICO

### VACUUM TUBE VOLTMETER KIT

Model 221K Complete Kit \$23.95

#### THE MOST USEFUL TOOL ON YOUR RADIO BENCH!

D.C. and A.C. ranges 0-5, 10, 100, 500, and 1000 volts; Ohmmeter ranges from 2 ohm to 1,000 megohms in steps of Rx1, Rx10, Rx1000, Rx10,000 and Rx1 megohm; Db scale from -20 to 55 Db in 5 ranges; D.C. input resistance is 25 megohms; Diode A.C. rectifier for greater accuracy and wider frequency range to 30 Kc. Large, rugged 4 1/2" meter with all A.C. and D.C. readings on one simple scale. Complete with tubes and test prods. COMPLETELY FACTORY WIRED . . . \$49.95



### OSCILLOSCOPE KIT

Model 400-K Indispensable for AM, FM, and TELEVISION. Horizontal sweep circuit 15 to 30,000 cycles. All controls on front panel. Linear sweep with 884 gas triode. Graph screen for measuring peak to peak voltage. Frequency response of horizontal and vertical amplifiers from 50 cycles to 50 Kc. Input impedance 1 megohm and 50 mmfd. Etched panel for long life. Tube complement: 2-6X4, 2-6V6, 1-884, 1-5BP1. Provision for external synchronization, test voltage and intensity modulation. Deflection sensitivity: 30 volts per inch full gain. Detailed instruction and pictorial diagrams included. NOTHING ELSE TO BUY! Size: 8 1/2" W x 13" H x 17" D. Shpg. \$39.95 wt. 40 lbs. 2-5V9. COMPLETELY FACTORY WIRED . . . \$69.95 20% Deposit Required with C.O.D. Orders

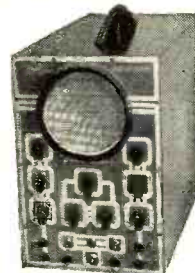

**ADSON**  
RADIO & ELECTRONICS CO.  
221 Fulton St. New York 7, N. Y.

# BARGAIN BULLETIN

All merchandise is guaranteed to be free from defects at time of purchase.

Type	Net Price	Type	Net Price	Type	Net Price
1B23	\$ 7.50	718DY	\$19.95	1B26	\$ .39
2C40	1.59	724B	3.95	1B29	.59
2E22	1.49	808	1.59	1B30	1.59
2X2	.39	810	7.50	1B33	.98
3BF1	1.95	811	1.95	1B42	.79
3E29	3.95	812H	4.90	1B55	.98
5BP1	1.95	813	7.85	7193	.29
5BP4	2.95	815	2.45	802P	2.95
5CP1	1.95	826	.49	802S	5.95
5FP7	2.95	838	2.95	9001	.49
10	.59	860	2.49	9002	.49
24G	.79	864	.49	9003	.49
304TL	1.49	872	.99	9004	.59
317B	.73	874	1.95	9006	.49
35T	4.75	954	.49	HY615	2.25
450TH	19.95	955	.49	RK34	.49
53A	.98	957	1.95	RK37	1.00
211	.98	1613	.49	VR150	.90
705A	1.95	1619	.65	VT-62	.98
715B	7.95	1622	.98	VT-127A	2.95
717A	.79	1625	.39	VU11S	.99

VFX680 Sonar exciter, complete with tubes, regular price, \$87.45	<b>\$ 69.95</b>
XE10 Sonar NFM exciter, regular price, \$39.45	<b>25.00</b>
MB-611 Sonar transmitter, less crystal and power supply, regular price \$72.45	<b>49.95</b>
PE-103 Motor Generator	<b>14.95</b>
140-005 Amphenol Beam, regular price, \$358.00	<b>295.00</b>
137-6Q 6-meter Johnson Q antenna	<b>3.10</b>
ST203A Stancor mobile transmitter, wired	<b>49.95</b>
ST203A Stancor mobile transmitter, unwired	<b>39.95</b>
108X Premax 10 meter beam elements per element	<b>4.00</b>
113M Premax 10 meter beam elements, per element	<b>6.00</b>
104M Premax 6 meter beam elements, per element	<b>2.00</b>
RB6108 Premax 3 element 10 meter beam kit, (elements and insulators only)	<b>22.80</b>
701 McMurdo Silver transmitter, regular price, \$36.95	<b>29.95</b>
908 McMurdo Silver micro-match, regular price, \$29.95	<b>19.95</b>
Mon-Key, regular price, \$29.95	<b>19.95</b>
MB-3RME Monitor, regular price \$29.95	<b>19.95</b>
BC348 Receiver with AC power supply & speaker	<b>89.50</b>
BC654A Transmitter & Receiver with dynamotor	<b>29.95</b>
600 Eastern Amplifier 10 meter mobile transmitter with tubes	<b>49.95</b>
S-53 Hallicrafters Receiver, regular \$89.95	<b>79.95</b>
Cornell-Dubilier and Sangamo high voltage micas in the following values: .01-4000; .01-5000; .00025-6000; .00025-8000; .0001-12500; .0005-12500; .00005-12500; .00025-12500; .02-3500 any capacity, each	<b>.98</b>

**LAVENDER RADIO SUPPLY CO., INC.**  
520 East Fourth, P. O. Box 596  
TEXARKANA, ARK.-TEX.

## STILL THE LEADER!

The famous ACA-100 Amplifier — a self-balancing, drift-correcting, direct-coupled amplifier — the most satisfying musical amplifier ever designed. Based on early Loffin-White circuits, perfected by A. C. Shaney in 1936, and now brought to a standard of quality far above that of any corresponding amplifier. Exclusive features include:

- Push-Pull Triode Expander.
- Non frequency-discriminating noise suppressor.
- Push-pull hi and lo freq. variable equalizers.

If you are satisfied with nothing less than the best, write today for free technical literature.

Special models for all magnetic cartridges.



## AMPLIFIER CORP. OF AMERICA

398-2 Broadway New York 13, N. Y.

**NOW! YOU CAN SOLDER WITH ONE HAND WITH A SODERGUN**

**SOLDER-FEED ATTACHMENT**  
FEEDS WIRE SOLDER TO TIP OF IRON AS NEEDED LEAVING ONE HAND FREE

Indispensable for MAINTENANCE REPAIR HOME USE, Etc.

Does not obstruct dressing slip

This Finger Tip FEED LEVER operates FREE WHEELING WIRE FEED CLUTCH (no ratchet) PRACTICAL POSITIVE-ACTION, Takes 1/16" & 3/32" Solder — FULLY GUARANTEED —

**INTRODUCTORY PRICE \$200** POST Cash, Mo. Order PAID or Your Check

**AUTOMATIC DEVICES INC.**  
761 VENICE BLVD.  
LOS ANGELES 15, CALIF.



## Looking for TUBES! What have you got?

Yes, we are looking for your excess or obsolete tubes. Dig them up TODAY and convert them into ready CASH NOW... no quantity too large or too small... we need them all.

Send your list to:

**MOHAWK ELECTRONICS CO.**  
160 GREENWICH ST., NEW YORK 6, N. Y.

quency to 6.000 and any changes in schedule. The official advised that 6.000 is the correct frequency and that there has been no change in schedule as given earlier—1200-2000, 0230-0400. This does not quite match the time Rosenauer has heard this station, sign-off having been 0500. He inquired as to current power output but received no answer to this query.

New Zealand—ZL3, 11.78, logged early as 1255 with orchestra; at 1300 announced ZL3 and ZL4 (15.28) and took relay of news from BBC; generally has "Breakfast Music" 1315, another BBC news relay 1400, followed by weather forecast 1415. (Pearce, England) Is used widely for relay of m.w. outlets; final closedown now appears to be around 0620 on both 11.78, 15.28.

Nicaragua—McPheeters, La., received verification from YNMG, "La Voz de Jinotepe," 8.007; proprietor is a woman, Margarita E. Gomez; schedule is 1230-1400, 2000-2130 daily; suffers bad CWQRM; listed 100 watts.

YNDG, 7.660, heard 2000 announcing in Spanish and English, continued with music. (Ferguson, N. C.)

Northern Rhodesia—ZQP, Lusaka, heard in Ontario on 9.715 at 1030, high noise level, fast fading. (Alfred) Carl Rosenauer, Calif., has received a letter from Lusaka, signed by John F. Murray, the Broadcasting Engineer, in which it was stated:

"Although we are using a high angle, omni-directional aerial on 9.710, we have had a number of reports from California, Sweden, and Western Australia. It rather looks as though we have some secondary lobes at a low angle; until the field-strength measuring apparatus on order arrives, we can't do much about it. The power on 9.710 is 2.5 kw. into the aerial, which is of the Marconi 'Quadrant' type, that is, two half-wave sections at right angles to each other in the horizontal plane, thus giving an omni-directional horizontal pattern. The elements are a quarter-wave above ground so that, theoretically, there should be no low angle radiation. We are supposed to cover Southern Rhodesia, Northern Rhodesia, and Nyasaland from Lusaka, i.e. a five hundred mile radius centered on Lusaka, providing programs in the various vernaculars as follows—Monday 1000-1200 Chibemba; Tuesday 1000-1200 English for Africans; Wednesday 1000-1200 Chinyanja; Thursday 1000-1300 Silozi and Chitonga; Friday 1000-1200 Sindebele; Saturday 1000-1200 Euro-African Program; Sunday 0400-0530 European Program, and 1030-1130 African Religious Service. We also transmit on 7.220 and 3.914, but on 500 watts only on each of these frequencies." At press time, Rosenauer flashed to me that Lusaka now appears to be on about 9.700, at least is lower than Lourenco Marques and has good signal 1100-1130.

Norway—Worris, N. Y., has learned that "economic restrictions will limit short-wave transmissions to present

## CLOSE OUT SALE



### RM-29A TELEPHONES

Reduced \$9.95  
to only \$4.95 each

Complete  
with handset  
and 4 1/2 volt  
"C" battery

Stock No. B-588H

Two or more of these units make an excellent private telephone system. Require only two wires connecting the two or more units. No external power required. Every unit has been completely reconditioned and tested and is guaranteed to be in excellent condition, ready to operate. Shipping weight - 16 lb.

Only a limited quantity in stock. Don't delay! This may be your last opportunity to take advantage of this outstanding surplus buy.

### Outdoor Telephone-Intercom 3-CONDUCTOR CABLE

at less than 1¢ per foot

Stock No. C-561H  
525 FOOT ROLLS

Only \$4.95 per roll



Each conductor consists of four #28 steel strands for added strength and three #28 copper strands for extra conductivity and flexibility. Rubber insulation with two-ply waterproofed braid covering around each conductor. Net wt. 20 lbs. A wonderful buy for any telephone or inter-communication use requiring 2 or 3-conductor cable. Shipping weight - 20 lb.

Anticipate your needs on this wire!

Lay in a stock now. You will never again be able to duplicate this value.

TERMS - cash with order, or 20% deposit - balance C. O. D.  
Prices are net. F. O. B. Dayton, Ohio

# SREPCO, Inc.

STANDARD RADIO & ELECTRONIC PRODUCTS  
135 E. Second St. - DAYTON 2, OHIO - Tel. FULTON 2174

## CREI Prepares Young Men for Professional Careers with Industry-Recognized training in a minimum of time RADIO-ELECTRONICS- TELEVISION ENGINEERING

GRADUATES of the Capitol Radio Engineering Institute residence school are preferred by industry because of their training and ability. This recognition is the reason that CREI men quickly find good jobs in radio-electronics-television engineering and technical fields.

With 22 years of practical teaching experience in these highly technical fields, CREI offers an outstanding faculty, modern and complete laboratories, shops and equipment.

New students are accepted twice monthly and each may advance as rapidly as he is capable. The basic course with one specialized course requires an average of 20 months to complete, depending on the ability of the individual student.

CREI is recognized as one of the country's leading technical institutes. Its work is of college level. It prepares the young man for a good job in industry in a minimum of time.



Approved for  
Veterans'  
Training

## CAPITOL RADIO ENGINEERING INSTITUTE

An Accredited Technical Institute Founded in 1927

### MAIL COUPON FOR FREE CATALOG

Capitol Radio Engineering Institute, Dept. 135A  
16th and Park Rd., N.W., Washington 10, D.C.

Please send me your catalog and details.

Name \_\_\_\_\_ Age \_\_\_\_\_

Street \_\_\_\_\_

City \_\_\_\_\_ Zone \_\_\_\_\_ State \_\_\_\_\_

I am entitled to training under G.I. Bill.

May, 1949

scope during foreseeable future. Currency restrictions made it necessary to use temporary, makeshift, home-made components in parts of the new 100 kw. transmitter." However, I understand several additional antennas are being erected at the present transmitters to broaden the range of the stations.

Oslo's LLN, 17.825, heard 0800-0830 with call in *English* and Norwegian; asks for reports to *Radio Norway*, Oslo, Norway; says also operating in 19-, 31-, and 41-m. bands (LKV, 15.170, LLG, 9.610 fairly good but the 41-m. channel of 7.240 is jammed by locals at this time). Now frequently announces in *English* 1500 on LLG, 9.61, and then gives frequencies for 19-, 25-, 31-, and 41-m. bands. (Pearce, England)

LLK, 11.850, heard 0130-0235 sign-off, fair level. (Balbi, Calif.)

LLS, 7.210, heard 1400-1500; LKJ, 9.540, Tromsø, heard 0530-0615. (Peddle, Newfoundland)

Panama—HP5A, 11.695, Panama City, signs off 2245. (Beck, N. Y.) HP5B, 6.030, *Radio Miramar*, Panama City, now signs on a half-hour earlier, that is 0700; QRA seems to be Aptdo. 1214. (McPheeters, La.)

Philippines—Manila, 9.640, heard with station announcement 0700, gave new m.w. call of DZRH; sponsored dance session followed. (Ferguson, N. C.) This one heard recently in California at 1100-1130 with popular music and *English* announcements, good signal; call of s.w. outlet appears DZH2 (Rosenauer).

Portugal—Lisbon, 6.350, signs off 1900 in Portuguese to Brazil; formerly on 6.374; this is a different transmitter from the one used to North America on 6.374. (Beck, N. Y.) However, Pearce, England, says Lisbon is now using approximately 9.726 (instead of 11.027) at 1600-1800 for Brazil, with news in Portuguese 1605, 1745. May be using both 31- and 48-m. bands to Brazil.

CS2W1, 12.865, Parede, power 250 w., heard 1900-2000; QSL'd in 27 days from Radio Clube Portugesa, Parede, Portugal; card blue with gold lettering. (Alfred, Ontario)

Portuguese India—From Nattuglan, Sweden, comes a report of a verification from "Emissora De Goa," Goa, giving current frequency as 9.610, with 500 watts power, and schedule of 0900-1000.

Portuguese Guinea—Bissau is definitely now on 6.997. (Kary) Has been heard on this channel at 1720 but has almost continuous CWQRM which generally blots out Bissau. (Pearce, England) Closedown remains 1800, when signs with "A Portugesa."

Rumania—Bucharest, 6.210, heard 1510 with news and talk in *English*. (Ward, England)

Under favorable conditions, the 9.252 channel can be heard in East at 1600 when has news; sign-off is 1630 now; has severe QRM. Is heard in Newfoundland by Peddle at around 1430-1540. Kary notes that uses 7-note

## NATIONAL TELEVISION BOOSTER



5 to 6 times the gain

OF ANY OF FIVE  
COMPETITIVE MODELS

... in our own exacting performance tests. Brings in clear, strong pictures in fringe areas and with indoor antennas. Greatly reduces noise. A real working RF stage, using separate tubes for high and low bands. Receiver power cord plugs into booster and booster plugs into AC outlet. Single switch on booster turns on both, Fine tuning control assures best possible definition. Balanced input coils. Electrostatic shielding. **\$39.95**

(Suggested Retail Price)

CAN BE OFF 2-6 7-13

SWITCHED

IN OR OUT!



When control is in OFF position, the booster is out of the circuit. Turn the switch to high or low band and—presto—the picture comes into clear, sharp focus right before your eyes!

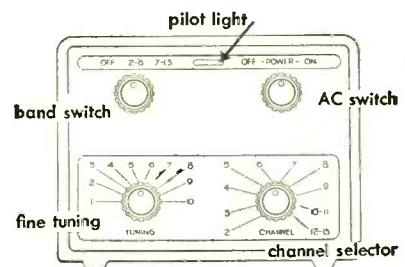

National  
EST. 1914  
NATIONAL COMPANY, Inc.  
MALDEN, MASSACHUSETTS

# RADAR, COMMUNICATIONS AND SONAR TECHNICIANS W-A-N-T-E-D For Overseas Assignments

## Technical Qualifications:

1. At least 3 years practical experience in installation and maintenance.
2. Navy veterans ETM 1/c or higher.
3. Army veterans TECH/SGT or higher.

## Personal Qualifications:

1. Age, over 22—must pass physical examination.
2. Ability to assume responsibility.
3. Must stand thorough character investigation.
4. Willing to go overseas for 1 year.

Base pay, Bonus, Living Allowance, Vacation add-up to \$7,000.00 per year. Permanent connection with company possible.

Apply by Writing to  
**D-4, P.O. Box 3575,  
Philadelphia 22, Pa.**

Men qualified in RADAR, COMMUNICATIONS or SONAR give complete history. Interview will be arranged for successful applicants.

## WHY PAY MORE! Save on Surplus Buys



### Telephone Handset Hanger

Fits most types on market. Made of heavy duty aluminum casting. Excellent for desk, mobile or marine use. BRAND NEW.

NEW LOW PRICE **\$1.49** Postpaid

**Westinghouse DC Volt Meter**  
(A) Front of panel mounting. 0-50 V DC. Easy to read 6, 12, 24 and 32 volts for mobile and marine use. Brand New. Boxed.

POSTPAID **\$2.95**

**LEACH DUAL INTERLOCKING TYPE RELAY**  
(B) FB for overload use. 24 volt, 95 ohm coils. Use in fil. return circuits for controlling primary of plate supply. Complete with instructions. Brand New. Boxed.

POSTPAID **\$1.69**

**BC-347 Interphone Amplifiers**  
(C) Contains 2 expensive 6uncer trans., 200 ohm to P.P. grids and P.P. plates to 200 ohm line and many additional parts. Mounted in undrilled aluminum case. Excellent for pre-amps and many others uses. (Less 6F8 tube).

POSTPAID **\$1.95**



**ALVARADIO, Dept. RN-19  
903 S. Alvarado, Los Angeles 6, Calif.**

chime for identification purposes 1530 and 1600, that schedule is now an hour later than formerly, and that closes 1630 with choral music.

*Salvador*—McPheeters, La., has received verie from YSR, "La Voz de el Salvador," 990 kcs. and 6.265; said using 900 watts on s.w. and 1,000 watts on m.w. channel; scheduled 1200-0000; also in network are YSF, *Radio Vanguardia*, 840 kcs. and 9.250; YSHQ, "La Voz del Progreso," San Miguel (first two are in San Salvador), 950 kcs. and 6.500; YSA, *Radio Cultura*, a new station to go on the air shortly, 1,020 kcs. and 9.490, located at Santa Ana.

YSUA, 6.250, uses recording (in *English*) to announce call on half-hour and then returns to Spanish; announces "Radio Mil Cincuenta"; appeared recently to be holding some sort of contest for listeners. (Weisberg, N. Y.)

*Siam*—From Johnston Island in the Pacific, Capt. F. Fellers informs me that the Overseas Broadcasting Station of Siam, Bangkok, now testing on 11.715 daily 0500-0630 in parallel with 6.010, has been heard by him on 11.715 with news 0515, *English* talk 0540, and news again 0615; signal good but has QRM from Australia's 11.71 and USA and Moscow; he cannot hear the 6.010 outlet due to terrific QRM from Noumea and South America. The 49-m. outlet, however, can be heard some days here in East in 0615 news; the 11.615 channel is "all noise" here in West Virginia 0500-0630. Reception reports on the 11.715 tests are requested, according to Desouza, Singapore, via *Radio Australia*.

*South Africa*—Pearce, England, says most reliable signal he has been getting from South Africa is Johannesburg, 4.895, heard from around 1230 to sign-off with "Suid Afrika" and "God Save the King" 1605, following the "11 p.m. Epilogue." Programs are all-Afrikaans; news in Afrikaans at 1500; *English* program on 4.800 at 1245 has poor intelligibility due to CWQRM.

Cape Town, 5.878, has had improved signal lately here, opening 2345 with *English* announcement, then goes into Afrikaans (setting-up exercises).

ZRB, 9.11, Pretoria, heard well recently, in clear, 0010 with setting-up exercises. (Bellington, N. Y.)

*Spain*—Radio SEU, EDV10, Madrid, is now back on 7.191 at 1400-1900. "La Voz de la Falange," 7.380, Madrid, has Spanish 1400-1530, 1700-1830, and French 1330-1400; much QRM from Moscow. *Radio Mediterraneo*, Valencia, verified by (*English*) letter, gave frequency 7.037.2, scheduled 0700-1000, 1400-1800; opens with march "Hacia Valencia," closes down with "Marcha de la Ciudad." (Pearce, England)

*Surinam*—PZC, 15.405, has Arabic Fridays 1900-1945 in parallel with PZH-5, 5.760. (Alfred, Ontario)

*Switzerland*—The Home Service from Berne at 0040-0140 is now on 6.165 (100 kw.) and 9.535 (instead of former 11.715). Berne signs off 1530 on 11.865 and 9.665 (new 100 kw.) in British Isles beam; returns 1545 on

## Music as the Masters played it! THE Bogen RANGE MASTER

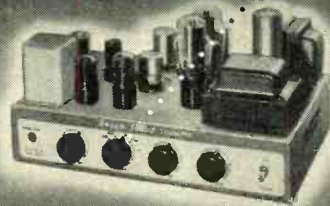

This new control permits your records to perform at their very best — an adjustable noise suppressor to correct for the particular condition of each record.

The Bogen PX15, fifteen watt high fidelity amplifier boasts eight other distinctive features, designed to multiply your listening pleasure.

Write for complete new FREE High Fidelity Catalog.

**David Bogen**  
CO., INC.

663 BROADWAY, NEW YORK 12, N. Y.

**BOOTH 44 at the RADIO  
PARTS SHOW!**

## Mass. Radio School

273 Huntington Ave., Boston 15, Mass.  
Offers Training Courses for Radio Technician (Pre-Television) and Licensed Radio Operator (All Types) including maintenance and operation of General Electronic Equipment. Over 20,000 Alumni and 30 years radio training EXPERIENCE. Courses approved for G.I. Training for Veterans.

Send for Catalog  
Licensed by Commonwealth of Mass.  
Department of Education

## FLEXIBLE TUNING SHAFTS

Tuning shafts for SCR274N, ARC5, MN26, ARN7, BC433, ARB in lengths up to 15 feet. Complete assembly, NEW, \$2.50 (specify approximate length desired).

MC211A r/angle drive 75c  
Dual transmitting rack SCR274N, NEW, 59c

**LONG ISLAND RADIO CO.**

164-21 Northern Blvd., Flushing, N.Y.

## TELEVISION SCREEN VIEWING FILTERS

Make television far more enjoyable. You can make your own filters at very low cost. Different colors, all very easy and inexpensive to make. Send 35 cents for complete instructions. Instructions do not include material.

**ELECTRONIC DEVICES CO.**  
Dept. R5, P. O. Box 1016, Morgantown, W. Va.

## COMMUNICATION and RADIO COURSE \$4

Not a correspondent course, but mailed complete. Written by a former Tech. Rep. with the Army Air Forces. Practical, includes necessary theory with physical explanations, absolutely necessary in radio repair, television, and communications. Not a basic course. \$4.00. Mr. Arthur J. Arruda, 70 Acusnet Ave., New Bedford, Mass.



11.865. (Beck, N. Y.) Berne's HER8, 21.520, heard 0745-0915. (Peddle, Newfoundland) The 9.665 channel heard with news followed by talk 1350-1400, only fair signal in North Carolina. (Ferguson)

Ward, England, confirms that *United Nations Radio*, Geneva, 6.672, has UN news in *English* daily (except Sun.) at 1330. Station informed Cushen, N. Z., that only the 6.672 transmitter is now in operation, is 7.5 kw. the 18.450 station is not now in use; stated "transmitters are still experimental, but as soon as budgetary considerations are increased, our services will be increased."

*Syria*—Sutton, Ohio, reports Damascus, 12.000, with music and Arabic 1200-1300, S6. Hagen, Ala., reports this one 0000-0100 with Arabic music, through heavy CWQRM. Is heard in North Carolina by Ferguson, opening in Arabic, followed by Eastern music. Confirmed by several other Eastern monitors lately.

ISWC, London, lists Damascus on 6.000, 7.500, and 12.000 with Arabic 0000-0100, 0630-0730. 1100-1455, *English* and French 0730-0830.

*Tibet*—I have asked an *ISW* monitor in Assam (India) to check on the rumor that a s.w. outlet is operating between 6 and 8 megacycles from Lhasa. Any information on this "rumor" will be welcomed.

*Trinidad*—Radio Trinidad, 9.625, Port of Spain, excellent opening 05.00. (Hankins, Pa.) Heard at that time "Down Under" by Sanderson of Australia. And in Ontario 1845 with news and sports, good signal, in clear, local news 1900, also heard 0545 with news. (Alfred)

*United States*—WVD, 6.980, Seattle, heard recently 0310 testing for receiver adjustment. (Alfred, Ontario) Recently heard on 14.867 at 1939-2018 by Starry, Pa.; stated "This is WVD, testing for the benefit of receiver tuning of our Northern stations"; played recordings between tests.

USSR—Home Service heard on 9.480, 9.645, 11.720, 11.880 with setting-up exercises 0000-0030, good level. The 15.410, 15.385 outlets heard with musical program 0030-0100. (Sutton, Ohio) Nattugglan, Sweden, lists Alma Ata, Kazakstan, on 9.625, opening 2000 in native and Russian, says closes 1000.

Soviets heard at 2300 and afterwards in Home Service include 6.020 (Kiev), 6.050, 7.270, 9.660. (Beck, N. Y.) Frequencies of 11.75 and 9.545 are used to China 0600-0700. (Balbi, Calif.)

*Vatican*—In summer, HVJ will have news 0900 on 15.095 and 9.660, at 1315 on 9.660 and 5.969; each Tuesday at 1000 will be on 17.445 for India and South Africa, news summary; each Sunday at 0430 on 9.660 and 5.969 with broadcast mass. (Ruglivedt, Norway) However, lately the 31-m. outlet appears to be low as 9.645, according to Pearce, England.

*Venezuela*—Radio Cabimas, YV1RC, 6.150, signs off 2235. (Beck, N. Y.) McPheeters, La., received verie-letter

*Nothing Finer!*

## CHICAGO FEATHERWEIGHT MULTI-TESTERS

**Highest Quality**—Chicago "Featherweight" Multi-testers are made with the precision of a fine watch. Strict tolerances provide accuracies far above commercial standards—readings are absolutely dependable.

**Most Compact**—Chicago "Featherweights" are the smallest multi-testers in the world. They are truly pocket-size instruments, weighing only a few ounces . . . a pleasure to use in or out of the shop.

**Lowest Cost**—Chicago "Featherweights" guarantee more real usefulness and dependability at considerably lower cost. There is nothing like a "Featherweight" for standing up under hard daily use. They are built to "take it."

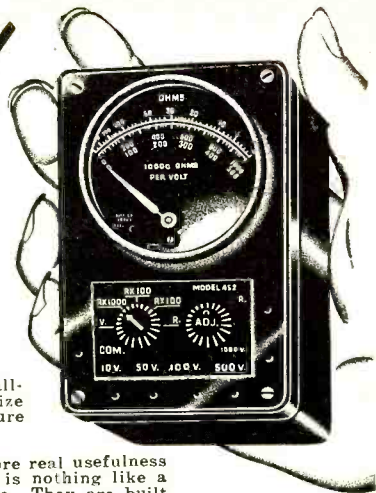

### Chicago "Featherweights"

<p><b>Model 450A</b> Volt-Ohm Milliampmeter for DC Volts 0-5/10/50/500/1000    Mils 0-1 Ohms Full Scale 5000/50,000/500,000 Ohms Center Scale 30/300/3000 <b>Net price \$10.90</b></p>	<p><b>Model 451A</b> Volt-Ohmmeter for AC and DC Volts DC 0-10/50/100/500/1000 Volts AC &amp; Output 0-10/50/100/500/1000 Ohms Full Scale 500,000 Ohms Center Scale 7200 <b>Net price \$14.90</b></p>
<p><b>Model 452A</b> High Sensitivity DC Volt-Ohmmeter Volts 0-10/50/100/500/1000    10,000 Ohms per Volt Ohms Full Scale 2000/20,000/200,000/2,000,000 Ohms Center Scale 30/300/3000/30,000 <b>Net price \$14.90</b></p>	

*Chicago*

There is a Chicago Multi-Tester for every purpose

Write for our complete catalog

CHICAGO INDUSTRIAL INSTRUMENT CO., 536 W. ELM ST. CHICAGO 10, ILL.

## ACORN

Moves to LARGER QUARTERS! More Space . . . Better Service! Visit in Person or Shop by Mail for BARGAINS in BRAND NEW STOCK



### ★ PRE-AMPLIFIER—Model K 1

Designed to raise the output level of magnetic pickups to that of crystal. Can be used as phono pre-amplifier with slight changes. Made by Packard-Bell. Comes complete with PL55, PL65, cordage 119B, less tubes. Wt. 3 lbs. With operating instruction book. Uses 2 tubes. **\$1.95**  
A GREAT BUY at . . .

### ★ ANTENNA BEAM ROTATOR

Last Call . . . **\$1095**  
While they last!

Perfect For TV Antennas  
A proved success with users throughout the country. Operates on 12-27VDC. 300 degrees rotation, self-reversing motor. Built-in potentiometer to operate 0-1 milliammeter to indicate position. Motors enclosed, water-proof housing. Used by U. S. Navy on destroyers for radar scanning. Wt. 19 lbs.

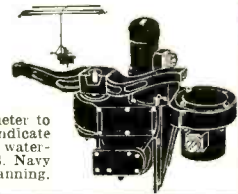

### ★ PLANETARY DRIVE

5-1 ratio for 1/4" shaft. **49c** ea. 3 for **\$1.25**

### ★ HEAVY DUTY POWER TRANSFORMER

Pri. 110/220 v 60cy. Sec. No. 1—410-0-410 @ 400 mils. No. 2—6.3v @ 3 amps. No. 3—6.3v @ 13.5 amps. No. 4—5v @ 3 amps. No. 5—2.5v @ 1.7 amps. Dimensions H—3 1/2", W—8 1/2", D—5 1/2". Wt. 33 lbs. Made by G. E. for U.S. Navy. Tremendous Value!  
**\$7.49**  
3 for **\$20**

### ★ POWER TRANSFORMERS

Thordarson power transformer. Pri. 115v 60cy. Sec.—780 c.t. @ 200 mils. 6.3v c.t. @ 1 1/2 amps. 5v @ 3 amps. 2 1/2v @ 4.75 amps. 2 1/2v c.t. @ 1.75 amps. Upright mtg. Wt. 12 lbs. REG. VALUE \$16.50  
**\$4.95**

Pri. 115v 25cy. Sec. 680v c.t. @ 225 mils. 10v tapped @ 6.3 @ 5 amps. 5v @ 4 amps. Wt. 16 lbs.  
**\$4.79**

Thordarson power transformer. Pri. 115v 60cy. Sec.—750v c.t. @ 145 mils. 6.3v @ 4.5 amps. 5v @ 3 amps. Upright mount. Wt. 7 lbs.  
**\$3.29**

Pri. 115v 60cy. Sec.—720 c.t. @ 150 mils. 6.3v @ 4 amps. 5v @ 3 amps. Half shell mount. Mounting centers 3 3/4" x 2 1/4". Wt. 6 lbs.  
**\$2.99**

Pri. 115v 60cy. Sec.—600v c.t. @ 100 mils. 6.3v @ 3 amps. 5v @ 2 amps. Half shell mtg. Mtg. centers 2 1/4" x 2 3/4". Dimensions H—3 1/4", W—3 3/4", D—2 3/4". Wt. 5 lbs. Made by Thordarson. BARGAIN!  
**\$2.69**

PHONE WORTH 4-3270

### ACORN ELECTRONICS CORP.

76 Vesey St., Dept. N-5, New York 7, N. Y.

### ★ CO-AXIAL CABLE

Very Special RG-8U 50 ft. reels. Wt. 4 lbs. **\$1.50**  
Per reel . . . . .

### ★ FILTER CHOKES

Hy	Mils	Ohms	DC	Each
10	55	350		\$ .74
15	70	420		.79
10	85	250		.97
10	100	200		1.09
10	150	70		1.49
2 1/2	235	60		1.59
10	250	100		2.95
5	400	300		3.25

### ★ 4 GANG FM TUNING CONDENSER

Perfect condenser to cover FM band and similar applications. 3-30 mmfd per section. Steatite insulated. Wt. 2 lbs.  
Each . . . . . **\$1.79**  
3 for . . . . . **\$4.75**

### ★ TOGGLE SWITCHES

	SPST	SPDT	DPST	DPDT
BALL HANDLE	17c	24c	29c	49c
BAT HANDLE	27c	31c	39c	59c

(Heavy Duty)

### ★ VOLUME CONTROLS

All sizes on hand from 5 ohms to 10 meg. IRC, Clarostat, Centralab, CTS, Mallory. Each **49c**  
10 for . . . . . **\$4.29**

TERMS: 20% cash with order. Balance C.O.D. All Prices F.O.B. our warehouse in New York City. No orders under \$2.50.

**VACO\* ZB 50**

5 screw drivers in 1  
5 blades... 1/8", 3/16"  
and 1/4" regular and  
No. 1 and No. 2  
Phillips... snap into  
one break and shock  
proof handle. Oil  
tempered chrome  
vanadium steel  
blades. Precision  
built in every  
detail! Price,  
only \$2.95.



**2 NEW TOOL KITS for Radio Men**

You'll like these two beautiful new kits by Vaco. Finest quality materials used throughout assure long service. Comfortable grip handles are of fire-safe Amberyl\* plastic! And the leatherette tool roll fits comfortably into your back pocket. See your jobber or write direct.

Wonderfully Convenient! Fully Guaranteed!



317 E. Ontario St.  
Chicago 11, Ill.



**VACO\* ZS 60**

5 nut drivers in 1  
5 hex. wrenches...  
1/4", 3/16", 1/2", 3/8"  
and 7/16"... fit same  
fire-safe Amberyl\*  
handle. All sockets  
of super-hard  
steel for longer  
life. Price, only  
\$3.50.

\*Trade Marks Registered



**JOBS IN TELEVISION**

YOUNG MEN 16 TO 60

There is a job opening for every qualified trained Television Technician.

**WE CAN TRAIN YOU FREE EMPLOYMENT SERVICE**

Visit Our Modern Laboratories and Class Rooms Approved Under G.I. Bill of Rights

**AMERICAN RADIO INSTITUTE**

New York, N. Y. Syracuse, N. Y.  
2010 Broadway 131 Shonnard St.  
Mt. Vernon, N. Y. Buffalo, N. Y.  
174 Gramatan Ave. 640 Main St.

"Teaching Radio Since 1935"

**HARD-TO-GET PARTS**

500M Volume Control	12c; W/sw	50.27
50L6 Output Trans.	32c; Pushpull	.45
6V6-6F6 Outputs	34c; Pushpull	.45
AC-DC Filter Chokes		.26
10 Watt Universal Outputs		.75
Replacement I.P. Trans. 458 KC Input or Output Shielded		.32
Same as above but unshielded		.25
Superhet Variable Cond. 2 Gang 365 mf.		3.39
TRE Variable Cond. 420 mf.	44c; Drum	.05
Meissner 12SA7 Osc. Coils		.15
Replacement 12SA7 Osc. Coils		.10
Antenna Loops Prim. & Sec.	12c; 10 for	1.00
Astatic JT-30 Xtal Mixer		6.95
Astatic DN-HZ Dynamic Mike W/G Grip to Talk Chromium Stand		16.50
Astatic Crystal Mike W/Handle		4.59
8 Button Push Switch	27c; 5 for	1.00
Solderless Test Prods 5 in. Red or Black		.22
Bayonet Pilot Light Sockets	5c; 3 for	.10
3AG Fuse Extractor Posts	2 screw	.12
2 Conductor Connectors Male & Female		.25
Tuning Drive Shafts in or out	12c; 10 for	1.00
Nylon Dial Cord. 25 feet for		.25
Fluorescent Ballasts 14w. 15w. 20w.	ea.	.59
Fl-Starters 15-20w. 17c; 22w. 23c; 30-40w		.23
4 Wire Speaker Cable 4 Ft. Long		.12
Single Lug Terminals 1c; 2 lugs 2c; 3 lugs		.03
Bakelite Terminal Strips. 2 screw lugs		.04
PL-55 Microphone Jacks Open Circuit		.12
Schematic Diagrams for Radios up to 1939		.50
Elmco 10 Watt HI-FI Amplifier. 5 Tubes AC 6V6 PP. 50-15000 Cp. W/Tubes. Wired.		22.95
Fluorescent Ballasts 40 Watt, single		1.95

\$1 on C.O.D. Orders—Please Enclose Postage. Send for Our Latest Bargain Bulletin

**RADIO MAIL ORDERS**

2 West Broadway Dept. RN, New York 7, N. Y.

from *Radio Barquisimeto*; new call-signs are YVMQ, 4.990, 4 kw., and YVMR, 1.475 kcs., 3 kw.; no schedule given; QRA Aptd. Postal 76. McPheeters lists new call of *Radio Carora* as YVMU, 3.340, signs off 2130; says YVMG, *Radio Popular*, 4.810, Maracaibo, is scheduled 0600-2230; that *Radio Maracay*, 3.430, appears to sign off usually 0800; new call-sign appears to be YVLI for the s.w. outlet and YVLJ for 930 kcs.

*Yugoslavia*—YUA, 6.107, Belgrade, has English 1545-1600. (Peddle, Newfoundland)

*Unidentified*—Alfred, Ontario, would appreciate identification of a station heard on approx. 9.560 at 2015 with tom-tom drums and African-type program.

An unidentified station on 6.150 has Arabic around 2300 and later; definitely is not Sharq-al-Adna which is heard on 6.170 with slightly better signal. (Beck, N. Y.) This may be Teheran, Iran, listed 6.155V.

**Last-Minute Tips**

"*Ici Radio Algiers*" was heard in February on 15.200 both during Arabic before 1500 and French from that time, same program as *Radio Algiers*, 9.570; occasional breaks in program; not heard since so may have been a test or a spurious transmission. (Pearce, England)

In a recent Swedish DX session from Stockholm it was reported that Jerusalem, 8.100, had not closed down as previously reported but had been heard 1330 when carrying same program as Kol-Yisrael, 6.820, Tel Aviv.

A station heard opening 0000 on approximately 8.017 is believed to be *Radio Beirut*, Lebanon; has had QRM. (Stark, Texas)

*Radio Makassar*, Celebes, heard recently on 9.550 from tune-in 0715 to fade-out 0900, mainly in Indonesian-Malay; the 11.086 channel was somewhat weaker, faded out earlier, and did not carry same program as 9.550. (Kary)

A new s.w. transmitter at Waneroo, Australia, to be used in Inland Service of ABC, may be operating around the middle of this year. (*Radio Australia*)

Nattuglan, Sweden, lists Hyderabad (India) on 6.110. *Can anyone confirm?*

COKG, Cuba, runs 500 watts; QRA is Apartado 82, Santiago de Cuba, Cuba. (Weisberg, N. Y.)

A Czech listener reported recently to *Stockholm Radio* that *Radio Venezia Giulia* is a clandestine (Italian) station operating on 6.400, signing off 1500. (Swedish DX)

Desouza, Singapore, reports "*The Voice of Sumatra*" on 7.620 daily 0730-0830; Javanese 0730-0800, news 0800, last 15 minutes in Indian dialect.

Hankins, Pa., has received verification stating definitely that *Juliana Sender, Willemstad*, Curacao, has been operating on 5.010 as well as 2.315 since December 1, 1948; the 5.010 is the exact frequency reported by Hankins. Manager of station CUROM,

**EXCEPTIONAL VALUE**  
SOUND POWERED HEAD AND CHEST PHONE SETS — Good, Used, Tested, While They Last \$9.50 per pr.  
NOTE: Shipping Weight 10 lbs. Include sufficient mailing charges.

**G. E. SWITCHETTES**  
CR-1070C103-B3 normally open .35  
CR-1070123-C3 norm. open or closed .35  
CR-1070C103-K2 normally closed .35

**MICRO SWITCHES**  
YZ-2R5 normally closed, ea. .30  
BZ-2R5 norm. open or norm. closed, ea. .35  
GZ-2R5C normally open, ea. .30  
BZ-RL norm. open or norm. closed, ea. .35  
YZ-2RL2 normally open, ea. .45  
MLR-304-15A-125V norm. open or closed .40  
WZ-RL8 normally closed, ea. .35

**WIRE WOUND RHEOSTATS**  
1.1 ohm 100 Watt with Switch .1.25  
6 ohm 25 Watt .65  
8 ohm 50 Watt 1.00  
15 ohm 1.30 Amps-25 Watts with Knob .75  
250 ohm 50 Watt 1.00  
2500 ohm 25 Watt .65

**SPST AN-3022-2B Bat Handle, Lum. Tip 6A-125V, ea. .25**  
**DPDT Slide Switch Stackpole 5A 125V .20**  
**SPDT Momentary, center-off, 10A 125V Long Bat Handle #8905K710 .50**  
**SPST Bat Handle, 3A, 125V C-H .25**  
**SPDT Bat Handle, 6A 125V H-H .30**  
**DPDT Momentary, #8905K674, center off long Bat Handle, 20A 125V .60**  
**DPST #AN-3023-2, 20A 125V Bat Handle .60**  
**DPST Momentary, Push Type, 10A 125V .35**  
**SPST Rotary, (enclosed) 6A 125V 1/4" shaft H-H .25**  
**SPDT Phono Radio Sw. 1/4" diam. Shaft .15**

**MOTORS**  
1/40 H.P. 3000 RPM Universal AC-DC 110 volt Shaft 1/4" diam. 1 1/2" long, double shaft ea. \$2.50  
Small 110 V AC 60 cycle, open frame motor 2700 RPM Shaft 1/4" diam. 3/4" long. 1/70 HP mfg. by Barber Colmann Co. ea. 2.00  
Synchronous motors, 110 V AC 60 cycles 4/5, 1 1/5 RPM, 2.2 Watts, shaft 1/8" diam. 1/2" long. mfg. by Hayden Mt. Co. ea. \$2.00 (Specify speed desired)

No sale less than \$2.00.  
All prices F.D.B. N.Y.C.  
20% deposit required with all orders.

**A. M. RADIO SALES COMPANY** 345 CANAL ST. NEW YORK CITY 13, N. Y.

## SAVE MONEY BRAND NEW GUARANTEED GENERAL ELECTRIC SELSYN

Type 2J1G1

Will operate from 110 volts, 60 cycle by using a resistor or a condenser in series. Size is 2 1/4" in diameter x 4 3/4" long. Ideal for beam antenna position indicator.



Price **\$2.75**  
per pair — removed from new equipment

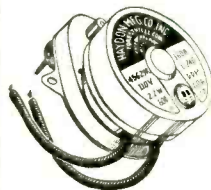

**HAYDEN TIMING**  
Type 45629R

110 volts, 60 cycle.  
2.2 watts, 1/240 R.P.M.

Price **\$3.00**  
ea. net. new.

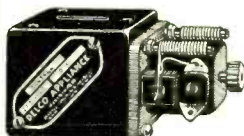

**DELCO ALNICO**  
Field Motor  
Type 5069466

27.5 volts D.C.  
10,000 R.P.M.  
1" x 1 1/2" x 2 1/4" long.

Price **\$3.00**  
ea. net.—new.

Delco Alnico Field Motor Type 5069611, 12 volts D.C. 10,000 R.P.M. 1" x 1 1/2" x 2 1/4" long.

Price **\$4.00**  
ea. net. new  
Write for complete listings

**INSTRUMENT ASSOCIATES**  
147-57 41st Ave., Flushing, N. Y.  
Independence 3-1919

## HIWAY COMPANY

May Flowers With  
Bargains!

**TUBE OF THE MONTH—6V6GT**

More of these tubes in use than any other type. Brand new, boxed. . . . . Each **69¢**  
Order 4 for \$2.25 and we prepay shipping!

**POWER TRANSFORMER C-288**

Brand new! Used in BC 342 receiver. Primary: 115V, 60 cycle. Secondaries: 310-0-310V 70 Ma. 2—12V good for 8 tubes and 1—5V for rectifier. The two 12V can be connected in series for 24V. The perfect power transformer for surplus receivers. Ea. **\$4.95**

**.19-.55 MC ARC-5 RECEIVER**

85 Kc. I.F. The top "Q" 5'er. Used but good condition. Also connections for loop ant. Less dyno. Wt., 12 lbs. Each **\$8.95**

**7-9 MC ARC-5 TRANSMITTER**

With tubes and crystals. Brand new but not packed in factory carton. Wt., 13 lbs. . . . . Each **\$9.95**

**ARC-4 TRANSCEIVER**

New shipment just arrived! The Navy VHF unit 15 watt xtal output, superhet receiver. Conversion dope supplied puts it in 2-meter band. 144-148 Mcs. Complete with tubes less dynamotor. Wt., 41 lbs.

Still a HIWAY HEADLINER. **\$17.49**  
Each  
With MT-230 Mounting. **\$20.99**  
Each

The Hiway Policy: 25% DEPOSIT WITH ORDER. Remit in full—SAVE C.O.D. CHARGES. SATISFACTION GUARANTEED OR YOUR MONEY BACK!

## HIWAY COMPANY

Electronic Division

1304 S. HOOVER ST.

(Just S. of Pico)

(Fitzroy 0343)

LOS ANGELES 6, CALIFORNIA

Send for our FREE catalogue!

Jan Doedel, stated "our broadcast in English is now Mondays 2000-2015." The 5.010 outlet is also reported heard by Peddle, Newfoundland.

Ferguson, N. C., received this data from Direction Centrale de la Radio-diffusion D'Albane, Rue Conference de Peza 3, Tirana, Albanie; *Radio Tirana*, ZAA, 7.850, scheduled 1300 news in Russian; 1315 news in Roumanian; 1330 news in Italian; 1345 news in French; 1400 relays with m.w. for re-broadcast the news in Albanian; 1415 news in Greek; 1430 news in Bulgarian; 1445 news in Turkish; 1500 news in Serbo-Croat; 1515 news in English; 1530 program for Albanians abroad; 1600 end of transmission.

In a DX broadcast from Leopoldville this data was given concerning *Radio Congo Belge*—OTM-1: 6.295, 0000-0200, 0500-0700, 1100-1500; OTM-2, 9.380, 0000-0200, 0500-1500; OTM-4, 11.720, 0515-0700; broadcasts in French, Spanish, and Portuguese to Europe. OTH was given on 9.210 at 1230-1330 in French and Congo dialects, power 15 kw. QRA is Radio Congo Belge, P. O. Box 171, Leopoldville, Belgian Congo. (Novomestky, Puerto Rico, and Cooley, Pa.)

Wooley, N. J., flashes that Denmark's 9.52 is now fine strength at 2015.

McPheeters, La., recently reported hearing Podebrady, Czechoslovakia, on 11.900 around 2300-0100, appeared to use trumpets played on Praha II. OLR4D, Prague, is listed 11.900 as "inactive."

The *Azad Kashmir Radio*, 6.230, Rawalpindi (with transmitter at Trar-khel) has not been reported for some time and is presumed to be off the air. This is probably the station referred to abroad (near end of 1948) as believed to be *Radio Pakistan*.

The Government of India is progressing in its Eight-Year Plan for expansion of broadcasting facilities. Many new high-powered stations (presumably on m.w.) are under construction and it is presumed some s.w. ones will be included in the plan. A news release from the Indian Embassy recently stated: "High-powered radio transmitters will soon be installed at Delhi, Bombay, Madras, and Calcutta. Pilot stations have already opened at Cuttack, Shillong, Gauhati, Nagpur, Vijayawada, and Allahabad. Giving further information on the government's eight-year program for the expansion of broadcasting facilities, the Information Minister said in Parliament on February 4 that a radio station at Ahmedabad would begin to function by the end of March 1949 and that pilot stations at Jullundur, Dharwar, and Calicut would be completed by June. The 8th new radio station of India since its independence went on the air on February 1 at Allahabad." (Joshi, W. Va.)

### Acknowledgement

Thanks for the FB reports this month, fellows! Keep them coming to 948 Stewartstown Road, Morgantown, West Virginia, USA.—K.R.B.

## HOW TO SOLVE TV RECEPTION PROBLEMS

### IN LOCAL AREAS

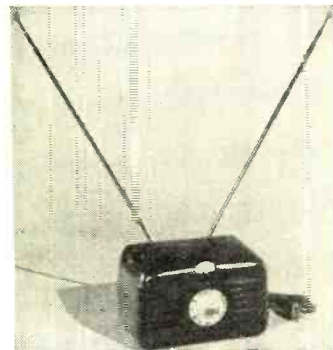

Jerrold In-Tenna is the only indoor TV antenna that will give you clear pictures on ALL TV stations in your area. It can be oriented easily to reduce noise and ghosts. The tuned pre-amplifier helps eliminate all kinds of interference from FM, TV and AM. It is easily and quickly installed in any home or apartment. The Jerrold In-Tenna will give your TV set the same performance that you could expect from a costly outdoor installation. List \$42.50

See the Jerrold In-Tenna at your radio wholesaler or parts jobber, or write to us for information.

### IN FRINGE AREAS



The Jerrold TV-FM Booster has a gain of 20 to 30 times over the entire 6 megacycle bandwidth of all TV channels—plus the FM band. Because of its high gain, Jerrold TV-FM Booster pulls weak stations out of the "mud" to give you the clearest possible pictures. Sight and sound tune together. There is no regeneration whatsoever. All kinds of interference, as well as ghosts, are either greatly reduced or completely eliminated.

See the Jerrold TV-FM Booster at your radio wholesaler or parts jobber. Or write to us for information. List, \$37.50.

**JERROLD ELECTRONICS CORP.**  
CITY CENTRE BUILDING  
121 N. BROAD ST. PHILA. 7, PA.

# FACTORY TO YOU DIRECT!

THE NEW  
*Certified*  
TELEVISION KIT

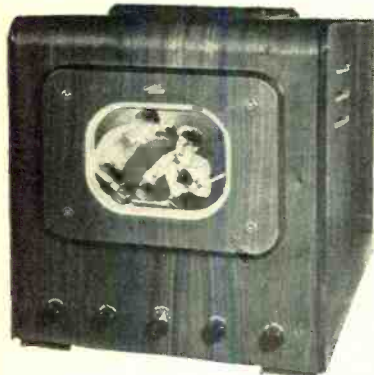

**10" KIT . . . . . \$74.50\***

\*LESS TUBES

**7" KIT \$64.50**

Less tubes

**\$99.50**  
with all tubes

Money Back Guarantee—Buy it, inspect it, if you don't think it's the best buy on the market—return unused within three days and your money will be refunded.

All prices F.O.B. New York. 20% deposit with order  
**IMMEDIATE DELIVERY**

*Certified* TELEVISION LABORATORIES  
5507 — 13th AVE. BKLYN. 19, N. Y.

**WANTED**—Western Electric Carrier Telephone and Telegraph Equipment and Components. Filters, repeating coils, transformers, equalizers. Types CFI, CF2, H, C, and other carrier equipment. Telephone and telegraph repeaters.

Box 450, Radio & Television News,  
185 N. Wabash, Chicago, Illinois

## LEARN RADIO!

**PREPARE FOR A GOOD JOB!**  
BROADCAST ENGINEER  
COMMERCIAL OPERATOR (CODE)  
RADIO SERVICEMAN

**Television Servicing**

(Approved for Veterans)  
SEND FOR FREE LITERATURE  
**BALTIMORE TECHNICAL INSTITUTE**  
1425 EUTAW PLACE, BALT. 17, MD.

# AFCA



# NEWS

This Association is a patriotic non-profit organization, with chapters in most of the larger cities, dedicated to developing and maintaining efficient personnel, commissioned, enlisted, civilian, for the supply (including design and development); installation, maintenance and operation of communications and electronic equipment for Army, Navy and Air Force and their supporting civilian activities. It publishes a magazine "SIGNALS" at its national headquarters in Washington. Every American interested in any way in communications is eligible and invited to join. Further details may be obtained by addressing the secretary at 1624 Eye St. N.W., Washington 6, D. C.

### AFCA CHAPTER NOTES

#### Baltimore

The March 3rd meeting of the Baltimore Chapter was held at Station WBAL of Baltimore and featured a broadcast of an address by Colonel Kirke B. Lawton, Deputy Chief Signal Officer of the Army, in commemoration of the 86th anniversary of the Signal Corps. Present as guests of honor were Admiral Earl E. Stone, Chief of Naval Communications, and Major General Francis L. Ankenbrandt, Director of Air Force Communications. At 6:15 p.m., Clinton H. Johnson, chapter member, interviewed Colonel Lawton, Admiral Stone, General Ankenbrandt and other distinguished guests on the WBAL Television. At 7:15, Colonel Lawton's address to the chapter was carried over the NBC network. Due to studio accommodations, the audience was limited to 160. The broadcast was followed by a tour through the station and included both TV and standard broadcast facilities.

#### Cleveland

A tour of the facilities of the Acme Telectronix Division of the Newspaper Enterprise Association Service, Incorporated was the feature of the March 10th meeting of the Cleveland Chapter. The primary interest in this program was the preparation and handling of news and transmission of pictures by wire for newspapers.

#### Far East

The charter of the Tokyo Post of the Far East Chapter was presented by Brig. Gen. George I. Back, President of the Far East Chapter, at a meeting of the post on January 25th. A post constitution was adopted and officers were elected as follows: Chairman: Lt. Col. W. D. Dillinger; 1st Vice-Chairman: Col. R. S. Carter; 2nd Vice-Chairman: Chief W. A. Whaley;

Secretary: Maj. R. P. Zebley; Treasurer: Capt. I. Koss.

#### Kentucky

Chapter members met on February 18th at the Stirrup Cup in Lexington to commemorate the 86th anniversary of the founding of the Signal Corps. After the dinner, a Signal Corps birthday cake was cut in traditional style—with a saber—by the past president, Col. William M. Mack, assisted by the new president, Murray P. McQuown.

Lt. Col. Robert H. McAteer of the Military Department of the University of Kentucky addressed the group on the "Evolution and History of the Signal Corps." After Col. McAteer's talk, Mr. William Prewitt, a Lexington businessman and one of the members of Company B of the 113th Field Signal Battalion, which was organized in Lexington at the start of World War I, gave a very interesting and humorous sketch of the history of the 113th Field Signal Battalion.

The meeting closed with the showing of the film "Westward is Bataan."

#### New York

A concrete example of the real meaning of the unification of the Armed Services was presented to a joint meeting of the New York Chapter and the New York Volunteer Reserve Electronic Warfare Company on February 9th. The main meeting room of the historic Seventh Regiment Armory was filled to capacity with Army, Navy and Air Force, regular and reserve personnel, and representatives of the communications industry in New York.

After opening remarks by Chapter President George P. Dixon, Capt. Aubrey Wyckoff, USNR, was introduced as Commander of the Naval Reserve Unit participating. The chairman then introduced in turn Major General Spencer B. Akin, Chief Signal Officer of the Army; Rear Admiral Earl E. Stone, Chief of Naval Communications; and Major General Francis L. Ankenbrandt, Director of Air Force Communications; each of whom gave a short address concerning communications in his branch of the service. The talks by the communications chiefs were enthusiastically received. Following the meeting, dinner was served to the largest chapter turnout since the 1947 annual AFCA meeting held in New York.

#### Philadelphia

On March 3rd, the Philadelphia Chapter also celebrated the 86th anniversary of the Signal Corps at its

**RADIO & TELEVISION NEWS**

# CUT HOLES 1/2 to 3 1/2 IN RADIO CHASSIS



WITH A GREENLEE  
RADIO CHASSIS PUNCH

• Save hours of work... no reaming or tedious filing. Punch cuts through chassis quickly... makes accurate, clean holes for sockets, plugs, and other receptacles. Just turn with an ordinary wrench. There's a GREENLEE Punch in each of these sizes: 1/2", 5/8", 3/4", 7/8", 1", 1 1/8", 1 1/4", 1 3/8", 1 1/2", 1 3/4", 1 7/8", 2 1/4". Write for complete facts. Also get information on Knockout Punches and Cutters for conduit and meter holes up to 3 1/2". Greenlee Tool Co., 1885 Columbia Avenue, Rockford, Illinois.



## THERE'S STILL SURPLUS VALUES AT FARWEST

Look at this list of new, scarce or hard to get items.

ART 113, Used. \$125.00. Complete.	\$240.00
SCR 522 Transceiver, new, ideal 2 meter rig.	40.00
PE 94B dynamotor for above, new \$5.00; Antenna 1.00	
BC 348 (no -R or -Q) reconditioned guaranteed.	125.00
ARN/7 Complete radio compass w/ th all plugs, etc	75.00
See us for all component parts. 1-81 or 1-82 and LI21A loop for dipole indication.	9.95
BK22K relay \$3.00, MC 124 tuning cable any length. 50c minimum. 240' \$3.50 (approx. .015c per inch).	
274-N or ARC/5 transmitters at \$6.95 (used, very good).	
274-N or ARC/5 receivers 6-9MC or 3-6. MC (used v.g.)	8.95
RTA1B transceiver or BC 610 xmtr (new)	900.00
Jewell lights, can be dimmed by turning, colors: red, green, amber, or yellow, for bayonet type lamps (new) your choice at 40c each or any three for	1.00
Co-ax fittings, PL 259A etc 25c chassis type.	.36
PL 55, PL 68, JK 26, PL 54 Phone plugs (new).	.25
Airplane type SPST switches any type, new.	.35
Airplane type DPDT switches any type, new.	.75
Large stock of airplane instruments and related electrical accessories write for our listings.	
HS33 Earphones, low impedance, new with rubber cushions, \$3.50 pr., without rubber cushions, used \$1.75 pr. (also HS38 High Impedance)	
AVT-23 RCA 25 watt transmitter, new.	125.00
TA-12 Bendix transmitter, new.	49.50
APQ-13 Radar plane units, used.	14.95
DM 33A Dynamotor \$2.50 New, DM 32 \$4.50 (new) DM 35	10.00
PE 73 \$5.00 (new); PE 118 \$10.00 (new) Cannon Plugs for 274-N gear 3 for \$1.00. 274-N Command Receiver tuning shafts.	1.00
Right angle drives for same 75c. Cannon Plugs for ARN/7 or 433-F or G Radio Compass, new at \$1.50. (PL 112, 118, or 122).	
RA10 Bendix xmtrs. (used)	50.00

FARWEST HAS ONE OF THE LARGEST STOCKS  
IN THE USA, MOST ANY ITEM AVAILABLE  
Sorry, no catalogues

FARWEST TRADING CO., Inc.

209 1st Ave., So. SEATTLE 4, WASH.

dinner meeting at the Officers Club of the Philadelphia Quartermaster Depot. After introducing the distinguished guests, Chapter President W. W. Watts called on Col. Benjamin Stern, head of the Signal Corps Procurement Agency, who outlined the assistance which he believed AFCA could give to his activity. Brig. Gen. S. H. Sherrill, National Executive Director, spoke briefly on the activities of other chapters. Col. A. M. Shearer, Deputy Chief of Distribution and Procurement Service, OCSigO, was the principal speaker and outlined the history of the Signal Corps since it was founded in 1863 by Col. Myer.

### Richmond

Members of the Richmond Chapter met on February 23rd at the Pantree in Richmond. Capt. E. L. Gibson, USAF, Langley Field Communications Center Officer for the Tactical Air Command, was the guest speaker. His subject was "Communications within the Tactical Air Command."

### Southern California

The Southern California Chapter is now meeting regularly on the second Thursday of each month. The January 13th meeting was addressed by Col. Martin Shakeley, of the California National Guard, on the subject of ground defense against atomics. Col. Shakeley commands a brigade charged with the immediate organization of such measures as are feasible for controlling and supervising matters in the case of such an attack. He held a discussion period after his talk which the members felt was of immeasurable value.

The feature speaker for the February 10th meeting was Lt. Col. Ralph A. Pender, who commanded the First Combat Camera Unit with the 15th Air Force and MAAF during the past war. Col. Pender showed pictures made by his units of the air attacks on Ploesti and discussed problems of aerial photography of this nature.

## VWOA AWARDS CITATIONS

FOUR citations were awarded by the Veteran Wireless Operators Association, Inc., at the 24th annual dinner-cruise February 26. At the Hotel Astor in New York, radio officers A. T. Newberg "SS Gulfstream," Clarence H. Scruggs, United Fruit Steamer "Junior," and Arthur E. Murray, Bull Steamship Co. "Suzanne" were cited in recognition of meritorious service and excellence in radiotelegraph operation aboard their vessels while assisting in the rescue of the crew of the cutter "Eastwind," after it had collided with the oil tanker "Gulfstream" on January 19, 1949.

A citation was also presented to Mr. Raoul E. Cowden of the "SS Mormacrey" for meritorious service during the distress of the British tanker "Adellen" early in January. Mr. Cowden was highly commended for service beyond the call of duty when he remained on watch aboard ship for 72 hours, handling distress messages for the disabled vessel.

# STAHL SLASHES Tube Prices

## RADIO TUBES

### Standard Brands—All Brand New

2C 34/VT 224 \$0.59	6 J6 . . . \$0.79	726A . . . \$14.95
2C 43 . . . . . 7.50	6 K6 . . . . . 59	801A . . . . . 39
2C 34 . . . . . 39	6 SA7 . . . . . 66	807 . . . . . 1.29
2N2 . . . . . 39	6 SH7 . . . . . 29	815 . . . . . 2.49
3C 24 . . . . . 39	6 SQ7 . . . . . 59	837 . . . . . 2.49
3C 30 . . . . . 79	6 SX5 . . . . . 59	843 . . . . . .69
4B 27/6C7 . . . . . 5.95	15R . . . . . 79	022 . . . . . 1.49
5 B11 . . . . . 1.95	30 SpL . . . . . 19	8012 . . . . . 1.95
5 F17 . . . . . 1.95	531 . . . . . 9.95	1626 . . . . . .49
6 AK5 . . . . . 79	717A . . . . . 79	2051 . . . . . .85
6 A15 . . . . . 79	724A/B . . . . . 4.95	7193 . . . . . .39
6 H6 . . . . . 59	724B . . . . . 1.50	9002 . . . . . .39

## STAND-BY STORAGE BATTERIES



GOULD Storage Battery—a completely covered black hard rubber case, with wing nut terminals on side. It's 6x10x10" high; non-spillable, 12 v. 34 amp. hours, 5 hour rate; weight 40 lbs. when fully charged. Brand New, shipped in original sealed

carton. Each. **\$9.95**

ELECTRIC Storage Battery—same description as above. 24 v. 11 amp. hours. Size 8x8x7 1/2" high. Weight 34 lbs. in original sealed carton.

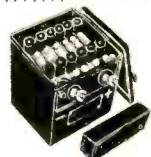

Each. **\$12.95**

Battery Acid 1275 Sp. Grav.—Can be used in any storage battery—in hermetically sealed bottles. 36 oz. bottle. 79c. 92 oz. bottle. \$1.95

## VISITING NEW YORK?

Stop in at our retail shop—filled with hundreds of items you may need.  
LEADER ELECTRONICS & TELEVISION CORP.

215 Fulton St. New York City

## TRANSMITTER CONTROL BOX Type C-30/ARC-5



Mfg. by W. E. Size 4 1/2 x 3 x 3". Equipped with slide fasteners, has 7 push button switches, 1 control switch and two multicontact jacks.

**\$1.49**

## Watt-hour METERS

GE 1-16 single phase 60 cycle 115-120 volt 5 amp. —two wire—glass case.



WESTINGHOUSE—metal case—115-120 volt 60 cycle—5 amp. single phase.

SANGAMO—metal case 115-120 volt 60 cycle—5 amp. single phase **\$6.95**

Sangamo 10 and 25 amp. \$7.95

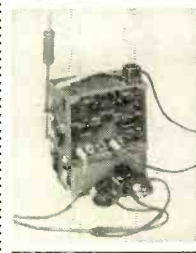

## NAVY TBY TRANSCIVER

28 to 80 Megacycles Frequency equipment. Types of transmission M/W. Telegraphy and Telephone Power output, 5 watts. Complete with tubes, aerial Head Set, crystal controlled. Microphone, 3 spare tubes and canvas carrying case. **\$32.50**

Prompt Delivery—25% deposit required on C.O.D. order. Shipped F.O.B. New York—Write Dept. RN5

# MICHAEL STAHL, INC.

## 39 VESEY ST.

New York 7, N. Y., WO 4-2882

**630 TYPE TELEVISION CHASSIS FOR 10" - 12" - 15" - 16" TUBES**

PHILMORE KIT, tuner, video & sound channels pre-aligned, all major parts mounted, 29 RCA tubes; step by step wiring instructions..... **\$169.50**

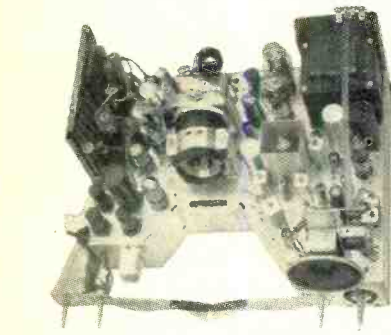

**PHILMORE COMPLETE CHASSIS**, as pictured, ready to operate, including 29 RCA tubes..... **\$185.00**  
Specify size picture tube you intend using, power supply and brackets will conform.

**PARTS FOR SAME SOLD SEPARATELY**

10" PICTURE TUBE, #10BP4.....	\$34.50
12½" PICTURE TUBE, #12TP4.....	51.95
15" PICTURE TUBE, #15CRT.....	72.50
16" PICTURE TUBE, #16AP4.....	79.50
PUNCHED CHASSIS PAN.....	5.45
RCA FRONT END, with 3-616 tubes.....	39.50
G.I. FRONT END, with tubes.....	24.75
POWER TRANSFORMER, 295ma, 115V.....	14.95
VIDEO & I.F. KIT, including peaking coil.....	11.97
DEFLECTION YOKE.....	5.45
HORIZONTAL OUTPUT TRANSFORMER.....	5.45
VERTICAL OUTPUT TRANSFORMER.....	3.15
HORIZONTAL BLOCKING TRANSFORMER.....	2.25
VERTICAL BLOCKING TRANSFORMER.....	1.80
FOCUS COIL, 247 ohms DC resistance.....	4.70
ION TRAP BEAM BENDER.....	1.45
HORIZONTAL CONTROL COIL.....	.54
WIDTH CONTROL COIL.....	.47
CATHODE TRAP COIL.....	1.10
PICTURE & SOUND SWITCH.....	1.55
VERT. & HORIZ. HOLD CONTROL.....	1.10
FOCUS COIL, 1500 ohms, wire wound.....	1.00
VOLTAGE DIVIDER, 1360 ohms; 250 ohms.....	.85
RECTIFIER SOCKET ASSEMBLY.....	1.10
ESCUTCHEON PLATE & 4 KNOBS.....	1.20

FREE—#630 Type schematic diagram with every order over \$5.00

**BROOKS RADIO DIST. CORP.**  
80 VESEY ST., DEPT. B, NEW YORK 7, N. Y.

**\$ FREE \$ FREE \$ FREE \$ FREE \$**

**F R E E**  
We have been buying Govt. & Mfr's surplus for 3 yrs. Our stock is terrific. Now we are unloading. If you will trust us and send \$3.50 we will give you \$25.00 worth of standard parts such as Wire, Res. Prec. & Carbon Condensers. Hi & Lo voltage; all kinds by the handful. IF & RF coils, transformers & chokes, sockets, plugs, switches, rubber tape, keys, fuses, pots, mica-lex, terminal strips and while our X-tals & standard tubes last they go too. Plus many more items too numerous to mention. If you are not satisfied or can not triple your money or swap same at the club we will refund your money. This is to show we are sincere. ALL good—no junk. No C.O.D.'s. Send postage for 10 lbs. Check our Trans. Tube Special. This issue.

**F R E E**

McCONNELL'S 3834 Germantown Ave. Phila. Penna. RA5-6033

**U T I C A**

**UTICA TOOLS**  
For More Tool Mileage

**TOOL No. 50**  
Electricians' Standard Side Cutting Pliers  
5", 6", 7", 8"

**SEE YOUR DEALER**

**UTICA DROP FORGE & TOOL CORP.**  
UTICA 4, NEW YORK

Classified

Rate 20c per word. Minimum 10 words

**RADIO ENGINEERING**

PANEL service. Completely equipped shop. Gilpin, Box 638, Rte. 4, Mt. Clemens, Mich.  
RADIO Engineering Broadcasting. Aviation and Police Radio. Servicing. Marine Operating and Electronics taught thoroughly. Expenses low. Write for catalog. Valparaiso Technical Institute, Dept. N., Valparaiso, Ind.

**SALE**

AMPLIFIER, 40W. portable. Cost \$380. Now \$149 complete. John S. Kirby, Jr., Box 299, Rte. 17, Indianapolis, Ind.  
RECEIVER, BC-348-Q. Converted, \$60.00. F.O.B. Carbin, 3088 Waldorf Ave., Camden, N. J.  
BC522. Converted to 6V. Variable tuning receiver. 6V. Dynamotor, \$49.00. John S. Kirby, Jr., Box 299, Rte. 17, Indianapolis, Ind.  
WESTERN Electric 118A 50 Watt Amplifier. 1 db. 50-12,000 cps. 0 db. Input Outputs 2 to 500 ohms. Good condition. Was \$275 new. Write offer. Station WPRU, Princeton, N. J.  
TO close out shop, offer two Speco AC-DC signal tracers with probes perfect like new condition, cost \$39.95, yours for \$20.50 each. Also 6 new Edwards Fidelotuner FM converters list price \$48.50 will sell for \$22.50 each. George Terpay, 7005 Wells Parkway, Hyattsville, College Heights Estate, Md.

CODE Tapes. Radiotelegraph practice tapes. designed for FCC preparation, Advanced Beginners. Fits most phototube keyers. \$2.50 postpaid. Write Ultradyne Electronics, Oswego, Ore.

BC-348P, 110VAC Broadcast Converter, Signal meter, Aerial, complete final Amplifier with Speaker, Mounting, Base, instructions. Like new. A bargain at \$85.00. Express prepaid. J. D. Kitchen, Caro, Mich.

VACUUM tube voltmeter plans. Special feature give appearance (and performance) equal to factory built. Use parts you have. Plans, 10c. Hawkins Radio Co., 621 E. 31 St., Kansas City 3, Mo.

SURPLUS Parts Bargains: Looking for some special item? Radio parts and equipment bargains as offered by leading U.S. and Canadian dealers are listed and cross indexed in the files of: Surplus Directory Service, 366 Madison, New York, N. Y.

12B8 & 25B8 TUBES. Adapter unit using 2 miniature tubes (6AT6 & 6BA6 for 12B8, and 12AT6 & 12BA6 for 25B8). Takes less space than original tube, nothing else to buy, just plug in and it works. Money-back guarantee. 12B8 or 25B8 unit complete: \$2.49 each, 10 units for \$22.50. Send 25% deposit, balance C.O.D. Write for free parts catalog. Commercial Radio, 36 Brattle St., Boston, Mass.

COAXIAL Cable. Identical characteristics as RG-58/U. Send dime for 3-foot sample. Harry H. Van Dick, Box 236, Little Falls, N. J.

RADIOS, record players, tubes, parts; send for free list. Mr. Morillo, Mike's Radio Service, 173 E. 101st St., New York 29, N. Y.

VIBROPACKS, Mallory VP555, 300 V. 200 Mil. output, 6 V. input. Brand new. Cartoned, \$25.00; Frequency Monitor, Link 230 D. Excellent. Used, \$25.00. John Beckwith, 1601 17th Pl. S.E., Washington 20, D. C.

TWIN-LEAD: 300 ohm; \$1.65 per 100 feet. Send stamp for sample. Harry H. Van Dick, Box 236, Little Falls, N. J.

6-BAND Portable, rechargeable battery, built-in charger. Push-button tuning. Excellent condition. Schematic, \$85. Mike Durko, 7541 Jackson, Hammond, Ind.

HALLICRAFTERS T54, Vee-DX Antenna, both new, \$190. Walter Kapinos, 304 Front St., Chicopee, Mass.

BARGAINS: 10,000 ohm vol. c., 29c; lots of 10, 24c. Write for bargain lists. Electronic Enterprises, Sherman, N. Y.

HALLICRAFTER, SX-42 with Speaker R-42. Excellent condition. Cost over \$330.00, sell for \$250.00. Irving Baer, 1294 Medford, Topeka, Kans.

POLYSTYRENE coil dope, cement for polystyrene parts and moisture proofing, pint \$1.00. Toggle switches, H & H arrow 3 amp DPDT, ball handle, stem length ½", 4 for \$1.00, 9 for \$2.00. Free "Shorty" tapered polystyrene alignment tool blank with each order. All items postpaid in U.S. Kissel Electric Products, 431-N Sherman, Galion, Ohio.

RADIO Diagrams Broadcast 30c; SW, FM or combined, 60c; Television \$1.00; Service information \$1.00 add'l. State manufacturer and model number. Kramer's Radio Service, 36 Columbus Ave., New York 23, N. Y.

GRILL Cloth, Celanese, light and dark pieces. 1000 square inches for \$1 bill. Write for list of lowest priced national brand parts in nation. Bursma Radio, Route 5, Grand Rapids, Mich.

TELEVISION. radio. tubes. parts. Send for free bargain list. Hallmark, 592 Communipaw, Jersey City, N. J.

BARGAINS: New and reconditioned Hallicrafters, National, Collins, Hammarlund, RME, Meissner, other receivers, tuner, television receivers, transmitters, amplifiers, speakers, etc. Lowest wholesale prices. Terms. Shipped on trial. Liberal trade-in allowances. Write, Henry Radio, Butler, Mo., and 11240 W Olympic, Los Angeles, Calif.

BARGAIN Hunting? Radio Servicemen write. Sensational catalog. Henshaw Radio Supply, 3619 Troost, Kansas City 3, Mo.

HEARING Aids. Zeniths, others. All used but working. Make miniature transmitters or receivers. Complete with cords, ear piece, \$20 ea. Shelby Instrument, 321 W. 7th, Long Beach, Calif.

LOWEST Prices. Radio Tubes, parts. Bargain lists. 3c. Potter, 1314 McGee, Kansas City 6, Mo.

WRITE Dept. RN18 for our free wholesale list of Radio parts & accessories. R. C. Radio Parts & Distributing Co., 731 Central Ave., Kansas City 6, Kan.

HOTTEST surplus list in the country. Electronics-Hydraulics, Aircraft-Gadgets. Dick Rose, Everett, Wash.

ALUMINUM tubing, angles, sheets and fittings. Write for list. Willard Radcliff, Fostoria, Ohio.

WESTON tube and set checker Model 798, like new, list \$290.00, will sell for \$95.00. I. E. Swire, 98 Bulwer Pl., Brooklyn, N. Y.

TV SETS and Kits, Signal Generators, Test Equipment, Radio Sets. Bargains. Complete Sewing Machine Electrification Kit \$15.00. Bendix, 727 N. Euclid Ave., Pittsburgh 6, Pa.

**WANTED**

WALKIE Talkies SCR 610 & 608 complete, crystal 270 to 389, large quantities. Radio sets ANTRC 8-11-12. Test sets for SCR 536. New or good condition. Martex Mfg. Co., 190 William St., New York, N. Y.

ELECTRONICS Surplus: Complete equipment, components, transformers, resistors, gov't surplus, speakers, sets, etc. Unlimited quantities. Plenty of ready cash. Write: Box 482, % Radio & Television News, 185 N. Wabash Ave., Chicago 1, Ill.

AN/ART-13, BC-348, RTA-1B, AN/APN-9, R5A/AR-7, AN/ARC-1, AN/ARC-3, BC-788-C, I-152, MN-26, Test sets with TS- or I-prefix, Dynamotors, Control Boxes, Transmitters, Receivers, Power Supplies, etc. State quantity, condition and best price first letter. HI-MU Electronics, Box 105, New Haven, Conn.

WILL buy all BC-348, 28V or 110V modified. Price \$60.00 all letters except "Q"-\$75.00. Ship via express C.O.D. Subject to inspection to H. Finnegan, 49 Washington Ave., Little Ferry, N. J.

FT 237 MOUNTS for BC 603 Receiver, BC 604 Transmitter in any quantity. Wm. C. Grove, 2110 Park Place, Cheyenne, Wyo.

APR-5A, APR-4 Receivers and Tuning Units, Antennas, Radar Scanners, VHF-SHF Gear, Laboratory and Test Equipment of all types. Also quantity stocks of all types of surplus materials for marketing. Engineering Associates, Farhills Branch, Box 29N, Dayton 2, Ohio.

WESTERN Electric CF-1, CF-2, CF-3, CF-4, CF-5, CF-6, H, H-1 Carrier, EE100, EE101A ringing equipments. All models teletype. All models ICA Marine transmitters. Box 485, % Radio & Television News, 185 N. Wabash Ave., Chicago 1, Ill.

SELL your communication receiver, transmitter, test equipment and tools for highest cash offer. Send details to Overbrook Co., Overbrook, Mass.

**SITUATIONS WANTED**

SELECTED group of men, graduates of well-known trade school, desire employment in Radio Field. Will travel anywhere. Qualified in radio servicing, installation, test instruments, circuit operation, etc. Contact Placement Dept., Eastern Technical School, 888 Purchase Street, New Bedford, Mass.

**HELP WANTED**

WANTED—Patent Examiner. Degree in Mechanical or Electrical Engineering. Must have experience in Electronics, Technical Writing, and Patent disclosures and applications. Give full details of experience and education to SLX-1, P. O. Box 5800, Albuquerque, New Mexico.

**RADIO & TELEVISION NEWS**

EXPERIENCED men to take charge of radio maintenance department for small scheduled airline. Write to Box 483, % Radio & Television News, 185 N. Wabash Ave., Chicago 1, Ill.

INSTRUCTORS in Electronics and Radio. Prefer former Navy Radio Technician instructors willing to locate in the Detroit, Mich., area. Write to Box 452, % Radio & Television News, 185 N. Wabash Ave., Chicago 1, Ill.

SALESMEN to sell Nationally Advertised Brand Radio Tubes to Dealers and Servicemen at liberal discounts. Good commissions paid. Box 480, % Radio & Television News, 185 N. Wabash Ave., Chicago 1, Ill.

### CORRESPONDENCE COURSE

HAM License! Got yours yet? If you find Morse Code difficult write for Free Code Memorizing lesson. Complete course \$1.00. Dept. R, Otto Luther, New Preston, Conn.

AMATEUR radio licenses. Complete code and theory preparation for passing amateur radio examinations. Home study courses American Radio Institute, 101 West 63rd St., New York 23, N. Y.

USED Correspondence courses and books bought, sold, rented and exchanged. Catalog free. Lee Mountain, Pisgah, Alabama.

### PATENT ATTORNEYS

LANCASTER, Allwine & Rommel, Registered Patent Attorneys. Patent practice before U.S. Patent office. Validity and infringement investigations and opinions. Booklet and form "Evidence of Conception" forwarded upon request. Suite 414, 815 15th St., N.W., Washington 5, D. C.

### MISCELLANEOUS

CONTRACT work. Electronics manufacturer now has facilities for handling additional contracts specializing in electronic equipment assembly, sub-assembly or complete unit manufacture. Television is our specialty. Lance Television Laboratories, Inc., 1738 Jerome Ave., Bronx 53, N. Y.

VITAL radio information for beginners to engineers published in 13 radio magazines instantly located with monthly cumulative index. 200 listings add each issue. One year of index service \$1.50; two years \$2.25. Indexes for 1946 through 1948 available. Postcard brings full details free. Radiofile, 255 W. 84th St., New York 24, N. Y.

ONE Set Riders 1-5, 6-16 and Changer Manual. Practically new, \$120 plus express. D. E. Burgess, 106 Lincoln Ave., Crookston, Minn.

NAMEPLATES. Give your set that new look with your call letters engraved in a plastic nameplate. Polished black surface, white letters. 1"x3", 85c; 2"x5 1/2", \$1.75. Postpaid. Turner Products, 115 Verlynn, Hamilton, Ohio.

"RADIOBUILDER" for Crystal Tube Experimenters. 3 issues 25c. Catalog. Laboratories, 578-H, San Carlos, Calif.

TELEVISION. Bright and clear. Adjust present aerial. Build low-cost Precision Antennae. Instructions, charts, diagrams, dimensions, plans. Free—Television Stations, kilowatts, tower heights. Carl F. Propson Co., Lumberton, N. J.

TUNE in to Practical Wireless, Britain's best radio monthly. Keeps you in touch with latest British and European radio-television developments. Widely read throughout United States. Leading experts contribute regularly. Famous for television and electronics features, authoritative constructional data, discussion columns, news of International Radio Trade Developments, etc. Annual subscription (12 consecutive issues direct to your address from London) only \$2.00 from George Newnes, Ltd., U. S. Subscription Office (PW 41), 342 Madison Ave., New York 17, N. Y. Two years \$3.75.

TECHNICAL Report No. 191. Practical Transformer design, construction and repairing. \$2.00 Postpaid. Conrad Roeschke, Buckhorn, New Mexico.

27 YEARS of experience Radio Repairing. Simplified system. No calculations. No formulas. Total price \$2.00 postpaid or C.O.D. Moneyback guarantee. Ross Radio, 14615 Grandriver, Detroit 27, Mich.

PHONOGRAPH records cheap. Catalogue free. Paramount, BN-313 E. Market, Wilkes-Barre, Pa. CRYSTAL Set—Telephone combination, diagram and instructions, 25c. Includes attractive offer, literature, year's membership in "XTAL-X Crystal Set Club." Box 608, Torrance, Calif.

ANY Radio, electronic Text Book rented, 1-2c per day. Address: TBRa, 780 E. 214th St., New York, N. Y.

RADIOMEN, Servicemen, Beginners. Make more money, easily, quickly. \$250 weekly possible. We show you how. Information free. Merit Products, 216-32R 132 Ave., Springfield Gardens 13, N. Y.

# TUBES! NATIONALLY ADVERTISED BRANDS TUBES!

RCA — Kenrad — Sylvania — Tung-Sol — National Union — Raytheon — Philco — Hytron  
All new tubes, 100% guaranteed. Individually boxed.

TYPE	PRICE	TYPE	PRICE	TYPE	PRICE	TYPE	PRICE	TYPE	PRICE	TYPE	PRICE
0A4G	\$.96	2X2	\$.15	6K6GT	\$.54	6Y7G	\$.15	I2C8	\$.15	35W4	\$.45
01A	.60	3A4	.72	6K7G	.60	6Z7G	1.40	I2C6	.65	35Y4	.65
0Z4	.80	3B7/1291	.96	6K8	.85	6Z3G	.80	I2J5GT	.54	37Z3GT	.54
1A3	.80	3D6/1299	.96	6L5G	.96	7A4	.72	I2J7GT	.72	37Z5GT	.45
1A4P	1.40	3D4	.90	6L6	1.26	7A5	.72	I2K7GT	.60	37Z6GT	.96
1A5GT	.65	3Q5GT	.85	6L6GA	1.15	7A6	.72	I2K9	.65	37Z7	.65
1A6	1.15	3S4	.72	6L7	1.15	7A7	.72	I2Q7GT	.65	38	.80
1A7GT	.72	5R4GY	1.15	6N7	.85	7A8	.72	I2S4GT	.65	39/44	.96
1B4P	1.40	5T4	1.40	6P5GT	.80	7F4	.72	I2S7	.80	40	.80
1B5/23S	1.15	5U4G	.54	6Q7	.72	7B5	.72	I2S8	.65	41	.60
1C5GT	.80	5V4G	.85	6R7	.96	7B6	.72	I2S9	.72	42	.60
1C6	1.15	5W4	.96	6R7GT	.65	7B7	.72	I2SGT	.72	43	.60
1C7	1.15	5X4G	.65	6S7	.96	7B8	.72	I2SH7	.80	45Z3	.65
1D5GP	1.40	5Y3GT	.45	6S8GT	.85	7C5	.72	I2S17	.60	45Z5GT	.65
1D7G	1.15	5Y4G	.54	6SA7GT	.60	7C6	.72	I2S7GT	.60	46	.96
1D8GP	1.40	5Z3	.65	6SB7-Y	.85	7C7	.72	I2SL7GT	.85	47	.85
1E3G	1.40	6A3	.96	6SC7	.72	7E6	.72	I2SN7GT	.80	48	1.40
1E7GT	1.40	6A3	.96	6SD7GT	1.15	7E7	.80	I2SO7GT	.60	50	1.40
1F4	.96	6A4/LA	1.15	6SF7	.72	7F7	.80	I2SR7	.80	50A5	.80
1F5G	.96	6A6	.96	6SF7	.72	7F8	.96	I2Z3	.96	50B5	.72
1G4	.96	6A7	.72	6SG7	.72	7G7	.96	I2Z5(6Z5)	1.15	50L6GT	.66
1G6GT	.96	6A8GT	.72	6SH7	.80	7H7	.72	I4A4	.96	50X6	.80
1H4G	.89	6A9	1.15	6S17	.60	7I7	.96	I4A7	.80	50Y6GT	.65
1H5GT	.60	6AC7	.72	6SK7GT	.60	7L7	.80	I4B6	.80	53	.96
1H6G	1.15	6AD7G	1.15	6SL7GT	.85	7N7	.80	I4C7	.80	56	.65
1H8	.96	6AF6G	.96	6SN7GT	.80	7Q7	.85	I4F7	.80	57	.72
1L4	.72	6AG5	1.25	6SQ7	.60	7V7	.96	I4H7	.80	70L7GT	1.40
1LA4	.96	6AG7	1.15	6SR7	.65	7W7	.96	I4J7	.96	71A	.72
1LB4	.96	6AK5	1.25	6SS7	.65	7X7		I4N7	.96	75	.60
1LC5	.96	6AL7	.66	6ST7	.96	(XXFM)	.96	I4Q7	.80	77	.60
1LD5	.96	6AQ7	.80	6SV7	1.15	7Y4	.72	I4R7	.80	78	.60
1LD5	.96	6AT8	.54	6T7G	1.15	7Z4	.72	I4W7	.96	79	.96
1LG5	.96	6B4G	.96	6U5	.72	1A	1.40	19	1.15	80	.45
1L9	.96	6B7	1.15	6U6	.65	12A	.65	22	1.15	81	1.40
1LH4	.96	6B8G	1.15	6U7	.65	12A5	1.15	24A	.80	82	.96
1LN5	.96	6C4	.60	6V6	1.15	12A6	.96	25L6GT	.60	83	.96
1P5GT	.72	6C5	.60	6V6GT	.72	12A8	1.15	25Z5	.54	83V	1.15
1P5GT	.80	6C6	.72	6V7G	.96	12AH7GT	1.15	25Z6GT	.60	84/824	.65
1Q5GT	.96	6C8G	1.15	6W7G	.96	12AT6	.60	27	.65	85	.80
1R4	.96	6D6	.60	6X5GT	.54	12BA6	.65	28	.54	89	.80
1R5	.72	6E5	.80	6Y6G	.85	12BE6	.65	29D7	1.15	117L7GT	1.40
1S4	.85	6F5GT	.60					30	.72	117N7GT	1.40
1S5	.65	6F6	.72					31	.96	117Z3	.65
1T4	.72	6F6G	.60					32	1.15	117Z6GT	.85
1T5GT	.96	6F7	1.15					32L7GT	1.15	VR-90	.96
1V	.80	6F8G	1.15					33	1.15	VR-105	.96
2A3	1.15	6G6G	.96					34	1.15	VR-150	.96
2A4G	1.45	6H6GT	.60					35	.72	9001	.80
2A5	.80	6J5GT	.84					35A5	.72	9005	.80
2A6	.96	6J6	1.25					35B5	.72	FM-1000	1.15
2B7	.96	6J7	.72					35L6GT	.66	HY-117	1.15

TERMS: 25% with Order —Balance C.O.D.—F.O.B. Chicago. Prices Subject to Change Without Notice. Minimum Order \$2.00.

## FRANKLIN-ELLIS CO. Dept. RN-5 1313 West Randolph Street Chicago 7, Illinois

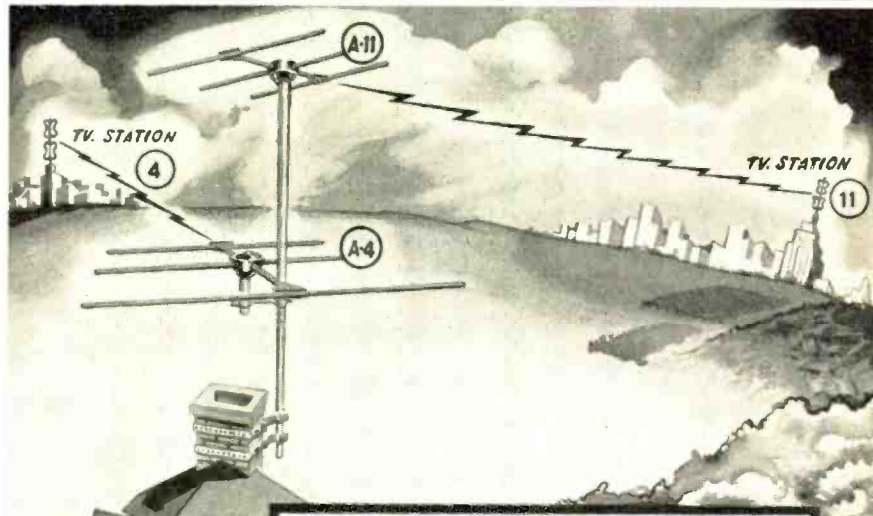

TELEVISION RECEPTION PROBLEM—No. 3 of a series  
**HOW TO GET IDEAL RECEPTION FROM WIDELY SEPARATED STATIONS**  
By using a WORKSHOP Series "A" three-element high-gain directional antenna for each channel, clear, ghost-free and noise-free reception is assured—with optimum performance on every channel.

Send for the new Workshop TV Catalog (No. 49)

**THE WORKSHOP ASSOCIATES, Inc.**  
Specialists in High-Frequency Antennas  
62 NEEDHAM STREET, NEWTON HIGHLANDS 61, MASSACHUSETTS



## TECHNICAL KO's

SPECIAL: 10% discount on orders of \$5 or more.

OIL FILLED CONDENSERS		TRANSMITTING MICAS	
.05 MFD 1000 V	\$0.35	.00005	2500 V \$0.15
1	2500 V .75	.00005	3000 V .35
.1	7500 V 1.65	.00005	5000 V .85
2x.1	7000 V 4.10	.000067	2500 V .20
.12	15000 V 7.95	.00025	2500 V .25
.25	1000 V .35	.00025	5000 V .85
.25	4000 V 2.15	.0005	2500 V .25
.25	6000 V 3.75	.00072	5000 V .85
10x.25	600 V 1.05	.0008	5000 V .85
.5	600 V .28	.0001	2500 V .25
.5	1000 V .40	.002	1000 V .20
.5	2000 V .75	.002	3000 V .65
.75	2000 V .60	.003	2500 V .30
.77	330 VAC .30	.003	3000 V .65
1.0	1000 V .45	.004	2500 V .35
2.0	200 V .20	.005	1000 T.V. .15
2.0	600 V .40	.005	3000 V .65
2.0	1000 V .80	.006	2000 V .35
4.0	600 V .60	.008	1200 V .15
4.0	1000 V 1.00	.01	1000 T.V. .15
5.0	220 VAC .55		
6.0	1000 V 1.45		
8.0	600 V .85		
8.0	1000 V 1.75		
10.0	600 V 1.00		
30.0	90 VAC 1.40		
30.0	330 VAC 3.75		

25.0 Electrolytic 25 V	.40
100.0 Electrolytic 25 V	.50

RESISTOR KIT ASSORTED 1/2 & 1 W 100 for \$1.49  
 BATHUB KIT 3x.1, .5, .05, etc. ....10 for .58  
 CONDENSER KIT .01-.00001 .....100 for 2.99  
 MICAS .01, .002, .005, etc. ALL VALUES .... .08  
 .01 150V PAPER (MIDGET) .....60 for 1.00  
 0.1 600V PAPER ..... 8 for 1.00

### TELEVISION

**BOOSTER—Your Troubles Are Over With Our High Gain Unit Channels 1-13**  
 Beautiful Mahogany Cabinet..... \$24.95  
 700 Ohm twin lead-100 Ft..... 1.75  
 72 Ohm co-axial cable-100 Ft..... 5.50  
 Standoff Ins. 3"-300 Ohm or co-ax..... .08  
 Expansion Joints 1/2"x3"..... 1.65  
 Carboly Drill 3/8" 5/16"..... .35  
 % Friction Tape 1/2 lb. Roll..... .35

\$2.00 min. order F.O.B. N.Y.C. Add postage 50% deposit, balance C.O.D. with all orders. Manufacturers' inquiries invited. Send for Flyer. Prices are subject to change without notice.

## TECHNICAL RADIO PARTS CO.

Moved to Larger Quarters  
 557 McDonald Ave. Brooklyn 18, N. Y.  
 Dept. RN12

## SURPLUS RESISTORS!

TYPE-OHMS	WATTS-TOL.	MAKE	YOUR COST
BW-1/2-27	1/2-10%	IRC	1.50 per 100
BW-1/2-47	1/2-10%	Speer	1.50 per 100
BW-1/2-47	1/2-10%	Erie	1.50 per 100
BT-1/2-1,200	1/2-10%	IRC	1.50 per 100
BT-1/2-3,900	1/2-10%	IRC	1.75 per 100
BT-1/2-8,200	1/2-5%	IRC	1.75 per 100
BT-1/2-10,000	1/2-10%	IRC	1.75 per 100
BT-1/2-22,000	1/2-10%	IRC	1.75 per 100
BT-1/2-47,000	1/2-10%	Stackpole	1.75 per 100
BT-1/2-180,000	1/2-10%	IRC	1.75 per 100
BT-1/2-220,000	1/2-10%	IRC	1.75 per 100
BT-1/2-470,000	1/2-10%	IRC	2.25 per 100
BT-1-22,000	1-10%	IRC	2.25 per 100
BT-1-27,000	1-10%	IRC	2.25 per 100
BT-1-100,000	1-5%	IRC	2.25 per 100
BT-1-220,000	1-10%	IRC	2.00 per 100
BT-1-470,000	1-5%	IRC	2.25 per 100
BW-2-22	2-10%	IRC	2.50 per 100
BW-2-55	2-10%	IRC	2.50 per 100
SI-2-220	2-10%	Speer	2.50 per 100
BW-2-220	2-10%	IRC	2.50 per 100
BT-2-4,700	2-5%	IRC	2.75 per 100
BT-2-22,000	2-10%	IRC	2.50 per 100
BT-2-27,000	2-10%	IRC	2.50 per 100
SI-2-220,000	2-10%	Speer	2.50 per 100

Some Stocks Limited—Order Yours Today  
 Write for FREE **ALMO** Broadcaster Magazine

10% CASH WITH OR-DERS  

 Phone LO 3-9225

509 Arch Street, Philadelphia 6, Penna.  
 Sixth & Orange Sts., Wilmington, Del.

# INDEX OF Advertisers

MAY 1949

While every precaution is taken to insure accuracy, we cannot guarantee against the possibility of an occasional change or omission in the preparation of this index.

ADVERTISER	PAGE	ADVERTISER	PAGE
A. M. Radio Sales Company	170	Instrument Associates	171
Abell Distributing Co.	116, 130	International Resistance Co.	141
Acorn Electronics Corp.	154	International Television Corporation	158
Acoustcraft Corp.	154	JED Manufacturing Co., Inc.	122
Alliance Radio & Electronics Co.	165	Jensen Manufacturing Company	6
Allied Manufacturing Company	159	Jerrold Electronics Corp.	171
Allied Radio Corp.	9	Johnson Co., E. F.	130
Almo	176	Kreneo Mfg. Co.	142
Altee Lansing Corporation	163	Lafayette-Concord	124
Alvarado	168	LaPointe-Plascomold Corp.	104
American Phenolic Corporation	119	Lavender Radio Supply Co., Inc.	166
American Radio Institute	170	Leeco Engineering Co.	151
American Sales Co.	90	Leeds Radio Co.	131
American Television & Radio Co.	116	Lehigh Television Company	16
Amplifier Corp. of America	153, 161, 166	Leotone Radio Co.	144
Arrow Sales, Inc.	106	Long Island Radio Co.	168
Arzuda, Arthur J.	168	Mallory & Co., Inc., P. R.	2nd Cover
Ashe Radio Co., Walter	115, 134	Martin School of Radio Arts, Don.	149
Atlas Sound Corporation	80	Martin Radio-Television	136
Audio Development Co.	123	Mass. Radio School	168
Automatic Devices, Inc.	166	Meissner Manufacturing, Division Maguire Industries, Inc.	114
Baltimore Technical Institute	172	Merit Co'l & Transformer Corp.	14
Belden Radio Wire	31	Mid-America Co., Inc.	112
Bell Telephone Laboratories	32	Midway Co.	162
Bliss Electrical School	143	Midwest Radio & Television Corp.	106
Bozen, David Co., Inc.	168	Miles Reproducer Co., Inc.	129
British Industries Corp.	90	Milwaukee School of Engineering	112
Brooks Radio Dist. Corp.	174	Mohawk Electronics Co.	166
C. & H. Sales Co.	152	Motorola Inc.	100
Candler System	162	Murray Hill Books, Inc.	79
Cannon Electric Development Company	102	McConnell's	28, 174
Capitol Radio Engineering Institute	3rd Cover, 167	McGee Radio Company	81, 82, 83
Central Electronic Supply Co., Inc.	131	McGraw-Hill Book Co.	160
Centralab, Division of Globe-Union, Inc.	20, 21	McMurdo Silver Co., Inc.	113
Certified Television Laboratories	139, 172	National Wide Radio	100
Chicago Industrial Instrument Co.	169	National Radio, Inc.	167
Chicago Transformer, Division of Essex Wire Corporation	10	National Radio Institute	3
Cinaudagraph Speakers, Division of Alreom Mfg. Corp.	120	National Schools	19
Cincinnati Ventilating Co., The	135	Nescorp Electronics, Division of National Equipment & Supply Co., Inc.	103
Cinex, Inc.	129	Newark Electric Co.	140
Clear-Vac Co.	95	Newark Surplus Materials Co.	161
Cleveland Institute of Radio Electronics	5	Newcomb Audio Products Co.	177
Clippard Instrument Laboratory, Inc.	165	Niagara Radio Supply Corp.	105
Columbia Electronics	150	Offenbach & Reimus Co.	89
Comet Electronic Sales Co.	137	Ohmite Manufacturing Company	30
Commercial Radio	141	Olin Industries, Inc.	25
Commercial Radio Institute	145	Onan & Sons, Inc., D. W.	157
Communications Equipment Co.	99	Opad-Green Company	117
Consolidated Publications	146	Opti-Gem Inc.	120
Coradio	137	Peak Electronics Co.	96
Cornell-Dubilier Electric Corp.	17	Phico Radio	34
Cosmic Counters	102	Photocord Sales	123
Coyne Electrical & Radio School	155	Potter Radio Co.	161
Crassdale & deAngelis, Inc.	140	Premax Products	154
Custom Craft Manufacturing Co.	106	Progressive Electronics Co.	124
DeForest's Training, Inc.	7	Pyramid Electric Company	26
Dielectric Products Co., Inc.	160	Quam-Nichols Co.	119
Dunn-Wright Electric Co.	145	RCA Institutes, Inc.	141
Eastern Radio Sales	152	R & M Radio Company	93
Editors and Engineers	74	R & T Electronics Company, Inc.	139
Eddie Electronics, Inc.	116	Radio Centre, The	102
Electric Auto-Life Company, The	94	Radio City Products Co., Inc.	127
Electro-Technical Industries	108	Radio Corporation of America	11, 29, 86, 87
Electro-Voice, Inc.	107	Radio Craftsmen Inc., The	163
Electronic Devices Co.	168	Radio Distributing Co.	158
Electronic Expeditors, Inc.	119	Radio Equipment Company	92
Electronic Instrument Co., Inc.	129	Radio Ham Shack loc.	109
Electronic Sales Co.	162	Radio Kits Company	148
Electronic Service Co.	140	Radio Mail Orders	170
Electronic Supplies	138	Radio Parts Company	127
Electronicraft, Inc.	137	Radio Supply & Engineering Co., Inc.	128
Electronics Institute, Inc.	156	Radianic Equipment Company	164
Engineering Assoc.	143	Rauland-Borg Corporation	119
Esege Sales Co.	141, 156	Rose Company, The	162
Espey Manufacturing Company, Inc.	28	Sams & Co., Inc., Howard W.	23
Fair Radio Sales	153	Sangamo Electric Company	90
Farwest Trading Co., Inc.	173	Scott, Incorporated, Herman Hosmer	144
Federal Telephone & Radio Corporation	15, 115	Senco Radio, Inc.	143
Federated Purchaser, Incorporated	147	Sewell, Inc., Norman M.	124
Feiler Engineering Co.	155	Simpson Electric Company	84, 98
Franklin-Ellis Co.	175	Sonotone	110
French-Van Breems, Inc.	100	Sovereign Television Co.	160
General Electric Company	33, 91	Spartan School of Radio and Electronics	115
General Electronic Distributing Co.	97	Spellman Television Co., Inc.	155
General Test Equipment	133	Sprague Products Company	92
Goodheart, R. E.	154	Stahl, Inc., Michael	173
Gonsat Co.	127	Standard Radio & Electronic Products	167
Greenlee Tool Co.	173	Star Expansion Bolt Co., Inc.	130
Greylock Electronics Supply Co.	147	Sternoff's Ham Shack	125
Hallcrafters Co., The	18	Sun Radio and Electronics Co., Inc.	145
Hallmark Electronics Corporation	152	Sun Radio of Washington, D. C.	118
Harvey Radio Company, Inc.	126	Superior Instrument's Co.	135
Heath Company, The	75, 76, 77, 78, 133	Supreme Incorporated	24
Henry Radio Stores	159	Supreme Publications	111
Hivay Company	171	Surplex Retail Sales, Inc.	143
Hollywood Sound Institute, Inc.	139	Sutton's Wholesale Electronics, Bill	151
Hytron Radio and Electronics Corp.	73	Sylvania Electric	27
Illinois Condenser Co.	165	TAB	85
Indiana Technical College	158	Tech-Master Products Co.	177
Instructograph Company	147		



Technical Radio Parts Co.	176
Tel-Craft Company	162
Telemarine Communications Company	121
Television Assembly Co.	4th Cover, 157
Telex Inc.	101
Transvision, Inc.	12, 13, 112, 152
Tri-State College	129
Troup Engineering Co.	149
Turner Company, The	133
Utica Drop Forge & Tool Corp.	174
Vaco Products Co.	170
Valparaiso Technical Institute	133
Walco Sales Co.	151
Walmar Distributing Co.	161
Ward Leonard Electric Co.	123
Ward Products Corporation	22
Warren Distributors	132
Weller Manufacturing Company	8
Wells Sales, Inc.	178
Western Sales Co.	162
Wholesale Radio Parts Co., Inc.	114
Workshop Associates, Inc., The	175
World Radio Laboratories, Incorporated	139
Y.M.C.A. Trade & Technical Schools	137

## PEORIA "HAMS" HOLD PICNIC

**H. C. SEVER**, acting secretary of the Peoria Amateur Radio Association, announces that it will hold its "Annual Hamfest" on June 12, 1949, at Woodland Knolls, which is located approximately 4½ miles east of McCluggage Bridge, near Peoria.

The members will bring their own basket lunches, but arrangements have been made for contests, sporting events, and lots of other entertainment. The Peoria ARA hopes to have a large turnout and has appointed H. E. Callander, 211 E. McClure, Peoria, Illinois, to answer all inquiries of those interested in joining the festivities.

-30-

## TV SET PRODUCTION

**D**ESPITE a shortage of cathode-ray tubes, which retarded production in some instances, February television receiver output was approximately at the same level as January, the Radio Manufacturers Association reported today. TV receivers produced by RMA member-companies in February numbered 118,933, slightly below the 121,233 sets manufactured in January.

Coincident with the decrease in all set production, the number of FM-AM and FM receivers produced in February dropped to 98,969 from 147,733 in January. Adding our usual 10 per-cent for non-RMA members will bring the total of television sets produced in January and February to approximately 133,362 and 130,832, respectively.

-30-

### ERRATUM

Footnote<sup>1</sup> on page 62, April issue, is in reference to the Cataldo & Richard article entitled "Servicing Simplified," published in the January, 1949, issue of RADIO AND TELEVISION NEWS.

### PHOTO CREDITS

Pages	Credit
35, 36, 37	Don Lee Mutual
47, 70	Radio Corporation of America
48, 49 (Fig. 9)	Philco Corporation
49 (Figs. 7 & 8)	North American Philips Co., Inc.
50	Acme
53 (Top)	Flexible Co.
53 (Bottom)	Oklahoman and Times
60, 61	McMurdo Silver Co., Inc.
64	(Left) The Hallcrafters Co. (Center) Sentinel Radio Corp. (Right) Tele-Tone Radio Corp.
68, 69	Burton Browne Advertising
138	U. S. Army
146	U. S. Navy
147	Sun Radio & Electronics Co., Inc.



## TECH-MASTER

de-luxe 630-TK TELEVISION KIT  
GENUINE RCA 630-TS CIRCUIT

With Tech-Master, you build the finest, commercial-type Tele-Set on the market... the exact duplicate of the 30 tube RCA 630-TS! Acknowledged by experts to be the world's best. The Tech-Master kit comes to you complete with genuine RCA parts—98% assembled. With the new, simplified, step-by-step and point-to-point instructions, you finish the final wiring in a few enjoyable evenings of spare time—turn it on and there's your picture! Whether you build for pleasure, profit or education, you get all three with Tech-Master. Be satisfied only with the finest. Insist on the genuine Tech-Master! See it at leading distributors everywhere. Write for name of distributor nearest you.

### CHECK TECH-MASTER'S FEATURES BEFORE

YOU BUY ANY TELEVISION KIT!

1. Genuine RCA parts and 29 RCA tubes.
2. RCA 13-Channel tuner
3. 98% assembled and mounted.
4. Ready for final easy wiring.
5. All coils pre-aligned under actual circuit conditions.
6. Ultra simplified, step-by-step instructions!
7. 42 page RCA TV service manual.

**BIG PICTURE TELEVISION!**  
For use with tubes up to 16 inches!  
**\$168.50**  
COMPLETE KIT LESS KINESCOPE

Several jobber's territories still available—write to

**TECH-MASTER PRODUCTS CO.**  
443 Broadway, Dept. N5, New York 13

## THE EVIDENCE of YOUR EARS

→ → POINTS TO **NEWCOMB**

What you really buy in a phonograph amplifier is "listening quality" . . . that elusive characteristic which, after all, is any amplifier's prime reason for being.

That's why we insist that **Newcomb amplifiers** must not only measure up electrically but, in addition, must provide more real listening pleasure.

IT IS POSSIBLE TO PRODUCE AMPLIFIERS THAT SHOW PERFECT LABORATORY MEASUREMENTS, YET FALL FAR SHORT OF PROVIDING THIS ALL IMPORTANT LISTENING QUALITY.

Years of experience and a devotion to the ideal of fine reproduction have given us an insight into the factors that make for true listening quality. Careful design and engineering have enabled us to translate this insight into actual production.

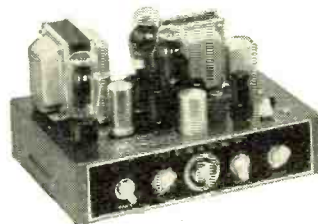

KXLP-30 30 WATTS

Let your ear be the judge: insist on hearing a Newcomb. Compare the listening quality of Model KXLP-30 with that of any other amplifier. Note the pure, natural quality and true character of each deep bass note. You will find none of the undesirable, false, harmonic bass emphasis of the usual amplifier. Listen to the clear, undistorted, brilliant high tones and remarkable freedom from surface noise which the Magic Red Knob makes possible. Your ear will agree, Newcomb Sound is the closest you can get to "live music."

Send for specifications on this and other Newcomb phonograph amplifiers priced from \$59.50 retail.

**Newcomb** AUDIO PRODUCTS CO.

DEPT. F, 6824 LEXINGTON AVE. HOLLYWOOD 38, CALIFORNIA

# TRANSMITTING

# Mica

# CONDENSERS

## PARTS SHOW VISITORS:

Be sure to visit our tremendous showrooms at 320 N. LaSalle St. Thousands of electronic components conveniently displayed.

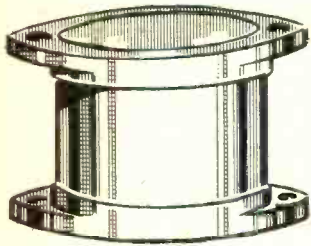

STYLE "AA"

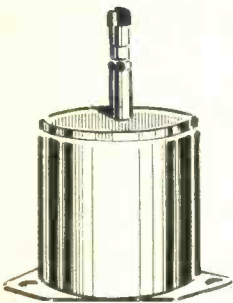

STYLE "A"



STYLE "B"



STYLE "C"

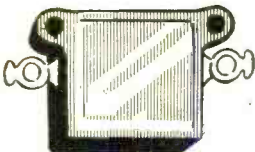

STYLE "D"

## SPECIAL LOW PRICES FOR IMMEDIATE SALE AND DELIVERY

We have literally hundreds of thousands of these top quality standard type transmitting mica condensers in stock for immediate delivery at a fraction of their original cost. Every condenser is brand new and carries the name of a fine nationally known manufacturer.

Despite the unusually low prices, these mica condensers, like all Wells Components, are fully guaranteed. Be sure to order sufficient quantities for your requirements.

Cap. Mfd.	Wrkg. Volts	Mfr. Leg.	Price Each	Cap. Mfd.	Wrkg. Volts	Mfr. Leg.	Price Each	Cap. Mfd.	Wrkg. Volts	Mfr. Leg.	Price Each
<b>STYLE "AA" CONDENSERS</b>											
.02	3000	2	\$4.50	.02	2000	2, 8	1.60	.0175	1200	2	.55
.04	1000	2, 7	3.50	.024	1500	3	1.60	.02	600	7	.35
<b>STYLE "A" CONDENSERS</b>											
25mmfd	10000	8	\$1.65	.033	1500	3, 7	1.60	.02	1200	7	.45
<b>STYLE "B" CONDENSERS</b>											
.00003	2000	2	\$0.70	.056	1000	3, 7	1.70	.022	1200	7	.45
.000047	3000	1	.80	.06	1000	8	1.70	.025	600	8	.35
.00005	3000	2, 9	.75	.1	1000	8	1.75	.03	600	6	.35
.00007	1140	6	.70	<b>STYLE "C" CONDENSERS</b>							
.00009	3000	2, 7, 9	.75	.000005	2500	2	\$0.40	.03	1200	2, 8	.50
.000091	3000	7	.80	.00005	600	7, 8	.30	.033	600	7	.35
.0001	3000	2, 7, 9	.80	.0001	600	2, 7	.25	.033	1200	7	.50
.000107	3500	1	.85	.0001	1200	7	.35	.04	600	7, 8	.35
.00011	3000	8	.95	.0001	2500	4, 7, 8	.40	.073	250	8	.40
.00137	3000	2	.95	.0001	600	2, 7, 9	.25	<b>STYLE "D" CONDENSERS</b>			
.000175	1500	8	1.00	.0002	2500	7	.40	.00004	600	7	\$0.20
.0002	1430	6	1.00	.0002	2500	7, 8	.45	.00005	1200	1, 7, 9	.25
.0002	3000	7, 8	1.00	.00024	2500	7, 8	.45	.00005	2500	2, 8, 9	.30
.0002	5000	1, 8	1.05	.00025	2500	2	.45	.0001	600	9	.20
.00025	5000	7	1.10	.0003	2500	7	.45	.0001	1200	7, 8	.25
.0004	3000	2, 7	.95	.00039	2500	7	.50	.00015	2500	2, 6	.35
.0004	5000	2, 7, 8	1.10	.0004	2500	2, 7, 9	.45	.00024	2500	6	.35
.0005	2000	7	.95	.0005	600	1, 7	.35	.00025	1200	6, 8	.25
.0005	3000	3	1.00	.0005	1200	2, 7	.40	.00025	2500	6, 8	.35
.00051	3000	7	1.00	.0005	2500	1, 2	.45	.0005	1200	7	.30
.00055	3000	7	1.10	.001	1200	2, 7, 8	.40	.00051	2500	1	.35
.0006	2500	7	1.05	.001	2500	6, 7	.55	.0007	600	2	.25
.0006	5000	8	1.15	.001	3750	7	.85	.001	600	2, 8	.25
.000625	3000	7	1.05	.0011	600	2	.35	.001	1200	6, 8, 9	.35
.0007	3000	7	1.05	.002	600	7	.35	.001	2500	6, 8	.40
.00075	2500	2	1.05	.002	1200	2	.45	.0011	2500	8	.40
.00075	5000	8, 9	1.15	.002	2500	1, 2, 8	.55	.002	600	1, 2, 9	.25
.0008	3000	7	1.00	.002	3500	8	.80	.002	1000	8	.30
.0008	5000	2, 8	1.15	.002	2500	7	.60	.002	1200	6, 7, 8	.35
.001	4500	2, 9	1.25	.0022	2500	7	.60	.002	1250	1	.35
.001	5000	7, 8	1.30	.003	600	8	.40	.002	2500	8, 7	.40
.0011	5000	2, 7	1.35	.0035	2500	7, 9	.60	.0022	1200	8, 7	.30
.00125	2000	7	1.10	.0039	2500	2	.60	.0022	2500	8	.40
.0014	5000	2	1.35	.004	2500	2, 7	.60	.0025	2500	8	.30
.0015	3000	7	1.10	.0045	600	8	.40	.0025	600	2	.25
.0024	3000	8	1.15	.0046	500	9	.45	.0025	1200	1	.35
.0025	2000	1, 2, 7	1.10	.0047	2500	8	.65	.0027	600	1	.25
.00275	2000	1, 7	1.10	.005	600	2	.35	.003	600	2, 7, 8	.25
.003	2000	7	1.20	.005	1200	7, 8	.45	.003	1200	6, 7, 8	.30
.004	3000	2, 8	1.50	.005	2500	7, 8	.60	.0033	1200	6	.30
.005	2000	2	1.40	.0051	1200	7	.45	.004	1100	8	.35
.005	5000	6, 8	1.70	.0051	2500	7, 8	.65	.004	1200	7, 8	.35
.006	2500	7	1.30	.0056	2500	8	.65	.004	2500	9	.45
.006	3500	8	1.45	.006	600	7, 9	.40	.0044	800	8	.25
.0068	3000	8	1.40	.006	2500	7	.65	.0047	2500	6, 8	.40
.008	3000	7, 8	1.45	.0068	1200	7	.60	.005	600	2, 6, 7	.25
.01	2000	1, 2, 3	1.55	.007	600	8	.35	.006	600	1, 2	.25
.01	1000	7	1.35	.0075	1200	2	.55	.01	600	2, 7, 8	.40
.02	600	7	1.30	.009	600	9	.50	.01	1200	6, 7, 8	.40
<p><b>Manufacturers' Legend</b>                      1—Aerovox; 2—Cornell Dubilier; 3—Faradon; 4—General Electric; 5—Illinois; 6—Mica-Mold; 7—Sangamo; 8—Solar; 9—Sprague</p>											

This is only a partial listing. Write or wire for information on types not shown and for receiving set micas and silver micas.

We advise distributors to order immediately from this ad. Our standard jobber arrangement applies.

Manufacturers and Distributors: Write for our complete Mica Condenser Listing No. 103A.



320 N. LA SALLE ST., DEPT. R-5, CHICAGO 10, ILL.



## Here's How CREI Home Study Training Prepares You NOW For a BETTER Job and a Secure Future in Radio-Electronics and Television

**CREI Courses for Every Radioman Keep You Ahead of Competition— Earn You More!** Never before have so many men like you had the opportunity to step ahead into better-paying jobs and enjoy lasting success. Men with up-to-date technical training are needed in every branch of radio-electronics. That's because radio's *manpower* has not kept pace with radio's *technical* developments.

What are you doing to meet this need for highly trained, expert technicians and engineers? You must improve your technical knowledge not only to qualify for the better job you want, but to *hold* the job you now occupy. CREI offers you a proved program of technical self improvement that you can study in your spare time, at home. The same type of practical,

If you have had professional or amateur radio experience and want to make more money, let us prove to you we have the training you need to qualify for a better radio job. To help us answer intelligently your inquiry—please state briefly your background of experience, education and present position.



## Capitol Radio Engineering Institute

An Accredited Technical Institute Founded in 1927

Dept. 115A, 16th and Park Road, N. W., Washington 10, D. C.

Branch Offices: New York (7) 170 Broadway • San Francisco (2) 760 Market St.

down-to-earth training for which thousands have enrolled since 1927.

Remember, too, there's a CREI course for *you*. No matter what your radio experience—CREI offers complete training in radio-electronics for *any* man who wants to improve his ability and his chances for advancement. You can "go all the way with CREI" from introductory basic principles to advanced training and on to specialized engineering subjects.

Read our new 32-page booklet . . . then judge for yourself. There is no obligation. You are already started in this field. Find out how you can rapidly prepare to advance beyond your present level. Send the coupon NOW!

**VETERANS! CREI TRAINING AVAILABLE UNDER G. I. BILL**

### MAIL COUPON FOR FREE BOOKLET

**CAPITOL RADIO ENGINEERING INSTITUTE**  
16th & Park Road, N. W., Dept. 115A, Washington 10, D. C.

Gentlemen: Please send your free booklet, "Your Future in the New World of Electronics," together with full details of your home-study training. I am attaching a brief resume of my experience, education and present position.

Check field of greatest interest:

- |   |   |   |
|---|---|---|
| <input type="checkbox"/> BROADCAST RADIO ENGINEERING (AM, FM, TV) | <input type="checkbox"/> PRACTICAL RADIO ENGINEERING      | <input type="checkbox"/> TELEVISION, FM & ADVANCED AM SERVICING |
| <input type="checkbox"/> AERONAUTICAL RADIO ENGINEERING           | <input type="checkbox"/> PRACTICAL TELEVISION ENGINEERING | <input type="checkbox"/> ADVANCED ELECTRONICS COMMUNICATIONS    |
| <input type="checkbox"/> PRACTICAL TELEVISION ENGINEERING         | <input type="checkbox"/> RADIO-ELECTRONICS IN INDUSTRY    |   |

NAME.....

STREET.....

CITY..... ZONE..... STATE.....

I AM ENTITLED TO TRAINING UNDER G. I. BILL.

Build the finest proven "CUSTOM-BUILT"  
TELEVISION ASSEMBLY

*Faster!  
More Economically!*  
when you build with . . .

"America's greatest  
Television Values  
per square inch of  
picture!"

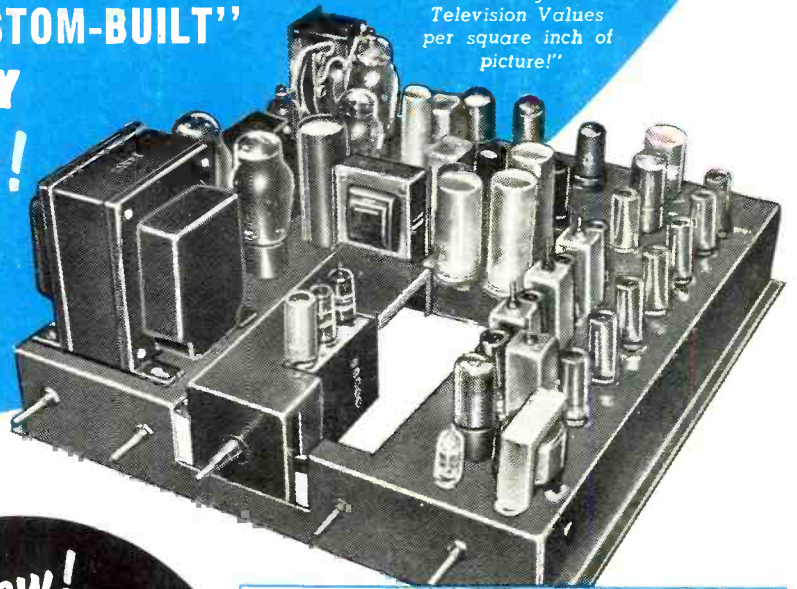

TELEVISION  
ASSEMBLY CO.

**Exclusive  
T.A.C. "VIVIDeo"  
feature!**

Prewired, pretuned and tubed I.F. sound and video strip (patents pending). An exclusive T. A. C. feature developed by our own research. All on one chassis.

**New!  
Super-Simplified**  
wiring and assembly  
**INSTRUCTIONS!**

—The most explicit, easiest-to-follow, most elaborately detailed instructions in television—that even the layman can follow.

CABINETS AND STANDS available with all direct view units. Write for literature.

**MODEL P-520 . . . 520 SQ. IN. PICTURE  
PROJECTION TELEVISION ASSEMBLY**



• Bausch & Lomb F. 1.9 Lens • Eastman Kodak Screen • DuMont Inputuner • 37 R.C.A. Tubes • Pre-Wired & Pre-Tuned Picture I.F. & Sound I.F. • Pre-Wired 30 K.V. Tripler Fly Back Power Supply • Automatic Gain Control • Aluminum Coated Top Mirror • Metal Rack • Specially Designed Hood and Picture Frame Supplied • 5TP4 Projection Tube • 12" R.C.A. High Fidelity Speaker • Two Low Voltage Power Supplies.

**MODEL P-520** Dealer's net **\$76950\***

**MODEL P-520W** Dealer's net **\$89500\***

The above unit completely wired and ready to install.

Front and rear panels optional at additional cost.

TELEVISION  
ASSEMBLY CO.

**Champion Models  
20" DIRECT-VIEW MODEL**  
with DuMont Inputuner and 20" DuMont Tube

213 SQUARE INCH PICTURE! Prewired Voltage Doubler 14KV power supply, Pre-wired "VIVIDeo" I.F. picture and sound strip (Pat. Pending). ALL channels TV plus ALL FM radio. Continuous tuning. DuMont Inputuner is Prewired. Delivered complete with all components and 30 RCA tubes plus 20-inch DuMont C.R. tube.

**MODEL F-201C** Dealer's net **\$56675\***

**"M" SERIES STANDARD and CHAMPION  
Direct-View Models  
for 10" CR TUBES**

**STANDARD MODEL**

29 tubes, including 13-tube "VIVIDeo" I.F. picture and sound strip (Pat. Pending). This portion completely wired, tested and aligned. Prewired, standard tuner ready to use. Handles ALL channels.

**MODEL M-101S** Less C.R. Tube Dealer's net **\$16950\***

**CHAMPION MODEL**

Same as above except that DuMont Inputuner replaces Standard Tuner. Gets ALL channels TV —PLUS all channels of FM radio.

**MODEL M-101C** Less C.R. Tube Dealer's net **\$20950\***

Write for literature on our complete line of 10", 12"-15" standard and champion assemblies.

**T. A. C. GUARANTEE**  
All components are of the finest quality and are fully guaranteed under the Standard RMA Guarantee. All TAC Assemblies are guaranteed to operate when assembled according to directions.

Distributed only through  
**NATIONAL PARTS DISTRIBUTORS**  
Write for the source nearest to you

540 BUSHWICK AVE., BROOKLYN 6, N. Y.

\*PRICES 5% HIGHER WEST OF THE MISSISSIPPI