

RADIO NEWS

NSE

JANUARY
1941
25c
In Canada 30c

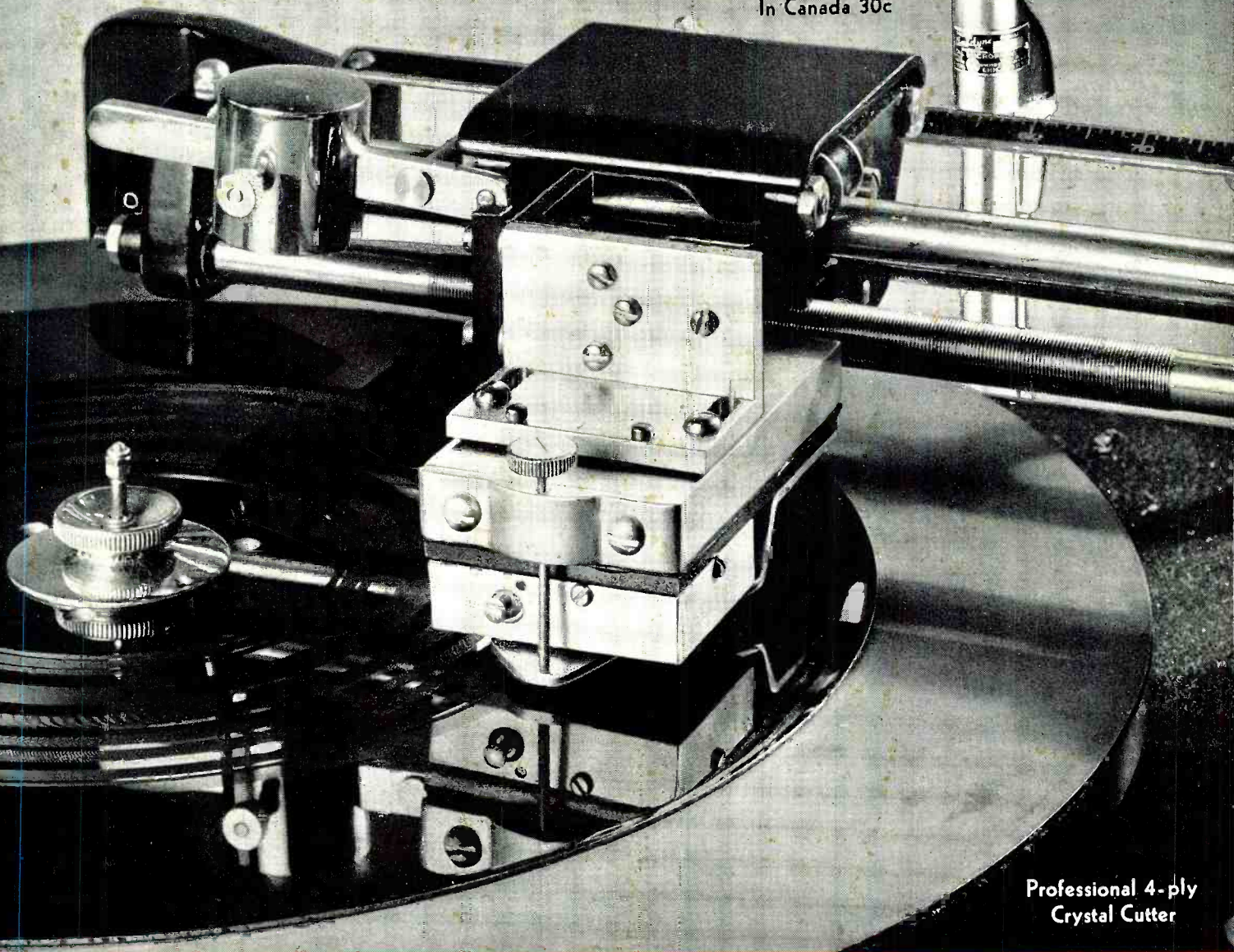

Professional 4-ply
Crystal Cutter

RADIO JOBS ARE WHERE YOU FIND 'EM

The Electronics of Talking Pictures

SPEAKER and MIKE PLACEMENT HAM DEFENSE RIG

Oscilloscope Video Receiver Audio Frequency Analyzer

Be Your Own Santa This Christmas with New Equipment from DAVEGA

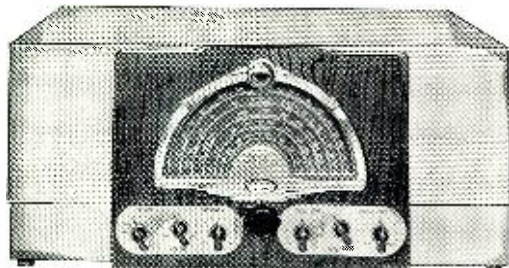

FINEST McMURDO CHASSIS EVER BUILT!

Two R.F. Stages
Variable Selectivity
Giant Jensen 18" Speaker
Finest Shielding
34 Watts Undistorted

Built to
Sell for
\$350.00

Christmas Special

189⁵⁰

Complete including 18" Speaker
made by Jensen



Made by Radio Headquarters RCA

AR 77 WITH DUAL
R.F. ALIGNMENT

Christmas Special

139.50

IMPROVED
IMAGE
REJECTION
ANTENNA
TRIMMER

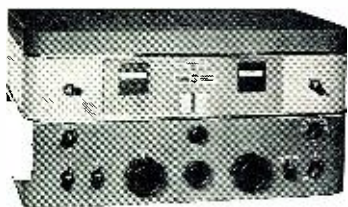

HALLICRAFTER SUPER SKY RIDER

6 BANDS • 15 TUBES
VARIABLE SELECTIVITY
2 R.F. STAGES
HI-FI-AUDIO SYSTEM
FOR FINE TONE

Christmas Special

159.50

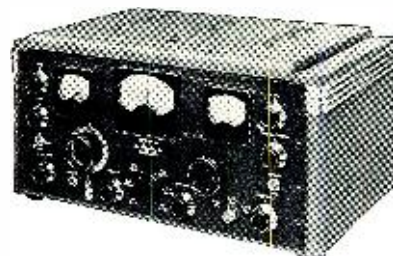

Hallicrafter S.20R

R.F. stage, 2 I. F. stages,
9 tubes, noise limiter,
bandspeed.

Christmas Special

49.50

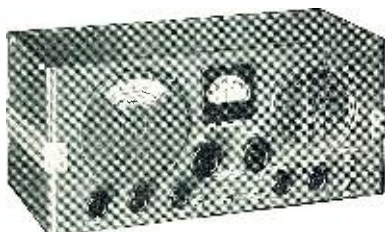

Hallicrafter SX23

THE SET THAT HAS
EVERYTHING. WRITE
FOR OUR SPECIAL
PRICE.



Federal Recorder Model P 12

Professional 12" recorder, 15
watt audio public address, 25.00
mike and stand. Perfect recordings.

Christmas Special

List Price
over **79.50**
\$200.00



ACR-III Communication Receiver

Made to
Sell for
\$189.50

89.50

The ACR-III employs a
single-signal, 16-tube Su-
perheterodyne circuit with
two tuned rf. stages, con-
stant-percentage electrical
bandspeed, and individ-
ual carefully isolated
oscillators.

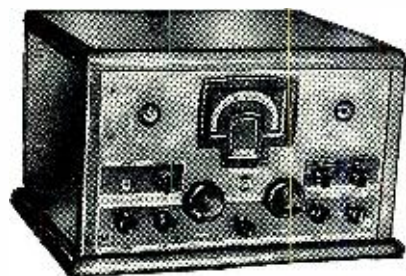

NEW HALLICRAFTER UNIVERSAL S-29 SKY TRAVELER 553-9.85 METERS

AC-DC battery operation, self-
charging unit built in. Self-con-
tained antenna, elec-
trical bandspeed....

59.50

Christmas Special



LARGEST STOCK OF
MICROPHONES at the
lowest prices. Let us
quote you.

DISTRIBUTORS FOR

- Hallicrafters
- National
- Sargent
- RCA
- Hammarlund
- Howard
- RME
- and other famous makes

Sargent WAC44

Regular
Price
\$139.50

94.50

Two stages, pre-selec-
tion, frequency monitor,
permanent alignment
from panel.

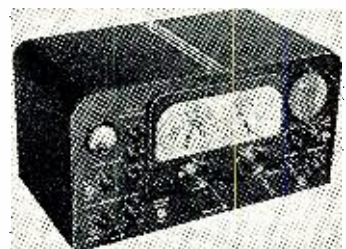

DAVEGA

AMATEUR DIVISION—63 CORTLANDT ST., N. Y., N. Y.

★ World's Largest Radio Dealer . . . Established 1879

A FREE LESSON
SHOWED BILL HOW HE COULD
MAKE GOOD PAY
IN RADIO

BILL, YOU'RE ALWAYS FOOLING WITH RADIO -- OUR SET WON'T WORK -- WILL YOU FIX IT?

I'LL TRY, MARY, I'LL TAKE IT HOME TONIGHT



I CAN'T FIND OUT WHAT'S WRONG -- GUESS I'LL MAKE A FOOL OF MYSELF WITH MARY

HELLO, BILL -- GOT A TOUGH ONE TO FIX? LET ME HELP YOU

HELLO JOE -- WHERE'VE YOU BEEN LATELY -- AND WHERE DID YOU LEARN ANYTHING ABOUT RADIO?

I'VE BEEN STUDYING RADIO AT HOME, BILL, WITH THE NATIONAL RADIO INSTITUTE. YOU OUGHT TO TAKE THEIR COURSE. I'VE GOT A GOOD RADIO JOB NOW. LET'S MAKE A CIRCUIT DISTURBANCE TEST -- STARTING WITH THE AUDIO OUTPUT STAGE AND TESTING EVERY STAGE RIGHT BACK TO THE ANTENNA. LISTEN FOR THE CLICKS WHEN I TAP THE GRID LEADS

SAY -- WHERE DID YOU LEARN THAT TEST? IT'S A GOOD ONE

HERE'S THE TROUBLE, BILL, IN THE FIRST I.F. AMPLIFICATION STAGE. I LEARNED THAT TEST EVEN BEFORE I STARTED TAKING THE COURSE, BILL. IT'S DESCRIBED IN A FREE LESSON WHICH THE NATIONAL RADIO INSTITUTE SENDS YOU WHEN YOU MAIL A COUPON FROM ONE OF THEIR ADS

I'VE SEEN THEIR ADS BUT I NEVER THOUGHT I COULD LEARN RADIO AT HOME -- I'LL MAIL THEIR COUPON RIGHT AWAY

I'M CONVINCED NOW THAT THIS COURSE IS PRACTICAL AND COMPLETE. I'LL ENROLL NOW

AND THEN I CAN MAKE REAL MONEY FIXING RADIO SETS

OR GET A JOB WITH A RADIO BROADCASTING OR TRANSMITTING STATION

AVIATION RADIO, POLICE RADIO, TELEVISION, ELECTRONIC CONTROLS -- RADIO IS SURELY GOING PLACES. AND THE NATIONAL RADIO INSTITUTE HAS TRAINED HUNDREDS OF MEN FOR JOBS IN RADIO

OR INSTALL AND SERVICE LOUD SPEAKER SYSTEMS

I will send you a Lesson on Radio Servicing Tips FREE
TO SHOW HOW PRACTICAL IT IS TO TRAIN AT HOME FOR
GOOD JOBS IN RADIO



YOU CERTAINLY KNOW RADIO SOUNDS AS GOOD AS THE DAY I BOUGHT IT.

THANKS! IT CERTAINLY IS EASY TO LEARN RADIO THE N.R.I. WAY. I STARTED ONLY A FEW MONTHS AGO, AND I'M ALREADY MAKING GOOD MONEY.

THIS SPARE TIME WORK IS GREAT FUN AND PRETTY SOON I'LL BE READY FOR A FULL TIME JOB

Clip the coupon and mail it. I'm so certain I can train you at home in your spare time to be a Radio Technician that I will send you a sample lesson free. Examine it, read it, see how clear and easy it is to understand. See how my course is planned to help you get a good job in Radio, a young, growing field with a future. You needn't give up your present job, or spend a lot of money to become a Radio Technician. I train you at home in your spare time.

conduct experiments, build circuits. This 50-50 training method makes learning at home interesting, fascinating, practical. I devote more than 10 Lesson Texts exclusively to Television, and cover Television fundamentals thoroughly in my Course.



You Get This Professional Servicing Instrument

This instrument makes practically any test you will be called upon to make in Radio service work on both spare time and full time jobs. It can be used on the test bench, or carried along when out on calls. It measures A.C. and D.C. voltages and currents; tests resistances; has a multi-band oscillator for aligning any set, old or new. You get this instrument to keep as part of your N. R. I. Course.

Get Sample Lesson and 64-page Book Free—Mail Coupon

Act today. Mail coupon now for Sample Lesson and 64-page Book. They're FREE. They point out Radio's spare time and full time opportunities and those coming in Television; tell about my course in Radio and Television; show many letters from men I trained, telling what they are doing and earning. Read my money back agreement. Find out what Radio offers you. Mail coupon in envelope or paste on penny postcard—NOW!

J. E. SMITH, President
Dept. IAR, National Radio Institute
Washington, D. C.

J. E. SMITH, President National Radio Institute Established 25 years

He has directed the training of more men for the Radio Industry than anyone else.



OH BILL -- I'M SO GLAD I ASKED YOU TO FIX OUR RADIO. IT GOT YOU STARTED THINKING ABOUT RADIO AS A CAREER, AND NOW YOU'RE GOING AHEAD SO FAST

OUR WORRIES ARE OVER. I HAVE A GOOD JOB NOW, AND THERE'S A BIG FUTURE AHEAD FOR US IN RADIO



Jobs Like These Go to Men Who Know Radio

Radio broadcasting stations employ Technicians as operators and maintenance men and pay well. Radio manufacturers employ testers, inspectors, servicemen in good-pay jobs with opportunities for advancement. Radio jobbers and dealers employ installation and servicemen. Many Radio Technicians open their own Radio sales and repair businesses and make \$30, \$40, \$50 a week. Others hold their regular jobs and make \$5 to \$10 a week fixing Radios in spare time. Automobile, Police, Aviation, Commercial Radio, Loudspeaker Systems, Electronic Devices, are newer fields offering good opportunities to qualified men. And my course includes Television, which promises to open many good jobs soon.

Many Make \$5 to \$10 a Week Extra in Spare Time While Learning
The day you enroll, in addition to my regular course, I start sending you Extra Money Job Sheets, start showing you how to do Radio repair jobs. Throughout your course I send plans and directions which have helped many make \$5 to \$10 a week in spare time while learning. I send special Radio equipment; show you how to

J. E. SMITH, President, Dept. IAR National Radio Institute, Washington, D. C.

Dear Mr. Smith: Mail me FREE, without obligation, your Sample Lesson and 64-page book "Rich Rewards in Radio" which tells about Radio's spare time and full-time opportunities and explains your 50-50 method of training men at home to be Radio Technicians. (No salesman will call. Write plainly.)

Name Age

Address

City State

23FR2



BY THE EDITOR

THIS is the first issue of the new year 1941. 1940 saw some remarkable happenings and advancements in the field of Radio. Frequency Modulation became rather common-place and Color Television was boomed. The European amateurs were taken off of all the bands, while the American amateurs were reduced to 5 Meter mobile and were finger-printed together with all other communications personnel. Television was off the air for a considerable period of time and the instantaneous recording business boomed. Ten inch recording discs with pseudo-acetate surfaces made their appearance and aided in the boom. A shift of the stations located in the broadcast band as foretold in the June, 1938, issue of RADIO NEWS was decided in 1940. It will take place on March 29, 1941. All in all, it was an exciting and eventful year in Radio.

* * *

IT IS the custom of radio magazine editors to take a chance and foretell what the future in the industry will bring, so we will follow suit. 1941 should see Commercial Television become a reality. Color Television will become more commonplace and will advance from the experimental stage to a more generally utilized form of entertainment. The amateurs will go in for Frequency Modulation in the mobile transmission band because of the greater amount of coverage with the small power available for mobile work. An active and lively fight between the gentlemen using Frequency Modulation and the regular broadcasters using Amplitude Modulation will take place to see which of the two will have the larger listening audience. Confidentially, we do not expect the Amplitude Modulation boys to be dislodged from No. 1 place as the advertising medium of radio.

Radio control will advance to further horizons. Radio controlled automobiles and radio controlled airplanes are fast becoming a reality.

Traffic control of buses, trucks and also trains will become quite commonplace in some localities.

Automobile traffic warnings and traffic control by means of automatic wired-radio signals to which the tourist may tune his receiving set will come into more general use, following the successful experimentations on the George Washington Bridge in New York City. Home garages will be built with radio-controlled doors, following the lead established in some of the newer communities in the Middle West. Frequency Modulated Phono-oscillators should make their appearance and should be well-received. In the field of Sound, mass production may bring the price per

(Continued on page 52)



Trade-Mark Registered

Including Articles on **POPULAR TELEVISION**

The Magazine for the radio amateur
experimenter, serviceman & dealer

VOL. 25, NO. 1

Contents for January, 1941

FEATURES

- Jobs Are Where You Find Them**..... Austin C. Hart **6**
Not all radio operator's jobs end up with mike & key.
- The Electronic Technique of Making Talking Pictures**.....
..... Jerry Coldby **8**
Showing to what extent the talking picture art has advanced.
- As I See It!**..... John F. Rider **11**
Some pertinent remarks to servicemen in general.
- A Ham's National Defense Portable Rig**.....
..... Karl A. Kopetzky, W9QEA **12**
Building towards a unified ham QRR rig for a National Emergency.
- Direct-Reading Audio Frequency Analyzer**.....
..... Rufus P. Turner, W1AY **16**
A valuable adjunct for any laboratory or service shop.
- Speaker & Microphone Placements**..... Clark E. Jackson **19**
Getting the most out of a Public Address System.
- High Fidelity Tuner**..... Oliver Read, W9ETI **22**
Constructing a tuner for the best in radio reproduction.
- Communication & Electronic Maintenance**..... W. H. Bohlke **25**
Part 3 of this very enlightening and interesting series.
- Use Your Oscilloscope for Television Reception**.....
..... Howard C. Lawrence, Jr., W2IUP **28**
How to "see" television programs with a gadget plus an oscilloscope.

Cover Picture: Composite picture of a Brush Development Co. RC-1 cutter and a Shure Bros. 55-C Microphone.

DEPARTMENTS

- | | | | | | |
|------------------------|----|---------------------------|----|--------------------------|----|
| Book Review | 42 | QRD? | 38 | Serviceman's Experi- | |
| What's New in Radio.. | 32 | Bench Notes | 21 | ences | 18 |
| Radio Physics Course.. | 45 | Manufacturer's Literature | 44 | Serviceman's Cases | 66 |
| Hamchatter | 35 | Cuttings | 24 | The Video Reporter.... | 42 |
| Servicemen's Legal | | Aviation Radio | 27 | Mikes-Heads-Pickups .. | 30 |
| Advice | 34 | Washington Communi- | | Ringin' the Bell..... | 31 |
| | | cation | 15 | | |

Copyright, 1940

ZIFF-DAVIS PUBLISHING COMPANY
Member of the Audit Bureau of Circulations

RADIO NEWS is published monthly by the Ziff-Davis Publishing Company at 608 S. Dearborn St., Chicago, Ill., William B. Ziff, Publisher; B. G. Davis, Editor; J. Fred Henry, General Manager; Karl A. Kopetzky, W9QEA, Managing Editor; Oliver Read, W9ETI, Technical Editor; Herman R. Bollin, Art Director; S. L. Cahn, Advertising Manager. New York Office, 381 Fourth Ave. Subscription \$2.50 per year; single copies, 25 cents; foreign postage \$1.00 per year additional, Canada 50c additional. Entered as second class matter March 9, 1938, at the Post Office, Chicago, Illinois, under the Act of March 3, 1879. Contributors should retain a copy of contributions. All submitted material must contain return postage. Contributions will be handled with reasonable care, but this magazine assumes no responsibility for their safety. Accepted material is subject to whatever adaptations, and revisions, including "by-line" changes, necessary to meet requirements. Payment will be made at our current rates upon acceptance and, unless otherwise specified by contributor, all photographs and drawings will be considered as constituting a part of the manuscript in making payment.

THE BEST SELLING *Quality* COMMUNICATIONS RECEIVERS

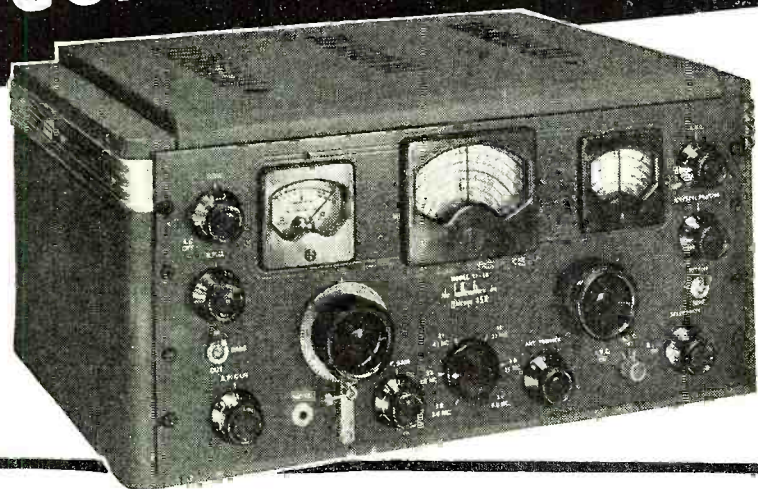

The SX-28 Check all these improved features! 15 tubes—6 bands—Frequency range 550 kc. to 42 mc.—Two stages preselection—Electrical bandspread on ALL BANDS including international short wave band—Calibrated bandspread inertia controlled—Micrometer scale tuning inertia controlled—Tone and AC On-Off—Beat frequency oscillator—AF Gain—RF Gain—Crystal phasing—Adjustable noise limiter—Send-receive switch—80, 40, 20 and 10 meter amateur bands calibrated—Wide angle "S" meter—Improved signal to image and noise ratio—Push-pull high fidelity, audio output—Band pass audio filter—6-step wide range variable selectivity—Phone jack—Improved headphone output. Dimensions 20½" x 10" x 14¾". Model SX-28 with crystal and tubes. \$159.50.

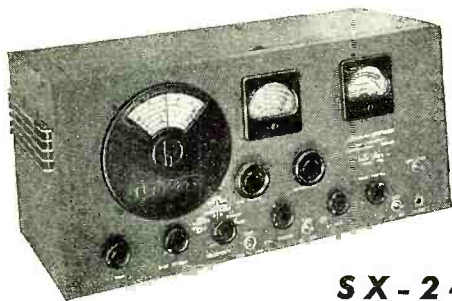

SX-24

The Model SX-24 is noted for its excellent performance. This 9 tube, 4 band receiver has a frequency range of from 540 kc. to 43 mc. Has frequency stability throughout a wide range of line voltage, humidity and temperature variations. One stage of pre-selection. Terminals provided for break-in relay operation. Single-signal crystal filter standard equipment. DC operation socket—battery or vibrapack. Complete with 9 tubes and crystal (no speaker). \$69.50.



S-20R

We believe that, without exception, the new 1941 Sky Champion, Model S-20R, represents the best value ever offered in the communications field. It has all the essential controls for good amateur reception. 4 bands, tunes from 540 kc. to 44 mc., 9 tubes. Separate electrical bandspread. Battery—vibrapack, DC operation socket. Dimensions 18½" x 8½" x 9¾". \$49.50.

Only 10% down, balance EASY PAYMENTS — prompt deliveries. Write TODAY for FREE Catalog just off the press, showing these and all other amateur equipment.

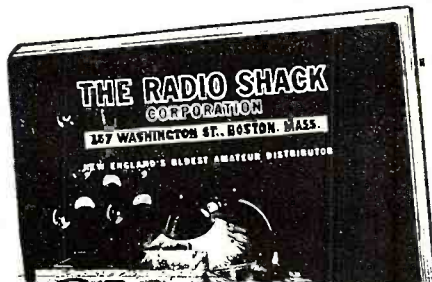

THE RADIO SHACK
167 Washington St., Boston, Mass.

{ } Please Rush Free Catalog.
{ } Enclosing \$..... Please ship model.....
Name.....
Address.....
City..... State.....

"The RADIO SHACK

167 WASHINGTON ST., BOSTON, MASS., U.S.A.



Broadcast studio monitor.



Broadcast studio "gain-rider."



Airplane radiop dispatcher.

JOBS ARE WHERE

FOR time on end radio publications have been so thoroughly devoted to the creed of publishing the newest, the latest and the most important discoveries of radio and the kindred arts, that never a thought ever entered the minds of the powers-that-be that perhaps some of their readers might like to put their radio knowledge to the test of earning a few shekels for them. That is, no one thought of this until our editor said, "Boy, search high and low for the various types of jobs available to radiomen and, also, how to go about applying for them." So we did as bid and here's the sum and substance of our findings.

We, of course, are beginning with the assumption that our readers have the immediate qualifications for these positions. That is, telephone first class

and telegraph second class licenses. Of course, we may be a bit presumptuous, so if you haven't as yet acquired these licenses, send a note enclosing fifteen cents to the *Government Printing Office, Washington, D. C.*, for the **REFERENCE GUIDE AND STUDY MATERIAL FOR RADIO OPERATOR'S LICENSE**. This will undoubtedly aid you in passing the examinations for the above licenses. Now that we have jumped over this hurdle, let us continue.

As told to **AUSTIN C. HART**

Kansas City, Mo.

The profession of radio operator may lead to any place but to operating; it is, however, the best way to get going!

Naturally, the first jobs we shall speak about are those which have the best opportunities, with a pension. These are the Civil Service positions which are to be found in local Police, Interzone and State Police departments, Civil Aeronautics Authority, Public Utilities and the Forestry Service. The requirements for these positions are all the same, with the exception of the CAA, which places special emphasis on the ability to handle traf-

Checking units at a power station.

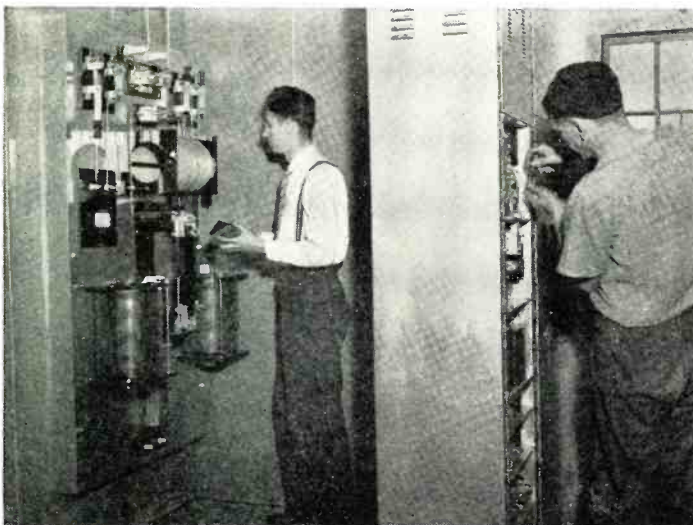

The "prowl car." Police radiop.





TWA airline traffic radiop.



Transatlantic flight radiop.

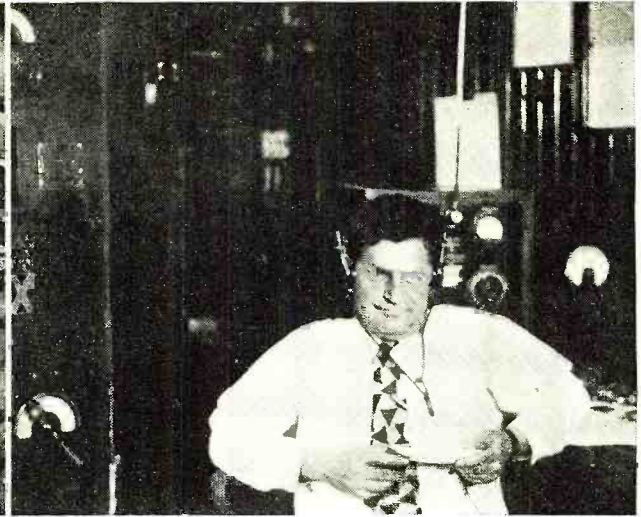

Ship-to-shore, ship's radiop.

YOU FIND THEM

fic at 35 words per minute, and the Forestry Service, which insists on a knowledge of Forestry plus physical fitness and the ability to make weather maps. Openings for these positions can be found on your local post office bulletin board, with dates when competitive examinations will be held.

One of the first requirements for local police departments and public utilities is residence qualifications. Sometimes, however, this is waived, as in the case of the Bureau of Power and Light in the City of Los Angeles, when they require operators for their Boulder Dam, Victorville or Silver Lake stations. Being outlying stations, it is sometimes very difficult to fill positions in these localities. If the local post office is outside of your immediate vicinity, you may request informa-

tion from the Civil Service Commission at Washington, D. C., relative to the dates for the examinations for CAA or any other positions pertaining to radio work. At this present writing the Civil Aeronautics Authority is contemplating the establishment of approximately one hundred new stations in the United States and Alaska.

The next possibility is the airway companies. Of course, TWA (Transcontinental), American and United Airlines are most likely to be well supplied with help for they are the best known, but there are many smaller airways organizations scattered all over the United States which not only pay well but with which the chances of obtaining employment are very good. But one must be an operator with real ability for speedy handling of traffic. The additional knowl-

edge of meteorology is an asset for these jobs. A list of these companies can be had from any call book containing radio calls.

Broadcast stations are next in line for assault, but, first, consider that the larger stations are fairly well organized under union regulations. Then, too, men over thirty years of age would do well to forget them. The smaller broadcast stations should be contacted. Here education and background are great assets. After one has had a lot of experience on these smaller stations then, and then only, should he try for the larger stations or the networks.

From here we go directly to the harbor telephone stations which are gradually encircling the United States from the Atlantic to the Pacific and
(Continued on page 61)

U. S. Army control radiop.

Pacific plane radiop.

S. A. Pan Am. flight radiop.



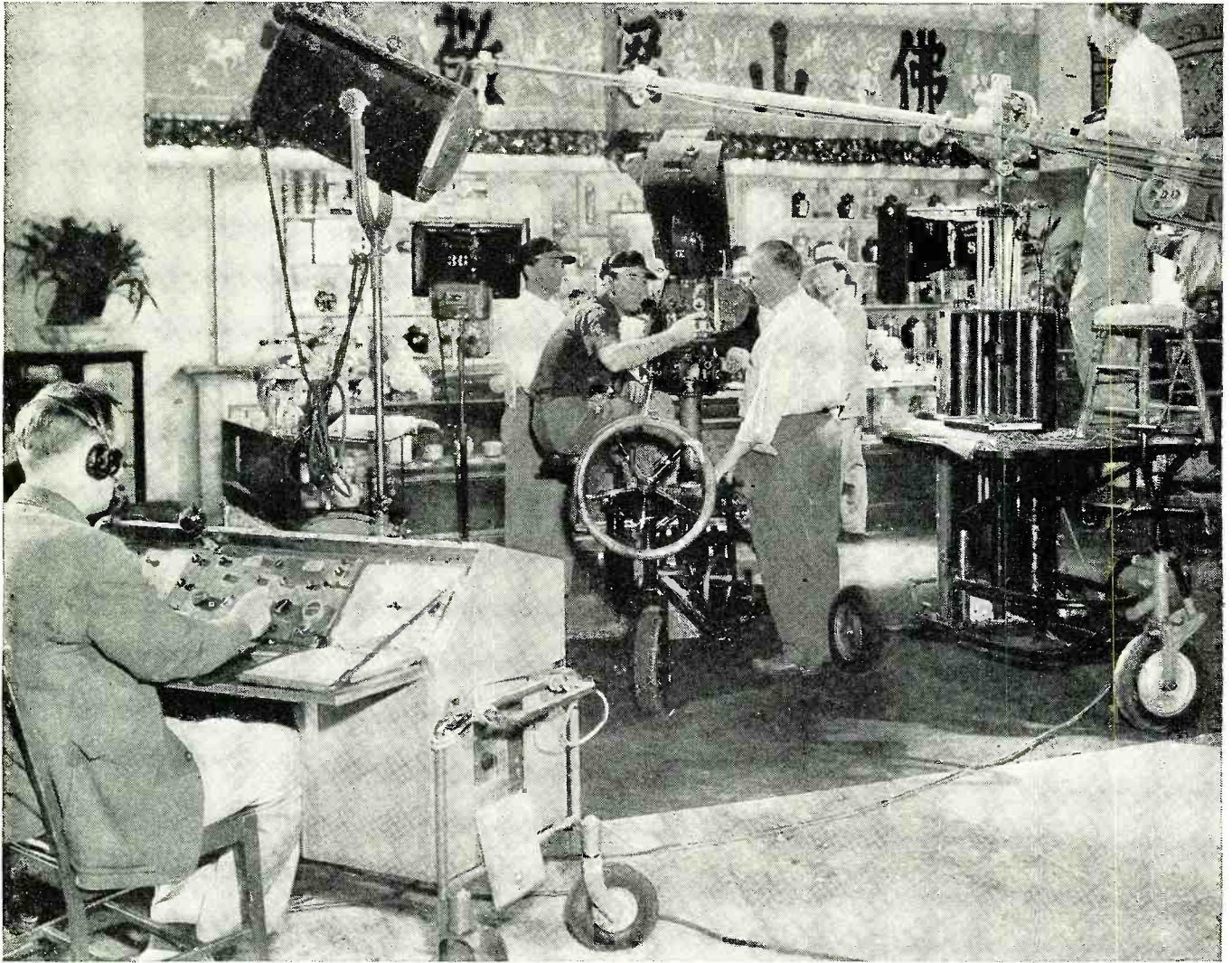

A typical scene from which are produced our talking pictures. Note monitor in the foreground, and boom microphone.

The Electronic Technique o Making Talking Pictures

by **JERRY COLDBY**

Van Nuys, California

Nearly everybody sees the "talkies", but here is the inside story of how the "sound" part is produced on film

SINCE the first commercially successful talking motion picture was shown to the world by Warner Brothers and the Vitaphone Corporation at Warner's Theatre in New York City on August 6, 1926, the motion picture industry with the aid of Western Electric as represented by Electrical Research Products, Inc., and the RCA Manufacturing Company, have endeavored to improve the apparatus for recording sound on film to the point of almost automatic perfection. Most of these improvements came about through the practical methods of experience and study,

where Mother Necessity made it imperative that certain special apparatus be perfected to cope with different temperature or acoustic conditions which cropped up during production work.

Although most of the major studios have been using either RCA or WE equipment or a combination of both, some of the latest developed apparatus is housed in the Paramount Picture Studios, Hollywood, California. There are two general types of recording in common use, the one generally in use in the WE system being called "variable density" and the RCA system is

termed "variable area." Both are used.

Recording by the "variable density" method gives a film record which varies in density, producing the modulations of light through a slit of constant width. The sound track is photographed on the film by passing a constant light through a device called the light valve which consists of two strips of duraluminum ribbon .0005 inch in thickness and .006 inch wide. These ribbons are spaced approximately .001 inch apart and when placed in a strong magnetic field and the signal passed through them, the ribbons alternately come together and push

apart. These ribbons have a natural frequency of their own and are tuned in a manner similar to that of a violin string to a frequency in excess of 10,000 cycles per second.

Recording by the "variable area" system consists of a slit of constant width upon which is impressed a beam of light which varies in its length by means of a small mirror attached to an actuated galvanometer producing a sound track, which while of constant density, varies in area.

In this article we will deal with the Variable Density system inasmuch as the sound engineers of the Paramount Studios believe that the almost perfect goal of high fidelity reproduction of sound on film you now hear in your favorite theatre is due to its method of recording the signal.

There are many places to start from in order to explain the various steps of electrical amplification which are applied to a sound wave, be it speech, piano recital or orchestration, before it is photographed on the final film, but we think it is best to take the signal from the time it leaves a performer's mouth through the various pieces of equipment until it reaches the Recorder, where the original negative has the sound track imprinted upon it.

As is commonly known, the Mike Boom suspends a microphone of the Dynamic type over the performers, sufficiently distant from the subject to be out of camera range. The Dynamic microphone is very similar to the common type of Dynamic speaker having a voice coil moving in a small airgap in a concentrated magnetic field but instead of the common paper cone, the cone in this motion picture Dynamic microphone is made of duraluminum about 1/1000th inch thick.

The performer's voice sets up a movement in the diaphragm which generates electrical currents. This signal then goes into the pre-amplifier portion of an RA-1001 pickup amplifier which has been designed especially for motion picture production. It consists of an input transformer feeding a WE 262A tube which is transformer coupled to a Mixer dial, commonly called a volume control. There are three of these units in the Mixer console, each of which may control the output of a microphone on the production set. These three amplifiers, each with its own volume control which are manually controlled and set by a Mixer operator, are coupled together to the input of a two stage amplifier composed of two 262A tubes, the output of which feeds the Main volume control for the recording circuit. This is called the Booster section which boosts the signal as much as 60 db (decibels) or approximately 1,000,000 times the power. There is a volume indicator in this pickup unit for measuring the level to the recording modulator and the headphone monitor level for the Mixer operator.

After the signal leaves the Main volume control it passes through a number of corrective circuits to enable the Mixer to make corrections for reflections of sound, boominess of the production set and other influences which tend to lower the quality of the signal. These circuits are, in the order named, a low frequency suppressor called a dialogue equalizer, tuned to 100 cycles, a high frequency booster tuned at 5000 cycles and a 60 cycle high pass filter designed to eliminate

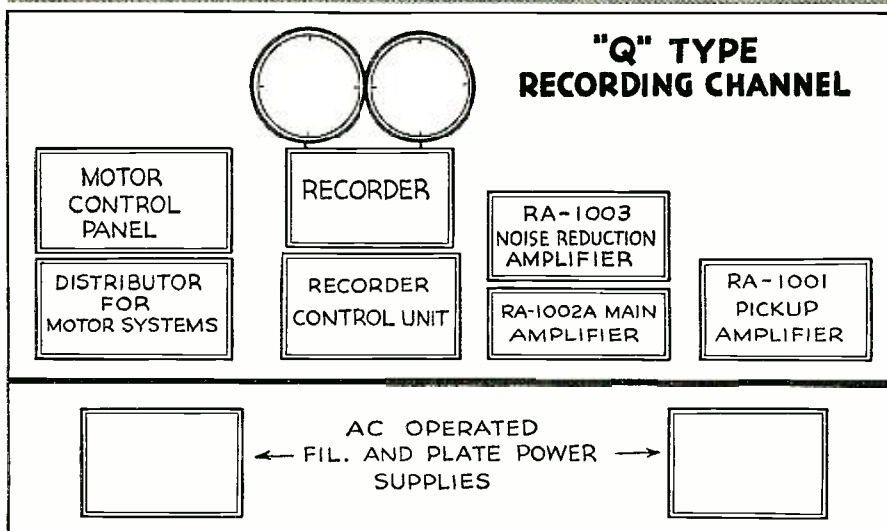

The "Q" type recording channel illustrated in diagram and picture.

rumble in the extreme low sounds. The first two named elements are adjustable in the amount of their effect. These units are constant impedance equalizing circuits which present a constant load regardless of the frequency and take the lows out and boost the high frequencies. Also, this circuit is used because of acoustic problems.

The characteristics of the human ear are such that it is necessary to reproduce a signal at the same volume as the source, assuming the use of a flat system, in order to make the final output an exact facsimile of the original signal. Actually for theatre use, it is necessary that the output be much greater than the original source and in order to compensate for this, the low frequencies must be partially removed to prevent "tubbiness."

From the corrective circuit we go into two more stages of amplification, the first being a single 262A tube transformer coupled to the grids of a pair of 294A tubes which are pentodes and simultaneously coupled to the grids of a pair of 262A tubes. The out-

puts of the 294A tubes has connected across them a volume indicator on the secondary of the output transformer which is a 500 ohm circuit. The outputs of the two 262A tubes are fed through another step-down transformer for the headphone monitoring of the Mixer and the Mike Boom operators. This is done so that these operators can judge the quality of the signal as it is being recorded.

In order to decrease high frequency losses due to cable capacitance between the production sets and the Recording Building, this circuit is further transformed to an impedance of 125 ohms and transmitted to the building.

Arriving at the Recording Building, the signal is routed to the proper recording channel and transformed to an impedance of 500 ohms and fed to a Bridging Bus. This Bus is a terminated line to which the recording circuits are connected. Various recording units through their own AC Bridging amplifiers are connected to this Bus. The monitoring circuit for the recorder is also supplied by this Bus.

Before the signal is imprinted on the

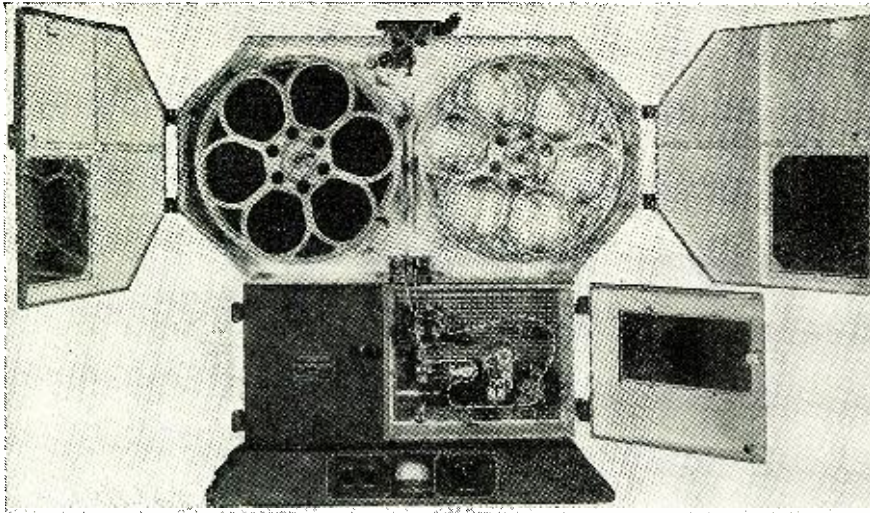

W.E. recording machine, known as a "dummy".

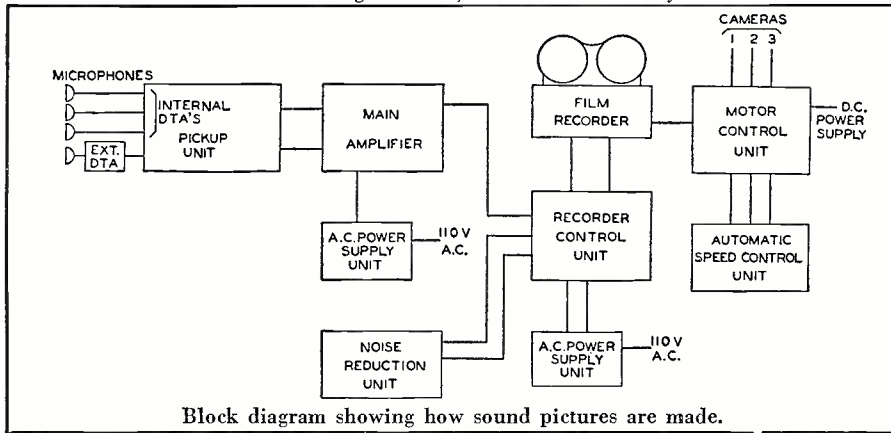

Block diagram showing how sound pictures are made.

original negative (dialogue) it must first go through an AC Bridging amplifier, a modified D-86840, which is designed essentially to drive various recording equipment. This is a single stage amplifier whose input impedance is designed to bridge a 500 ohm circuit and which incorporates a pair of WE 271A's in push-pull.

Following the bridging amplifier is a 7500 cycle low pass filter which feeds a resistance pad followed by a matching transformer which matches the 500 ohm circuit to the 2 ohm circuit of the light valve. The output of this 7500 cycle low pass filter is bridged by a Noise Reduction amplifier.

Noise reduction is accomplished by decreasing the slit-width to approximately 3/10ths its normal width when no signal is being transmitted. This reduces the exposure on the negative making the track lighter. The negative when lighter obviously makes the print darker, and less unmodulated light will fall on the photocell in the sound projector. This reduces the hiss due to the grains in the film emulsion. With the reduced spacing between the light valve ribbons it is easy to see that the passage of the signal would cause the ribbons to "clash" more easily so some means must be introduced to prevent this. This is the function of the Noise Reduction amplifier. This latter amplifier takes a portion of the signal, amplifies it and feeds it to a rectifier and filter network which is also fed to the light valve. This light valve is so polarized as to buck out the fixed DC bias on the ribbons thereby opening the valve up to its normal width permitting the passage of the signal of greater in-

(Continued on page 40)

TABLE I
VACUUM TUBE CHARACTERISTICS OF TUBES DISCUSSED IN TEXT.

WE Tube	Heater or Filament	Plate Voltage	Screen Grid Voltage	Control Grid Voltage	Plate Current	Screen Current	Amplification Factor	Plate Resistance Ohms	Power Output Watts	
262-A	10 V	135		-7.5	0.7		13.7	29,000		Low power triode with indirectly heated cathode. RCA 76 type nearest equivalent.
294-A	10 V	180	180	-18.0	14.5	3.3	105	100,000	1.2	Power amplifier pentode with indirectly heated cathode. RCA 41 type nearest equivalent.
271-A	5 V	350		-20	51.0		8.6	2460	1.6	Moderate power triode with indirectly heated cathode. No RCA equivalent.
300-A	5 V	300		-61	60		3.85	700	5.6	Moderate power filamentary triode for Class A service. RCA 2A3 nearest equivalent.
275-A	5 V	250		-65	41		2.7	1170	3.2	Moderate power filamentary triode. No RCA equivalent.
284-A	10 V	1000		-165	85		4.8	1700	33.3	Filamentary air-cooled triode. RCA 845 nearest equivalent.
310-A	10 V	180	135	-3	5.4		1800	1.2 megohms	0.34	Voltage - amplifier suppressor-grid pentode with indirectly heated cathode. RCA 1603 nearest equivalent.

A S . . . SEE IT!

by **JOHN F. RIDER**

Dean of the Servicemen

FM Goes Commercial

THE latest word from the FCC is that they have licensed about 15 stations operating with frequency-modulated carriers to accept commercial programs. Don't confuse this number of stations with the total number now in operation in the United States. There are many more in action than these fifteen, but a large portion of the total group are still functioning as experimental stations. The fifteen stations are spread around the country and according to the FCC report, the area served by these stations is about 110,000 square miles with a population of about 27,000,000.

Some of these stations are actual networks, as for example the *Yankee Network* covering New England and the *Don Lee Broadcasting System* in Los Angeles. The operating frequency range of the stations which have been granted permission to go commercial, lies between 43.5 mc and 45.5 mc.

Just how soon the other FM stations on the air will be given similar permission is not known, or for that matter the exact number of station licenses pending, but it is known that the requests for FM station licenses are advancing at a rapid rate and that construction of such stations is also on the move.

All of this means one certain thing, namely that activity in FM receiver sales will receive a definite push forward and when receiver sales advance, service activity advances along with it. Since the major trend today is towards the sale of receivers which embrace FM as well as AM form of signals, the servicing of FM receivers will have to be taken in your stride. This will not prove a problem. A greater problem might be the explanation of just what FM operation is to people who might buy FM converters and want them installed and those who buy a combination receiver and want to know what FM is all about.

Learning by Doing

ABOUT 15 years ago we conducted a radio school in New York City. Being occupied in the daytime, the school operated only at night and those who were interested in attending (and if our memory does not fail us, we had an enrollment of about 90 students) were content to show up around 7:30 p.m. and stay until maybe 1 or 2 a.m., at least until the evening lectures were finished. After several terms we had to give up the school because our energy ran out. However, what happened there has for all these years occupied a niche in our mind.

Well, since that time we have observed the manner in which students react to different methods of training and as is to be expected the man who puts facts into his brain by actually performing the deed seems to remember it much longer. With this in mind we have wondered why more stress has not been placed upon home study by actual experiment. We realize that numerous correspondence schools

provide equipment for the student so that he can build the apparatus covered in the text and observe its operation. That method of teaching is ideal for those people who are not in a position to attend a resident school.

But how about the practicing serviceman—the man who is not taking any courses of any kind, the man who is doing service work each day as his means of earning his livelihood? He gathers facts from books, which is all right as far as it goes, but would it not be a good idea during some of those spare moments, or perhaps during an hour a day assigned for study, to investigate the theory contained in books by working upon equipment in the shop? . . . We've tried that and it works marvels, so that we speak from experience and that goes for a number of men we know.

No book can cover every variable during the explanation of a phenomenon, nor can a book devoted to theory anticipate every question which might arise in the mind of that reader. But when a man who is reading a text, or has read a text, tries the things spoken about, the means of answering the questions which crop into his mind are at his finger tips. More than that, he can introduce the variables which are seldom, if ever, covered in radio texts, since their comprehension is taken for granted when the basic conditions are stated, and actually note what final results develop. The mind retains such details to a much greater extent than when they are read in a text or when they are quoted in a lecture. In fact experience proves that the laboratory work in school contributes a tremendous amount to the absorption of knowledge. And last, but by far not the least, is the fact that operating in this manner makes it easier to read a text.

All of this does not mean that a service shop must be turned into a laboratory. Every radio service shop



John F. Rider

has all of the needed equipment on hand. If a man is reading a text on vacuum tubes, it is a relatively simple matter to make up an experimental and very versatile test set-up for checking operating conditions. In this connection it is very interesting to note, and this is not said in the way of criticism, that much of the data about available tubes does not conform with the specific conditions created when the tube is used in the receiver or amplifier or oscillator. By this we do not mean that the tube data are wrong, for such is not the case, but we honestly believe that it is not as practical as it could be.

The majority of texts quote the correct conditions and say very little about what happens if the conditions are incorrect. And strange as it may seem, the condition which must be understood is what happens when conditions are not correct, for that represents the trouble which the serviceman must remedy. Why not take the time to supplement text book reading with some experiments? It'll pay out in the long run.

Those Constructional Articles

WE'LL start this short discussion by first explaining to those men who prepare constructional articles for radio magazines that these few comments are not intended as dis-

(Continued on page 56)



A HAM'S NATIONAL DEFENSE PORTABLE RIG

by **KARL A. KOPETZKY, W9QEA**

Managing Editor, RADIO NEWS

FROM time to time numerous attempts have been made, both by this publication and by others, to engage the amateur in general in the construction of a large number of universal transmitters and receivers, which might be used in a national emergency such as we might face were this country to go to war.

One of the major problems confronting such a program has been that the design of either the receiver or the transmitter produced a unit which had a very limited application whenever it was used for something other than portable, or mobile, or emergency use. Going into this matter more carefully, it was discovered that the weak link in the chain was the receiver, many hams preferring not to build one since they were unable to accomplish the same efficient results in home construction which might be obtained in a manufacturer's product. Quite the reverse was true with regard to transmitters. In the matter of these rigs, the amateur has long been known for his ability and his desire to construct his own transmitter along ideas which he himself either originated, or copied. In fact, the transmitter of the amateur is one of his expressions of individuality. Taking our lead from this situation, it was decided to dispense with the construction of a receiver and to design the emergency rig around a manufactured receiver which might be obtained from any regularly reliable source.

A number of considerations controlled the choice of a receiver. It had to be selective, it had to be reasonably priced, and it had to cover all frequencies in the broadcast spectrum and to include everything down to beyond 10 meters. In addition to this, it had to be portable and it would be even more flexible if it were capable of operating not only from batteries but also from a 115 volts a.c. or d.c. line. It also had to be light-weight and not cumbersome in size, and in the final analysis there would have to be room within the receiver cabinet itself for the inclusion of a small, light-weight, low powered transmitter.

Although there may be several receivers which fully meet this qualification, the one chosen was the *Hall-*

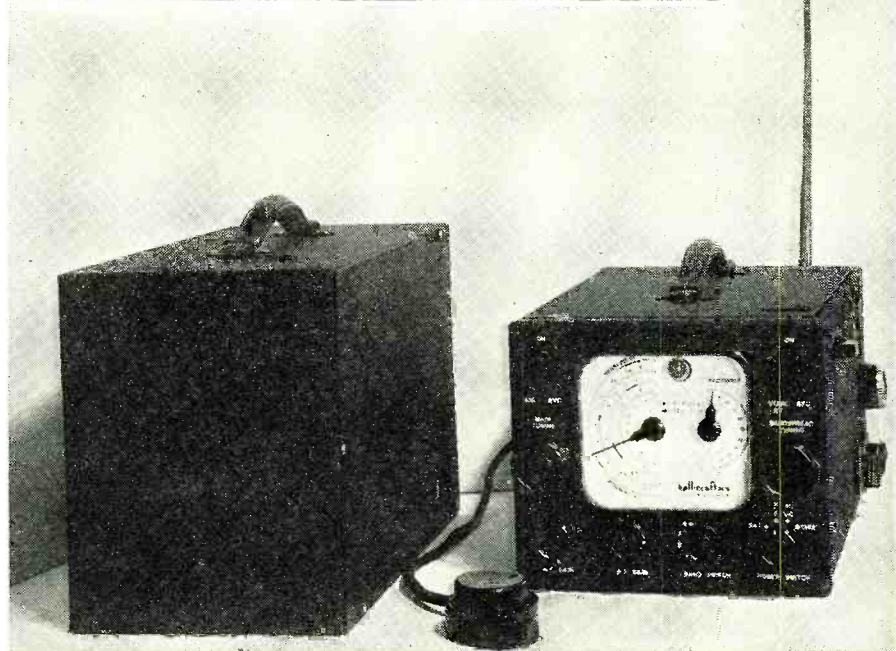

The completed unit can be used on 115v. AC or 6v. DC.

An ideal unit for short hauls; and a starter towards a standardized ham rig for Uncle Sam should a National Emergency ever be declared.

crafters Model S-29 Sky Traveler. This little superheterodyne is tunable from 540 to 30,500 kcs. in four bands. Its size was not cumbersome, and batteries are included directly within the carrying case containing the receiver. In actual field tests made with the *Model S-29* it was discovered that the unit was extremely sensitive and selective and that it was worthy of any amateur's desk if for no other reason than that it was a steadfastly excellent performer. For example, using it on a long trip through the West, we found that the small collapsible antenna with which the *S-29* is equipped gave sufficient pick-up to hear amateurs from both coasts and from Canada to Mexico. The receiver can also

be used with 115 volts a.c. and d.c. Included is a BFO and a bandspread dial so necessary for communications purposes. As its sole drawback it might be stated that the antenna would be very small when used for transmitting purposes. However, since the conversion was ours and not the manufacturer's, no blame for this can be attached to the latter since he designed the receiver especially to work with its own antenna.

After we had removed the batteries and designed the little transmitter to go into the spot normally taken up by them, we found that we had a truly portable station and also one which could be used on occasion with 115 v. a.c. and 6 v. d.c. storage battery.

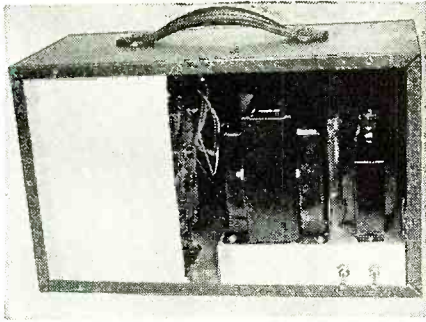

Inside the power-pack cabinet.

The completed unit, illustrated above, is compact in every respect, sufficiently light-weight to be easily transportable, and even on the small 28 inch antenna, using 160 meter phone, has done excellent DX work in the neighborhood of from 10 to 50 miles with an input power of 12 watts. On 10 meters a slightly greater amount of DX has been experienced.

Following the customary design of the U. S. Signal Corps, the power supplies are included in a separate case to which a carrying handle has been attached. Within this case are located the batteries (and large over-size "B" batteries were substituted for the small ones which formerly were in the receiver), the 6 volt d.c. vibrator power supply (which is easily convertible to 110 volt a.c. power supply by merely changing a plug), and the 115 volt a.c.-d.c. lines emanating from the receiver itself.

Sufficiently long connecting cables were allowed between the battery and power case and the receiver-transmitter to permit the unit to be placed upon a table and a power-supply-battery case to be placed upon the floor. This obviated the necessity of disturbing any antenna connection and any settings of the transmitter in renewing the batteries or doing any servicing of the power supply, it being presupposed that more than one power supply would be available. In this latter case, one simply detaches the case which contains the exhausted batteries and connects a fresh one; meanwhile the one that is removed may be renewed with new batteries, or service work done on the power supply as the case may be, without interrupting the operating of the transmitter-receiver proper.

Circuit Considerations

Nothing much will be mentioned concerning the circuit of the S-29 since it is a standard superheterodyne circuit, and it comes fully wired, ready to go. The transmitter, however, is another story. Following the circuit of the transmitter which appeared in the February, 1940, issue of RADIO NEWS and which proved itself so successful, the little transmitter is de-

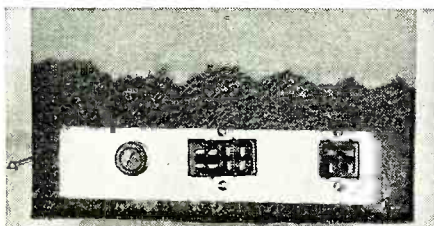

Connector end of power-pack cabinet.

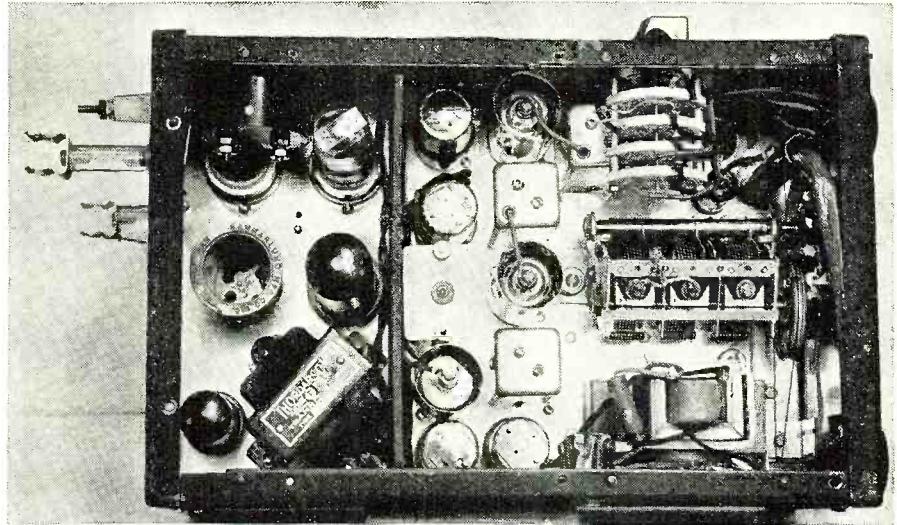

The transmitter-receiver: Hallcrafters S-29 at right, xmtr, left.

signed along the very same lines. It covers all ham bands down to and including 10 m. It consists of a 6J5GT Pierce oscillator coupled to a 6L6 metal tube amplifier. This is in turn modulated, whenever phone bands are used, by a 6V6 modulator. The modulator tube is driven directly by a single button microphone coupled through a transformer. The power supply is of the universal 6 volt d.c., 115 volt a.c. type and contains a Malory vibrator and a 6W5G rectifier tube for use with 115 volts a.c. No 115 volt d.c. power input is provided to the transmitter.

The crystal is mounted externally on the rear of the receiver unit and the coils in the amplifier section of the 6L6 are easily changeable through a small door cut in the rear of the receiver compartment itself.

A number of other refinements were made. For example, a change-over switch consisting of four Isolantite pies was inserted in the side of the receiver cabinet so that rapid change-over from transmitting to receiving could be made by means of only one switch. One section of this change-over switch parallels the "stand-by" switch appearing in the front of the receiver itself, while the balance of the pies are used to disconnect the "B" of the power supply of the transmitter and to disconnect the antenna from the receiver during transmission.

Since the insulation of the collapsible antenna as furnished by the manufacturer is of a rubber grommet variety, and while entirely satisfactory

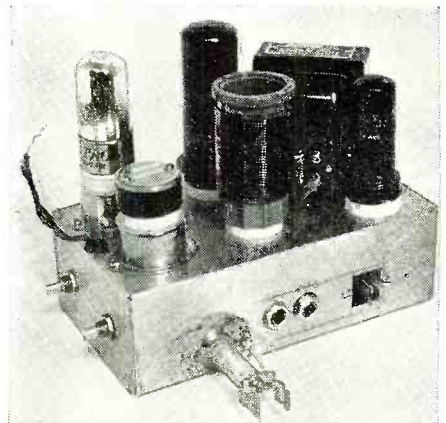

The transmitter chassis.

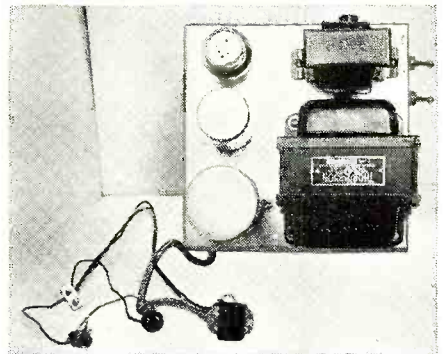

The power-pack chassis.

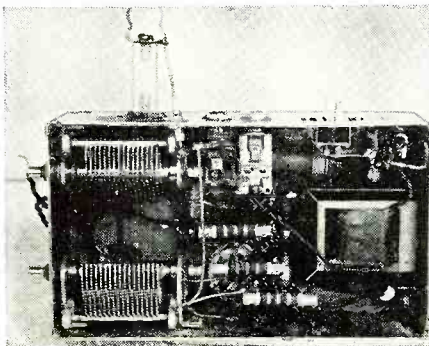

Underchassis view of transmitter.

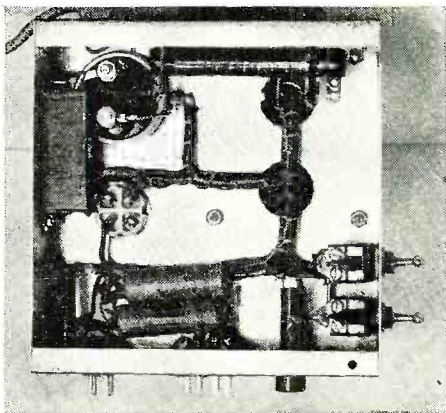

Underchassis view of power-pack.

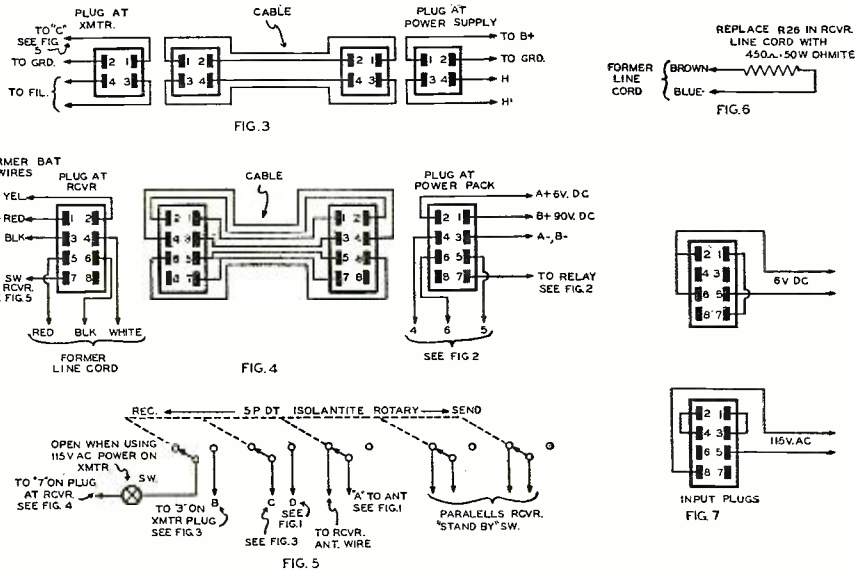

Plug and switch details.

for receiving purposes, would prove very poor for transmitting purposes, the collapsible antenna was removed from its socket and placed in the rear of the receiver case. Here it is mounted on two *Amphenol* Polystyrene stand-off insulators and held in position by means of *Mallory* clips. Connection to the antenna is made by wire fed through the transmitter chassis itself by means of *Millen* feed-through bushings which occupy little space and do an excellent job.

Key and 'phone jacks to the transmitter are reached through the rear of the receiver cabinet in a slot which already comes cut by the manufacturer. In order to use this slot, the rear of the cabinet is removed, the swinging metal "door" is removed and the rear panel is turned up-side down so that the slot, which formerly held the a.c. receiver line, is placed on the bottom where it affords easy access not only to the plugs, but to the antenna posts and to the key and microphone jacks.

The resistance line, which the manufacturer furnishes with the receiver, is removed and two *Ohmite* 450 ohm vitreous 50 watt resistors are substituted. One of these resistors is placed in the bottom of the receiver itself and the other is placed in the power supply chassis. In making this change, the constructor is advised to follow the wiring carefully so as not to place the resistors in the wrong legs.

In connecting the receiving part of the antenna, a lead is run from the former bushing which fastened to the base of the column of the collapsible antenna to the proper pie of the change-over switch. From there it is run directly to an upper stand-off insulator, making connection with the collapsible antenna when it is placed in the clips. In other words, when the receiver is in operation, the antenna is not disconnected from the transmitter; but when the transmitter is in operation, the receiver is disconnected from the transmitter antenna circuit.

Construction

The transmitter chassis can be made to order at a reasonable price by almost any radio jobber, and it measures 4½" by 7½" by 2¼". Ordinary electrical material is used. The

power supply chassis is a standard *Bud* component measuring 7" by 7" by 2" and the power supply cabinet is also a standard *Bud* unit measuring 14¾" by 7" by 9¼". Considering first the construction of the transmitter, it is extremely necessary that the following advice on the wiring and location of parts be followed if the constructor is to get all of his parts within the small space allowed in the transmitter chassis.

First, locate all necessary holes and drill them. Punch out all necessary socket holes, wherever they are indicated in the illustration. The crystal 6J5GT oscillator tube and the crystal socket proper must be mounted above the chassis by means of the *Amphenol* cups, which may be obtained at slight cost. A 5-prong plug is made by sawing off the base of a *Millen*

5-prong coil form since not enough room remains between the top of the crystal socket and the bottom of the meter were a regular 5-prong plug to be used. A regular *Millen* feed-through crystal socket is mounted in back of the side of the receiver, and connected by means of flexible leads to the 5-prong plug so that the crystal may be placed externally on the side of the receiver where it may be easily changed for rapid band-switching and changing of frequency within any one band.

After the crystal and oscillator tube sockets have been mounted, the balance of the tube sockets may be mounted and the speech and modulator transformers. Proceed now with the wiring in the following order. First, wire all filaments, terminating them at the proper plug contacts. Second, wire all r.f. wiring, including the connections to the coil sockets and to the Marconi network, which is included in the amplifier output section. After all the r.f. wiring has been completed, and there remains nothing else to do in connection with this, then the audio is wired. In connecting up the r.f. circuit it is wise to bring out the leads from the oscillator tube and the crystal because with the inclusion of the Hammarlund condensers, it will be difficult, if not impossible, to get at these connections in order to do the soldering. Do not forget to leave sufficiently long leads to connect in the plate supply of the final amplifier the meter which is indicated on the diagram. Run all wiring by the most direct route possible and make certain that all leads are properly and tightly soldered before going on to the next one. A poorly soldered lead, in this particular rig, will be most difficult not only to trace, but to correct since the units are jammed in so tightly due to the small space available for the transmitter within the receiver unit.

There is nothing tricky about this

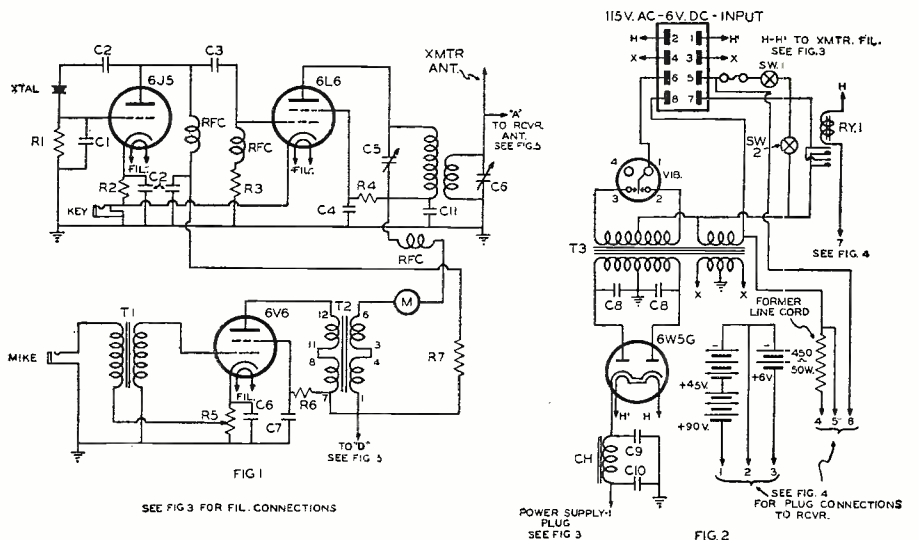

Circuit diagram of the transmitter part.

- R₁—25,000 ohms, 1 w. *Aerovox*
- R₂—1,000 ohms, 1 w. *Aerovox*
- R₃—100,000 ohms, 1 w. *Aerovox*
- R₄—15,000 ohms, 10 w. *Ohmite*
- R₅—300 adjustable. *Ohmite*
- R₆—25,000 ohms, 1 w. *Aerovox*
- R₇—5,000 ohms, 10 w. *Ohmite*
- C₁—.00005 mfd. mica. *Sprague*
- C₂—.002 mfd. mica. *Sprague*
- C₃—.00025 mfd. mica. *Sprague*
- C₄—.002 mfd. mica. *Sprague*
- C₅, C₁₁—200 mmfd. variable. *Hammarlund MC200M*
- C₆—25 mfd. 25 v. electro. *Mallory*

- C₇—.1 mfd. 600 v. paper. *Sprague*
- C₈—.05 mfd. 1,600 v. *Aerovox*
- C₉—4 mfd. 1,000 v. *Aerovox*
- C₁₀—8 mfd. 500 v. electro. *Mallory*
- T₁—Mike-to-grid. *Thordarson T-25A57*
- T₂—Modulation Trans. *Thordarson T-19M13*
- T₃—Universal trans. *Thordarson T-14R40*
- CH—100 ma. filter choke. *Thordarson T-57C53*
- Vibrator—*Mallory 825*
- RFC—2½ mhy r.f. chokes. *Millen*
- Connectors—*Howard B. Jones*
- Tubes—*RCA, Sockets. Millen*
- Tube socket shells. *Amphenol*

circuit. It is an old-time and tried one which has achieved publicity in a wide number of radio publications, but it is well to remember that grid and plate leads should not be run close together and that wire of sufficient size, certainly not less than No. 16, should be used in wiring the various components together. The connections on the modulation transformer are as follows: Terminal Number 12 connects to the plate of the 6V6, while Terminal Number 7 is connected to the high voltage supply, as is Terminal Number 1 of the secondary, while terminal Number 6 of the secondary is connected to the meter, which in turn is wired to the plate of the 6L6. The use of series feed in the final amplifier requires that condenser C5 in the plate circuit be insulated from the chassis, while condenser C11 has its rotor at ground potential.

As the constructor proceeds with the work on the transmitter chassis, numerous short cuts and idea will doubtlessly present themselves. These should each be carefully weighed before putting them into action. This is one type of transmitter that ought not to be "thrown" together.

The construction of the power supply should be commenced now. There is nothing outstandingly difficult or different about this particular unit. The construction is straightforward and extremely simple. Holes are drilled in the chassis to accommodate the various components in their proper position, and the sole wiring precaution is that the proper socket or out plug contact, as indicated on the diagram, should be used in order to prevent a burn-out either of the vibrator or of the power transformer. In the laboratory unit, wiring was all tied in the best approved fashion. This is a "show" policy which need not be followed by the amateur unless he is the type of person who is as proud of the bottom of his chassis as he is of the top.

After the power supply has been completed, the chassis of the power supply and the batteries should be inter-connected with the receiving transmitter unit for test.

Testing the Unit

It is wisest to follow this procedure in testing the completed unit. First, the receiver is tested as if there were not any transmitter present. Follow the manufacturers' instructions, switch the receiver to battery position and check for reception on all bands. Naturally, the collapsible antenna must be extended to its full length, and the change-over transmitting-receive switch must be in the "receive" position. If the receiver does not operate in the battery position, the "bugs," incorrect wiring, or mistakes in the cable connections should be instantly traced down and all further testing should be suspended until the receiver operates in the battery position. Next, the receiver is placed in the "receive" position for a.c. line operation, and a similar test is made. The same precautions as stated for battery operation apply to the a.c. operation of the receiver and no further tests should be made until the receiver operates properly on 115 volts a.c. Having gone this far, the transmitter is all ready for test on 115 volts a.c. *Caution: The transmitter does not operate on 115 volts d.c.!* Insert the proper plug
(Continued on page 60)



by ALFRED TOOMBS

Special Washington Correspondent for RADIO NEWS

Cryptographic Broadcasts

SECRECY which surrounds the work of the *Defense Communications Board* serves to emphasize the difficulties of the dynamite-laden situation which they approach.

The Board, which has been working steadily to draw up the plans by which radio would be regulated in this country in the event of war, has one of the toughest assignments handed any of the defense agencies. There is no precedent to guide them and they proceed with the knowledge that oversights in regulation of radio invite disaster.

There is evidence to support the belief that armies and nations have fallen in Europe in the last few months because of the use of radio. It is, if anything is, truly the dictators' "secret weapon."

The Federal Communications Commission has been quietly looking into an incident which is illustrative of one type of radio activity against which we must quickly devise an airtight defense. This incident involved the use of cryptography in a most startling fashion.

The names of the individuals and the broadcasting chain involved in this story are withheld, because they were as innocent as European broadcasters who were duped often in similar fashion—and when the chips were up.

There was a program broadcast one night over a national hook-up in the course of which a sports announcer interviewed a former heavyweight boxer. The continuity sounded entirely natural. Not a single one of the millions who listened, not the station managers who put on the program nor the men who spoke it knew he had sent out the following message:

"S112—S. S. Queen Elizabeth sails tonight with hundreds of airplanes for Halifax, N. B."

The message was concealed in the continuity by means of cryptography. The words were arranged by a predetermined code and the men who had the key were able to get the message. There was no element of espionage involved, however. The message was sent out by a man who took this means to convince skeptics that such things were possible.

That our Army and Navy intelligence services are woefully unaware of and unprepared for the possibility of such espionage activity is a truth which is worrying a few young and alert officers. The French were unaware and unprepared—while traitors had used Government stations to broadcast cryptographic messages which guided the Germans to the weakest place in the defense line, at Sedan. So were the British—until a weak transmitter ashore had guided into Scapa Flow the submarine which sunk the battleship Royal Ark.

Reserve Officers, familiar with radio, who have gone on active duty during the past few months have told this writer that the armed services are blissfully unaware of the espionage possibilities inherent in radio.

These young officers have pointed out the ease with which cryptograms can be hidden in regular broadcasts. Anyone who owns a banana stand can put a spot commercial announcement on the radio—and write the script himself. On a clear channel station, an advertising spot with numbers and words would carry for hundreds of miles.

Those who are patrolling the short waves—the Government agents and the *Radio Minutemen*—are naive if they are looking for code messages which will betray the fact that they ARE code. For the secret of a good cryptogram lies in the art of compos-

ing it so that no one will suspect that a message is concealed.

Nor are carefully chosen words the only method by which messages are hidden. For example, consider the discovery which was made about a broadcast emanating from one of Europe's most powerful short wave stations. Listeners noted that the broadcast was always preceded by a strange, buzzing sound which apparently was a burst of static, and that the same sound followed the program.

Convinced that the sound was not static, but a signal, an investigation was begun. At last, it was discovered that the noise was made by a record, sped up so that it didn't appear to be separate sounds. It undoubtedly was recorded by a listener somewhere, slowed down to normal tempo and the message translated.

The possibilities are almost endless. The FCC recognizes the diathermy sets which doctors use as a potential tool of the spy. A doctor with offices in New York which overlooked the harbor could observe ship movements, broadcast his observations by code to a doctor on the other side of town who could rebroadcast to an outlying station capable of sending the message to a ship at sea.

The FCC announcement of recent date that it was summoning doctors to discuss means by which diathermy machines could be regulated so as to stop interference with regular broadcasting reflected, in reality, this concern. The FCC is anxious to get these machines under control—and with good reason.

This will give some idea of the problem which the *Defense Communications Board* faces. Observers are hoping that the Board will approach the job with more vigor and imagination than did the luckless Europeans.

Army Radio Schools

THE Army for some weeks has been conducting a survey of American radio schools. It had directed inquiries to almost every school of any size in the country. Behind this activity lies the story—which this column tells here for the first time in full—of the Army's plans for building a corps of expert radiomen for defense.

As soon as the conscription machinery had been set in motion, the Signal Corps began to circularize radio schools to determine which were qualified to give courses of training in radio to the selectees. The answers have now been analyzed, the schools chosen and the training begun in some.

Young men who are drafted indicate on their Army cards their profession and hobbies. If either of these is radio, the chances are they will be assigned to the Signal Corps. Those whose experience is limited will be sent to regular radio schools at the Army's expense. There they will learn to operate and service radios, under a course, lasting about three months, suggested by the Army.

In most cases, the school will be located in the area in which their training camp is set up. The students will room and board at the school. When they have completed their studies, they will return to camp for practical training.

The Army is going to execute contracts with individual schools for the service and will include in the contracts the cost of room and board in schools where they are available.

This program is expected to continue for several years—and it looks like prosperity for a lot of schools.

One of the first schools to be "appointed"

(Continued on page 54)

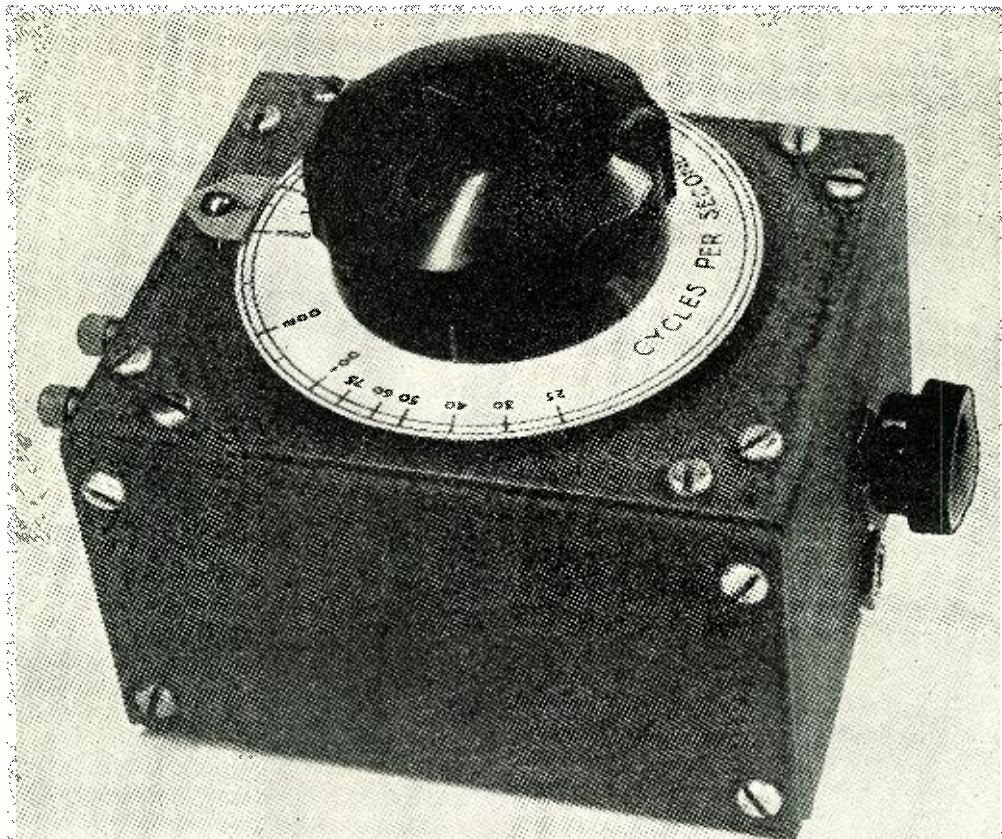

The finished instrument is easy to operate; makes a good lab unit.

DIRECT-READING AUDIO FREQUENCY ANALYZER

by RUFUS P. TURNER, W1AY

Cambridge, Massachusetts

The author describes a meter which has a myriad uses in the service shop or in the laboratory. Inexpensive to build.

WHETHER to meet a necessity or only to gratify scientific curiosity, to be able to identify audio frequencies is a useful advantage. The need arises often in the usual round of radio experience. A technician equipped to perform this operation has no difficulty in setting audio oscillators to desired frequencies, determining frequency drift from the measured pitch of a beat note, adjusting r.f. oscillators to a fraction of a kilocycle, or identifying the tones that serve as indicators in certain laboratory measurements.

Perhaps, the most familiar method of establishing the frequency of any sound consists in zero-beating the latter with a beat-frequency audio oscillator and reading the "unknown" frequency from the dial of that instrument. This method is widely used but requires special skill and somewhat costly apparatus. At the same time, it is neither rapid nor foolproof.

At least two instruments which simplify audio frequency measurement have been marketed for some time as laboratory gear. Both types are rapid enough of manipulation to hold down berths on a fast production line if they have to. But they are priced too dear

for the likes of amateurs and servicemen.

The author has duplicated one of these audio frequency meters on a less expensive scale and it is shown in this article. It is the well-known bridge-type instrument; and while this version will cost the builder just a trifle more than five dollars if it is built in accordance with the specifications given here, it is definitely not a toy and will give mighty good account of itself. It is only necessary to feed a tone signal of unknown frequency into this device, turn the dial until a null point is located, and then to read the frequency directly in cycles per second on the dial.

Looking at the Meter

Our bridge-type audio frequency meter is shown in photographic per-

spective in figure 1; its simple circuit diagram in figure 2. Constructional details appear in the section drawings of figure 4 which illustrate the most facile manner of mounting the few parts for straightforward wiring.

The instrument is very compact, measuring only 4¼ inches long, 4 inches wide, and 3 inches high, and is correspondingly light in weight. Being of such small girth, it is barely a single handful. Some idea of its small size may be gained by reference to the assembly screws appearing in the photograph, on the top and sides of the box.

The device covers the useful audio-frequency spectrum—25 to 10,000 cycles per second—in one complete rotation of the frequency dial. There is no range switching. The dial is calibrated to read 37 frequencies directly.

The dial scale is not uniform, as may

Serviceman's Experiences

by LEE SHELDON

Chicago, Illinois

Speed is a necessary thing if you want to be a success in servicing.

UR 'phone rang, and Al answered it. My partner is one of those fellows who repeats everything he hears, so it was easy to follow the conversation:

"Salutary Sales & Service! (Pause) Yes, ma'am—we do. (Pause) Brandon, B-r-a-n-d-o-n, 4445 45th Street. (Pause) Brunswick. Oh—Brunswick 31. (Pause) Right away, if you wish. (Pause) Yes, I'll send a man immediately. Thank you, Mrs. Brandon."

He hung up quickly and turned to me.

"Here, hired help," he announced, "here's a call to—"

"I got it," I interrupted. "Brandon, 4445 45th. Brunswick."

"Right away," he added.

"I got that, too," I said, pulling on my mackinaw. "Who knows—maybe I'm psychic!"

"Right away means now," he replied. "Stop talking and travel!"

I slowed down instinctively. No one can crack the whip over me. I got rights. When I reached the front door, I stopped, snapped my fingers, and said: "Whoops! Almost forgot!"

While he watched, wondering what was wrong, I deliberately took off my coat and mackinaw.

"Look, my Fabian friend," he said, "answer that call, and we'll play games later!"

Without answering, I slowly rolled down my shirt sleeves, buttoned my

cuffs, and put on my coats.

"One must always be dressed properly," I remarked, as if to myself. Then, brushing my hands against each other, I picked up my toolcase, stepped back elaborately as I opened the door, and walked sedately to the truck. I'd show him!

I got a rag from under the seat and wiped the windshield. Then I checked the oil, and looked into the radiator. I walked slowly around the bus and kicked each tire. Then I went to the spare, and listened for a leak at the valve, holding the valve cap with unnecessary daintiness.

When the inspection was finished, I jumped into the driver's seat and drove off briskly. As I swung around to the opposite curb, I glanced back. It was very gratifying to get Al's reaction; at fifty feet, I could see his neck was red.

Of course, I knew the customer was waiting—but why not? They think more of you when you're late. After all—Brunswick 31! Chances are that a set like that is ten years old, and if a customer has waited ten years, what difference would ten minutes make? With these thoughts in mind, I stopped off for coffee.

I arrived at 4445 a little later than I'd planned; but no matter—I'd be able to boast of it later to my partner. Let the customer burn! I rose high on my toes and hummed as I walked into the building.

Stooping over, I hunted for the push-button under "Brandon." Incidentally, why is it the placement of all apartment house bell buttons is never more than three feet from the floor? We live in a marvelous age: men fly through the stratosphere, most peanut machines work, and gadgets have been devised to do everything but wrap Christmas packages. Then why doesn't some contractor install a bell plate that can be examined without dropping to your knees?

Finally, under 4B, I found the button, and the door release buzzed its mechanical welcome. I walked through the lobby to the automatic elevator and pressed the call button. Nothing happened. This is unnatural. Man, in this automatic world, has become so conditioned that he expects action whenever he pushes a button or turns a knob. He feels gypped when there is no whir, no music, or no swish of water.

I opened both car doors, stepped inside, and closed them. With a toolbag, this action is not simple. The car began to ascend before I could reach the number 4 button. It's a weird feeling, being wafted through a strange elevator shaft to an unknown destination. There were six floors in the building; the car, of course, went to the top.

The doors opened, and I stepped back politely. An angry man entered, slammed both doors shut, and—without looking at me—poked button number 1.

"So who cares?" he muttered to himself, pushing his mashed hat back on his head. "Go back home to your mother!"

At the main floor, he yanked the doors open and strode to the street.

Just as I incarcerated myself again and was reaching toward the control panel, I heard a woman call.

"Yoo-hoo! Yoo-hoo!" she shouted. "Would you mind waiting, please?" She was leading a huge dog—a St. Bernard that would be more at home in a hunting lodge than in an apartment house.

"Here," she added, handing the leash to me, "please hold him while I get my baby buggy."

Well, it was pretty tight after we all got in. The woman had to lean over the perambulator to reach the control panel. The dog—which had to stand on its hind legs—looked down at me as if I was to blame.

"That animal been fed lately?" I asked, hoping I didn't resemble a lamb chop.

"What floor?" she parried.

I knew I couldn't get out first, so I said:

"Go on to number six—I'll get out later."

"How do you know I live on the sixth floor?" she asked on the way up.

"You'd know such things, too," I re-

(Continued on page 65)

SOMETIMES WE FEEL LIKE THAT!



Mike and Speake Placements

by Clark E. Jackson

Sound Engineer, New York, N. Y.

By following the principles laid down by the author the sound technician will be able to save time and money.

In order to apply intelligently the correct placement of microphones or speakers, the layman should have a fair knowledge of audio acoustics and their application. Up to the time that *directional* units were made available it was largely a matter of hit-and-miss in locating the various microphones and speakers at a "difficult location" and the results were always in doubt as far as satisfactory reproduction was concerned. Not only are the basic fundamentals needed by the PA man, but by the studio engineer, the recordist, and the amateur operator who spends his time at the mike in preference to the key.

Those who have engaged in public address applications have gained most of their knowledge from actual installation and operation of the equipment. There are many, on the other hand, that have had no opportunity to learn from actual service in the field and these are always eager to learn as much as possible from those who have been more fortunate.

Much information has been gleaned from working with microphones in recording and in PA work. These findings will be passed along in the form of information that has been found to be most effective for specific cases. Two things are certain: first that a microphone be so positioned that it will pick up, all frequencies with equal effectiveness and fidelity, and second, that in the case of a loudspeaker that it be placed in such a position that full coverage without feedback be obtained.

Microphone Placement

To begin with, the microphone should be chosen for the particular job at hand. If an installation is to be made in a large concert hall, for example, certain acoustical conditions

must be studied and analyzed before a permanent setup can be made properly. First is the general layout of the hall or auditorium. Is it large or small, high ceiling or low, are there any drapes scattered about over bare walls, are any other factors present which will add to or take away from the efficiency of the microphone as it is called upon to pick up the orchestra? All of these must be carefully examined and considered.

Any large hall—unless treated acoustically—offers quite a headache to the PA man or to the sound engineer from two basic phenomena—echo, or reverberation, and absorption. Echoes are caused by the hard surfaces of walls which permit sound waves to bounce around and actually to return to their original source. Absorption is caused by over-draped rooms with heavy carpets, too many open windows, overtreatment with sound-absorbing materials and also from the presence of a large audience in the auditorium.

Take, for example, the orchestra setup illustrated in Fig. 1. This stage is located at one end of a large auditorium and the seating capacity in the audience is, say, 4,000 people. A balcony and gallery are also included. The problem is to project and amplify the sounds picked up by the microphone to the highest seat in the gallery at a comfortable volume level. This level must be carefully adjusted so that the sound coming from the speakers will be above those heard direct from the orchestra without amplification. Remember that *time* or *time lag* is all important in an installation of this kind. If the loudspeakers are improperly located, the audience may "hear double."

This is caused by the ability of the sound to travel into the mike and out through the speakers at a faster rate than the direct sounds reach the audience. For that reason it is always best to place the speakers on a line

with the front of the stage so that they will be the same distance from the audience as the performers, or nearly so.

The correct type of microphone to use for this particular installation will depend upon whether it is to be permanent or temporary. If only a temporary setup is to be made it will be quite satisfactory to place a battery of microphones in front of the performers in a circle around the conductors stand. If the orchestra is large in number, fewer units will be required as a rule. In some cases it will be necessary to *reinforce* some particular section of the orchestra with another microphone and this must be done properly in order that a pleasing balance result.

A lot depends upon the ability and discrimination of the operator who "rides gain" on the program. While on the subject of riding gain, may we stress the importance of this when such a large installation is used. Don't rely too much on the mikes for such a large setup. The uni-directional type of dynamic microphone can be used to full advantage in this setup and their use is recommended. These have the ability to offer discrimination between sounds that appear in front or in back of the unit. They are designed so that the sensitivity, or pickup ability, is kept down for all sounds that appear in back of the mike, and possess maximum sensitivity from the front. If a Velocity mike is used, the singer may face the microphone on one side with the piano on the other.

Skating Rink

A typical installation for a skating arena is shown in Fig. 6. Note that a cluster of speaker trumpets are assembled in a group and suspended above the ice as indicated. These will

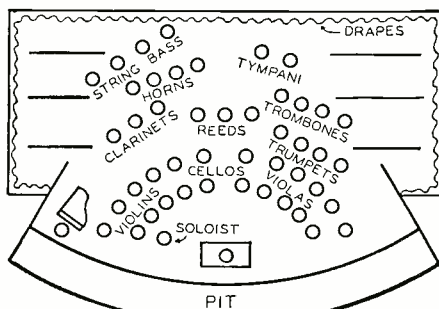

CONCERT ORCHESTRA
FIG. 1

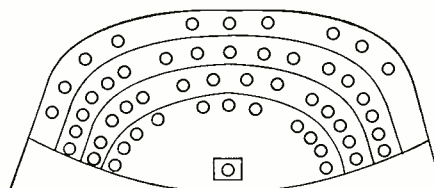

CONCERT BAND
FIG. 2

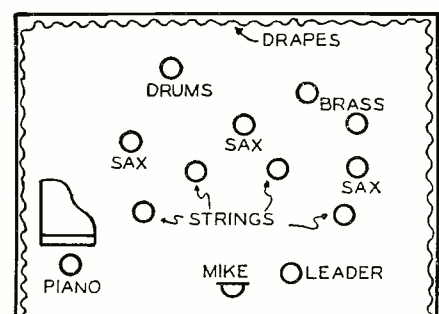

SMALL ORCHESTRA
FIG. 3

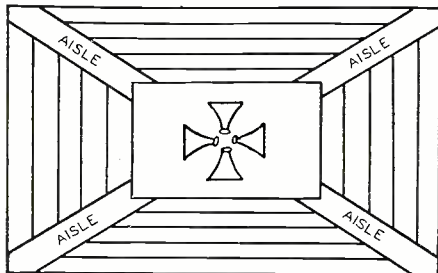

FIG. 6
SKATING RINK OR BOXING SHOW

vary in height according to the size area to be covered. This same setup would be used for a boxing show, etc. The announcer usually is stationed right at the ringside so it is necessary that the speakers be kept out of range of the microphone.

A close-talking variety of microphone is best suited for this type of installation as they have the ability to keep out a lot of crowd noise from being reinforced by the loudspeakers. At any rate, it is a good idea to try several types if they are available in order to select the one most suitable.

Auditorium

One type of installation that appears every so often is illustrated in Fig. 7. This is commonly found in high schools, etc. Many times a large group of singers must be picked up as they are assembled on the stage and where they occupy considerable floor space. It is well to use two or three microphones of similar types mounted on floor stands and placed in positions about 8 feet apart as indicated. This will permit satisfactory pickup and it will not become necessary to increase the audio gain of the amplifier to the point where feedback will occur. This might happen if we attempted to use only one microphone and tried to force it to take in too much territory. Many auditoriums are not treated for echo effects, and it is hard to adjust an installation of this kind when all of the seats in the audience are empty. Suitable tone controls will offer some help in reducing or offsetting certain conditions, but in many cases they will only tend to take away from the fidelity of the equipment.

Many of the most successful pickups of large orchestras are made with only one microphone. This is suspended from the ceiling, about 20 feet above, and to the front of the stage. If a soloist is to perform, another mike is added for that purpose only. Some installations use the solo mike as the announcers mike. The correct type to use, of course, will depend upon the acoustics of the auditorium, but, as a rule the uni-directional will be most satisfactory. These may be adjusted for maximum front pickup and are capable of responding to a wide frequency range.

Concert Band

An outdoor installation designed to reinforce band music from a shell is one that requires considerable experiment. A combination of speakers, in-

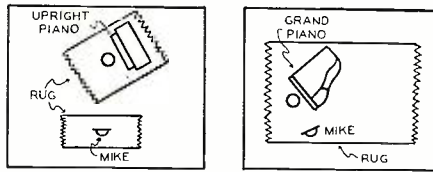

FIG. 4

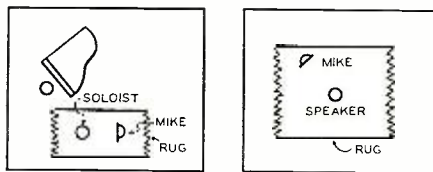

FIG. 5

cluding both trumpets and flat baffles have been found to suffice in most applications. More trumpets, or directional speakers, will be required when the space to be covered is unusually large in area. The time lag out-of-doors is quite long and for that reason the speakers must be located near the band shell so that the people in front will not hear "double." A rather high sound level must also be maintained so that the sounds from the speakers will predominate.

One of the best installations we have heard is located here in Chicago in Grant Park. Up until this last season, the quality of reproduction was very tinny and most unsatisfactory to listen to. In fact, the distortion from bass instruments was enough to discourage the music lover and to give a rather poor representation of what actually could be done with good equipment and proper microphone placement. There are other factors which must be considered when making an outdoor installation—the wind being foremost. Most of the larger setups use an operator, or some member of the band may "fill in" and ride gain to compensate in volume for varying wind conditions.

Pickup may be had from but one microphone of the "8 ball" type, suspended from the roof of the bandshell. This will generally be sufficient for the proper pickup characteristics needed for this type of installation. Another mike on floor stand may be used if a soloist is to perform.

Small Orchestra

The proper type of microphone to use for this will depend upon whether the orchestra is to play out in the

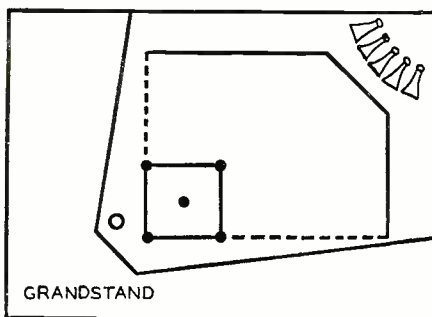

FIG. 8
BALL PARK INSTALLATION

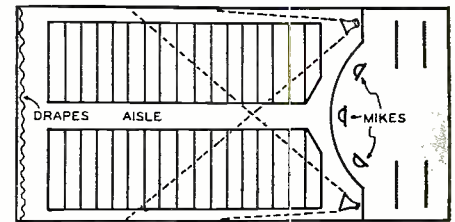

FIG. 7

open, or on a small stage that has plenty of drapes or other sound absorbing materials. Proper placement for this is illustrated. If the speakers are to be used close to the microphone, a directional type should be used. For this we have used the Uni-Plex crystal and the Uni-dyne dynamic with excellent success. The loudspeakers should be enclosed at the rear as much as possible to prevent audio-feedback. The directional type might also help to eliminate this condition if they can be used without destroying the effect of wide distribution of the sound. The speakers should be mounted as high as practical in order that those sitting nearby not get too much volume in proportion to those farther away.

Piano Solo

First and foremost, the microphone must always be positioned at the treble end of the piano and never at the bass end for best results. This is due to the predominance of volume at the bass end. The correct position for this type of installation is illustrated in Fig. 4. Always provide a carpet or rug under the piano, and especially under the microphone if it is mounted on a floor stand. This is required in order to eliminate unwanted reverberation from the hard floor surface which would cause a peculiar echo effect. The correct distance for the mike from the piano will depend upon the type used. Usually a grand piano will have the greater volume, particularly if the top is open. Some experimenting will need to be done for proper placement.

Vocal or Instrumental

The ideal setup is illustrated in Fig. 5. This may not be possible to use in some cases. Much leeway is to be had in the selection of proper microphone for solo work. The broadcast studios favor the *Velocity* and the *Dynamic* types over practically all others. This is one application where the *Velocity* can be used to its full advantages. The mike should be placed as near the height of the soloists mouth as possible and the soloist should sing towards the mike from a distance of 18" or more. One thing must be avoided and that is to avoid crowding of the mike if a *Velocity* is used. Failure to do so will result in a boomy response and the quality will suffer. The distance from the piano or orchestra will also need consideration. If only piano accompaniment is used, and a single microphone, the setup will be simply as illustrated. A satisfactory distance

(Continued on page 62)

HIGH-FIDELITY TUNER

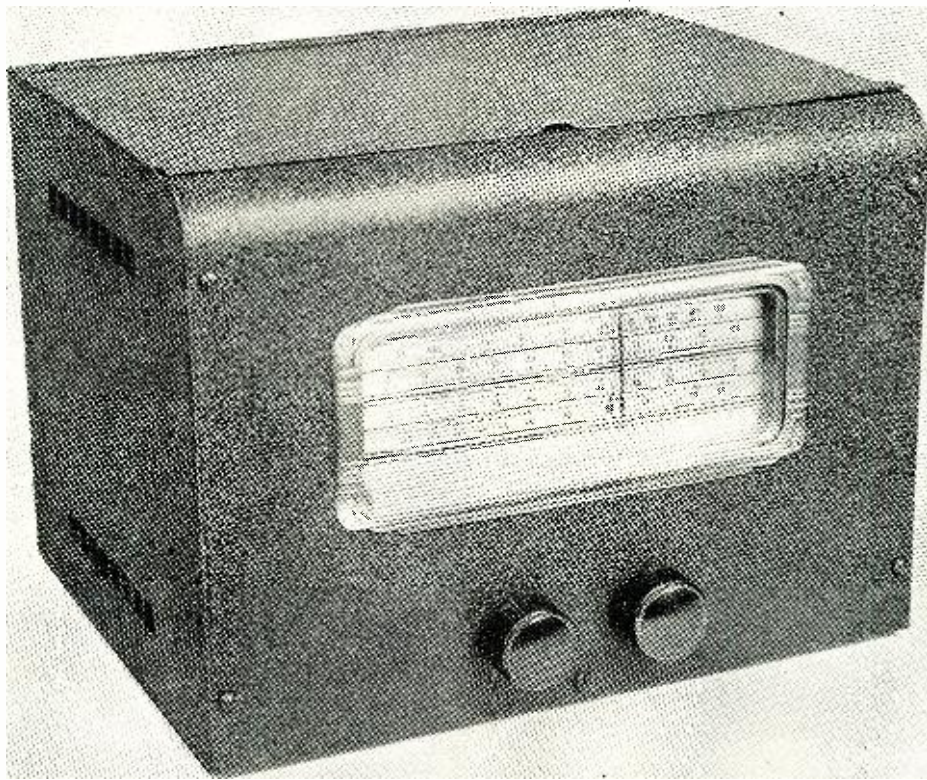

The finished high-fidelity tuner presents a pleasing appearance.

by **OLIVER READ, W9ETI**

Technical Editor, RADIO NEWS

For those who desire the very best in radio reproduction, or a fine recording unit, this simple, inexpensive tuner will exactly fill the bill.

MUCH importance has been placed on the equipment used in conjunction with high fidelity recording as far as the amplifier itself is concerned, but little has been said about the radio tuner. It is the tuner that is responsible for the quality of the signal as it appears at the input of the amplifier, thence to the cutting mechanism of the recorder. If the tuner is not capable of doing its job, it stands to reason that the general results from the finished records will be unsatisfactory.

Most of the modern radio stations are capable of transmitting all frequencies as high as 5,000 cycles, some even higher. For that reason it is necessary that the radio tuner, which is used to pick up these programs be capable of detecting the full range of audio frequencies in order that they may be amplified and used for cutting purposes or for regular radio reception and entertainment.

Now, a tuner which is suitable for general reception is not the ultimate as far as being well adapted for recording. In other words, it should be

especially designed for the purpose. The music lover, too, is always interested in obtaining the finest type of reception possible. In most cases, these programs are broadcast from local transmitters, at least within the range of say 50 miles maximum from the point of reception. This includes practically any large city in the United States, or even the smaller towns. In other words, nearly everyone is within range of some local chain broadcast. If it is possible to limit the reception to the local, it will then be possible to eliminate much of the back-ground noise which accompanies the more distant received signals. So, it is only necessary that we include say a range of 50 miles in order to have satisfactory reception and that which is capable of giving the utmost in tonal fidelity.

The tuner itself, as we have stated, must be fully capable of including the full range of audio frequencies and do this without any form of distortion. Of equal importance is the elimination of hum. If this were present from the tuner, obviously this would be ampli-

fied by the amplifier and our reception would be ruined. For that reason it is important that we design the tuner with component parts which will give hum-free operation. There must be no tube noise and for that reason we must eliminate any high gain radio frequency stages that might be guilty of causing such a condition.

The detector of the tuner must be of the type which allows perfectly linear characteristics. In other words, the rectified signal, or the program as it appears at the output of the tuner must be a true reproduction of the original as far as is possible.

Now, there are two types of tuners commonly used. The first is the standard superheterodyne tuner which makes use of one or perhaps two, intermediate frequency stages. The more stages that are used, the greater will be the selectivity and the greater the selectivity the less will be the full range of audio that can be had through the circuit and then on through the detector. For that reason, the tuner herein described makes use of a standard T. R. F. circuit. In other words,

it goes back to the "old" days when we had what is known as a *tuned radio frequency receiver*.

These were capable of excellent reproduction and this was made possible by the characteristics of the circuit which allows an even tuning range to be employed on all received stations that are at least 10 kc. apart. It is possible to include the full range of 10 kc. without actually tuning into the adjacent channel. If any "birdies" or "whistlings" are present after the tuner is constructed, we know that we are actually passing a band width greater than 10 kc. A special device is made to eliminate the 10 kc. whistle and it is obtainable as a standard part. Its inclusion is justified in cases where the "whistling" is heard at the output of the tuner.

If the tuner and its associated amplifier are capable of a flat frequency response, then we will be assured that we will have a good chance of getting an excellent recording. If they are not, then it will be impossible to include the full range of audio frequency.

For purposes of home entertainment, of course, it is necessary that a good loud speaker be used. Preferably one which has been designed for general reception of the new Frequency-Modulated signals. These speakers are usually ideal in their ability to reproduce all audio frequencies from approximately 30 cycles on up to 15,000 cycles, or better. Their use is highly recommended particularly when they are used in conjunction with the proper type of baffle. The whole system, of course, will be worthless if the loud speaker is not capable of reproducing the frequencies given out by the amplifier. Therefore, we have factors which must be carefully co-ordinated in order to get the ultimate; first, the tuner; second, the amplifier; and third, the loud speaker; or perhaps the cutter head on the recorder, if used for that purpose.

Some superhet tuners are capable of giving excellent quality, while others are not. The ones that are suitable are those which make use of only one i.f. stage and have a detector, preferably of the *infinite impedance type*, so that a true reproduction may be had. Nothing is simpler than constructing a t.r.f. receiver, or tuner, and the one included in this article can be duplicated by anybody who is handy with a soldering iron, a pair of long-nosed pliers, and simple tools.

We spoke of the detector, and it is best, of course, to consider the detector linearity in the t.r.f. receiver as it is in a superhet. *The detector must be linear.*

The use of automatic-volume-control is important if we are to keep the received signal at a steady level. This is particularly true if the tuner is to be used in conjunction with a recording machine. The operator, in order to do a good job, must be sure not to overcut or undercut the record. If the tuner is not equipped with automatic volume control, it is quite possible that when a fade does occur on the received signal that the operator will advance the volume control on the recorder and then when the station returns to its normal signal strength the operator might fail to return the volume control on the recorder to its normal position. This might easily result in overcutting of the record. So we have included the automatic volume control

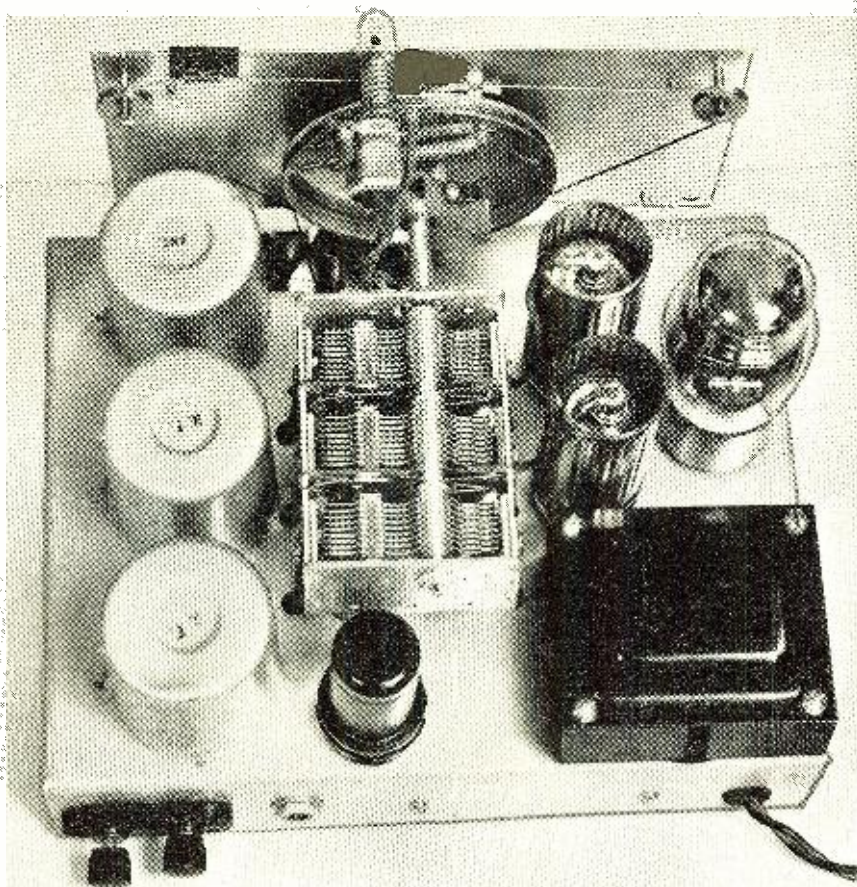

Notice that no wiring at all shows above the chassis.

circuit in the tuner. It requires only a few parts over a conventional tuner designed without this feature. The detector tube is a duo-diode-triode type and was selected for its ability not only as a detector but also the fact that it included a suitable triode which could be used either to make

possible a *step-up in impedance* or as an additional audio stage.

Our own particular application called for some means whereby we could step up the impedance so that the output would be suitable for feeding into standard inputs such as found on practically all amplifiers. There

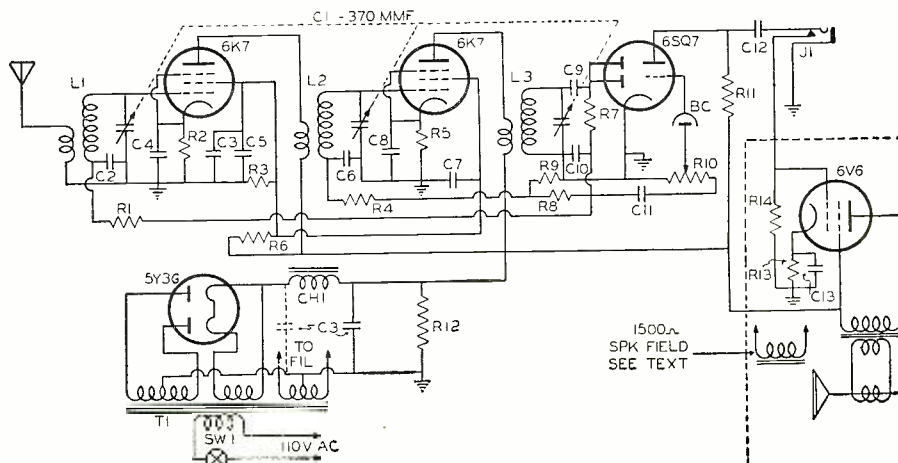

R₁—2 megohms, 1/2 w. IRC
R₂—300 ohms, 1/2 w. IRC
R₃—35,000 ohms, 1 w. IRC
R₄—2 megohms, 1/2 w. IRC
R₅—300 ohms, 1 w. IRC
R₆—35,000 ohms, 1 w. IRC
R₇—100,000 ohms, 1/2 w. IRC
R₈—100,000 ohms, 1/2 w. IRC
R₉—100,000 ohms, 1/2 w. IRC
R₁₀—500,000 ohms pot. Mallory
R₁₁—250,000 ohms, 1/2 w. IRC
R₁₂—25,000 ohms, 10 w. Mallory
R₁₃—300 ohms, 10 w. Mallory
R₁₄—500,000 ohms, 1 w. IRC
C₁—3 gang, 370 mmfd. Meissner
C₂—.05 mfd. 400 v. Solar
C₃—.1 mfd. 400 v. Solar

C₄—.1 mfd. 400 v. Solar
C₅—8 mfd. 450 v. electro. Mallory
C₆—.05 mfd. 400 v. Solar
C₇—.1 mfd. 400 v. Solar
C₈—.1 mfd. 400 v. Solar
C₉—.0001 mfd. mica. Mallory
C₁₀—.0001 mfd. mica. Mallory
C₁₁—.05 mfd. 400 v. Solar
C₁₂—.05 mfd. 400 v. Solar
C₁₃—10 mfd. 50 v. electro. Mallory
T₁—Plate & Fil. trans. Thordarson T-13R11
CH—Filter choke, Thordarson T-43C92
Cabinet—Parmetal, Chassis—Parmetal
Tubes—Hytron, RCA
BC—Mallory 1 1/4 v. Bias cell
L₁—Antenna Coil. Meissner
L₂, L₃—RF Coils. Meissner

is some gain to be had from the triode as far as audio is concerned, but this is actually not required. We spoke before of hum content. It is necessary to *eliminate* this hum wherever it might appear. One of the most common points where hum is found in modern circuits is *cathode leakage hum*. By grounding the cathode direct, as shown on the accompanying diagram, and by making use of a standard bias cell, we can keep the cathode at ground potential and apply bias by means of a separate potential to eliminate hum that might appear at the second detector cathode.

The general layout of the tuner is rather important if short leads are to result. It is imperative, of course, that these leads be kept as short and direct to the point as possible in order to eliminate any overcoupling within the circuit. Of particular importance is the placement of grid and plate leads. These should be kept as far apart as possible consistent with good wiring and in no case should they be run together, or coupling will result and the tuner will actually go into oscillation.

We do not recommend any deviation from the original parts used and those which are contained on the parts list. There are, however, many of the units to be found in the average experimenter's junk box, or stock, and these may be used providing the same characteristics are had as on the original. For example, the power transformer may be one taken from one of the conventional mantle type receivers. These transformers are designed to handle at least four tubes, including a power tube, and the current range is in the neighborhood of 65 m.a.

These will be very suitable for use in this tuner. We might mention that a conventional electro-dynamic speaker may be used for the tuner providing the power transformer is capable of delivering the required current. The field coil of the speaker should be approximately 1500 ohms and if used this field coil may replace the filter choke shown on the diagram. Due to the added voltage drop, occurring if

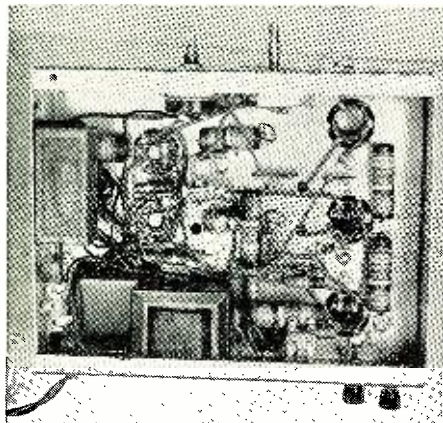

we use such a dynamic speaker, it will be necessary to add an input filter condenser as indicated on the diagram by dotted lines. If we fail to do this, the voltage will drop lower than the value required, which is approximately 250 volts.

An alternate circuit is shown which includes a single output stage, or
(Continued on page 58)

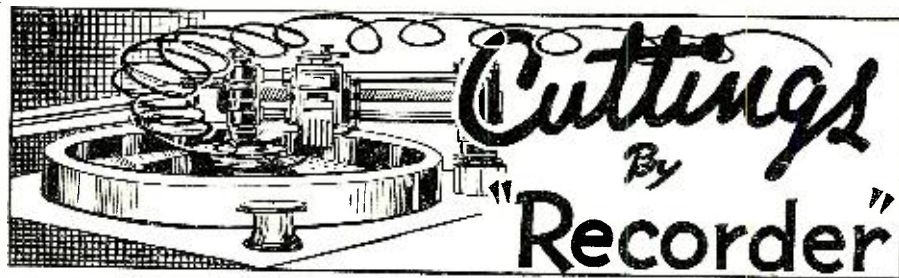

Manufacturer's Specifications

Make: Talk-A-Phone.

Model: R-80.

Manufactured by: Talk-A-Phone Manufacturing Co., 1219 W. Van Buren St., Chicago, Ill.

Motor: Constant speed, 115 v. 60 cycle.

Turntable: Weighted 10" diameter.

Cutting Head: Crystal—high-impedance.

Pickup: Crystal—high-impedance.

Turntable Speed: Standard speed (78 r.p.m.)

Drive: Undercarriage type.

Amplifier: Self-contained 3 stage.

Remarks: Cuts records up to 10" diameter. Uses inexpensive cutting and playback needles for maximum economy. Entirely self-contained in a portable carrying case.

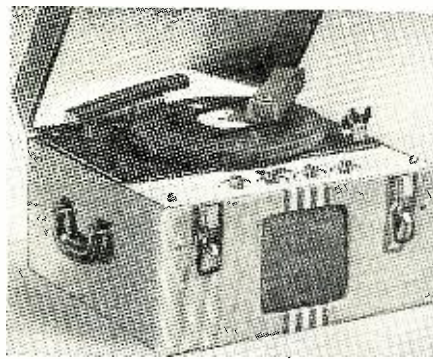

Description

The Talk-A-Phone Portable Recorder has been designed to offer a wide range of applications. The Model R-80 is actually three instruments in one. (1) a well-designed, easily operated recorder; (2) a very efficient, high quality record player; (3) a complete public address system.

The model R-80 makes records of an exceptionally fine quality when used with a microphone or when used with a radio. It plays the recordings it makes, or also plays any standard ten-inch or twelve-inch commercial phonograph records. When used as a public address system, it develops full three watts power output.

The recording equipment contains a powerful induction motor, with an internal rim-drive to a balanced turntable. The motor maintains a constant 78 r.p.m. speed. The Model R-80 employs a crystal head for cutting, and a crystal pickup for playback. Cuts records up to 10 inches, outside to inside, grooving 110 lines per inch.

The amplifier tube complement is as follows: 6J7, 6Q7, 6K6, and employs a 6U5 as a volume indicator, the amplifier is powered with a 5W4. The Model R-80 employs a 6½ inch loud-speaker. A selector switch is employed to instantly shift from "Record" to "Playback" to "PA"; a combination volume control and on-off switch; tone control; and a separate motor switch are included.

The control panel contains an extra input jack which can be used in conjunction with a radio tuner, in this position it is possible to mix the radio tuner with the microphone for recording purposes, or may be used as an amplifier for the Radio Tuner.

Comments

The Talk-A-Phone Model R-80 recorder utilizes a basic recording mechanism that is to be found on practically all inexpensive recorders. It has been designed for non-professional use and is not capable of cutting records having diameters in excess of the 10" size. This limits the recording time

to approximately 3½ minutes per side on a 10" disc. We have received many requests for a discussion on this type of recorder which is representative of many appearing on the present market. Regular commercial records up to and including the 12" size may be played on this equipment, however. The operation of this recorder is simplicity itself, and anyone may cut records with good success by following a simple procedure. It is only necessary to place a blank disc on the turntable, start the motor, place the cutter arm in place directly over and above the starting position on the blank (about ¼") and lower the arm on to the disc. The thread should "kick-in" toward the center of the disc. If it does not, the pitch of the cutting needle should be altered so that it does. The thread must never be permitted to become caught under the cutting needle, as this would cause the needle to jump over the thread and then return to the disc. This would spoil the recording. The cutting needle (stylus) should be changed after cutting two 10" records. The built-in amplifier has satisfactory quality for all but the finest installations where high-fidelity would be required. The 6½" dynamic speaker provides sufficient output so that the amplifier may be used for a small public address system. This operates in conjunction with the microphone supplied so that a system may be set up on a few minutes notice and will be ready to operate. The complete recorder comes complete with recorder mechanism—microphone—amplifier—and playback pickup all mounted in a sturdy carrying case which is finished in striped airplane cloth with a comfortable handle. Size 16" long, 16" deep, 14" high. Weight approximately 45 lbs.

The Reader Asks

What is the basic difference between so-called "Home Recording" and "Semi-Professional Recording"?

ANSWER: The difference may be seen readily by considering the following explanation: Home recording is chiefly a hobby similar to amateur photography. Instantaneous records are cut on inexpensive discs (blanks) with inexpensive needles and on inexpensive equipment. The entire mechanism is designed for maximum economy and for simplicity of operation. Even a child may turn out records successfully with the home recorder by following a few simple rules and instructions as provided by the maker for his particular machine. The limitations are: that the recorder is only capable of cutting up to records of the 10" size at standard speed of 78 r.p.m. at approximately 100 lines-per-inch. This limits the playing time to about 3½ minutes which is not sufficient for anything but a short topic. Moreover, the equipment, being of inexpensive design and construction, must use component parts that may be turned out by the manufacturer on a quantity basis, and this large production procedure does not allow much time to be spent on each individual machine in order that it receive the attention given to the larger recorders to obtain a high degree of accuracy on all of the moving parts.

The Semi-Professional recorder differs from the home recorder in several respects. These are usually housed in larger portable carrying cases, include a much heavier turntable of either the 12" or 16" size, contain an amplifier that is capable of greater power output at lower distortion, provide means for more accurate adjustments to be made on the equipment, includes a constant-speed motor having greater horsepower, and are equipped with a high-quality cutter and playback pickup. These machines are capable
(Continued on page 60)

Communication & Electronics MAINTENANCE

by **W. H. BOHLKE**

Director of Test Equipment Merchandising, R.C.A. Mfg. Co., Camden, N. J.

Examples of high resistances & low voltages; their detection and measurement with new type equipment.

Part 3

In this article we shall deal with the requirements of apparatus suitable for the measurement of voltages and resistance in the various types of receivers and transmitters utilized in the different fields which are encountered in the communication service shop.

Voltage measurements upon receiving and transmitting equipment may be varied. When analyzed, they consist of three major classifications, namely, operating, control, and signal. In the classification of operating voltages will be found both d.c. and a.c. voltages, the former being the fixed d.c. potentials which are applied to the various elements of the vacuum tubes used in the communication systems. The second group, those which are identified as being of alternating character, are the alternating voltages applied to the vacuum tubes to heat the electron emitters, those applied to the rectifying vacuum tubes from power supply transformers, and primary power-supply voltages. Essentially this group embraces all a.c. voltages other than those which can be construed as being signal voltages.

By "control voltages" are meant those d.c. voltages which are variable and are developed as the result of the application of a signal to some circuit, where, by the process of rectification and proper filtering, the final d.c. voltage used to control the operation of other components is created.

By "signal voltage" is meant the signal itself irrespective of its frequency, origin or application. In view of the fact that signal voltages are not vital to the contents of this issue, we shall say very little more about it. This leaves operating and control voltages as subjects of interest in this issue.

Very closely associated with both operating and control voltages is the

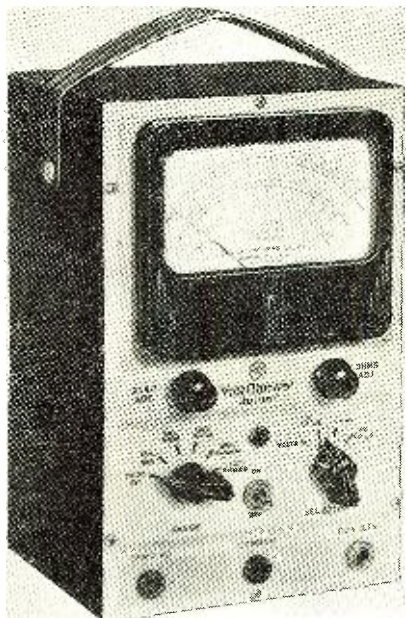

Figure 3.

matter of resistance. This is easy to understand in view of the fact that the operating and control voltages appear across numerous resistance units; in fact, a form of control with respect to magnitude of the control and operating potentials is the function of resistance in numerous installations. Therefore it is logical that when one is concerned with operating and control voltages, that interest should simultaneously be focused upon resistance. So that a clear picture is available of what the requirements are for such measurement of voltage and resistance, it might be well to look into the conditions found in the various types of radio receivers which come

within the operating zone of this communication service shop.

Although it is true that the basis of this series is that such similarity exists between the servicing requirements of the conventional radio broadcast industry and numerous branches of the communication field that the competent service shop should be capable of communication service, sufficient difference nevertheless is found in the units employed in the different branches of the communication field and electronics in industry, that a general resumé is in order.

Operating Voltage Requirements

Speaking in generalities we find that d.c. operating voltages employed in receivers used for broadcast reception, private aircraft, private marine and police systems approximate from about 1.0 volt to several hundred volts. In this there is nothing unusual, but when we examine the conditions under which these voltages are applied to the various tube elements, then we find that in very many instances comparatively low d.c. voltages are applied to circuit components through fairly high resistance values. This establishes one required characteristic for the voltage measuring device, namely, that it have a high input resistance, or high ohms-per-volt value, if you want to put it that way. The second requirement, which is easily met, is the high voltage measuring limit of about 1,000 volts d.c.

Concerning the input resistance characteristic of the d.c. voltmeter, we note that during the past three or four years a general movement towards the use of higher input resistance voltmeters has taken place. Starting with the 1,000 ohms-per-volt unit, the next step was the 20,000 to 35,000 ohm-per-volt instrument. This second category offered definite advantages over the

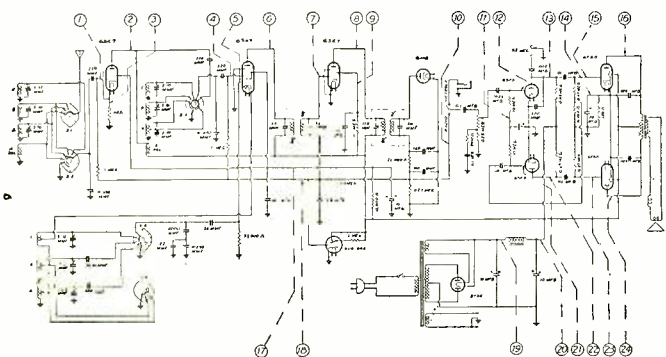

Fig. 5. Receiver points of voltage measurement.

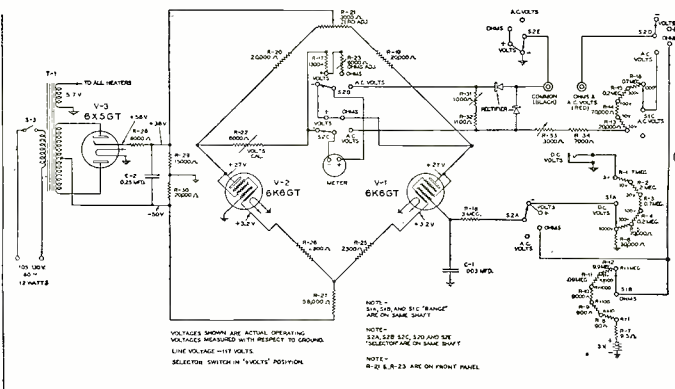
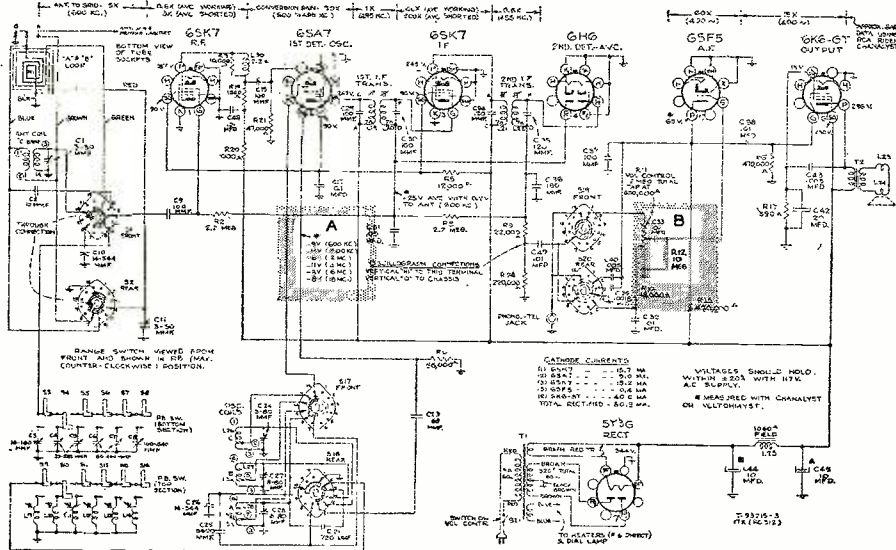

Fig. 2. Schematic of RCA VoltOhmyst Jr.



Note oscillator grid voltages at A; high resistance at B.

first in that it minimized loading of the circuit under measurement. As a strictly portable instrument for possible use in places where neither a.c. nor d.c. power-supply sources are available, this medium high ohms-per-volt type of d.c. voltmeter has application and affords advantages over the 1,000 ohms-per-volt d.c. instrument. This is so even though it will tend to load some of the low-voltage circuits, particularly diode rectifier and control voltage circuits. For shop use and in those places where a.c. power is available, the a.c. operated electronic type of vacuum-tube voltmeter designed to measure d.c. voltages, is the ideal instrument which meets all of the d.c. voltage requirements of the complete gamut of receivers found in the general communication field.

In this connection it is of particular significance to appreciate the importance of control voltage measurement. Recognizing the importance of control voltages in home broadcast receivers and the tremendous advantages which are established when these voltages can be measured during operation, even greater advantages accrue when

such measurements can be made on the receivers utilized for aircraft and police operation. In these systems sensitivity is of tremendous importance and since both sensitivity and noise control are associated with those systems wherein control voltages are developed and those circuits to which control voltages are applied, it is of paramount importance that the device utilized to measure these d.c. potentials be of such design that measurement is possible with the receiver in operation.

This is best accomplished with the electronic type of instrument. In fact, it is entirely justifiable to say that it is about the only way that it can be done accurately and rapidly without in any way interfering with the actual performance of the receiver. And since this advantage is possessed by the electronic voltmeter under the most adverse conditions, it stands to reason that all of the other d.c. voltage measurement requirements are fulfilled best by a measurement device of this character. This is not a theoretical statement. It already has become an established fact.

The reasoning behind this statement is simple to comprehend when we check the circuits employed in radio receivers of private aircraft, private marine, home radio and auto radio, which includes the police systems. Voltages ranging from 1 to perhaps 10 or even 20 volts are developed across, and applied through, resistance networks approximating between 100,000 ohms and as high as several million ohms. Measurement of from 1 to 5 volts, representing the low limits of control voltage for maximum sensitivity, by means of voltmeters which have total input resistance ratings of from 200,000 to 350,000 ohms for the 10-volt range results in erroneous conclusions simply because of the loading of the circuits under measurement by the comparatively low resistance of the meters not of the electronic type. In fact, under certain conditions depending upon the constants of the circuit being measured, the application of a conventional voltmeter probe which is not specifically designed for use in circuit where signals exist, will materially influence the magnitude of the signal, therefore the amount of control voltage. In fact, such application

might kill all of the signal entirely.

Operating Voltages in Industrial Applications

A similar condition, although not necessarily related to radio applications, exists in electronic equipment of numerous types employed in industry. Some of these units involve fairly high power, in which case sensitivity of the voltage-measuring device is not paramount, but on the other hand there are very many industrial applications of electronic equipment where a very high order of sensitivity is especially needed. And as it would happen the radio serviceman who has a communication type of service shop is far more apt to secure work covering the latter type of equipment than the former.

In this second classification of apparatus we find very high gain amplifiers operating at very low values of voltage, some of which are associated with photocell units. In these units the important voltages developed are between a fraction of a volt to about 6 to 8 volts across resistances ranging from 1.0 megohm to about 10.0 megohms and sometimes higher. Some of this apparatus operates over quite a range of voltages between light and dark values of illumination, whereas others are within much closer limits. The closer the limits, the more accurate must be the voltage measurement under actual operating conditions, which calls for minimum loading. An example of photocell type of electronic apparatus is shown in the schematic of Figure 1.

Resistance Measurements

In line with the measurement of voltage, as stated before, is the measurement of resistance. In this connection no special considerations are found in the various types of installations embraced in this general subject which are not found in the usual run of broadcast receivers. Perhaps we might say that the tolerance of resistors is more generally specified in the different communication systems than in radio receivers. As a part of resistance measurement is not only the determination of ohmic values of fixed resistors but leakage resistance values as well. But this again is not native to communication systems only. When we consider electronic equipment in industry, there we find that leakage in a number of different kinds of systems is important, which introduces the need for measurement of high values of resistance, anywhere from 50,000,000 ohms to 1,000,000,000 ohms.

Considering the new trends in circuit design of radio receivers, the range of resistance embraces the low values of coil resistance to fixed plate load resistances approximating 15 megohms. About the same range, perhaps slightly higher, embraces, elec-

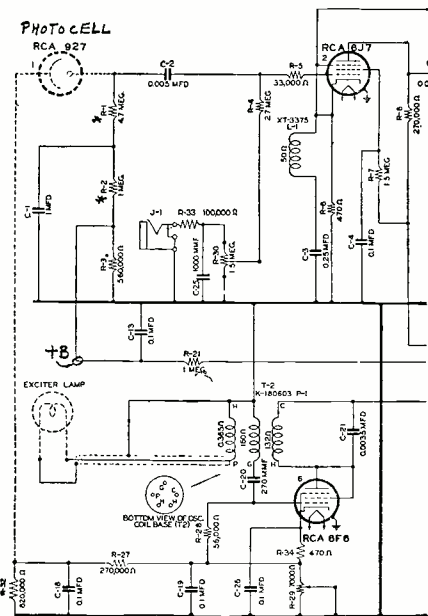

Fig. 1. Typical photocell application.

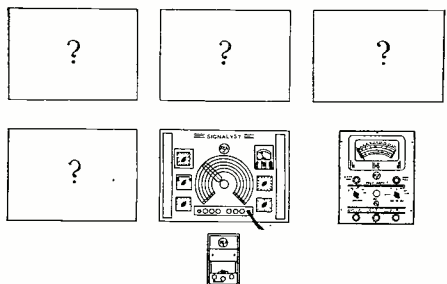

Fig. 4. Second step towards the bench.

AVIATION RADIO

by CHARLES J. SCHAUERS

tronic apparatus in industry. Values in excess of these limits appear in the form of leakage, which, as stated, can run very high, yet comparatively low values of say 25 to 50 megohms are quite significant when resistances of the order of 5 to 15 megohms are used in any one of a number of balanced circuits, requiring certain voltages across these balanced circuit resistors.

We appreciate the fact that many different types of resistance measuring devices are available, but even so it is necessary to recognize certain requirements. The higher the value of resistance to be measured, the lower must be the current used during measurement. Expressed differently, this means that since the normal wattage rating of these high values of resistance is low, the resistance measuring device must be of such character as not to overload the resistor being checked by passing too much current through the circuit. In other words, the sensitivity of the device must be high.

Efficiency of Operation

The efficiency of d.c. voltage measurement is the ability to measure whatever d.c. voltages exist in a radio receiver, amplifier or other form of device between normal limits of a small fraction of a volt to say 1,000 volts, irrespective of circuit arrangement—that is the paramount item. We can look at schematics of various kinds until blind, and imagine myriad combinations of elements to form circuits, but by no means will we embrace all of the combinations which all of the people who work on such receivers can conceive. Naturally some of these circuits may prove to be beyond the scope of any existing equipment. But it is also true that it is possible to project existing circuit combinations and add them to those already extant and so establish the required scope of equipment so as to cover the needs of a field of operation.

Essentially, and we say this without fear of contradiction, such a voltage measuring device is one which is electronic in application and measures voltages up to 1,000 volts or higher. Since the measurement of resistance is practically synonymous with the measurement of d.c. voltage, we again say that the ideal instrument required for such application, one which will have not only the longest possible life, but which will afford the greatest efficiency, is a combination of a resistance-measuring unit and a voltage-measuring device. Admittedly, separate units will function and produce the same final result, but when cost, speed of use and all of the other related factors are considered, the combination of these units is the ideal.

A.C. Operating Potentials

As far as a.c. operating potentials are concerned, there isn't very much to be said, except for one thing. Today the industry classifies power-frequency measurements as one group and audio-frequency voltage measurements as another. Yet when we consider the full range of the audio frequencies utilized in practice we automatically embrace the power frequencies. Practically all the apparatus embraced by this general communication field and the other equipment makes use of a.c. voltages which are within the power frequency range or in the

(Continued on page 46)

WITH 1940 being "forced down" into retirement by the swift "take-off" of 1941, the aircraft radio industry looks back in retrospect to find that it had contributed more than its usual share of services and equipment to the aviation industry during the preceding 12 months; not only from a "pure" business standpoint, but also from the viewpoint of added safety and flying efficiency for aircraft in the air, which utilize the newer radio aids to navigation.

The *Civil Aeronautics Authority* (CAA), the well known government agency, in collaboration with other governmental agencies and civilian research organizations, conducted many experiments and did much research work with new and old equipment; the latter, in new applications to some of the old problems.

Experiments with ultra-high frequency (UHF) transmission and reception for aviation use were carried out, and notable among them were those dealing with frequency modulated transmission and reception for airport traffic radio control work, instrument landing systems, ground to aircraft radio teletype and vice versa; UHF radio beacon systems; and many other devices inherent to the radio navigation of aircraft.

The outcome of these experiments was very encouraging, and readily indicated that the CAA was on the correct path for solving the many perplexing problems which confronted them during the year.

Although the CAA and the *Radio Technical Committee for Aeronautics* played prominent parts in the advances made thruout the year in aviation radio research; the manufacturers also did their parts in a most cooperative manner.

The military forces with their departments of research, and the airlines with theirs, did much to help the "research plane" to "lift off the runway."

An estimated \$40,000,000 was spent during the old year for aviation radio; the largest part of this amount being spent by the government for necessary aircraft radio equipment and accessories, under the vast defense expansion program.

Many new jobs were created in the aviation industry for radio personnel in 1940 because of the increased sales, which necessitated the employment of radio engineers, radio operators, factory installation men, and aviation radio maintenance men.

The new year, 1941, will no doubt offer many more opportunities which were not available in 1940 to the men trained in aviation radio.

Inspections of Aircraft Radio Stations

DURING the license period of an aircraft radio station, which usually expires on April 1 of each year, it is necessary that an aircraft radio station be inspected by one of the *Federal Communications Commission* (FCC) inspectors, who may be found in any one of the 27 field offices located thruout the United States and its possessions.

This inspection is in no way related to CAA activities; and even though a separate body was appointed some time ago by the FCC to study aviation radio problems, regulations, etc., in order that they could administer aviation radio matters more efficiently, it has been rumored that a separate "inspection body" may be formed, which will work "collaboratively" with both the FCC and the CAA.

If this "inspection body" is created, it will no doubt alleviate a large amount of congestion in FCC field offices, but will it help the CAA? This seems to be problematical at this time. However, a body of this nature would, if formed, take care of the periodical radio inspections, new and renewal licenses, and accomplish this at about the same time as the aircraft inspection normally performed by the CAA.

Due to the "transient" nature of most aircraft, and when the time factor is con-

sidered; it is often necessary for the owner of an aircraft radio station to make a special effort to contact an FCC inspector at the convenience of the field office to have the inspection made. If the radio inspection was performed at the time of the CAA aircraft inspection, "two birds would be killed with one bomb," and the small annoyances experienced by the private aircraft owner would be overcome.

The rumor concerning the formulation of a new "inspection body" has been added to by comments of different writers. However, this writer feels that one of the reasons for such a rumor being started is because many of the private flyers do not seem to want to take time out to find out what there is to a private aircraft two-way radio installation and the many considerations involved.

It is certainly true, that if a separate "aircraft radio authority" were formed, and restrictions placed on its activities, confining their biggest efforts toward helping those who do not know the intricacies of aviation radio, much would be done to further general acceptance of two-way radio in private aircraft. Instead of the estimated 1300 planes carrying radio transmitters, there would no doubt be three times that many. Nevertheless, the formulation of the body mentioned is just another rumor, and is to be taken as such. Put no stock in rumors, and believe nothing until it is seen physically or in "black and white."

Manufacturer's Equipment Tests for CAA Certificates of Approval

MANY CAA Type Certificates were issued during the past year to various manufacturers of aircraft radio and electrical equipment which is used in scheduled foreign or domestic air commerce. These certificates are obtained after the designed equipment has been thoroughly inspected and tested, utilizing the manufacturer's own test equipment.

There are many aircraft radio technicians who have signified their desire to know what these tests are, and how they are made; we will give them to you this month.

Before any equipment is considered for test, a preliminary inspection is usually made of the materials used in construction, an inspection of over-all workmanship is made; and it is ascertained whether or not good engineering practices have been used thruout, in design. If these preliminary tests are passed, the apparatus then undergoes seven tests, as prescribed by the Authority.

These tests more than parallel conditions encountered by the equipment in actual service in aircraft, and if these specific tests are passed, it is a safe bet that the equipment will stand up for indefinite periods. But this doesn't mean that the equipment will not require regular maintenance and adjustment. The first test we will describe is the "spray test."

Water is sprayed over the apparatus at different angles, at pressures approximating "rain force." While this test is being conducted, and it usually lasts two hours, the equipment is actually operated. After the test under spray is finished, the equipment is left untouched for approximately 48 hours and at the end of this period is operated for two hours. If the last two hour operation test shows no appreciable losses in performance of the equipment, and a visual inspection reveals no harm has been done to internal or external parts which would prevent the normal functioning of the unit, this test has been passed.

A test whereby the finished equipment is dropped 100 times or more, with the distance of each drop varying between 6 and 18 inches, is always made. This test is called the "drop test." In order to prevent "shock surface contact damage" to cabinets, etc., a rubber mat not more than 1" thick is usually employed. When the equipment is dropped,

(Continued on page 64)

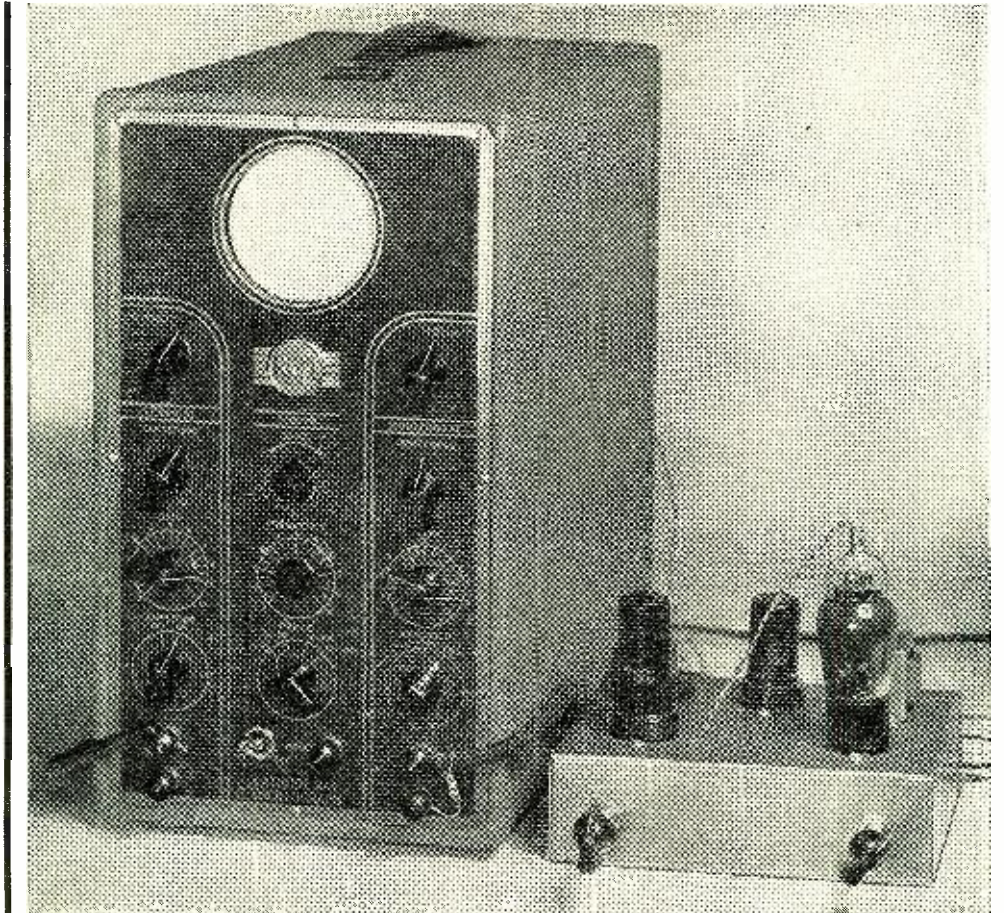

Believe it or Rip! This is a television receiver!

Use Your Oscilloscope in Your Television Reception

by **HOWARD C. LAWRENCE, W2IUP**

Haddonfield, New Jersey

Why not enjoy television programs? If you have an oscilloscope, a few tools, and a very few parts, you can build your receiver. The ideal set for the experimenter, ham or the serviceman to own.

WHILE working on television receiver circuits, it occurred to the author that a great many radio amateurs and service men already have on hand a large part of a television receiver in the Cathode Ray Oscillographs that they use in their other radio work. The adaptor to be described, was designed to convert these oscillographs into television receivers in as simple a manner as possible and yet not destroy the usefulness of the oscillograph for regular test work. The circuits shown are for everything after the second picture detector. Something will be said about the r-f and i-f and of the receiver later. The components found in a television receiver from the second picture

detector on are the video amplifier, the two sweep oscillators and their associated amplifiers and amplitude controls, the sync. separator and sync. amplifier, and the cathode ray tube for viewing the picture and its associated power supply and controls. Of these, the usual cathode ray oscillograph contains the sweep amplifiers and gain controls, the picture tube and all its associated controls and power supply. The oscillograph also contains one sawtooth oscillator. Consideration was given to using this oscillator as one of the sweeps, but it was decided that it would be more desirable to use an external circuit.

The usual gas discharge type of oscillator found in oscillographs has too

long a return time at 13 kc. to be of value in a television receiver. Past experience has also shown that gas discharge tube oscillators are more subject to noise and less stable as to frequency than the type of oscillator shown in the circuit diagram. Furthermore, the number of tubes in the final circuit would not be changed because all present tubes are double purpose tubes.

In designing and building television sweep oscillator and synchronizing circuits, it is necessary to make sure that no horizontal synchronizing signal, or signal from the horizontal oscillator itself gets into the vertical oscillator circuit. Any such coupling would destroy the interlace, making the two

sets of lines in the picture fall on top of each other and decrease the apparent definition in the vertical direction. It was found that it is possible to combine the functions of sweep oscillators and sync. separator and amplifier into two tubes as shown without destroying this interlace. The sync. separator was combined with the vertical oscillator because the separator handles the lowest level signal and there would therefore be less possibility of this signal getting into the vertical oscillator. Grounding the plate of the triode used as the separating diode further shields the separator from the oscillator. Using the grid whose connection is on the top of the tube as the diode plate and running the lead directly to the amplifier tube as shown in the picture completes the isolation.

The Circuit

The circuit is shown. For clarity, all tubes have been shown as single tubes in the schematic diagram. Base pin numbers are given for the 6F8-G because both triodes are not exactly alike. The 6AC7 is a conventional video amplifier using a high mutual-conductance tube. The signal fed to its grid should be of negative polarity. That is, the voltages corresponding to black parts of the picture are positive with respect to those corresponding to white parts of the picture. This type signal is obtained from a diode second detector, the plate of which is connected to the last i-f transformer and the cathode of which is connected to a load resistor going to ground. The signal is taken off the cathode. It has been assumed that there is a gain control in the i-f stages for use in controlling picture contrast. This gain control usually takes the form of a variable resistor of about 10,000 ohms in series with the cathode resistor of one or two i-f amplifier tubes. If possible, the proper size for the high frequency compensating coil, L_2 , should be determined by experiment to give a flat frequency response.

(Note: Analysis and Design of Video Amplifiers—Seeley and Kimball, RCA Review, October, 1937.)

The output of the video amplifier is fed into the grid of the picture tube and to the sync. separator. It is necessary to open up the intensity control grid lead to the oscillograph cathode ray tube and insert a resistor, R-20, so that this grid can be modulated. In the model shown, this resistor was placed right at the tube socket. The

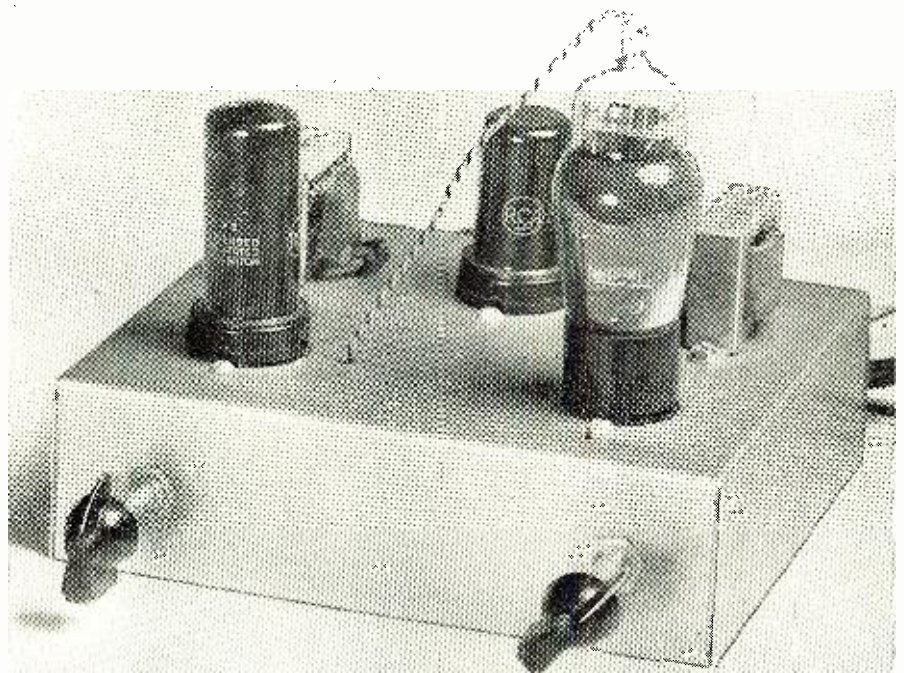

This plus an oscilloscope equals a video receiver!

grid comes out to No. 2 pin on the tube. In most oscillographs, this grid is several hundred volts negative with respect to ground. For this reason it was decided to include the coupling capacitor C-12 in the oscillograph. Two terminals on the back of the oscillograph allow connection of this capacitor to the adaptor chassis for television reception or to ground for regular oscillograph use.

With the plate resistor, R-10, of the separator diode constant, the point at which separation takes place depends on the size of the cathode resistor, R-9. Larger values of this resistor will cause the lower part of the sync. to be clipped off, while smaller values will allow part of the picture to pass through. R-12 was included to make

the amplifier tube do a little clipping on the top of the sync. and help smooth it off. It is not especially effective because its value must be kept small enough to not seriously change the shape of the horizontal sync. pulses. Grid bias for this amplifier is obtained from the grid resistor, R-11.

The plate of this sync. amplifier works into the circuit for separating the horizontal and vertical synchronizing pulses from each other. The low frequency pulses appear at the plate of the amplifier and pass through a low-pass resistance-capacity filter consisting of R-14, R-3, C-2 and C-3, to the 60 cycle sweep oscillator. This filter removes the high frequency pulses. As built in the model, the vertical oscillator and the sync. amplifier are on op-

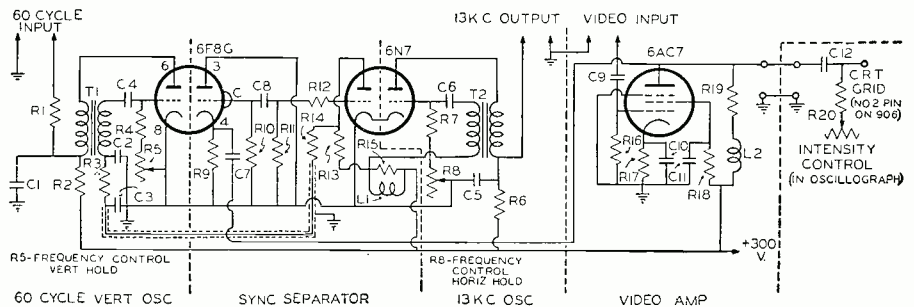

R₁— $\frac{1}{4}$ megohm, $\frac{1}{2}$ w. IRC
 R₂— $\frac{1}{2}$ megohm, $\frac{1}{2}$ w. IRC
 R₃—10,000 ohms, $\frac{1}{2}$ w. IRC
 R₄—2.0 megohms, $\frac{1}{2}$ w. IRC
 R₅—2 meg. pot. (Claroostat type 37)
 R₆—50,000 ohms, $\frac{1}{2}$ w. IRC
 R₇—10,000 ohms, $\frac{1}{2}$ w. IRC
 R₈—50,000 ohms pot. (Claroostat type 37)
 R₉—200,000 ohms, $\frac{1}{2}$ w. IRC
 R₁₀—10,000 ohms, $\frac{1}{2}$ w. IRC
 R₁₁—1 megohm, $\frac{1}{2}$ w. IRC
 R₁₂—20,000 ohms, $\frac{1}{2}$ w. IRC
 R₁₃—10,000 ohms, $\frac{1}{2}$ w. IRC
 R₁₄—10,000 ohms, $\frac{1}{2}$ w. IRC
 R₁₅—1,500 ohms, $\frac{1}{2}$ w. IRC
 R₁₆— $\frac{1}{4}$ megohm, $\frac{1}{2}$ w. IRC
 R₁₇—150 ohms, $\frac{1}{2}$ w. IRC
 R₁₈—65,000 ohms, $\frac{1}{2}$ w. IRC
 R₁₉—3,000 ohms, $\frac{1}{2}$ w. IRC
 R₂₀— $\frac{1}{2}$ megohm, $\frac{1}{2}$ w. IRC
 C₁—0.5 mfd. 400 volt paper. CD

C₂, C₃—0.005 mfd. 400 volt paper. CD
 C₄—0.02 mfd. 400 volt paper or mica. CD
 C₅—0.025 mfd. 400 volt paper. CD
 C₆—0.001 mfd. 400 volt paper or mica. CD
 C₇—0.1 mfd. 400 volt paper. CD
 C₈—0.02 mfd. 200 volt paper. CD
 C₉—0.25 mfd. 400 volt paper. CD
 C₁₀—50 mfd. 25 volt electrolytic. CD
 C₁₁—2 mfd. 300 volt electrolytic. CD
 C₁₂—0.1 1,000 volt paper. CD
 L₁—300 turn coil (RCA stock No. 33541). Includes coil L₁ mounted on resistor R₁₅.
 L₂—75 turn coil (RCA stock No. 33538). If possible the exact number of turns on this coil should be determined by experiment.
 T₁—Vertical oscillation transformer (RCA stock No. 32898)
 T₂—Horizontal Oscillation transformer (RCA stock No. 32899)
 Tubes—6AC7/1852, 6F8G, 6N7. RCA

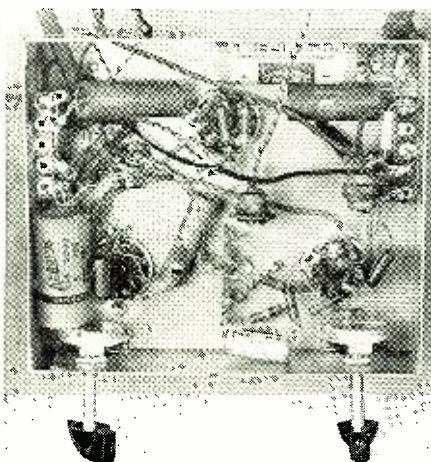

Underchassis view of the adapter.

posite sides of the chassis. It is desirable to locate most of the filter near the vertical oscillator and shield the wire between R-3 and R-14 as shown in the schematic diagram. The high frequency synchronizing pulses appear across the coil L-1 from which point they are coupled into the horizontal oscillator. Increasing the size of R-15 will give a little more horizontal sync signal, but this makes the receiver more susceptible to noise.

The oscillators are of the grid blocking type using transformers to obtain feed-back from the plate to the grid circuit. The frequency of oscillation is controlled by the variable resistors R-5 and R-8. In some cases, it may be found desirable to alter the size of the resistors in this frequency control position to reduce the controllable frequency range. This can be done by measuring the total resistance between grid and ground when the controls are set to the proper position and then making the fixed resistor slightly less than this. A variable resistor of about 25 percent of the fixed resistance is then used.

The oscillator tubes draw a pulse of current once each cycle. This pulse is shaped into a sawtooth by the resistor and capacitor R-2 and C-1, in the vertical oscillator and R-6 and C-1, in the horizontal oscillator. The amplitude of the developed sawtooth depends on the product of the R and C. The susceptibility of the oscillator to the synchronizing pulses is greatly influenced by the size of the resistor in this combination. The smaller the resistor, the less the synchronizing pulses control the oscillator. When building the adaptor, the value of R-6 in the high frequency oscillator should be adjusted to give the proper sweep amplitude with the oscillograph gain control almost all the way open. This is because the controls in most oscillographs attenuate the high frequencies quite badly when they are turned down, causing the left edge of the picture to be crowded and bright.

No blocking capacitors are included in the sweep output circuits because these are usually in the oscillograph. The leads for the sweep voltages to the oscillograph terminals should be shielded. R-1 is included in the vertical oscillator output circuit to help isolate the usual $\frac{1}{2}$ megohm volume control from the oscillator. C-1 was made quite large to keep R-2 small, but even with the size used, the oscillograph loading spoils linearity if R-1 is not included. In cases where the input resistance to the oscillograph is over one megohm, R-1 should be omitted. It may be necessary to adjust R-2 to obtain the right amount of vertical sweep for a particular oscillograph.

Possible Oscillograph Changes

While the experimental work on this chassis was done with an RCA Type 155 Oscillograph, most oscillographs are enough alike that what is said here will apply to all. In some cases, it may be necessary to rotate the tube to get the picture right side up, or add a little extra filtering to take hum out of the picture. A two mfd. oil capacitor across the high voltage should be enough. The low voltage on the cathode ray tube in most oscillographs does not give as bright or sharp a picture as could be obtained. An extra capacitor across the input of the high voltage

(Continued on page 61)

MIKES-HEADS-PICKUPS

Helpful Hints for the Recordist

EVER since the introduction of home recording, a problem has always existed. This problem deals with the removing of the chip, or scrap material as it leaves the cutting needle. Many a record has been spoiled by the failure to keep this scrap from engaging the cutting stylus. Nearly all home recording equipment is designed so that cutting takes place from the outside to the inside on the record. It has been necessary, in most cases, to "steer" the thread toward the hub.

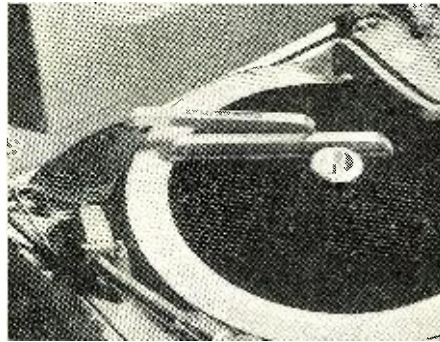

Now, it is possible to remove the thread automatically by means of an accessory item known as a "Chip Chaser." This gadget is manufactured by Audio Devices, Inc., New York, New York.

In operation the instrument is set alongside the recording turn-table and the wiper is placed on the record as shown. The recorder is placed in operation and the thread will automatically be wound toward the hub of the table. Furthermore, the wiper will remove dust from the surface of the disc, and, for that reason, will add protection during the process of cutting. The unit is entirely automatic and is self-adjusting. It is available for either a 12" or a 16" turn-table. Inasmuch as the wiper material is very soft, damage to the record cannot occur.

The Reader Asks

R. G., Lancaster, Pa.: What would cause a peculiar "thump-thump" when my home recording blanks are played back?

ANSWER: This is known as "turn-table rumble" and is caused principally from vibration of the motor being transmitted to the turn-table. It may be corrected by proper adjustment of the Idler wheels, if used, or by removing some of the tension between the idler wheel and the rim of the turn-table.

A. S., Norfolk, W. Va., wants to know what causes an echo to be heard when playing home recording blanks.

ANSWER: The term "echo" used in referring to recording is defined as follows: When a groove has been over-cut and when high amplitude modulation has been used (volume) the soft material which is the coating of the record is caused to move over to an adjacent groove, which has just been cut. When the record is played back, the distorted groove resulting from the above will actually have some slight

indentures on the walls and these will be heard. In other words, the action usually follows one groove. The remedy to off-set this condition, naturally, is to adjust the depth of cut so that not more than .002 inch scrap is removed.

R. Y., Denver, Colorado, wants to know why there is a variation in speed on his turntable.

ANSWER: This may be caused by one of several factors. One, slippage between the idler wheel and the turntable rim; two, variations in line voltage; three, over-cutting of the record; four, the lack of a guiding stud to engage the disc so that it cannot slide on the table. Most recorders are provided with a stud and all home recording discs are provided with guide holes to fit over the stud in the table so that the disc itself has no alternative but to follow the speed of the table. The tension of the idler wheel must be great enough to prevent slippage. This may be checked by placing ones finger in the side of the revolving table and exerting a slight pressure. If the table slows down materially, it indicates that more tension is needed.

L. W. O., Chicago, Illinois, wishes to know if the scrap material removed from home recording discs is inflammable and how should this scrap be discarded.

ANSWER: Most of the better quality discs use a surface coating that is inflammable. This material, being similar to that of lacquer, should be placed into a metal can or container that has been provided with a tight fitting cover. Some discs, on the other hand, use a material which is non-inflammable, and these may be placed in the conventional waste-basket.

P. W., Kokomo, Indiana, would like to know what causes a visual change in the appearance of cut grooves when they are played back for the first time.

ANSWER: If a cutting stylus is used that is not absolutely sharp on its edges, it will cut a groove which appears dull. If this disc is played back with proper needle, the polishing action which takes place, due to friction, will tend to smooth down the groove and it will take on a slightly shiny appearance. Obviously, this indicates that the cutting stylus is working overtime and a new one should be used after approximately 20 minutes cutting time, if this is of the steel variety.

F. E. S., South Boston, Mass., asks, "Can you suggest some way to clean an acetate disc that was exposed to the air and picked up quite a bit of dust?"

ANSWER: There is only one method for cleaning an acetate disc that is entirely satisfactory. That is, to hold the disc under the faucet and to apply a hard stream of cold water right into the groove. The record should be dried with a silk cloth.

J. W., Moline, Illinois, wants to know the playing time of recording discs of different diameters.

ANSWER: Assuming that a recorder

(Continued on page 60)

Ring the Bell



Why make use of repaired replacement parts and lose your good customers?

by **SAMUEL C. MILBOURNE**

Expert Serviceman, Greenwood, Miss.

IN spite of many articles to the contrary which the author has read, we find no justifiable reason for the use of repaired parts in radio receivers by the average serviceman.

We have heard all the so-called reasons—cheaper, faster, allows immediate use of the radio, doesn't tie up a lot of money in parts, customer-satisfaction, "just as good" as a new part, etc., etc., Let's take apart these reasons and see if they are valid—any of them!

Cheaper. Is it really cheaper to rewind an i-f transformer than to slap in a new one? A good line of general i-f replacement transformers can be obtained at a unit list price of \$1.00 to \$1.25 less the regular trade discount. Eight types will service just about anything you will run across. You make your profit on the sale of the part without it requiring any additional labor time.

Let's assume that you made 50c on the sale of the part and that you charge \$2.00 per hour for labor. A repaired part certainly is not worth more than one-half the value of a new replacement part so that the most you can ethically charge the customer for repairing the i-f coil would be about 50c. But you had to work at least 15 minutes repairing the coil to justify even that charge! Thus, you still haven't bettered your profit and you expended an extra one-quarter hour which could have been used to repair another set.

Recently, we ran across an i-f transformer that had been "re-wound" by some penny-wise serviceman. Believe it or not, the winding was merely scatter-wound and the inductance was so far off that the trimmer wouldn't begin to peak the winding. Besides this, the connections were made so poorly that one broke in a short time, resulting in our getting the repair.

Replacing this coil with a new one was a matter of minutes and we knew

that there would be little chance of another come-back on that job.

It is admitted that any attempt to carry even a skeleton supply of volume controls would tax the serviceman's credit considerably. However, on the other hand, we make the definite statement that 95% of the "repairs" made on volume controls will not hold up. Our method is to advise the customer that we are ordering the control and that the set will be laid up for three days. That's approximately the time it takes for us to obtain a replacement control from our Memphis jobber. If he wants the set the next day, we offer to telephone or telegraph for the part at his expense. If he is really in a hurry, he will O.K. this and we get our part in the next day's mail. If he wants the set the same day, we offer to lend him one of several used table models we have just for that purpose. 99% of our customers appreciate this service, and once in a while we strike up a trade or sell a new set as a result.

Faster. By re-reading the above, it can readily be seen that faster service is actually on the side of the new part. After all, if you expect to get a maximum of profit from your business, you must "get it in and get it out." Needless re-handling of sets is time-wasting. We are thinking particularly of the idea of fixing a man's set "temporarily" until the new part arrives.

Allows immediate use of the radio. Yes, it may, but it is only temporary use requiring another round-trip by the serviceman to put it in proper shape. A much better way is to carry some spare small radios and lend one to the customer while his is being fixed.

Just as good as a new part. This statement has a big IF in it—or should have. IF it has been repaired so that it operates and will stand up under continual use in exactly the same manner as a new part, then it is just as good as a new part. Frankly, we believe that few servicemen can do

this because they have no standards by which to check their results. Arbitrarily, we believe that the majority of repaired parts are not as good as new replacement units.

Doesn't tie up a lot of money in new parts. This is probably the only correct statement of the lot. But, why run a service business if you can't or don't sell parts? How many garages are there which do not carry a stock of auto parts? No service station is worthy of the name unless some parts are stocked for immediate use.

Customer-satisfaction. When you patch a man's radio so that he can
(Continued on page 63)

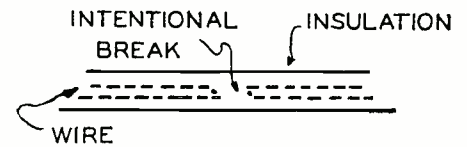

WIRE

Wire cut inside insulation; looks OK.

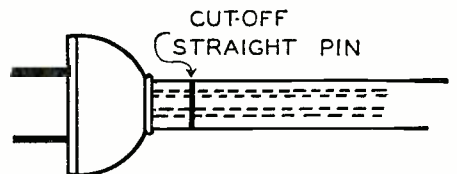

Jimmied plug causes fuse blowout.

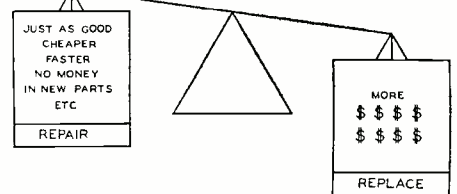

Never repair parts you can replace.

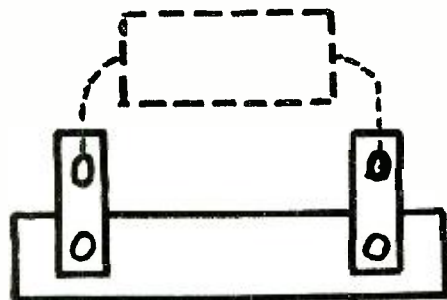

Removed coupling condenser.

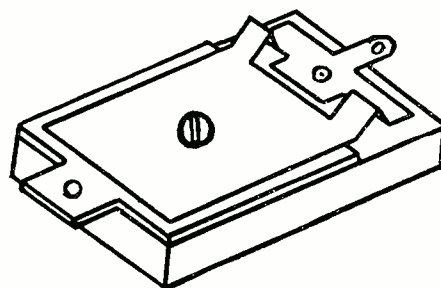

Trimmers screwed down tight.

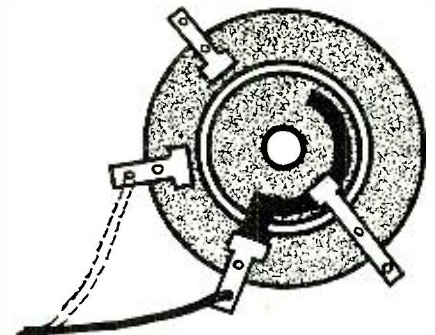

Incorrectly re-soldered connection.

What's **NEW** in Radio

One of the most important developments ever to be presented by the *Midwest Radio Corporation*, Cincinnati, Ohio, is its new 18-tube 5-band radio chassis.

Mr. A. G. Hoffman, Midwest President, said that this new 18-tube chassis represents the finest engineering achievement in *Midwest's* 20 years of radio pioneering. He pointed out that this new *Midwest* chassis represents a real contribution to the field of radio not only because of its super power and world-ranging ability but because its advanced and ingenious circuit design incorporates many unusual features and advantages such as 25 watts power output, Organ Fonic Filter, Dual Speakers, Fidel-A-Stat (Tone Adjustor), Adjustable Loop Antenna, Stat-Omit (Static Reducer), Microphone provision, etc.

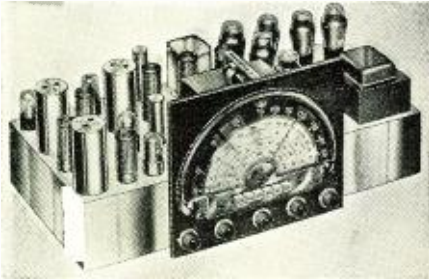

According to Mr. Hoffman, the Organ Fonic Feature is regarded as an important advancement because multiple resonant acousti-chambers deliver the true round rich tones of all the instruments being reproduced. Organ type pipes of proper size and shape directly connected to the rear of the speaker absorb peaks and produce beautifully clear concert realism.

Of particular interest to those interested in securing foreign distant reception, Mr. Hoffman added, is the fact that this new Midwest 18-tube radio offers 25 watts power output. This unusual amount of power offers plenty of reserve to faithfully reproduce crescendos and loud passages in music even when played at home levels. It is this reserve power, he pointed out, which aids tremendously in bringing in far distant overseas stations with the clarity of locals.

Introduced by *DeWald Radio Mfg. Corp.*, 436 Lafayette Street, New York City, this 4-tube Superhet, Model 410 is a miniature personal radio weighing only about 4 lbs. Inside its beautifully streamlined simulated cowhide case (saddle stitched) is a dynamic speaker. Has also

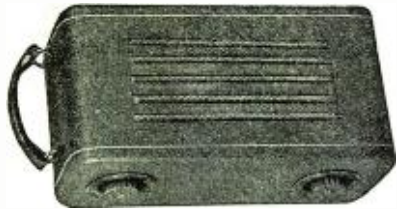

automatic volume control, easy vision tuning dial, inside Loop Antenna and long-lasting batteries for independent operation anywhere. Tuning range from 1700 to 540 kilocycles, exceptionally pure tone, modestly list-priced at less than \$18.00. Complete details may be had from the manufacturer direct.

In applying filters for the purpose of eliminating radio interference caused by electrical appliances for the home, and fluorescent lamps in particular, it is by all means advisable to locate the filter directly at the offending appliance.



To make this possible *Cornell-Dubilier Electric Corp.*, South Plainfield, N. J., offers an extremely compact "Quietone" filter unit with a spade type mounting lug designed to slip under the head of any convenient screw on the casing or

frame of the appliance. Its two insulated flexible leads are then connected across the supply line, either inside the appliance or at the point where the line enters. This provides a minimum path-length for the interference by-pass circuit, with the possibility of interference radiation reduced accordingly.

This type IF-24 "Quietone," for application in 110-volt a.c. or d.c. circuits, is only 2" long by 1/2" diameter. It is entirely sealed in metal for maximum shielding and protection, and is Underwriters Approved. Lists at 75 cents.

For 220-volt lines, a.c. or d.c., the Type IF-25 "Quietone" measures 3 1/2" long by 1 1/2" diameter and is completely sealed in a heavier casing. It also has an additional ground or frame lead brought out and provides a 2-hole mounting.

Both units contain capacitors of the highest quality and internal connections offering the lowest possible impedance.

The *Emerson Radio and Phonographic Corporation*, 111 8th Avenue, New York City, announces the addition of the 6AE7GT to its line of receiving tubes. A combination triode driver, this tube is housed in a T9 bulb.

CHARACTERISTICS

Heater voltage: 6.3 a.c.-d.c. volts.

Heater current: 0.6 ampere.

Plate voltage: 250 volts.

Grid voltage: -13.5 volts.

Plate current: 5 ma.

Amplification factor: 14.5.

Transconductance: 1800 umhos.

Plate resistance: 8000 ohms.

The 6AE7GT is used in *Emerson Console Model 369*, and *Emerson Automatic Console "Phonoradio" Model 370*, both having 12 watts output.

Sonora Radio & Television Corporation, Chicago, announce the release of a new Compact model named the "Coronet." Molded in rich Catalin, it is available in three models; each with an alabaster body with trim colors in a choice of maroon, pastel blue, and pastel green.



The "Coronet" has been developed especially for the Holiday and gift market. The color combinations have been carefully chosen by leading stylists to harmonize with the decorative schemes of practically any setting. The receiver itself is a 5-tube Superheterodyne with built-in Sonora scope loop aerial. The receiver measures 8 1/2" x 6 1/2" x 6 1/2". The list price for each of the models is \$18.95.

Small in size but no midget in performance is the *RCA Victor Personal Radio*, the ultimate in radio compactness. Light as a handbag, it can be carried everywhere, and gives perfect reception no matter where it is played.



Tough, lustrous, Monsanto polystyrene helps make this radio a truly top-notch performer. For polystyrene has remarkably good electrical properties for radio work, which unlike those possessed by most other molded plastics and other materials that might have been used from a cost standpoint, do not impair the effectiveness of the highly efficient loop antenna concealed in the decorative molded cover.

The cover and polystyrene coil forms used throughout this set are molded of Monsanto polystyrene by Mack Molding Company, Wayne, N. J.

A unique, new, convenient Ohm's Law Calculator has been specially designed by the *Ohmite Manufacturing Company* of Chicago for engineers, servicemen, amateurs, experimenters, salesmen, countermen, electricians, laboratory men, maintenance men, purchasing agents, teachers, students, etc. It gives the answer to any Ohm's Law problem in a jiffy, with one setting of the slide. No decimal points to worry about. All values are direct reading. It does not require any knowledge of a slide rule to operate.



The Calculator has scales on both sides so as to cover the range of currents, resistances, wattages and voltages commonly used in both radio and commercial work. It covers the low current high resistance radio, sound and electronic applications. Also the commercial higher current range for motors, generators, lamps, electrical appliances, and other applications.

The Calculator also has a convenient Stock Unit Selector, listing hundreds of Stock Values, immediately available, in Dividohms, Fixed Resistors (including Ohmite Brown Devils), and Rheostats. A setting of the slide shows you the stock number of the resistor or rheostat you may need. Simple instructions appear on the Calculator. The Ohmite Ohm's Law Calculator can be obtained from your jobber or from the *Ohmite Manufacturing Company*, 4835 Flournoy St., Chicago, Illinois, for only 10c in coin to cover the cost of handling.

Electro-Voice cardak Poly-Directional Microphone. The new CARDAK (model 725) brings to the PA and musical fields an extremely versatile microphone which not only has excellent frequency response but a CONSTANTLY VARIABLE sound pick-up pattern, enabling the operator to select the correct directivity for each particular installation. It is especially suited to the needs of orchestras who travel with their own sound systems and who encounter a great variety of acoustic problems.



A control (screw driver slot) allows the microphone to function as a true cardioid for elimination of sound striking it from the rear or (in extreme opposite position) as a bi-directional for elimination of sidewall reflected sound. It is adjustable for any combination of reflected sound direction, thereby correcting unusual feedback or reverberation conditions.

The response is substantially flat from 30 to 10,000 cycles. Average level, 1 volt/bar -52 DB. Finished in Butler chromium. Built-in on-off switch. Tiltable for non-directional use. Three contact wiring connector. Available in all impedances (low impedance balanced to ground). Popularly priced. Literature from manufacturer, *ELECTRO-VOICE MFG. CO., Inc.*, 1239 South Bend Avenue, South Bend, Indiana.

Ward Leonard Electric Co., Mount Vernon, N. Y., announces a new Break-In Relay used in 'phone transmitters for push-to-talk operation.

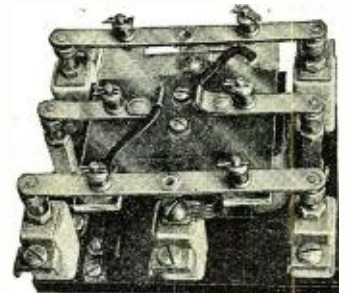

When the relay coil is energized the antenna is switched from the receiver to the transmitter position. The oscillator is turned "On" and the

receiver plate circuit is opened.

High test insulating materials used in the new heavy duty type consist of a Lucite cross arm carrying the contact fingers and Isolantite blocks mounted on a Bakelite base support the contact posts.

All contacts are rated 25 amperes. These relays are described in a supplementary data sheet, Circular 507B, which will be sent on request.

Philco Corporation announces the introduction of two new compacts, Models PT2 and PT6, to its 1941 Transitone line.

Launching the first national scale delivery of radios by Western Union, **Philco** delivered more than 5,000 of the PT2s to key **Philco** dealers throughout the country.

The most sensational feature of these two sets is a new ovalshaped speaker with a full six-inch axis permitting greater volume without distortion.

"The six-inch axis speakers in these sets have been made possible by placing the dials in a horizontal position with the speakers below. This change has afforded an amazing increase in speaker efficiency without any increase in cabinet size," stated Larry Hardy, **Philco** Manager of Compact Sales.

The first of these new **Philco** compacts, the PT2, presents an entirely new 5-tube superheterodyne circuit with a beam power output tube and a built-in loop aerial. The streamlined plastic cabinet, with an illuminated dial in three colors, is 7 3/16 inches high, 11 3/4 inches wide and 6 inches deep.

The PT6, with a larger cabinet in walnut measuring 8 21/32 inches high, 12 1/4 inches wide and 6 15/16 inches deep also has five tubes, an a.c.-d.c. superheterodyne circuit and a built-in loop aerial.

The **Emerson Radio and Phonograph Corporation** presents a new radio which is aptly called "The Patriot."

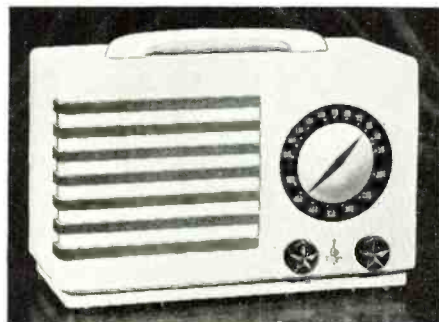

"The Patriot" comes in three different red, white and blue color selections. The cabinet, which is made of Monsanto plastic, is 11 1/2 inches wide, 7 3/8 inches high and 5 3/4 inches deep. It has a new type illuminated dial and a convenient carrying handle. Other features are a large dynamic speaker, built-in "Super-Loop" antenna, two watts beam power output. The list price is \$15.00—slightly higher in South and West.

In a large broadside which describes "The Patriot" and ten other new models, **Emerson** is featuring an "Uncle Sam Hat" window and store display, as well as streamers, local newspaper publicity, mats and other helps which will be augmented as the promotion develops.

Among the new **Emerson** models described in the broadside is a new a.c.-d.c. superheterodyne table model in a Colonial style wood cabinet which lists at \$12.95. A new **Emerson** table "Phonoradio" lists at \$29.95. Several new automatic "Phonoradio" consoles are described, beginning at \$69.95 list.

Shure Brothers, Microphone Headquarters, announce a new 708A "Stratoliner" Crystal Microphone.

The "Stratoliner" has been functionally designed by Industrial Designers, and engineered in the **Shure** Laboratories to meet the need for a handsome, modern, high quality microphone at low cost for public address, paging, call systems,

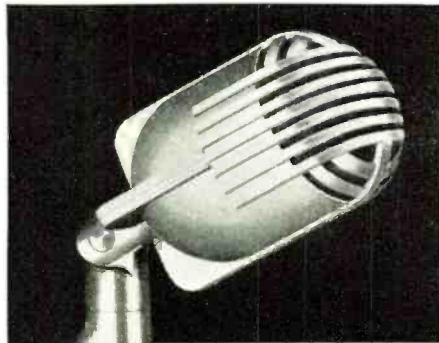

and other general purpose uses. It has smooth, wide-range frequency response, and high output level (49.7 db below 1 volt per bar at end of 7 ft. cable). Moisture-sealed Bimorph Crystal mechanically isolated. Sturdy die cast case finished in Iridescent Gray and highlighted in Satin

Chrome. Semi-directional on non-directional operation. Swivel head easily aimed at source of sound. Built-in cable connector. Locking microphone plug attached to cable. Diam., 2 1/4". Length, 4 7/16". Standard, 3/8"-27 thread for stand mounting.

The Model 708A "Stratoliner" Crystal Microphone, complete with 7 ft. single-conductor shielded cable, lists at \$17.50. Model 708A—25 ft. Same with 25 ft. cable, lists at \$19.00.

For full details, write to **Shure Brothers**, Microphone Headquarters, 225 W. Huron Street, Chicago, Illinois.

The **Carter Motor Company**, Chicago, announce a new line of small, light weight, Aircraft Type Dynamotors for Aircraft, Police, and Marine Radio.



They are made in two frame sizes, 35 and 100 watts output. The 35 watt frame, weighing only 4 1/2 lbs. with aluminum bearing brackets, measures 5 3/4" long by 3 1/4" wide by 3 13/16" high. The 100 watt frame weighs 7 1/2 lbs. with aluminum bearing brackets, and measures 7" long by 3 1/4" wide by 3 13/16" high.

Some of the outstanding features incorporated in both frames are a one-piece field ring simplifying construction and insuring perfect alignment; double enamel and silk wire is used on the armatures preventing shorts and grounds; an especially designed commutator with mica insulation extending beyond the copper bars at all points except where the brushes ride; grease packed double sealed ball bearings that require no oiling or attention; cartridge type brush holders insuring long brush life.

For further information and descriptive circulars, write to the **Carter Motor Company**, 1610 Milwaukee Avenue, Chicago, Illinois.

Micamold Radio Corp., Flushing and Porter Avenues, Brooklyn, N. Y., announce the addition of a complete line of Type MP Dry Electro-

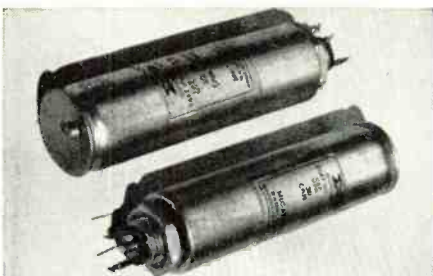

lytics. They are available in sufficient capacity and voltage ranges to care for practically all replacement requirements. Standard lug mountings with both 3 and 4 terminals; both 1 inch and 1 1/8-inch diameters. Literature on request.

Combining the experienced efforts of craftsmen in fine furniture and modern radio-phon-



graph engineering, a new series of de luxe instruments bearing the name "Musaphonic" has been

created by the **General Electric Company**, Bridgeport, Connecticut. The first three models of the series—a small table cabinet and two console types—were introduced to invited groups of decorators, dealers, and general magazine and trade editors during the week of October 7 at special showings at the Manor House, the display rooms of the Baker Furniture Company, in New York City. The instruments are to be displayed further and demonstrated in various parts of the country as samples become available.

The design and production of the Musaphonic series marks the beginning of an entirely new but long-planned activity of **General Electric's** radio and television department. The new models differ in most respects from ordinary instruments, with exacting standards of precision, tonal fidelity and convenience of operation as uncompromising inherent requisites, the G-E engineering staff was requested to design units devoid of the usual restraints and limitations imposed by mass production on an assembly line and by the necessity of meeting popular price brackets. Each instrument is fully custom-built and must undergo rigorous individual testing before its release. In respect to the design, material, and finish of their cabinets, the Musaphonic models, are likewise subject to none of the usual manufacturing and marketing dictates. Each is a separate piece of furniture craftsmanship, created to appeal to discriminating individual tastes, according to Fred A. Ray, who has been designated as manager of the section.

The three models just announced by **General Electric** to comprise the Musaphonic line will be augmented later by several additions including a combination FM radio-phonograph-television instrument. One of the present series provides for the reception of frequency-modulation broadcasting in addition to standard amplitude-modulation programs.

Precision Counter Type Tube Merchandiser. This new Series 914 is an attractive streamlined mutual conductance type tube tester and set analyzer. It features a large 7-inch swivel mounted, easy reading meter that can be fully



rotated in a complete circle, as well as back and forth. It provides a full view of test results from all positions. The Series 914 is fully described in the **Precision** catalog for 1941, which may be obtained direct from **Precision Apparatus Company**, 647 Kent Avenue, Brooklyn, New York.

Allied Radio Corporation, Chicago, has just placed on the market an ultra low-cost 5-tube



midset radio receiver, Model B10508. This new KNIGHT set is designed for operation on 110-120 volts, 50-60 cycles a.c. or 110-120 volts d.c. Tuning range is from 535 to 1720 kc. Many outstanding features are incorporated in this unusually low-priced set. For example, there is the new "Magna-Beam" built-in aerial; a new type of tuning dial arrangement; A.V.C.; big p.m. dynamic speaker; develops 1 1/2 watt power output, etc. Latest 1941 circuit design, licensed by R.C.A. and Hazelting, incorporates the following tubes: 12A6GT, 12R6GT, 12Q6GT, 35L6GT, 35Z5GT. The KNIGHT 5 is offered in a smartly styled molded plastic cabinet—available in ivory or walnut-brown finish. Size, 8" x 4 3/4" x 4 5/8".

A product of **Allied Radio Corporation**, 833

West Jackson Boulevard, Chicago, Illinois.

Talk-A-Phone Mfg. Co., Chicago, announces a new Automatic Changer Instrument in both the wireless and wired table models. Designed for use with any radio set. Features the newest type Automatic Record Changer—plays ten 12" or twelve 10" records—almost an hour's enter-

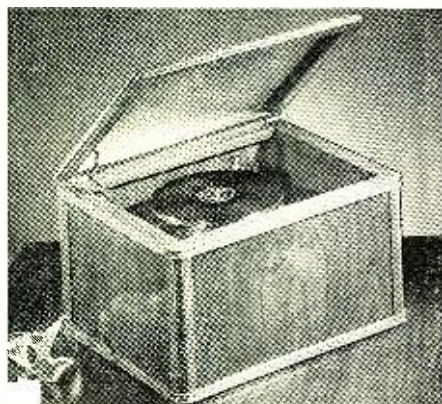

tainment with each loading. The TALK-A-PHONE Wireless Changer Player uses steady 78 r.p.m. rim-drive motor and Crystal pickup. Built-in is a 2-tube "wireless" oscillator. Presented in a simple, attractive table model cabinet fashioned of selected walnut veneers. Size: 21" wide, 16 3/4" deep, 12 1/4" high. For operation from 110-120 volts, 60 cycles a.c.

The incorporation of a roll-type tube chart as a built-in feature of some of the newest tube testers greatly increases their businesslike appearance, in addition to speeding up tube testing and avoiding the use of separate charts, often soiled and torn from constant handling.

These same advantages can be provided for many older tube testers through the introduction by Radio City Products Co., Inc., 88 Park Place, New York City, of their new "Rolindex" tube chart which, mounted in its own neat hardwood case, can be easily attached to existing tube-testing equipment.

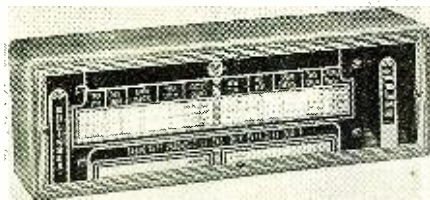

The "Rolindex," with case measurements of 11" x 3 3/4" x 3", consists of a highly developed and everlasting mechanical movement driving the roller chart and actuated by a knurled disc projecting edgewise through the front panel. Set into this panel is a window of transparent plastic with a hairline engraved across its center to make it easy for the eye to follow across the columns of test-control settings.

The chart roll is easily replaced by up-to-date charts which will be available from R.C.P. as new tube types require. Suitable charts are now available for a number of the older R.C.P. tube testers and for more recent models which do not incorporate the roll chart as a built-in feature.

The "Rolindex" is supplied in two models, the only distinction being that the Model 102 has its own internal illumination while the Model 101 does not.

A newly-designed 15-watt portable public address system for sound reinforcement applications for indoor audiences of up to 2,000 persons.

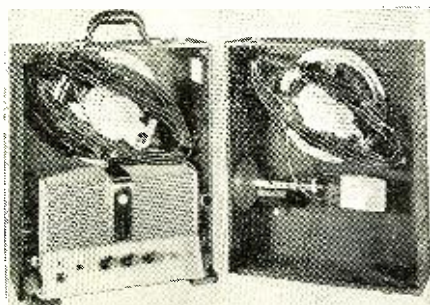

has been announced by the Commercial Sound Division of the RCA Manufacturing Company. The new system is priced 15 per cent lower than the popular 12-watt system it replaces in the RCA line.

SERVICEMEN'S LEGAL ADVICE



THE interest of the country has been focused on the expansion of the armed forces of the United States, under the Selective Training and Service Act of 1940. Very little is known, however, of the Soldiers and Sailors Civil Relief Act, approved October 17th, 1940, which Act grants certain relief to persons inducted into the military service. The following is a brief résumé of certain parts of the Act, which should be of interest to all service men.—T. J. H.

THE purpose of the *Soldiers and Sailors Civil Relief Act of 1940* is to promote and strengthen the national defense by suspending enforcement of certain civil liabilities of certain persons serving in the military and naval establishments, including the Coast Guard. The Act is to remain in force until May 15th, 1945, but if the United States be then at war, the Act shall remain in force until six months after such war is terminated by a treaty of peace proclaimed by the President. The term "Persons in military service" covers all branches of the service, including the Coast Guard and all officers of the Public Health Service detailed for duty with the Army or Navy. The purpose of the Act is to enable persons in the military service to devote their entire energy to the defense needs of the nation, and to this end the provisions of the Act are made for the temporary suspension of legal proceedings and transactions which may prejudice the civil rights of persons in such service during the period over which the Act remains in force. The provisions of the Act shall apply to the United States, the several states and territories, the District of Columbia, and all territory subject to the jurisdiction of the United States.

Affidavit Prerequisite to Default Judgment

In any action or proceeding commenced in any court, if there shall be a default of any appearance by the defendant, the plaintiff, before entering judgment, shall file in the court an affidavit setting forth facts showing that the defendant is *not* in military service. If unable to file such affidavit plaintiff shall in lieu thereof file an affidavit setting forth either that the defendant is in the military service or that plaintiff is not able to determine whether or not defendant is in such service. If an affidavit is not filed showing that the defendant is not in the military service, *no judgment shall be entered without first securing an order of court directing such entry*, and no such order shall be made if the defendant is in such service until after the court shall have appointed an attorney to represent defendant and protect his interest.

Stay of Execution; Vacation of Attachment or Garnishment

In any action or proceeding commenced in any court against a person in military service, before or during the period of such service, or within sixty days thereafter, the court may, in its discretion, stay the execution of any judgment or order entered against such person, or the Court may vacate or stay any attachment or garnishment or property, money, or debts in the hands of another, whether before or after judgment as provided in this Act.

Exclusion of Military Service Period from Periods of Limitation

The period of military service shall not be included in computing any period now or hereafter to be limited by any law for the bringing of any action by or against any person in military service, whether such cause of action shall have accrued prior to or during the period of such service.

Eviction or Distress for Rent

No eviction or distress shall be made during the period of military service in respect

of any premises for which the agreed rent does not exceed \$80 per month, occupied chiefly for dwelling purposes by the wife, children, or other dependents of a person in military service, except upon leave of court granted upon application therefor or granted in an action or proceeding affecting the right of possession. On any such application or in any such action the court may, in its discretion, stay the proceedings for not longer than three months, as provided in this Act, or it may make such other order as may be just. Any person who shall knowingly take part in any eviction or distress otherwise than as provided . . . shall be guilty of a misdemeanor, and shall be punishable by imprisonment not to exceed one year or by fine not to exceed \$1,000, or both.

Repossession of Property for Non-Payment of Installments

No person who prior to the date of approval of this Act has received, under a contract for the purchase of real or personal property, a deposit or installment of the purchase price from a person who, after the date of payment of such deposit or installment, has entered military service, shall exercise any right or option under such contract to rescind or terminate the contract or resume possession of the property for non-payment of any installment falling due during the period of military service, except by action in a court of competent jurisdiction: PROVIDED, That nothing contained in this section shall prevent the modification, termination, or cancellation of any such contract, or prevent the repossession or retention of property purchased or received under such contract, pursuant to a mutual agreement of the parties thereto, of their assignees, if such agreement is executed in writing subsequent to the making of such contract and during or after the period of military service of the person concerned. Any person who shall knowingly resume possession of property which is the subject of this section shall be guilty of a misdemeanor and shall be punished by imprisonment not to exceed one year or by fine not to exceed \$1,000, or both.

Enforcement of Mortgage Obligations

The provisions of this section shall apply only to obligations originating prior to the date of approval of this Act and secured by mortgage, trust deed, or other security in the nature of a mortgage upon real or personal property owned by a person in military service at the commencement of the period of the military service and still so owned by him. In any proceeding commenced during the period of military service to enforce such obligations arising out of nonpayment of any sum thereunder due or out of any other breach of the terms thereof occurring prior to or during the period of such service the court may stay the proceedings as provided in this Act; or make such other disposition of the case as may be equitable to conserve the interests of all parties.

Repossession of Motor Vehicles

No court shall stay a proceeding to resume possession of a motor vehicle, tractor, or the accessories of either, or for an order of sale thereof, where the same are encumbered by a purchase money mortgage, conditional sales contract, or a lease with a view to purchase, *unless the court shall find that 50 per centum or more of the purchase price of said property has been paid*, but in any such proceeding the court may, before entering judgment or an order, require the plaintiff to file a bond to indemnify the defendant, if in military service, against any loss or damage that he may suffer by reason of any such judgment or order should the judgment or

(Continued on page 64)

HAM CHATTER

THOSE of us who are fortunate enough to be in the Chicago area and attend the Chicago Council Dance, had a most enjoyable evening. It is reported that over 300 couples were present. Cy Read, W9AA, and his band furnished the music and certainly left nothing to be desired for those who like to "trip the light fantastic." The prizes were numerous, the entertainment was superb, and a fine evening was had by all. The grand prize of the *Hallcrafter* receiver was won by George Ashton, W9PNV. Incidentally, George stopped us on the way in and told us that he was positive he was going to win this time because his hat check read "73," which, of course, meant "good wishes." George said that that meant good wishes to him in the prize drawing, which proved to be true. This was the Second Annual Chicago Council Dance and, since it was such a success, a similar Annual Fall Dance is assured every year from now on.

IN the month of November the Council had an excellent Open Technical House at which a number of featured speakers were present. The attendance at the Technical Open House, while not as large as that of the dance, was nevertheless gratifying. The Council should be encouraged in its joint policy of furthering the social and technical aspects of ham radio. The former field, the good fellowship and friendli-

ness, the get-together spirit, are a definite asset in moulding the amateurs into a cohesive group; while the technical meetings enable each and everyone who attends to improve himself in the field of radio. Since the National Defense of this country is going to lean heavily on radio, and since the amateur may be called upon to act in any one of a great number of capacities, it will pay him to attend these meetings and to improve his knowledge. More power to the Council, and we hope that their future meetings and dances will be as successful as those which have gone before.

WE are not sure how many HAM CHATTER readers and how many amateurs happened to be tuned in on that broadcasting chain when it broadcast the monstrosity which purported to be Ham Radio, but we are certain it must have been a great number. Aside from the glaring technical mistakes which were apparent throughout the entire script, we also found a number of mistakes in ham "slanguage." The main character was supposed to say, "83's" instead of "73," his CQ's were not only badly sent out but they were not sent out in the proper and approved form, he misused the "Q" signals, etc. Licenses assigned to the fictitious characters in the script were wholly impossible and couldn't, under any stretch of the imagination, have been assigned by the F. C. C. to anybody. The type

of transmission and reception which was engaged in was ridiculous, and the situations which were supposed to have been handled by amateur radio were as foolish as they were numerous. While we do not mention either the chain, or the product which it advertised, we feel certain that such glaring inaccuracies appearing on a nationally advertised program can only result in wholesale disgust in the radio amateur.

In view of the fact that there are 55,000 of us available who would gladly furnish the correct information without charge (not to mention the American Radio Relay League, the Ham-chatter column, "Radio" of the West Coast, and a large number of manufacturers and jobbers, if they were but consulted), we fail to understand why either the broadcast chain or the advertising agency which represents the manufacturer of the product, or, in the final analysis, the manufacturer of the product itself, did not go slightly out of its way to have the script proof-read by someone familiar with the subject-matter.

The thought arises in our mind that if radio amateurs are so misrepresented in script, Yehudi must be the only man who knows how badly the detectives, the firemen, the army, the navy—in fact, the whole field of little-known technicians may be similarly misrepresented on the air waves.

We'd give a good plugged nickel to know how

C. A. R. C. C.—Oct. 26, 1940—CHICAGO DANCE

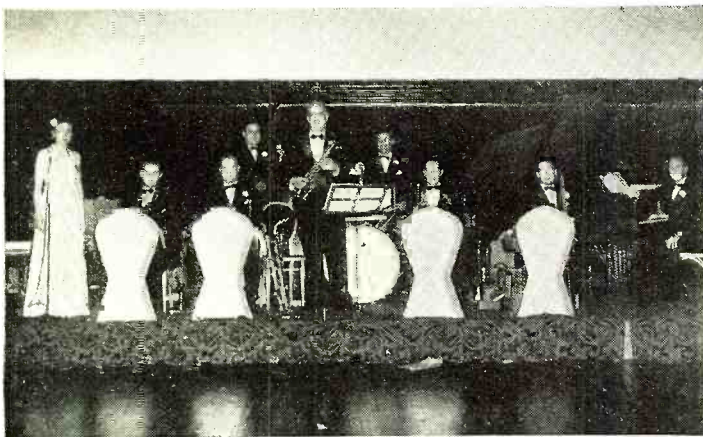

Cy (w9aa) Read and his NBC Orch. played the dance.



w9aa es w9fxb.



Ex-w9zn talked. . . .



Sally Fairbanks draws a ticket . . .



Bill Halligan picks out the prize . . .



and congratulates Grand Prize winner.



CARCC prexy, W. Clark, was there. . .



Just the gang that turned out. . . .

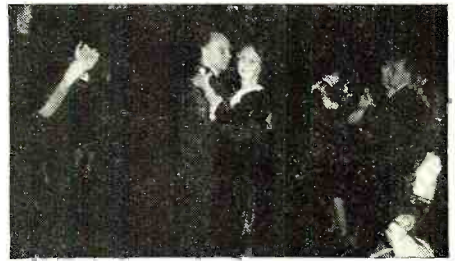

Herb w9mrq dances the missus. . . .



Hamop "Art," w4gfn.



The bar at the C.A.R.C.C. Dance.

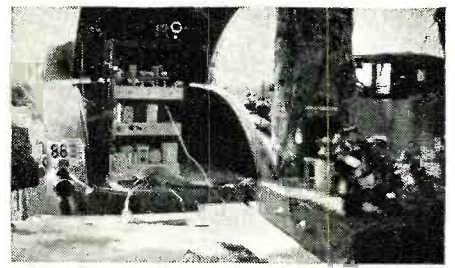

F. D. Hamstation of w1inn.

many complaining letters were received on that program.

W6SYT & SYX are both new hams hr in Burbank, Calif. SYX is ex 7EGM. Both on 160 but Royal, SYT, worked 8 states in 1st 2 months (1/2 wave ant. hi!)

Suggestion: The old Hallierafters 5 tube T.R.F. (before 1st Sky Buddy) makes excellent E. C. Osc. witness: W6SLF, yours truly. New tube lineup (42-42-6L6G) but only minor changes in band change sw. wiring and there u are as band switching exciter 20 to 160 meters. No xtal in shack, hi! 160 chief band hr too. Carbon mike bleeder system from power supply works fine.

W6 SCN finished rebuilding es 65 watts nw. on 160 fone.

Glendale Amateur Radio Society acquiring new members almost every meeting. 100% ARRL club. Have license pending for club emergency station.

W6QQX new member of AARS. W6OSP exhibited his rig at Los Angeles County Fair recently.

W6RIP—Rest In Peace—is ardent 40 M. man. When on 160 words fail, hi!

W6PGJ Ant coil on h.p. rig went up in flames es overheated HF 100 so it in the west nw too.

Pretty good dx rolling in regular nw—5's, 7's, & 9's with an occasional 4 and-8 etc. very sporadically. Only trouble: most of us hear *them* but they don't hear us HI. 160 even delivering a few K6's nw.

W7HPH. W7's "Hen Pecked Husband." (Go ahead and print the above. I'll not let the XYL knock your block off.)

W7FIJ took advantage of his vacation by helping the painter give his house a face lifting. Nice looking job, Beregy.

W7FYO is about to take a flyer in aviation business. You will have to take us for a hop some time. Henry. Gud luk.

W7GPM is in the mining business at present, but comes home over the week end to radio and take a bath. Hi.

W7CTT puts in a nice sig. down here with only 13 watts. Nice going, Ray.

W7HOV is busy running his power house now. His XYL is still under the weather; so Bill's haming is going behind some. Hope you snap out of it soon, Madge.

W7EPN. Working portable on field day with 8 watts from Dodge gen. Put a 5-8 signal in here recently. Nice going, Tate.

W6QYL was worked some time ago. 240 watts. 9,000 ft. elev. A whale of a sig. too.

The next contact was with W6RPX who had a nice sig. also, and said his elevation was 9,000 ft. Talk about swell spots to do your haming.

W6JDN reports poor location, but lots of power. Maybe you need a mountain Harold.

W7HDF, W7LBY, W7CBS and W7HVX, sorry about QRM. We sure hope to work you when conditions are better and will keep an eye open.

W6PBH uses a 1 K.W. gas driven generator and talks until he runs out of gas (in the engine), so he won't have to go outside and shut the thing down. Hi! Hi! Some class, Myrl.

W7KJ and XYL finally got around to pay us a visit, and have a long delayed rag chew. Hurry back, Ken.

HERE'S more news and doings of the gang from in and about Detroit. Now with the Fall season here more of the rigs are coming back on the air.

The Great Lakes Amateur Fone Association held their first fall meeting at which the following officers were elected for the coming year: WSJDG prez, WSPZQ vice prez, and WSQIX as keeper of the books and cash. James A.



Greater Cleveland, 2nd YLRL Meeting.



w8brjg es his xyl and bull pup.

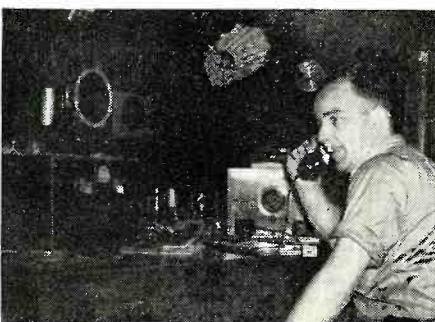

Hamop w1kxu.

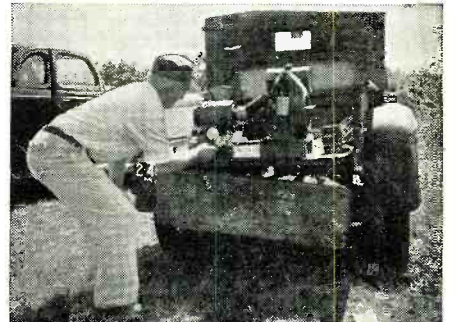

Hamop w1IEG sets up the mg.

McLaughlin, radio engineer was the guest speaker, who as usual delivered a fb talk on the need for more experimenting with receiver circuits.

W8QFF is still very much bothered with qrm, especially with line noises. Maybe another new qth will help OM.

W8UQX is one of the newer hams heard here abouts. He is on 40 CW at present and running 50 watts for the time being.

W8GA spent some time in the northern part of Mich. along the trout streams, and he caught some fb fish too, something to tell the boys back home.

W8SEC is now using a tree replacing the pole atop his shack, as the tree grows he figures the height of his antenna should increase. Quite a bright idea OM. hi.

W8QNA of the local RI office has been transferred to Texas, his many friends will miss him, but he promised as soon as he is settled he will have a rig going on 20. Good luck OM and we will keep look-out for your new W5 call.

W8HOO, the hoot owl is finally able to get out after being bedridden for several months. We are all glad to hear the good news OM and hope to see you active on 160 fone again.

W8TNU has the proud distinction of having worked KC4USA and having only shortly before received his Class A ticket.

W8VAC is one of the new calls heard on 160, has a FB sigs on fone.

It seems that the local hams must be enjoying outdoor life as noted by their absence on the various ham bands. Also the local foto takers are quite busy with the fellows flocking in to have their foto taken in compliance with the new FCC order.

W8RNC must figure to work some dx, he has recently received his Class A ticket.

W8UYG is a new ham and is operating on 10 meters.

W8QFF and the XYL recently celebrated their 35th wedding anniversary, we wish to extend our belated congratulation to the happy couple.

We wonder what W8LEC is going to do now since he cannot work dx any more.

W8PHE is spending his vacation in Kansas on a farm. Wonder how he is enjoying the heat.

W8PVN is back on the air after being off for quite a while.

W8SPK spent a couple of days recently in the Upper Peninsula taking in the sights and the cool weather.

W8NDT and W8MAS have just received their commercial tickets.

W8VUP has received his ticket recently and can be heard on 40 meters.

W8SKE has been working dx on 112 meggies, his best dx being around 25 miles.

W8RUO is finally on the air after numerous setbacks both in obtaining his ticket and equipment. He can now be heard on 160 phone.

W8LZV is spending his vacation motoring through the east. Hope he has a nice trip.

W8BL has given up Ham Radio, we hope it is only temporarily.

W8SSLJ is building a 45 foot tower on which to hang a three element rotary for 20. Wonder if he plans to work dx.

W8ATO was recently presented with a daughter, congrats OM.

This winds up on the dope from the Detroit gang, hope to see you next month.

BETH, the YL opr at W8NCJ is now member of ROWH, she also joined AEC & was recently awarded membership in A-1 opr club.

W8NCJ keeping daily tlc skeds with W3GKO and few other irregular skeds on high end of forty meter band during summer months. Those fellows interested in summer tlc work should get on PTS frequencies or any place between

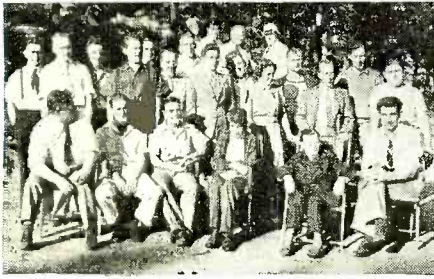

North Shore & Boston Ham Picnic.

7200 and 7300 kcs. Plenty of tlc available here including lots coming from W2USA.

W8POX trying his luck at cutting & grinding xtals from some native quartz he recently acquired.

W5WQ is now on the air with his new "Bug" and he sure does handle it very fb.

W8BLQ was a recent visitor at W8NCJ and reports drawing up plans for a new ten meter phone rig.

W8NUH now has finally gotten QSL cards from all states but hasn't sent them in to ARRL yet for the WAS certificate.

Both the YL opr at W8NCJ has WAS certificate No. 1129.

YL opess W9IGU is a Senior in Normal School this fall.

W9HWI is entering the University of Wisconsin.

W9EBI is back on the air after a long absence. He is the proud father of a YL Junior Op.

W9NHZ has traded his W9 call for the new call W4GUY, and has a new rig on the air at his new location. "Sammy" is with Pan American Airways in Miami. He was formerly with WTMG at Ocala, Fla. He is a brother of W9IGU.

W9YXH and W9QBJ joined the Signal Corps recently, and at present are at WVT. Several Sparta CCC District operators have also joined the Signal Corps.

W5PH of Tyler, Tex. has been on the air for over 20 years. Heath says he still gets a kick out of it.

W5YR Bob of Wilson, Ark. can really chew the fat hi.

W3LAD on 40 is another Dallas, Tex. ham.

W5DAM really has a FB call dont you think hi.

W5DLR has a nice sig on 160.

W5ZD has a nice fist on old 40 CW.

W5LM in Temple, Tex. works out on ten.

W5HD also works out nicely on ten.

W5LUG dropped in to visit W5HKJ and Doc had the RARE privilege of working W5HMV on fone (sum fun eh keed).

W5AVO N. O. La. Bob an old timer is now on 160.

W5IGW after a long troublesome time now is working out on ten.

W5ITS old Windy Frank of Winfield, La. really gets out.

W5HRC of Bunkie, La. has a system of working on his ant. with a 22 rifle.

W5DAN really put up a holler about being finger printed I always knew that Scoofer had a past (Hi Curley)

W5AJW has one of the better fists on 40.

W5EY is back on the air again.

W5GXO my dear old friend Jake of McComb, Miss. will be heard early and late on the air (his little new YL harmonic gets him up hi).

Well I guess thats about the crop but before ringing off tdi next month I would like to broach this question. Why in the H . . . is it that after some of these kids and punks who work 160 for about five years get a Class A ticket they immediately start calling the poor old 160 boys names I wonder if they ever listen to some of the asine nutrid drivel on 75 es 20 that can be heard daily. Judge not lest ye be judged hi-diddle-de-bump.

YLRL NEWS

CALLING all gals—calling all gals (licensed ops) from these 12 states still missing from the YLRL roster: ALA., LA., MISS., NEBR., NEV., N. MEX., N. C., OKLA., S. C., UTAH, VA., & W. VA. In some of these states, girls have already been informed of the League and if they



SWL, Johnnie the Shadow!



w6mfh, w6mdi, w6kme, & w6lmd.

have not already joined, perhaps this notice will serve as a gentle reminder to get into action. If you have some spotted, will appreciate hearing about them. How about it?

W8PZA—ex-W7FKS of Eugene, Oregon, Eighth District Chairman, entertained the No. 1 Unit at her home in honor of W8SPU's visit. The girls agreed that the "baby business" must be flourishing in Sycamore, Ohio, as Helen sported a new squirrel coat, a present from the om, W8QOV (Doc). Incidentally Helen got news of her WAS certificate, while she was visiting the Cleveland girls.

W7FWB, President, expects to be xmtg from Wenatchee, Wash., swell sigs from her new xmitter which she is completing—802-813 with a separate 6L6 eco stage. With 250 watts on 40 and a coverage on 20 & 30, she'll be able to keep at the pulse of activity more readily.

Speaking further of furs—K7HUT tells about the mink, red fox, otter and an occasional cross fox which they have around Ugashik, Alaska. (The way the wind blows around that Bristol Bay district, it's a wonder there's any hair left on those animals, let alone Verna's antenna poles escaping the fury of those "blows.")

K7ENU has recently acquired the start of their dog-team with the gift of three puppies. She didn't say how she expects them to pal with her two Persian cats. Mary ought to be pretty well settled in Nome by now and its probably sampling her winter supply of blueberry jell.

W9HIG—Jerry, Flaxton, N.D., is a "teen-age" clever young lady. She conceived the idea of a "ham" blouse, embroidered all over with "handles" of ops she has worked. The idea has crystallized and the YLRL emblem adorns the middle of the decorative blouse's back. (It should make a good ad at the ham conventions.)

New Jersey is represented in the Second and Third districts by W2EKA, Kitty in River Edge, and W3HVO Pauline in Trenton.

W8VFL Martha Lee Bishop, the first licensed Akron YL about whom the writer knows, lost no time in joining the YLRL. The boys of the Buckeye Club have always been progressive, they failed to get the proper share of publicity until Martha came into the picture. She is a reporter on the staff of a local paper and as a hobby, even while she was a swl, she published *The Amateur Sentinel*, a ham sheet which you favorable comment and gained her the McKim Technical School scholarship. Among the subjects offered was radio. It is not difficult to guess which course Martha chose so we look for big things in the future from our Akron member. She'll be operating on 40 CW and 160 fone.

YLRL First Anniversary party the early part of November kept the gals glued to their receivers and transmitters and when "the gong sounded" despite their friendly rivalry to pile up points for that cup donated by Norm (Corky) Corcoran of Wyoming, Ohio, whose wife is Marie, W8TPZ, the girls took enough time out in their qso's to make many new air acquaintances. First YL to win the cup three times retains it permanently. The cup is ten inches high with a sun-ray finish, mahogany tone bakelite base and engraved band.

The writer has discovered that she shares the Lombard line of ancestry as does a Washington, D. C. YLRL'er. She learned too that W9CHB and herself have the same birthdate—March 1—but not the same year, hi. Flo is younger, so you figure it up. Flo recently left Pine River, Minn., for a trip to New York and Canada. The day before she left, she lost a 14 year old Irish Setter (*Red Rex*) so you dog fanciers can appreciate the cloud overcasting the joys of vacation leaving.

W4GUZ, Dean of Eagan, Tenn., gets up early



w4inn & w4krg.



Would-be hams start their instruction at RCA research laboratories.

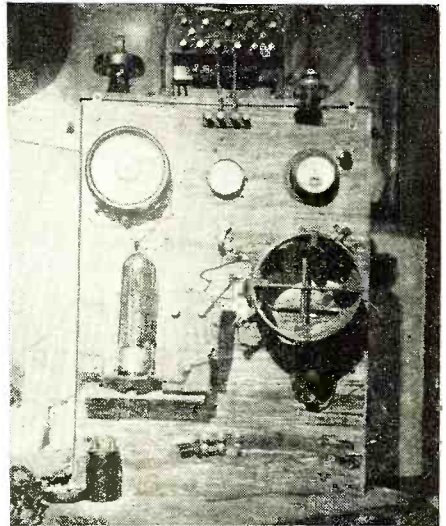

w9edb in 1922.



"The Fireman," w1imme.



YLRL member, w3fzx.



Hamstation w2knp.

to gab with the 160 fone gal ops. She has been heard talking on the net which at times includes several or all of the following: WSUEZ, W9LDN, W9JWL and W8TPZ.

W8NCJ, Beth, got her 35 wpm proficiency certificate, making solid copy in longhand. W1FTJ, Dot, got the 30 wpm Manchester Club Award Prof. Cert. (on the mill). These are just two of the girls who have received code recognition at 30 wpm or plus. Dot represented the YLRL at the Boston Hamfest. Her call letters suggest a good slogan: "Full Time Job" because besides being NH SCM, she recently got another appointment—Asst. Director for the N. E. Division of the ARRL—and don't think for a minute that just because she sat at the head table with the ARRL President, that had anything to do with it—hi.

RV December column promised list of Net Control Stations on the nets so here goes: NCS W8TPZ 160, NCS W9LH 80 cw, NCS W9ZTU 40 cw., ALT W9OWQ 40 cw., NCS W2IXY 20 fone with ALT. W9DBD, NCS W9OWQ 20 cw. with W8SJE as ALT. (Any girl interested can get in touch with these control stations.)

W4GIW's slogan: "Gosh I wonder"—wonder who'll come back, I suppose.

W8ODI who is now living in Columbus, Ohio, recently visited several Army Stations and said "Wow the QRM—sounded like the 40 meter band with everyone on at one time and all RQ sigs." Ruth found the tape punching machines fascinating.

W3BAK, Jean, also holds the call W1KNP. This is the girls' camp station in Lake Spofford, N. H., the Jean herself lives in Delaware as does her sister, W3IRR—Dorothy Hudson Elliott—and we understand she is a violinist. She keeps busy too with her Red Cross Work. Dot lives in Georgetown. Their brother is W3AXP and Dad is W3BAK.

When W6SGD failed to get a confirmation from several Massachusetts boys she had worked (betcha they all ran out of cards at the same time?). W1GQT, Lida, obliging First District Chairman, got up early one A.M. to keep a sked with Kitty in Arizona and knowing Lida, we are certain a qsl left Holyoke pronto for Prescott.

W2MQY Horatia and W2IXY Dot, Second District Chairman, keep up their 10 meter cw skeds which they laughingly say "just for practice." Incidentally W2MQY has been appointed Asst. Emergency Co-ordinator for NYC. Dot isn't using her fb kw rig on cw but a 60 watt rig for those Long Island sigs to travel on the 14.884 kc. channel.

W2MJS, "Lucky" Emma worked KC4USC, the Snow Cruiser, on 10 meters. She once made the statement that she spent 90% of her time dx hunting and we believe it. Some of the other girls too have been pretty fortunate in working the various KC4 bases.

Many of the girls are seen sporting their new YLRL pins. The same emblem, tho magnified, adorns their imprinted letterheads, which the members are losing no time in ordering.

W8TPZ is the happy recipient of pins and plates (in black with silver letters). One plate was for her rig and the larger one "YLRL W8TPZ" was for display on her desk at the Indianapolis Convention, where she did a grand job. (Pins were donated by a fellow GCHARA member, W8PBB, who deserves a big hand, girls.) While there, Marie brought together many girls, among them the following, where they met either at "Brunch" or one of their many gab-fests: W9JTX, III, W9ZTU, Ky, W9LH, III, W9TLJ, III, W9DBD, Mo., W9LDN, Ind., W8SJE, Ohio, et al. Understand W9EFT—Esther from Ft. Wayne—received a telegram and hastened away. We hope it wasn't bad news but it left W8EFT of Cleveland Heights disappointed as he planned to meet the gal whom the government honored with the same letters as his but in an adjacent district. (Too bad, Paul, but let's hope the gang gets bigger and better for all future conventions.)

W2MIN, Violet, is another registered nurse to join the ranks of the YLRL. She is a graduate of the Pasadena Hospital and holds a certificate from the American Radio Institute. So 33.—W8TAY.

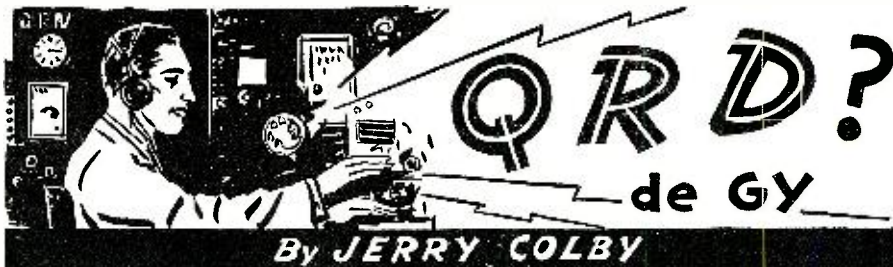

WE see by the papers that Brother Merv Rathborn, President of the ACA, has resigned his position because of ill health, to return to Frisco where he formerly lived. We wonder whether this isn't a move to get that west coast appointment to the FCC which Thad Brown just recently resigned. The ACA has tried for years past to get one of their boys appointed to the Commission. First, there were rumors that Hoyt Haddock would get the post, then Brother Ward was pushed to the front, and now Merv Rathborn. Of course, with Rathborn's political connections (he was appointed to the Advisory Board of the National Youth Administration by President Roosevelt) it is possible that he has a good chance. But we believe that he's going to get a real run for his money by a west coast chap who has the backing of businessmen, broadcastmen and politicians. His background as a radiop and technician is unimpeachable and there is every possibility that this fellow will get into the home stretch ahead of Brother Rathborn. May the best man win, sez we.

DUE to ever increasing demands for VWOA news from our readers we have been fortunate in getting Leroy Bremmer, Secretary of the Los Angeles-Hollywood Chapter of VWOA to do the honors and pass out whatever news is available. Gentlemen of the moss-eaten old brass pounders, we present Brother Bremmer:

During the recent visit of David Sarnoff (RCA prexy) some 40 members of the local gang got together and threw Dave a luncheon at the Brown Derby. Everyone who counts in the radio business was there, including Fred Sammis, the guy who gave Brother Sarnoff his first job as office boy in the old Marconi Co. Dr. Lee DeForest was



given one of the finest tributes when Dave said "This is the man to whom I owe my job and to whom we all owe our respective positions today. If it hadn't been for his audiotron tube there would not be radio as we know it today and many other industries which have grown big because of his tube." Brother Sarnoff was presented with a gold honorary membership card in our chapter. And a goodly time was had by all.

SINCE Brother "Bud" Morris resigned from the managership of the Hotel Clark, our chapter is temporarily without a "Wireless Shack." Although we've been offered some choice spots, we'll only be able to give you the final resting place in the next issue.

THE Hollywood Chapter was signally honored when we presented the Marconi Memorial scholarship to Robt. J. Stahl of Redwood City, California, over the facilities of the Don-Lee-Mutual coast-to-coast

hookup. Presentation was made in the KHJ studios by Hal Styles. Incidentally, Stahl won this \$1000 scholarship over 27 contestants who represented every section of the country.

W. J. O'BRIEN from down under in Australia writes, "On your list of Directors I notice Duke Hancock who I remember on the Matson ships in the early 20s. Also Harrison Holliday who was a KFRC about the same time. . . ." Fred Cookson who is doing duty at the Traffic Fines Bureau in S.F. sez, "Certainly was refreshing to hear about the old bunch. . . . So many have dropped out of the immediate picture during the past few years. Ike Colbert, Cronkrite fm KHK, Willets of SF (with whom I worked ten or fifteen years ago) O. M. Windser of KOK, etc. Chapple, Jack Dunn and all the rest. Conspicuous was the absence of old Fred Dewey. . . . The Duke Hancock-City of Honolulu incident in which I was implicated because I was running on the old WML from Honolulu to Kahului. . . . Here's a pip from A. R. Rice in Berkeley, Calif. "Perhaps the enclosure may be of interest to you. I have not met DeForest since he thanked me for my testimony at his trial in New York City, 1912. At this trial I hold up the 'Audion' as something that DeForest had created for Science, and got a big laugh from the spectators. I recollect also when Kent met me at San Diego, 1908, with a handful of crystals, and requested I substitute them for the 'Audion' as Lee DeForest said the 'Audion' was no good as a detector. I told Kent nothing doing, my only trouble was getting more 'audions' or making them to last longer than one nite. Tell him to double the voltage of the 'B' battery, hook it to a Pierce tuner, knock the audion elements together as close as possible and to use a modern expression, 'go to town.' Regeneration—I had it and did not know it. There is about a three thousand word report in the Navy Dept. relating to how the Connecticut received while in Peru HV NY PT on the East Coast, to say nothing of the Pacific Coast. . . . Maybe see the Doctor during DeForest Day at the World's Fair as I want to see him and remind him of his station at the Highlands of Navisink, New Jersey in 1903, and other old times too numerous to mention. . . . Mrs. "Jack" O'Neill of Los Altos, Calif. sez "Jack O'Neill has asked me to tell you how much more than pleased he was to receive the gold membership card from your VWOA. Nothing could have touched him more deeply and he is greatly appreciative of the honor bestowed on him. In other words 'thanks a million' for the card and write up. 73 to all and success to the VWOA."

BROTHER MacDougall of Nova Scotia, Canada, (RN does get around) inquires where do Cannuck radiops get jobs and how much salary. So we sent him a dry piece of literature from the Ottawa Maritime Commission (sounds silly, his writing us from Canada for info which we had to get from Canada for him) which gave him the info necessary for acquiring a radiop license. But what shippers pay Canadian radiops is still a deep, dark mystery. So if any one can enlighten Mac and us, it'll kind of help.

HERE'S the kind of a msg that makes us continue to believe that Admiral Sims was right. Quote . . . Dear GY: Several years ago I wrote you to comment on some (Continued on page 52)

BOB HENRY (W9ARA) Says

"Here is the best selling quality Receiver"

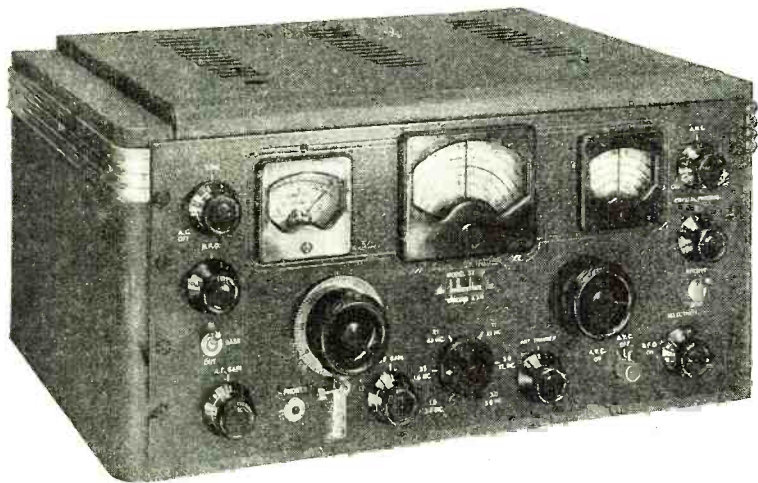

Here is one of the many reasons for Hallicrafters supremacy in the amateur communications field. The new 1941 SX-28 gives you top quality performance plus the finest precision craftsmanship obtainable.

Check all these improved features! 15 tubes—6 bands—Frequency range 550 kc. to 42 mc.—Two stages preselection—Electrical bandspread on ALL BANDS including international short wave band—Calibrated bandspread inertia controlled—Micrometer scale tuning inertia controlled—Tone and AC on-off—Beat Frequency Oscillator—AF Gain—RF Gain—Crystal phas-

ing—Adjustable noise limiter—Send-receive switch—80, 40, 20 and 10 meter amateur bands calibrated—Wide angle "S" meter—Band pass audio filter—Improved signal to image and noise ratio—Push-pull High fidelity, audio output—6 step wide range variable selectivity—Phone jack—Improved headphone output. Dimensions 20½" x 10" x 14¾".

IT PAYS TO DEAL WITH BOB HENRY (W9ARA)

1. You get terms arranged to suit you. I finance all terms myself so I can give you better terms with less cost to you—no red tape—Quicker delivery. Write to me for terms.
2. You get best trade-in for your receiver. Send me a description of it and get my offer. Terms on the balance if you wish.
3. You get personal attention you can't get elsewhere. I will cooperate with you to see

that you are 100% satisfied.

So write to me for any amateur equipment in any catalog or advertisement. Or send me your order and I guarantee that you can't buy for less or on better terms elsewhere. Write and tell me what you want and how you want everything handled. Your inquiries invited.

Bob Henry
W9ARA

HENRY RADIO SHOP

BUTLER, MISSOURI



Talking Picture Electronics

(Continued from page 10)

tensity before overload or clash occurs. The Noise Reduction amplifier is composed of a single 294A tube transformer coupled to a pair of 275A's and equalized in close accordance with the natural characteristics of the light valve which is approximately 24db more sensitive at its tuning frequency than 1000 cycles.

After the sound is transformed into electrical impulses which are amplified

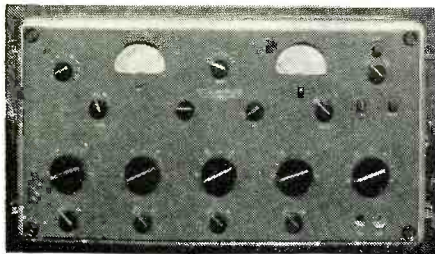

W.E. Pickup unit and monitor.

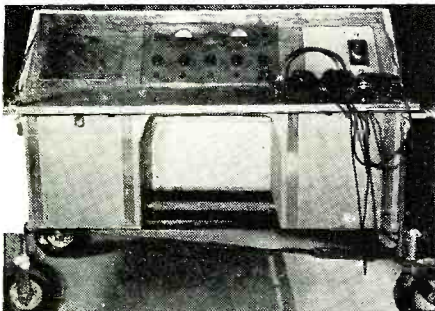

Front side of stage pickup unit.

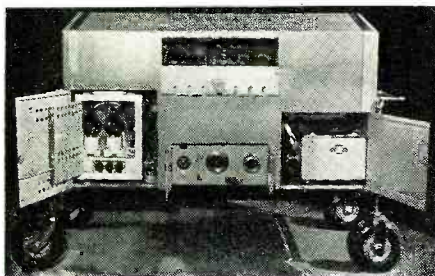

Rear view of stage pickup unit.

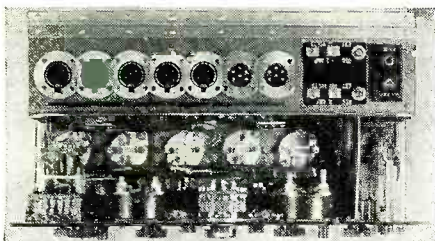

Underchassis view of pickup unit.



Top chassis view of pickup unit.

and qualified through the various stages as hereinbefore set forth, it feeds the light valve which modulates a light beam. This is photographed on a regular motion picture stock film. (Positive stock is used because its contrast is somewhat greater and is not nearly so "fast" which makes a better sound record.)

But this original negative film has only a record of the performers' voices imprinted on it so that any special effects or musical scoring have to be imprinted on the final negative film before it is ready for release.

The recording of music for motion pictures is done with an orchestra in a specially constructed room in which the acoustic conditions are minutely controllable. Although the wiring on the scoring stage is essentially permanent, the facilities are similar to those described for recording on a production set. However, instead of monitoring with headphone, the Mixer listens to a full sized theatre speaker system which is equalized to give him an output comparable to that which will be produced from the film after it comes from the laboratory. Facilities are also supplied for a PA system from the Monitor room. This is a separate sound insulated room which looks into the orchestra stage room through a glass window composed of three sheets of plate glass separated by two inches of air space. Facilities are provided so that the Musical Director in the Monitor room can speak directly to the Orchestra Conductor for changes in tempo, synchronization or orchestral balance.

The monitoring facilities on the scoring stage consist of a WE 1086-A amplifier which is composed of four cascaded stages of 262A tubes driving a pair of WE 300A in push-pull. The output of this amplifier is fed to the power amplifier which is a single stage unit consisting of a pair of 284D tubes. This amplifier is capable of an output of 60 watts at a distortion of not over 2%.

After the musical track is recorded on a separate negative film it often becomes necessary to supply additional sound effects other than those originally available during the shooting of a picture. This is done on another stage similar to the scoring stage though somewhat smaller and furnishes a third film with the desired sound effects. This work is done in small units or sequences of perhaps only a minute's duration which permits concentration of effort on only a small portion of the picture at a time.

After all three of these tracks are available it is then necessary to mix them together onto a final negative. This process is called dubbing. Incidentally, these tracks are oftentimes combined with other previously recorded effects which are carried in the

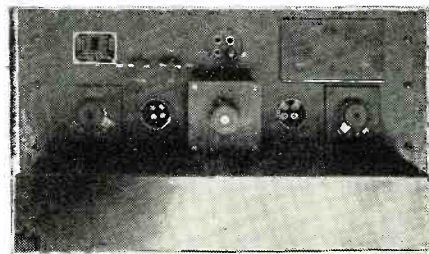

W.E. 17B talkie recording amplifier.

sound library of every studio and called "loops." These were so named because they are in the form of a continuous loop of film which, when once set into a sound projector or "dummy," will run as long as the machine turns over. The average motion picture sound library contains over 2000 different effects making available sounds like crowd noises, murmurs, trains, street traffic, galloping horses, crickets, etc.

These films are all taken to a room known as the "dubbing" machine room which has a number of "dummies" for the reproduction of sounds from film. This process involves a completely different sequence of events. In a "dummy" a light beam of constant intensity is projected to a narrow slit onto a film which in passing through this

(Continued on page 50)

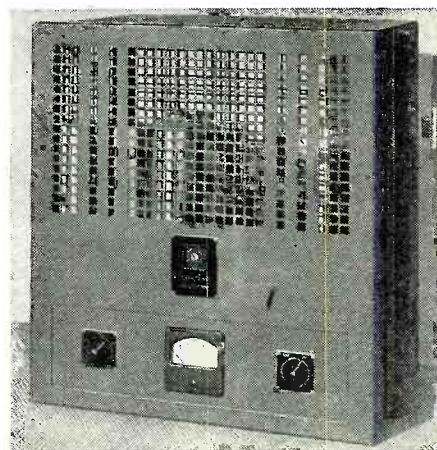

W.E. 1086A general purpose amplifier.

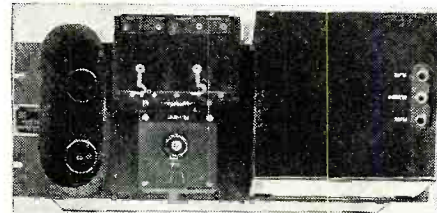

D-8684 bridging amplifier. W.E. make.



Front view of the RA 1056 amplifier.

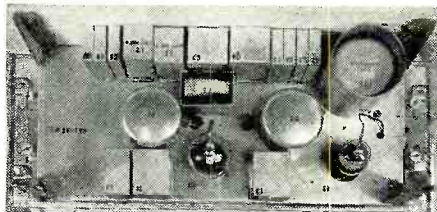

Rear view of the RA 1056 amplifier.

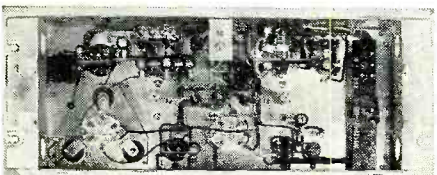

Underside chassis, W.E. R.A. 1056.

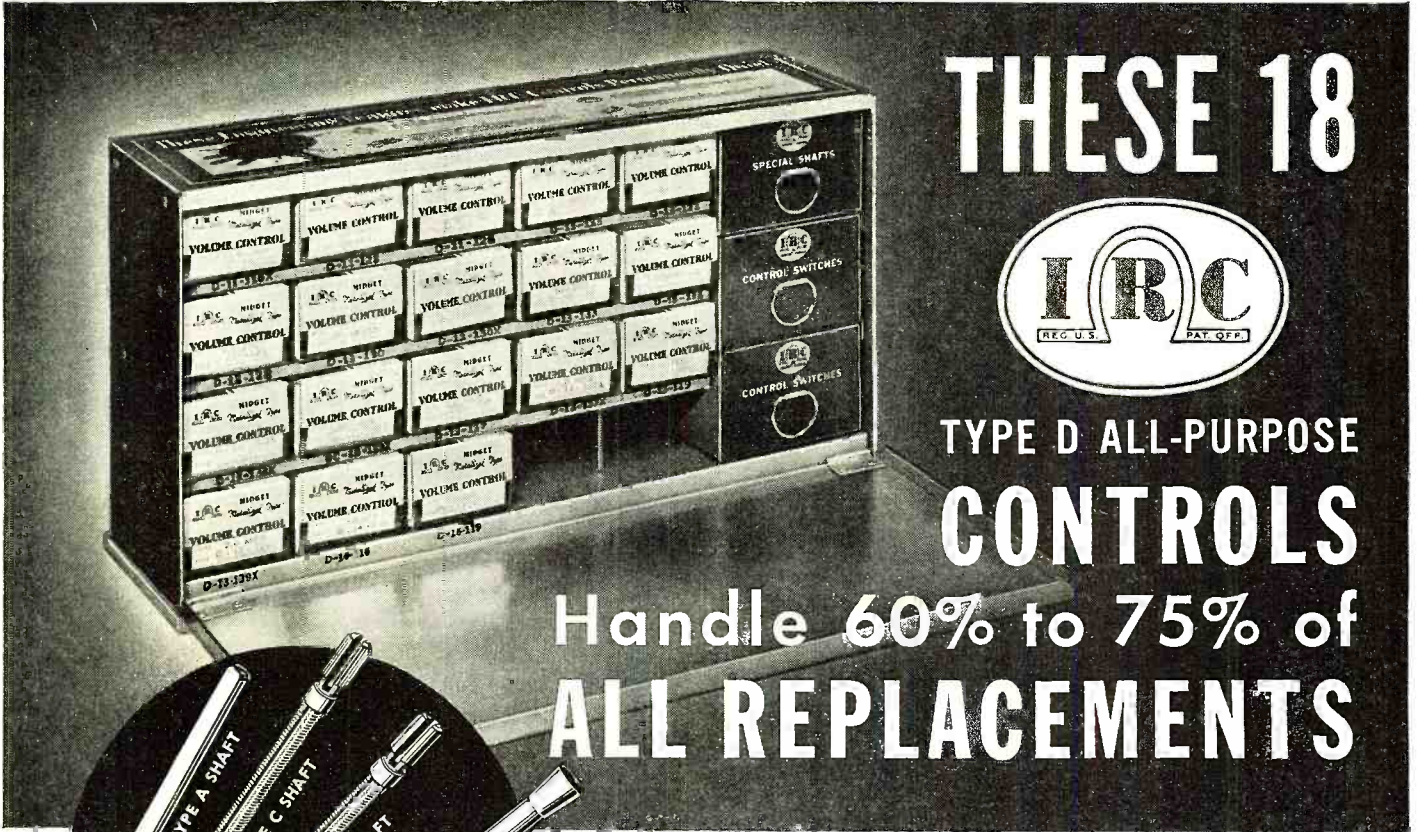

TAP-IN SHAFTS Stay Put!

Type D All-Purpose Controls are exact reproductions of the larger IRC Type CS Controls, with exactly the same design, exactly the same features and with the added convenience of Tap-in Shafts.

Just pick the control you need, select the proper shaft, tap it into position in the cone-shaped control receptacle following simple instructions enclosed with each control, and the job is done. The shaft won't pull or vibrate loose—and you're sure the quality of the control is the highest money can buy.

HERE IS WHAT YOU GET!

The IRC Master Radiotrician's Cabinet is factory-packed with the following 18 Type D All-Purpose Controls, switches and special shafts of the most popular types shown by records to be capable of handling the big majority of all control replacements.

IRC Control Type No.	Resistance	Purpose	IRC Control Type No.	Resistance	Purpose
2-D13-133	500,000	A	1-D13-133 X	500,000	F
1-D11-116	10,000	B	1-DC13-133 X	500,000	G
1-D11-123	50,000	C	1-D13-137	1.0	A
1-D11-128	100,000	C	1-D13-137 X	1.0	F
1-D11-133	500,000	C	1-D13-139	2.0	A
1-D13-123	50,000	D	1-D13-139 X	2.0	F
1-D13-128	100,000	A	1-D14-116	10,000	H
1-D13-130	250,000	A	1-D16-119	20,000	B
1-D13-130 X	250,000	E			

- A—Tone or Audio Circuit Control
- B—Antenna Grid Bias Control
- C—Potentiometer Voltage Divider
- D—Tone Control
- E—Tapped for A. V. C.
- F—Tapped for Tone Compensation
- G—Friction Clutch Auto Radio Type
- H—Antenna Grid Bias of 2 Tubes

Switches: 5—No. 41 S.P.S.T.; 1—No. 42 D.P.S.T.
 Shafts: 1—Type B Auto Radio; 2—Type C with slotted, knurled terminals; 2—Type D with slotted, unknurled terminals.

Dealer Net on above controls, 6 switches, 5 shafts . . . **\$14.97**
THE CABINET IS INCLUDED FREE!

USE THIS HANDY ORDER FORM

...The All-Metal Cabinet is Included — AT NO EXTRA COST!

Now, for the first time, you can purchase a stock of only 18 Controls, 6 switches and 5 special, extra shafts . . . and be prepared for quick, efficient service on more than two-thirds of the radios you are called upon to repair!

You save time, because it is no longer necessary to order a control every time you need one! You simplify installations because IRC Type D All-Purpose Controls with their Tap-in Shafts are easier to install and can be used universally to replace midget size or larger, old-style controls! You save money—and you assure your customer of a first-class job!

Best of all, you pay only the standard price for the controls, switches and shafts. The handy new IRC Master Radiotrician's Control Cabinet, as illustrated, is included with your purchase at not one cent of extra cost.

The Cabinet itself is of all-metal construction. Attractively decorated, it is an asset to the appearance of your shop. It is 14½" x 7½" x 4", weighs approx. 6 lbs. complete. IRC Control numbers are marked underneath each compartment so you can tell at a glance just what values should be reordered to keep your stock complete. Three drawers supply ample space for shafts, switches or other spare parts. Front metal cover snaps securely shut for carrying, or may be removed when Kit is used in your shop. The regular net price of the 18 Controls, 6 switches and 5 special, extra shafts is \$14.97—and the Cabinet is included for not one cent extra!

INTERNATIONAL RESISTANCE CO.

401 N. BROAD ST., PHILADELPHIA, PA.

Attached is \$14.97, check, money order (or send C.O.D.) one IRC Master Radiotrician's Control Cabinet complete with the 18 Type-D All-Purpose Controls, 6 switches and 5 Tap-in Extra Shafts as described. It is understood that, if this does not meet my full approval, I can return it in good condition for full credit within 5 days.

NAME _____

STREET _____

CITY _____ STATE _____

Name of your regular jobber _____ City _____

(Jobber's name must be given to secure net dealer cost shown) State _____

ONLY

P. R. MALLORY & CO. Inc.
MALLORY
**TRANSMITTING CAPACITORS
 ARE BUILT WITH X-64**

IMPREGNANT

**MAN, OH MAN, THEY CERTAINLY
 STAND UP!**

Mallory X-64 is the symbol that designates the exclusively developed synthesized plastic dielectric which contributes so much to the amazing performance records established by Mallory Transmitting Capacitors. X-64 is a non-oxidizing, non-polar translucent resin of exceptional stability. Among its many special advantages are:

Excellent for high temperature operation up to 200°F. (93°C). Power factor decreases with increasing temperature throughout normal operating temperature range.

At high temperatures the power factor is below that of other types of dielectrics at normal temperatures.

Capacitor may be mounted in any position without danger of leakage.

Semi-solid impregnant provides anchorage for capacitor components and helps resist effects of extreme vibration and physical shock.

Average breakdown higher than usual for oils or wax.

Capacity change with temperature less than 12% from -80°F. to +200°F.

Extremely high insulation resistance—long life—low leakage.

High dielectric constant (K). Smaller size with maintained quality.

Non-inflammable.

Moisture-repellent.

Low vapor pressure.

Types available for all standard applications. See your Mallory distributor.

P. R. MALLORY & CO., Inc.
INDIANAPOLIS INDIANA
 Cable Address—Pelmallo

**TECHNICAL BOOK
 & BULLETIN REVIEW**

AMATEUR RADIO, a beginner's guide, by J. Douglas Fortune, published by the *Thordarson Electric Co.*, Chicago, Ill., 156 pp. Price 80 cents. This Radio Amateurs Beginners Guide is dedicated to those people young and old, who, although interested in amateur short wave transmission, have found it difficult to get started. It is written in simple, understandable language expressly for the beginner so that the fundamentals of short wave radio may be grasped without previous knowledge or experience. With the aid of this book, the prospective amateur is guided by easy steps to the completion of a first-class amateur transmitter. The method of presentation in this book is a little different from that of a regular textbook. A presentation confined strictly to radio fundamentals may prove to be rather uninteresting. In this book the fundamental theory is interspersed with construction data, and each chapter has enough theory to enable the reader to understand the subject covered. In this way the necessary theory is presented in easy stages so that at no time will the reader find himself burdened with a presentation of strictly technical facts without apparent connection to practical applications. Price 80 cents. *Thordarson Electric Mfg. Co.*, Chicago.

TELEVISION TODAY AND TOMORROW, written by Sydney A. Moseley and H. J. Barton Chapple, published by *Pitman Publishing Corporation*, 2 West 45th St., New York, N. Y. Contains 179 pp. Price \$3.00. Fifth Edition. This standard work has been carefully revised and brought completely up-to-date. It gives detailed information on the apparatus and methods employed, and includes accounts of the successful work in ultra-high short wave television, and the latest "Televisors." The book is indispensable to every enthusiast who wishes to be completely up-to-date with the latest advances in this branch of applied science. The work is fully illustrated with a large number of photographs and diagrams. This book, while much of it is of a technical nature, is sufficiently descriptive to be followed in a general way by the man in the street and to provide him with some guide to the general aspects of television, in addition to which the chapters devoted entirely to technicalities deal with the latest advances in a manner useful to the technician. This book should be in the library of every television student and enthusiast. Price \$3.00. *Pitman Publishing Co.*, 2 W. 45th St., N. Y. C.

PUBLIC SPEAKING TODAY, by William G. Hoffman, published by *Whittlesey House, Inc.*, 330 West 42nd Street, New York City, 351 pp. Price \$2.75. Thoroughly up-to-date, *Public Speaking Today* offers a more than ordinarily practical approach to the technique of public speaking. It is based on careful examination of the materials, methods, and practice of the best contemporary speakers, and

(Continued on page 64)

**THE VIDEO
 REPORTER**

by Samuel Kaufman

As we write these lines, CBS is still going over board on its color television system. It's surprising to note the number of endorsements the system is getting. Usually, though, the quoted plugs from notables—Charles Chaplin—for example, come from non-technically trained men. How in the world they can ignore the drawback of a motorized scanning disk in the home receiver is a thing we don't understand.

We concede that the CBS demonstrations of Dr. Peter C. Goldmark's method proved one important thing—that color television is preferable to black-and-white. But we believe that the Goldmark system is yet completely unproved. It is a great scientific achievement in revealing good results in color transmission of Kodachrome films. But it has yet to prove its value in live pickups as well as in the commercial practicality of home receiver models.

In the meanwhile, CBS is going to town with repeated demonstrations of its system to scientific and technical groups.

One day we passed the CBS Madison Avenue lobby when a sign was hung proclaiming that there was an "NTSC demonstration" upstairs.

"What does NTSC mean?" a passerby asked.

"I don't know," said his companion, "I guess it must be a secret society!"

Actually, of course, the initials stood for *National Television Systems Committee!*

WALKING along a street in Chicago the other week, we noticed a sign stretched across a second-floor beauty parlor window. It proclaimed the arrival of a television talent scout who was in Chicago that day to "discover" talent to meet the huge demand for faces and figures in the video entertainment world.

Actually, we didn't stop to inquire. But, somehow, we assumed that the huge demand for television talent was exaggerated. Now, we're not saying the beauty parlor was misleading in its sign. And we don't even imply that there was a catch in the way of a possible "service" or "photographic" fee from the would-be television stars.

But this seems a good time to call atten-



DuMont portable televisior.

tion to the fact that any demand for television talent on a broad scale must first await the arrival of commercial television. Or, at least, improvements in the technical side of the art that would prompt the early arrival of sponsored video airshows.

Even the television program experts—men who have worked on sight-and-sound program development for several years—concede that they don't know what perfect television program fare really is. They say that the ideal program for home kinescopes is an elusive thing and while they have achieved some formulas they believe to be of high rating they won't go so far as to label them ideal program fare.

(Continued on page 62)

BUY DIRECT FROM THE MANUFACTURER AND SAVE

WE KNOW OUR PRICES ARE VERY LOW and expect a certain amount of skepticism from servicemen who have never purchased the SUPERIOR way, but five years of sticking to our way of doing business has convinced us and many thousands of servicemen who have purchased from us that it is a practical and mutually profitable way of doing business. We know that the average income of the Radio Serviceman prohibits his purchasing high-priced equipment, and yet the very nature of his work makes it necessary for him to use accurate, dependable and up-to-date equipment. We know we have solved the problem for him and our continually expanding business proves that servicemen recognize this claim to be true.

BESIDES THE THOUSANDS OF SERVICEMEN AND TECHNICIANS, THE FOLLOWING WELL-KNOWN NAMES ARE LISTED AMONG SUPERIOR INSTRUMENT PURCHASERS: Standard Oil Company of New Jersey; U. S. Dept. of Agriculture; U. S. Dept. of Commerce; U. S. War Department; C.C.C. Camps; National Youth Administration; Goodyear Tire and Rubber Co.; E. I. duPont de Nemours & Co.; University of Nebraska; Leland Stanford Junior University; Westminster College; Oberlin College; University of Michigan; Boston College; Pomona College; Board of Education, Remus, Michigan; Board of Education, City of New York; Board of Vocational Education, State of Illinois; City of Bartow, Florida; Florida State Dept. of Education; Educational Dept., Custer, North Dakota.

The New Model 1220 POCKET LABORATORY

- ★ WEIGHS ONLY 28 OUNCES!!
- ★ USES A 2% ACCURATE 0-200 MICROAMMETER—ENABLING MEASUREMENTS AT

5000 OHMS PER VOLT SPECIFICATIONS



- ★ 6 D.C. Voltage Ranges: 0-3-10-50-250-500-5,000 volts.
- ★ 3 A.C. Voltage Ranges: 0-15-150-1500 volts.
- ★ 4 Resistance Ranges: 0-3000 ohms, with 15 ohm center, direct reading to 0.2 ohm; foregoing base range multiplied by 10, by 100 and by 1,000, to read up to 3 Meg. with self-contained 3 V. flashlight battery.
- ★ D.C. Current Ranges: 0-200 microamperes; 0-2-20-200 Milliampers, using wire-wound shunts.
- ★ 3 Output Meter Ranges: Same as A.C. Voltage Ranges.
- ★ 3 Decibel Ranges: From -2 to +58 D.B., based on .006 watt in 500 ohms.

Model 1220 comes complete with cover, self-contained battery, test leads and instructions. ONLY **\$10⁴⁵**

The New Model 1240 TUBE TESTER

Instantaneous snap switches reduce actual testing time to absolute minimum. Tests all tubes 1.4 to 117 volts.

Sockets for all tubes—

No adapters. SPECIFICATIONS:

- ★ Tests all tubes, 1.4 to 117 volts, including 4, 5, 6, 7, 7L, octals, loctals, Bantam, Jr., Peanut, single ended, floating filament, Mercury Vapor Rectifiers, the new S series, in fact every tube designed to date.
 - ★ Spare socket included on front panel for any future tubes.
 - ★ Tests by the well-established emission method for tube quality, directly read on the GOOD ? BAD scale of the meter.
 - ★ Jewel protected neon.
 - ★ Tests shorts and leakages up to 2 megohms in all tubes.
 - ★ Tests leakages and shorts in all elements AGAINST all elements in all tubes.
 - ★ Tests BOTH plates in rectifiers.
 - ★ Tests individual sections such as diodes, triodes, pentodes, etc., in multi-purpose tubes.
 - ★ Latest type voltage regulator.
 - ★ Features an attractive etched aluminum panel.
 - ★ Works on 90 to 125 volts 60 cycles A.C.
- Model 1240 comes complete with instructions and tabular data for every known type of receiving tube. Shipping weight 12 pounds. Size 6" x 7½" x 10¾". Our Net Price. **\$11⁸⁵**
- PORTABLE COVER \$1.00 ADDITIONAL

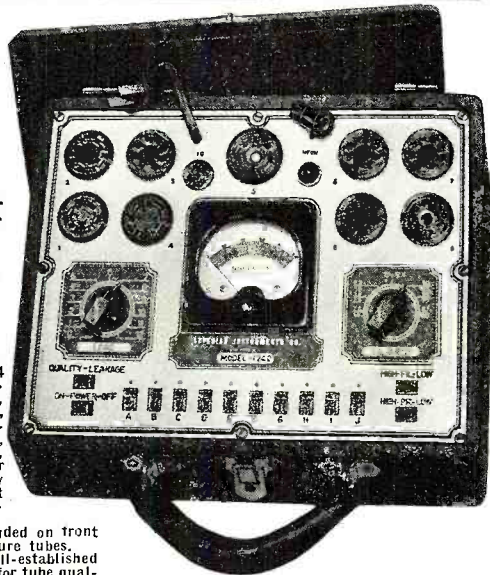

THE NEW CHANNEL-ANALYZER

FOLLOWS THE SIGNAL

FROM ANTENNA TO SPEAKER OF ANY SET

The well-established and authentic SIGNAL TRACKING METHOD of locating the very circuit in which there is trouble, and the very component that causes the trouble, is now for the first time available at a price any radio serviceman can afford.

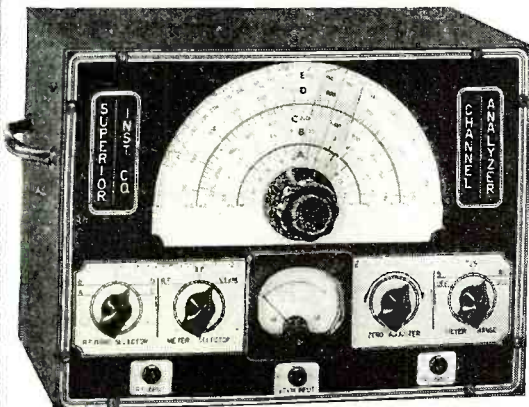

THE CHANNEL-ANALYZER WILL

- ★ Follow the signal from antenna to speaker through all stages of any receiver ever made.
- ★ Instantly track down exact cause of intermittent operation.
- ★ Measure both Automatic-Volume-Control and Automatic-Frequency-Control, voltages and circuits without appreciably loading the circuit, using built-in highly sensitive Vacuum-Tube Voltmeter.
- ★ Check exact gain of every individual stage in receiver.
- ★ Track down and locate cause of distortion in R.F., I.F., and A.F. amplifier.
- ★ Check exact operating voltage of each tube.
- ★ Locate leaky condensers and all high-resistance shorts, also show opens.
- ★ Measure exact frequencies, amount of drift and comparative output of oscillators in superhets.
- ★ Track down exact cause of noise.

The Superior Channel-Analyzer comes housed in shielded cabinet and features an attractive etched aluminum panel. Supplied complete with tubes, three specially engineered shielded input cables, each identified as to its purpose. Also full operating instructions. Size 13½" x 10" x 6". Shipping weight 19 pounds. Only... **\$19⁷⁵**

MODEL 1230 SIGNAL GENERATOR

WITH FIVE STEPS OF SINE-WAVE AUDIO

SPECIFICATIONS:

1. Combination R.F. and A.F. Signal Generator, R.F.—100 K.C. to 90 Megacycles, A.F.—200 to 7500 cycles; Sine-Wave—WITH OUTPUT OF OVER 1 VOLT. All direct reading, all by front panel switch manipulation.

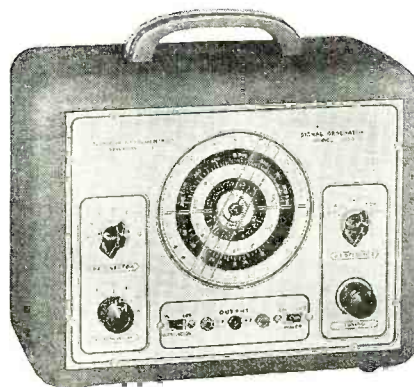

2. R.F. and A.F. output independently obtainable, alone or with A.F. (any frequency) modulating R.F.
 3. Latest design full-range attenuator used for controlling either the pure or modulated R.F.
 4. Accuracy is within 1% on I.F. and broadcast bands; 2% on higher frequencies.
 5. Giant etched directly on front panel, using a new mechanically perfected drive for perfect vernier control.
 6. Operates on 90 to 130 V. A.C. or D.C. (any frequency).
- The Model 1230 comes complete with tubes, shielded cables, molded carrying handle and instructions. Size 14" x 6" x 11". Shipping weight 15 pounds. Only... **\$12⁸⁵**

SUPERIOR INSTRUMENTS CO. 136 Liberty St., Dept. RN1 New York, N. Y.

new*

* Webster defines "new" as: "Lately made. Lately discovered. Renewed. Different." All of these descriptions apply to the Rider Books listed below. They have all been recently published. They all bear on lately discovered developments or currently revived subjects—and they are *all different*—in approach, handling and even in physical make-up. Order the ones you need—TODAY.



new* MAKE-UP OF BOOK

Embodies a new feature exclusive to Rider Books. Pages are split so that the upper parts (containing diagrams and charts) can be turned without disturbing the lower parts of the pages (containing text.) Obvious advantage in the reading and study of "Meters at Work." Only \$1.25.

OUT NOV. 30th—ORDER YOURS TODAY

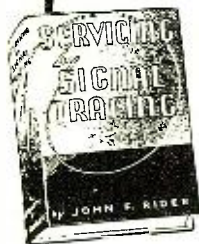

new* SERVICING TECHNIQUE

Servicing by Signal Tracing is being used by an ever increasing number of professional radio servicemen for locating troubles in every conceivable type of radio communication system. It is the most fundamental method—free from every limiting factor heretofore encountered. 360 pages—188 illus.—\$2.00

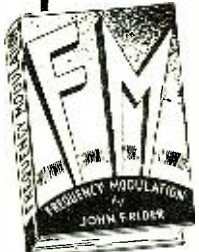

new* DEVELOPMENT IN RADIO

Frequency Modulation is not just a coming thing—it is here! This book explains transmission and reception of F-M signals—discusses the new F-M sets. 136 pages—Illustrated—\$1.00

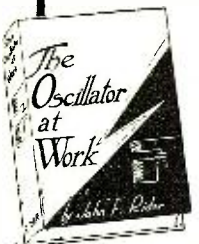

new* EXPLANATION OF THEORY

Know all about Oscillators. Get your money's worth out of them. Know how to test them—repair them. Protect the investment you have in oscillator equipment and make any future investment in the light of the knowledge this book gives you. 256 pages—167 illus.—\$1.50

JOHN F. RIDER PUBLISHER, INC.

404 Fourth Avenue, New York City
Export Division: Rocke-International Elec. Corp.,
100 Varick St., New York City. Cable: ARLAB

Read RIDER BOOKS

MANUFACTURERS' LITERATURE

NEW KOOLOHM CATALOG. A new Koolohm Wire Wound Resistor Catalog specifically designed for industrial users and illustrating many of the unique economies and design opportunities made possible by this exclusive resistor type has just been issued and may be obtained from the manufacturer, *Sprague Products Company*, North Adams, Mass.

Due to the fact that every bit of their wire is insulated before winding with a special moisture-resistant and heat-resistant (1,000° C.) material, Koolohm Resistors are distinctly different in design and construction and smaller in size. Layer windings are used for greater resistance in less space, heat dissipation is more rapid than that of any other resistor of equal size and rating and larger wire sizes provide an extra factor of safety. Moreover, Koolohms lend themselves to simplified mounting, while providing still further economy in the fact that there is no cement or vitreous coating to chip, peel or crack. These features as well as many others, all presented in detail in the new catalog, should prove distinctly helpful to engineers, maintenance men and industrial users. Free. (RADIO NEWS No. 1-101.)

SHURE CATALOG 153. A new colorful 12 page *Shure* Catalog No. 153 covering the complete *Shure* Line is ready for the trade. This enlarged catalog includes the new items for 1941 developed by *Shure* Engineers, such as the "Stratoliner" Microphones, Magnetic Recording Head, etc. It is attractively illustrated and provides helpful information for Sound Men in the selection of the proper units for their needs.

It covers *Shure* Cardioid and General-Purpose Microphones, in Dynamic and Crystal types for every need in every price class—Microphones for Broadcasting and Professional Recording—Communications Microphones for Amateur, Police, and Commercial 'Phone—Military Type Microphones, Lapel Microphones, Laboratory Non-Directional Microphone for Sound Measurement Work—Crystal Vibration Pickup—Stethophone—Magnetic Recording Head—Crystal 'Phono-Pickups—Microphone Stands and Accessories.

A copy of this new Catalog may be obtained by writing to *Shure Brothers*, 225 W. Huron Street, Chicago, Illinois. Free. (RADIO NEWS No. 1-102.)

NEW BIRNBACH CATALOG. The attractive No. 41 *Birnbach* Catalog describes new and additional items added recently. A complete line of antennas and transmission cables for F-M and television together with

broadcast and master antennas for apartment houses, in addition to accessories is fully described. Ceramic insulators for Amateur and Industrial purposes, has been listed more completely with full specifications. Complete electrical and physical specifications of all the wire and cables is a highlight by which selection is done with ease. Microphone connectors together with cables completely assembled with connectors, is listed. A complete line of screws, nuts, washers, and miscellaneous hardware in addition to jacks and plugs are described. Free. (RADIO NEWS No. 1-103.)

STANCOR'S NEW COMPLETE CATALOG. *Stancor's* entire line of transformers for the amateurs, servicemen or industrial users, as well as transmitter kits and a complete line of packs are all combined in a condensed form in complete catalog No. 140B.

Complete technical, as well as mechanical data is given on each unit. A numerical index, together with price list, and buying data are given on the inside front cover to help identify each unit.

The 140B catalog is free of charge by writing the *Standard Transformer Corporation*, 1500 North Halsted St., Chicago, Illinois, U.S.A. Free. (RADIO NEWS No. 1-104.)

NEW R.C.P. CATALOG (NO. 124). A new 16-page catalog in two colors covering its complete line of "Dependable" radio and electrical test equipment for 1941 has just been released by *Radio City Products Co., Inc.*, 88 Park Place, New York City.

In this Catalog No. 124, *R.C.P.* introduces the most complete line in its history, with over forty-five models of equipment, ranging from tiny pocket-type multi-purpose meter units, to large counter-type combination tube and set testers, and including analysts, analyzers, trouble tracers, speed meters, and a highly flexible signal generator.

As in the past, this expanded line features maximum utility with economy, and the increased variety results in a test instrument for every requirement.

Copies of the new catalog can be obtained without charge from local radio and electrical distributors everywhere, or by writing direct to the address above. Free. (RADIO NEWS No. 1-105.)

STANCOR HAMA MANUAL. This new manual for the radio amateur will soon be available from radio jobbers in all parts of the country. *Stancor Hamanuals* enjoy a unique position in
(Continued on page 66)

RADIO PHYSICS COURSE

by Alfred A. Ghirardi

Each time a grid goes positive, grid current flows, and makes up for the current that leaks off through the grid leak during each cycle.

At times when the signal amplitude is decreasing in size, it is necessary that the grid leak allow the grid condenser charge to leak off at a rate that will cause the average grid potential to reduce at least as fast as the signal amplitude is changing. This requirement calls for values of grid condenser capacity and leak resistance smaller than usually used.

If high-quality output is to be obtained from the grid-leak power detector, it is necessary to have the proper grid leak and condenser combination. Suitable values for any tube are, a grid leak of about $\frac{1}{4}$ megohm and a 0.0001-mfd. grid condenser. With these proportions the average grid potential will be able to change as fast as the signal amplitude, up to modulation frequencies of 5,000 cycles.

The overloading point of the grid-leak power detector is reached when plate rectification causes increase of plate current, while grid rectification causes decrease of plate current. Plate rectification thus neutralizes the grid action and causes distortion.

As the maximum amplitude of a fully modulated wave is twice the carrier amplitude, a particular tube will handle half as big a carrier wave acting as a power detector as it can amplify, using the same plate voltage in both cases. Thus, a 201A-type tube with 90 volts on the plate usually uses a $4\frac{1}{2}$ -volt C bias. The peak amplitude of carrier wave that can be handled at a plate voltage is one-half of this, or about $2\frac{1}{4}$ peak volts.

The maximum audio-frequency power output obtainable from the grid-leak power detector is slightly over one-fourth of the undistorted power the tube can give as an amplifier at the same plate voltage and a suitable grid bias. Thus, the 210-type tube at $247\frac{1}{2}$ plate volts will put out 340 undistorted milliwatts as an amplifier, and will put out about 100 undistorted audio milliwatts as a power detector.

The approximate audio-frequency output of a grid-leak power detector can be obtained by a simple computation. It is apparent that the average grid voltage of the power detector follows the modulation of the signal. This variation in average grid potential applies to an audio-frequency voltage to the grid of the detector tube, and it is this audio-frequency grid voltage when amplified by the tube acting as an amplifier that constitutes the audio-frequency output of the detector.

In the ideal detector, the audio-frequency voltage applied to the grid would be equal to the modulation voltage in the signal. If the degree of modulation is m , and the carrier amplitude is E_s , the ideal amount of modulation voltage is mE_s . The actual power detector is only about 75 to 85 per cent perfect, and will apply to the grid an audio-frequency voltage about 75 to 85 per cent of mE_s . The percentage tends to rise slightly, as the signal amplitude becomes large, but under ordinary conditions it is nearly constant.

(To be continued)

SAVE with Meissner

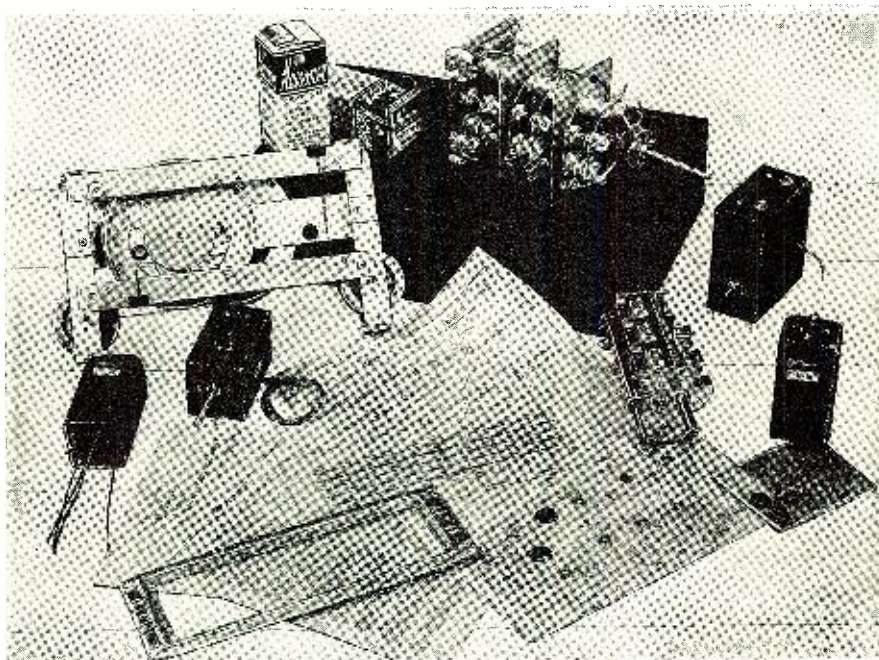

ESSENTIAL KITS

Latest innovation gives you highest quality in home-built radio at lowest possible cost!

SAVE TIME—No need to fuss around with experimental designs; Meissner Kits are fully engineered and supplied with complete instructions and detailed Schematic and Pictorial Wiring Diagrams.

SAVE MATERIALS—Use up a lot of spare parts now lying around useless; odds and ends of condensers, resistors, sockets, hook-up wire, etc. are all that are required to make a complete receiver out of one of these Kits!

SAVE MONEY—Not only by using up parts that are on hand but by buying the Essential Kit you get these "special" parts at a material saving over the regular Catalog Price.

Wide Variety of Designs to Fit Any Need!

With the continued success of Meissner Complete Kits assured by ever-increasing sales, Meissner now offers a means of building one of these fine, fully engineered receivers at even lower cost—by using these new Essential Kits! They contain all of the special Meissner parts such as coils, tuning condenser, dial, I-F transformers, punched chassis, etc. with detailed wiring instructions, same as furnished with the Complete Kit. A complete Parts List is also furnished so that the remaining small parts may be readily obtained from your regular Parts Jobber. Many of these parts, however, will probably be found in your own shop! All of the major designs in the Meissner Kit line are now available in this form, from the 14-tube Traffic-Master down to the 6-tube sets.

Write for Your Free Copy of the New Meissner General Catalog!

ADDRESS DEPT. N-1

Meissner
 "PRECISION-BUILT PRODUCTS"
 MT. CARMEL ILLINOIS

Fidelitone

PHONOGRAPH NEEDLE

*Filters Scratch
Through Floating Point*

6 MONTHS PERFECT SERVICE
FROM EACH NEEDLE

Platinum metals point . . .
used in preference to jewels
. . . protects your records . . .
gives perfect reproduction
. . . used by record collec-
tors . . . no needle changing
. . . satin smooth lubricating
point . . . millions used per
year . . . enjoy recorded
music at its best . . . sells
for 50 cents.



Obtainable
from the better music stores
or write the maker

Manufacturing  Metallurgists
PERMO PRODUCTS CORP.
817 Lawrence Blvd. Ave., Chicago

**DON'T MISS THE IMPORTANT
ANNOUNCEMENT ON PAGE 62**

HOW TO LEARN CODE

Whether you wish to enter radio as a career or merely add another valuable and fascinating accomplishment to your achievements, the All Electric Master Telex Code Teaching Machine will show you how. Telex records your sending in visible dots and dashes on a specially prepared waxed paper tape and then sends back to you at any speed you desire. It does not merely show you code.

It is code. No experience needed. While not designated as standard equipment, Telex is used at many U.S. Army Posts, Naval Training Stations as well as by the American Tel. & Tel. Co. Also by practically every private school in the U.S. teaching code; and many foreign governments. We furnish you complete course, including practice messages, the All Electric Master Telex, plus a personal service on a MONEY BACK GUARANTEE. Low cost. Easy terms.

terms. Without obligation write for booklet "RN1."
TELEPLEX CO. 67-69 PARK PLACE
In Canada write:
CANADIAN ELECTRONIC INST., TORONTO, ONT.

Electronic Maintenance

(Continued from page 27)

audio frequency range. Consequently, the most logical type of a.c. voltage measuring device which is needed by such a communication service shop is one which covers them all. Such is a copper oxide rectifier meter which has an ohms-per-volt value of at least 1,000 ohms. A device of this type is not necessarily suitable for the measurement of audio signal voltages in signal carrying circuits of high impedance, but there are so many applications for an instrument of this type in the equipment embraced by the communication, public address and industrial fields, that it is rather a "must" unit.

Electronic Voltmeters for D.C. Measurement

We can say with complete assurance that the most satisfactory method of measuring d.c. voltages of all types is with electronic apparatus. However, there are numerous units of this character upon the market, made by such organizations as *Supreme, Triplett, Hickock, Clough Brengle, RCA* and others. Space does not permit a full description of the exact circuits utilized in all of the different d.c. vacuum tube voltmeters, but we do have space to give the highlights of some of the basic systems.

The man who is equipping such a communication service shop is in a position to select that apparatus which he prefers and the only recommendation we make is that whichever he selects, he make certain it fulfills the requirements of electronic d.c. measuring apparatus. We say this because we have given very critical inspection to such requirements.

There are a number of commercial vacuum tube voltmeters available which make possible the measurement of d.c. voltages under actual operating conditions without loading of the circuit being tested. These voltmeters make use of the high input resistance and the amplifying properties of the vacuum tube. As a result of these tube properties, it has been possible to design d.c. voltmeters which afford numerous advantages over the less sensitive d.c. voltmeters which do not employ the thermionic tube.

Of the various types of d.c. vacuum tube voltmeters which have made their appearance over a number of years, the recently developed direct reading type known as the *Rider Chanalyst*, since become very popular in the radio service test equipment field, is basically sound and excellent in character.

In contrast to what was the practice in normal vacuum tube voltmeter design wherein a tube was invariably employed as a rectifier, the *Rider Chanalyst* introduced the tube as a class A amplifier. The tube is self biased by means of a cathode resistor. The plate voltage is adjusted for whatever line voltage conditions exist by means of a variable control for a flow of 500 microamperes of plate current. This is the equivalent of the electrical zero setting upon the center zero scale. When a positive voltage is applied across the input of the tube, the plate current naturally increases and the pointer swings "up" from the center zero. By suitable calibration of the

scale (that is, interpretation of this plate current change in terms of voltage), the voltage applied to the input is indicated. If the input voltage is negative, the plate current decreases, consequently, the pointer swings "down" from the center zero and that swing is similarly calibrated as voltage.

Such an arrangement is made possible by the adjustment of the tube constants so that the tube operates over the linear portion of the grid voltage-plate current characteristic for a range of input voltages between -5 volts and +5 volts. A voltage divider located in the input circuit enables measurement of voltages between limits of -500 volts and +500 volts. Any number of ranges can be provided by arranging the correct type of voltage divider in the input circuit. The use of this input divider affords the advantage that operation is maintained over the correct portion of the characteristic regardless of the magnitude of the input voltage. Sufficient degeneration is introduced into the system by the use of a high value of cathode resistance so that calibration of the meter in the cathode circuit can be read directly in volts applied to the input.

The filter in the input circuit consisting of a resistor and a condenser in grid circuit eliminates whatever a.c. may be present at the point where the d.c. voltage is measured. As a result it is possible to measure d.c. voltage at places where a.c. voltage is present without any possibility of the a.c. voltage interfering with the d.c. voltage measurement.

By the use of an isolating resistor at the tip, or end, of the "high" or active probe of this voltmeter, one very much needed requirement of d.c. voltage measuring devices was realized. This was the ability to measure d.c. voltages in circuits where signals were present, as for example at the grids of amplifying and oscillator tubes and at the plates of amplifiers and detectors, oscillators. One very important application possible with such an arrangement and one which eliminates a tedious process hitherto required is the measurement of the rectified grid voltage developed across the grid leak of an oscillator. This measurement is a direct and easy method for determining the oscillator signal output amplitude.

By suitable design of the input voltage divider resistance, the input resistance of the voltmeter can be established at a high value, say 10 megohms, which provides sufficient latitude of operation to cover practically every case where d.c. measurement is to be made. The isolating resistor in the probe, usually of the order of 1.0 megohm is, as far as the voltage calibration is concerned, a part of the divider.

The Voltmyst Circuit

When viewed from the angle of all around application of a d.c. voltmeter, which is not necessarily a part of signal tracing equipment, other requirements developed and resulted in a modification of the direct reading d.c. voltmeter and ohmmeter as it appears in the *Chanalyst*. Of this modification there are also various varieties. However, we will only discuss the Voltmyst. This instrument also embodies the same basic principles of providing a direct reading high resistance d.c.

voltmeter, but employs a different circuit arrangement from the other using the center zero meter as well as also incorporating a multi-range ohmmeter so as to provide in one instrument instantaneous changeover for d.c. voltage or resistance measurement. In this unit the zero of the meter is at the left end of the meter scale and a switch provides the changeover for the measurement of either positive or negative voltages. Thus the convenience of operating with one active probe, as was the case with the center zero meter, is still retained.

The use of the full scale—to permit more accurate reading—for the voltage calibration in combination with a polarity changing switch requires that the circuit be perfectly balanced and symmetrical in order to obtain an accurate calibration. This symmetrical operation for both positive and negative voltages is achieved by using a push-pull balanced symmetrical circuit of new design as shown in Figure 2. Unlike the conventional balanced vacuum tube voltmeter, the two tubes V1 and V2 are linked by a common high resistance R27. Because of this coupling any changes in the input voltage to the grid of V1 changes the cathode bias of V2 and as a result the change in the plate current of V1 is accompanied by a simultaneous change in the plate current of V2, but this latter change is in the opposite direction.

A differential voltage* is thus developed across the load resistors R19 and R20 and is applied to the meter. This voltmeter is calibrated in terms of the voltage applied to the input. (As will be discussed later, this voltmeter also is calibrated in terms of resistance for use in the voltmeter section.)

In addition to the push-pull action, a high degree of self-regulation is obtained as a direct result of the high value of cathode resistance R27. This is analogous to the regulating effect secured through the use of self bias, but because R27 is considerably higher (56,000 ohms) than the value of cathode resistance which it is possible to use in conventional systems, the self-regulating action is correspondingly increased. At the same time the excessive loss of sensitivity normally experienced when using such a high cathode

resistance is eliminated because of the balanced nature of the circuit. A controlled amount of inverse feedback to obtain independence of tube characteristics is secured by means of the two wire wound resistors R25 and R26.

This alone may pay for the instrument's cost over its lifetime of use.

Grid Current and High Input Resistance

One of the prime requisites of d.c. voltmeters which are needed for the measurement of d.c. voltages in modern communication systems, is high input resistance. But the procurement of a high input resistance in d.c. vacuum tube voltmeters has been quite a problem due to grid current error. The

HANDI-MIKES



An indispensable part of all portable sound equipment . . . sports, call sys., sound trucks, sm. transmitters, etc. Clear, crisp voice reproduction. Bal. grip, pol. chrome plate, snap switch, 6 ft. flex. cord. Choice of circuits and switches, single and double button carbon, crystals, dynamics, all impedances. At your dealer or jobber.

UNIVERSAL MICROPHONE CO. LTD.
INGLEWOOD CALIF., U. S. A.

STANDARD

with Experts

SUPER PRO and HQ-120-X

AN ENVIABLE record has been established by both the "HQ-120-X" and the "Super-Pro." They have been selected for service from Alaska to the antarctic and their outstanding performance is continually making new friends. It seems as though the more difficult the service the more likely you are to find a Hammarlund receiver doing the job. There's a reason for this too. Our receivers are built of parts which are made in our own factory where quality is more important than cost. Every "HQ" and "Super-Pro" has that built-in quality which can only be appreciated after you have had the pleasure of operating them. Try whichever falls into your price range and you will see why experts use Hammarlund receivers.

MAIL COUPON TODAY!

HAMMARLUND MFG. CO., INC. RN-1
 424 W. 33 St., New York City
 Please send "HQ" booklet
 Please send "Super-Pro" booklet
 Name
 Address
 City State



Canadian Office:
41 West Ave. No., Hamilton

HAMMARLUND

EXPORT DEPARTMENT, 100 VARICK ST., NEW YORK CITY

**Scientifically
DESIGNED
RADIO PARTS**



MIDGET CONDENSERS

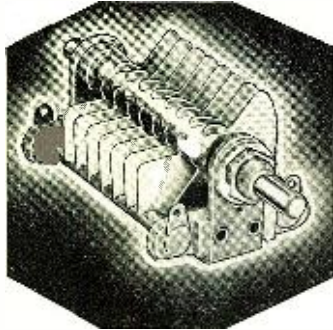

For peak performance . . . for longer, more dependable service—use BUD Midget Condensers.

DOUBLE BEARING TYPE

Cat. No.	Max. Cap.	Plates	Amateur Net
MC-1850	15	3	\$.78
MC-1852	35	5	.84
MC-1853	50	7	.90
MC-1855	100	14	1.23
MC-1857	150	21	1.47
MC-1858	200	27	1.59
MC-1859	250	33	1.65
MC-1860	320	43	1.98

Our No. 141 Catalog lists all BUD condensers from the "Tiny-Mite" to the "Giant." Get yours free!

**BUD
RADIO, INC.
CLEVELAND, OHIO**

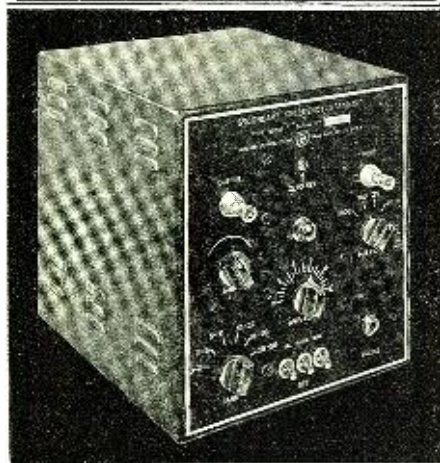

**A NEW Precision Crystal
Secondary
Frequency Standard
THAT HAS BEEN
"Designed for Application"**

A precision frequency standard capable of being adjusted to WWV or some other primary standard and putting out uniformly accurate calibrating signals with 10, 100, 1000 KC intervals. Uses the new GENERAL ELECTRIC No. 18A 1000 KC crystal having a frequency temperature coefficient of less than one cycle / Mc/C°. The crystal is sealed in Helium in a standard metal tube envelope.

The self-contained AC power supply has VR150-30 voltage regulator tube.

In addition to oscillator, multivibrators, and harmonic amplifier, a built-in mixer with phone jack and gain control on panel is incorporated.

Catalogue Upon Request

JAMES MILLEN MFG. CO. INC.
150 EXCHANGE ST. MALDEN, MASS.

problem was solved, for those who may be interested, by the combination of a number of factors which tend to reduce grid current. By no means the least of these considerations was the choice of the correct and separate tubes, which, when operated under the same conditions tending to minimize grid current, would actually do so under all conditions. The most suitable tube type found was the 6K6G.

An idea of the extent to which the grid current is reduced in this type of circuit can be had from the statement that in the laboratory model of the *Voltohmyst* circuit the input resistance of the instrument or measurements of voltage between 500 and 5,000 volts is fixed at 160,000,000 ohms. Contributory to the creation of this condition is the operation of the two tubes at plate voltages far below the rated values, which is also true in connection with the plate current, while at the same time obtaining perfect linearity. In the instrument, illustrated in Figure 3 and which could well be the d.c. voltage and resistance measuring device of our typical test bench in this communication service shop, the input resistance is approximately 11,000,000 ohms over all the ranges. This provides the highest ohms per volt value where it is most desired, namely, over the lower range of voltages where low values of voltage are measured across high values of resistance. On the 3 volt range this is 3,666,666 ohms per volt!

Electronic Ohmmeter Circuit

Resistance measurement being a vital operation as stated earlier in this article, and since a tremendous range must be covered, it was considered extremely fortunate that an electronic d.c. voltmeter system could find application as a part of a resistance measuring system capable of covering a resistance ratio of 10,000,000,000 to 1. The basis circuit was first introduced in the *Rider Voltohmyst* and now has become standard in a number of different instruments. A quantity of standard resistors, arranged in decade steps is placed in series with a low voltage battery and the electronic voltmeter. When there is no unknown connected across the terminals "Rx.", the voltmeter indicates the full battery voltage, since the voltmeter does not draw any current. When an unknown resistor is connected across the proper terminals, the voltmeter indicates the voltage drop across the standard, which voltage varies in proportion to the relative values of the standard resistor and the resistance of the unknown. Thus, if the standard and the unknown are 10 megohms each, the voltage across the known will be one-half of the battery voltage, hence the resistance value of the unknown will be equal to the value of the known resistor.

All of this calculation is of course unnecessary since the meter is directly calibrated in resistance values. This is made possible by the fact that the resistance steps are in decade values. The highest value of resistance which can be measured with the instrument without any supplementary voltage source is 1,000,000,000 ohms (1,000 megohms), but if for any reason high values of resistance must be measured, a supplementary voltage source will permit measurement of resistance up to 100,000,000,000,000 ohms—a fantastic figure, it is true, but possible just

the same. The low limit of resistance measurement is 0.1 ohm.

Such a design of a combination d.c. voltmeter and ohmmeter of the electronic variety provides all of the facilities which are needed for this type of service operation for all of the fields which are covered by the term "communication" as well as the other branches of activity which have been mentioned.

A.C. Voltage Measurement

As to the measurement of a.c. voltages, the need exists and equipment of this character provides these facilities in a manner intended to convey utmost convenience. In the particular unit, the *Jr. Voltohmyst*, which we show in the typical bench panel layout of Figure 4, the a.c. voltmeter is of the copper oxide rectifier type and so arranged that it is entirely isolated from the power supply system so that it is equally suitable for the measurement of power supply voltages or audio voltages even when the instrument is connected into the power line. This discussion of a.c. voltage measurement is deliberately brief in view of the fact that we wish to focus most of our attention upon d.c. voltage measurement and resistance measurement. As we progress through this series, and get to build up this ideal service bench, the subject of a.c. voltage measurement will receive its full concentration, for in many respects it is tied up with signal voltage measurements.

Application of D.C. Electronic Voltmeters

As to application, we are still not ready to dissect the various types of circuits used in the many different types of receivers, but an examination of a typical receiver shown in Figure 5 with points of d.c. voltage measurement will at least provide some idea of both requirements of such voltage measuring devices. Although there is nothing very special about this receiver in particular, it is our opinion that whatever d.c. voltage measuring device is to be incorporated in this communication service shop, it must be capable of measuring the d.c. voltages at various points designated, with the signal present with minimum interruption of normal receiver performance and with maximum speed.

With respect to speed of operation, one of the most troublesome conditions experienced in most electronic equipment, and for that matter, in ohmmeters in particular which are not of the electronic type, is the need for continual rebalancing—and shorting of leads—as ranges are changed. One of the major requirements of apparatus consistent with the modern needs of this shop is freedom from such readjustments for maximum speed. To accomplish this end with such electronic equipment, much dependence must be placed upon freedom from grid current. It might seem strange to so tie up two different kinds of tests, yet they are definitely related when electronic equipment is used for d.c. voltage and resistance measurement.

("Trademarks: Chanalyst, Voltohmyst Reg. U. S. Pat. Off. by RCA Mfg. Co., Inc., Camden, N. J.")

-50-

**See important announcement.
Page 62.**

Bench Notes
(Continued from page 21)

Rider's report is in line with our own experience with these "dollar-guaranteed" receivers in the past two or three years, as none of the receivers sold by us were returned to the factory for service.

Since more than half of the receivers sold in recent years have been small table models retailing for less than \$25, it is clear that the service man's prospects of service income from this source are sharply reduced. The owners of these small receivers often operate them until the final wheeze and rattle, and then bring them in with the fond hope of having them repaired for a dollar or so. By the time most of such receivers are brought in for service the cost of putting them back in good condition is far out of proportion to their original cost, with the result that the prospective customer stalks out mumbling "Why, I can almost buy a new set for that much." It is not unusual for a shop to lose a half a dozen jobs of this kind in a week, which does nothing to create any large affection for midget receivers or their owners, in the service man's bosom. However, harsh words may break no bones, nor do they put any coin in the till, so there is no use yodeling about this unpleasing condition, which rather calls for a little head-scratching in an endeavor to extract what few crumbs of comfort there may be in the way of a little cash profit.

A typical case of this kind usually

runs along these lines: Mr. Bjones enters bearing the defunct midget under his arm, and announces that the set has been "kinda punk" lately, and finally quit for good last night. "Probably just a tube," says he hopefully, which means he is prepared to spend all of a buck, but not much more. When the little junker is pried out of its shell, the immediate cause of its collapse is found to be an open coupling condenser—BUT, a quick check reveals a number of other frazzled-out components, which are listed on the back of a tube manual, and when complete looks something like this:

1—25L6	\$1.25
1—25Z6	1.25
1—Volume control & sw.....	1.50
2—20 mf. condensers.....	1.10
1—.01 condenser25

Total parts\$5.35
Labor (minimum) 1.00

Total\$6.35

The service man announces this modest total with as much nonchalance as he can muster, whereat Mr. Bjones give him a narsty look, and counters with the statement "The set only cost \$12 two years ago," and leaves with a hearty laugh. But it is only a raucous horse laugh as he darkens your door on the way out for probably the last time.

What then? The total of the bill can be reduced by splitting discounts, waiving the labor charge, or using cheaper repair parts, all of which slash the service man's profit, without greatly reducing the bill to the customer. For instance splitting dis-

counts would only reduce the bill about \$1.00, and even then would not likely prove sufficient inducement to have the work done. Unless the bill in such cases can be held to something noticeably less than five dollars, the chances are 10 to 1 the customer will refuse to have the work done; and a charge say of \$4.50 would give the service man a gross profit of about \$1.10, which means practically no net profit at all, probably a loss. It is, of course not impossible to wangle a pay job out of such cases, but in any event the service man is not going to get much more than cigarette money out of it. There is an easier way of making a neat profit out of these situations, without the worry of a cheap patch-up job of doubtful satisfaction—namely sell the man a new set.

When Mr. Bjones faded from sight, with the little wreck under his arm, it is an even money bet that before the day is over *somebody is going to sell him a new set*, as he cannot bear the thought of missing Gabby Gus recite the same news dispatches that Mr. Bjones has only read in two newspapers, and will hear four times before Gus comes on. Why shouldn't the service man be that salesman that brightens Mr. Bjones' day? Even with a short discount the profit on a \$9.95 set is something more than would be made on a cut-price service job; with no more labor involved than shaking hands with Mr. Bjones, and folding up his money. If the service man can screw up his courage enough to sell a \$14.95 model, his profit will be somewhere around what he was trying to collect for stitching up the old junker.

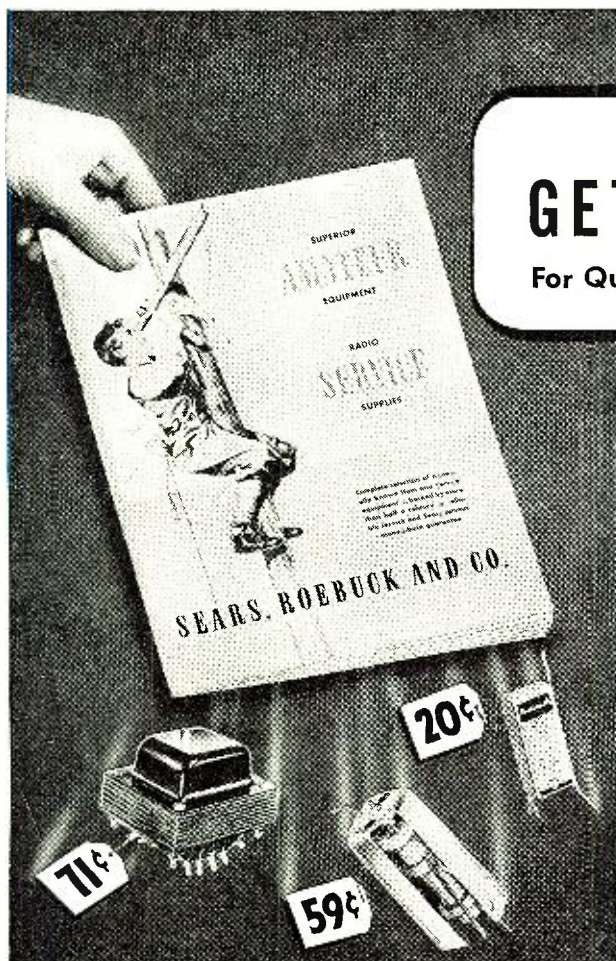

Radio Service Men! Hams!
GET THIS FREE CATALOG
For Quick Service . . Complete Selections . . Right Prices

WRITE FOR CATALOG F717RN-1

NOW—Service Men as well as Hams can get everything they want from Sears—and pay for it on Sears Easy Payment Plan!

And Remember—when you buy from Sears, you pay shipping charges *only from your nearest Sears Mail Order House!* You'll Save Time—You'll Save Money—and you'll be Satisfied! Sears famous Money-Back Guarantee assures your complete satisfaction.

Sears, Roebuck and Co. carry *in stock* the most up-to-date and complete assortments anyone could ask for—in Radio, Public Address and Recording equipment. Get this big FREE catalog *today*. Write for F717RN-1.

Attention, Public Address Users!
THIS CATALOG'S FREE, TOO!

Prominent Public Address users and Rental outfits have found it pays big dividends to get their equipment from Sears. Latest equipment at amazingly low prices—and you save Real Money on shipping charges! Order this big book *today*—write for F732RN-1.



SEARS, ROEBUCK and CO.

Chicago, Philadelphia, Boston, Kansas City, Minneapolis, Atlanta, Memphis, Dallas, Seattle, Los Angeles

TRIPLET THERMO AMMETERS

FROM \$4.50 UP

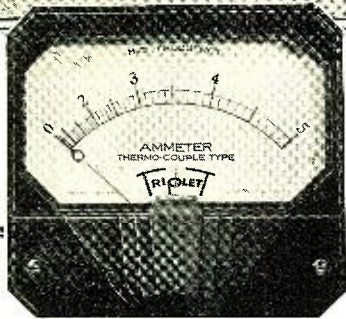

Model 446 . . .

● EVERY circuit is capable of improvement when reduced to engineering standards by measuring with precision instruments. Use Triplet Thermo Ammeters to give you a truly efficient antenna circuit. (Accuracy to 2%.) Available in 2", 3", 4", 5" and 7" sizes in popular ranges. Internal or external couples.

SPECIAL PRICE REDUCTION

Dealer Prices from \$4.50. (For Model 341 internal couple 0.5 to 0.5 amp. ranges.) Model 446, as shown above, less front illumination attachment with external couple, \$7.84 net.

WRITE FOR CATALOG
Section 151 Harmon Avenue

THE TRIPLET ELECTRICAL INSTRUMENT CO.
Bluffton, Ohio

USE Par-Metal FOR CHASSIS OR COMPLETE SYSTEM

THE LINE OF QUALITY and BEAUTY

Here are but two of the many units which are available to amateurs, servicemen and others who emphasize QUALITY in the jobs they build!

Whether you contemplate a simple amplifier or a complete P.A. system; a mobile transceiver or a Kilowatt transmitter—be sure that you get a professional looking job — streamlined, handsomely finished, accurately machined. You can get them all if you specify Par-Metal.

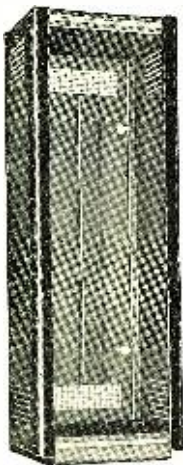

RACKS
PANELS
CHASSIS
CABINETS

PAR-METAL
PRODUCTS
CORP.

3262 49th St.,
LONG ISLAND
CITY, N. Y.

EXPORT DEPT.:
100 Varick St.,
NEW YORK, N. Y.

Talking Picture Electronics

(Continued from page 40)

beam modulates the light by virtue of the variable density of the film emulsion. This modulated light beam becomes in truth a talking beam which, when introduced into a photo-electric cell, is converted into electrical impulses. These are boosted in an amplifier whose characteristics are designed to compensate for film transfer losses which term is given to the difference in frequency characteristic between the signal as applied to the recording light valve and the result when reproduced from the print. This amplifier is called the "dummy" amplifier (RA-1056) which consists of two stages of 310A tubes which are similar to 6J7s. These tubes are coupled together by two transformers with a 500 ohm link circuit in which the equalizing network of a constant impedance is inserted, together with a volume control to adjust the output level from the "dummy." The "dummy" is, therefore, in effect a film phonograph which reproduces from film instead of from a record.

The outputs of as many as twelve or more of these "dummies" are then routed to a dubbing stage which has a mixing console with twelve separate mixing dials which control as many circuits. These twelve mixing dials are grouped in fours and are capable of being controlled by a master dial. These control the volume of the various tracks which have been reproduced in the dubbing machine room. The "dubbing" console also has a group of special equalizer controls which provide high, low and middle frequency attenuation, equalization, various phone, P.A. and special effects. The amplifying equipment on the dubbing stage consists of a combining amplifier into which these groups of mixer dials are fed, a booster amplifier and a line amplifier. The combining amplifier consists of four transformers whose primaries are individually connected to the groups of mixer dials and whose secondaries are connected in series to feed the grid of a single 262A tube. The booster amplifier is a two stage amplifier consisting of a 262A tube which is resistance coupled to a single 6J5GT tube. The line amplifier is an ASL23055 consisting of a 262A tube transformer coupled to a 271A tube. This amplifier has a maximum gain of approximately 49db and an output of one watt at a distortion of 1%. All these amplifiers boost the signal from the original tracks that are being mixed together. The output from the line amplifier is fed to the Bridging Bus of another recording channel similar to the one previously described whereon is recorded the final "dub" track.

The monitoring equipment for the dubbing stage is identical to that on the scoring stage, loud speakers being located behind the screen upon which is projected the final "dub" track.

The speaker system itself is worthy of some comment. It consists of two separate units. One unit reproduces the frequencies from 20 cycles to 250 cycles, the other reproduces the frequencies from 250 cycles on up. The low frequency unit is composed of two 15 inch loud speakers of a type especially developed for a two-way system

having large voice coils and a cone material which is most efficient in the low frequency range and in which standing waves do not develop readily. These standing waves cause distortion which is present in most loud speakers when driven to high output. These two speakers are mounted in a large exponential horn which is folded back upon itself reducing depth necessary for the assembly. As it is, these horns are about twelve feet across and eight feet high. The high frequencies are reproduced by a unit which is especially efficient in the upper registers and projected to the listener through a series of individually exponential cells which distribute the sound over a large area. This unit is commonly called a multi-cellular horn. In order to separate these two frequency bands, a dividing network is used which consists of a high pass filter and a low pass filter connected for parallel operation permitting low frequencies to be impressed upon the low frequency horns and the highs on the high frequency horns.

To make for efficient operation and to nullify time loss, the Paramount Studio sound executives and staff have worked out a system which for ease of operation is highly noteworthy. This studio contains 15 to 20 production sets and 12 fixed recording channels, which made it necessary to have some means to inter-connect these various units, common practice being to use one recording channel for a certain production regardless of whether it is being produced on stage 1 or stage 15. This is done by means of a patch bay similar to a telephone switchboard on which all the circuits for monitoring, recording signal and order wire (house phones) terminate in jacks. These all may be patched together with cords. The same applies to the monitor systems, but due to the different voltages and the fact that they cannot be in too close proximity to speech circuits to prevent hum pickup, this is done in another room with cords and plugs of a heavier type.

This is all housed in a large room called the Amplifier room, which also contains auxiliary apparatus for play-backs from acetate recordings to loudspeakers on production sets used in the making of musical pictures and in checking the quality of such recordings as may require immediate aural inspection. Several of the bays are given over to test equipment such as oscillators, gain sets, distortion meters and apparatus especially designed for the proper alignment of light valve and noise reduction circuits. Power switching facilities for recording lamp batteries, amplifier filament and plate batteries and signal system batteries are also housed in this room. It is a complete central station having control over all of the far-flung units or production sets. Another innovation is a specially designed mobile recording unit which is used on location in remote places from the studio. Very often scenes must be taken in the mountains or at sea depending upon the locale of the story. These mobile units contain equipment essentially identical to that used for production set work but which operates from batteries which furnish power for amplifiers, for turning cameras and recorder motors and for lighting the recorder lamp. This unit is entirely self-contained and can operate any place with-

out the necessity for connections to a source of electricity. The input equipment is identical with that used in the studio, although the recorder itself is considerably smaller and lighter.

All the tubes herein mentioned are of the heater type with the exception of the 284D tube which is similar to an 845, the 275A which compares to the 45, and the 300A which most closely resembles the 2A3. The 262A tube is a heater type tube with the filament operating at 10 volt AC-DC at a current of .32 amps. It is an extremely low noise tube which is especially suitable in low level circuits, its feature being that it is a triode with the grid connection to the cap.

The frequency response of all the amplifiers in this variable density system is essentially flat from 30 to 10,000 cycles, except wherein noted to compensate for deficiencies that may arise due to the many elements that are involved in a recording system.

The most recently developed amplifier at the Paramount Studios is a two stage unit for compensating the frequency response of a 9A disc reproducer when used in the playing of recordings made on acetate discs. The gain frequency characteristics of this amplifier are approximately plus 42 db at 30 cycles, 23 db at 400 cycles, 22 db at 1000 cycles, 20 db at 3000 cycles, 15 db at 5000 cycles, 17 db at 8000 cycles and 18 at 10,000 cycles. This frequency correction is obtained by feedback for the low frequency boost and by constant impedance equalizer in its output to give the suppression at 5000 cycles. This 5000 cycle suppression is necessary due to the characteristics of the acetate discs. The low frequency boost is necessary on all types of phonograph records which are recorded with a constant amplitude characteristic up to 300 cycles and a constant velocity characteristic above that which is the type of recording in general use on phonograph records.

Table II
Western Electric AC Bridging Amplifier,
Type D-86840

This is a rack mounted, single stage, pushpull amplifier, using 271-A vacuum tubes and arranged to operate as a bridging amplifier with a high impedance input into a 500 ohm load. It has a power gain of 18 db with a practically flat frequency response characteristic from 35 to 9500 cycles. Its harmonic content is approximately 1% at +23 db/.006 watts.

Western Electric Type 1086-A. Amplifier
The 1086 type amplifier is a rack mounted, all AC operated, four-stage transformer and resistance coupled. The final stage is pushpull, using 300-A vacuum tubes. The maximum gain is approximately 99 db with facilities for reducing the gain by internal strapping. Its output level is normally rated at +34 db/.006 watts. The frequency characteristic is practically flat from 35 to 10,000 cycles and it is designed to operate from a nominal 200 ohm circuit into a 6 or 12 ohm load. The output transformer may be replaced for operation into a 500 ohm load.

**Western Electric Dummy Amplifier,
Type RA-1056**

The RA-1056 amplifier is a rack mounted, two-stage, heater type rerecording PEC amplifier, designed to operate out of a Western Electric reproducer set. This amplifier, under ordinary gain measurements with the attenuator and equalizer

on minimum loss, is approximately 56 db. It is equipped with a high frequency equalizer to compensate for optical and film processing losses, with 15 db range of equalization in 1 db steps. The unit is designed to operate into a 500 ohm load. The power output is approximately -8 db/.006 watts for 1% harmonics.

**Western Electric Line Amplifier,
Type ASL-23055**

This is a rack mounted, two-stage, transformer coupled amplifier, designed to operate between 500 ohm impedances. The amplifier is equipped with a key so that it may, when necessary, be operated tube out. Gain potentiometers are provided to vary the gain between 26 and 48 db. Its frequency characteristic is practically flat from 35 to 9000 cycles. Its 1000 cycle harmonic content is 1% at +17 db/.006 watts.

Amazing New "WALSCO" STAPLE DRIVER

for radio men, electricians or anyone doing stapling. Makes wire and cable installations twice as easy—much neater—saves half the time. Wires can be stapled in corners, behind pipes, into molding—places never accessible with a hammer and ordinary staples. Drives staples even into walls, brick, mortar, etc. Magazine works automatically and holds strips of staples which come in several colors. Ask your jobber for demonstration and catalogue 41-C of all WALSCO PRODUCTS

or write **WALTER L. SCHOTT CO.**
5264 W. Pico Boulevard, Los Angeles, California

SOLAR RED-CAPS
Smaller Diameter Dry Electrolytics

SPEED Servicing

Write for Catalog

SOLAR MFG. CORP. Bayonne, New Jersey

BRUSH

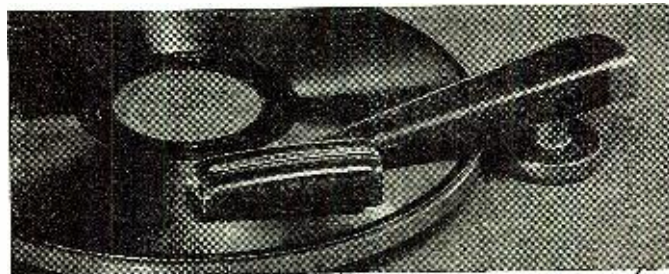

**CRYSTAL
PHONOGRAPH
PICKUPS**

—for the finest reproduction of both soft and hard record materials, with virtually no record wear. Adopted by leading broadcast stations and recording studios after the most exacting tests.

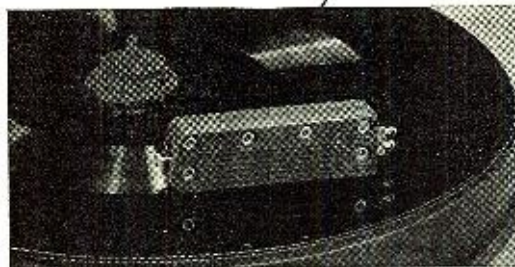

**NEW BRUSH
RECORD CUTTER (RC-20)**

—professional quality at a very moderate price.

Technical Bulletins gladly furnished on request.

• THE BRUSH DEVELOPMENT CO. •
• 3311 PERKINS AVE. • • • • • CLEVELAND, OHIO •

The New
TURNER
Microphones
 Engineered for Professional Results

CD Dynamic "Challenger"
 Engineered to give smooth response at all frequencies for P.A., amateur and recording. Complete with 7 ft. removable cable set using Amphenol connectors. Finished in rich brushed chrome. Fully protected, yet rugged enough for toughest jobs. 200-250 ohms, 500 ohms or hi-impedance, complete with cable set. List. \$16.00. CX Crystal, same appearance, List. \$15.00

Han-D Model 9D Dynamic
 Suited for voice or music pick-up or sound car use. Hold it, hang it by suspension hook or mount on desk or floor stand. Positive contact slide switch permits off-on operation. Hand some brushed chrome finish. With 7 ft. removable cable set and protective bag. 9-D hi-impedance, list \$22.50. 9X Crystal, same appearance, list \$22.50

33D Dynamic Model
 Rich satin chrome finished inlaid that amplifies smoothly. Built-in transformer for hum-free performance. With 7 ft. balanced line removable cable set, 200 or 300 ohms or hi-impedance, list \$22.50. 33X Crystal, same appearance, list \$22.50. Send for New Catalog

The TURNER Co.
 908 17th St. NE., Cedar Rapids, Iowa
 Crystals licensed under patents of The Brush Development Co.

QRD? de Gy
 (Continued from page 38)

remarks you made about ARTA. I was radiop on the SS LIBERATOR at that time. I said that your column was the first thing I turned to in RN. Well, that still goes. Your column is really interesting to us marine operators. I believe I told you that once another opr sent me the whole column by spark transmitter while we were out in the Pacific. And here's some news for you. Most of us ops always are looking for that good "shore job." Well, I hope I have mine at last. When I learned that TRT was going to abandon their coastal station at Mobile, WNN, I decided that here was my big chance. So I made application to the FCC for the facilities TRT had abandoned last January. After considerable negotiation, including a trip to Washington to let them look me over, the FCC granted me the Construction Permit. I still think it's a miracle I actually got it, because I'm just me, with no influence, money or pull. But I worked mighty hard, and I apparently convinced them it wouldn't be a bad idea to give me a chance. The CP was granted May 28th and I've been working ever since to raise the dough, build the 750 watt transmitter, and get on the air. Today is my first day (October 5th) in service, and I'm quite relieved I've actually done it. While building the xmtr and trying to get it going I found out how much I really don't know about radio. [Why not read more of RN? Ed.] But I got the rig going at the cost of only 1 plate transformer and a KY866 keying tube and a few resistors, Hi. I was QSO WPA at Pt. Arthur, Texas, this morning, so I guess it gets out. Now my main problem is to get all the fellows to know about my station. I think many will route their msgs via WLO to help a fellow opr. This pasture looks big enough, but I don't know yet just how green the grass is, Hi. Anyway, it's interesting to note that when fellows first hear me call they don't think they've got the call letters right, since all ships have four letters. I am not affiliated with any other interests, although I have the moral support of all the local shippers. Signed Norman B. Underwood . . . unquote.

JUST goes to show what an op can do when he really tries. We can appreciate what it must have meant to get that FCC ticket for the station. And what courage to take a chance on losing the hard-saved cash. But that's what we call "rugged individualism." So here's our wish for plenty of good luck and a basketful of msgs daily. A couple of years ago an American radiop worked out a schedule directly with a Swedish radiop to supply Swedish newspapers in the USA with daily, untarnished and uncensored news reports. He contacted all the Scandinavian publications in this country, sent them daily mimeographed bulletins, and drew down more than \$300 per week, standing two watches per day. Which goes to prove that there's more than one way of paying the landlord,—or skinning a cat. . . .

IT has come to ye ed's notice that radiops are continually in danger of being coerced by unscrupulous individuals who dangle big money in front of their eyes. For example, west coast horserace bookies would like to get the eastern tracks' race information as soon as the ge-ge's hit the wire. Telephone and telegraph wires are out, so radio is the next step. Ingenious ideas to get this info to the west coast via short-wave with a radiop on a ship outside the three mile limit transmitting the dope to a Mexican station which would then broadcast it, is one of the ideas that has been given some thought. But we quote from the FCC release, "A Californian inquires about the possible establishment of a 'broadcasting station' on a ship stationed 12 miles at sea. The FCC points out that international agreement prevents establishment of any type of radio station without prior authorization being obtained from the government concerned. It follows that any xmting equipment on board a ship of US registry must be approved and licensed by the FCC and oper-

ated in conformity with its rules and regulations." Just a word to the wise. . . .

SOME time ago a reader wanted to have the circuit of an AC-DC radio for which we sent out an SOS. In our mail we find that Wilbert Misner of Radio Mjrs. Service, Rexis Hill, Uniondale, Pa. wins the furlined teacup by sending in the best diagram. Although the schematic is done in true "ham" fashion (no offense, OM), which means grasping a lead pencil and beginning at one end of the paper, drawing the circuits without taking the pencil off the paper, our old, weak, watery eyes tell us that the circuit should work. And Brother Misner believes it will work because . . . quote . . . if you'll examine the 6C6 circuit you will find this tube acts not only as a detector but also as an audio amplifier, as well as furnishes AVC for the 6DC. Well, anyway, that is how I figure it works and I know that it works. I've tried it. And I hope it works for you . . . unquote. So tnx, om, for your aid.

WE did not know that Hal Styles, President of the Pacific Coast chapters of the VWOA was a former radiop until we met him at the 'Frisco World's Fair Deforest Day celebration. So when we found out that this fellow who has helped over 25,000 unemployed get jobs with his "Help Thy Neighbor" program (broadcast over KFVB, Los Angeles) was a former brasspounder, we gave him the twice-over. Can he reminisce! Over a sandwich (or was it?) Brother Styles shyly remarked as how he had visited over 50 countries and sailed on everything from a tanker to a schooner. There was the time, back in '16, during the wee sma' hours of the nite, as they were arriving at Mejellones, Chile, that he suddenly heard weak sigs emanating (he said that, s'help me) from Wrangel Island, Alaska, 7500 miles away. Flabbergasted, he called the op who answered, giving him some iceberg reports. Then suddenly the sigs gave out. On returning to NY he called at RCA headquarters to proudly boast of his achievement . . . until E. E. Winter, then Op in Chg of assignments, introduced him to the guy whose ship left Mejellones just before Styles' boat pulled in, and who confessed that he had sent the "iceberg reports" as a gag. Needless to say, Hal's face did a slow burn. We're mighty proud to hear of a former radiop doing such noble work as Styles' program is accomplishing. We hope he continues forever.

THERE you are, me hearties; radiops from the past, to the present and for the future. Radiops who have gone down to the sea in everything from a windjammer to an ocean liner, who never knew from day to day whether their rigs would hold together because of the haywire lashups that held them together. But they're mostly successful men today. They have used the old maxims which they learned during their operating days to get to their present positions in the radio industry. Those maxims were loyalty, industry and honesty and wherever they went they let it be known that an American, a truly great and patriotic representative, was there. 73 . . . gc . . . GY.

For the Record

(Continued from page 4)

unit of the better type of recording apparatus within the reach of the man with the flatter pocket-book. Better quality 12" recording blanks should come down in price due to improvements chemically in the production of these extremely necessary units. It is definitely established that 1941 will be an electronic year, and, of course, if this is true, it will certainly be a radio year.

LAST July we were in Washington and had occasion to speak to some of the officers of the Signal Corps anent amateur radio activities in connection with the National Defense. The worthy officers expressed a desire

RADIO OPERATORS' LICENSE GUIDE

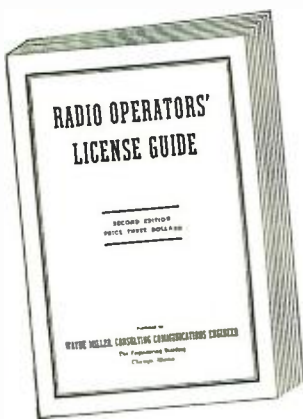

ONLY \$3.00
 Postpaid

Here's a new Guide Book that contains over 1250 questions and answers which will help you pass the new six element examinations for a commercial radio operator's license. It correctly answers all questions contained in the study guide that was recently released by the Federal Communications Commission for the use of those proposing to take its examination. It will not only see you through your examination, but will also serve as a valuable future reference book. \$3.00 postpaid. Refunded if not satisfactory. Send check or money order.

WAYNE MILLER
 The Engineering Building • Chicago, Ill.

that the hams develop a transmitter and a receiver which could be built in large quantities by the amateur fraternity so that should an emergency ever arise, the army would have a large number of similar transmitters and receivers for immediate use. In this issue appears the Radio News version of a ham National Defense radio transmitter and receiver. Designed around the excellent unit built by the Hallicrafters of Chicago, the little rig is capable of operating on 160, 80, 40 and 20 meters fone and c.w. No changes were made in the receiver and the additional space previously occupied by the batteries now holds the transmitter section. A separate battery—a.c.-d.c. box is added, and the two units together comprise a complete transmitting and receiving station. The transmitting portion may be operated either from a 6 volt storage battery, or from 110 volts a.c. The portable receiver is operated from its own batteries or 110 a.c. or d.c. line. While the radiation element in the form of the antenna is merely the short collapsible mast with which the receiver is equipped at the factory, it is possible to substitute an antenna wire for transmitting purposes to increase the range. The input is in the neighborhood of 12 watts; the circuit itself being fool-proof and extremely simple. We recommend that all amateurs who are able, to build a set similar to this so that they may be in a position to help Uncle Sam if the occasion should arise.

* * *

IN response to many requests from our readers for a high fidelity tuner, suitable for making records, and for giving better-than-usual quality reception, the Technical Editor, Oliver Read, got out his slip-stick and a ream of paper and designed the unit you find in this issue. Surprisingly enough, the parts can be assembled new for less than \$10.00, but it must be remembered that while the tuner might come under this very reasonable category, the reception quality comes mostly from the loud speaker which, in turn, will be greatly dependent upon the amplifier. Manifestly, it is very foolish to use a fine high quality high fidelity tuner with a very poor amplifier. We believe this tuner will fully meet all of the requirements of a good high fidelity unit and we suggest to our readers that if they should own such a unit as this together with a suitable amplifier they will find many hours of enjoyment listening to the radio. Especially fine is this unit for the reception of opera, concerts and even swing music.

* * *

ALSO taking a lead from our readers who have repeatedly written in requesting information on how and where to place a microphone or a speaker in a P. A. installation, we have given them the answer in the article, "Speaker and Microphone Placement." While the article itself is very comprehensive and takes up almost every imaginable condition, P. A. specialists should remember that each and every hall has its own acoustics which are not duplicated elsewhere any place in the world. And, while he may very well use the article as a guide, it is not a cure-all. However, by following the principles laid down by the author you will find that his response will be better than if he

had just gone about the matter in a hit or miss fashion.

* * *

A GREAT deal of interest has been shown in the "Build Your Own Studio" series of articles. Originally intended to be a short treatise on this subject, the readers' response was so large that the series has been widened in scope to take up a great many problems which have to be presented. Two parts of this series have already found their way into print and the third part will appear in the next month's issue. We ask our readers to watch for it.

* * *

THOSE of you who are located within range of a television transmitter and who have despaired of receiving television because of the cost involved in obtaining a receiving set, will be interested to know that it is

possible to enjoy television if you own an oscilloscope and are willing to build a small out-board gadget. Mr. Lawrence, an able television engineer, presently in the employ of Radio Corporation of America, has furnished us with the necessary information in an article appearing in this issue. We are told that the television images resulting from the use of the oscilloscope together with the out-board gadget are remarkable for their clarity and detail. So why not enjoy this type of reception?

* * *

YOU will all be interested to know that the Army has made the statement that they are not going "over board" on behalf of Frequency Modulation. In view of the statements made to us on our last trip to Washington, that the Army was very much

BUY DIRECT FROM THE MANUFACTURER AND SAVE

THE NEW DYNAROMETER

Features New Giant 8½" Double Jewelled Meter



This amazing versatile instrument is our answer to the demands of radiotricians for a combination instrument which, in addition to making the usual V.O.M. measurements, will also permit DYNAMIC D.C. VOLTAGE MEASUREMENTS without interfering with or upsetting delicately balanced circuits, such as tuned circuits, electronic apparatus, control voltages, etc. Actually, as you will note from the specifications listed below, the DYNAROMETER is a combination Vacuum-Tube Voltmeter and V.O.M. besides permitting additional measurements such as Capacity, Decibels, Inductance, etc. All calibrations printed in large, easy reading type on the giant 8½" double jewelled meter. The Input Impedance for the V.T.V.M. is 11,000,000 ohms with 2,000,000 ohms per volt on the lowest range. The 4 V.T.V.M. ranges are 5, 25, 100 and 500 Volts, and because of the zero center no attention need be paid to polarity since the meter will read either in the plus or minus direction, depending on the position of the probes.

HAVE YOU EVER —

Tried to measure Control Voltages such as A.V.C., A.F.C., oscillator, etc.?

Impossible with the ordinary V.O.M. due to loading of the circuit BUT the 11 megohm input impedance of the DYNAROMETER enables measurements without molestation at any point in the receiver.

Tried to locate distortion in the audio section of a receiver?

A long tedious job with the ordinary V.O.M. but almost instantaneous with this new DYNAMIC method of testing.

Tried to isolate the cause of trouble in an intermittent job?

A cinch with the DYNAROMETER. Extreme sensitivity and flexibility enable speedy measurements at points usually impractical when using a standard MULTIMETER.

SPECIFICATIONS:

- 4 D.C. VOLT RANGES AT 11 MEGOHMS INPUT: 0-5/25/100/500 Volts
- D.C. VOLTAGE MEASUREMENTS IN 5 RANGES: (at 1000 ohms per volt) 0-10/50/250/500/5000 Volts
- A.C. VOLTAGE MEASUREMENTS IN 4 RANGES: (at approximately 800 ohms per volt) 0-15/150/1500/3000 Volts
- RESISTANCE MEASUREMENTS IN 3 RANGES: 0-1,000 Ohms, 0-10,000 Ohms, 0-30 Megohms.
- D.C. CURRENT MEASUREMENTS IN 4 RANGES: 0-1, 0-10/100/1 Amp./10 Amp.
- 4 OUTPUT RANGES: 0-15/150/1500/3000 Volts
- 2 CAPACITY RANGES: .0005—1 Mfd. .05—100 Mfd.
- INDUCTANCE: 1 H.—70 H. 7 H.—10,000 H.

The Dynarometer operates on 90-120 Volts 60 cycles A.C. Comes complete with test leads and all necessary instructions. Shipping weight 20 lbs. Size 13½"x10"x8¼". Our net price.....

\$18⁷⁵

SUPERIOR INSTRUMENTS CO.

136 Liberty St., Dept. RN-1
NEW YORK, N. Y.

NEW!



**• MILLION •
NEW DF TUBE CHECKER**

TESTS THE NEW 7 PIN
MINIATURE BATTERY TUBES,
BALLAST TUBES AND 024
GAS RECTIFIERS.

New, with wider application range. Tests emission of all tubes. Twelve sockets cover all types from the new Raytheon "hearing aid" tubes and RCA 7-Pin battery types to new loktals and S series. Filament switch covers 1.4 to 110 volts with spare positions for the future. Gives instant "good-bad" readings on oversize D'Arsonval meter. Makes neon short or leak test with tube hot. Tests by-pass condensers, etc. Literature on request.

MODERN
ACCURATE
DEPENDABLE
ECONOMICAL

\$16⁹⁵
NET

IF YOUR JOBBER CANNOT SUPPLY, WRITE
US DIRECT—GIVING THE NAME OF YOUR
JOBBER.

MILLION RADIO AND TELEVISION
577 No. Union St. Chicago, Ill.

SAVE MONEY

WITH THIS

Free Book



What a book to have! Just open it to the section you are interested in—there's your radio, sound system, your choice of nationally advertised parts. Everything in radio is here. But that's only the start of the story! Lafayette prices are the lowest—saving you money on everything you buy. Send for your FREE copy of this great buying guide today. Just tear out and mail the coupon.

Lafayette Radio

100 SIXTH AVENUE, NEW YORK, N. Y.
CHICAGO • ATLANTA • BOSTON
NEWARK • BRONX, N. Y. • JAMAICA, L. I.

LA FAYETTE RADIO CORP.
DEPT. 2A1, — 100 SIXTH AVE., NEW YORK, N. Y.
Rush FREE Catalog No. 82

NAME.....
ADDRESS.....
CITY..... STATE.....

interested in this type of radio communication, we are wondering whether or not it is just a policy of "playing possum" or whether they have found out that Frequency Modulation might not produce the type of communication which they were seeking. We believe it is the former because we still have fresh in our minds the statements made to us, that the German war machine was operated so successfully entirely due to the use of Frequency Modulation communication between the outposts of the Panzer (attacking) unit and the home, or field station. One thing is sure, and that is that recent field tests made with our own Frequency Modulation transmitter, built from the plans described in last month's issue, shows that Frequency Modulation offers an extremely reliable source of mobile transmission. This has been proven true by virtue of the fact that there are several police stations who have gone over to the F. M. for their radio squad cars. Just what effect the steel building and large piles of brick in the large cities will have on the reception of F. M. is a proposition which can only be answered when the F. M. transmitters are tried out by the police in those types of localities.

* * *

A WORD about our MINUTEMEN. Presently numbering over 650 members, spread from coast to coast, the RADIO MINUTEMEN OF AMERICA are going to town in a fine fashion. A number of members have sent in reports of subversive and 5th-column activity which have come to their notice. These reports have been forwarded in the original form as received to the proper government agency for whatever action it cares to take. We were amazed to find a number of radiomen who were anxious to help Uncle Sam. As soon as the list of members stabilizes itself, and as soon as the MINUTEMEN list becomes complete, it is intended to turn the entire list over to Uncle Sam.

An accusation has been made that the RADIO MINUTEMEN OF AMERICA are taking over monitoring functions which normally were assigned to Government agencies. This is not true. RADIO MINUTEMEN OF AMERICA is, as has been stated many times, a purely voluntary organization of men who are keeping their eyes and ears open for whatever they may see or hear which is un-American. When such activities come to their attention, they promptly send in a report in writing, and it is this report which is turned over to the Government agency for whatever action it may take. RADIO MINUTEMEN OF AMERICA are not in any sense of the word "Government Agents," nor are they engaged in any counter 5th-column or subversive element activities. They are merely reporters and are doing a fine job as such. From time to time, and whenever the Government will permit it, we will release figures and statements as to what good has been done by the RADIO MINUTEMEN.

* * *

STARTING with the next issue, RADIO NEWS advances its on-sale date at the newsstands to the 25th of the month. This is a definite step forward and is the first time that RADIO NEWS has changed its on-sale date in almost twenty years. After

long series of conferences between the editorial, advertising and production departments of the magazine it was decided that it would be an advantage to our readers to have the publication date closer to the on-sale date. By this we mean that the reader for instance will receive the February copy on the 25th of January. Thus he will be closer to the actual happenings and a smaller amount of time will elapse between the occurrence and the time that the reader sees it in RADIO NEWS. We hope our readers will appreciate this service to them. Among the advantages of changing the on-sale date to one later in the month will be the fact that we will be better able to give more accurate coverage on the radio National Defense situation. Things happen so rapidly in this particular picture that it is virtually impossible to bring the news to our readers fast enough in order that it will still be fresh and new. With the later on-sale date, it will be easier for us to do this, and, of course, the reader will have the benefit.

AND that just about winds up another column and another month. We look forward with interest to what the new year will bring. We feel confident that Radio is on the verge of a terrific boom not only from a financial standpoint but also from the standpoint of bringing new and greater developments to the experimenter, the amateur, the serviceman and the engineer. While it is true that the war abroad has brought many of these changes and many advantages to Radio, it is sincerely hoped that we will be able to maintain our neutrality so that we may continue to benefit from these advantages.

But of one thing we are absolutely sure. No advantage we can possibly acquire in radio or any other field, can supplant the advantage of a free and independent people. And if that freedom and that independence be challenged, we will gladly sacrifice the advantages of neutrality for a course of national defense.—K. A. K. —30—

**Washington
Communication**
(Continued from page 15)

was Dodge Telegraph & Radio Institute at Valparaiso, Ind., where 125 men from Ft. Knox, Ky., were sent for training.

Paw-Print Returns Being Sorted
THE job of sorting out more than 100,000 answers to the "proof order" has just about thrown the Amateur Section of the FCC. The small staff there is swamped with fingerprints, birth certificates, etc.

Which explains two orders issued last month affecting hams. The first order extends until March 1, 1941, the license of any ham who applies for a renewal—unless he has been suspended for some reason. In other words, those who apply for renewal will get it, until March 1, automatically.

The second order allows ham stations to be moved from one permanent location to another permanent location until May 1 and be operated from the new location—provided proper application is made. Approval of the application is not necessary.

The reason for these orders is that the Amateur Section is so far behind its work that it will not have a chance to do the routine which goes into license renewals or approvals of change of location. Rather than put anyone off the air until they catch up, the FCC has decided to let the hams operate under these extensions.

FCC Adds "Board" for Radiops
Y E Ed's blast last month at the low remuneration offered to the operators

sought for FCC monitoring work brought action. The FCC is going to provide sleeping quarters wherever possible—the lack of which was one thing that was criticized.

But the pay rates won't be raised. Officials point out that this pay is higher than most Government agencies offer. The FCC ops get \$1,800 and \$1,620. And, insist FCC chiefs, this must look pretty good—because the jobs were filled with men of the highest type. [Glad we were wrong!—Ed.]

More on Pt-to-pts.

LAST month this column discussed the spread of point-to-point stations to parts of the world where the U. S. looked for trouble. We suggested that you keep an eye on Greenland.

Reports reached Washington not long ago confirming this tip. They told of one of the Nazi's rare failures—an attempt to take Greenland. The reports stated that a boatload of Germans was captured by a Norwegian gunboat not far from Greenland. They said they had been sent out to carry out an Arctic blitzkrieg. Their objective: the radio stations in Greenland which supply Europe, among other things, with vital weather information.

Licenses during the past few weeks have been granted for extension of point-to-point facilities in Martinique, the French island in the Caribbean, and to St. Pierre et Miquelon, French isle near the mouth of the St. Lawrence. Watch those spots—Uncle Sam is.

Defense Purchases

THE defense purchasing program in the radio field began to speed up last month. This rate of increase will continue, we are told. Manufacturers are being urged to complete their work as fast as possible—and get set for more orders. Some Military men are afraid that plane production is going to get ahead of radio production. Since planes won't be any good without the radios to go into them, this is a serious worry.

AMONG the contracts let during October—the biggest month yet for orders—were the following:

Bendix Radio Corp., Baltimore, five contracts, totalling \$6,199,419, as follows: frequency meter sets, \$878,631; radio compasses, \$1,834,436; radio set components, \$246,642; radio "equipment," \$3,565,803. and \$673,906.

Western Electric, \$3,585,934, components for radio sets.

R. C. A. Manufacturing Co., Camden, two contracts, totalling \$10,994,127, for receivers.

Radio Receptor Co., New York City, \$70,216, for radio set equipment.

Lear Avia, Inc., Dayton, \$691,500.

Philco Corp., Philadelphia, \$671,000, for receivers.

General Electric Co., Schenectady, \$8,303,296, for radio "equipment."

National Co., Malden, Mass. (through G. E.), \$13,066, for receivers.

J. H. Bunnell & Co., Brooklyn, N. Y., \$252,125, for receivers.

The Rauland Corp., Chicago, \$363,251, for receivers.

William J. Murdock Co., Chelsea, Mass., \$22,722, for headsets.

American Automatic Electric Sales Co., Chicago, Ill., \$78,934, for handsets.

Airplane and Marine Direction Finder Corp., Clearfield, Pa., \$11,427, for receivers.

Collins Radio Co., Cedar Rapids, Ia., \$299,990, for transmitting equipment.

Farnsworth Television and Radio Corp., Fort Wayne, Ind., \$226,127, for receivers.

Doolittle Radio, Inc., Chicago, \$12,515, equipment for Naval aircraft.

Eicor, Inc., Chicago, \$17,568, for dynamotors.

The total for the month comes to over \$30,000,000—equal to the total amount spent up to the first of October on the radio defense program. This bears out our prediction of last month that the orders placed before that time were but a drop in the bucket to those yet to come.

Transformer Cases

IT is reliably reported that the Army is still buying transformers which are placed in cases, the patterns of which date back to 1922. The sole manufacturer presently owning the dies for these cases is one

located in the East. The demand for these cases is compelling other manufacturers to expend up to \$1,500 for new dies to meet Army requirements and, of course, the Army is paying the freight. A concerted move by the manufacturers will shortly take place to have the National Defense purchase orders standardized especially in the matter of radio parts, so that not only will the price-per-unit come down, but the number of bidders on each item will be increased.

Odds & Ends

THE fire in the War Department hit the Signal Corps hardest... damaging the Army Message Center, the Signal Corps Code Room and the purchasing headquarters of that Corps... It is not believed that sabotage was involved, but if a saboteur had wanted to hit the Army radio, he couldn't have planned it better...

FCC is making plans to extend licenses of ops—ham and commercial—who go into the Army, until they are discharged...

A chain of FM stations is in the offing, now that the FCC has given them the go ahead...

The new engineering report on television is expected to be presented soon... insiders say it will recommend a standard of 441 lines at 30 frames per second... which is where it was when the FCC called off all bets a few months ago!

The United Electrical Radio & Machine Workers of America (CIO), was certified as sole bargaining agency of the Belmont Radio Corporation, Chicago...

Vacuum tubes are now being turned out by the industry as a whole at the rate of 400,000 daily...

RCA announces that it has arranged with a group of banks to borrow \$15,000,000 for 5 years for expansion of research and production facilities to speed National Defense orders for the Gov't...

The Navy purchased 359 acres of sugar cane land, near Schofield Barracks, Oahu Island, T. H., for a \$1,000,000 radio station. The land cost Uncle Sam \$36,000...

The FCC acquired a lease on the north-

RECORD CHANGER

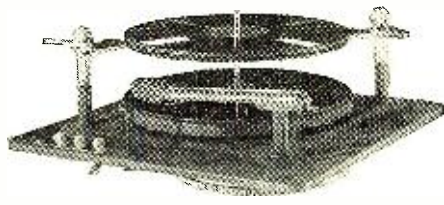

Plays 10 12" or 12 10" records. 14" by 14" by 5" high crystal pickup. Handles warped records. Will not chip or crack records. Reject switch—automatic or manual change—2 point record suspension.

ONLY \$12.95 F.O.B.

UNCUT CONSOLE CABINETS

Many types and styles. Combinations \$4 up

SHORT WAVE & BC KIT

Includes airplane dial gang, two band osc. and ant. coils, padders, matched pair of IF coils and Band Switch.

Send for latest folder

LAKE RADIO SALES CO. 618 W. RANDOLPH ST. CHICAGO

OHMITE Ohm's Law Calculator

Solves any Ohm's Law problem with one setting of the slide

There's nothing else like it! It's the handiest Ohm's Law Calculator ever made—specially designed for you by Ohmite Engineers. Gives the answer to any Ohm's Law problem with one setting of the slide. Simple, easy, complete. Requires no slide rule knowledge. All values are direct reading. Covers the range of cur-

rents, resistances, wattages and voltages commonly used in radio and commercial work. Also has convenient Stock Unit Selector—a setting of the slide tells the stock number of the resistor or rheostat you may need. Size 4 1/2" x 9". Available to you for only 10c to cover handling cost. At your Jobber, or send 10c in coin now.

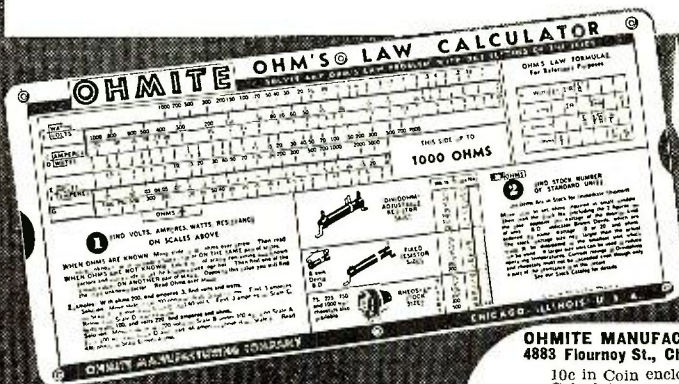

It's NEW

It's Complete

OHMITE MANUFACTURING CO. 4883 Flournoy St., Chicago, Illinois

10c in Coin enclosed. Send Ohm's Law Calculator. Name _____ Address _____ City _____ State _____

Be Right with OHMITE

INDUSTRIALS - RESISTORS - TAP SWITCHES

Radio News—Jan.

Direct Reading Analyzer

(Continued from page 17)

struments offered recently to the service trade.

Two of the bridge legs contain resistance only (R1 and R2), while the remaining two are comprised by both resistance and capacitance. In one of these (C1-R3) the resistive and capacitive components are in parallel; in the other (C2-R4) they are in series.

A voltage of unknown frequency is applied to the terminals marked INPUT. Headphones are shown in figure 3 as the null detector.

For frequency measuring work, the ratio arms, R1 and R2, are so proportioned that R2 is twice R1; and the condensers C1 and C2 are made equal in capacitance. R3 and R4 are variable resistors which are adjusted simultaneously so that at any setting the two have identical ohmic values.

Since R3 and R4 have the same value at any setting in their range which balances the bridge for a particular frequency, and since C1 equals C2 and R2 is twice the value of R1, the frequency balanced out may be determined from the equation:

$$f = \frac{1}{2\pi RC}$$

Where f is in cycles per second, C is in farads, And R is in ohms

It will be evident that since R3 and R4 are identical at any setting, the two might conveniently be combined in a dual ganged rheostat and as a result adjusted simultaneously to balance the bridge in a labor-saving manner. As a matter of fact, this expedient is used in the meter circuit (figure 2) to lend simplicity of operation. Note that R4 and R5 are sections of a standard dual ganged volume control and that the main dial is affixed to the shaft of this part.

The auxiliary potentiometer, R2, is included in the circuit to compensate for the lack of exact similarity between R4 and R5 at certain settings, thereby affording a "cleaner" null and correspondingly greater accuracy of reading.

From the Wien bridge equation it may be seen that an appropriate choice of resistance range in the balancing arms and of capacitance values for C1 and C2 will enable complete coverage of the common audio spectrum with one set of components. R4 and R5 in the instrument to which this article is devoted each have a maximum value of 1/2 megohm, and C1 and C2 each a capacitance of 0.0133 microfarad for that very reason.

A study of the equation will also reveal that the bridge may be balanced for only one frequency at a time. It follows then that any voltage present in the bridge output circuit to render the null point less distinct is due to some other frequency (or frequencies), particularly to harmonics of the balanced frequency. However, since the bridge offers a different order of attenuation to different harmonics, it is not reliable as an indicator of total harmonic percent in the simple system of wave form analysis that is apt to occur to the reader.

How to Build It

Since the audio frequency meter is

by nature such a simple device, its construction presents no major difficulty. The builder is free to exercise whatever latitude he fancies in the matter of arrangement of the components, since he will encounter none of the annoyances of electrical interaction such as arise in radio-frequency construction.

The sectional views of figure 4 show clearly the assembly scheme employed by the author, while figure 6 illustrates the method of making a direct-reading dial for the instrument.

The dial is a National type O. The knob is removed by taking out the three machine screws that secure it to the metal disc and a ring of white Bristol board cut as shown in figure 6 to be fitted on the disc. This paper ring is carefully cemented to the dial disc with a thin application of Duco household cement, the knob reinstalled, and the calibration points marked later on the paper surface. A ring of thick transparent celluloid is cut to the same size as the Bristol board ring, and after the calibration points have been inked in, the knob is once again removed and the celluloid ring mounted on the face of the dial and clamped securely by the knob.

In the interests of shielding, a metal box is recommended for housing the bridge. The author's was made of 1/16-inch aluminum, 4 3/4" x 4" x 3". But it is obvious that the reader may "draft" into service any small case in his possession. The open-circuit output jack (figure 2) J, passes through the case making contact and grounding the "bottom" of the bridge.

The input binding posts, comprised by the R39-insulated National FWH terminal assembly, clear the box

5000 RADIOMEN can't be wrong!



CREI Graduates, As A Group, Are The HIGHEST PAID in the Industry!

CREI Provides Advanced Practical Engineering Training for Professional Radiomen to Qualify for Better Jobs in Every Branch of the Industry.

● The success of CREI men in every branch of radio should prove an incentive to investigate thoroughly the opportunities that await you through CREI training in Practical Radio Engineering. We are not interested in bringing "beginners" into the industry, but WE ARE interested in helping professional radiomen NOW in radio to advance to better-paying jobs. 5,000 students and graduates prove we are doing it—surveys show that CREI men, as a group, are the HIGHEST PAID! New opportunities for trained men are being created constantly. Now is the time for you to advance yourself with advanced practical training.

DO THIS NOW! If you are a professional radioman and want to make more money—write today for facts that prove you can! Let us prove to you we have something you need to qualify for job opportunities that can be yours. To help us intelligently answer your inquiry, please state briefly your education, radio experience and present position.



Free Booklet Sent

CAPITOL RADIO ENGINEERING INSTITUTE

Dept. RN-11, 3224-16TH ST. N. W., WASH., D. C.

COMPLETE RADIO COURSE \$1.95

AMAZING REDUCED PRICE

This is your chance to get exact reprint of regular \$39.00 Radio Technical Institute course for only \$1.95, the full price. This is the latest Radio and Television Course, complete in every way, and exactly the same as the much higher priced original lessons.



1940 EDITION

The training is up-to-the-minute and remarkably complete. You quickly learn radio servicing from simple circuits to signal tracing. From the very start you are introduced to real practical radio methods and equipment.

REGULARLY \$39.00

Includes all lessons and supplementary materials of the original course priced at \$39.00. Take advantage of this most unusual bargain in radio education. Send coupon today for free examination of the entire course.

TELLS HOW TO USE INSTRUMENTS, SIGNAL TRACING, TELEVISION

Many active servicemen have found this reduced-price course excellent for brush up and study of new servicing methods. Reprinted in 1940, with added information on signal tracing, television, visual alignment, P.A. application, photo-cells, etc. All about A.V.C., how to use an oscilloscope, what is feedback, resonance action, and every other fact you must know to be the best serviceman. Forty-three radio manufacturers helped to prepare this course. Just think what this backing by the radio industry means to you. This practical training gives you facts and real data you need on the job. Hundreds of diagrams and illustrations to help. One of the BEST radio courses is yours for only \$1.95, complete.

PREPARED FOR HOME-STUDY

This complete, low-priced course will give you all the training needed to get ahead in the growing field of Radio. No special education or previous experience required. The streamlined lessons are clear, interesting, easy to master and use. Follow just like you have found this course the stepping stone to better jobs and higher pay. A final examination and diploma available after course is finished. Special \$1.95 price for the entire course can be earned the first hour of radio work.

- PARTIAL LIST OF LESSONS**
- Elementary Electricity, Radio Parts, Batteries, Circuits, Magnetism, Electromagnets, Ohm's Law, Radio Mathematics, Wattage Calculation, Induction, R.F. Coils, I.F. Transformers, Condensers, A.C. Filters, Rectifiers, Mixed Circuits, Vacuum Tubes, Stage Gain, Detectors, R.F. Amplifiers, Superhet Principle, A.V.C. Ballast Tubes, Motors, Testing Methods, Instruments, Service Fundamentals, V.T. Voltmeter, Using the Oscilloscope, Alignment, Sound and Hearing, Public Address, Amplifiers, Loudspeaker Placement, Microphones, Inverse Feedback Methods, Recording, Power Supplies, Auto Sets, Servicing Short-Cuts, Case Histories, Radio Transmission, Modulation, Crystal Oscillators, Photocells, Sound Movies, Television Principles, Setting Up a Radio Business, Extra Profit Ideas, And many others.

GOOD REVIEW COURSE

Learn new speed-tricks of radio fault finding, servicing short-cuts, case histories of common troubles, extra profit ideas. Two large lessons on use of regular test equipment, explanation of signal tracing test methods, television to the minute, recording dope. With this information you will save enough time on one radio job to pay the special \$1.95 price for the complete course.

NEW LIMITED EDITION

Rush your order to us today. You may not have another opportunity like this. Only a small number of courses reprinted to sell at the reduced price. You are protected with our money-back guarantee. Catch up with your radio education. Begin studying this course this very week.

Guarantee
You must be satisfied or your money will be refunded immediately.

FREE EXAMINATION COUPON

SUPREME PUBLICATIONS, Room 434
3727 W. 13th St., Chicago, Illinois

Ship the complete Radio Course at the special reduced price. I must be pleased, or will get my money back.

I am enclosing \$1.95, full price, send postpaid.

Ship C.O.D. I will pay postman \$1.95 and a few cents for postage.

Name

Address

City..... State.....

Bliley Crystals

**ACTIVE, ACCURATE
DEPENDABLE**

**FOR ALL POPULAR
AMATEUR BANDS**

priced from \$3.35 up

**Your Bliley Distributor will
supply you with descriptive
literature for the asking.**

BLILEY ELECTRIC CO. Erie, Pa.

**RADIO EVERYTHING
IN RADIO**

This one big book serves your entire radio needs. It includes sets, parts and supplies, public address systems, amateur equipment, testers, kits and fluorescent lighting. You'll find the nationally known favorites at the lowest possible prices. Get your copy of this big FREE CATALOG today.

BIG FREE CATALOG

BURSTEIN-APPLEBEE COMPANY

1012-14 McGEE STREET, KANSAS CITY, MISSOURI

RADIO ENGINEERING

• Complete Radio Engineering Course in 96 weeks. Bachelor of Science Degree. Radio (television, talking pictures and the vast electronic field) offers unusual opportunities for trained radio engineers. Courses also in Civil, Electrical, Mechanical, Chemical, Aeronautical Engineering; Business Administration and Accounting. Tuition, living costs low. World famous for technical two-year courses. Special preparatory department for those who lack required high school work. Students from all parts of the world. Enter January, March, June, September. 57th year. Write for catalog.

1611 COLLEGE AVE. ANGOLA, IND.

TRI-STATE COLLEGE

DEGREE IN 2 YEARS

GOLDENTONE...50% OFF

DEAL DIRECT...FACTORY PRICES... Over 60 models to choose from... 4 to 12 tubes, Portables \$8.08 up. Firm sets \$8.98 up. Car sets \$8.98 up. Foreign band sets \$8.08 up. Samples 50% off. Quantity discounts. Free 1941 Barstien catalog gives details of 10 day FREE trial agent's proposition and discounts. No obligation. Mail postcard to GOLDENTONE RADIO CO. Dept. R. N. DEARBORN, MICH.

Free Catalog

49¢

10 DAY TRIAL

YEAR GUARANTEE

RADIO-TELEVISION

Oldest, largest Radio-Television school in West training you for good pay job. Complete instruction including Radio Construction and Service, Broadcast Operating, Sound, Talking Pictures, Television, Public Address, etc. Flexible plan to meet specific needs of those with or without jobs. Transportation allowed to L. A. Barn room and board while learning. Request Free Catalog.

NATIONAL SCHOOLS Dept. RN-1
Los Angeles

amply due to the serrated bosses and stout shoulders designed into the assembly.

The 0.0133-ufd. condensers, C1 and C2, are each made up by connecting in parallel one each of 0.01, 0.003, and 0.0003 microfarads. Each of these components is an *Aerovox* type 1467 mica condenser ordered with a tolerance of two percent.

All parts are mounted firmly and the unit is wired with heavy bus bar to insure rigidity and permanence. Insulated terminal strips of the single and double types are used liberally as tie points to prevent dangling resistors and condensers. Every mounting screw and nut must be driven home with a vengeance—if the instrument is properly built, they will never be unscrewed.

Let's Calibrate

After the wiring of the instrument is completed, the main dial is installed less its celluloid cover and the a.f. meter is ready for calibration. R2 is set at approximately the middle of its range; and, assuming that calibration will be initiated at the low-frequency end of the spectrum, the ganged resistor, R4-R5 is set at maximum.

There are two ways to calibrate this instrument. The one followed will depend upon the facilities available to the builder. Either one requires the utmost of care and patience and should be undertaken only at such time as the operator has the necessary time to devote to the task and the environment necessary for concentration.

The first method, which is by far the most accurate, requires a freshly calibrated and "preheated" beat frequency audio oscillator to supply the following frequencies: 25, 30, 40, 50, 60, 75, 100, 150, 200, 250, 300, 350, 400, 450, 500, 550, 600, 650, 700, 800, 900, 1000, 1500, 2000, 2500, 3000, 3500, 4000, 4500, 5000, 5500, 6000, 6500, 7000, 8000, 9000, and 10,000 cycles per second. The audio oscillator and a suitable null detector are connected to the a.f. meter and the various frequencies, starting with 25 cycles, successively balanced out, a reference point and number being pencilled lightly on the dial at each null position. For reasons stated earlier, it is strongly recommended that the null detector used in this calibration be a vacuum-tube voltmeter. The auxiliary resistor, R2, should be adjusted as needed to provide a more definite minimum indication.

The second method consists in setting the dual potentiometer to a series of values which will satisfy the conditions for the above frequencies in the Wien bridge formula and pencilling reference points on the dial at these settings.

The various values of resistance may be determined by measuring the instantaneous resistance of either R4 or R5, since these two arms are identical or very nearly so. In order to reduce the arithmetical labor involved in this method of calibration, however, a table of resistance values corresponding to the dial frequencies is given for the reader's convenience in figure 7.

The accuracy of the first method will be dependent largely upon the accuracy with which the audio oscillator itself is calibrated and its dial set by the operator, and to a lesser extent upon the ability of the operator to recognize the exact points of minimum signal. Error due to the last condition is, of course, reduced very materially

by the use of a vacuum-tube voltmeter.

The resistance values given in figure 7 are exact calculated values given more closely than most experimenters can read them with their ohmmeters or bridges and assume that C1 and C2 are each of *exactly* 0.0133 microfarads capacitance (which may not be the case). From this it will be apparent that the accuracy of the second method of calibration will depend upon the precision with which the operator can measure resistance and the exactness to which the capacitances of C1 and C2 are known.

After the 37 calibration points have been located by either method and pencilled on the dial, the latter is removed from the potentiometer shaft and the lines and figures made permanent with black India ink. The celluloid cover is placed over the scale and the dial reassembled and replaced on the shaft. One or more frequency points may then be checked to determine if the dial has been replaced properly, any discrepancy being remediable by loosening the set screw and rotating the dial slightly to place the proper graduation opposite the pointer index.

F Cycles per Second	R Ohms
25	500,000
30	412,500
40	312,500
50	250,000
60	200,000
75	162,500
100	125,000
150	82,500
200	62,500
250	50,000
300	42,500
350	35,000
400	31,250
450	27,500
500	25,000
550	22,500
600	20,000
650	18,750
700	17,500
800	15,000
900	13,750
1,000	12,500
1,500	8,250
2,000	6,250
2,500	5,000
3,000	4,125
3,500	3,500
4,000	3,125
4,500	2,750
5,000	2,500
5,500	2,250
6,000	2,000
6,500	1,875
7,000	1,750
8,000	1,500
9,000	1,375
10,000	1,250

High Fidelity Tuner
(Continued from page 24)

power stage. This may be added if one cares to make a complete high fidelity receiver using the components illustrated. It is only necessary that the power transformer be capable of supplying the additional current drawn by the 6C6 power amplifier tube.

Construction

There is a definite order of wiring which makes for ease in assembly. First is to get all of the filament wir-

ing done, second, to mount the coils and make all connections to the radio frequency coils before placing the bypass condensers and resistors in place. These may be wired and soldered after the above procedure has taken place. We have mentioned the necessity for isolating the plate and grid leads. If this is done, no trouble should be had when the final testing is done.

The testing of the amplifier may be done simply by tuning in a station on the broadcast band toward the high frequency end, at approximately 1500 kc. The trimmer condensers which mount on each section of the three-gang variable tuning condenser are adjusted until the signal is received at maximum strength. If one has an output meter, this should be connected across the output of the tuner and the trimmers set for maximum indication on the output meter. When going through the procedure of padding, or trimming the tuner, the dial or condenser should be rocked back and forth while the adjustments are being made because sometimes a false point will be thought to be the correct one. It is a good idea to securely fasten each part before soldering is done.

It will be found that adequate output is had from the tuner for very satisfactory head-phone reception. In fact, several head-phones may be connected in parallel or in series across the output of the tuner, and plenty of volume will be had for complete enjoyment by many people. This would be particularly nice to have in a hospital ward.

Connections to the Amplifier

Most amplifiers have two inputs. One of high gain and one of low gain. The low gain input is usually designed for an impedance of approximately 50,000 ohms. This is ideal for direct connection to the tuner. The cable, or connecting leads between the tuner and the amplifier, should be shielded. This should be done with low capacity shielding so that too much capacity will not attenuate the signal to any marked degree. The distance which is allowable between the tuner and the amplifier is approximately 10 feet under these conditions. Remember that as the length of cable increases the loss also will increase, for that reason it is better to keep them as short as possible consistent with satisfactory reproduction.

As far as hum is concerned, we should not attempt to hook up the tuner to the amplifier until we are definitely sure that no hum is present at the output of the tuner. This may be tested by turning the gain control of the tuner on full and by listening to the output of the tuner in a pair of headphones. If any hum is heard, it must be removed completely before we may proceed. If any is present, this is almost a sure indication that the general layout has not been followed, or, possibly, that a defective tube is in service. Tubes should be carefully checked upon an accurate tube tester to determine their condition.

Antenna

The antenna used with a high fidelity tuner should be designed so that it presents just enough pickup from the received station so that it is satisfactorily reproduced through the tuner. In other words, it should be as short as possible. A long antenna, naturally will also pick up distant stations to-

gether with accompanying static discharges, etc. For that reason the shorter the antenna, the less will be this incoming noise, and the better will be the reception. Almost any type of conventional antenna will be satisfactory for use with this tuner and, in fact, a short piece of wire, say two or three feet long, has been found to be sufficient in most applications. At any rate, the location will determine the type of antenna to be used. If this happens to be in an apartment house where a long lead-in must be used, it would be better to use a short piece of wire on the roof and to run the lead-in through shielded cable to the tuner. This will keep out man-made interference which might be sent out by various appliances within the building or in the proximity. In other words, keep the antenna as high in the clear as is possible. The antenna should be securely tied in position, good insulation should be used, and all joints should be soldered. Never attempt to use one side of the light line as the antenna for high fidelity. It just doesn't work so well.

Cabinet

We have selected a metal cabinet. This would be representative of a tuner designed for use in the ham shack. If one is to build such a tuner for use in the living room, naturally, he would select a more suitable cabinet. Fortunately, the overall dimensions of the tuner are rather small and for that reason almost any type of construction may be used for a cabinet or suitable container. In fact, the tuner may be built into an existing radio console, either as a replacement for some receiver, or as a new addition. It is also small enough so that it may be mounted on a shelf normally designed for holding books.

It makes little difference whether or not we use wood or metal for cabinet construction. But it does matter what we use for making the baffle. The larger the baffle, the better will be the general over-all reproduction, particularly on the bass notes. Many types of speakers are available commercially which feature the so-called *bass reflex* type of baffle. These actually reinforce the low frequencies so that they are heard in all of their natural mellowness. The high frequencies are projected directly from the cone itself, and it should be so positioned that the person actually sitting in the room and listening to the program will be approximately on a line with the sound as it comes from the speaker.

One of the finest types of amplifiers to be used in conjunction with this tuner would be that described in the December, 1939, January and February, 1940, issues of RADIO NEWS. This amplifier was designed with one thought foremost in mind and that was that it be capable of giving the finest reproduction possible and it also featured separate expansion controls for both treble and bass so that the person operating the instrument actually has a definite choice as to the proper balance to enhance different types of music. For example, there are passages within certain symphonies which require a boost of high frequencies in order to bring them up to the original playing level.

GET THE ALLIED BOOK OF RADIO VALUES NOW!

IT'S NOT JUST THE BIGGEST RADIO CATALOG IT'S THE BEST!

212 PAGES **Bargain Section** **15,000 ITEMS** **FREE**



63 NEW SETS

PA. 7 TO 75 WATTS

NEW TESTERS

LATEST HAM GEAR

BUILDERS SUPPLIES

- You'll want to see the KNIGHT 1941 "Radio Hits!" 83 new models to choose from — a new "Camera" and 3-way Portables; Plastic models; World-wide sets; Farm Radios. Also new Recorders, Phono-Combinations, Phonograph Players and accessories, Auto Sets, etc. No finer radio set values anywhere! Just compare these KNIGHT "Leaders!"
- You get more for your P.A. dollar when you buy 1941 KNIGHT Sound Equipment. Never before so wide a selection, never so many fine features. 24 new Systems—7 to 75 watts — for every kind of P.A. application. Complete accessories listing. Get the details of our Easy Payment Plan and 15 Day Trial!
- You've never seen a bigger or better Service Section! Over 100 value-packed pages of new Test Equipment, tools, — more than 15,000 quality parts for servicing every make of set. Radio's best Parts Guide — Radio's Lowest Prices! Also new and bigger Bargain Section—don't miss it! See the big Fluorescent Lighting Listings!
- Amateurs — you'll find the most complete Amateur listings you've ever seen in this 1941 ALLIED Catalog! See them all—the latest communications receivers, new transmitters, all the newest gear in every leading line. Really a catalog in itself — jam-packed with Amateur values that you can't afford to miss. Time Payments, too!

Builders—Latest brand-new kits. Complete listings of the latest builders and experimenters supplies. New diagrams.

New! Radio Dictionary—Compiled by leading authorities. Gives concise definitions of all commonly used radio words and terms. Historical data, etc. Everyone in Radio should have it. Send coupon **To-10c** day—only

See our Fluorescent Listing

ALLIED RADIO

833 W. Jackson Blvd. Dept. 1-A-1 Chicago, Illinois

Send me your FREE 212-Page 1941 Catalog.

I enclose 10c for New Radio Dictionary.

Name.....

Address.....

City..... State.....

FREE

Surplus Radio Equipment Drastically Reduced for Immediate Clearance

Here's a once-in-a-lifetime opportunity to obtain that Transmitter, Receiver, P.A. System, or other radio equipment you've always wanted at a fraction of the regular price. Every item listed below was equipment intended for RADIO NEWS magazine articles.

All equipment is guaranteed as represented herein. Terms: Cash. All prices are F.O.B. Chicago. Crating, where necessary, at the expense of the buyer.

TRANSMITTERS

- The "Beer Mug" 2½M transmitter, complete, less mike, described in November, 1940, RADIO NEWS..... \$ 15.00
- AC operated 2½ or 5M transmitter, less mike, described in November, 1940, RADIO NEWS..... 17.50
- The "QRR" Rig, 18-w. input, with tubes & xtals, less mike, described in May, 1940, RADIO NEWS..... 75.00
- 5-band switching portable transmitter-receiver, new model for 10-20-80M, complete with generator & tubes, less xtals, described in June, 1939, RADIO NEWS..... 55.00
- 5-10-20-40-80-160M, 15-w. input, plug-in coils, less xtals & mike, for phone, ICW, and CW, cabinet mounted..... 50.00
- The "Unicontrol," 300-w. input, phone-cw, complete with tubes, less xtals, mike & key, bandswitching for 10-20-40-80-160M, needs some work on a power-line short, as is, described in March, 1940, RADIO NEWS, revamped for dual control & S13 final tube. Must be crated..... 175.00
- The "Private Flyer's" 12-w. output, complete with generator, less xtal & mike, usable for 80M portable from 6V Storage Battery, described in February, 1940, RADIO NEWS..... 50.00
- All-Purpose transmitter, 10-20-40-80-160M, as is, complete with RME-69 built-in, equipped with xtal and Noise Silencer, also working VOX system, built-in Meissner Signal Sifter with 80M coils, 3 power auto-transformers, 15 meters including a db and 2 voltmeters, including hand mike and switching mike-stand for rapid break-in, etc., described in August, 1939, RADIO NEWS, less xtals, DC generators (needs "cutting-up" in transmitter section—receiver is perfect). Must be crated..... 400.00

RECEIVERS

- 56MC FM-AM superhet, less tubes, power supply and cabinet, described in December, 1940, RADIO NEWS..... \$ 22.50
- 1-Howard 498 superhets complete with tubes & crystals, less cabinets, for AC operation only..... 20.00
- Infinite detector tuner, no amplifier, complete with tubes, less speaker, described in January, 1941, RADIO NEWS..... 12.00
- RME-69 with xtal in perfect condition, used very little, receiver & speaker in one grey cabinet..... 125.00
- Full-Range, complete with tubes and meter, less mike and speaker, with RCA record player, as described in the January, 1940, issue of RADIO NEWS..... \$115.00

MISCELLANEOUS

- Collins pi network, built in lab with 2 Johnson condensers, will handle up to 1 kw. Chassis mounted..... \$ 15.00
- General Radio, Model 377B audio frequency generator, in working condition, including two Weston MA meters & 1 GE meter..... 25.00
- Assorted mica condensers, fixed, tested, in lots of 10, each lot. No sorting, no breaking of lots..... each lot .35
- Assorted resistors, 1-w size & up, tested in lots of 10, each lot. No sorting, no breaking of lots..... each lot .35
- Assorted electrolytics & paper condensers, tested, in lots of 5. No sorting, no breaking of lots..... each lot .45
- RME Special directional RMP, cost new \$95.00 with biasing network..... 50.00
- Visual frequency meter, tells when you are on frequency, described in February, 1939, RADIO NEWS..... 9.00
- WE telephone handset, fair condition..... 2.00
- 1 SPST 115V AC relay, large contacts, fair condition..... 1.50
- 1 DPDT Antenna relay, bakelite insulation, for 115V AC operation..... 2.00
- Assorted potentiometers, tested, in fair condition, in lots of 2 each lot. No sorting, no breaking of lots. Most pots suitable for audio work..... each lot .45
- Assorted sockets, insulantite, bakelite, fair condition, in lots of 3, no sorting, no breaking of lots..... each lot .25

RADIO NEWS

ENGINEERING DEPT.

608 S. Dearborn St., Chicago, Ill.

Cuttings

(Continued from page 24)

of cutting all record blanks up to and including the 12" size, and some of them include the 13¼" master size. They are available in dual-speed types so that records may be cut at slow speed (33⅓ r.p.m.) for approximately 15 minutes playing time per side, cutting 120 grooves-per-inch on a 13¼" disc.

From the above comparison, we see that a greater flexibility is provided by the Semi-Professional type of recorder as more playing time is available and a better quality recording may be made. Then too—the microphone supplied with the Semi-Professional recorder is usually of better quality and is capable of better fidelity. The difference in selling price varies. Most Home Recorders sell within the range of from \$50.00 to \$85.00, while the Semi-Professional types fall in the class from \$100.00 to \$250.00 complete with accessories.

Several home recorders are available that include a built-in radio tuner. These come in handy for making records of ones favorite radio program. As a rule, the Semi-Professional type does not include a tuner, it being better to have this in a separate case so that vibration set up by the recording mechanism will not effect the performance of the tubes in the tuner that might be subject to microphonic's. In conclusion we may sum up the basic difference between the two types as follows: More expenditure must be made for the Semi-Professional Recorder, less for the Home Recorder. Far better results may, as a rule, be expected from the former with respect to overall fidelity, flexibility, and in accuracy. The life of the unit should be greater, and the trade-in value higher, the same as with any other commodity. —30—

Mikes—Heads—Pickups

(Continued from page 30)

having a standard speed of 78 r.p.m. is used, we find that a 6" record has a one minute duration, an 8" record has 2¼ minutes duration, a 10" record has 3½ minutes duration, and a 12" record has 5½ minutes duration. Practically all home recorders are designed to cut all size discs up to and including 10 inches at 100 lines (grooves per inch). —30—

Ham Defense Portable

(Continued from page 15)

for 115 volt a.c. operation into the power supply chassis. Turn on the a.c. and observe whether or not the tubes light. Close the "B" supply by means of the change-over switch and resonate the condensers and load the antenna in the normal fashion. Do this for each band, noting the position of the condensers by the numbering on the dial at the culmination of each test. The normal current to the final amplifier should be 40 milliamperes. As the transmitter is placed on each of the 'phone bands, and the antenna is loaded, tests should be made with the microphone to determine whether or not modulation is present and if in the proper direction, either up or down. Downward modulation would indicate that the oscillator might not be working, or that some fault lies in the speech amplifier section. Since the speech amplifier is actually the modulator check should be made at the transformer connections and at the sliding resistor R5. It is from the cathode resistor of the 6V6 that the microphone obtains its current and voltage, and this should not exceed 2 to 3 volts. Continue testing the trans-

mitter on all bands with 115 volts a.c., making note of the condenser settings as each band is completed and as progress is made.

Having completed the test of the transmitter with 115 volt a.c., the 6 volt plug is inserted into the power supply chassis and a connection is made to a 6 volt storage battery. Repeat the same test with the transmitter for each and every band, noting the modulation, and the output at the antenna by means of a neon tube. There should be no difference between the 115 volt a.c. operation and the 6 volt d.c. operation if the construction hints laid down here are followed.

There are some who may question the advisability of cutting down with the 115 volt a.c. power line input to 300 volts d.c. at the plates of the 6V6 and the 6L6, but if they will consider the insulation problem, which would be aggravated by raising this voltage to four or even five hundred volts, they will see the wisdom of restraining the transmitter power to 300 volts. At this voltage, tube components and parts run extremely cold and no trouble should be experienced.

When the transmitter has been completely tested, both for 6 volt operation and 115 volt a.c. operation, a combination receiver and transmitter test should be conducted. Proceed as follows:

Picking a certain band, listen on the receiver in that band for signals, then, throwing the receiver off by means of a change-over switch ascertain by means of a wavemeter whether or not the transmitter is on the proper frequency and determine by use of the microphone whether or not modulation is upward. If the constructor has been careful in the layout, design, wiring and testing of the unit, he will find that the rig will work perfectly.

Conclusion

It is not claimed that this little transmitter-receiver is the very best which could be built under the circumstances, nor is it claimed that this unit is extraordinary either in its application, or its construction; but it is claimed that were the amateurs in general to build up several thousand of these units, Uncle Sam's Army, Navy and Marine Corps might be beneficiaries should an emergency arise.

Provision for a long wire antenna has been made in the rear of the transmitter-receiver unit by inserting a feed-through insulator to which this wire may be attached. Just how long the antenna should be for each band is hard to say since no experiments along this line were carried out. However, that much wire as can be loaded to 50 mils. in the final can be added with a corresponding increase in the range of the transmitter. This increase in range due to the better antenna will also be apparent in the receiver, since the receiver will also be using the longer antenna. A combination of the vertical collapsible antenna and a long wire antenna is also possible and is a system currently in use in many of the airplane installations.

For those who may build this unit and should like to test it in the field, it is to be remembered that the new F.C.C. regulations permit the testing of such a unit in the field from 6 volt storage battery operation, but prohibits such testing from 115 volts a.c. lines. It is only necessary to notify the Radio Inspector of your intention

to test. Such notification should be in writing addressed to the nearest Inspector's office of your district and should state the place and the time, and band on which you expect to operate. Operation is restricted to Saturdays and Sundays only.

In a recent test conducted at Lockport Airport, with former W9USB, specially licensed station for the Third American Open Soaring Contest, 160 meter 'phone contacts proved themselves extremely valuable and extremely reliable with antennae ranging in size from 28" to 32". While this is not the normal size of antenna for use with this band, nevertheless, it will be found that these small antennae and low power give excellent point-to-point contacts where great DX is not desired.

In the final analysis, it may be said that while the price of the receiver as purchased from the manufacturer is slightly higher than the ordinary portable job of its kind, still the benefits obtained by purchasing a receiver which can be used on the operating table for excellent communications work is not to be minimized. The transmitter itself is inexpensive to construct and possesses "rock-like" stability in operation. The quality has been reported as being excellent for communication purposes; and all in all the unit makes an excellent all around QRR and a ham's National Defense Portable Rig.

-50-

See important announcement next page.

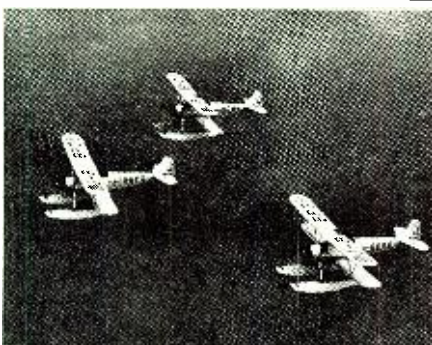

How Strong is the Japanese Air Force?

How many planes has the Japanese army and navy at their command? How does the quality of these ships compare with the planes of other major powers? What effect has the 3½-year bombardment of China had on Japan's air force? Do Japanese pilots understand the tactics of massed aerial warfare on the World War II model? Read Leonard Engel's timely and revealing article about the 1940 Japanese air force! It's exclusive in the big

JANUARY ISSUE

FLYING AND POPULAR AVIATION

NOW ON SALE AT ALL NEWSSTANDS—25¢

Television Oscilloscope

(Continued from page 30)

filter will sometimes increase this voltage.

In operating the receiver, it is well to turn the internal oscillator to the lowest possible frequency to keep it from interfering with the picture.

The front end of the receiver can be any of the many circuits described to date. It may consist of three or four wide band i-f stages using any of the television transformers now on the market and 6AC7 or 6AB7 tubes, a 6H6 second detector, 6AC7 first detector and 6J5 oscillator. For distant reception, an r-f stage can be added. Aside from the tubes and transformers used, this part of the receiver is very much like a sound broadcast receiver.

The sound part of the program can be received either on a separate receiver or taken off the first detector output by a separate i-f system. Circuits for doing this have been published before and will not be discussed in detail here.

-50-

Jobs Are Where You Find Them!

(Continued from page 7)

from the Great Lakes to the Gulf, including the Mississippi River. Most of these stations are part of the Bell Telephone System, so that if you do not live within close proximity to their main office it would be wise to write to them: American Telephone and Telegraph Company, Marine Division, John Street, New York City, New York. Also write to the Southern California Bell Telephone Co., Los Angeles, California; Donnelley Radio Telephone Company, Mackinac Island, Michigan; Diamond State Telephone Company, Wilmington, Delaware, and the Lorraine Telephone Company in Ohio, which owns most of the stations around the Great Lakes area. The main requirements for these positions are: youth (not over 30); schooling (the higher the better) and your tickets. These jobs pay well and are not only yours for life, but are pensioned as well.

In connection with the telephone harbor stations is the comparatively new field of installation, repair and maintenance for transceivers for the small craft which operate with these stations. A licensed operator of second class ticket or better is necessary to do this work as well as any adjustments which may be necessary. Here is a field which has not been exploited to any great extent so that the possibilities are good for an opening. The list of companies which are actively engaged in this field can be obtained from some of the boat publications.

Then, of course, we have the marine field. I suppose everyone is familiar with this setup, but does everyone know that ninety percent of the ships are covered by union regulations and also that the "beach" in the various ports has many first class ticket men with years of experience waiting for a billet? The Neutrality Law has dras-

LEARN

RADIO AND

EARN

REAL MONEY

I. C. S. Radio Courses, Studied at Home, Prepare You for Part Time or Full Time Radio Jobs!

• Golden opportunities are ripe on the tree of Radio—waiting to be picked by *properly trained men!* Radio jobbers and dealers—manufacturers—broadcasting stations—airlines—public address systems—all require men whose background includes *sound, modern training!*

A recent article in *Radio News* says the U. S. Army and other armed forces need 100,000 radio and communications men!

Yet you don't have to give up your present job to prepare for the splendid opportunities Radio offers! A few hours of your leisure time each day—in the comfort of your own home—spent studying an I. C. S. Radio Course—and you'll soon be qualified to earn real money in this "field of the future"!

It's a *thrilling adventure* to master the mysteries of Radio the I. C. S. way! And the cost is surprisingly low!

YOUR CHOICE OF 5 COURSES! Radio men today must have thorough knowledge and understanding of electrical principles, principles of electronics, radio communication, vacuum-tubes, construction, operating, testing, and other fundamentals. This is the foundation on which *specialized training* is built.

For those who wish to secure broad, comprehensive training, I. C. S. offers a General Radio Course and a Radio Operating Course. The I. C. S. Practical Radio Servicing Course makes it possible for you to begin to practice soon after you start studying—*earn as you learn!* The Sound Technician's Course is an advanced course for the service technician. The Sound-Picture Projectionist's Course deals with operation, maintenance and repair of sound equipment such as is used in talking-picture installations. All these courses include FM and Television.

One of these I. C. S. Radio Courses, or a combination, may fit you for bigger earnings than you ever dreamed possible! Before you turn another page—

MAIL THIS COUPON TODAY FOR A BRIGHTER TOMORROW!

INTERNATIONAL CORRESPONDENCE SCHOOLS - 1891★1941 -

Box 8283-V, Scranton, Penna.

Explain fully about your course in the subject marked X:

GENERAL RADIO
 RADIO OPERATING
 PRACTICAL SERVICING
 SOUND TECHNICIAN
 SOUND-PICTURE PROJECTIONIST

Name.....Age.....

Address.....

City.....State.....

tically cut down the number of jobs available so that a newcomer has very little chance here. The tuna fishing boats and the cod fishing fleets are likewise unionized to a great extent, but a few private yachts are still floating around wherein a second class ticket might be able to get a look-see. But here, too, the chances are very slim. The RMCA and the MacKay Telegraph should be contacted for these latter billets. The same goes for the Point to Point stations of the RCA, Mackay, Federal, Globe, etc., which are fairly well union organized. But if you still wish to try them, go to it. A knowledge of teletype and simplex machines for these positions would be quite a help.

In closing we would like to bring

RADIO COURSES
Mid-Term Classes Now Starting

RADIO OPERATING—BROADCASTING
● RADIO SERVICING—a practical course
● RADIO AMATEUR CODE ● TELEVISION
● ELECTRONICS—1 yr. day course, 2 yrs. eve.
Day and Evening Classes. Booklet Upon Request.

New York Y. M. C. A. Schools
7 W. 63rd St. New York City

OTHER MEN have read and profited by our free books "Patent Protection" and "Selling Invention." Fully explain many interesting points to inventors and illustrate important mechanical principles. With books we also send free "Evidence of Invention" form. Reasonable fees, deferred payments, forty-three years' experience. Write to: Victor J. Evans & Co., Registered Patent Attorneys, 428-A, Victor Building, Washington, D. C.

PATENT YOUR IDEA

special attention to bear on the experimental television stations where knowledge in this new and untried field is but a matter of schooling and practical application. If you are lucky enough to be hired for any position with a television experimental station or laboratory, you've really got something that has unlimited future possibilities. There is the case brought to mind of the blacksmith who, when seeing the first automobile go by his open door, was heard to remark, "They won't work," and he went back to shoeing a horse. Don't you make the same mistake.

So good luck to you all. Pick out the spot you'd like to make your life's work and keep sending out applications. Just remember the old saying, "If you keep plugging, you'll click."

Video Reporter (Continued from page 42)

And, until the program directors know the types of programs they want on regular schedules, there is little chance that they would desire to recruit—no less contract—television talent on a commercial basis.

The watchword to would-be television entertainers is a literal "look before you leap." Make sure there is such a thing as profitable television before expecting to make personal profits out of it.

MOST pleasant news to television fans in the New York area was the resumption on Election Day of the RCA-NBC television transmissions on the old 441-line standard. This meant that receiver screens, long darkened, were once again useful on

the old standards, not yet necessitating altering of the home models to the increased number of lines due to follow. But it was very apparent that the transmissions of W2XBS would remain on a strictly experimental plane until the FCC sanctions wider commercial application.

NBC is going to town in a promotional way on its plans for a television station in Washington, D. C.

There are reports that, stirred by the attention given the CBS color television demonstrations, NBC will spring a surprise by introducing an RCA color method in the New York area at an early date. It is reported that RCA has demonstrated color privately but didn't consider it just right for public eyes up to this time.

JOHAN F. ROYAL, formerly NBC vice-president in charge of programs, has been named vice-president "in charge of new activities and developments in broadcasting." That's a long title and an impressive one. And inasmuch as the appointment places him in charge of television among other things, it's quite likely that his name will figure prominently in future television news originating from New York.

In his many years as NBC program chief, Royal made a world-recognized name for himself. He is credited with many program innovations and frequently toured the Americas and Europe on NBC program business. His name in the television ranks adds prestige to an already important art.

Speaker & Mike Placement

(Continued from page 20)

between mike and piano is about 7 feet.

The uni-directional dynamic mikes are perfect for this application and their use is recommended, or at least given a try. The center mike should

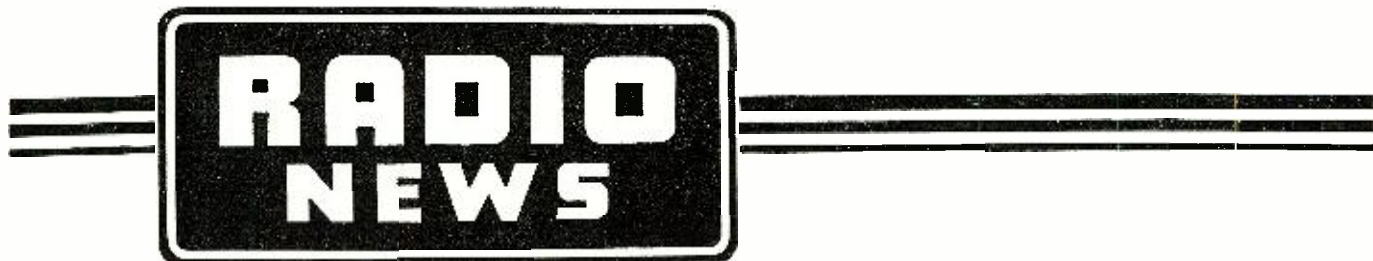

Announces an **IMPORTANT CHANGE**

In keeping with its enviable policy of bringing the latest radio news first, RADIO NEWS is proud to announce another new service for its readers. Beginning with the next issue the on-sale date will be advanced to the 25th* of the month. This new on-sale date enables RADIO NEWS to keep you more nearly abreast of National Radio Defense and other timely and important phases of radio.

FEBRUARY ISSUE ON SALE AT ALL NEWSSTANDS JANUARY 25th

*In the event that the 25th falls on a Saturday or holiday the on-sale date will be on the 24th.

be readily adjustable so that variations in height of a soloist may be compensated for. It will help if a circle can be marked off on the floor of the stage with white chalk to designate the proper position for the soloists to maintain during a performance. This will help to eliminate any sudden spurts of volume from entering close to the microphone.

Ball Park Installations

Here is a project for the experienced sound man. Many difficulties will be encountered in reaching every scattered seat within the average park unless a complete survey is made to determine which speakers, or combination of speakers, will give the greatest possible coverage at low distortion and without unnecessary blasting. A typical setup is shown in Fig. 8. Note that the speakers are all located near the far center corner of the park and that these are of the large trumpet type. They must be capable of handling large volume levels and have characteristics that will give plenty of directional effect. Some parks will require additional speakers located in remote corners of the stands where a balcony or some other obstruction might prevent sounds coming from the main speakers to reach the audience. One of the major manufacturers of loud speakers should be consulted as to the proper type and capabilities for any particular setup. Inasmuch as a long time lag will be had from the loudspeakers to the grandstand, it is important to keep the group of speaker trumpets close together so that the sounds will have to travel for approximately the same distance.

The announcers microphone is usually located near the home dugout. This may be equipped with a plug so that it may be removed when not needed in service. The microphone jack must be mounted within some sort of a box to keep it out of the weather and to prevent corrosion. Likewise, the speakers must be waterproof and all connecting cable be made from lead-coated wire, or run in conduit.

Conclusion

While the above examples are typical of but a few, nevertheless they will serve to illustrate the procedure used in mike and speaker placement for many similar applications. —30—

Ringling the Bell

(Continued from page 31)

"get by" until the job is done right, you, no doubt, have performed a worthy service to your customer. However, lend him another set in place of the one he is using and nine times out of ten he will appreciate it more. Also, in the first case, the repair seems trifling. In the second case, an impression is left in the customer's mind that his set needs repair *badly* and *cannot be used until fixed*. It's easier to collect, the second way.

Thus, we find that, by and large, it is good policy to make replacements of parts rather than repairs. Writing from experience, we state that return

trips on receivers are costly and every means possible should be taken to avoid them. They are bad financially and psychologically. They create a feeling of doubt in the customer's mind as to the ability of the serviceman.

Don't "hope the old part will get by." Replace it and ring the bell on another successful service job.

THERE is another condition which may or may not be present in other localities. This is the "jimmied" set. A customer sends a radio to a serv-

iceman for estimate. The estimate is refused because it is too high. The set is returned to the customer and later sent to another serviceman who finds one of several things has happened:

1. The adjustment trimmers have all been screwed down tight.
2. A wire has been unsoldered and resoldered in such a way as to make its detection difficult and the consequent repair a tedious and time-wasting one.
3. Ditto No. 2 except that a wire has been cut or broken in such a man-

Home Recorder FREE!



SELF-STARTING ELECTRIC-PHONO

MAKE RECORDS AT HOME

FACTORY-TO-YOU SAVES UP TO 50%

15-TUBE

MIDWEST

RADIO-PHONO COMBINATION

with FREQUENCY MODULATION and TELEVISION ADAPTATION



PUSH-OUT OF TUNING

30 DAYS TRIAL

PUT THIS RADIO-PHONO CHASSIS IN YOUR PRESENT CABINET

EASY TERMS

15-TUBE TILT-FRONT



CABINET MODEL

RADIO-PHONO COMBINATION

\$29.95

COMPLETE

MIDWEST RADIO CORPORATION
DEPT. 11-FF CINCINNATI, OHIO

THRILLING WORLD-WIDE FOREIGN NEWS DIRECT!

UP TO \$25. TRADE-IN ON YOUR OLD RADIO OR CHASSIS (On Many Models up to 18 Tubes)

YOU'LL enjoy listening to fine recordings on this new type electric phonograph, and you'll be delighted with this amazing, ocean spanning radio. Make your own records on the Home Recorder (sent FREE for a limited time) with this Radio-Phono Combination. Big FREE catalog pictures many beautiful 1941 factory-to-you radio chassis and console values—from 6 to 18 tubes—up to 5 bands—including automatic record-changing, radio-phonograph, home recorder etc. Get our LIBERAL TRADE IN PLAN, and 30 day home trial offer. Write for FREE catalog today.

ONLY

\$22.50

COMPLETE RADIO-PHONO CHASSIS with TUBES and SPEAKER

HOME RECORDER FREE

USER AGENTS WANTED



★

NOW YOU CAN BUY THESE BETTER

AUTO RADIO VIBRATORS AT NO PREMIUM IN PRICE

Now—you need pay no premium to replace with the best. These new lower prices on James Vibrapowr units are made possible through increased manufacturing facilities—as well as an ever increasing sales volume. In design—in engineering and in their many exclusive features, they stand head and shoulders above the field.

DeLuxe Push-pull non-synchronous James Vibrapowr units, formerly \$3.95 list are now \$2.95 list. Standard Units formerly listing at \$2.95 are now \$2.25. The Push-pull synchronous type lists at \$4.95. The Universal unit that serves over 80% of replacement calls lists at only \$1.75. There is a James Vibrapowr unit to meet every replacement requirement. Write for specification sheets.

AT ALL GOOD JOBBERS • LITERATURE ON REQUEST
JAMES VIBRAPOWR CO., INC., CHICAGO, ILL.

EASY TO LEARN CODE

It is easy to learn or increase speed with an Instructograph Code Teacher. Affords the quickest and most practical method yet developed. Available tapes from beginner's alphabet to typical messages on all subjects. Speed range 5 to 40 WPM. Always ready—no QRM.

MACHINES FOR RENT OR SALE
The Instructograph Code Teacher literally takes the place of an operator-instructor and enables anyone to learn and master code without further assistance. Thousands have used and endorse the Instructograph System. Write today for full particulars and convenient payment and rental plans.



INSTRUCTOGRAPH COMPANY

Dept. NR. 4701 Sheridan Rd., Chicago, Ill.
Representatives for Canada
Radio College of Canada, 54 Bloor St. West., Toronto.

RADIO ENGINEERING,

broadcasting, aviation and police radio, servicing, marine radio telegraphy and telephony, Morse telegraphy and railway accounting taught thoroughly. 48 weeks' Engineering course equivalent to 3 years of college radio work. All expenses low. Catalog free. School established 1874. Dodge's Institute, Oak St., Valparaiso, Ind.

RADIO TECHNOLOGY

RCA Institutes offer an intensive course of high standard embracing all phases of Radio and Television. Practical training with modern equipment at New York and Chicago schools. Also specialized courses in Aviation Communications, Radio Servicing and Commercial Operating. Catalog Dept. RN-41.

RCA INSTITUTES, Inc.

A Radio Corporation of America Service
75 Varick St., New York 1154 Merchandise Mart, Chicago

Classified

Rate 15c per word. Minimum, 10 words.

CORRESPONDENCE COURSES

AMATEUR Radio licenses, training in code and theory. Resident and home study courses. Hundreds of licensed students. American Radio Institute, 1123 Broadway, New York.

USED Correspondence Courses and Educational Books sold or rented. Inexpensive. Money-back guarantee. Write for Free Catalog listing 4000 bargains. (Courses Bought.) Lee Mountain, Pisgah, Alabama.

CORRESPONDENCE courses and educational books, slightly used. Sold, Rented, Exchanged. All subjects. Satisfaction guaranteed. Cash paid for used courses. Complete details and bargain catalog free. Nelson Company, 500 Sherman, Dept. A-237, Chicago.

PATENT ATTORNEYS

PATENTS—Advice and booklet free. Highest references. Best results. Promptness assured. Watson E. Coleman. Patent Lawyer, 724 9th Street, Washington, D. C.

PATENT Your Idea—Simple inventions often valuable. Two advisory books—free. Victor J. Evans & Co., 429-A Victor Building, Washington, D. C.

INVENTORS—Before disclosing your invention to any one send for Form "Evidence of Conception"; "Schedule of Government and Attorneys' Fees" and instructions. Sent free. Lancaster, Allwine & Rommel, 414 Bowen Building, Washington, D. C.

INVENTORS—Don't delay. Protect your idea with a Patent. Secure "Patent Guide"—Free. Write Clarence A. O'Brien, Registered Patent Attorney, 1A17 Adams Building, Washington, D. C.

RADIO ENGINEERING

RADIO Engineering, broadcasting, aviation and police radio, servicing, marine and Morse telegraphy taught thoroughly. All expenses low. Catalog free. Dodge's Institute, Elm St., Valparaiso, Ind.

RADIO

WE buy and sell used radio testing equipment. Harold Davis, Inc., Jackson, Miss.

RADIO Kits—\$3.95 up. Single band; all wave. 5-10 tubes. Fluorescent lighting. Save 50%. Radio-parts catalog—FREE. McGee Radio, P-2076, K. C. Mo.

PHOTO FINISHING

ROLLS DEVELOPED, two prints each and two free enlargement coupons, 25c, reprints, 2c each; 100 or more, 1c. Summers Studio, Unionville, Mo.

ner that the insulation appears O.K., or a piece of spaghetti is placed over the break.

4. Wires have been cut indiscriminately in such a manner that to make the set play again would require the tracing of every wire in the set.

5. Removing a coupling condenser in an "off-brand" set.

It hasn't happened to you? Well, the writer can personally verify every one of the above as actual experiences.

What can be done to stop this petty "sabotage"? Nothing that the writer knows except directing some very dark and ominous thought-waves toward the so-called serviceman. My personal thoughts along this line are unprintable. (Of course, signal tracing is the only answer. —50—)

Aviation Radio

(Continued from page 27)

it must be dropped in such a manner so as to rest in the normal operating position. The set is usually operated while this test is being conducted if cable connections or facilities can be provided which will allow operation. Connections which are unstable will usually show up under this inspection, and "mal-construction" will also be apparent.

The vibration test is performed with the equipment under test being mounted in normal operating position. Different frequencies of vibration are used, varying from 30 to 150 cycles per second, and the equipment is operated and visually inspected while under this test. If resonant vibration is apparent in one of the parts which may affect the operation of the set by this vibration, it must either be replaced or relocated. However, a part which will not affect the operating characteristics by vibrating resonantly, need not be replaced, unless it is evidenced that the part may fail later due to peculiar mechanical characteristics which are subject to such vibration.

Tests involving the operation of the apparatus under various temperatures under different conditions of input power are made. The temperatures employed vary from a -40°C. to a +55°C. While these tests are being made, the set's performance must not drop below the allowable minimum.

Pressure tests are made of the equipment in a pressure chamber, wherein the pressure is varied between 8.52" to 31". These tests are made to determine whether or not high altitude will affect the normal operation of the set.

The humidity test is conducted in such a manner so as to disclose defects in manufactured parts which may be subject to humidity, which in turn would lead to corrosion. The equipment is subjected to a humidity of not less than 95% for approximately 48 hours at temperatures varying from a minus/plus 3 degrees to 50° Centigrade. Immediately, or within a ten minute period, (time for connections to power supply, etc.) the apparatus is operated for two hours with normal voltage applied. An inspection is then made for corrosion which is detrimental to good connections and parts which are capacitive or resistive in nature.

The last of the seven tests is the "orientation test." It is performed by mounting the apparatus first, to a rotatable test stand which may be "fixed" for angle mounting. The equipment is then operated for fifteen minutes in each of the eight positions assumed at the 45 and 90 degree angles.

Upon completion of the tests outlined above, the set is usually flight tested. However, if the apparatus in question passes the tests given, it is usually awarded the CAA's Type Certificate.

One can readily appreciate the fact that most aircraft radio equipment is subjected to various conditions which vary with the type of aircraft, and the climate of the territory in which the aircraft is flown. Because of the thoroughness of the CAA specified tests, the buyer of aircraft radio equipment with CAA certification is assured of good dependable equipment.

Technical Review

(Continued from page 42)

considers every common type of speech, including radio and round table. No important psychological problem affecting public speaking has been overlooked, but explanation and advice have been economically restricted to what is actually useful and stimulating. Important features include: A chapter on voice, which discusses the elements of quality, force, pitch, and timing, and contains many corrective exercises and plenty of passages for reading aloud. Full reprints of ten thoughtful, entertaining speeches and a lively round table discussion, each with a pointed and helpful introduction analyzing the speaker's problem and his methods in handling it. Hundreds of live topics and titles for speeches, many of them suggested by the illustrated material. Professor Hoffman is author of the highly successful Public Speakers Scrapbook and co-author of Write and Speak Better. Price \$2.75. *Whittlesey House, McGraw Hill Book Co., Inc., 330 W. 42nd St., N. Y. C.*

Servicemen's Legal Advice

(Continued from page 34)

order be set aside in whole or in part. **Sale of Property for Non-Payment of Taxes**
The provisions of this section shall apply when any taxes or assessments, whether general or special, falling due during the period of military service in respect to real property owned and occupied for dwelling, agricultural, or business purposes by a person in military service or his dependents at the commencement of his period of military service and still so occupied by his dependents or employees are not paid.

When any person in military service, or any person in his behalf, shall file with the collector of taxes, or other officer whose duty it is to enforce the collection of taxes or assessments, an affidavit showing (a) that a tax or assessment has been assessed upon property which is the subject of this section, (b) that such tax or assessment is unpaid, and (c) that by reason of such military service the ability of such person to pay such tax or assessment is materially affected, no sale of such property shall be made to enforce the collection of such tax or assessment, or any proceeding or action for such purpose commenced, except upon leave of court granted upon an application made therefor by such collector or other officer. The court thereupon may stay such proceedings or such sale, as provided in this Act, for a period extending not more than six months after the termination of the period of military service of such person.

When by law such property may be sold or forfeited to enforce the collection of such tax or assessment, such person in military service shall have the right to redeem or commence an action to redeem such property, at any time not later than six months after the termination of such service, but in no case later than six months after the date when this Act ceases to be in force; but this shall not be taken to shorten any period, now or hereafter provided by the laws of any State or Territory for such redemption.

Whenever any tax or assessment shall not be paid when due, such tax or assessment due and unpaid shall bear interest until paid at the rate of 6 per centum per annum, and no other penalty or interest shall be incurred by reason of such nonpayment. Any lien for such unpaid taxes or assessment shall also include such interest thereon.

The Secretary of War, the Secretary of the Navy, and the Secretary of the Treasury shall make provision in such manner as each may deem appropriate for his respective department, to insure the giving of notice to



AS THE COMET FADES

Symbolic of dread portent, Cunningham's Comet now sweeps the sky. Before it fades the fate of the world may be decided. For in the time between now and next March Britain will gain the strength to stop Hitler, or Hitler will crush her.

If Britain falls our turn is next.

Make the comet a fateful portent for Hitler—not for us!

Send Britain every available plane, gun, tank and ship which we can spare.

Use your influence in these ways:

1. Wire the President.
2. Write your Senators and Congressmen.

Urge them to send all possible aid to England NOW!

The Committee To Defend America By Aiding The Allies

William Allen White,
National Chairman

8 West 40th Street, New York, N. Y.



persons in the military service under their respective jurisdictions, of the benefits accorded by this section and the action made necessary to claim those benefits in each case.

Deferment of Collection of Income Taxes
The collection from any person in the military service of any tax on the income of such person, whether falling due prior to or during his period of military service, shall be deferred for a period extending not more than six months after the termination of his period of military service if such person's ability to pay such tax is materially impaired by reason of such service. No interest on any amount of tax, collection of which is deferred for any period under this section, and no penalty for nonpayment of such amount during such period, shall accrue for such period of deferment by reason of such nonpayment. The running of any statute of limitations against the collection of such tax by distraint or otherwise shall be suspended for the period of military service of any individual the collection of whose tax is deferred under this section, and for an additional period of nine months beginning with the day following the period of military service.

-50-

Serviceman's Experiences (Continued from page 18)

plied, "if you'd spent as much of your life here as I have!"
"Don't get fresh," she said, glancing at my toolbag. "You're not supposed to bring luggage into the passenger elevator, you know!"

From six, I was snatched to the basement. The janitor stepped into the car.

"Where ya goin'?" he asked, running his finger up and down the row of buttons.

"Never mind," I replied bitterly, "I'll walk!"

To tell the truth, I ran. I was getting a bit worried about that Brunswick. Just as I arrived on the fourth floor, the janitor stepped out of the car, and stood in the hall, slowly shaking his head.

I rang the 4B bell. A scowling woman answered the door.

"Radio man," I panted.
"Too late," she declared, "I've got someone else!"

The door slammed. There was one job I sure hated to lose to Redoubtable Radio Repairs, Inc.—our closest competitors.

I walked past the janitor into the elevator car.

"Are you," I suggested, as evilly as the spider to the fly, "going down?"

"Never mind," he replied, backing away warily, "I'll walk!"

My spirits fell with the car. What was I to tell Al?

"I lost the job," I confessed as soon as I got back to the shop, "but it wasn't my fault. If that—"

"Before you begin lying or apologizing," Al cut in, "go take a look at the chassis on the workbench."

It was a Brunswick 31—upside down, and playing!

"I knew," he explained pleasantly, "that you were going to stall when you left here, so I answered the call myself. In order to save time, I used the freight elevator—it's not as dignified, but it's not as crowded, either. Perhaps you were right when you resented my snappy orders—but that was no excuse for wasting a customer's time."

"I'm sorry, Al," I said, surprised by his mild manner. "I'll take it back right away—in record time!"

SPRAYBERRY TRAINS YOU
for **GOOD PAY!**
STEADY WORK!
ADVANCEMENT!
in **RADIO and TELEVISION**

DON'T WAIT! START NOW!

You Can Make Money Almost At Once
You'll be quickly shown how to get and do neighborhood Radio Service jobs — for practice and profits. You easily learn Television, Frequency Modulation, Signal Tracing, Mobile Radio (Auto-Tanks), Aviation Radio, Electronics, Facsimile Radio, Radio Set Repair and Installation Work. I'll Prepare You Quickly In Spare Time

At Home Or At Camp
SPRAYBERRY Training does not interfere with your present work. You will receive personal coaching service all the way. You'll be fitted to hold down a good paying job in Radio or to have a Radio business of your own.
You Get Professional Test Equipment
... Plus Experimental Outfits
... Includes 146 RADIO PARTS (to build complete Radio Receiver), RADIO TOOLS and a TESTER-ANALYZER. MY EXPERIMENTAL OUTFITS enable you to conduct actual experiments with your own hands.

NO EXPERIENCE NEEDED
It makes no difference what your education has been. You can fit you to become a real RADIO TECHNICIAN. Your success is my full responsibility.

THE SPRAYBERRY COURSE IS SOLD UNDER MONEY-BACK AGREEMENT

RUSH COUPON for BIG FREE BOOK

SPRAYBERRY ACADEMY OF RADIO
F. Sprayberry, President
425-A University Place, N. W.
Washington, D. C.

Please rush my FREE copy of "HOW TO MAKE MONEY IN RADIO."

Name..... Age.....
Address.....
City..... State.....
(Mail in envelope or paste coupon on penny postcard)

FREE! NEW 1941
PROFIT GUIDE
Everything in
RADIO!

Complete Selections... Guaranteed Quality

Replacement Parts
Everything you need in exact duplicate or universal replacement or repair parts. Tubes, condensers, resistors, transformers, hardware, tools, etc. Leading brands.

Latest Radio Sets
A model for every purse and purpose. Auto Sets, Midgets, Battery Portables, Table Models, Consoles, Phone-Radio and recorder combinations—for operation on AC or DC.

Public Address Equipment
A complete line of amplifiers, microphones, baffles, recording equipment and accessories for every type of installation—permanent, portable and mobile, from 5 to 100 watts.

Newest Electric Appliances
Extra profits for you! Standard Brand Electric Irons, Grills, Toasters, Percolators, Waftie Irons, Vacuum Cleaners, Clocks, Mixers and many others, all at lowest prices.

YOU SAVE MONEY AT RADOLEK

MAIL THIS COUPON TODAY

The RADOLEK CO.
601 W. Randolph St., Chicago, Dept. B-49
Send the New 1941 Radio Profit Guide FREE.

Name.....
Address..... Dealer?
Experimenter?... Serviceman?... Amateur?.....



Here are two recent additions to the Hyvol line, to meet higher-voltage requirements such as in cathode-ray tube supplies, by-pass circuits in transmitters, high-powered rectifiers and P-A systems, etc. ● Type 12 (left) offers advantages of high-voltage terminals but requires less space due to new bakelite top with separator ribs. ● Type 14 (right) has one-piece molded bakelite pillar insulator top for maximum insulation between live terminal and grounded can. ● Both are immersion proof. Both with adjustable mounting ring.

Type 12—2 1/4" dia. Can					
Can Height in Inches					
Mfd.	2000 v.	3000 v.	4000 v.	6000 v.	7500 v.
.01	3 1/4	3 1/4
.02	2 3/4	3 3/4
.03	...	2 1/4	2 3/4	3 3/4	4 3/4
.05	...	2 1/4	3 3/4	4 3/4	...
.1	...	3 3/4	5 1/4
.25	...	3 3/4
.5	3 3/4	5 1/4
1.0	5 1/4
2.0

Type 14—1 3/8" dia. Can		
3000 v. D.C. Working		
Mfd.	Height in Inches	
.01	2 1/4	
.05	2 1/4	
.1	2 3/4	

Ask Your Jobber . . .

Ask him about those COMMERCIAL-GRADE transmitting capacitors now made available to amateurs by Aerovox. Tell him what you are building or altering, and he will show you these better-grade components in our latest engineering data.



"Never mind," he replied. "Mrs. Brandon was only in a hurry for us to get there, not for the set. We have three days to work on it. Once a customer is shown some quick service, he's usually willing to wait for a delayed delivery. But remember—when you get the next hurry call, get there fast. If you *must* waste time, do it on the way back—after you've got your grip-pers on the set!"

I was plenty ashamed, so I promised. Gee, it's good to have a partner you can depend on!

-30-

Manufacturers' Literature

(Continued from page 44)

the radio field because, even though prepared by a radio parts manufacturer, they are manuals in every respect. All information is presented in a manner appreciated by the beginner as well as the "old timer". It is unbiased in its presentation and all components used were chosen for their availability as well as practicability. This enables the customer to readily purchase component parts. Each transmitter and amplifier is completely presented on two pages. Technical specifications and a general description of the apparatus are shown, followed by a complete circuit diagram with important voltage and current values indicated. The values of all component parts are listed. Also the necessary accessories required to place the equipment in operation. The Hamanual contains 48 pages, measures 8 1/2 x 11", and sells for 15 cents a copy. Standard Transformer Corporation, Chicago, Ill. (RADIO NEWS No. 1-100.)

JENSEN DATA SHEET No. 119. Published by the Jensen Radio Manufacturing Co., Chicago, Ill. Several of the new Jensen speakers are described in this new sheet. Among them are the type "J" Dual Speakers of the PM class. They are designed for extreme high-fidelity reproduction up to as high as 15,000 cycles. Many bass-reflex speakers are described and illustrated. These are available in many models and at various prices. Other units include the new 12" Extended range speakers and the new 8" units. A copy of this data sheet may be obtained from the Jensen Radio Manufacturing Co., 6601 S. Laramie Ave. (RADIO NEWS No. 1-106.)

-30-

Use this coupon for catalogs

RADIO NEWS, Catalog Dept.
608 S. Dearborn Street, Chicago, Ill.

Please send me the literature I have checked below. If there is any charge I have enclosed the money.

...1-100 ...1-101 ...1-102 ...1-103
...1-104 ...1-105 ...1-106

Name

P. O. Address

PRINTED IN U. S. A.

SERVICEMAN'S CASE HISTORIES

Reprinted with permission, from **RADIO Trouble Shooters Handbook**. Copyright, 1939, Radio & Technical Publishing Co. Copyright in Canada and Great Britain, and all countries subscribing to the Berne Convention, by Radio & Technical Publishing Co. All rights reserved.

GENERAL ELECTRIC 18

Hum1) faulty antenna condenser

GENERAL ELECTRIC 40 (Auto Radio)

Noisy after ...1) "ground" the rubber-mounted standard "suppression" preventors have been installed
triangular plate of the tuning control sheath to the side of the chassis with a short piece of "bonding" braid

GENERAL ELECTRIC 51-R

Same Case Histories as those listed for Radiola 80

GENERAL ELECTRIC 63, 65

Intermittent re-1) broken small ceramic bushing on the band switch (one band only)
These bushings are held in place by pressure, and are easily replaced

GENERAL ELECTRIC 75

Fading1) faulty volume control

GENERAL ELECTRIC 78

Inoperative ...1) lack of plate voltage on the '56 driver tubes, caused by a faulty 1,100-ohm bias resistor connected from the cathodes of these tubes to the chassis.

GENERAL ELECTRIC 80

Fading1) faulty AVC tube

GENERAL ELECTRIC 86

Noises like ...1) condenser in "Sentry box" under 6AS tube "shorted." static but station cannot be tuned in
Unsolder all leads on Sentry box, remove front dial screws, lift up dial assembly, pull out band shaft, remove front section of sentry box from bottom

GENERAL ELECTRIC 105

Weak1) replace the 5Z4 rectifier (no Colorama tuning)

Calibration "off" 1) check AFC, 6J7 and 5Z4 tubes before adjusting trimmer condensers

Transformer ...1) loosen transformer bolts and insert strips of cardboard between transformer and chassis; tighten bolts

2) connect a 500-ohm 10-watt resistor in series with center-tap of power transformer

GENERAL ELECTRIC 109

Intermittent re-1) open-circuiting or open-circuited 0.1-mfd. audio coupling condenser
Inoperative ...1) corroded contact segments at dio or phono reception

Fading1) open-circuited 0.05-mfd. r-f. first detector and i-f secondary-return by-pass condensers

Weak reception, Station hiss, Poor control of volume, Distortion at resonance, Noisy tuning, Oscillation, Motorboating between stations

1) leaky 0.05-mfd. r-f. first detector and i-f secondary return by-pass condensers

2) corroded condenser-gang rotor contacts. Bond rotor to chassis with flexible pigtails

3) remove meter and decrease tension upon pivot of meter needle

GENERAL ELECTRIC 118

Continual frying 1) induction from a-c transformer leads running under volume control at either minimum or maximum setting
noise with volume control at either minimum or maximum setting

GENERAL ELECTRIC 125

Fading, ...1) open-circuited 0.1-mfd. r-f. first detector and i-f secondary-return by-pass condensers

Station hiss, Fading, ...1) snapped tabs on oscillator series condenser

Dial settings incorrect, Poor control of volume, ...1) leaky 0.1-mfd. r-f. first detector and i-f secondary return by-pass condensers

These 3 GHIRARDI Books are TOPS in RADIO!

2 Great Money-Makers for SERVICE MEN

MODERN Radio SERVICING

Learn Servicing by High-Speed "FACTORY METHODS"

This inexpensive, big 1300-page book gives you the complete famous Ghirardi training course in practical radio service work. The only book in the world that teaches you everything you need to know right in your own home—easily, and in your spare time.

THEORY FROM A TO Z

- **Test Equipment**—First, a thorough 420-page course in Test Instruments—Theory, Descriptions, Diagrams of all Commercial Instruments, How They Work, Construction Data, etc.
- **Trouble-Shooting**—Next, all newest short-cut factory methods for Trouble-shooting and Testing all makes of radio sets (and electronic equipment)—explained clearly and step-by-step.
- **Repairing**—Then how to Align and Adjust receivers; how to Repair or Replace faulty parts. "Factory" methods explained fully.
- **Business Promotion**—Finally, how to Manage, Promote and Advertise a radio service shop for greatest profits.

MODERN RADIO SERVICING brings you an illustrated gold mine of servicing knowledge—all based on practical servicing experience! 720 Self-Examination Review Questions check every step of your progress. Order yours now—costs you only \$4 to learn radio service work this EASY way! Money back if not satisfied!

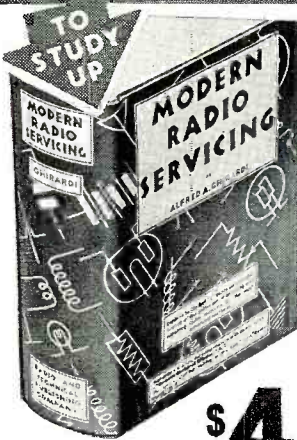

1300 PAGES
706 Illustrations
720 Review Questions
766 Topics

\$4

-and RADIO Trouble Shooters HANDBOOK

Save Servicing Time with this Practical "FLASH DATA"

Regardless of what radio set you are called upon to repair, this new "Ghirardi" Handbook is guaranteed to save you Time. Chock full of factory-checked "bench data" that will speed up every service job you do. That means More Money for you!

518 BIG 8 1/2 x 11 PAGES—134 ILLUS., DRAWINGS, CHARTS, TABLES—GIVE VITAL INFORMATION ON:

Time-Saving Trouble Case Histories for 3,313 receivers—I-F Peaks for 15,000 Superhets—Trouble-Shooting Charts—Auto Radio Gear Ratios—Auto Radio Installation, Servicing, Interference Suppression Charts—Servicing Sound Recorders and Intercommunicators—Condenser & Resistor Charts—Grid Bias Resistors—Color Codes—Wire Tables—Coils—Transformers—Formulas—Calculations—Decibel Charts—Tube Charts—Dial Lamps—Ballast Resistors—Filters—Trade Directories—and dozens of other detailed subjects.

The only book of its kind! Contains the greatest mass of practical working service data ever assembled in one book. A servicing gold mine! Used daily by thousands of service shops. Order yours now—Money back if not satisfied.

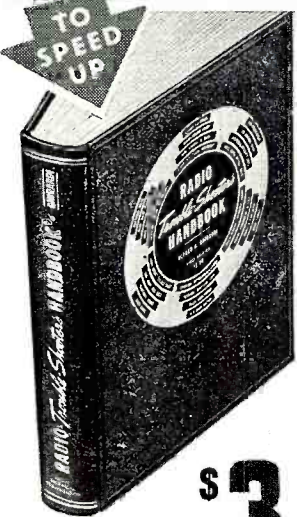

518 PAGES
134 Illustrations
Standard Manual Size
(8 1/2 x 11) Fabrikoid-bound

\$3

\$6.50 USE THEM 5 DAYS—our risk for BOTH BOOKS TOGETHER

Radio & Technical Publ. Co., Dept. RN-11
45 Astor Place, New York.

Enclosed find payment for, and rush to me postpaid with 5-Day Money-Back Guarantee:

- MODERN RADIO SERVICING at \$4. (\$4.50 foreign)
- RADIO TROUBLE-SHOOTER'S HANDBOOK at \$3. (\$3.50 foreign)
- BOTH BOOKS AT \$6.50 Special Money-Saving Combination Price. (\$7 foreign)

NAME
ADDRESS
CITY STATE
 Please send me FREE descriptive literature about both books.

FREE Circular on request



MY BIG BOOK WILL GIVE YOU A COMPLETE TRAINING FOR RADIO IN SHORT ORDER — AND ALL FOR ONLY \$4 !!

A Fascinating Career Lies Before You — LET ME HELP YOU GET STARTED NOW!

NOW — at last — you can get your start in Radio... you can prepare for a good-paying radio job, without expensive schooling or lengthy study. Here in one inexpensive volume is a complete Radio Education for you—everything clearly explained and illustrated—right from basic electrical theory up through television—36 different chapter-sections in all, condensed into 1 easy-reading, home-training book.

It's all here — The Complete Ghirardi Course—in 1 Handy Volume

Radio Physics Course is a miracle of condensation. It's really 36 different instruction courses covering the vast field of Radio all packed into 1 big book of nearly a thousand illustrated pages. Step by step, Ghirardi takes you rapidly from the very first principles of Sound and Electricity up through the very newest things in Radio, Television, and Cathode-Ray Tubes. He explains all the essentials—everything you need for a complete knowledge of modern radio fundamentals!

YOU LEARN AT HOME —Ghirardi TRAINS YOU Quickly!

Sit in your easy chair and let Ghirardi train you for whatever type of radio work you want to do. It's as simple as that! Just spend a few minutes a day of your spare time reading this fascinating book. No previous study or experience necessary—no "math"! You teach yourself—checking your progress with the 856 self-testing Review Questions.

CLEAR EXPLANATIONS— EASY AS A. B. C.

It's absolutely amazing the way Ghirardi's simple explanations, supplemented by over 500 diagrams, drawings and photos, make every phase of Radio clear and easy to understand. Never before has it been possible to master the basic fundamentals of Radio so easily, so quickly, so economically.

TELEVISION MADE EASY, TOO!

The Television section is a whole course in itself! And as for Sound Engineering, you get up-to-date instruction in Public-address Systems, Sound Recording, Phonograph Pickups, Sound Motion Pictures, etc., etc. It's the same with Photographic Cells and Cathode-Ray Tubes—each of these specialized sciences a career in itself. Yes, you get all this in addition to the basic training in Electricity and Radio—everything you want—all right here!

USED IN ARMY AND NAVY SCHOOLS The U. S. Army and Navy use this very same book for their radio training courses. It's used, too, by civil aviation schools and radio schools everywhere use it more than any other radio text published. Ghirardi's course is TOPS!

YOU SAVE MONEY!

You'd have to pay many times four dollars to cover the same ground in any other course—and even then you'd never duplicate "Ghirardi's" clear explanation. Think of it—for only \$4 you get it all—all 36 sections—the whole background of Radio and its allied sciences—everything in one big book. Send for your copy TODAY! Rush the coupon to us at once!

972 PAGES
508 ILLUS.



Only \$4.00 No Further Payments

Its 972 Pages give you a Thorough Course in the Fundamentals of SOUND, ELECTRICITY, RADIO, TELEVISION, CATHODE-RAY TUBES, Etc.

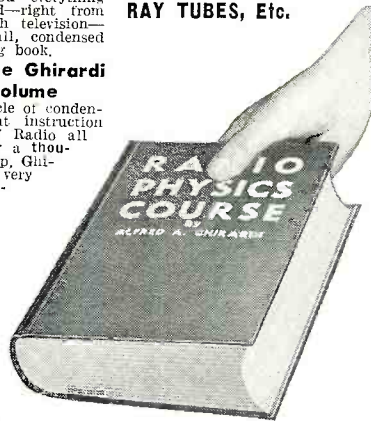

36 VOLUMES IN ONE!

1. Radio Broadcasting System
2. Sound, Speech, Music
3. Electron Theory; Electric Current
4. Electrical Units; Ohm's Law; Resistance
5. Electrical Circuits. Batteries
6. Magnetism
7. Electro-magnetism
8. Electromagnetic Induction
9. Inductance; Condensers
10. Capacitance; Condensers
11. Alternating Current Circuits
12. Electric Filters
13. Measuring Instruments
14. Radio Waves
15. Broadcasting
16. Receiving
17. Vacuum Tube Principles
18. Vacuum Tube Characteristics
19. Vacuum Tube Construction
20. Vacuum Tube Detector and Amplifier Action
21. Radio Frequency Amplification
22. Superheterodyne Receivers
23. Radio Frequency Amplifiers; Tuning Coils
24. Audio Amplifiers
25. Speakers
26. Battery Operated Receivers
27. Power Supply Units
28. Electric Receivers
29. Automobile and Aërial Radio
30. Phonograph Pickups; Public Address Systems
31. Short-Wave Reception
32. Phototube Cells; Cathode-Ray Tubes
33. Television
34. Antennas and Grounds
35. Testing; Servicing
36. Sound Motion Pictures

RADIO & TECHNICAL PUBLISHING CO.,
45 Astor Place, New York, Dept. RN-11

Enclosed find \$4 (\$4.50 foreign) for my copy of Ghirardi's "RADIO PHYSICS COURSE" with your 5-day Money-Back Guarantee.

NAME
ADDRESS
CITY STATE
 Please send me free illustrated literature describing Ghirardi's "RADIO PHYSICS COURSE."

USE IT 5 DAYS -OUR RISK Money-Back Guarantee

THE BEST SELLING

Quality

COMMUNICATIONS RECEIVERS

SX-28

CHECK all these improved Hallicrafter features! 15 tubes—6 bands—Frequency range 550 kc. to 42 mc.—Two stages preselection—Electrical bandspread on ALL BANDS including international short wave band—Calibrated bandspread inertia controlled—Micrometer scale tuning inertia controlled—Beat frequency oscillator—AF gain—RF gain—Crystal phasing—Adjustable noise limiter—Send-receive switch—80, 40, 20 and 10 meter amateur bands calibrated—

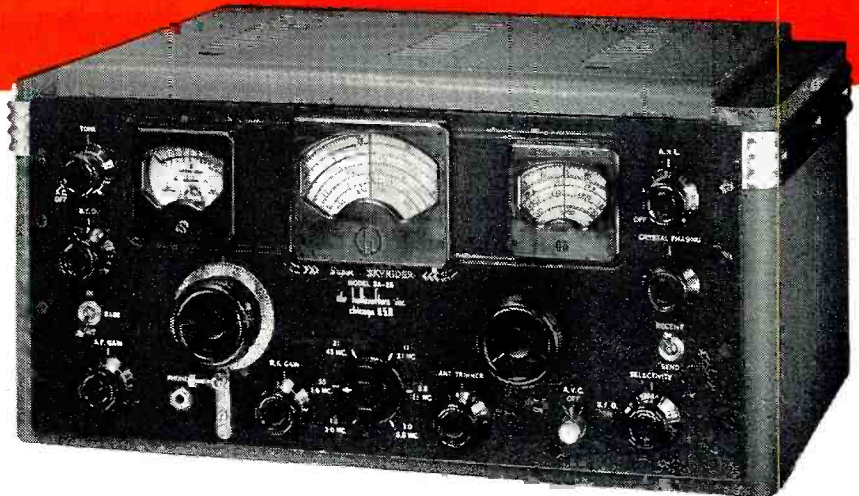

Band pass audio filter—Improved signal to image and noise ratio—Push-pull high fidelity, audio output—Phone jack. Dimensions 20½" x 10" x 14¾". Model SX-28 with crystal and tubes.....\$159.50

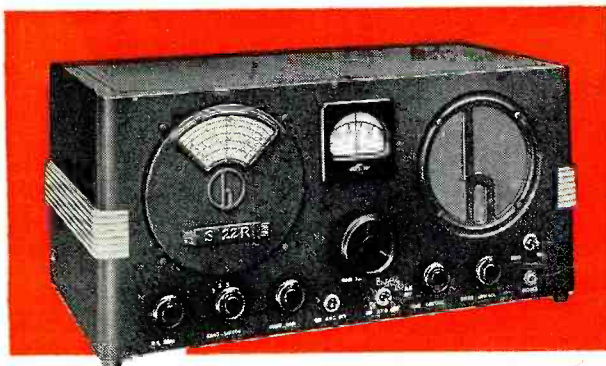

The S-22R

Designed by Hallicrafter engineers for service in the range from 16.2 to 2150 meters (18.5 mc. to 110 kc.). Directly calibrated main tuning dial. Efficient mechanical bandspread with separate dial provides easy logging. 110 volt AC-DC operation. (Operates from 6 volt battery supply with addition of No. 301 Electronic Converter.) Dimensions 18½" x 9¼" x 8½". Model S-22R.....\$64.50

The S-29 Communications Portable Receiver



Hallicrafter's Universal Portable Receiver—take it with you—use it at home. Operates on either 110 volts AC or DC or from self-contained batteries. Tunes from 542 kc. to 30.5 mc. (553 to 9.85 meters). Self contained antenna. One stage preselection on all bands. Electrical bandspredding. Model S-29\$59.50

Newark Electric Company

323 W. Madison St., Dept. RN, Chicago, Ill.

Please rush literature—I am interested in Model.....

Name

Address

City State.....

NEWARK

Electric Company

323 W. MADISON ST.
Dept. RN CHICAGO, ILL.