

RADIO NEWS

SEPTEMBER
1940
25c
In Canada 30c



**UNCLE SAM NEEDS
100,000
RADIOMEN**

NATIONAL DEFENSE

New 56mc Mobile Transmitter ★ Bafus

Build Your Own Recc

AMATEUR DIVISION

DAVEGA CITY RADIO

No. C 63 Cortlandt
N. Y. CITY

Davega, World's largest retail radio organization, stocks more communications receivers than any other radio retailer. The Davega name has been associated with radio since its infancy and Davega has been in business for over sixty years. No other radio organization has such a record and so many satisfied customers.

SMASHING LOW PRICE!

McMURDO SILVER 15-17

New r.f. amplifier equalizes gain at all wave lengths and provides in single stage, selectivity and gain heretofore available only in best two stage r.f. amplifiers. Four bands. Special Jensen-Silver 15" Giant electro-dynamic speaker. 30 to 8000 cycles. Heavy welded one piece chassis, 20" by 12 3/4".

MCMURDO SILVER MASTERPIECE VI—Reg. Price \$355.

Regular Price \$205.00

SALE PRICE

\$99.50

You Save \$105.50

Sale Price \$184.50

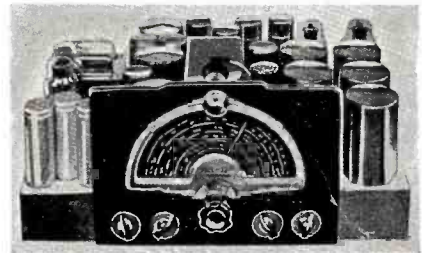

LATEST HALLICRAFTER TRIUMPH



Model S.X.28. 15 tubes, 2 R.F. stages, calibrated bandspread, high fidelity, high image rejection.

\$159.50

LATEST R.C.A. MODEL A.R. 77

Dual R.F. alignment, negative feedback, variable selectivity, new type dial.



\$139.50

LATEST R.M.E. ACHIEVEMENT

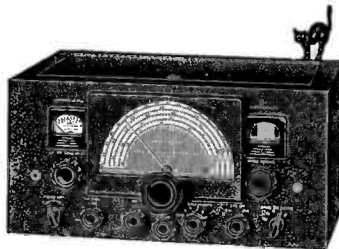

Model 99. New bandspread, R.M.E. dial, ceramic band switching, solid chassis, new type crystal.

\$137.40

NEW HALLICRAFTER

UNIVERSAL S-29

SKY TRAVELER

553-9.85 Meters

A.C.-D.C. battery operation, self charging unit built in. Self contained antenna, electrical bandspread.



\$59.50

THE NEW WONDERBOX



Model E.C. 1

6 tubes, A.C.-D.C. self contained speaker, three bands, direct calibration, headphone jack, beat oscillator.

\$19.95

HALLICRAFTER S.20R

R.F. stage. 2 I.F. stages, 9 tubes, noise limiter, bandspread.

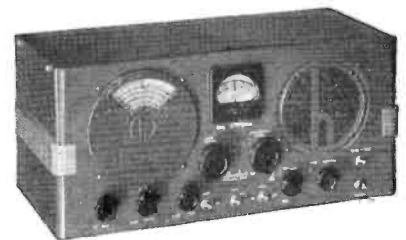

\$49.50

USED RECEIVER VALUES

Hammarlund Pro	\$ 29.00
Hallcrafter S.9	24.50
Hallcrafter S.11	39.00
National F.B.7	10.00
Hammarlund Super Pro	110.00
Hammarlund H.Q.120	110.00
Hallcrafter S.X.23	65.00



RECEIVERS

We stock the
corders and

DAVEGA

AMATEUR DIVISION, 63 CORTLANDT ST., NEW YORK, N. Y.

"World's Largest Retail Radio Dealer"



BY THE EDITOR

WE have just completed a trip which took us about 3000 miles throughout the East. We visited the manufacturers, the stores and Washington, D.C. What we saw was interesting. Consider first the manufacturers. In spite of the slight decrease in orders from the stores dealing exclusively in ham-gear, we found manufacturers whose sole outlet was to the hams, doing a land-office business . . . for Uncle Sam! Some plants were operating on two shifts, and others while not placing more employees on the job, were so far in arrears of their orders on hand, that they had work to do for quite a time to come. In most places of manufacture we found a fine spirit of co-operation with the Government, and an optimism that speaks well for the American Way of Doing Things.

* * *

WASHINGTON was a mad-house. We have never seen such hustle, such bustle and such activity. While the first glance seemed to make out the place as helter-skelter, we soon found out that everyone knew their business and was going about it in a most intense and quiet manner. The Army Building is crowded with new arrivals from outlying Army Posts to assist in the welter of new work that has sprung up with the National Defense Plans going into effect. We were courteously treated, given ample opportunity to talk to whomever we needed, but were quietly and quickly shunted out as soon as the interview was over. There is no wasted time in Washington, and one gets the feeling that if there were 48 hours in a day instead of the customary 24, there would still not be enough time for everything to be done.

* * *

MOST alert of all the departments having to do with Communications are the Federal Communications Commission and the Federal Bureau of Investigation. The latter will shortly be engaged in sorting out and filing over 100,000 fingerprints of radiops. The FCC is busy promulgating new and tighter rules looking towards the stamping out of 5th Column and Subversive Element activities. They are not fooling down there in Washington, and the results, we are sure, will be to make this country, for one, well prepared and ready for whatever may come. Incidentally, there is very little politics being played in Washington wherever the matter of National De-

(Continued on page 62)

RADIO NEWS

Trade-Mark Registered

Including Articles on POPULAR TELEVISION

The Magazine for the radio amateur
experimenter, serviceman & dealer

VOL. 24, NO. 3

Contents for September, 1940

FEATURES

- An Editorial on National Defense** William B. Ziff **5**
Uncle Sam Needs Radiomen! Charles E. Chapel **6**
 The first of a series on our Government's Communications Schools.
National Defense Net Alfred Toombs **9**
 The U. S. A. will have a defense network of hams—built by the NYA.
Installation and Maintenance of Modern Aircraft Radio
 Charles J. Schauers **10**
 Part I of two; timely and instructive for any serviceman patriotic.
Simple Audio Oscillator R. K. Wheeler **13**
 Calibrated against a piano, this unit will help the service-PA man.
A New 56MC Mobile Installation
 Karl A. Kopetzky, W9QEA & Oliver Read, W9ETI **14**
 Meeting the new regulations with superior mobile equipment.
Improved T.R.F. Receiver Paul Popenoe, Jr. **17**
 An extremely sensitive, yet simple trf receiver to build.
As I See It! John F. Rider **18**
 Hind-sight on the Factory Service Charge; foresight on instruction.
Build Your Own Recording Studio Oliver Read, W9ETI **19**
 The first of a series on how to get into this hobby seriously.
Washington Communication **21**
 A new department devoted entirely to what goes on in radio at the Capitol.
The All-Star Jr. As a 3-Band Exciter Paul V. Trice, W8QHS **27**
 Rebuilding an old stand-by receiver into a modern exciter.
Portable Tester James R. Blundin **28**
 A unique instrument incorporating four units in one case.
The "Servistat" Rufus P. Turner, WIAY **35**
 An old instrument in a new setting—and a new term.
Mikes, Heads, Pickups **37**
 A new department devoted to recording accessories.

Cover Picture Courtesy of United States Army Air Corps.
(The radio code class at Randolph Field, Texas.)

DEPARTMENTS

- | | | |
|---|------------------------------|--|
| Book Review 34 | QRD? 34 | Serviceman's Experi-
ences 22 |
| What's New in Radio . . 30 | Bench Notes 23 | Serviceman's Cases . . . 42 |
| Radio Physics Course . . 48 | Manufacturer's Literature 44 | The Video Reporter . . . 29 |
| Hamchatter 38 | For Immediate Release . 33 | The Money Page 41 |
| Servicemen's Legal
Advice 26 | Cuttings 24 | Ringling the Bell 25 |
| | Utility Radio 16 | |

Copyright, 1940

ZIFF-DAVIS PUBLISHING COMPANY

Member of the Audit Bureau of Circulations

RADIO NEWS is published monthly by the Ziff-Davis Publishing Company at 608 S. Dearborn St., Chicago, Ill., William B. Ziff, Publisher; B. G. Davis, Editor; J. Fred Henry, Vice-president; Karl A. Kopetzky, W9QEA, Managing Editor; Oliver Read, W9ETI, Technical Editor; Herman R. Bollen, Art Director; John H. Reardon, Circulation Director; S. L. Cahn, Advertising Manager. New York Office, 381 Fourth Ave. Subscription \$1.50 per year; single copies, 25 cents; foreign postage \$1.00 per year additional except Canada. Entered as second class matter March 9, 1938, at the Post Office, Chicago, Illinois, under the Act of March 3, 1879. Contributors should retain a copy of contributions. All submitted material must contain return postage. Contributions will be handled with reasonable care, but this magazine assumes no responsibility for their safety. Accepted material is subject to whatever adaptations, and revisions, including "by-line" changes, necessary to meet requirements. Payment will be made at our current rates upon acceptance and, unless otherwise specified by contributor, all photographs and drawings will be considered as constituting a part of the manuscript in making payment.

HARVEY OFFERS TIME PAYMENTS LIBERAL TRADES—Accepts Cameras in Trade on Any Ham Receiver

3 NEW COMMUNICATIONS RECEIVERS

2 by hallicrafters plus the new

Echophone
COMMERCIAL

1941 SUPER SKYRIDER—a deluxe 6-band (540 kc-43 mc) 14-tube communications receiver with 2 stages of preselection, high fidelity push-pull audio, band pass audio filter, new crystal filter, noise limiter, relay rack size front panel, etc. Complete with crystal and tubes. (Shown at right)... \$159.50 net.



PORTABLE COMMUNICATIONS RECEIVER operates on 110 volt AC or DC or from self-contained batteries. Covers 542 kc to 30.5 mc on 4 bands. Built-in collapsible antenna extends to 3 feet. Battery life prolonged through self-contained charging circuit. Automatic noise limiter, electrical bandspread, built-in speaker, etc. \$59.50 net.



ECHOPHONE COMMERCIAL new 6-tube AC/DC communications receiver sells for only \$19.95. 3 bands (545 kc to 30.5 mc) Electrical bandspread. Beat frequency oscillator. Automatic volume control. Self-contained speaker. Headphone jack. Calibrated dial with various channel services marked. Complete only. (Shown at right)... \$19.95

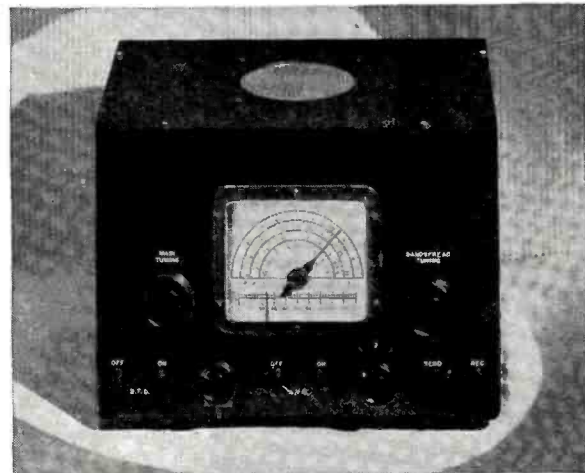

W21JL W2LJA W2KWY

OUR *Best* VALUE IS OUR RECORD OF LOYAL SERVICE

CABLE ADDRESS "HARADIO"

HARVEY
Radio Company of New York

103 WEST 43rd STREET • NEW YORK, N. Y.

AMERICA *must prepare* NOW!

IT HAS BECOME increasingly clear to those who have eyes with which to see, that America is facing the gravest emergency in her history. It is also clear that the steps now being taken to prepare our country against this emergency are shockingly inadequate.

WE FACE A combination of powerful enemies in both Europe and Asia, who control between them military establishments of the most fantastic proportions ever contemplated in this world. Hungry and predatory, they are ruled by an acknowledged dream of world conquest. Their hatred and contempt for us and our system of life is implacable and unbounded. Also, the greatest booty in the world is to be found here in the rich and unprotected United States.

AMERICANS HAVE only one course to pursue; they must organize immediately with every resource in their power to meet the shattering attack soon to be made on them, or, by being strong, avert it. The half-way measures now employed and contemplated are far from sufficient. Unless we are to suffer the fate of France and China, we must immediately organize to take summary action against the traitors within our gates, and must arm to the teeth to discourage attack from abroad. We should demand universal military conscription. We should take over immediately all the islands in the Caribbean which may have a bearing on our national defense. We should do these things now.

LET US NOT be entangled in glib catch-phrases which belong to a dead era, or be lulled into insecurity by the agents of foreign powers in whose interest it is to keep America helpless and weak. Modern war is swift and complete. It can only be fought with trained men and machines, not hoarded dollars or beautifully expressed social definitions. Its onslaught can no more be resisted by antiquated weapons than the bows and arrows of the Indians could stop the coming of the white man. Smug talk of our industrial greatness as indicating a capacity to turn out the sinews of modern war within a matter of weeks or months, so as to be able to repel a determined invader, is so much mischie-

vous nonsense. Read the speech of our American Chief of Staff, General George Marshall, to the Senate on April 30th. He states that "we have not manufactured a big gun for many years," and that it would take two and a half years to manufacture an ordinary 16-inch gun and carriage. To revamp our industrial establishment to turn out anti-aircraft and anti-tank guns, as well as a formidable air and tank corps, will take a period of years, even under the best organization. Neither can an adequate military and naval reserve be established over-night. Modern war demands expert organization and intensive training of men.

ALL OF THIS must be taken out of the hands of the politicians and placed in the custody of competent men who should be given full authority to act swiftly and energetically. If we do not immediately take every step in such a preparation program with vigor and iron will, our rich nation is inviting attack and despoliation.

SUCH A COURSE will demand a certain amount of sacrifice from all. It will involve huge expenditures, which will have to be paid for by the American people in the form of extra taxes; it may involve a violation of our present wage and hour definitions. It represents a profound change in our way of life and in our thinking; but it is urgently required if we are to save our institutions from ruin.

THE WRECKAGE OF France and China and the imminent disaster threatening Britain are living examples of the folly of any other course than that of complete armed preparedness.

LET US NOT wait until we are attacked. We must act fully and competently now, while there is yet time. Impress this on the minds of all public officials as being the will of the nation, and it will be done . . . Write, wire or phone your congressman or senators.

WILLIAM B. ZIFF

William B. Ziff
 Publisher

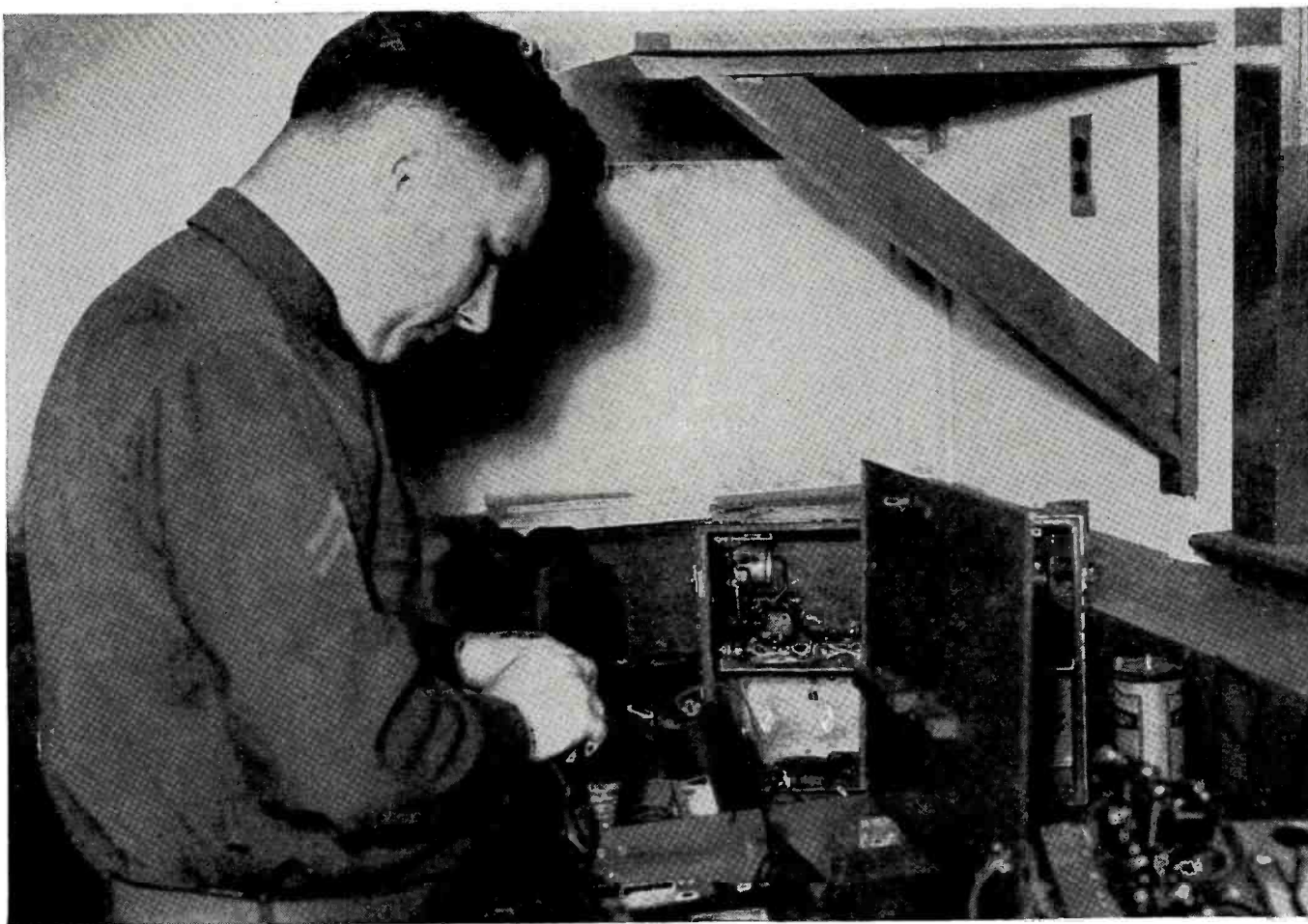

Included in the training of the Signal Corps men is work on field radio sets.

UNCLE SAM NEEDS RADIOMEN!

by **CHARLES E. CHAPEL, 1st Lt., U.S.M.C. Ret.**

San Leandro, California

The Army trains fine radiomen; and not the least of their training is their grasp of the International Radio Code.

EVERY day the newspapers have small items that the U. S. Army is enlisting men. Among those needed are the communications staff. Normally these are the personnel of the Signal Corps. It is said that over a 100,000 radio and communications men are sought by the government armed services. This is the first of a series dealing with the military communications schools and military radio. Particularly it deals with the learning of the code. Many an ordinary soldier can be transformed into a radio man with at least sufficient knowledge to operate a receiver if he can take code at reasonable speed. The care and maintenance of radio equipment will be treated later.

LEARNING the Code was our biggest hurdle back in the days of spark-coils and loose-couplers, and it is still a headache to many "hams" who operate radio-telephones and regard the code as a necessary evil on the road to an operator's license. This code "bogey" can be conquered easily and effectively if you follow the procedure used at the United States Army Signal Corps School, at Fort Monmouth, New Jersey.

The Army Signal Corps School teaches the beginner the 36-code characters (26 letters and 10 numerals) in six steps, each step embracing a group of six characters. The groping of these characters is this:

Group 1. DH89XZ	Group 4. WESMAU
Group 2. 6OYLJ2	Group 5. VR1FRI
Group 3. 7O34K5	Group 6. BNGQCP

Beginning with Group 1, the student hears in his receivers the character "D" sent five times in succession, enough space being allowed between the sending of code sounds to enable him to identify and print the character correctly and repeat it mentally to himself. Then, the character "H" is sent five times, followed by the other characters of Group 1 in the same manner.

When the six characters of Group 1 have been sent to the student several times in the regular order, they are

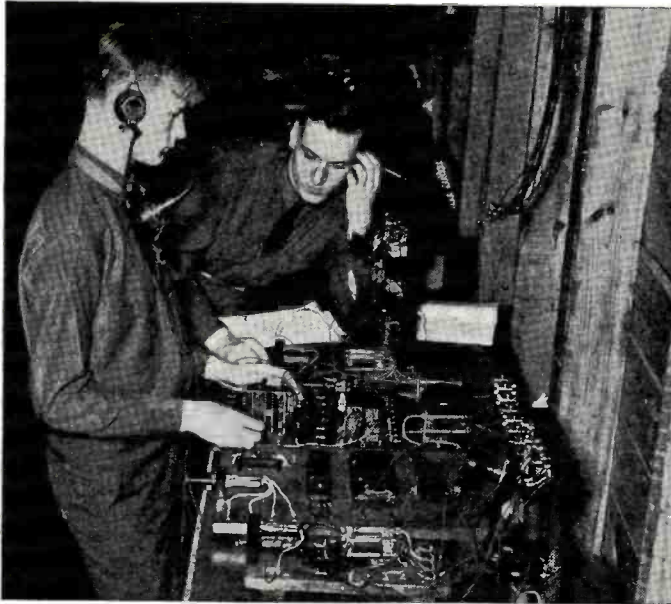

These men are learning about more complicated telephones.



Teletypewriters, and automatic code machines are studied.

then sent to him in random order and he tries to recognize and print the various characters. Since the reception of the first group in random order is in the nature of a test, he must thoroughly master the first group before he can proceed to Group 2.

The second group is learned in the same manner as the first, but the beginner now has 12 characters which he must recognize when sent in random order before he goes on to Group 3. This cumulative process of reviewing past groups is continued until all six groups have been mastered, when the student can then say that he really knows the code and is ready for acquiring more speed in reception.

An important feature of this Army system is that the dots, dashes, and spaces are made of the same length in sending each character, their duration being that which comes at a transmission speed of 20 words per minute. This means that each character is heard so quickly that the student has no time to analyze it into its component dots and dashes; instead, he must learn to recognize the code sound of the character as a whole.

The result of this method is that the same code sound is maintained throughout a student's training until he reaches a speed higher than 20 words per minute. Any other method means that the beginner must relearn or modify his previous learning of code sounds each time he advances to a higher code speed.

Although each character is made at a 20-word per minute rate, the transmission to beginners is actually 25 characters or 5 words per minute. The character itself always remains the same up to the time when the operator can receive faster than 20 words per minute; any increase in speed is obtained by simply reducing the time interval between the characters.

Veteran operators will remember that back in the spark-coil days we tried to "beat the game" by short-cut

methods of learning the code. One of these methods was to learn first the dot-letters, EISH, and then the dash-letters, TMO, following these by the dot-dash-letter, AUV, and the dash-dot-letters, NDB. That gave us one-half of the alphabet and many of us then learned the other 13 letters by opposites, like G and W, or R and K. The numerals were easy, as they obviously are to this day, for they follow a regular order, but in spite of our short-cut methods, many of us spent long hours in learning the code by a method that was neither scientific nor efficient.

The fallacy of learning the code by analyzing the characters into dots and dashes, and then memorizing these combinations, has been recognized for more than 25 years by the best teachers of code, but in spite of its weakness many schools still employ this obsolete system. To prove to yourself

that this is wrong, let us see what happens, for instance, when the letter "A" is transmitted.

1. You hear the code sound of the character.

2. You break it into dots and dashes.

3. In your mind you see a dot and a dash. Believe it or not, you may even make an unconscious attempt to say "dot-dash."

4. Now you recognize in your mind that this is the letter "A", and you may even start to say "A" to yourself.

5. You can now write the letter "A."

This long process, consisting always of 5, and sometimes 7, distinct steps between hearing the code sound and writing the corresponding character, is the principal reason why operators who analyze code sounds for dots and dashes have difficulty in acquiring high speed. The proper objective is to eliminate all of the steps except 1 and 5

The code class at Ft. Jay, Governor's Is., N. Y. C., is one of the best in the U. S. A.



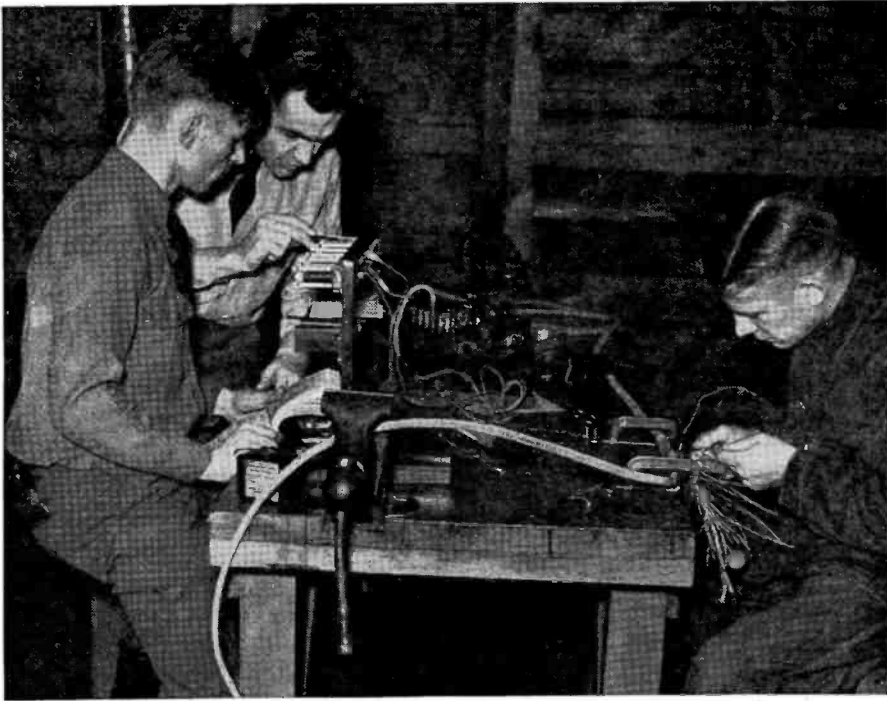

These Army students are learning how to splice cables, and to service and adjust relays. All this makes a Signalman.

so that the operator merely hears the sound and writes the character for that sound automatically.

Psychologists would say that the shortening of the thought process requires the development of a "motor habit," or properly 36 "motor habits" so that on hearing a code sound ("Stimulus" to the psychologist), the operator automatically prints the corresponding letter or figure (his "response"). This is what the scientists call "the establishment of a stimulus-response-bond." You need not bother with these terms, but we have given them to you so that you can use them in arguments with other "hams." These are all good \$5.00 words and it is remarkable how they silence opposition in an argument.

We have seen that at the Army Signal School, Steps 2 and 3 of the above mental process are eliminated by making the character so fast that it can not be split into dots and dashes. Furthermore, no beginner or instructor is ever permitted to refer to dots and dashes when talking about code sounds. Instead, the student is told to use the words "dit" and "dah" to simulate the actual code sound, as no mental picture is associated with these.

Using "dit" and "dah" instead of "dot" and "dash" has been recognized for many years by the best radio teachers, but the full value of this method is not received unless the dit-dah-dit is sent at the 20-word rate used so successfully by the Army.

Having eliminated Steps 2 and 3, we have left only Steps 1, 4, and 5. These Steps are:

1. The code sound of the character is heard in the phones.

4. The student recognizes the code sound as the letter "A" and forms a mental picture of "A." He may even try to say the letter "A" out loud.

5. The letter "A" is printed on paper.

Step 4 is gradually eliminated by practice. At the Army Signal School it has been found that the direct mental short circuit between Steps 1 and 5 occurs when the student has attained a receiving speed of approximately 12 words per minute. Practice beyond this speed merely cements the habits he has already formed, gives him increased speed in printing and develops the ability to read behind.

Having learned the code sounds of the 36 characters, the Signal School student is given practice at 8 words

per minute. Characters are sent in random order in groups of five characters each, allowing a longer space between groups than between characters.

At least one test is given the student each week. To advance to the next higher speed he must, for two days in succession, copy without a single mistake, at least 2 minutes of a 5-minute transmission. This is a strict requirement, but it is essential to insure the accuracy necessary for the handling of Army tactical radio traffic which may come in the form of a cipher or military code—that is—not in plain English. For this reason, the plain English text is not transmitted to the student until he can receive 15 words per minute.

The success of this Army system is proved by the improvement records of the students of the Army Signal School. A typical group of radio electricians of the Signal Corps may start with an average code speed of less than 6 words per minute. After 32 hours of instruction, the average receiving speed is 10 words per minute. At the end of 60 hours of instruction, the rate is 13 words per minute, and it climbs steadily until we find that at the end of 210 hours of instruction the average reception speed is 20 words per minute.

The rate of progress we have shown here is the record of three classes of radio electricians, selected at random from the files. In judging the receiving rate, the strict requirements of the Army Signal Corps must be considered—that is—this means reception of characters which are not necessarily in plain English text, with no errors permitted or ignored.

Transmission at the Signal School
(Continued on page 45)



More and more telephone equipment must be studied intensively, along with radio transmitters, receivers and associated units.

National Defense Net

by

AL TOOMBS

Special Washington Correspondent,
for RADIO NEWS.



Left—Two NYA students who will become the nucleus of the National Defense Net, test and build their ham set. Above—Two girl operators of the Toccoa, Ga., NYA club. They are Ruth Gaines (L) and Jessie Suddath, both licensed.

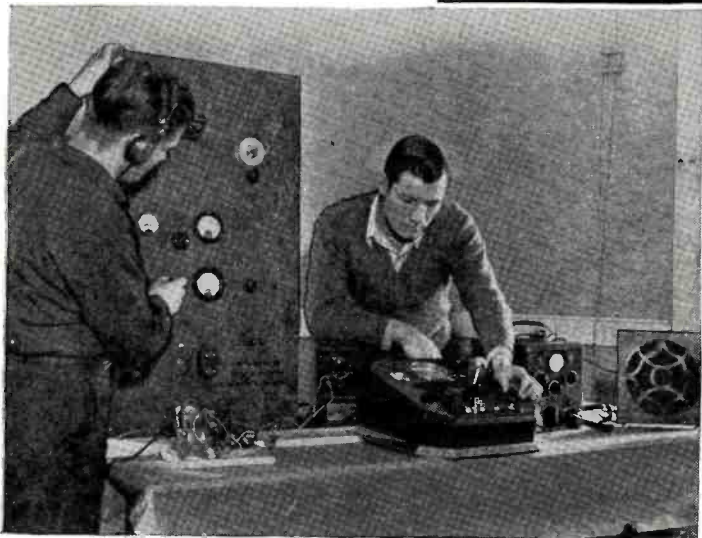

Not waiting for the rest of the hams to organize into the Army & Navy networks, Uncle Sam has started his own NYA hamnet.

THE formation of a National Defense Net will not come as a shock to the hams who through their American Radio Relay League have kept such networks in operation for the last twenty years. It will be of interest that the government has actually gone into the business of subsidizing a National Defense Network to be administered under the National Youth Administration. Another thing that holds the attention is the large prevalence of woman operators in the proposed network. It will pay all amateurs to read this article since it shows which way the "wind is blowing." It is the first of a series on what our government is doing to meet emergency defense conditions in the communications field.

A NEW National Defense Network of ham stations, which will link important centers in continental America, is being established under auspices of the *National Youth Administration*. The set-up has the blessing of national defense planners in Washington and represents one of the important contributions of young radio enthusiasts toward making America invulnerable.

The plans call for establishment of about 535 stations, manned by 10,000 youths. The stations will be strategically located and the operators will be drilled in the work they would be expected to do in an emergency. The work will be integrated with that of hams who are already affiliated with the Army and Navy systems.

Some 50 stations of the network are already on the air, operated by 1,000 members of NYA radio clubs in 22 states. Each week the *Federal Communications Commission* is approving applications from members of new NYA clubs. The thoroughness with which the plans are being carried out is indicative of the importance being attached to ham station in the defense program.

The new defense network was born of a depression, a hurricane and a few *blitzkriegs*. The need for such a ham chain was another of the lessons we learned from Europe.

Our military observers, in their reports from European battlefields, have stressed the importance of communications in Hitler's successes. His enemies' communications have been

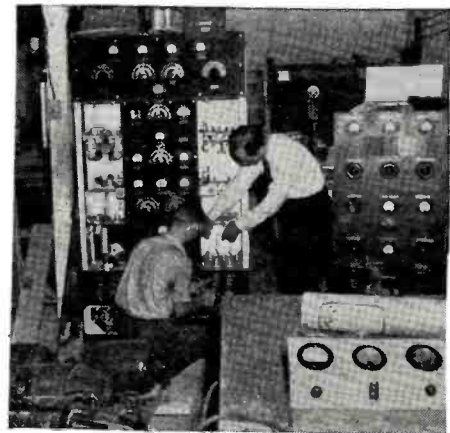

Ranger, Tex. NYA men building a biggie.

put in such a tangle that a servicemen's convention couldn't straighten them out, while the German troops have been able to coordinate their activities by excellent radio work. So in planning for the expansion of our defenses, Washington has been trying to build the sort of radio system that couldn't be disrupted by anything

(Continued on page 63)



When the airman is in the sky, then he *must* know that he can depend on his radio.

INSTALLATION and MAINTENANCE of AIRCRAFT RADIO EQUIPMENT

by Staff Sgt. CHARLES J. SCHAUERS

Communications Chief, 73rd Bomb. Sqdn., (M) GHQ,
McChord Field, Tacoma, Washington.

**Some important pointers on the installation
of aircraft radio by an author who has been
thoroughly trained for this work by the Army.**

Part I.

WHILE this article concerns itself with the maintenance and repair of civilian aircraft radio, it is equally applicable to military radio. The crying need of men trained in the installation and maintenance of aircraft radio was never so apparent as it is now. Even if you never expect to have a chance to do work like this, it will pay every person interested in radio in any form to read and digest this article. You may find yourself working in just such a position should an emergency develop.



The Author.

THE safety of aircraft in the air today is largely dependent on the radio equipment installed, which must operate at the highest peak of efficiency at all times.

The proper installation and maintenance of this equipment must be consummated by properly trained technicians who are drawn from all branches of the radio industry, but who are usually recruited from the ranks of graduates of schools which have offered these graduates a course of specialized training in aircraft radio in conjunction with the conventional radio course. One of the schools offering such a course is the *Air Corps Technical School*.

This school offers a course in aircraft radio

repairing and operation which covers all phases of the subject, even to associated communication equipment, such as teletype, etc.

The *Civil Aeronautics Authority (CAA)* in collaboration with other governmental agencies has provided communication facilities, both teletype and radio, which efficiently blanket the United States and are used to great advantage both day and night by all the aeronautical services.

If these facilities, as well as many others, are to be utilized by the aeronautical services in a manner which will elevate the "safety factor" of flying, it is well known that trained technicians possessing the necessary licenses, must also be employed and be available for both maintenance

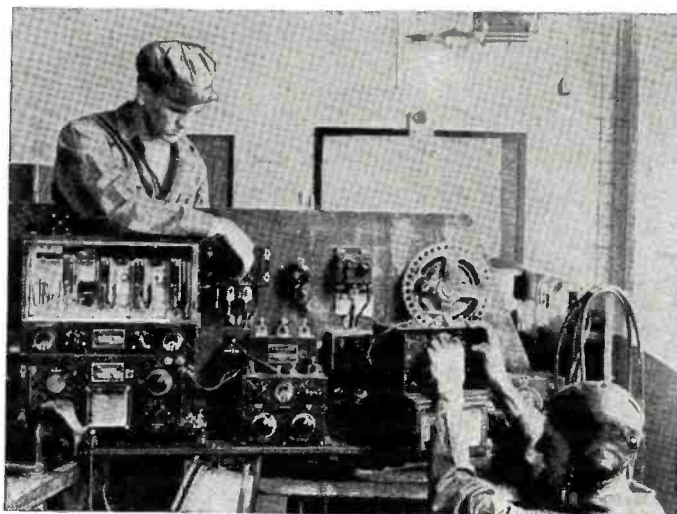

Less than 4 years ago, Army radio equipment looked like this and was tested by trained men from the Signal Corps.

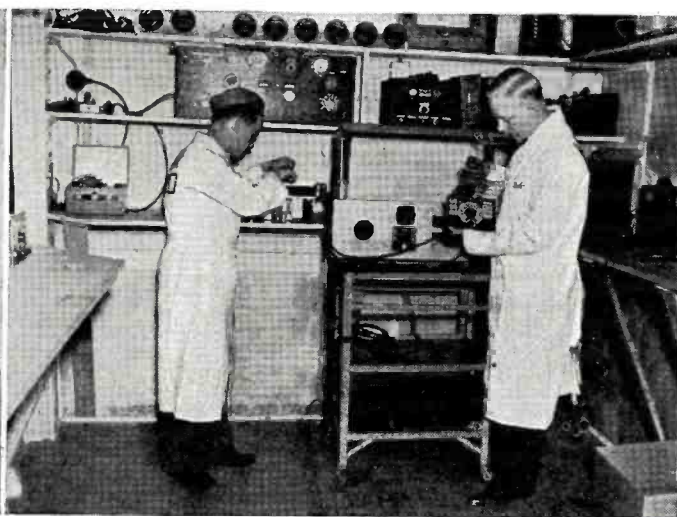

A modern radio laboratory where the latest units are tested by men, many of whom were trained by the Army.

and installation of the radio equipment in aircraft.

The CAA has established standards which directly affect the manufacture and installation of aircraft radio equipment that is to be installed in specific aircraft. These standards take into consideration all technical details inherently affecting the operation of the equipment under various conditions, such as temperature, humidity, over-loads, vibrations, etc.

The average of efficiency is computed after painstaking tests have been made upon the manufactured equipment, and it is known that if these specifications are complied with, the "average of efficiency" will be very high, which in turn raises the "flying safety factor." But regardless of the specifications conjured, troubles do develop after so many hours' operation of the equipment, due to wear and tear; and this is where highly skilled maintenance technicians are required.

The original installation of all aircraft radio equipment must be performed in such a manner that future

failure of the equipment cannot be attributed to the installation.

The *United States Army Air Corps*, as well as commercial aviation services are constantly utilizing new equipment, both aircraft and radio; and with the advent of these new developments, a greater understanding of the highly technical aspects of this equipment must be grasped by the technician in order that the "safety factor" will not be lowered by incompetent installation and maintenance.

The installation and maintenance of radio equipment in modern aircraft entails many detailed considerations due to the many different designs of aircraft and radio equipment. However, by basing our considerations on the "average of types," it is quite possible to arrive at a point whereby these considerations may be considerably generalized and applied to most equipment now available for use in aircraft.

Many articles and papers have been written by competent technicians and engineers concerning aircraft radio

equipment as a whole. However, the installation and maintenance of this equipment is a highly specialized field due to the development and progress of this equipment, and is quite evident by the conspicuous absence of articles on the subject in many of the magazines published today.

In endeavoring to acquaint the readers of this magazine with the many considerations involved, especially the aircraft radio serviceman, it is my sincere hope that this article will in some small way, contribute to the furtherance of better installation and maintenance of aircraft radio equipment.

Prior to the actual installation of equipment, it is advisable for the installation technician to consult both the radio and aircraft manufacturer for suggestions and recommendations which are usually cheerfully given. Instruction books are usually provided with all equipment and should be carefully studied, because a successful installation depends upon how well the manufacturer's instructions are fol-



An up-to-date plant where modern radio transmitters are built.



One of the smaller, compact transmitters developed for the itinerant flyer.

lowed. However, a technician must know how to apply these instructions and use his general aircraft radio knowledge and experience in following them.

As was mentioned above, there are many and various designs of aircraft radio equipment, and no two installations are alike or present the same in-

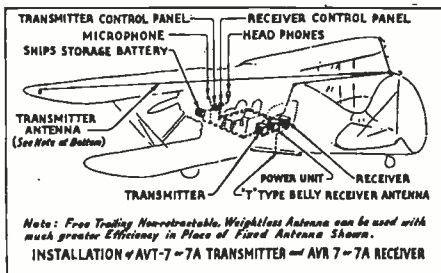
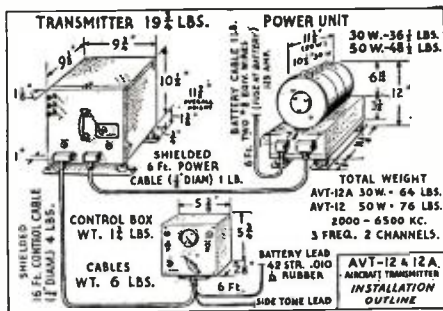
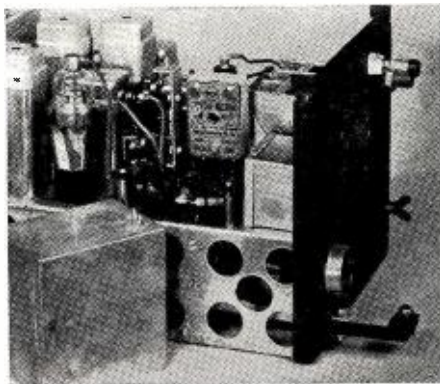

Top: The private plane owner's transmitter. Diagrams are for installation.

stallation difficulties; but by applying generalized considerations, many problems encountered can usually be solved.

The antennae usually receives first consideration, therefore, we will begin with the actual choice and installation of the antennae as used by modern aircraft.

The antennae installed on aircraft is a capacitive element, using the aircraft frame and structure as a counterpoise, and in the case of modern aircraft, the entire plane, due to metal construction.

If the correct amount of capacity is not obtained with airplanes of fabric and metal construction, it is necessary to "metallize" the structure. This is accomplished by attaching metal sheets, preferably of light aluminum to the structure adjacent to the "flat" portion of the antennae. However, it is very seldom that an airplane is found where this is necessary. The correct amount of capacitance may be determined, usually, after the transmitter has been connected to the antennae.

The operating characteristics of the transmitter are observed, and if the correct amount of capacitance has been obtained, the transmitter will usually indicate this, by displaying the correct characteristics of operation, i. e., correct loading, radiation, etc. That is, if the proper internal tuning elements of the transmitter are properly resonated to the antennae itself.

The correct choice of antennae is a very important and major problem, because the entire installation is only as efficient as its antenna.

When a "common antenna" is used for both transmitting and receiving, that is, one antenna; an antenna switching relay is usually used, which switches the common antenna between the receiver and transmitter, when a switch usually installed as an integral part of the microphone, is depressed. However, 2 antennae are common.

There are many classes of antennae

used by various types of aircraft today, six distinct types predominating, i. e., the vertical mast, the "V" type; the wing to wing type; the "T" type; the loop antenna; and the "belly T."

Considering them in order: The vertical mast antenna is seldom used for transmitting purposes except when utilized as an ultra-high frequency radiator which aircraft rarely use today, but which are coming into greater prominence as the development of high-frequency communication equipment for aircraft progresses. This antenna is used mainly for reception of "beacon stations," is very non-directional, and is often used as a supporting mast for the wing to wing type antenna, and as such is commonly used as a receiving antenna. The length of this antenna varies from five to seven feet in height, and is usually installed by the aircraft manufacturer as an integral part of the aircraft, when specific radio equipment is to be installed. The mast is hollow, streamlined, constructed of wood and contains a copper wire which travels from the top insulator down to an insulated fitting or another insulator which has an appropriate connection for the lead-in. All vertical antennae have bases which are drilled for screw mounting to the airplane's fuselage at the center junction of the right and left wing. If it is desired to install an antenna of this nature on an airplane, one can be readily obtained from leading aircraft manufacturers or from the aircraft radio manufacturer, and the actual installation of this antenna is not difficult in itself, but requires careful study, and in all cases the manufacturer's instructions must be followed.

The "whip or fish-pole" antenna has about the same characteristics as the vertical mast. However, more maintenance is required on the whip or fish-pole antenna in contrast to the vertical mast.

The "V" antenna is used for both
(Continued on page 55)

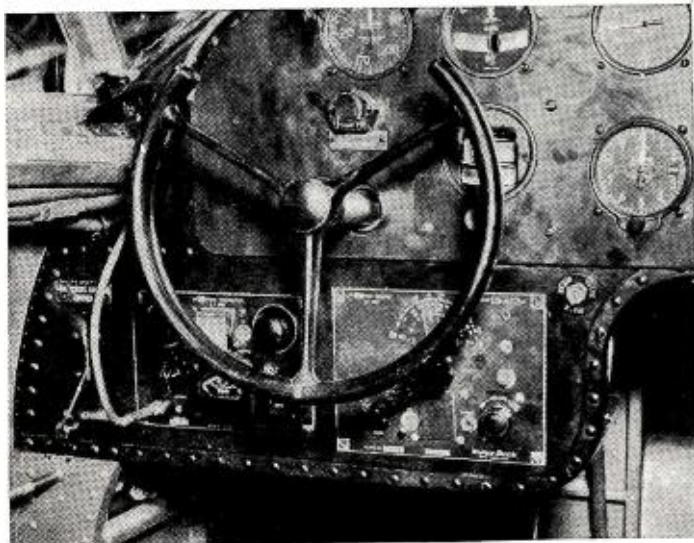

This is the type of radio which is installed in private owner's planes. Job must be fool-proof.



Installations in super-airliners present different problems than those of the private airplanes.

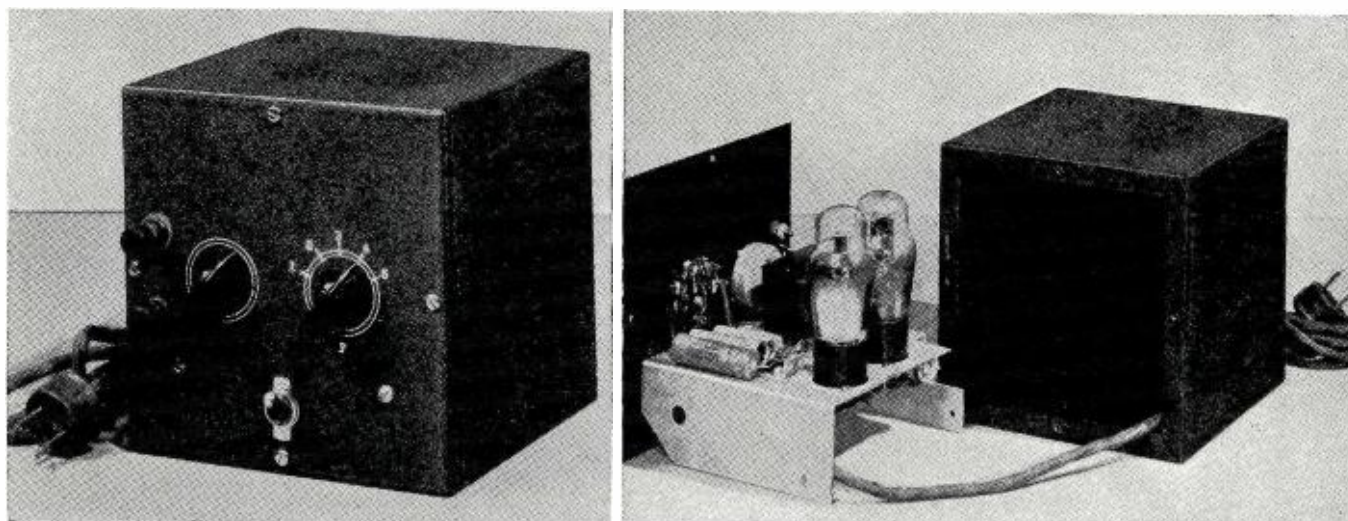

Note the clean commercial lines of this home-built unit. While easy to build, the serviceman will find many uses for the audio oscillator in his P. A. work.

THE audio frequency signal generator is one instrument not generally found in the average radio shop. There are several reasons for this omission, the principal ones being the fact that the R.F. signal generator commonly used, generally provides an A.F. signal of same sort; and the comparatively high cost of a generator of the beat frequency type is often out of proportion to the average man's actual need for such an instrument.

However, the occasion does arise from time to time, when the service man would find a separate source of one or more audio frequencies useful, and the simple generator to be described is one that may be easily assembled at low cost, with a number of different tones, in a frequency range of about 10 to 1, and sufficient output to drive a speaker directly.

Nearly all radio men are familiar with the method that employs an audio transformer as an inductance, with a single oscillating tube in a Hartley circuit. When the standard transformer is used, of 2 or 3 to 1 ratio, the tone produced is usually rather low in pitch due to the high inductance of the windings, which is further increased by a fairly large iron core. This limitation may be easily removed by the use of a transformer with a lesser number of turns in the oscillating circuit, and a smaller iron core. The characteristics of a transformer of the midget variety intended for use as a class B input, approach these requirements, and one may be purchased for as little as 49c if not already on hand.

As shown in the accompanying diagram, the secondary winding is used as the inductance in the tank circuit by connecting the cathode of the oscillator tube to the center tap. The primary is used only as an output coil, and is not directly a part of the oscillating circuit, although it does have some effect on the secondary, due to the close coupling through the iron core. The output is controlled by a potentiometer across the winding,

SIMPLE AUDIO OSCILLATOR

by **R. K. WHEELER**

Indianapolis, Ind.

A simple 2-tube audio oscillator, calibrated against a piano, makes a nice instrument for the serviceman's bench.

with a .25 mfd. condenser in one side of the line, to avoid removing the grid bias in some cases, when connected directly across a tube from grid to ground, or chassis. The volume control may be anything from 10,000 to 100,000 ohms, preferably one with an audio taper.

The oscillator and rectifier tubes may be any triodes of the 6 volt—.3 ampere family, which will allow the filament voltage to be taken directly from the power line through a suitable line cord. No bias is applied to the oscillator tube, which affords a fairly high A.F. voltage output; the tube's current being regulated by the size of the resistor in the R/C filter of the power supply. The size of this resistor, shown as 15,000 ohms, is not critical, and may be anything from a

minimum of 10,000 ohms up to 25,000 ohms. The assembly is completed by four fixed condensers of different capacities connected across the secondary by a suitable tap switch.

It will be noticed in the diagram that no condenser is connected to the first terminal of the tap switch. When the switch is in this position, the circuit oscillates at its natural frequency, and the tone produced will be the highest that can be obtained without alteration of the transformer. As it is hardly worth while to produce notes that are less than one octave apart, the condenser for the F2 position is selected by placing the generator in operation, connected to an amplifier. It is not at all difficult for a person with the average ear for music to dis-

(Continued on page 60)

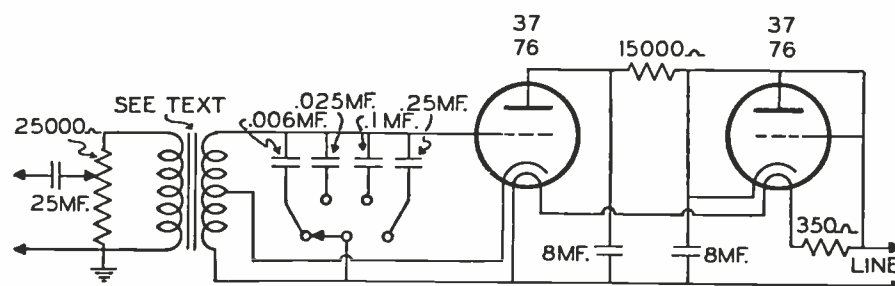

Circuit diagram of the Audio Oscillator.

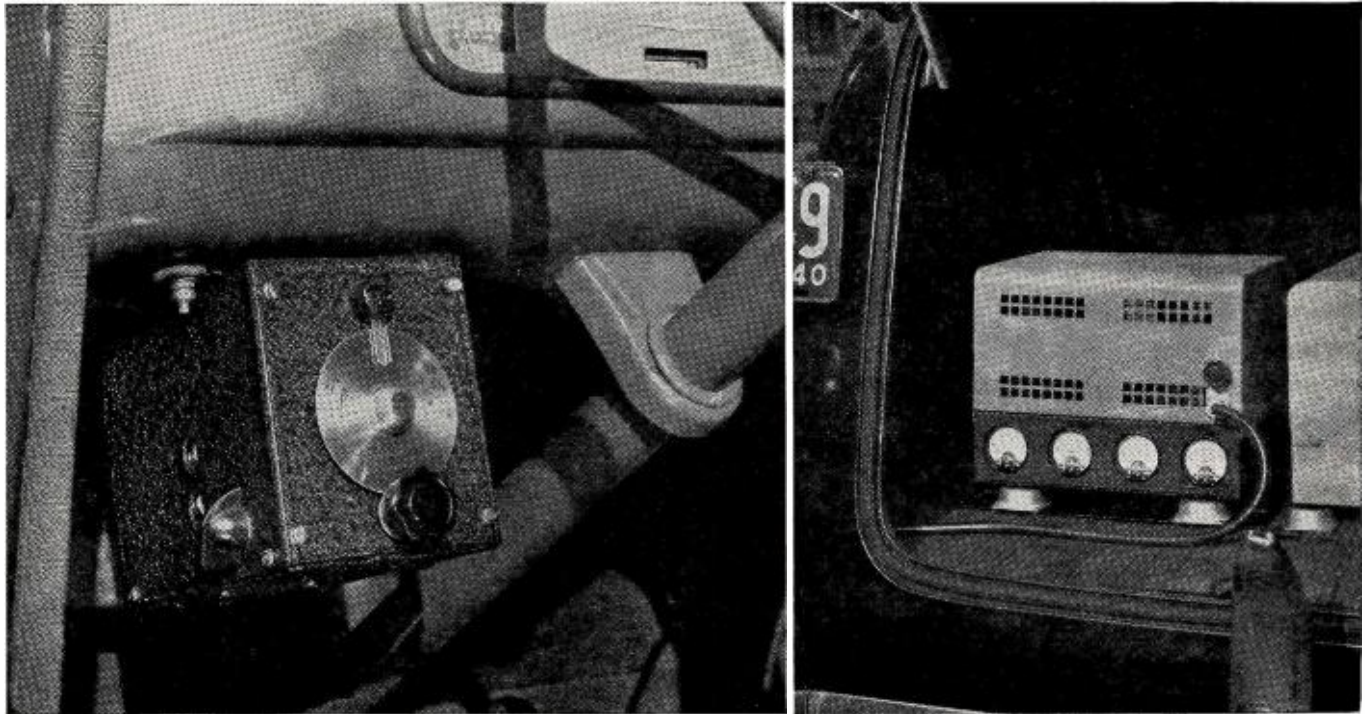

A converter (*Browning*) shown at the left is used with a regular receiver for the 56MC reception, while the transmitter, remotely dash-controlled, is in the rear.

A New 56 MC Mobile Rig

by **KARL A. KOPETZKY, W9QEA & OLIVER READ, W9ETI**

Managing Editor,

Technical Editor

Mobile operation on 56MC is still permitted, so the authors designed a rig that uses the latest improvements, and which was the most efficient possible.

WASHINGTON has indicated that the amateur can best serve his country at this time by designing and building mobile equipment that really works well. Our weakest point in communications is in the inadequacy of mobile communications. In spite of the fact that the Federal Communications Commission has limited the amateur to 56mc mobile transmissions, much work can and must be done in this field. Herewith RADIO NEWS presents the first of a series of articles which will feature the mobile equipment typical of that which can be used by government agencies in any emergency. From time to time this series will be enlarged and the latest designs will be shown.

NOW that the Amateur Regulations have been altered, as far as mobile operation is concerned, it is well to consider the design and construction of transmitting equipment designed especially for the

high frequencies. Past experiences with mobile units have continually stressed the importance for proper mechanical design. A transmitter designed for the frequencies from 56 megacycles and higher require that we take added precaution in order to prevent any form of frequency drift or unstable performance. We have designed the 5 meter transmitter herein described to meet present day conditions and each part has been carefully selected with an eye towards simplicity, stability and economy.

If the constructor will follow the details as set forth in the following paragraphs, he may be sure of obtaining excellent results. The transmitter circuit is simplicity itself and we have kept the total number of r.f. stages to two. This affords economical battery operation while the use of a type 89 tube in the oscillator circuit permits harmonic operation to be had which

further reduces the total number of stages required.

Note that 20 meter *Bliley* crystals are used with a choice of two frequencies made available by means of a selector switch. The circuit is the well-known Tritet and by proper selection of plate, screen, and suppressor potentials, we are able to obtain a high order of efficiency in the oscillator section. The optimum values chosen are as follows: plate voltage 300, screen voltage 140-160, and the suppressor adjusted to approximately 50 volts. The plate tank coil is provided with a tap which is located approximately 2½ turns from the plate end of the coil. Loading was found to be most efficient at this point when used in conjunction with a 50 mmf. coupling condenser.

The plate circuit is resonated approximately midway between the resonant point of the two crystals so that once tuned we can QSY simply by throwing the crystal switch. A refinement would be to incorporate a single-pole-double-throw relay in the crystal circuit and by this means we would be able to change the frequency by means of a switch located at the dash-control position. This relay, preferably, should be of the ceramic insulated type and should so be located that short leads will be had from the two crystals to the 89 grid.

A closed circuit jack is provided in the cathode coil return circuit of the

oscillator to permit keying of the transmitter when desired. Note that one side of all filaments are grounded. Inasmuch as the 89 tube has a cathode, no isolation is required in the filament circuit and the use of r.f. chokes is thereby eliminated. All by-pass condensers must be located as close to the tube socket pins as possible in order to be completely effective. All of the variable tank condensers are provided with locking nuts. These are almost indispensable in mobile operation and the ones used were chosen because they included this feature in addition to the use of isolantite insulation. The Radio Frequency chokes used in the grid circuits and the one used in the oscillator plate circuit are standard Hammarlund 2½ millihenry chokes, while the choke used in the HY75 tank circuit is one especially designed for 5 meter operation.

It will be noticed that a total of four meters are used and these may be seen mounted on one side of the chassis. It is possible to use only one meter connected up by means of some switching arrangement to read all positions indicated but past experience has shown the desirability for incorporating a separate meter in each circuit. We are, then, able to have an instantaneous indication of the operation of the transmitter at a glance. These meters, *Triplet Model 221*, are mounted in back of the cutouts, as

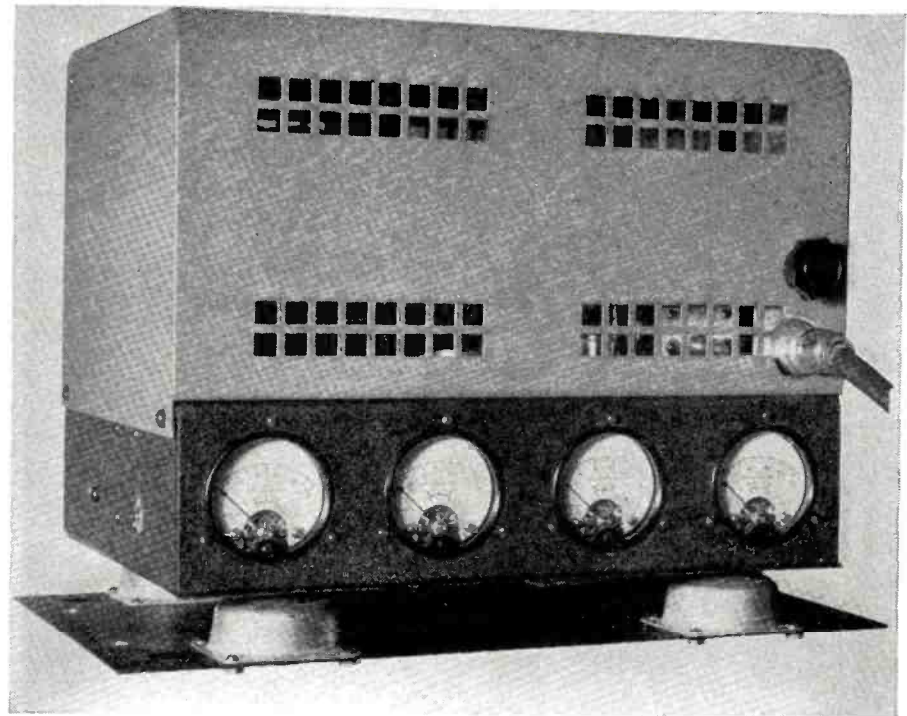

Front view of the transmitter proper. This is installed in the rear of the car and controlled, remotely, from the dash. Push-to-talk is used.

shown. Instead of the flanges being in front of the panel, they are mounted on the inside. This results in a more pleasing appearance whenever meters are grouped close together as these.

R. F. Amplifier
The usual 5 meter mobile transmitter is limited to power outputs ranging from 4 to 10 watts. In order to obtain more consistent contacts, we

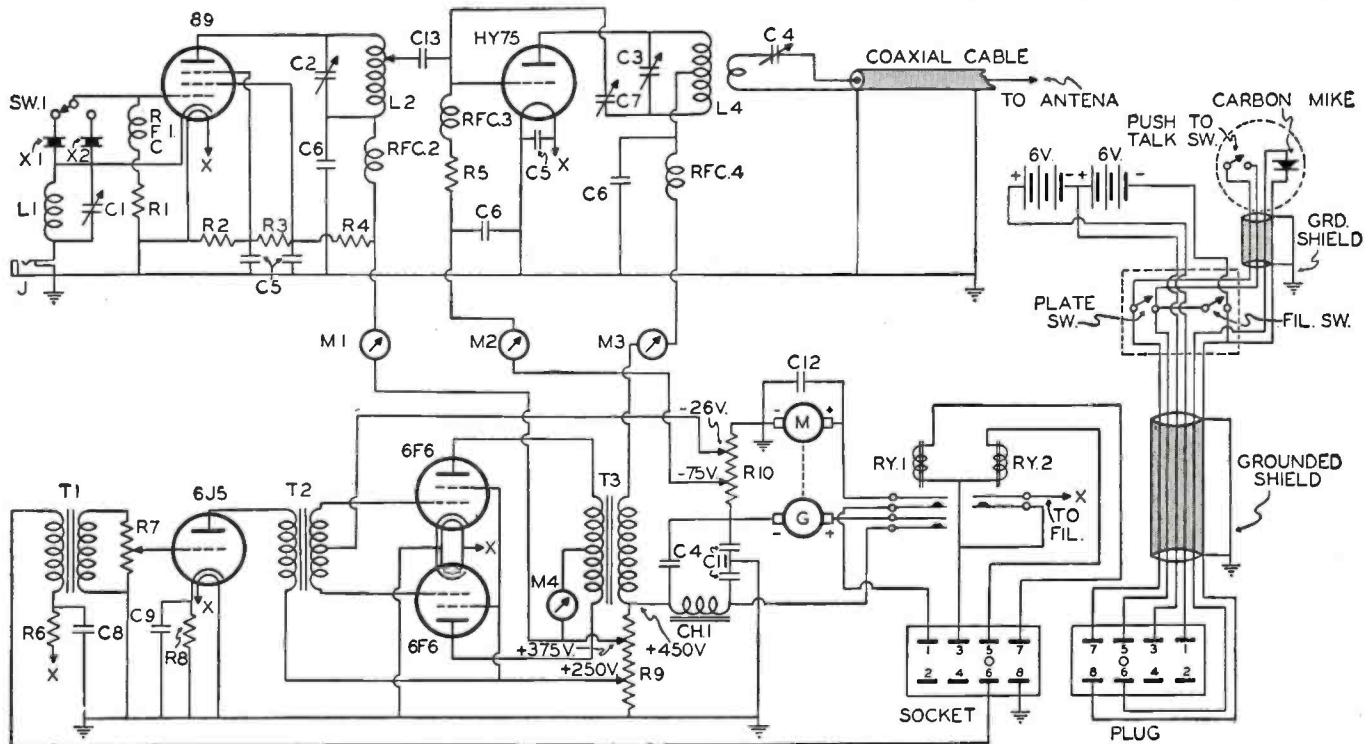

- R₁—50,000 ohms, 1 w. Aerovox
- R₂—10,000 ohms, 2 w. Aerovox
- R₃, R₄—25,000 ohms, 10 w. Ohmite
- R₅—10,000 ohms, 10 w. Ohmite
- R₆—100 ohms, 10 w. Ohmite
- R₇—5 meg. gain control Mallory
- R₈—2000 ohms, 1 w. Aerovox
- R₉—50,000 ohms, 100 w. Ohmite
- R₁₀—200 ohms, 10 w. Ohmite
- C₁—75 mmf. Cardwell Trim-Aire
- C₂—35 mmf. Cardwell Trim-Aire
- C₃—15 mmf. Cardwell Double-spaced
- C₄—100 mmf. Cardwell Trim-Aire
- C₅—.01 mf. 600 v. mica Sprague
- C₆—.002 mf. 1000 v. mica Sprague
- C₇—Neutralizing Cond. Bud NC1929

- C₈, C₉—20 mf. 25 v. electro. Mallory
- C₁₀—1 mf. 1000 v. Oil-filled Aerovox
- C₁₁—.01 mf. 1600 v. Mallory
- C₁₂—.5 mf. 200 v. Mallory
- C₁₃—50 mmf. mica Sprague
- R_{Y1}—R100 G Guardian relay
- R_{Y2}—R100 Guardian relay
- RFC₁, 2, 3—2½ mhy. RF Chokes, Millen, or Hammarlund
- RFC₄—5 meter choke, Bud
- P—Jones S-8AB Connector
- P—Jones P-8FHT Connector
- CH₁—200 ma. filter choke, Thordarson T-7471
- MG—600 v. 200 ma. Pioneer Genemotor FR-562
- M₁—O-75 DCMA Triplet 221
- M₂—O-25 DCMA Triplet 221

- M₃—O-150 DCMA Triplet 221
- M₄—O-100 DCMA Triplet 221
- T₁—Mike to grid Thordarson 55A16
- T₂—Driver Thordarson 81D52
- T₃—Mod. Trans. Thordarson 19M14
- J—Closed circuit keying jack. Mallory
- X₁, X₂—Bliley HF2—20 meter crystals
- Chassis & Case—Par Metal 10"x12"x2½"

Coil Data

- L₁—8½ turns No. 14 close-wound, 1" diameter
- L₂—8 turns No. 14 double-spaced, 1" diameter Tap 2½ turns from plate end
- L₃—4 turns No. 12, 1" inside dia., ⅛" spacing
- L₄—2 turns No. 14, 1¼" diameter

definitely decided to use a special high frequency triode known as the "Hytron Type HY75." This tube is especially designed for operation on the high frequencies and inasmuch as it has a filament designed for 6 volt operation, it lends itself admirably to the purpose. The tube is operated at its maximum rating of 450 volts on the plate, while the maximum safe plate current is 100 ma. when fully loaded with a plate-power input of 36 watts at 60 mc. Under the above condition, the plate dissipation rises from 12 to 15 watts under full modulation. This is within the safe plate dissipation rating of the tube. With 15 watts

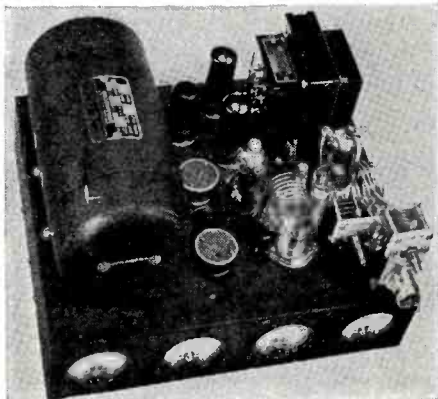

Topside view of the 56MC mobile.

plate dissipation, the anode of the HY75 shows no color. The presence of a red glow would indicate that the rated dissipation had been exceeded, and if such occurs, the plate input power should be reduced or adjustments made in the transmitter to increase the plate circuit efficiency thereby lowering the value of plate dissipation to its rated value.

Neutralization is afforded in the conventional manner. This condenser

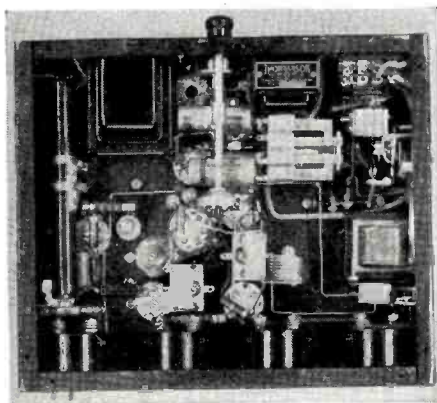

Underchassis view of the mobile.

made by Bud, is so designed that extremely short leads will result in the plate circuit when this condenser is mounted properly. The mechanical requirements for any high frequency amplifier are generally understood by most amateurs; however, a word of caution is in order. For maximum results it is imperative that the layout shown be followed carefully in order that the results had will equal those

(Continued on page 53)

UTILITY RADIO DEVELOPMENTS

THE West Coast from San Diego to Seattle has literally been turned into an aircraft manufacturing plant insofar as the radio and radio parts manufacturers are concerned. Not only is it difficult to get machine tool manufacturers to make new tools and dies for newly designed radio, sound or television equipment, but those radio parts manufacturers who have a machine shop of their own are having trouble getting experienced men to operate the machines. The aircraft plants are hiring all the experienced men available to make machine parts for their own needs, which, of course, is first call inasmuch as they are manufacturing items for the national defense.

There are many newly designed and developed radio items which are only waiting for the dies necessary to turn them out in quantity. Manufacturers are leathe to give publicity to any items unless they are sure that they can supply the demand.

In the field of radio sets, many of the largest radio set manufacturers are turning their engineering departments over to the task of producing suitable equipment for the aviation industry. Right now *Gilfillan Bros.*, considered to be the largest manufacturers on this west coast, are working under the direction of their Chief Engineer E. Frederick Wolcott to perfect a special transceiver for the *Lockheed Aircraft Corporation* of Burbank, California. A problem here, also, is personnel which has the necessary requirements to build radio equipment.

But television is not being left by the wayside. Although most of the transmitters which will be used by three new licensees in the Los Angeles and San Francisco area will be built in the east by the *Dumont* organization of Camden, New Jersey, many new parts will be built right here as the developments continue. *The Hughes Tool Co.*, which is better known from the exploits of its youthful president, Howard Hughes, speed flier and motion picture producer, is expected to spend one million dollars for the further development of the television art, while *Television Productions*, a subsidiary of the powerful *Paramount Pictures* organization, intend to spare neither money nor effort in making television the foremost industry.

So it can easily be seen that in spite of speed-up production in the war items industries, radio and its kindred sciences will suffer but slightly on this west coast.

The McProud Padget and Quadget

THE *Quadget* and *Padget* are two new devices designed by C. G. McProud to allow rapid determination of circuit values in the design of pads or equalizers. The *Padget* gives directly values for T, Bridged T, H, pi, and balanced pi pads, for use in 500 ohm

circuits, with any attenuation up to 60 db. In addition values for four unsymmetrical pads are given and data supplied for rapid calculation of any other unsymmetrical combinations. The *Quadget* gives directly values for constant impedance equalizers or suppressors, and shelf suppressors having resonant frequencies from 60 to 10,000 cps. Values for three different selectivities are given at each frequency. A simple transformation factor is given on both the *Quadget* and *Padget* to obtain values for use on any impedance other than 500 ohms. *Norman B. Neely*, 5334 Hollywood Boulevard, Hollywood, California, is the agent.

Cinema Engineering Gain Set

THE *Cinema Engineering Company* of 1508 South Verdugo Avenue, Burbank, California, manufactures a precision gain set which is available in assembled or kit form. A balanced H input attenuator provides 115 db of attenuation in 1 db steps. The output attenuator covers a range of from minus 10

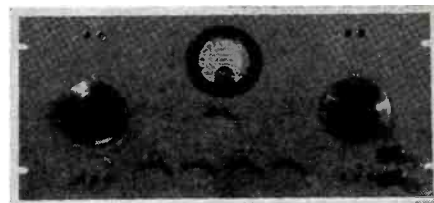

to plus 30 db in 2 db steps and employs a Weston model 301 DB Meter. Artificial loads are automatically switched in to preserve the impedance match when the VI meter is switched to the input side of the input attenuators, thus enabling the VI meter to approach the performance of the vacuum tube type.

Hewlett-Packard Audio Oscillators

THE *Hewlett-Packard Company* of 481 Page Mill Road, Palo Alto, California, is manufacturing resistance-tuned audio oscillators which are particularly unique in that they require no zero adjustment. The *Model 200A* covers a range of from 35-35,000 cps, while the *Model 200B* has a range of 20-20,000 cps. The oscillator employs a resistance-capacity network which supplies feed-

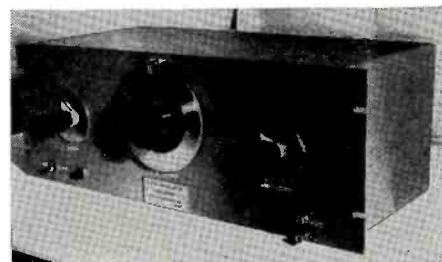

back over a stabilized amplifier. The thermal drift is less than 2% even including initial warm-up, and line voltage variations, for all practical purposes, have a negligible effect on calibration. The main dial covers a range of ten to one which is multiplied by powers of ten by a selector switch on the panel. The *Hewlett-Packard Company* is prepared to build oscillators for special applications embodying the principles of the 200 series.



IMPROVED T.R.F. RECEIVER

by **PAUL POPENOE, Jr.**
Altadena, California

*There are still many who prefer
a T.R.F. receiver. This one will
prove exceptionally sensitive.*

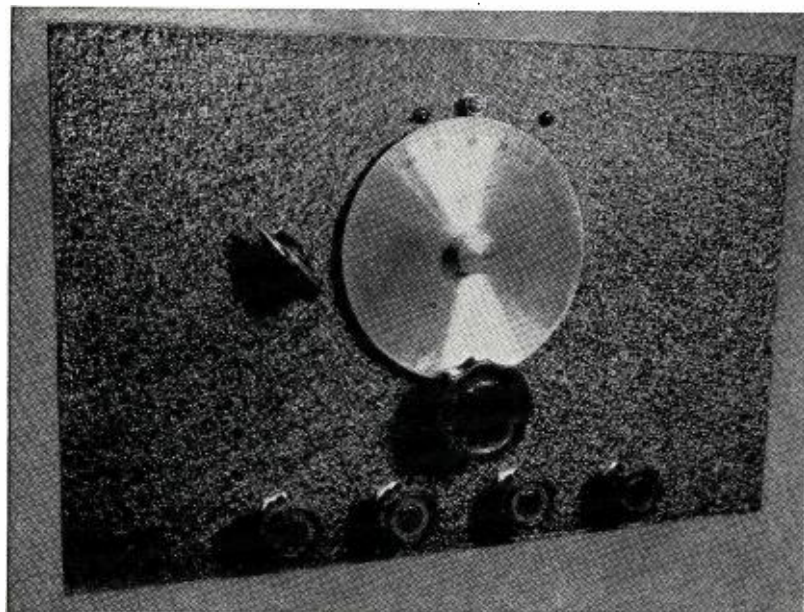

A single tuning control makes DX hunting rather easy.

STILL a favorite among many amateurs, experimenters, and short wave listeners, the T.R.F. receiver is built where high efficiency at low cost is desired. The regenerative receiver is also good at low cost, but it has several drawbacks, namely, lack of sensitivity and selectivity, antenna dead spot effects; and radiation. The T.R.F. receiver was built to overcome these various difficulties. It overcomes lack of sensitivity with greater gain, and lack of selectivity with another tuned stage. Radiation and dead spots are completely eliminated.

However, in spite of its superiority, there are a number of drawbacks in the average T.R.F. receiver. The most serious one found is the poor operation at high frequencies. Many times the detector won't even oscillate at the order of ten meters, and at other times the efficiency of the r.f. stage is very low, even causing a signal drop. These problems should not worry us because at the present time it is possible to

obtain parts and tubes which will overcome both of these difficulties. Let us examine more closely the troubles which confront us.

Non-oscillation of the detector is generally due to poor circuit layout or to the use of poor high frequency insulation. Circuit layout trouble is often due to long leads carrying r.f. which will remove enough r.f. to throw the detector out of oscillation. With a little forethought on the part of the constructor, long leads can be eliminated giving a return much greater than the effort expended. The other trouble of poor r.f. insulation can also be overcome with little effort. In fact, there is really no excuse for using poor insulation at the high frequencies when it is possible to get all of the latest material such as victron, isolantite, and polystyrene at such a low cost as the present.

As for the r.f. stage, the troubles are much the same as those in the detector. The main thing we want in

the r.f. stage is higher gain. In many receivers the use of long leads and poor insulation has resulted in much loss of the weak r.f. currents entering through the antenna. However, in many cases we find that through the
(Continued on page 66)

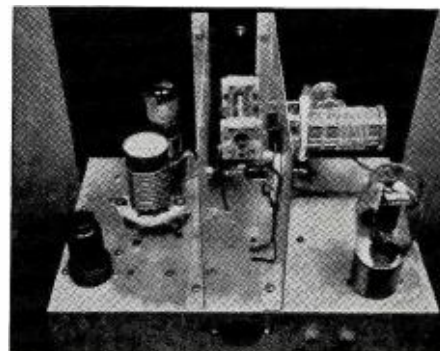

Rear view of the T.R.F. receiver.

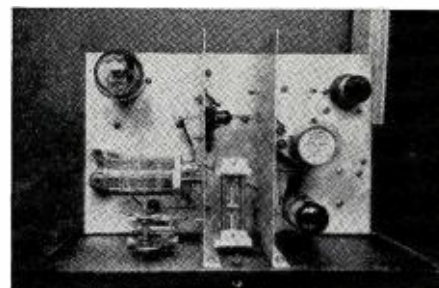

Topside chassis view of the unit.



Underchassis view of the T.R.F. unit.

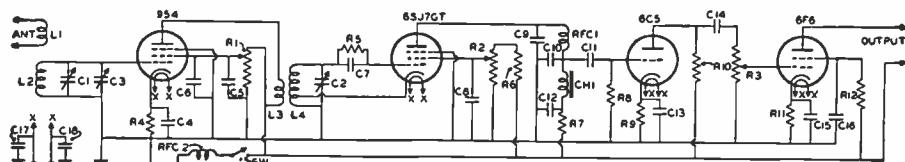

C₁, C₂—Dual 25 mmf. var. cond. Bud
C₃—Single 20 mmf. var. cond. Hammarlund
C₄—0.004 mf. mica. Sprague
C₅—0.001 mf. mica. Sprague
C₆—25 mf. 600 v. tubular. CD
C₇—0.001 mf. mica. Sprague
C₈—5 mf. tubular. CD
C₉, C₁₀—0.001 mf. mica. Sprague
C₁₁—0.06 mf. mica. Sprague
C₁₂—5 mf. tubular. Sprague
C₁₃—1 mf. tubular. Sprague
C₁₄—0.1 mf. tubular. Sprague
C₁₅—10 mf. 25 v. electro. Sprague
C₁₆—5 mf. tubular. Sprague
C₁₇, C₁₈—0.01 mf. mica. Sprague
R₁—250,000 ohms pot. IRC
R₂—50,000 ohms pot. IRC
R₃—500,000 ohms pot. IRC
R₄—1500 ohms, 1/2 w. Ohio
R₅—5 meg. 1/2 w. Ohio
R₆—100,000 ohms, 1/2 w. Ohio
R₇—25,000 ohms, 1 w. Ohio
R₈—25 meg. 1/2 w. Ohio
R₉—200 ohms, 1 w. Ohio
R₁₀—100,000 ohms, 1/2 w. Ohio

R₁₁—600 ohms, 1 w. Ohio
R₁₂—10,000 ohms, 1 w. Ohio
RFC₁, RFC₂—2 1/2 mhy. RF chokes. Bud
CH—250 hy's, 3 m.a. audio choke. Bud
SW—SPST Toggle switch. Arrow
Chassis—7" x 11" x 2" Bud
Panel—8" x 12" Bud
Shields—5 1/2" x 7"

Coil Data

R.F. Coil
L-1 covers 1/4"; L-2 covers 1", spaced 1/4" from primary. All coils wound on 1 1/4" Hammarlund forms.
Meters L-1 L-2
9-16 4 turns #30 d.c.c. 6 turns #18 tinned
15-25 6 turns #30 d.c.c. 9 turns #22 d.c.c.
25-38 9 turns #30 d.c.c. 14 turns #22 d.c.c.
35-55 11 turns #30 d.c.c. 19 turns #22 d.c.c.
Detector Coil
L-4 covers 1 1/2"; L-3 interwound on L-4.
Meters L-3 L-4
9-16 4t. #22 d.c.c. 7t. #18 tinned, cath. tap 1/3t.
15-25 6t. #22 d.c.c. 11t. #18 tinned, tap at 1/3t.
25-38 13t. #30 d.c.c. 19t. #22 d.c.c., tap at 1/3t.
35-55 18t. #30 d.c.c. 24t. #22 d.c.c., tap at 1/3t.

AS I SEE IT!

by **JOHN F. RIDER**

Dean of the Servicemen

The author investigates the \$1.00 Factory Service charge, and finds it innocuous.

SOME time ago we commented that the \$1.00 factory service program, wherein a defective receiver is returned to the manufacturer with a \$1.00 and service is given, does not interfere with the radio servicing industry. During a recent trip to Chicago, we had the opportunity of definitely checking this matter. What we said is the truth. The percentage of these radio receivers returned to the manufacturer for service is so small as to be entirely negligible as a limiter of serviceman's income.

In one instance a well-known manufacturer who had the program in effect for a year and who had shipped about 85,000 of these receivers, received less than 400 back for service on the \$1.00 factory service plan. Figure this for yourself and you will see that it is less than $\frac{1}{2}$ of 1 per cent. Another manufacturer who sold less than this amount of receivers received a number back on this plan, which when figured on a percentage basis was even less than $\frac{1}{2}$ of 1 per cent. Several others did not have their exact figures available, because the returned defective sets were so few in comparison to the number sold as to be of no consequence.

Thus is blasted another hocus-pocus to the effect that receiver manufacturers were inaugurating programs which would tend to harm the servicing industry—that their sales and service plans were formulated without any re-



"Scram, Pop! This is a one man job!"

gard to the needs of the individual independent serviceman.

Food for Thought

HERE is some food for thought. About ten months have passed since we moved into our present apartment. Not a single circular has been received from any of the radio service shops located in the vicinity. Not a single solicitation of any kind of radio service work has been received. And it is not due to the fact that the shops in the vicinity know that we are in a position to do our own service work because anybody who stuffs a mail box does not first glance at the name—or anyone who makes a mailing to the tenants of a group of buildings does not first examine the names in the building.

And it's a new building, only up ten months. The rents are far from being the cheapest in the city. This is said merely to show that the people living in that building can afford to own one or more radio receivers and in all probability to have them serviced. . . . Maybe the servicemen in that neighborhood are so prosperous that they do not need any additional business.—This we doubt. . .

How many more service organizations are there in the nation who are not making any particular effort to secure business?

Selling Parts

WE have before us as we write these lines the tabulations of a survey made several months ago. It took quite some time to digest all of the facts gleaned from the mailing to about 26,000 servicemen in the nation. Among the data gathered is that relating to the manner in which parts are sold to the public when a job is serviced. For a long time past many people have discussed this problem and felt that the sale of parts at cost, that is, the parts figured at cost in estimating the service charge, contributed greatly to the fact that serviceman income was not as high as it should have been.

The tabulation of about 5000 answers shows that fully 98 per cent of all of the servicemen are charging list prices for the parts they figure in a job, thereby eliminating one item from future discussions. It is indeed gratifying to note this change from examinations of previous surveys conducted years ago showed a very marked difference, namely the sale of parts at cost; due primarily to the fact that the owners of service stations did not fully



John F. Rider

appreciate the significance of cost, mark-up and profit. Today they do, and it feels good to be able to say "finis" to this subject. It is hoped that the present condition continues for the future as long as there will be a servicing business.

At least there is one item on which most servicemen agree and competition is on a fair and square basis. Some who read these lines might consider it peculiar that we place such faith in surveys. But we do, because we have found them to be pretty accurate in the past and there is no reason why this one should be any different; particularly so when the answers to the questions asked did not require individual identification or signatures of the person answering.

Just how this situation applies to tubes, we do not know and will not guess. It will be the subject of future inquiries and we feel sure that the answers will be equally enlightening to all the people who are interested in the sale and distribution of tubes to the servicing industry.

Cost Price of Receiver Influence Service Charge?

THIS item also was mentioned in the survey and the opinions seem to be divided equally with a slight leaning towards the affirmative. We realize that this subject has been discussed before but it is of sufficient importance to justify further elaboration. It is our sincere opinion that profitable servicing makes necessary recognition of this factor in establishing the service charge. In plain language, the more expensive the receiver being serviced the higher should be the service charge for any one particular type of operation.

Again we reiterate a statement made some time ago and we cannot help but stress the fact that in every branch of business and industry where maintenance is carried on, the final charge established is definitely influenced by the basic cost of the item repaired, by the investment being protected by the successful maintenance operation. Frankly we do not know the exact basis upon which this can be

(Continued on page 47)

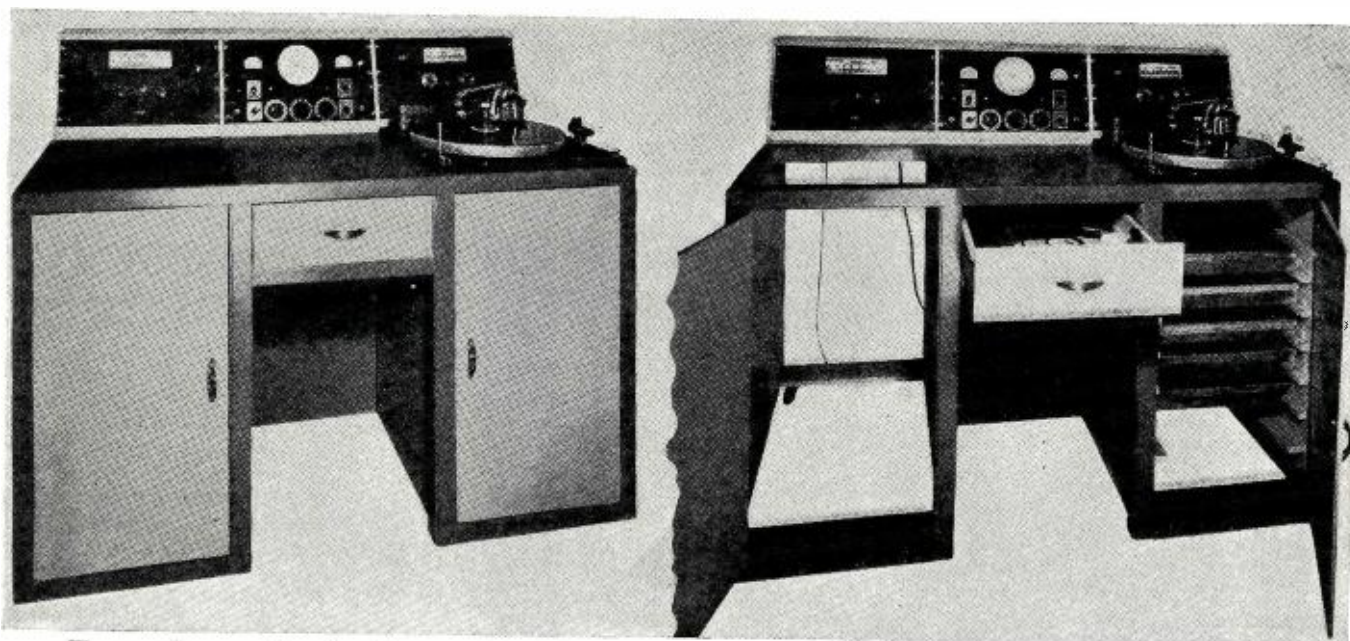

The recording console as it will appear when it has been completed. It will then be ready for any work.

Opening the doors shows the internal construction of the console. It is built entirely of wood and plywood.

It is conceded by the radio industry that home recording, as such, is the one field in electronics that is growing by leaps and bounds. Its progress from a little known art to one rapidly approaching that of home movies has been made possible by the strides made in perfecting fool-proof equipment. Now, at this time, with National Defense and Fifth Column Activity placing first on almost every news page, the home recordist is in a unique position to be of material assistance to our government. Recordings of suspicious radio communications can be sent directly to the *Federal Bureau of Investigation*, Washington, D. C. These recordings should be accompanied with all possible information about the subject recorded such as the date, the approximate frequency and location. If the station call-letters are known, they should be given, together with the time of day the transmission took place and any other available information. Join the fast growing group who are helping to stamp out 5th Column activities. Be an *alert* recordist, not alone a good one. This is the first of a series on this newest hobby which may yet become a factor in the safety of our country and its democratic ideals.

MANY radio amateurs are now looking forward to entering the recording field, either as a profession or as a hobby. Many others, too, are interested in this new and fascinating work as it provides not only a lucrative market for making records of personal and commercial acquaintances, but also offers the opportunity for a serious study into the art.

It is impossible to cover the art of recording in one article completely, and the reader will be taken through each stage so that he may get a firm foundation and background that he may purchase his equipment knowing full well exactly what it will do. At first, recording appeals simply as an additional hobby to go along with

Build Your Own Recording Studio

by **OLIVER READ**

Technical Editor

The author describes a home-built recording studio with all units console self-contained.

amateur radio communications. Later, better equipment is obtained and a careful study made in order to be able to turn out instantaneous recordings which will not only be pleasing to hear but many which will have historical backgrounds and values.

Take, for example, the recent European situation. History has been made at a rapid pace during the past few months. At the very beginning of hostilities, we thought it would be a valuable adjunct to our record library to make a daily transcription of the news as it came over the ether. To do this economically, it was necessary to resort to the most inexpensive type of instantaneous recording discs. These were 12" in diameter and are normally cut at a standard speed of 78 r.p.m. However, as we shall explain later, it is possible to record on these discs at the transcription speed of 33½ r.p.m. in order to be able to realize approximately 14 minutes of playing time on one side of the disc. These cost 25c each, or figuring one 15-minute news broadcast per day, amounted to 12½c for each daily transcription.

Many outstanding historical events have been thus transcribed, including the scuttling of the *Graf Spee*, the return of the *Howard Hughes* flight, addresses by many outstanding personalities, both here and abroad, and an endless variety of radio programs.

Now, there is one point which should be made very clear, and that is that in order to obtain the finest results in recording, it is necessary that we select not only the equipment, but the accessories and discs, with care. Many readers will decide to proceed along the lines that we set forth in this series of articles, while others will be satisfied to use more inexpensive equipment and to dispense with the conveniences and elaborations that we have chosen.

It was decided that a "recording console" be constructed in order that we might have a compact recording laboratory, in effect, which would include all of the necessary machinery and storage space that would otherwise have to be spread throughout several departments.

Practically all of the professional

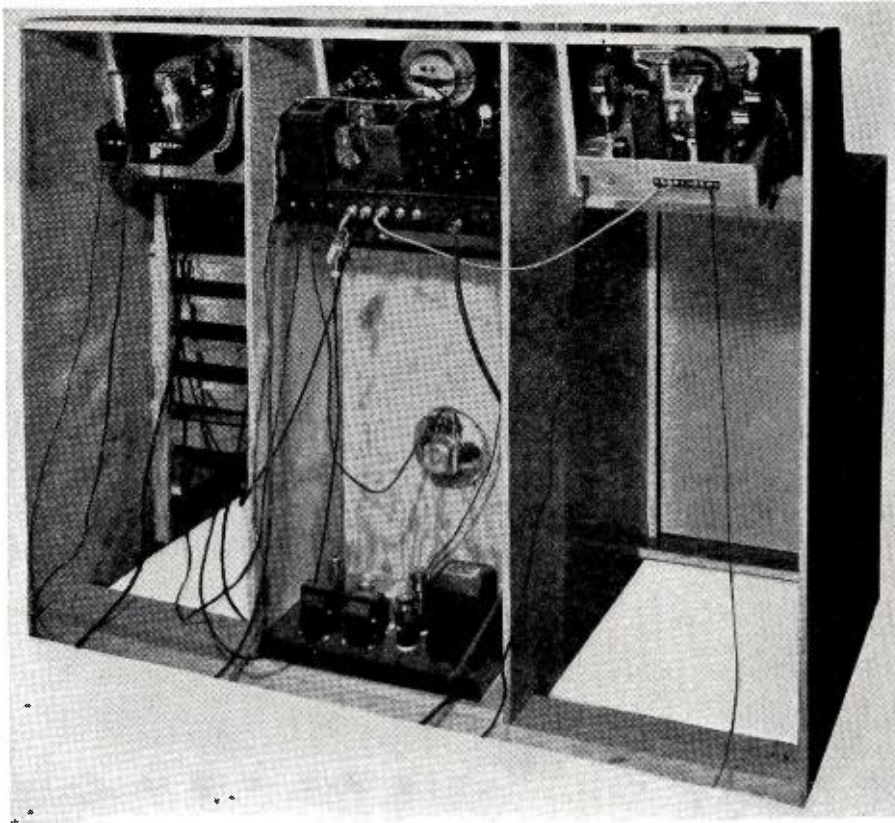

Rear view of the console showing the placement of the various units. The amplifier power supply is on the bottom to avoid hum.

recording studios use the Broadcasters type of console to house their equipment. I arrived at the design of my own particular unit by referring to various catalogs put out by the manufacturers of broadcast equipment. The problem then was to be able to make an attractive looking job with ordinary material, which could be purchased from the local lumber yard. Inasmuch as I wished to have the sloping type of instrument panelling, it was decided to make up the skeleton of the assembly from standard $\frac{3}{4}$ " plywood, which was cut to the dimensions shown on the illustration. Two 8-foot pieces of $\frac{3}{4}$ " plywood were purchased and each of these two were cut exactly in half. These sheets come in standard widths of 2', 3' and 4', and I used the 3' size as being best adapted to the console.

We now have four pieces of material which measure 3' x 4'. These are carefully marked, as indicated, and cut so that they will all be exactly alike. A bit of planing and sanding is now done and these pieces are put to one side. The top piece, which mounts on the four pieces of plywood, is a piece of 1" x 12" and is 5' long. The balance of the assembly is held together with two lengths of 2" x 2"s for the part which will hold the recording tables in place and pieces of 2" x 4"s placed within the two outside compartments so that these will hold the casters.

The framework must be carefully made in order that proper alignment be had. I use standard steel panels for my audio equipment and these must exactly fit into the sections as indicated. Ample room must also be

provided for the turn-tables, as they will vary in dimension.

The photograph shows only one of the tables mounted in place. The second fits into the opening on the left hand side of the console and details of this will be covered in a future article.

A drawer is provided which is large enough to hold many accessories and

is conveniently placed out of the way of the operator. Directly under this drawer, and placed considerably farther back from the front, is mounted a piece of $\frac{3}{4}$ " plywood which serves as the baffle for the monitor speaker. Excellent reproduction is had from this speaker due largely to the amount of baffle realized. Two braces are constructed from scrap lumber so that the plywood will be held rigidly.

It is very important that we provide ample space to store the records made on the equipment. It is imperative that all types of instantaneous recordings be kept away from dust or extremely dry air. The right hand compartment is furnished with a series of wood slides so that standard 16" square record tins may be used and so that these will slip into the slides provided for permanent storage. I might stress the point that most of the better grade of recording discs are rather heavy when several are piled one on top of another. For this reason, the wood slides must be constructed with care. Large flat-head screws are used to hold the slides onto the inside pieces of plywood.

The left-hand compartment will have a similar arrangement with the exception that the discs will be stored in a *vertical* position instead of the horizontal. This compartment will be used, largely, for commercial pressings and an index file will be provided so that easy identification can be made. The construction is clearly shown for the portion which contains the recording equipment, and both sides are identical.

A piece of plywood has been tacked into the center opening which is later to be used to mount a standard re-

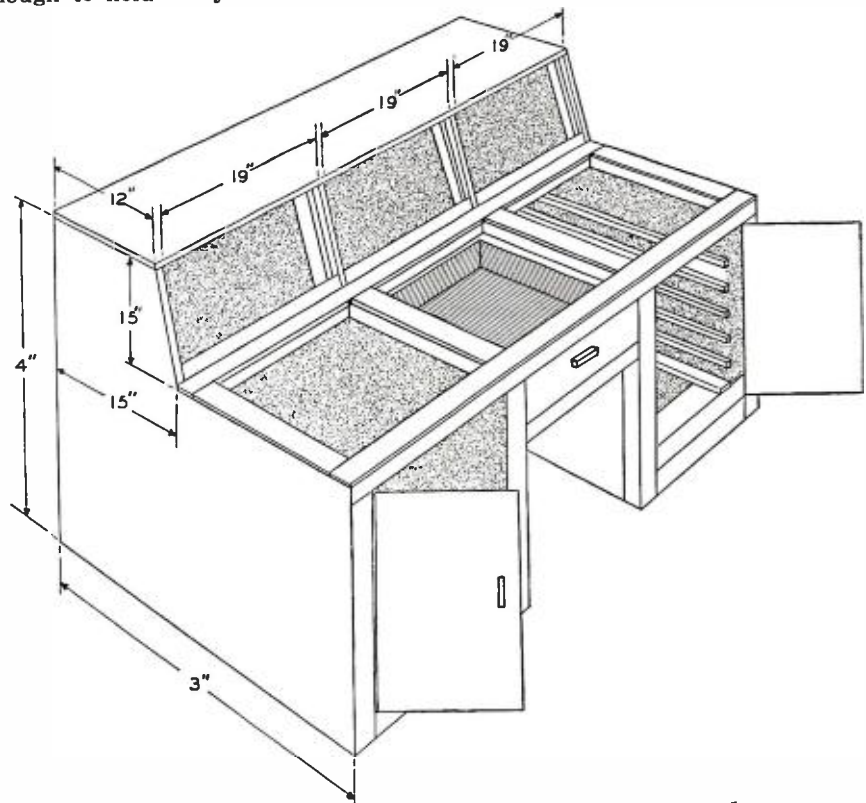

Constructional details of the wooden recording studio console.

cord changer, or for a standard 12" dual-speed play-back table. This will be used for the play-back of commercially purchased records. It might also be of the single speed type, namely 78 r.p.m. This will be a valuable addition to the console inasmuch as certain changes have been necessary when changing over from 16" slow speed transcriptions recorded with "constant amplitude" to standard commercial records which are made with what is known as "constant velocity" cutting.

Small pieces of 1" x 2"s are tacked to the sides of each recessed section. These are set in 1/4" from the edge of the plywood pieces. Standard panels may then be inserted and are held in place with oval head wood screws in conjunction with washers so that they will present a neat appearance.

All parts of the console are carefully sanded before paint is applied. Several long strips of 1 1/2" lath were purchased and these are tacked around the edges of the assembly and are carefully rounded and smoothed. The console is finished in two-tone gray. This paint is of the semi-gloss variety and is neither flat nor shiny in appearance. Heavy truck type casters are used to support the console. These should have extra wide wheels as the combined weight of all the equipment will have to rest upon them. They are screwed securely to the 2" x 4"s on the bottom of the bench and may be seen in the illustration by examining the left-hand compartment.

A word of caution is in order. The size of the bench prohibits its being moved from one room to the other and if one falls under the "transient" category, he should do his assembling entirely by means of wood screws so that the console might later be dismantled for transportation.

Recording Equipment

Starting from left to right, we find the following units, in order: *Meissner F. M. Tuner*; High Fidelity Recording and Playback Amplifier; *Meissner High Fidelity A. M. Tuner*. These units are all mounted on standard 12 1/4" x 19" steel panels finished in black ripple. We have a choice of two entirely different types of radio reception. The new Frequency Modulation transmissions and the universally used Amplitude Modulated signals. The *Meissner F. M. Tuner* comes completely wired and tested and it is only necessary that this be mounted to a steel panel to complete that section. Separate antennae are used for both tuners. The F. M. being supplied with a half-wave doublet, with concentric line to the tuner, while the A. M. tuner utilizes an 8' vertical fish pole antenna with open wire feed. This is of sufficient length so that all local broadcasts may be picked up efficiently without danger of cross-overs from DX stations. It is imperative that we employ tuners that are capable of high fidelity reception if we are to obtain first class recordings.

Recently, we have been making
(Continued on page 49)



WITH all eyes, including those of the radio industry turned towards Washington and what goes on there on Capitol Hill and at the F.C.C., we believed that we should serve our readers best by employing a competent correspondent familiar with the Washington scene to get us the "hot" news. Here then, the Situation from Washington. Until the international and internal crises abate and the threat of war is gone from these shores, this column will continue to give forth the latest,—and wherever possible—the inside of what goes on at the Nation's Capitol that is of importance to radiomen everywhere.

Rigamarole

THE Washington radio scene is one of intense activity, divided into two main objectives. First to bring the communications of these United States up to a Defense par; and second, to stamp out the use of the radio as a means of disseminating information within the 5th Column. It is hard to say which phase of activity has the most push behind it.

IN the communications field, Chairman Fly of the FCC reported in press conference that a Defense Communications Committee was to be organized at the order of the President. At the time that this goes to press, that committee has not yet made its appearance. Chairman Fly said he could not say whether or not he would be a member of the Defense Communications Committee, but did state that the Army, Navy and the Radio Industry would be represented. The power for the President to install such a Committee, Mr. Fly said, rested in the now famous Paragraph 606 of the Act giving the President emergency powers. That no emergency had been declared, seemed no obstacle to the appointment of the Committee, was the opinion of the Chairman. The Committee, when formed, would act to advise the Stettinius Committee in matters concerning communications. Who the members would be was not said.

One of the jobs of the Defense Communications Committee would be the purchase of radio equipment outside of that already ordered by the Government under separate appropriations. It is to be hoped that the purchasing will be centralized in one man or at best a small group. Centralized purchasing will tend to give better buying power to the government dollar, and at the same time eliminate the vast amount of red tape and difficulties usually encountered in government orders. It was indicated that a survey would first be made to determine the type and amount of equipment needed.

TALKING to some of the members of Capitol Hill, it was discovered that while Uncle Sam might have use for 100,000 receivers almost instant should an emergency develop, that no immediate plans had been made to supply these. There is not a single manufacturer who could, at this writing, produce that number of sets, communications receivers, in the month's time that they are said to be wanted. Suggestion was made that the purchasing committee place orders not on the basis of *what kind* of a set (as long as it was a good one, previously acceptable to the industry at large) but on the basis of *how many*. Further information, possibly just rumor, was advanced that the final analysis would show that there was not any reason why several different makes of receivers could not, and would not be

used. There seems little essential difference to communications work between the "Doakes 13 tube superhet" and the "Doe 13 tube super." If this would not work out, there is always a great amount of receivers on the shelves of the jobbers, distributors, and the manufacturers themselves which would more than go half way in supplying the initial demand. No particular difficulty is expected in filling the orders.

TALK abounds as to just where the 100,000 trained radio men will come from to run this equipment. Certainly, there are not that many available even if the Signal Corps and the independent schools work at top speed. Some of these men will come from the ranks of the hams, but probably only from that portion which is now enrolled in the Army Amateur Radio System and the Naval Communications Reserve. These are men already trained in the ways of the Militia, and they would be our first line of radio defense. The rank and file of the hams, however, will make excellent transmitter maintenance men, since that has been the more virile part of their hobby. The servicemen for some part will find themselves in the maintenance-of-receiver-group. This, because they are trained to service and maintain almost *any* kind of receiver. Of course, all this is "paper" work, and the emergency might never occur where the government would actually be pinched for trained men, but could supply them itself through its regular channels.

INFORMATION has leaked out, that not the least part in the success of the German offensive, and the concurrent failure of Norway, Holland, Belgium and finally, France, lies in the superb communications system which was able to establish and maintain communications with moving tanks and troops at as great distances as 250 miles from home stations. Nothing available over here can touch that at present. Development work along lines towards obtaining long range mobile type of equipment will probably be done jointly by the Government and the great body of American Hams.

Already some have indicated that the Germans took away just enough of frequency modulation via General Electric's engineering office, where a prominent Nazi engineer is known now to have worked, that FM may be the solution.

THAT some work by the Government is being done with FM is to be found in the recent news report that airways beacons in Alaska will be on Frequency Modulation and not Amplitude Modulation. This, with the increased Army personnel just sent there will afford a complete test of the system in a land where static of the aurora borealis and snow, not to mention the motors (the Alaska Army detachment is fully mechanized) will give the first opportunity for testing FM on *long waves*. This is just a presumption on the part of this column, and based on the fact that usual airline beacons are to be found in the neighborhood of 278 kc. Were the tests to be tried in continental United States on that particular frequency, the interference to present systems would be terrific.

Amateurs, too, are to be asked to help by devoting much of their time to perfecting mobile equipment both of the FM and AM type.

Finger Prints and Such

THE move to fingerprint every radio operator is the result of the FBI's discovering that the radio waves were being used in subversive element work. If anyone imag-
(Continued on page 61)

Serviceman's Experiences

by LEE SHELDON

Chicago, Illinois

There is nothing so true as the statement that the boss never can take a vacation, as Lee finds out.

THE weather was so pleasant when I came into the shop Monday morning I hated to start work. Al was already clearing the bench of the past week's debris; we had stayed open until after midnight Saturday to make the last of the day's deliveries.

I tore a page off the calendar and remarked wistfully:

"How time flies!"

My partner stopped work and turned to me. "I can tell from the tone of your voice," he said, "that you have more on your mind than sand running through a glass funnel. Come to the point, and let's get back to work!"

"Well," I parried, "it's getting rather late in the season. The weather is wonderful, and I was thinking how nice it would be to take a vacation."

"Every time you think it costs us money," Al replied. "It's not the weather alone that makes you think of taking time off—it's the feeling of indolence which invariably comes to you following each period of good business. Whenever you have a few more dollars than usual in your pocket you want to lay down on the job."

"Year after year—" I began.

"Why don't you use some of the money we get during business peaks to fill in the hollows?" he continued. "Every time you get more than five bucks in your pocket you run around like it's your last day on earth!"

"I worked *very* hard last week," I pointed out, "and that's another good reason for taking a vacation. See how pale I am. Look—my knees bend in both directions. I've been overdoing things—I can't *stand* it any longer!"

"Baloney!" Al replied, coming as close as he ever gets to delicacy. "During last week's flurry—for the first time since we've been in business together—you had a wide-awake gleam in your eye. You were doing good work, doing it rapidly, and were well in the swing of things. You never looked healthier in your life."

"Al," I declared firmly, "there comes a time in every man's career when his esthetic nature demands attention; a time when routine becomes unbearably revolting; in brief, when he's fed up. *This is it!*"

"Listen, my former friend," Al said, throwing a handful of small parts against the meter panel, "when you and I went into business together, we both realized there were only two of

us to take care of the store. We realized that if one of us fell sick, the other would have to lead a double life to help the other through the emergency. Today, in good health, you want to walk out on me. Fine partner *you* are!"

"Do you mean to stand there and tell me," I shouted, "that it's wrong to take a vacation? Everyone knows—"

"Look, Lee," Al said, lowering his voice but not his guard, "I know I can argue you out of taking a vacation; but I also know that if I do, you'll still believe you deserve one. In such a condition you won't be of much use in the store. Go *take* your vacation!"



"Hurry up and repair that radio. You do want to be rescued, don't you?"
"Can't say that I do!!!"

I'll hire a girl to answer the 'phone, and do both the inside and outside work while you're away. It'll be worth the expense and suffering to have you work the martyr complex out of your system!"

That softened me a bit. "Thanks, fellow," I said, "anything I can do before I leave?"

"Yes," he replied. "Listen to this and remember it: a businessman must take work whenever it comes. If trade is too good he shouldn't leave on a vacation because he loses money; if it's too bad, he should stay and *make* money. At infrequent intervals there may be a middle period when he can

take time off; but even then—no matter where he is or what he's doing, he should remember his store instinctively. I am disappointed to learn you lack such instinct, for we will never be really successful if you haven't got it. A man in business for himself never is able to 'let himself go' like a man on straight salary. Bitter medicine, but it's one of the penalties we must pay when we own a small store."

I ran home, packed, and got a timetable for Wet Lake. The next train was scheduled to leave at noon. On the way to the station I dropped off in Bill White's fishing tackle store on Steinway Avenue.

"Bill," I said, "give me a pole and a good lure. I'm going on a week's vacation."

"Great!" he replied. "Here's a snappy number—an eight-foot *Montague* rod. Hang a *Kid Flasher* lure on it and the fish will climb trees after you!"

I felt new blood run through my veins as I whipped it back and forth.

"Wrap it up," I said in happy anticipation. While he was writing the receipt, I noticed his clerk tuning a midget. He was having trouble, and—naturally—I was interested. Bill noticed me watching the set and straightened up from the counter.

"That set's been acting bad lately," he remarked. "Why don't you take a look at it while you're here? Been meaning to call you, but—"

"Nothing doing," I said. "I'm on a vacation. Call my partner."

"I don't know your partner," White replied. "Besides, did I make any lame excuses when you asked me for tackle?"

Of course, I didn't want to offend him. "Gee, Bill," I stalled, "I haven't even got my tools with me."

"Elmer," he called to his clerk, "run over to *Salutary Sales & Service* and get Mr. Sheldon's tools!"

After that, I barely made the one-fifteen. I sat in the coach, catching my breath for a while; then I looked about. The man across the aisle from me was operating on a battery portable, using a nail file as a combination screwdriver and probe. Finally, after he wedged the blade under the chassis and began to poke, I couldn't stand it any longer.

"Don't do that," I ordered. "You'll blow something out!"

I opened the toolbag and went to
(Continued on page 64)

BENCH NOTES



by **LEE WARD**

Service Manager, San Francisco, California

A lot of odds and ends including some of Ward's awards, are the subject of this month's column.

Modern Minstrelsy

ONE night after work, while walking *Pups* (the wife's pedigreed bonechaser) we passed a vagabond guitarist. No unusual city sight, but *this* fellow was using a contact mike and portable amplifier.

Always on the alert for trade, I strained back on the leash and handed my business card to him. He laughed and said he took care of his own repairs—used to be a serviceman himself.

Had me worried for a while—until I checked up and found there were no strings in my horoscope.

Clapograph Details

THE announcement, in the May issue, of a visible-meter method of indicating applause brought forth requests for further information. The manufacturers — *Atrutone Laboratories*, Chicago—forward the following:

"The entire set-up, including amplifier (see diagram), meter, lenses, photoflood, and a small fan for cooling it are enclosed by a carrying case with a projecting lens barrel. Holes are drilled in the bottom and top to increase heat dissipation, and they are shaded with fins to prevent light from coming through the holes.

"The meter case is removed and the mechanism and needle are inverted so the needle will swing clear of the magnet. A transparent meter scale is mounted between the lamp and first lens (as shown in the second diagram). The adjustment between the photoflood and meter scale is critical. The light should shine directly in the center of the scale so that the figures of the scale are shown on the screen with equal clarity.

"To adjust for operation, call for test applause and set the gain control at 0.6 of full scale deflection. The 0.4 margin will be necessary on peaks when the judging narrows down to the last few contestants."

Many thanks, *Atrutone*. Some of the readers have tried similar stunts, but have had trouble. This should help them.

Tough Job

TWELVE serviceman's duties are outlined on a throw-away which comes to this desk indirectly from a tire company. Stretching their field of endeavor, they inaugurate a radio repair service. Their 6"x9" card, having all the concinnity of a circus poster, announces a trial job is available for "\$1.25—regular price \$2.50."

Service includes (2) "x-ray all tubes," (4) "compensating condenser adjusted," (6) "clean exposed volume control," and (11) "speaker checked for vibration."

However, new and appealing the plan, it will eventually end in failure. One of these days a "factory-trained" man is going to come across a speaker that *doesn't* vibrate.

Initiative

THE photos on this page show Serviceman Henry Farber's workbench improvement after guidance by the well-known RADIO NEWS departments RINGING THE BELL and BENCH NOTES.

Farber is located in Grand Rapids, Michigan, and—since the city is sometimes known as "Jerusalem of the Nation"—he publishes a quarterly booklet of religious program schedules. Gets requests from as far out as Sheboygan and Kalamazoo.

Sent one to the Governor—religious
(Please turn the page)

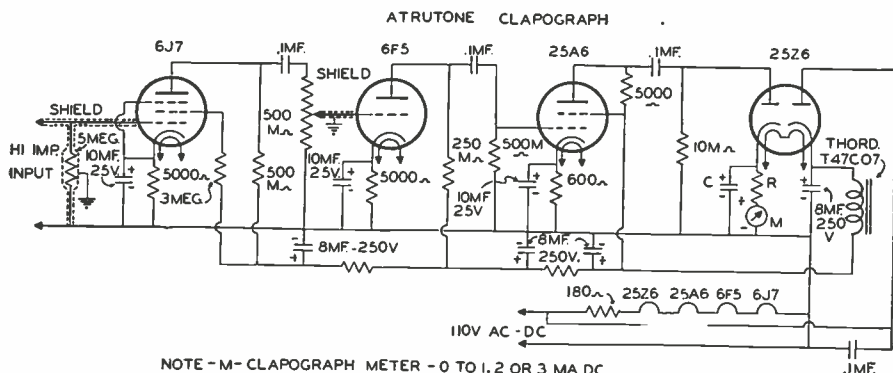

NOTE - M - CLAPOGRAPH METER - 0 TO 1.2 OR 3 MA DC.
 REMOVE CASE AND SUSPEND BEFORE LENS
 R - METER MULTIPLIER - CURRENT LIMITER APPROX. 5M.
 C - TIME CONSTANT CONDENSER TO SLOW METER MOVEMENT APPROX. 50 MF

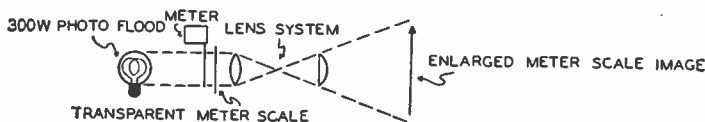

A diagram of the highly prized, and sought-after, "Clapograph."



The influence of Bench Notes and of Ringing The Bell can be seen in the improvement in this service bench.

by national reputation—and received a letter of thanks in reply.

Ward's Awards

REPAIRMAN'S RIDDLE NO. 6, involving a hold-up man and the problem of getting rid of him quickly, brought forth some exciting solutions. Many of them were dependent upon props not mentioned in the story for their success.

Two men were in the store; the problem was to get the suspicious character out without violence or the use of weapons. The simplest way would have been for Pete to come from the back room and stand in a line drawn through Lee and the robber. This could be done casually if Pete pulled the radio from the right wall and pretended to work behind it. If the robber moved to right or left, so would Pete. No gunman likes to work with a person on each side of him—not even a two-gun artist would feel at ease if he had to cover victims 180° apart. The smart thing was to get the gunman out of the store under his own steam before a stickup occurred, rather than to overpower or outwit him after he had decided to pull his gun.

Comment

Serviceman G. A. Wall of Fort Lauderdale, Florida, states:

"As the thug approaches the till, Mr. Ward rings 'no sale.' There before the eyes of all, lies one Canadian nickel, two cents change from the purchase of a .01 mfd. bypass condenser, one Majestic knob, and one and one-half inches of brightly-colored spaghetti. Meanwhile Pete has made his exit through the rear door and announces his arrival at the front window with a loud Bronx cheer. This embarrasses the thug no end."

A New York serviceman describes a burglar-frustrating apparatus using a loudspeaker, and adds he has rigged the arrangement up to protect his own store. Then he says: "I am most anxious to have a chance to try it out, but please give me no publicity in this connection."

James Scott of Dearborn, Michigan, says that "Pete either shorted out an outlet to blow the fuses . . . thus turning off the lights and leaving all and sundry in the dark. I am also somewhat in the dark as to how this would work in a daylight stickup but with a good many brethren and their dust and dirt covered windows, it could take care of any situation."

There's a legitimate crack if there ever was one. How long's it been since your windows have been washed down? Mine? Oh, well—that's different!

The Winnahs!

JAMES HARILLD HOOD of 37 Club Drive, Greenville, South Carolina, takes first prize—a 0-1 milliammeter.

Second prize—Ghirardi's *Radio Trouble-Shooter's Handbook*—goes to Hideo Ito, 3048½ Eagle Street, Los Angeles.

(Continued on page 61)

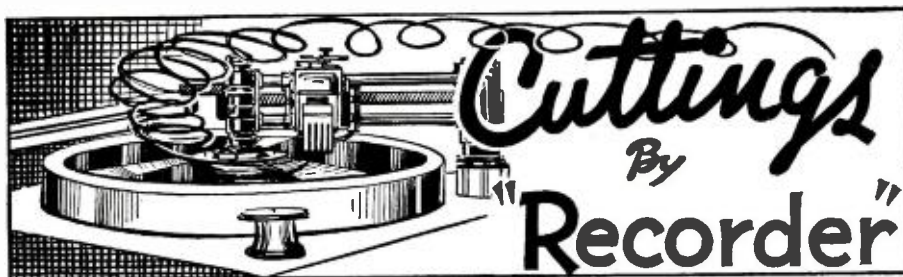

Manufacturer's Specifications

Make: RCA Victor.
Model: M-12701.
Manufactured by: RCA Manufacturing Co., Inc., Camden, N. J.
Motor: Synchronous — 105-125 volts, 60 cycles.
Turnable Speed: Standard 78 rpm.
Cutting Head: Magnetic type, low impedance.
Drive: Rim driven.
Amplifier: Self-contained, Power output 3 watts at 5% max. distortion.
Tube Complement: RCA—6J7, 6J7, 6F6.
Feed: Undercarriage feed screw type, adjustable.
Microphone: Aerodynamic, high-impedance.
Turntable: Heavy 12" weighted type for smooth cutting.
Remarks: Cuts record blanks up to the 12" size at standard speed of 78 rpm. Attractive, gray carrying case with handle. Volume indicator meter. Tone and volume control. Completely self-contained. All necessary elements for recording and reproducing, including RCA Aerodynamic Microphone. Employs outside-in recording method.

Description

The MI-12701 is a portable type instantaneous disc recorder consisting of a turntable, cutter head, pickup head, 3 watt amplifier, dynamic speaker and MI-6228 type microphone. The turntable speed is 78 rpm. and the turntable will accommodate discs of any diameter from six to twelve inches. The MI-12701 Recorder is for use on 105-125 volts a.c., 60 cycles only. It is recommended that RCA instantaneous Recording discs be used for recording with this equipment.

The equipment may also be used for playing standard 78 rpm. records. RCA Victor Green Shank Chromium Needles are recommended for this use.

This instrument will record and instantly play back records of the lacquer coated aluminum disc type. Either a steel or sapphire cutting tool may be used. The steel cutter is satisfactory for approximately 15 minutes of actual recording after which it must be discarded, while the sapphire can be used for approximately 12 hours of recording and then may be returned to the factory for re-sharpening. Records made with a sapphire cutter tend to have less surface noise than records made with a steel cutting tool, however, the surface noise is very low on records made with either type of cutter.

The feed screw should be adjusted so that it has a minimum amount of end play yet re-

tates freely. Loosen the two set screws before attempting to adjust the cone pointed end play screws. The feed plate should be adjusted so that there is no back lash and no play between the feed plate and the feed screw.

The motor should be adjusted so that when the motor switch is in the "off" position, the motor pulley does not touch the edge of the turntable. When the motor switch is in the "on" position, the motor pulley should engage the turntable securely. This adjustment may be made by loosening the right-hand motor mounting screw and moving it in its slot in the desired direction.

A flat bronze spring for adjusting pickup needle pressure on the record is located between the tone arm and its horizontal supporting arm. This spring should be bent upward or downward as necessary so that the pickup needle pressure on the record will be approximately three ounces.

The feed screw and feed plate should be lubricated every two or three months with a small amount of clean high-grade light body grease, such as vaseline.

The motor should be lubricated about every 500 operating hours with a few drops of S.A.E. No. 50 oil placed in the two red oil holes one at each end of the motor. Access to the motor is gained by removing the motorboard.

The pickup used is of an improved design. The horseshoe magnet is rigidly welded to the pole pieces and is irremovable. There is a centering spring attached to the armature to maintain proper adjustment and to provide a limiting effect on the movement of the armature. The frequency response is substantially uniform over a wide range.

The viscoloid damping block which is attached to the front end of the armature shank serves as a mechanical filter to eliminate undesirable resonances and to cause the frequency response to be uniform.

Loss of magnetization will not usually occur when the pickup has received normal care. When the pickup has been mishandled, subjected to a strong a.c. field, jolted, or dropped, there may be an appreciable loss of magnetic strength, in which case it will be necessary to remagnetize the entire structure. To do this, it will be necessary to first remove the pickup mechanism from the tone arm, and then remove the magnet assembly. Place the magnet assembly on the poles of a standard pickup magnetizer such as the RCA Stock No. 9549 Pickup Magnetizer and charge the magnet in accordance with the instructions accompanying the magnetizer. It is preferable to check the polarity of the pickup magnet and to remagnetize it so that the same polarity is maintained.

Comments: Several records were made on various classifications of discs. These ranged from the 6" size, to the 12". Some of these blanks were of the "cardboard base" type, while others featured the metal base. The cutting was unusually quiet and accurate. The noise level was kept to a minimum for inexpensive discs — due mostly to the efficiency of the magnetic cutting head. Standard test records were played back and the response checked. The fidelity was excellent and the range was wide enough to include all types of performances. The recorder, using the rim type of drive, runs smoothly and without waver. This is important if one is to enjoy sustained notes that will be free from "wows" that would be caused by any variation in speed.

The microphone furnished with the complete instrument proved to be one of the best we have seen for the home recordist. Being of the dynamic type, it lends itself:

(Continued on page 60)

Ring the Bell

The author describes how the serviceman, too, can help in National Defense Plans.

by **SAMUEL C. MILBOURNE**

Expert Serviceman, Greenwood, Miss.

THESE are grave times for all peoples of the world. As this article is being written, the *Allies* teeter on the brink of an international catastrophe.

The *United States* has awakened to the fact that we must build up our defenses against the enemy without and the enemy within.

"Trojan horse" and "fifth column" activities bid well to hold our national attention for months to come. Espionage and sabotage activities will undergo the strictest scrutiny, and anti-American organizations and individuals will be tracked down.

Now, this may seem an odd way to begin a monthly article on "Ring the Bell," but does it not appear more and more clear to you that all of this anti-spy activity cannot be completely effective unless every one of us participates in helping root out the weeds of subversive activities? Is it not quite understandable that inasmuch as we are a part of the great American *communications* industry that, as a vital part of our national life, spies and saboteurs will no doubt aim some of their activities communication-ward? Does it not seem reasonable that we,

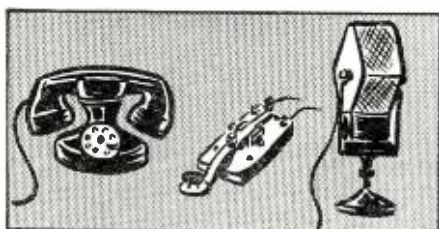

Telephone, telegraph, radio and allied means must guard against saboteurs.

as practicing radio service men who have entrance into all types of homes and businesses, could act as "listening-posts" against such anti-American activities?

Let those of you who think that the writer is calling "Wolf" look back over the results of the present world war. Nations died with hardly a struggle because they were so attacked from within that resistance became rout and democracy became but a death rattle.

Liberty is kept only at the price of eternal vigilance! And, liberty as we know it, is more precious than life itself!

"Well, Buddy," you say, "all that's O.K. and I agree with you 100%, but what can I do as an ordinary radio service man to curb anti-American activities?"

That's a fair question and the answer is contained in four words—**KEEP YOUR EARS OPEN!**

There are some 40,000 radio service men throughout the United States and they are located in almost every city, town and hamlet. Besides this group, there is an even greater group of radio amateurs. Here is a formidable army of real Americans who can act as "ears" for our Government.

For instance, you are called to repair a radio receiver. The customer states that he is most interested in getting the short-wave band playing at its



Keep your eyes and ears open but your mouth closed. Do not usurp authority.

best because he listens to the foreign stations. Now, there is certainly no harm in his listening to the foreign stations, and we might think nothing of the matter, but in casual conversation the customer shows that he holds positive convictions for a type of government not democratic in principle and further shows that he listens regularly to that country's programs. It would be well for the service man to keep such a person in mind against the day when such information would prove valuable to the government.

Let us suppose that you are a radio amateur and in the course of your hobby you happen to tune in on a coded message from a station operating in the ham bands or on some frequency which is not regularly occupied by a commercial station. By all means get the message and keep watch on that frequency for other messages. If activity is shown, get as many of the messages as possible and forward them to your F. C. C. district office, or to the F. B. I. district office with full particulars. At the time of this writing F. C. C. regulations prohibit the ex-

change of messages between a ham in the U. S. and one located on other than U. S. territory. Also the *coded* (not *code*) message is banned.

Several states have set up or are considering the setting up of intra-state volunteer secret service organizations. Find out if your state has one and offer your services. You may be the means of rooting out activities which are against the country's best interests.

Now, I want to emphasize the fact that *the average volunteer is more hindrance than help because he doesn't use his head.* The usual result is to stir up more "mare's nests" than six Federal agencies can cope with. Sometimes well meant but over-enthusiastic exposing of subversive activities flushes the birds before the hunter is ready to shoot.

Remember, you are most effective when you use your **EARS** and under no condition should you use your *mouth* or *physical force*.

These activities come under *federal* investigation and enforcement. Thus, it is well to turn over all pertinent information *directly* to the F. B. I. or the F. C. C. Local enforcement officers, no

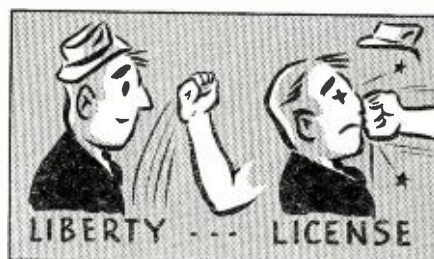

If you threaten, that's liberty; but if you punch him,—that is license!

matter how interested or zealous, are not trained in this work any better than you are.

If you do not know the address of the nearest F. B. I. office, merely address your letter to:

FEDERAL BUREAU
OF INVESTIGATION,
WASHINGTON, D. C.

If the report is of an infraction of an F. C. C. ruling, address your letter to:

FEDERAL COMMUNICATIONS
COMMISSION,
WASHINGTON, D. C.
Another method of co-operating

with the Government's anti-American round-up is to help sponsor *pro-American* activities. In the years since the last war, we have slipped badly in our patriotic duty as citizens of the United States. We have made the prize an easy one. We have not insisted upon proper respect toward our flag and toward the country it represents. We have allowed *license* in the name of *liberty*.

I think that the old farmer's differentiation between *liberty* and *license* is the clearest and simplest of all.

"*Liberty*," said the farmer, "is when you wave your fist in front of my nose. *License* is when you get too close and hit it!"

License is when you get too close and hit it. Anti-American activities are definite *hits below the belt!* It makes no difference who does the hitting. It makes no difference whether the hitter is American or foreign born. He must be stopped if we expect to hold

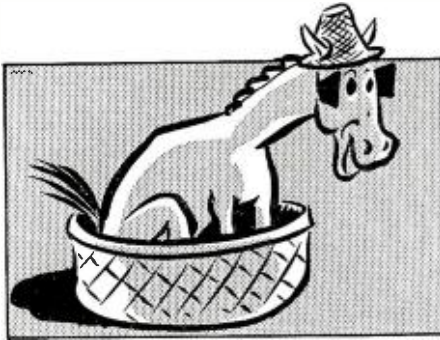

Don't stir up a mare's nest! Be sure of every bit of your information!

that which to us is worth so much—our liberty!

Thus, you can start right at home by being a good American yourself. Guide your own life and your own business according to the high precepts of *the American way of life*. Rekindle the fires of patriotism in your heart—they're only smoldering now. Pay your respects to the flag when it passes—salute it according to your privilege.

See that the schools in your town display the flag of the United States. Insist that every child (and every teacher too) takes a daily oath of allegiance. Help sponsor public patriotic gatherings at which the National Anthem is sung and the Oath of Allegiance taken. Push, actively, laws requiring the daily reading of the Bible in all public schools. Whether you be Jew or Gentile, Catholic or Protestant, the acknowledgment of a supreme God on high is the corner-stone of democracy. We can afford to forget our petty religious differences and unite under one banner—Old Glory—to fight, if necessary, for our civic and religious liberty, and the defense of our Homeland.

If there be those who read and think that this is too "war-like" an attitude, let them strike the blinders from their eyes and look at the situation realistically.

(Continued on page 65)

SERVICEMEN'S LEGAL ADVICE



IN last month's issue, we discussed the negotiability of notes and checks and pointed out the distinction between a note and a check. In this issue, we discuss other phases of checks and notes and start with a discussion of post-dated checks.

Let us assume that a service man completes a job on the 10th day of a month and the person for whom the work is done gives him a check dated twenty days later, bearing date the 30th day of the month. This would be a *post-dated* check. A post-dated check is one containing a later date than that of delivery. The presumption is that the maker has not sufficient funds in the bank at the time of giving it, but that he will have enough funds at the bank on the date of presentation. Such a check is payable on or at any time after the day of its date, the effect being the same as if it had not been issued until the date which appears on the check. The bank will not pay the check if it is presented earlier than the date appearing on the check.¹

If a *post-dated* check is, before its date, delivered to the bank on which it is drawn, the bank has no authority to pay the check, the check, not being payable until the date appearing on the face of it. A *post-dated* check is in effect a promise to pay in the future, the future being the date appearing on the face of the check.

Frequently, the writer of a check will write on the margin or on the body of a check a memorandum of the purpose for which the check is delivered. This is for the convenience of the check writer in order to preserve a record showing the purpose for which payment is made. Where a check is delivered to a service man, containing a memorandum setting forth the purpose for which it is delivered, he should see to it that the memorandum accurately sets forth the transaction involved. For example, if a check is delivered on account of a job, the memorandum indorsed on the check should not recite that it is in full payment of the job, but merely a payment on account.

Where a job is sizeable, a service

man will want the check certified. Under the *Negotiable Instruments Law*, where a check is certified by the bank on which it is drawn, the certification is equivalent to acceptance of the check. The effect of the certification of a check by the bank before its delivery to the person to whom the check is payable, is that the bank guarantees the genuineness of the signature of the writer of the check, and that the bank has in its custody sufficient funds to meet them, and it agrees that the money shall not be withdrawn to the prejudice of the holder of the check. This transaction of certification is between the maker of the check and the bank; the person to whom the check is made, in such a case is not a party to the transaction and is not bound by it.²

In a case where a bank certified upon the face of a check "good when properly indorsed," that means an acceptance of the check by the bank according to its tender; that is, a formal engagement that the check has the genuine signature of an existing maker, and that he has authority and capacity to make the check and that the person to whom the check is drawn actually is a "real" person and that he exists and has the capacity to indorse, and the bank will pay the check when it is duly presented, and indorsed.³

Where the person to whom the check is drawn causes it to be certified, the maker of the check is thereby discharged, but if the maker causes its certification before delivery to the payee, the maker is not discharged from liability in case the bank fails to pay the check; though in the latter case, the bank is not liable to the maker but to the person to whom the check is drawn.

In any sizeable transaction, the service man should see to it that the check he receives is certified, particularly where the credit of the person with whom he is dealing is doubtful. By the certification of a check, the bank represents that it has on deposit the amount of the check and agrees that it will retain the amount and apply it in payment of the check, if it is indorsed by the service man.

It should be remembered that a certification should be in writing; the writing constituting the certification will appear on the face of the check. A mere telephone inquiry to a bank inquiring into the worth of a check, does not constitute a certification. Thus an inquiry over the telephone of the bank whether a check is "good," and the bank replied that it was "Perfectly good" is not sufficient, for should

(Continued on page 52)

1. Frazier v. Thoms Printing Company, 60 N. Y. 678.
2. Cullian v. Union Surety, etc., Company, 79 App. Div. 400.
3. Adams v. Manufacturers, etc., Nat. Bk., 116 N. Y. S. 595.
4. Schlessinger v. Kurzrok, 94 N. Y. S. 442.
5. Schlessinger v. Kurzrok, 94 N. Y. S. 442.
6. Lyons v. Union Exchange National Bank, 150 App. Div. 493.
7. Davenport v. Palmer, 211 N. Y. 556.
8. Mitchell v. Surety Bank, 147 N. Y. S. 470.
9. Hintz v. National City Bank, 144 N. Y. S. 979.
10. Palmer v. Stephens (1 Derrio 471), N. Y.
11. Crandall v. Rollins, 82 N. Y. S. 317.
12. Brooklyn First National Bank v. Wallis, 150 N. Y. 455.
13. Section 38, N. J. L. (N. Y.).
14. Eldridge v. Husted, 52 N. Y. S. 681.
15. Sect. 37 N. J. L. (N. Y.).

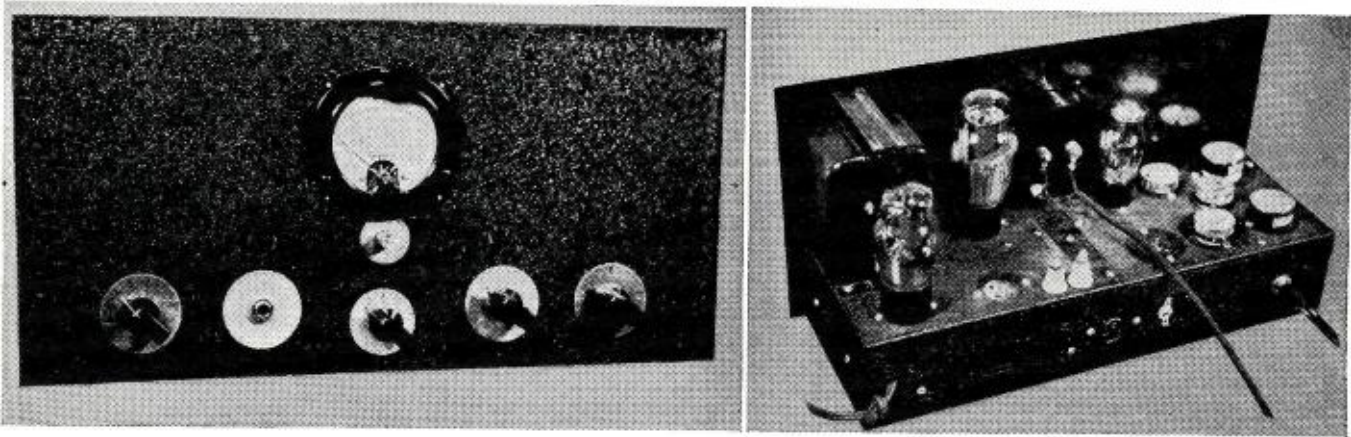

Front and rear views of the 3-band exciter. Looks just like newly built, doesn't it?

Converting the "All-Star" Jr. Receiver to a 3-band Exciter

by PAUL V. TRICE, W8QHS

Sharon, Penn.

Converting what was once a very popular receiver into a fine 3-band exciter, should appeal to "All-Star" owners.

THE fact that an Emergency layout is an essential addition to any Ham station was probably the deciding factor in the evolution of the *All-Star Jr.* Receiver, after a new station receiver had been secured. But the final results were much better than what was originally expected of the old inhaler. Its features include a 350 volt power supply which can be used independent of the rest of the transmitter, for experimental purposes; a low powered xtal osc.-r.f. amp. which can be operated from the 110 volt a.c. source or used with Emergency power such as batteries, Gene-

motor, etc.; and also a station exciter.

The r.f. transmitter-exciter has provision for three-band operation; choice of 6 crystals by switch selection, and choice of either band-switch coils or plug-in coils. If economy is desired in building the rig, the original plug in coils of the receiver can be rewound for the transmitter, but for ease of operation and at slight added expense, the band-switch coil is much preferred. Needless to say both were tried and worked very well.

In changing the *All-Star* over for use as a transmitter-exciter, all parts are removed from the chassis except

those of the power supply, the output of which is wired up to the socket at the rear of the chassis which formerly served as outlet for the dynamic speaker in the receiver. The power supply is *not* grounded to the chassis at this point, but rather through the cable which connects the r.f. and power supply. After all parts have been removed, new socket holes are punched (as shown in the chassis diagram) at the points formerly occupied by the i.f. transformers and the b.f.

(Continued on page 43)

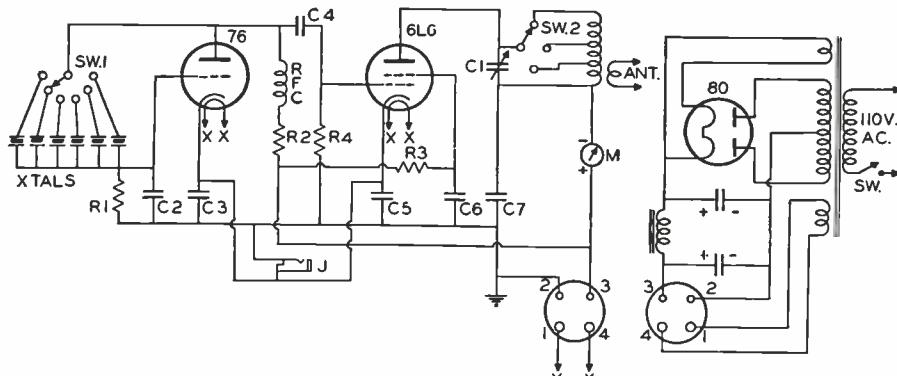

Circuit of the converted "All-Star Jr."

C₃, C₄, C₅—.0001 mf. mica
 C₆, C₇—.1 mf. 400 v. tubular Solar
 J—closed-circuit jack Mallory
 RFC—2½ mhy RF choke Millen
 S₁, S₂—6 point sw. Mallory
 M—0-100 DCMA Triplet

R₁—50,000 ohms 1 w. IRC
 R₂—10,000 ohms 1 w. IRC
 R₃—7,500 ohms 1 w. IRC
 R₄—50,000 ohms 1 w. IRC
 C₁—140 mmf. Hammarlund
 C₂—.0001 mf. mica Solar

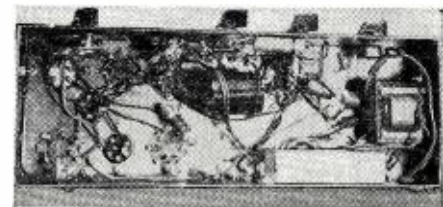

Underchassis view of the exciter.

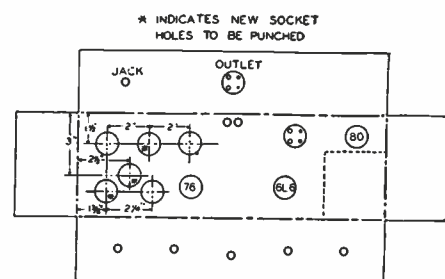

Chassis placement diagram.

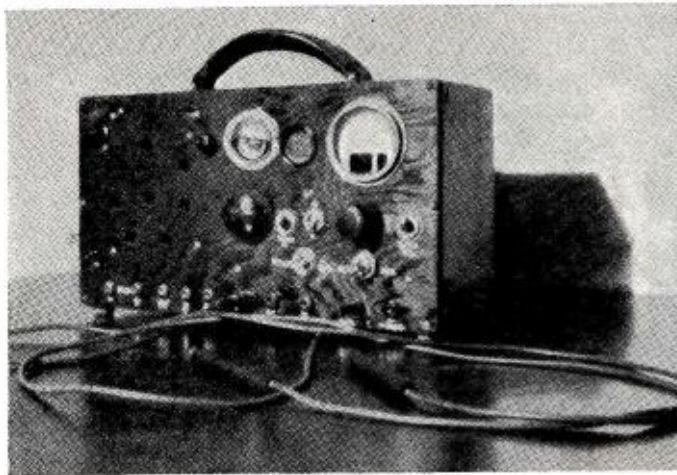

A front view of the portable tester.

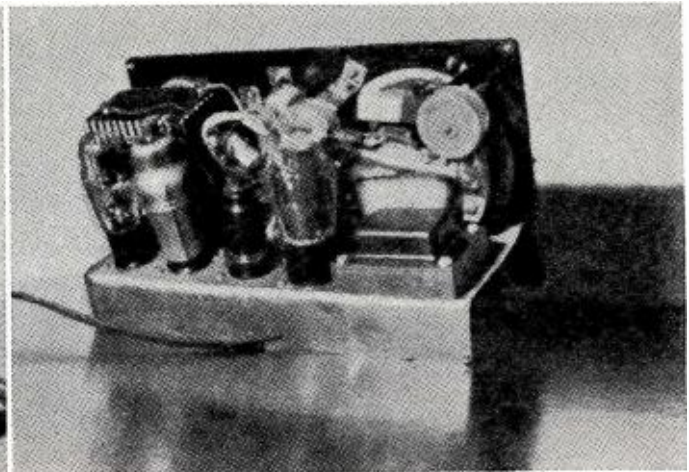

Rear view of the tester. Note compactness.

PORTABLE TESTER

by JAMES R. BLUNDIN

Mt. Carmel, Penn.

While the individual circuits are not original, the idea of placing four units into one case merits the attention of every energetic serviceman.

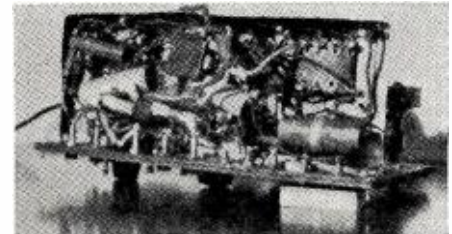

Underchassis view of the tester.

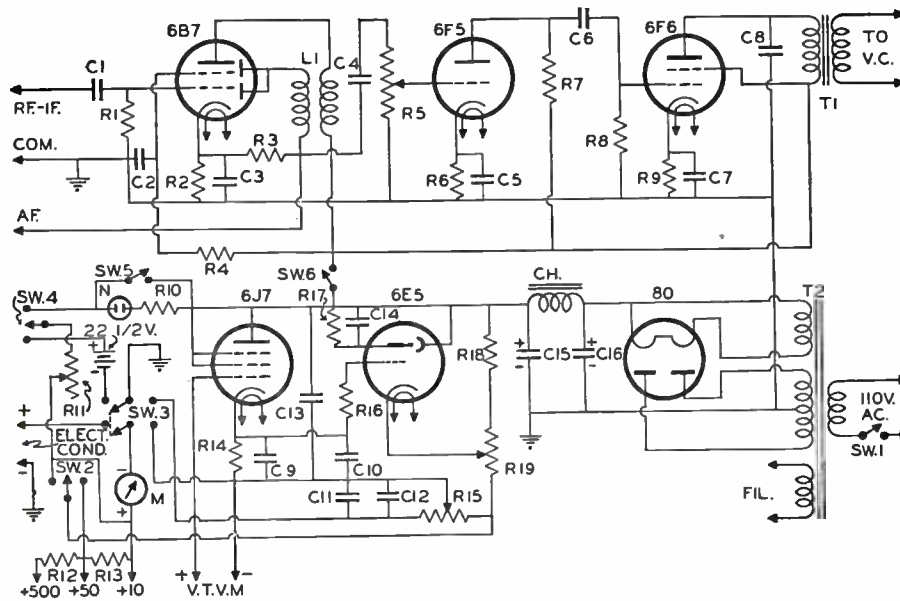

Circuit diagram of the portable tester.

- R₁—2 meg. 1/2 w. Centralab
- R₂—300 ohms, 1 w. Centralab
- R₃—250,000 ohms 1 w. Centralab
- R₄—5 meg. 1 w. Centralab
- R₅—5 meg. control Mallory
- R₆—5000 ohms 1 w. Centralab
- R₇—100,000 ohms 1 w. Centralab
- R₈—5 meg. 1/2 w. Centralab
- R₉—500 ohms 1 w. Centralab
- R₁₀—50,000 ohms 1 w. Centralab
- R₁₁—Bradleyohm
- R₁₂—90,000 ohms 1 w. Centralab
- R₁₃—8000 ohms, 1 w. Centralab
- R₁₄—2 megohms 1 w. Centralab
- R₁₅—10,000 ohms 10 w. Utah
- R₁₆—100,000 ohms 1 w. Centralab
- R₁₇—1 meg. 1/4 w. Centralab
- R₁₈—25,000 ohms 1 w. Centralab
- R₁₉—3000 ohms pot. Mallory
- C₁—.0001 mf. mica Solar

- C₂—.1 mf. 400 v. Solar
- C₃—.05 mf. 400 v. Solar
- C₄—.01 mf. 400 v. Solar
- C₅—10 mf. 25 v. electro. Solar
- C₆—.1 mf. 400 v. Solar
- C₇—10 mf. 25 v. electro. Solar
- C₈—.006 mf. mica Solar
- C₉—.01 mf. mica Solar
- C₁₀—4 mf. paper Solar
- C₁₁—.01 mf. mica Solar
- C₁₂—4 mf. paper Solar
- C₁₃—.01 mf. mica Solar
- C₁₄—.1 mf. paper Solar
- C₁₅, C₁₆—8 mf. 450 v. Solar
- N—1/4 w. Neon Bulb
- M—0.5 DCMA Readrite
- CH—Speaker field, Utah
- T₁—Output trans.
- T₂—Replacement power transformer
- L₁—175 KC closely-coupled IF coil

THERE comes a time in every service shop when one becomes dissatisfied with the equipment available no matter how extensive it may be, and the urge creeps in to make something different. It was during one of these times that the writer conceived the idea of building an instrument that would incorporate all the necessary equipment that the normal service job requires, without the necessity of using a half dozen pieces of test equipment that clutters up the bench, when one box with one power supply will do the same thing.

No originality is claimed for the circuits of the various instruments involved, but the combination of the four into one compact job is the purpose of this article.

First, we will start with the power supply. This is conventional as far as power supplies go. Any suitable transformer of about 650 or 700 volts across the secondary will do provided that it has a 6.3 v. filament winding. Incidentally the smaller this transformer is the better it will serve on account of the compactness of the instrument.

Any suitable chassis or cabinet that you may have around will suffice as long as you use small enough parts to fit it. The one we used was a discarded R.C.A. IIIA cabinet, with a chassis made from some scrap block tin. The size is approximately 7"x12"x5" outside. The output of the power supply is about 400 v. d.c. This is about right for the vacuum tube voltmeter whose

range is 0 to 50 volts, a.c. or d.c. If a higher range is desired a higher voltage will have to be used.

The vacuum tube voltmeter is of conventional design and the circuit has appeared in various issues of *RADIO NEWS*. In combining it with other instruments which use the same power supply it is necessary to isolate the negative leg from the chassis in order that the meter may be used for other purposes. In order to make this easy we use a plywood panel as the potentiometers we used in the V.T.V.M. were not of the insulated shaft variety, which would make it necessary to insulate them from the panel, if it were metal. For those who do not understand the principle of operation of the "Slide-Back" V.T.V.M. it will be explained later.

The "Signal Chaser" section, of the "Four-in-One" Tester, as we have called it, is nothing more or less than an r.f. detector and amplifier combined. The 6B7 tube amplifies and rectifies any r.f. or i.f. signal that is fed into the r.f. or i.f. tip jack. The rectified signal is passed through an a.f. amplifier and is heard in the speaker.

A signal generator is connected to the set under test and the prod is touched to the plates of each successive stage until the signal disappears. This is the stage that is bad. Note that the test lead is not connected to the grid of the tube but to the plate. This is to prevent detuning the circuit as would be the case if the grid were touched with the prod. The blocking condenser in the input of the 6B7 prevents the plate current from being impressed on the 6B7 grid. This allows the signal to pass through without disturbing the circuit of the set. Of course, some loading of the plate circuit will be present, but it will not be sufficient to detune the stage under test so as to throw the signal so far out of tune as to be inaudible.

This is not to be compared with the tuned method of "Signal Tracing," but in an instrument of this size there is not enough room to make provision for a tuned detector. The all around performance is satisfactory for the purpose intended.

Audio signals are applied to the posts marked a.f., and are passed through the a.f. amplifier in the usual manner.

The meter used in this instrument has a 0-5 ma. movement. This was used in place of a 0-1 ma. due to the fact that it is used as a leakage tester for electrolytic condensers. Of course, a more sensitive meter could be used provided a suitable shunt were used for the leakage test, but it was not necessary to use a more expensive meter because the vacuum tube voltmeter circuit does not require such a sensitive movement. This saves the use of an expensive meter and also does not make the condenser tester section of the instrument so delicate as to need any special precautions to

(Continued on page 59)

The VIDEO Reporter

by SAMUEL KAUFMAN

IN telecasting the G.O.P. National Convention from Philadelphia, *NBC* and *RCA* achieved a great technical feat by conveying the daily proceedings to look-and-listeners in the huge New York television service area. And the feat was enhanced by the retransmission of the New York video impulses by the General Electric station in Schenectady.

But the fact that W2XBS had to yield all other programs during the convention week was a self-admission of being short-handed in both personnel and equipment. Can you imagine a newspaper that printed nothing but convention news during a convention week just because its ace reporters were dispatched to the scene?

Looking-in on the convention in New York was a thrilling thing, indeed, even though quality was occasionally below the standard of local pickups not requiring long coaxial cable relay. But everyone likes a bit of variety. It would have been pleasant to have something else—even the usual poor commercial films—between convention pickups.

There's a growing tendency on the part of the W2XBS staff to prefer outside news pickups to original studio productions. First, there's no talent cost—a considerable item to the telecasters even though the entertainers claim they are paid very small fees. But considering the eagerness with which even stellar names volunteer for video programs, perhaps they are not being underpaid at all. Many are willing to go on just for the prestige and experience.

What television needs is a good sense of program balance. Nothing seems to be done on proportionate basis. And, in an art catering to persons with many tastes, it seems silly for the program lads to go overboard on single program topics.

PHILADELPHIANS, too, were able to look in on the convention proceedings originating in their very own city. All of which seems fair enough. Arrangements for the local telecasting of the Republican sessions were made in a joint effort of the Mutual Broadcasting System and Philco's video transmitter, W3XE. Outstanding fact of the arrangement was the MBS statement that W3XE serves 5,000 set owners; this, if accurate, is an amazing total of television receivers in an area where the new art is highly experimental.

The transmissions were jointly supervised by David Grimes, chief engineer of Philco, and Jack Poppele, ditto of WOR-Mutual.

This Philadelphia effort might imply future video tie-ups between Philco and Mutual. What with hints of CBS going into the equipment field and NBC already tied up with RCA, there may be nation-wide alliances between telecasters and makers of home receiving equipment.

WOR, incidentally, soon expects to operate a television station in the New York area. The site wasn't announced but it seems likely that it will be atop a Madison Avenue skyscraper where the Newark broadcasting firm recently leased roof space for its frequency-modulation station. If so, the move will consolidate all of New York's television facilities—NBC-RCA, CBS, DuMont and Mutual—within a half-mile area of the midtown zone.

NOW that the FCC has put a temporary crimp on the mass merchandising possibilities for television receivers. RCA shows that participation in the new art by amateur experimenters is by no means curtailed. The firm recently demonstrated its latest assist to

amateurs. It consists of a small television transmitting tube which opens the way for hams to operate two-way television stations in their own shacks. Obviously, the application of the apparatus will be limited, despite the low estimate of \$300 for a complete two-way set-up.

The Video Reporter was among the press representatives attending the first demonstration of the equipment at the RCA labs in Harrison, New Jersey. While impressed with the low-cost of the equipment and the simplicity with which it can be set-up and operated, it is difficult to see any wide demand for the apparatus which has technical limitations.

Getting out an iconoscope-type tube at \$25 is an achievement, but the 120-line image is



Above: Cause—Republican Convention. Below: Effect—H. Hoover televised.

not too desirable and the receiver tube, too, offers too small a picture.

It's all interesting. And, perhaps, it will appeal to some hams, not in its demonstration form, but in just certain features that they can individually adapt to their own experimental theories.

WORD reached the Video Reporter that there was "wholesale" firing of television personnel at W2XBS shortly after the FCC expressed itself on the course video progress should take. But on checking with NBC we were told that "just ten persons" were let out and that undoubtedly they will be recalled with "an anticipated television revival" in the Fall of this year. The suspended ten employees were drawn from both the program and engineering sides of the W2XBS set-up.

SOME folks around Radio City seemed a bit skeptical when the Video Reporter mentioned the fact that television reception on board an ocean liner was nothing new. So here are a few details concerning the feat:

(Continued on page 58)

What's NEW in Radio

The new MILLEN THRU-BUSHING illustrated herewith is of very unusual design. Instead of conventional lock washer and nut for holding in place, a metallic sleeve has been die cast around the Isolantite tube. Thus when the bushing is dropped in a $\frac{1}{4}$ " hole in the chassis or panel and the metallic sleeve touched with a drop of solder, the bushing is held firmly in place and cannot

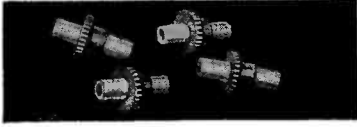

vibrate loose, etc. This type of mounting also takes up considerably less space than the more conventional type. While originally designed for aircraft and mobile equipment, the compactness and low price of this new style bushing makes it suited for many applications in all types of equipment. Manufactured by the James Millen Manufacturing Co., Inc., Malden, Massachusetts.

A new Wave Meter primarily intended for identifying the various amateur bands has been recently introduced by *Bud Radio, Inc.*, of Cleveland, Ohio. This Wave Meter is particularly intended for adjusting the various stages of a transmitter to the desired wavelength. It consists of an accurately calibrated coil and condenser combination together with a suitable pilot

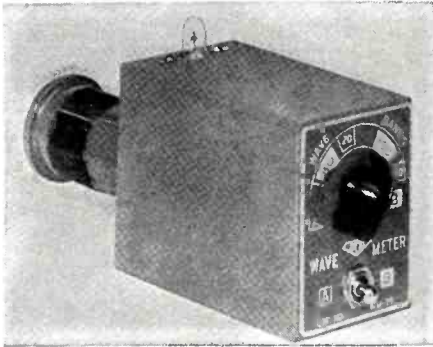

bulb for resonance indication, and band switching is employed enabling the unit to cover all amateur bands from 10 to 160 meters. Calibration is indicated on an attractive etched nameplate, and the case of the unit is finished in attractive Grey Crackle. More complete information is available by writing the manufacturer, *Bud Radio Inc.*, 5205 Cedar Ave., Cleveland, Ohio.

FARNSWORTH FEATURES New Record Player Radio-phonograph combination instruments in the *Farnsworth* line for 1940-41 are equipped with a new automatic record-changer of improved design and simplified operation.

The record changer, known as Model P-2, was developed by engineers of the *Caphart* division. It is neat, compact and streamlined, and company engineers assert its performance represents new achievements in the low priced field in re-



gard to deft and delicate handling of records and its precision and economy of operation. It automatically plays either fourteen 10-inch or ten 12-inch records.

As a unit in the new *Farnsworth* line, this

record changer also is offered separately in an attractive table model cabinet, equipped for plugging into the phonograph jack of a modern radio receiver. The cabinet, finished in walnut, is 10 $\frac{1}{4}$ " inches high, 16 inches wide and 16 $\frac{1}{4}$ " inches deep.

In commenting on the new mechanism, company engineers emphasized the point that, although it has fewer moving parts than any other similar device, its performance is excelled only by the famous deluxe *Caphart* record-changer of the turn-over type.

Weight of the P-2 chassis is 17 pounds. The base of the chassis, which is 14 $\frac{1}{4}$ " inches square, and all other visible parts, except the two record shelves, are finished in a rich maroon baked enamel. The record shelves are finished in chrome.

The action of the new record changer is described by *Pierre Boucheron*, general sales manager as simple, rapid, unflinching and quiet. The mechanism lowers only one record at a time, and neither variations in the thickness of records nor warped records impede its positive action. Only one adjustment is necessary to change from 10-inch to 12-inch records, or vice versa. After the shelf arm has been set and records placed on it, the tone arm, which is equipped with a sealed crystal pick-up, automatically adjusts itself for record size.

Mechanical and record-handling noises are reduced to a degree not previously attained. Each record, as released, momentarily is held on a spindle table, thus causing it to be lowered to the turn-table quietly and softly, cushioned by an air column.

Another feature of the mechanism is that it will not wear holes, tear labels or break or chip records.

Three separate insulated sound-deadening bridges are used in the tone arm to reduce surface noise. In addition, the base rests on self-compensating springs to reduce vibration and cabinet resonance.

Operation of the changer is trouble-free and requires no complicated adjustments. In the normal open position of the shelf, fourteen 10-inch records are played automatically. All that is necessary is to place any number of records up to fourteen on the open shelf. In order to load ten, or fewer, 12-inch records, one merely turns the record shelf to the left. Before removing records from the turn-table, it is only necessary to turn the shelf to the right. With the shelf in this position, all non-standard records from 6 inches to 12 inches can be played manually.

The changer is equipped with an amply powered phonograph motor.

Ward Leonard Electric Co., Mount Vernon, N. Y., is now marketing a new midjet relay known as Bulletin 103.

Designed for use on either a.c. or d.c., the relay is available with contacts arranged for single pole, normally open, normally closed or double throw.

The relay is rated to handle approximately



one horsepower and is furnished with coils for operation on standard voltages, either a.c. or d.c. up to 110/115 volts at standard frequencies. On 220/230 volts, coils can be supplied for not less than 50 cycles.

With overall bakelite base dimensions of 2 $\frac{1}{2}$ " by 1 $\frac{1}{2}$ " and an overall depth of 1 $\frac{1}{4}$ " the new relay can be mounted in the familiar wall type push button box.

Two new radio receivers, a console and table model, which are the advance guard of the *G-E* radio line for the coming year, have been announced by the *General Electric* radio and television department, Bridgeport, Conn. The two receivers, selected from the group which has been shown privately to *G-E* distributor principals in a recent series of meetings from coast to coast, are being released in advance of other models in order that dealers may have fresh models with which to meet the demand expected as a result of the coming national political activity. Both bear the name "Electioneer" and will be advertised and promoted with national party conventions and pre-election campaigns as a predominant theme.

Outstanding feature of the new console, model J-805, is the incorporation of dual beamscopes,

extending still further the antenna-eliminating development first presented by *General Electric* two years ago. Both beamscopes in the new



set have been designed for a specific purpose, one for the better reception of short-wave programs and the other for standard broadcasts. As in previous sets, all need for either antenna or ground connections has been done away with. Foreign programs can now be received with a much higher degree of sensitivity than was formerly experienced with the standard beam-scope alone. The standard broadcast rotating beam-scope is a highly efficient self-contained antenna circuit which reduces local static disturbances and objectionable noises, permitting a more interference-free signal to be picked up and conducted to the receiver's circuit.

A new line of dry electrolytic tubular capacitors just announced by *Cornell-Dubilier* fills a long felt need for high-capacity units in low-voltage applications. This new Type BRH capacitor is available in capacities ranging up to 500 mfd. at 25 volts, 1000 mfd. at 15 volts and 2000 mfd. at 8 volts. In circuits where it has heretofore been necessary to parallel two or more conventional high-capacity units in order to obtain the required high values for certain cathode by-pass and resistance-capacity filter applications it is now possible to obtain the same effectiveness with less bulk and at a considerably lower cost.

The BRH capacitors are similar in physical appearance to the standard Type BR. They are enclosed in vented aluminum containers over which a varnished cardboard tube is drawn for

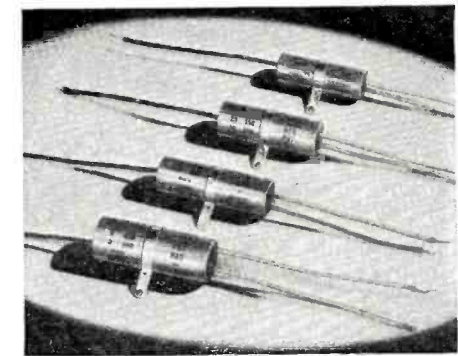

protection. Dimensions vary from $\frac{5}{8}$ " x 1-1/16" for the smaller sizes, to 1" x 2 $\frac{1}{2}$ " for the higher capacities. A choice of either pigtail or lug terminals is provided.

Etched foil of the highest purity is employed and the internal assembly is impregnated under extreme pressure, with rigid chemical control throughout to insure uniform and stable characteristics. Engineering Bulletin describing the Type BRH High Capacity-low voltage electrolytics free on request. *Cornell-Dubilier Electric Corp.*, South Plainfield, New Jersey.

"Model T" 750 Watt Vitreous Enamelled Rheostat is now offered by the *Ohmite Manufacturing Company*, Chicago, in addition to their already wide range of *Ohmite* Rheostats.

This new unit, filling in between the 500 and 1000 watt rheostats, provides engineers and manufacturers with an even more complete range of wattages to meet their specific rheostat requirements.

The "Model T," like all other *Ohmite* Rheostats, provides permanently smooth, close control. The resistance wire is accurately wound on a solid porcelain core, and perfectly insulated by *Ohmite* Vitreous Enamel which separates the individual turns of wire and binds the entire assembly rigidly to the core. There is nothing to smoke, char, shrink or shift. The Rheostat dissipates heat rapidly and is mechanically strong. The Rheostat shaft and mounting are insulated

from all parts which are electrically "live." Large copper graphite contacts are used to combine long life and negligible contact resistance. "Model T" is 10" in diameter, with a 3/4" shaft. Regularly supplied to mount on panels up to 1 1/4" thick. Ohmite Vitreous Enamelled Rheostats are now available in 25, 50, 75, 100, 150, 225, 300, 500, 750 and 1000 watt models in a wide range of

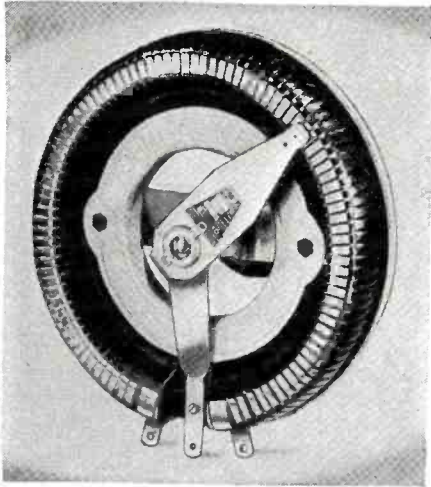

resistance values. Available in straight or tapered winding. Single or tandem assemblies, or rheostat cages can be furnished if desired. Ohmite Manufacturing Company, 4835 Flournoy Street, Chicago, Illinois, U.S.A.

The new Hom-O-Cord recorder Model 110 just announced cuts and plays a twelve inch disc with cover closed. Seven tube licensed super-heterodyne radio set. Eight inch well baffled speaker. Crystal cutter and crystal pick-up, both housed in precision built, well balanced



arms and highly polished. Patented, fool proof feed screw, that a child can operate. Dual motors, both center and rim drive, mounted in rubber-crystal microphone and desk stand to match, with eight feet of shielded cable. Beautiful walnut cabinet with water fall effect. Homocord Manufacturing Co., Inc., 457 W. 45th St., N. Y. C.

A new Jensen speaker, Model MT-8 has re-

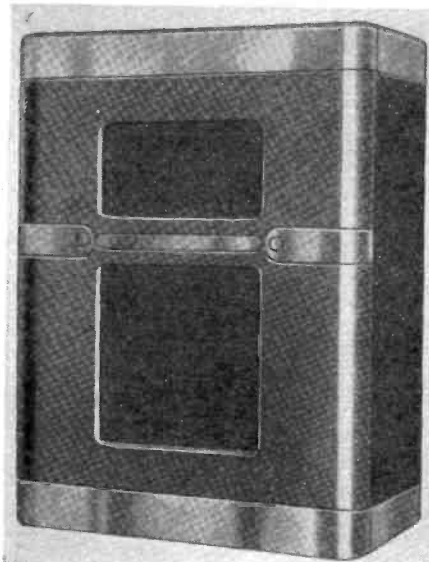

cently been announced. The Reproducer employs a single, especially designed eight-inch loud speaker working in conjunction with the well known Jensen Para-dynamic and Bass Reflex Principles. Mean energy density acoustic measurements, when conducted in an average listening room, show an excellent frequency response characteristic from 50 to 10,000 cps. No appreciable depreciation in high frequency output is observed within a 45° angle and the performance is highly satisfactory within a 60° angle; thus, the polar characteristic of the Reproducer is substantially superior to that of any comparable single speaker device we know of. Power handling capacity—6 watts; Voice coil impedance—6 ohms at 400 cycles; Cabinet dimensions—24x17 1/2 x 11 1/4; Weight, Complete Reproducer packed for shipment—38 pounds. Jensen Radio Mfg. Co., 6601 So. Laramie Ave., Chicago.

Styled in the modern manner with wrap-around "waterfall" cabinet and contrasting woods, this Westinghouse case a.c.d.c. Superheterodyne receiver features—automatic volume control—5" dustproof electro-dynamic speaker—0 1/4 to 1 ratio vernier drive—illuminated clock-type dial—beam power output—built-in loop antenna and terminals for auxiliary outside antenna. Frequency Range—530 kc. to 1600 kc. Power Supply—105-125 volts, 50-60 cycle a.c. or d.c.

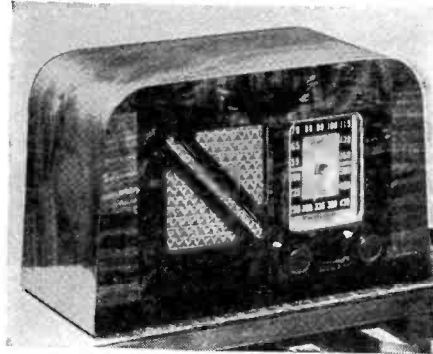

current. The cabinet is especially designed and built of selected walnut woods in flowing lines, the gently sloping ends give the model sturdiness yet pleasing grace. The front is characterized by a panel of rich burl walnut framing the dial and speaker. Two streamlined splats of the same wood cross the grille diagonally. Across the bottom a band of dark walnut binds the whole design together. The entire cabinet is hand-rubbed to a glossy finish.

With the addition of a complete line of plug-in shafts by the International Resistance Co., 401 N. Broad St., Philadelphia, Pa. IRC Midget Controls are recommended for universal use in practically every control replacement a serviceman may be called upon to make. The new

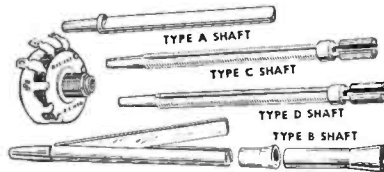

plug-in shafts assure easier installations and mean that fewer special controls at higher prices will be required by the serviceman. A comparatively small stock of the most popular midgets will handle the big majority of jobs. The IRC Midgets will fit, even in small receivers, and may safely be used to replace old-style larger size controls.

Type A. Plug-in shaft, a standard 3" brass shaft with flat, is supplied with all IRC Midget Controls. Also available are the Types B, C and D shafts which meet most present day requirements for auto radio receivers and for other receivers requiring knurled, unknurled or split shafts.

Installation of the controls is greatly simplified by the plug-in shafts. Even in crowded chassis it is not necessary to remove other parts in order to insert the control. Shafts have tapered ends and may be driven securely in place in the control socket by a light tap with a hammer or other tool. A copy of the 1940 Supplement to the IRC Volume Control Guide, giving full details as well as listing replacements for most radios introduced since Vol. 2 of the IRC Guide, will gladly be sent upon request.

A new, De Luxe Tel-Ohmike Condenser and Resistor Analyzer, just announced by the Sprague Products Company, North Adams, Mass., includes built-in voltmeter and milliammeter with switch and pin-jacks provided so that the meters may be used for measurements external to the instrument.

Meter ranges, selected through an 8-position switch, are 15, 150, 500, 1500 volts d.c., and 1.5, 15, and 50 ma. d.c. An "off" switch position is provided between the voltage and ma. ranges, and the ranges are graduated downward on either side of this for maximum meter safety. A rugged, double-pivot meter movement and a broad, easily-read meter scale are used.

Otherwise, the new de luxe model is the same as the Standard Tel-Ohmike announced some time ago by Sprague and now one of the most widely used instruments of this type on the market. Owners of Standard Tel-Ohmikes can have them converted into De Luxe Models including the meters at nominal cost.

Tel-Ohmike paves the way for complete, accurate tests of all condenser and resistor characteristics. It measures leakage current and power factor of electrolytic condensers; measures insulation resistance up to 10,000 meg.; and analyzes all condenser types at their exact working voltages. Capacity measurements range

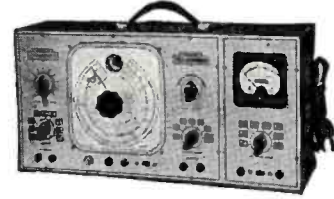

from .000010 mfd. to 2000 mfd., and resistance measurements from 5 ohms to 5 megohms. All balance indications are given by a "magic eye" tube and all measurements are taken from large, direct-reading scales. An important feature to the serviceman is the fact that Tel-Ohmike indicates open and short-circuited condensers, and shows up intermittent open condensers and resistors.

The overall dimensions of the new De Luxe Tel-Ohmike are 17 1/2 x 9 x 6. Carrying weight is 12 1/2 lbs. Net price is \$47.50. Descriptive bulletin will gladly be sent upon request to Sprague Products Company, North Adams, Mass.

A new, small size, lightweight motor offered by Eicor, Inc., Chicago, is 2-5/16" in diameter, 2 3/4" long, weighs 1 1/2 pounds, and delivers 1/13 hp. at 8500 r.p.m.

This new Model 2310 Motor is designed and built by Eicor to give smooth, trouble-free performance in exacting aircraft service. Used for

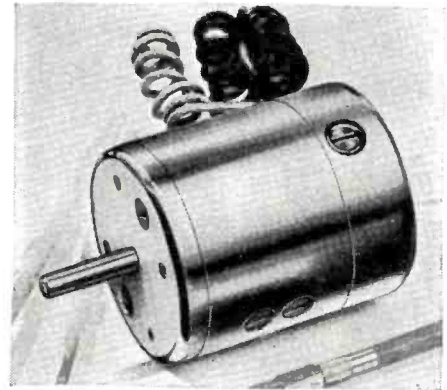

bandswitching, antenna reels, or any type of remote control.

Eicor now offers motors in a range of sizes for all aircraft and similar applications. Eicor, Inc., 515 S. Laflin Street, Chicago, U.S.A.

Cornell-Dubilier announces a comprehensive line of capacitors for power factor correction applications in fluorescent lamp circuits. Included among these are three general types, varying in their physical dimensions to fit all standard wiring channels and in capacity values



to most economically satisfy the p.f. correction requirements of any fluorescent lamp lighting installation.

These units are "Dykanol" impregnated and filled to insure long life, compactness and low loss, and are hermetically sealed in sturdy steel containers to provide complete protection against severe atmospheric conditions.

The Type KP capacitors are 2 1/4 inches wide by 1 1/4 inches thick and vary in length from 3 inches for the 3 mfd. unit to 13 1/2 inches for the 28 mfd. size. These are equipped with mounting lugs and 15-inch insulated wire leads. They are available in seven values from 3 to 28 mfd., with voltage rating of 240 except for the 6.5, 11 and 28 mfd. units which are rated at 120 volts.

The Type KS measures 2-1/16 by 1 inches and is furnished in eleven capacity values ranging from 2 to 8 mfd. with the container lengths varying from 3 to 6 1/2 inches. Connection terminals with soldering lugs are brought out through the seal on one end and are spaced 1/2

inch between centers. The KS units are all rated for service on 120-240 volt lines.
 The Type KW is identical with the Type KS except in physical proportions and terminal spacing. The width is 1-7/16 inches, thickness 1 1/8 inches and spacing between terminal centers 9/16 inch. *Cornell-Dubilier Elect. Corp.*, 30 Rockefeller Plaza, N. Y. C.

The RCP Model 414 (Universal DeLuxe Multi-tester) is now available in four additional series—V7, V9, RP7 and RP9, each with its own distinguishing characteristics in addition to the multi-purpose features of Model 414, it has been announced by *Radio City Products Co.*, 88 Park Place, New York City.
 Model 414 Series V7 has a large 7 1/4" bakelite square meter, with jewel indicating light.

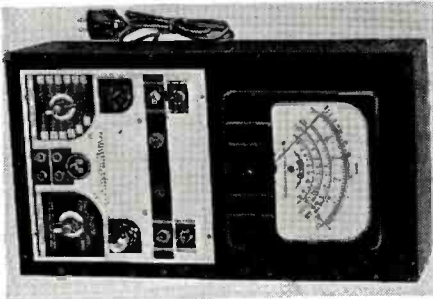

and front panel screw cap holder for immediate replacement of meter fuse. In black crackle finish steel case. RCP Model V9 is the same, except that meter is the 9 inch Jumbo round type.

Similar to V7 is Model RP7, except that here the panel is arranged horizontally for rack mounting and there is no overall case. The 414 unit (less meter) is housed in an open faced case and may be instantly removed from the panel for convenience while working some distance away. Model RP9 is identical to RP7, with the exception of the meter which is a 9 inch round type.

A low priced 50-watt amplifier, complete in one unit and incorporating the latest circuit designs for improved performance and tone quality, has been announced by George Ewald, Manager of the Commercial Sound Section of the *RCA Manufacturing Company*.

The new unit is designed for general public address applications where high power and low



cost are the principal considerations. It does not replace any existing RCA amplifier, but is an addition to the extensive line of 8, 15, 24 and 50-watt units for both portable and permanent installations.

"The new amplifier's low cost is made possible through new design, combining pre-amplifier and the power unit on a single base, with emphasis on essentials for economical, efficient operation," Mr. Ewald said. It is designated as Model MI-12214, and is styled in the modern trend, with rich two toned gray finish.

It incorporates an inverse feedback circuit for low distortion and improved tone quality, and has automatic bass compensation for phonograph record reproduction. Two microphone and two phonograph input plugs are provided.

Each of the phonograph inputs has been compensated for its type of pickup. One is a low impedance input for magnetic type pickups, with the other compensated to take care of high impedance crystal type pickups.

Frequency response is essentially flat between 50 and 10,000 cycles, within 3 db. A terminal board is provided with output impedances of 4, 7 1/2, 15, 60 and 250 ohms. By making certain indicated connections, additional impedances from .05 to 192 ohms may be provided. Equipment includes an a.c. line cord and plug and carrying handles on either end of the chassis.

Still smaller dimensions and two independent sections with four leads distinguish the new PRS Dual Dandees just added to its already extensive line of midget-can electrolytics by *Aerovox Corporation*, New Bedford, Mass.

The new dual PRS 450 8-8 and the PRS 250 16-16 measure 1x2 1/4", while the new PRS 150 20-20 measures 1x2 1/4". These dimensions are believed to be the smallest for any dual midget electrolytics of corresponding voltages and capacities now available. The units have two entirely independent sections and four leads, permitting the independent use of either section and either common positive or common negative con-

nections. Because of the obvious convenience of independent sections, the *Aerovox* Dual Dandees will eventually be changed over to separate-se-



tion units but this manufacturer will continue to make concentrically-wound common-negative duals to meet demands for such duals.

The development of a new 500 ma. iron core r.f. choke having extremely high impedance over wide range of frequencies has just been announced by the *James Millen Manufacturing Co.*, Malden, Massachusetts. While originally designed for use on all of the amateur bands between 30 megacycles and 1.6 megacycles, the ex-



tremely high impedance developed over this wide range of frequencies makes this new choke ideally suited for many commercial applications. A unique type of mounting comprising die cast end terminals with threaded stud inserts makes the new choke easy to use. The catalog number is 34150.

This new *Triplet* counter model has advanced features never before offered in any tube tester. It has every facility that could be desired including anti-obsolescence design; a new highly flexible switching system; giant 6-inch scale RED DOT Lifetime Guaranteed indicating instrument; unsurpassed beauty and customer appeal. It will add distinction to any shop or store in addition to giving conclusive tests of all present types of receiving tubes, say the manufacturers.

Non-Obsolescence Design. . . Every precaution is taken to provide facilities for testing tubes in the event of future changes. . . Individual connections for each tube element as



well as a spare socket. . . Even in case of unanticipated radical changes in tubes, this tester need not be discarded, nor will expensive remodeling be required. . . This is made possible by the four separate panel sections, (socket, meter, roll chart, switching and power supply) which can be entirely replaced by anyone at nominal cost with a trade-in allowance for the old section. There is no loss of time when replacement or servicing of any section is required.

Flexible Switching, new lever-type, gives individual control for each tube prong. This also takes care of roaming elements, dual cathode structures, multi-purpose tubes, etc. Operation is simplified.

Model 1620. For 60 cycles, 110 volts. List Price, \$56.75; U.S.A. Dealer Net Price, \$37.84. *The Triplet Electrical Instrument Co.*, Bluffton, Ohio.

Raytheon is pleased to announce the addition to the receiving tube line of the recently developed types 7H7, 35Z6G, 50Y6GT and 117M-79T. The types 2X2/879, 6AG7, 6C5GT and 12SF5 have also been made available by *Raytheon* in keeping with their desire to have a

most complete line of radio receiving tubes.

7H7 is a high mutual conductance pentode which has been designed to have as wide a cut-off as is consistent with a good ratio of Gm to plate current. This tube has a 2.0 watt cathode in place of the usual 3.0 watt cathode used in other high Gm amplifier tubes and hence may be used in series with other 2.0 watt cathodes. This new type will find application in untuned r.f. circuits, wide band, high frequency amplifiers and other equipment where the high Gm characteristics are desirable.

35Z6G is a twin diode rectifier designed for use in voltage doubler circuits in a.c.-d.c. receivers. It is characterized by a plate current rating of 110 ma. which is somewhat higher than similar ratings for other voltage doublers such as the 25Z6G.

50Y6GT is a double diode heater type rectifier for use in full wave or voltage doubler circuits in a.c.-d.c. receivers where the 50 watt heater rating is of advantage.

117M7GT is a two section high heater voltage tube for service as both rectifier and beam power output amplifier in applications where it is desired to connect the heater directly across the 117 volt power line.

2X2/879 is a high vacuum heater type half wave rectifier designed for use in suitable rec-

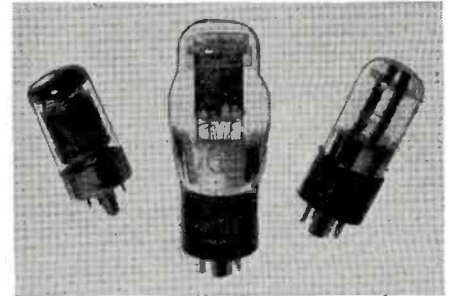

tifying devices to supply the high d.c. voltage requirements of cathode ray tubes.

6AG7 is a high mutual conductance pentode designed for use as a video voltage amplifier in television receivers.

6C5GT is a triode for use as a general purpose amplifier or detector.

12SF5 is a metal shell high mu triode which is particularly suitable as a resistance coupled audio frequency amplifier in a.c.-d.c. receivers with series filament connections. *Raytheon Production Corporation*, 55 Chapel St., Newton, Mass.

With this new *Victor* Amplifier regular theater continuity is now possible for continuous shows without any breaks for changing reels.

This added flexibility and famous *Victor* multiple use is brought about by the model "R" Amplifier which can accommodate two *Animatophone* Sound Projectors (as shown above) and as many as eight 12" or 15" speakers. A flick

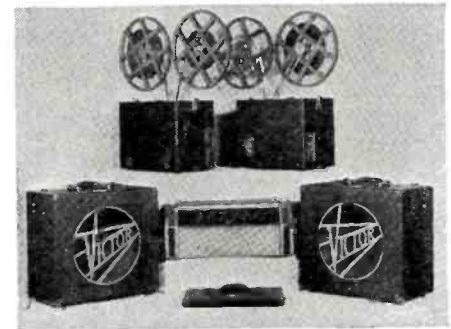

of the change-over switch stops one projector and puts the other into operation to permit threading without loss of projection time.

Public Address equipment and a record player can also be used at the same time to supplement the sound projectors. Complete information may be obtained by writing to the *Victor Animatograph Corporation*, Davenport, Iowa.

This new *Hickok* Instrument with its patented circuit embodies a new conception in bridge measurements. Besides being used as a conventional bridge this instrument can be used as a percentage bridge and also as a synchronometer. It permits electrical triangulation not possible with conventional bridges.

The circuit, which is shielded, features a cosine galvanometer, has built-in standards and provisions for external standards. The galvanometer cannot be injured by extreme unbalance of the bridge. A.c. power is used for operation. Despite the fact that it operates on a.c. current the *Hickok* Electronic Bridge has null balance the same as all standard d.c. bridges. Measurements include capacity, resistance, inductance, impedance, power factor and frequency.

This bridge is extremely sensitive and can detect change in capacity as low as 1 micro-microfarad. It measures capacity beyond 1000 microfarads. Measurements to 500 megohms are by true bridge balance. Binding posts have high resistance and low capacity to panel.

Electronic tubes are included with the instrument. Enclosed in a portable case.



For complete information write the maker, The Hickok Electrical Instrument Co., 10511 Dupont Ave., Cleveland, Ohio.

Allied Radio Corporation, Chicago, is currently featuring a new KNIGHT 7-tube 2-band console radio. This radio is housed in a cabinet built of selected matched walnut veneers and featuring an inclined instrument panel. The cabinet is hand-rubbed to a rich, lustrous finish and has gracefully curved ends. Features include: 8-inch Electro-Dynamic speaker; continuously variable tone control; A.V.C.; individual coils on each band; push-button tuning on 6 stations; "Air-Magnet" aerial (eliminates out-



side aerial and ground); built-in Electro-Static Shield; big slide-rule dial; 3 watts output; phono and Television-Sound attachment, etc. Tunes two bands, 545-1550 kc. and 5.8-18.1 mc. Incorporates a Superhet circuit licensed by RCA and Hazeltine, using the following tubes: 6A7, 6D6, 75, 76, 2-41, and 80.

This new KNIGHT 7-TUBE 2-BAND radio is supplied by Allied Radio Corporation, 833 West Jackson Boulevard, Chicago.

RCA Manufacturing Company, Inc., has recently made available two new tubes designated as the RCA-117N7-GT and the RCA-827-R.

The 117N7-GT is a multi-unit tube containing a half-wave rectifier and a beam power

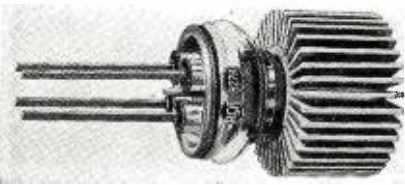

amplifier in the same envelope (T-9). It is intended primarily for use in portable battery/a.c./d.c. receivers. The power amplifier unit delivers 1.2 watts with 100 volts on plate and screen. The heater is designed for operation directly across a 117-volt power-supply line.

The 827-R is a new air-cooled radiator type of u-h-f transmitting beam power amplifier. It has a maximum plate dissipation rating of 800 watts in class C telegraph service, and is particularly suitable for use in frequency-modulation and television transmitters.

The 827-R has several unique design features
(Continued on page 61)

FOR IMMEDIATE RELEASE...

GENERAL ELECTRIC announces that it has sold 4 Frequency Modulation Transmitters to the Civil Aeronautics Authority for use as airways beacons to be located at Hinchbrook Island, which is near Cordova, Alaska, and Ralston Island, near Juneau, Alaska. It was predicated in RN over six months ago that the FM transmitters would eventually find their greatest use in non-broadcasting communications.

A NEW guarantee policy against price fluctuations in the new 1941 models is being offered to dealers by Emerson-New York and Emerson-New Jersey. The plan provides definite assurances to dealers "that whatever investment they make in this merchandise will be fully protected and that no loss will be experienced by them regardless of any later changes in dealer prices." The guarantee policy will be effective until April, 1941. If successful, it might be continued thereafter.

FARNSWORTH of Ft. Wayne, Indiana, has stepped up their production line to the high figure of 20,000 units a month. The plants at Ft. Wayne and Marion, Ind., had been closed during the week of July 6th to provide for employee vacations.

THE RMA reports that the television show sponsored by the Television Institute of America, Hollywood, Calif., is not approved by the Association. It is said that the I.R.E. has also refused recognition to the show. The Television Institute of America plans its show for August 22-24, at Hollywood.

WITH the European continent whipped into a state of upheaval by the terror of war, adequate defense of American shores becomes a matter of prime importance. Modern mechanized warfare demands new avenues of defense and the ingenuity of the country's inventive genius is prepared to meet the challenge.

Television, the greatest entertainment media to emerge from the scientific laboratory in the 20th century, looms also as one of the most potent weapons for defense of the American shores.

A mobile television unit, recently perfected and undergoing tests at the Allen B. Du Mont Laboratories in Passaic, N. J., for use at the new Du Mont television station W2XWV, now under construction in New York City, could serve the government handsomely in its defense plans. Weighing less than 400 pounds and compact enough to be transported in the rear of an ordinary automobile, the mobile unit, employing the most flexible equipment and standards yet devised, could be carried in airplanes, on ships and transported with army units.

Its uses for defense, either in reconnaissance flights or in radio-controlled planes, would give the Army, Navy or Air Corps an advantage of inestimable value. Thus television, naturally designed as an instrument of peace, can become a barrier of defense for the United States against possible invasion or attack in wartime.

FLEXIBLE equipment, like flexible standards of transmission, is essential in television. The Allen B. Du Mont television station, W2XWV, now under construction at 515 Madison Avenue, New York City, will have both.

Engineers constructing equipment for the

new station, which will occupy channel No. 4 in the 78-84 mc. band, have designed a compact mobile transmitting unit that can be rushed to any point within range of the transmitter, and set into action in no more time than it takes a newsreel mobile outfit to start its cameras whirling.

The camera or iconoscope is controlled by a synchronizing generator that scans and synchronizes the images. What is most important is the fact that the synchronizing generator is not limited to a single set of standards. By the mere flip of a switch, the synchronization can be altered to transmit several different line and frame frequencies.

For example, synchronization can be jumped from 441-lines at 30-frames to 441-lines at 15-frames by the simple process of flipping a switch. With the same operation, the pulses can be changed to provide for 525-line images at either 15 or 30 frames; 625-line images at 15 frames or as high as 875-line images at 15 frames.

This flexibility is highly desirable not only in transmission, but in reception as well, since it precludes the possibility of obsolescence. In keeping with its policy of flexible standards for transmission, the Du Mont firm is pursuing a course of flexibility in reception, as well. Thus, Du Mont receivers now on the assembly line at the Passaic laboratories, are capable of receiving any form of transmitted images ranging from 400-lines at 30 frames to 875-lines at 15 frames.

Erection of station W2XWV is progressing rapidly, with indications that a program schedule of experimental transmissions, presented with the authority of the Federal Communications Commission, will go on the air late next autumn.

RECEIVING FM signals from Major Armstrong's frequency modulation station 75 airline miles away, radio dealers of Nazareth, Pa., had their first taste of the excellence of staticless FM reception. The occasion was a demonstration of the new FM type of broadcast reception held at the Mattas Radio Shop of Nazareth under the sponsorship of the Joseph E. Hornberger Distributing Co., Stromberg-Carlson distributors of Reading, Pa.

Despite the distance between Alpine and Nazareth, the reception lived up to everything that might be expected of FM even within the limits of the horizon.

Programs were heard over a Stromberg-Carlson No. 480-M, a home set equipped with Labyrinth and Duo Coaxial Speakers with Carpinchoe Leather Suspension. This speaker system, according to A. R. Royal of the Hornberger Co., made possible the reproduction of the extremely wide range of frequencies broadcast by the Alpine station. "The resulting realism from the extended range of frequencies and increased dynamic range of reproduction, especially since it was unmarred by static or cross talk, was enthusiastically acclaimed by the dealers," Mr. Royal said.

Also demonstrated before the group was Stromberg-Carlson's No. 425-H FM table model. It was shown how this model, though a complete FM set in itself, could be attached to the phonograph jack of a Labyrinth radio. This, it was pointed out, provides staticless high fidelity reception of FM programs, utilizing the tonal advantages of the larger cabinet and Labyrinth in the

(Continued on page 49)

TECHNICAL BOOK & BULLETIN REVIEW

HOW TO MAKE GOOD RECORDINGS, published by *Audio Devices, Inc.*, New York, U. S. A., price \$1.50, 127 pp. Numerous treatises have been written from the scientific point of view on the subject of home recording, yet few have written directions for the use of their machine and which tell the whole story in simple non-technical terms. The authors of this book, who are in constant everyday touch with the problems confronting the recordist, have combined their experiences and knowledge in such a way as to present a very complete explanation on the subject. Since this is a limited exposition on a complex subject, it is not the intent of this book to discuss every consideration from every angle, but rather to make clear the fundamental principles of sound recording, thereby rendering fuller and more pleasurable the pursuit of this new art. These pages contain valuable information compiled through experience in dealing with many leading broadcasting stations, record manufacturers, and professional recording studios both in this country and abroad. While this book is not intentionally written for the benefit of the professional recording engineer, many of the practices described herein being to him everyday routine, these wide and diversified contacts have nevertheless made it possible here to bring together information of value not only to the novice but, in many cases, even to the most seasoned engineer. In short, most of the practical information any recordist may desire is in these pages, but we do not wish to imply that the everyday recordist need digest all this information in order to make intelligent use of a modern recorder.

GETTING ACQUAINTED WITH RADIO, by Alfred Morgan. Published by *D. Appleton-Century Company*, New York, London. 279 pp., price \$2.50. Those of us of inquiring minds who wish to pierce the mystery that surrounds our radio set, will find this book invaluable. And those of us who contemplate adopting radio as a hobby will find here valuable advice of the most practical sort. "Getting Acquainted with Radio" gives the average person interested in radio the basic principles of the science, and then gradually progresses to the more technical detail which is essential to complete understanding. The first section is devoted to radio's development, radio waves, the basis of transmission and receiving, things you should know about electricity to understand radio, tuning, what the radio tube does, and antennae. Then, for future or present radio hobbyists, Mr. Morgan devotes his remaining chapters to learning to transmit and obtaining a license, how

(Continued on page 61)

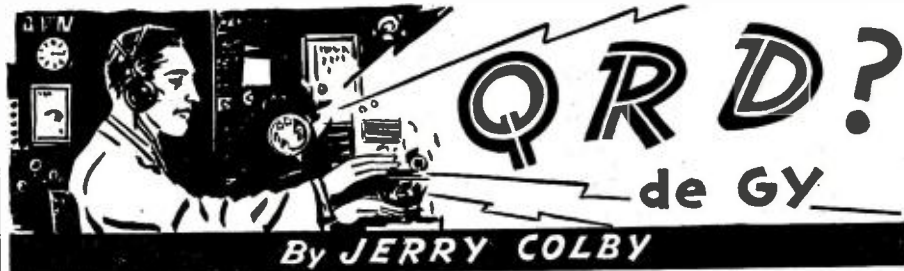

WHEN we heard of the wire which was despatched to the Navy Department by the Pacific Shipowners' Assn.: "Request Navy furnish regular Navy radioprotectors for this voyage at ship's expense, permitting ship to proceed so that national defense materials, US mails and commerce not be interrupted," we galloped down to the *ACA* local No. 7 to find out why the *Matson Liner, SS Monterey*, carrying a cargo of defense materials for the Naval Base at Samoa, plus the US mails, was unable to sail on schedule because of the action taken by her three radiops. Secretary Chet Jordan, when asked for the inside dope, the behind the headline news, waved his hands and declared that *ACA* had nothing to do with what had happened—that it was purely a private matter between the ship's radiops and the *Matson Company*. But at this moment in walked one of the *Monterey's* radiops. Refusing to give his name, he stated that they had decided to quit when they were refused demands for either their back overtime wages (\$58.00 for the three ops) earned on their last trip, or a solution to their problem, the signing on of a fourth operator. The *Matson* outfit then contacted two successive sets of three radiops, but they also refused to sign on when they were informed of the dispute. So, therefore, the message to the Navy. The men, however, have returned to the vessel after promises were made by the *Matson Company* through the Federal Mediator that back pay would be granted and negotiations on the matter of the fourth operator would be resumed.

The *Matson Company*, on the other hand, insists: that the men held the ship up for thirty hours because they refused to sign articles without an increase in pay and without a fourth radiop; that they attempted to get in touch with local *ACA* officials but could not, and that they even sent a msg to President Rathborne in Washington to straighten out the matter.

It is not now a question of whether the company was wrong or the men were right. It is a question of patriotism over petty squabbles. This vessel was carrying defense material for a US possession in the Pacific Ocean; wasn't that reason enough for the men to put themselves above temporary disputes which they could turn over to their *ACA* organization? After all, aren't they paying them monthly dues to take care of their interests?

Today we are facing one of the most trying times in the history of this country. We are beset with enemies from within and without. Our allies, upon whom we had formerly depended, to a certain extent, are in a sorry state, and those of us who call ourselves Americans would be a tool, unconsciously or otherwise, of subversive or fifth column elements, to deter in any way, shape or form the movement of materials and supplies for the defense of our nation and our possessions.

Let's not kid ourselves with the thought that the other fellow can do it . . . that the other fellow should stick by the rules . . . that we're only one little person and what we do won't make much difference. Because we're all in the same boat, we've all got to stick together and do our part, wholeheartedly and unreservedly. Do as we did in the U. S. Navy: obey your last order first; complain afterwards to the C. O., but *obey your last order first!*

WHEN word got about that 400 CCC boys were to be trained by the *Coast Guard Maritime Commission* for the American Merchant Marine, radiop organizations set up a howl. There are only 1700 radiop jobs available and there are 10,000 radiop

licensees available for them . . . so why train more men? Which is a logical and warranted howl! We don't know the answer either, but here's a msg from a Limy reader that may hold the secret . . . quote . . . one result of the war has been to create a huge demand for qualified radio ops for the British Merchant Marine. The radio schools are crowded with young men anxious to obtain an operator's ticket, because when qualified, the government knows them to be too valuable to be conscripted for the Army, Navy or Air Force. In place of the usual First and Second class certificates, radiop students can, in war time, obtain only the "special certificate of proficiency in radio telegraphy," the school course lasting five months on the average. Among those who have obtained their op's certificate in England is John R. H. Dennis of Manchester, who is now "Sparks" at the age of 14½ years. In the examination he competed with men well over twice his age . . . Signed Alan G. Clarke, 175 Bacup Road, Cloughfold, Rossendale, Lancs., England . . . unquote . . . So if England's experience is any measure, we're going to need all the radiops that can be mustered out . . . just in case.

L. HUMPHRIES, another British subject, from 2 Russell Street, Toronto, Canada, wants the dope on a National SW3 for use on 600 meters; such as size of plug-in-coils to use and, if possible, a hook-up of receiver. Is our class this evening full of vim, vigor and vitality? Then how's to aid this ally with the above info . . . shoot it directly to him, tnx.

THE following msg from Brother J. F. DeBardeleben, KPRC, is self explanatory . . . quote . . . Are you carrying in your magazine the news column called "Veterans Wireless Operators Association News"? I have been told that your magazine might start carrying it and missed it from its regular place in another mag . . . unquote . . . Which goes to prove that something is all hay-wire in the old hayloft. Quite a few of the *VWOA* boys have written in to us suggesting that RADIO NEWS carry the column and we've said "sure" because this is the only mag carrying radiop news which is read by all radiops hither, thither and yon. But so far we haven't even heard a rustle of a rumor from the throttleman on the *VWOA* news pump. What he needs is proddin' . . . so go to it. If it doesn't appear here, it isn't our fault.

SOME of youse chappies may have missed receiving the following communication from the FCC quote . . . Communications Act of 1934 specifically prohibits the transmission of superfluous, unnecessary or unidentified communications. Moreover, both the International Regulations and the Communications Act place the radio service of a ship station under the supreme authority of the Master of the ship. The Commission intends to uphold vigorously these provisions of law and treaty and will hold ship station licensees, Masters of ships, and radiops on board fully responsible for any violations . . . unquote. And they ain't foolin'!

BACK to our main theme, let petty jealousies be forgotten and forgiven. If you're a communitarian then you've got a reason for causing disruption, but if you're an American, with American, democratic ideals of freedom of speech, freedom of movement and freedom of thought, then for Heaven's sake, work for America by working together, and remember that, thank God, you and I are Americans. So with 73 . . . ge . . . GY.

The "Servistat"

by

RUFUS P. TURNER, W1AY

Malden, Massachusetts.

With a number of different powered potentiometers and rheostats, the author has devised a unique unit.

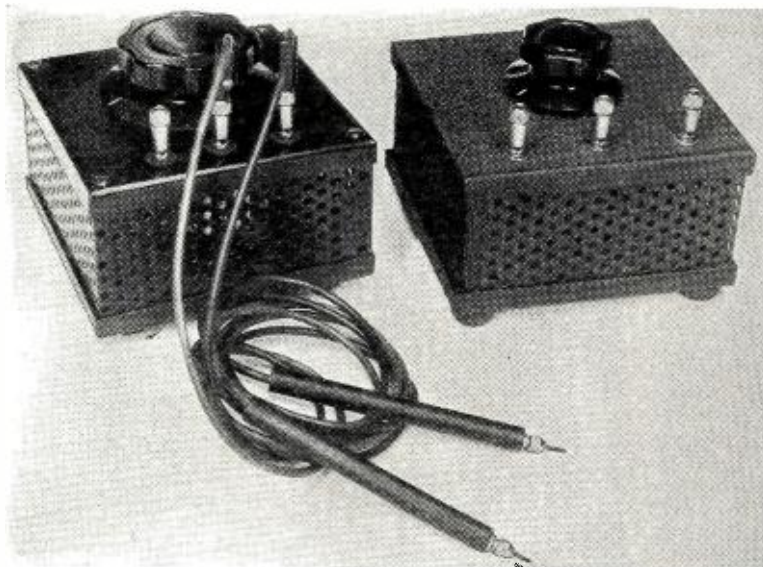

A 400-watt "Servistat" to the left, a 150-watt to the right.

THE word looks odd, but should give no trouble. *Servistat* is the name we have coined for specially-mounted rheostat-potentiometers which may be set to any ohmic value within a wide resistance range and "bridged over" open resistors. The device, though it will be found immensely flexible, is nothing more than an adjustable replacement resistor which may quickly be clipped-in around a burned-out resistor when shooting trouble, giving greater speed to a substitution operation which formerly consisted of digging up and soldering in a trial resistor. A hoard of other experimental uses around the shop or ham shack will be at once apparent.

The paramount value of the *servistat* to the serviceman lies in its ability to pinch-hit for a disabled resistor of any value while the business of diagnosis is carried along to other points. Open resistors can, and often do delay a *complete* diagnosis unseasonably, and both time and completeness of trouble shooting are profit factors in the service business. Until a burned-out resistor is replaced and the dependent voltage restored, other troubles cannot be detected. The usual practice of temporarily soldering in a good resistor to bridge a defective one is equivalent to repairing that much of the set—an uneconomical operation when diagnosing only for an estimate, since it generally is neither speedy nor permanent. A *servistat* may be set quickly to the value of the open resistor, clipped into the circuit (whereupon the operating voltage is restored) and the tracing operation carried forward. When no longer needed, the gadget is taken out of position and set aside. Being of permanent construction, it has none of the inefficiencies of hay-wire test gear.

An attendant outstanding application of the *servistat* is in the determination of the proper resistance value, when the original resistor is missing altogether or has had its color coding obscured beyond recognition. The *servistat* is clipped into the circuit and its resistance varied until the proper operating voltage appears at a given point in the circuit.

Types

Obviously, the wattage rating of the *servistat* will be determined by the requirements of the circuit in which it is operated. A universal instrument, continuously variable up to the very high values encountered in receiver resistors would not be heavy enough for use in the power supply circuits (e.g., in bridging an open voltage-divider section), since commercial heavy-duty rheostat-potentiometers are not normally supplied above 10,000 ohms.

Consequently, it will be noted that two general types of *servistats* are shown here; the *power type* (figures 1 to 3) and the *decade type* (figure 4). The power type employs a *Ward Leonard Vitrohm* ring-type rheostat, a component of superior construction which permits an even variation of resistance, mounted in a ventilated steel case. The decade type has been designed to replace the ¼-, ½-, 1-, and 2-watt resistors encountered in receiver and amplifier circuits proper and is so named because of its resemblance to the decade resistor boxes found in laboratories. It has a total range of over 11 megohms and may be set in one-ohm steps at selected values between 1 ohm and 11,111,110 ohms.

The power type *servistat* may be used to bridge over open-circuited sections of voltage dividers, heavy-duty filter or dropping resistors, to deter-

mine the proper value of either of these resistors when the manufacturer's circuit diagram is not available or when the defective resistor has had its color coding burned beyond recognition; or, in experimental work (particularly the design of new equipment), the *servistat* may be used as the voltage divider or resistor itself.

Power Types

Two power-type *servistats* are shown in the photographs (figures 1 and 2); the left-hand model is rated at 400 ohms, 150 watts and was designed particularly to replace a.c.-d.c. line cord resistors, although its use will not be restricted to this application. The unit will be found to be of service wherever a rheostat or potentiometer of its resistance and wattage is indicated. Figure 2 shows its internal construction. The right-hand box is rated at 10,000 ohms, 100 watts and was designed particularly for substitution in voltage dividers.

The nucleus of the line-cord unit is a *Ward Leonard* type 1108-15, 400-ohm, 150-watt Vitrohm ring-type rheostat. This component is four inches in diameter and is a beautiful mechanical job. It contains 408 turns of wire, giving approximately that number of resistance steps. The sliding contact is a heavy shoe of special alloy and large area, and the entire job is vitreous enameled and ceramic insulated. The maximum current which may safely be passed through the winding is given by the manufacturer as 612 milliamperes.

The value of 400 ohms covers all possible values of line cord resistors (the highest encountered commercially being of the order of 360 ohms to light one 6.3-v., 0.3-amp. heater).

A.c.-d.c. line-cord resistors are notable offenders in the open resistor category and they particularly delay com-

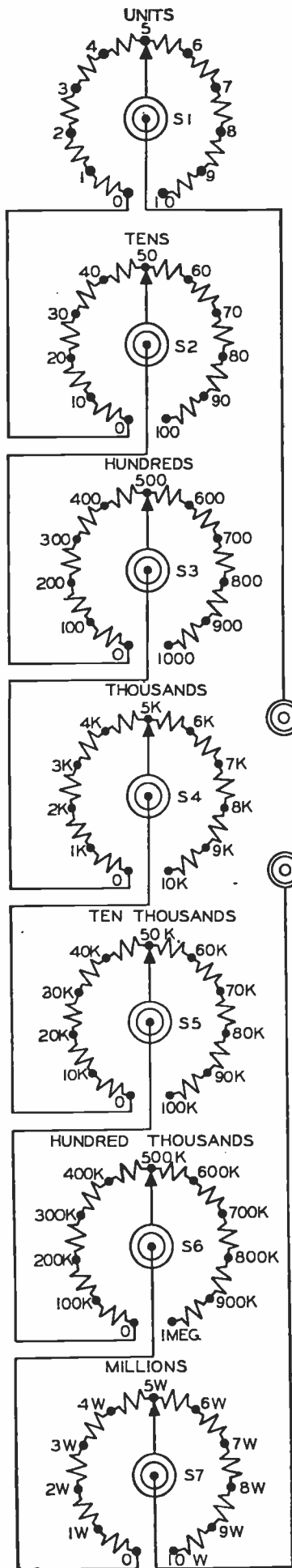
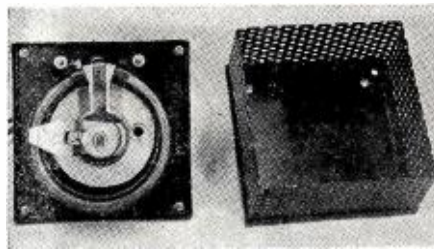

FIG. 4



The insides of a "Servistat."

plete diagnosis of a receiver, since their failure removes voltage from all of the filaments, completely killing the set.

Most line-cord resistors are of odd values and, ironically enough, the required value is seldom in the shop or immediately available from any nearby supply store. When a customer must have a spot estimate, the serviceman too often inclines toward placing sole blame on the burned-out "cord-ohm" only to suffer later embarrassment when the resistor unit is replaced and other "more expensive" troubles not covered by his estimate show up to be corrected at his expense. Indeed, it was this identical embarrassment that originally gave birth to the *servistat*!

The power *servistat* foregoes such incomplete diagnoses by at once replacing the defective line-cord resistor, whatever its value, and rendering the receiver immediately operative for further trouble shooting which will doubtless be aided by the second power *servistat* or the decade model.

The right-hand *servistat* (figure 1) is the voltage divider model, built around a *Ward Leonard* type 1107-22, 10,000-ohm, 100-watt *Vitrohm* ring-type rheostat similar in characteristics other than resistance, current, and wattage to the one included in the line-cord unit. This rheostat-potentiometer is three inches in diameter and finds its widest *servistat* application in substituting for open voltage divider sections. But since the variable resistor is provided with three terminals, this *servistat*, like the previously described model, may be used directly as a complete voltage divider, rheostat, or potentiometer.

In cases where it is anticipated that defective voltage divider sections larger than 10,000 ohms will be encountered, it is recommended that two

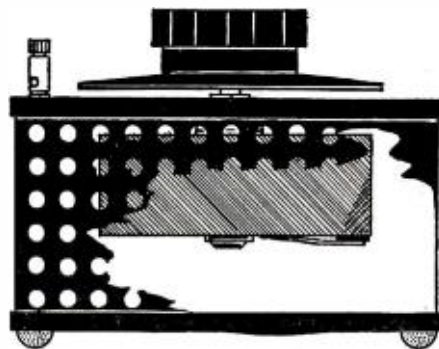

FIG. 3

Fig. 3. Cutaway view of "Servistat."

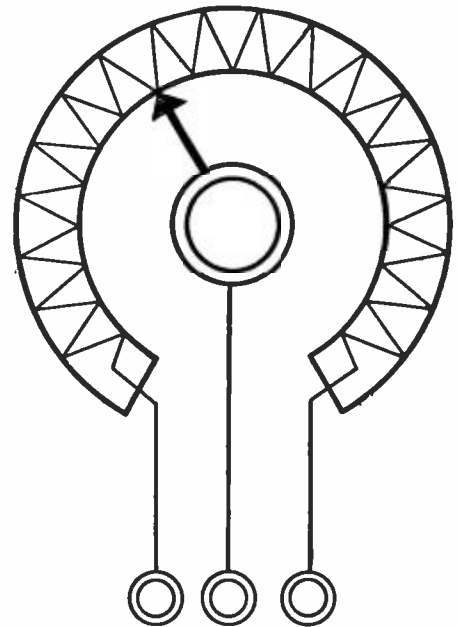

FIG.3A

Fig. 3A. The "Servistat" connections.

or more 10,000-ohm *servistats* be connected in series or that a special model be constructed to include two or more 10,000-ohm rheostat-potentiometers series-connected internally.

The cases for both units are made of 0.054-inch thick steel, 5"x5"x2 3/4". The covers and bottoms are of solid stock with 7/16" lips folded down on all four edges to extend around and grip the sides of the case, while all four sides are made of perforated steel stock of the same thickness for ventilation. The bottoms carry four rubber feet, mounted one in each corner, to make for non-skid mounting on the work table.

Connections are run between each of three terminals of the rheostat-potentiometer and *National* type *FWA* metal binding posts shown mounted on the cover. These binding posts extend through large clearance holes drilled in the cover plate and are insulated externally and internally by fiber washers. They are conveniently designed to admit connector wires through holes near their bases or banana plugs in their screw tops. The

FIG.4A

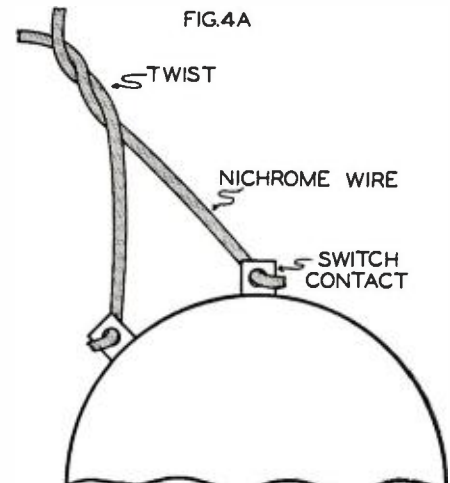

Fig. 4A. How to wire the "Servistat."

pinch screw is of such finish that it will not shear wires fed into the lower hole, and its threaded head is constructed to admit a spade-type lug if that sort of terminal is encountered.

The rheostat-potentiometers are adjusted in both models by means of large fluted knobs with skirts. This type of control was chosen because of the excellent finger grip it provides and the ease with which it permits close settings to be accomplished. The knob will take a special blank dial plate if the builder desires to make up calibrated resistance indicator plates.

Using the Power-Type Servistat

Use of either power or decade type of *servistat* in trouble shooting consists simply of (1) setting the instrument to the value of the defective or unknown resistor and connecting it by means of clip-terminated test leads in place of the defective resistor, or (2) with the *servistat* set initially to zero ohms and bridging the defective resistor, advance the former until the recommended operating voltage (as indicated by a voltmeter suitable to the particular circuit) appears at the termination of the resistor circuit. The instrument is used here as a rheostat; that is, connections are made to the central binding post and to either of the outer ones.

The setting of the *servistat*, which indicates the proper resistance required in the circuit, may then be determined with sufficient accuracy by means of an ohmmeter. However, for greatest operating and interpreting speed, the power-type *servistat* may be equipped with a dial or pointer-scale marked off directly in ohms, instead of the simple knobs shown. The original calibration may be performed to sufficient accuracy with a simple ohmmeter and the dial may be anything from a simple cardboard disc to an engraved metal plate, depending upon the tastes and facilities of the builder. Tests show that the *Ward Leonard* units specified will maintain resistance calibration over a considerable period when not subjected to extraordinary abuse.

Two methods are available for adjustment of the line-cord *servistat*. The first requires that the unit be pre-set to the required value of resistance, after which it is clipped-in in place of the defective cord element. The proper resistance value is determined from the formula:

$$E - E_h \\ \frac{\quad}{I}$$

Where E is the power-line voltage (a.c. or d.c. volts)

E_h, the sum of tube-heater voltages (volts)

I, is the tube-heater current (amperes)

As an example: An a.c.-d.c. midget receiver has the following tube lineup: 1-25L6, 1-25Z6, 1-6J7, 1-6K7, 1-6C5, and 1-6 v. pilot light. What value of line-cord resistor will be re-

(Continued on page 50)

MIKES-HEADS-PICKUPS

The art of "Home Recording" is fast taking its place as one of the most fascinating hobbies or professions in the electronic field. We are of the opinion that not only do the readers want descriptions of recorders in general, but actually wish complete technical data on the various units that enter into the assembly of these machines. It will be the specific purpose of this column to review the all-important accessory items, such as microphones, pickups, cutting heads, discs, needles, styli, and any others that find application in the art of recording. Most of these accessories will be given a fair trial in our own recording studio under conditions that will simulate those found in normal applications. Tests will be made as to fidelity and general performance wherever needed to describe the part accurately and to be able to guide the reader in his selection of merchandise.

Manufacturer's Specifications

Make: Astatic Microphone Lab., Inc.
Model: X-26.
Type: Crystal.
Range: Depends on network.
Stylus required: Steel, stellite, or sapphire.
Shank: 3/8" overall.
Shank diameter: .060" to .070".
Used on: Acetate or similar blanks.
Input volts limit: 250 volts rms.



Description

Model X-26 Cutting Head has been designed specifically for recording on acetate and similar blanks in home-recording service. Motors and feed mechanisms adapted to the X-26 have been and are being developed by other manufacturers.

No detailed discussion will be attempted here of conditions necessary to obtain smoothly cut grooves, with low surface noise, and free from speed and spacing troubles. It should be mentioned, however, that surface noise level depends primarily on the condition of the stylus cutting edge, and to a lesser extent, on proper placement of stylus in the cutter chuck.

Steel, stellite or sapphire stylus points may be used without significant change in cutter response. Useful cutting life increases in the order named, and also, the surface noise level obtainable with a new stylus is likely to be reduced in the same order, since the harder point materials usually are capable of taking a keener edge and smoother polish. Steel points give quite satisfactory performance and life, and are recommended for home-recording applications, because they are least expensive and less easily broken.

Shank should be straight and round, and should have a flat, parallel to the cutting face, at the point where the stylus screw bears. The screw, bearing on this flat, will position the cutting edge approximately right, while also allowing the slight adjustment necessary to make the shavings travel inward toward the turntable center.

Response

In measuring performance of the X-26 Cutting Head, the following procedure has been found most accurate and simple of a number of methods tried. It is recommended to those designing complete recording outfits.

(a) Cut a tone record, using a beat-frequency oscillator feeding into amplifier and cutter network being tested. A series of definite frequencies, rather than a gradual

sweep tone, is recommended for easy identification later. Frequencies of 50, 100, 250, 500, 1000, 2000, 2500, 3000, 3500, 4000, 5000, 6000 cps are suitable. There are no sharp peaks in the cutter response which would be obscured by this selection.

(b) Calibrate a pickup, amplifier, and output meter hookup on the *Audiotone 78-1 Test Record*.

(c) Measure the tone record from (a) on the calibrated pickup and calculate the difference between *Audiotone* and tested tone records.

(d) Plot this difference, as Recorded Level vs. frequency. This "Recorded Level" curve then represents the discrepancy between the response of the measured cutter system and the standard commercial recording characteristic, typified by the *Audiotone*.

While crystal pickups and cutters offer interesting possibilities in making "constant-amplitude" records, one should remember that home recordings must reproduce well on playbacks other than that in the recording

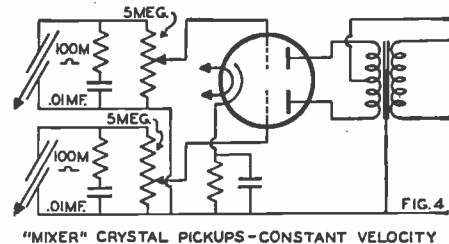
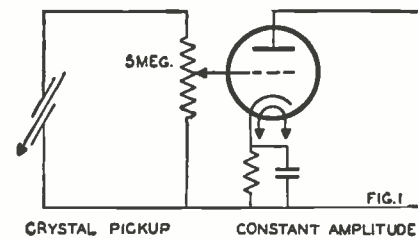

Constant amplitude v. Constant velocity inputs for crystal pick-ups.

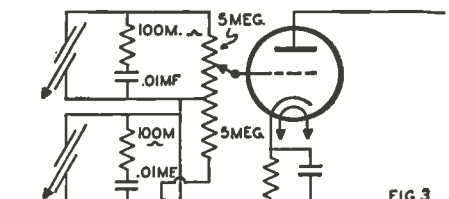
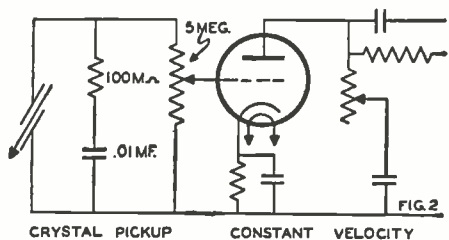

Mixer-fader crystal input circuits.

outfit. Also, the home-recorder playback system must function on commercial records. For these reasons, the commercial recording characteristic should not be departed from too far.

A crystal-driven cutter inherently wants to work on a "constant-amplitude for constant applied voltage" basis. The recorded level curve, as defined above, of a crystal cutter, therefore, tends to be flat below 250

(Continued on page 46)



w4gff's xyl.



w1ksa.



w4gff & w4dfe.



w1lpx.



w1jqh.



w8kyr.



Hamopess & her shack—w 8 p z a .



"Joajah" Peach Opress. (Name on request.)



Pretty pre-war v e 4 v o .

H A M ☆ ☆ C H A T T E R

ABOUT the funniest story that we have heard about the hams and the present day crises goes like this.

A ham who lived way out in the southwest where men and women know it, not to mention that they like it—had himself erected a swell basket-weave-type vertical antenna. You know, one of them that looks like the real broadcasting McCoy. And did that sky hook go to town! Gosh, before *The Edict*, he worked more furriners than you can shake a stick at. Of course, when *The Edict* was signed, he quit his furrin qso's even as you and I.

Well, this here ham was in the chicken business. Yep, he had hisself some mighty fine pullets (use a "p." Mr. Printer, and not a "b"). All of these chickadees had to be housed so they could perduce the aigs which were the means of the ham's livlyhood. (In case that's too complicated: the eggs were sold and the ham lived by the sale of them.)

The ham had his coops set out all over the prairie and they were interconnected with nice planks fer the hens ter walk on. Yep, nothing to good fer those hens, nosir! As time went on, and it does do that little thing, he got hisself more and more hens, and consequently he hadda build more and more coops. He added each coop on to the last one like a game of dominos, and interconnected them with the same old planks. (This is a plank by plank description of a successful ham's hen house.)

One day, in the not too distant past, there roared over the ham's coops radio station, a grand and complete quota of Unca Sam's very finest airplanes. Yessir, there were bombers, observation ships, fighters and everything. They passed overhead, and then, strangely, returned and kept going around in circles over his hen farm. Finally, they disappeared into the blue distance.

Next day *FBI* men swarmed all over the place. They looked over the radio station and the hen houses. They 3rd degreed the ham, and finally, after many hours of grilling, made ready to leave.

The ham was frantic. He was a patriot from the word go. His ancestors had put the lone star into the state's flag; they had fought at the Alamo, or whatever battle one has to fight at to "belong" in that part of the country. All these things the ham called to the attention of the *FBI* boys.

"Whatsa matter," he pleaded with tears in his eyes. "whasa matter wid youse guys? I'm for the old Yousaysay, first, last and foremost. What have I done; ain't my record clean and don't it show that I'm okay?"

"Yep, it sure does, pal," answered one of the *FBI*men.

"Then why are you here?" queried the ham.

"Remember those planes that went over here yesterday? Them was Army planes!" said the *FBI*men.

"Sure I remember them," answered the ham, "but what about it?"

"Get a load of these pictures they took," answered the *FBI*man.

The ham looked, and swooned away. There against the nice greensward he saw pictured his radio tower, his home and his hen houses carefully joined with planks. But the hen houses and planks seemed to draw a perfect Nazi swastika in the prairie land.

Was he busy changing all that the next day . . . and wouldn't you have been too?

From the Mail Bag

(Following our custom to print *all* the material in this very complicated and delicate situation which the Editors of *RN* have been following with considerable interest, we hereby publish a letter received the other day. It speaks for itself. If those who have been bombarding us with letters on the other side of the controversy want to say anything, we will print those letters too. One thing make

certain of: *RADIO NEWS* and *Hamchatter* is absolutely neutral about the whole thing, acting merely as a clearing place, or a forwarding medium to proper authorities. It is these authorities who will act, if and when they see fit. We make no charge, offer no suggestions, and truthfully have had nothing to say. It is not our baby. It belongs to those who hatched it. We are merely reporters.—The Hamchatter Editor.)

Rosemont Farm,
Franklin, Pa.

Hamchatter Editor,
RADIO NEWS.

My Dear Sir:

Noticed your item in the June issue regarding the "well-known W8" who, allegedly, has been short-changing *F88AB*.

Dad burn it, man, why don't you find out from the W8 and also from *F88AB* before you go tossing items like that around? I personally am familiar with the story, and was aware of the facts of the case long before they ever reached your ears; and I'm just one of the few fellows who know how things really stand. You better do some up-checking before things go much farther, as (as you remark in the column) a good many of the DX gang in this country are familiar with the facts in the case; and with them right about now, you are most definitely unpopular. Do you know that the "well-known" W8 has already sent several dollars worth of tubes, parts, and miscellaneous equipment to *F88AB*, some months back? I thought not. Perhaps they just hadn't reached Paul when you heard the story and got yourself all overheated. Also do you know what it was that Paul wanted this "well-known" W8 to send down? And do you know how much money was involved in the transaction? I do. . . . And so do you know the rest of us. . . . And do you know just how much more the parts cost that have already been sent than was covered by the money remitted by *F88AB*? Perhaps you better do a little job of asperiting around before you go casting aspersions and implying and imputing dishonesty on the part of this "well-known W8." Practically all of the DX men in the country who are real DX men know who it is you are taking for a ride, and the sentiment is that you are making yourself darned unpopular. How much investigating have you done beside writing this letter to Paul (*F88AB*) which, evidently, hasn't been received? And, by the way, have you heard *F88AB* complaining that he has been getting gyped? And do you know that this "well-known W8" has already on two or three different occasions tried to send a *SECOND* package of parts to *F88AB*, which parts have been consistently refused at the post-office, as they decline to handle radio parts for delivery in a colony of a belligerent country? Yesterday, it was my pleasure and privilege to attend an outing held at the home of one of the country's top-ranking DX men; in attendance were some six or seven members of the *DX Century Club*, and some ten or twelve other DX men (by DX men I mean having 75 or more countries confirmed and over 100 worked); and all of them are familiar with the facts in this case, and all were equally loud in their opinions of your injustice to this W8. Do you for a moment think that such a short-changing procedure could fail to come to the attention of the *ARRL*, if such things were actually going on, what with the DX gang being so clubby and intimate together? Of course not. The *ARRL* is in possession of the facts, and you don't hear them griping about it, do you? Well, then, friend, cool down, and don't go implying dishonesty to one of the finest DX men in the country, who has already sent more parts, tubes, etc., etc., out of this country to *F88AB* and others, than you'd ever dream of. Hoping that you may see fit to investigate before tossing out any more cracks, I remain,

Yours very truly,
(Sgd.) CHARLES C. MILLER, W8JSU.



Hamstation & ye op at w4evx.

YLRL NEWS

(The Hamchatter Column is fortunate in its appointment as the official column for the YLRL (Young Ladies Radio League) NEWS. While the OM's and the OB's have, for many years basked exclusively in the limelight of the ham game, their light will now be somewhat dimmed. And rightfully so, since the YL's are supposed to be the beauty in life. So, you OM's, let's raise our glasses with whatever you are drinking and "Here's to the Ladies!"—The Hamchatter Editor.)

W1KUI—Ellen is planning a vacation in Mexico.

W2HXQ—Kay Kibling, Rye, N. Y., is battling by correspondence for Women's Checker Crown with Gertrude Huntley of Minn., who took the Women's World Championship title at Flint, Mich., last Summer. Kay is also Secretary and Station Trustee of W2USA; is YL of W2EOA and both operate on all bands.

W1FOF—"Cookie" acted as YLRL Chairman at the ARRL Convention recently held in Worcester. YLs interviewed at H.Q. there: W1GQT-KKQ-MPP-MDV-MJE-KUI; W2KBG-MWY per W1OR, Chairman of Convention.

W3BAK—Jean Hudson and her sister Dorothy, W3IRR, are among the new YLRL members.

W6RGX—Peggy will act as YLRL Chairman for the Southwestern Division ARRL Convention to be held in Long Beach, California, around Labor Day.

W7NH—Nellie (WLMM) is ORS and is one of the most active women in the Army Net. She is OSRS (Over-Seas Relay Station).

W8KYR—Clara Reger, Buffalo, N. Y., is a pianist and has played for various chains. In spare time teaches radio code and theory and has been quite active in the Buffalo Radio Clubs. Holds 3 Public Service Certificates.

W8PZA—Mil is temporary 8th District Chairman of YLRL.

W8TPZ—Marie of Wyoming, Ohio, active in Greater Cincinnati Radio Club and is Associate Editor of their paper "MIKE & KEY." Was nominated as Vice-President of YLRL.

W9NBX—Enid completed AARS Cryptography course with a grade of 99 plus.

W9ILH—Carrie, Acting SCM for Illinois, took 4th place in the 6th Corps Area AARS Speed Contest.

W9CHD—Lenore is now Portable 2 operating in New York City. (Hinah, Lenore, Ye Ed.)

K7ENU—Mary and K7HUT—Verna, are the Alaska representatives.

Porto Rico's Chamber of Commerce can save on its advertising since K4EZR—Alice and K4-FOW—Jenny are both on 10 meter fone.

Hawaii's merits are extolled by Ella—K6ROJ, Canadian girls in the league: VE4HI Ethel; 4VO Dorothy; 4WY Micky and 4AFT Gladys.

G2YL—Nell Corry—well known in radio for years, is the first European to join.

ELECTION RESULTS: W7FWB, Ethel, who was Temporary President of YLRL, came out winner over W3IXY Dot and W8TAY Nita as the League's First President. W1GQT, Lida, and W8TPZ, Marie, gave W9WWP, Carol, a race for the Vice Presidency but Carol won. Voting for District Chairmen is in progress, each district handling its own nominations and voting.

W1FRO Alice purchased a 12 ft. open runabout boat with a 22 horse Speeditwin Evinrude Motor. She is eager to hear from YLs (not OMs, hi) likewise interested. ("Fraid all the boys would be interested.")

W2MIY Dorothy certainly belongs in an emergency net. She is Red Cross Life Saving Examiner and Water Safety Instructor, holding First Aid Certificate, plus Amateur License.

A well-known W2 op says she likes animals. Has 1 dog, 2 cats, 1 monkey and the OM.

W2HXQ Kay teaches Radio to Boy Scout and Girl Scout Troops. She delves into proper message handling, procedure, code, theory, treasure hunts and broadcast radio.

Says she'll be glad to pass along her working program to YLs interested in this phase of scouting.

W3FXZ Mary had the pleasure and privilege back in 1937 to secure the Special Inaugural Message to Franklin D. Roosevelt from George Earle, Governor of Pennsylvania and relay it to Washington, taking six minutes of good CW work to relay from Harrisburg to Washington, D. C. Mary also kept regular skeds for 1 1/2 years with K6NXd in Schofield Barracks, getting on duty at 4:00 a.m. from 3 to 7 days a week to avoid disappointing the boys and their relatives and friends.

W5IRS Ann who came from Texas recently "petitioned" for a W2 call in NYC and the girls are wondering what combination of letters she received.



w2eoa's much better 1/2, w2hxq.

K7HUT Verna might wish she could receive some BCL complaints as her nearest neighbor is 10 miles away and there is only 1 other white woman in Ugashik, Alaska. She and OM, K7-HAI, are located in the Bristol Bay, Bering Sea district, 400 miles SW from Anchorage where the wind blows a gale most of the time.

W9ZTU Mickey Helland, YL of Sgt. Helland (W9ZTU) at Ft. Knox, keeps the boys in touch with home thru her handling of numerous messages for the Cavalry Brigade.

W9WJ Joanna and escort W9TCG at the Washington U. Engineers' Mask Ball created considerable comment with their costumes of black, appliqued all over with schematic diagrams in yellow bias tape; topped with cap supporting a three-inch antenna tower holding a lighted flashlight bulb. (Batteries hidden in the cap.) They told the gaping crowd that the bulb was lighted with...

W9OUD Lotha has in the past made a record of bringing in more AARS recruits than any other station in the CA. Wonder if any YL has topped her salesmanship?

Seven Greater Cleveland YL hams attended the 2nd meeting of the recently organized local chapter of the YLRL: W8CKH-W8ODI-W8PZA-W8-SBB; W8TAY-W8TLZ and W8UCY. W8TLE was ill and unable to attend. They hope to corral W8PXE and W8OHN ere their next meeting, making Greater Cleveland girls YLRL 100%. This is the first organized local club known comprising only licensed YL amateur operators. W8CKH Gertrude Roddy, formerly of Garfield Heights, Cleveland, Ohio, is taking a Summer Craft course at Kent University and will entertain the Greater Cleveland group at its July meeting as she will soon return to her home in Dayton. The girls gather on the 3rd Friday of each month.

W8NAL Carmella, familiarly known in AARS circles as "The General" or more intimately as "Gen." has been vacationing in Pittsburgh this last month.

W1MDS blurts out wid:

W1KPD, W1AP and W1TP represent 2 1/2 m. activity in Berlin, N. H. All work portable-mobile with transceivers.

W1HXC is a proud father of a new junior operator.

W1MSX (mighty small xmtr) is a new ham in Lancaster, N. H., with 5 watts to a 6LGG. Pat is so busy now this time of year that he had to put his 160 m. Zepp up by moonlight.

W1YY has bought a sport coupe which will keep him off 160 m. as long as he can keep something in the gas tank.

W1LGV has finished his first year at the University of Maine and will be on 160 m. phone during the summer.

W1LBJ (one little brown jug) has moved his haywire across the river into N. H. and invited some of the locals in one afternoon to raise a sky hook on the cliff in back of his new location. Bill's 210 has a large hole in the plate but he says there are a few more qso's left in it yet.

W1MOC, W1MOC, and W1MEV all of Skowhegan, Me., jumped in the old jalopee and paid a visit to W1LYS in Cotebrook, N. H.

W1MDS is working 160 with 35 watts to a 6C5-6LGG rig.

W1MCS is building a new all band cw. rig.

FROM W1JOM of 1st Dist. we learn:

W1KJD is in the mrlkt for a superhet. He is at present bldg a 275 wt mod & wl probably go up on 20.

W1SI came home frm wrk the other day, when it was raining "cats & dogs." He found his YL sitting under an umbrella with pans all over the place to catch the rain. The day before, SI, had put up a 16 el 5 meter ant wid the help of W1KUD, & a few other invited guests. SI's YL sed the place was so filled up wid people on the roof it looked like a penthouse. As they strolled arnd the roof they must hve stepped on some nails & punctured the roof. So when "the rains came," they also came thru the roof. His wife is planning tt their next house will be bilt like a tower, so the OM will not be able to invite his friends to walk on the roof.

W1BWP is having a swell time on 75 fone using only 40 wts. Hermon is located in Middleboro.

W1TZ on 10 fone frm Stoneham wid a 3 el rotary.

W1MME decided to clean up the shack a little so he bot a rack & dumped all the equip in.



Big rig of hamop w4fsf; also him.



Hamop-ess w8tpz es her shack.



Flagstaff's Ariz. pride & joy; w6rxp.



"DOUBLE U FOUR BATHING BEAUTIES," BRUNSWICK, GEORGIA

w4bb's bootfoolish qsl crd.



Army Orders: "Don't let your code book out of your sight."

But don't look behind the thing. Hi hi. W1MJK is a new ham in Boston. He is planning on constructing a beam.

W1MQO the well known Billy Dale has at last got his ticket. Now he'll know how it feels when a SWL turns knob on the transmitter etc. etc. hi, hi. Welcome to the 10 meter gang Billy, and u don't hve to worry abt getting into the Screwball 10 meter Net, fella, no sirreee.

Now tt 10 has gone dead, W1LEU wants to go West to Texas, like the old pioneers usta do. & he adds "Maybe I'll stumble across an oil well." Good Luck Pete. & if u do discover oil, w1 u give the ol' gang a brk on the "LEU Gas"?

W1IVX & W1MOO r brothers. W1MKW of 10 meters, sings for Women's Clubs. He is bidding a hi pwr rig, tt will run abt 600 wts wid band switching frm 10 to 160. W1LWS using .8 of 1 watt on 10 fone.

W1DSN bidding a rig fer W1DWG. W1AHD of Ashmont is a Dentist by profession.

W1LMB's new QTH is 10 Crocker st., Somerville. So all u XU & J SWL's plae send Al's repts to his new address.

The Parkway Radio Club is nw on th air. The freq for the club net is 3915 kc. W1KK is running freq modulation. Tom also wrks on 20 fone.

W1EDL of Gorham, Maine, is a great fishing fan. Plans to take a trip to Georgia. W1LX teaches chemistry at the Somerville High School.

W1MPJ is W1MOO's gl friend. W1ASN Saugus, Mass., on 20 fone. Ditto W1WE. WE recently put up a nw beam. He is running 60 wts to 10's in final & 46's in mod. W1GWK takes traffic Mon & Wed on 14.276. Art is running a 3 el rot.

Say Ed, this Ham Chatter colum certainly is getting arnd. Just hrd frm W1IUY (who's call was mentioned a couple of issues back), tt he got one of those "LimeLight" crds while off the coast of China. When they got on shore they docked & bot an issue of RN at one of the mag stands, to find out wat it was all abt. (You shud put out a edition in Chinese ED.) He sezs it sure is fb to read abt the boys down the home town & to keep up the fb wrk. OK, Cal, we'll keep u informed of wat the boys in Southie are doing, thinking & saying. Hi, hi. (If it's printable.)

W1LMG planning on increasing pwr up to 150 or so wts. Since the 10 meter bnd has gone flat Bill has gone in for cooking. hi, hi. Send a couple of those LMG special Brownies dwn the hill, Bill, to the Jolly Ole Man.

W1CIB gg to bild a frq & Modulation meter & monitor.

W1GKY dwn in Chicopee, Mass., is wid the Chicopee Light & Pwr Co.

W1SI playing arnd on 5 wid xtal. W1IPA in the "Lunatics Paradise, the Weird, Wide, Woolly, Fantastic Plains of Jamaica" (whew) is nuts abt bowling. His average is a little over 100.

W1BEV is the call of the North Shore Radio Club at Lynn. The last time they were on they were drawing straws to see who wud climb the 2 new 40 ft poles on top of the club house to make sum adjustments. Frm the fb sigs they put they cud hv left it alone.

W1MRK of Auburndale, Mass., is a newcomer to our ham fraternity. At present he is operating on 10 fone. His rig is Meissner Sig Shifter wid a T125 in the final, running abt 225 wts. Modulating wid 203A's in class B. Revr is a Meissner 14 tube outfit. Nick only got his ticket 2 days when the BCL's started in. Just think wat will happen when the whole town gets wind tt u hv a ticket Nick, then th'll blame u even if the dog starts barking. hi. (Honestly tho fellows, they call the FCC abt JOM every time the baby cries or refuses to take his bottle.)

DX isn't too bad, but it is rather sad the boys can't resist calling Europeans as long as there is trouble abroad. We know of one W2 who came strutting in with tales of how he worked a D. This same DX man has over 100 D cards, yet he willingly broke the amateur neutrality code to do nothing but satisfy his own ego. W's will probably find the best policy to pursue is work in the Western Hemisphere only.

20 meter DX, which may be found from one end of the band to the other includes: Phone: CR6AP; BA1AA; TG6AA; YV1AZ; H1P; PE1OG; K7HAR; HH3B; HR3C; YS1MS; CE1AA; YN1FS; K6QOV; T1R3C; YN1EO; HH2AP; HK4DJ; LU2FC; YNU1; HK3CC; CE1AP; PY7AI; XE1A; XE1E; CP1XA; CE3EE; PY2FO; PY4BI; ES2F; LY1S; LY1J; CW; HA7P; HA9U; HK2BD; CT1JV; LY1SAR; CR6AP; LU6DJK; LU3FB; XU6OH; LU5CR; PY4AP; XE1LS; XE1AM; KE6SRA; KH6SHS; K5AA; K5AG; XE3AF; CM7FR; YV6AO; K6PCM; K6ILW; XU0A; KAIHR; HH2MC; HH3L; KAILB; J3FK; KF6SJ; HCLVT; KB6RWZ; K7GOM; H13C; HK5EJ; ZP6AB; OQ5AV; OQ5AB; and PY2LN. We are not listing over 35 D's because working them is a violation of the Amateur Neutrality Code. On 7MC: KF6RA; J2IX; J2OP; K6PAL; K6PDQ; K7TP; CM6ZE; and K7CBF. 28MC, is pretty poor with little of anything coming through. K6PIT, HK5EE and KC4USB are also on 40. XE1GE is coming through well on 75 meter phone.

G5RI, or should we say ex-G5RI wrote an interesting letter to W2IOP, parts of which we are quoting. "Since the beginning of September we have been shut down as you know and all xmitting gear has been interred for the duration in Post Office Stores. I have a receiver yet and frequently listen to W on 14 and 7MC. The Asians also come through well, and spend most of their time calling CQ and working nobody, as there is nobody left to work! (Italics ours) One wonders whether the government will appreciate the part that so many trained men came from the ranks of the radio amateur and whether they will suitably reward us by allowing the re-issue of licenses after the cessation of hostilities. I must admit that I am pessimistic about it. The 7MC band here has degenerated into a bedlam of SW BC stations shouting propaganda in all languages and they will be difficult to shift. Perhaps we shall lose 7MC.— who knows?? Who knows?"

IF you don't know of it by now the FCC is changing the method of giving license examinations. Questions will be of the multiple choice type in which the candidate selects the one correct answer from a list of several. The idea is to speed up grading and time in taking of this test. Subject matter will remain the same, so it need be of no concern to prospective hams. Present exams will run until July 1. The standard *ARRL License Manual* is being revised and will be ready before that time for those who want practice.

W3FHU keeps his KW purring on 75 meter phone. Jack uses a pair of T200's. W4DLW's 65 watts and SX25 run the 20 meter KW's plenty of competition. The two element rotary really works. W9RFA is now on the East Coast, working for *American Airlines*. Murray plans on acquiring his W2 call soon, and by the way also an XYL. In fact by the time you read this W9RFA will probably really be QRT. W2MSY is also an *American Airlines* employee, and like all travelers has held numerous calls, among them 6SU; 5AHB; 5BIT; 5AQ, all of which add up to 17 years of hamming. Andy now has a 350 watt *Collins* on the air—all bands.

W9QCD of Crescent City, Illinois, can tell you about technocracy and the farm. Ward has a 500 acre farm and enough machinery to run it almost entirely automatically. City slickers will do well to talk to W9QCD for some interesting conversation. Bugs are plaguing the new 20 meter phone of W2JDG. Sam has replaced his T200's with the new TW150's. W2OT has a FB new electronic key using a single tube. Much to Kirke's

credit is the fact that it was built before *QST's* article on the construction of such an instrument. 75 seems to be the happy hunting ground of KW's. Heard within 7 minutes were W3CNY; W1DQA; W3FHU; W1DG; and W1LAU, all running over 750 watts.

W8LYW in Utica is cathode modulating his T240's with single 2A3. W2MBI is contemplating high power to the tune of a KW. At the present time he is using a 100 watt bandswitching transmitter and operates largely on 28MC. phone. W9ZDO in South Bend, Indiana, has a unique rig, even if he won't answer QSL's. The exciter and speech is contained in a carrying case with the receiver for portable work. When Rex is home he uses the 807 to drive a pair of 813's at a half KW and uses the 807 modulator for speech drive through a 500 ohm line. W1IMP has a parasite chasing him out of his shack. Ted was toasting his T55's around in a rage one AM and now they won't even take 100 watts.

W3HNS is making a come-back on the UHF's. W3EQK is a member of the *Baltimore Police Department Pistol Team*, and the Colonel doesn't aim (no pun) to put up with any nonsense on the ham bands, so watch out boys. W2SN, able Second district QSL manager, is a Jersey officer. W3SL was rudely awakened by a powder explosion near Wilmington at 5:30 one morning this month and couldn't get back to sleep. Net result was some FB 75 meter phone QSO's with various W7's and hearing of an unidentified K7 also.

BET you'll never guess where W3BES and B WITS ended up in the ORS party. That's too easy for the RN forecaster to even bother predicting. W9BBR has the sign to end all signs. "Buck Benny's Radio Station" in Waukegan, Illinois. W9AGJ in Minneapolis keeps in contact with his folks through his old cronies on L. I. W2JBQ keeps busy working phone and CW on 80. If you are in doubt ask W9NJO if Kentucky isn't the home of beautiful women, fast horses, good whisky, and R9 signals.

W6USA won't be on the air this year. W2USA will continue operation in N. Y., however. In case you're wondering why you haven't received your W2USA QSL, most of the cards will be replied to at the end of the fair.

W6ONQ is boasting he hasn't torn the rig apart in over ten days. John is using a *6SK7EC0-807-5T-250T* and a pair of, we think, 46's in the final. He won't talk.

W6NAD's grid modulated 500 watt rig really rolls in with a sock.

W9DHO in Weisner, Nebraska, has a special shack on the edge of town which houses his T55 rig; HQ120X; shop and himself.

W6ONQ is praying that ARBEE is O.K.

QSL to KE6SRA at this address: Roger Parnell, Johnstone Island, C/O Postmaster, Honolulu, T. H.

W4GN is with the CA4. Jacks Creek, Alabama has a population of 75, so he and W4AAO don't have much BCL QRM. W9PBL is a school teacher, as is W2MET. W3FJU, and W4DW.

W2E2C's drugstore is a local meeting place for hams. Best record is 8 in one evening.

W2MNR has 900 watts on 160. One of the first test CQ's brought 18 calls, which makes us think W2MNR must have been signing XU or something like it. UHF activity is booming all over the country. In the second call area so many stations are working 2 1/2 that it is impossible to list all their calls. However, consistent 40-mile work is being carried out, including a 25-mile sked on 1/4 of a meter. (L. I. to N. J.)

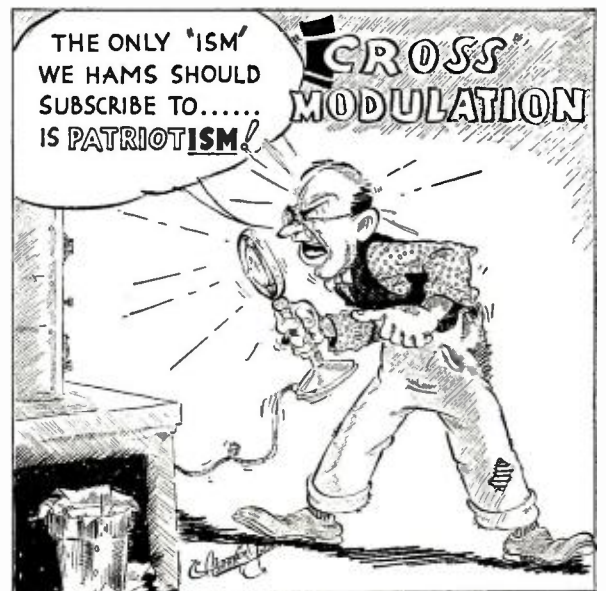

§ Serviceman's Money Page §

A NEW SERVICE TO READERS

Some handy gadgets which may mean money.

Trimmer Condenser Mount

You can adjust a trimmer type condenser on regenerative or other sets from the front of the panel by mounting it on the "chassis" of a discarded volume-tone control. Reject the metal shaft and replace with a wood

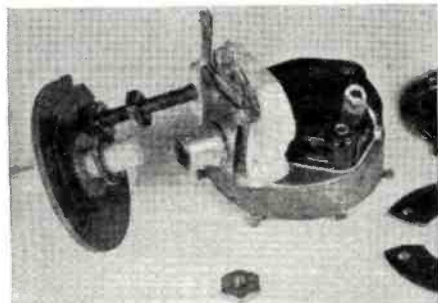

dowel. Solder a metal tube $\frac{1}{4}$ " long on the head of the trimmer condenser adjusting screw, to receive the end of the wood shaft. Only one machine screw is necessary for mounting.

Adding a Pointer to Improve Tuning

You can easily convert the small knobs of midget sets which have a dot for dial locators or pointers, into arrow type knobs. Flatten the head of a round headed brass escutcheon



pin, or nail, and file the flat head to the shape of an arrow head. Drill the hole in the dot of the knob and cement the pointer into the hole with speaker cone cement.

Asbestos Collar Prevents Burns

While trouble shooting receivers, one can tolerate hot tubes coming into contact with

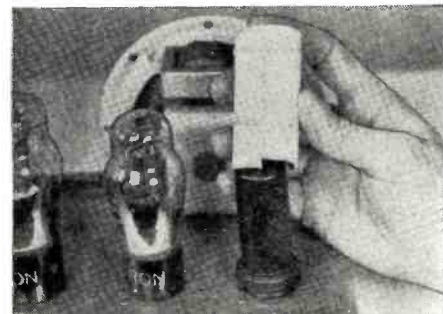

the hands or arms, but those metal ballast tubes sure can cause a lot of cussing from burns. You can work with ease if you will slip a five turn collar of asbestos paper on the ballast while servicing. The tube won't burn your arm or hand, or the bench when the chassis is turned upside down.

Chassis Kink

You can eliminate the hazards of the straight edge unprotected side of a metal chassis by placing a rubber tube over the

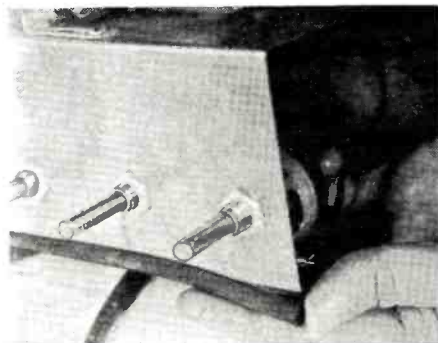

sharp edge. Auto windshield wiper tube costing a cent a foot, slit lengthwise is inexpensive and serviceable.

Dial Illuminator

By bending in a gas flame the solid glass rod removed from a high-watt burned out light bulb and mounting, by passing it through the panel as shown, a dial can be spot-illum-

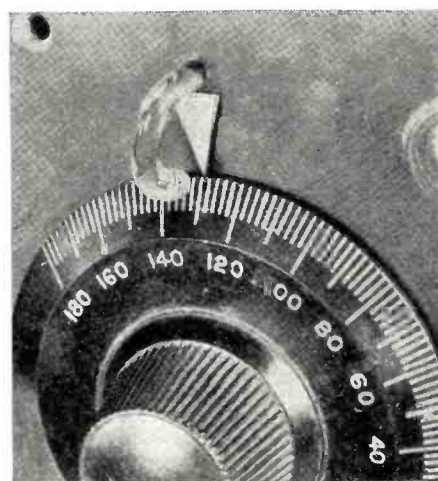

inated. The illumination is furnished by a dial light placed on the other side of the panel and against the end of the glass rod on this rear side.

All-American Mohawk

An *All-American Mohawk* was brought into the shop. Local signals on it were very weak. Plate voltages on the r-f stages were low.

Located the trouble in an r-f coil. The primary was laid in a groove cut into the form; the secondary was wound over it. There was a short between the two windings. Both were rewound with thin paper separator between them.

RCA 5-T1

Complaint was fading and noise. It would start frying for a few minutes, and—pop!—reception would be clear. Tubes checked O.K.

Using a magic eye output meter on the

audio circuit showed the trouble wasn't there—although its effects were. The "eye" was then connected in the AVC circuit. I removed the first tube (the detector-oscillator) and fed a signal from my impact oscillator into the I.F. The tone was then steady.

I melted the solder at the top of the 6A7 tube, cleaned the cap, and resoldered it. The fading stopped. The job proved to me that tube testers don't always show up a defective tube.

Tailor-Made Grommets

When you reach for a grommet to insulate that hole in the metal chassis and find they have ossified or petrified—roll your own. Do it by cutting off a piece of rubber tubing half



an inch long. Slit it along the side, turn it inside out, and insert it into the hole. The rubber tube, in its effort to turn inside out in two ways, grips the hole with a force applied in two directions.

Insulated Lead-in from Wet Condenser

The big threaded insulated end nuts on junk wet electrolytic condensers of the can type will serve nicely as insulated bushings



or lead ins. The can is cut from the end with a hack saw, and the insulated threaded mount is removed. You can thread a portion of brass rod to be used as the lead-through connection.

Emergency Soldering

Service men often find themselves out in the country repairing a set with no available power for their electric soldering iron. A very efficient one can be made that works off of a six volt battery. Take the carbon electrode out of a number six dry cell and trim the end, opposite the screw terminal, to a point. An old pocket knife will do this beau-

(Continued on page 61)

SERVICEMAN'S CASE HISTORIES

by **ALFRED A. GHIRARDI, B.S., E.E.**

Author of "The Radio Physics Course," "Modern Radio Servicing"; member Radio Servicemen of America, New York Electrical Society, Institute of Radio Engineers.

GENERAL ELECTRIC F-107

Automatic tun-1) "Touch Tuning" button leads er unit oper- not making good contact at adjustable contact pins. ates unsatisfac- Clean contacts and re-insert torily—skipping sliding contactor blade either past stations 2) covered by thin piece of bakelite or dirty. Carefully run fine file over top of sliding contactor, making sure not to leave any sharp corners. Sliding contactor should have a small amount of vaseline on beveled surface to prevent chattering

3) nipple too sharp on adjustment contacts will cause sliding contactor blade to jump across. Smooth with fine sand paper

4) relay armature out of adjustment causing sluggish operation of relay switch. Adjust the relay . . . Backstop for relay armature should be adjusted so that a potential of 4.5 volts is sufficient to snap relay closed. The backstop must make positive contact with armature when relay is open. If the relay will not close at 4.5 volts and still maintain proper travel and sequence, weaken the spring holding armature open. After any adjustment on relay, sequence in which contacts open should be checked to open in the order described in paragraph No. 1 under "noise in audio output" (see below)

5) excessive side play in sliding contactor. Loosen the set-screw on the back of the sliding contactor, and slide holder together. Final adjustment should allow sliding contactor to rock freely

6) not enough tension on sliding contactor arm. Loosen collar on shaft in rear of contact segment and move sliding contactor arm towards the contact segment; then tighten collar on shaft

7) if the contacts at the rear of the "Touch Tuning" button assembly shafts do not close or make good contact, the motor will continue to scan the dial without stopping at the desired station. Adjust by bending contacts.

8) contact segment may be bent out of shape. This should be perpendicular to parallel to rear chassis apron in order to allow the contactor arm to wipe the adjustable contacts evenly

9) contacts at rear of the button shafts touching, or shaft is touching contact. Adjust by bending contacts

10) relay remains energized and audio continues to function —push button escutcheon grounded. Be sure dial and push button escutcheons are insulated from each other or from the control shafts

11) "Off" switch contacts do not close

12) if set does not tune automatically unless scan button is also depressed, contacts No. 6 require closer spacing

13) open or shorted motor capacitor —characterized by motor armature "humming"

but no torque. Replace 1,000-mfd. capacitor C58

14) open or shorted coil in motor —characterized by no torque or low torque in one direction. Replace motor or repair coil

15) drive mechanism bound, or too tight for motor to drive not enough friction in Slip Pulley—the friction of the Slip Pulley is adjusted by tightening the collar on the end of the motor shaft. Care should be exercised that the set-screw does not hit the relay armature

16) belt slippage—the tension of the belt may be increased by raising the motor on the relay bracket. If the belt slips, reverse belt and use other surface or use belt dressing. (Unsatisfactory operation of the automatic tuner unit on some of the earlier models is caused by a slipping drive belt. A small hole drilled through the back corner of the motor base plate and a tapped hole into the chassis will enable a small screw and spring to be used as a belt tightening unit to secure the proper tension)

17) push-button escutcheon "grounded" to chassis of set. This trouble is usually caused by control shafts touching escutcheon. Centering chassis in cabinet, or placing fibre sleeves on shafts will remedy this trouble. This trouble is characterized by the relay remaining closed

Noise in audio 1) contacts of switch not opening in proper sequence—if

"Touch Tuning" the relay switch contacts open in improper sequence, audio output will be available too soon, and the break in the motor switch will be heard in the speaker. Center contacts (motor) should open first, contacts farthest from armature (AFC) second, and contacts nearest armature (silent tuning) should open last

2) "dressing" of Silent Tuning Lead—early production receivers had silencing lead from 6L6 grid run to connector socket on rear apron, up to "Push Button" switch, and return through socket connector to the relay switch where the ground wires of AFC, motor and silent tuning contacts were connected together and grounded to chassis. Reconnect as follows: Ground AFC and motor contacts to a point of the chassis directly underneath the motor. The green grid lead from the 6L6 should be rewired over the top of the chassis deck to the silencing contact of the relay switch; the lead from the other relay silencing contact should be connected to a prong of the connector plug; from this point, connection is made to the silencing portion of the "Touch Tuning" switch, and a return to ground from this point is made through the connector plug to the chassis near the connector plug socket

3) noise through filter circuit—the "blurr" in the speaker on early production due to the sudden application of audio may be reduced by placing a .05-mfd., 600-volt capacitor (RC-092) across the output filter capacitor (C-61)

"Touch Tuning" button will not remain in locked position

Hum when . . . 1) the pole-piece of the relay is divided to form two semi-circles. The relay armature should touch only the semi-circle nearest the motor shaft. There should be a 10-mil clearance between the other segment and relay armature when the relay is energized. Bending the entire armature support may correct this condition, otherwise the pole-piece should be filed down. Hum may also be caused by a bump on the segment with which the armature comes in contact. This may be removed by filing. Be sure all filings are removed after adjustments have been made

After any adjustment on relay, sequence in which contacts open should be checked to open in the order indicated below

Motor inoperative 1) center contacts on relay not making good contact

2) faulty motor-reversing switch

3) "cold-solder" connection on motor-reversing switch

4) "open" or "shorted" coil in motor—this will be evidenced by no torque, or low torque in one direction only

5) "shorted" motor capacitor. Replace with 1000-mfd. 12-volt unit (A.C. working voltage)

Motor hums, . . . 1) check the pilot light socket and bracket assembly for "shorts"

2) "shorted" 580-kc padder

Low-frequency stations weak or inaudible 1) A.F.C. out of line. Adjust hex nut on A.F.C. transformer until "pull-in" is equal on both sides of station carrier

Motor-boating 1) reverse voice coil leads on speaker

2) make sure both contacts for plates of 5Z3 rectifier are making good contact

Excessive hum 1) the fork on the tuning condenser should be adjusted so that the motor reversing switch clicks over when the pointer approximately reaches the 540 and 1620 kc. markings on the dial scale. With the pointer at the extreme end of calibrations when tuning manually, the reversing switch lever should be set so there is not more than 1/16 in. nor less than 1/32 in. clearance between the lever and the switch trigger after the switch has snapped

2) the motor and relay mounting plate should rest parallel to the chassis deck. Do not adjust the spring tension foot; raise or lower motor on bracket, as required. Make sure that there is no electrical connection between the motor frame and the chassis

Miscellaneous 1) the "Off" switch on the "Touch Tuning" assembly should stay closed for at

Reprinted with permission, from RADIO Trouble Shooters Handbook. Copyright, 1939, Radio & Technical Publishing Co. Copyright in Canada and Great Britain, and all countries subscribing to the Berne Convention, by Radio & Technical Publishing Co. All rights reserved.

least one-half the movement of the key, opening only on the final click. If firm contact does not exist between the points, vibration of the set may cause an intermittent noise

4) the silent tuning contacts of the "Manual" and "Scan" switches should open last to permit quiet operation

GENERAL ELECTRIC F-135

See also the Case Histories listed for General Electric F-107 receiver

Automatic tun-1) tap the relay on the left front side (looking at chassis from rear) to "free" the contacts. If still inoperative, clean and adjust the relay contacts

GENERAL ELECTRIC H-31

(Uses same chassis as RCA Radiola-80 receiver.) See the Case Histories listed for the RCA Radiola-80 receiver

GENERAL ELECTRIC H-32

(Uses same chassis as RCA Radiola-50 receiver.) See the Case Histories listed for the RCA Radiola-50 receiver

GENERAL ELECTRIC H-51

(Uses same chassis as RCA Radiola-82 receiver.) See the Case Histories listed for the RCA Radiola-82 receiver

GENERAL ELECTRIC H-71

(Uses same chassis as RCA Radiola-86 receiver.) See the Case Histories listed for the RCA Radiola-86 receiver

GENERAL ELECTRIC H-72

(Uses same chassis as RCA RAE-59 receiver.) See the Case Histories listed for the RCA RAE-59 receiver

GENERAL ELECTRIC H-91

Oscillation . . . 1) "open" or "shorted" 1-mfd. condenser connected across the 170-ohm r-f cathode resistor. If it is "shorted", also check the 13,000-ohm r-f screen bleeder resistor (cathode to screen). If this is "open", screen grid voltage will be high

GENERAL ELECTRIC "J" Series (J-70, J-107, etc.)

Motorboating, 1) replace the entire filter block. Poor sensitivity, if only the bad condensers are replaced, since they remain in the block they affect the remaining ones capacitively

Oscillation

GENERAL ELECTRIC J-70

(Uses same chassis as RCA R-4 receiver.) See the Case Histories listed for the RCA R-4 receiver

GENERAL ELECTRIC J-75

(Uses same chassis as RCA R-6 receiver.) See the Case Histories listed for the RCA R-6 receiver

GENERAL ELECTRIC J-79

Oscillation, . . . 1) poor electrical connection between tuning condenser rotors and chassis. Clean and bend contact springs—or better still, install pigtail connections

Broad tuning, Noise when tuning

GENERAL ELECTRIC J-80

(Uses same chassis as RCA R-8 receiver.) See the Case Histories listed for the RCA R-8 receiver

GENERAL ELECTRIC J-82

(Uses same chassis as RCA R-71 receiver.) See the Case Histories listed for the RCA R-71 receiver

GENERAL ELECTRIC J-83

(Uses same chassis as RCA R-73 (with 47's) receiver.) See the Case Histories listed for the RCA R-73 (with 47's) receiver

GENERAL ELECTRIC J-83-A

(Uses same chassis as RCA R-73 (with 2A5's) receiver.) See the Case Histories listed for the RCA R-73 (with 2A5's) receiver

GENERAL ELECTRIC J-85

(Uses same chassis as RCA R-12 receiver.) See the Case Histories listed for the RCA R-12 receiver

All Star Jr.

(Continued from page 27)

ocs. The dial is removed and by drilling several small holes near the edge of the hole, a 3" meter can be bolted in place for metering the rig. In the small hole directly beneath the large dial hole, an insulated flashlight socket is mounted, to which a single turn loop is wired. This loop is placed in the field of the r.f. coil and serves as a visual check during tuning-up of the rig, and can be used as a check on keying. Since the bulb will take up some of the r.f., it can be unscrewed during operation of the rig, if desired. The small dial plates at the bottom of the chassis are removed and the blank sides are lettered to coincide with the different controls. This will eliminate the expense of purchasing new dial plates. A small hole is drilled at the rear of the chassis for a jack to meter the plate circuit of the 6L6 stage.

The band-switch coil is home-made and is self-supporting on the switch by means of the leads. The coil consists of 46 turns of No. 18 wire 1½" in diameter, tapped at the 10th and 22nd turns for 80 and 40 meter operation. The link consists of 2 turns of No. 18 insulated wire, and is brought out at the rear of the chassis by means of two feed-through insulators.

As can be seen in the diagram, the circuit is that of a conventional Emergency rig, consisting of a triode *Pierce Osc.* and a 6L6 Amp. Since it is almost fool-proof, little difficulty should be encountered in getting it in operation. It will be noted that the full 350 volts are applied to the osc. without use of a cathode biasing resistor. The use of the large grid bias resistor permits operation at this voltage without excessive heating or damage to the tube. Better output from the osc. was obtained from this method than by using a smaller grid resistor and a resistor in the cathode. However, the builder can use whichever method he prefers.

The controls at the bottom of the panel are, reading left to right, the crystal switch; keying jack; band-switch; amplifier tuning condenser and a.c. line switch. The r.f. tubes are located directly behind the panel in order that the leads may be kept as short as possible. Also, the crystals are mounted at the opposite end of the chassis from the power supply in order to eliminate any possibility of frequency variation due to vibration or feed-back. The fact that both stages are keyed simultaneously, allows for break-in operation and eliminates the necessity for a stand-by switch.

A word about operating conditions for the rig. When operated as an amplifier, the plate current of the 6L6 at resonance will be about 7 mils using a 160 meter crystal (with no load); on 80 it will read about 10 mils and on 40 should be about 20 mils. This reading will increase about one half the

original reading when doubling. The output when doubling is quite good on all bands except 20 where it is only fair.

When this unit is used as a portable outfit, it is recommended that a husky power supply be used in order that the output may approach that obtained with the a.c. supply. The one used here is a *Genemotor* taken from an old car radio, which has an output of about 280 volts under load. This still permits a good signal for portable operation, and does away with the expense of batteries which will not stand up long under the current drain of the 6L6 tube.

After the transmitter was finished, it was found that there were almost

enough parts left from the original receiver to build a small two tube regenerative receiver for use with the rig as a complete portable layout. Moreover, the original receiver chassis is sufficiently large that such a small receiver could readily be incorporated in with the transmitter provided the builder is willing to eliminate two of the six crystals provided for. If such a receiver is built in with the rig, the same a.c. power supply could be used to operate both units. However, for portable "B" batteries should be used for the receiver as the hash from a *Genemotor* (if used) is quite bad on the short waves.

Ed. Note: This "hash" may be removed with proper filtering. -30-

IT'S RCA FOR UNMATCHED QUALITY...UNBEATABLE LOW PRICES!

RCA AERODYNAMIC "MIKE"



Priced right for even the lowest cost job!

THE RCA Aerodynamic Microphone is typical of the world's most complete line of "mikes"! It's tops in quality, low in cost. Has proved its value through splendid performance under the most difficult conditions. In the air, on the ground—even in a diver's helmet under water, the quality is outstanding.

No matter what kind of installation you make you have satisfied customers when you use RCA microphones. Pressure, velocity, lapel, uni-directional, bi-directional, non-directional—all types are available, for use outdoors or in. And remember—the prices are right.



RCA Junior Velocity Microphone MI-4036G.



RCA Uni-Directional Microphone MI-4043, RCA 3-Way Microphone MI-4044.



RCA Pressure Microphone MI-4048A.



RCA Velocity Microphone MI-4027B.



Commercial Sound

RCA Mfg. Co., Inc., Camden, N. J. • A Service of Radio Corporation of America

Any sound system sounds better, equipped with RCA Radio Tubes

MANUFACTURERS' LITERATURE

A RADIO NEWS READERS' SERVICE

CORNELL-DUBILIER CATALOG 180-X. *Cornell-Dubilier Electric Corporation* has just published a special catalog (No. 180X) describing its high-voltage capacitors for heavy-duty X-ray and impulse or surge-generator applications. These units are especially suitable for use in technical research and university laboratories. The catalog includes a table indicating the maximum operating voltage to which C-D X-ray capacitors may be subjected. Write Cornell-Dubilier Electric Corp., South Plainfield, N. J., U. S. A. Free. (RADIO NEWS No. 9-103.)

NEW PERMO BOOKLET. *Permo Products Corporation*, manufacturing metallurgists, have prepared a comprehensive booklet for the layman on home recording which gives complete information on cutting needles, records and how to improve all kinds of recordings.

This booklet also gives information on how to record different musical instruments, where to place microphone for better pick-up, pertinent information or details on how to make better recordings and general useful information for anyone using the new home recording instruments as manufactured by the various companies who have placed equipment of this type on the market recently.

This new booklet is outstanding in presenting useful information on recording and includes an audible chart showing range of various musical instruments compared to a piano keyboard so that more consistent and improved results may be had by the layman as well as by the professional recordist. Free. (RADIO NEWS No. 9-102.)

THORDARSON ELECTRIC MFG. CO. BROADCAST CATALOG. The tremendous progress in the application of advanced engineering and technical knowledge, and the development of broadcast components is strikingly illustrated in the new THORDARSON *Tru-Fidelity* catalog just issued. A glance through the catalog indicates that there is hardly an item in this field which cannot be supplied by THORDARSON. The classifications and descriptions are arranged in such a manner that it is a simple matter to turn to any item desired and get complete information about it.

"Transformer Specialists Since 1895," THORDARSON has made notable contributions toward the efficiency of modern broadcasting service. For nearly half a century THORDARSON has been designing and manufacturing better transformers to meet the ever-

changing requirements of the electrical and radio world. Broadcast engineers accept THORDARSON *Tru-Fidelity* broadcast components on their merits, and today these products are used in broadcast station equipment in every part of the world.

Those interested in broadcast components are invited to write for a free copy of this new catalog. Ask for Catalog No. 500-E, addressing the request to the THORDARSON ELECTRIC MFG. CO., 500 West Huron St., Chicago, Ill. (RADIO NEWS No. 9-101.)

STANDARD TRANSFORMER CORPORATION SERVICE GUIDE NO. 125-B is now offered by the *Standard Transformer Corporation* of Chicago in addition to their other catalogs.

This new SERVICE GUIDE has 4300 listings of sets manufactured by over 70 manufacturers, and provides the Serviceman with more complete information than ever before on transformers and their requirements. This SERVICE GUIDE like its predecessors provides instantly available information concerning tube data, the transformer requirements, whether it be power, audios, or chokes.

Many new items are listed here for the first time, and in addition there are now circuits for the Serviceman, items that he can build during his spare time—items that can be sold, used, or possibly rented. A copy of this SERVICE GUIDE might be obtained by writing the Standard Transformer Corp., 1500 N. Halsted St., Chicago, or from any regular Stancor Distributor. Free. (RADIO NEWS No. 9-100.)

SUCCESSFUL SOUND INSTALLATION. Published by *John Meck Industries*, Chicago, Illinois. This new booklet provides practical data for distributors and servicemen and deals with the design and matching of speaker systems for efficient sound distribution and uniform coverage. Proper design of sound installations is a very simple matter to those familiar with the many practical methods of solving problems that can become quite complex if viewed solely from the technical standpoint. In this and succeeding bulletins they will contribute to your success in sound work by bringing you many of these true, practical applications. Many subjects are covered in this booklet, including discussions on How Many Speakers for the Job, Reducing Volume on Some Speakers, Controlling Volume at the Speaker, When to Use Speaker Transformers, and schematics covering various types of installations as to the proper method in hooking up different

combinations of speakers. Further information includes data on Attenuator Pads for Reducing Speaker Volume and Adjustable Volume Pads. A copy of bulletin No. 1002 may be obtained from the John Meck Industries, 1313 Randolph Street, Chicago, Illinois. Free. (RADIO NEWS No. 9-104.)

MALLORY-YAXLEY SUPPLEMENT NO. 8. The *Mallory-Yaxley Radio Service Encyclopedia* is further enlarged by the addition of this supplement which bears the heading **AUTOMATIC TUNING.** This is intended for use with the preceding sheets to be added to the **THIRD EDITION.** A complete listing of all manufactured receivers employing automatic tuning is given. The preparation of a supplement presented numerous difficulties with regard to methods for complete coverage of the subject, without the necessity of repeating instructions previously published in the second edition. That edition contained 25 pages of descriptions on automatic tuning devices produced prior to, or during 1938-39. This addition, therefore, is to supplement in character the one appearing in the **SECOND EDITION** of the *Encyclopedia*. At the time of publication, of the original **AUTOMATIC TUNING** text, there were numerous receivers contemplated, or partially designed, which used tuning systems identical, or very similar to the types discussed in the text. All types of mechanisms are described and illustrated and include Rocker Bar Mechanisms, Cam and Lever Mechanisms, Buick Sonomatic, Emerson Instamatic, Hudson Feather-Touch Tuner, and other popular types. Full instructions are also included for the setting up of push-button controls and their repair. A chapter is also devoted to Permeability Tuning. Concluding, this booklet makes a splendid addition to the serviceman's library. These supplements are issued monthly and the price of \$1.50 per year includes all releases for that period. Obtainable from the P. R. Mallory & Co., Inc., Indianapolis, Indiana. (RADIO NEWS No. 9-105.)

BELL SOUND EQUIPMENT. The *Bell Sound Systems, Inc.*, Bulletin No. 33, illustrates and describes a complete line of P. A. amplifiers and accessories suitable for all types of installations. Amplifiers are included that have ratings from 5 to 70 watts in both fixed and mobile types. This company also manufactures a line of recorders which are illustrated and described within the pages of the bulletin. A wide selection of microphones

(Continued on page 66)

Uncle Sam's Radiomen

(Continued from page 8)

is by machines, and this brings us to an old point of contention among radio code teachers, many of whom argue that a student should copy *manual* rather than *mechanical* transmission.

The Signal School instructors believe that the peculiarities of the various manual transmissions should not be studied until the student has acquired thoroughly the "motor response habits," and the "stimulus-response-bond" has been thoroughly set for the 36 characters. This stage is reached with the average student about the time he has learned to receive 12 words per minute, and this is why the Army does not require the copying of manual transmissions and air traffic until the soldier-students have progressed to at least 15 words per minute in receiving.

The replacement of manual sending by machine transmission at the Signal School has made possible a reduction in the number of skilled instructors, the perfect transmission of code at any desired speed, the maintenance of constant character code sound at all speeds, and the elimination of the personal peculiarities found in manual transmission.

The individual civilian who wants to perfect himself in the code may feel that he is unable to follow these advanced ideas in radio teaching used by the Army Signal School, but this problem is easily solved by any "ham" who is handy with tools. Many amateurs have built their own code-sending machines, using either discs or tape to carry the make-and-break mechanism, and either clockwork or an electric motor to operate the machine. It is necessary, of course, to have a variety of tapes or discs, but when two or three "hams" are working together they can make the circuit-breakers for one another, thus preserving the surprise element in reception.

The Signal School has 11 Ediphone transmitters, 1 Creed, and 1 Kleinschmidt tape transmitter. Code practice material is first typed out on a tape perforator; the tape is then inserted in one of the tape transmitters. This transmission is then recorded on an Ediphone wax record. This record may then be placed on any of the transmitting Ediphones. As the wax record revolves, the impressions on the record move a stylus up and down. Movement of this stylus actuates a make-and-break contact, opening and closing a relay. This relay places an 800-cycle tone on the outgoing circuit during the dot and dash interval and removes this tone during the spaces.

The 800-cycle tone is obtained from any one of a battery of six-tone generators, type GN-33. The outgoing transmission from any or all of the Ediphone transmitters may be switched to any code room in the building.

In each code room a supervisor's switchboard is provided by means of which an instructor may place any code speed desired on any table and maintain constant supervision. A telephone and signaling system connects him with the transmission room. When the tape transmitters are not being employed in recording they may be switched to any code room. Extreme flexibility is thus provided for this system.

Transmission begins after the students have completed six beginner's records. Instructors carefully check the arm and finger positions because the prevention or immediate correction of mistakes in sending is always easier than the correction of bad hab-

its after they have been formed.

Students at first merely send code to themselves, but they are soon connected in pairs and send to each other, correcting one another's mistakes. Every now and then an instructor has a student make a record of his transmission and an undulation tape. The record of his own sending is reproduced to him and he tries to copy his own transmission.

You may be very proud of your sending ability, but when you try to receive a record of your own transmission your balloon of conceit is punctured at once. Errors almost hit you in the face, and instruction at this stage in the game is received with due humility. If you doubt this, go to any

BUY DIRECT FROM THE MANUFACTURER AND SAVE



**THE NEW MODEL 1230
SIGNAL
GENERATOR
WITH
FIVE STEPS
OF
SINE-WAVE AUDIO**

SPECIFICATIONS
RADIO FREQUENCIES from 100 K. C. to 90 Megacycles in 7 bands by front panel switch manipulation. All direct reading and accurate to within 1% on I.F. and Broadcast bands, 2% on higher frequencies. The R.F. is obtainable separately or modulated by any one of the five Audio Frequencies.
AUDIO FREQUENCIES: 5 steps of SINE-WAVE audio 200, 400, 1000, 5000 and 7500 cycles WITH OUTPUT OF OVER 1 VOLT. Any one of the above frequencies obtainable separately for servicing P.A., hard-of-hearing aids, etc.
ATTENUATOR: Late design, full-range attenuator used for controlling either the pure R.F. or modulated R.F.

CIRCUIT: The Model 1230 employs an improved electron coupled oscillator circuit for the R.F. affording positive protection against frequency drift and a Hartley oscillator circuit for the A.F. section.
DIAL MANIPULATION: Large 5 1/2" dial etched directly on front panel, using a new mechanically perfected drive for perfect vernier control.
APPEARANCE: The front panel is etched by a recently perfected process which results in a life-long attractive finish and the instrument comes housed in a streamlined shielded cabinet.
CURRENT SOURCE: The Model 1230 operates on 90 to 130 Volts A.C. or D.C. any frequency.

The Model 1230 comes complete with tubes, shielded cables, moulded carrying handle and instructions. Size 14" x 6" x 11". Shipping weight 15 pounds. ONLY.....

\$12⁸⁵

**THE NEW MODEL 1220
POCKET LABORATORY**

***WEIGHS ONLY 28 OUNCES!!
*USES A 2% ACCURATE
0-200 MICROAMMETER—
ENABLING MEASUREMENTS
AT**

5000 OHMS PER VOLT

SPECIFICATIONS

- ★ 6 D.C. Voltage Ranges: 0-3-10-50-250-500-5,000 volts.
- ★ 3 A.C. Voltage Ranges: 0-15-150-1500 volts.
- ★ 4 Resistance Ranges: 0-3000 ohms, with 15-ohm center, direct reading to 0.2 ohm; foregoing base range multiplied by 10, by 100 and by 1,000, to read up to 3 Meg. with self-contained 3 V. flashlight battery.
- ★ 4 D.C. Current Ranges: 0-200 microamperes; 0-2-20-200 Milliamperes, using wire-wound shunts.
- ★ 3 Output Meter Ranges: Same as A.C. Voltage Ranges.
- ★ 3 Decibel Ranges: From -2 to +58 D.B., based on .006 watt in 500 ohms.
- ★ Uses full-sized 3" square 0-200 microammeter, with 2% accuracy and finely damped movement, contained in a handsomely-designed, square moided Bakelite case.



Model 1220 comes complete with cover, self-contained battery, test leads and instructions. ONLY.....

\$10⁴⁵

SUPERIOR INSTRUMENTS CO.

136 Liberty St.

Dept. RN 9

New York, N. Y.

Get *Quiet* Reception with **MALLORY** **NOISE FILTERS**



DX no longer need be hashed by the crashes of man-made static originating from nearby sparking electrical appliances. Quiet reception is desirable for the enjoyment of broadcast programs. But quiet reception is vital in communication work. Important messages must not be blotted out—service must not be delayed.

Elimination of man-made radio interference is simple and inexpensive with Mallory Noise Filters. These scientifically designed filters are the product of long research on the part of Mallory engineers. They are inexpensive and easy to install. Selection of the correct filter for each application is made simple by following the instructions in technical data folder Form NF-100.

Enjoy clear reception—get complete data today. Ask your Mallory Distributor for a copy of Form NF-100, or write—

P. R. MALLORY & CO., Inc.
INDIANAPOLIS INDIANA
Cable Address—Palmallo



of the shops in the nearest big city where they specialize in making phonograph records and have a record made of your own transmission. Even though you are licensed as a commercial operator, the record will show that your transmission is far from perfect.

Radio electricians of the Signal Corps, and radio operators from both the Signal Corps and the Air Corps, are taught transmission at the Signal School with the Vibroplex key in addition to the usual sending key, and these men are also taught elementary touch typing. As soon as the student can copy code at the rate of 15 words per minute with a pencil, he is permitted to start copying code directly on a typewriter.

Here again is a tip that the civilian operator can take from his Army brother. Typing as you receive is a sure aid to speed and accuracy, and an essential for "hams" who aspire to commercial jobs.

When the Army operator is proficient in copying his reception on the typewriter he studies "net procedure," copying typical traffic, first from the Ediphone or tape transmitter and then from the air. He now copies actual War Department net traffic, press, meteorological reports, and other messages that he will encounter when he leaves the Signal School.

To train men in receiving air signals, a remote receiving station was established. This station contains six different types of receivers, with the station furniture and radio sets arranged just as they are at the War Department message center in Washington, D. C. Students are rotated here by schedule, so that each man obtains experience closely approximating that of an operator on duty in the War Department.

Signals from any one of the six receivers in the Signal School Station may be sent over a channel through the Ft. Monmouth telephone system to the radio division school building. Here they are again amplified, when necessary, and redistributed throughout the building to any or all of the code practice rooms, or recorded on wax records for future use.

To cut down the time previously lost in acclimating a new operator to his job after leaving school, a transmitting station, operating on high frequency, has been installed, and here the finishing touches are placed on the education of the Army operator.

Code practice is not the only subject at Ft. Monmouth. If we have seemed to emphasize code to the disadvantage of the other subjects, it is because a thorough knowledge of code is a major requirement in the training of operators, whether for the Army or for civilian employment.

Some of the other subjects taught at the Army Signal School, in addition to code and typing, are: Radio procedure; War Department Nets; Field Nets; and Portable Field Sets.

Mikes, Heads & Cutters (Continued from page 37)

cps and to rise with increasing frequency above 250 cps, for constant voltage across the cutter. The input impedance of the cutter being capacitive, the simplest method of equalizing the recorded level curve is to connect a series resistance between constant-voltage source and cutter. A value of 50,000 ohms is optimum, and at room temperature, produces the slightly rising curve shown. Higher values of resistance can be used to make the curve either flat or slope upward at the low frequencies.

The input impedance in some circuits is a constant resistance for high frequencies but becomes capacitive and very high at extreme low frequencies. Pentodes and other constant current output stages will produce more low frequency response with a given network than will triode output stages. A shunt resistance, for a 6 B5 amplifier (pentode output characteristics), will limit the undesirable change in load with frequency.

In common with other voltage-driven crystal devices, the X-26 shows considerable variation in sensitivity with temperature, for constant voltage across the cutter. While careful attention should be given this factor in recorder design, it should be remembered that the predominant temperature effect is caused by loss of motional sensitivity (amplitude of motion per volt applied) at higher than room temperatures, and that this is fairly constant over the entire frequency range. The change in motional sensitivity is inherent in the crystal, and not much can be done about it in designing the cutter. However, a great deal can be done with the X-26 to make a recorder assembly free from temperature effects, by choosing circuits which employ the capacitance vs. temperature curve of the crystal to balance changes in motional sensitivity, and by connecting the volume indicator at the proper point in this circuit.

It should be pointed out here that, in the X-26, the crystal temperature does not rise materially in operation because of dissipation of driving energy. Measurements with input power well above normal showed crystal temperature change from this source to be less than 0.5 degree C.

The upper temperature limit for the X-26 is the same as for other crystal devices; i.e., 52 degrees C. (125 degrees F.), at which temperature permanent damage to the crystal begins. The melting point is 56 degrees C. (133 degrees F.).

The crystal is well protected against extremes of humidity by multiple waterproof coatings. Life expectancy for any given humidity condition should be the same as for a crystal pickup using the same heavy crystal (.060" thickness).

It is of course highly desirable to keep the operating temperature rise at the cutter to a minimum, by proper design of the recorder assembly. The amplifier or radio chassis should be kept as far as possible from the cutter, and ventilating openings to the atmosphere provided if a lid is used.

In a recorder-playback system using a crystal pickup, the playback itself can have objectionable temperature characteristics in circuits not properly designed. In crystal pickups generally, by far the greatest part of the temperature effect is caused by capacitance change. There is very little change with temperature in the voltage generated per unit amplitude, on open circuit. A crystal pickup playback can, therefore, be made practically independent of temperature by working the pickup into a high load impedance.

The calibration of the volume indicator should be adjusted so that a suitable safety factor is obtained, at its operating peak point, against low frequency crossover at 20 degrees C. For home-recording conditions, it is believed that a safety-factor of 6 db. based on recorded level at 100 cps will be the minimum allowable.

Crystal failure, when it occurs, takes one of two forms:

- Mechanical fracture, due to excessive amplitude of motion.
- Melting of the crystal and consequent dielectric break-down at small spots where local heating occurs.

As I See It!
(Continued from page 18)

carried out, that is, we know the answer but not the process of solution. It might sound funny but we feel that some sort of an equation or a formula can be developed which when multiplied by a constant, also to be developed, and predicated upon average costs and a minimum mark-up or profit, would provide the required relationship between the service charge and the basic cost of the receiver.

This is not as crazy as it sounds or reads. Certain existing basic conditions are in its favor. We know that there is pretty much of a minimum list price for receivers, namely the average price of the midgets. We also know that it is proper to establish a minimum service charge for operations in the shop. We further know that it is proper to establish a charge for pick-up and delivery, although if you desire, you can omit this charge. We also know that on the average, localization of a defect can be accomplished within a certain specified time, for which a maximum of say one hour could be established in arriving at the cost of this time. We further know that on the average, it is possible to decide upon a time limit in which any repair and/or adjustment can be effected. Next, we know that the average service station operation can approximate his fixed and operating costs. And last, we can segregate receivers into various list price classifications. With all of these data and conditions existent, it is not a hopeless task to attempt to solve for such an equation. . . . Somebody is going to do it!

Electron Flow

WHAT is to follow does not seem to have very much to do directly with the radio servicing business, but if comprehension of technical radio influences successful servicing operations, then "electron flow" is allied with service operations. At first glance you might consider what we will say as a peculiar idea, but much discussion seems to indicate tremendous merit, even if we say it ourselves.

It is pretty much agreed that "electron flow" is electric current and all radio texts start out with the discussion of matter and finally get around to "electron flow." Then follows a discussion of electric charges and the electron is mentioned here and there in connection with why a wire has resistance and why the resistance in wires differs,—in other words conductivity. Then when the basic discussion of condensers is reached, mention is made of the displacement of electrons around a circuit or if the author so chooses, away from or to the condenser plates. Then suddenly a transition occurs and when discussing inductance, transformers, alternating currents, etc., we speak of *back-emf*, *reactance*, *impedance*, *bypassing*, etc. Forgetting the vacuum tube for the moment, wherein electrons are dis-

cussed, what has happened to the electronic viewpoint in connection with inductance, transformers, reactance, impedance, bypassing, resonance, etc.

Maybe we are wrong but it seems to us and a certain amount of investigation seems to substantiate the opinion, that a better physical picture of what is happening in radio components can be gleaned from a presentation of existing radio theory if the electronic viewpoint is included and continued. Today there are ever so many arbitrary conditions set up in radio theory wherein certain terms are used to indicate a condition without in any way giving any data which would furnish the picture of what is happening.

We recognize the existence of me-

chanical analogies and the fact that they have been used for years, but really does it mean that these analogies provide the clearest physical picture? Conversations with many people who have been associated with the teaching of radio and also with students brings to light certain weakness in the use of analogies. An analogy should provide the physical conception, but what it does is call upon the reader or viewer to imagine certain relationships so that he still does not have the physical picture, particularly when the device in question becomes a part of some complete circuit and its function appears entirely different from that indicated by

(Continued on 3rd column p. 48)



WHAT HAS HE GOT THAT I HAVEN'T GOT?

DID you ever stop to wonder how some servicemen get more business and make more money than you? Here, perhaps, is the answer. The most successful men in *any* business are those who have learned never to pass up *anything* that will help them to accomplish an important job *in less time*.

This practice of taking advantage of every aid to *better work in less time* is often the only thing that stands between success and failure. In the radio service business, the man who uses all the information he can get to make trouble-shooting quicker and surer is the one who forges ahead. *He's* the man who has always had a complete set of RIDER MANUALS. He knows how foolish it is to depend on his own memory or intuition when complete, authoritative data can be at his fingertips for only 3c a day.

RIDER MANUALS give you, in the most convenient form, complete data on every set you may be called upon to service . . . data on alignment, I-F

peaks, operating voltages, parts lists and values, voltage ratings of condensers, wattage ratings of resistors, coil resistance data, etc.

If *you* don't have a complete set of eleven RIDER MANUALS, you are overlooking one of the surest ways of speeding up your trouble shooting and increasing your profits.

YOU NEED ALL ELEVEN RIDER MANUALS

Volume	Price	Covering Up to	Volume	Price	Covering
XI	\$10.00	May 15, 1940	V	\$7.50	1934-35
X	10.00	1939-40	IV	7.50	1933-34
IX	10.00	1938-39	III	7.50	1932-33
VIII	10.00	1937-38	II	7.50	1931-32
VII	10.00	1936-37	I	7.50	1920-31
VI	7.50	1935-36			

JOHN F. RIDER, PUBLISHER, INC.
404 Fourth Avenue, New York City
Export Division: Rocke-International Elec. Corp.,
100 Varick St., N. Y. C. Cable: ARLAB

VOLUME XI HAS MANY NEW FEATURES

Includes data on FM receivers released up to press time.
New Index . . . cross-indexed for easy reference.
New "How It Works" section, with up-to-date information on the latest developments.
New Vest Pocket Supplement contains much useful information for on-the-spot reference.

You **NEED RIDER MANUALS**

Simplest WAY TO REPLACE BALLASTS

4 STANDARD TYPES of Amperite Regulators replace over 200 types of AC-DC Ballast Tubes now in use. . . Has patented automatic starting resistor.

List \$1.00

WRITE FOR REPLACEMENT CHART "S" Amperite Co. 561 Broadway, N. Y. C.

AMPERITE

GOOD JOBS! for RADIO MEN in National Defense Industries

PREPARE NOW!

LEARN RADIO and SERVICE WORK with Ghirardi's **BIG 2**

RADIO PHYSICS COURSE

BASIC FUNDAMENTALS

Here's your start in Radio! If you are a beginner, this one big, all-inclusive, short-cut, self-instruction book of nearly 1,000 pages with over 500 illustrations will give you a thorough training in the important Fundamentals of Electricity, Radio, Sound, Television, Cathode-Ray Tubes, etc.—all the essentials, all the background you need for a complete radio knowledge. No math—no previous training necessary. It starts at the very beginning, teaching you all about Electricity first. And you can learn it all easily by yourself at home, checking your progress with the 856 self-examination Review Questions. Ghirardi makes every thing crystal-clear and easy to understand. That's why this same Radio Physics Course is used by the U. S. Army and Navy, and by more radio schools and students than any other radio book!



972 PAGES
508 ILLUS.
856 REVIEW QUESTIONS **\$4**

MODERN Radio SERVICING

LEARN HOW with this!

This famous Ghirardi text gives you a complete 1300-page training course in practical radio service work. It's an illustrated "gold mine" of servicing knowledge. 420 pages explain all types of servicing tests & instruments—how they work, how constructed, how to build them, how to use them. Then 900 more pages give you a complete step-by-step procedure course in trouble-shooting, testing, aligning and repairing all makes of radio sets—all based on latest Servicing Methods! Here's what you learn:

- Test Equipment—Theory, Descriptions, Diagrams of all Commercial Instruments, How They Work, Construction Data.
- Trouble-Shooting—Newest short-cut methods for all sets.
- Repairing—Advanced "Factory Methods" explained fully.



1300 PAGES
708 ILLUS. **\$4**

MAIL COUPON TODAY!

RADIO & TECHNICAL PUBL. CO., Dept. RN-90
45 Astor Place, New York City

Send postpaid, with 5-Day Money Back Guarantee:

RADIO PHYSICS COURSE \$4. (\$4.50 foreign)

MODERN RADIO SERVICING \$4. (\$4.50 foreign)

Name

Address

City..... State.....

Please send FREE illustrated descriptive literature.

MONEY BACK IF NOT SATISFIED

RADIO PHYSICS COURSE

by Alfred A. Ghirardi

(Continued from August, 1940)

The normal operating filament temperature of the usual oxide-coated filament is 750 degrees Centigrade, and this is greatly exceeded when the voltage overload surpasses the 5 per cent limit or allowance specified by the tube manufacturer. The main advantages of the oxide-coated filament or cathode over the thoriated filament, is the lower operating temperature (about 950 degrees Centigrade lower) with consequent increase in filament life and reduced filament power consumption and higher saturation currents. Improved oxide-coated filaments have made possible the construction of tubes designed to obtain their filament current economically from 2-volt batteries of the dry-cell or air-cell type. These filaments are thinner than a human hair and consume .06 ampere at 2 volts. This is a filament power consumption of only .12 watts per tube. Compare this with the old 201 type of tube used several years ago. This required 1 ampere at 5 volts, (5 watts) or 40 times as much power to heat its tungsten filament sufficiently to give off a rather limited supply of electrons.

Indirectly heated cathodes. In some cases a more mechanically rugged filament unit consuming a small supply of heating power is required, than is found in the ordinary direct-heated cathode types of filaments just described. Examples of this are in the use of radio receivers on automobiles and airplanes where the tubes are subjected to considerable vibration unless elaborate and costly shock-absorbing mounting schemes are resorted to. The tubes in these receivers must usually obtain their filament current from a battery and economical operation is essential. Also, in those radio receivers in which the filaments are heated by low voltage alternating current supplied by the 110 volt a.c. electric light line by a suitable step-down filament heating transformer as shown at (D) of Fig. 189, the use of the ordinary type of electron emitter consisting of a coated filament has not proved satisfactory, due to the fact that the varying current causes the filament temperature, the associated fields, the electron emission and plate current to vary, resulting in an annoying hum heard in the loud speaker. For vacuum tube applications of this general class, the indirectly-heated cathode has been developed and is used in many types of standard tubes. The construction of the heater element, insulating bushing and oxide-coated metal cathode thimble proper, were described in Article 264 (which should now be reviewed carefully) and shown in elementary form at (D) of Fig. 189. In this construction the filament simply serves the purpose of producing heat.

(To be continued)

As I See It!
(Continued from page 47)

the analogy which accompanied the basic discussion.

Now, all of this is not intended as pure criticism. What we have in mind applies particularly to elementary instruction of radio theory. Why not carry on the electron concept and explain various phenomena in terms of electron motion, if only to provide the very basis for those many things which are set up as being existent without any elaboration upon their creation. For example, the subject of resonance is extremely vital in radio theory, yet we have no physical picture of what resonance is—why a circuit is resonant to a certain frequency. Yes, we have the familiar analogy of the pendulum and the periodic impulse; the balance of reactances, but that still does not provide the picture.

We know that certain current relations exist in a resonant circuit, therefore some sort of electron motion takes place and some relation exists between the electron motion in the circuit with respect to the capacity and the inductance. Many phenomena are explained by reference to a law without providing a physical picture. For example the conductor moving through a magnetic field. Why should not the present explanation be further supplemented by a discussion of the basic electron motion through the conductor and the relationship between the magnetic lines of force between the pole pieces of the generator and the electron flowing through the conductor so as to explain why a difference of potential is developed across the terminals of the armature windings?

Such presentation of basic theory does not alter the normal course of study, change terminology or even eliminate the use of analogies. It simply provides a better physical picture of what is happening, for just as it is possible to convey the present kind of basic electron theory to a person who is first studying elementary radio, it seems logical that it should be possible to continue the use of the moving electron so as to explain radio.

It seems to us that the use of the moving electron as the basis of explaining inductance and various phenomena associated with inductance provides a much clearer picture of what is happening than the present system, which obviously is a short cut, of simply defining inductance, speaking about self induction, counter emf, etc. All of this can still be continued but the "why" of the matter should also be included.

These few words by no means present the whole case in favor of the presentation of basic radio theory in terms of electron motion, but it is hoped that what is said in these pages will set some people thinking and perhaps even examination of the pros and cons of the subject, for it rightfully deserves much contemplation.

—50—

For Immediate Release
(Continued from page 33)

console to which it is attached.

THE Federal Communications Commission announces that the existing rules governing standard broadcast stations, and the new rules governing high frequency broadcast stations are to be combined in Part 3 of the Commission's rules, which will be entitled "Rules Governing Standard and High Frequency Broadcast Stations." Subpart A of the rules, applicable only to standard broadcast stations comprises existing rules 3.1 to 3.86 inclusive. Subpart C, containing general rules applicable both to standard and high frequency broadcast stations, will comprise existing rules 3.87 to 3.104 inclusive. Subpart B, comprising the new rules governing high frequency broadcast stations is available by writing for a copy of Release No. 41741, dated June 22, 1940.

RECENT events prompt the Federal Communications Commission to reiterate that, having no authority to censor radio programs, it can neither put anybody off the air nor on the air.

In the matter of broadcast time for candidates for public office, the Communications Act specifies: "If any licensee (station) shall permit any person who is a *legally qualified* candidate for public office to use a broadcasting station, he shall afford equal opportunities to all other such candidates for that office in the use of such broadcasting stations . . ." and shall have "no power of censorship" over the material so broadcast. However, there is no requirement that the station must give such time in the first place, for Section 315 of the Act stipulates: "*No obligation is hereby imposed upon any licensee to allow the use of its station by any such candidate.*" (This subject was covered in detail in a general information release, "Campaign Use of Radio," issued March 11th last, copies of which are available for the asking).

Under the statute injunction against interference with individual radio programs, the Commission has had to advise inquirers that it is equally without authority to—

Censor statements of radio commentators, as requested by a New York man.

Require a national network to grant time to a Florida man to discuss national defense.

Deny the radio to "pressure groups interested in involving the United States in the present European conflict," as demanded by a New York woman.

Accede to request by a California woman that "pressure be put on radio stations to allow only 'sane' and 'unbiased' programs, which cut out all propaganda for war."

Pass on the type of wording of advertising announcements, as suggested by many listeners.

Likewise, the Commission has no authority to handle a New Orleans request that a radio station be made to employ six musicians instead of a trio.

Take action on complaint of a Peoria, Illinois, property owner relating to the height of his neighbor's aerial.

Help a New York woman develop a radio device for detecting and destroying enemy airplanes—or perfect a District of Columbia inventor's radio horn.

Incidentally, FCC's first printed general information booklet, "An ABC of the FCC," 13 pages in pocket size, is now being distributed on request.

ATENTION of the Federal Communications Commission has been invited to alleged use of radio by a Philadelphia taxicab concern for dispatching purposes. The

Commission has granted no authorization for such class of private service and is making inquiry.

The Commission warns an Illinois undertaking firm that intercepting police radio calls for the purpose of dispatching private ambulances to the scene of traffic accidents for the solicitation of business is a violation of the law. -50-

Build Your Own Studio
(Continued from page 21)

"constant amplitude" cuttings in conjunction with the frequency-modulated tuner. Here we find an abundance of rich overtones, freedom from any extraneous noise and an over-all fidelity that can be truly called "high fidelity." As more F. M. stations are added to the service areas we will, no doubt, enjoy their benefits to an even greater extent. At this writing there is only one F. M. outlet in Chicago and we have not actually had the opportunity to include all types of broadcast repertoire.

The amplifier was especially built for the purpose, that is, to be able to amplify the full range of audio frequencies with a minimum amount of distortion. This amplifier must possess extremely good regulation in its power stage. The best type of tube to use for general recording work is the 2A3. The circuit is similar to that used in the RADIO NEWS "Full-Range" Amplifier with the exception that the complete power supply is located as far below the amplifier chassis as possible. This prevents any induced hum from entering the amplifier.

Broadcast type gain controls are used throughout in order that quiet operation may be had under all conditions. Two meters are used, one to indicate the volume level to the cutting head and the other to read the individual plate current of the power tubes so that they may be balanced. These meters are Simpson 3" square illuminated types and are read easily from all angles.

One of the most indispensable items in the complete set-up is the synchronous clock which is located as shown on the panel and where it may be read with the least possible effort. Most records made at present are 16" transcriptions from "off the air." For that reason we must have a timekeeper which is actually set to the time signals that are sent out by the various transmitters. Nearly all of the chain programs are scheduled to end at approximately 45 seconds before the time limit. One may also soon learn when a program will begin and several grooves in the disc may be conserved by a bit of analysis.

Brackets must be used to hold the three chassis to their panels so that they will be self-supporting. All of the transformers used in the amplifier are *Thordarson Tru-fidelity* units. Complete details on this amplifier will be given in a later article. Other controls appearing on the amplifier panel are: the meter change-over switch; the input selector switch; the treble

New
WIDE BAND
SYSTEM OF RADIO
BROADCASTING AND RECEPTION

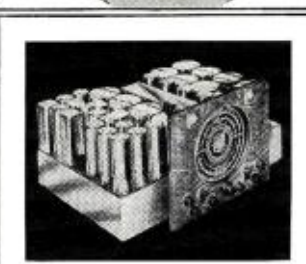

SCOTT CUSTOM-BUILT
Frequency Modulation
RADIO

MARVELOUS INVENTION NOW BRINGS STATIC-FREE, FULL FIDELITY RECEPTION

Highly perfected, FREQUENCY MODULATION radio is ready right now, for full commercial operation. A special wave band has been set aside for it by the Federal Communications Commission. You'll be first with radio entertainment of breathtaking beauty and realism, with the magnificent new custom built Frequency Modulation receiver developed and far advanced by E. H. Scott.

UNDREAMED OF TONAL REALISM

Scott "F.M." radio sound reaches the full capacity of the human ear . . . 2 to 3 times more fidelity than our present system of broadcasting! Tone and detail are more real and beautiful than can possibly be imagined. Because entirely new and different electrical characteristics are used, YOU HEAR NO STATIC OR NOISE, even with lightning flashing within the "F.M." station area. The wonder of the new Scott Frequency Modulation receiver is beyond description. For the first time, voice and music *exactly* as heard in the auditorium can be brought into your home by radio!

GUARANTEED FOR 5 YEARS!

Custom built-to-order, with the precision of fine scientific equipment, yet moderately priced. Be first to own this revolutionary new kind of receiver. ACT NOW . . .

MAIL COUPON FOR MONEY SAVING OFFER!

E. H. SCOTT RADIO LABORATORIES, INC.
4440 RAVENSWOOD AVE.
DEPT. 5P40
CHICAGO, ILLINOIS



Send all the facts, analysis of SCOTT receivers, and order blank. NO obligation.

Name.....
Address.....
STUDIOS: NEW YORK, CHICAGO, LOS ANGELES, DETROIT, BUFFALO

PREPARE NOW!

It's Easier to Keep Abreast
Of These New Develop-
ments Than It Will Be
To Catch Up With Them!



Your future in the servicing business will depend largely upon your knowledge of these new developments in radio. NOW is the time to prepare... if you expect to be able to compete successfully for the service that will soon be required. Don't put it off! Start now, by devoting a few minutes each day to study of these easy-to-understand books by John Rider. You can look them over at your jobber's. Do it today!

FREQUENCY MODULATION

by John F. Rider

The most talked-of subject of the moment—Rider offers this introduction to frequency modulation with special attention to F.M. receivers and the problems they will present to the serviceman. Get this now—be ready. 136 pages—only \$1.00.

SERVICING BY SIGNAL TRACING

by John F. Rider

Use the system of servicing which is proved and endorsed, fastest—most modern, the system you can apply to all receivers regardless of age, type or make. Servicing by Signal Tracing operates independently of every limiting factor heretofore encountered. In this new book you learn how all receivers are brought to a common servicing level. Learn how components receive a functional check! This is the most definite and positive form of trouble localization! Over 360 pages—hard covers—only \$2.00.

OTHER RIDER BOOKS YOU NEED

The Oscillator At Work—256 pages—illustrated—\$1.50. Automatic Frequency Control Systems—144 pages—hard covers—\$1.00. The Cathode Ray Tube At Work—336 pages—over 450 illustrations—\$2.50. Hour A Day With Rider Books on subjects you should know—hard covers—60c each. And, of course—All Eleven Rider Manuals.

JOHN F. RIDER PUBLISHER, Inc.
404 Fourth Avenue, New York City
Export Div.: Rokee-Int. Elec. Corp., 100 Varick St.,
N. Y. C. Cable: ARLAB.

Read **RIDER BOOKS**

LEARN CODE

the way you'll be using it
by **SOUND**



The best way to learn to read code is by listening to code. The best way to learn to send code is by hearing your own sending repeated back to you. With the new All-Electric Master Teleplex Code Teaching Machine, you learn code

the natural, easy, fascinating way. Only instrument ever produced which records your sending in visible dots and dashes—then SENDS BACK your own key work at any speed you desire. That's why practically every school teaching code uses TELEPLEX. We furnish complete course, lend you All-Electric Master Teleplex, give you personal instruction with a MONEY-BACK GUARANTEE—All at a surprisingly low cost per month. Write today for FREE catalog RN-9. No obligation.

TELEPLEX CO.—87-69 PARK PLACE—NEW YORK
In Canada, Write
Canadian Electronic Inst., Toronto, Ont.

equalizer; the bass equalizer; the microphone gain control; master gain control; low gain control; amplifier bias control; output selector switch. One more control is set to a fixed position. That is the multiplier switch for the db meter. This meter is normally set so that a maximum indication of 24 db will be shown.

The normal recording level used at any one time will depend upon many factors, all of which will be discussed in the following article.

The controls must be so positioned that they will be accessible to the operator and should be arranged so that the more prominently used ones are grouped as indicated. No back-piece has been provided for the console as it is necessary to provide ample ventilation to all of the units. A piece of copper screen can be tacked to the back of the assembly for a more finished appearance.

The Recording Table

At the present time, as previously mentioned, we are making use of only one recording table. This is a *Presto Model 6D*. This was originally included in a portable leatherette carrying case and was removed from this container and placed above the cutout in the console. The mounting area for this particular recorder is approximately 21" square. Wood screws are used to hold the tables securely to the wooden members of the console. This equipment was completely described in the February 1940 issue of *RADIO NEWS* and a complete discussion of recording with this table will be found with that article.

Several refinements over the original *RADIO NEWS* "Full-Range" Amplifier were added so as to make the equipment more flexible. These additions include a selector switch at the low-gain input position so that a transfer can be made between various pickups when they are added and, also, to shift from the F. M. tuner to the A. M. tuner, etc. The output circuit has been designed so that a constant impedance load will be had no matter where the position of the switch may be. Two secondaries are provided in the output transformer of the amplifier. One is used to drive the cutting head, and the other for monitoring purposes. A resistance network has been included so that the volume of the monitor speaker may be adjusted to a much lower level than that of the cutting head. This combination is used whenever we are recording "off the air." Where microphone pick-up is used, and when the console is located in the same room as that of the microphone, it is necessary that the recordist wear a pair of headphones so that no feedback will take place to spoil the recording.

In next month's article we shall discuss each and every component part in detail and full schematics will be shown for the entire recording set-up.

The total cost of the bench was kept below \$12.00, which included all hardware. The console is not difficult to construct.

Servistat

(Continued from page 37)

quired (or to what resistance must the *servistat* be set to take the place of this element?)

25L6.....25.0 volts
25Z6.....25.0 volts
6J7..... 6.3 volts
6K7..... 6.3 volts
6C5..... 6.3 volts
Pilot..... 6.3 volts

75.2 = sum of heater voltages (Eh)

Heater Current (I) = 0.3 amp.

Line Voltage = 115 volts

Substituting in the Formula:

115 - 75.2 = 39.8 = 398

0.3 = 0.03 = 3 = 132.6

The 150-watt power *servistat* must be set to 132.6 ohms. This adjustment must be made with the aid of an ohmmeter; or, if the instrument is provided with a dial reading in ohms, the latter may be set at once to this value.

The line-cord *servistat* is invaluable for lighting tube heaters other than in a receiver and may be used for that purpose in lieu of a filament transformer in experimental setups in the laboratory or ham shack. Any exact voltage between 1½ and the line voltage value is readily available at the twist of the knob. In this application, the *servistat* is equivalent to a dozen or more special filament transformers supplying various voltages. The instrument is likewise of considerable utility as a potentiometer for balancing out heater circuit hum in experimental layouts.

When working with voltage dividers, when the required resistance of the burned-out section is known, the *servistat* is set to that value and clipped-in to replace the defective section. No further manipulation is necessary. If the required resistance is not known, the *servistat* is set to zero ohms and clipped in place. A suitable d.c. voltmeter or v.t.v.m. is then connected between B-minus and the high side of the *servistat* and the latter is adjusted carefully until the voltage, as indicated by the meter, is the required value. If no voltage data is available, a reasonable estimate may be made by observing which tubes are supplied by the "high" tap of the defective voltage divider section and setting the *servistat* to deliver the maximum plate voltage normally recommended for that type of tube. With either procedure, the *servistat* is read or measured for the correct value of the defective resistor.

The same procedure would be followed in substituting for d.c. dropping resistors, audio swamping resistors, and the like. Where the defective resistor serves as a filter element with or without a filter choke, however, the *servistat* is adjusted for the highest degree of filtration as evidenced by minimum hum level in the receiver speaker or a levelling out of the horizontal cathode-ray trace if a

scope is employed in the test.

In audio amplifier testing (p. a. work and amateur modulator testing), the 10,000-ohm power *servistat* is useful as an output load resistor, being adjustable to the recommended load impedance in applications where the slight inductance of the rheostat is of no consequence and the power delivered to the load is safely within the 100-watt rating of the winding. Connection is made, of course, to the central binding post and to either of the outer ones.

The Decade Servistat

The decade unit, providing a range extending from 1 ohm to 11, 111, 110 ohms in one-ohm steps, is comprised by seven groups of resistors arranged with ten identical resistors in each group and with the groups in multiples of ten. The first group (units) contains ten 1-ohm resistors, the next group (tens) contains ten 10-ohm resistors, and so on until finally the last group (millions) comprises ten 1-meg-ohm resistors. The circuit diagram of this arrangement is given in figure 4.

The resistors of each group are connected in series and are placed in or out of the circuit progressively by an 11-point rotary selector switch. Each group is series connected to the next in line so that any group or portion thereof may by proper switch settings be added to or subtracted from the total resistance. To obtain a total resistance of 1211 ohms, for example; the *millions*, *hundred thousands*, and *ten thousands* switches are set to zero, *thousands* to 1,000, *hundreds* to 200, *tens* to 10, and *units* to 1:

1,000
200
10
1

1,211

The next highest step, 1,212 ohms is obtained simply by switching *units* to 2.

The selectors, S1 to S7 are *Centralab* bakelite-insulated, single-pole, single-gang, 11-position, non-shorting rotary selector switches. The resistors are connected as shown between the contact terminals of these switches but are mounted parallel to the axis of the shaft in order to conserve space.

All but those in the *units* and *tens* groups are *I. R. C.* type *BT2*, 2-watt insulated resistors. Resistors in the *units* group are made by soldering 1-ohm lengths of nichrome wire between the switch contacts; those in ten *tens* group by similarly soldering in 10-ohm lengths. These lengths may be kept quite short by using small-gauge wire. Acid flux or *Nokorode* paste must be used in the soldering process, and the nichrome will have to be scrupulously clean. All traces of the flux *must* be carefully removed after soldering and the joint wiped dry with a soft cloth.

A simple albeit highly satisfactory method of manufacturing and making fine adjustments on these 1- and 10-

ohm sections is illustrated in figure 4-a. Each unit, it will be seen, consists of two separate lengths of nichrome wire which have been soldered to adjacent switch contacts and twisted tightly together over a portion of their length.

An ohmmeter is connected to the contacts and the two wires further twisted with small-sized, long-nose pliers until the meter indicates the exact value desired. Twisting reduces; untwisting increases the resistance. The twist must be kept as tight as possible without breaking the brittle nichrome wire; since in the case of 1- and 10-ohm units, a relatively tiny bit of looseness can create a sizable percentage increase in resistance. For the same reason the ohmmeter leads must be connected with a firm, biting grip.

After the adjustment is completed, the surplus twist may be clipped off and a drop of solder applied to prevent unwinding.

The seven units of the decade *servistat* are connected in series as shown in figure 4 after assembly into a suitable metal case. It is not necessary that this case be ventilated like that of the power-type *servistat*. Two *National* type *FWA* binding posts, passing through clearance holes in the top cover and insulated internally and externally with fiber washers, receive the test leads.

The top cover of this case, acting as a panel, is marked or engraved with the denoting words and figures given in the diagram to indicate actual resistance settings of the selector switches.

The accuracy of the decade unit can be considerably improved and its experimental value enhanced accordingly by "hand picking" the resistors that go into it. A previously standardized ohmmeter may be taken to the store and used as a basis for selecting the closest values in stock.

Using the Decade Servistat

It has previously been pointed out that use of the decade unit does not differ extraordinarily from that of the power type except that the former finds lighter-duty application in positions where resistance values run many hundred times higher than in positions where the power type is demanded.

The clip-in substitution procedure is identical; but the manipulation is slightly different, there being seven controls against the single one on the power *servistat*. It need only be remembered when manipulating the decade unit that the total resistance offered by the unit is simply the arithmetic sum of the values indicated by the individual selectors. Selectors which read zero are, of course, not counted in.

A word of caution is in order regarding use of the decade unit in touchy circuit positions where resistors within the scope of this instrument are generally encountered. In



In high frequency work, electrolytic condensers are very satisfactory. Yes?.....No?.....

Are standard glass tubes and metal tubes interchangeable? Yes?.....No?.....

Are electron emissions due indirectly to impact by electrons or ions known as Secondary Emissions? Yes?..... No?....

Does shielding help to keep interelectrode capacities at a minimum? Yes?.....No?.....

Are the filaments of 1.4 volt battery tubes heated directly? Yes?.....No?.....

Does Sylvania produce as many as 17 different types of panel lamps? Yes?.....No?.....

In converter tubes is low frequency drift desirable? Yes?.....No?.....

IF YOU aren't positive of the answers to these and thousands of other questions about radio tubes and their application, the latest edition of the Sylvania Technical Manual has all the answers in useful, handy form. 272 pages of information including operating conditions, characteristics and circuit applications on 374 types of tubes. Write to Hygrade Sylvania Corp. Dept. RN90, Emporium, Pa., enclosing 35c for your copy of this great book today.

SYLVANIA
SET-TESTED RADIO TUBES



TRIPIELET
MODEL 1181-C

This Portable Laboratory includes a 16-range Volt-Ohm-Milliammeter (AC and DC Volts 0-15-75-150-750 at 1000 ohms per volt; DC Milliamperes 0-1.5-15-150; AC Milliamperes 0-15-150; 0-1500 Ohms; 1.5 and 3 Megohms). Battery operated Signal Generator with direct reading dial from 115 to 18,000 Kc.; and a complete Free Point Tester. Dealer Net Price...\$44.84

Write for Catalog—Section 159
Harmon Drive

TRIPIELET ELECTRICAL INSTRUMENT CO.
Bluffton, Ohio

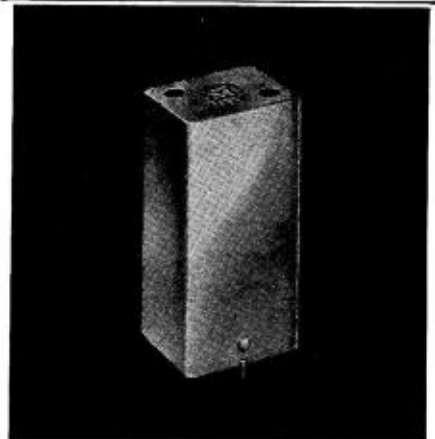

**IFs and Discriminators
for F M
COMMUNICATION RECEIVERS**

Air dielectric condenser-tuned 5 mc IF and Discriminator units for frequency modulation communication receivers.

#60503, 5 mc IF transformer, net price. \$3.00

#60504, discriminator for use with 5 mc IF above, net price.....\$3.00

Mica dielectric condenser-tuned 5 mc IF and Discriminator units for frequency modulation communication receivers.

#67503, 5 mc IF transformer, net price. \$1.50

#67504, discriminator for use with 5 mc IF above, net price.....\$1.50

JAMES MILLEN MFG. CO. INC.
150 EXCHANGE ST. MALDEN, MASS.

the majority of these places, the capacitance introduced by connection of the instrument will give rise to detuning effects, hum pickup, or oscillation, neither of which will necessarily indicate trouble. Notable among the points where these misleading effects are apt to occur are grid leak resistors, screen dropping resistors in superheterodyne oscillators, cathode bias resistors in certain less conventional circuits, and second detector input circuits. -30-

**Servicemen's
Legal Advice**
(Continued from page 26)

the maker immediately thereafter stop payment, the bank would not be liable.⁵

Referring to the reason for the rule that the holder of a check in procuring it to be certified, discharges the maker from liability, it is for the obvious reason that the maker of a check, after it is certified, cannot draw out the funds necessary to meet it. The money ceases to be his and is appropriated to the payment of the check.⁶ A further reason for the rule is that the contract is between the maker and the person to whom the check is drawn, and that the latter shall be entitled to payment upon presentation of the check to the bank upon which it is drawn. The person to whom the check is drawn may not accept the bank's certification in lieu of immediate payment. When the payee, instead of insisting upon immediate payment, causes a check to be certified, he in effect causes the funds to be withdrawn from the control of the maker and leaves them with the bank for his own accommodation. Such certification operates substantially as a "certificate of deposit" in favor of the payee and the law treats his act in obtaining it as a discharge of the drawer.⁷

Sometime, it may be necessary to stop payment on a check. A check, being a mere order upon the bank to pay from the depositor's account, is subject to revocation by the maker at any time before it has been paid or certified by the bank. But a notice to a bank to stop the payment of a check must be explicit and describe the check with reasonable accuracy. Thus, a notice to stop the payment of a check dated December 21st, for \$196.76 is not sufficient notice for a check dated *December 23rd* for \$196.76.⁸

Where payment on a check has been stopped by the drawer of it, the serviceman cannot bring a law suit against the bank to cover the amount of the check where the bank has not accepted or certified the check, even though the maker has funds on deposit sufficient to cover the check.⁹ In this case, the payee of the check must look to the maker for payment.

Let us now refer to one or two phases of the *Negotiable Instruments Law* respecting the making of notes. We now consider the liability of a person signing as agent. The *Negotiable Instruments Law* states that where the note contains, or a person adds to his sig-

nature words indicating that he signed for or on behalf of someone else, or as his representative he is not liable on the note *if he was duly authorized*; but the mere addition of words describing him as an agent, or as filling a representative character, without disclosing for whom he acts, does not exempt him from personal liability. For instance, where the body of a note says "We promise" and it is signed with the name of one person with the initials of another under it, the presumption is that it is a joint note and that both are liable as makers. However it may be shown that the person signing his initials did not intend to be bound as a maker, but was merely the *agent of the maker* and signed the maker's name thereto and added his initials as agent.¹⁰ Where an agent signs a note with the addition of words which are merely descriptive of a person signing, and the payee *knows* that the person is merely acting as such agent for another, and that he does not intend to bind himself individually, the agent is not liable *personally* to the man to whom the note is made.¹¹ Where a note is signed, not in the name of a corporation, but in the name of an officer with an addition of the office he holds, the name of the office is deemed merely a description of the person and the officer is, as against the holder of the note, liable individually and the corporation is not liable.¹²

Of course, the signature of any party may be made by a duly authorized agent. No particular form of appointment is necessary for this purpose.¹³ The authority of an agent, however, is strictly interpreted. It is well settled that one who takes a negotiable note, purporting to be made by an agent, *is bound to inquire as to the power of the agent*. Said parties cannot rely upon the agent's mere assumption of authority. In dealing with an avowed agent, they are put upon their guard by the very fact. Where the agent oversteps the limit of his authority, and the person with whom he deals has notice of this sufficient to put him upon inquiry, he cannot hold the principal.¹⁴

Under the *Negotiable Instruments Law*, no person is liable on an instrument whose signature does not appear thereon, except as expressly provided in the said law. But one who signs in a trade or assumed name will be liable to the same extent as if he had signed his own name.¹⁵ There is no doubt that a person may draw, accept or indorse a bill by his agent or attorney, and that it will be as obligatory upon him as though done by his own hand. But the agent in such case must either sign the name of the principal to the bill, or it must appear on the face of the bill, in some way or another, that it was in fact drawn for him, or the principal will not be bound. The particular form of the execution is not material, if it be substantially done in the name of the principal.

Next month we will discuss *Corporations and Partnerships*. -30-

5 Meter Mobile Rig
(Continued from page 16)

obtained on the two units constructed in our own laboratories. The positioning of all component parts was carefully engineered with a result that resistance losses in wiring are kept to a minimum.

Both plate and grid connections are made to the top of the HY75 glass envelope. For that reason, it is necessary to mount the tank coil in the position shown. This coil is constructed of No. 12 wire and provides a rigid assembly when completed. The problem of finding suitable low loss insulation for the support of this coil was solved with the selection of the new *Amphenol* standoff and feed-through insulators. The mechanical strength of these is considerably greater than most of the insulators used in the past on mobile equipment. This feature will be appreciated by those who have encountered cracking of the ceramic type of unit.

The method used for coupling to the antenna will depend entirely upon the one selected. For mobile operation, the best antenna is either a ¼ wave or ½ wave vertical fish pole, mounted either on the rear bumper, or mounted by means of special brackets as used on most police cruiser installations. Our link coil consists of two turns of No. 12 wire placed around the center of the plate tank coil. Some variation in tuning is provided by using a 100 mmf. condenser in series with the antenna. If the transmitter unit is placed close to the base of the fish pole, the concentric cable may be dispensed with, but we have found that by the use of a high grade coaxial cable, such as is made by *Amphenol*, that we are able to keep the radiation out on the antenna where it belongs and its use is therefore recommended.

Final adjustments on the link and the setting of the series condenser can best be made with the aid of a field-strength meter. The one used in our own particular installations is the new *Browning* Frequency Meter Monitor. By some cut and try, the proper operating point will be found, and the link turns may be cemented in place with *Amphenol 912 Liquid Cement*, or by means of low loss strips.

Power Supply

There are two possible types of plate supply that can be used to operate a mobile transmitter, and these are the motor generator and the vibrator. The selection of one over the other will depend upon three factors. First, the cost; secondly, the regulation afforded by the unit; third, the upkeep or servicing of the unit. Now, let's see what we mean by these factors. In order to get high voltage from a vibrator it is necessary to use a *dual unit*. This actually consists of two vibrator supplies connected in series and, therefore, will require the use of at least two vibrators, in addition to careful filtering. Moreover, all vibrapaks do not inherently possess regulation of voltage and current, which is suitable for the operation of a modulator where a wide variation in plate current is had.

On the other hand, the motor generator has the ability to put out high voltages with good regulation, chiefly because of its ability to "follow-through" on current peaks when these are encountered. This fly-wheel action allows us to use either Class B or Class AB modulators without upsetting the regulation to the r.f. amplifier tube. The one best suited to our purpose is a *Pioneer Gen-E-Motor*, which furnishes a maximum of 600 volts at 200 ma. The highest voltage we encounter in the rig is 450 volts so that we will have available an additional 150 volts for bias purposes. Reference to the schematic will indicate how this is obtained.

Note that the negative return from the generator passes through part of the resistance network to ground. The amount of voltage available will depend upon the value of this dropping resistor together with the amount of current drawn by those tubes which are provided with this fixed bias. Those of our readers who constructed the RADIO NEWS "Dialomatic" are familiar with the method used to control the input and output of the motor generator. By using a double-pole, single-throw control relay we are able to break both the low voltage input and the high voltage output at the same instant. This will relieve the tubes from receiving plate voltage when the motor generator is slowing down and coming to rest when we switch to the standby position for receiving and we will eliminate any lag or delay which would be caused if this precaution were not taken.

Inasmuch as the motor generator is not required to furnish current to a receiver, the problem of correct filtering will be simplified and the values indicated on the diagram were selected for hum-free output of the carrier. A single filter choke is used, which has a low resistance winding, and no substitution should be made for this unit. The *Gen-E-Motor* is mounted on four rubber grommets to absorb mechanical vibration. The bolts which pass through these grommets and which hold the motor must be provided with a slight amount of leeway so that the complete unit may be free to move slightly in all directions. Note that the *Genemotor* has been mounted where it may be serviced without disturbing any other part on the chassis. A periodic inspection of the brushes can thus be made and this will add to the life of the genemotor.

Speech and Modulator Unit

A careful examination of the tube manual pointed out that the best possible modulator tube for use in this unit would be a Type 6F6. Push-pull operation would provide us with 18 watts of audio, which would be ideal to modulate the HY75, which operates at

Free ALLIED 1941 RADIO CATALOG!
212 PAGES JUST OUT
BIGGEST EVER 100% RADIO



EVERYTHING IN RADIO AT LOWEST PRICES

65 NEW SETS

See them all — 1941 RADIO HITS! New type Plastic models — new world-wide sets — new "Camera" and Three-Way Portables. Also newest 1941 low-cost Phono-Radio-Recorders, Combinations, Phonograph Accessories, Auto Sets—all at new low prices in a big 40-page section.

NEW SOUND SYSTEMS

1941 P.A. design—types for every P.A. application. 7 to 75 watts—new features, new ideas, new low prices. Time Payment Plan — 15 Day Trial. Complete listings of mikes, speakers, phono equipment, recorders, etc. — all in a big 35-page special P.A. section.

SERVICE SECTION

More than 100 value-packed pages—all the new Test Equipment—new tools—new Service books—more than 15,000 quality parts for servicing every make of set. Radio's best Parts Guide—Radio's Lowest Prices! Also new and bigger Bargain Section—don't miss it!

BUILDERS! HAMS!

Biggest Amateur section in Radio—all the new Ham Receivers, Transmitters and gear—best Time Payment Plan. Dozens of brand-new Builders' Kits, diagrams, supplies. There's nothing in the field like this great 100% Radio Book. You'll want a copy handy for reference.



Count on ALLIED for Higher Quality, Better Service and Bigger Savings!

ALLIED RADIO FREE SEND COUPON
833 W. Jackson Blvd. Dept. 1-J-1 CHICAGO, ILL.

Send me your FREE 212 Page 1941 Catalog that covers Everything in Radio.

Name.....

Address.....

City.....State.....

(Paste Coupon on Penny Postcard and mail.)



Less Noise with An HQ-120-X

AN IMPROVED noise limiter and careful circuit design has made the HQ-120-X famous for its low noise level. Internal receiver hiss has been reduced to a minimum through the use of quality materials and improved circuits. External noises, such as caused by automobile ignition and many other types of electrical apparatus, are limited by a very effective automatic noise limiter which requires no adjustment. The low noise level of the HQ-120-X has made its extreme sensitivity doubly effective. Weak distance stations can be received with marked clarity. If you want better reception try an "HQ" and you'll agree it's tops.

WRITE FOR "HQ" BOOKLET!

HAMMARLUND MFG. CO., Inc. RN-9
424 W. 33 St., N. Y. City
Please send 16-page "HQ" booklet

Name

Address
City State



Canadian Office: 41 West Av. No., Hamilton, Ont.



BATTLES are fought with military precision, field pieces are put through their paces, and wounds are bandaged in strictly approved manner, all for the eyes of the Signal Corps' movie cameras! Do you know that motion pictures have been found ideal for showing how maneuvers should be carried out and for depicting the operation of mechanical devices used in warfare? Don't fail to read how motion pictures are making better soldiers for the United States Army. Here's a timely, brilliantly illustrated article you can't afford to miss!

SEE PAGE 14 **SEPTEMBER**
OF YOUR BIG

Popular Photography

NOW ON SALE At All Newsstands

an input of 36 watts, and these were, therefore, selected in preference to all other types. In order to keep the transmitter compact, it was convenient to use a small tube in place of the more bulky types and much space was saved by the choice of a 6F6. Fixed bias is used at the modulator stage and this is set to minus 26 volts for correct operation. The plate and screen voltages are set to 375 and 250 volts, respectively, and this presents a 10,000 ohm load to the primary of the modulation transformer, which is a *Thordarson Type 19M14*. The secondary taps are selected so that a load of 4,500 ohms will correctly match the modulators to the r.f. stage. A meter is provided in the plate circuit of the modulator where correct operation may be observed. The plate current will vary from 34 to 82 ma. for full modulation.

Almost any type of triode may be used to drive the modulator tube. We selected a type 6J5. Inasmuch as a single button microphone is used, this will provide more than sufficient gain to be realized, and its output will be adequate enough to serve as a driver tube. The gain control is adjustable and once set need not be changed unless a different microphone is substituted, after the initial setting has been made. The current for the microphone is obtained through a 100 ohm, 10 watt resistor to the "A" supply. The use of a heavy capacity condenser as indicated provides sufficient filtering to the microphone circuit.

We have used several types of microphones in mobile installations and the single button carbon stands out well above the rest for all around operation. We selected the *American Type AT2*, which is provided with a push-to-talk switch for break-in operation. This unit has been especially designed to be most effective at voice frequencies and is, therefore, admirably suited to mobile work. Other type microphones are usually too sensitive for mobile installation, and they tend to pick up extraneous noises, such as passing automobile horns and the like, which make reception rather difficult to the one receiving the transmission. The audio gain control should be set while talking in a normal voice directly into the microphone in the same manner as one would use a standard telephone.

Receiver Installation

The problem of obtaining good 5 meter reception is simplified by using a sensitive converter, such as the *Browning 5-10 meter Converter*, which is designed to operate in conjunction with any reasonably sensitive radio receiver which will tune to between 1500 kc. and 1600 kc. This converter was designed primarily for mobile use.

When the converter is connected to the mobile or broadcast receiver, the receiver is set at a definite frequency and acts as an IF amplifier and audio system. A mounting bracket with rubber cushioning washers is provided for dashboard mounting. This bracket is

mounted across the top of the converter by removing the two hex head self tapping screws and attaching the bracket to the converter by means of these screws. The bracket is then mounted to the dashboard of the car, the mounting screws being placed through the rubber grommets provided in such a manner as to give a cushioning effect and at the same time insulate the converter from the dashboard.

A shielded lead with two male connectors are provided for connecting the output of the converter to the antenna connection of the receiver. One of the male connectors should be inserted in the lower female socket on the left side of the converter and the other end of this lead should be inserted in the antenna female socket of the mobile receiver (most mobile receivers have a female socket which will fit this connector). The antenna proper is then connected to the upper female socket in the left-hand side of the converter by means of the male connector provided. As the mobile receiver supplies the B power for the converter and the car storage battery supplies the filament voltage appropriate shielded connections must be made from the converter to the receiver. The shielded lead is connected to the chassis of the mobile receiver while the black lead is connected to the "hot" A lead of the 6 volt battery. The red lead is the +B. This lead is provided with a clip-on connection which can be clipped over the screen grid prong of the power output tube of the mobile receiver and the tube reinserted in the socket. For mobile work, this type of connection may not be entirely satisfactory and many amateurs installing this converter will prefer to solder this lead directly to the +B supply. All these leads are run in the shielded cable provided. The shield should extend into the cabinet of the auto radio. In some cases, vibrator hash may be fed into the converter through either the "hot" A lead or the +B lead. A 2½ mh. choke in series with the +B lead or a small choke in the "hot" A lead is usually effective in eliminating this hash. The problem of vibrator hash is one of these interference problems the correction of which will vary with various installations. A check can readily be made as to the magnitude of this hash by utilizing 90 to 180 volts B battery as a B supply for the converter. The shielded leads must not be allowed to rub on metal parts as noise will result. Bond to, or insulate from metal parts. In some cases auto ignition will cause considerable interference. Choke coil type spark plug and distributor suppressors may be required, condensers between leads to the dome light and car frame, etc.

Receivers in which one side of the 6.3 filament winding is grounded will readily supply filament voltage. Connections should be made in this case between the shield and the receiver chassis and the black lead connected

to the "hot" side of the filament winding of the transformer. In receivers in which the center tap of the 6.3 winding is grounded, it is possible to obtain a filament supply for the BL-510 by the following procedure: Cut off the shield on the filament and B supply leads and run a separate lead from the shield to one side of the 6.3 volt filament winding and attach the black lead, to the opposite side of the 6.3 volt winding (the red lead is attached to the +B supply as usual.) In this case the converter must not contact the chassis of the receiver as this would short-circuit 1/2 of the filament winding (in this latter case no lead will be connected between the chassis of the converter and the chassis of the receiver).

Tuning the converter will be facilitated by making two bracket legs which tip the dial end of the converter at an angle of about 30°.

A red dot is placed on the oscillator trimmer condensers so that their position may be readily observed. This red dot is so positioned that the plates of the condensers are completely in mesh (maximum capacitance) when the red dot is at a position of about 3 o'clock. The knobs are placed on the antenna trimmer in such a position that the white line is at about 3 o'clock when the condenser plates are completely in mesh (maximum capacitance).

The mobile or home radio receiver should be tuned to between 1500 kc. and 1600 kc., the tuning point being so adjusted that no local or other stations will readily be received. The switch with the pointer knob on the right-hand side of the converter selects the desired band, position No. 1 being the 10-meter band and No. 2 being the 5-meter band. An example of tuning on the 10-meter band will be given. The 5-meter band will be tuned in a similar manner. With the volume control of the receiver advanced, a hiss should be obtained and rotating the antenna trimmer very slowly, should give maximum hiss when the white line is in approximately the location shown on the converter. (There may be two positions of this trimmer that gives maximum hiss; the one with the trimmer tuned towards 3 o'clock is the correct position.) Having tuned the antenna circuit for maximum noise, rotate the dial slowly, as the tuning of the converter is usually very sharp indeed depending somewhat on the receiver with which it is used. The antenna trimmers are controlled by knobs in order to allow maximum gain at all frequencies and also to allow the receiver to which the converter is connected to be set at various frequencies as will be explained later. When it is desired to use the receiver in a normal manner with the antenna connected to the antenna of the receiver, rotate the antenna throw-over switch on the left-hand side of the converter to its counter-clockwise position.

Conclusion

The chassis measures 10"x12"x2 1/2"

and is provided with an overall cover. Ample ventilation is provided by large cutouts. The placement of all parts is clearly indicated in the illustrations and needs no further comment. The meters, reading from left to right, are Modulator - Plate, Oscillator - Plate, Amplifier-Grid, and Amplifier-Plate. The entire unit is mounted by means of four Lord Shock-mounts, Type 150HH6. These are obtainable from most of the airport service departments and are used commonly in police installations. The chassis is equipped with an overall base plate to which the shock mounts are mounted by means of long bolts. An extra plate is obtained that is approximately 2" longer than the base plate. Four holes are drilled, one in each corner, so that this plate may be bolted securely to the floor in the trunk compartment of the car. The unit will ride comfortably without shaking and the parts and tubes will be relieved of a lot of punishment caused by vibration and jarring.

As a final word of caution, be sure to tie down all parts securely as a transmitter designed for mobile operation must be able to take a lot of punishment while in service. By observing this, the reader will be assured of a rig which will perform under fire for the greatest period of time.

Installation of Aircraft Radio
(Continued from page 12)

transmitting and receiving radio signals, is quite efficient, somewhat directional, and is sometimes called the "flat-top antenna." The ends of this antenna are fastened to the airplane by either a shock cord or spring and pulley assembly, as are most aircraft antennae; and the tension of the antenna is governed by these assemblies. One end of the antenna, tied to the usual streamlined insulator from one wing tip to the rudder, to the other wing tip, forms a "V," thus given that name. It is sometimes desirable to have more antenna for the transmitter than the receiver, if the opposite sides are so insulated. This is accomplished by inserting an insulator from three to five feet past the rudder, resulting in more antenna for the transmitter which, in turn, results in fewer tuning difficulties.

The down-lead for this antenna is brought into the fuselage by means of an antenna lead-in insulator mounted on either side of the fuselage.

The "wing to wing" type antenna is an antenna used by most large aircraft, and is fastened from one wing tip to another wing tip and suspended from the fuselage by a sub-mast, or the vertical antenna mast. This antenna seems to be one of the most efficient antenna used. However, it does have some pronounced directional characteristics which are sometimes objectionable, but it is highly recommended.

The "T" type antenna is an antenna

COMING!
FREE
50,000 BARGAINS

196 PAGE RADIO CATALOG

All the latest developments in nationally advertised radio parts, plus many items out of manufacture. Everything you need in radio, now within arm's reach. Easy to order . . . easy to have what you want!

Choose your favorite test equipment here. Enjoy real savings. Every known name is represented. Stocks are always complete and up-to-date. Order by catalog—it's quick and it's thrifty.

More models to choose from and more P. A. for your money! In features, performance and watt-per-dollar, Lafayette leads. Three complete lines of portable, permanent and mobile sound systems. A model for every purse and purpose.

Compare Lafayette Radio feature for feature, line for line, and dollar for dollar. Why pay more when Lafayette offers all the wanted features and beauty of styling for so much less? In this book, 64 beautiful models to choose from.

Nowhere else will you find so complete an array of nationally-famous amateur transmitters, receivers and ham equipment. It's a catalog within a catalog, and low Lafayette prices make it a book you'll want. Reserve your copy now.

BIGGER IN EVERYTHING! Be sure to see the complete line of low-priced, easy-to-attach auto radios, the newest record players, radio tubes, tools and guide books. They're all here and priced to save you real money.

RIGHT NOW RESERVE a copy of the greatest catalog in radio—this year bigger than ever. The coupon below, mailed at once, will bring a FREE copy to you soon.

RUSH COUPON NOW

Lafayette

LAFAYETTE RADIO — DEPT. 2J
901 W. JACKSON BLVD., CHICAGO, ILL.
or 100 SIXTH AVENUE, NEW YORK, N. Y.

I don't want to miss this great catalog. Please reserve my FREE copy.

NAME

ADDRESS

CITY

STATE

PASTE COUPON ON PENNY POSTCARD

ASSURED STABILITY
WITH
BLILEY CRYSTAL UNITS
10-20-40-80-160
METER BANDS



TYPE B5—This highly active crystal unit for the 40 meter band has less than 4 cycles/mc/°C drift. Price \$4.80.

TYPE LD2—An efficient and powerful low drift crystal unit for the 80 or 160 meter band. Price \$4.80.

TYPE HF2—Simplifies the construction of 5, 10- and 20-meter transmitters. Drift, 20 meters, 20 C/mc/°C; 10 meters, 43 C/mc/°C. Price, 10 or 20 meters, \$5.75.

TYPE BC3—A moderately priced mounted crystal with unusual activity and power output. Drift 23 C/mc/°C. Price, 40, 80 or 160 meters, \$3.35.

BLILEY ELECTRIC CO. • ERIE, PA.

World's Smallest
Radio
HEALTHY PLASTIC CABINETS



Midget radio fits your pocket or purse. Wt. 6 ozs. Small as a cigarette package. Receives stations with clear tone. **PATENTED FIXED RECTIFIER.** Tubeless. Batteryless. Coated luminous color dial for easy tuning. M.L. OF ILL. SAYS: "MIDGET RADIO WORKS FINE!"

ONE YEAR GUARANTEE!
Sent ready to listen with instructions and tiny phone for use in homes, offices, hotels, in bed, etc. **SIMPLE TO CONNECT—NO ELECTRICITY NEEDED!** SEND NO MONEY! Pay postman only \$2.99 plus postage & charges on arrival or send \$2.99 (Check, M.O., Cash) and yours will be sent postpaid. A most unusual value. **ORDER NOW! FREE! PLUG IN "MAGICTENNA"—ELIMINATES OUTSIDE WIRES!**

MIDGET RADIO CO. Dept. HG-9 Kearney, Nebr.



GUNS Pointing Up!

AFTER too many years as a military stepchild anti-aircraft artillery is coming into its own as an important defense weapon. In an authoritative discussion, Lieutenant Robert A. Rankin tells all about modern anti-aircraft guns, height finders, gun directors, searchlights, sound locators, and anti-aircraft ammunition. Read how anti-aircraft artillery, in its present stage of high development, is one of the most important factors in any scheme of the national defense . . . how the United States at last will be able to cope with the possibility of an aerial invasion. Don't miss this intensely interesting article in the

SEPTEMBER ISSUE

FLYING AND
POPULAR
AVIATION

NOW ON SALE AT ALL NEWSSTANDS—25¢

fastened from rudder to one wing tip or to a sub-mast located in the center of the fuselage, and is usually used on small aircraft. It is also used by the airlines and commercial aviation services. However, it is quite directive due to "wave-front" caused by metal mass reflection, if mounted on the "top side" of the fuselage.

The loop antenna is utilized by modern aircraft daily for radio compass work and radio direction finding, and often used for the reception of beam stations and weather reports when static makes reception nearly impossible with the conventional antennae system.

A loop consists of an insulated ring upon which is wound a number of turns of wire, depending upon the type of receiver used (input terminals). This loop may have two or more bank windings, and is mounted on a base sometimes rotatable. When the loop is of the rotatable type it is used frequently by the pilot or radio operator in large aircraft for navigational purposes. It is usually mounted on the front of the aircraft underneath the nose where it is rotated electrically, and in the case of aircraft employing a radio operator, operated manually; and when operated in the latter manner, is mounted directly above the operator's position on the aircraft.

The policy of installation is dictated by the design of the aircraft and the design of the loop itself.

To prevent icing of the antenna, deicers are placed around the loop, and in some cases this loop is inclosed in a weather-proof, streamlined housing.

The loop antenna is often used in conjunction with another antenna, which is from three to six feet in length, and mounted horizontally near the loop. This short antenna is used in most cases, as the main "pick-up" antenna for the radio compass. If connected as a doublet, and very seldom connected as such, it is used by both the compass and marker beacon radio receivers in conjunction with a switch for separate or collaborate operation.

It has been found that by employing another type of antenna, i. e., the "belly T," that the directional qualities often exhibited by the usual top-side "T" can be partially eliminated by suspending an antenna underneath the belly of the ship. This antenna is very efficient and often used for the reception of beam stations.

Another reason for the "belly T" or "under belly" suspension is due to the ice which may form and cause breakage of the conventional antenna installed in line with the slip stream created by the propellers, it is recommended for that one reason, it is not as susceptible to icing conditions as other types of antennae.

An antenna used quite frequently by aircraft today is the general purpose trailing wire antenna. This antenna is reeled in and out of the aircraft, the length being proportional to the fre-

quency used, but it is usually operated at a $\frac{1}{4}$ wavelength.

The installation of this antenna is quite simple in most cases, because the reel mechanism is electrically operated and can be installed in nearly any remote spot in the plane out of the way of cables, controls, etc. The efficiency of this antenna is very high, even more so than the wing to wing type antenna.

This antenna is used where distance is a requisite and reliable communication necessary. It is not too susceptible to ice formation if not too heavily weighted, and is recommended highly for small as well as large aircraft, but when used on the former is usually manually operated.

The location and length of the receiving antenna is governed by the size of the aircraft and made as long as possible in all cases. It is not as critical as the transmitting antenna. However, it must receive as much consideration from an installation standpoint.

The length of the transmitting antenna is always critical. The frequencies being transmitted govern the length.

Most antennae today are operated at frequencies below their fundamental frequency, but by utilizing the tuning unit supplied with most transmitters, it will be found that efficient operation will result if the unit is tuned properly.

When an antenna is too long for the frequency desired, the tuning unit will supply the correct amount of series capacitance to electrically shorten it, and when too short, the tuning unit in turn will supply the correct amount of series inductance to electrically lengthen it. By utilizing the correct amount of both, and by using tap switches connected to both the capacitive as well as the inductive tuning elements, a combination will be found whereby the antenna is resonated properly to the power amplifier stage of the transmitter, and maximum radiation will be realized.

If an increase in the actual length of a transmitting or receiving antenna is desired mechanically, the length should always be in a direction away from the main body of the metal mass, that is, the airplane structure. Due to the high capacity encountered in aircraft antenna installations, it will be noticed at times that if an r.f. ammeter is used to indicate antennae current, the deflection is sometimes high and the radiation very low. Absorption losses in aircraft antennae are quite high, and these must be minimized as much as possible by installing the antenna as far away from the metal mass of the airplane as practicable.

The normal resistance of an aircraft antenna is usually taken to be between 5 to 12 ohms. However, this isn't always the case, because antenna resistance in some aircraft has been measured to be as high as 75 ohms. The antenna resistance varies with

frequency, and usually capacity is taken to be from 80 to 165 micro-micro-farads. That is, if the transmitter operates between the frequencies of 6210 and 6800 kilo-cycles. At these high frequencies, dielectric losses are one of the greatest reducers of efficiency.

If an antenna cut to approximately $\frac{1}{4}$ wavelength is used, the right amount of operating capacitance and approximately the correct amount of antenna resistance is usually realized when the present frequencies now used by aircraft for transmitting purposes are taken into consideration.

The dielectric losses and the conductor losses should be a small influence upon the radiation resistance of the aircraft antenna. The impedance should be the influencing factor. So when designing the antenna, the many factors which influence efficiency should be taken into consideration.

Due to the limited space available on most aircraft, it is necessary for the installation technician to exercise a reasonable amount of discretion, and it has been found that a cut and try system must sometimes be employed when installing antennae, before satisfactory results are obtained.

The lead-in which connects the various antennae to the radio equipment must also be given consideration, because if this lead were installed haphazardly, the efficiency of the installation would be impaired.

The down-lead from the antenna proper should be securely connected by utilizing the "T" splice, made by wrapping the same type of wire as used for the antenna for approximately ten turns around the antenna proper, doubled back, and wound for ten turns in the opposite direction of the first wrap; then down-leaded upon itself for another ten turns and then stagger wound for three turns. One drop of solder being used for a secure connection in the center of the tie. The free-end is then brought to the lead-in insulator, wrapped, and tied in, in the same manner as the antenna is tied into the strain insulator.

Co-axial cable, preferably, should be used for connecting the radio equipment to the lead-in insulator. However, un-insulated copper wire of about Number 16 B&S gauge strung with insolantite beads may be utilized. This wire should never be rubber covered, and should always have a little "slack" in it in order to cope with vibration at the receiver end. The actual size of this lead is dictated by the power output of the transmitter, and the lead running to the receiver is approximately the same size for uniformity.

The proper antenna wire that should be used for all antennae, should be wire, which is composed of materials which add to the strength as well as to the conductivity. Wire often used is that composed of steel for strength, copper coated for good conductivity and low resistance. It can usually be

purchased from wire manufacturers in different sizes by asking for "Copper-clad steel" wire, single strand.

When working with this wire, it is well to bear in mind that pliers should never be used except for actual cutting, because the smallest material nick will weaken it mechanically. Copper-clad steel wire withstands much vibration and will hold up very well under severe icing conditions.

The proper method of tying the strain insulators to the antennae without the use of pliers is accomplished in the following manner: The first end of the antenna is securely tied in by using an extra piece of wire about 24 inches long. Pull the antenna wire proper through the insulator for about sixteen inches, seizing it close to the insulator end, then pull through the extra piece of wire. Separate the leads, and while holding the antenna lead and one end of the extra lead against itself, wrap in close spiral with the first extra lead; after ten turns have been wrapped tightly, clip close to the antenna with a pair of diagonal pliers and proceed to wrap as the second lead for about ten turns. Clip and wrap the antenna lead the same amount around the antenna proper, and for the last five turns, wrap in staggered fashion with five tightly wound spirals. After completing one end, pull the antenna through the other strain insulator and give it



JUST LOOK AT THIS VALUE
MILLION
LAB
METER → \$19⁹⁵

and LOOK at THESE FEATURES

- Giant 8 $\frac{1}{2}$ " Meter • 1000 Ohms Per Volt
- 0-6-120-300-1200-3000 Volts, D.C. • 0-6-120-300-1200-3000 Volts, A.C. • 500-500,000 Ohms
- 0-5 Megohms • 0-1-3-30-300-600 Milliamperes
- 0-12 Amperes • -10+10 Decibels

Price, Each
 Batteries, Extra . \$1.70 **\$19⁹⁵**
 Test Leads, Extra 1.25

*If Your Jobber Cannot Supply You
 Write Us Direct*

MILLION RADIO AND TELEVISION
 577 No. Union St. Chicago, Ill.

WHY DIDN'T SOMEONE TELL JEREMIAH SMUDGE ABOUT ATOMS?

UP until yesterday, Jeremiah Smudge was a radio serviceman. Now he's working for the W.P.A.

The trouble is that Jeremiah is a wee bit old-fashioned.

He drives a Model T Ford on which everything makes a noise but the horn, uses a mustache cup and still thinks the Philadelphia Athletics have a chance for the American League pennant. He runs—we mean *ran*—his service business just about the same way. Take condenser replacements for instance:

Jeremiah spent weeks and lost half a dozen good customers waiting for exact duplicate replacements to arrive.

No one ever told him that he could get a couple of Sprague Atoms (midget tubular dries) from his jobber, strap 'em together and make up almost any "duplicate" he'd ever heard of—in smaller size and actually at less cost.

Plenty of times Jeremiah lost his temper trying to fit an old-style condenser into a midget set—then lost the customer, too, when the repair bill ran almost as much as the set was worth.

No one ever told him that Sprague Atoms are no bigger than his little finger, reliable as the North Star, and cost but a fraction of the price of larger types.

Jeremiah wore out eight tires and the seats of six pairs of pants riding down to the jobber to buy a condenser every time he needed one.

No one ever told him he could save money buying Atoms in handy kits—and

that a kit or two would enable him to handle 80% of all dry electrolytic replacements—in less time than it took him to crank his flivver.

Jeremiah did go modern—once. He tried a midget condenser of some other make. It exploded like a firecracker, scared Jeremiah so badly he swallowed his chewing tobacco, then decided once and for all he'd never try any more new-fangled ideas.

No one ever told him that Sprague Atoms are positively guaranteed against blow-ups, and have been ever since they were introduced.

Last but not least, Jeremiah was always complaining about price-cutting competition. He even wrote his Congressman about it. However, the Congressman

didn't tell him that maybe these fellows weren't cutting repair prices at all—that they were probably using Atoms and other parts that enable them to do good work for less money and still make a nice profit doing it. Get the idea?

Of course you do! The fact is Sprague Atoms are just as far ahead of old-style condensers as those sleek, speedy automobiles of today are ahead of Jeremiah's Model T. Use Atoms universally—regardless of the size of the unit they replace. They'll save you time—money—space. They're made in all capacities—all voltages—and many popular dual combinations. Catalog free.

SPRAGUE PRODUCTS COMPANY
 NORTH ADAMS, MASS.

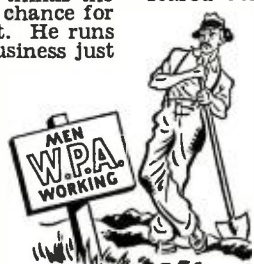

Advertisement

IF ITS RADIO

ALL YOUR RADIO NEEDS

Here in this one big book you will find everything you need in radio... sets, parts and supplies... public address systems... amateur equipment... testers and kits... your nationally known favorites at lowest possible prices. Write today for this big valuable catalog and save money.

PROMPT SERVICE

BURSTEIN-APPLEBEE COMPANY

1012-14 McGEE STREET, KANSAS CITY, MISSOURI

Now **Radio**

BROADCASTS YOUR VOICE LIKE A RADIO STATION—

to any ordinary radio within 100-150 ft away! Between rooms, apt., house, auto office—almost anywhere! No electric plug-in—Not an Attachment or Teyl Ready to operate with self-contained batteries, "Mike-Phone," tubes, and attachable "Magitenna" (eliminates aerial). Size only 3x4x1 1/4". Wt. 22 ozs. Simply connect and broadcast to nearby radios or other "Tlaydynes."

ONE YEAR GUARANTEE!

Also receives many radio stations clearly!—With No Changes or Extra Wires! New Model broadcasts and receives on short and standard wave! Anyone can operate it with our simple directions. A barrel of fun & amusement for everyone. Many practical uses! Finished in beautiful color sparkle steel case! **Saved Only \$1.00** (Check, M.O., Cash) and pay \$4.99 plus postage on arrival. **Order Now!**

MIDGET RADIO CO. Dept. THG-3 Kearney, Nebr.

SOLAR RED-CAPS

Smaller Diameter Dry Electrolytics

SPEED Servicing

Write for Catalog

SOLAR MFG. CORP. Bayonne, New Jersey

TURN YOUR SPARE TIME INTO CASH!

Here's an Easy, Pleasant Way to Earn EXTRA MONEY!

Would you like to add \$10, \$25, or even \$50 a month to your income? Then join the friendly, money-making **RADIO NEWS Boosters' Club** and turn your spare time into dollars and cents! Just represent **RADIO NEWS** in your community and tell your amateur and servicemen friends about the advantages of a **RADIO NEWS** subscription. Send for full particulars at once. Paste the coupon below on a penny postal and mail now!

SEND COUPON TODAY!

RADIO NEWS Boosters' Club
608 S. Dearborn St., Chicago, Ill.

Please rush subscription supplies together with information on how I may turn my spare time into cash.

NAME.....
ADDRESS.....
CITY & STATE.....

the correct amount of tension and proceed to wrap it as the first connection. It will be necessary for an assistant to hold the antenna against itself while the actual wrapping is being completed, in order that the correct amount of tension will be maintained.

The correct amount of tension as applied to an aircraft antenna is customarily accomplished by noting the amount of pull upon the shock-cord assembly or the spring and pulley attachment. It should never be tightened to the point where all elasticity is utilized. A certain amount of elasticity must be present in the antenna in order to cope with structural bends and vibration. If icing conditions occur, an antenna which is too tight will usually snap. However, by having the correct amount of tension applied to it, it will stand up much longer under severe icing conditions. It is well to note here also, that if solder is used in the installation of an aircraft antenna that some means must be provided whereby corrosion is minimized. By spotting the soldered connection with either shellac or varnish, corrosion will be held at a minimum. It is not advisable however, to use too much solder at any time, because this increases the r.f. resistance somewhat at the connection. One or two drops are sufficient on any connection utilizing the tie-in described above, because the tightly wound spirals take care of "surface contact."

The actual installation of any aircraft antenna should be carefully performed, and care taken with each connection made; making certain that good insulation is maintained throughout the entire installation by utilizing insulators placed at least six to fourteen inches from end supports.

(To be continued next month)

Video Reporter

(Continued from page 29)

The demonstration was conducted by the Baird Television Development Company, of London, and the images, transmitted from a studio in the British capital, were received in mid-Atlantic aboard the *S.S. Berengaria*. And here's the most amazing fact of all. The demonstration occurred in the Spring of 1928—a full dozen years before the recent RCA shipboard reception test! Of course, the methods employed are generally obsolete now, but shipboard observers declared that the images were clear and faces were easily recognized.

SPEAKING of old-time television demonstrations brings to mind one of the first video displays we witnessed. It was arranged by WOR, Newark, New Jersey and took place at the department store of L. Bamberger & Company in that city.

It was a peep-hole, scanning-disk affair and the program consisted of a puppet show. We mention it because at the moment the idea of puppets is leaping to the fore as ideal program fare in the New York television area.

Bill Eddy, the clever television craftsman imported to the New York NBC-RCA studios from the old Farnsworth station in Philadelphia, has perfected a mechanical puppet which moves about by an intricate arrangement of gears and motors. And we're told he expects to build several other "characterizations" along similar lines so that NBC could have an entire stock company of robot puppets.

AND it's a puppet, too, that captures stellar honors at the RCA television show staged for visitors at the New York World's Fair. A young fellow named Burr Tillstrom presents an extemporaneous act with doll-like figures manipulated by his hands. His clever, unrehearsed repartee has all the makings of smash hit television program fare but his demonstrations are limited to receivers displayed in the RCA building on the Fair grounds. There are other excellent video performances, too, presented solely for the entertainment of Fair visitors. The shows are presented continuously by a small company of variety performers. On the whole, the programs are superior to the telecast fare on W2XBS in recent months. But an RCA spokesman told us that there's a definite ruling prohibiting the acts to go on the air so that all video set owners in the metropolitan area could look-in in addition to the observers in the Fair building proper.

Maybe it's spite. And maybe it's something else. But, in turn, the demonstration sets in the building don't carry the W2XBS programs, even when they originate in the very same Fair building—as they occasionally do.

WHILE there are no apparent new strides in equipment demonstrated at the Fair, RCA has done a bit of sound thinking on how to display its television sets to best merchandising advantage. The idea of letting crowds swarm around receivers and view the images while standing was rejected this year. Instead, a group of individual settings—each representing a living room—is employed. The visitors file in and are comfortably seated in small groups and are able to view a short variety show in complete comfort. The programs originate before large audiences outside and are repeated after short intermissions so that visitors can observe both the transmitting and reception techniques.

IMPROMPTU television demonstrations in semi-public spots in the New York area are running a bit out of hand insofar as manufacturers and dealers are concerned. The makers of video equipment can do much to instruct the retailer on how to demonstrate his sight-and-sound receivers in a manner best suited to merchandising practice. But the growing use of television sets in restaurants, bars, hotel lobbies, theater lounges, etc., is what's worrying the men concerned with future sales.

To some extent, the public demonstrations that are in the hands of men in other trades do promote the video art. But the manner in which the receivers are operated bothers the equipment men because they feel that a large share of the sets are operated in a negative manner that would curtail rather than boost the sale of television models for the home.

HERE'S an example of what takes place. The Video Reporter was having dinner at a New York restaurant one night when the voice of Lowell Thomas reporting the day's news was heard from a loudspeaker. Looking ceilingward in the direction the sound came from, we noticed that reception was made on a television receiver mounted high on the wall almost flush with the ceiling. The viewing angle was terrible and the distance of the diners from the television screen made the image seem of postage-stamp size.

We reached one definite conclusion concerning the demonstration: It certainly wouldn't boost set sales. Furthermore, it wouldn't boost patronage of the restaurant either. Hoisting the receiver to ceiling height represented a teaser that was annoying. A bad view is worse than none at all. Actually, reception of the Lowell Thomas program on sound radio alone would have served a better promotional and entertainment purpose for the restaurant.

Retailers give careful instructions on operating a receiver to every purchaser of a set for home use. They should take especial care in advising buyers who intend using the sets for semi-public demonstrations. The latter purpose can boost or hamper additional video sales. And it's to the best advantage of all concerned—user and seller alike—to operate the receiver in the most practical manner for comfortable viewing.

Four-in-One Tester

(Continued from page 29)

prevent overloading the meter for leakage tests. Any spare meter that you may have around from one to eight ma. movement will be entirely satisfactory for this circuit.

Multiplying resistors will have to be used to extend the range of the meter as a voltmeter for the V.T.V.M., but that is easily done once the internal resistance and the current rating is known. The values given here are for a 0-5 ma. Readrite Meter.

As you will notice in the diagram the meter is used as a leakage indicator for electrolytic condensers. This is an accurate means of determining the condition of the condenser as the one under test should be discarded if the leakage is more than 1/2 ma. per microfarad.

Of course, this leakage should be measured at or near the working voltage of the condenser. The variable resistor controls the amount of current that passes through the meter. With the test leads in jacks 1 & 2 and shorted, resistor RX is advanced until the meter reads full scale. This setting gives approximately 300 volts across the test leads. If more voltage is needed advance RX in a clockwise direction. For this test switch No. 4 must be in high position and switch No. 5 closed, shorting out the neon bulb.

If electrolytic condensers of low voltage are being tested for leakage, switch No. 4 should be thrown to the low position and RX advanced until the meter reads full scale. The voltage will now be 22 1/2 volts across the test leads and no damage will be done to the condenser from high voltage. It is always best to use this range first on the condenser to determine if it is shorted, and then switch to the high range later for leakage test. The low position of the condenser tester makes a fine continuity tester with very low voltage on the test leads, which safeguards damaging any parts.

For paper condensers, shift the test lead from No. 2 to No. 3 jack and throw switch No. 4 to high position and switch No. 5 to off or open, thereby putting the neon bulb in the circuit to test leakage of paper condensers. If the neon flashes once the condenser is good. If the neon continues to flash, the condenser is leaky, and should be replaced. The voltage across the test leads is also controlled by RX as in test above. Always be sure the condenser under test can stand high voltage before advancing the resistor RX beyond full scale of the meter. This will not hurt the meter if the condenser is good, but if the condenser were shorted it might burn it out. The maximum voltage attainable with the control RX advanced full on, is the full output of the power supply you are using.

By placing the test leads in jacks No. 1 and No. 2 once more, you can now

calibrate the meter as an ohmmeter. Short the test leads and adjust RX for full scale of the meter. Now, take several known resistors and draw a scale on paper to correspond with the meter scale, marking the position of the needle with the value of the resistor. Use both high and low ranges and you will have an ohmmeter covering approximately 500 ohms to 1 megohm.

As long as we had to put in two scales of voltage for the V.T.V.M. we put in a third tip jack and another resistor and this gave us a 500 volt range as a voltmeter. This is not a very accurate voltmeter, but it will do to measure voltages which are not critical as to load, such as power supplies, plates and screens of power tubes, etc. Thereby adding to the versatility of the instrument.

Now a word about how to use the entire instrument as a composite piece of test equipment. Supposing we have a set on the bench which is dead as far as we can determine by ear. We first put the test leads in tip jacks No. 2 which is common, and the other lead to No. 3, No. 4, or No. 5, whichever range is desired, and test the various stages for plate, screen and cathode voltage. Suppose all of these stages have a voltage near to the correct voltage for normal operation. We now plug in the power cord and turn on the switch No. 1 and allow a few seconds for the tubes to heat up. Hook up a test oscillator to the aerial and ground of the set and place test leads in jacks marked r.f., i.f. and gnd. Connect gnd. lead to chassis of set.

Set the tuning condenser in the set to the frequency of the test oscillator. Turn on volume control R6 of the "Signal Chaser" section of the tester. This throws switch No. 6, which is ganged with the volume control. Now with the other test lead start at the aerial post and trace the signal from the oscillator. Touch the plate of each successive stage until the signal disappears. This is the stage which is defective, so continue to make careful study and tests on this stage alone.

If a voltage is to be measured that requires a very high resistance meter such as the A.V.C., A.F.C. voltage, the V.T.V.M. comes into play. Turn off the volume control and switch No. 6 and throw switch No. 3 from Analyzer Position to V.T.V.M. position and switch No. 2 to the 50 volt range. Connect the test leads to jacks marked V.T.V.M. Short the leads and adjust R5 until the eye shadow closes. Place the leads on the terminals to be tested and adjust R7 until the eye shadow closes again. The reading on the meter will now indicate the actual voltage being impressed on the test leads. If the eye will not close by adjusting R7 the voltage being impressed is more than the range of the instrument, in this case 50 volts a.c. or d.c. If the voltage is too small to read on the 50 v. range, switch No. 2 should be thrown to the 10 volt position and the process repeated.

FACTORY-TO-YOU
Save up to 50%



EASY TERMS

30 DAYS TRIAL PUT THIS NEW 1941 **14-TUBE CHASSIS** IN YOUR OWN CABINET

FREQUENCY MODULATION and TELEVISION PROVISION
Now, you can enjoy the mighty power of a 14-tube 1941 radio at the price of an ordinary 7 or 10-tube set!
only \$19.95 COMPLETE WITH TUBES AND SPEAKER



14-TUBE CABINET MODEL \$29.95 COMPLETE

AMAZING FOREIGN RECEPTION
You can enjoy brilliant performance and beautifully clear tone. Now, tune in broadcasts direct from distant overseas stations. Big 1941 catalog shows how to buy at wholesale price . . . direct from factory.
Read about sensational new 14-tube cabinet model at \$29.95. Also other chassis and cabinet models from 5 to 17-tubes . . . up to 5 wave bands . . . including Radio-phonograph-combinations and Home Recorder. **Write today!**
GET MIDWEST'S ANSWER TO TRADE-INS! **FREE RADIO CATALOG** SEND 1¢ POST CARD FOR FREE 1941 CATALOG NOW!

MIDWEST RADIO CORPORATION
Cincinnati, Ohio Name _____
Dept. 11-88 Address _____
Send me your new FREE catalog, complete details of your liberal 30-day Trial Offer and factory-to-you prices. Town _____ State _____
User-Agents Make Easy Extra Money. Check here 1 for details.

THE SHORT CUT TO CODE SPEED!

Don't be discouraged if you are "stuck" or have failed! The Candler System can teach you to receive and send code at high speed. The Candler System teaches you to learn code the right way—by sound. Hours of un-directed practice won't help. Candler teaches you to coordinate mind and hand properly, to read code as easily as you do print. You can learn to handle code as smoothly as the best "top" on the air—and in amazingly short time. Code is easy to learn, the Candler way, and the cost is remarkably low.

FREE!
Send today for Candler's big book of code facts—it costs you nothing—you owe it to your future to read this book. There's no obligation—Write today!
CANDLER SYSTEM CO.
Dept. N-9, Asheville, N. Carolina, U. S. A.

RADIO OPERATORS' LICENSE GUIDE BOOK

Here's a new Guide Book that contains over 1200 questions and answers which will help you pass the new six element examinations for a commercial radio operator's license. It correctly answers all questions contained in the study guide that was recently released by the Federal Communications Commission for the use of those proposing to take its examination. It will not only see you through your examination, but will also serve as a valuable future reference book. \$3.00 postpaid. Refunded if not satisfactory. Send check or money order.



ONLY \$3.00 Postpaid

INLAND WIRELESS SUITE 2017, FIELD BLDG., CHICAGO, ILLINOIS



New Hand Set AIRCRAFT Type

... for mobile, pack transmitters, amateur, aircraft, 2-way phone systems, etc. Dependable, long life, low price. Black Bakelite case with 6 ft. cord. Microphone and receiver terminated separately. Switch not available. Wt. complete only 7 oz., packed 1 lb. 75 ohms match line impedance; 2,000 ohms match plate cir. **\$10.00** List. **UNIVERSAL MICROPHONE CO. LTD.** Inglewood, Calif., U.S.A.

Burroughs

CASH REGISTERS
LOW PRICES-EASY TERMS
COLORS TO HARMONIZE
WITH SURROUNDINGS

For a free demonstration call the nearest Burroughs office or write—
BURROUGHS ADDING MACHINE CO.
DETROIT, MICHIGAN

CAMERA FANS! HERE'S A WELL-ROUNDED PHOTOGRAPHIC EDUCATION

Whether you are a beginner or an advanced amateur, you need the PHOTOGRAPHIC SERIES of the Little Technical Library at your fingertips all year 'round! With this handy set of 20 pocket-size text books you are assured of unprecedented guidance in every phase of photography. Every chapter of every book is bulging with authoritative photographic information that's easy-to-read and easy-to-understand. Beautifully printed and richly bound in blue leatherette, each volume is complete in itself, authored by an outstanding photographer ... yes, and chock-full of brilliant illustrations.

Little Technical Library

PHOTOGRAPHIC SERIES

At all leading book, department and camera stores—or write for FREE list of titles! **LITTLE TECHNICAL LIBRARY, 608 S. Dearborn St., Chicago, Ill.**

20 POCKET-SIZE TEXT BOOKS

50¢ EACH

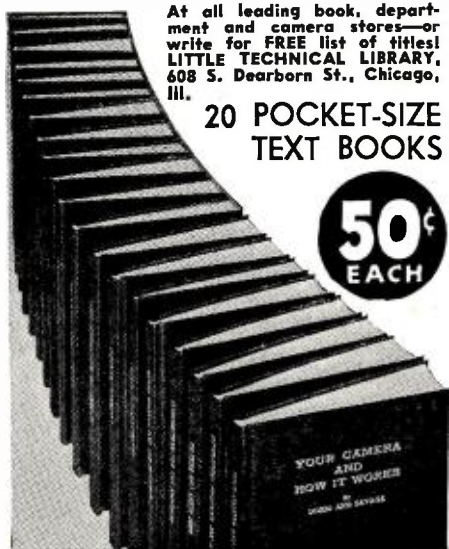

Simple Audio Oscillator

(Continued from page 13)

tinguish tones by octaves, and condensers should be connected for trial, until a tone one octave lower than the first tone is obtained. The size of the condenser required for the remaining positions is then easily determined, as the capacity for the next octave lower will be four times the capacity of the first condenser.

The constants shown in the accompanying diagram will serve as a concrete example. In the F1 position the tone produced was approximately 2800 cycles. In order to obtain a tone one octave lower, for the F2, a .006 mfd. condenser was required. The condenser value for F3 would be $4 \times .006 = .024$. Almost any .025 condenser will be found satisfactory. The condenser for the F4 position would then be .1 mfd., another stock size. When switched to the F5 position for the lowest tone, the circuit will not oscillate with a condenser much larger than .25 mfd. across the secondary. With a .25 condenser in the circuit the generator oscillates at 240 cycles, with some reduction of output. At the first four frequencies the output, as measured with an ordinary rectifier type meter, is 20 to 25 volts, but at 240 cycles the output drops to 7 or 8 volts.

When the generator is completed and these adjustments made, the user will probably want to have some idea of the frequencies generated. The simplest method that is likely to be most generally available, is the use of a piano as a standard, and one of the frequency charts that are often published. By reference to the chart it will be noted that a tone that is one octave higher than another, will be exactly twice the frequency of the first tone.

In the case of the generator shown, the highest frequency F1 is 2800 cycles, which is roughly equivalent to the highest "F" on the piano. At F2 the frequency is 1400 cycles; at F3 700 cycles; and at F4, 350 cycles. The lowest frequency, 240 cycles, is equal to the "B" below middle "C." If a printed chart is not available, the frequency of any note may be determined by reference to the following list. The highest and lowest frequencies for the notes of the scale are given:

	Cycles	
A	26½	3413½
B	30	3840
C	32	4096
D	36	2304
E	40	2560
F	42½	2730½
G	48	3072

To determine the frequencies of the intermediate tones, double the frequency of the lowest note given, and then double each result until the desired note is reached. For example, the frequencies for the "B" notes are: 30, 60, 120, 240, 480, 960, 1920, and 3840 cycles. The piano should not be relied

upon as a precision standard however, as all are not tuned to the same pitch. There has been a tendency to raise the pitch slightly, with the note "A" at 440 cycles for reference. For ordinary purposes the difference is negligible, and the tables above may be used with acceptable results.

The circuit used is practically fundamental, and susceptible to many variations to fit the individual constructor's ideas or requirements.

Cuttings

(Continued from page 24)

admirably to all purposes. It is well suited to both voice and instrumental music, responds well to the speaking voice, and has a wide angle of pickup that permits a large group of instrumentalists to be recorded with only one microphone.

The play-back response is especially pleasing to hear. A large self-contained speaker is included in the carrying case. This permits enough volume to be used to fill a very large room at good fidelity. The following information will help the recordist to get the best possible results from his equipment:

1.—Be sure the instrument is level at all times.

2.—It is advisable to test for depth of cut of the cutter after the cutter has been changed. The proper depth of cut may be determined by looking at a test cut through a magnifying glass. As the width of the cut depends on the depth, because of the shape of the cutter head, the depth of each groove is properly adjusted when the width of each groove is approximately equal to the space between the grooves. It may be advisable to have an extra blank record to test for depth of cuts before each recording.

To adjust for depth of cut, proceed as follows: To cut a shallower groove loosen the machine screw that holds the clip in place on the recorder arm, slide the clip toward the base of the recorder arm a very small amount and tighten the machine screw. Cut a new groove and test for depth and width. If the groove is still not shallow enough, proceed as above until the desired depth is obtained.

To cut a deeper groove proceed as above except move the clip toward the recorder head thus removing some of the tension from the weight adjusting spring.

3.—To remove any "flutter" or needle "chatter," it is necessary to change the angle of the cutter, this may be accomplished as follows:

Loosen the two screws which hold the recorder head to the casting, slide the recorder head upwards slightly and tighten the two screws. This adjustment will cause the stylus to cut more perpendicularly to the record and may remove the "flutter." If raising the recorder head does not eliminate the "flutter," then the reverse should be done, that is, lower the recorder head nearer to the record.

4.—Before recording, the volume of voice or music or whatever it is desired to record should be tested at the actual volume to be used while recording, and the volume control set so that the meter indicates in the green area of the meter dial during average recording passages.

5.—Do not shut "off" the motor switch before lifting the recorder head off the record.

6.—The cuttings should be removed from the recording by moving the fingers or a small fine brush in a gentle circular motion over the record. Do not scrub.

7.—When a new cutter is used, loosen the machine screw which holds the spring adjusting clip in place on the recorder arm, slide the clip toward the base of the recorder arm and tighten the machine screw. This is to make sure that the groove depth for the new cutter is not too deep. If the groove is too deep the cutting tool may be easily chipped, if it cuts through the lacquer coating and touches the aluminum disc.

8.—Correct grouping of recording artists and microphone placement are of extreme importance in order to get the best possible

results. This grouping and placing will be facilitated by listening in on a pair of RCA High Fidelity headphones, such as MI-3453-B, plugged into the monitoring jack on the front panel, prior to making a recording.

9.—When cutting a record it is advisable to lower the cutting head and let it cut two or three blank grooves before starting the modulation. At the end of the recording, when the modulation is stopped, the cutter head should remain on the record to cut two or three blank grooves before it is raised.

What's New in Radio

(Continued from page 33)

which include multiple-ribbon filament leads, two multiple-ribbon grid leads to minimize the effect of lead inductance, and an entrant metal header. The header serves not only as a low-inductance terminal for the screen but facilitates isolation of the input and output circuits. As a result, neutralization is usually unnecessary except at the very high frequencies. —30—

Book Review

(Continued from page 34)

to build simple receivers and transmitters, the power supply for amateur radio, more about radio tubes, and amateur receiving and transmitting antennae. The book is written in clear and simplified style, and the many explanatory drawings by the author add greatly to its value as a complete introduction to radio receiving and transmitting. —30—

Bench Notes

(Continued from page 24)

Third, fourth, and fifth prizes—each a year's subscription to RADIO NEWS—are taken by Thomas F. Conneen, Lafayette Hotel, Portland, Maine; Arthur Dickenson, 605 Johnson Ave., Seguin, Texas; and Victor Baccari, 19 Phelps Street, Salem, Massachusetts.

Honorable Mention: Tom Ito, 445 S. Evergreen Avenue, Los Angeles, and Fred E. Berry of Berry's Radio Service in Olive Hill, Kentucky. —30—

Servicemen's Money Page

(Continued from page 41)

tifully. Obtain a double cord of No. 18 wire or larger. Fasten battery clips to three of the ends. On the fourth and remaining wire screw the carbon electrode. You will find the existing terminal on the carbon electrode ideally fitted for this.

Clip the two adjacent ends of the cord to the battery. Clip the remaining clip to the object to be soldered. Apply the solder and carbon electrode to the object at the same time and you will find that you have an excellent soldering iron for soldering joints in auto sets while on the car. Its uses will be found too numerous to mention, once you have caught the "hang" of it.

Washington Communication

(Continued from page 21)

ines that the fingerprints are to go to the FCC, they are wrong; they go right into the FBI's files. Just what that will prove is hard to estimate, but one thing it will do, is to make it a crime *not* to have your fingerprints on record, if you want to continue as a radio operator. Some among the profession might want to avoid having their fingerprints taken, and those are the ones which will be under the closest surveillance. Finally it

will be these men who will find that the radio channels—at least licensed radio channels—are closed to them.

ANOTHER move is on foot by the FCC to compel the licensing of each and every transmitter. Heretofore only the stations have been licensed, and in the matter of broadcasters and marine radios, the transmitters have been identified. The great bulk of USA transmitters are, however, in the hands of the amateurs who have never been asked to register them.

They may have to do so now. The new legislation will be applied equally to the transmitters which are bought ready-made and those which are home-made. Whenever a transmitter is sold, the seller and the buyer will each have to advise the FCC. The system closely parallels that in use by the Civil Aeronautics Authority in the matter of airplanes, and is the same that the aviation industry has been accustomed to use practically since its inception. The possession of a transmitter not licensed to the operator or owner, or the possession of a transmitter that is unlicensed, will be made prima-facie evidence of a violation of the Radio Act. To bring about this change, an amendment to the Act will have to be passed. Preparation of the Bill is going forward now.

ONE of the ripest fields yet uncovered for 5th Column activity is in the use of the lowly phono oscillator. Here is an instrument originally intended to supplant the phonograph, and to be used by music lovers, which has been found being used as miniature broadcast stations by the Subversive Element. The FCC presently has no control over these oscillators as long as they comply with the FCC rules regarding power. That Rule, however, has not prevented the oscillators from being used as a regular (and in this case legitimate) broadcast station at Dartmouth College. Another, but illegal use of the oscillator was in the recent bookie roundup in Chicago, where Special U.S. Attorney Klaus uncovered its use in giving race track information. The FCC will seek to license each and every phono oscillator under the same act above mentioned in regard to transmitters. It is hoped that these "teeth" will suffice to deter the use of phono oscillators by 5th Column and Subversive Elements.

Ham-Army Stations

THE gathering of information useful to the Army is to be expected. It has been going on in all industries. Now questionnaires are to be mailed to every radio amateur seeking information about his station. Of particular interest to our Government is whether or not the station is set apart from the domicile of the ham. The purpose behind all this is to find and list stations which could be occupied by the Army in time of emergency. Another part of the questionnaire deals with a detailed report by the ham of each and every piece of equipment he owns, its condition, and its use. The amateurs have indicated every desire to cooperate with the Government. It is not to be doubted that this will turn up great quantities of equipment which might be emergency-useful, but will also show to just what state of advancement the amateur has attained in the radio art. This is important, since the amateur must be evaluated not only from a military viewpoint, but from a civilian viewpoint as well. On the results of this report may hinge the extent to which this government is ready to permit the amateur to operate and the extent to which the government will be ready to allow the amateur to occupy bands when the International Situation finally clears up. It is expected that a great many hams will be found who are totally inactive in the game, and whose weight of numbers has heretofore influenced the FCC in the granting of bands. Once thinned down to the actual active amateurs, the FCC and the government will know how many hams it has to contend with, and on how many it can depend in time of emergency.

Random Shots

IT is reported that Philco has purchased some of the capital stock of National Union Tubes by putting a cool \$250,000 into

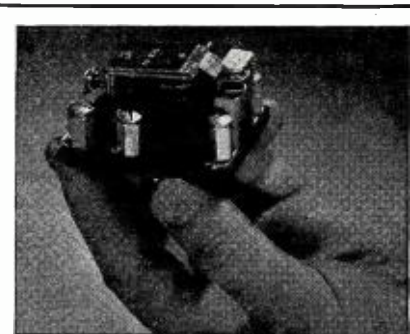

A NEW RELAY HUSKIER, COSTS LESS

The design of this new compact Ward Leonard single pole heavy duty relay is simplicity itself. It is sturdily built yet there is not an ounce of material in it that is not essential to efficient performance. Measures only 1 7/8" x 2 3/8". Will control 3/4 h.p. on 115-230 volts. Described in Bulletin 105.

WARD LEONARD RADIO SPECIALTIES

WARD LEONARD ELECTRIC COMPANY
47 South St., Mount Vernon, N. Y.
Send me Bulletin 105.

Name

Street

City and State.....

Call Signal

YOU CAN BECOME A MONEY-MAKING RADIO EXPERT

WITH THE **New SPRAYBERRY**
Personalized **HOME TRAINING in RADIO**

You Learn Easily in Your Spare Hours ... By Doing Many Experiments with Up-To-Date Equipment

Here's a really fine, up-to-the-minute Radio and Television Training that's specially designed to give you quick results. **TRAINING PREPARES YOU FOR GOOD RADIO JOBS... AT EXCELLENT PAY.** My training starts right at the beginning of Radio... unfolds each subject in a simplified, logical, understandable style. You easily learn Television, Electronics, Facsimile Radio, Radio Set Repair and Installation Work, etc. **NO PREVIOUS EXPERIENCE NEEDED** It makes no difference what your education has been, I can fit you for a good-paying Radio job. Your success is my full responsibility.

YOU GET PROFESSIONAL TEST EQUIPMENT PLUS EXPERIMENTAL OUTFITS

... Includes 146 Radio Parts (to build complete Receiver), Tools, All-Wave, All-Purpose Analyzer, and Experimental Outfits for conducting actual experiments with your own hands.

I Supply My **BUSINESS BUILDERS** show you how to put your Equipment to practical use in handling actual money-making Radio Service Jobs shortly after you begin training.

SERVICEMEN I offer Advanced Training for those already in Radio. Get complete details in my FREE 52-page Book. **The Sprayberry Course is Sold Under a Money-back Agreement**

RUSH COUPON for BIG FREE BOOK

SPRAYBERRY ACADEMY OF RADIO
F. L. Sprayberry, Pres.
325-J University Place, N.W., Washington, D. C.

Please send me FREE copy of "HOW TO MAKE MONEY IN RADIO."

Name..... Age.....

Address.....

City..... State.....

Tear off this coupon, mail in envelope or paste on penny postcard. Servicemen—check here D

the company and taking up an option. National Union stock was marked down from \$1 to 30c par value as a result of the move. . . . Building 89 of General Electric in Schenectady, N. Y., heretofore bleak and deserted, and containing only a few draftsmen and engineers, is now jammed to the roof and employees working in the aisles. All this change on account of the large number of Army and Navy orders received. . . . The

RADIO ENGINEERING DEGREE IN 2 YEARS

• Complete Radio Engineering Course in 96 weeks. Bachelor of Science Degree. Radio (television, talking pictures and the vast electronic field) offers unusual opportunities for trained radio engineers. Courses also in Civil, Electrical, Mechanical, Chemical, Aeronautical Engineering; Business Administration and Accounting. Tuition, living costs low. World famous for technical two-year courses. Special preparatory department for those who lack required high school work. Students from all parts of the world. Enter September, January, March, June. 57th year. Write for catalog. Burton Handy, Pres. 1690 COLLEGE AVE. ANGOLA, IND.

TRI-STATE COLLEGE

RADIO TECHNOLOGY

RCA Institutes offer an intensive course of high standard embracing all phases of Radio and Television. Practical training with modern equipment at New York and Chicago schools. Also specialized courses in Aviation Communications, Radio Servicing and Commercial Operating. Catalog Dept. RN-40.

RCA INSTITUTES, Inc.
A Radio Corporation of America Service
75 Varick St., New York 1154 Merchandise Mart, Chicago

RADIO ENGINEERING,

broadcasting, aviation and police radio, servicing, marine radio telegraphy and telephony, Morse telegraphy and railway accounting taught thoroughly. 48 weeks' Engineering course equivalent to 3 years of college radio work. All expenses low. Catalog free. School established 1874. Dodge's Institute, Oak St., Valparaiso, Ind.

RADIO-TELEVISION

Oldest, largest Radio-Television school in West trains you for good pay job. Complete instruction including Radio Construction and Service, Broadcast Operating, Sound, Talking Pictures, Television, Public Address, etc. Flexible plan to meet specific needs of those with or without jobs. Transportation allowed to L. A. Earn room and board while learning. Request Free Catalog.

NATIONAL SCHOOLS Dept. RN-9
Los Angeles

RADIO COURSES

Start September

- RADIO OPERATING—BROADCASTING
- RADIO SERVICING—a practical course
- RADIO AMATEUR CODE • TELEVISION
- ELECTRONICS—1 yr. day course, 2 yrs. eve. Day and Evening Classes. Booklet Upon Request.

New York Y. M. C. A. Schools
7 W. 63rd St. New York City

RADIO ENGINEERING

DEGREE IN 2 YEARS

Intensive, specialized course, including strong basis in mathematics and electrical engineering, advanced Radio Theory and Design. Modern laboratory. Low tuition. Self-help opportunities. Also 2-year courses in Aeronautical, Chemical, Civil, Electrical and Mechanical Engineering. Participation in Civilian Pilot Training Program. Enter September 3, December, March, June. Catalog.

INDIANA TECHNICAL COLLEGE
790 E. Washington Blvd., Fort Wayne, Ind.

RADIO and ELECTRICAL ENGINEERING

Correspondence Courses in
ELECTRICAL ENGINEERING Get good electrical field. Prepare yourself at Low Cost. for secure future. Modern course. So simplified anyone can understand quickly.
RADIO ENGINEERING Extra fine course in radio, public address, photo-electric work. Training you to be super-service man, real vacuum-tube technician. Experimental kits furnished. Diploma on completion.
1st Year course only \$25. Deferred payment plan available. Write for free copies of school catalog, student magazines, full details.
LOWAS '25 SEND NOW!
LINCOLN ENGINEERING SCHOOL, Box 911-R 21, LINCOLN Neb.

RMA vs. DuMont-FCC Television fight continues sub-rosa. DuMont having hired Ball-tin of New Brunswick to handle its proposed television shows this fall, is putting up a new station in New York City which will transmit television signals on the *DuMont Scheme*. Sufficient difference between the type of signal transmitted by the NBC-CBS group and the DuMont exists, that the DuMont station will not be able to be picked up legibly by the television receivers using the present RMA-RCA-NBC-CBS standards. It is said that the DuMont sigs are very fine for 20" television C-R tube reception. . . . A far-reaching opinion in radio matters occurred when the Patent Office recently refused to issue a patent on the ground that its issuance would tend to create a monopoly. Whether the inventor who was refused the patent will appeal to the Supreme Court on the ground that this ruling contravenes the Constitution, remains to be seen. The fine hand of Trust-Buster Attorney General Jackson is felt behind the move of the Patent Office in its refusal. . . . So many transmitter orders are floating around Washington, that some of the biggies are turning the orders in full over to the smallies. Sub-contracting of Government orders is prohibited. So the smallies are making hay while the biggies are swamped. . . . Lots of manufacturers are putting up signs reading, "No admittance—U. S. Gov't Orders" on their factory doors. Sometimes it is really true, too. . . . This Column is cooperating closely with the Enforcement Division of the FCC in the promulgation of new regulations to keep the ham in existence. —50—

For the Record

(Continued from page 3)

fense comes up. Republicans and Democrats seem to get along well with one another as long as there is the slightest threat to the safety of this country. * * *

SOME of the new rulings and the reasons behind them will be found in the column headed "Washington Communication" appearing for the first time in the issue. From time to time, as our new special Washington correspondent gets information firsthand down there, we will have the results in that column. We recommend your reading of "Washington Communication" every month. It will keep you abreast of the times in matters of radio. * * *

ONE radio store complains that the manufacturer places catalog information on radio units, weeks and even months before the first actual unit is ready for delivery. Another store complains that the manufacturer changes and adds to his "line" so often, that it cannot keep up with him. It seems that there is no happy medium. Both these practices should be discouraged, and better cooperation between the manufacturers and the jobbers should be arrived at. Perhaps the various Sales Managers and Jobbers Clubs could lay down a theme which all could follow, with increased sales. We don't know, we're just guessing. * * *

PLEASE do not fail to read our new department, "Mikes-Heads-Pick-ups." In it you will find all information on the accessories that go into the making of good recordings. The

column should be of great interest to those who are following this latest and most interesting of hobbies. Recording bids fair to have a high place in the National Defense Plans of our government, too. Get in on it!

RADIO stores varied widely with their reports of business being done. In Pittsburgh we found the ham-stores well patronized, and the manufacturers told us that the orders seemed to be coming through slightly better than for the same period for last year. Elsewhere we found conditions rather slack. This may or may not be due to the restrictions placed on the hams. But as we talked further with the store proprietors they admitted that they, too, were not running far behind the same period for last year. All in all, the radio industry as far as the ham is concerned, seems to be holding its own; this in spite of restricted activity on the part of the ham-buyers. Radio stores catering to the broadcast listener report good advances all along the line, and a brisk business in home recorders and the accessories thereto is developing throughout the East. This is in ac-

Classified

Rate 15c per word. Minimum, 10 words.

CORRESPONDENCE COURSES

USED Correspondence Courses and Educational Books sold or rented. Inexpensive. Money-back guarantee. Write for Free Catalog listing 4000 bargains. (Courses Bought.) Lee Mountain, Pisgah, Alabama.

CORRESPONDENCE courses and educational books, slightly used. Sold. Rented. Exchanged. All subjects. Satisfaction guaranteed. Cash paid for used courses. Complete details and bargain catalog free. Send name. Nelson Company, 500 Sherman, Dept. I-237, Chicago.

PATENT ATTORNEYS

INVENTORS—Before disclosing your invention to any one send for Form "Evidence of Conception"; "Schedule of Government and Attorneys' Fees" and instructions. Sent free. Lancaster, Allwine & Rommel, 414 Bowen Building, Washington, D. C.

PATENTS—Advice and booklet free. Highest references. Best results. Promptness assured. Watson E. Coleman, Patent Lawyer, 724 9th Street, Washington, D. C.

PATENT Your Idea—Simple inventions often valuable. Two advisory books—free. Victor J. Evans & Co., 583-K Victor Building, Washington, D. C.

RADIO ENGINEERING

RADIO Engineering, broadcasting, aviation and police radio, servicing, marine and Morse telegraphy taught thoroughly. All expenses low. Catalog free. Dodge's Institute, Elm St., Valparaiso, Ind.

RADIO

WE buy and sell used radio testing equipment. Harold Davis, Inc., Jackson, Miss.

USED Radio sets, equipment, parts, tubes, etc., bought, sold, exchanged. J. C. Thimijan, Lake City, Minn.

MISCELLANEOUS

AMBITIOUS? Extra money showing talkies. Home or neighboring towns—no investments—sound equipment, films rented reasonably—\$100—\$300 monthly possible—wonderful opportunity—No. 512 State Theatre Building, Pittsburgh, Pennsylvania.

cord with the predictions both here and elsewhere in RADIO NEWS.

* * *

TAKING everything into consideration, we found conditions most favorable, and very little, if any, grumbling.

* * *

ONE of our contemporaries who was a demon newsman when we were a cub reporter, and is now "City Desk" of a large daily told us that the FBI was watching the foreign broadcast stations of the USA most carefully. Already one has been uncovered which featured a German singer alleged to have been singing simple folk songs, but in reality giving out information of military nature. What happened to her? She disappeared; but we'll bet a smoked fish that the FBI knows where she went!

Another big daily in a smaller town had its radio editor interviewed with regard to his pro-Nazi leanings. He treads the straight and narrow now.

In an Eastern village, a complete radio station, unlicensed, plus a quantity of German arms and ammunition, not to mention some hand grenades were found and 8 men apprehended.

Thus are we going about the stamping out of the enemies to our Great American Democratic Way of Living.

* * *

PHONO oscillators, heretofore considered harmless, are now coming for the scrutiny of the FCC and the FBI. Fear is felt that they may be, and are actually being used for Subversive Activity. Some new regulations with regard to these are in the making. We hope that these will help to keep the phono oscillators where they belong—in the hands of music lovers, for whom they were originally intended.

* * *

PLANS are being completed by our Government towards filling the obvious need for an increase of receiving equipment for military use. Speaking to Mr. Al Ready, president of the National Company of Malden, Mass., the other day, he said that this would present no problem to the manufacturers, if the government did not pounce upon the manufacturer suddenly, but gave him time to get organized. With such a warning, Mr. Ready said, there was no reason he could see why the manufacturers could not put out as many receivers as the government needed and in short order, too. That is encouraging.

* * *

WELL, that is about that for this month. We are aiming to make RN the tops as a magazine with not only the latest in technical radio, but also, and what is more to the point, the very "hottest" news of what is going on in the field, specially Washington—where all eyes are now turned. Your comments will be appreciated. KAK.

-30-

National Defense Network

(Continued from page 9)

short of the bubonic plague.

The Youth Administration was selected to supply some radio talent when its officials remembered about the hurricane. That was the storm that struck around Albany, Ga., last winter, wiping out the communications system. But an NYA station in the area did heroic work in keeping contact with the world outside and NYA officials learned what many others have found out during similar emergencies—that the ham stations of America are much more than mere playthings.

The blitzkriegs had demonstrated the need and the hurricane had suggested the source of an expanded radio system. It was the depression that produced the hams who were needed. For the 10,000 youngsters who are to man the network are the depression's children.

The NYA operates work and educational projects for unemployed youths or young people from modest homes who are trying to pay their way through school. Part of the work it does is to provide recreation—and radio is one of the most popular forms.

Under direction of Robert Burton, an experienced radio engineer, the NYA has established centers in various parts of the country where young people are trained for careers in radio or initiated in the joys of hamhood. In many of these centers, radio clubs have been formed and rigs have been installed.

These radio centers and clubs form the nucleus for the new network. The NYA headquarters have plenty of room and most permit the use of large antennae. The Government will put up the money needed for the transmitters, or will furnish material from surplus stocks. The youngsters will put the sets together, under expert direction.

The sets used in the defense network will incorporate the RCA 811 and 812 tubes, and most of them will be built to plans drawn by RCA. The transmitters are rated at 1/2 kilowatt and are designed for both voice and CW. They operate on a band around 160 meters for relaying messages to close neighbors, using this frequency because it is less crowded. For sending messages that must travel long distances, the stations will operate around 20 meters. Some will have directional antennae.

The outfits will cost around \$300 each, experience has shown. In some clubs now operating, hams have put together rigs for as little as \$25.

The clubs now in operation meet once a week, but their stations are on the air every night. States already represented include Maine, New Hampshire, Washington, Texas, North Carolina, Iowa, Georgia, New York, Michigan, Idaho, West Virginia, Wisconsin, Illinois, Ohio, Alabama, Louisiana, Virginia, Massachusetts, Florida,

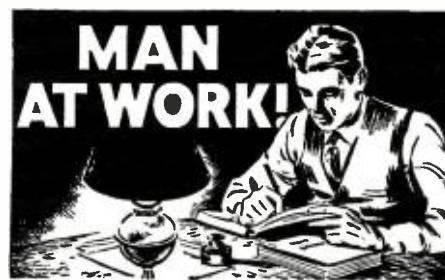

Here's how you can make more money by increasing your technical ability

● It takes ability to earn big money in Radio. New developments, new equipment, demand men with modern technical training. The man who does not keep pace with radio advancement is deadlocking his own future. You can develop your ability. Tonight hundreds of men throughout the world are devoting their spare time to CREI training . . . "tomorrow" they will be equipped to take advantage of the opportunities that await trained men in Radio and Television fields. If you have the ambition, CREI can supply the training. It costs nothing to get the facts.

Write for details in FREE BOOK

To enable us to send you complete information, please state briefly your radio experience, education and present position—and whether you are interested in home-study or residence training.



CAPITOL RADIO

Engineering Institute

Dept. RN-9, 3224 16th Street, N. W., Washington, D. C.

FREE! VERY LATEST PROFIT GUIDE
Everything in RADIO!
 At Lowest Prices

Complete Selections Guaranteed Quality
Replacement Parts
 Everything you need in the way of exact duplicate or universal replacement or repair parts. Tubes, condensers, resistors, transformers, hardware, tools, etc. Leading brands. Every item guaranteed. Prices are low. Clean fresh stock.

Latest Radio Sets
 A model for every purse and purpose. Midgets, Battery Radio combinations—for operation on AC, DC, or battery power.

Public Address Equipment
 A complete line of amplifiers, microphones, speaker baffles and accessories for every type of installation—permanent, portable and mobile. Amplifiers from 5 to 100 watts.

Auto Radios & Accessories
 Complete auto radio section—lists the latest and finest auto radios, aerials, vibrators, custom panel controls, suppressors, padding condensers, pilot and dash lights, etc.

New Electrical Appliances
 Extra profits for you! Standard Brand Electric Irons, Grills, Toasters, Percolators, Waffle Irons, Vacuum Cleaners, Clocks, Mixers, etc., at lowest prices.

SAVE MONEY AT RADOLEK

MAIL THIS COUPON TODAY
 The RADOLEK CO.
 601 W. Randolph St., Chicago, Dept. B-45
 Send the latest Radio Profit Guide FREE.

Name.....
 Address..... Dealer?.....
 Experimenter?..... Serviceman?..... Amateur?.....

First with the news! RADIO NEWS!

BANDIT DOG of Chicago!



Old Wary was great in size, strength, courage, ferocity, and ingenuity! Developing from a landless wanderer, warring for his own stomach, into an organizer and leader, and then into an autocrat who forced others to work for him. Old Wary seemed to know and enjoy the fear he had excited. Read how this monster of a dog ruled his gang with an iron jaw . . . how this daring canine thief and his band of cunning servitors terrorized Chicago for years; prowled deserted streets at night in search of meat; robbed hen-roosts; plundered refrigerators of beef and milk; slew purebred dogs; chased cats for diversion!

A true story by H. S. CANFIELD



TEACH YOUR DOG to count

Of the various tricks which a dog can be taught to do probably one of the most interesting is teaching him to count. John H. Klok, outstanding dog trainer, shows exactly how you can teach your dog, regardless of size, breed, or age, to count to 2, 3, 4, and 5, and this in any rotation! If you follow the simple instructions patiently and persistently from five to ten minutes twice a day, within a month your dog will be a good counter.

Don't let THE DOGNAPPER CATCH YOU Napping!

Do you know that there are 50,000 dogs stolen in the United States every year? Who are the thieves? How do they work? How can we prevent their depredations? Read *Dognappers* in the September PETS! In this intensely interesting article, Robert Forejt, Chicago poundmaster, tells just what precautions should be taken by dog owners to prevent theft of their pets. Remember, these dognappers are clever, and dogs don't talk!



PETS

Formerly POPULAR PETS

Don't miss these and the many other great articles about pets of all kinds in the big

September Issue
NOW ON SALE AT ALL NEWSSTANDS

New Jersey, South Dakota and South Carolina. When all the stations are completed, the NYA will compile a listing.

Once a week, the network will stage a drill, simulating emergency conditions. The purpose of the drill is to accustom the operators to relaying messages accurately and quickly. Their training will be similar to that given hams affiliated with the Army and Navy systems.

During these drills, many of the stations will go on the air with their own power. For in a real emergency, of course, power is one of the first things to go. Ask the Army command of a few former nations in Europe. Generators in the NYA stations will be operated by small engines which, along with some d.c. high voltage generators, are being obtained from other Government agencies. Thus the hams will learn the work they would have to do should they find themselves the last means of rapid communication.

This is probably the greatest service that ham stations could render in war time. The stations would also probably be tied in with any kind of air raid warning system and their services would be commandeered in case of troop operations in the vicinity.

The NYA has done admirable work in the past in training young operators and service men. Radio projects, sponsored by states and municipalities, have been the training ground for these youngsters. They have worked on the installation of state police radio systems in Maine and Colorado; on the city system in Waco, Texas; and on radio facilities for extension education in cooperation with the University of Kentucky.

There is a heavy representation of YLs in the radio work of the NYA. The first two young ladies who tried to crash what had been strictly a male proposition were laughed at. That was in Toccoa, Ga., and the girls finally won their way into the class. They were the honor students and then became the first two to obtain their licenses. There has been no tendency to sell the YLs short since.

It will take several months to get the complete network established and trained. But when it is in operation, Federal officials predict that it will be a defense chain that nothing will be able to break—hell, high water or Hitler.

-30-

Serviceman's Experiences

(Continued from page 22)

work with the set on the next seat. Nothing but a tube, and the fellow was so happy he not only paid me for the tube, but insisted on my taking two bucks extra. There were some blanks in the toolbag, and I gave him a receipt so he'd have the store address and 'phone number. We can always use a customer like that.

The conductor had taken my ticket while I was working, and as he passed

the second time he heard the set playing.

"Say," he asked me, "would you mind looking over the console in the club car?"

"I'm on vaca—" I attempted.

"It's rather important," he persisted. "Group of officials heard of a program coming on at 2:30 p.m. which makes no mention of the war, and they're all anxious to hear it."

Only thing wrong was a defective receptacle; I replaced it, but didn't have nerve enough to charge anything. The whole gang was appreciative, and asked for business cards. I passed them out; a steward brought a highball, and the conductor let me ride in the club car the rest of the way, although I had bought a coach ticket.

At Wet Lake, I was at last a free man. In the cab I took to the hotel, I noticed a radio control. What a novelty, I thought, to turn on a set without having to do anything but enjoy the music! I snapped it on, but the driver leaned back and said:

"Better turn it off, buddy. It's on the nut!"

I covered my toolbag with my coat and kept my mouth shut the rest of the trip, but when I got out to pay him, he noticed the label and sparks on my bag, and said:

"Serviceman, ain't you?"

"Ya got me, pal," I said. "Let's drive to your garage—I'll take a look at the damn thing!"

Isn't that the way, though? A repairman sweats yellow half-dollars trying to get business, and then—when he tries to dodge it, he can't!

I finally got to the hotel, determined that my new life would start at that moment. As I walked to the desk, I noticed a sign boasting "a radio in every room."

"I am Mr. Prymzmzl, a taxidermist from Honky Snack, Utah," I told the clerk, "and I break out with hives whenever I hear a radio. If there's one in my room, take it out before I go in!"

After a bath, a change of clothes, and a few breaths of fresh evening air, I again felt like a free agent. I walked slowly to a roadhouse, took a table as far from the record-changer as possible, and sat so I could watch the sun slide behind the lake. Except for two persons—evidently the owners—none of the booths were occupied. I ordered a sandwich and coffee and sat there blotting up the scenery. Truly an ideal spot!—where every prospect pleases, and only broken-down receivers are vile.

As soon as mustard met meat, I overheard a conversation that stopped my pleasant thoughts.

"—but how are we going to run the Midnight Waltz with an amplifier that's busted?" one of the two men asked.

I gritted my teeth in determination.

"We can get a fellow out from Hayes repair service here in about two hours if we put in a long distance call," the second fellow replied.

"At this hour of night?" the first argued. "There won't be anyone at the store."

"Then call Hayes at home," said the second. "Tell him we'll pay ten bucks extra for the trip. If he says no, make it twenty—we've got to get the thing running before twelve!"

The hair on the back of my neck bristled, but I didn't move.

"Okay," the first fellow said, coming over toward my table. The 'phone was on the wall behind me. He apologized for making me move, and had the receiver in his hand before I broke down.

"Need a repairman?" I asked.

I got a few hours sleep on the 4 a.m. train back into town, and reported to the shop just twenty minutes before Al came in.

"You take the vacation," I said, throwing down a big handful of receipts and crumpled currency. "I can't stand one!"

Al didn't say anything, but his answering smile made me feel proud.

The *Montague* rod and *Kid Flasher* lure are now hanging on the south wall of the shop. A leaping fish, cut from the label of a can of salmon, is snapping at the hook. My partner pasted the label there as a concession to my esthetic nature.

He's sure right about time off. For businessmen like us—vacation or no vacation—life is what we make. —30—

Ringling the Bell

(Continued from page 26)

The United States of America is *always* at war against any element, nation or ideology which threatens to overthrow it. Only by preparedness and constant vigilance can we hope to survive. If we can root out subversive activities within our boundaries and militantly prepare to resist any invader, we *will* survive the wave of flame which is enveloping the world.

Now, there is another way for you to help your country if you are inventive-minded. (And what service man isn't?) Start thinking about radio controlled weapons of war. You know, the depth bomb of the last war was invented by a pioneer in radio—Dr. Sidney Baruch. There are many fields yet to conquer in inventing more and more fiendish weapons than the enemy.

For instance, you might try to work out a method of remotely-controlled bombs, i.e., a method whereby a defender could release a bomb from the ground at an attacking airplane, the bomb to be winged and its direction controlled from the ground. Thus, the bomb (or "flying shell") could be directed at the attacking plane. A refinement would be to have the "flying shells" also directable from a mother ship in the air.

If you don't care for that idea, you might try working out a miniature bomb carrying plane which is projected by the defenders against an attacking plane and its direction is dependent upon the sound of the enemy engine, i.e., the sound of the enemy airplane

Be a Radio Technician



Learn at Home to Make \$30, \$40, \$50 a Week



Chief Operator Broadcasting Station

Radio is a young, growing field with a future, offering many good pay spare time and full time job opportunities. **Send you don't have to give up your present job to become a Radio Technician. I train you right at home in your spare time.**

Why Many Radio Technicians Get Good Jobs at Good Pay

Radio broadcasting stations employ operators, technicians, Radio manufacturers employ testers, inspectors, servicemen, in good-pay jobs. Radio jobbers, dealers, employment and service men. Many Radio Technicians open their own Radio sales and repair businesses and make \$30, \$40, \$50 a week. Others hold their regular jobs and make \$5 to \$10 a week fixing Radios in spare time. Automobile, police, aviation, commercial Radio; loudspeaker systems, electronic devices are other fields offering opportunities for which N. R. I. gives the required knowledge of Radio. Television promises to open good jobs soon.

Many Make \$5 to \$10 a Week Extra in Spare Time While Learning

The day you enroll, I start sending you Extra Money Job Sheets—start showing you how to do Radio repair jobs. Throughout your course I send plans and directions which have helped many make \$5 to \$10 a week in spare time while learning. I send special Radio equipment to conduct experiments and build circuits. My 50-50 training method makes learning at home interesting, fascinating, practical. **YOU ALSO GET A MODERN, PROFESSIONAL, ALL-WAVE, ALL-PURPOSE SET SERVING AS INSTRUMENT to help you make money fixing Radios while learning and equip you for full time work after you graduate.**

Find Out What Radio, Television Offer You—Mail Coupon

Act TODAY! Mail the coupon for my 64-page Book "Rich Rewards in Radio." It points out Radio's spare time and full time opportunities and those coming in Television; tells about my course in Radio and Television; shows more than 100 letters from men I have trained, telling what they are doing and earning. Read my money back agreement. **MAIL COUPON** in an envelope, or paste on a penny postcard—NOW!

J. E. SMITH, President
Dept. OJTR,
National Radio Institute
Washington, D. C.

\$200 to \$300 a Month in Own Business



"For the last two years I have been in business for myself making between \$200 and \$300 a month. Business has steadily increased. I have N. R. I. to thank for my start in this field." —ARLIE J. FROENNER, 300 W. Texas Ave., Goose Creek, Texas.



"I am now making from \$10 to \$25 a week in spare time while still holding my regular job as a machinist. I owe my success to N. R. I." —WAL. F. RUFF, 611 Green Street, Bridgeport, Pa.

Mail this Now FREE
Get 64-page Book

RICH REWARDS IN RADIO

Mr. J. E. Smith, President
Dept. OJTR,
National Radio Institute
Washington, D. C.

Mail me FREE without obligation, your 64-page book "Rich Rewards in Radio." (No salesman will call. Write plainly.)

AGE.....

NAME

ADDRESS

CITY..... STATE.....

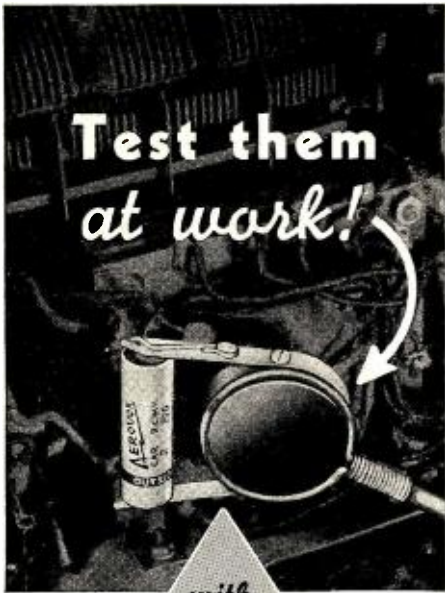

● Just imagine testing condensers right in their own circuit—no disconnecting, no unsoldering. A truly radio test, which checks for capacity, opens, shorts, intermittents.

The L-C Checker does a score of things. Checks inductances and circuits; aids align r.f. and i.f. stages; tunes traps; checks chokes, natural period of antenna and transmission lines, etc., etc. Yet it costs only \$29.50 net.

Ask to See It . . .

● Your local AEROVOX jobber will gladly show you the L-C Checker. Ask for data—or write us direct.



engine attracts the bomb-carrier to it and the bomb and carrier wreck the enemy plane by collision and explosion.

You're not air-minded? Well, you might try remote control as applied to tanks. Consider the possibility of manless tanks of small size, controlled from an airplane, which could put up a pretty stiff fight against any attackers. Or, they could be steered into the midst of an attacking column and blown up by remote control.

Visionary? Impossible? Not practical?

Don't let those words scare you. They have been applied to almost every new idea from the beginning of time.

Study. Experiment. Work. Perfect. Yours may be the glory of a new defense weapon. It is, admittedly, a poor way to use inventive talent but events force the issue.

Remember that one hundred and seventy-five years ago Rousseau, the great French patriot proclaimed.

"As soon as public service ceases to be the chief business of the citizens, and they would rather serve with their money than with their persons, the state is not far from its fall!"

It is our job as business men and as United States citizens to do all we can to uproot the weeds of foreign doctrines and kill the moths of political ideologies which are eating out the very fibre of our public life.

To those who prefer regimentation, Democracy has no quarrel—so long as their activities are confined to their own countries. Democracy will never supinely allow the virtual strangulation, the moral and political enslavement, of those whose only wish is to live peacefully as free men. Let's "Ring the Bell" for America. —50—

Improved T.R.F. Receiver
(Continued from page 17)

use of tubes with a high input capacity and through the use of high capacity tank condensers our signal is cut down considerably. This difficulty is due to the by-passing action of the capacity and also to the low input resistance of such tubes and circuits. Lowering the input capacitance also allows increasing the inductance of the coil which will give a higher Q factor. A high Q factor is desirable because it gives greater selectivity and a higher peak at resonance.

The mechanical construction of this set is somewhat different from the usual layout for a receiver of its type. The whole set is built on a 7"x11"x2" chassis with a front panel of 8"x10". The r.f. stage is shielded from the detector with two 5½"x7" inter-stage shields. The two-gang tuning condenser is mounted between these shields with leads going through the victron feed-through bushings.

The detector is mounted on the chassis in the usual way—vertically. However, the r.f. stage is mounted horizontally on one of the inter-stage shields.

This serves to make shorter leads and also to keep the axis of the coils at right angles to each other. The acorn tube is mounted with the tube socket facing toward the center of the set. A hole is drilled through the shield for the grid lead, all the other connections being on the other side of the shield. A study of the photographs of this set will give a more detailed idea of the mechanical construction of the set as well as of the wiring.

On the front panel there is the main tuning control in the center and to its left the r.f. padder. The main tank condensers are tuned with a *Radio-crafters* four-inch dial, but any good vernier dial without backlash will be satisfactory. The controls underneath the chassis are, from left to right, the audio gain, the r.f. control, detector regeneration, and the stand-by switch. With these controls the receiver becomes very flexible. The stand-by switch is useful both for transmitting and for making adjustments on the receiver. The power supply must have a bleeder resistor; otherwise, a filter condenser is likely to blow.

After the set has been laid out carefully, and all the parts are mounted, it is ready for wiring. I will not go over the rules for wiring except to say do look out for the r.f. leads.

Manufacturers' Literature
(Continued from page 44)

is available so that the purchaser may choose the one best suited to a certain type of installation. Special speaker enclosures have been designed which offer a most pleasing combination together with the amplifier in any of several combinations. A self-contained phono unit, Model 577, is also illustrated and described. The finish on all *Bell* amplifiers is in keeping with the modern trends and presents a very distinctive appearance. Probably one of the most interesting units described in the bulletin is the new Zephyr School System which has provision for 16" transcription turn-table, which is optional. Service from ten to forty rooms may be given from this unit, and it is capable of high fidelity reproduction from either radio tuner, or from radio phonograph records. Copy may be obtained from the *Bell Sound Systems, Inc.*, 1183 Essex Avenue, Columbus, Ohio. Free. (RADIO NEWS No. 9-106.)

RADIO NEWS, Catalog Dept.
608 S. Dearborn Street, Chicago, Ill.

Please send me the literature I have checked below. If there is any charge I have enclosed the money.

...9-100 ...9-102 ...9-104 ...9-106
...9-101 ...9-103 ...9-105

Name

P. O. Address

City State.....

I am a Svcemn . . . Ham . . . Experiment'r . . .
This offer expires Oct. 1, 1940

YOU NEED THESE 20 HANDY PHOTOGRAPHIC TEXT BOOKS

for better pictures this summer
... and all year 'round!

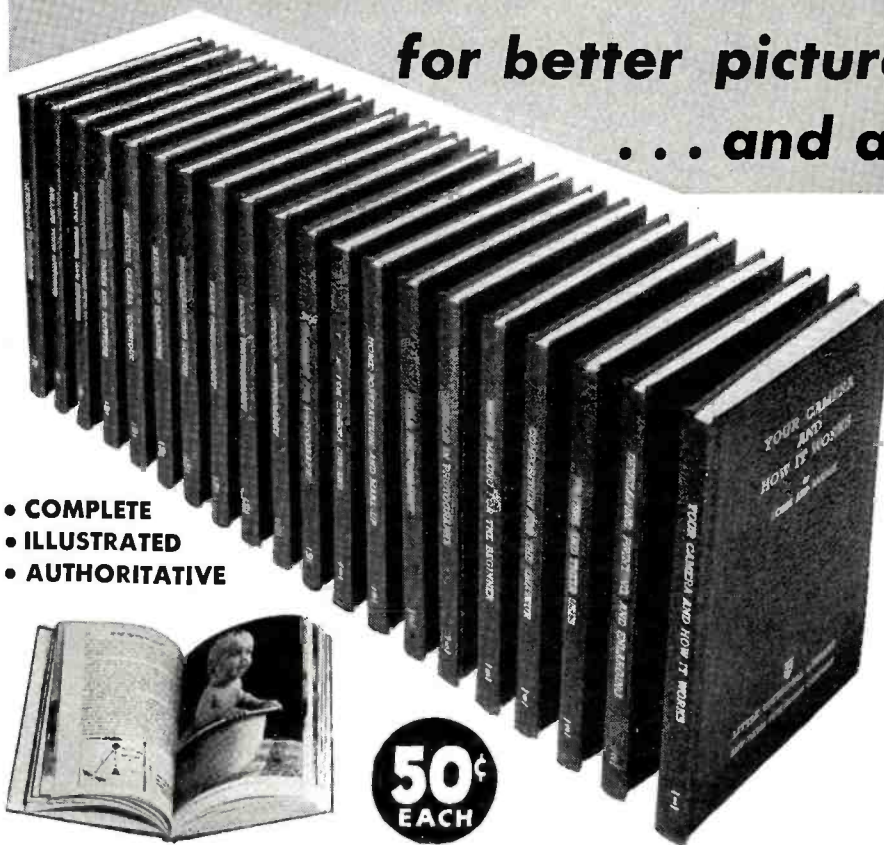

- COMPLETE
- ILLUSTRATED
- AUTHORITATIVE

50¢
EACH

No. 1—YOUR CAMERA AND HOW IT WORKS by W. E. Dobbs and Charles A. Savage, with a Foreword by C. B. Neblette, F.R.P.S. Selection, use, focusing, composing, lenses, shutters, roll film translators, cut film and film packs, making an exposure, filters, problems and accessories, etc.

No. 2—DEVELOPING, PRINTING, AND ENLARGING by Al and De Vera Bernsohn. Elementary and advanced developing, chemicals, types of printing, elementary and advanced enlarging, enlarging equipment, care of prints, etc.

No. 3—FILTERS AND THEIR USES by W. Bradford Shank. Light, film sensitivity, types and care of filters, infra-red and ultra-violet photography, polarizing screens, color separation, lens shade, problems, etc.

No. 4—COMPOSITION FOR THE AMATEUR by Kenneth Heilbron. Selecting subject and picture, the picture as a whole, masses and accents, tone, lines, rhythm, etc.

No. 5—MOVIE MAKING FOR THE BEGINNER by Herbert C. McKay, F.R.P.S. Modern movies and cameras, using the camera, production, the photography of movies, the art of titling, editing the film, processing, projection, etc.

No. 6—COLOR IN PHOTOGRAPHY by Ivan Dmitri. Types of subjects, editing, mounting, projection, separation negatives, density scales, wash-off relief printing, making carbos, chromatic printing, etc.

No. 7—CHILD PHOTOGRAPHY by Harold Lambert. Cameras and equipment, taking the shot, posing, finishing and processing, do's and don'ts, etc.

No. 8—HOME PORTRAITURE AND MAKE-UP by Maurice Seymour and Syd Symons. Part I: Tools, artificial lighting, your model, posing, background, suggestions, etc. Part II: Restyling contour, eyes, eyebrows, lips; powdering, equipment, character make-up, finishing touches, etc.

No. 9—TRICKS FOR CAMERA OWNERS. An outstanding collection of the latest and most valuable kinks and hints on every phase of amateur photography.

No. 10—A GLOSSARY FOR PHOTOGRAPHY. Compiled by Frank Fenner, Jr. Over 3,000 words having photographic significance are defined. They cover still and motion-picture photography in black-and-white and color.

No. 11—OUTDOOR PHOTOGRAPHY by Samuel Grierson. A comprehensive coverage of the picture possibilities found outdoors: landscape, pictorial, seascape, portraiture, sunset, nature studies, etc.

No. 12—INDOOR PHOTOGRAPHY by Hillary G. Bailey, F.R.P.S. Posing, lighting, and exposure for portraiture, table-top, still-life, etc.

No. 13—FLASH PHOTOGRAPHY by Rus Arnold. Flash equipment, synchronization, exposure, indoor and outdoor work at night or in daytime, etc.

No. 14—PHOTOGRAPHING ACTION by Victor De Palma. Selecting the proper shutter speed for various rates of motion. Special discussion of candid sports, and other fields of photography outdoors and indoors where motion is a factor.

No. 15—MANUAL OF ENLARGING by Stephen White, A.R.P.S. Complete guide to projection printing, printing technique, paper selection, dodging and printing-in montage and other effects, etc.

No. 16—MINIATURE CAMERA TECHNIQUE by Fenwick G. Small. Discusses different types of miniature cameras, special technique in shooting, finegrain developing, printing, types of lenses, etc.

No. 17—PHOTOGRAPHIC LENSES AND SHUTTERS by Richard W. St. Clair, A.R.P.S. An understandable and clearly illustrated handbook on photographic optics: camera lenses; auxiliary lenses and shutters; optical formulas, etc.

No. 18—PHOTO TRICKS AND EFFECTS by Jacob Deschin, A.R.P.S. Montage, double exposure, solarization, photograms, reflection pictures, and other odd effects obtained by the photographic process.

No. 19—SELLING YOUR PICTURES by Kurt S. Safiranski. Markets, saleable material, legal aspects, and numerous hints on making money with your camera.

No. 20—DARKROOM HANDBOOK—AND FORMULARY by Morris Germaine, A.R.P.S. Formulas for film and paper developers, fixing baths, intensifiers, reducers, and paper developers, fixing baths, intensifiers, reducers, toners; darkroom plans, equipment, technique, conversion tables, etc.

Are you fired with ambition to take better pictures . . . determined to get the full enjoyment out of your hobby? Then make sure that your camera technique and photographic knowledge is on a par with your ambition—have America's most popular books on photography at your fingertips for ready reference.

If you have yet to become acquainted with the PHOTOGRAPHIC SERIES of the Little Technical Library, go to your camera store or book dealer. Browse through these twenty authoritative pocket-size photographic text books. Note how each complete volume covers its chosen subject with unprecedented thoroughness and accuracy . . . how each chapter is easy-to-read and easy-to-understand. Examine the scores of brilliant illustrations, the beautiful printing, and the rich binding.

Camera fans, you'll need no words to convince you that here is the photographic library you have been dreaming of . . . twenty instructive volumes worth their weight in gold . . . yes, they're yours for better pictures this summer—and all year 'round!

AT ALL LEADING BOOK SELLERS,
CAMERA AND DEPARTMENT STORES

Or—Clip Convenient Coupon

LITTLE TECHNICAL LIBRARY, Dept. C-940
608 South Dearborn Street, Chicago, Illinois

Please send me the books of the PHOTOGRAPHIC SERIES whose numbers I have circled below. If I am not completely satisfied, I have the privilege of returning them within five days for refund in full.

- | | | | | | | | | | |
|----|----|----|----|----|----|----|----|----|----|
| 1 | 2 | 3 | 4 | 5 | 6 | 7 | 8 | 9 | 10 |
| 11 | 12 | 13 | 14 | 15 | 16 | 17 | 18 | 19 | 20 |
- Send the complete set (20 volumes). Enclosed \$
 Send C.O.D. postage added. (C.O.D. in U.S.A. only)

NAME

ADDRESS

CITY & STATE

(80c each outside of U.S.A.—Payment with order)

DEALERS! Order from your photo supply jobber today!

Little Technical Library
PHOTOGRAPHIC SERIES

THE NEW CHANNEL-ANALYZER
Follows the SIGNAL from Antenna to Speaker

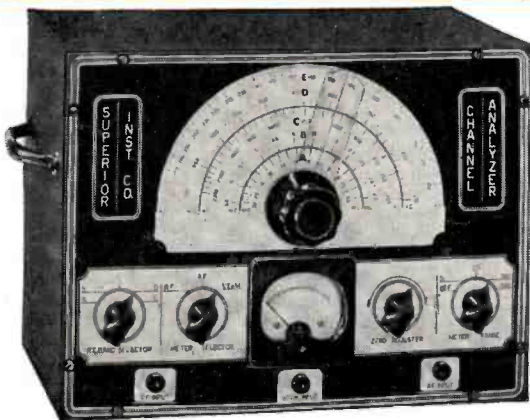

The well-established and authentic SIGNAL TRACING METHOD of locating the very circuit in which there is trouble, and the very component that causes the trouble, is now for the first time available at a price any radio serviceman can afford.

THE CHANNEL-ANALYZER will

- ★ Follow signal from antenna to speaker through all stages of any receiver ever made.
 - ★ Instantly track down exact cause of intermittent operation.
 - ★ Measure both Automatic-Volume-Control and Automatic-Frequency-Control, voltages and circuits without appreciably loading the circuit, using built-in highly sensitive Vacuum-Tube Voltmeter.
 - ★ Check exact gain of every individual stage in receiver.
 - ★ Track down and locate cause of distortion in R.F., I.F., and A.F. amplifier.
 - ★ Check exact operating voltage of each tube.
 - ★ Locate leaky condensers and all high-resistance shorts, also show opens.
 - ★ Measure exact frequencies, amount of drift and comparative output of oscillators in superhets.
 - ★ Track down exact cause of noise.
- The Superior Channel-Analyzer comes housed in shielded cabinet and features an attractive etched aluminum panel. Supplied complete with tubes, three specially engineered shielded input cables, each identified as to its purpose. Also full operating instructions. Size 13"x10"x6". Shipping weight 19 pounds. Only

\$19⁹⁵

THE NEW MODEL 1280 SET-TESTER Combines Models 1240 and 1250

A complete testing laboratory in one unit, the Model 1280 combines the Models 1250 Multitester and 1240 Tube Tester. (See specifications of each below.)

- ★ Instantaneous Snap Switches Reduce Actual Testing Time to Absolute Minimum.
- ★ Spare Socket and Filament Voltages Up to 120 Volts. Make the Model 1280 Obsolescence Proof.
- ★ Latest Design 4 1/2" D'Arsonval Type Meter.
- ★ Works on 90 to 125 Volts 60 Cycles A.C.



Even those servicemen who through past purchases know they can always get SUPER-VALUES from Superior, will be amazed and delighted when they read the specifications of this all-purpose instrument and then note the unbelievably low price. The Model 1280 features a 4 1/2" D'Arsonval type meter for easy reading of the various scales, and in line with our new policy of stressing appearance as well as serviceability in our new 1200 line of test equipment, our Model 1280 utilizes an aluminum etched panel, designed for beauty as well as ruggedness. The primary function of an instrument is, of course, to make measurements accurately and when designing test equipment this is our first thought. However, we also appreciate the important part the appearance of an instrument plays in the impression a serviceman makes on his customers, especially on home calls. We have, therefore, paid special attention to the outward design of all of our new instruments. For instance, the panel of this Model 1280 is made of heavy-gauge aluminum and etched by a radically new process which results in a beautiful, confidence-inspiring appearance.

Model 1280 comes complete with test leads, tabular data and instructions. Shipping weight 18 pounds. Size 13"x11"x6 1/2". Our net price

\$19⁹⁵

Portable cover \$1.00 additional

THE NEW MODEL 1250 MULTI-METER



SLOPING PANEL FOR PRECISE RAPID SERVICING

Etched Aluminum Panel

Specially Designed Electronic Rectifier Enables Linear A.C. Scale, High Stability and Little or no Temperature Drift.

Here is an opportunity to acquire a Multi-Service, Precision Engineered Instrument, for less than you would have to pay for an ordinary Volt-Ohm-Milliammeter. Besides making the usual volt, resistance and current measurements (both A.C. and D.C.) this unit accurately measures the CAPACITIES of mica, paper and electrolytic condensers, INDUCTANCE of coils, chokes and transformers, DECIBEL gain or loss, of power amplifiers and public address systems, WATTS output of amplifiers, receivers, etc.

SPECIFICATIONS

- | | |
|---|------------------------------------|
| Complete A.C. and D.C. Voltage and Current Ranges | High and Low Capacity Scales |
| D.C. Voltage: — 0-15, 0-150, 0-750 volts | .0005 to 1 mfd. and .05 to 50 mfd. |
| A.C. Voltage: — 0-15, 0-150, 0-750 volts | 3 Decibel Ranges |
| D.C. Current: — 0.1, 0-15, 0-150, 0-750 ma. | —10 to +19, —10 to +38, —10 to +53 |
| A.C. Current: —0-15, 0-150, 0-750 ma. | Inductance: 1 to 700 Henries |
| 2 Resistance Ranges | Watts: Based on 6 mw. at 0 D.B. |
| 0-500 ohms, 500-5 megohms | in 500 ohms .006000 to 600 Watts |

Model 1250 works on 90-120 volts 60 cycles A.C. Comes complete with test leads, tabular charts and instructions. Shipping weight 9 lbs. Size 9 1/2"x11"x6 1/2". Our net price

\$11⁸⁵

Portable Cover \$1.00 Additional

THE NEW MODEL 1240 TUBE TESTER

Instantaneous Snap Switches Reduce Actual Testing Time to Absolute Minimum

▲ Tests All Tubes 1.4 to 117 Volts

▲ Sockets for All Tubes—No Adapters

▲ Superior is proud to offer the newest and most practical tube tester ever designed. Unbelievably low in price—unbelievably high in performance.



- ★ Tests all tubes, 1.4 to 117 Volts, including 4, 5, 6, 7, 7L, octals, loctals, Bantam Jr., Peanut, single ended, floating filament, Mercury Vapor Rectifiers, the new S series, in fact, every tube designed to date.
- ★ Spare socket included on front panel for any future tubes.
- ★ Tests by the well-established emission method for tube quality directly read on the GOOD / BAD scale of the meter.
- ★ Jewel protected neon.
- ▲ Tests shorts and leakages up to 2 megohms in all tubes.
- ★ Tests leakages and shorts in all elements AGAINST all elements in all tubes.
- ★ Tests BOTH plates in rectifiers.
- ★ Tests individual sections such as diodes, triodes, pentodes, etc., in multi-purpose tubes.
- ★ Latest type voltage regulator.
- ★ Features an attractive etched aluminum panel.
- ★ Works on 90 to 125 volts 60 cycles A.C.

Model 1240 comes complete with instructions and tabular data for every known type of receiving tube. Shipping weight 12 pounds. Size 6"x7 1/2"x10 1/2". Our Net Price

\$11⁸⁵

Portable Cover \$1.00 Additional

SUPERIOR INSTRUMENTS CO.

136 LIBERTY ST., DEPT. RN9
NEW YORK, N. Y.