

THE 1940 FULL-RANGE AMPLIFIER

RADIO NEWS

DECEMBER
25c

Build the
Wireless Mike

★
**A JUNK-BOX FIELD
STRENGTH METER**

★
An Analyzing Power Supply

★
Also Features by:
RAYMOND P. ADAMS
SEYMOUR BERKOFF
and others



R.N. 2 MAY 20 1944
MR. M. HART
BX 2
SHAWOMET R 1

W6CHD
ter

ACR-111 COMMUNICATION RECEIVER Made to Sell for \$189.50 **\$99⁵⁰**
 Single signal 16-tube Superheterodyne circuit. Two tuned r.f. stages, electrical band speed, crystal filter, Dual Noise Silencers, and an integral power supply. Limited Quantity

DAVEGA

AMATEUR DIVISION—63 CORTLANDT ST., NEW YORK, N.Y.
 "World's Largest Retail Radio Dealer"

We have sold thousands of amateur receivers. We have tested them all. But the king of the lot is the "SKYRIDER 23." It has everything anybody ever dreamed of: Drift compensation! Reset accuracy on the bandspread system! The same station always comes in at the same place on the famous "venetian blind" main dial! Frequency stability! Noise eliminator! Almost every circuit is under complete front-panel control: RF gain, Pitch control, Tone control, Band switch with illuminated indicator, Send-receive switch, Audio gain, Crystal phasing control, Main tuning control, Phone jack, S-DB meter.



THE BEST COMMUNICATION RECEIVER WE HAVE EVER SEEN!

The SKYRIDER 23 has a sensational new bandswitch arrangement—8 positions. Bands 1—2—3—4 cover 545 kc. to 34 mc. continuously. Bands 5—6—7—8 are pre-set bandspread for the amateur 10, 20, 40 and 80 meter bands!

A six-step wide range variable selectivity circuit gives easy control from needle sharp CW crystal to broad high-fidelity, with automatic switching of the AVC to suit the selectivity!

These are just a few of the features of the greatest receiver the Hallicrafters ever built!

It's **YOURS** for \$23.10 down and very easy monthly payments!

ALMOST HALF-PRICE!

McMURDO SILVER 15-17

New r.f. amplifier equalizes gain at all wave lengths and provides in single stage, selectivity and gain heretofore available only in best two stage r.f. amplifiers. Four bands. Special Jensen-Silver 15" Giant electro-dynamic speaker. 30 to 8000 cycles. Heavy welded one piece chassis, 20" by 12³/₄".

Regular \$205⁰⁰
 Price
SALE \$109⁵⁰
 PRICE
 You Save \$95.50

MCMURDO SILVER MASTERPIECE VI—Reg. Price \$355.
 Sale Price \$199.50

DAVEGA AMATEUR DIVISION
 63 CORTLANDT ST. (N.Y.C.)



H. Q. 120
 HOWARD
 TEMCO
 TRANSMITTERS
 SARGENT MARINE
 PATTERSON
 GARRARD

Men NOW in Radio who Don't Think they know it All Read This

You don't want to see younger, better-trained men push ahead of you I know. You don't want Radio's new technical developments to baffle you either, I am sure. You want to get ready to "cash in" on Television, too. I have helped many already in Radio to get ahead, to win promotions, to make more money. Read my message below.

J. E. SMITH, President
NATIONAL RADIO INSTITUTE
Established 25 years

He has directed the training of more men for Radio than anyone else — has helped men already in Radio to get ahead, and men not in Radio to get into Radio and win success.



If You're NOT Working in Radio Now Read This

Do you want to make more money? Do you want to cash in on your present interest in Radio and Television? Do you want a full-time job with good pay in one of Radio's many fascinating branches? Or do you want to make extra money in your spare time to boost your present income? If you want to do these things—you owe it to yourself to find out how I have trained hundreds of men for jobs in Radio. READ the facts below —and MAIL THE COUPON TODAY.

Make Me Prove I Can Train You at Home for RADIO and TELEVISION

Clip the coupon and mail it. I'm so certain I can train you at home in your spare time to be a Radio Technician that I will send you my first lesson free. Examine it, read it, see how clear and easy it is to understand. See how my course is planned to help you get a good job in Radio, a young, growing field with a future. You don't need to give up your present job, or spend a lot of money to become a Radio Technician. I train you at home in your spare time.

MANY RADIO TECHNICIANS MAKE \$30, \$40, \$50 A WEEK

Radio broadcasting stations employ engineers, operators, technicians and pay well for trained men. Radio manufacturers employ testers, inspectors, foremen, servicemen in good-pay jobs with opportunities for advancement. Radio jobbers and dealers employ installation and servicemen. Many Radio Technicians open their own Radio sales and repair businesses and make \$30, \$40, \$50 a week. Others hold their regular jobs and make \$5 to \$10 a week fixing Radios in spare time. Automobile, police, aviation, commercial Radio; loudspeaker systems, electronic devices, are newer fields offering good opportunities to qualified men. And my course includes Television, which promises to open many good jobs soon.

Charles F. Helmuth, 419 N. Mass. Ave., Atlantic City, N. J., writes: "I started Radio in the Marines. Later I took the N.R.I. Course. Now I am my own boss, and get jobs over others who were sure they had them. I owe plenty to N.R.I. Training." James E. Ryan, 1535 Slade St., Fall River, Mass., writes: "I was working in a garage when I enrolled with N.R.I. I am now Radio service manager for the M— Furniture Co. for their four stores."

MANY MAKE \$5 TO \$10 A WEEK EXTRA IN SPARE TIME WHILE LEARNING

The day you enroll, in addition to my regular course, I start sending you Extra Money Job Sheets which start showing you how to do actual Radio repair jobs. Throughout your Course I send plans and directions which have helped many make \$200 to \$500 a year in spare time while learning. I send special Radio equipment; show you how to conduct experiments, build circuits. This 50-50 training method makes learning at home interesting, fascinating, practical. I devote more than 10 Lesson Tests exclusively to Television, and Television fundamentals thoroughly in my Course.

I ALSO GIVE YOU THIS PROFESSIONAL SERVICING INSTRUMENT

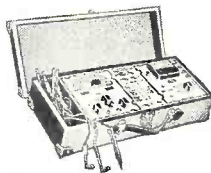

Here is the type of instrument Radio Technicians use — an All-Wave Set Servicing Instrument. It contains everything necessary to measure A.C. and D.C. voltages and current; to check resistances; adjust and align any set, old or new. It satisfies your needs for professional servicing after you graduate — can help you make extra money

fixing sets while learning.

GET SAMPLE LESSON AND 64-PAGE BOOK FREE—MAIL COUPON

Act today. Mail coupon now for Sample Lesson and 64-page Book. They're FREE. They point out Radio's spare time and full time opportunities and those coming in Television; tell about my course in Radio and Television; show many letters from men I trained, telling what they are doing and earning. Read my money back agreement. Find out what Radio offers you. Mail coupon in envelope or paste on penny postcard—NOW!

J. E. SMITH, President
Dept. 9NR, National Radio Institute
Washington, D. C.

SAMPLE LESSON FREE

I want to prove that my Training gives practical, money-making information, is easy to understand—is what you need to master Radio. My sample lesson text, "Radio Receiver Troubles—Their Cause and Remedy" covers a long list of Radio receiver troubles in A.C., D.C., battery, universal, auto, T. R. E., superheterodyne, all-wave, and other types of sets. And a cross reference system gives you the probable cause and a quick way to locate and remedy these set troubles. A special section is devoted to receiver checkup, alignment, balancing, neutralizing and testing. Get this lesson FREE. No obligation. Just mail coupon.

GOOD FOR BOTH 64 PAGE BOOK SAMPLE LESSON FREE

J. E. SMITH, President
Dept. 9NR, National Radio Institute
Washington, D. C.

Dear Mr. Smith: Send me FREE, without obligation, your Sample Lesson and 64-page book "Rich Rewards in Radio" which tells about Radio's spare time and full-time opportunities and explains your 50-50 method of training men at home to be Radio Technicians. (Write Plainly.)

(Please Check)
 I AM doing Radio work. I am NOT doing Radio work.

Name Age

Address

City State 14X1

WITHIN

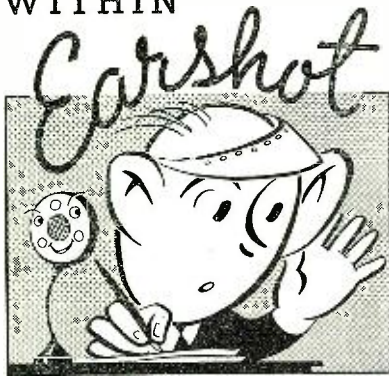

OF THE EDITOR

YOU can't say that war does not bring on some good things. For over a year the newspapers and the radio broadcasters have been tiffing. It finally ended up by the scribes taking out the radio columns wholesale from their sheets, and leaving the public to get information as to what was on the air from wherever they had a mind to. As far as the commentators on radio broadcasts were concerned, they were the first to go.

Now all is changed. Most papers are running columns devoted not only to the listing of stations, but also to columnar opinion on the foreign broadcasts. The run on shortwave receivers has been heavy; and we have been telephoned more than once in the last month with the inquiry as to which receiver would bring in the belligerent nations' transmissions the best. So, welcome back to the fold, you newspapers! We are happy that the breach between the broadcasters and yourselves has been healed. It was a silly thing from the outset, and we reiterate the broadcasters will be a long, long time in supplanting the newspaper at Dad's breakfast table or on the 5:15 home. There is ample room for both media of news dissemination.

WE have again expanded, we are happy to report. After trying for months to get along in our small offices, the Publisher took pity on us (or perhaps the noise was too much) and moved us into larger and more luxurious quarters. Not only that, but we are now busy establishing a real laboratory with all the trimmings. Ray W9JU Franke has been placed in charge under the able leadership of our Technical Editor, Ollie W9ETI Read. We expect to do great things with the lab, and many problems heretofore untouchable because of the amount of equipment needed, will be undertaken with confidence.

LEAVING the fertile fields of transmitters and ultra short wave receivers, we have invaded the precincts of the subtle "amplifier." The results of the incursion appear in our first effort, "The 1940 Full-Range Amplifier" (More Earshot on page 54)



Including Articles on POPULAR TELEVISION

The Magazine for the radio amateur experimenter, serviceman & dealer

VOL. 22, NO. 6

Contents for December, 1939

FEATURES

- The 1940 Full Range Amplifier** Oliver Read, W9ETI & Karl A. Kopetzky, W9QEA **6**
A new design makes this unit provide "three-dimensional" audio reproduction.
- Photographic History of Radiotelephony** Charles R. Leutz **10**
Photographic history of radiotelephony from about 1901 to date.
- Mechanical Layout of the E.C.O. Exciter** Glenn Browning **13**
Mechanical construction of the well-known Browning exciter.
- Combination Receiver-Transmitter** Raymond P. Adams **14**
Now is the time to start building for next summer's vacation.
- Homebuilt 8 Tube Super** Seymour Berkoff **18**
An excellent homebuilt receiver especially useful for foreign broadcasts.
- Inexpensive Tester** Glenn Haldeman **22**
Third prize winner of the recent radio-picture contest.
- Ringing the Bell** Samuel C. Milbourne **26**
How to use pluggers and other advertising media.
- Junk Box Field Strength Meter** Howard Burgess, W9TGU **29**
A simple unit to adjust the transmitting antenna.
- Wireless Mike** N. C. Settle **31**
Remote controlled microphone for P.A. use.
- As I See It!** John F. Rider **32**
Television—alignment—1939's odds and ends.
- An Analyzing Power Supply** James W. Hoskins **33**
An engineer's laboratory equipment piece for delivering calibrated voltages.

DEPARTMENTS

- | | | |
|-----------------------------------|---------------------------------|---------------------------------------|
| Book Review 28 | The Video Reporter 37 | Hamchat 34 |
| What's New in Radio 23 | QRD? 28 | Serviceman's Experiences 20 |
| Radio Physics Course 51 | Bench Notes 21 | Serviceman's Cases 38 |
| Short Wave Flashes 41 | Manufacturer's Literature 42 | |

Copyright, 1939
ZIFF-DAVIS PUBLISHING COMPANY
Member of the Audit Bureau of Circulations

RADIO NEWS is published monthly by the Ziff-Davis Publishing Company at 608 S. Dearborn St., Chicago, Ill. William B. Ziff, Publisher; B. G. Davis, Editor; Karl A. Kopetzky, Managing Editor; Oliver Read, Technical Editor; Herman R. Bollin, Art Director; John H. Reardon, Circulation Director; S. L. Cahn, Advertising Manager. New York Office, 381 Fourth Ave. Subscription \$1.50 per year; single copies, 25 cents; foreign postage \$1.00 per year additional except Canada. Entered as second class matter, March 9, 1938, at the Post Office, Chicago, Illinois, under the Act of March 3, 1879. Contributors should retain a copy of contributions. All submitted material must contain return postage. Contributions will be handled with reasonable care, but this magazine assumes no responsibility for their safety. Accepted material is subject to whatever adaptations, corrections, alterations and revisions necessary to meet requirements. Payment will be made at our current rates upon acceptance and, unless otherwise specified by the contributor, all photographs and drawings will be considered as constituting a part of the manuscript in making payment.

COMPLETE COURSE IN PHOTOGRAPHY.

Just What You've Always Wanted

The LITTLE TECHNICAL LIBRARY Photographic Series . . . 1136 pages of the latest facts and trends in the entire field of amateur photography! This complete, up-to-the-minute photographic library, ten authoritative textbooks, is entirely different from the average run of photographic books, both as to contents and makeup. Among the contributors are a host of outstanding writers and photographers, including such well-known names as Ivan Dmitri, Harold Lambert and Herbert C. McKay. Each book is complete in itself . . . pocket-size (5"x7") . . . profusely and brilliantly illustrated throughout . . . very handsomely bound with sturdy, blue leatherette . . . and printed on a good quality of paper. At only 50c per book, The LITTLE TECHNICAL LIBRARY Photographic Series is the wisest investment a camera fan could possibly make!

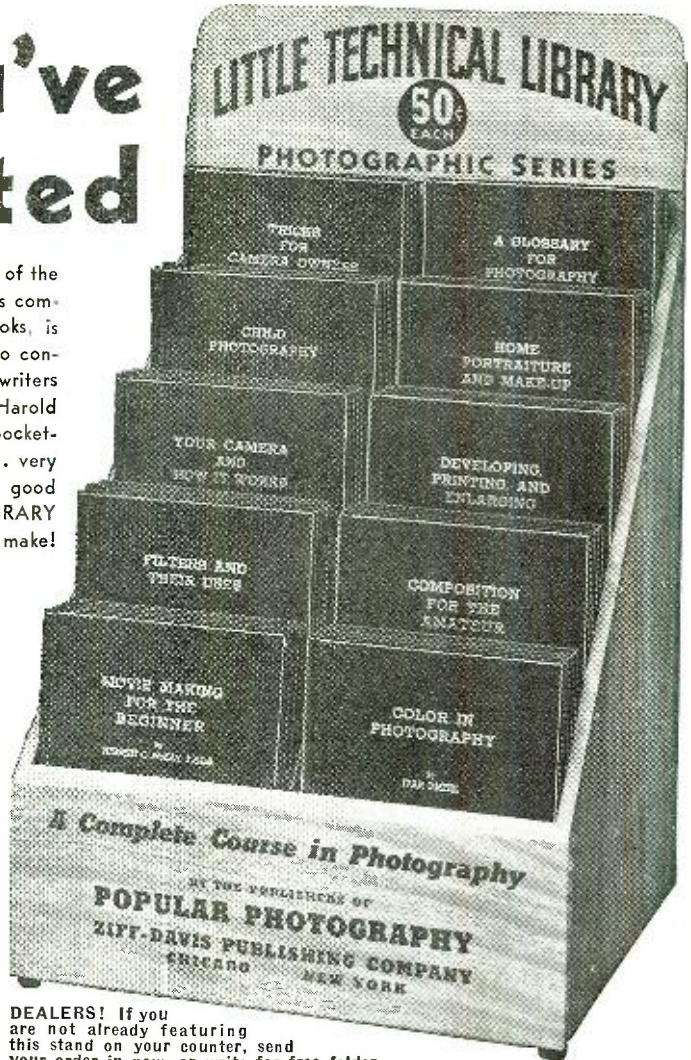

TEN POCKET-SIZE TEXT BOOKS...

- ★ COMPLETE
- ★ WORKABLE
- ★ THOROUGH

50c
EACH

- NO. 1—YOUR CAMERA AND HOW IT WORKS** by W. E. Debbis and Charles A. Savage, with a Foreword by C. E. Whetstone, F.R.P.S. Detailed information on all phases of the camera, including: selection, use, focusing, composing, lens, shutters, roll film translators, cut film and film packs, accessories, etc. 132 pages.
- NO. 2—DEVELOPING, PRINTING, AND ENLARGING** by Al and DeVera Bernsohn. An extremely useful guide on elementary and advanced developing, chemicals, types of printing, enlarging equipment, elementary and advanced enlarging, care of prints, etc., compiled in very simple language. 96 pages.
- NO. 3—FILTERS AND THEIR USES** by W. Bradford Shank. A complete and authoritative treatise on filters. Types, selection, use, requirements, advantages, problems, suggestions, the care of, etc. Informative and up-to-the-minute. 96 pages.
- NO. 4—COMPOSITION FOR THE AMATEUR** by Kenneth Heilbron. This book is complete and workable. It covers the joining of subject and picture, tones, lines, rhythm, problems, suggestions, the controls, etc. 96 pages.
- NO. 5—MOVIE MAKING FOR THE BEGINNER** by Herbert C. McKay, F.R.P.S. Comprehensive information on modern movies and cameras, use, movies versus photography, producing, editing, processing, projection, etc. Indispensable to movie fans. 100 pages.
- NO. 6—COLOR IN PHOTOGRAPHY** by Ivan Dmitri. This renowned authority in color photography brings complete information on types of subjects, natural color film, mounting, projection, color separation, density scales, printing and many other facts that will serve as an inspiration to enthusiasts of color photography. 96 pages.
- NO. 7—CHILD PHOTOGRAPHY** by Harold Lambert. An authoritative course that covers every phase of child photography, including: cameras and equipment, posing, types of pictures, finishing and processing, in natural color, problems, etc. 96 pages.
- NO. 8—HOME PORTRAITURE AND MAKE-UP** by Maurice Seymour and Syd Symons. Part I is a thorough study of home portraiture, covering tools, lighting, camera, model, posing, background, and suggestions. Part II is an ultra-modern presentation of make-up. It includes re-styling contour, eyes, eyebrows, lips. Powdering, equipment, character make-up, etc. Profusely illustrated. 112 pages.
- NO. 9—TRICKS FOR CAMERA OWNERS.** An outstanding collection of the latest and most valuable kinks and hints, covering every phase of amateur photography. 160 pages.
- NO. 10—A GLOSSARY FOR PHOTOGRAPHY.** Edited by Frank Fenner, Jr. Over 3000 words having photographic significance are defined. They cover still and motion-picture photography in black-and-white and color, photochemistry, standard abbreviations, biographical notes, and terms commonly used in the photomechanical processes. 152 pages.

DEALERS! If you are not already featuring this stand on your counter, send your order in now, or write for free folder.

LOOK FOR THIS STAND DISPLAYED ON THE COUNTERS OF LEADING PHOTOGRAPHIC STORES

OR—USE THIS CONVENIENT COUPON

ZIFF-DAVIS PUBLISHING CO., Book Dept.
608 South Dearborn Street, Chicago, Illinois

gentlemen: Please send me immediately the books whose numbers I have checked below. I understand that if I am not satisfied with the books, I have the privilege of returning them within five days for complete refund.

1 2 3 4 5 6 7 8 9 10

Please send me the complete set (10 volumes attractively boxed)

Amount enclosed \$..... or Send C.O.D. (postage added)

NAME

ADDRESS

CITY & STATE

The 1940 FULL-RANGE AMPLIFIER

By **OLIVER READ, W9ETI**, & **KARL A. KOPETZKY, W9QEA**.
 Technical Editor, Managing Editor

Three-dimensional audio! That was the goal set by the designers. They seem to have accomplished just that; and any P. A. man can duplicate the unit!

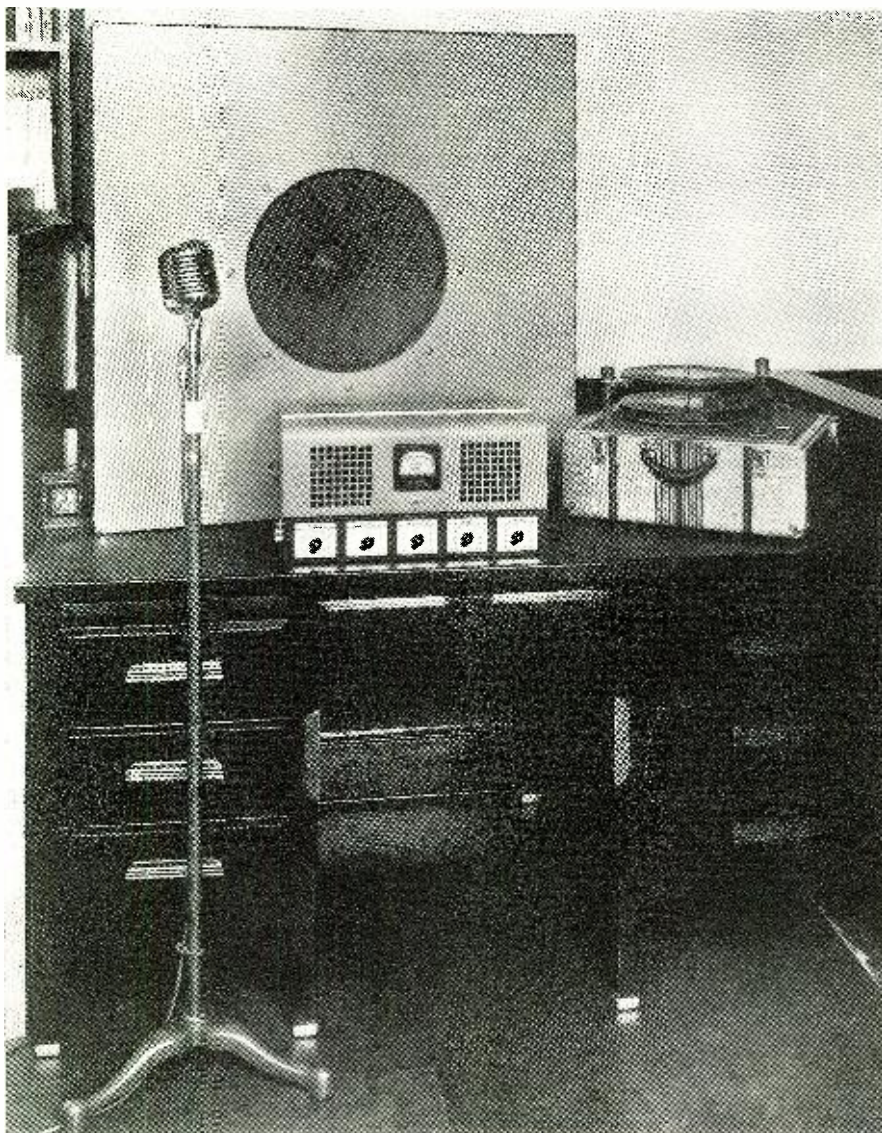

WHEN may we refer to a PA amplifier as a musical instrument? Can we use this term to describe a conventional amplifier that cannot be handled to produce effects of correct tone compensation both to *accentuate* or *attenuate* both high and low frequencies? Musicians will tell us no. The reason lies in the inability of the amplifier to reproduce all of the *true range and proportion* or to balance the combination of both to put realism into the performance as it comes from the loudspeaker.

A tremendous amount of interest is always to be found in a discussion of anything new or unusual in either the design, or in the application of audio amplifiers. In an attempt to give the reader a true picture of so called high-fidelity as related to audio equipment—we have made a complete analysis of the best features of several outstanding amplifiers; and various combinations were built and the results noted on an oscilloscope.

The greatest appeal to an individual listener is found in the ability to be able to make adjustments in the response range of the amplifier to suit his particular likes. This has been attempted in most equipment by including some sort of tone control in the form of a condenser from grid to ground in order to suppress certain high frequencies from the speaker. At best, this is a somewhat crude and inaccurate way of attenuating the high frequencies, which to the ear, are just as important for music appreciation as are the lows.

Remember the older receivers along about 1928? The public got so used to hearing the boom-boom from these that the high frequency notes on newer models became almost annoying to the average person and a lot of them blamed the broadcasters for transmitting such squeals. The broadcasters, on the contrary, were striving to attain better fidelity and apparently the public was slow to become educated to the better overall results they could have by including the high frequency notes as they were transmitted from the studio along with the lowest ones.

Later, when public address amplifiers became generally used, the effect was almost as bad, only at the opposite end of the audio range. This was chiefly the fault of the speakers and not of the amplifier, as the importance for using correctly designed baffles had not been fully realized. As time went on, receivers included more and more of the spectrum and each year we may hear a wider range than before. The future adoption of frequency-modulated transmitters may possibly add to the spectrum. As it now stands, present transmitters are capable of putting out programs, with an audible frequency range up to 5000 cycles. Such a range is considered satisfac-

The complete set-up to create a reproduction so life-like that it will leave you gasping! Easy to build.

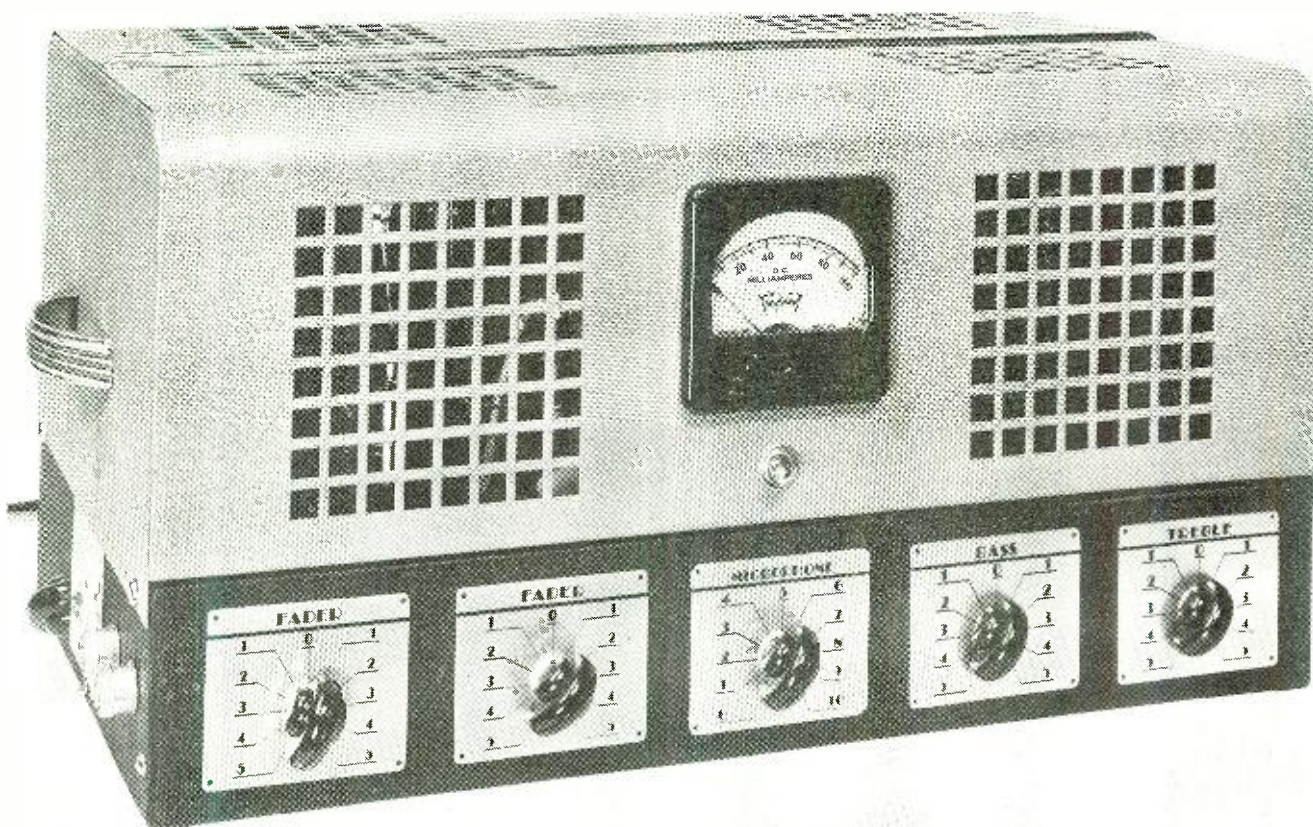

Metering in both of the final amplifier plate circuits is possible with the switch.

tory for all instruments except a very few, like the piccolo, harp, and violin.

One can enjoy music to the fullest degree if a high grade phonograph playback, speaker and amplifier is at hand. The listener must be able to make certain adjustments to the unit in order to maintain a balance suitable for his particular hearing ability. Furthermore, there are times when some certain frequency range is wanted to stand out for purposes of study of some particular instrument. To accomplish this we have included circuits and many other features previously omitted or neglected by other designers.

No modern amplifier would be complete without means for the expansion of a recording. There are several ways of accomplishing the desired results, and the one shown has, to our knowledge, as great a practical rate-of-expansion as is desired for all applications. Furthermore, if we can expand the signal *after* the tone range has been set, we may emphasize certain frequencies for observation and enjoyment.

Many orchestras and dance bands use a PA for amplification and reinforcement in halls and auditoriums where entirely different acoustic conditions exist. A great many have definite reverberation points that are annoying to the audience. In an effort to cut these out, the tone control is usually called upon to attenuate that

unwanted portion which annoys. The resulting music suffers to a high degree.

From the above, we can see that it would be far better to limit the cutoff to the point in the audio range where this condition is encountered, and to allow the upper frequencies to be heard in a normal manner. The usual tone control is usually worthless for this purpose and we have included a network within this amplifier that is able to accomplish the desired results in a very efficient manner, and yet not detract from the general spectrum of frequencies we want to hear.

The fundamental circuit of a conventional amplifier is shown in figure 1. The range is set, more or less, by the quality of the transformers and the values of all condensers and resistors used. The input is designed for a conventional high-impedance microphone such as a crystal, dynamic, or velocity. The response of the mike into the first tube will be largely determined by the value of the resistor from grid to ground. If this is too great a resistance, the low notes will not be heard; while if too low, the high notes will suffer and the overall voltage gain of the amplifier will be reduced.

Therefore it is important to use that grid resistance set forth by the manufacturer of the microphone. In order to pass the low notes, the value of C1 must be of high capacity for bypass purposes. Likewise, the value of the

coupling condenser must be large enough to pass all of the audio frequencies to the next tube. We may improve on response of the first tube by eliminating the cathode bypass condenser and by substituting a fixed bias from a battery or bias cell. These cells are not required to furnish any current to the grid circuit and are, therefore, more or less a permanent part of the amplifier. Hum will be greatly reduced with this method. Another source of hum is usually found in the grid lead connection. Much improvement can be had by using the type 6SJ7 in place of the older 6J7. The former has no top grid connection and the shielding between elements is greatly improved. When adding a bias-cell to an existing amplifier, it is well to caution the builder against shorting the cell, as this will reduce its life or make it completely inactive.

Referring again to figure 1 we stress the importance of using capacity coupling to the transformer T3. This is necessary in order to prevent core saturation by current flowing in the primary of the transformer. Many builders overlook this and do not consider that some of the best transformers use a small gauge wire in the coil in order to attain the best possible performance. Examination of the push-pull grid circuits reveals that unless the center tap is exactly centered electrically, the resistance in one grid return will not be the same as the other

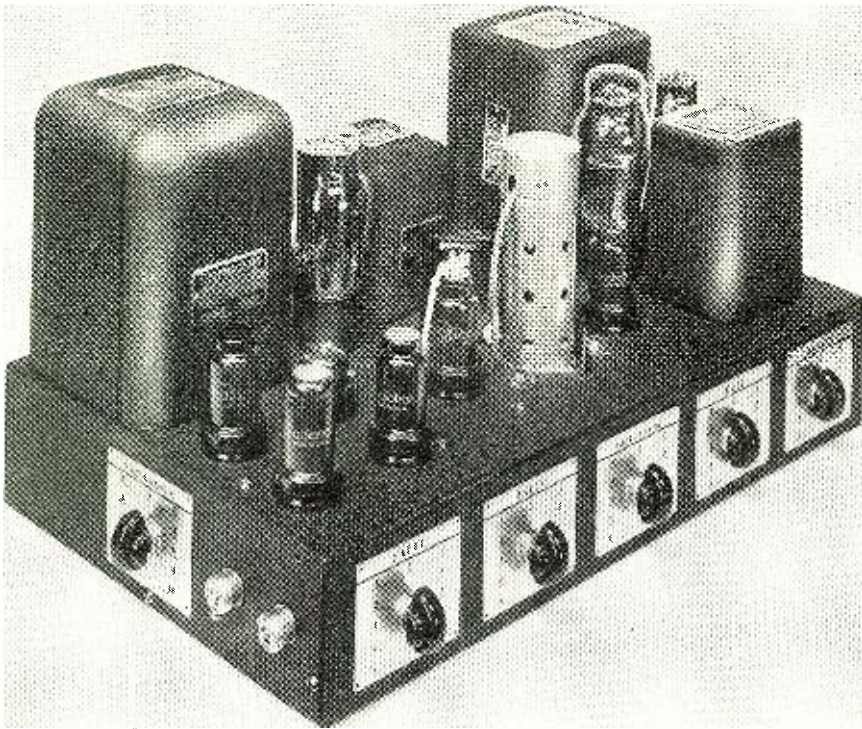

Symmetrical arrangement of the parts on top of the chassis keeps the hum level down and the appearance up. All controls are used.

and an unbalance will result. The plate current in each tube must be the same for true push-pull action, and this may best be accomplished by using *individual* bias on each tube.

The output transformer is equally important, and the better units may be relied upon to give the desired results with proper handling. Inverse feedback is a standard means of reducing the distortion which is present in most amplifiers and is included in the new RADIO NEWS amplifier.

Improvements in quality can often be attained by including a "loss pad" between the output transformer and the speaker. This circuit will reduce the normal, or phonograph disc surface noise by any amount we choose, depending upon the values of resistance chosen for the pad. A loss of 5 db. or 10 db. will suffice in most cases. The amplifier which has an output of say plus 20 db. will be reduced to an output of 10 db. if a pad designed for this value is used. A slight mis-match is permissible and for a 500 ohm line to speaker the pad may consist of two

series resistors, each of 250 ohms resistance, and a shunt of 350 ohms connected as shown on the schematic diagram. Lines of other impedances will require a pad having other values. These may be found in most radio handbooks or textbooks.

Remember that this loss can be carried out too far and it is necessary to determine the normal output of the amplifier before deciding on the loss to be deducted. If the output is only about 10 db. there would be little gained by including a loss of, say 5 db., as the output would be reduced to a level of 5 db. or only a fraction of the initial output. In any case, it is desirable to design the amplifier for an abundance of power to offset these losses.

The Expander Circuit

Audio expansion in an amplifier is desirable from the standpoint of bringing out the same proportion of crescendos and diminuendos that are originally played before the recording microphone at the studio. In order to prevent overcutting on the master wax

record, the heavy audio passages are reduced in volume by the operator or by means of an automatic volume compressor. Much of the effect is thus lost to the listener when the record is reproduced on the playback turntable, since a crescendo may appear only as a slight increase in audio level, when in reality, it was an increase of some 5 or 6 decibels.

We may bring back much or all of this original increase by incorporating some automatic means for increasing the gain of the amplifier at a definite rate according to the signal passing through the amplifier. This is known as "volume expansion." Suppose an audio signal passes into the amplifier and has a level at a given part of the circuit of 0 db. or .006 milliwatts. We can feed part of the signal to a suitable amplifier tube and into a rectifier for the purpose of effecting a bias change to some tube in the circuit which has a definite control on the overall gain of the amplifier.

By setting an input "expansion" control to a proper point, the amount of signal to be rectified may be controlled, and in turn, vary the bias at the control tube by a certain amount. Of course, *too much expansion* will result in a false reproduction of the original and too little will not give much improvement over conventional amplifiers. The operator may set this control so that the degree of expansion may be fixed for a certain type of music and left in position for the duration of the record or series of similar types. Dance records, on the other hand, do not require the amount of expansion as do the serious music types, as the average volume level is closer to being constant.

One of the finest applications for volume expansion is in playing an organ recording. The chief difficulty in the playing back of this type is that the loud bass passages of the organ have been reduced to a large degree and, in playback without expansion, these sound on the same order as would a normally small increase. Furthermore—any part of the range may be expanded in the *Full Range Amplifier*. This will appeal to the most discriminating listener.

Specifications

We recommend that the builder use the transformers specified in the parts list in order to duplicate the performance of the amplifier. If not, it should

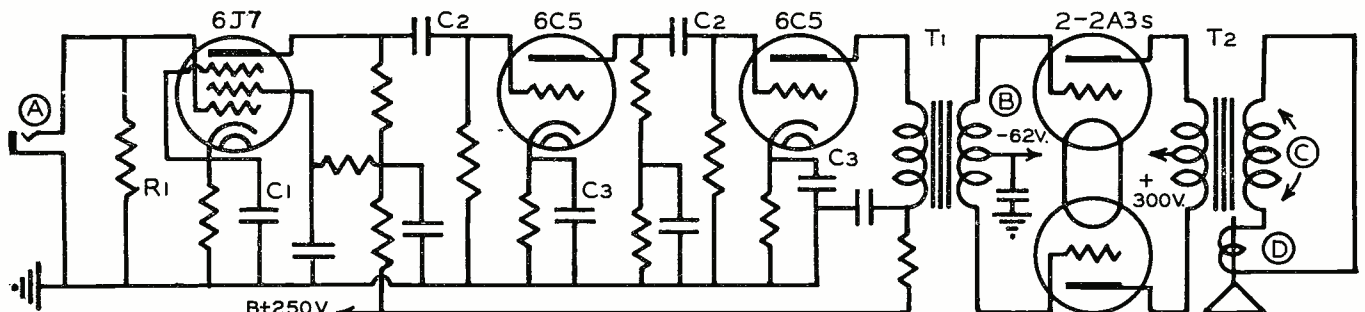

Circuit diagram of a standard amplifier circuit which was the basis of the new design.

be remembered that the range of the amplifier with the parts used in the original model is made possible by proper selection of all components, and if substitution is made, the units should have the same electrical specifications.

The tube line-up is as follows: A 6SJ7 as a high-gain microphone amplifier, 6C5 voltage amplifier, 6L7 mixer-injector, 6C8G amplifier-control tube, 6C5 driver, and a pair of 6A3's as push-pull amplifiers Class A. The expander tubes are: 6C5 voltage amplifier, and a 6H6 rectifier. The overall gain of the amplifier is approximately 115 db. with the volume expander in the "off" position and 126 db. with the expander "on."

The frequency response is within ± 1 db. from 30-15,000 cycles with the tone compensators in normal positions. The hum level is extremely low, even without a loss pad it measures 63 db. below zero below the maximum output. It is best to use metal tubes in the high-gain stages for their ability to be self-shielded. The chassis must not be relied upon to act as a ground return point for the various connections, and a length of bus-bar should be run between all circuits for this purpose.

A novel feature of this amplifier is in the application of the tone compensators. By using a double triode for the degenerative tone control circuit we may utilize the effect of the independent cathodes as means of accomplishing the desired results. One of the cathodes has a heavy by-pass and coupling condenser to the bass control.

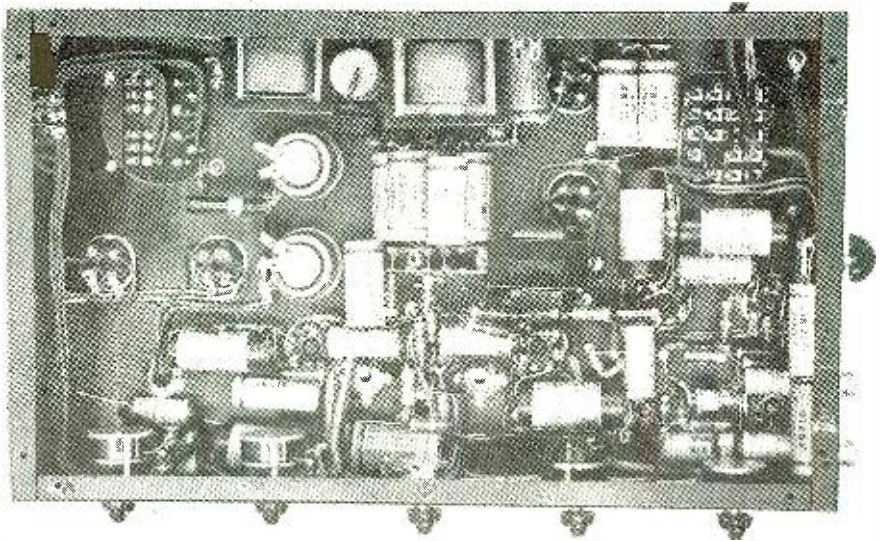

One of the first and most important considerations in building a P.A. system is to be orderly in arranging the parts. This reduces the hum.

This allows the lowest notes an easy passage into the control. The other cathode, on the other hand, does not use a by-pass and the coupling condenser is of small capacity which permits the higher notes to pass at low distortion. The combined signals, consisting of the high-note channel and the low-note channel are fed in parallel to a potentiometer where blending of these tones may be had at will.

Almost any combination of frequency response may thus be had in conjunction with the two tone controls

plus the "blender," and the effect is most startling. Music seems to take on a "third dimension" while the degree of expansion may be set to bring out the life-like realism of the original recording. The expander may be used in connection with a microphone or for regular broadcast reception by adding a suitable r.f. tuner. (See RADIO NEWS, November 1938, p. 18).

Speaker Requirements

Any amplifier, no matter how good, will sound no better than the speakers (Continued on page 55)

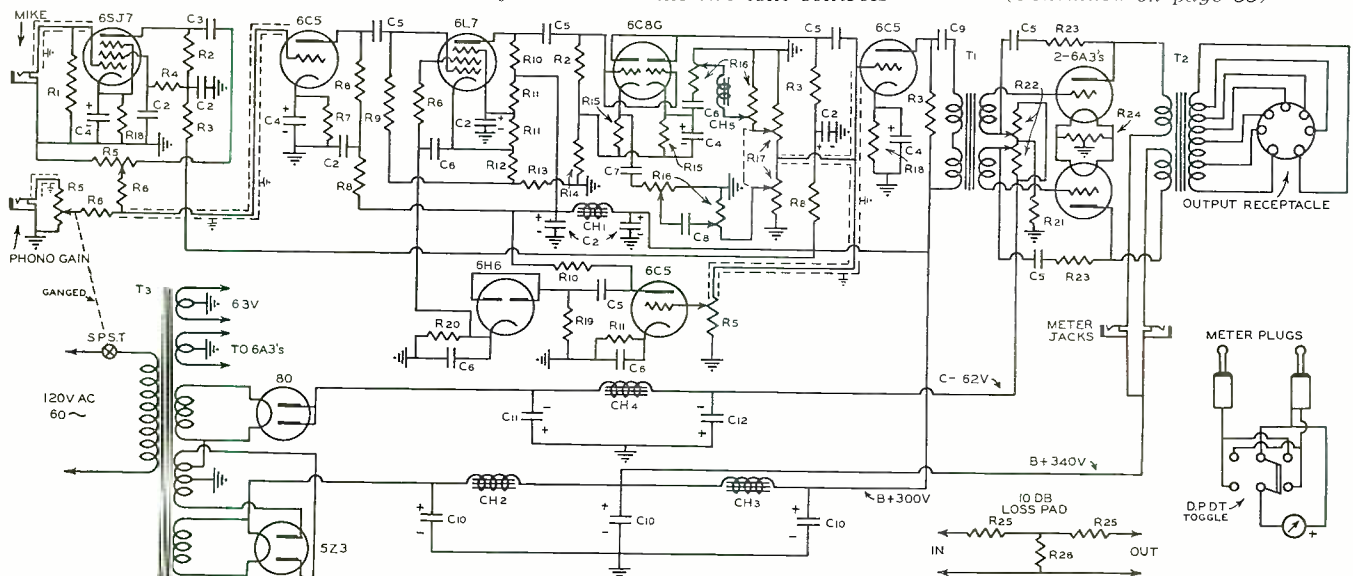

Circuit of one of the experimental models built in the laboratory.

R₁—500,000 ohms 1/4 w. Aerovox
R₂—250,000 ohms 1/2 w. Aerovox
R₃—50,000 ohms 1 w. Aerovox
R₄—1 megohm 1 w. Aerovox
R₅—1 megohm pot. Centralab
R₆—500,000 ohms 1/2 w. Aerovox
R₇—2,000 ohms 1 w. Aerovox
R₈—22,500 ohms 1 w. Aerovox
R₉—1 megohm 1/2 w. Aerovox
R₁₀—100,000 ohms 1 w. Aerovox
R₁₁—10,000 ohms 1 w. Aerovox
R₁₂—800 ohms 1 w. Aerovox
R₁₃—200 ohms 1 w. Aerovox
R₁₄—20,000 ohms 1/2 w. Aerovox
R₁₅—3,000 ohms 1 w. Aerovox
R₁₆—Dual 40,000 ohms-500,000 ohms Thordarson R1068
R₁₇—500,000 ohms pot. Centralab

R₁₈—1,000 ohms 1 w. Aerovox
R₁₉—100,000 ohms 1/2 w. Aerovox
R₂₀—250,000 ohms 1 w. Aerovox
R₂₁—3,500 ohms 10 w. Ohmite
R₂₂—3,500 ohms 5 w. pot. Ohmite
R₂₃—15,000 ohms 1 w. Aerovox
R₂₄—100 ohms center tap Ohmite
R₂₅—250 ohms 10 w. Ohmite
R₂₆—350 ohms 10 w. Ohmite
C₁—.05 mf. 200 v. paper Sprague
C₂—8 mf. 450 v. elect. Sprague
C₃—.02 mf. 400 v. paper Sprague
C₄—10 mf. 25 v. elect. Sprague
C₅—.1 mf. 400 v. paper Sprague
C₆—.5 mf. 200 v. paper Sprague
C₇—.01 mf. 400 v. paper Sprague
C₈—.04 mf. 400 v. paper Sprague

C₉—.25 mf. 600 v. paper Sprague
C₁₀—8 mf. 500 v. elect. Sprague
C₁₁—8 mf. 350 v. elect. Sprague
C₁₂—16 mf. (2—8's in parallel) 450 v. Sprague
M—Triplet Model 321, 0-100 DCMA
T₁—Class A input. Thordarson T-90A04
T₂—Plate & filament trans. Thordarson T-15R05
T₃—Plate output. Thordarson T-9013
CH₁—Filter choke, Thordarson T-15C54
CH₂—Input choke, Thordarson T-74C30
CH₃—Filter choke, Thordarson T-18C92
CH₄—Audio choke, Thordarson T-14C70
Cabinet and chassis—ParMetal DF-1017
Speakers—Utah H15P or Cinaudagraph SU-18-12
Microphone—Shure Bros. Model 55C Dynamic
Tubes required: 1—6SJ7, 3—6C5's, 1—6L7, 1—6C8G, 1—6H6, and 2—6A3's or 2A3's

PHOTOGRAPHIC HISTORY OF

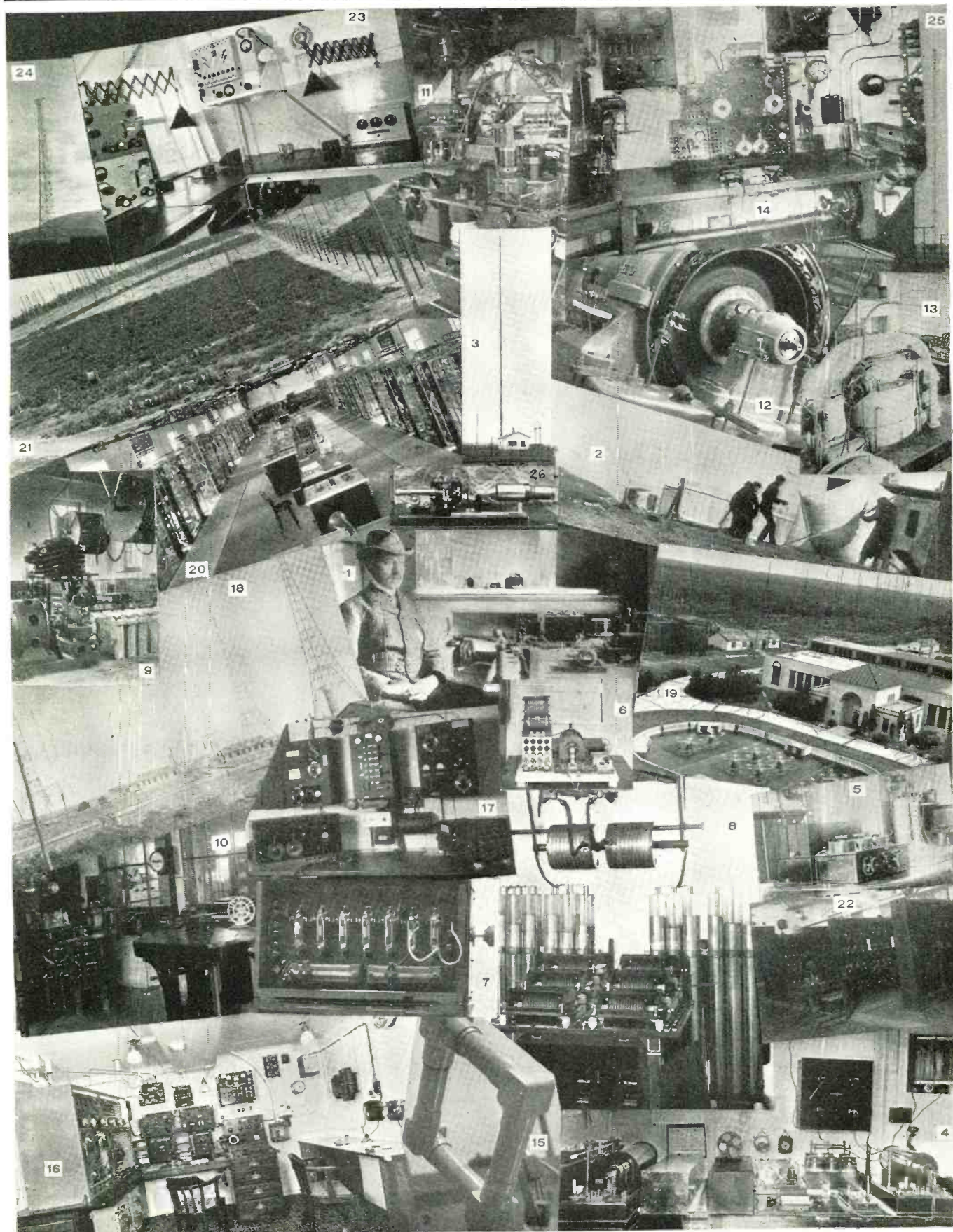

See how many of these events in the history of Radiotelephony you can guess. Then turn to Page 8 for the key.

RADIOTELEPHONY BY CHAS. R. LEUTZ

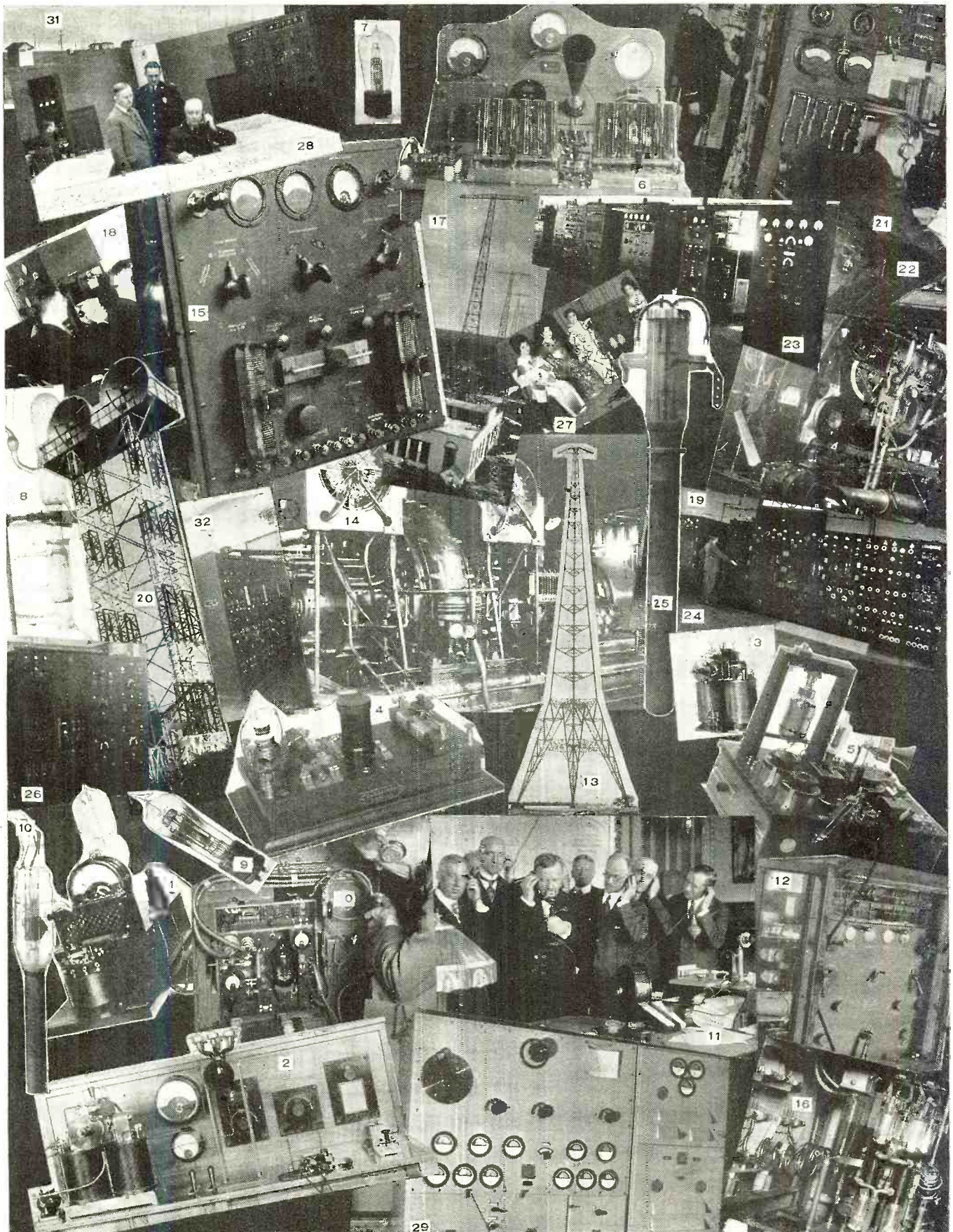

With this page you will be brought right up to date. There are many historic events noted here. Can you remember some?

WHEN the Editors saw the magnificent pictorial history of Radiotelephony, they thought that the readers would be interested to see just how far the art has progressed. Unfortunately, the reproduction would have to be about the size of the average house wall to be as striking as the orig-

inal, but the pictures on pages 6 and 7 still have a great deal of value in them.

We have grown so accustomed to the "radio," that some of us do not know the struggle, the heartbreaks, and the disappointments that lined the pathway. These pictures, all historically accurate, depict only the suc-

cessful goal posts of the profession. They should be carefully studied.

It is hard to say where radiotelephony will end up, or when this will happen. One thing is sure, however, the progress of the future, fast though it be, will not equal the development speed of the past.

Key to Page 6

1. The late Marchese Marconi sitting before the original receiver when he first received transatlantic wireless signal at Signal Hill, Newfoundland, from England; December 12, 1901. Marconi's Wireless Telegraph Co. Ltd., Photo.

2. Erecting a kite aerial for the Marconi tests at Signal Hill, December 12, 1901. Marconi's Wireless Telegraph Co. Ltd., Photo.

3. Prof. Valdemar Poulsen's original aerial used in connection with the invention of the arc oscillator, Lyngby, Denmark, 1907. Photo courtesy of the inventor, Dr. V. Poulsen.

4. Wireless Room on board the S. S. Minneapolis, 1902. Spark Coil Transmitters in duplicate are shown. Marconi's Wireless Telegraph Co. Ltd., Photo.

5. Early Marconi Triple Circuit Receiver, Cullercoat, England, 1910. British Post Office Photo.

6. Early Spark Coil Transmitter, 1902. Telefunken Photo.

7. Marconi Valve Receiver (Fleming Valves). Marconi's Wireless Telegraph Co. Ltd., Photo.

8. 25 K. W. Quenched Spark Transmitter with Leyden Jar Condensers, Nauen, 1914. Telefunken Photo.

9. English 30 K. W. Rotary Spark Transmitter, 1915. British Post Office Photo.

10. High Speed Automatic radiotelegraphic transmission and reception equipment, Nauen, 1911. Telefunken Photo.

11. Marconi Timed Spark Transmitter wherein several damped spark transmitters are combined to produce continuous wave oscillations, 1914. Marconi's Wireless Telegraph Co. Ltd., Photo.

12. Goldschmidt High Frequency Alternator, similar to the American Alexanderson Alternator, 1914. Telefunken Photo.

13. U. S. Navy Arc Transmitter, 1917, 500 K. W. Photo courtesy Federal Telegraph Co. and U. S. Navy.

14. Radio Room on U. S. Army Transport "Mount Vernon," 1917. Equipment includes a 5 K.W. Arc Transmitter and a 2 K.W. Quenched Spark Transmitter. Receiver is a one tube regenerative circuit with two audio stages and the audio transformers are air core. Photo courtesy of Federal Telegraph Co. and U. S. Navy.

15. Modern Marine Radio Compass Loop. RCA Photo.

16. Radio Room, S. S. Empress of Britain, equipment including a tube transmitter, an emergency spark transmitter, an all wave receiver and direction finding apparatus. Marconi's Wireless Telegraph Co. Ltd., Photo.

17. Modern low power American Ship Radio Installation. RCA Photo.

18. U. S. Navy Lafayette Radio Station, near Bordeaux, France, 1919. Photo courtesy of Federal Telegraph Co. and U. S. Navy.

19. Part of the RCA Rocky Point, Long Island, N. Y. transmitter station housing modern vacuum tube transmitters for world wide service.

20. Dorchester, Dorset, England, Bank of Vacuum Tube Transmitters for direct communication to numerous foreign points. Photo courtesy of Imperial and International Communications Ltd.

21. Diversity Aerial System for foreign reception, at RCA Riverhead, Long Island, N. Y. station. RCA Photo.

22. Diversity Radio Receivers at Fukuoka, Japan, similar to RCA equipment at Riverhead. Photo courtesy of the Japanese Government.

23. Radio Room on board dirigible "Graf Zeppelin," 1933. Photo courtesy "Luftschiffbau Zeppelin."

24. Transmitting Aerial Tower at a Japanese Radio Station. Photo Courtesy of the Japanese Government.

25. One of the transmitting aerials towers at Nauen. Telefunken Photo.

26. Einthoven Galvanometer, used in the development of tape recording of wireless signals, 1910. Marconi's Wireless Telegraph Co. Ltd., Photo.

Key to Page 7

1. First Electronic Tube successfully used for radiotelephony transmission; a Leiben-Reiss Mercury Vapor three element tube; used by Dr. Alexander Meissner, Berlin, 1913. Distance covered about 11 miles, tube filament life only a few minutes. Telefunken Photo.

2. Poulsen Arc Radiophone transmitter with a multiple microphone in the antenna circuit, 1907. Photo courtesy of the inventor, Dr. V. Poulsen.

3. Poulsen Arc Generator, the first system of producing undamped oscillations, 1904. Photo courtesy of Dr. V. Poulsen.

4. Vacuum tube Radiophone receiver, 1914. Telefunken Photo.

5. Vacuum tube Radiophone Transmitter, 1915. Photo courtesy Marconi's Wireless Telegraph Co. Ltd., London.

6. Multiple Arc Radiophone, 1908. Telefunken Photo.

7. Original high vacuum electronic tube, 1915. General Electric Photo.

8. Dr. Langmuir's Mercury Vapor Condensation Pump for producing true high vacuum electronic tubes, 1915. General Electric Photo.

9. Early Screen Grid Vacuum Tube, 1923, designed by Dr. Hull. General Electric Photo.

10. 1000 watt Water-cooled Electronic tube, 1919. General Electric Photo.

11. First U. S. Naval order given to a warship at sea by radiophone, May

1916, Secretary of Navy Josephus Daniels telephoning an order to the U. S. S. New Hampshire. Photo courtesy of A. T. & T. Co. and U. S. Navy.

12. U. S. Army Field Radiophone Transmitter, 1920. General Electric Photo.

13. Antenna Tower, Pearl Harbor. Photo courtesy Federal Telegraph Co. and U. S. Navy.

14. 200 K. W. Alexanderson High Frequency Alternator at U. S. Naval Station, New Brunswick, N. J., 1917-19; used to keep President Wilson in touch with the United States, while he was on the European Peace Mission. General Electric Photo.

15. First U. S. Navy H-16 Flying Boat Radiophone Transmitter, 1918. Marconi Wireless Telegraph Co. of America Photo.

16. British Short Wave Transmitter for service to Canada, view of final 60 K. W. Amplifier Stage, 1934. British Post Office Department Photo.

17. Transmitter Station and Antenna system at Rocky Point, Long Island, N. Y., used for experimental radiophone transmission to Europe, 1927. RCA Communications Co. Photo.

18. Broadcast of the Harding-Cox Election returns from KDKA, Nov. 2, 1920. Westinghouse Elec. & Mfg. Co. Photo.

19. British Post Office Radio Station, Rugby, England, 1930.

20. Short Wave Beam Antenna for transmission of radiophone signals across the English Channel, France to England.

21. Radiophone apparatus aboard the S. S. America for Ship to Shore Radiotelephony, 1922. American Tel. & Tel. Co. Photo.

22. Radio Telephone installation aboard the Paris-New York plane of Costes and Bellonte, 1933. S. F. R. Radio, Photo.

23. Nazaki Transmitter, Central Telegraph Bureau, Tokyo. Photo courtesy of the Japanese Government.

24. English Radiophone Transmitter, 1933. Photo courtesy British Post Office.

25. Modern Water-Cooled Transmitter Tube. G. E. Photo.

26. Short Wave Radiophone.

27. Japanese Broadcast Studio, Atagiyama, Japan.

28. Police Radiophone Dispatch Headquarters, New York City, 1934. Western Electric Co. Photo

29. Ship Radiotelephone apparatus aboard the S. S. Bremen, North German-Lloyd Photo.

30. Radiophone apparatus in British Tank, 1935 model. Photo courtesy of Armstrong & Vickers Ltd., and Marconi's Wireless Telegraph Co. Ltd., London.

31. Radiotelephone Station at Pozuelo del Rey, Spain.

Mechanical Layout of the E. C. O. Exciter

by **GLENN BROWNING,**

Browning Laboratories, Winchester, Massachusetts.

To insure mechanical stability for the users of electron-coupled exciters, the author's suggestions should be rigidly followed. Makes a nice cw set.

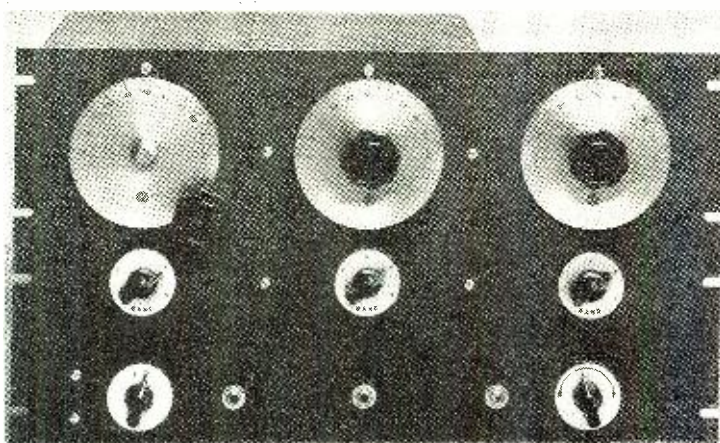

The front of the panel has all the necessary controls.

EARLY versions of the *Browning Exciter* which appeared in articles in *RADIO NEWS*, Jan. 1939, and *QST*, July 1938, left the mechanical design and layout more or less up to the individual constructor. Some preferred to use a standard chassis-type-of-construction, while others went to great effort in order to improve over the *conventional*. Much progress has been made in this exciter from the standpoint of better mechanical and electrical layout which has improved its performance and made the adjustments more simplified for the builder.

Reference to the illustrations will disclose that each stage has its own shielded compartment to house the parts used in any one stage. This prevents undesirable coupling from reacting on unwanted portions of each. The tubes are mounted in the same manner as was used in the exciter for the *RADIO NEWS DIALOMATIC*. This horizontal position will allow the grid input circuits to remain in the shield which houses the 5G coil assembly, while the plate, end cap, is situated in another compartment containing the 5P plate coil assembly.

Short leads are thus possible which are highly desired in any type of electron-coupled oscillator. The placement of parts has been carefully worked out from both a mechanical as well as an electrical standpoint and should thus follow in order to obtain the excellent results that are possible with an electron coupled oscillator.

Certain definite precautions are needed to insure best results. These are:

1. Short r.f. leads—no sharp bends.
2. Rigid wiring—especially in the ECO circuits.
3. Use bare wire (no spaghetti) on all leads carrying r.f. currents.
4. By-passing on all of the various circuits returning to a common ground.
5. Variable condenser rotor plates should be connected to the common ground for the associated circuit by heavy leads (do not depend upon the chassis for a ground).
6. Filament leads so positioned that they may be in high-frequency electrostatic fields and so shielded that no feed-back is obtained from stage to stage.

All high-voltage and r.f. leads that

pass through the chassis or through the shields go through isolantite bushings. The Amphenol socket for the RK25 is mounted on stand-off pillars on the first partition shield. The positioning of this socket is such that the grid terminal lug is closest to the 5G tuner.

If the complete exciter is duplicated as shown, the builder may be assured of fine performance and with the ability to QSY over the ham bands and "slide out under QRM" when the going is tough. It is generally conceded that an e.c. oscillator should be operated with the plate circuit tuned to twice the frequency of the grid circuit for stability.

The power supply is an entirely separate unit. However, it was thought advisable to incorporate in the exciter itself a filament transformer for the three tubes utilized allowing the filaments to be turned on and amply warmed up before the power supply is thrown on.

Exceptional care should be taken to insure good soldered joints. It will pay dividends in excellent results.

-30-

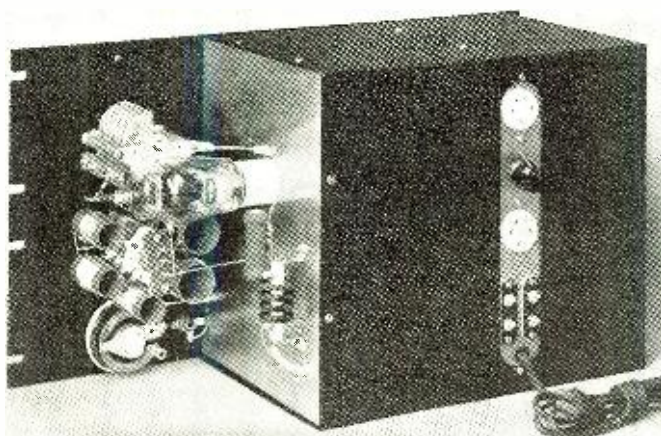

The output tube fits to the left of the enclosed space. The input to that tube may be 100 watts.

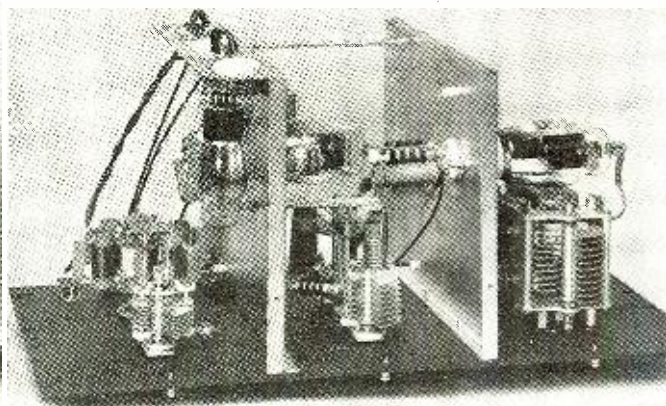

The mechanical construction is clearly shown here. Each stage is isolated from the preceding one.

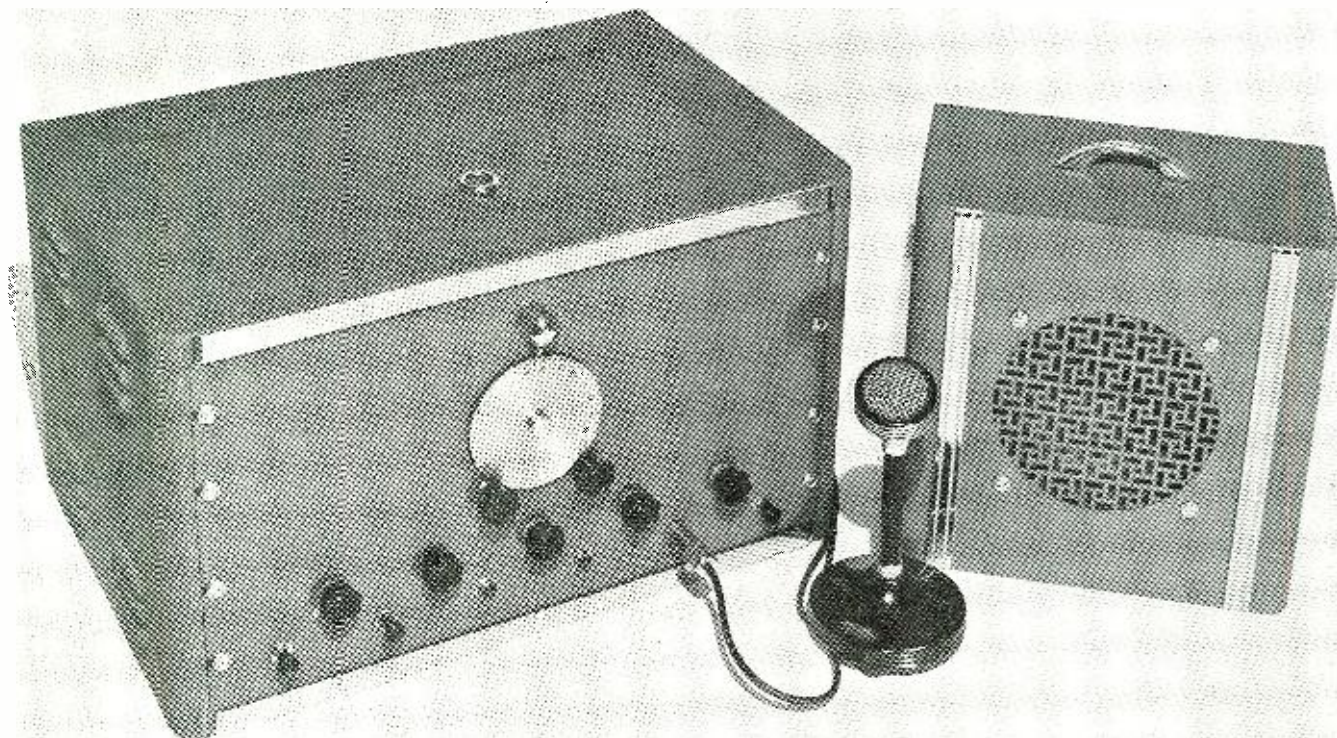

The combination transmitter-receiver is compact and useful for next year's pleasure craft vacation.

COMBINATION RECEIVER-TRANSMITTER

by **RAYMOND P. ADAMS**

Hollywood, California.

Now is the time to build for that boat of yours. Don't wait for the hot summer with its diversions; the winter is when you can profitably spend the long evenings building this unit.

IN designing and constructing this new radio telephone assembly, every effort has been directed toward producing a job combining in general layout the essential and most practical features of both the amateur and the marine radio-telephone transmitter. As a result, the completed instrument becomes adaptable with but few refinements upon the basic array as described herein to either type of application. Featuring simplicity of operation, it becomes specifically suitable for installation aboard-ship for 'phone communications on the assigned ship-to-ship and ship-to-shore frequencies. It features alternative AC pack or vibrapack-dynamotor powering and, means of easy changeover, for amateur low-frequency band operation, and usable by the ham in either station or emergency application.

The rig as shown in the photographs uses a fundamental layout which should be duplicated regardless of the special application in which the individual builder will be interested. The array is quite complete except for the antenna loading coil and series condenser (or both), the load coil tap connections to the third selector switch section, and the various fixed tank condensers beyond the initial one shown (which tunes the tank coil to the highest desired frequency as related to one specific crystal and which incidentally provides for a suitable tank "Q").

These various items and connections have been removed both to permit a clear view of other important under-chassis components and to indicate that antenna and tank tuning values and layout are to no little extent dependent upon matters of particular set application.

The speaker is in a separate case. Likewise the power supplies—both AC and battery driven (our photograph shows the AC pack for the transmitter and the disassembled Vibrapack unit for the receiver). The large, attractive cabinet houses all other components, which are mounted on one chassis and which include the two-band receiver, the 20 watt transmitter, the modulator and crystal-mike driven speech amplifier, and the various potentiometers and switches providing for complete assembly control.

The receiver tunes over two bands—the standard broadcast, and a medium short wave band which includes the ham 75 and 160 meter, the marine radio telephone, the Coast Guard, and the storm warning and marine advisory broadcast frequencies. A dial is employed for tuning this assembly, as

a selector switch adjustment would greatly limit the receiver's usefulness.

The receiver circuit is quite conventional. One RF stage provides ample pre-selection. The 6K8 does an excellent job in the mixer stage, and two i-f stages using manually and automatically controlled 6K7s afford a high degree of signal selectivity. A 6Q7 is employed as second-detector and first AF amplifier, with a 6F6 as output tube. The R Meter circuit indicated is optional.

The transmitter circuit is similarly straightforward, following recommended amateur design practice though departing somewhat from the usual layout found in marine jobs. The oscillator circuit is the simple and surefire Pierce and uses a 6C5—which furnishes ample drive for the parallel T21s in the Class C stage; the final is neutralized—a split tank coil being featured to provide feedback voltage of proper phase, and the coil being tuned to the highest frequency desired (as related to a selected crystal) by a 360 mmfd condenser.

Neutralizing is incorporated for the reason that in Pierce layouts like this one, with the output tank tuned to crystal frequency, even a beam amplifier will have a tendency to lock-in and oscillate and though the oscillation is at crystal frequency, the effect, under modulation, would be undesirable. As for the large value of condenser—this has been incorporated, as we have said before, so that we may tune to the 80 meter, 160 meter, or marine radio telephone frequencies using the one coil—and further, so that a suitable tank Q will be effected, particularly for 160 meter operation.

Four crystals are used to provide a selection of desired frequencies over one or the other of the low frequency ham bands, or to permit operation (if the assembly is to be used aboard-ship and not for amateur purposes) on the marine radio-telephone channels. One is cut for ship-to-ship, one for ship-to-Coast Guard, and two for communications with the shore stations in any two areas in which the vessel normally cruises.

One section of a three gang switch selects the crystal, a second section connects in a parallel tank for the T21 plate circuit (tuning this circuit to crystal resonance); a third selects the proper tap point on a suitable antenna load inductance. The capacity of the plate tanks will depend upon the band in which the signal is emitted and thus the setting of the large minimum frequency tank and the actual frequency

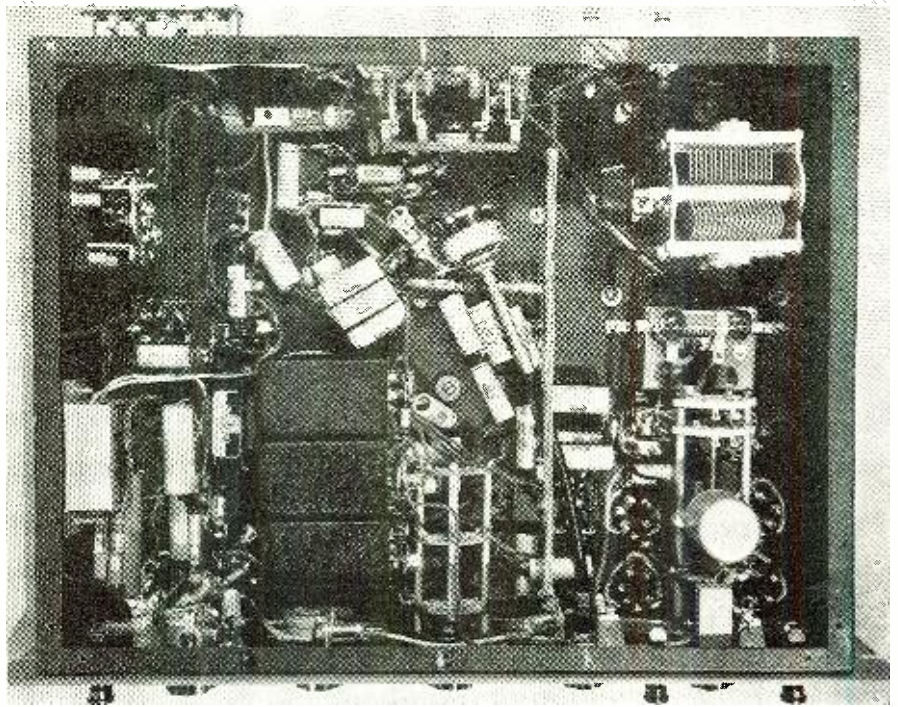

Underside the main unit's chassis. The receiving IFs can easily be identified dead center with the band change switch alongside.

range involved. Generally, condensers of .00014 maximum capacity will be satisfactory.

The tapping for the load inductance will depend upon the size of the load coil used, which will in turn depend upon the length of the antenna. Sixty turns of No. 14 wire on a 2½ inch form, tapped every two turns, will do the trick. Note, by the way, that we have brought out the ground side of the plate coil swinging link to a separate post so that an external ground or counterpoise may be employed and so that a series tuning condenser may be inserted in the antenna circuit where such is required for proper resonance tuning.

Plate modulation for the final amplifier is provided by two additional T21s, driven to entirely adequate output (on speech) by a 6C5 and a pre-amplifying 6J7. The microphone must be a high output diaphragm type (crystal)—the level about -50 d.b. or better.

Powering Devices and Circuits

The a.c. power supply for the transmitter supplies a well filtered 400 volts. The layout and circuit are quite standard—choke input being featured, the two chokes in the filter system being husky affairs rated to carry 300 ma., and the filter capacitors being paper units of 4 mfd. value each. A

separate transformer supplies all filament voltages (5.0 for the Taylor 866 Jr. rectifier filaments connected in series, and 6.3 for the transmitting tubes).

Independent toggles for this and the high voltage transformer permit all filaments to be lighted before the high voltage is applied. The a.c. power supply for the receiver (not shown in the photographs) incorporates a single transformer, two filter chokes, the three 8 mfd. electrolytics, and a bleeder to provide the required 250 volts output at full receiver drain.

As we have earlier advised, any suitable dynamotor supplying 400 volts of filtered d.c. at 300 max. ma. will be satisfactory as a powering device for the transmitter when battery operation is imperative. The supply unit for the receiver, on the other hand, must be home-built. Components should be wired according to our circuit diagram and built into a small shield can.

Controls

Potentiometer controls include one for a.f. gain on the transmitter, one for receiver sensitivity, and one for receiver a.f. level. Selector switches include the three-section, six-gang two-place affair for receiver band change, and the three-gang isolantite-

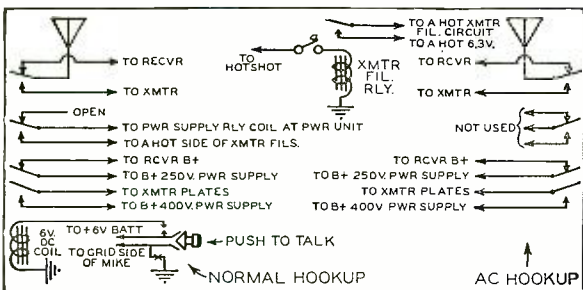

Minor details of antenna switching and tuning arrangements. Fully described in the article.

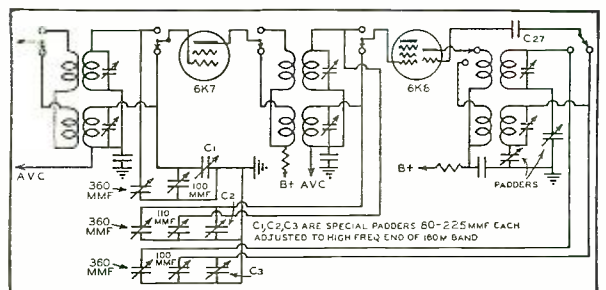

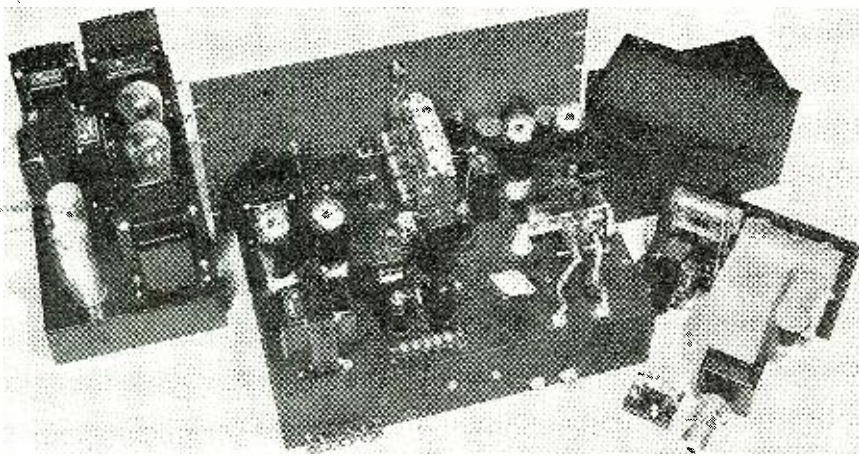

All the units which together comprise the complete transmitter-receiver. The power supply at left is for 115 V. A.C., at right for 6 V. D.C.

insulated job for selection of transmitter frequency. These various switches and controls are in line across the panel.

The switch for turning on the receiver filaments (and, through a relay circuit, the Vibrapack assembly) is on the volume control. The switch used on the transmitter filaments (through another relay circuit) is a push-button affair. Other push-button switches are: that for a.v.c. off-on and for push-to-talk. The push-to-talk switch energizes a multi-pole relay which, in the "transmit" position, breaks the B plus circuit to the receiver, makes the B plus circuit to the transmitter, switches the antenna from receiver to transmitter, and closes an external circuit operating still another relay closing the 6 volt battery line to the dynamotor.

The two relays (send-receive and transmitter filament circuit) below chassis are wired for external energizing by a Hotshot or similar 6 volt battery layout—rather than for operation by the source of filament supply, which under conditions of a.c. powering would, of course, be a.c. and would not operate the d.c. relays.

General Layout

The positioning of the various components for the main assembly is clearly indicated. Under-chassis components are shown in the below-chassis view. The layout is quite complete except for the necessary three midget variables (which must be mounted at the rear of the switch on a supported insulating plate and wired to the middle section switch terminals) and for the antenna loading inductance—which may be mounted anywhere at the back of the chassis but *NOT TOO*

CLOSE to the Class C tank coil. It may be located externally, the four tap lines from the last switch section running to feed-through terminals on the rear chassis drop. The empty socket near the tank coil by the way, is not used. It was placed in position simply so that the a.m.c. rectifier might be added to the line-up.

Construction

Before drilling the chassis, study both the circuit drawing and the photographs carefully until a clear understanding of layout is had. Remember that modulator and speech amplifier components are at the right, running from the panel back toward the rear of the pan. The transmitter r.f. components are at the left in a similar line-up, and the receiver parts are at chassis-center—somewhat staggered in stage-to-stage positioning so that ample room will be left for the bulkier transmitter parts.

The tank coil for the transmitter is mounted on large insulators so that the center link will have full swing. Below it, mount the main tank condenser, likewise supported from the chassis by ceramic pillars and positioned so that rotor plates will clear the bottom of the cabinet. Connect the condenser across the coil, using grommets or feed-through insulators at the chassis. Connect one side of the tank circuit to the paralleled T21 socket plate terminals and to the selector arm of the second switch section.

Connect the other to the above-chassis neutralizing condenser (which may be a *Hammarlund MEX* trimmer with screw removed or any well spaced midget variable which may be adjusted to the grid-plate capacity of the two T21s— 2×1.4 mmf.). Mount the screen

and plate circuit by-pass condensers near the sockets, using the values specified in the circuit diagram. The rather unusual idea of by-passing the plate circuit to the screen and then to ground, makes for surprisingly good screen-plate modulation.

Wire the four crystal sockets to the first section of the switch, complete the r.f. wiring (keeping leads short and using well insulated wire for all connections). Then mount and wire the modulator-speech components—connecting the output transformer *brown* and *blue* primary wires to the T21 modulator plates, the red primary wire to B plus, and the *black* and *black-red* secondary wires the first to B plus and the second across the rear width of the chassis to the Class C r.f. stage.

Mount and wire the receiver components, referring to layout and photographs for proper placement of individual items, and follow the circuit diagram carefully. Group by-pass condenser, filter and dropping resistors, and other small parts at the sockets with which they are associated. Keep all r.f. and a.f. leads short and direct and bring returns for any one stage to one common ground point.

Note that the audio-control and on-off switch unit is mounted near the second detector socket and on a supporting angle. The angle is raised until the potentiometer's shaft is in vertical line with the audio control hole in the front chassis drop.

The r.f. coils are placed below chassis, in line (Ant., r.f., Osc.). The antenna coil is mounted about an inch back to provide ample clearance for the gain control, and all cans placed so that the open ends point toward the two-band selector switch. In mounting the coils, by the way, use the small securing nuts which hold the inductances to their shield cans—drilling the chassis both so that the mounting screws will protrude through both shields and chassis and so that access will be had to the coil trimmers. If coils, tuning condenser, and selector switch are all placed as indicated, the r.f. leads associated with the tuned circuits will then be as short as the general layout will permit.

Bear in mind that you can use either of two types of tuning condenser: a regular three gang job of 365 mmfd. capacity (max.) per section; or a three gang special having two sections in each gang—one the regular 365 mmfd., and one 100 or 140 mmfd. If general short wave band coverage is desired, the *standard* unit should be employed.

If bandspread is desired for any portion of the 67-200 meter short wave

(Build further on page 62)

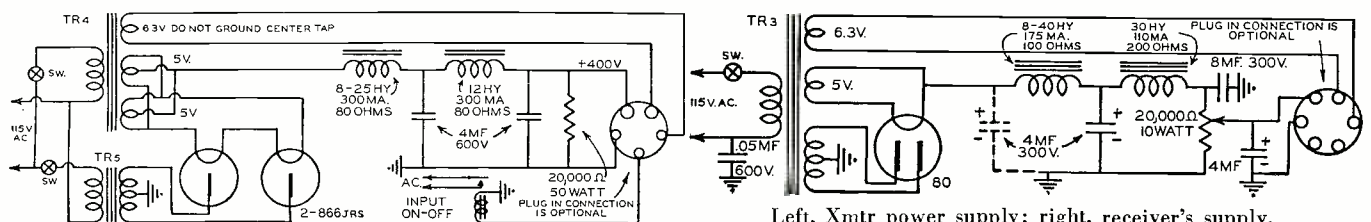

Left, Xmtr power supply; right, receiver's supply.

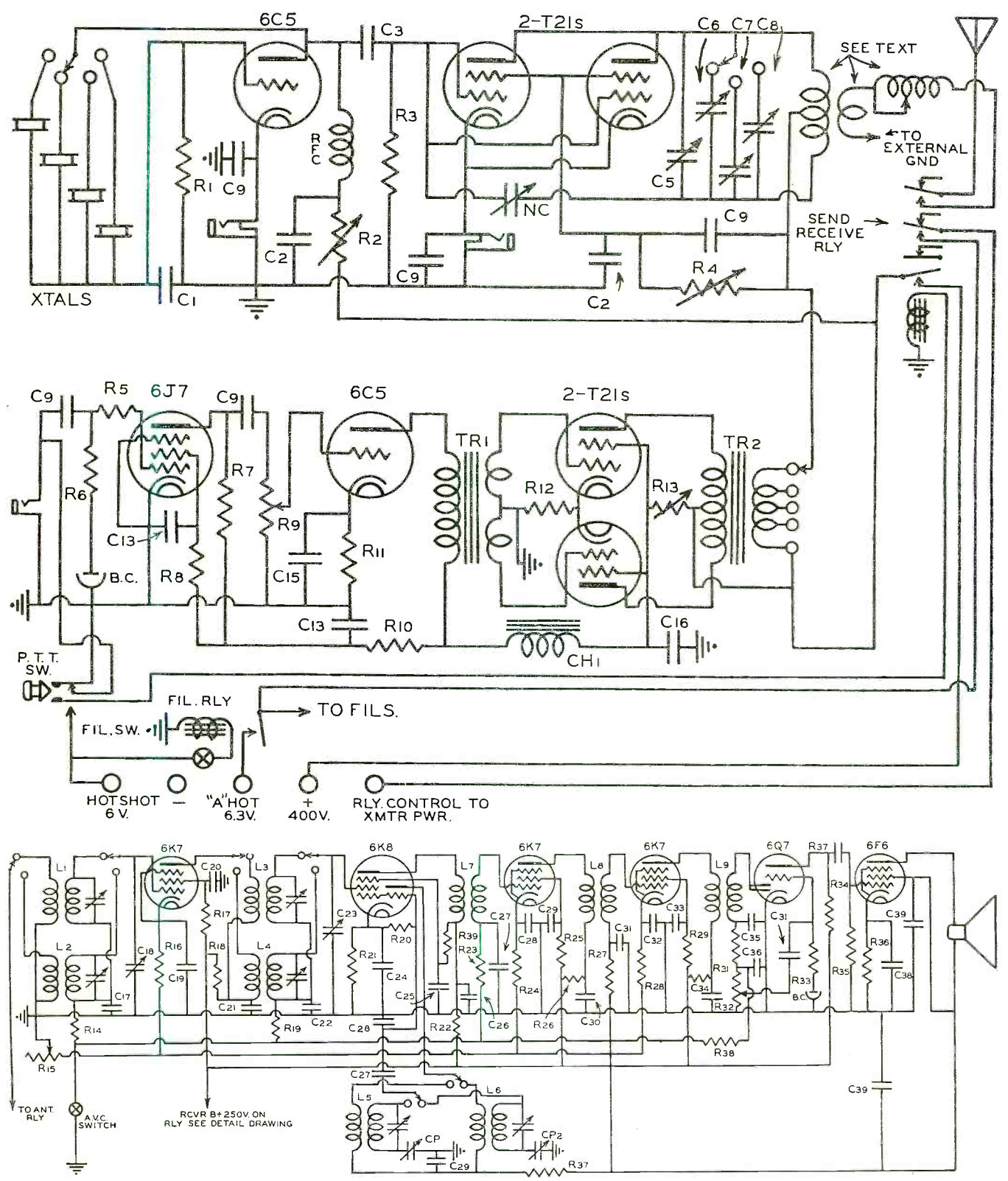

- TR₁—Driver trans. Stancor A-4702
- TR₂—Mod. trans. Stancor A-3835
- TR₃—Power trans. Stancor P-4080
- TR₄—Fil. trans. Stancor P-6167
- TR₅—Plate trans. Stancor P-4024
- CH₁—50 hy. choke Stancor C-1515
- CH₂—8-40 hy. choke Stancor C-1400
- CH₃—30 hy. choke Stancor C-1001
- CH₄—8-25 hy. choke Stancor C-1403
- CH₅—12 hy. choke Stancor C-1413
- L₁, L₂—530-1550 kc. Meissner 14-7467
- L₃, L₄—530-1550 kc. Meissner 14-7471
- L₅, L₆—Osc. coils Meissner 14-7475
- L₇—456 kc. input Meissner 16-5740
- L₈—456 kc. interstage Meissner 16-6131
- L₉—456 kc. output Meissner 16-5742
- R₁, R₂, R₃—30,000 1 w. Continental
- R₄—25,000 ohms, 25 w. Ohmite 0389
- R₅—50,000 ohms, 10 w. Ohmite

- R₁, R₁₂—10,000 ohms, 25 w. Ohmite 0385
- R₆—30,000 ohms, 1/2 w. Continental
- R₇—1 megohm, 1/2 w. Continental
- R₈—250,000 ohms, 1 w. Continental
- R₉—1 megohm, 1 w. Continental
- R₁₀, R₃₂—Speech control—Yaxley type N
- R₁₁—50,000 ohms, 1 w. Continental
- R₁₂—1000 ohms, 1 w. Continental
- R₁₃—200 ohms, 10 w. Ohmite
- R₁₄—RF gain control, Yaxley type G
- R₁₅, R₁₆, R₁₇, R₁₈, R₁₉, R₂₀, R₂₁, R₂₂, R₂₃, R₂₄, R₂₅, R₂₆, R₂₇, R₂₈, R₂₉, R₃₀, R₃₁, R₃₂, R₃₃, R₃₄, R₃₅, R₃₆, R₃₇, R₃₈, R₃₉, R₄₀, R₄₁, R₄₂, R₄₃, R₄₄, R₄₅, R₄₆, R₄₇, R₄₈, R₄₉, R₅₀, R₅₁, R₅₂, R₅₃, R₅₄, R₅₅, R₅₆, R₅₇, R₅₈, R₅₉, R₆₀, R₆₁, R₆₂, R₆₃, R₆₄, R₆₅, R₆₆, R₆₇, R₆₈, R₆₉, R₇₀, R₇₁, R₇₂, R₇₃, R₇₄, R₇₅, R₇₆, R₇₇, R₇₈, R₇₉, R₈₀, R₈₁, R₈₂, R₈₃, R₈₄, R₈₅, R₈₆, R₈₇, R₈₈, R₈₉, R₉₀, R₉₁, R₉₂, R₉₃, R₉₄, R₉₅, R₉₆, R₉₇, R₉₈, R₉₉, R₁₀₀

- C₁, C₂, C₃, C₄, C₅, C₆, C₇, C₈, C₉, C₁₀, C₁₁, C₁₂, C₁₃, C₁₄, C₁₅, C₁₆, C₁₇, C₁₈, C₁₉, C₂₀, C₂₁, C₂₂, C₂₃, C₂₄, C₂₅, C₂₆, C₂₇, C₂₈, C₂₉, C₃₀, C₃₁, C₃₂, C₃₃, C₃₄, C₃₅, C₃₆, C₃₇, C₃₈, C₃₉, C₄₀, C₄₁, C₄₂, C₄₃, C₄₄, C₄₅, C₄₆, C₄₇, C₄₈, C₄₉, C₅₀, C₅₁, C₅₂, C₅₃, C₅₄, C₅₅, C₅₆, C₅₇, C₅₈, C₅₉, C₆₀, C₆₁, C₆₂, C₆₃, C₆₄, C₆₅, C₆₆, C₆₇, C₆₈, C₆₉, C₇₀, C₇₁, C₇₂, C₇₃, C₇₄, C₇₅, C₇₆, C₇₇, C₇₈, C₇₉, C₈₀, C₈₁, C₈₂, C₈₃, C₈₄, C₈₅, C₈₆, C₈₇, C₈₈, C₈₉, C₉₀, C₉₁, C₉₂, C₉₃, C₉₄, C₉₅, C₉₆, C₉₇, C₉₈, C₉₉, C₁₀₀

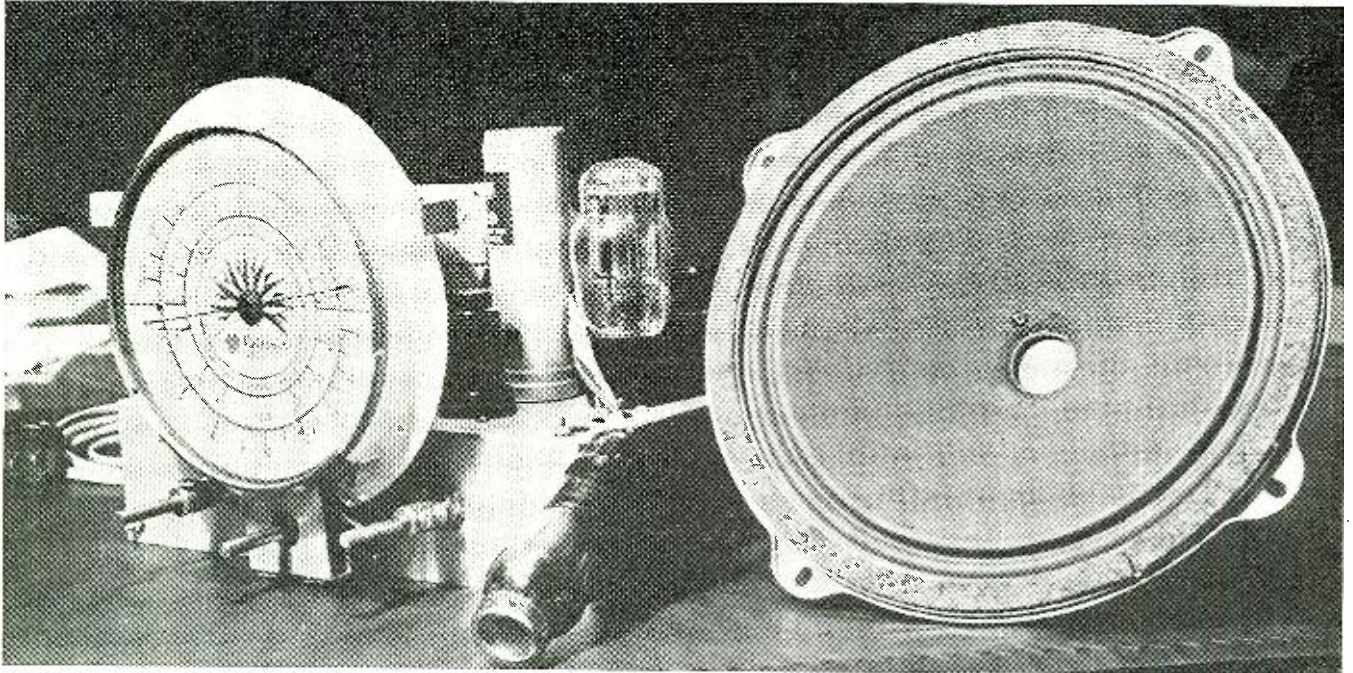

Just the type of set for use in picking up those foreign news broadcasts.

Homebuilt 8 Tube Super

by SEYMOUR BERKOFF

Bronx, New York

MOST radio experimenters keep a good receiver for permanent use around the workbench. Most of the time it is a home built job, and the builder usually incorporates at least two bands, a high degree of sensitivity and selectivity, and most important of all, simplicity in design and lack of strain on the pocketbook. With these thoughts in mind, the writer painstakingly experimented over a period of several weeks and finally produced a completely satisfying receiver that fulfills these requirements.

This little receiver has eight tubes and covers the 540-1700 kc. and 6-18 mc. bands. It is probably one of the smallest eight-tube receivers ever built, for the chassis measures only 7" x 10". However, its size is by no means a drawback. Its sensitivity on the short wave band is between 1 and 5 microvolts, while on broadcast it is better than 1 microvolt, with a surprisingly low noise level. Its maximum output into the primary of the output transformer was measured at 3.2 watts, and the set easily works a ten-inch speaker.

The harmonic distortion at maximum output is very low, for reasons which will be given later. The amplification before the detector is so large that the shadow angle of the 6G5 indicator tube overlaps on practically all of the local broadcast stations. Aligning the tuned circuits is so simple that

no signal generator or output meter is required. And the cost, excluding speaker and tubes, is about fifteen dollars, a small price, considering the capabilities of the set.

The first thing to be decided on was the choice of tubes to be used and the function each was to perform. It was quite a problem whether to use a t.r.f. stage. The advantages of a t.r.f. stage are a slightly lower noise level and a better image frequency ratio, while its chief disadvantages are the increased cost and the fact that its r.f. gain on short wave is very low. It was decided to use an extra i.f. stage instead of a t.r.f. stage for the latter two reasons. The lineup of tubes would then be: oscillator, mixer, two i.f. stages, a detector a.v.c. and audio tube, power amplifier, rectifier, and a tuning indicator.

Experiments showed the 6C5 to be a very satisfactory oscillator, but the choice for mixer was to be made from three tubes, the 6A8, 6L7, and 6K7. Experiment was again resorted to, and the 6K7 as a mixer proved superior to the other two, because it afforded considerably more gain without losing any of the advantages of the other two. The 6K7 was again the logical choice for the i.f. stages, and the 6Q7 detector, a.v.c. and audio, and 41 power amplifier followed, with the 80 rectifier and 6G5 indicator falling in line.

So much for the tubes and now for

the circuits. Starting at the antenna, the first thing is a 465 kc. wave trap, designed to suppress interference from code signals. There are two different types of wave traps on the market, and each is connected differently into the circuit. One of them consists of a small coil which is tuned by a fixed condenser. This type *must* be connected in series with the antenna to the primary of the antenna coil. The second type consists of a small winding which is linked with but not connected to a second winding, the unit resonating at 465 kc. This trap must be connected *between* antenna and ground. Either type of wave trap is satisfactory, but the builder should make sure which he

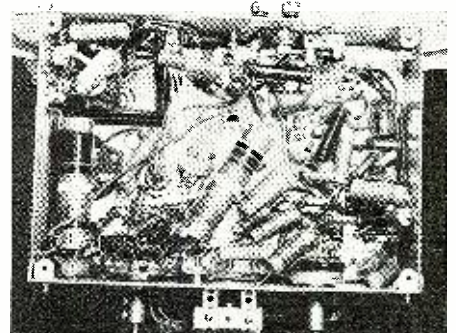

Underside the chassis looks the same as under any receiver.

For those who would wish to listen in on foreign broadcasts—or for the amateur radio man—this superheterodyne receiver really “goes places” in style. It is not too difficult to build, either.

is using, because it will ruin the operation of the set if the trap is connected in the wrong way.

The primary of the short wave antenna coil is connected in series with the primary of the antenna broadcast coil. The usual method calls for a switching arrangement between the two primaries, but in this case it is necessary to use the series connection. The series connection will not weaken signal strength on either band.

It is desirable to use electron coupling between oscillator and signal voltages because of its stability, so the oscillator voltage is applied directly to the suppressor grid of the 6K7 mixer. The screen grid is located between the control grid and the suppressor, and is thus an effective electrostatic shield between oscillator and signal voltages. In this manner, the 6K7 retains the advantages of electron coupling afforded by the 6A8 and 6L7, and has the additional feature of providing considerably more gain.

The circuits around the 6C5 require

special explanation.

The oscillator circuit, as originally designed, called for a single .00025 mfd. grid condenser. With this arrangement, however, the oscillator efficiency was so high that the receiver spilled into audio oscillation on both bands. In order to reduce the oscillator efficiency so the set would be stable, the impedance in the grid circuit had to be increased which meant using a smaller value of grid condenser. On the short wave band, the maximum permissible value was found to be .00003 mfd., although as low as .00001 mfd. may be in its place.

The value .00003 mfd. was not as

satisfactory for the broadcast band, however, since the impedance of a condenser is higher for low frequencies than high frequencies. The most satisfactory value for the broadcast band was found to be .0001 mfd. and a

(Build further on page 59)

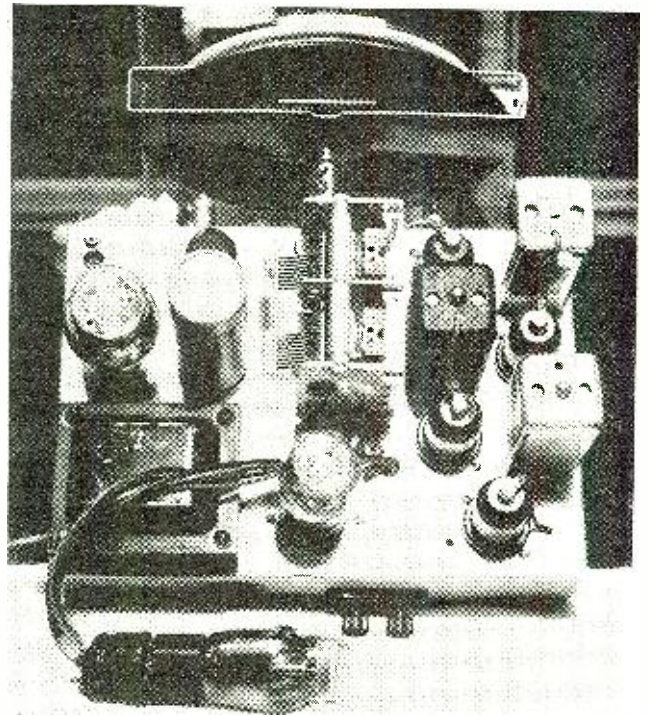

Note the simplicity of the layout of the parts on the top of the chassis. A “shadow-tube” is included.

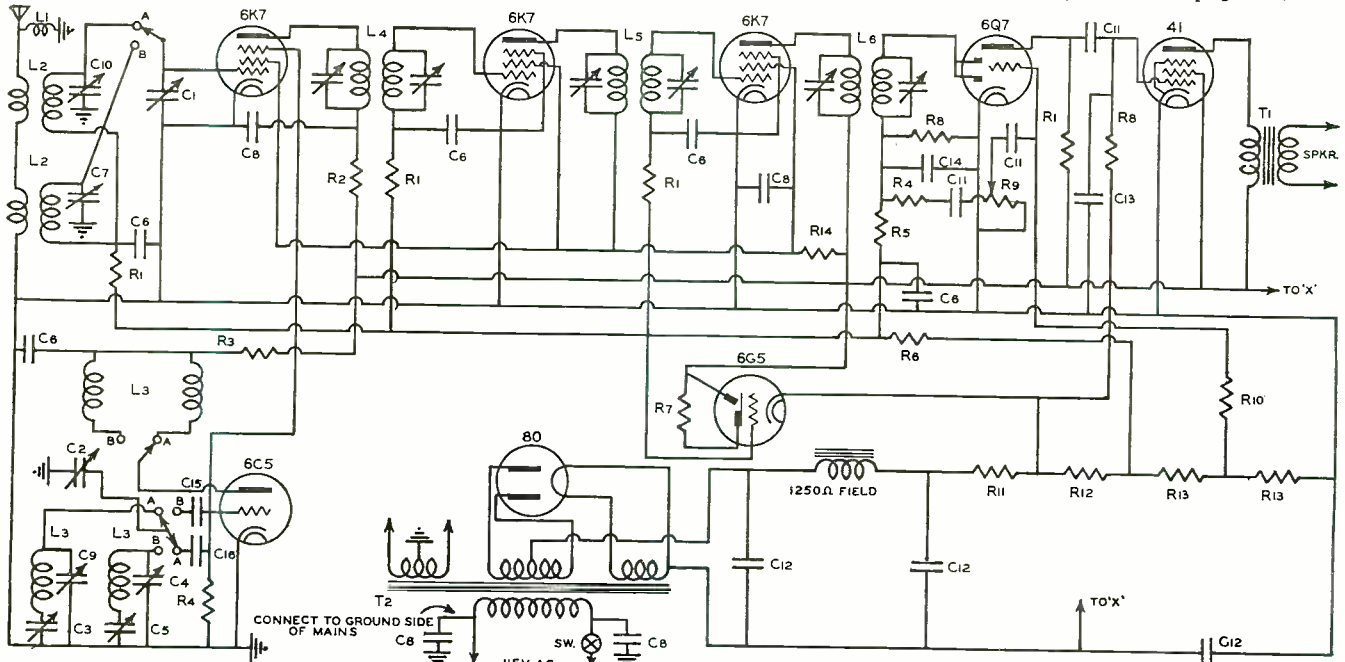

Circuit diagram of the Home-built Superhet.

C₁, C₂—.00035 mfd. variable. Meissner.
C₃—.005 mfd. mica. Cornell Dubilier.
C₄, C₇, C₁₀, C₁₀—1-12 mmf. trimmer. Meissner.
C₅—.0005 mfd. padder. Meissner.
C₆—.1 mfd. paper. Cornell Dubilier.
C₈—.05 mfd. paper. Cornell Dubilier.
C₉—.02 mfd. paper. Cornell Dubilier.
C₁₁—8 mfd. 450 v. electrolytic. Cornell.
C₁₂—.00025 mfd. mica. Cornell Dubilier.
C₁₃—.0005 mfd. mica. Cornell Dubilier.
C₁₄—.0001 mfd. mica. Cornell Dubilier.
C₁₅—.0001 mfd. mica. Cornell Dubilier.
C₁₆—.00003 mfd. mica. Cornell Dubilier.

R₁—100,000 ohms, 1/4 w. IRC.
R₂—3000 ohms, 1/4 w. IRC.
R₃—15,000 ohms, 1 w. IRC.
R₄—50,000 ohms, 1/4 w. IRC.
R₅, R₆, R₇—1 meg., 1/4 w. IRC.
R₈—500,000 ohms, 1/4 w. IRC.
R₉—500,000 ohm control with switch. IRC.
R₁₀—2 meg. 1/4 w. IRC.
R₁₁—300 ohm, 10 w. Ohmite.
R₁₂—200 ohm, 10 w. Ohmite.
R₁₃—20 ohm, 1 w. IRC.
R₁₄—25,000 ohms, 2 w. IRC.

L₁—465 kc. I.F. transformer. Meissner.
L₂—2 band antenna coil. Meissner.
L₃—2 band oscillator coil. Meissner.
L₄—465 kc. input. Meissner.
L₅—465 kc. intermediate. Meissner.
L₆—465 kc. output. Meissner.
Spkr.—10 inch, 1250 ohm field dynamic. Jensen.
Power transformer—Pri. 110 v. 60 cycle, secondaries of 6.3 v. @ 3 A., 5.0 v. @ 2 A., and 700 v. @ 75 ma. Thordarson or Stancor.

Service man's Experiences

by LEE SHELDON

Chicago, Illinois

Use your head. Never try to impress your customer with instruments.

First try to determine what the trouble is, and then—use your head.

AL had an inverted *Bosch* on the bench when I came in, and I watched him as he took a two-mike paper condenser off the shelf, grounded one wire, touched the other to a hot set lead, and then touched the two together. A spark snapped between them.

"Fine way to test a chassis!" I said. "Why didn't you use a meter?"

"Every year at this time it's the same story," my partner replied. "Before Christmas, you kill time in the store waiting for a rush. Then, after it fails to materialize, you try to excuse yourself by saying so many customers saved money for presents they couldn't afford to buy new sets or parts. Why don't you work up your own holiday rush?"

"I was merely trying to point out," I said, "that you were using very crude methods of analysis on our repair jobs."

"That wasn't set analysis," Al replied. "The work on the *Bosch* is finished. I was checking the condenser. I hate to change the subject abruptly," he continued, "but have you located any holiday prospects—or isn't our Christmas to be a merry one?"

"There might be a remote connection between your antiquated test methods and the local depression now in force," I said, with what, to an ordinary person, would have been telling sarcasm. "Why haven't you established a uniform servicing routine, accomplished entirely by instruments, for all the receivers we get? If regimentation is good enough for factories, it's—"

"I'm not running a production line," my partner replied. "When sets are being assembled, a prime cost consideration is to make them all alike; but when they fly to pieces, they are liable to go in *any* direction. A fixed routine would waste too much time—visual observation should make most of the checks unnecessary, and should clear the way for proper instrument use on the remaining parts."

"What a man!" I third person'd. "He finds and fights faults with his bare hands! Listen, Al," I switched, "such primordial servicing technique may have been passable twenty years ago, but don't forget, my Tarzan of the t-r-f, this is today. We live

in a rapidly-advancing era of science!"

"Yes, I know these are short-changing times," Al replied, "but I also know you're the type of repairman who overlooks too many obvious indications of fault. When you service a set, you misuse every instrument in the shop by trying to make them think for you. You're so eager to scorch a pathway



"Somehow all the joy is gone out of my life,—without my radio!"

through science you set up a scientific panorama around your work and test for three days before you replace a pilot light. Why keep the customer waiting? Look for the simple causes first!"

"Next," I declared, "you'll be telling me that oscillators and 'scopes are not necessary!"

"No," Al replied, "that's not what I'm saying. They *are* necessary—but not at times when the manufacturer doesn't recommend it. Save them for their proper uses—they occur often enough without inventing others. Sure—one 'scope picture is worth 10,000 ergs—but only when the receiver requires it!"

"A repairman who doesn't take full advantage of *all* the instruments in his shop," I maintained, "is like a photographer who uses a tripod with one leg missing."

"You can usually get a good picture without a tripod," Al argued, "providing you let in enough light and keep both feet on the ground. Now—what about that holiday trade?"

"Let the customers come in," I said, "why should I bother them when they are busy combing out whiskers and cleaning charred mail-order catalogues out of fireplaces?"

Just then a customer *did* interrupt us. I glanced at Al with an I-told-you-so expression; he couldn't have come in at a better time. Our holiday trade was beginning to pour in!

"I want," the customer—the slight, dark, excitable foreign type—requested, "the largest set you have in the store. My family is away—due back Christmas eve. Meanwhile, I am preparing a surprise for them—many surprises. A radio is one of them."

"You say you want the largest one?" Al inquired. "We have—"

"The *largest*," the little fellow confirmed. "I have promised Bernice—my daughter—the biggest set I could find if her department was all it should be during the trip. Mrs. Dupre—my wife—reports good conduct. Have you a yardstick handy?"

"Want a record-changer with it?" Al suggested.

"Excellent!" he replied. "That will surely please them both!"

The largest job we happened to have in stock was a *Stromberg-Carlson* combination. Dupre, aglow with the arrangements for the surprise, kissed his fingertips, paid cash, and insisted upon taking the set home with him in his car.

He left some of his holiday glow in the store with us, and the sale took the edge off any difference of opinion Al and I might have had about test equipment. There's nothing like a clean, quick cash sale to immure partner argument! But we were wrong in thinking we had heard the last of Mr. Dupre.

Things went along pretty well until I relieved Al for lunch the afternoon of the day before Christmas. I had made all the last minute deliveries, and had drunk the usual run of pre-holiday spirits which are poured down every serviceman's throat at that time of year. There was a warm gin high-

(More Experiences on page 44)

BENCH NOTES



by **LEE WARD**

Service Manager, San Francisco, California

How smart are you? Here's a chance to win a fine prize just for using your eyes, brains and serviceman's intuition.

HOW good a serviceman are you? This month's BENCH NOTES provides a quick test of your ability in REPAIRMAN'S RIDDLE NO. 3. You don't have to be a serviceman to compete—just keep Ohm's law in mind as you read it. The prizes are worthwhile—so drop us a line as soon as you get your answer. *Write complete explanation.*

Here's a tip: Be brief! Lee Ward writes: "The boys who replied to the previous problems have been responding too generously. Some send in very lengthy solutions. Last week I mistook one of them for the first draft of BYE-BYE WITH THE BREEZE. While I appreciate their interest enough to read through anything under 15,000 words, please let the readers know their answers are not appraised by weight."

That's just his way of saying that a few well-chosen words behind a post-card should be enough to put you in the running, and

that brevity—being an expression of understanding—makes it easier for you to win.

Ward's awards for Problem No. 2 will appear in the next issue. Did you submit? Then get in on No. 3! Lee shouts "Lights! Action! Camera!" to which we add, with editorial dignity: "Illumination! Movement! Photography!"

Address all answers to REPAIRMAN'S RIDDLE NO. 3, c/o RADIO NEWS, 608 South Dearborn Street, Chicago, Illinois. Duplicate prizes to tie winners. Entries must be received at RADIO NEWS on or before December 31, 1939, to qualify.

PRIZES

for those sending in the best answers:

First Prize: Your choice of either a Triplet, Model 426, 4" square, 0-1 MA, DC meter or a Simpson Model 29, 4 1/2" x 4 1/8", 0-1 MA, DC meter.

Second Prize: The famous and useful book, *The Radio Trouble Shooter's Handbook*, by Ghirardi.

Third, Fourth, and Fifth Prizes: A twelve month's subscription to RADIO NEWS (if you are a subscriber, then a 12 mos. extension).

These are not intended as prizes in the usual contest sense; rather, we offer them in tribute to your technical ability. Perhaps we are too idealistic, but we believe that—in a radio store, or in a radio magazine—material reward should follow proficiency as immutably as dogs follow cats.

Simply draw upon your experience. All the information needed for the correct analysis and solution is given here-with; the complete data is before you. No box-tops. Easy—if you know your stuff!

ETE—the *Signal-Chaser*—left a distributor's service department to join us. I remember he stated on his application blank that his "reason for leaving last position" was because it had become "too routine—found myself getting stale." I wondered at the time how work as continuously different as radio repairing could ever become routine.

Later, as I watched him diagnose troubles in the shop after the outside men had failed, I understood. He knew the particular sets the distributor carried so well he could usually tell what their faults were as soon as he heard the model and serial numbers.

He wasn't so hot on the other models, but he learned quickly, and—topnotch repairmen being as rare as they are—I allowed him plenty of time to broaden his experience.

Because of his impatience with the other men, he was very unpopular at first. I kept him in the shop, where all the toughest jobs landed sooner or later, leaving the "guarantee" and "tube" calls to the boys whose talents ran along sartorial lines. Pete's talents, you see, did not run into banter or dress. He thought anyone with more than two ties was effeminate, and I believe—had I permitted it—he would have come to work in overalls.

As time passed, his nickname lost its jealous connotation, and the *Signal-Chaser* came to be the undisputed king of the main bench: tyrannical, abrupt, and often discourteous—but sympathetic.

I enjoy witnessing his treatment of

outside men who come to him with recalcitrant chassis. Pete is at his best under such conditions, and many a lazy repairman has learned to think for himself rather than feel the bite of stinging words.

Last week Cliff sheepishly brought in a *Philco 20*.

"What's wrong with it?"

Naturally, if Cliff had known, he wouldn't have brought the thing in; Pete had asked merely for the pleasure of watching him squirm.

"I don't know," Cliff admitted. "All the voltages are normal."

"Then take it back to the customer," Pete ordered. "Why leave it here?"

"It has poor tone quality," Cliff replied, "and the volume doesn't follow the control up the way it should. I checked the tubes—"

"That's the one thing you do well!" Pete derided.

"—and I replaced the detector and output tubes to make sure the checker wasn't wrong," Cliff continued. "I even put up a longer antenna to make sure the low volume wasn't caused by too little antenna gain."

"Did you expect r-f gain to declare a dividend in the audio system?" Pete asked. "It *might* have helped if you mowed the customer's lawn."

"It didn't need it!" Cliff said angrily.

(Follow the problem to page 66)

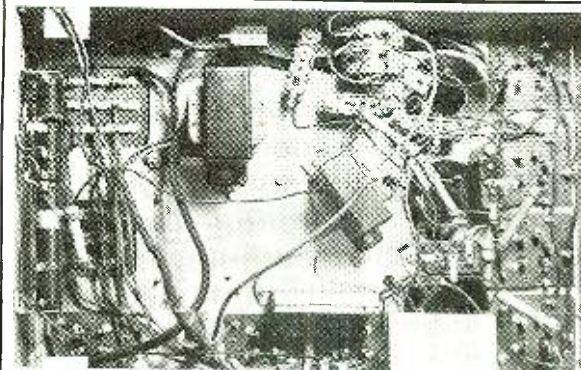
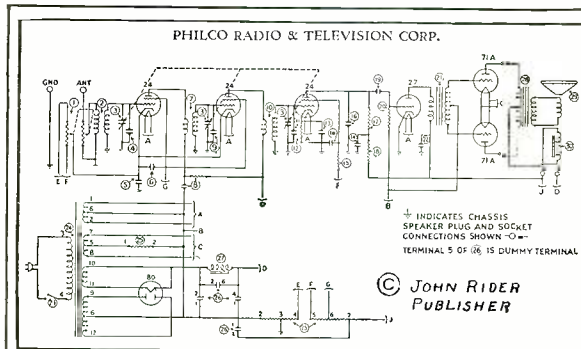

Schematic and underside of the offending set with the defective part in plain view.

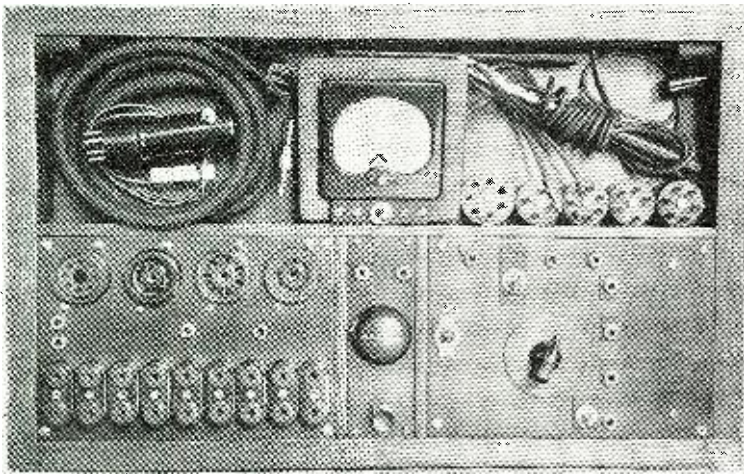

The completed tester is quite commercial in appearance.

The third prize winner of the recent picture-radio contest tells how to build a simple tester for the ham and serviceman. Its uses are many and cost very, very low.

by GLENN HALDEMAN
Elkins, West Virginia

“INEXPENSIVE TESTER”

THE instrument consists of two main sections, the *Meter Section* and the *Analyzer Section*. The *Meter Section* is made up of an a.c. and d.c. voltmeter, a d.c. milliammeter, and an ohmmeter. These instruments cover the voltage, current, and resistance ranges found in the average radio, with the exception of filament and heater currents. These could also be covered by adding suitable shunts to milliam-

meter. The a.c. voltmeter may be used as an output meter by connecting C1 in circuit, S5 to OFF position, when connections are made to plate of tube and ground of receiver. Output may be read with a.c. voltmeter across voice coil but the plate to ground connection is more readable as the deflection of meter pointer is about twenty times as great.

The *Analyzer Section* makes it possible to make most voltage, current, and resistance tests, also output tests, without removing the chassis from the cabinet. *Yaxley* Shorting Jacks were used instead of switches, as, in my opinion, they are quicker, more flexible, and less chance of error.

A good idea of the worth of a tube may be had quickly, while it is in the *Analyzer* socket, by connecting the 4.5 volt ohmmeter battery in series with control grid, by means of jumpers be-

The voltage readings on resistance coupled circuits will sometimes be inaccurate, especially on the lower voltmeter ranges, but approximately the correct voltage may be calculated by allowing for the meter resistance and the resistance of the circuit in question. For instance: Grid voltage on a tube with a 500,000-ohm grid resistor in the grid circuit will actually be about six times the reading on the 100-volt range, due to the shunting of 100,000 ohms meter resistance across the 500,000-ohm grid resistor.

Safety Pushbutton Switch, S4, must be ON for accurate ma. and ohms readings, especially low ohms, due to about 15 ohm resistance of fuse.

There is some difference in actual a.c. voltage and reading on scale of the d.c. meter used. This is shown on Scale Comparison chart on tester section diagram.

METER SECTION

M—O-1 Ma. Foundation Meter. 3" square, "Lafayette" from Wholesale Radio Service Co., Inc., New York City. 50 ohms internal resistance.

S₁—Range Selector—12 point Yaxley Rotary Switch.

S₂—SPST Toggle Switch—Close for Ma. and Ohms—Open for Volts.

S₃—DPDT Toggle Switch—for Hi and Lo Ohms, should be on Hi at all times, except for Lo ohms reading.

S₄—SPST Push Button Switch across Fuse, On for accurate reading of Ohms and Ma., due to resistance of Fuse.

S₅—SPST Toggle Switch—Off when Output Meter is used connected to plate of tube and ground, or across P P tubes. Keeps d.c. out of meter.

S₆—SPST Toggle Switch—On for a.c., Off for d.c.

R₁—505 Ohm Shunt for 100 Ma. Range.

R₂—1.02 Ohm Shunt for 50 Ma. Range.

R₃—5.55 Ohm Shunt for 10 Ma. Range.

R₄—1 Megohm Semi-Precision Resistor. 1,000 Volt Range d.c.

R₅—500,000 Ohm Semi-Precision Resistor. 500 Volt Range.

R₆—100,000 Ohm Semi-Precision Resistor. 100 Volt Range.

(Continued on page 58)

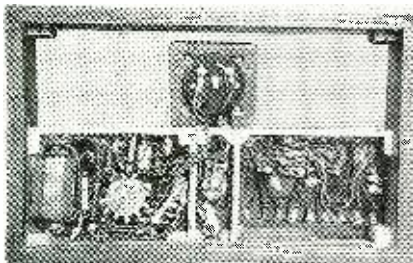

The back of the tester.

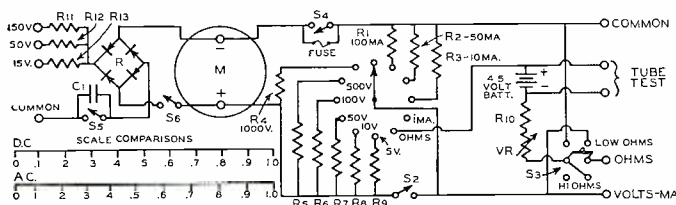

Circuit diagram of the tester section.

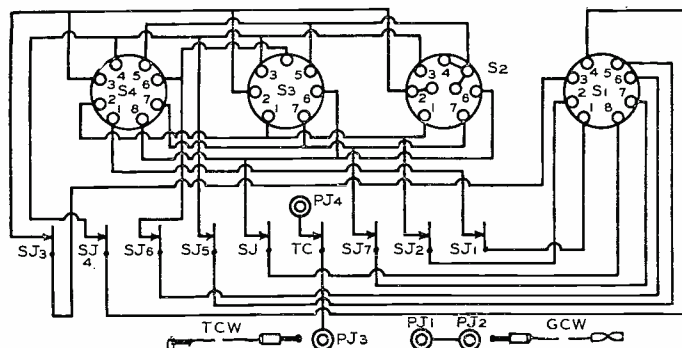

tween pin jacks and shorting jacks and shorting jacks, with milliammeter in plate circuit, and note change in plate current, if any. Positive to grid should increase, negative to grid should decrease current. Amount varies according to type of tube and circuit.

When making tests of resistance on circuits shunted by electrolytic condensers polarity of meter and condenser should be the same or inaccurate reading may result.

What's **NEW** in Radio

Montgomery Ward & Co. present a new idea in amplifiers.

This new sound system has its foundation on the need existing for a means of reinforcing the public speaker's voice at small and medium meetings—without the bother and intricacies of setting-up the usual "so-called" portable sound system.

This new ORATOR is a complete sound system, including special microphone, amplifier and speaker mounted in a single case. It is set-up by plugging into any a.c. light socket, and requires no further connections.

The crystal microphone is of special design, allowing operation in close proximity of the reproducer without feedback at reasonable volume levels. An illuminated manufacturing stand is built into the top of the case, which places the microphone close to the orator, thus assuring good pickup and elimination of extraneous noises.

The amplifier provides 15 to 18 watts power. Volume and tone controls are located on the top panel of the case for ease of operation during use.

There is an 8-inch P.M. Dynamic Speaker built into the carrying case, with special acoustic chamber which to a great extent makes possible the remarkable operation of this unit. One or two external speakers may be connected to sockets provided on the rear of the case. There are also phonograph input jacks.

Dimensions are 18" high, 22" deep and 12" wide. Shipping weight is 7.5 lbs.

Hytronic Laboratories has just developed a filament-type beam-power tetrode for use in mobile and portable transmitters. This tube, known as the HY69, has characteristics that make it suitable for applications now calling for our type HY61 or the R.C.A. 807.

Our type HY69 has a thoriated-tungsten filament designed for operation directly from a 6-volt storage battery. The amperage of this filament is 1.5 and the heating characteristics of it are such that it will reach operating temperature before the motor generator has reached its normal operating speed.

Therefore, the tube is ideally adapted for those transmitters in which the stand-by period is very much greater than the transmitting period.

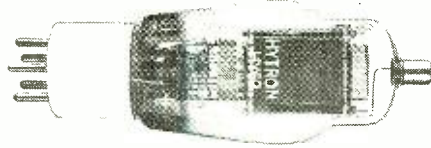

Also, the tube can be used to advantage in transmitters where the filaments are continuously lighted, for such operation has a tendency to reactivate the filament. This is in direct contrast to the characteristics of a cathode which has a tendency to dissipate itself during those periods when the filament is lighted and no voltage is applied to the tube.

The Hytron HY69 has a plate dissipation of 40 watts which makes it desirable for use in frequency multipliers or low level modulated amplifiers where hitherto the plate dissipation has been the limiting factor. The tube carries a maximum plate rating of 600 volts at 100 ma. for both c. w. and radio telephone operation.

As an audio amplifier, one type HY69 in Class A will deliver approximately 7.5 watts with only 350 volts on the plate. At a plate voltage of 500, the power output for a single tube is increased to approximately 14 watts. Naturally, in push-pull two tubes will deliver more than twice this amount of power. In Class AB-2, more than three times this power is obtainable from a pair of HY69's.

The HY69 can in many instances be used to replace the cathode type tubes now in use. Data available from Hytron Corp., 76 Lafayette St., Salem, Mass.

Condensers up to 200 mf. used in refrigeration work are tested on the No. 230 A-C Bridge of the Clough-Bengtle Co., Chicago, while the instrument ranges down to 2 mmf. for measurement of small trimmers, wiring and switch capacity.

Through a unique switch circuit, up to 550 d.c. volts can be applied to condensers during capacity measurement, so as to insure correct readings of capacity and power factor under conditions of actual use.

Electrolytic leakage is checked with new speed, accuracy and meter-safety by an exclusive inverse voltage drop method of test that is read directly on a new "Leakage-per-Mf." scale, with rejection calibrated to U. S. Navy specifications.

Leakage-resistance is by volt-ammeter method, widely employed in commercial laboratories, and here adapted for use in a portable instrument. Range is up to 2500 megohms, read directly on the meter.

Both electrolytic leakage and leakage-resistance tests can be made (through toggle switches) with the same control settings for measuring capacity—a great time saver. Complete ranges are as follows:

Capacity: 2 mmf. to 200 mf. in three ranges. Also shows opens and shorts.

Resistance: 2-5000 ohms, 5000 ohms—20 megohms.

Inductance: With external standards, as desired.

Paper Power Factor: .0-5% on second capacity range.

Electrolytic Power Factor: 0-50% on third capacity range.



Transformer Turns Ratios: .01-100.
Leakage-and-Insulation Resistance: 0-2500 megohms.

Electrolytic Leakage Test: Direct reading "Leakage-per-Mf." scale as above.

The new EXAM-ETER, new Circuit-and-Components-Analyzer introduced by Solar Mfg. Corp., Bayonne, N. J., is claimed to be a rapid and effective trouble-shooter combining more test functions than ever before at the price. EXAM-



ETER is an output indicator, dual range peak voltmeter, r.f. circuit alignment indicator, capacitance bridge, resistance bridge, power factor indicator, leakage indicator, and continuity checker, telling the quality story of components, "Quick as a Wink." For detailed information, write the manufacturer.

Universal Microphone Co., Inglewood, Cal., is now producing its new "M4" series, a new 4 magnet velocity microphone that was formerly cataloged as "RH."

The new model reflects continued scientific advancement in ribbon-velocity microphone construction and is said to be a general all-purpose instrument for p.a., amateur and semi-professional uses.

It is equipped with adjustable cradle and thumb nuts for tilting and locking the instrument in any desired position. It includes a removable bayonet-locking plug and 25 feet of low capacity rubber covered cable.

The frequency range for the "M4" series is from 40 to 10,000 CPS and the output level —64 db and comes in the following standard output impedances: direct to grid (high impedance); to match 500 ohm line, 200 and also 33 ohms to match inputs, mixers or other low impedance lines where dynamic microphones have been used.

A three-prong plug to permit grounding of center tap is available for all models except the direct to grid type.

Manufacturer's claims for the "M4" include

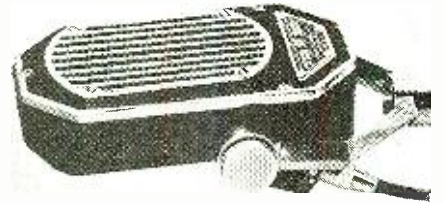

the fact that the instruments are self-energizing, no polarizing voltage, no field or button current required, non-resonant and no background noises or feedback.

Transformer Corp. of America presents its latest contribution to the medium-powered Sound System field in the new Model C-418 Complete Sound System.

Conservatively rated at 16 watts with an 18 watt peak, the amplifier is of the latest circuit design using 6L6 Beam Power Tubes in push-pull in the output stage. The microphone input gain is 113 db and the two phono inputs available have a gain of 60 db. Frequency response is from 40 to 9500 cycles. The output transformer is tapped for a variety of impedances from 2 to 500 ohms.

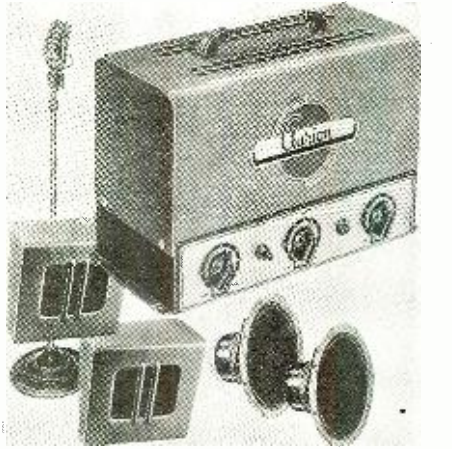

The C-418 System is complete, ready to operate. Two 10" p.m. Speakers in attractive wall baffles, microphone, floor stand, all cables and plugs are supplied. A choice of five modern Crystal, Dynamic or Velocity Microphones is offered.

Streamlined in appearance, dependable and versatile in operation, the C-418 is the ultimate in sound equipment for all average installations and is extremely modestly priced—only \$99.95 List.

Further information may be obtained by writing Transformer Corp. of America, 69 Wooster Street, New York City.

RCA Manufacturing Company, Camden, New Jersey, have produced three new pieces of television test equipment, a piezo-electric calibrator, a 5-inch wide-range oscillograph, and a television alignment oscillator. All three have been carefully designed in accordance with present-day television receiver development, and in addition include provision for future television progress, thus minimizing the possibility of obsolescence.

The instruments have been designed primarily for servicing RCA Victor television receivers, but may be adapted readily to other present-day sight-and-sound receivers. The alignment oscillator is a newly developed instrument specifically designed for visual alignment of the r.f. and i.f. circuits in television receivers. The calibrator and the oscillograph, while indispensable for television servicing, have many applications for other high frequency radio work.

The calibrator is a small crystal oscillator unit having fundamental frequencies at 250 and 2000 kilocycles. Harmonics of these frequencies are such as to provide exact calibrating frequencies for use in all high frequency work. It is accurate to the degree of plus or minus .05%. The unit is complete with its own power supply and acorn type oscillator tube. Selection of either fundamental frequency is obtained by a two-way switch. An output jack has been included for ease of connection.

The 5-inch oscillograph gives a large image of unusual clarity for the finest work. All con-

trols are located on the front panel, and a special step-attenuator (plus a fine control to cover between steps) is provided to prevent changes in frequency characteristics at various input levels. Provision is made for synchronization on positive or negative peaks, an important feature because in certain television tests it is desirable to choose which is to be used.

In television servicing, this capable oscillograph is ideal for viewing synchronizing and blanking impulses, horizontal and vertical sawtooth waves, and grid and plate voltages on the horizontal and vertical oscillators. A special input cable having high input resistance and low capacity is provided. It is easily portable, has a snap-in carrying handle, and is finished in durable blue-gray baked lacquer.



When the new alignment oscillator is used with a cathode ray oscillograph, the selectivity curve of the circuits under test is produced on the television screen. Operation of the new instrument is surprisingly simple. There are only four highly-accurate, easily read controls: the power selector switch for i.f. or r.f. operation; two range switches for selecting the desired i.f. and r.f. channels; and the phase control and switch for adjusting the oscillograph horizontal deflection to provide single image operation. The output frequency sweeps through the r.f. and i.f. bands at a rate of 60 times per second, providing a steady, non-flickering pattern on the oscillograph screen. R.f. and i.f. coaxial transmission lines with proper terminating loads are included.

The new Lafayette Model S-50 receiver presented in the latest Fall catalog of Radio Wire Television Inc. (formerly Wholesale Radio Service Co., Inc.) of 100 Sixth Avenue, New York City, furthers the trend toward small sizes and elegance of appearance in battery portables. Only 12 1/2 inches long, 7 1/2 inches high and 5 1/2 inches deep, overall, it is covered with a most realistic simulation of alligator hide which makes it a fit traveling companion for the finest luggage.

Its combination of four of the newest battery tubes provides excellent sensitivity, using the built-in loop. Other features include a permanent magnet loudspeaker built in, approximately 200-hour service from one set of batteries, coverage of the complete broadcast band plus police services to 1725 kc. and a carrying handle that provides complete comfort in transportation.

Eicor, Inc., 515 S. Laffin Street, Chicago, Illinois, have a new line of Utilite Electric Power Plants with higher capacity at lower cost.



These new units, rated at 450 watts a.c. and

500 watts d.c., and driven by a well-known engine, represent a distinct advancement in the power plant field.

The a.c. models operate at 1800 r.p.m. and furnish 450 watts 110 volt 60 cycle current with ample reserve for temporary overloads. This high output assures plenty of light at all times, or sufficient power to operate a variety of small appliances for farm or camp use.

Electric push button starting is built in— with 6 volt starter battery which can be charged automatically. A.C. types are also available with remote control starting and stopping stations. These highly efficient Eicor power plants are safe, easy to install and simple to operate. Size of all models: 17" high, 15" wide, 17" long. Net weight, 90 lbs.

Other Eicor products include a complete line of electric plants from 300 to 2000 watts, a.c. and d.c.; also Dynamotors and Rotary Converters.

Erwood Sound Equipment Company has just announced a new 18 watt amplifier, known as the Model 2-118-A.

Particularly adapted to general public address requirements, it is of outstanding appearance and capable of superb reproduction.

Model 2-118-A has input facilities for two microphones, or one microphone and a phonograph, a tone modifying control permits adjust-

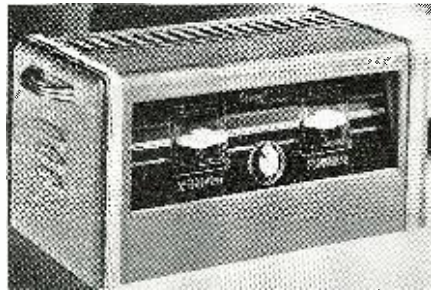

ment of the reproduction to installation conditions. Output impedance is variable. Careful engineering has resulted in a greatly increased dynamic power range, as well as long and trouble free operation.

The circuit utilizes seven tubes which are located in a well ventilated compartment accessible through a hinged door. All transformers are varnish impregnated and wiring is cabled using flame resisting wire.

The cabinet which is of spot welded steel is finished in a deep sheen bronze maroon, the dial plate is translucent, edge illuminated made of a plastic material.

Model 2-118-A amplifier is equipped with a fuse and six foot power cord and plug, and will carry Underwriters' listing.

Webster-Chicago, have designed a new portable PA System for bands, etc.

Many an eye-filling dance-band songstress has blushed half-unseen because there wasn't anything to hold the microphone up before her, except an unsightly table—perhaps pieced-out for height by a frayed trumpet case. Orators, too, have been known to object to bulky objects set

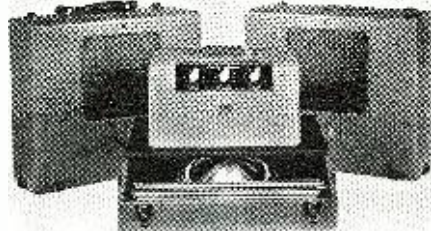

in front of them. Carrying a microphone stand with the portable sound system has been an awkward job. All this is changed in the new "814" system just placed on the market by Webster-Chicago. The two loud speakers still fit together in the familiar manner, into a handy carrying case. But there's now a false bottom. Below it is a full 47-to-60 inch length floor stand, in three sections with full-size round base. Setting it up and taking it down is a matter of a moment or so. The singer's new gown can then be seen, and the band leader needn't scurry about hunting a table. The amplifier is the popular 14-watt size, with plenty of power for all but the largest halls or picnics.

A new multimeter unit of true pocket size yet capable of a wider variety of measurements than many full-size multi-meters is announced by Radio City Products Corporation, New York City, in their Model #12.

A 400-microampere meter of the D'Arsonval type with an Alnico magnet (such as used in the finest meters) is utilized. This is housed in a 3" square Bakelite case which is mounted on the clearly labeled terminal jacks, selector switch and zero adjustment knob. The case, which measures 3 1/2" x 2 1/2" x 6" is of natural finished wood. In spite of the small size the self-contained battery provides for all resistance measurement ranges up to 1 megohm.

Thirteen ranges are provided as follows: D.C. volts 0-10/50/250/1000/5000 (all at 2500 ohms

per-volt sensitivity), d.c. microamperes 0-100, d.c. milliamperes 0-10/100/1000, d.c. amperes 0-10, resistance 0-500/100,000/1 megohm. An unusual feature of this #12 model is that resistance measures as low as 1/10th ohm and current measurements of only 8 micro-amperes are easily read in full divisions of the meter scale. Manufacturing tolerance of 2% maximum error for meter, shunts, multipliers, etc., insures overall accuracy beyond the requirements of most serv-

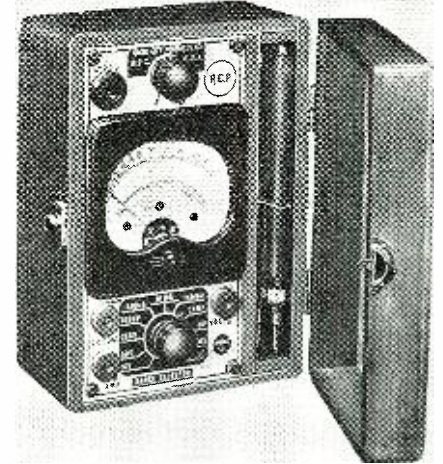

ice and experimental applications.

A Model #12P is also available. This is identical with the #12 except that it is supplied with a hand-rubbed, piano finish, solid walnut case with hinged cover and latch, and with separate compartment for the test probes which are also supplied.

RCA Manufacturing Co., Camden, N. J., have received many requests from dealers and servicemen for a high quality, low cost automatic record changing mechanism. The Accessories-Test Equipment Section of the RCA Manufacturing Company has announced an improved automatic record changer which lists for only \$44.95. Identical with the record changer used in the finest current Victrolas, this improved unit embodies many improvements over a preceding model costing nearly twice as much.

Of simple, fool-proof design, the mechanism plays seven 12-inch records or eight 10-inch rec-

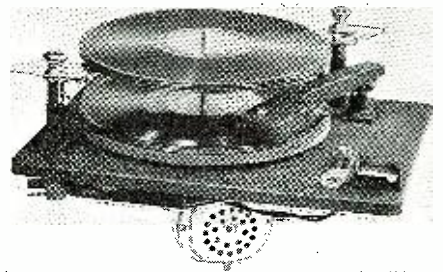

ords automatically. Records of any size may be played manually. Easily installed in any model radio-phonograph combination with a sufficiently large cabinet, it combined ease of operation with excellent fidelity of reproduction.

The record changer Stock No. 0865 is equipped with a top loading crystal pickup with an automatic needle ejector. When removing a used needle before loading the pickup, it is only necessary to loosen the needle screw and push the ejector lever down. The entire unit is finished in brown wrinkle lacquer with chromium trim. Dimensions of the motorboard are 14 1/4 inches wide and 11 1/2 deep; space required above the motorboard is only 4 1/4 inches.

Radio City Products Co., 88 Park Place, N. Y. C., are now in production on a new signal generator.

The Model 702 provides fundamental, contin-

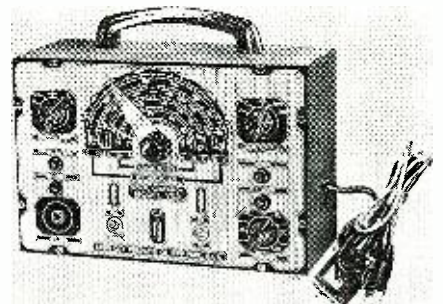

uously variable frequencies from 95 kc. to 25 megacycles, with harmonics extending this use-

ful range to 100 megacycles. All ranges are directly calibrated in frequency with scales designed for easy and accurate reading. To further facilitate accurate adjustment provision is made for direct tuning or through a 5-to-1 planetary drive.

A specially prepared chassis and cabinet provide triple shielding in a high degree and in addition the coil assembly, attenuator and r.f. circuits are individually double-shielded. Thorough filtering in the power supply and an electrostatically shielded power transformer avoid feedback into the line.

Sine-wave, 100-cycle modulation (30%) is provided by a built-in oscillator for use when desired. This modulation frequency is also available for external use and likewise there is provision for applying external modulation to the signal generator output, a feature especially desirable in oscillographic wave analysis.

The attenuation obtained by means of the 5-step ladder attenuator is variable over the range of 1 microvolt to 1/2 volt with approximate calibration in microvolts.

The Model 702 is a.c. operated and doubly protected by quick replacement fuses. The overall size is 8" x 11 3/4" x 7". All controls and terminals are clearly labeled.

The Hickok Elect. Inst. Co., Cleveland, announce a new Tube Tester, No. 530, which measures Dynamic Mutual Conductance on three ranges of Micromhos (0-3000-6000-15000)—a basic patented circuit testing tubes to manufacturers and engineering standards. Dual reading scale indicates, "Good, Bad, Doubtful," as well as micromhos. The roll chart has been greatly enlarged. Note the arrows pointing from the chart on the panel.

No. 530 tests all tubes: Octal, Loktal, Ballast,

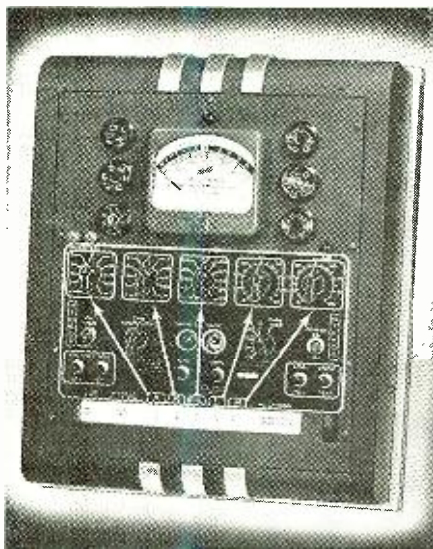

up to 117 volt filament type tubes, Magic eye tubes, new Battery tubes, Gas tubes such as O 4, OA 4, etc., and pilot lamps.

This instrument has many exclusive features of which the following are only a few: Checks gassy tubes—detects both short and open elements—short tests made hot or cold—Diode plates tested separately. Available in counter type (illustrated) and portable case.

For complete information write the maker, The Hickok Electrical Instrument Co., 10514 Dupont Ave., Cleveland, Ohio.

R. C. A. Manufacturing Co. announce three new transmitting tubes.

The 811 and 812 are companion tubes having unusually high power capabilities for their small size. These new tubes feature (1) a "zirconium-coated" plate which has remarkably high heat-dissipating qualities as well as excellent gettering characteristics, and (2) a new, low-loss "M-CANOL" base which has both excellent insulating qualities at high radio frequencies and low hygroscopic characteristics. Both types have high permeance and can be operated at high plate efficiency.

The 811 is designed with a high mu and is intended primarily for operation as a class B modulator without bias up to 1250 volts on the plate. In such service, two 811's are capable of modulating 100 per cent an r.f. amplifier input of 450 watts. The 811 is also useful in r.f. services with full input to 60 megacycles and reduced input to 100 megacycles. Two 811's in class C telegraph service (ICAS ratings) may be used with a plate input of 450 watts and a driving power of only 16 watts. Maximum plate dissipation of the 811 for this service is 5.5 watts.

The 812 is designed with a lower mu than the 811 and is intended primarily for operation as an r.f. power amplifier in the same frequency range as the 811. In class C telegraph service (ICAS ratings), two 812's may be operated at a plate input of 450 watts with the exceptionally low driving power of only 13 watts. Maximum plate dissipation of the 812 for this service is 55 watts. The 812 is also suitable for use as a biased class B modulator and as such is capable of modulating 100 per cent an r.f. amplifier input of 450 watts.

The 828 is a beam power tube designed par-

ticularly for class AB, modulator and a.f. power-amplifier service, but is also useful as an r.f. power amplifier, frequency multiplier, oscillator, and grid- or plate-modulated amplifier. Two 828's in class AB₁ service (ICAS ratings) are capable of delivering 300 watts of radio power

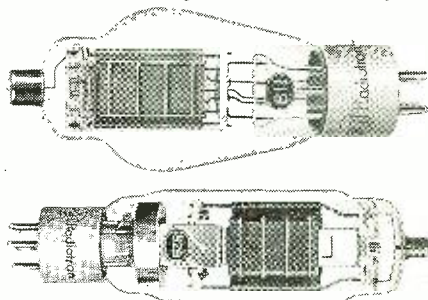

with only 1 per cent distortion. Maximum plate dissipation of the 828 for this service is 80 watts. Because of its high power sensitivity, the 828 can be operated in r.f. services to give full power output with very little driving power, and consequently, with a minimum number of driver stages.

Shure Bros., 225 W. Huron St., Chicago, announce a new dynamic mike. Very latest in dynamic microphone design—a high-quality low-cost moving-coil type dynamic with true cardioid unidirectional characteristics. Eliminates feedback, audience and background noise—greatly reduces reverberation pickup. Employs the exclusive Shure "unimphase" principle. Gives smooth wide-range reproduction from 40 to 10,000 cycles over a wide angle at the front, yet is dead (down 12-15 db) at the rear. Solves many troublesome sound pickup problems in public address, recording and broadcasting. Permissible line length practically unlimited with low impedance models. Rugged, shock-proof construction with specially-suspended double-



wind-screened moving-coil system. Practically unaffected by heat and humidity—ideal for severe outdoor as well as indoor service. Ultra-modern streamlined design finished in beautiful satin chrome. Head tilts through full 90-degree angle. Built-in cable connector. Special locking microphone plug attached to cable. 5/8"-27 thread for stand mounting. Case dimensions: 4 1/4" high; 3 1/4" wide; 3 1/2" deep. Net weight, less cable, 2 1/2 lbs. Shipping weight, 4 1/4 lbs.

American Phenolic Corporation are now making a complete line of ultra-low-loss coil forms molded of Amphenol "912" pure polystyrene. Won't absorb moisture, and won't break. Maintain "Q" of coil, with no insulation losses. Coils may be painted with Liquid "912" to keep moisture out of wire serving, and to hold winding tight. Easy to drill. Available with 4, 5 and 6 prongs, standard RMA spacing. Also manufactured in other sizes and types for ultra-high-frequency use.

Made by American Phenolic Corporation, 1250 Van Buren Street, Chicago, Illinois.

Cornell-Dubilier Electric Corporation, South Plainfield, New Jersey, present new midjet box type multiple electrolytics. Types JR, JRC and JRX dry units in their double cardboard, wax-dipped box containers provide a number of outstanding advantages to the constructor of receivers, test equipment, etc. Among these are unusually high resistance to moisture and temperature changes, insulated pig-tail leads, mounting feet for screw or rivet mounting on chassis, and superb electrical characteristics.

Flexibility of application is provided through the availability of these condensers in single, double and triple units with either common negatives or separate positive and negative leads for each capacitor. Working voltage ratings are 250 and 450 d.c. At the former value the capacities available are: 4, 8, 10, 12, 16, 4-4, 4-8, 8-8, 16-16, 8-8 mfd. The 450-volt types provide capacity ratings of 2, 4, 6, 8, 10, 12, 16 in the single units, 4-4, 4-8 and 8-8 in the dual units, and 4-4-4 and 8-8-8 in the triple units.

All units are 2 1/2 inches long, the other di-

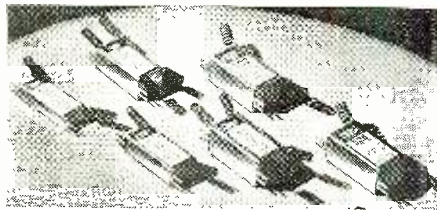

mensions varying from 1/2 to 3/4 inch for the smallest single unit to 1 1/8 x 1 5/8 for the largest triple unit.

Cat. No. 175A describing these and other Cornell-Dubilier capacitors available on request at the main office of the Cornell-Dubilier Electric Corporation in South Plainfield, New Jersey.

Operadio Manufacturing Co., St. Charles, Ill., announced a new portable amplifier.

This new unit is known as Model 425-GG. By incorporating individual bass and treble tone compensators in the amplifier, Operadio engineers have made it possible to bring out the true tonal qualities of the artist or musical aggregation whose performance is being amplified. The controls are set in an illuminated recess in the face of the amplifier.

This unit has provisions for the Operadio Remote Mixtrotor, enabling the operator to mix two microphones from any position he may choose to occupy within hearing of the equipment.

The Model 425-GG is furnished in two carry-



ing cases: one holding the amplifier, microphone and floor stand; and the other a split case, in each half of which is mounted a 12" Operadio extra heavy duty permanent magnet dynamic speaker. These cases are designed to incorporate the Operadio "Infinite Baffle" principle. This speaker assembly is most flexible. The cabinets may be set or hung in almost any conceivable position to allow for the proper distribution of sound.

A regular part of the equipment furnished with the unit, is a sectional type floor stand and one microphone, complete with 25 feet of microphone cord and plug. There are provisions for carrying microphone, cord, and stand on the inside of the amplifier carrying case. Specifications and further details may be had by writing Operadio Manufacturing Company, St. Charles, Illinois.

The new Sprague Interference Locator just announced by the Sprague Products Company, North Adams, Mass., combines high quality, extreme practicability with an unusually low price. Specifically designed for locating sources of man-made radio interference, the Locator consists of a specially designed portable, battery-operated super-sensitive radio frequency amplifier and an audio frequency amplifier, complete with loud speaker. It is equipped with a highly directional, self-contained loop antenna, a "fish pole" antenna, an output meter and 'phone jacks. The combination of loop and telescoping pole antennae is provided to allow the determination of both direction and height of interference sources. The output meter provides an accurate means of measuring the interference level, as well as indicating noise reduction after corrective filters have been applied. Earphones may be used in locations where there is a great deal of audible noise, jacks being provided for these.

The entire unit is completely self-contained and is equipped with a carrying handle. Batteries are guaranteed for a life of 150 hours, and a battery "economizer" switch is also provided to increase battery life when the receiver is used in locations of high signal level.

The receiving unit has an average sensitivity of 40 micro-volts for a 50 milli-watt output, over the entire broadcast range.

By means of a switch, the Locator is convertible into a regular radio receiver, thus permitting demonstration to the customer of the actual reduction in noise level achieved by corrective measures. The receiver tunes the complete broadcast range from 500 to 1600 kc. and may be used for ordinary radio reception.

(Continued on page 56)

Ring the Bell



How to make up and use "pluggers" with the maximum returns and business.

by SAMUEL C. MILBOURNE
Expert Serviceman, Greenwood, Miss.

IN our first article, we decided to make more money in Radio Service. We found out that this could be done only by getting new business through *Effective Advertising!* Thus, 5% was to be saved from our total sales to be applied to an advertising budget. This money was to be kept in an envelope marked "ADVERTISING BUDGET." Another envelope marked "SHOP MODERNIZATION" was to hold a growing fund for modernization of our shop into the *finest looking radio repair shop in town.* Temporarily, we cleaned up the shop and vowed never to let it get dirty again. (By the way, how does it look *right now?* Is that promise being kept?)

Last month we concentrated on telephone campaigns to old customers, new customers and prospective customers. We found that it was absolutely necessary to have a phone in a radio repair business and that it would pay for itself over and over again if correctly utilized. We also found that after selling the first radio repair customer by phone, the second was much easier. Remember that *effective* telephone advertising is based on *perseverance.* We also decided that we could use our satisfied customers as a "springboard" for new customers through a systematized "call-back" service.

This month we will consider other effective modes of advertising, principally by means of small printed materials.

As soon as you bring up the relative merits of various types of small advertising media such as book-matches, station logs, hand-bills, fans, pencils, etc., it usually raises a storm of dissenting ideas and opinions regarding their value. Some do not believe in them at all, some believe in certain types while others think they are all good.

Once more let me impress upon you that *you must fit your advertising to the community and to yourself!* What is one man's profit is another man's poison. You must try each one to see

how it works for *you.* In a short while you can formulate an advertising policy which will be beneficial to *your* business. *Do not be afraid to try something new!*

One of the oldest forms of small printed radio service advertising is the station log. In this item, the serviceman tries to combine an advertising message with information the customer needs and with information that will result in his keeping the ad near the radio for at least a few weeks. This

You will very likely get even better results in some cases than you would get with material locally printed.

The radio log will evolve into a combination radio log and program indicator, particularly in those communities where daily programs are not carried by the local paper.

If you have the use of a mimeograph machine—such as did the serviceman who distributed the little radio paper shown, you can give a very timely aid to community radio enjoyment. He

first obtained a national radio program magazine which listed the programs for the coming week. He then picked the program for each half-hour period which he believed was most interesting to the people in his community. He had to be very careful here, as he was

catering to those who liked classical music, those who liked to "swing it," those who liked the continued stories and plays, and even the youngest element who "went for" the rip-roaring adventure series and children's hours. His selections had to be catholic enough to give all groups their favorites.

These selected programs were arranged according to the days of the week and the hour of the day just like a big city newspaper might run them. He placed his station log at the top of the page and in between each day's program, he inserted little sales messages like: "Do you need an aerial?"; "All types of electrical appliances repaired;" "A fair price for the best radio service;" "Does your radio need new tubes?"; "Man-made static can be eliminated;" "Rapid radio repair service;" "Your radio gives you the most in entertainment for the least money;" "For students of foreign languages—tune to the foreign short wave stations;" "Half-way reception is worse than none;" "A thorough check and adjustment of your set, tubes and aerial," etc., adding his phone number in each case.

He *personalized* this service by offering to give information by phone on

RADIO PROGRAMS CALENDAR FOR USE IN OR NEAR GREENWOOD, MISS.

P. M.	SUNDAYS	MONDAYS	TUESDAYS	WEDNESDAYS	THURSDAYS	FRIDAYS	SATURDAYS	P. M.
6:00	Charlie McCarthy NBC	Accent on Music CBS	Johany Presents NBC	One Man's Family NBC	Rudy Vallee NBC	Lucille Manners NBC	Dick Tracy NBC	6:00
6:30	Charlie McCarthy NBC	Firestone Voice NBC	Eugene Conley NBC	Tommy Dorsey NBC	Rudy Vallee NBC	Lucille Manners NBC	Avalon Time NBC	6:30
7:00	Jim Ameche NBC	Radio Theatre CBS	Battle of Sexes NBC	What's My Name NBC	Major Bowes CBS	Frank Munn NBC	Lanny Ross CBS	7:00
7:30	American Album NBC	Guy Lombardo CBS	Bob Crosby CBS	George Jessel NBC	Major Bowes CBS	First Nighter CBS	Lanny Ross CBS	7:30
8:00	Symphony NBC	Contented Hour NBC	District Attorney NBC	Kay Kyser NBC	Bob Burns NBC	Guy Lombardo NBC	Benny Goodman NBC	8:00
8:30	Symphony CBS	Blondie CBS	Men in Doghouse NBC	Kay Kyser NBC	Bob Burns NBC	Robt. L. Ripley CBS	Jamboree WVA	8:30
9:00	Walter Winchell NBC	Fred Waring NBC	Fred Waring NBC	Fred Waring NBC	Fred Waring NBC	Fred Waring NBC	Barn Dance NBC	9:00

Where To Find NBC STATIONS On Your Radio Dial

KARK - Little Rock - 890 WAC - Memphis - 760
 WJDX - Jackson - 1370 WSB - Atlanta - 740
 WLW - Cincinnati - 700 WSM - Nashville - 650

MILBOURNE RADIO SALES AND SERVICE

RCA VICTOR RADIOS, TUBES AND PHONOGRAPHS

ALL MARKS OF RADIOS PROMPTLY REPAIRED

202 VIRGINIA ST., NORTH GREENWOOD

1214 - PHONE - 1214

Where To Find CBS STATIONS On Your Radio Dial

KMOX - St. Louis - 1090 WHAS - Louisville - 820
 WBBM - Chicago - 770 WREC - Memphis - 600
 WBT - Charlotte - 1080 WWL - New Orleans - 850

The type of "plugger" used by the author with great success.

type of plugger is still working in smaller communities where people cannot remember the location on the radio dial of their favorite stations which may be located in several adjoining states. The cost of these station logs is nominal and they can sometimes be obtained through tube manufacturers at less than cost.

While we are on the subject, let me heartily recommend the advertising aids offered you by the manufacturer of the tubes you sell. Postcards, letterheads, book-matches, tube stickers,

Where To Find CBS STATIONS On Your Radio Dial

KMOX - St. Louis - 1090 WHAS - Louisville - 820
 WBBM - Chicago - 770 WREC - Memphis - 600
 WBT - Charlotte - 1080 WWL - New Orleans - 850

Part of a "plugger" which the author incorporated in his throw-away.

calling cards, signs, package tape, guarantee certificates, decalcomanias, newspaper mats, window displays, counter displays and every imaginable help is offered you either free or at a greatly reduced price. Why not study the sales aids offered by your tube manufacturer and try some of them.

any program not listed and kept a copy of a complete radio program by his phone. He also offered to list in subsequent issues any programs, not previously listed, to which his customers listened. As he received comments or questions regarding the program material, he tactfully asked the prospect if his radio set was receiving the program satisfactorily. If the prospect admitted that the set was not working correctly, the service man launched a service sales campaign to get the repair.

The problem of time necessary to assemble, mimeograph and distribute his program was minimized insofar as

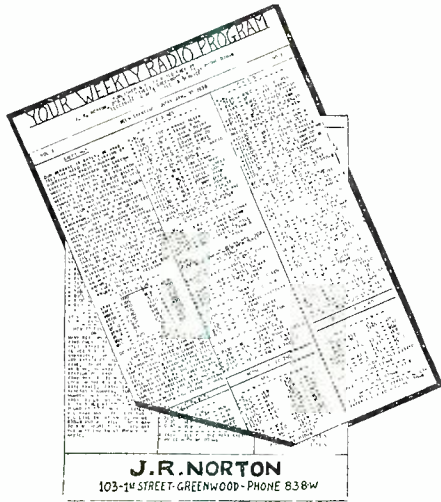

A good serviceman's pluggler.

distribution was concerned by approaching several stores in town and offering to place a small free ad in the program if the store would keep a supply of the programs on the counter and distribute them to its customers. Grocery stores, gas stations, druggist and radio dealers were enlisted and little trouble was encountered for he sold the store owner on the idea that *he was giving his customer added value* for his purchases. A fresh supply of corrected programs were delivered every Saturday morning to catch the heavy week-end shopping. This would have been even better if the delivery date had been advanced a day because during Friday and Saturday the average grocery store does at least half its weekly business and thus has its heaviest floor traffic and package deliveries. Acknowledgement was given in the program of the co-operation of the stores and it was suggested throughout the program that the user should ask for next week's program at *Blank's Grocery* or *Earl Can's Garage*. The idea in using the gas stations and garages for distribution points was to catch the *auto radio owners*.

One of the drawbacks to such a complete program service was the time necessary to assemble the material and mimeograph it. Thus, in my own radio business, I borrowed a type of program which first came to my attention as being used by a Jackson, Mississippi, service organization. As seen,

this is a simplified, card type, combination program and station log measuring 9" x 3½". It is printed on light cardboard (*Navaho Bristol*). I picked yellow for the card color and black printing for the same reason as the originator, namely, these two colors are the easiest to read in all lights. [*That's why they use them for highway signs.—Ed.*]

The main program block is divided into 49 sections, each representing a half-hour portion of the week's time. There are seven columns, one for each day of the week. Each day is divided into half-hours starting at 6:00 p.m. and ending at 9:30 p.m. The programs were carefully picked for listener interest, and available station outlets. As in most smaller communities, reception is limited to stations from 100 miles or more away. Thus, care must be taken not to list a program which cannot be received easily.

Under each program is listed the *chain* through which it is broadcast. In the lower left hand corner is listed six of the stations on the NBC chain which are received satisfactorily in this location. In the right hand corner is listed six CBS stations in the same manner. After each call letter is given the town and frequency.

In the lower middle center is the shop name and a small ad.

For those doing business in a city which "sports" a station on each chain, the actual station call letters can be used in the individual program blocks in place of the chain letters.

An arrangement with a local printer allows the type to remain "made-up" and revised programs are printed as the changes in program material warrant.

The cost of this type advertising should be nominal. Five hundred cards were obtained for \$6.00 with reprints of the same amount of \$4.00 plus labor cost of composition changes.

Here, again, the local merchant will be glad to help distribute these programs for you, *particularly if you allow him to imprint the back of the program with his ad*. This he can and will pay for and, in large cities where the amount of cards distributed would be over a thousand you should be able to get him to pay the entire cost (or a large percentage of the cost) of the program card.

I spent about four hours distributing these programs throughout the business district. In every case I was thanked for the card, it was hailed as something quite valuable to the recipient and I received enough radio repair business *that morning* to *more than pay* for the cost of the card.

Once more let me repeat that this type of advertising will be most effective where local newspapers do not carry daily programs, but it has also

been very successful in a city which supports at least two daily papers, both of which carry their own daily programs.

Another very satisfactory method of stimulating interest in your business is to print schedules of local school activities, such as football, baseball or basketball games. These can usually be made up on a cardboard about 3½" by 4", folded in half. This makes a convenient pocket size folder for the average man's wallet. The schedule can be printed on the inside, with the firm name and advertising on the outside.

This same idea can be used for the backs of calling cards. I happen to be one of those who feel that a regular calling card is not worth its weight in salt. It must have something else to compel the prospect to hold it. Imprint a number with local high school schedules or college schedules if you are in a college town. Another idea is to imprint a list of holiday dates with spaces for relative's birthdays. Few men can remember when their wife's or mother's birthdays occur and if they will fill this in and keep it in their pocket-book, they may be spared an embarrassing moment—to your advantage.

The distribution of these advertising helps *should be personalized*. You should make this, in the form of gifts, directly to the recipients.

This is as good a time as any to consider joining local civic organizations. Inquire among your friends as to what organization in your town appears to be the most "up and coming," has the most members and appears

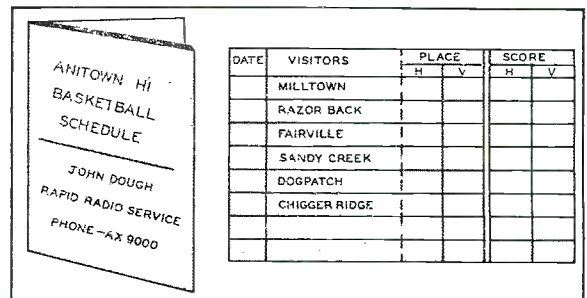

Score cards make good advertising media!

most in the local news. You should also consider the *type* of men in the organization. See that they are the "substantial" citizens—those who contribute most to the town and who have normal financial means. If you are looking for business, look for it in the most likely places.

In your contacts with members of your local organization, you have the best means of making both business and personal friendships which will go a long way toward "Ring the Bell" of your business success.

Next month we will take up another phase of business promotion. In the meantime, keep those two funds on the increase, watch your appearance and cultivate your customers and prospects. Try one of the above types of advertising and *give it a fair trial!* —30—

TECHNICAL BOOK & BULLETIN REVIEW

The Chemical Rubber Publishing Co. have just completed their 23rd edition of the **HANDBOOK OF CHEMISTRY AND PHYSICS** for 1939. The general features and scheme of arrangement which have received extensive endorsement in former editions have been retained. Since the beginning special consideration has been given to the requests and suggestions of those who have used former editions. An attempt has been made to include material on all branches of chemistry and physics and the closely allied sciences, which would be likely to find any extended use. On the other hand, in order to retain the convenience of moderate dimensions and at the same time to allow for natural growth due to the extension of knowledge in these sciences, and logical additions along lines already developed, it has seemed necessary to exclude types of material of use only in certain highly specialized lines of work.

This book contains 2221 pages of valuable information to the student or engineer and includes many charts and information tables. Price six dollars in U. S. and Canada, six dollars and fifty cents elsewhere.

One of the oldest names in the industry is signed to a new book on the latest radio subject: "LOOK AND LISTEN" — **THE TELEVISION HANDBOOK**, by M. B. Sleeper, published by the Norman W. Henley Publishing Co., 2 West 45th St., New York City, price \$1.00.

This book, soon to be published, has been written in the easy-to-find-the-facts style which has characterized M. B. Sleeper's magazine articles and books since 1915.

In the *Television Handbook*, you will find a practical presentation of the television art as of April 30th, 1939, the inaugural date of telecasting. Leaving all historical description to the textbooks, the author has divided this volume into two parts: First, a profusely illustrated, tersely written description of the NBC studios and the transmitter on the Empire State Building; Second, a simple exposition of television receiver circuits with the most elaborate instructions, including 6 large diagrams for wall mounting, for assembling and servicing the assembled kit as well as the equivalent Andrea factory built receiver, and a dictionary of television terms has been included, to explain a great number of new words which we must add to our technical vocabularies.

Planned and written from his personal knowledge and field experience, and from his activities in contact with dealers, servicemen and set builders, Sleeper's *Television Handbook* should be of practical value to everyone connected with television in its various phases.

Proceedings of the I. R. E. for September 1939, includes a description of the new Doherty system as applied to a 50 kilowatt transmitter to be installed at WHAS, Louisville, Kentucky. This article will find much favor in material for discussion both by the

(Continued on page 49)

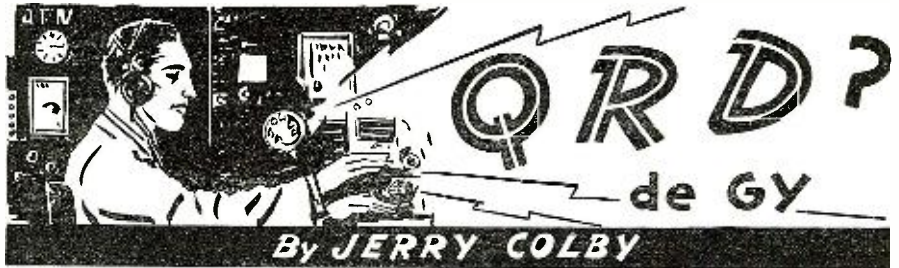

WE once read the *Soliloquy of an Executive* which we thought, at the time, was the bunk. But when we saw the downcast expression on the face of Secretary Jordan of *ARTA Local 7*, we began to realize the truth of the story. The executive worries, plans and connives for the benefit of every one. And Jordan was doing just that. When we gently prodded him as to the whys and wherefores of his woebegone expression, he replied, "Tomorrow is September 30th and we still haven't settled the new contracts. Of course," he added, "they'll all be extended, but we're trying to get increased wages, vacations, etc. . . ." Ah, the joys of being an executive! All you guys and gals have to do is pay your dues and go on your merry way, yousah!

JORDAN tells us that the Matson boats are all paying overtime for Abstracting. This sometimes amounts to approximately \$90.00 per month. Which is nice work if you can get it. . . . That the Maritime Commission pays overtime on the East coast. And we remember the time when overtime was nobody's time but time after time . . . oh well. . . .

WELL, the war is on and war bonus talk is on every one's lips. When this subject first arose the SS Pres. Polk's crew signed on for \$500.00 per month retroactive to Frisco, with \$300.00 if she went into the War Zone and an additional \$300.00 for each port entered in the W.Z. All this, plus a \$25,000 insurance policy and a 40% increase in pay. But the latest dope is that the shipping companies temporarily agree to raise wages 25%. The Maritime Commission is expected to further legislation for insurance plus \$250.00 per month bonus for the men who travel on vessels which enter war zone waters. These are so designated by the State Department. Which is all OK if you come back intact.

BROTHER YURGIANOS, erstwhile acting skipper of the *ARTA* San Pedro home port, is now doing yeoman work down in 'Diego where he is supervising the organizing of the Tuna Fleet boats. It was about time some one took charge of the situation down there where a radiop is nothing more than a glorified fisherman with an education. In a back issue of *RN* there's a story on how this type of radiop actually puts in a day's work. How the catch of the boat determines his wages and why he apparently is under no one's jurisdiction: shooting the breeze and opening up and working in code with other vessels of his fleet. It gives the lowdown on the tuna-fisher-operator. So Yurgi is down thar, amongst the heathens, to give them religion. So far four boats have come through with wage increases, but it's a long and hard fight.

SHIP telephone service is giving both organizations the jitters as to who will operate the equipment once it is installed. Both organizations are wise not to hinder progress but their cause is just in insisting on having only their licensed radiops handle the apparatus. The Mates and Masters who can, unquestionably, acquire their third class tickets should be permitted to speak over the phone service but it is absolutely necessary for the safety of both passengers and crew to have a technically-minded and educated radiop on board just in case of a tie. The *FCC* is fully in accord with permitting the installation of phone equipment on coastwise and lake vessels as shown by their granting four special channels for this service, but

they should give more consideration to the safety of crews than to economy. We are sure that if this matter is brought in front of the commish in the proper manner, they will see the light.

IT'S really big business in the *ARTA* organization now that Teletype machines have been installed in the New York, Seattle, Frisco, Pedro and Portland locals. This private line keeps each and every office in close touch with one another and does away with the time lapse in negotiations, decisions and conferences via the mails. The charge is small, three minutes for ninety cents. Communication men using communicating equipment,—that is sumpin'.

EFFECTIVE Labor Day, September 4th, the *Federation* radio press was inaugurated by the Maritime Federation to be sent each Monday and Thursday, Frisco Local Meridian Date, by the *Press Wireless* stations KJH on 7820KC and KPF 14635 KC simultaneously at 1900 to 2000 PST. This was part of a msg transmitted to ships on the West Coast by the MF of the Pacific. The msg furthermore states quote the copying of this broadcast should take precedence over any inter ship or other schedules of a routine nature which you may have as normal ship's business unquote This is a quote free press unquote but we wonder whether there isn't some technicality for shipping company lawyers to stop the publication of such information to the crews by radiops.

SHIPPING has been very good because of the war across the pond, and many ships are being put into commission. Strange as it may seem, the many foreign bottoms which were moving merchandise to South American ports from the U. S. are now either interned in their respective native ports or are being used for war work. So American ships are now being placed in their proper spot for the Americas. McCormick lines which usually ran four ships to South American ports have placed twenty-three more boats on this run and they are expecting to put four more vessels into commission before long. Which goes to prove that one man's bread is another man's . . . etc. . . .

OUR Boston correspondent, *CTU-Mardiv* Brother Anderson, tells us that Cyril Hemingway, who holds down a billet on the *Trawler Squall*, is complaining about the *FCC*'s new regulations re Silent Periods. So does Wally Simon, who manages to draw down his monthly stipend from the *Holy Cross*. This latter crony sez he's written out "Silent Period Observed" so many times in his log that he feels like a school boy whose teacher makes him write over and over again some word misspelled in class. But the teacher will spank if it isn't done, so. . . . He reports good fishing in the *Trawler* fleet and very few boys on the inactive list. A perusal of the list of radiops in the Boston *CTU-Mardiv* local is like a roster of the old-timers who began in radio way back when. 'Tis good indeed t'see names like Hogan, Potter, Goodwin, Gormley and the rest, too numerous to mention, still taking the Cape sea spray out of their eyebrows, who remember when a good piece of "galena" was something to brag about.

IN reference to our question paragraph in a recent issue, we were pleasantly surprised to hear from so many who certainly won't get fired now if anything like this or even more difficult trouble would be encountered.
(More *QRD?* on page 64)

JUNK BOX Field Strength METER

by HOWARD BURGESS, W9TCU.

Elliott, Iowa

You will find the adjustment of the antenna easy with a field strength meter. Here is one that you can build cheaply from parts usually found in the junk box.

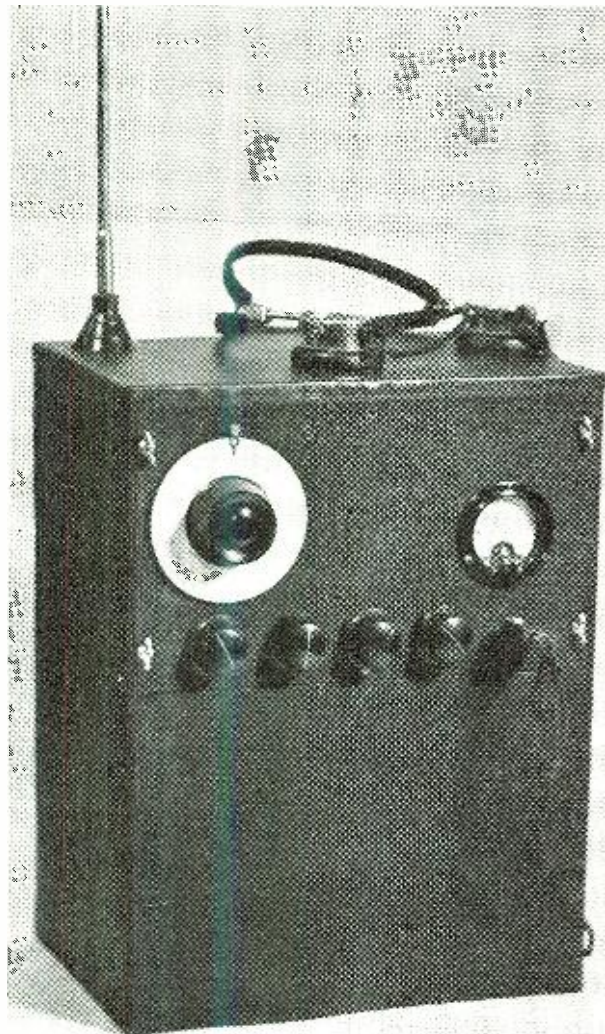

Professional in appearance, one would never guess that it had been built up with old odds and ends.

TRANSMITTING antennas have the peculiar characteristic of being very important. The correct design and construction of such an antenna can spell the difference between success and failure of a transmitter. Many long hours of exacting labor in constructing a fine piece of apparatus and many dollars spent on the latest developments in amateur transmitters are nullified completely by the antennas which they feed.

Not only is the proper design of great importance but also the correct adjustment of the completed antenna. This is especially true of those types with directive characteristics. Directive antennas on the higher frequencies must be tuned correctly or they become more of a detriment than an advantage. The direct current meters in the transmitter may tell a lot about the correct loading but the only true method of determining whether or not any actual improvement is made is by the use of some sort of field strength meter. To take some kind of reading of the r.f. power in the field of the antenna is desired in any case.

There are several methods of overcoming the problem. The simplest and

most common way is by actual contact with some other amateur station. This is not entirely satisfactory as it is very unlikely that reports will be received from equal distances in every direction under the same conditions. At best this is a very rough check.

A more direct but less used method is an actual reading taken of the *field pattern* by means of a simple detector and a d.c. meter which reads the rectified r.f. voltage. More actual information is gained by this method but it has the great disadvantage of being very insensitive. All readings must be taken in the direct field of the radiating antenna. In close surroundings, nearby masses of metal will sometimes give a plotted field pattern far different from the pattern which exists a few miles distant.

The ideal way then would be to take comparative measurements on the field pattern at a few miles distance from the antenna on the lower frequencies and perhaps a little closer on the higher frequencies. By this method the *actual* field can be determined and the antenna and transmitter adjusted for maximum efficiency. A receiver with an S meter would be suitable for this type of checking but a great many amateurs do not own a receiver which boasts of such a meter and a great many more do not own one which can be carried over the country side. The answer to such a problem, then, would be a simple inexpensive meter which would give comparative readings on

signal strength at a distance of several miles from even a low powered station.

In setting out to design such a meter, the unit described here was finally developed. This circuit is by no means the ultimate in this type of meter. There is no doubt but what the number of tubes could be decreased by using several of the newer types of dual purpose tubes. As the whole meter was to be a bit of a luxury, it was decided to keep it within the limits of the junk box. Only such tubes as were to be found around the shack were used. As few hams build any piece of apparatus without injecting much of their own originality into the design, we offer this piece of gear only as a starting point or suggestion.

It was soon found that the only circuit that would satisfy the sensitivity



Detail of tube and coil mounting.

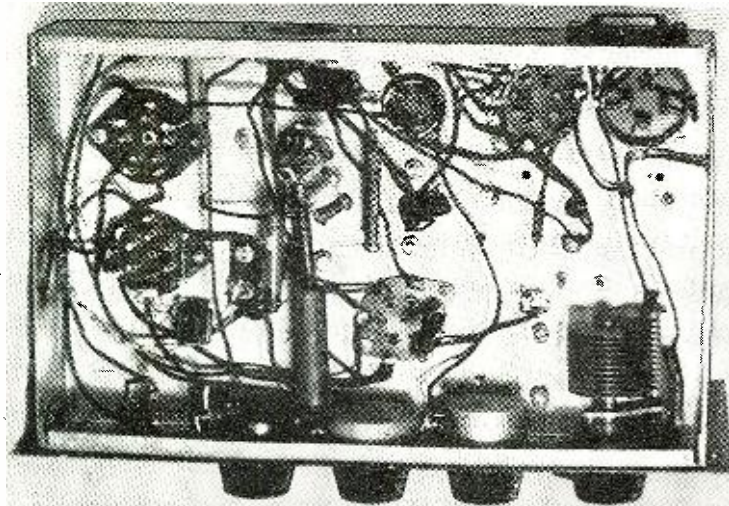

Underside view of the chassis, showing how the connections are run in the most direct manner possible. Works very fb.

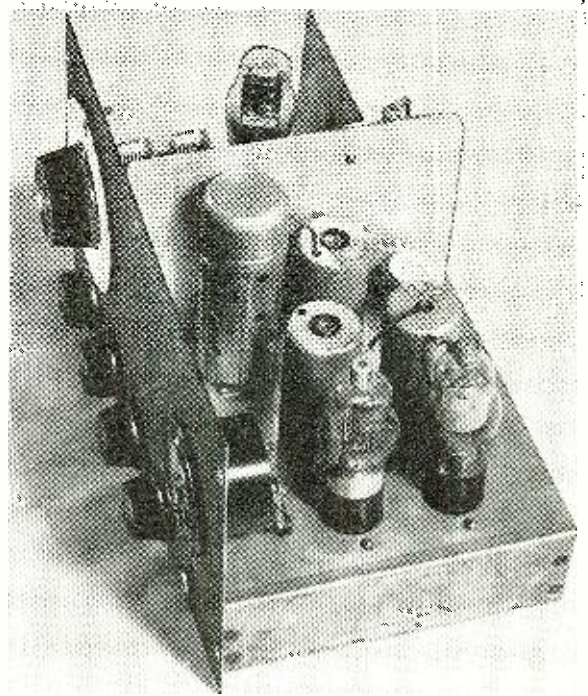

(Right) The side view of the field strength meter shows how the calibrated dial and its assembly is shielded.

requirement was a superhet. Due to the condition under which such a circuit was operated it proved to be neither expensive nor difficult of construction. The circuit is a straight forward superhet with a meter tube added. As it was to be used on local signals of good strength, extreme sensitivity or images were of little concern. For this reason no r.f. stage is used. Of course for this purpose no automatic volume can be used so this also simplifies the circuit. Only one i.f. stage is used. Since headsets are used to tune in the signal, no power audio stage is used.

In the tube line up, a 6A7 is used as a first detector and mixer tube but to improve the operation on the higher frequencies, a separate type 37 was used as the oscillator in place of the oscillator section of the 6A7. To prevent too much interaction between the oscillator section and the first detector, the entire unit is built on a small aluminum shelf and mounted above the chassis. A square aluminum shield is then mounted around it. First detector tuning is accomplished by means of a small condenser mounted beneath the chassis. With this type of mounting the two tuning circuits are isolated. The dual-section tuning condenser shown in the illustration is used as a single condenser and tunes the oscillator. Each section contains 140 mmfd of capacity. A single section only is

used except on the broadcast band.

The next section is just an ordinary 456 kc. i.f. stage. This frequency was chosen to give the greatest spread between the image and signal frequency. A type 78 tube is used in this stage and a variable cathode resistance is used to control the sensitivity of the stage. For best results a good grade of i.f. coil should be used but even the cheaper ones such as those made for the smaller midgets seem to give satisfactory results for this kind of work. The ones used in this particular set were salvaged from a small broadcast set and the ambitious young ham can even build his own from r.f. coils.

The output of the i.f. stage is fed to the diode section of type 75. The audio

from this is then fed to the grid of the triode section of the same tube. The triode provides enough audio for the headsets which are used to find the desired signal. The audio is filtered from part of the rectified i.f. voltage taken from the diodes and the resulting direct current drives the meter tube.

A 39 was chosen for the meter tube although almost any other type of screen grid tube may be used. A tube with a variable μ proved to be the most satisfactory as such a tube responds well to the weak signals and does not overload on the very heavy ones. For those who have never used a meter tube, the action is as follows: The cathode resistance R8 places a small amount of bias on the control

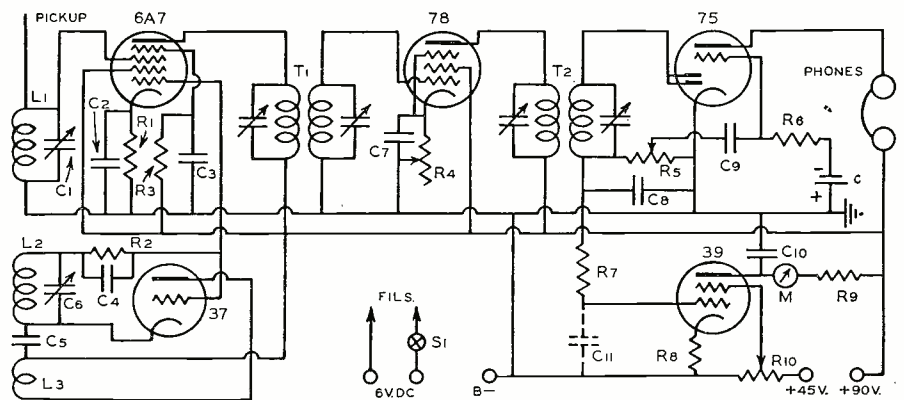

Circuit diagram of the junk-box field strength meter.

- C₁—150 mmfd. midget variable. Bud.
- C₂—.05 mfd. Aerovox.
- C₃—.05 mfd. Aerovox.
- C₄—.0001 mfd. Aerovox.
- C₅—.1 mfd. Aerovox.
- C₆—150 mmfd. variable. Bud.
- C₇—.1 mfd. Aerovox.
- C₈—.0005 mfd. Aerovox.
- C₉—.01 mfd. Aerovox.
- C₁₀—.05 mfd. Aerovox.
- C₁₁—Optional, to dampen meter action during quick fades on distant signals.
- R₁—300 ohms 1/2 w. Ohio.
- R₂—50,000 ohms 1/4 w. Ohio.
- R₃—30,000 ohms 1/2 w. Ohio.
- R₄—50,000 ohms. var. IRC.
- R₅—500,000 ohms var. IRC.
- R₆—500,000 ohms 1/2 w. Ohio.
- R₇—500,000 ohms 1/2 w. Ohio.
- R₈—1000 ohms 1 w. Ohio.
- R₉—50,000 ohms 1 w. Ohio.
- R₁₀—50,000 ohms var. IRC.
- R₁₁—15,000 ohms var. IRC.
- C—1 1/2 volt flashlight cell. Burgess
- B—15 volt C battery. Burgess.

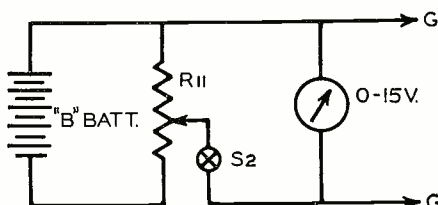

Meter calibration hook-up.

grid of the 39. Potentiometer R 10 varies the screen voltage and thus controls the plate current. R 10 is adjusted then so that with no signal input to the set, the meter will read *full* scale. When a signal is tuned in, the rectified and filtered voltage taken from the diodes of the 75 biases the control grid of the 39 to a more negative amount and so reduces the amount of plate current flowing through the meter.

This constitutes one of the advantages of the meter tube. The greater the r.f. input to the set, the less actual current is flowing through the meter. The sensitive meter is thus protected from burnouts due to severe overloads. When very high r.f. voltages are encountered such as near a high power station the meter merely reads zero. For the amateur who does not wish to use the more expensive O-1 milliammeter, a less sensitive meter such as an O-5 may be used and by substituting a tube which draws more plate current such as a 38, meters requiring as much as 10 mils may be used. This is of course at some sacrifice in sensitivity.

No attempt is made to cramp the parts. They are mounted on a 7"x11"x2" chassis and this with 90 volts of portable B battery and 6 volts of dry A battery are contained in a leatherette covered box measuring 12½"x16"x8½". For use in a car the dry A may be omitted and the car battery used instead. The antenna used is one of the 40" variety of car antenna and is mounted on the top of the carrying case. When such an antenna is used, it is tied directly to the grid of the first detector.

No exact data for coil construction will be laid down as most amateurs use various types of tuning condensers which they have in the junk box. There are only two requirements for the coils. That L1-C1 resonate at the desired signal frequency and that L2-C6 resonate at either 456 kc. above or below the signal frequency. The proper size is easily found by a little *cut and try*.

In most instances only a comparative check will be sufficient to furnish the desired information but it must be remembered that the scale of the meter is not linear. By a little study it will be seen that for the most sensitive readings the *upper* portion of the scale should be used. As the carrier voltage is doubled the corresponding movement of the meter hand becomes less and less for each increase in power. For field work then it is recommended that the sensitivity control be turned down or the receiving antenna kept short so as to keep the meter reading in this part of the scale.

For the more critical, an auxiliary voltmeter and battery may be attached as shown. A signal reading is taken on the meter with S2 *off*. Then with no signal input R11 is adjusted to give the same meter reading. The voltmeter reading will then equal the
(Measure further on page 49)

WIRELESS MIKE

by N. C. SETTLE
Dallas, Texas

A new wrinkle for the PA man to sell to his customers. No tripping over mike-cords; just tune in the mike on the usual BC receiver.

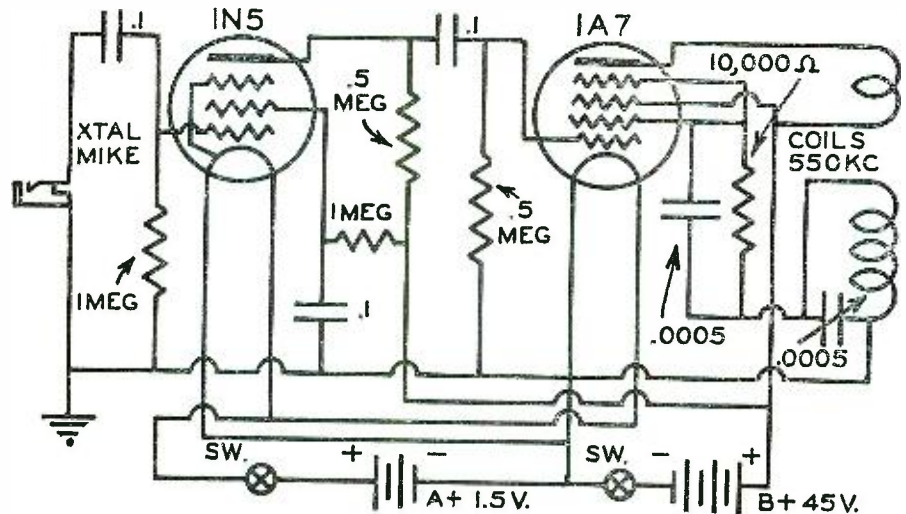

Circuit diagram of the "Wireless Microphone."

ONE of the newest applications for "wireless control" is in applying this circuit in conjunction with a microphone and amplifier to reproduce a "cordless connection" between the two units. Many PA installations are set up on a stage where the mike cord is very much in the way and is continually stepped on, sometimes with embarrassing results. The same type of oscillator circuit may be incorporated with a microphone that is now commonly used with several automatic devices to transmit the modulated carrier to a tuner or receiver and in to a suitable amplifier for PA purposes.

The transmitter is simplicity itself, having but two tubes—a 1N5 and a 1A7. The first is used as a voltage amplifier for the microphone while the second is used as a modulated oscillator. A B battery of 45 volts is contained within the altered mike stand as shown and a single 1½-volt dry cell also included.

Any good receiver may be used in connection with this unit, as long as it has sufficient output to be comfortably heard in the auditorium or wherever it is to be used. Most of the needed parts are to be found in the junk box or may be obtained easily from any dealer. The placement of parts is not critical as long as leads are kept as short as possible and that the microphone input is shielded all the way up, to the tube grid.

The oscillator coils are wound to cover the regular broadcast band and may be any of those available from a

jobber or dealer. The coil is resonated at 550 kilocycles by listening in on the receiver tuned to that frequency. Thereafter, the procedure is exactly
(Build further on page 57)

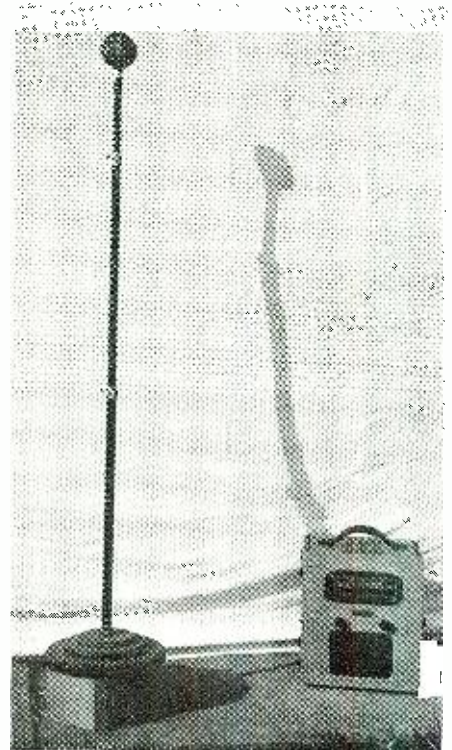

The unit does not take any more space than the usual mike stand.

AS I SEE IT!

by **JOHN F. RIDER**

Dean of the Servicemen

Cleaning up some odds and ends for the year 1939, so as to start with a clean slate for "Radio's Greatest Year!"

(The opinions expressed herein are solely those of the author, and do not necessarily represent those of the Publisher nor Editors of RADIO NEWS.)

What's in a Name?

ARE you one of those men who have rushed pell-mell into the act of adding the word "Television" into the name of your organization? . . . I wouldn't if I were you. It is not so bad if you are located in those few portions of the country where television service is available, but why complicate matters unnecessarily when you are out of the zone of television signals. . . . As things look today, many portions of the country will not get television service, but many service shops have added "Television" to the name of the establishment.

In the first place, changing the name of an organization tends to nullify a long period of service rendered to the public. The name which was known, even if only by a few, is no longer known by even that few. . . . Adding to a name makes the name longer—more troublesome to pronounce.

And maybe after it's all over, some people might have a negative reaction to television. They might reason that the organization is specializing in television and since their receiver is not of the television type, maybe it would be better to call just one of the radio service companies. Of course, it does not make sense, but lots of things we do, do not make sense. That's why we are human. Until such time as television becomes a factor in the community, I'd be tempted to stick to my regular name—the name my friends recognize and know.

Alignment

THIS is just a suggestion based upon experience. It's easy to understand that set designers learn from experience the same way as everyone else. What we mean to say is that the modern medium priced and naturally high priced radio receivers produced during the past two or three years are much more stable than their predecessors. Coil impregnation technique, trimmer design and lead dress knowledge has improved and the net result is less need for frequency realignment.

Properly to capitalize upon such advances, the radio servicing industry should be given information whereby it becomes possible to rapidly test the condition of alignment. Given the i.f. peak a man should be able to check the mixer system and the receiver oscillator by identifying the mixer output

frequency being fed into the i.f. system. After that he should know the approximate gain in the i.f. amplifier when alignment is correct and by making a test between the mixer output and the i.f. amplifier output establish rapidly and easily if the amount of amplification being obtained is within the tolerance limits.

Having worked upon many receivers and service test oscillators during the past fifteen or so years we experienced innumerable instances when need for realignment was indicated by the fact the oscillator we used was "high" or "low" by as much as 1 per cent from that used by the man who previously handled the radio receiver. In fact, many receivers known to be perfectly aligned upon one service test oscillator indicated need for realignment when checked upon another test signal source. Further check established that the frequency difference between the two oscillators when set to supposedly the same frequency was about 1 per cent, yet it amounted to about 9.4 kc. at 465 kc. because one was "high" and the other was "low."

Such oscillators operating within a 1 per cent variation are entirely within all reasonable tolerance limits, hence cannot be criticized. It is just an unfortunate circumstance that extremely high accuracy cannot be obtained unless extremely high price is paid, hence some change is due which will enable a revision of technique so as to save the serviceman's time. To expect test equipment manufacturers to make oscillators to better than 1 per cent is expecting too much in view of the definite limitation in the price which servicemen can afford to pay. However, time must be saved, so another means must be used and this means more information from the set manufacturer.

Such information is of definite value to all servicemen. If not equipped at the moment to properly employ such information, there is no doubt that in time to come more and more men would see to it that they would be able to properly employ such facts, because they serve a dual purpose—both of which mean much to the servicing industry at large. For correct alignment does not mean correct sensitivity—whereas when the gain in the amplifier is correct, it is a safe assumption that alignment is correct. Hence, such sensitivity data means better servicing and more rapid servicing.



John F. Rider

We're Going on Tour

PLANS for the coming fall and winter call for serviceman meetings in about 35 cities in the United States, starting with Boston on September 20th. We expect to cover about 15,000 miles shuttling back and forth. Most certainly we expect to get an insight into what is happening in the radio service business throughout the United States. We are looking forward to it with a great deal of pleasure because we know that the men at these servicing meetings are always in a position to give us the facts and we hope that we can give them some. Hence, the next column you'll get will be written on either a train or while riding a sky broncho.

The last time we made an extensive trip we had a few interesting experiences—such as riding 150 miles between Galveston and the San Jacinto Inn located in the San Jacinto battlefield, during a terrific rain storm. Never again will we tell Bob Campion of Dallas that we would enjoy eating some sea food.

Then again we were almost accused of kidnaping. Some charming young lady decided to leave her home town with a New Yorker—naturally against the will of papa. . . . And Pop thought it was yours truly— Yes sir, the sheriff was all set to wire the railroad police to ask me to alight at the next train stop—and not in gentle terms. . . . Fortunately for the entire Rider menage—the pater discovered that his filly had another New York boy friend. . . . [So you *must* have been one of her b.f.'s, eh, John? Ed.]

Then again I remember the time I hurried to catch a plane. It was late at night and I was kind of sleepy. . . . So by mistake I took the Westbound instead of the Eastbound plane. Both were at the airport and departed at the same time. To cap it off, the stewardess while checking me in mistook Rider for Ryan. I promptly went to sleep, woke up several hours later and found myself about 400 miles further away from home. . . . Ryan had missed the plane and I was the perfect sub.

Several years ago I was headed for
(More "As I See It!" on page 64)

Analizing Power Supply

by **JAMES W. HOSKINS**
Oneonta Sound Laboratories
Alhambra, California

Experimenters and engineers will find a great deal of use for a calibrated power supply. The author explains how it is made.

THE analyzing power supply is one that can furnish many "B" and filament voltages. This type of equipment was designed for an experimental laboratory. The bleeder resistor is tapped to give the different "B" voltages. In this case it was an Ohmite 1209 tapped every 2500 ohms.

The parts used for the construction of the unit are standard replacement parts. It is advisable to use the same type of power transformer and chokes shown to preserve quality and create the identical construction. The electrolytic condensers should be of wet type; as there is more capacity in a smaller can, and they will last longer. The power transformer furnishes the following voltages:

High Voltage: 300 volts center tapped at 150 to 200 milliamps.

Rectifier Voltage: 5 volts at 3 amps.

Filament Voltage: 6.3 volts, center tapped, at 4 to 6 amps.

Any other filament voltage is available at 2 amps. or more.

The filter system must have good regulation. A swinging-choke is used to improve this.

Assembly

The parts should be placed to avoid any hum pick-up. All parts should be fastened securely to the chassis, the ends of which should be left open for

ventilation. It measures eight by twelve inches and is two inches high. A *Hadley, Bud* or *Purmetal* chassis with a bottom plate may be used for this unit. The bottom plate protects the wiring and prevents contact with the high voltage.

If the unit is going to be used as a portable unit in public schools the wiring should be enclosed for safety. The terminals may be mounted in a small box. A small relay rack can be used for bench use.

Wiring

The wiring is very simple as the basic unit is a standard power supply. The most important part of the work is to get the different B voltages wired in sequence. Use No. 16 wire for the filament circuits and No. 18, 1000 (*Consolidated Wire Co.*) volt wire for the balance of the circuit. The *banana* jacks should be of the *insulated* type unless a nonmetallic panel is used, such as wood, masonite, or bakelite.

Wire the filament and primary circuits first. Place these leads in shielding, if necessary, to reduce hum, and

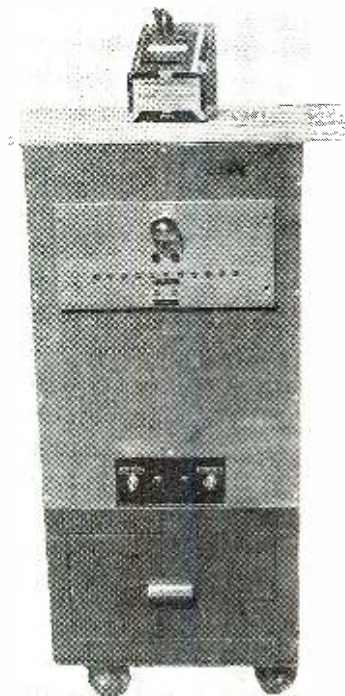

The author's completed laboratory power supply. Meter reads voltage.

as near the chassis as possible. The B voltage and rectifier circuit should be wired with the utmost care to prevent shorting.

Voltage Test

If all connections are found to be correct, the tube may be inserted and the line cord connected to a 115 volt

(Continued on page 48)

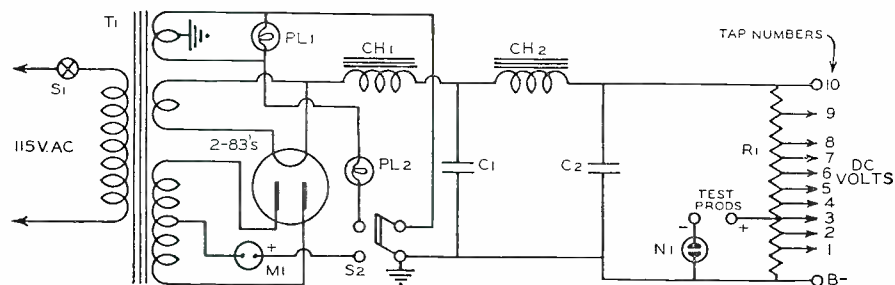

The circuit of the final power supply.

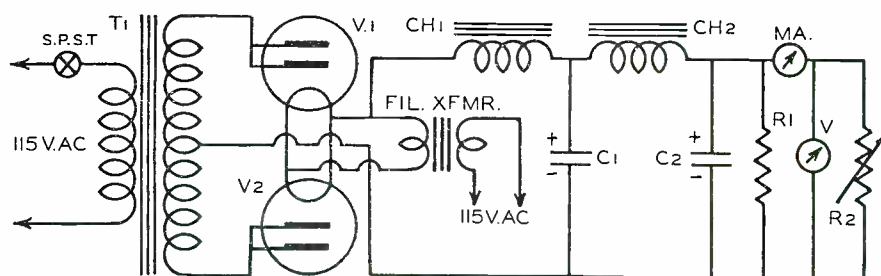

Test circuit to calibrate the power supply.

T_1 —Power transformer. Thordarson T-92R21.
 CH_1 —Input choke. Thordarson T-19C39.
 CH_2 —Filter choke. Thordarson T-1700-B.
 C_1 —18 mf. 450 v. electrolytic. Sprague.
 C_2 —25 mf. filter. 450 v. electrolytic. Sprague.
 R_1 —25,000 ohm bleeder. Ohmite No. 1209.

MA —0.300 DCMA. Simpson model 27.
 V —0.500 DCV. Triplett model 321.
Chassis—Bud CA1125.
Bottom plate—Bud BP685.
Dust cover—Bud CA1125 cover.
 V_1, V_2 —Type 83 or 5Z3 Raytheon tubes.

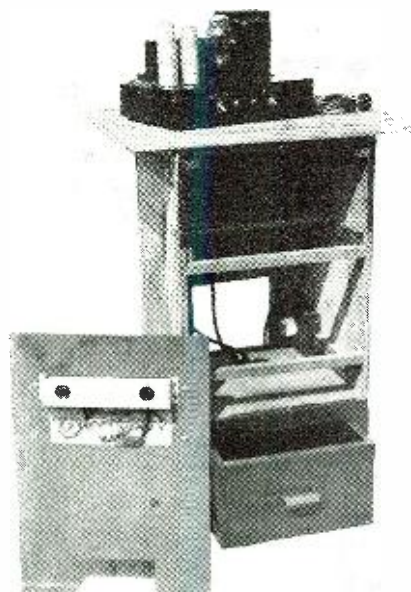

The rear of the calibrated supply.

H A M C H A T T E R

FAMILY STORY: She was the belle (and we don't mean dumb, either) of the little village, and he was the "radio engineer" ham with the ever popular call W3... They saw each other occasionally, and then of a sudden their romance rotted into a first class marriage. His promises were that he would give up his radio and stick solely to the business of running his father's garage; and her's were that she would give up most of her rather expensive (for that town) social contacts with the girls. They were happy. Came the depression (remember?) and the garage went to hell. So did the ham's income; so did the food on the table and the clothes for the little guys of which there were now three. The OM was desperate, so to keep from going nuts he went back to his old love, ham radio, and she finally got back into the swing of her social contacts again because with none having any mazzuma, they could well afford it. For odds and ends to be met in the family household, he did an occasional radio repair job. The depression passed, and his radio business grew until he now has one of the largest and most complete stores in the county while she brings in more than 90% of the business as the store's only walking delegate. That's all there is to it... silly, ain't it?

W4FXF, Atlanta, Georgia reports that he is running 12 watts to a single 6L6 on 160 and getting out FB.

W4FOJ is a new ham in Atlanta on 40 meter c. w.

W4FPI, Opp, Ala reports that he is running 230 watts to a pair of TZ40s and is operating mostly on 160 phone.

W4FVO is on phone wid a single TX 40 from Cottonwood, Ala.

The Atlanta Radio Club under the capable guidance of President James W. Geeslin were host to over 200 hams from Georgia and neighboring states on Sunday, Oct. 8th. Free prizes, archery shooting, demonstration of portable units and of course swell eats were the order of the day. This is an annual event for the club and gets better and bigger every year.



Mid-States Convention of the International DX'ers Alliance. Looks ok!

We recently inspected a nearly complete file of RADIO NEWS from 1923 up until now. Even back in the good old days hams were complaining about conditions and maybe after all there hasn't been so many changes among the fraternity. Hi!

W4FVI is pounding brass from Americas Georgia. Reports that there is some new hams on the way from that sector. . . .

The Miami gang probably bit at our mere scribbling and, after all, their peanut whistles don't get into our shack. Hi!

Heard **W4EYH** at Winston Salem putting out a swell sig the other day. **W4AP**, Montgomery is heard occasionally on same band.

W4GAA reports several active hams in his part of Florida with **W9SVI** getting a **W4** ticket at Tallahassee.

W4FOD has returned to St. Petersburg, Florida.

W4FNC is working wid Georgia Army Net on 160. Being careful wid high voltage is better than a silent key on mike.

W4AXP reports that there is a ham in Nw Florida that worked 2 W9s on 5 wid 2 watts power. We still believe anything!

And then there is a certain **W4** that has had a streak of hard luck lately and capped it all off the other day by finding a real live snake under the xmitter. He asked us not to mention his call or name. Incidentally he killed the snake after paralysis left him.

W4FCZ is rebuilding and will be back on shortly. **GFF** and **FFI** have some new power

BAC is still active at Waycross. . . . **W4PBW** is active on 160 at Pensacola, Florida

. . . Lots of the gang are agreeing that a free for all 100 kcs. would be Fb on 40. . . **W4EZV** at St. Andrews, Florida, is once more active on 160 and is taking on all rag chewers on that band. . . . Ditto **W4FBK** at Auburn, Ala. . . .

W4EEU at Troy, Ala. is rag chewing on 160. . . . **FCW** is taking another trip. . . **ERS** lost his antenna mast recently and is now figuring on a method of putting it up on his own lot. Hi—

FPF says that he now has, count 'em, 150 watts. . . .

[Many thanks to Montezuma, Georgia's Keith C. Mathis, **W4ARX**, for the above. Keep up the good work! Ed.]

EXCERPTS from the Asheville, N. C. A. R. C.:

According to **W4FIX**:
When the CC members start rag chewing on 7 mc., condx must be bad.

W2UK and **W2IOP** both heard within 15 minutes kicking about conditions.

W4GW has been working **OQ5AE** on a regular sked. Ralph has had various members of Ray Spigall's family in his shack to talk to the Congo.

W4TW reports **OQ5AE** coming through on 28 mc. Wait said he hadn't worked him yet but had worked **OQ5AB** on 28 mc. By this time **OQ5AE** will have been on 28 mc.

W4TW also reports having worked a number of South Africans on 28 mc. Seems to be opening up.

The ZSs reported ordered off the lower frequencies are still on 10 meters.

W4FIX was fortunate in grabbing **U9ML** and **YU7AS** but, according to **YR5VV** it's next to impossible to get a card from Russia. He's worked more than 200 Russian stations and has only 3 cards to show for it.

WAR, DX's latest obstacle, has turned out to be a greater handicap than even **ECOS**. (?) Nevertheless the boys are still plugging away. Asia and Oceania are being heard until 9 a.m. on the East Coast, Europeans and Africans from noon until midnight, while South Americans may be heard almost any time. Tastiest bits for the month are **LZIID** and **AC4JS**. **LZIID** (14:350 kc., T6) is Bulgaria's only active amateur and he's one you'd better grab before someone else does.

AC4JS (14415) and **AC4YN**, both in Zone 21 are probably the most sought after DX on the air. You'll find **4JS** around 6 p.m. E.S.T. **KB6ILT**, **KB6OCL**, and **KB6RWZ** have kept plenty of boys from sleeping late in the morning.

D4BUCF surprised everyone by staying on the air. Countries you won't work for a while: **SP**, **OK**, **OE**, and **EZ** (Sarr).

Countries off the air for reasons other than extinction include Great Britain and most of her colonies, France and most of her's, Netherlands, Belgium, Cuba, Spain, and just about 70% of existing DX. DX on 7 mc. ain't what it used to be.

Only reports are **HC1AZ** (7111 kc.), **HR3CQ**, **K6QHX**, and **K6JFM**. **W2IOP** reports **U8DQ**, **UK3AH**, **U9AW**, **LU3HK**, **XE1AM**, **XE2AR**, **PY1GJ**, **OQ5AA**, **OZ2M**, **OZ2XA**, **OZ4H**, **OZ1WP**, **OZ7UU**, **OZ7CC**, **OZ7HO**, **D4BUCF**, **YR5VV**, **CX2BF**, **CX2AJ**, **ZS6EZ**, **ZS1BB**, **ZS6BJ**, **ZS1W**, **PY7AO**, **ZS6GI**, **ZS1DB**, **SX1J**, **KB6ILT**, **HR3CQ**, **K6QHX**, and **K6JMF**. Others for **W2IOP** were **CR4HT**, **CR6AI**, **CR7AF**, **LZIID**, **V66AF**, and the usual run of stuff.

WIHSA, a post-grad at Harvard still finds time to come through with **J20V** (14410) and **U9ML**, **U9AW** outside of high end of 14 mc.

KB6RWZ is 14390 should you care to work **GUAM**.

W2GT one of Ridgewood, N. J.'s famous DX'ers was awarded the pair of Eimac's 500TH's for September. [By request, Ed.] Eddie modestly admits working **J2KN**, **CS1B**, **K6HDB**, **PZ1AB**, **YR1AM**, **AC4JS**, and **V51AP**. He also heard **MX3H**.

Talking about DX, some photos of **U2NE** have been circulating and sharp eyed DX'ers are turning green with envy. The reason? **QSL**'s from **FN1C**, **uOAC**, **uOLC**, **AR5VP**, **FQ8AB**, **ST2BN**, **ST2CM**, **MX2B**, **FK8AA**, **FR8ABJ**, and a few others on the wall.

Out in Jersey every time someone hears something good it seems **W2GT**, **W2JT**, **W2GVZ**, **W2CMY**, and **W2BHW** automatically work 'em. While we're in Jersey, who is the fellow who wouldn't let the gang in on **AC4JS**?

The already famous **DX Century Club** has proven to be a big success because it is an incentive to the DX'er as well as an organization which gives recognition to worthwhile performances. However, the club has already run into several difficulties. One, often mentioned, is the unscrupulous practice of forging **QSL** cards. The fact that it is the same as cheating at solitaire doesn't stop these honorable gentlemen. The second point is not often mentioned. This is *not* meant to be a crack at the *A.R.R.L.*, but rather to offer a solution to an annoying, if not perplexing, problem. Rule 2 of the *CC* By-laws states, "In cases of countries where amateurs are licensed in the normal manner, credit may be claimed only for stations using regular government assigned call letters. This shall not militate against claimed credits for contacts prior to publication of this section (December, 1938), that might otherwise have been claimed earlier." Obviously that statement "in the normal manner" is open to various interpretations. Amateurs claiming credit for such stations as **YS2LR**, **YV2CU**, and **HP1X** were always given credit despite the fact that these stations were not assigned call letters in the normal manner. Recently **YN9G** sent in a list to the *ARRL* to give credit to **W**'s who worked him and they would not honor it on the grounds it violated Rule 2. There isn't the slightest iota of difference between the operating circumstances of many DX stations and **YN9G**, yet the *DX CC* will not give credit for him. Then there is another case. The

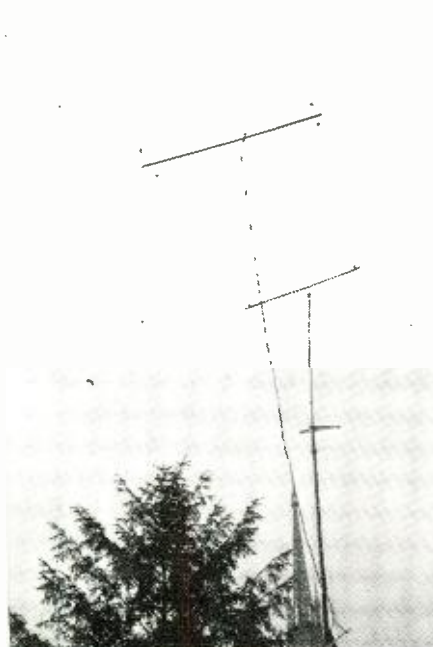

F8UE's masts tower above the Rouen Cathedral. Now they are down a/c War!



William Naken of Chicago has a complete portable receiver on his bike.

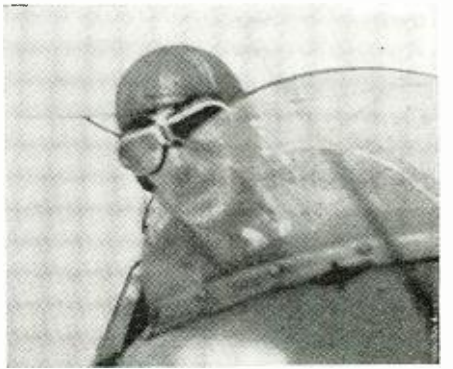

This is **G5FA**. It was taken in peace times. Perhaps he's doing this now!



An unusual QSL card from Lietuva!

League will not give DX CC credit for QSO's with W10XAB, yet they do for ON2QY. These are the same stations operating under two different calls. If you worked Gerry when he was signing ON2QY fb. If not, you couldn't get credit because W10XAB is an expedition call. Recently the league gave credit for FK6XX, another expedition. The grounds were it was an amateur call, despite the fact that calls in New Guinea aren't anywhere near "XX." VQ9AA was accredited to those who worked him although the ham using it just took the call by adoption, in a country where there is a regular manner of obtaining licenses. What it all boils down to is there are a few too many technicalities involved in this country-claiming-business. Why not change the rules to read that any confirmed contact with a land station can count for new country credit. After all it's only a hobby and there is no point in getting all hot and bothered over an ambidextrous set of rules.

We are certainly going to miss the Canadian amateurs on the air.

Elvin Feige, W6TT, is seriously considering a move to the country in order to improve his antenna location.

Sam Houston, W6ZM, the "Old Reliable," besides being secretary of the Oakland Radio Club is organizer of the American Legion net on the Coast.

Porter Evans, W6BF, is doing a good job with the Mission Trail Network.

W6GIN apparently has given up farming and is active around San Francisco again.

A marvelous job has been done by Stewart Ayres in over-seeing the Treasure Island Radio Station, W6USA.

W6BIP, and his hilltop location were hosts to many visiting amateurs during the A.R.R.L. Convention in San Francisco.

Horace Greer, W6TI, is really putting on a "bay window" these days.

It looks good to see S. G. Culver, W6AN, back on the job, as in days of yore.

Jack Tait, W6IT, has been one of our most consistent amateurs.

D. Reginald Tibbetts, W6ITH, has moved to the country, to the town of Moraga.

W6PAP is busy editing the "Tattler."

W6NGQ, and his mother, were visiting the World's Fair, as well as the Treasure Island Convention.

W6GRL is next to the top in the DX Century Club, for the United States. We imagine that "Doc" will put it over to top in the next few weeks.

W6OCH was reported by KLRR, the Yacht Contender, as the loudest ten meter signal heard during the period of the Honolulu Yacht Race.

Johnny Griggs, W6KW, tells us that San Diego would like to have the Southwest Division Convention in 1941.

W6FBW is active on 80 meters CW.

K6JPB now sticks to CW.

W6SJ is now going in for television.

W6NAT has been doing some swimming at Long Beach lately.

W6KJE is showing the boys some speed on 40 meter CW.

K6JPD kept daily schedules with the Yacht Contender during the last few days of the Honolulu Yacht Race.

W6FDO, the Famous Scotchman is still as active as ever.

We are all wondering when W6PHM, Professor E. A. Yunker, will be returning to his old sev-

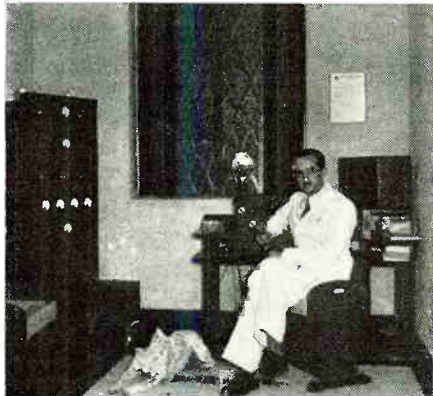

PY2DA, one of the furriners who is still pounding 'em out. Be C N U!

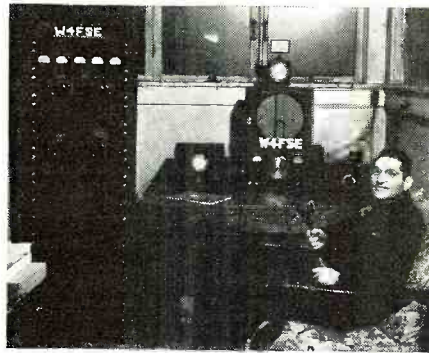

ARC's Editor, W4FSE, relaxes in QSO.

enth district. I know that the boys miss him up there.

K6KRG can be heard at intervals on 20 meters, when he isn't running the Yacht Radio Stations in Honolulu.

W6DEP is putting up a new Mims rotary for 20 and 10 meters.

W90KB dropped in to see W6LS on a visit.

W9GUU is visiting California. It looks as though he is going to desert Chicago and stay with us for good.

W6DX and W6LA are both working out of the FCC office at Los Angeles.

W6RI is in the FCC Office, San Francisco.

Henry Jones, W6GCT, is slowly recovering from the bad automobile accident he had.

W7VS has designed some excellent equipment for the Portland Ultra high Frequency two-way Police System.

We all missed the Big Sax, and Little Sax, at Yakima. It seems as though they are usually at all conventions.

GETTING back to working DX, W3DUK upholds the honor of the third district with an "ain't-you-green" list including KA1PG, XUSMI, U9AW, HC2HP, I1MQ, YN1F, VP3CO, TG9AA, VP6YB, VU7BR, UK6WA, LZ1LD, ZB1J, HB1CE, OQ5AU, U2NE, VQ3HJP, PJ5EE, KB6ILT, TF3F, YU7BJ, CR4MM, EK1AF, and on phone ES5D and ES4D.

ES5D can be heard almost any night on the East Coast with an R9 signal, but he's a tough one to raise. All those tones are down in the low end of the CW band. W2KYO gets the how-do-you-do-it award by producing a QSL from a real LZ.

WITH all international contests in a bad way, including "Radio's" newest plan, the annual Sweepstakes party this month deserves watching as the foremost operating event of the year. Top men for the past year are almost all active and promise to do their bit. Most discouraging news is that W3BES will not be in the 1939 fracas. Ham circles have it that Jerry's XYL has taken very ill and W3BES was forced to sell out in order to meet expenses. No SS contest will be complete without Jerry, but in this case we can only hope for his XYL's speedy recovery.

W2APT, W2GSA, W4ECL, and several others who came up from contest obscurity with big scores all will be out for blood.

W8OPN can be heard limbering up the old fist. Doc is going to run low power for the first time in his contest career.

W2IOP is rebuilding. His rig threw in the



Now-silent French F8UE used to put out a swell signal from this rig.

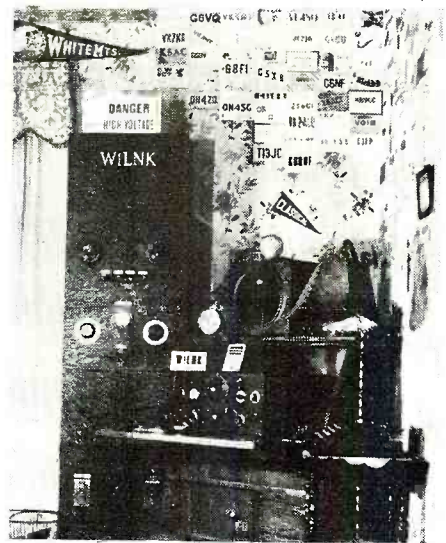

The shack of artist(?)-ham WILNK



Maxim Award Winner, W2JHB.

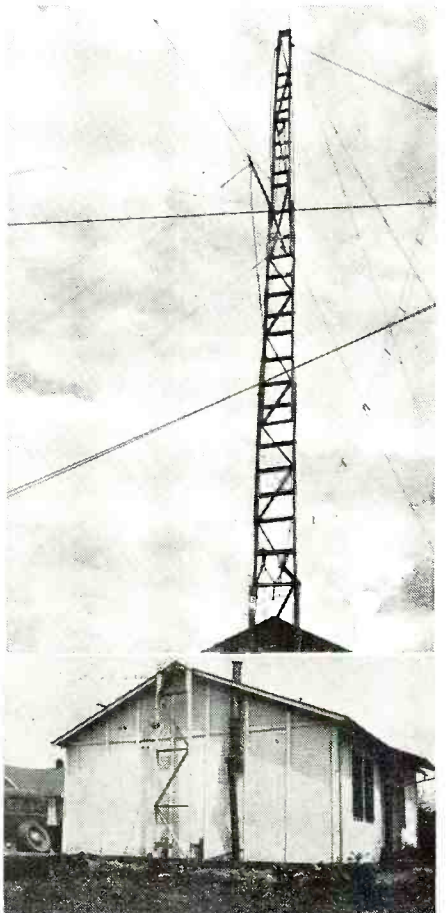

W8ESN's shack and sky-hook which rises sooooooooooooo high in the sky.

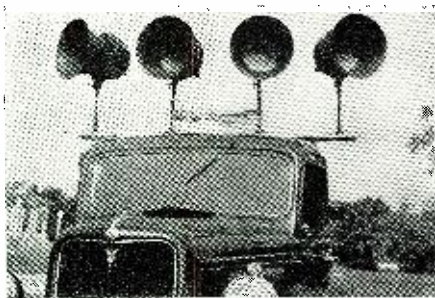

Robert D. Cichy of Belding, Mich., has this fine business-getting P.A. unit.

sponge half way through the '39 SS and Larry is determined it won't happen again. W3DUC can be counted on on worrying everyone. Talking about worrying people these wise hombies who send out high numbers and claim large scores when they don't have them better watch out because they will get some very unpleasant publicity.

Rumors have it that the W2's are organizing a super-club whose members will be dedicated to the downfall of the *Frankford Radio Club of Philadelphia*. It seems that the boys from Philly have walked off with just about everything in the way of club prizes in ARRL competition. Anyhow W2HMJ or W2IUJ might know more about it than they admit. This year the fellow with one crystal will probably win the SS because all the ECO's will come to him. Hi!

LISTENERS in on 7 mc. will find plenty to keep them interested. Since the middle of September "old faithful" has been in fine shape. On the East Coast the fifth district is heard soon after 5 p.m., with W6's coming in RS as early as 10:30. W6NSA, W6NHA, W6AOR, W6DUC, W6NKR, W6RBQ, and W6OMR are a few of the stalwarts.

Only DX reported is HC1AZ, K6JMF, K6QH, and HR3CQ.

The Pacific Islands will probably be well represented on 40 this winter and presents an excellent opportunity for all to partake in the glorious combat called DX. On 40 there is a swell group of ops who may be found almost any evening on the LF end. W1MFC, W2HZY, W5BML, W8PRX, and W9LH are some of them. Their round tables are already a classic for something or other.

Latest topic of the gang seems to be W6RBQ always dropping out to QSO W9LH. *[Grab your call books and you'll see who. Ed.]*

The *Forty Traffic System* continues to grow. Latest dope has it that they are adding several new members daily. The net holds informal meetings between 8 and 9 p.m. E.S.T. from 7200 to 7250 kc. They will handle traffic anywhere in the states, just CQ FTS.

TWO and a half meters is rapidly increasing in popularity. On Long Island, New York, the following have been reported active. Power, where known, is indicated in brackets after call letters: W2LFL (5/10), W2MLO (15), W2MCJ (60), W2MLM (10), W2DJU (10), W2HDG, W2JMK, W2LUW (10), W2LAA, W2MAL, W2LNP, W2VY, W2JCS, W2LPC, W2JND, W2TY, W2GYE, W2MAH, W2HZV, and W2KXC.

Best DX logged to date is W2BZB, Ridgewood, N. Y., and W2KTW, Bronx, N. Y. W2LJJ, W2LFC, and W2KXC played checkers on 2 1/2 when activity first got going. Is W2LJJ the first guy beaten in checkers on 2 1/2?

On 5, DX continues with the ninth district generally reported as best on the East Coast. W2ERC complains there isn't enough activity on 5. From the looks of our reports there isn't.

ODDS and ends from all around. W2GAU has left Hewlett and now sports W1MGF. Charlie has some new beams up and ran through a 1000' of wire without any trouble.

That 75 footer that everyone uses for a land-



The now-silent ham-shack of British G6QX. He used different finals to QSY.

mark at Hewlett is just W2ERC's mast. Outside interests have kept him QRL.

W2JKE is QRL college at Bowdin, Maine. He used to operate VE1LN at Kents Island.

East Rockaway, N. Y., has one of the ham-fest families of them all. Pop W2JDG, Ma W2JZX, and son W2LJJ. Daughter Betty Jane was born with an anti-amateur virus in her blood.

W2IUJ in Far Rockaway just rebuilt. First QSO on 7 mc. was with HC1AZ (7111).

W2GSC gave up 20 as a bad job and can now be found on 160.

Since DX has left 20 many of the boys are QSYing to 80. Among them W2AU, W3FJU, and others.

W2IUQ has left Brooklyn for Far Rockaway and will soon move to Boston.

WSAU gets on the air once and a while.

W2BMX is back at Utica, but without a rig. Prose does all his operating from the boys around town. He also knows other things about Utica.

W2JB of NYC has a super compact half kw. The entire rig is in a cabinet the size of an NC81.

W2GWE has left the air for work and you-know-what.

K6JMF was so loud on the East Coast that everyone is wondering. Maybe he is too?

The wise egg signing HH1DQJ on 40 must think he is Snow White.

W2GNE out on L. I. is running the local police station competition. Seems he only bothers them at the local "parking lot." Even the signal knows where to go, eh, Charlie?

W1ZCC on 7 mc. kinda shocks everyone with his call.

W9QBT has three blood relations, all amateurs. Al, while QSP'ing for W2IOP told of tele-

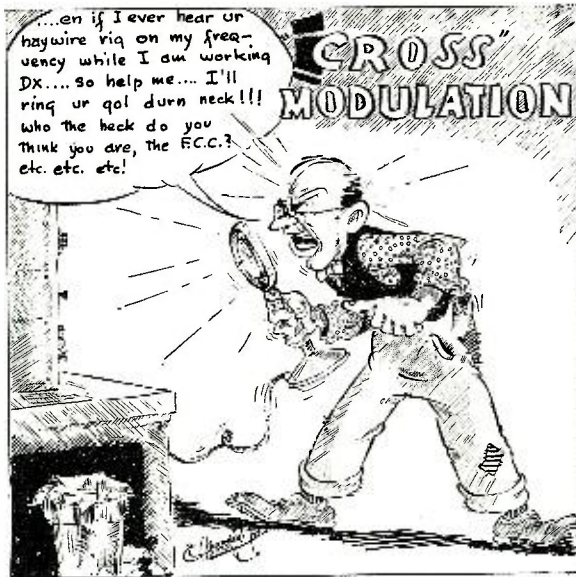

phoning a message 110 miles.

W1HSX once telephoned a message to W2IOP from G5FA in London.

Who holds the land line record for a message? W9ORQ, W9RFA, and lots of other once familiar calls to 40 are being heard again.

ARRL trunk lines and ARRS nets are all under way now. According to the *League* only net not in operation is the Canadian one. In case you're interested in an amazing bit of operating take a look at W4PL's traffic totals each month.

Interesting skeds heard recently—W4USA, W2USA, and W6USA. Only USA calls not issued by FCC are for the first, fifth, and seventh districts.

National column by well known gossip recently carried nasty bit of scandal about amateurs engaged in spy work. Watch for details—"if and when" in RADIO NEWS. Newspapers would do well to give more credit to hams for splendid cooperation they have always gotten in times of disaster and emergency. News in times of hardship usually always comes through amateurs, but you'd never know it from the press. In recent floods, only N. Y. paper to give complete credit to amateurs was the *N. Y. Daily News*.

W2AZ, the first phone station to make the *DX CC* has up and left the second district. Frank gave his three 75 footers back to the power company and has gone to a farm he owns in Michigan. Now he'll probably be the first WS on phone in the CC.

Flashes: *Unconfirmed* as yet, that the FCC has stopped issuing station licenses in view of international difficulties. Makes less stations to watch, they say. There is something big going to break open on the East Coast and when it finally does the instigator of the trouble is going to be behind the proverbial eight ball. More about it in future issues of *RA*.

EXCERPTS from the Hamfester's (Chicago) "Ham-Gab" which for the first time was photographed. . . .

George Forrest, W9ISM, wishes to announce a Ham Radio Course which he is teaching at the

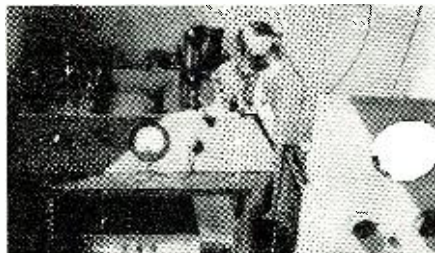

G5FA's ham rig before he was called to the colors. Drop us a line, G5FA!

Washburne School, 400 West Division Street. School started Sept. 11. Classes are on Monday and Wednesday evenings 6:45 to 9:45. This course has been successfully taught by him at Crane for several years. George is a Hamfester too. We apologize for this announcement being late, but "Ham-Gab" was not published Sept. 1st.

Nate Heaton also announces a new code class this fall at 7300 Princeton Avenue. Classes are held on Tuesday evenings at 8:00. There have been numerous graduates from this class who now have their tickets and are active Hamfesters. For further information, call Nate Heaton, W9UVU, Aberdeen 2894.

W9ISM, George Forrest, Millie Ward's big moment, won the 100th at the last meeting. He also won the men's door prize.

REMEMBER! The U. S. is neutral. Is there a printer in the club who would put out some placards for the fellows to put up in their shacks. "Please do not discuss the international situation over this station." This is especially desirable on fone.

The *Chicago Area Radio Club Council* has bid for the *ARRL 1940 Central Division Convention* to be held in Chicago. A committee has been appointed.

Johnny Huntoon's new call is W1LVQ. so keep an open ear for him. . . . W9SUJ is back in Chicago again after a brief sojourn in the East. Welcome Home!

It is said that the girls in Brewster, Ohio, also think our vice president, W9ZYL, looks like Gene Raymond. . . .

W9YDV acted as model at a facsimile and television demonstration. . . . W9CMV holds regular skeds with Chicago "Hamfesters". . . . *[Please give time and freq next time. Ed.]*

W9IWX turns on his and "she no go".

Our star reporter W9YZV is attending the code class of W9UVU. Good luck, Bill. . . .

W9ZYL's fiance helped with the raffle at the last meeting, and her work was appreciated very much. Incidentally, she won the ladies' door prize. . . .

W9MTW wants to hear from anyone on 2 1/2 m.

The "Bills", W9TLB, W9EDS and W9YZV are all on the membership committee. You can also say the same for the "Ham-Gab" committee, for it has "Three Bills" too, W9EDS, VSX and YZV.

The XYL at W9HWN is the proud possessor of a cute little puppie. Guess T.Q.M. will have to stay in the basement all the time now. You know he was allowed to eat upstairs before. . . .

Mrs. Moloney won another door prize, but that's no news. She's always winning prizes.

If you don't believe Mrs. Powers can cook, just ask Hank Woods.

W9GPS and his wife were recently the guests of John Barrymore to see "My Dear Children," and were entertained by him after the show. He kissed Louise's hand when they left, and they claim she hasn't washed that hand since. Hi! . . .

It must be a "Hamfester habit." Another of our c. w. men went down the center aisle on Sept. 30th. Her name is Billy and they are going to live at 3015 W. 61st St., Chicago.

Clara Johnson, XYL of W9WOG, her mother, Mrs. Stone, and Hank Woods have just returned from a tour of their old home state of Oregon where they visited relatives.

The Hamfesters were represented at the Columbus Convention by W9JU, W9TJD, W9VSX and W9ZYL, and Joe Haenle. Of course, they paid their own expenses.



HH2B, famous ham station of Haiti, is heard from this super fb. shack.

W9JU claims he REMEMBERS everything at the convention at Columbus.

A real gang of "Hamfesters" attended the wedding of Miss Mary Birks to Clarence (CW) Read, W9LUS on August 19th. "A good time was had by all" at the reception.

"Ahem." Frankly, we doubt it, but it is claimed that George Fenton, W9SXZ, left his picnic lunch to go over and win the pie eating contest. AGAIN! And was his face blue when he finished.

W9SXZ now receives your note thru a HRO. W9ZKQ had his receiver revamped so it really works now.

W9ZYL is engineering a new four element beam on 20 mtrs.

W9JZA sold W9TDX a ticket to the picnic. TDX won the RME-70; then he politely presented JZA with his SX-16. Who sez the days of chitzery are gone forever?

Amongst the new members announced at the last meeting were: W9OAO, W9DBT, W9WPK, W9CHW, W9KGL, W9JHA, W9JCK, W9IME, W9KRH, W9PFA, W9MGH, W9WOS, W9OZE, W9WAC, W9QIF, W9NCJ, W9ZAM and W9PRN. Congratulations, fellows, we hope you like the Hamfesters.

ANENT the Picnic of the Hamfesters:

The spirits of the executive committee were running high when W9EDS made a motion from the floor that the committee be permitted to have their picnic at club expense by throwing a party. But alas! it was voted down. Thanks just the same, Bill.

W9ZHR estimates that he and his helpers parked over 2,200 cars. The State police caused quite a "rush" at the gate when they broke the blockade of cars standing bumper to bumper from 147th to 197th streets. Registration of these cars was impossible.

The loud speaker system was furnished through the courtesy of *Allied Radio*. Thanks. Didn't ANYBODY take any pictures at the picnic? They are scarce as hen's teeth. If you have some, please advertise it.

Our Kansas YL, Opal Sisk, W9CMV sez she has been to numerous picnics, but never one like the Sixth Annual of the Hamfesters.

It was reported in Coral Gables, Fla., that there were 10,000 in attendance at the picnic!!!! Well, there was quite a crowd.

Stan Cox, W9BRN and Bob Henry, W9ARA, of Butler, Mo., said they heard of the picnic and read the "Special" issue of "Ham-Gab" and thought was a lot of ballyhoo, but (after being sighted) now they think the publicity committee fell down on the job.

By being at the picnic, Johnny Huntoon, Asst. Sec'y of ARRL, was able to see all the hams he knew, and saved several days' time thereby, so he can visit with relatives.

IN general: W9QBT of Chi QSP'd important info to W9QEA es held W2IOP hung while QEA made up his alleged mind abt it all; then reported back to IOP the result. Super fb fer QBT, es many tnx to him fm the gang at RN.

In particular: Sez the FCC: "The Federal Communications Commission announced today (Sept. 30, 1939) suspension of W3SFU and W1DIF. Following an investigation both licenses were suspended for a period of six months. The licensees have 15 days in which to make written application to the commission for a hearing on this action."

W3SFU got hissen fer QSO'ing a bootie, es W1DIF got his comeuppance fer permitting operation of his rig by a bootie. Watch urselves fellers.

VE2PF QSP's the following: W3FVS spent part of his vacation mulling in northern USA. He hooked VE2PF fm W1LTW's shack on 160.

W3HIA was heard here on 160 on Aug. 29. W8QAY visited VE2AYL es did he enjoy himself!!!

W2JIB paid a surprise visit to Canadian 2PF this summer.

Heard on 160: W3HYY, VE2PU, VE2QN.

VE2DO is portable wlt 3 watts in N. Quebec.

QRD VE Operators Ass'n?

H7G heard way up to here on 80 the other AM. His sigs wr Q4R6-7 on 3875 kc approx.

Excerpts from *Toledo Radio Club's Official Bulletin*:

The Toledo Blade for September 22nd had quite an article on a local family who keeps in touch with each other through the medium of radio. Mr. R. O. Holloway, W8QUL, operates the home station, and his wife is quickly mastering the mysteries of code and theory and plans to go to Detroit this winter to get her license. His sons, Jack, W8RYX and Norman, W8QWR, are law students at Ohio State University. A son-in-law, Lt. Howard Skeldon, at Fort Warren, Wyo., operates W7HCG and his wife recently passed the class A requirements and is awaiting the receipt of her advancement. Mr. Holloway has a brother at Green Bay, Wisc., W9ZDY. Only one member of this interesting radio family has not been bitten by the bug. It's easy to see the Holloway nets on the air.

One of the many reasons why the Civilian Air Reserve should be proud of their communications personnel is because of a queer situation which faced W8PNX when his section was scheduled to maintain radio communication between our two famous (?) airports. At the last moment it was found impossible to use the transmitter used previously and it looked very much as though one of the airports would be silent. With the ingenuity with which some hams are blessed, PNK looked the situation in the eye, grabbed up some loose equipment, soldered some wires, and in no time was the proud possessor of an ideal portable job, 15 watts input, crystal controlled.

(Pse QSY to page 66)



by SAMUEL KAUFMAN

The statements made herein are those of the author, and do not necessarily represent the views or opinions of the Editors or Publishers of RADIO NEWS.

THE slowness of television receiver sales in the New York area is causing the entire nation to eye the new field quizzically. America's largest city has been unofficially accepted as the video proving ground and even though radio enthusiasts may live hundreds of miles from Manhattan—far removed from the television program service area—they all are anxious to follow the progress of the new art. But, alas, there seems to be a bit of skepticism in their minds as to whether all this television stuff is what it's been cracked up to be. And in this view they have loads of company among New Yorkers themselves.

As far as the *Video Reporter* could observe there's no dissension over technical progress. But it's pretty hard to convince people that there's merchandising progress. And things are getting in such a state that no one is trying to convince them.

So, for this month's column, the writer decided to concentrate on just why—after five full months of regularly scheduled telecasts—sets aren't selling.

Now, if he could answer that problem accurately while the industry's high-salaried merchandising counsellors are shaking dandruff over their coat collars and lapels, he'd probably want to give up writing to become an h.-s. m.c., himself.

We won't tell any of the television big-wigs where to get off, but someone might do them a favor by whispering that they've passed their station. The lads who were shouting the statement that television was soaring sky-high forgot to mention that it was an autogyro flight that's just about where it started.

But, truthfully, it's difficult to place the blame on individual executives. The fault seems to lie in a varied assortment of reasons and we think it boils down simply to an outright lack of coordination.

The program, manufacturing and merchandising angles have been kept miles apart instead of being closely knitted in promotional campaigns. There have been mild efforts to this end but none of them really jelled.

The television situation in New York is turning out to be a classic example of buck-passing. And, when a buck is passed in television, it's just a squawk and not a dollar!

Talk to someone on the program side, for example, and you'll hear that the telecasters are doing their job, but, after all, they can't be blamed for receivers being priced too high for average budgets.

Then discuss the topic with a manufacturer. "Prices are not too high," he'll say, "there just aren't enough programs yet."

And, to round out the brief survey, ask a dealer his viewpoint. You'll find that it's a combination of what the telecaster and manufacturer each said.

But the one fellow who is rarely quizzed in such a fact-finding study is the most vital of all—the home-listener. After all, he's the potential (we hope!) look-and-listener. What does he think of television at the moment?

Oddly enough, the first-mentioned fault is that the image is too small. Every "average listener" the *Video Reporter* interviewed pointed this out. Next faults, in order, were high prices and limited programs. Most quizzed persons who witnessed store demonstrations were impressed on the whole with the live-talent programs put on the air by NBC's initial telecast station, W2XBS, but the filmed stuff was just plain "stuff" to them and nothing else.

What television needs—and needs darn fast—is a coordinator. The post we have in mind would call for a master mind who can present the industry's video sales *spiel* to the public in an intelligent, well-knitted fashion. His promotional ballyhoo should be aimed to sell *programs and receivers at one and the same time*.

The way things are going now, the manufacturers' attitude seems to be that, without them, telecasters couldn't exist. That is, if there were no sets, the video transmissions would be worthless. And the telecaster, quite naturally, can take up the argument in reverse, claiming that without programs, television receivers are as useless as a Milwaukee pretzel without beer.

Now's the time for harmony. A *unified* campaign by all branches of the video industry at a very early date will more than pay for itself in receivers sold and public confidence gained. And when these goals show signs of being achieved, the money being spent on aspirin alone (a *must* in the present diet of many, many television executives) will represent a sizable economy.

NBC, as the sole breaking-the-television-ice pioneer, has been doing a well-rounded job from the program angle. It's easy to criticize some of their efforts, but everyone must concede that the task of launching a regular television schedule in the nation's major market was a *Herculean* task, and that all in all the program lads showed plenty of ability.

We doubt that any nation in the world presented better live shows than those created and produced over W2XBS during the first five months of regular programming. The choice of films was on the poor side but it's obvious that that's because NBC virtually had no choice—the better films being unavailable.

It will be a long, long time before NBC realizes any return on its television program investment. At the same time, the network isn't forgetting that it's in the *sound* broadcasting business—and that end of it is very lucrative indeed.

But television isn't being relegated to a second fiddle role for more reasons than one. It is obvious that the network hopes to build up a video program division that will reap big profits when television goes commercial. On top of this, NBC is serving a vital need to the *Radio Corporation of America*—and its many licensees—in supplying the sight-and-sound programs that are expected to boost a demand for home equipment.

At CBS, the television picture is quite different. Actually, as we write these lines, there is no "picture" at all. The opening of the New York video station atop the Chrysler Building was delayed and postponed from month to month, season to season and practically year to year. Among the reasons for the delay were changes in transmitter design, getting bulky equipment up to the lofty skyscraper perch, and replacing some equipment after original installation.

It seems, though, that CBS saved a lot of money in not launching W2XAX according to the original plans publicized in the summer of 1937. But, it only *seems* so. Time will show whether the postponements were costly.

Some trade observers hold that CBS had nothing to lose and plenty to gain in not being on the air with television programs during the early stages of the new art. They point to the fact that NBC has invested heavily in its telecasts without any material return and they add that the sets sold to date don't even put television into the public service category.

But all those points are debatable. And the *Video Reporter* for one disagrees with them. NBC is getting a substantial return in publicity and good will that should ultimately lead to more material gains. And getting a program schedule started comes pretty close to a public service considering that it will pave the way to mass look-and-listening in due time.

If the video lads at CBS think they can catch up with the NBC achievements in short time, they're mistaken. Regardless of what amount of program work is going on before W2XAX takes to the air, the CBS television job will first start when a regular schedule is launched.

Long ago, when *BBC* launched its public-participating service in London, American television men took the attitude that we had nothing to lose by letting Europe take the lead. The thought was expressed that American laboratories had everything—and possibly more—than British firms had produced and that we could benefit by merely observing the foreign endeavors. But it took NBC a considerable time to reach the British video program standard. A visiting Britisher told the *Video Reporter* that the program he viewed at *Radio City* was as good as the best of the London telecasts he had seen. NBC reached that standard in shorter time than England, and it did benefit by *BBC's* experience to some extent. But it couldn't start on an equal plane over night.

NBC and CBS can be expected to build considerable prestige through their television efforts while waiting for commercial profits to arrive. With both firms competing in the populous New York area, it is expected that video programs will constantly get more and more elaborate. However, an elaborate show, soloquy may be more entertaining than a Hollywood mob scene. From all indications, the chains will try to outdo each other within their respective and necessarily limited budgets.

The fact can't be overlooked—and it is a fact—that television is a secondary activity at both NBC and CBS. The outlook is that sight broadcasting—when commercialized—will offer strong competition to sound broadcasting. Hence, it is important to the networks that they be in on the ground floor. While competition between the two chains can be expected to be keen, there is a likelihood that it won't be too keen in direct campaigns to win over video recruits from the

(More *Video Reporter* on page 64)

Reprinted with permission, from **RADIO Trouble Shooters Handbook**. Copyright, 1939, Radio & Technical Publishing Co. Copyright in Canada and Great Britain, and all countries subscribing to the Berne Convention, by Radio & Technical Publishing Co. All rights reserved.

SERVICEMEN'S CASE HISTORIES

by **ALFRED A. GHIRARDI, B.S., E.E.**

Author of "The Radio Physics Course," "Modern Radio Servicing"; member Radio Servicemen of America, New York Electrical Society, Institute of Radio Engineers.

BRUNSWICK 18

See also the Case Histories listed for Brunswick 11, 12 and 16 receivers

Inoperative.1) install an I.E.C. 14,000-ohm 2-watt resistor in place of the 14,000-ohm carbon type screen-voltage resistor now located between the two i-f coil cans mounted under the panel

BRUNSWICK 21

Same Case Histories as those listed for Brunswick 14

BRUNSWICK 22

See also all Case Histories listed for Brunswick 15 receiver

Fading.1) connecting lug of input winding on one of the r-f coils short-circuiting to shield can intermittently. Insulate the lugs with tape to eliminate recurrence of this trouble
2) corroded joints at the local-distance switch. Replace with new unit
3) defective "Bradley" unit tone control. Replace with a new unit

BRUNSWICK 23

Fading.1) tighten screw which fastens 10-mfd. coupling condenser to stator section of first-detector tuning condenser

BRUNSWICK 24

Same Case Histories as those listed for Brunswick 17 and Brunswick 25 receivers

BRUNSWICK 25

See also Case Histories listed for Brunswick 17
Insensitive on high frequencies.1) try replacing the oscillator tube (even if it tests O.K.)
2) make certain that porcelain insulators on the turret condenser gang are not broken
Inability to tune below 650 k.c.1) check for "burrs" on the plates of the tuning condensers. Disconnect all leads to condensers and "burn" off burrs by high-voltage method
Noisy reception.1) power transformer burnouts are quite frequent on this model. Use high grade replacement. Do not use center-taps on heater windings—install centertapped resistors at filament circuits instead. Filament winding supplying the 47 tubes is resistance-centertapped externally
Noisy when tuning
Replacing power transformer1) power transformer burnouts are quite frequent on this model. Use high grade replacement. Do not use center-taps on heater windings—install centertapped resistors at filament circuits instead. Filament winding supplying the 47 tubes is resistance-centertapped externally

BRUNSWICK 31

Same Case Histories as those listed for Brunswick 14

BRUNSWICK 32

Same Case Histories as those listed for Brunswick 15

BRUNSWICK 33

See also all Case Histories listed for Brunswick 11, 12 receivers

Radio reception interference during playing of records1) lead to "change-over switch" snapped

BRUNSWICK 42

See also all Case Histories listed for Brunswick 15 receiver

Strong vibration.1) solenoid improperly centered
2) hardening of rubber damper in solenoid
Mechanical hum1) adjust cycle switch
Mechanism stops after few revolutions1) clean motor brushes and commutator
Mechanism slows down or stops during operation cycle1) jammed solenoid plunger
Records reject continuously2) insufficient tension of stop lever spring
Record rejecting mechanism inoperative (motor operates)2) too much tension on stop lever spring
Records are not rejected1) contacts on tone-arm switch fail to open, usually because they are set too close to-

gether. Adjust the contacts so that they open when the end of the record is reached
Record-rejecting mechanism resumes another rejecting cycle immediately after completing one and before record is played
Pick-up lowers off record1) cabinet not level
Pick-up lowers past first record groove2) tension of suspension arm spring too great
Needle does not slip into first record groove1) insufficient tension of suspension arm spring
Mechanism jams.1) record gate incorrectly adjusted
Records Jam.2) records warped
Records split

BRUNSWICK 81, 82

Same Case Histories as those listed for Brunswick 14 receiver

BRUNSWICK 83

Weak reception (voltages check O.K.)1) reduce 100-ohm wire-wound screen cathode resistor down to 50 or 25 ohms
2) melt wax off and reverse r-f choke and antenna loading coil leads to position of max. signal strength
3) re-align condenser gang
4) "shorted" or "grounded" pig-tail carbon resistors
Motorboating1) "open" small 0.1-mfd. tubular condenser fastened to large 0.5-mfd. tubular condenser mounted under r-f amplifier section
Oscillation1) open-circuit in the 0.5-mfd. tubular condenser mentioned above
2) "shorted" or "grounded" pig-tailed carbon resistors
Hum (B voltage low)1) 45C-bias resistor shorted
2) braided tubing on push-pull transformer leads to resistor strips "charred", forming high-resistance "grounds" to chassis
General frequent difficulty1) a large proportion of the trouble found in these receivers is caused by "shorts" or "grounds" in the pigtail carbon resistors. It is well to check them whenever you are working on the chassis—and replace all units found faulty

BUICK

See Case History listings which follow. Also see models listed under B.O.P.-Buick

BUICK 1933 Auto Radio

Brake static1) loose cotter pin in front wheels. Place a lock washer under each pin to hold it tight

BUICK 1934 Auto Radio

Motorboating.1) "break" in the lead of an r-f cathode by-pass condenser. Look for this trouble in largest condenser of a cluster of three, jammed between lid and other two
Steady whistle

BUICK 1936 Auto Radio

Weak reception1) realign i-f stages at 610 kc and low-frequency padder at 600 kc (goes out of alignment due to temperature change)
Volume drops periodically1) speaker field coil "opens" spasmodically. Check the black wire from the field coil. This is riveted to the frame of the speaker, and often does not make a good "grounding" contact
Hum1) "75 tube faulty

BULOVA M501

Same Case Histories as those listed for Brunswick 10-AC receiver

BURLEY 31

Inoperative intermittent operation1) "open" primary winding in push-pull input transformer

BUSH & LANE 10

Oscillation1) check all r-f by-pass condensers
2) check the volume control
3) check the output filter
4) check excessive exposure of control-grid leads causing interaction between stages
5) check voltage-divider
6) try reducing the screen voltages by connecting the volume control to the extra tap provided on the voltage divider
7) try increasing the size of the r-f bias resistors
Hum1) remove the wire from the high-voltage end of the voltage-divider that goes to the filter condenser. Connect it to the junction of the choke and speaker field. Connect a 1-mfd. 300-volt paper condenser as an output filter condenser in place of the one whose position you changed

BUSH & LANE 12

Oscillation over entire dial range1) faulty output filter

BUSH & LANE 20, 20B

Same Case Histories as those listed for Bush & Lane 10 receiver

CADILLAC MASTER 1935 Auto Radio

Large 2,000-ohm resistor burns out1) secondary of last i-f coil short-circuiting to primary. Replace with new i-f transformer.

CADILLAC 06W Auto Radio

Poor tone when volume control is turned to low level1) replace volume control with a 500,000-ohm unit

CAMDEN 1480, 2480

Same Case Histories as those listed for Clarion 480 receiver

CANADIAN WESTINGHOUSE

The Case Histories for these receivers are listed under Westinghouse (Canadian) receivers

CAPEHART 400 SERIES

(Automatic phonograph record changer section of receiver)
Records keep rejecting1) automatic-stop trip lever needs oiling
2) hair-spring on clutch-throw-out lever broken
3) clutch gears set too close
4) adjust record tray
Records do not hit spindle correctly1) adjust record tray
2) adjust magazine
Pick-up arm does not set on records correctly1) adjust pick-up arm lever hook
"On-Off" and phonograph switch defect1) fibre insulation worn. Take apart and back it up with metal; be sure it does not ground to shaft

CASE 80

Weak reception.1) change detector to '56 power detection
Broad tuning2) install a trimmer on each tuning condenser and align receiver
3) for better selectivity, try shortening the aerial, or connect a 0.00025-mfd. condenser in series with it
4) try throwing the last r-f stage slightly out of neutralization

CHAMPIONETTE 5 TUBE MIDGET

Inoperative a few minutes after being turned on.1) decrease in value of 25,000-ohm resistor connected between the plate and screen grid of the detector tube. Replace with new unit

CHEVROLET B.O.P. Auto Radio

See Case History listed for B.O.P. Chevrolet Auto Radio

CHEVROLET 364441 (1933 Model Auto Radio)

Inoperative over part, or all, of dial1) oscillator dead. Check the first (4,200 ohm) section of the candom resistor strip, the 0.002-mfd. condenser across this strip, and the os-

illator tube. If they are all O.K., replace the oscillator coil even though it checks O.K.
Noisy (1) the noise is generally picked up by the shielded antenna lead which runs behind the instrument panel and is frequently in the inductive field of the cable running from the ignition key to the ignition coil of the car. Run the antenna lead at right angles to this cable

CHEVROLET 1931 Model Auto Radio

Inoperative (1) open-circuited 3000-ohm section on resistor strip next to first '36 tube
Motorboating, Whistling (1) "break" in an r-f cathode bias by-pass condenser lead. Look for largest condenser of cluster of three jammed between the lid and other two

CHEVROLET 1935 Model Auto Radio

Weak reception (1) if adjusting the first i-f transformer trimmer has no effect on the signal, check the transformer for excessive wax. Remove the wax by heating carefully in an oven
 —or, replace the entire unit. Realign the receiver (i-f peak is 262 kc)

CHEVROLET 500565 Auto Radio

Loud vibrator (1) check filter condensers and replace

CHEVROLET 600219 Auto Radio

Low (or inter- (1) check primary of push-pull mittedly low) volume accompanied by poor bass response

CHEVROLET 60049 Auto Radio

Severe chassis pickup of noise (1) see if ground lead is connected to the lighting switch. If so, move it to one of the door jamb bolts, or bond the dash to the door jamb bolts and to the firewall with heavy conductor

CHEVROLET 600565 Auto Radio

Inoperative (1) faulty 0.04-mfd. vibrator (vibrator buzzing O.K. but no plate voltages at sockets)

CHEVROLET 601038 Auto Radio

Intermittent operation (1) replace the 30,000-ohm screen grid dropping resistor

CHEVROLET 601571 Auto Radio

Improvements made by factory on sets (1) resistor No. 14 changed from 3,000 ohms to 25,000 ohms
 (2) resistor No. 42 changed from carrying serial numbers above 0374000
 (3) vol. control changed from 0.5-megohm to 1.5-megohms
 (4) 750-mmfd. cond. No. 28 removed from circuit—also 0.05-mfd. cond. No. 18-C
 (5) 1,000-ohm resistor has been inserted in series with the B+ end of the second i-f transf. secondary
 (6) condenser No. 29 has been changed from 867 mmfd. to 950 mmfd.
 (7) output tube changed from type 41 to 42

CHEVROLET 985251 Auto Radio

Oscillation (1) if a loud "pop" results when finger is touched to grid cap of the 6U7G i-f tube, replace it with a new tube
Distortion (1) faulty 300,000-ohm volume control
Eliminating stubborn motor noise (1) when installing in '37 cars, try bonding the muffler to the frame
 (2) also try omitting the ammeter by-pass condenser
Vibrator noise on all stations (1) if rectifier, all condensers, and vibrator shield can check O.K., change the 6F6 tube to a Sylvania 6F6 tube

CHEVROLET 985255 Auto Radio

Intermittent reception (1) remove chassis from case and examine the small 1-megohm resistor connected between the No. 2 and No. 4 prongs of the '6R7 tube socket. Vibration and jolts due to driving the car over bumps and rough roads frequently causes this small resistor to touch the No. 3 prong (which is at plate potential). Unsolder and lengthen the wire so that the resistor cannot touch this prong

CHEVROLET 985400 Auto Radio

remove the AVC on the first Double-spot r-f tube and apply it to the '6D6 i-f amplifier tube

CLARION A.C.-D.C. 5 TUBE RECEIVER

Low volume (1) defective detector-plate load resistor

CLARION 40

See also Histories listed for TCA Chassis
"Popping" noise while set is warming up (1) replace the 1-megohm grid resistor of the '47 tube with a ½ megohm unit
Uneven control of volume (1) faulty 5,000-ohm vol. control pot.
 (2) connect a 100- or 200-ohm resistor in series with the low-potential end of the volume control and chassis, so as to prevent the possible reduction of grid-bias to zero
Poor selectivity (1) short-circuited volume control
 (2) burnt-out antenna coil. Rewind with silk-covered wire
Oscillation (1) connect a 0.002-mfd. condenser from one side of power line to chassis
Excessive hum (1) loose laminations in the filter choke

CLARION 51, 52, 53, 55, (A.C.)

Oscillation (1) r-f cathode by-pass cond. "leaky", "open"
Intermittent reception, Noisy reception (2) clean all rotor-wipers on condensers, or put them in if they are not already there to facilitate balancing
 (3) "open" ground strap between condenser frame and chassis
 (4) poor contact between variable condenser canopy and chassis
 (5) "open" screen by-pass condenser
 (6) "open" plate by-pass condenser
 (7) poor contact between the r-f choke and main choke
 (8) chassis base plate loosely attached to chassis
 (9) poor ground connection
 (10) tube shields not secure and making good grounding contact
Low volume, Low voltages (1) "shorted" 1-mfd. condenser across the 900-ohm output bias resistor

CLARION 60, 61

Inoperative, Noisy (1) primary of special a-f input transformer faulty. This receiver has a '24 detector tube, and use of an ordinary push-pull input transformer is not satisfactory for replacement, as it will result in poor tone quality. Unless a transformer similar to the original is available for replacement, resistance coupling should be substituted instead. To do this, leave the faulty transformer in, but disconnect the primary connections to it. Connect a 100,000-ohm resistor from the plate of the detector tube to the high-B-plus line, and connect a 0.01-mfd. 600-volt condenser from the detector plate to the grid of one of the '45 tubes
Intermittent operation, Noise (1) inspect "local-distance" switch for loose contacts and terminals
Volume control burns out (on Model 60 receiver) (1) check resistor shunting volume control for "open" or change in value
 (2) check rest of voltage divider for proper value
No detector plate voltage (in Model 61 receiver) (1) "open" primary in push-pull transformer. If open, remove the transformer and take off wrapper. Usually the break (due to corrosion) will be found right where the lead joins the winding—and can be repaired

CLARION 70

Selectivity poor (1) volume control "shorted"
 (2) antenna coil burned out. Rewind with silk-covered wire of any size between No. 28 and No. 24

CLARION 80

Inoperative (1) if 260-ohm resistor overheats, test red lead to by-pass condenser block for a "short"

CLARION 90, 91, 95

Weak reception (1) replace the 0.05-mfd. (0.02-mfd. in models 91, 95, 160) condenser connected in the r-f and first detector tube grid-return circuits. These constitute part of the antenna and first detector coil assemblies. Remove the cans and replace
Inoperative (1) defective 500,000-ohm resistor connected between the plate of the AVC tube and the r-f filament rating

CLARION 100

Inoperative (1) the oscillator circuit in the receiver employs a '24 tube which also functions as a detector (autodyne). The circuit is quite critical as regards tube characteristics, and usually the proper '24 tube for this use must be carefully selected by trial from a number of tubes. Realign the tuned stages. As soon as the new tube ages (possibly after a few months) the condition may reappear.
 (2) in many cases it has been

found more satisfactory to use the old tube and decrease its control-grid bias by using a smaller value grid-bias resistor. A value of about 2,000 ohms in place of the 4,000-ohm unit is satisfactory

CLARION 160 Series

See also all Case Histories listed for Clarion 90, 94, 95 receivers
Noisy reception (1) replace wire-wound, metal-clad 1000-ohm first-audio and AVC bias resistor with (one of 300 ohms and the other of 700 ohms value)
Volume control inoperative (1) check 0.35-mfd. condenser in plate circuit of second detector. Replace with 0.1-mfd. 600-volt unit
Intermittent reception (1) check 0.00005-mfd. mica condenser in '27 oscillator grid circuit

CLARION 220

Inoperative (1) change in value of 4,000-ohm bias resistor of type '24 autodyne det.-oscill. tube, preventing it from oscillating. Replace with a new 1-watt unit, soldering it to one end of chassis and by-passing it with the 0.001-mfd. mica-type condenser
 (1) change in value of 4,000-ohm resistor between oscillator coil and cathode of the tube. Replace with a new detector-oscillator 1-watt unit
 (2) open-circuited or loose control-grid wire to the type '24A detector-oscillator tube
 This is a short piece of 1,000-ohm wire inside a sheath, making it difficult to detect an open circuit. Replace it with a plain wire lead connected in series with a 1,000-ohm, ½-watt resistor
 (3) "open" control-grid clip connection to the '24A detector-oscillator tube

Inoperative (1) check the 11,000- and 4,100-ohm sections of the voltage divider, and the primaries of the i-f transformers
 (2) '24 tube (oscillator-first detector autodyne) may check O.K. in tube checker but does not oscillate properly over entire band. Replace existing 5,000-ohm cathode bias resistor for this tube with a 4,000-ohm unit. Also disconnect the 0.35-mfd. second-detector cathode by-pass condenser and connect it to the screen grid of this tube. Connect in a 0.1-mfd. cond. for cathode by-pass instead. Realign
Inoperative (1) oscillator padding condenser (below about 1000 kc)
 (2) "shorted" or "leaky"

CLARION 240

Weak reception on short waves (1) shunt the 200-ohm fixed i-f bias resistor with a resistance of about 75 ohms. This will reduce the bias on the i-f tubes
 (2) at the Police Band position of the selector switch, one contact is not being used. If a wire is run from this terminal to the terminal of the detector coil next to the antenna, it will short out the antenna choke and increase the volume

CLARION 260 AC, 25-260

To increase the sensitivity (1) connect grid-return of second i-f transformer to a slightly "positive" point on voltage-divider (the a-f cathode tap will be a satisfactory point). This removes the noise-suppression feature by removing the delay bias from second detector
 To equip receiver with phono-pickup (1) insert a 5,000-ohm type pickup in the grid lead to the 56 audio tube. Shunt the pickup with a "shorting" switch

CLARION 280 A.C., 25-280

Poor tone (1) incorrect connection at voice-coil or speaker field. Reverse connections at either point and note the effect
Intermittent operation (1) change in value of one of the sections of the metal-clad voltage divider (part No. 14035) located at side of chassis
 To equip receiver with phono-pickup (1) insert a 5,000-ohm type pickup in the grid lead to the 56 audio tube. Shunt the pickup with a "shorting" switch

CLARION 300

Poor sensitivity (1) if tuning meter has a restricted swing when a station is reached, the trouble is likely in the circuits preceding the twin diode second-detector stage. If meter reads normal, the trouble is likely in some circuit between the second i-f stage and the speaker
 (2) go over all connections at the antenna, oscillator, first detector and oscillator coils with a hot soldering iron to eliminate any possible high-resistance connections here
 (3) faulty connection in grid cap of one of '58 tubes. Try new tube in each socket

Intermittent operation . . . 1) the same hints listed above for "Poor sensitivity" should be followed as regards the action of the tuning meter
2) faulty grid connection in the r-f oscillator or i-f stages. Will show up by a change in values of the receiver voltages and currents (measured with the set tuned to a constant signal) when the faulty part is tapped sharply
Hum 1) loose laminations in filter choke
2) short-circuited, or partially short-circuited filter choke winding
3) air gap disturbed (strike core with hammer)
Oscillation, . . . 1) open-circuited 0.01-mfd. condensers by-passing first detector, first and second i-f secondary return-leads to ground
Motorboating
Intermittent oscillation, . . . 1) open-circuiting 0.01-mfd. r-f, first detector, first i-f and second i-f secondary return by-pass condensers
Intermittent motorboating.
Weak reception
To equip receiver with phono-pickup . . . 1) insert a 5,000-ohm type pickup in the grid lead to the '56 audio tube. Shunt the pickup with a "shorting" switch

CLARION 320

Intermittent reception 1) replace the fixed condenser in the cathode lead of the '57 oscillator-detector tube with a 0.0008-mfd. mica condenser
2) check first i-f transformer at point where flexible lead connects to coil winding. A poor connection may exist here
3) check 8,000-ohm oscill. bias-resistor
Fading, 1) tube shields touching the control-grid caps of the i-f or r-f tubes. Wrap pieces of fish paper around control-grid caps
2) this receiver is sensitive to line-voltage fluctuations which cause the oscillator plate voltage to vary—with resultant fading. Connect an a-c voltmeter across power line to determine if the voltage changes when set fades. If so, install a line-voltage regulator
Hand-capacity effects . . . 1) most noticeable when a short antenna is being used. It is due to the fact that the pre-selector coil is located close behind front panel unshielded. Use a longer antenna
Oscillation 1) "open" by-pass condenser, or a high resistance connection to by-pass condensers. First apply a hot soldering iron to all connections. Then test by shunting the various condensers with good ones of approximately the same size
2) if the "dress" of the wiring has been disturbed it may cause oscillation and even weak signals. This possibility should be checked
Motorboating . . . 1) in early models, the suppressor grid of the '58 i-f tube is connected to ground. Connect it to the cathode instead

CLARION JR. 320

Rattling 1) insert just a few drops of (especially at high volume) light oil between the pole piece and the voice coil. Use just a few drops—do not flood it

CLARION 360

Excessive "boomy" bass response 1) remove the permanent, fixed tone-control condenser and resistor from across the output circuit. Use the variable tone control on the receiver alone

CLARION 400

Weak reception 1) check the dual 5-mfd. cathode condenser. Replace if faulty

CLARION 470

Intermittent reception, Distortion, Poor sensitivity 1) replace the present 10,000-ohm type '2A6 tube bias resistor with a 5,000-ohm unit

CLARION 480

Intermittent reception, Volume drops abruptly, Resonance hiss, "Tunalite" action poor, Intermittent reception, "Tunalite" operates O.K., and squeeze the socket contacts slightly to increase their tension
Weak reception, 1) broken pigtail lead to the 0.25-megohm carbon resistor mounted on the "Tunalite" socket assembly
2) faulty, "open-circuiting" 0.02-mfd. grid filter condensers in r-f, i-f and first-detector circuits
3) poor contacts between "Tunalite" tube base pins and socket. Clean the pins
4) poor contacts between "Tunalite" tube base pins and socket. Clean the pins and squeeze the socket contacts slightly to increase their tension
Choked, distorted, "Tunalite" action poor 2) replace "Tunalite" bulb filter choke laminations loose short-circuited, or partially short-circuited, filter choke winding
Fuses blow, . . . 1) first section of dual filter condenser block leaky
Type '5Z3 rectifier tube burns out

tion poor 2) replace "Tunalite" bulb
Hum 1) filter choke laminations loose short-circuited, or partially short-circuited, filter choke winding
2) first section of dual filter condenser block leaky
Fuses blow, . . . 1) first section of dual filter condenser block leaky
Type '5Z3 rectifier tube burns out

CLIMAX 4-Tube A.C.-D.C.

Low volume, . . . 1) open-circuit in the detector load resistor. Replace with a good 0.5-megohm, 1-watt unit. The detector plate voltage should be about 150-volts when the resistor has been replaced
Weak reception

CLINTON 52

Hum 1) pickup by the grid lead to the 6G6 detector. Re-route the grid lead directly to top of tuning condenser (using shielded wire)

COLONIAL 1933 Models

Microphonics, Noise . . . 1) try changing the detector tube
2) loosen the nuts on the four rubber-cushioned condenser-mounting studs. Make sure that neither the condenser shaft, dial, or knob touch the chassis or cabinet or the cushioning effect of the rubber mounting will be lost

COLONIAL 28

Inoperative . . . 1) "open" 160,000-ohm screen-grid resistor. Make the connections of the replacement directly to chassis to avoid long leads and to eliminate cathode coupling

COLONIAL 31 A.C.

Inoperative, . . . 1) open-circuited center-tapped r-f filament resistor, which is sealed in the power transformer case. Replace by mounting a 10- or 20-ohm center-tapped unit on the transformer terminals
No r-f bias voltage (even though r-f bias resistor tests O.K.)
Weak reception, 1) tuning condensers not synchronized
Broad tuning
Hum at resonance . . . 1) "open" 0.5-mfd. filament by-pass condensers in '26 tube circuit
Oscillation
Fuses blow . . . 1) short-circuited 1-mfd. line-buffer condensers

COLONIAL 31 D.C.

Receiver continues to play with switch off . . . 1) disconnect the ground lead while receiver is operating. If this stops reception, the 0.5-mfd. condenser in series with the ground lead is "shorted" (this is one of the three condensers at the left of the chassis when the set is turned upside down with the back of the set forward)

COLONIAL 32 A.C.

Inoperative . . . 1) broken tuning condenser mounting brackets
2) antenna lead shorting to metal braid
3) "shorted" condenser across grids of '45 tubes
Reception of one or two stations over entire dial . . . 1) tuning condenser shaft loose from pulley
2) broken tuning condenser drive
Weak reception 1) tuning condensers not synchronized
at higher frequencies
Weak reception, 1) open-circuited detector cathode bias resistor
Distortion 2) open-circuited first audio cathode bias resistor
3) "open" field coil in dynamic speaker
Choked reception, Distortion 1) open-circuited 100,000-ohm resistor in secondary return of push-pull input transformer

Fading, 1) open-circuiting 0.1-mfd. audio coupling condenser
Intermittent reception 2) open-circuiting 0.1-mfd. detector secondary return by-pass condenser
3) open-circuiting sections of 4407-P by-pass block in audio circuit. This condenser is located directly behind the push-pull input transformer and has 3 lugs on it
4) broken porcelain tuning-condenser mounting brackets
5) loose or broken volume control resistance elements
6) poor or unsoldered connections to the carbon resistor pigtailed
7) open-circuited or leaky sections of first, second, third r-f and detector by-pass condenser blocks
8) open-circuiting 750,000-ohm red carbon resistor in first r-f secondary return circuit
9) defective tubes (even though they test O.K.). Replace with new tubes by substitution

Note: fading in this receiver as a result of defective tubes is often due to the double tube shields which provide poor ventilation. It may

be well to drill large holes in the shield to provide better dissipation of the heat. In any event, adequate ventilation should be provided for the tubes

Oscillation, . . . 1) open-circuited 35,000-ohm resistor connecting from first r-f screen to chassis
General instability
Microphonic at resonance 1) insert small felt washers between stator plates of tuning condensers
2) corroded or loose fuse-block clips
3) volume control carbon resistor elements caked or cracked
4) noisy 65,000-ohm carbon resistor in first audio plate circuit
Phono-radio switch trouble . . . 1) an "open" detector cathode-bias resistor (black resistor) will make the radio volume improve if the phono-radio switch is switched to the "phono" position. Replacing this resistor will eliminate this trouble

COLONIAL 32 D.C.

Fading, 1) open-circuiting 0.1-mfd. audio coupling condenser
Intermittent reception 2) open-circuiting 0.1-mfd. detector secondary-return by-pass condenser
3) open-circuiting sections of by-pass block in audio circuit
4) broken porcelain tuning condenser mounting brackets
5) loose or broken volume control resistance elements
6) poor or unsoldered connections to the carbon resistor pigtailed
7) open-circuited or leaky sections of first, second, third r-f and detector by-pass condenser blocks
8) open-circuiting 750,000-ohm red carbon resistor in first r-f secondary return circuit
Poor selectivity 1) "short" the 750,000-ohm red resistor from third r-f secondary return circuit
Weak reception 1) connect a 0.5-mfd. condenser from one of the line r-f chokes to one side of power line

COLONIAL 33

See also Case Histories listed for Colonial 34
Inoperative, . . . 1) open-circuited 15,000-ohm section of voltage divider
(no r-f plate or screen voltages)
Inoperative, . . . 1) open-circuited 60,000-ohm section of voltage divider
(no screen voltage)
Inoperative, . . . 1) open-circuited 50,000-ohm resistor in audio plate circuit plate voltage)
(no first-audio plate voltage)
Inoperative, . . . 1) open-circuited 210-ohm section of center-tapped resistor in high-voltage secondary return circuit
(no d-c voltages on any tubes)
Inoperative, . . . 1) open-circuited 800-ohm bias resistor
(no output tube plate voltage)
Low volume . . . 1) receiver circuits out of alignment
2) open-circuited aerial connection
3) open-circuited 60,000-ohm screen-grid resistor section of the three-section voltage divider located near the two r-f screen-grid tube sockets. Replace with a 25,000-ohm unit in order to obtain an increase in volume
4) sensitivity may be increased by loosening each individual coupling coil on its shaft and adjusting it for maximum-gain position. Then re-align the compensating condensers
Weak overen-tire dial . . . 1) open-circuited band selector coupling coil
Low volume, . . . 1) change in value of "lavite" or graphite voltage-divider resistors or high-resistance contacts at their terminals. Check the resistance values and go over the connections with a soldering iron
Distortion, (low plate or screen-grid voltage; high grid-bias voltage) 1) open-circuited 100,000-ohm resistor in secondary return circuits of first or second r-f transformers
2) open-circuited or burnt-out speaker field
Intermittent reception, Fading 1) open-circuiting or leaky 0.2-mfd. r-f secondary return by-pass condensers
2) open-circuiting screen by-pass condenser
3) leaky r-f plate circuit by-pass condenser
4) "shorted" or broken phono switch controlled by tuning condenser
Fading 1) loose elements in type '24 tubes. Replace by substituting new tubes
2) intermittently open-circuiting primary in the first audio transformer. Replace with new transformer
Oscillation 1) open-circuited 50,000-ohm resistor in secondary return circuits of first or second r-f transformers
(More data on page 50)

SHORT WAVE FLASHES

BY CHARLES A. MORRISON
and JOHN D. CLARK

By Charles A. Morrison

Frequency in megacycles

Time is Eastern Standard

DX Transmissions

SUNDAY, November 12, and Sunday, November 19, at 10 a.m. EST, over YL2CD (28.08), operated by A. Vitolinis of Miera Isla 52-5, Riga, Latvia. . . . Wednesday, November 15, from 4 to 6 a.m. EST, over ZP14 (11.721) of Villarica, Paraguay. . . . Sunday, November 19, from 1 to 2 a.m. EST, over TG2 (6.19) of Guatemala City, Guatemala. . . . Sunday, December 17, from 1 to 2 a.m. EST, over YNDG (7.06) of Leon, Nicaragua.

NEWS BULLETINS IN ENGLISH FROM THE WARRING COUNTRIES

(Times and frequencies given are those in effect as we go to press.)

3 a.m.—Daily: ENGLAND GSB (9.51), GSD (11.75), GSI (15.26).
5:45 a.m.—Daily: ENGLAND GSG (17.79).
6:30 a.m.—Daily: ENGLAND GSG (17.79).
7:30 a.m. (ex. Sun.): AUSTRALIA VLR (9.58).
8:15 a.m.—Daily: ENGLAND GSA (17.79).
11 a.m.—Daily: ENGLAND GSG (17.79).
12:30 p.m.—Daily: ENGLAND GSG (17.79).
1 p.m.—Daily: FRANCE TPA2 (15.243).
2 p.m.—Daily: ENGLAND GSG (17.79).
GSI (15.26).
3:50 p.m.—Daily: ENGLAND GSG (17.79).
GSP (15.31), GSD (11.75).
4:45 p.m.—Daily: ENGLAND GSP (15.31).
GSD (11.75).
6:00 p.m.—Daily: GERMANY DJB (15.2).
DJJ (11.77).
6:30 p.m.—Daily: ENGLAND GSD (11.75).
GSF (15.14).
7:00 p.m.—Daily: U. S. S. R. RV96 (15.18).
RAN (9.6).
7:30 p.m. (ex. Sat.): HUNGARY HAT4 (9.12).
7:30 p.m.—Daily: ITALY 2R03 (9.63), 2R04 (11.81), 2R06 (15.3).
7:30 p.m.—Daily: ENGLAND GSD (11.75).
GSB (9.51), GSF (15.14).
8:15 p.m.—Daily: GERMANY DJB (15.2).
DJJ (11.77).
8:15 p.m.—Daily: FRANCE TPA11 (11.885) (9.68).
8:25 p.m.—Daily: SPAIN EAQ (9.86).
9:45 p.m.—Daily: ENGLAND GSD (11.75).
GSC (9.58), GSB (9.51).
10:30 p.m.—Daily: GERMANY DJJ (11.75).
DJB (15.2).
11 p.m.—Daily: ENGLAND GSD (11.75).
GSC (9.58), GSB (9.51).
11:30 p.m.—Daily: FRANCE TPB11 (11.885) (9.68).
12:15 a.m.—Daily: FRANCE TPB11 (11.885) (9.68).

AMERICAN NETWORK PICKUPS FROM EUROPE

8 a.m.—Daily: Rebroadcast over WPIT (21.541), WGEA (21.5).
8 a.m.—Weekdays: Rebroadcast over WCBX (21.57).
12 noon—Weekdays: Rebroadcast over WGEA (15.33), WPIT (15.21).
3:30 p.m.—Sundays: Rebroadcast over WGEA (15.33).
5:15 p.m.—Daily: Rebroadcast over WPIT (11.87).
6:45 p.m.—Weekdays: Rebroadcast over WCBX (11.83).
7 p.m.—Sundays: Rebroadcast over WCBX (11.83).
7:15 p.m.—Daily: Rebroadcast over WGeo (9.53).
10 p.m.—Daily: Rebroadcast over WPIT (11.87).
12 mid.—Daily: Rebroadcast over WPIT (6.14).

New Short-Wave Stations (On the Air)

ANDORRA—"Radio Andorra," inaugurated last August 7, has been conducting experimental transmissions on approximately 11.835.
ARGENTINA—LRA2 (6.185), Buenos Aires, an optional frequency for LRA1 (9.69), operates weekdays from 5:30 to 9 p.m. and on Saturdays and Sundays from 7 to 9 p.m.
CHINA—Central Administration Station XGOY/XGOX at Chungking, was bombed on September 3. The national programs formerly heard over this station are now being broadcast over the Yunnan Broadcasting Station XGX according to the following schedule: on 17.8 mcs., from 9 to 10:40 p.m., beamed on North America; on 11.9 mcs., from 5:30 to 7:20, beamed on N.E. China; from 7:20 to 7:50 a.m., beamed on Japan; from 8 to 11, beamed on

South China; from 11:10 to 11:30 a.m., beamed on the U. S. S. R.; from 2 to 4:20 p.m., beamed on China and from 4:30 to 6:20 p.m., beamed on Europe. English news bulletins are given at 6:15, 9 a.m. and at 9:50 p.m. Signals are heard best in this country near 6 a.m. . . . Desmond Callan of Readville, Mass., reports reception of a strong Chinese station on 9.525 mcs., from 5 to 7 a.m. Mr. Callan does not believe this station is ZBW3 at Hong Kong.

CUBA—COHI (6.45), 5,000 watts, of Santa Clara, went on the air, September 1. Schedule is from 7 p.m. to midnight. . . . A COX4 (6.39), location unknown, has been heard testing near mid-day. . . . A second transmitter is now relaying the programs of COCQ, Havana, on a frequency of 6.36 daily from 7 p.m. to midnight. . . . A second transmitter is now operating in parallel with COCH, Havana, Cuba, on a frequency of 6.46 mcs.

ENGLAND—GST (21.55), a third 13-meter band frequency for Daventry, has been operating daily from 5:45 to 10:15 a.m. in parallel with GSJ and GSH.

FRANCE—The new 100,000 watt transmitter of "Paris Mondial" at Paris, is now on the air nightly from 8 to 11:45 p.m. on a frequency of 9.68. It is also being used on a frequency of 15.243 mcs., under the call TPA2, daily from 12:30 to 1:30 p.m. for a special transmission to North America. News in English is read at 1 p.m.

ITALY—Several new Rome frequencies, namely 2R013 (11.9), 2R014 (15.23), 2R015 (11.76) and 2R016 (21.51) are being used experimentally. 2R014 (15.23), is on the air almost every afternoon up to 7:30 p.m.

PARAGUAY—ZP8 (11.85), power 500 watts, located at Asuncion, is said to be on the air.

POLAND—A few days before the start of the present war, a new Polish station was heard testing on a frequency of 11.99 mcs., from approximately 7 to 9 p.m.

UNITED STATES—KGEI of San Francisco, Calif., is now operating on a new frequency of 6.19, nightly from midnight to 3 a.m.

VENEZUELA—A new station in Caracas, announcing as YV5RJ/G (4.907), signs off nightly at 9:30 p.m. with a military march, according to John Larsen of Geneva, N. Y.

YUGOSLAVIA—The new 10,000 watt short-wave transmitter at Belgrade, went on the air September 1. Under the call YUC (9.505), it has been operating in parallel with YUA (6.1), daily from 4 to 5:30 p.m.; news in English at 4:15 p.m. Under the call YUG (15.24), it broadcast a special transmission for North America nightly from 7:30 to 9 p.m., for several weeks. The new transmitter then shifted to another frequency of 11.74 mcs., for the North American transmission, where it is still operating as we go to press.

Under Construction

AUSTRALIA—The new Perth transmitter, which will operate as VLW on 6.13; as VLW2 on 9.56 and as VLW3 on 11.83, should be on the air soon.

CHILE—A new 5,000 watt transmitter to relay the programs of CB118 and CB150, on a frequency of 9.46 mcs., is said to be under construction.

LIECHTENSTEIN—If present plans materialize, this tiny Principality may soon have a short-wave station which will carry commercial sponsored programs beamed on Great Britain and North America.

SPAIN—According to Egyptian Radio, the Government of Spain has ordered a new 40,000 watt national short-wave station.

VENEZUELA—A new 30,000 watt national short-wave station which will operate as YV6F on 6.172; as YV5C on 9.04; as YV0R on 11.725, and as YVXP on 15.315, is now under construction at Caracas.

Notes of Interest

AUSTRALIA—VLR (9.58), is the best dx signal being heard on the 31-meter band at present. VLR3 (11.89), relays the BBC program daily from 11 p.m. to 12:30 a.m. . . . Desmond Callan of Readville, Mass., claims he has never been able to receive VK2ME (9.59) on Sunday mornings despite its rated 20,000 watts power.

COLOMBIA—HJDU (4.805) signs off at 8:50 p.m. with a march.

DENMARK—Despite reports to the contrary OZG (11.805) has not radiated since August 10, 1937, because there is too much interference on this channel.

DUTCH GUIANA—Although off schedule and off frequency, the station recently heard by John Larsen of Geneva, New York, from before

7:30 until 8:30 p.m. on 6.79 mcs., is believed to have been PZH of Paramaribo.

ENGLAND—According to Marvin Seidman of Los Angeles, Calif., Daventry is now verifying reception reports. On many occasions he had sent letters to Daventry requesting verifications but none had been forthcoming. Determined to try once more he was agreeably surprised to receive early in September a nice verification card 7 by 5 inches in size. . . . Since the beginning of the war, GSG (17.78), has been beamed on North America, daily from 3:45 to 8:30, 9 a.m. to noon and from 12:25 to 4 p.m. . . . GSA (6.05), Daventry's winter frequency is back on the air and being used daily from 1 to 6 and from 6:20 to 9:15 p.m. for the European program.

FRANCE—News in French is now being broadcast over the Paris Mondial station daily at 8 p.m. and 12:15 a.m. on 11.885, 11.714 and 9.68 mcs.

FRENCH INDO-CHINA—"Radio Saigon" broadcasts the news in English on a frequency of 6.116 at 6 a.m. and on a frequency of 11.78 mcs., at 6:30 a.m. The announcer is Lady.

GERMANY—In Germany a decree is now in effect which makes it a major offense to listen to foreign short-wave stations. Those who violate this law will be imprisoned and those guilty of passing on any information thus intercepted can be put to death.

HUNGARY—The Budapest experimental transmitter HAD will be testing intermittently from October 24 to November 12, and from Jan. 24 to February 12, 1940, on the following optional frequencies: 21.48, 11.85, 9.625 and 7.22 mcs.

ITALY—August Balbi of Los Angeles, California, writes that 2R03 (9.63) has been broadcasting an unlisted transmission to the Far East, nightly from 1 to 2 a.m. . . . 2R012 (15.1), is in use almost every afternoon. . . . 2R09 (9.67), Rome, often relays the American Hour, nightly from 7:30 to 9 p.m. Other stations that broadcast the American Hour regularly include 2R03 (9.63), 2R04 (11.81), 2R06 (15.3) and IRF (9.83).

LUXEMBOURG—Experimental transmissions of the new Luxembourg station, first reported in the last issue of RADIO NEWS, have been received by August Balbi of Los Angeles, California, from 9 to 11 p.m. of 11.785, by Desmond Callan of Readville, Mass., from 6 to 7 a.m. on 15.35; by R. B. Oxrieder of Corozal, Canal Zone, from 5 to 6 p.m., on 11.782 mcs.; and by Robert Froelich of Evansville, Indiana, from 10 to 11 p.m. on a frequency of 11.782 mcs.

MANCHOUKHO—MTCY (11.775), broadcasts a Japanese program daily from 9:45 to 10:30 a.m. according to Harry Honda of Los Angeles, California.

NORWAY—LKV (15.165), Oslo, is easy to identify when broadcasting news in French at 9:15 a.m.

POLAND—The Warsaw short-wave stations which have been off the air since early in September, may soon be broadcasting again, under Nazi sponsorship.

PORTUGAL—CSW7 (9.735), Lisbon, may be operating on a revised schedule since it is reported to be broadcasting frequently until after 10 p.m.

PUERTO RICO—Broadcast station WKAQ at San Juan, has received an extension of its temporary permit to relay non-commercial programs of short-wave stations WCBX and WCAB.

SIAM—HS6PJ (19.02), will soon be operating in parallel with HS8PJ (9.51), daily from 7 to 10 a.m.

SPAIN—EAQ (9.86), now signs off nightly at 8:30 p.m. Just before closing-down a clock may be heard striking the half-hour, followed by the National Anthem and "Vive La Espana."

SWITZERLAND—The Swiss Government may acquire the powerful League of Nations station "Radio Nations," at Prangins, to replace the short-wave station at Schwarzenburg, which was destroyed by fire some months ago.

UNITED STATES—The National Geographic Society—University of Virginia Expedition to the South Seas, described in last issue, has been called off for the duration of the war. . . . Eugene Darlington's "Mail Bag" feature, one of the most popular programs broadcast by General Electric stations WGEA and WGeo at Schenectady, New York, has been cancelled due to war conditions.

WRUW (WIXAR) of Boston, Mass., has been granted an additional frequency of 25.6 mcs., in addition to those already assigned, namely 11.73 and 15.13. An European News Hour, including news in German, French, Italian and English, is now being radiated on Mondays, from 4 to 5 p.m., over Boston stations WRUW (15.13) and WRUL (11.79).

Despite hostilities, Prof. John Scammell's popular "Listeners' Postbox," is back on the air and can be heard Tuesdays at 4:30 p.m. over WRUW (15.13) and WRUL (11.79) of Boston. . . . Cincinnati, Ohio, short-wave station WLWO sometimes remains on the air 24 hours a day to bring the latest European news to its listeners.

Providing the supply has not already been exhausted listeners can obtain a fine map of the war zone and Europe in general by writing to stations WLW/WLWO of Cincinnati, Ohio. The Federal Communications Commission proposes to deny the application of the Chicago Federation of Labor for renewal of license for international broadcast station W9XAA. It is claimed the licensees failed to live up to the terms of their license.

U. S. S. R.—RNE (12), Moscow, has been added to the network of Moscow stations that transmit to North America nightly from 7 to 8:50 p.m. Other stations include RV96 (15.18), RAN (9.6) and RKI (15.04). RKI (15.04) and RNE (12), broadcast a program in German, Sunday afternoons, which is very well received in North America. . . . RZZ (14.96),

(More S.W.F. on page 44)

N. A. N. J. A. J. J. E. S. L. I. N. E. A. J. E.

A new catalog has been issued by Bliley Electric Company describing a complete line of quartz crystals, ovens, and holders for crystals in the range from 20kc. to 30mc. The Amateur type crystals are not included in this catalog and the contents are devoted to the listing of commercial types only. Catalog G-11 will be of interest to radio engineers, station operators, purchasing agents and experimenters interested in the application of quartz crystals for frequency control, for use in filters or for special optical and electrical applications. An attached note gives a true explanation of "Frequency accuracy" that is a handy and valuable reference for the station operator. A copy may be had on request. (RADIO NEWS No. 12-100.)

Aerovox Corporation has issued a new 1939-40 catalog. This 28 page book is packed with a complete choice of condensers of all types, as well as essential resistors and test instruments. Many new items are introduced for the first time, including the L-C checker and the motor starting capacitor-selector and emergency unit kit. The compilers of this catalog have evidently striven for attractive simplicity of text and illustration so as to conserve the time of the reader. There are sketches, complete specifications and illustrations contained in a most compact manner. The various types of condensers are classified and indexed, so that the user will have no trouble in locating just the right unit for a given application. Copy obtainable. (RADIO NEWS No. 12-101.)

RME, Radio Manufacturing Engineers, 111 Harrison St., Peoria, Ill., have printed a new catalog describing the complete line of RME receivers. Among the several new items are: the DM-36 Band Expander, the 510-X expander, the DB-20 Pre-selector, DB-20-70 Pre-selector, the 510-X-70 Expander, and the DM-36-70 Band expander. Many special accessories have been added to the line which include a new Frequency Inverter LF-90, an Oscilloscope Amplified type OA-1, a noise suppressor, LS-1, and a Quartz Frequency Control NC-1.

New receivers include a six tube super-heterodyne covering the range of 180-4100 kc. This set uses the latest low-drain battery type tubes. Another is a new 5 and 10 meter job, incorporating the latest in r.f. circuits and using the latest tubes. Copies of this catalog available. (RADIO NEWS No. 12-108.)

The Cornell-Dubilier Electric Corporation has recently issued a new 1939-40 sixteen page edition of its catalog, Radio Capacitors for all Requirements. Listed as No. 173-A in the series, this catalog deals with Mica, Paper, Dykanol, Wet and Dry Electrolytics for Amateurs and servicemen gives a complete description and listing of the Cornell-Dubilier Capacitor Test Instruments and Quietone Interference Filters. The pages are laid out for quick, easy reference and follow a definite pattern throughout. Features of each unit in the Cornell-Dubilier line are conveniently placed in highlight near the center of the page. Many new types of capacitors recently developed in the Cornell-Dubilier laboratories are described for the first time in this catalog. (RADIO NEWS No. 12-102.)

In its Test Equipment-Accessories Catalog for 1939-40, which is just off the press, the RCA Manufacturing Company has announced many new additions to the extensive line of RCA test equipment, accessories and parts, including the lowest priced carbon microphone in the Company's history and three improved phonograph pickups.

A valuable reference for distributors, dealers, and servicemen, the catalog contains a fully illustrated listing of accessories, parts and test equipment. Prices, stock numbers, specifications and general descriptions of all items are included. In addition, it presents a 16-page index of the principal replacement parts for all RCA Victor radio, Victrola and phonograph models of the past five years.

Among the many other outstanding items

listed in the new catalog are the popular Rider Chanalyst and Voltohmyst; a new RCA five-inch general purpose oscillograph; an automatic record changer, an extensive line of television parts and antennas; and an automatic auto antenna. The catalog, which is printed in two colors and has a striking television cover design, is now available from RCA Parts Distributors. (RADIO NEWS No. 12-103.)

In a new edition of their Official Characteristic Handbook, National Union Radio Corporation has listed 584 tube types according to Mr. F. M. Paret, National Union Sales Engineer.

Says Mr. Paret: "The new edition of National Union's Characteristic Handbook is, to the best of my belief, the most complete compilation of its kind in the industry. It contains essential characteristics and base pin connection diagrams for 584 tube types including numbers now considered obsolete, types in general popular usage, and brand new types which have been developed during the past few months. We have so designed this booklet that it is extremely handy from the standpoint of size—may be carried around in your pocket."

The new Handbook is being made available free of charge to individuals in the radio industry through National Union distributors in all parts of the country. (RADIO NEWS No. 12-104.)

The 1939-40 catalog of the Insuline Corporation of America, 30-30 Northern Blvd., L. I. City, N. Y., is now available to manufacturers, amateurs, servicemen, and experimenters, etc. It contains 44 pages measuring 8½ by 11 inches, and describes the extensive "ICA" line of receiving and transmitting parts and accessories, service tools and attachments, racks, panels and chassis, antennae and auto radio accessories, and hundreds of other items.

Copies of this new catalog, which bears the number 205 are being distributed by parts jobbers and dealers everywhere, and are obtainable, free of charge. (RADIO NEWS No. 12-105.)

With war in Europe stimulating peak interest in newscasts and short-wave broadcasts direct from battle areas, Stromberg-Carlson has just published a war map and radio log for its dealers to hand out.

One whole side of the sheet contains a large, seven-color map of the European war zone for reference in keeping tabs on progress of the war. On the opposite side is given a log of "News In English" broadcasts direct from European capitols together with a log of foreign language news broadcasts beamed at North America. Also included are short-wave tuning tips, a time conversion table, and a chart showing when to use the various short-wave bands.

A dozen Stromberg-Carlson radios offering short-wave reception are illustrated and described in this new piece, as well as the Stromberg-Carlson No. 5 Antenna Kit which is recommended for short-wave reception.

The combination war map and short-wave log, in addition to being an appreciated counter "give-away", is valuable to canvassing radio salesmen to offer as an introductory gift when making their purpose known. It has also proved a successful "puller" when offered as a gift to anyone visiting the dealer's store. (RADIO NEWS No. 12-106.)

The General Ceramics Company of 30 Rockefeller Plaza, New York, N. Y., has recently released a fully-illustrated twenty-four page catalog containing complete and concise information on General Ceramics Steatite and Ultra-Steatite Insulators.

This catalog, indexed for ready reference, is divided into sections dealing with Antenna Insulators, Stand-off Insulators, Lead-in Insulators and Entrance Bushings, and Coil Forms. It contains data on the high-lights of General Ceramics Steatite, a table of its physical characteristics as well as an account of its various miscellaneous applications.

Copies of this booklet (Catalog 100) may be obtained by writing to the company at the above address. (RADIO NEWS No. 12-107.)

Radio Wire Television Inc., (formerly Wholesale Radio Service Co., Inc.) announces that its "Master" Catalog for 1940 is now ready for distribution, with 188 pages crammed full of items to meet every radio requirement. This is said to be one of the most comprehensive radio buying guides in the world, with 40 pages of home, portable and auto radios and accessories; 35 pages of public address equipment; 50 pages of equipment, parts and tools for the serviceman; and 30-odd pages for the "Ham" and television experimenter, as some of its major sections.

A post-card addressed to the above company at 100 Sixth Avenue, New York City, will bring this catalog to any of our readers, without charge, or a copy may be obtained by a personal call at this or at any of the following branch stores: 265 Peachtree Street, Atlanta, Ga.; 110 Federal Street, Boston, Mass.; 901 West Jackson Blvd., Chicago, Ill.; 542 E. Fordham Rd., Bronx, New York; 90-08 166th Street, Jamaica, L. I.; and 24 Central Avenue, Newark, N. J. (RADIO NEWS No. 12-109.)

The new Sprague Manual of Radio Interference Elimination just off the press, paves the way for profitable new business for servicemen, operating either individually or in cooperation with local public utility companies or with their jobbers.

Written by Sprague engineers following a long study of interference problems and assistance in the actual suppression at the source of more than two thousand cases of man-made interference, the Manual tells exactly what to do and how to do it. It tells the reader how to locate noise-making devices, then how to determine exactly what units are required before any filters are bought or any permanent installation made. Described and illustrated are the correct filter circuits and parts needed and the procedure for connecting them to electrical devices such as single or polyphase motors, DC generators, alternators, switches, thermostats, sign flashers, arcing devices, oil burners, gas engines, vibrating contacts, mercury vapor lamps and many others. In practically every case, the procedure entails filter installations directly at the electrical device, as long experience has proved this is the only means by which radio noises can be eliminated satisfactorily.

In addition, the Sprague Manual tells servicemen how to go about building profitable interference business and describes numerous sales helps such as direct mailing pieces and newspaper advertising mats that are available free.

Attractively printed, easy to understand, the manual sells for 25c net per copy. It may be obtained either through Sprague jobbers or from the manufacturer at this price. (RADIO NEWS No. 12-110.)

The 1939 Catalog and Data Book of Elastic Stop Nut Corporation, 1015 Newark Avenue, Elizabeth, New Jersey, is now ready for distribution. This 56-page book explains graphically the Elastic Stop principle, whereby the nut is locked to the bolt through the action of a resilient non-metallic collar which eliminates all thread play between nut and bolt.

Contained also are comparative test data, suggestions as to where Elastic Stop Nuts can be used to advantage, numerous illustrations of applications in various industries, and a complete listing of the standard nuts available. (RADIO NEWS No. 12-111.)

The Black & Decker Manufacturing Company, Towson, Maryland, recently published a twelve page booklet—"The Proper Care and Maintenance of Portable Electric Tools"—which gives some very helpful hints, not only on care and maintenance, but also methods of properly grounding to protect the operator, currents, proper sizes of extension cable and pointers on what to look for when a tool fails to operate. The book is a real

"pocket pal" for the portable electric tool user. (RADIO NEWS No. 12-112.)

The A.R.R.L. Antenna Handbook is now off the press. A comprehensive manual of amateur antenna design, by the staff of the American Radio Relay League. Eighteen chapters, profusely illustrated. Both the theory and the practice of all types of antennas used by the amateur, from simple doublets to multi-element rotaries, including long wires, rhomboids, vees, phased systems, u.h.f. systems, etc. Feed systems and their adjustment. Construction of masts, lines, and rotating mechanisms. Over 100 pages of valuable information is included. Of particular interest is the inclusion of tables to show, at a glance, the proper impedance presented by various lines under varying conditions. Price, 50 cents postpaid. American Radio Relay League, Inc., West Hartford Conn., U.S.A. (RADIO NEWS No. 12-113.)

Columbia workshop plays, 14 RADIO DRAMAS, published by McGraw-Hill Book Co., N. Y., and edited by Douglas Cooper contains original scripts used in the series of plays dramatized over the Columbia Broadcasting System during the past three years. This book is not only good reading for anyone who enjoys the drama; it is also filled with practical suggestions for writers, and will provide student groups and organizations with copies of the better scripts for study. Mr. Coulter has written a special general introduction to the volume and complete notes on each play are given. Eight of the scripts were scheduled for rebroadcast during the summer of 1939 as a part of the Columbia Workshop's Summer drama festival. The book contains 378 pages and sells for \$2.75. (RADIO NEWS No. 12-114.)

Volume X incorporates a revised "How It Works" section, in which all of the latest technical features of the new receivers are fully explained. To meet a need which will soon be felt by servicemen, it also contains the most advanced information on television, radio facsimile receivers, and electronic musical instruments—their installation and servicing. A completely revised Index, covering all ten volumes of the Rider Manuals, makes it easy to locate servicing data on any popular radio receiver issued up to the present time.

In line with the new and faster schedule, John F. Rider, Publisher, 404 4th Ave., New York City, also announces that future editions of the Rider Manual will be published twice yearly. This will make it possible for the radio technician to have up-to-date information on the very latest receivers reaching his bench. Publishing date for Volume XI has been set for February, 1940. (RADIO NEWS No. 12-115.)

INTRODUCING a new service to RADIO NEWS readers. Each month we will print short reviews of the leading manufacturers' literature. Under each review will appear a reference number (for instance, the Thordarson Catalog number this month is, RADIO NEWS No. 11-111). All you have to do is to fill out the coupon at the end of the page indicating by number the catalogs you wish to receive, and we will do the rest. There is no charge, unless the review says that there is, and then that is charged by the manufacturer, not us. Each coupon is good for the time limit stated thereon, and no guarantee is made by us that the manu-

facturer will send out catalogs to all who ask for them, though they usually have done so in the past. We merely forward your request to them.

RADIO NEWS, Catalog Dept.
608 South Dearborn Street, Chicago, Illinois.
 Gentlemen:

I have checked the literature I should like to have the manufacturers send me. If I have checked an article for which I must pay, I enclose the money.

FREE LIST

.....12-10012-10212-10612-110
.....12-10112-10412-10712-111
.....12-10812-10512-10912-112

12-103

NON-FREE12-113 (\$0.50)12-115 (\$10.00)12-114 (\$2.75)

Name

Address

Occupation

Call letters, if any..... This offer expires January 10, 1940.

NOW YOU CAN BUILD THE BROWNING BANDSWITCH ELECTRON-COUPLED EXCITER

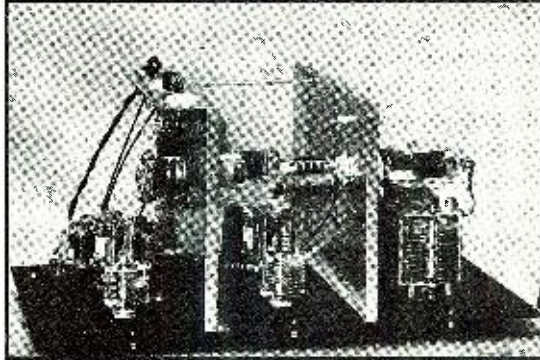

- SPONSORED BY**
- ★ AMPHENOL
 - ★ CARDWELL
 - ★ CORNELL-DUBILIER
 - ★ KENYON
 - ★ OHMITE
 - ★ PAR-METAL
 - ★ RAYTHEON

RAPID BANDSWITCHING PLUS THE ABILITY TO SHIFT FREQUENCY WITHIN ANY ONE BAND IS NOW POSSIBLE

In designing this Electron Coupled Exciter, Glenn Browning considered one thing: A long term investment for the Amateur at low initial cost. In order to accomplish this he called upon seven of the greatest names in Radio to supply the parts for this truly fine piece of equipment. Careful design plus quality parts have combined to produce a flexible, all-band Exciter which features:

- Power enough to drive a 200-watt final amplifier.
- Output on 5 bands, 160 to 10 meters inclusive.
- Crystal or E.C.O. selected at will.
- Operation in any part of any band at will.
- Stable E.C.O. allows calibration of the exciter which is permanently reliable.
- E.C.O. may be keyed for break-in operation. Note cannot be told from crystal.
- Greatest possible simplicity for ease of construction together with flexible operation and low cost.

Determine NOW to build this Exciter. Leading jobbers everywhere have all the parts required to build this quality job. See YOUR jobber today. FREE parts list, circuit diagrams, and literature are also available through him. If he has not yet received his supply, address any of the cooperating manufacturers or write direct to **Browning Laboratories, Inc., Winchester, Mass.**

START WITH THE FOUNDATION KIT

You need not buy ALL the parts at once. The Foundation kit is all that is necessary to get you started. This includes Par-Metal front panel, two partition shields, one back shield, Kenyon filament transformer, three Browning tuners, all dials, escutcheons, knobs, five RF chokes Isolantite tubing, two DPDT switches, wire and miscellaneous hardware. Net price to the amateur, including circuit diagrams, constructional data, etc. **\$36.90**



BROWNING *Electron-Coupled* EXCITER KIT

For Amateur Radio Hardware See MALLORY-YAXLEY

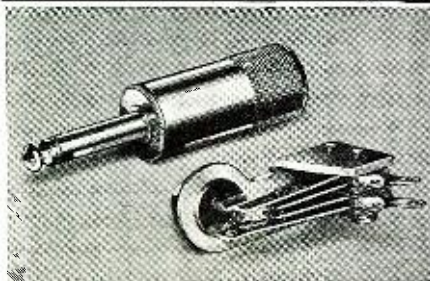

Two-way phone plug No. 75N, with shielded nickel shell. Other types—three-way, tie cord, etc.—in both bakelite and nickel shells.

Junior Jack No. 704—springs are parallel to panel for compactness—thirteen combinations available in this type.



This three circuit microphone jack No. 2B is typical of the famous Mallory-Yaxley Line. A variety of spring combinations is available for practically any application and special models can be furnished on order.

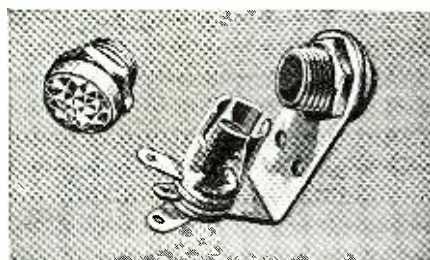

Avoid run down batteries, or increased power bills by using Mallory-Yaxley Pilot Lights and Jewels as indicators. They will keep you "informed" at all times, and enhance the appearance of your rig.

P. R. MALLORY & CO., Inc.
INDIANAPOLIS INDIANA

Cable Address—PELMALLO



Serviceman's Experiences

(Continued from page 20)

ball after the *Philco* installation—with apologies instead of ice cubes; there was a Martini—shaken, I believe, in a rubber glove—after the *Sonora* installation. Later, after the antenna installation, a quick ounce of Cointreau. But it was the last one—a double *Dockwalloper's Delight*—that put me to sea; it was—

The 'phone rang. "Salutary Sales & Service," I said, "Happy holiday!"

"Come quick!" someone shouted. I was instantly on the alert.

"Yes, sir—be right over!" I replied, hanging up snappily and running toward the door. I paused at the truck. "Wonder who that was?" I thought.

I soon found out. He called back in ten minutes, very excitedly.

"Have you started?" he asked. "I need help quickly!"

"Not yet," I admitted. "Who is this?"

"This is Santa Claus, playing Mr. Dupre. That is, this is Mr. Dupre, playing Santa Claus," was the answer.

"Yes, Mr. Santa," I said, in full possession of my business acumen, "what's the trouble?"

"The *Strawberry-Carlsburg!* A terrible noise comes out! There's static in the dynamic!" were the replies, "and it must be stopped before the family returns. Hurry!"

"Maze wee," I shouted, briskly hanging up and snapping my heels together, foreign legion fashion. The heels, however, were of rubber, and they did not click very satisfactorily.

I loaded the car: a battery portable, to locate the noise source; a tube tester; voltmeter; two oscillators—one as a spare; oscillograph; tools; small parts; tubes—one of each type; and a slide-rule. As an after-thought, I took the ohm-meter—in case I had to measure the antenna resistance.

Finally, I got in the car, juttied my chin, murmured "*Semper Fidelis!*" and—stopped. How forgetful Dupre had been! He hadn't given me his address!

I got it when he called the third time, and arrived at his house in short order. He lived around the corner.

The house was lighted to the shingles; new furniture and presents had been appealingly placed; wreaths, tinsel and colored lights were in all the windows. An electric candle blinked a welcome from the vestibule door. A perfect touch!

Dupre, poor fellow, was frantic with disappointment. His wife and child were due in two hours. I listened to the set; the noise was bad. A high-level rasp was hitting the speaker every three seconds, and it rode over the strongest signal. I plugged in everything I had and went furiously to work; Dupre paced back and forth behind me, wringing his hands. Soon I saw I would need help, and 'phoned Al rather than risk losing the sale, or at least good-will.

"We've been robbed!" my partner shouted, "there's not a meter left in the shop!"

"I am using all our test apparatus in Mr. Dupre's home," I explained. "Come and help me—I'm stumped by a terrible set noise, and his family will be here within a half hour!" I hung up and went back to work. After ten minutes, with no Al, I 'phoned again.

"What's the trouble?" I asked, "hurry!"

"What's the trouble?" Al yelled. "What's the ADDRESS?"

I told him, and he made it in five minutes. When he came in, he saw the litter of equipment on the floor, and said: "Twas the night before Christmas—what a mess!" Then, seeing me standing on the back of a divan, balancing myself while I explored the ceiling with the battery portable, he added: "There, but for the god of grace, be I!"

Dupre shouted: "You jest at a time like this—when static is going to spoil my Christmas—the whole New Year—my entire life?"

"Sorry, Mr. Dupre," Al replied, "I was laughing at a peculiarity of my partner. If you will listen closely, you will find the noise has stopped!"

We listened. Not a click!

"It'll come back!" Dupre declared.

"No it won't," Al said, "not as long as you carry this talisman in your pocket!" My partner handed him something, and Dupre instantly was a changed man. Happily he invited Al back to the kitchen to open a new bottle of old Benedictine, leaving me to gather up my equipment.

As we left, Mrs. Dupre and Bernice arrived. We both stood at the curb a moment, watching the touching scene. The house, fully lighted; the joyous greetings; the ecstatic childish shouts as Bernice skipped from one enchanting room to another. Then Al and I, without a word, walked back to the shop together.

I reassembled the store, and, just before we locked up, I asked:

"Al, what was that thing you gave Dupre?"

"As I came up the front steps," Al replied, "a vestibule light blinked as if in welcome. I took out . . .," he paused just enough to give me the needle, "I took out the flasher!"

—30—

Short Wave Flashes

(Continued from page 41)

Moscow, broadcasts the North American transmission irregularly.

VENEZUELA—YV4RX. "La Voz de Aragua." Maracaib, has now moved down to the 62-meter band and is operating on 4.84 mcs. YV5RY. "La Voz de la Esfera." is being heard on 4.76 mcs.

Revised Schedules

ENGLAND—At press time the overseas transmissions of the B.B.C. were being radiated over the Daventry stations as follows: **Transmission 1**, 1:30 to 3:45 a.m. over GSI (15.23), GSD (11.75), GSB (9.31); **Transmission 2**, 3:45 to 8:30 a.m. over GSJ (21.53), GSH (21.47), GST (21.5), GSV (17.81), GSG (17.79) and GSF (15.14); **Transmission 3**, 9 a.m. to 12 noon, over GSJ (21.53), GSH (21.47), GST (21.5) to 10:15 a.m., GSG (17.79), GSV (17.81) to 11:15 a.m. and GSF (15.4); **Transmission 4**, from 12:25 to 4 p.m., GSG (17.79), GSP (15.31), from 1:15 p.m.,

GS1 (15.26), GSD (11.75) and GSC (9.58), from 1:30 p.m. . . . **Transmission 4**, from 4:20 to 6 p.m., over GSP (15.31), GSO (15.18), GSF (15.14), GSC (9.58) and GSD (11.75); **Transmission 5**, from 6:20 to 9:15 p.m., over GSF (15.14), GSD (11.75) and GSB (9.51); **Transmission 6**, from 9:40 p.m. to 11:30 p.m., over GSF (15.14), GSD (11.75) and GSB (9.51). In addition a **transmission is beamed on Latin-America**, daily from 6:25 to 9:20 p.m., over GSO (15.18) and GSC (9.58); an **Arabic transmission**, daily from 12:17 to 1:15 p.m., over GSP (15.31) and an **European transmission**, daily from 6 a.m. to 12:45 p.m., over GSE (11.86) and GSW (7.23) and from 1 to 6 p.m., over GSA (6.05) and GRX (9.69).

FRANCE—The daily transmission to North America, now radiated from 8 p.m. to 12:45 a.m., over TPB11 (11.885), TPA4 (11.713) and the new frequency 9.68 mcs., is best heard on the last named channel.

ITALIAN EAST AFRICA (Ethiopia)—IABA (9.65), is now broadcasting daily from approximately 5:30 to 7:30 a.m. and from 12 noon to 3 p.m.

ITALY—The Rome Short-Wave Station is now operating as follows: over 2R03 (9.633), from 12:07 to 2:55 and from 5:30 to 9 p.m.; over 2R04 (11.81), from 4:30 to 8:45, from 10 a.m. to 3, and from 6 to 9 p.m.; over 2R06 (15.3), from 4:10 to 4:55, from 10 a.m. to 12:06, from 1:38 to 2:30, from 3 to 5:30 and from 7:30 to 9 p.m.; over 2R08 (17.82), from 5 to 8:45 a.m. and from 6 to 7:25 p.m.; over 2R09 (9.67), from 12:40 to 5:30 and from 6 to 6:30 p.m.; over IAC (6.355), daily from 3 to 3:35 p.m.; over IQA (14.795), from 4:30 to 4:55 a.m.; over IQY (11.673), from 5:20 to 5:40 a.m., from 12:07 to 12:56 and from 1:50 to 2:30 p.m. and over IRF (9.835), from 5:20 to 5:40, from 12 noon to 12:25, from 12:40 to 1, from 1:50 to 2:30 and from 6 to 9 p.m.

MANCHOUKUO—MTCY (11.775), is now operating from 1:30 to 2:20 a.m. for North America; from 9:50 to 10:50 for Japan and from 11 to 11:50 a.m. for Europe.

UNITED STATES—KGEI, San Francisco, now operates daily on 6.19, from 12 mid. to 3 a.m.; on 9.53, from 7 a.m. to noon and on 15.33 from 6:30 to 11:15 p.m. . . . WCAB, Philadelphia, operates on 21.52, daily from 9 a.m. to 6 p.m.; on 9.59, Mondays, Thursdays, Saturdays, from 6:30 p.m. to 2 a.m. and Wednesdays, from 10 p.m. to 2 a.m.; on 6.06, Sundays from 7:30 p.m. to 12 midnight, Tuesdays and Fridays, from 6:30 p.m. to 12 midnight and on Wednesdays, from 10 p.m. to 2 a.m. . . . WGEO, Schenectady, N.Y., now operates daily from 3 to 6 p.m., beamed on Europe and from 6 p.m. to 12 midnight beamed on Latin America. . . . The schedule for WLWO of Cincinnati, Ohio, is now as follows: Sundays, from 8 a.m. to 6:30 p.m. and from 11 p.m. to 2 a.m.; Mondays and Thursdays, from 5:45 a.m. to 2 a.m.; Tuesdays, Wednesdays and Fridays, from 5:45 a.m. to 5:30 p.m. and from 11 p.m. to 2 a.m. and on Saturdays, from 5:45 a.m. to 11 p.m.; Boston, Mass., stations WRUL/WRUW are now operating as follows: over WRUW (15.13), weekdays except Saturdays, 3:30 to 5:30 p.m.; Mondays, Tuesdays and Fridays, from 5:30 to 7 p.m.; weekdays except Saturdays from 8 to 9:30 p.m. and on Saturdays from 2 to 6:30 p.m.; over WRUW (11.73), Mondays, Tuesdays, Wednesdays and Thursdays from 8 to 9:30 and from 10 to 11:30 p.m. and on Sundays, from 2 to 5:30 p.m.; over WRUL (11.79), weekdays except Saturdays, from 3:30 to 5:30 p.m. and on Saturdays from 2 to 6:30 p.m. and over WRUL (6.04), weekdays except Saturdays, from 6:30 to 7 p.m. and from 10 to 11:30 p.m. and on Sundays from 2 to 5:30 p.m.

Frequency Changes

BRAZIL—PRAS, Pernambuco to 6.015.
COLOMBIA—HJCD, Neuva-Granada, to 9.4.
COSTA RICA—TIEM to 10.065.
CUBA—COBC to 9.99; COBZ to 9.02; COCA to 9.09; COCH to 9.44; COCQ to 8.85; COGF to 11.8; COKG to 8.95.
CURACAO—PJCI to 5.941.
D.R.—HIIS to 5.926; HI4V to 6.175; HIGH to 6.9.
ECUADOR—HC1ETC to 8.00.
MEXICO—XEQQ to 6.029.
PANAMA—HP5F, Colon to 6.05.
PERU—OAXIA to 6.18.
VENEZUELA—YV5RN to 5.035.

Data

AUSTRALIA—VLR (9.58), operates daily from 1 to 9 a.m. . . . Short-wave transmitters of the Australian Aerial Medical Services are: VK8SI (1600-5300-8830), Wyndham; VK8SC (1600-4030-6960), Port Hedland; VK8UB (1600-5360-8750), Kalgoorlie; VK8US (1600-5410-8690), Alice Springs; VK8SK (2020-5110-8630-6890), Broken Hill and VJ1 (2020-5110-8630), Cloncurry. Reports should be sent to Federal Council of Australian Aerial Medical Services, 434 Collins St., Melbourne C. 1.

BAHAMAS—ZNS2 (6.09), 200 watts, Nassau, operates daily from 8:30 to 9 a.m., from 3 to 4 and from 7 to 8:30 p.m.

BOHEMIA—The North American transmission from Prague, heard nightly from 7:55 to 10:15 p.m., is now being radiated over OLR4A (11.84).

BOLIVIA—CP5 (6.2), La Paz, 1000 watts, transmits daily from 6:30 to 11:30 p.m.

CANADA—The 2 watt short-wave station in Vancouver is CKFX, not CFXK as stated in our last issue.

CHILE—CB970 (9.74), relays CB76, Santiago, intermittently from 7 a.m. to 11:30 p.m., signing-off with the selection "Pomp and Circumstance." . . . CB1174 (11.74), "Radio Huckle," Santiago, relays CB93 nightly to 10:30 p.m.

CHINA—XPSA (7.01), operates daily from 5:30 to 11 a.m. and from 5 to 6 p.m. XPSA relays the news in English as given by XGX at 9 a.m.

CUBA—There are three eradio networks in Cuba, namely: Cadena Crusselas (Crusselas Network: Colgate-Palmolive), composed of CMQ (main station), CMJK, CMJA, CMKD, CMKG, and short-wave stations COCQ and COKG; the Cadena Azul (Blue Network), composed of CMHI (main station), CMCF and CMKQ and relayed by short-wave stations COHI and COCH, and the Radio Cadena Nacional (National Network), composed of CMK (main station), CMHW, CMGF, CMAR, CMKP, CMKR, CMJ, CMJX and relayed by short-wave station COGF.

DENMARK—OZH (15.32), is now broadcasting daily from 1 to 1:30 p.m. in addition to its usual Sunday broadcast from 8 to 1:30 p.m. . . . OZU (7.26), a new frequency for the Skamlebak station, is now in operation daily from 2 to 5 p.m.

D.R.—HIJJ (5.925), signs-off near 7:40 to 7:45 p.m. . . . HIIN (6.243), issues an attractive white QSL card with a red outline, and call letters in red with blue shading, picturing a Caribbean map and a photo of the President of the D.R. . . . HIGH (6.9), comes on the air as early as 5 p.m. and signs off near 8:45 to 8:50 p.m. with the National Anthem. At 20

(Please turn the page)

EASY TO LEARN CODE

It is easy and pleasant work to learn the modern way—with an Instructograph Code Teacher. Ideal for the beginner or advanced student. Many tapes available ranging from alphabet for beginners to typical messages on all subjects. Speed range 5 to 40 WPM. Always ready, no QRM, beats having someone send to you.



FOR SALE OR RENT
STANDARD with 10 tapes, book of instructions, A.C. motor, \$25.50 with spring-wound motor . . . \$18.50
JUNIOR with 5 tapes and book of instructions (not rented), \$10.00
RENTAL Standard with 10 tapes and book of instructions \$3.00 first month, \$2.25 each additional month. References or \$10 deposit required. All rental payments may be applied on the purchase price should you decide to buy the equipment.
 Write for details today

INSTRUCTOGRAPH COMPANY

Dept. NR, 912 Lakeside Place, Chicago, Illinois
 Representatives for Canada:
 Radio College of Canada, 54 Bloor St., West, Toronto

5 Radio Books in 1



DEALERS SAY: "The new Knight Sets are a scoop. Those remarkably low prices can't be beat! Your catalog is invaluable for supplies of all kinds!"
SERVICE MEN SAY: "Your 1940 Catalog is the best ever! Bigger listings than ever before, with all the repair parts for every Service requirement!"
P. A. MEN SAY: "Thanks for the complete range of great new P. A. systems. Your 'Choice of 3 Systems' serves every P. A. purpose!"
AMATEURS SAY: "That big new Ham Section takes the prize! The full dope on all the newest gear and everything a Ham might want! Thanks for a real catalog!"
BUILDERS SAY: "You sure know what a Builder wants! More kits, diagrams and projects than ever before in your 1940 Catalog! It's a honey!"

Free THE CATALOG WITH EVERYTHING IN RADIO!

New Knight sets for every purpose, 4 to 12 tubes, newest features, "Air Magnet," Genfold Dials, etc.—latest portables, 1-tube electric photographs, 3, 7, 11-tube phono-radios, complete phono accessories,—all sensational values!



Now, "Economy," "Standard" and "Deluxe" lines—14 new systems, 6 to 70 watts, new beauty, utility and performance!—new "mikes," latest recording equipment, all at lowest prices. Investigate ALLIED'S New low-cost Time Payment Plan!

15,000 Radio Items with parts for every purpose, tubes for all radios, latest books, tools, etc. at lowest prices! Complete Test Equipment, Rider VoltOhmyst, etc. Dozens of new kits, diagrams and projects! Free Parts Lists.

Special 8-page section of the country's biggest radio bargains! Smashing values in BRAND NEW standard radio parts, cabinets, headphones, and miscellaneous accessories. Don't miss these super-values!

Thousands of radio men find ALLIED'S 204-page radio catalog the answer to the problem of "where to buy at lowest cost." For, whatever you need is always in ALLIED'S catalog at lowest prices! Get your FREE copy TODAY!

Mail this Coupon

ALLIED Radio Corporation
 Dept. 1-M-O, 833 W. Jackson Blvd.,
 Chicago, Illinois

RUSH me your FREE 204-page Radio Catalog.

Name

Address

City State

ALLIED RADIO CORPORATION

833 W. JACKSON BLVD. CHICAGO

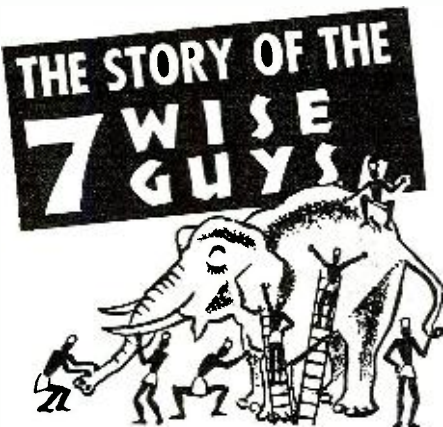

THE STORY OF THE 7 WISE GUYS

WHO WERE LICKED BEFORE THEY STARTED

Seven blind fakirs tried to describe an elephant. One grabbed the tail and said: "It's like a snake."—Another felt an ear and said: "It's like a plant."—Another threw his arm around a leg and said: "It's like a tree." So—unable to see the whole big picture at one time they were licked before they started.

Today, there are servicemen equally blind, who think their business is the repairing of radios only. There are others who think that work on P. A. systems will offset the losses due to cheap receivers. There are others who think that television will be their salvation. The truth is that individually they are wrong—yet collectively they are right. The successful service business of tomorrow will do all those things—and more.—And, the serviceman who doesn't broaden himself to match the expansion of his industry will be licked by his own "blindness".

Be ready—know the fundamentals of your business—study up on the developments of tomorrow. Check the books listed below and order those you need TODAY!

New "SERVICING by SIGNAL TRACING"

by John F. Rider

Use the system of servicing which is fastest—most modern—the system you can apply to all receivers regardless of age, type or make—independent of the kind of circuit or tubes used—independent of every limiting factor heretofore encountered. In this new book you learn what happens to the signal currents—the development of control voltages—and how all receivers are brought to a common servicing level. There is one thing that is common to every radio set—the signal. Read this book and you will be able to service the most complicated set with greater speed and less effort.

360 pages.....\$2.00

THE CATHODE-RAY TUBE AT WORK

This book has established itself as a standard work. It is the most complete and practical book ever written on the subject. If you want to be ready for television you must have the facts contained in this—the only book on the subject written especially for servicemen. Get it today!

336 pages—Over 450 illustrations....\$2.50

"AN HOUR A DAY WITH RIDER" BOOKS

ON AUTOMATIC VOLUME CONTROL. Will speed up your AVC work. 96 pages, 65 illustrations, hard cover.....60c

ON RESONANCE AND ALIGNMENT. You need this book. Thousands sold! 96 pp., 48 illus...60c

ON D-C VOLTAGE DISTRIBUTION IN RADIO RECEIVERS. How d-c voltages are led to tube elements, etc. Full of facts you need. 96 pp., 69 illus., hard cover.....60c

ON ALTERNATING CURRENTS IN RADIO RECEIVERS. With drawings and diagrams....60c

—AND REMEMBER...

You Need All 10 Rider Manuals for Profitable Servicing

RIDER BOOKS

For Servicemen who want to be "Ready"

JOHN F. RIDER, Publisher 404 FOURTH AVE. NEW YORK CITY

minutes past each hour the same recording of a song and crude laughter is played.
D.E.I.—PMN (10.26), now broadcasts regularly to 11:30 a.m.

FRANCE—The new 100,000 watt transmitter of "Paris Mondial" broadcasts daily on 15.243, for North America, from 12:30 to 1:30 p.m. and on 9.68, for South America, from 6 to 7:45 p.m. and for North America, from 8 p.m. to 12:45 a.m.

ITALIAN EAST AFRICA (Ethiopia)—According to the Newark News Radio Club, IABA (9.65), issues a QSL card showing a shaded map of Ethiopia, with Addis Ababa spotted like a target with the lines all around the dot.

LUXEMBOURG—"Radio Luxembourg" will make the following experimental broadcasts during November: on 15.35 mcs., Nov. 9-10-11, 1 to 2 a.m.; 12-13-14, 2 to 3 a.m.; 14-15-16, 7 to 8 p.m.; 17-18-19, 8 to 9 p.m.; 20-21-22, 9 to 10 p.m.; and 23-24-25, 10 to 11 p.m. on 6.09 mcs., Nov. 8-9-10, 9 to 10 p.m.; 11-12-13, 10 to 11 p.m.; 14-15-16, 11 p.m. to 12 mid.; 18-19-20, 12 to 1 a.m.; 21-22-23, 1 to 2 a.m. and 24-25-26, 2 to 3 a.m.

MEXICO—XEQQ, Mexico D.F., has been broadcasting for the past few months on 6.029, just below CFVP. It relays XEQ (730 kcs.), nightly until 12:30 or 1 a.m.

NEW CALEDONIA—According to Harve Amers of Pomona, Calif., FK8AA (6.12) of Noumea, issues a white QSL card with call letters in red and printing in blue, which gives the schedule of the station as weekdays from 2:30 to 3:30 a.m. Power of FK8AA is 50 watts.

NEW ZEALAND—Short-wave transmitter ZL4ZF relays broadcast station 4ZB on a frequency of 4.25 mcs., when ordinary line facilities are out of action due to heavy snows.

PARAGUAY—500 watt station YNPR of Managua, has five optional frequencies, namely: 8.58, 7.7, 7.9, 8.4 and 8.2 mcs.

PANAMA—HP5K (6.005) of Colon, issues a gray QSL card, with call letters in red and printing in blue. The slogan is "La Voz de la Victor."

ROMANIA—A 300 watt transmitter in Bucharest has been transmitting daily from 2 to 3 p.m. since its inauguration last November.

SWEDEN—Reports to Swedish short-wave stations are verified by letter. No QSL cards are issued.

SUMATRA—YDX (7.22), Medan, 500 watts, relays the Western network of the NIROM daily from 8:30 to 10:30 a.m. and from 10:30 p.m. to 2 a.m. and broadcasts a strictly native program daily from 6 to 8:30 a.m.

UNITED STATES—Improvements for Boston stations WRUW and WRUL, include newly enlarged studios at the University Club; seven new antennas and a new transmitter at Hatherly Beach, Massachusetts.

U. S. S. R.—The long unidentified station on 15.41 mcs., is according to G. M. Kosolapoff, of Dayton, Ohio, a Russian reader of RADIO NEWS, definitely RV96 of Moscow, U. S. S. R., the same station that transmits to North America, daily from 7 to 8:50 p.m. on a frequency of 15.18. Frequently during the course of the broadcast brief pauses are made, with the local Moscow time and the duration of the pause given prior to each. The frequency and wavelength is also announced at frequent intervals. The program from 8:55 to 10:30 p.m. is primarily for workers in the Collective Farms and in the Army and Navy who have to get up at 5 a.m. Moscow time. All announcements are in Russian.

Ultra-High Frequency

CBS evening programs are now being piped into the 40,000 watt experimental station W2XMN (42.8) at Alpine, New Jersey. Static-free, distortionless, realistic reception is provided through the new type "frequency modulation" broadcasts. . . . W6XDA has moved to 42.3 mcs. from 38.6 mcs., and is operating daily from 3 to 9 p.m. . . . W9XTA (26.5) at Harrisburg, Illinois, transmits the program, "Ham Forum," Saturdays at 2:15 p.m. . . . W2XJ1 (25.9) of New York City, N. Y., issues a blue and yellow folder-type QSL which gives the stations schedule as daily from 11:30 a.m. to 3:45 and from 5 to 6 p.m. EST. . . . The Spartan School of Aeronautics at Tulsa, Oklahoma, has been granted a construction permit for a new flying school radio station to operate on 33.42 mcs., with a power of 50 watts. The Zenith Radio Corporation of Chicago, Illinois, seeks permission to build a 5,000 watt broadcast station to operate on 42.8 mcs. . . . General Electric is building a new frequency modulated radio transmitter to operate on 43.2 mcs., atop the Helderberg Mountain, 12 miles from Schenectady, where the television transmitter is also located. Construction permits have been issued to WHEC, Inc., of Rochester, N. Y., for a new 1,000 watt broadcast station to operate on 42.6; to Bamberger Broadcasting Service, Inc., of New York City, N. Y., for a 1,000 watt broadcast station to operate on 43.4; to Stromberg-Carlson Tel. Mfg. Co. of Rochester, N. Y., for a 1,000 watt station to operate on 43.2; to the Milwaukee Journal Company of Milwaukee, Wisconsin, for a 1,000 watt broadcast station to operate on 42.6; and to the Bell Tel. Labs, Inc., of Whippany, N. J., for a 5,000 watt developmental broadcast station to operate on 43.2 mcs. . . . There is said to be a new broadcast station in St. Louis, Missouri, operating on 25.3 mcs., under the call W9XOK.

Television

The development of a "television torpedo" entirely operated by radio, which aimed through its television eye might fire bombs from points a dozen or more miles away, has been proposed by famous television inventors Dr. DeForest and

U. A. Sanabria. . . . The Farnsworth Television and Radio Corp., which is now located at Fort Wayne, Indiana, seeks a construction permit to install a 1,000 watt visual station to operate in the band 66 to 72 mcs., at that city. . . . NBC Television Station W2XBS in New York City, N. Y., is now telecasting studio shows Tuesdays through Fridays, from 8:30 to 9:30 p.m. and sports and film transmissions Wednesdays through Saturdays at 2:30 p.m.

Amateur Reception Notes

Amateur stations in many countries, including almost the entire British Empire, France, Germany, the U. S. S. R., and others, are now off the air for the duration of the war. This cuts down the number of stations available for DX reception tremendously, but at the same time by reducing the station interference opens the way for the logging of weak stations in remote parts of the world which it would be impossible to log under ordinary conditions.

BAKER ISLAND—According to Harve Amers of Pomona, California, after a six months wait he finally received the yellow and blue QSL card of KF6PUL, which gives his home address as 230 Kaia St., Honolulu, Hawaii.

BEIJAN CONGO—OQ5Z's QSL card has a large black call and pictures a tiger in its upper right hand corner. . . . Nick Hock of the Newark News Radio Club, recently logged OQ5RT at 3:46 p.m. on the low-frequency side of the band. The location was given as Elizabethville and the power as 125 watts.

CURACAO—Howard Woodard, W4EVX of Lawrenceburg, Tenn., writes that he received a very attractive QSL card and a stalk of bananas from PJ5MS (14.4). Mountains are pictured in the background; a Cockatoo bird with colors of dark red, light blue and yellow on the left side of the card, and the call letters in bright red running like a crescent along the top of the card.

ESTONIA—Roger Legge of Binghamton, N. Y., reports hearing ES4G (14.11), with R7 signals, from 3 to 4 p.m.

GUAM—Earl Roberts of Indianapolis, Indiana, recently logged KB6OCL (14.17), with R5 signals at 7 a.m.

MAURITIUS—VQ8JM (14.11), heard from 7 to 7:30 a.m. with very strong signals during August, is apparently off the air now along with other amateurs in the British Empire.

PANAMA—According to Harold Schrock, W9QWM of Pontiac, Illinois, W9TSD is the 2nd op. at HP1A. HP1A does not answer SWL reports unless they are of exceptional value to the station and contain lots of good data.

PHILIPPINES—M. W. Slopoff of Allegheny, N. Y., reports receipt of a very picturesque card from KA4LH (14.11), depicting a crocodile at the milk and a serpent wrapped about a pole holding up one end of the antenna.

TURKISTAN—F. H. Smith of the Newark News Radio Club, reports a real catch, when at 12:38 a.m., on the low frequency side of FBNT, he tuned in an amateur giving his location in very poor English as Samarkand, Turkistan. He mentioned that he used an SX17 receiver and that the Afghanistan border was only a few miles to the south. The call was not identified.

UNITED STATES—W9ZJB has worked all amateur districts in the United States on 5 meters. . . . The "W2USA Radio Club" of New York's World Fair, is now radiating its weekly amateur broadcasts on Fridays at 9:45 p.m.

The Federal Communications Commission states that the international situation makes it doubly necessary that all amateurs of this country observe closely the Rules and Regulations laid down for them, as unauthorized activities by a few amateurs during this war period may tend to bring about curtailment of the short-wave operations of amateurs generally.

SHORT WAVES FOR DX'ers on the WEST COAST

by JOHN D. CLARK
All Times Are PACIFIC STANDARD

China

THE Chinese Government station at Chungking has changed call letters from XGOX and XGOY to XGX for all frequencies. The time schedule has again been shifted, and the station is now operating as follows:

On 11.9 meg. from 11 A.M. to 1:20 P.M. Chinese News.

On 11.9 meg. from 1:30 to 3:20 P.M. to Great Britain, France, Italy, Germany, and Spain.

On 17.8 meg. from 6 to 7:40 P.M. to North America.

On 11.9 meg. from 2:30 to 4:20 A.M. to Northeast China and Siberia.

On 11.9 meg. from 4:20 to 4:50 A.M. to Japan.

On 11.9 meg. from 5 to 8 A.M. to South China and South Seas.

On 11.9 meg. from 8:10 to 8:30 A.M. to U.S.S.R.

The location of station XPSA has been shifted to Kweichow and the transmitter is now working on 6.976 meg. with a power of ten kilowatts from 2 to 3 P.M. and from 2:30 to 8 A.M. daily.

The station on 6.87 meg. which many listeners have confused with XPSA, is actually X0JD of Hankow. It usually signs off shore after 5:30 A.M. with announcements only in Chinese. The entire schedule is somewhat in doubt and seems to be very irregular. Programs consist almost entirely of native Chinese music.

Japan

The extended schedule is still in effect for all Nipponese Overseas stations. Although the transmission for America's Pacific Coast is still re-

leased on 15.16 meg. as we go to press, the expected shift to 11.8 meg. should be made almost any day. Last year the changeover went into effect on November 6.

For interested listeners, it should be noted that while the programs open with complete English announcements and news in English, the final half hour of the 9 to 10:30 P.M. broadcast and all closing announcements are only in Japanese.

JZL (17.78 meg.) is still on the air from 5 to 6 P.M. daily, although the shift to JZK (15.16 meg.) for this transmission was made on Sept. 15 last year.

JVW3 (11.72 meg.) has been heard near midnight and 1 A.M. several times lately. Schedule is still 10:40 to 11:20 P.M. and 2 to 4:40 A.M. daily.

Manchukuo

The powerful new station MTCY in Singking, Manchukuo has extended its schedule considerably, and is now audible in all parts of the Pacific Coast with excellent volume.

The evening programs open at 10:30 P.M. with chimes and march selections, followed by announcements in English and English news bulletins. The station closes down at 11:30 P.M., returns to the air at approximately 4 A.M., and again closes down at 6 A.M.

At 6:15 A.M. programs are resumed on the same frequency (11.775 meg.) with greatly increased volume (probably due to the use of a different beam antenna). News bulletins in English are broadcast at 7:30 and concluding announcements are usually given in English just before sign-off which usually takes place shortly after 8.

Two listeners also report reception of MTCY near 1:30 A.M., but this has not been confirmed.

Philippines

Another new Philippine broadcaster has appeared on the lower wavelengths. A station announcing as KZRB, Manila, has been heard almost daily on about 6.00 meg. giving news commentary near 5:30 A.M. West Coast reception is surprisingly strong.

The short wave relay of KZEG, heard several times on 6.14 meg. during the early morning hours, seems to have vanished.

KZRH, another newcomer, has shifted frequency to exactly 6.1 meg., and is now almost lost in the heterodyne of several Orientals which operate in that part of the dial between 2 and 6 A.M.

It is no longer possible to separate the weak KZHS from VLR of Melbourne, Australia. VLR has been so strong lately between 3 and 5:30 A.M. that KZHS (only 5 kc. higher in frequency) is almost entirely blocked out.

KZRM, "Radio Manila," has been extremely strong during the last 30 days on 9.57 meg. It now maintains a good signal from 1 to 7 A.M. daily.

Siam

HSSPJ of Bangkok, Siam, has now extended its international broadcasting schedule. Listen for this one on 9.51 meg. daily, except Monday, from 4 to 7 A.M. News in English follows the weather forecast at 5:55 A.M., and English announcements are given frequently throughout the entire program.

Indo-China

"Radio Saigon" of Saigon, Indo-China, is not following the time schedule recently released by station authorities. The printed schedule calls for operation on 6.12 meg. from 4:30 to 5:30 A.M. and 8:45 to 9:45 P.M.; on 11.78 meg. from 9:15 to 9:45 P.M. and 6:15 to 6:45 A.M. To date evening reception on either of the two frequencies has not been confirmed. The A.M. schedule on 6.12 meg. is correct, but on 11.78 meg. "Radio Saigon" has been reported as early as 5:30 and as late as 7:30, but rather irregularly.

During the past few weeks, MTCY of Singking, Manchukuo has been so strong on its 11.775 meg. frequency that it partially blocks the Indo-Chinese broadcaster during its A.M. transmission.

Several west coast fans report reception of a new Saigon station on about 4.93 meg. near 5 A.M. Call letters are not known, but volume is fairly good, and listeners will find this transmitter just above India's VUD8 which is now working on 4.92 meg. at the same hour.

Siberia

A new Siberian station is now broadcasting on about 15.40 meg. between 6 and 7 A.M. irregularly. Although not definitely confirmed, this newcomer is believed to be RW99, located in Irkutsk.

With the coming of winter, the old reliable RV15 of Khabarovsk, Siberia, is steadily increasing in volume and reliability. It may now be heard on 4.27 meg. with surprisingly strong signals from 11 P.M. to 7 A.M. daily.

Tuning Tips

Our listeners tell us . . . that the one-hour extension of London's transmission six (which now concludes at 9:30 instead of 8:30 P.M.) has greatly improved west coast reception . . . that Australia's VLR is now audible on 10.52 meg. regularly near 6:30 P.M. for phone contact with London . . . that VPB of Colombo, Ceylon, which has been off the air since the first of June is back on 6.15 meg. irregularly near 6 A.M. . . . that Moscow's RNE is again reaching the Pacific Coast on 12.00 meg. from 6:30 to 8:30 P.M., and that RKL is coming through strong on 15.18 meg. after 8:30 P.M. . . . that XMLA of Shanghai, China, occasionally relays W6XBE on 11.86 meg. near 5:30 A.M. . . . that JDY of Daricn, Kwangtung (9.92 meg.) operates on phono irregularly between 1 and 4 A.M. in addition to its daily 4 to 5 A.M. broadcasts . . . that Treasure Island's W6XBE (now KGEI) is using a new frequency of 6.19 meg. for the daily 9 P.M. to midnight transmissions.

New BC Band

Innumerable Asiatic stations have been flocking to the new short wave BC band which seems to include 4.75 to 5.20 meg. The following stations are being received in this band daily near 5 a.m. at the present time, and it is very probable that many more will be logged during the next few months when winter reception conditions improve the carrying power of these low frequencies.

- 4.78 meg., Unidentified Oriental.
- 4.81 meg., YDE2, Solo Java. Native Javanese Programs.
- 4.82 meg., Unidentified Japanese phone station.
- 4.84 meg., VUC2, Calcutta, India.
- 4.85 meg., Unidentified Javanese. Sometimes relays YDE2.
- 4.88 meg., VUB2, Bombay, India.
- 4.90 meg., YDE3, Semarang, Java. Native music only.
- 4.92 meg., VUM2, Madras, India.
- 4.94 meg., YDF, Semarang, Java. Relays PMH network programs.
- 4.96 meg., VUD2, Delhi, India.
- 5.14 meg., PMY, Bandoeng, Java.

(Please turn the page)

READ SEND CODE Like an Expert

Learn Quickly at Home—Get Real Speed

It's easy, fascinating, to become a good op. with the NEW ALL ELECTRIC MASTER TELEPLEX CODE TEACHER to help you. Only instrument ever produced which records your sending in visible dots and dashes—then sends back to you at any speed you desire. Also sends practice work, recorded by an expert. That is why so many schools teaching code prefer Master Telex. Why thousands agree this method is surest and quickest.



FREE BOOK

We furnish Complete Course, and you Master Telex, give your personal instruction with a MONEY-BACK GUARANTEE. Low cost.

Send today for booklet RN12, no obligation. **TELEPLEX COMPANY** 67-69 Park Place, New York In Canada write: CANADIAN ELECTRONIC INST., TORONTO, ONT.



NEW

SUPER PRO

FULL RANGE "Selectivity" Single signal to HIGH FIDELITY

HIGH SENSITIVITY in a communications receiver is only usable when the proper degree of selectivity is also available. If selectivity is not sufficient, no amount of sensitivity will permit satisfactory reception. Here, the new Series 200 "Super-Pro" stands supreme. The extremely high sensitivity available in the "Super-Pro" is always usable because of the continuously variable selectivity characteristics. The I.F. band width control varies the selectivity from approximately 3 kc. to 16 kc.; in addition to this feature, the variable selectivity crystal filter permits the selectivity to be varied from 2½ kc. down to better than 100 cycles. The operator can adjust the selectivity of the new "Super-Pro" to a point where interference is reduced sufficiently to permit reception of the desired signal. This optimum point of selectivity permits the greatest possible fidelity without interference. The selectivity of the I.F. amplifier in the new "Super-Pro" is varied by mechanically changing the coupling between the primary and secondary of the I.F. transformers. This method provides a smooth control of selectivity.



In addition to the above features, the operator of a "Super-Pro" has available such other refinements as: noise limiter; continuous band spread; an AVC system designed for greatest effectiveness; a new adjustable "S-Meter"; two stages of tuned radio frequency amplification which practically eliminate images, and many others. If you want the best, get a "Super-Pro." Write Dept. RN-12 for descriptive folder.

424-438 West 33rd Street, New York City, N. Y.



HAMMARLUND

Canadian Address: 41 West Ave., No. Hamilton, Ont.

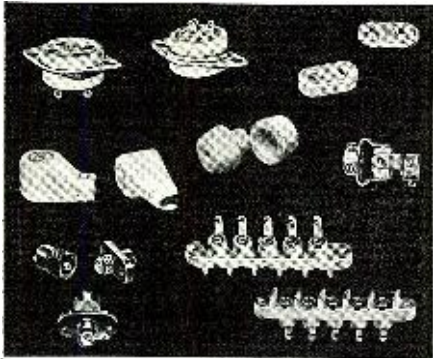

**For Engineers, Amateurs
and Experimentors**

★ NEW ★

Safety Terminals, Insulated Rectifier and Thyatron Connectors, High Voltage Tube Sockets, Iron Core RF Chokes, Quartz Polystyrene Insulation, High Frequency Variable Condensers, Meter Type Dials, Cast Aluminum Chassis, etc.

Catalogue Upon Request

**TO YOUR OWN PARTS
JOBBER**

JAMES MILLEN MFG. CO. INC.
150 EXCHANGE ST. MALDEN, MASS.

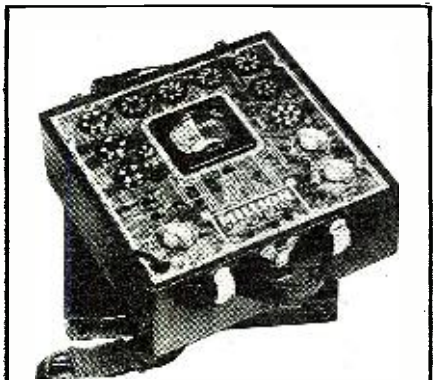

**• MILLION •
NEW DF TUBE CHECKER
FOR ALL NEW TUBES**

New, with wider application range. Tests emission of all tubes. Ten sockets cover all types from "hearing aid" peanut tubes to the new 10kials and S series. Filament switch covers 1.4 to 110 volts with spare positions for the future. Gives instant "good-bad" readings on oversize D'Arsonval meter. Makes neon short or leak test with tube hot. Tests by-pass condensers, etc. Literature on request.

**MODERN
ACCURATE
DEPENDABLE
ECONOMICAL**

**\$16.95
NET**

If your Jobber cannot supply you,
write us direct.

MILLION RADIO AND TELEVISION
577 No. Union St. Chicago, Illinois

We Hear:

that many fans are hearing the new KZEH of Manila on 9.58 meg. This one sometimes heterodynes VLR until the latter signs off at 5:30 a.m. Don't confuse KZEH with KZRM which is on the air at the same time that the powerful new Manchukuan broadcaster MTCY is now giving news in English nightly on 11.78 meg. from 10:30 to 10:45 p.m. that KGEI (formerly W6XBE), located on Treasure Island, San Francisco, is now operating on 15.33 meg. from 3:30 to 8:15 p.m., and on 9.53 meg. from 4 to 9 a.m., and from 9 p.m. to midnight that VPD2 of Suva, Fiji Islands, has been heard irregularly as late as 5 a.m. on 9.54 meg., although supposed to sign off at 4 o'clock that JLG3 (11.705 meg.) and JLU3 (15.135 meg.) are no longer in use for Japanese Overseas Program relays that a new Nipponese transmitter with a call which seems to be JL3 is working on about 9.65 meg. irregularly near 5 a.m.

Across the Dial at 7 A.M.

This month RADIO NEWS presents the fourth in a series of sections designed to show west coast listeners just which overseas stations may be heard at various hours of the day and night. Stations listed include only the strongest and most reliable. During the past thirty days, the hour of 7 a.m. has produced surprisingly good reception, and those stations shown below may be heard at this time of day.

- 19.02 meg., HSSPJ, Bangkok, Siam (Monday only. Closes at 7).
- 17.79 meg., GSG, London, England.
- 17.78 meg., W3XAL, Bound Brook, N. J.
- 15.23 meg., HSSPJ, Bangkok, Siam. Usually broadcasts simultaneously with 19.02 meg. (Mon. only. Closes at 7).
- 15.20 meg., DJB, Berlin, Germany.
- 15.14 meg., GSF, London, England.
- 11.90 meg., XGOY, Chungking, China.
- 11.86 meg., XMHA, Shanghai, China.
- 11.83 meg., XEBR, Mexico City, Mexico.
- 11.80 meg., ZRO, Rome, Italy.
- 11.78 meg., "Radio Saigon," Saigon, Indo-China (uses this frequency quite often in place of 6.12 meg.)
- 11.78 meg., MTCY, Manchukuo. (Heard irregularly at this hour, and usually heterodynes "Radio Saigon.")
- 11.00 meg., PLP, Bandoeng, Java.
- 10.53 meg., JIB, Taihoku, Taiwan.
- 10.26 meg., PMN, Bandoeng, Java.
- 9.69 meg., ZHP, Singapore, Straits Settlements. (Usually signs off at 6:40, but sometimes stays on air until 7:30.)
- 9.68 meg., JIE2, Tyuriki, Taiwan. (Relays programs of JFAK until 7:15 a.m.)
- 9.61 meg., ZRK, Johannesburg, South Africa.
- 9.60 meg., JFO, Taihoku, Formosa. (Relays programs of JFAK until 7:15 a.m.)
- 9.59 meg., VUD2, Delhi, India.
- 9.58 meg., VLR, Melbourne, Australia. (Usually signs off at 5:30, but sometimes heard as late as 7:30 relaying London.)
- 9.57 meg., KZRM, Manila, P. I. (Closes down at 7 o'clock except on Saturday when it closes at 8.)
- 9.55 meg., YDB, Batavia, Java. (Closes at 7:30 daily except Sat. and Sun. Closes 8:30 Sat. and 6:30 Sun.)
- 9.53 meg., KGEI, Treasure Island, San Francisco, Calif.
- 9.52 meg., ZBW2, Hongkong, China. (Closes down at 7 o'clock except on Saturday when it closes at 8.)
- 9.50 meg., HSSPJ, Bangkok, Siam. (Thurs. only. Closes at 7.)
- 9.42 meg., PLV, Bandoeng, Java. (Irregular just before 7.)
- 8.83 meg., COCQ, Havana, Cuba.
- 7.30 meg., JIE, Tyuriki, Taiwan. (Relays JFAK to 7:15.)
- 6.98 meg., XPSA, Chungking, China. (Usually closes at 7:20.)
- 6.72 meg., PMH, Bandoeng, Java. (Usually closes at 7:30.)
- 6.12 meg., "Radio Saigon," Saigon, Indo-China.
- 6.10 meg., CRP, Portuguese Macao, China. (Mon. only. Closes at 7.)
- 6.00 meg., XYZ, Rangoon, Burma. (Closes at 7.)
- 4.27 meg., RV15, Khabarovsk, U.S.S.R.

News Casts in English

Recent overseas political explosions, plus increased speculation regarding the future, have greatly increased the interest in foreign news broadcasts. In answer to many requests from western listeners, "Radio News" presents this month a completely revised and up-to-date schedule of overseas newscasts in English. The listing below includes only those transmissions which are being heard regularly on the Pacific Coast at the present time.

- 1:30 a.m.—AUSTRALIA, Melbourne, VLR (9.58 meg.). Excellent.
- 1:55 a.m.—JAPAN, Tokyo, J V W 3 (11.73 meg.). Excellent.
- 3:00 a.m.—CHINA, Hongkong, ZBW3 (9.53 meg.). Good.

- 4:45 a.m.—KWANTUNG, Darien, JDY (9.92 meg.). Fair.
- 5:20 a.m.—AUSTRALIA, Melbourne, VLR (9.58 meg.). Excellent.
- 5:20 a.m.—CHINA, Canton, XGOK (11.81 meg.). Weak and Irregular.
- 5:25 a.m.—JAPAN, Tokyo, JZK (15.16 meg.). Weak; JZJ (11.8 meg.). Fair.
- 5:30 a.m.—STRAITS SETTLEMENTS, Singapore, ZHP (9.69 meg.). Fair.
- 5:30 a.m.—CHINA, Hongkong, ZBW3 (9.53 meg.). Good.
- 5:30 a.m.—INDIA, Delhi, VUD2 (9.59 meg.). Weak.
- 6:00 a.m.—CHINA, Chungking, XGOY (11.9 meg.). Fair.
- 6:05 a.m.—FORMOSA, Taihoku, JIB (10.53 meg.). Fair; JFO (9.61 meg.). Fair; JIE (9.69 meg.). Good; JIE2 (7.30 meg.).
- 6:15 a.m.—CHINA, Shanghai, XMHA (11.85 meg.). Weak and Irregular.
- 7:00 a.m.—CHINA, Kwei Yang, XPSA (6.98 meg.). Fair.
- 7:15 a.m.—INDIA, Calcutta, VUC2 (4.84 meg.). Weak.
- 8:00 a.m.—ENGLAND, London, GSG (17.79 meg.). Fair; GSF (15.14 meg.). Fair.
- 8:05 a.m.—ITALY, Rome, ZR04 (11.81 meg.). Fair; ZR06 (15.30 meg.).
- 10:00 a.m.—ENGLAND, London, GSG (17.79 meg.). Fair; GSP (15.31 meg.). Fair; GSD (11.75 meg.). Weak.
- 1:30 p.m.—ENGLAND, London, GSO (15.18 meg.). Good; GSD (11.75 meg.). Weak; GSP (15.31 meg.). Good.
- 4:30 p.m.—ITALY, Rome, ZR04 (11.81 meg.). Fair; ZR03 (9.63 meg.).
- 4:30 p.m.—ENGLAND, London, GSD (11.75 meg.). Good; GSF (15.14 meg.). Fair; GSB (9.51 meg.). Weak.
- 4:50 p.m.—SPAIN, Madrid, EAQ (9.86 meg.). Weak.
- 5:05 p.m.—JAPAN, Tokyo, JZL (17.78 meg.). Fair.
- 5:45 p.m.—RUSSIA, Moscow, RKI (15.08 meg.). Weak.
- 7:20 p.m.—CHINA, Chungking, XGOX (15.2 meg.) of (17.81 meg.).
- 8:00 p.m.—ENGLAND, London, GSD (11.75 meg.). Good; GSC (9.58 meg.). Excellent; GSB (9.51 meg.). Good.
- 8:00 p.m.—FRANCE, Paris, TPA4 (11.71 meg.). Weak; TPB11 (11.88 meg.). Fair.
- 8:45 p.m.—NICARAGUA, Managua, YNRF (6.71 meg.). Fair.
- 9:35 p.m.—JAPAN, Tokyo, JZK (15.16 meg.). Good; or JZJ (11.8 meg.).
- 10:00 p.m.—ENGLAND, London, GSD (11.75 meg.). Fair.
- 10:30 p.m.—MANCHUKUO, MTCY (11.78 meg.). Good.

-30-

Analyzing Power Supply
(Continued from page 33)

50-60 cycle receptacle and the additional parts connected as shown. Turn the rectifier switch on and allow about three minutes for warm up. Turn the plate voltage switch on and have R2 open or with the most resistance.

If the voltages are not of proper value, turn the power off before checking the circuit for mistakes. R2 is of the compression type of carbon control and should be handled with care. A graph of the output voltage can be made by applying a load with R2 and plotting. These curves are very helpful as the voltage can be determined at a given current drain.

Mounting

The power supply and distribution panel can be mounted in many ways. For an experimental laboratory the method shown is the best. The strap containing 2 tube sockets is used for connections between this unit and the power supply. The one shown is a typewriter box.

The fuse block is a handy addition because it gives room for another plug. It is shown in the lower right corner

of the box. The complete unit is shown. The cables used to connect the power supply to the set are hung on coat hooks at the left end of the assembly. Mount the distribution panel above the bench and put the power supply in any convenient place.

For the radio shop, the relay rack is the best method for mounting the unit. A twelve-inch panel with a shelf on the rear side for the power supply and a six-inch panel for the distribution unit make a good arrangement. For the shop, school laboratory or home workshop this analyzing power supply will be invaluable.

-30-

Field Strength Meter

(Continued from page 31)

signal voltage developed in the second detector. After once beginning to make readings the antenna or sensitivity control should not be changed until the full set of readings are taken. Otherwise no comparison can be made between readings. If a transmitter with a linear final is handy the meter readings can be plotted against power input variations and a curve drawn up. Then any increase in reading due to antenna adjustment can be interpreted

SCALE CONVERSION

Detector volts	Meter reading in 1/10 mils
1	7 1/2
2	5.2
3	3.7
4	2.7
5	2.1
6	1.67
7	1.27
8	1.00
9	.77
10	.50
11	.40
12	.30
13	.25
14	.14
15	.10

Use this chart to convert scale.

in terms of power increase that would have been necessary to bring about the same increase.

As simple as this little piece of apparatus is, it proved to be quite sensitive. With only 90 volts on the plates as much as 2 volts of detector current could be read from the BBC stations in London when a small outside antenna was used. In the 75 meter phone band fifteen volts at the second detector are not uncommon from stations as much as 300 miles away.

-30-

Book Review

(Continued from page 28)

engineer as well as the Amateur operator as the explanation is very complete and covers all of the important phases in the design and adjustments of the system. Other articles included are: Recent Improvements in the Design and Characteristics of the Iconoscope, The Image Iconoscope, A Phase-Shifting Device for the Rapid Determination of Audio-Frequency Amplifier Characteristics, The Electrostatic Electron Multiplier, Resonant Impedance of Transmission Lines, and Currents Induced by Electron Motion. Subscription \$10.00 per year; foreign, \$11.00.

**WITH SERVICE ON THE MOVE:
YOU and a SIMPSON
TESTER can "go places!"**

WHEN servicing jobs were scarce, you may have hesitated to "treat" yourself to some much-needed Simpson Testing Equipment. But now it's a different story. With service again on the march, Simpson speed, convenience and accuracy can put dollars right into your pocket.

A few of the "hit numbers" of today's Simpson line are illustrated here. Notice the wide range of requirements they cover—and the better way they cover them. Men who know testers have acclaimed Simpson equipment the first real advance in ten years of instrument building—and the proof of this is as close as your jobber!

See the Simpson line today and you will decide to put it to work tomorrow. You and Simpson Testing Equipment can form a mighty profitable partnership right now.

SIMPSON ELECTRIC CO., 5206 Kinzie Street, Chicago

**SIMPSON
INSTRUMENTS THAT STAY ACCURATE**



**MODEL 325
GIANT TUBE TESTER**
Tests All Tubes—Filament Voltage 1.5 to 120 Volts

● Has handsome, illuminated red, green and black scale on a silver etched dial with full 9-inch meter. Checks each element separately; shorts on dual-sensitivity neon tube. Has jack for noise test. Convenient drawer contains neat tube charts. Meter is reversible for horizontal use. Wings available for rack mounting. Your price... **\$34.50**



MODEL 440 "TEST MASTER"
Tests All Tubes—Tests All Circuits

Filament Voltage 1.5-120 Volts Has screen fluorescence and angle test; hot cathode-leakage neon test; "high sensitivity" neon short check; "good" and "bad" scale, and "noise test." Has six A.C. and D.C. voltage ranges; three resistance ranges; four milliamperage ranges; six Decibel ranges. Your price... **\$59.00**

**MODEL 320
GIANT SET TESTER**

● First set tester with giant (9-inch scale) illuminated dial meter—first with 50 ranges which include nine voltage ranges both A.C. and D.C.; six milliamperage ranges; five resistance ranges; four capacity ranges; seven Decibel ranges. Test leads, insulated for 5,000 volts furnished with each tester. Entirely A.C. operated—no batteries needed. Wings are available for rack mounting. Your Price... **\$37.50**



MODEL 260

● The new high sensitivity set tester for television and radio servicing. At 20,000 ohms per volt this instrument is far more sensitive than any other in its price range. Six voltage ranges, both A.C. and D.C. Resistance ranges from 1/2 ohm to 10 megohms. Current readings from 1 microamp to 500 milliamps. Your Price... **\$27.50** (Similar model, No. 215, with 5,000 ohms per volt at \$22.85.)

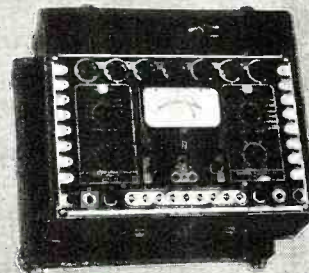

PAR-METAL PRESENTS

RACKS CHASSIS PANELS

IN A GREAT NEW 1940 CATALOG

When you build your next transmitter, amplifier, public address system, exciter kit, frequency meter . . . or any other job, be sure you use Racks, Panels and Chassis by PAR-METAL. It's the most widely publicized line and is specified in constructional articles more frequently than any other line. The Reason: Highest quality, beautiful streamlined design and popular price.

OUR NEW CATALOG

is now ready. It describes the most complete line in the industry. Two big sections: Amateur and Commercial—devoted to relay racks, enclosed racks,

transmitter racks, all purpose metal cabinets, several new types of rack panels, speaker cabinets and new models of amplifier foundation chassis. Many new Deluxe chromium trimmed, streamlined models in both black or grey ripple finish are included.

PAR-METAL PRODUCTS CORP. 3525 41st Street Long Island City, N. Y.



LETTER BRINGS IT FREE

AMATEURS!
Dress Up Your Rig with These NEW CROWE PRODUCTS

ADD a dash of class to your equipment with these NEW Crowe components. They include—brilliantly colored knobs—modern types of precision dials and controls—illuminated call-letter emblems—title plates—precision tuners, etc.

Modern anodized dial plates—etched dial and switch plates—escutcheons—panel lights—tuning units—are other Crowe items.

A number of these Crowe items are used in "The 1940 Full-Range Amplifier" appearing in this issue.

ASK FOR NEW BULLETIN

CROWE NAME PLATE & MFG. CO.
 1746 Grace Street... Chicago, Ill. U.S.A.
 Cable Address: CRONAME CHICAGO.

Servicemen's Case Histories
 (Continued from page 40)

section of voltage-divider

- open-circuited 0.5-mfd. screen by-pass condenser
- open-circuited 0.2-mfd. plate circuit by-pass condenser
- open-circuited 0.2-mfd. first r-f, second r-f, or detector secondary-return by-pass condensers

Distortion, . . . 1) open-circuited 100,000-ohm resistor in push-pull input transformer secondary return circuit

No output tube grid bias

No control of volume 1) cable of volume control shaft off pulley
 2) volume control shaft pulley loose

See also Case Histories listed for Colonial 33 receiver

Inoperative . . . 1) open-circuit in one of the sections of the 121,000-ohm voltage divider resistor. Check each section carefully, replacing if defective
 2) open-circuited 420-ohm center-tapped resistor (usually at the negative end) connected in the negative leg of the power supply, located between the two type '45 sockets. This may be short-circuited temporarily, but a replacement is advisable

Low volume at 1) open-circuit in one of the high frequencies (poor reception on the lower frequencies)

Oscillation . . . 1) short-circuited section of voltage-divider resistor. Replace with new unit

Slight oscillation, (poor reception on the lower frequencies) 1) open-circuit in one of the 0.2-mfd. condensers located under the condenser gang shield and used as secondary return by-pass units. One terminal is soldered to each coil. Replace with new units if found defective

Oscillation, . . . 1) open-circuited 50,000-ohm center section of voltage divider

Distortion, . . . 1) open-circuited grid-bias resistor—a 10,000-ohm carbon unit connected from the secondary center-tap of the input push-pull transformer to chassis. Replace with new unit

COLONIAL 35 A.C.

Inoperative between 500 to 550 kc. 1) dial "shorts" out phonograph switch. Loosen the nuts which hold the switch, push it further back, and tighten the nuts

COLONIAL 36 A.C.

Intermittent reception . . . 1) leaky 0.25-mfd. by-pass condensers. Replace if defective.
 2) defective 0.5-mfd. condenser between the first audio transformer and cathode. Replace with a new unit
 3) defective tube sockets, resulting in poor contact at tube base prongs. Clean and bend contacts or replace with new sockets
 4) faulty 0.1-mfd. coupling condenser between the detector and power stage. Replace defective phonograph switch. Replace with a new switch
 5) high-resistance grounds at r-f shields. Bond together all the grounding lugs with a piece of bus-bar and solder the latter in turn, securely to the chassis
 6) faulty 100,000-ohm r-f screen-grid bleeder resistor. May also cause fading and loss of volume

Insensitive . . . 1) open-circuited antenna winding in the first r-f coil
 2) loose connection at the antenna-end terminal of the first r-f coil

Excessive hum 1) open-circuit or increase in value in the 400,000-ohm resistors connected between the grids of the type '45 push-pull tubes and the hum-balancing potentiometer. Replace the dual unit with single 1/2-watt resistor
 2) faulty 0.1-mfd. coupling condensers between the detector and power stage
 3) check for "short" between the 2.5-volt filament winding for the '45 tubes and that for the '80 tube
 4) make sure the grid returns of the power tubes are not "open"

Low volume, Distortion, Inoperative . . . 1) replace the 350-ohm bias resistor connected between the chassis and first and second r-f tube cathodes, with a 1-watt carbon unit
 2) replace the two 400,000-ohm grid leaks in the output tube grid circuits
 3) replace the 60,000- and 100,000-ohm voltage-divider resistors

Low voltages on all tubes, distortion, abnormal plate current on 45's . . . 1) "leaky" coupling condensers to the '45 grids

High voltages on all tubes, Distortion at all but low volume . . . 1) "open" field coil (the field is used as a bleeder in this receiver)

COLONIAL 36-P

Intermittent reception, Fading, Loss of volume . . . 1) faulty 100,000-ohm bleeder resistor between r-f screens and ground. Install new one

COLONIAL 41

Hum . . . 1) if ordinary causes of hum are not responsible, check the hum-bucking coil located in the detector circuit between the cathode and a 0.5-mfd. condenser (the other side of this condenser being grounded). If this condenser is faulty, the control-grid bias on the detector will be low and a hum will appear

COLONIAL 85

Inoperative . . . 1) remove speaker plug from chassis and test for continuity between the two smaller prongs. These go to the primary winding of the output transformer which is subject to burnout due to the heavy plate current of the parallel 47's

COLONIAL 136

Type '25Z5 tube flashes 1) defective electrolytic condenser in power supply unit. Replace with a 225- or 250-volt unit
 2) replace the 0.02-mfd. condenser across the plates of the type '25Z5 tube with a 400-volt unit
 3) check the antenna series condenser. Connect a 0.001-mfd. unit in the circuit if one is not there

COLONIAL 250

Inoperative . . . 1) defective heater cord
 (Continued on page 52)

New! Tear out this ad, write your name and address in the margin, and mail it in for your copy of the NEW AMATEUR RADIO CATALOG. It is chock full of the latest nationally advertised amateur equipment. Everything is fully guaranteed, shipped within a few hours of the time your order comes in—and everything is sold on WARD'S TIME PAYMENT PLAN! Write Dept. RN-33.

MONTGOMERY WARD
 CHICAGO

WARD'S 1940 RADIO CATALOG

RADIO PHYSICS COURSE

by Alfred A. Ghirardi

(Continued from November issue)

Inducing voltage in the receiving antenna: We may consider the voltage induced in the aerial circuit to really be caused by the following two actions:

First, the passing electrostatic fields which are alternating in direction very rapidly (at a rate equal to the carrier frequency of the broadcasting station), produce distortion of the electron orbits in the air dielectric around the antenna system. This causes unbalanced electrical forces which tend to cause motion of the free electrons in the antenna wire in contact with the atmosphere; in other words an e.m.f. is induced in the wire. The e.m.f. will vary in direction and strength exactly in accordance with the variations in the passing fields. The action is practically the converse of the action taking place during the charging of a condenser by an applied e.m.f.

The other portion of the induced e.m.f. may be considered as being caused by the electromagnetic induction set up by the rapid movement of the passing electromagnetic field. The high-frequency e.m.f. induced in the antenna circuit will cause a surge of electrons rapidly up and down the circuit at a frequency equal to that of the carrier wave of the transmitting station, the strength of the individual cycles varying in accordance with the modulation impressed on the carrier wave.

A connection to the earth is not necessary for the reception of radio signals. Anything which will serve the same purpose as the ground does in forming the other plate of the condenser made up by the antenna circuit, will operate just as well. We usually employ a connection to the ground for this purpose simply because this can be conveniently obtained by simply connecting to a conveniently located water pipe. This saves us the trouble of erecting a counterpoise. In some radio receiver installations, as in the case of a receiving set in a moving automobile or aeroplane, it is not possible to make an actual connection to the ground. The "ground" side of the antenna circuit may be connected to a wire or network of wires supported a short distance above the earth and insulated from it. This network of wires then acts as one plate of a condenser (taking the place of the ground) and the antenna as the other plate. It is called a *counterpoise* ground. The counterpoise is usually located directly under the antenna. When a radio receiver is operated in an automobile, a short wire is erected in the roof of the car, and the metal frame and body of the car are used as a counterpoise ground. In an aeroplane, the engine frame and bracing wires are electrically connected together and used as a counterpoise.

RADIOS... SAVE UP TO 50%

Deal Direct—Factory Prices
Many models to choose from at wholesale prices
AC-DC midsets \$4.98
Portable, battery sets \$8.98
in Car sets \$11.75
Free Catalog

495
R.C.A. MADE IN U.S.A.

GOLDEN TONE
RADIO CO., Dept. RN, Dearborn, Mich.

PATENT YOUR IDEA

Other men have read and profited by our free books "Patent Protection" and "Selling an Invention." Fully explain many interesting points to inventors and illustrate important mechanical principles. With books we also send free "Evidence of Invention" form. Prompt service, reasonable fees, deferred payments. Write immediately to: Victor J. Evans & Co., Registered Patent Attorneys, 159-P, Victor Building, Washington, D. C.

MY BIG BOOK WILL GIVE YOU A COMPLETE TRAINING FOR RADIO

IN SHORT ORDER — AND ALL FOR ONLY \$4 !!

A Fascinating Career Lies Before You— LET ME HELP YOU GET STARTED NOW!

Ghirardi's Famous Short-Cut Home-Study Course will fit you Quickly for a Good Job in RADIO

AT LAST!—Your start in life! No longer need you be held back from the Radio Career you've dreamed about. No longer is lack of money an obstacle. The opportunity you have been waiting for is here! Ghirardi is ready to give YOU every advantage that he has already given to thousands of men who have made successful careers for thousands in all branches of Radio work. Now you may get just as good a training in radio as they did, for they too studied the easy-but thorough "Ghirardi Way." Today many of these men are making good money... they're going ahead... and they are happy in their work! What they have done, you, too, can do! No matter what your previous education and experience has been, Ghirardi's course has been written so that you can master the subject easily and quickly, by yourself in your own home!

All here COMPLETE in 1 Big Book— Your Practical Training in Radio

Sit in your easy chair in your own home and let Ghirardi train you for whatever type of radio work you want to do. Yes, it's as simple as that! Just plan to spend a few minutes a day of your spare time reading this interesting book. You'll find it hard to put down, for it makes the subject so absorbing. Surely Ghirardi will take you step by step from the very first principles of Electricity right on up through RADIO, TELEVISION and other important electrical sciences of today!

TELEVISION MADE EASY, TOO!

Each step of your study, each section of the course is complete in itself—and just as plain and easy to understand as a primer. The Television section is by itself a whole course in the basic fundamentals of this exciting new profession. As for **Sound Engineering**, you get up-to-date instruction in Public Address Systems, Sound Recording, Phonograph Pickups, Sound Motion Pictures, etc.—a great group of specialized new sciences, each of them offering you a promising future. So with Photo-electric Cells and Cathode-Ray Tubes—one of these days you may be very glad that you let Ghirardi explain to you the principles and applications of the "Electric Eye." Yet all this, and much more besides, is given to you in addition to the thorough training in Radio itself—broadcasting, receiving, short-wave, high fidelity, testing and repairing, auto-radio, police radio, airplane radio, etc. Everything essential is here—nothing is omitted—nearly a thousand illustrated pages full of practical knowledge for you to make your own!

USE IT 5 DAYS—OUR RISK!

You take no chances with Radio Physics Course. Send for it today—read it for 5 days—then, if not satisfied in every way, you may return it in good condition and get your money back immediately. Our guarantee protects you 100%. You will never know how much this book will do for you until you get it and see for yourself. That's why we take all the risk. So now it's up to you. Do you want to learn radio quickly, thoroughly, inexpensively? If you do, there's just one thing to do—fill out the coupon—clip and mail it without delay—right now!

36 VOLUMES IN ONE

- Radio Electricity and Sound Complete. Plus Many Other Valuable Special Features are covered in these 36 Big Chapter-Sections. 972 Pages. 508 Schematic Diagrams, Charts and Photos. 856 Review Questions.
1. Radio Broadcasting System.
 2. Sound, Speech and Music as Related to Broadcasting.
 3. Electron Theory, Electric Current.
 4. Electrical Units, Ohm's Law, Resistance.
 5. Electrical Circuits, Batteries.
 6. Magnetism.
 7. Electromagnetism.
 8. Electromagnetic Induction.
 9. Inductance and Inductors.
 10. Capacitance and Condensers.
 11. Alternating Current Circuits.
 12. Electric Filters.
 13. Electrical Measuring Instruments.
 14. Electromagnetic Radiations.
 15. Radio Transmission, the Broadcasting System.
 16. The Receiving Station, Detection with Crystals.
 17. Elementary Study of the Vacuum Tube.
 18. Vacuum Tube Characteristics.
 19. Construction Features of Vacuum Tubes.
 20. Vacuum Tube Detector and Amplifier Action.
 21. Radio Frequency Amplification.
 22. Superhetrodyne Receivers.
 23. Design of R.F. Amplifiers and Tuning Coils.
 24. Audio Amplification, Loud Speakers.
 25. The Battery Operated Receiver.
 26. The Power Supply Unit.
 27. The Power Supply Unit.
 28. Automobile Receivers.
 29. Automobile and Aircraft Receivers.
 30. Phonograph Pickups and Public Address Systems.
 31. Short Wave Reception.
 32. Vacuum Tube Applications and Photo-electric Cells.
 33. Television.
 34. The Antenna and Ground.
 35. Testing and Servicing.
 36. Sound Motion Pictures, Charts, Tables, etc.

972 PAGES

Get Started - RUSH THIS COUPON NOW!

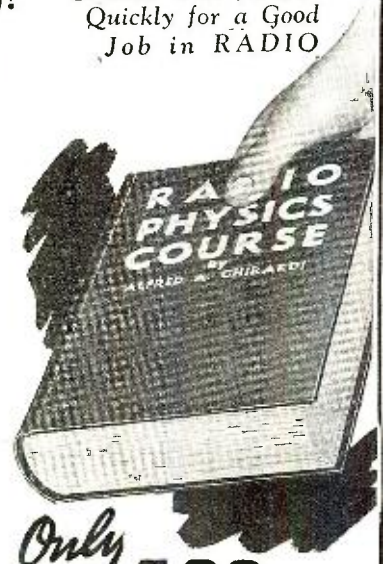

Only \$4.00

No Further Payments

A MARVEL OF CLEARNESS

Ghirardi has an amazing genius for making the most intricate problems of Radio crystal-clear. In plain, everyday language he explains every topic with equal clarity. Hundreds of Illustrations—schematic diagrams and photos—picture for you graphically the points he describes so vividly. When you have finished reading this great book you will have a solid grasp of radio fundamentals that will stick by you for life. Once Ghirardi tells you—you'll never forget it!

A MIRACLE OF CONDENSATION

How is it possible, you ask, to boil down a complete radio education into one single book? Separate books covering the many different subjects included in Ghirardi's Radio Physics Course would cost you over \$50. This famous book, all in 1 volume is only \$4! Think of it—your basic training for a lifetime career—all for only \$4. Read over the section titles at the left—just see what you get.

"PRICE INSIGNIFICANT" writes Ghirardi Enthusiast

"I have never seen a text book as complete, as easy to understand, and as helpful as this one. The price I paid for the book is insignificant in comparison to the value of the knowledge gained. I feel it is my duty to tell you that this book should be more widely advertised for the good of all those concerned and for the cause of the science of radio, physics and electricity."—Tom W. Danielson, Lockland, Ohio

MAIL COUPON TODAY

RADIO & TECHNICAL PUBL. CO. Books Shipped
25 Astor Place, New York Postpaid Anywhere!
Dept. RN-129

Enclosed find \$4 (\$4.50 foreign) for my copy of Ghirardi's "RADIO PHYSICS COURSE," with 5-day Money-Back Guarantee!

NAME

ADDRESS

CITY..... STATE.....

Please send me free descriptive literature about "RADIO PHYSICS COURSE."

40 DB Gain Guaranteed



The Meissner SIGNAL BOOSTER

● Designed expressly for amateur and commercial communications. Complete coverage from 1.6-31 mc. in 4 bands. Dial has 7/4" scale. Antenna-compensating condenser with control knob on front panel, permits adjustment for maximum sensitivity and signal-to-noise ratio. Connections for either standard or doublet antenna.

Here is the PRESELECTOR you've been waiting for! The PRESELECTOR you NEED for MAXIMUM RESULTS!

Completely assembled and wired. Net **\$38.25**
LESS TUBES



OPPORTUNITY FOR SERVICEMEN!

CASH IN ON RADIO NOISE ELIMINATION PROFITS!

Radio noise elimination is one of the liveliest subjects in the trade today—a real potential money-maker for the man who qualifies as a specialist now. Jobbers are taking it up—public utility companies have specified their willingness to cooperate—and now Sprague, after years of field work, shows you exactly what to do, how to do it and just what equipment to use in the new

WHAT TO DO—HOW TO DO IT

24-page Sprague Interference Manual, just off press. Contains more than 100 circuit diagrams, many illustrations. Easy to understand. An indispensable book. Order today.

IT PAYS TO USE ATOMS

For inexpensive radio service condenser replacements use Sprague Atoms—the fastest selling, most reliable midge dry on the market today. All voltages—all single and dual capacities. Save time—money—space.



SPRAGUE

SPRAGUE PRODUCTS CO.
North Adams, Mass.

Servicemen's Case Histories

(Continued from page 50)

Hum 1) defective type '25Z5 tube
No AVC action 1) adjust speaker and grid leads
open-circuit, or change in value of AVC resistor connected in the circuit of the type '6B7 AVC tube. Replace with new unit

COLONIAL 300

Poor tone 1) defective condenser bank. Replace
Inoperative . . . 1) replace dual 4-mfd. filter condenser

COLONIAL 600A

Intermittent . . . 1) replace the solid grid lead of the 6A7 with flexible wire

COLONIAL 601

Type '83 rectifier tube flashes . . . 1) short-circuited electrolytic filter condenser. Replace with new unit
Distortion 1) overloading of rectifier tube defective type '37 tube (even though it may test O.K.). Replace with new tube
2) defective type '37 tube resistor. Check all resistors in this circuit for changes in value

COLONIAL 654

No control of volume on local stations . . . 1) connect a lead from the unused lug of the volume control to the point where the 0.001-mfd. condenser is connected to the antenna coil primary

COLONIAL 995-C

Installing 1) a hi-lo sensitivity switch which will cut down interstation noise when tuning
noise suppression
(a) remove wire lead between lugs 1 and 2 of the Candohm resistors
(b) connect a 100-ohm resistor across these lugs
(c) detach ground connection from lug 1
(d) attach ground connection to lug 2
(e) drill a hole in the right side of the cabinet to receive a single-pole single-throw switch
(f) connect the switch terminals across the 100-ohm resistor

COLUMBIA C-2

Intermittent . . . 1) check all r-f coils for faulty "frying" noises insulation between primary and secondary windings. Check for the slightest leakage as well as for outright "shorts"

COLUMBIA SCREEN-GRID 8

Inoperative . . . 1) open-circuited detector choke
2) short-circuited condenser in detector choke and condenser assembly
3) open plate choke in one of r-f circuits
4) short-circuited r-f coupling condenser
Inoperative, . . . 1) rubber grommet on pilot Hum light assembly may be defective, allowing either side of the pilot light circuit to become grounded. This may cause the power transformer to become damaged, the 300-ohm center-tapped resistor to burn out, or a strong a.c. hum to appear

Intermittent . . . 1) "break" in fine wires of volume control
2) poor contact between slider arm and resistance element of volume control

Intermittent . . . 1) "open" r-f choke in the first reception r-f stage. It is well to check all the chokes, and their lugs and connections to them, as an "open" in the winding, or in one of the connections will cause one of these troubles

Fading 1) check the 0.1-mfd. coupling condenser between the detector and first a-f tube
2) check for faulty r-f by-pass condensers
3) check for poorly soldered connections

Oscillation 1) check the 0.88-mfd. cathode by-pass condenser for an "open" or "shorted" condition. Test it for an "open" by shunting it with a 1-mfd. condenser. An ordinary 1-mfd. condenser may be used for replacement

2) "open" screen-grid by-pass condenser
3) realign tuning circuits
4) if receiver oscillates only when volume control is advanced, insert a 5,000-ohm resistor in the grid circuit of the detector

Loss of volume 1) loose rotor section on the over a period of time condenser gang. Drill and tap the condenser gang hub for a set screw, in order to hold the rotor section in place

COLUMBIA SCREEN-GRID 9

Inoperative . . . 1) "open" 1,500-ohm section of "Candohm" resistor
Weak reception, 1) detector plate choke open-circuiting. Replace with new unit
Frying noise, 2) "leaky" condenser connected from screen-grid of the fourth '34 r-f tube to the common cathode-return lead (this condenser and another are connected inside the condenser can)
Distortion

COLUMBIA C-31

See Case History listed under Brunswick 10-AC receiver, and those for TCA chassis

COLUMBIA C-100A

Cuts off during 1) defective type '47 tube (even though it may test O.K.). The insulation in this tube breaks down on strong signals, causing the cut-off. Intermittent reception (voltage drops across power supply and at plate of the power pentode)

COLUMBIA C-101

Distortion 1) replace 40,000-ohm 1-watt resistor in cathode circuit of detector (located under a triple bank of coils). This unit changes to high value

COLUMBIA 205, 310

Same Case Histories as those listed for Kolster K-20 receiver

CONTINENTAL Z4, Z5 (CHASSIS)

Inoperative . . . 1) check connections from battery cable to storage battery. If connections are reversed, set will not operate
2) check all tubes
3) check tube shields for good "ground" connections. Check grid caps for good connection. See that grid caps and tube shields are not "shorted" to each other
4) reversed connections on Antenna and Ground terminals. Try both ways
5) vibrator unit not securely in socket
6) '1C6 oscillator tube not oscillating. To ascertain whether it is oscillating, check the oscillator plate voltage. If this is O.K., ground the oscillator grid of the '1C6 tube ("short" the stator plates to the rotor plates on oscillator section of the gang condenser). If the tube is oscillating properly, grounding this grid will cause an appreciable drop in oscillator voltage—otherwise it will not

Hum 1) a poor ground connection, or no ground at all being used on receiver
2) vibrator unit not securely in socket
3) antenna picking up interference from high-tension power lines
4) weak or rundown batt. Defective cell
5) poor battery connections
6) extending or lengthening battery leads causes enormous increase in "hum". The battery to the receiver is of special design and its ends must be connected directly to battery posts

Howling, 1) poor ground connections—or no ground being used on receiver
2) speaker leads placed near the '32 tube. These leads should be kept away from this locality by running them along end of chassis and front corner of cabinet
3) check the '34 tube shield for good connection to chassis

Microphonic . . . 1) loosen the four mounting screws that secure the chassis to the cabinet, and remove the two wooden strips that are underneath the chassis. This allows the chassis to "float" and rest on the four rubber pads used for this purpose. After the strips have been removed, adjust the chassis in the cabinet so that the dial will be in the center of the front escutcheon plate. Do not retighten the mounting screws

Coronado 6B (6-volt Power Converter Unit)
Inoperative . . . 1) storage battery run down
2) battery connections "loose"
3) relay not closing—heavy red or black battery wires may be twisted inside the unit, holding the relay armature open

4) fuse blown—check all wiring before inserting a new fuse. Also check the vibrator. A good vibrator will have a smooth hum when holding your ear close to it; a worn vibrator will "sputter"

R-f "hash" 1) a good antenna and ground noise in receiver, usually a frying- 2) power unit should be located away from the set by the ing-buzzing sound length of the cable

- 3) on sets having short-wave bands, noise may always be noticed on some parts of the band but is usually not objectionable
- High battery drain (batteries run down too frequently) 1) the total drain on the six-volt battery should be approximately one ampere plus the normal "A" drain of the receiver. Excessive drain may be caused by a faulty transformer, vibrator or filter condenser in the power unit, or a faulty switch or by-pass cond. in the set

CORONADO 11-B

- Intermittent reception, 1) check all tubes
2) intermittent "open" in coupling cond.
- Noisy reception 3) corroded socket or tube pin contacts
4) speaker voice coil out of center
- Weak reception 1) check tubes
2) check antenna and ground connections for poor contacts
3) faulty by-pass condenser
4) faulty filter condenser
5) faulty loudspeaker
6) receiver out of alignment (465 kc i-f)
- Poor selectivity 1) receiver is naturally "broad" in the high-fidelity position, but should be very selective position—if it is not, check

in "normal" tone i-f alignment (456 Distortion)

- 1) speaker voice coil out of center
2) check tubes carefully, especially the 6C5, 6F5 and 6L6 types
3) i-f or i-f stages overloaded due to "short" or "open" in AVC line
- Hum 1) abnormally high line voltage
2) faulty filter condenser
3) speaker field "shorted"
4) faulty tubes—check the 6C5, 6F5, 6L6 or 5Y3 tubes carefully
5) change 100,000-ohm resistor (connected between main B+ line and the resistor that connects to the plate of the 6C5 first audio (inverter) tube) to 50,000 ohms. Also disconnect the end of the 250,000-ohm detector plate resistor which now connects to the main B+ line. Connect this end of the resistor to the junction of the 25,000-ohm inverter tube plate resistor and the 50,000-ohm resistor you just installed

- Motorboating . . . 1) faulty 6L6 tube
2) "open" coupling condenser
- Tuning belt slipping . . . 1) idler spring too loose
2) belt worn or stretched
3) condenser thrust bearing too tight, or not lubricated
4) faulty gear on condenser
5) if belt slips only slightly, apply a small amount of "belt dressing" or rosin it

CORONADO 410-B

- Weak reception 1) check alignment of oscillator (tubes, batts., etc. O.K.) (The i-f of this receiver is 456 kc)

CORONADO 540

Same Case Histories as those listed for Coronado 650, 850

- Rattle, distortion 1) this model is equipped with a balanced armature type magnetic speaker. If rattling occurs proceed as follows:

- (a) "Quam" type speaker: bend bracket holding armature snubber cup up or down until armature "centers". This bracket is located on bottom of magnet housing
- (b) Wright De Coster type speaker: to center the armature, remove the small aluminum plate on bottom of the magnet housing, loosen one of the small set screws and tighten the other until the armature is "floating" in the center between the poles

CORONADO 550

- Oscillation . . . 1) #34 tube shield makes poor contact with ground clip. Bend the clip to make better contact with the shield

CORONADO 575

- Fading 1) poor "ground" on the battery switch—due to grounding wire working loose. This runs from the switch to one of the i-f can lugs. A permanent cure for this trouble lies in grounding the switch shaft with a pigtail lead

CORONADO 650

Same Case Histories as those listed for Coronado 850

CORONADO 650-A, 650-B

- Oscillation, . . . 1) connect a 0.02-mfd. 600-volt whistling condenser from the plate of one of the 950 tubes to 650 kc. region
2) check alignment of i-f stages

CORONADO MODEL 810

Same Case Histories as those listed for Coronado 11B receiver

CORONADO 850, 850B (Battery Operated)

- Intermittent reception 1) check all tubes
2) intermittent "open" in coupling

- plung condensers, coil terminals or switch contacts
- 3) loose connection in any of the wiring including antenna and ground lead-in
- 4) corroded socket or tube-pin contacts
- Weak reception 1) check all tubes
2) check batteries
3) check antenna or ground connections
4) "shorted" lightning arrester-check resistors, coils, a-f transformer, condensers and loudspeaker
5) check alignment of receiver i-f amplifier out of alignment
- Poor selectivity 1) antenna too long
2) speaker voice coil out of center
- Distortion 1) check tubes—especially the '30 and 950 tubes
2) AVC line "shorted" or "open"—evidenced by overloading of i-f or r-f stages on strong signals
3) one side of a-f transformer "open"

—30—

FREE CATALOG

ALL RADIO NEEDS

Here in this one big book you will find everything you need in radio . . . sets, parts and supplies . . . public address systems . . . amateur equipment . . . testers and kits . . . your nationally known favorites at lowest possible prices. Write today for this big valuable catalog and save money.

PROMPT SERVICE

BURSTEIN-APPLEBEE COMPANY

1012-14 MCGEE STREET, KANSAS CITY, MISSOURI

First with the news! RADIO NEWS!

IT'S LIKE HAVING YOUR OWN BROADCASTING STATION

MYSTIC MIKE WIRELESS Outfit

Now! This perfected Mystic Mike Wireless Outfit, with variable frequency control, enables you to do your own broadcasting from any part of your home, office or store WITHOUT the use of any interconnecting wires. NO WIRES CONNECTED TO RADIO. Simply plug this unit into a AC or DC electric socket, speak or play music into the microphone and your voice, or the music, will be picked up by ANY radio ANYWHERE within the same building. Use it at home for entertaining . . . use it in your office or store as a public address system . . . for auditions . . . for rehearsals . . . in fact it can serve you in hundreds of ways. Order today.

WRITE FOR FREE BULLETIN RN-12 MONEY BACK GUARANTEE!

OLSON MFG. CO., 362 Wooster Ave., Akron, Ohio

COMPLETE SET, WITH MICROPHONE and TUBE

\$3.95

NET PRICE

Tear out this ad, write name and address in the margin, mail \$3.95 or order C.O.D. and we will send outfit at once.

Speed up YOUR RADIO SERVICE WORK with Ghirardi's 2 Helpers

THEY'VE MADE ALL MY SERVICE JOBS EASY!

CASE HISTORIES, —Plus! Basic Course in SERVICING METHODS

Here's a helper for you that will do many a full day's work, yet you pay it no wages. Just get this new Ghirardi manual-size Handbook—put it to work in your shop—and count the time and money it will save for you. It saves all that time-wasting, tedious searching through magazine clippings and manufacturers' literature for needed receiver data. It gives you proven tips for spotting trouble and making repairs in practically every set ever made—3,313 factory-checked Case Histories! It provides you with table after table of priceless servicing data of every description—518 large pages full of it. Here at last is a book that gives you in 1 source at a single glance, the very kind of reference service data you really need—a book to use every day. And it's packed-jam-full of information.

PRACTICAL JOB DATA:

- **Case Histories**—Trouble Symptoms and Remedies for 2,312 sets, compiled from actual Service Records. This is by far the largest and most authentic Case History compilation ever published.
- **I-F Peaks**—Over 16,000 listings for alignment of all Superhets, old and new.
- **Auto-Radio**—Gear Ratio and Dial Directions of Tuning Controls of all sets; Installation and Circulation System Data for all cars; Special Interference Elimination Instructions for over 80 car models; Electrical Wiring Diagrams, etc.
- **Other Data**—Over 100 more pages of data, including Quick Trouble-Shooting Charts; Servicing Home Recorders; Servicing Intercommunications; Trade Directories; Charts and Tables on Tubes, Filters, Transformers, etc.

RADIO Trouble-Shooter's HANDBOOK

518 Pages-134 Illus.-Standard Manual Size (8½x11) Fabrikoid Bound

MODERN Radio SERVICING

1300 Pages - 706 Illus. - 720 Review Questions - 766 Topics

Money-Back Guarantee

\$5.00 for BOTH BOOKS

USE THEM 5 DAYS

MAIL TODAY!

Radio & Technical Publ. Co., Dept. RN-129
45 Astor Place, New York, and rush to me postpaid
Enclosed find payment, and guarantee:
• **5-Day Money-Back Guarantee:**
• **MODERN RADIO SERVICING** at \$4. (\$4.50 foreign)
• **RADIO TROUBLE-SHOOTER'S HANDBOOK** at \$5. (\$5.50 foreign)
• **BOTH BOOKS** at \$8.50. Special Combination Price. (87. foreign.)

NAME _____ STATE _____
ADDRESS _____
CITY _____

Please send me FREE descriptive literature.



• Short wave reception really means something these days . . . and when it is a bit "frazzly" on the higher frequencies the Radio Serviceman comes into his own. The wise brothers carry Centralab "spares" for satisfactory replacement service, and please the most critical cash customers. So, if you would glean the golden harvest these days . . . see your jobber for sufficient Centralab replacement parts.

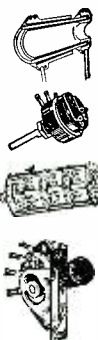

CERAMIC CAPACITORS

VOLUME CONTROLS

WAVE CHANGE SWITCHES

TOGGLE SWITCHES

Centralab

DIVISION OF CLOSS-UNION INC.
MILWAUKEE, WIS.

NEW TURNER DYNAMIC 33D
Removable Cable Set
Full Tilting Head

Style and performance at low cost! Balanced line cable eliminates noise pick-up. Ideal for recording, P.A. work or for the Ham. Level—54DB. Range 40-9000. Trouble-free operation.

Available All Impedances
Free Wiring Diagrams

The TURNER CO. With 7 Ft. Cable Set... **\$23.50** List
908 17th St. N.E.
CEDAR RAPIDS, IOWA

WRITE FOR FULL INFORMATION

Examining **SOLAR**

EXAM-ETER

CIRCUIT and COMPONENTS ANALYZER
Including PEAK VOLTMETER

A sensational! Combines more important test functions than ever offered before for only . . .

\$39.00 YOUR COST

Write for full details

SOLAR MFG. CORP. Bayonne, N. J.

Within Earshot

(Continued from page 4)

fer" in the issue. It has been as refreshing as it has been difficult to acquaint ourselves anew with "load-lines," "inverse feed-back," "cutoff filters," "db hum components," "AC voltage increment," etc.—all the terms that apply to this fascinating field of research.

You PA men will be pleased with the results of building this unit. We hope that you will all give it a whirl. We understand that there is a terrific market for such units, and that you should be handsomely repaid in pecuniary gain for the sweat and effort you put into the project. We would welcome any reports or suggestions.

IN response to many requests for the results of the survey recently completed, we promise faithfully to record them as soon as the *International Business Machine Company* get through with their tabulations. One thing we were pleased to see, and that was that our readers are a wide-awake, energetic, aggressive bunch who make no bones about their likes or dislikes. That's the sort of thing that makes our efforts seem worthwhile.

LEE WARD (*Bench Notes*) has a fine contest on in this issue. All that you need is a sharp pair of eyes and a good brain. The prizes are nice, too. We hope that all you servicemen will take a try for the honor of being the one who will stump "*Signal Chaser*." If the contest goes over as well as Lee the former ones by Lee Ward, we will have one of them every two or three months. Let us know how you like it.

WHILE we are writing this, the frost has not yet appeared on the pumpkin. In fact the pumpkin is still green. (*Are they green, or do they grow orange colored?*) Still this is the December issue. Another year has gone by. So slowly did the time pass during its passing, and so rapidly has the year run out in retrospect. The advances this year have been tremendous, and it seems but yesterday that we're writing, "We freely predict that 1939 will be a great radio year. . . ." Well, it has been a great radio year. And if it hadn't been for the War and Hitler, we believe that radio would rate first place as the News of the Year.

This has been the year in which Television was supposed to have turned the corner . . . yet it seems more like a will-o'-the-wisp than ever before.

This was the year when the Frequency-Modulated signals were to have covered the US . . . yet that, too, waits patiently for further developments.

We will do our usual predicting with the first issue of 1940—next year—

and we hope that our neck will not be out too far.

Meanwhile, we wish you and yours a most merry Christmas and a prosperous, healthy New Year.—KAK.

-30-

SUPER ACTIVE

HIPOWER

LOW DRIFT
CRYSTAL UNITS

LOOK! LOOK! LOOK!
GENUINE LOW DRIFT CRYSTALS
AT
"X" CUT PRICES

HIPOWER "EMERALDS"

Large production facilities plus exclusive HiPower grinding method allows these sensational low prices. Only best grade Brazilian Quartz used.

160-80-40 meter bands	\$3.35
20 meter band	\$5.50

Send for catalog "E".
In Chicago see Newark Electric.

HIPOWER CRYSTAL COMPANY
2035 CHARLESTON ST. CHICAGO, ILL.

RADIO NEWS

The Ideal Gift For Christmas

BUSINESS ORGANIZATIONS!
Plan to send RADIO NEWS subscriptions as Christmas presents to old customers, prospects, dealers, salesmen, office employees, servicemen, students, and other friends. RADIO NEWS will be a monthly reminder of your thoughtfulness and kindness. A beautiful Christmas card will announce the gift with the donor's greetings.

Write for Our Special Christmas Rates

MAIL COUPON TODAY!

RADIO NEWS, Christmas Gift Dept.
608 S. Dearborn St., Chicago, Ill.

Please send RADIO NEWS to names written on attached list and bill me.

MY NAME

ADDRESS

CITY & STATE

Full-Range P.A.

(Continued from page 9)

ability to handle all of the frequencies coming out of the output tubes. Just any speaker will not do for high-fidelity reproduction, the best ones for the purpose should be used. Some of the speaker manufacturers supply excellent units with specially designed baffles of all sizes. The choice of the best type to use will depend upon the range of the amplifier and the power delivered from the amplifier.

Reference to the illustrations will show the types of baffles that gave the best results in the tests in our laboratory. Many now own speakers capable of giving satisfactory results with an efficient baffle. Directions are given, for those wishing to enjoy fine reproduction, for constructing an excellent infinite baffle to be used with a 12" or 15" speaker, and one capable of projecting frequencies as low as 35 cycles.

First we must choose a suitable speaker. One having a permanent magnet is best for high-fidelity as the hum problem is greatly reduced. It must have a magnet with a large force factor, and with plenty of weight, such as a Utah H15P. The speaker should be securely held onto the baffle by means of eight 8-32 machine screws and lockwashers as the total weight is 18½ lbs. and is subject to heavy vibration when operating at large levels. The speaker diameter is 15".

The baffle is constructed from a sheet of ¾"-5 ply veneer which may be had in a standard width of four feet. We used a piece four by eight and cut it in half. The sides may be made of 1"x12" No. 1 pine. The method used in lining the inside of the baffle is shown in the process of construction. A heavy hair felt material is excellent for the purpose, or some absorbent material such as celotex might be used instead. The hair felt is one inch thick and is cut to cover all surface except that occupied by the speaker itself.

A small hole should be drilled in the center of the back cover to allow free motion of the speaker cone. Screws are used in preference to nails in construction and should be at least 2" long in order to have sufficient pull to hold the pieces together. So much for the "home-built" unit.

Naturally, there will be many who will want to depend on the laboratories of a manufacturer who has developed the baffle to a high degree. They will feel that the superior equipment available, the greater monetary stake, and the reputation of that manufacturer will all be deciding factors in the turning out of a superior product.

After testing the various Cinaudagraph models, we decided on the Cinaudagraph 18" model SU 18-12.

The weight of the unit was about 41 lbs. To this we added the infinite baffle cabinet made by the same concern. For those who will want to re-

COMPLETE RADIO COURSE \$1.95

Amazing Offer of R. T. I. Training



GREATLY REDUCED

A limited number of the latest R.T.I. \$29.00 radio courses have been reprinted and are offered to you for only \$1.95. These courses are complete in all details and exactly the same as the higher priced originals.

New modern developments help to make Radio the present-day opportunity field. Men like you are making real money in radio. R.T.I. unique radio training will bring rich rewards to you. You can get ready quickly, inexpensively, easily, and in your spare time for a good job in radio.

ACCEPTED BY INDUSTRY

Forty-three large radio manufacturers helped to prepare the R.T.I. course. Just think what this backing by the radio industry means to you. R.T.I. practical training will give you facts and real data you will need on the job. Hundreds of diagrams and illustrations to help you. You will pass quickly from lesson to lesson and in surprisingly short time will be ready to do real radio servicing and earn bigger money.

COMPLETE IN ALL DETAILS



Arthur Gold says, "From the very start I learned about practical equipment and methods. I was told how to open my own shop. You can earn spare-time money on radio repairs before you reach the fourteenth lesson."

R.T.I. course will give you all the radio training you need. No special previous education or experience is needed. The lessons are clear, interesting, easy to master and use. Fellows who know nothing about radio before taking a home-study radio course are now the leading servicemen in their communities. The special \$1.95 price of the complete course can be earned in a single hour's work of radio servicing. This is your opportunity.

Your Guarantee

You must be pleased, or your money will be cheerfully refunded. We guarantee these courses to be exact reprints from original Radio Technical Institute course.

3 COURSES IN ONE

R.T.I. course is really three complete essential courses combined. (1) Practical and Applied Radio; (2) Fundamentals of Radio Principles; and (3) Advanced Specialized Training. This is the training that will place you above the average radio serviceman—and you get this training for only \$1.95.

There are over 40,000,000 radio sets in use. The R.T.I. easy practical course will pave the way to your success in Radio work. A final examination may be taken and diploma obtained if wanted.

TELLS HOW TO USE INSTRUMENTS

The training is complete. Everything from simple facts to complex alignment problems. Many servicemen have found that R.T.I. training is excellent for brush up and study of modern servicing methods. This is the best buy in a radio education. Take advantage of the reduced bargain price today.



LATEST DATA

Yes, in the R.T.I. course you will find a complete explanation of A.V.C., how to use an oscilloscope, sound feed-back, resonance phenomenon . . . every possible fact you must know to be the best radio serviceman. You get a real radio training. One of the BEST radio courses is yours for only \$1.95.

LIMITED QUANTITY

Hurry your order to us today. There is but a small quantity of the courses left at the special bargain price. You are completely protected with the unconditional "you must be satisfied" or money-back guarantee.

FREE EXAMINATION COUPON

SUPREME PUBLICATIONS, Agents,
3727 W. 13th St., Room 204,
Chicago, Illinois

Please send the complete R.T.I. radio course at the special reduced \$1.95 price.

- I am enclosing \$1.95, send prepaid.
- Send C.O.D., I will pay mailman \$1.95, plus a few cents postage.

NAME

ADDRESS

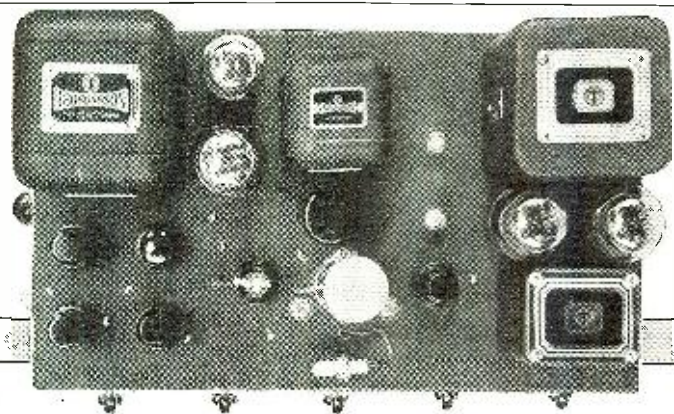

N O M I N A T E D A G A I N !

TOP QUALITY was an essential in every part used in the Radio News 1940 Full-Range Amplifier. It is no wonder that THORDARSON transformers were specified.

DESCRIPTION

	DESCRIPTION	PRICE
T-90A04	Interstage transformer	\$15.00 List
T-9013	Output transformer	29.00 List
T-15R05	Power transformer	10.50 List
T-67C46	Choke	1.75 List
T-15C54	Choke	5.50 List
T-74C30	Choke	1.50 List
T-18C92	Choke	1.50 List
T-14C70	Tone Control Choke	2.50 List

Ask your Parts Distributor for your copy of Catalog No. 400-D. Fully describing these and other Thordarson transformers.

THORDARSON

Elec. Mfg. Co., Chicago

THERE IS 44 YEARS OF EXPERIENCE BUILT INTO EVERY THORDARSON TRANSFORMER

PEAK EFFICIENCY

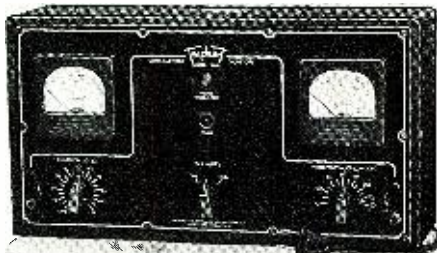

get more out of your power with **TRIPLET**

MODULATION MONITOR AT A PRICE!

• Usable On All Amateur Bands • Permits compliance with Federal Regulations • 110 Volt AC 60 Cycle Operation • Two Meters—One for Carrier, One for Per Cent Modulation • Calibrated Modulation control for neon flasher from 50% to 120%. Polarity switch permits checking positive and negative peaks. Tip Jacks for Phone Connection • Uses Vacuum Tube Rectification • RED DOT Lifetime Guaranteed Meters . . . In Metal Case . . . DEALER NET PRICE. \$33.00 Also available as rack panel mounting unit . . . Dealer Net Price. . . \$33.67

WRITE FOR CATALOG
Section 1512, Harmon Avenue

TRIPLETT ELECTRICAL INSTRUMENT CO.
Bluffton, Ohio

Servicemen! MAKE MORE MONEY renting

LAFAYETTE P.A.

Every special event in your area is an opportunity for you to make money today renting and installing sound systems. The auto show, prize fight, football game, political campaign—these are just a few of the pressing needs for P.A. Cash in on them all with Lafayette—the P.A. line that costs less to own.



EASY TO BUY. Lafayette offers a complete line of modern sound systems priced surprisingly low. Because they pay for themselves more quickly, because they're outstanding in dependability, outlasting many units that cost twice the money, your profits are greater with Lafayette. Send today for new FREE 1940 catalog. See this amazing P.A. line, note the features, and the prices.

Radio Wire Television Inc.
formerly WHOLESALE RADIO SERVICE, INC.

NEW YORK, N.Y. • CHICAGO, ILL. • ATLANTA, GA.
100 SIXTH AVENUE • 501 W. JACKSON, BLDG. • 285 PEACHTREE ST.
BOSTON, MASS. • BRONX, N.Y. • NEWARK, N. J. • JAMAICA, L. I.

LAFAYETTE PUBLIC ADDRESS EQUIPMENT

Radio Wire Television Inc.
Dept. ZMP9- 100 Sixth Ave., New York.
Rush FREE Lafayette Catalog No. 78.

NAME.....
ADDRESS.....
CITY..... STATE.....

PASTE COUPON ON PENNY POSTCARD

produce the laboratory model in its entirety the number is 4BC. Though large, it more than justified its choice by the fine reproduction it gave.

Since the input to this speaker was only 8 ohms, it was necessary to include a transformer which would accommodate this resistance. By introducing a 500 to 8 ohm step down transformer, the speaker was coupled to the *Full-Range amplifier*. There are some who will question why the output transformer was not directly connected to the speaker, since the former had a tap of 8 ohms. However, it was found that the 10 db. loss pad mentioned above in the opening of the article, was an impractical apparatus to insert in any 8 ohm line. The 500 ohm line was, therefore, retained, and the pad inserted between the 500 ohm output of the PA system and the 500 ohm input terminals of the 500-8 ohm step down transformer placed ahead of the speaker.

In the next and concluding installment, we will discuss the actual construction of the unit, and describe the results of the various tests to which it was put. The opinions of men high in the music world will have been sought and their reactions recorded.

-30-

What's New in Radio

(Continued from page 25)

Micamold Radio Corporation announce new condensers possessing several features.

A special process cellulose derivative is the dielectric for a new 1,000 volt tubular condenser, slightly smaller in size than the ordinary 600 volt units of the same capacity rating. It is not only superior in its ability to stand higher than rated voltages under ordinary conditions but also under high humidity. Tests show their life to be three times that of ordinary paper-insulated condensers. Especially adapted for use in public address equipment, television receivers, and other devices requiring a high-voltage capacitor with an extra margin of safety.

Micamold Radio Corp., 1087 Flushing Ave., Brooklyn, N. Y.

The Browning Laboratories, Winchester, Mass., has recently announced a new 100-1000 kc. oscillator standard. Stability of a high order is obtained through a judicious choice of components and careful electrical design. Adjustments are provided so that circuit capacitances may be taken into account and each oscillator set to zero beat with WWV. The adjustments for the 100 and 1000 kc. oscillators are absolutely independent. A switch which is an integral part of the apparatus chooses either the 100 or the 1000 kc. at will. This unit is known as the BL-2FS. It will find hosts of uses wherever an economical precision standard is required.

Cornell-Dubilier Electric Corporation, South Plainfield, New Jersey, are producing new high-voltage tubular paper capacitors.

Particularly appropriate for television receivers, test equipment and amateur transmitter applications are the Cornell-Dubilier Type MD Dykanol impregnated tubular paper capacitors. With rated work-voltages up to 1600 v. they meet substantially all requirements of the above services in this respect and are available in a wide variety of capacity values ranging from .0001 to .15 mfd. at 80 volts; .001 to 1 mfd. at 1200 volts; and .001 to .05 mfd. at 1600 volts.

These capacitors utilize the highest quality aluminum foil and multi-laminated Kraft paper, non-inductively wound. The winding is sealed with a wax outer coating and thoroughly impregnated with Dykanol "D". It is then inclosed in a specially treated and dehydrated cardboard tube and sealed at the ends with a high melting point compound which not only repels moisture but serves to provide added strength as well as added protection for the bare, tinned flexible leads.

This combination of features provides greater permanence of electrical characteristics including high resistance, lower power factor and stability of capacity. For this reason these Type MD units will find wide application in the construction of high-quality receiver equipment and other electronic apparatus.

Catalog No. 175A describing these capacitors in detail available on request at main office of the Cornell-Dubilier Electric Corporation, South Plainfield, New Jersey.

Barker & Williamson announce four new B&W Baby Coil Turrets. These are receiving favorable

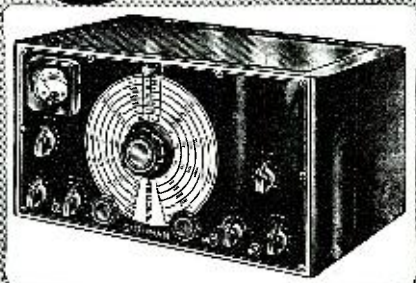

U-50 "SUPER"

HERE'S THE BUY! 11-Tube Communication Receiver, complete with sensational new Gun-Sight Tuning, illuminated and magnified 2½ times; Six bands, 525 to 62,000 kc. Controlled regeneration; R.F. Stage 2 gang condenser; improved Noise-Silencer; Pre-selection Stage and every other vital control, only \$69.98, amateurs net wired with tubes, or build it yourself. Kit supplied assembled \$49.95

At your jobber's, or order direct, giving jobber's name, if out of stock.

EDWIN I. *Guthman* & CO. INC.
400 S. PEARIA ST. CHICAGO, U. S. A.
CABLE ADDRESS: GUTHMA-CHICAGO

DEATH OVER CHICAGO!

The sidewalks in Chicago's "Loop" were crowded with men, women and children . . . all looking up at the darkening, November sky! Through the gray clouds appeared a weird, incredible light . . . like a huge ship glowing with some eldritch illumination! Nearer and nearer it came . . . until . . . ! Then—all hell broke loose! A panic-stricken metropolis was being invaded by an army of metal men . . . robbing . . . ravaging . . . killing! Who were they? Where did they come from? What did all this mean? Could it be possible that science was remaking the world? Relax in sheer breathlessness . . . read DEATH OVER CHICAGO . . . one of the many complete, entertaining stories in the

JANUARY ISSUE

fantastic ADVENTURES

Now On Sale At All Newsstands!

Antenna Matching Simplified!

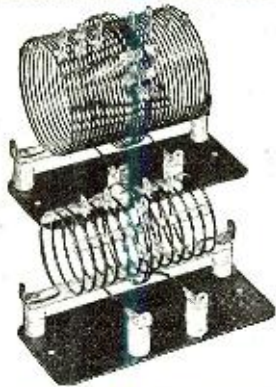

BUD ANTENNA COILS

- 500 watt and 1 KW sizes.
- Two coils cover all bands.
- Large number of taps on both main and link windings.
- Mounting insulators and base furnished.
- "Air-Wound" construction.
- Reasonably priced.

Write for free BUD Catalogue RN-129

Your jobber has these in stock. **BUD** Drop in and see them!

BUD RADIO, INC.
CLEVELAND, OHIO

CAN HISTORY BE CHANGED?

Legends say Lemuria sank beneath the waves 12,000 years ago! . . . but, what if time reverses itself and those 12,000 years cease to exist? Travel in imagination and adventure to a world of 12,000 years ago with two bold American soldiers of fortune! Don't fail to read Nelson S. Bond's **SONS OF THE DELUGE**, a truly sensational new novel beginning in the gigantic, thrill-packed

JANUARY ISSUE

AMAZING STORIES

GET YOUR COPY NOW!

acceptance as highly efficient 5-band switching units for use in low-power transmitters and exciter stages say the makers. Each Turret utilizes five of the familiar B&W Baby Coils, covering the amateur bands from 10 to 160 meters and may be tuned in all types of service with any of the midget condensers having an effective capacity of 100 mmfd.

Switches employed in the Baby Coil Turrets have ceramic sections for the coil ends where high voltage is encountered. The link terminals and center tap sections are switched by bakelite sections. The coils are mounted as an integral part of the switch by means of a stamped metal spider which maintains permanent coil alignment and a maximum of rigidity in the assembly. All leads from the coil to the switch are extremely short. It is recommended that the unit be mounted directly above its associated tuning condenser in order that all tunable tank circuit leads be kept at a minimum length to provide maximum voltage at the end of the coil.

B&W Baby Coil Turrets are rated at 35 watts and are available in four distinct types. Type BTM is a straight untapped coil unit for single-ended unneutralized stages. Type BTCT consists of center-tapped coils for balanced output with either single tube or push-pull. Type BTEL is an end-linked unit, each coil having a low impedance link as an integral part, and is designed for single-ended stages, unneutralized. Type BTCL is a center-linked unit for low impedance coupling in balanced output stages either single-ended or push-pull.

The Turrets are extremely compact and sturdy. They answer the need of many amateurs who desire practical low-power stage band-switching with a minimum number of tubes and a maximum of electrical and mechanical efficiency. Complete details and prices will be sent upon request to Barker & Williamson, Ardmore, Pa.

Keeping pace with the growing popularity of midget-metal-can electrolytics for many service jobs, Aerovox Corporation of New Bedford, Mass., announces the addition of several dual-section numbers to its Dandee line. These are the 8-8 and 8-16 mfd., 450 v., 8-8, 8-16 and 16-16 mfd., 200 v. and the 20-20 mfd., 150 v. and 10-10 25 volt. The 10-10 mfd. 50 volt, previously included in the line, rounds out the dual-section numbers.

Aerovox, while expanding its Dandee line, continues its policy of pointing out that these midget-can electrolytics are not to be confused with standard-sized large-can electrolytics. The former are suitable for many applications, but the large-can units are still recommended for heavy-duty service over a term of years. The midget type, Aerovox insists, is not a 100% replacement for the standard-sized unit, and should always be considered with that reservation in mind.

Million Radio and Television, 685 W. Ohio St., Chicago, announce a new instrument, MODEL VV—MULTIMETER. 1,000 ohms per volt, 4" meter, built in test leads, separate switch for shunts. Complete scales for A.C. and D.C. Milliamperes, ohms, decibels. Rotary type range selector switch. Self contained battery gives ohms to 2.5 megohms. Size 8x5 3/8 x 3 1/2".

Burlington Laboratories, Inc., of 1617 N. Damen Ave., Chicago, Ill., have just announced a new internal Loop Antenna, called the "Permascope," which, installed in a set, will give the same results as any of the new sets with built-in antenna, which is said to eliminate the antenna coil, and the need for an aerial and ground.

The inductance of the Loop Antenna can be adjusted to track to any radio set, regardless of the size of tuning condenser and coils.

This Loop Antenna is enclosed in a very attractive case and is furnished with rubber suction cups, which makes mounting on any radio a simple matter.

Wireless Mike

(Continued from page 31)

the same as is used to tune in a station at 550 kilocycles. Volume is adjusted to suit the requirements at the receiver, so no adjustments are needed at the oscillator other than to turn the filaments on and off.

A range of about fifty feet is possible between units and the constructor is cautioned that this device—like all similar units—will radiate a signal. Therefore the use of higher plate voltage or larger tubes might cause illegal operation if attempted. Any frequency in the broadcast band can be used, but one should be selected where a broadcast station cannot be heard at full volume setting on the receiver.



RADIO'S No. 1
Free Catalog
COMPLETE UP-TO-DATE
saves you money!

If you're connected with radio or sound, this book can be of tremendous help. It's **BIG**—188 pages of receivers, xmitters, parts, tubes and supplies. All the nationally advertised names. It's **COMPLETE**—even has the hard-to-get items out of manufacture. It's **UP-TO-DATE**—includes a complete stock of television apparatus, Build-it-Yourself Kits, etc. You can't beat the quality—or the low prices. Speedy service. Mail the coupon below for your **FREE** copy of catalog No. 78 **TODAY**.

Just 1 of the Buys!



AMAZING 7 tube Hi-Fi RECEIVER only \$9.95

You build it yourself! In convenient Kit form, complete with instructions including pictorial, schematic and wiring layouts. TRF circuit used is similar to that found in this year's high priced receivers. Four of the seven tubes are single end type. Assembly simplified by grouping by-pass condensers within a single case. **R20359**—Complete Kit of parts less speaker, tubes and cabinet. (Add postage. Shpg. wgt. 6 lbs.) Own a high-fidelity receiver at the remarkably **\$9.95** low price of



one minute!

You will want our special **FREE** Christmas gift-catalog, too. This coupon brings both. Just double check and mail.

Radio Wire Television Inc. formerly WHOLESALE RADIO SERVICE, INC.

LAFAYETTE RADIO

NEW YORK
100 SIXTH AVENUE
CHICAGO
901 W. JACKSON BLVD.
ATLANTA
265 PEACHTREE STREET
BOSTON • BRONX
NEWARK • JAMAICA

Radio Wire Television Inc.
Dept. ZM9-100 Sixth Ave., New York, N. Y.
Rush **FREE** 1940 Radio Catalog No. 78
Rush **FREE** Xmas Catalog No. 79

Name.....
Address.....
City..... State.....

PASTE COUPON ON PENNY POSTCARD

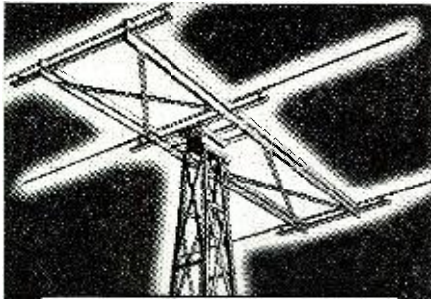

**AMATEURS
SERVICE MEN
P. A. EXPERTS**
Be Sure and Get This
SEARS 1940 CATALOG

Here's the finest radio catalog we've ever printed . . . page after page of nationally famous radio and test equipment, plus a completely new line of Silvertone Sound Systems. And everything in the catalog is available on Sears Easy Payment Plan. Just a few dollars down and you can buy the best. Send for this great catalog today. Simply address a card to Sears Personal Service Department asking for Radio Equipment Catalog RN8132D and mail to

SEARS, ROEBUCK AND CO.
Chicago, Philadelphia, Boston, Minneapolis, Kansas City, Atlanta, Memphis, Dallas, Seattle, or Los Angeles (Address nearest one)

Inexpensive Tester

(Continued from page 22)

- Volt Range.
 - R₇—50,000 Ohm Semi-Precision Resistor. 50
 - Volt Range.
 - R₈—10,000 Ohm Semi-Precision Resistor. 10
 - Volt Range.
 - R₉—4,950 Ohm Semi-Precision Resistor. 5
 - Volt Range.
 - R₁₀—4,000 Ohm Metallized Resistor—1 R C Type BT.
 - R₁₁—120,000 Ohms (100,000 and 20,000 in series) Semi-Precision Resistors 150 Volt a.c.
 - R₁₂—40,000 Ohms Semi-Precision Resistor. 50 Volts a.c. Range.
 - R₁₃—12,000 Ohms (10,000 and 2,000 in series) Semi-Precision Resistors. 15 Volt a.c. Range.
 - C₁—1 MFD. Tubular Condenser 600 Volt.
 - R—Copper Oxide Rectifier.
 - VR—1,000 Ohm Variable Wire Wound Resistance.
 - Fuse—1/32 Amp. "Littlefuse."
- PARTS LIST**
- 1—Bud Analyzer Kit. Allied Radio Co., Chicago.
 - 1—Combination 4-5-6 prong socket. S₂.
 - 1—Combination 7 small, 7 large prong socket. S₃.
 - 1—Octal Socket.
 - 13—Pin Jacks.
 - 9—Yaxley Shorting Jacks.
 - 1—0-1 Ma. Foundation Meter—3" Square "Lafayette," from Wholesale Radio Service Co., New York City. 50 ohms internal resistance.
 - 1—12 point Yaxley Rotary Switch. S₁.
 - 3—SPST Cutler Hammer Toggle Switches. S₂—S₃—S₄.
 - 1—DPDT—H & H Toggle Switch. S₅.
 - 1—Yaxley SPST Push Button Jack Switch. S₆.

- 1—1/32 Amp. Fuse—"Littlefuse" instrument fuse.
- 1—.505 Shunt-Homemade from manganin wire from Radolek Co., Chicago.
- 1—1.02 Shunt-Homemade from manganin wire from Radolek Co., Chicago.
- 1—5.55 Shunt-Homemade from manganin wire from Radolek Co., Chicago.
- 11—Continental Semi-Precision Resistors as follows: 1—1 Meg., 1—500,000 ohms, 2—100,000 ohms, 1—50,000 ohms, 2—10,000 ohms, 1—4,950 ohms, 1—40,000 ohms, 1—20,000 ohms, 1—2,000 ohms.
- 1—4,000 ohms, 1 Watt, International Resistance Co., Type BT Metallized Resistor.
- 1—.1 MFD. 600 Volt Tubular Condenser—Radolek Co., Chicago.
- 1—Copper Oxide Rectifier, Conant Elec. Laboratories, Lincoln, Neb. Type B.
- 1—Yaxley 1,000 ohm variable wirewound resistance.
- 2—5"x7"x3/16" Bakelite Panels.
- 1—1 3/4"x5"x1/8" Panel.
- 1—4"x4"x3/4" Quartered Oak Panel, for meter, slanted for easier reading.
- 1—Cabinet—made of 3/4" Oak, 17 3/4"x11 1/2"x2 1/4", partitions of 1/4" Oak, made in this odd size to fit a carrying case on hand and panels on hand.
- 1—5 ft. test lead wire connection with phone tip for P₁, clip for connection to receiver ground.
- 1—Test Lead Kit with phone tip terminals, needle point and phone tip prods and alligator clips.
- 2—12" test lead wire jumpers equipped with phone tips, for tube test.
- 1—4 1/2 Volt Battery—3 small flashlight cells soldered together in series. Various name plates for switches, a.c. and battery pin jacks. Made from a red plastic dish from 10c store. Values put on with India ink. Do not show up well in photograph due to color. (Turn to page 59)

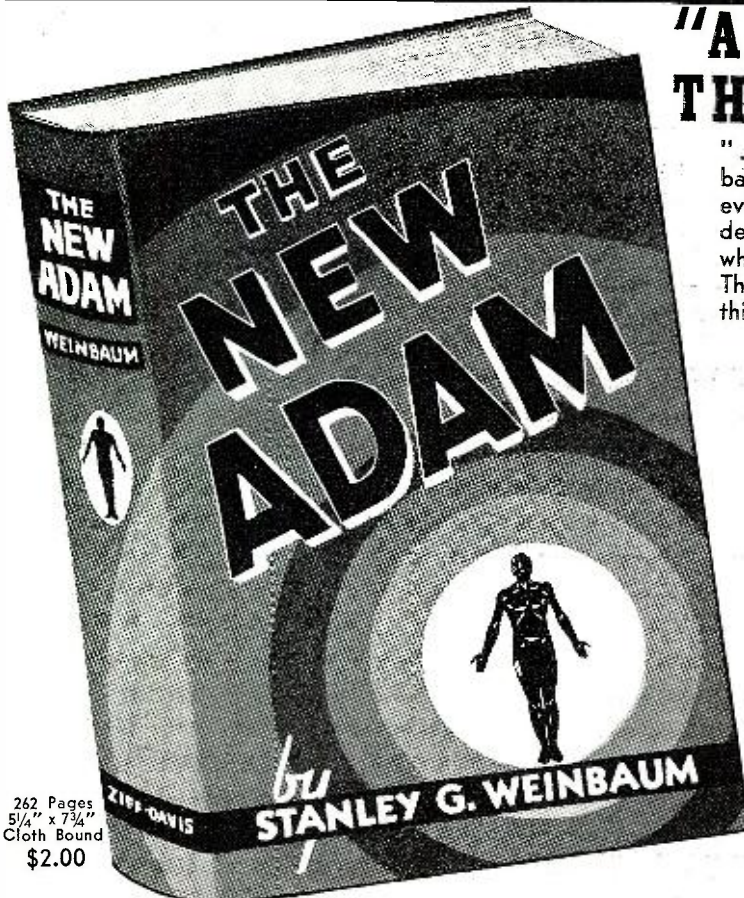

262 Pages
5 1/4" x 7 3/4"
Cloth Bound
\$2.00

"A LITERARY EVENT OF THE FIRST MAGNITUDE"

"... conceded by all who have read it to be Weinbaum's outstanding masterpiece . . . This is a literary event of the first magnitude . . . all his writings held deep, gripping significance, while still remaining light, whimsical yarns, without any tinge of preachment . . . The New Adam represents the crowning achievement of this formula."

Ralph Milne Farley

★ This is the story of a superman . . . the story of the coming of a man whom nature has placed yet another rung higher up the ladder of evolution. How will he fit into a world populated, in his opinion, by creatures as far below him as the ape is below us? What will he achieve? What will he want? How will he find happiness? What is his destiny? Would we be his enemies or his slaves? The gifted pen of Stanley G. Weinbaum answers these questions in this brilliant novel relating the life of Edmond Hall, The New Adam. Here is a story of amazing scope, of tremendous meaning, of fine entertainment. It is new, different, imaginative.

ORDER NOW!

You will want THE NEW ADAM, a super novel, to read . . . to read again . . . to treasure in your library for years to come! The number of first edition copies is limited . . . they are going fast! Don't miss this once-in-a-lifetime opportunity. Get your copy **now!**

ZIFF-DAVIS PUBLISHING CO.—Book Dept. R12
608 South Dearborn Street, Chicago, Illinois

Gentlemen: I enclose \$2.00. Please send me a first edition copy of THE NEW ADAM (postpaid). Please send C.O.D. (postage added).

NAME

ADDRESS

CITY & STATE

SEE YOUR BOOKDEALER...OR SEND COUPON TODAY!

CATH-O-DRIVE MODULATION

Again KENYON leads the way with a series of three low price CATH-O-DRIVE modulation transformers. These new and extremely flexible units are designed to match 6V6's, 2A3's, 6L6's, etc., to various class "C" loads between 40 and 3,000 ohms. Impedance matching is not critical and a rather wide variation from the above values will give satisfactory results. This new method of economical modulation was described in the October issue of RADIO and should be attractive to those amateurs who have long wished to operate on phone but who have been held back because of the high cost of plate modulation.

TYPE	MAX. SEC. D.C.	AUDIO TUBES	AMATEUR NET PRICE
T-471	200 M.A.	Single 6F6	\$2.40
T-472	300 M.A.	PP 6V6 or 2A3	3.00
T-473	450 M.A.	PP 6L6's-AB ₁ or AB ₂	3.60

Send today for complete sheet showing various combinations possible and technical information. Catalog free upon request.

KENYON TRANSFORMER CO., Inc.
840 BARRY ST. NEW YORK, N. Y.

IS AMELIA EARHART STILL ALIVE?



... could she possibly be living today on some uncharted island in the Pacific Ocean? Why do reports of her "safe landing" constantly come to her husband, George Palmer Putnam? Dean Jennings, renowned author and friend of Mr. Putnam, gives a thrilling, inside account on the question the world has been asking since July 2, 1937. This authoritative, exclusive article is supplemented with authentic photographs and copies of reports sent to Mr. Putnam. Remember, it can be found only in the

**DECEMBER ISSUE
POPULAR
AVIATION**
Now On Sale At All Newsstands!

ANALYZER SECTION

- S₁—Socket for Bud Analyzer Cable Plug AP.
 - S₂—Combination 4-5-6 prong socket.
 - S₃—Combination 7L-7S socket.
 - S₄—Octal Socket.
 - PJ1-PJ2—Pin Jacks for ground connection to receiver, through GCW, and meter.
 - PJ3—Pin Jack for Tip Plug on AP.
 - PJ4—Pin Jack for Top Cap connection (TCW) to tube in Analyzer Socket.
 - S—Mounting Screws for Shorting Jacks. Connected to either side of Shorting Jack with lug. Voltage and Resistance may be read by touching test prod to brass ferrule in center of Shorting Jack, not necessary to plug in.
 - SJ1-SJ2-SJ3-SJ4-SJ5-SJ6-SJ7-SJ8—Yaxley Shorting Jacks. Mounting screws on Shorting Jacks are actually between connections, shown at side on diagram for clarity. It would make a better looking job to mount Shorting Jacks under panel.
 - TCW—Top Cap Connection with Combination Top Cap for Glass and Metal Tubes, connects PJ4 to tube on test in Analyzer Socket.
 - GCW—Connection Analyzer to Receiver, tip plug one end, clip on other end, 5' wire.
 - AC—Analyzer Cable—Bud Mfg. Co. Comes in Kit form, 9 wire cable, 2-8 prong plugs and 5 adapters.
 - AP—Analyzer Plug.
 - RP—Receiver Plug.
 - A₁—4 prong Adapter.
 - A₂—5 prong Adapter.
 - A₃—6 prong Adapter.
 - A₄—Small 7 prong Adapter.
 - A₅—Large 7 prong Adapter.
- It is suggested that No. 14 stranded wire be used for filament circuits. No. 18 or No. 20 is satisfactory for other circuits. —30—

Homebuilt Super

(Continued from page 19)

switching arrangement between the two grid condensers was necessary.

Since only a four-pole band switch was available, the series connection of the antenna primaries was resorted to in order to use a section of the switch for the antenna primaries. Incidentally, the short-wave primary must be connected to the antenna and the broadcast primary between short wave primary and ground. Reversal of this arrangement will result in loss of signal strength on both bands.

The i.f. stages are quite conventional. It will be noted, however, that the cathodes of the 6K7's, 6Q7, and 41 are grounded. Usually, cathode resistors, shunted by by-pass condensers, are used to provide bias for these tubes, but a considerable saving in parts was effected by obtaining the bias from the power supply. The grid returns go through resistors to negative taps on the power supply filter. The bias for the 6K7's is obtained by a slightly modified version of the same idea. The fixed bias circuit is combined with the a.v.c. circuit at the juncture of the two 1 megohm resistors, R5 and R6. When no signal is applied to the diode plates of the 6Q7, no a.v.c. voltage is developed, and the minimum bias on the 6K7's is minus 3 volts.

Any signal applied to the diode plates will simply increase the negative bias on the 6K7's through the a.v.c. filter, and the sensitivity and volume

I'LL SHOW YOU HOW TO MAKE REAL MONEY IN RADIO AND TELEVISION



*New
Practical
HOME TRAINING
fits you
quickly*

**YOU GET
PROFESSIONAL
TEST
EQUIPMENT plus
EXPERIMENTAL
OUTFITS!**

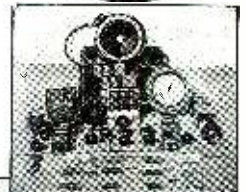

**146RADIOPARTS
RADIO TOOLS
All-Purpose, All-Wave
ANALYZER**

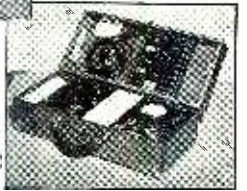
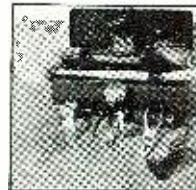

**I'LL PROVE THAT
YOU CAN HAVE**

**A GOOD JOB IN RADIO . . .
OR A BUSINESS OF YOUR OWN**

I offer you a new and altogether different type of practical Training for a money-making career in Radio and Television. No matter if you desire to BE YOUR OWN BOSS in your own business, or hold down a good job in Radio, my Personalized Training will give you the useful knowledge to win success.

EASY TO LEARN—Earn from the Start

YOU DO PRACTICAL EXPERIMENTS with real Radio Equipment . . . with your own hands. Thus the principles of Radio become crystal-clear to you. The valuable spare-time BUSINESS BUILDERS I supply will show you how to put this knowledge to work in handling profitable Radio service jobs while learning.

NO PREVIOUS EXPERIENCE NEEDED

It makes no difference what your education has been. My Training starts at the beginning of Radio, covers in a simple understandable style all essential subjects including Television, Electronics, Facsimile Radio, Radio Set Repair and Installation.

**READ WHAT THIS STUDENT SAYS
Earned \$250, Since Starting Course**

"I have only completed one third of the Sprayberry Course and I find it very interesting, which makes it easy to learn. By devoting several hours' spare time daily to studying and servicing I have made about \$250 gross since starting the Course." Earl W. Hostetter, R. No. 4, Lebanon, Pa.

SERVICEMEN

I offer Advanced Training for those already in Radio. Get complete details in my FREE 52 page Book.

REMEMBER—THE SPRAYBERRY COURSE IS SOLD UNDER A MONEY-BACK AGREEMENT



RUSH THIS COUPON FREE for BIG FREE BOOK

DON'T DELAY! ACT NOW!

SPRAYBERRY ACADEMY OF RADIO
F. L. Sprayberry, Pres.
225-M University Place, N.W., Washington, D. C.

Please send me FREE copy of "HOW TO MAKE MONEY IN RADIO."

Name Age

Address

City State

Tear off this coupon, mail in envelope or paste on penny postcard. Servicemen—Check here

Now!

BALLAST REPLACEMENT
made
**AMAZINGLY
SIMPLE!**

Only 4 standard types of
Amperite AC-DC Regulators
will replace 90% (over 100 types) of
AC-DC Ballast Tubes now in use!
WRITE FOR CHART A.R.

New Low Price \$1.00. List

AMPERITE AUTOMATIC
REGULATORS

AMPERITE CO. 561 BROADWAY N. Y.



will decrease. Grounding the cathodes of the 6Q7 and 41 also improves the low frequency response of the set, because of the elimination of the cathode by-pass condensers, the impedance of which increases as the frequency decreases. Incidentally, attention is called to the fact that the 6G5 cathode is *not grounded* as per conventional custom. If it were, the minimum grid bias on the 6G5 would be minus 3 volts, which would allow the shadow angle to open only about halfway on no input signal. To offset this, the cathode is connected to the same point as its

grid return resistor, making the minimum grid bias equal 0.

Proceeding next to the triode audio section of the 6Q7, the grid of which is slightly overbiased intentionally. This, together with the low value of plate load resistance, 100,000 ohms, causes a comparatively large amount of harmonic distortion to appear in the output circuit of the tube. This distortion is out of phase with the distortion produced by the 41, and the two cancel each other to a large degree, the net result being a high attainable output with very small distortion. The required load impedance in the output transformer for a 42 is practically the same as for a 41, so a 42 may be used if desired, with no circuit changes.

The power supply furnishes a humless high voltage for the receiver. The three filter condensers may be all in one can or may be separate, but in any case, two of the condensers must have separate negative leads which are *not grounded* to the can, since these leads are off ground in the circuit. Use only the specified resistor values in the power supply for correct biasing of the tubes.

As is the case with nearly all circuits, various minor changes may be made without altering receiver characteristics appreciably, but there are a few portions of the circuit which should not be changed. In the plate circuit of the 6K7 mixer, the 3000 ohm resistor and .01 mfd. condenser should not be removed. The gain in the first three stages is so large that the primary of the first i.f. transformer must be isolated from the other B minus circuits or i.f. oscillation will result.

Similarly, it will be noted that there is a separate .5 megohm load resistor for the diodes of the 6Q7, and a 50,000 ohm resistor and .02 mfd. condenser are connected in series with the a.f. volume control. It is common practice to use the volume control as the diode load resistor in addition to its function as volume control. This often results in noisy volume control operation, particularly in high gain circuits, and it was to obviate this difficulty that the 50,000 ohm resistor minus .02 mfd. condenser filter is used to "isolate" the volume control from "critical" circuits.

No portion of the oscillator circuit should be revised.

In wiring the receiver, run all a.c. and B— leads around the edges of the chassis. Keep the i.f. plate leads as far away from each other as possible, and position the sockets for the shortest grid and plate leads. The screens of the mixer and i.f. tubes are connected together and by-passed at the second i.f. tube socket.

Although built on a chassis especially drilled for it, this set is well adaptable to the so-called "general-purpose" chassis, obtainable at any bargain basement. It is so simple in design that the only consideration in laying out the set on a chassis is to position the parts for the shortest possible leads. Either one or both of the two band coils may be mounted on top

"TAKE YOUR CHOICE

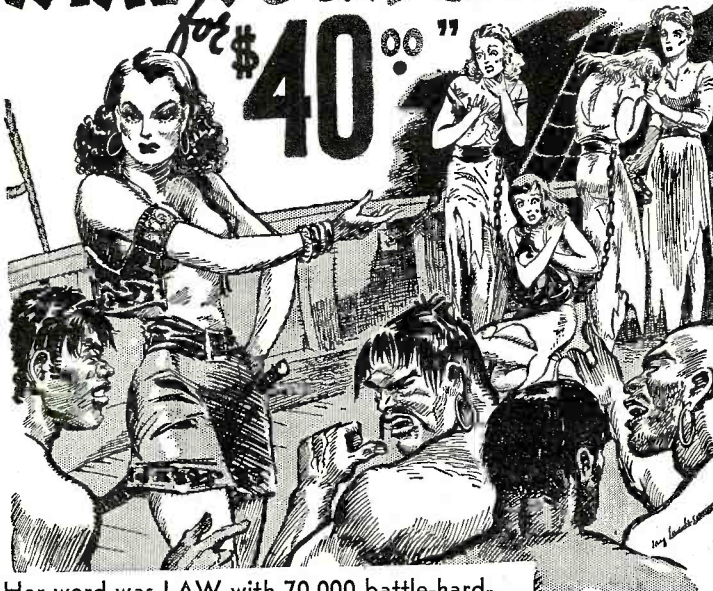

Her word was LAW with 70,000 battle-hardened pirates! She ruled with an iron hand! Yet Hsi-Kai had a softer side . . . the woman showed through this relentless pirate as she sold the captured women to her men . . . for forty dollars apiece! Don't fail to read the QUEEN OF THE PIRATES . . . an exciting, true story brimming with adventure, romance, and action of the South Seas! But, it's just one of the many stirring stories gathered between the covers of this amazing NEW MAGAZINE . . . the only one of its kind in the world!

6 EXCITING STORIES of Romance and Adventure—ALL COMPLETE!

★ **BLOOD WILL TELL**—All hell broke loose on the Island of Avulla when the white and native girl fought for the love of handsome young Allen!

★ **TWO MEN AND A GIRL**—Donald Campbell considered Aleuha as his native wife . . . but, he didn't realize his wife believed in bigamy!

★ **THE END OF KING PENNY**—King Penny deserved the horrible vengeance of the tribe for his crime against the chief's daughter.

★ **SOUTH SEA DICTATOR**—"Damn it!" he rasped, "let her alone! Can't you see she doesn't want to . . ." Larry McQuinn faced the most daring character in the South Seas, a slaver and a pirate!

★ **THE STRANGE TREASURE OF AH MUN**—What priceless treasure was it that Ah Mun wanted salvaged? Pierre Fournier would kill a hundred men to get it. Pemberton knew it, but took the job anyway!



**NOW ON SALE
AT ALL
NEWSSTANDS**

YOU CAN HAVE A PROMISING CAREER in the ARMY, NAVY or the COMMERCIAL FIELD

You can begin now to prepare yourself for such an interesting position through Candler Home Training, even if you know nothing of radio code or fundamentals. Or, if you know code but are compelled to copy "letter-for-letter" and send jerkily, Candler will smooth this out by giving you that "Coordinative Knack" necessary to speed and copying behind.

You may be practicing wrong, pursuing antiquated methods that are long, slow, tedious. Candler will set you RIGHT in a few days—will make the process of learning code or acquiring speed and skill, easy and interesting. When you can read code as easily as you read print, copying behind and acquiring speed cease to be a factor.

CANDLER SPECIALIZED TRAINING

backed by over a quarter century success, makes possible a wonderful career for you. The New BOOK OF FACTS, the whole, interesting story. Send for IT TODAY. A postal will do. No obligation.

CANDLER SYSTEM Co.
DEPT. N-12, ASHEVILLE, NORTH CAROLINA

CLEANING HOUSE!

We're selling our used equipment to make room for new parts and test equipment. Here is your chance to buy used completed units and parts at a big reduction in price. Each part has been tested and is in good condition. First come, first served. Cash or Money Order with first letter. Please include postage or shipping expenses.

- One only—3-band midget Super-Het receiver. (See April 1939 RADIO NEWS) for 1.4 tubes. . . . \$10.00
- One only—1.4 volt midget receiver. (See June 1939 RADIO NEWS) (less loop) . . . \$10.00
- One only—Visual Deviation Monitor. (See Feb. 1939 RADIO NEWS) . . . \$10.00 (Above receivers include tubes, less batteries)
- One set Hammarlund plug-in coils, covering 10-20-40-80 meters. . . . Set, \$1.20
- One Hammarlund 100 mmf. midget condenser . . . \$.35
- Two 50 mmf. midget variables. Each, \$.30
- One double-spaced midget variable. . . \$.35
- Two Bud 25 mmf. midget variables. . . Each, \$.25
- Five Hammarlund 5 prong isolantite sockets. . . . Each, \$.10
- Three Hammarlund 7 prong (large) isolantite sockets. . . . Each, \$.10
- One 4 prong isolantite socket. . . . \$.10
- One Cardwell transmitting condenser, 100 mmf. split stator. . . . \$1.00
- One Hammarlund 100-100 mmf. transmitting condenser. . . . \$1.25
- One Kurz-Kasch vernier knob. . . . \$.40
- Eighteen assorted mica transmitting and receiving condensers. . . . Lot, \$1.75
- Two Yaxley volume controls with switches. . . . Each, \$.25
- Two Hammarlund 5 prong isolantite coil forms. . . . Each, \$.10
- Two Crowe 3 1/2" Dia. plates. . . . \$.05
- Two Thordarson T1934 Plate trans. 25-60 cycle, sec. 600-600 volts at 250 ma. . . . Each, \$1.00
- Two Thordarson T2029 chokes. 15 Hy. at 300 ma. . . . Each, \$1.00
- One Thordarson 83D21 driver transformer. 500 ohm line to pp 616 or 50 grids. . . . \$1.00
- Two dual 20 henry, 65 ma. filter chokes. . . . Each, \$1.00
- One Filter choke—12 henry, 300 ma. . . \$1.00
- Three Aerovox type R.5 mf. 600 v. oil filled condensers. . . . Each, \$.75
- Two Polymet 2 mf. 1200 v. oil filled condensers. . . . Each, \$.85
- One dual electrolytic condenser 16 mf. at 200 v. and 12 mf. at 200 volts. . . \$.75
- Three electrolytic condensers. 16 mf. at 450 volts. . . . Lot, \$.50
- One Heavy-duty driver transformer. Single plate to push-pull plates. . . \$1.00
- One audio transformer single plate to single grid. . . . \$.50
- One Leeds and Northrop laboratory standard condenser. .0015 mf. Bargain. . . . \$4.00
- One General Radio laboratory standard inductance. 1 henry. Bargain. . . \$5.00
- One General Radio Type 164 Audibility meter. . . . \$5.00
- One Rawson type PE Thermo-junction. \$4.00

ZIFF-DAVIS ELECTRONIC LABORATORIES

608 South Dearborn St., Chicago, Ill.

or on the bottom, as long as they are not laid out parallel within an inch of each other.

When the wiring is completed, check it carefully. Do not leave pieces of solder where they can cause shorts. Insert the tubes, the speaker plug, connect the antenna, and turn on the a.c. line. The receiver is now ready for testing.

If the builder has *neither* signal generator *nor* output meter, the alignment procedure will be no more difficult than if they are available. The 6G5 tuning indicator will very satisfactorily take the place of the output meter, while any bc station will serve as the signal generator. First, loosen the broadcast oscillator trimmer, C4. Tune to some point on the *low frequency* end of a correctly calibrated dial, where a strong local station should come in. This station should be somewhere between 540-700 kc.

Adjust the oscillator padder C5, until the station comes in at the correct spot on the dial. Maximum resonance will be indicated by the narrowest shadow angle of the 6G5. Then tune to the *high frequency* end of the dial, between 1350-1550 kc., and adjust the broadcast oscillator trimmer, C4, until a given station comes in at its correct spot on the dial. On the same station, adjust broadcast antenna trimmer, C7, for maximum resonance. All adjustments should be for the narrowest shadow angle on the tuning indicator tube.

The next procedure is to align the i.f. stages. Tune again to a station at the low frequency end of the band, and adjust the trimmers on top of the i.f. cans for maximum resonance. Then repeat the alignment procedure just to make the adjustments a little finer. It only remains to align the short wave band, and this may be done simply by loosening short wave oscillator trimmer C9, and antenna trimmer C10, and the short wave will then be completely aligned.

No padder adjustment on the short wave band is necessary because a fixed padder C3, is used, making the oscillator track automatically. Neither oscillator nor antenna adjustments on short wave are critical; hence a slight loosening of the trimmers is all that is required.

If a single generator is available, the i.f. stages should be aligned first. Remove the grid cap lead of the 6K7 mixer and connect the generator output to the grid. *Make sure to ground the generator or there will be a small frequency shift.* Set the generator at 465 kc. and align the i.f.'s. The rest of the alignment procedure is the same.

The entire circuit was designed to use as few parts as possible, without sacrificing on performance. It afforded the writer so many delightful hours of *dx* hunting that it was retained as a permanent fixture around the workbench. If the station is on the 6-18 mc. band, this little set will pick it up, with surprising ease and clarity.

WHAT IS AN "EXPENSIVE" RESISTOR?

You can buy resistors at almost any price—but, remember, you generally get just about what you pay for. One lost service customer, one call-back as the result of trouble with a "cheap" resistor can cost far more than you can possibly save on dozens of resistor "bargains."

Insist on IRC Insulated Metallized Resistors—the finest most reliable resistors at any price. You can rely on them any time, any place, under the most severe conditions. They are a good investment in long, satisfactory performance. They are the least expensive resistors to use because they are the best resistors for protecting your reputation for highest quality workmanship on every job.

INTERNATIONAL RESISTANCE CO.

401 N. Broad St., Philadelphia, Pa.



INSULATED Metallized RESISTORS

"They Stay Put"

RADIO plus TELEVISION

pre-mastered by
pre-tested Training

No matter where you are or what you do, National has a complete training plan for you—to fit your circumstances. National's plan is for those seeking immediate shop-training as well as for those who cannot give up present employment and income. Mail coupon below. Find out how you can get the finest in radio and television training.



NATIONAL SCHOOLS

NATIONAL SCHOOLS, Dept. 12-RN
4000 So. Figueroa St., Los Angeles, Calif

Please send free Literature and full details.

NAME _____ AGE _____

ADDRESS _____

CITY _____ STATE _____

Treat Yourself or Your Friends to a Practical Christmas Gift!

"JIFFY" Magazine Binders

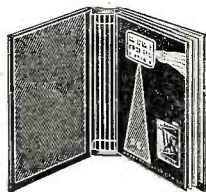

Sturdily built and covered with black fabricoid. Has two stamped metal end caps with 12 spring wire separators. Magazines can be inserted and removed in a jiffy. No fuss—no lost time—no labor.

- No. 1. 12 3/4" x 9 1/2", with 2-inch back for Radio News, R.&T., Radio-Craft, etc. — \$1.50
- No. 2. 10 1/2" x 7 1/2", with 3-inch back for QST, Radio, Popular Mechanics, etc. — \$1.25
- No. 3. 8 1/2" x 6 1/4", with 3-inch back for Reader's Digest, etc. — \$1.00

P.P. Prepaid in U.S. and Canada. Send for catalog containing full descriptions of many other interesting items.

GOLD SHIELD PRODUCTS

Dept. RN-129 350 Greenwich St. New York

Combination Revr.-Xmtr.

(Continued from page 16)

spectrum, use the special condenser, connecting the 365 mmfd. sections across the broadcast coil windings (secondaries, of course), and the 100 mmfd. sections across the short wave coil secondaries. Make the connections directly to the coil lugs or to associated selector-switch points—and not the switch selector arms, as required with the regular condenser.

This will keep the one capacity across the one inductance, the other across the other, at all times. Band-switching, instead of selecting desired coils and throwing these into connection with the one condenser, simply connects the desired condenser-inductance combination. In such a layout, grid caps cannot be conveniently connected to upper condenser stator lugs. Leads from them must be brought down through the chassis to associated bandswitch selector arms.

If this outfit is to be used by the builder as an amateur rig and under conventional powering conditions, the 400 volt dynamotor and 300 volt Vibrapack units will not, of course, be required. All relays may be replaced by a.c. operated jobs—those at transmitter and receiver power packs. Such relays become entirely optional, as toggle switches can be made to do the job instead. The push-button switch for turning on the transmitter filaments should be replaced by a toggle, wired to operate the relay line (if any) controlling a.c. input to the transmitter power supply. The switch on the receiver volume control is used only to operate the receiver power supply relay line controlling a.c. input to this transformer. The 6 volt a.c. relay coils, are energized by the receiver's filament voltage rather than by the external "Hotshot" recommended for alternative a.c.—or d.c. operation with d.c. relays.

DC-AC Ham Application

If the assembly is to be used for both station and emergency applications—that is, if it is to be powered at times by the a.c. packs and at times by the Vibrapack and dynamotor units, the basic circuit as shown should be carefully followed. This will permit the use of d.c. relays, "Hotshot" operated regardless of the type of powering. A.C. packs should be provided with toggle switches for on-off; and the operator should remember to keep the receiver and transmitter filament switches (at the assembly) in the "on" position at all times so that power will not be applied to the tube plates and screens before the filament circuits have been completed.

Marine Radio-Telephone Application

In marine radio telephone application, the basic layout again should be followed—with this one simplification in the wiring possible: the d.c. relays may be so wired in their primary or operating circuit that the source of filament supply voltage will be the



A NAZI SHALL DIE!

"...Lichter, damn his soul, killed my father in the last war—twenty-one years ago. I'll kill that Nazi if it is the last thing I do!"... thus a deep hatred rules the lives of two daring, young pilots fighting on the Western front! Don't fail to read this exciting air story based on today's war!

8 THRILLING STORIES! ALL COMPLETE—Including:

- ★ TREACHERY OVER THE MAGINOT LINE—"You're damned right it stinks, you rotten, yellow rat!" Larry Wilson started for the enemy pilot... but—!
- ★ WINGS ABOVE WARSAW—Carradine wasn't going to let a Dictator's bluff keep him from flying back to England! No sir!
- ★ THE COWARD—Stringer laughed. "Me a spy? Hell, no! Would I be breaking my neck to knock down these barbarians if I were?"
- ★ WHY GERMANY CANNOT WIN—by Major Roger Sherman Hoar. A brilliant discussion and forecast by an outstanding military expert. Don't miss it!

Plus MANY OTHER FEATURES AND ARTICLES

THE VERY LATEST IN AIR-WAR STORIES... published and edited by aviation experts.

ONLY 15¢ AT ANY NEWSSTAND

AIR ADVENTURES

1st ISSUE NOW ON SALE

source of relay supply voltage—the external "Hotshot" being eliminated. Certain refinements and certain special attentions to the antenna circuit layout are quite necessary, however. These we shall mention briefly and paragraphically in closing:

1. On the marine radio-telephone channels, we have more to worry about than being "in the band." We have to be on the exact allocated frequencies: 2738 k.c. for ship-to-ship communication; 2670 for communication with the Coast Guard; and the specific frequencies designated for transmission to shore stations (in the band between 2100 and 2200 k.c.). Certain definite tolerances are allowed and *must not be exceeded*. For example, the allowable deviation in the 2100-2200 k.c. ship-to-shore band is plus or minus .04 percent for equipment of more or less recent installation. This means, for one thing, that we can't use crystals guaranteed to be within 10 k.c., plus or minus, of the specified frequency. Remember that in selecting your "rocks."

2. The average operator of a marine radio-telephone assembly holds a third class radiotelephone license. Rule 443 of the f.c.c. regulations (as amended April 1, 1938) defining the scope of license operator authority specifically states that the holder of a third class radiotelephone ticket is *not* permitted to make any adjustments to the equipment that may result in its improper operation. This of course includes transmitter circuit adjustments—and it means that the operator isn't permitted to fool around with load coils, antenna series condensers, and coupling mechanisms.

Our assembly, if it is to be applied in marine service, must be complete and self-contained insofar as the trans-

mitter proper is concerned—and more than this, it must be so simple to operate that no technical understanding is required to *make* it operate. The four-position switch permitting selection of the ship-to-ship, Coast Guard, or proper and specified ship-to-shore frequencies is the one and only control which the operator should find necessary to handle other than those turning the set on and off. This, of course, means two things in particular: first, that the speech gain control must be removed from the front panel and the a.f. circuit left in fixed adjustment providing for a suitable modulation of the final under normal speech conditions (or the crystal mike and preamplifier stages removed and a high output carbon affair substituted for direct modulator drive); and second, that the load coil must be installed within the cabinet, then properly tapped at the time of the actual set installation aboard-ship.

3. In marine radio telephone application, the selection of trimmer tanks for the transmitter will depend upon the required capacity for final tank resonance at the operating frequency, as in the case where the layout is used in amateur service. The main tank condenser is tuned for amplifier resonance with a 2738 k.c. crystal in use. A bridging, or trimming condenser, is then selected which when switched across the main tank at position 2 will tune to 2670 k.c. Other trimmers are connected which individually bridged across the tank for positions 3 and 4 of the switch will permit resonance adjustments at the specified two frequencies for ship-to-shore communications within the 2100-2200 k.c. band. Again max. values of .00014 would seem to be satisfactory.

4. The ground side of the antenna circuit link coil connects to chassis rather than to an external ground or counterpoise.

5. The load coil must be experimentally built. It must be small enough to go into the cabinet, yet large enough to give sufficient inductance to load the antenna to resonance. It must be built, of course, whether experimentally or not, with a particular antenna considered. It must be tapped at those four points, which related to frequency selector switch position, will provide for resonance.

A design like this one might use meters to advantage, if only to provide a means of facilitating pre-installation adjustments and to give the operator some idea as to whether or not his transmitter is working. A single milliammeter of 200 ma. range may be connected into the cathode circuit for the Class C T21s to read total current for the final stage (grid, plate, and screen); 100 ma. reading would indicate proper set operation and adjustment. A second meter having 10 volts d.c. range might be connected across the transmitter or receiver filament circuit. It would afford a means of continuous or switch-in check of storage battery potential.

Save Money! With the RADOLEK RADIO PROFIT GUIDE!



Radolek offers you the MOST for your money! Lowest Prices! Best Quality! Biggest values! Most complete Stock! Fastest Service! Send for your FREE copy NOW!

OVER 15,000 REPAIR PARTS

The world's most complete stock of radio repair parts and exact duplicate replacements. All leading brands. All guaranteed. Lowest Prices!

COMPLETE TUBE SELECTION

All types. RCA, Sylvania, Raytheon, Philco, etc. Includes Kellogg, special Majestic types and transmitting tubes. Complete selection.

NEWEST TEST INSTRUMENTS

The most complete line ever displayed in any catalog. All leading makes. Latest improved models at lowest prices.

GREATEST RADIO VALUES

A Huge selection of money-saving set bargains! New Phono-Radio combinations. Automatic tuning sets. Beautiful cabinets. New "Ham" receivers and equipment.

EVERYTHING FOR AUTO RADIO

Complete auto radio section. Includes vibrator, replacement guide, new auto aerials, custom panel control plates for all autos, newest Auto Sets.

COMPLETE P. A. SELECTION

New 1940 public address amplifiers from 5 to 100 watts. Complete P. A. Systems for permanent, Mobile and Portable installations. Best values!

NEW ELECTRICAL APPLIANCES

Extra profits for you! Standard Brand Electric Irons, Stoves, Heaters, Percolators, Waffle Irons, Vacuum Cleaners, Trains, Clocks, Mixers, etc., at lowest prices!

FREE!
Mail Coupon Catalog

The **RADOLEK Co.**

601 W. Randolph, Chicago
Dept. B-36

Send the 1940 Radolek Radio Profit Guide FREE.

Name.....

Address.....

Service man? Dealer? Experimenter?

RADIO ENGINEERING DEGREE IN 2 YEARS

Intensive, specialized course, including strong basis in mathematics and electrical engineering, advanced Radio Theory and Design. Modern laboratory. Low tuition. Self-help opportunities. Also 2-year courses in Aeronautical, Chemical, Civil, Electrical and Mechanical Engineering. Participation in Civilian Pilot Training Program. Enter December, March, June, September. Catalog.

INDIANA TECHNICAL COLLEGE
Washington Blvd., Fort Wayne, Ind.

LES Correspondence Courses in RADIO and ELECTRICAL ENGINEERING

ELECTRICAL ENGINEERING Get good grasp of electrical field. Prepare yourself at Low Cost, for secure future. Modern courses. So simplified anyone can understand quickly. **RADIO ENGINEERING** Extra fine course in radio, public address, photo-electric work. Trains you to be super-serving man, real vacuum-tube technician. Experimental kits furnished. Diploma on completion.

LOW AS \$25 Either course, only \$25. Deferred payment plan available. Write for free copies of school catalogues, student magazines, full details. **SEND NOW!**
LINCOLN ENGINEERING SCHOOL, Box 931-NR 12, Lincoln, Nebr.

RADIO ENGINEERING

RCA Institutes offer an intensive course of high standard embracing all phases of Radio and Television. Practical training with modern equipment at New York and Chicago schools. Also specialized courses and Home Study Courses under "No obligation" plan. Catalog Dept. RN-39.

RCA INSTITUTES, Inc.
A Radio Corporation of America Service
75 Varick St., New York 1154 Merchandise Mart, Chicago

RADIO KITS—COMPLETE

\$3.95 up—ready to assemble. Single hand and all-wave; 5 to 10 tubes. Save 50%. New Radio Parts catalog—sent FREE.
McGEE RADIO P-1263 Kansas City, Mo.

MR. RADIOMAN:
What are you doing about TOMORROW?



Start Training Now for a Better Job in RADIO & TELEVISION

ENGINEERING

Radio plays no "favorites." The GOOD men get the GOOD jobs. Prepare yourself today with CREI modern technical training for a better job and more money tomorrow. We can help you get ahead as we have helped hundreds of other ambitious men.

INSURE YOUR FUTURE

CREI home-study courses are for EXPERIENCED radiomen who want to become ENGINEERS. Every phase of practical radio and television engineering is covered. If you combine your own experience with CREI training, you should be equipped to take advantage of every opportunity to improve yourself.

Write for Free Booklet: "The CREI Tested Plan"

48 interesting pages with scores of photographs and complete outline and description of CREI radio and television courses.



CAPITOL RADIO Engineering Institute

Dept. RN-12, 3224-16th St. N. W., WASH., D. C.

RADIO ENGINEERING DEGREE IN 2 YEARS

• Complete Radio Engineering Course in 96 weeks. Bachelor of Science Degree. Radio (television, talking pictures and the vast electronic field) offers unusual opportunities for trained radio engineers. Courses also in Civil, Electrical, Mechanical, Chemical, Aeronautical Engineering; Business Administration and Accounting. Tuition, living costs low. World famous for technical two-year courses. Special preparatory department for those who lack required high school work. Students from all parts of the world. Enter January, March, June, September. Write for catalog. 1612-9 COLLEGE AVE. ANGOLA, IND.

TRI-STATE COLLEGE

Wausau POCKET SLIDE RULE

Greatest Slide Rule Values!

10 inch enameled slide rule, made of kiln dried genuine mahogany wood, has auxiliary removable magnifier with pins to fit (cursor) runner. This rule has inch, millimeter, sine, log and tangent scales. Packed in individual carrying case. This rule is equal in performance to a \$10.00 rule. Our special price, P.P. prepaid anywhere, **\$1.00**. 8 inch slide rule in case with 36 page illustrated Book of Instructions & Examples. **40c**. Parcel post prepaid.

GOLD SHIELD PRODUCTS

Dept. RN-129 350 Greenwich St. New York

RADIO COURSES

New Classes Start in January!

RADIO OPERATING—BROADCASTING

- RADIO SERVICING—a practical course
- RADIO AMATEUR CODE • TELEVISION
- ELECTRONICS—1 yr. day course, 2 yrs. eve. Day and Evening Classes. Booklet Upon Request.

New York Y. M. C. A. Schools
 7 W. 63rd St. New York City

Video Reporter
 (Continued from page 37)

long-established, important and lucrative broadcasting audience. The networks have too much at stake in sound programs to make any such effort. The network story has always been that television will supplement and not supplant sound broadcasting. That's a good story—if they can stick to it.

But the approaching entry of television stations promoted by firms not directly engaged in sound broadcasting will make it tough for anyone to adhere to that theory. Future stations in the New York area will boost television and nothing else, and they will make no bones about the fact that they're out to win over broadcast audiences and convert them into look-and-listeners. The network telecast stations will undoubtedly strive to attract as many viewers as possible but some embarrassing moments might pop up for them when the non-network telecasters aim promotional campaigns at weaning broadcast listeners to the television fold.

It is unfortunate that television in London was suspended with the outbreak of the European War.

England had such splendid video achievements to its credit that there was a tendency in the U.S.A. to compare most television progress with trade accomplishments in London. But it is anticipated that England will once again command its important ratings as a leading television nation.

-30-

QRD? de Gy
 (Continued from page 28)

tered while on the high seas. To publish each and every answer would be impossible, but we are happy to note the decided raising of the I.Q. (intelligence quotient) in the average op of today. No more can any one say that a radiop is nothing more than a brass pounder with a classy uniform. Here's a reply from a radiop who lives right smack in the middle of the waters that cause more ops gray hair from temperamental recvrs, than R.N. has pages. Brother C. J. Burger of HQ Co. Fort Davis, Canal Zone, sez quote in ref to the lad who lost his job because of an intermittent recvr (he's polite) I must say it is sad indeed to be caught on the briny with limited facilities, and with a set that would probably cause any radio man to have a nice big headache. In addition to the usual causes this set was subjected to those tropical elements fatal to any piece of machinery, namely, salty sea air and high humidity which corrodes metal and lowers the effect of insulation and which will also change the frequency of any unprotected coil that may be critical in setting such as oscillators, etc. In the case of this intermittent, I believe my first thought would be to clean all tube prongs and sockets and replace any tube that was microphonic or noisy. If a check for loose wires and corroded joints failed to show anything wrong, I would look to the coils which may need drying out with heat which the entire set may need, as the heat from the tubes and transformers will not reach all the parts such as under the sub panel and in shields over the coils. . . . Which is exactly the answer. . . . Put into an oven and bake for a few minutes to dry out. Sounds like a cooking recipe. And that, me hearties, closes the class room until another session, so until then, with best 73, ge . . . GY.

-30-

As I See It!
 (Continued from page 33)

a service meeting in Cleveland. Fog set us down in Kylerstown and the talk went on over the land line from the field manager's home. . . . His phone was on a party wire and it really was a party. . . . I think all of Kylerstown, including the chickens, listened in. The boys in Cleveland did themselves proud that night. I think it was Neal Bear who tapped a P.A. system onto the telephone line—without the company's knowledge.

We'll see what will happen on this trip. [So will we! Ed.]

-30-

RADIO ENGINEERING, broadcasting, aviation and police radio, servicing, marine and Morse telegraphy taught thoroughly. 48 weeks' engineering course equivalent to three years' college radio work. School established 1874. All expenses low. Catalog free. **DODGE'S INSTITUTE**, Oak St., Valparaiso, Ind.

LANGUAGES Made easy By LINGUAPHONE

This amazing new Method enables you, in your own home, to speak and read any of 27 foreign languages in an incredibly short time. Endorsed by leading university professors and thousands of men and women as the quickest, simplest and most thorough language method. Send for FREE book.

LINGUAPHONE INSTITUTE
 83 RCA Building New York City

Sleeper WOODSTOCK TYPEWRITERS

Classified
 Rate 15c per word. Minimum, 10 words.

CORRESPONDENCE COURSES

USED Correspondence Courses and Educational Books sold or rented. Inexpensive. Money-back guarantee. Write for Free Catalog listing 4000 bargains. (Courses Bought.) Lee Mountain, Pisgah, Alabama.

CORRESPONDENCE courses and educational books, slightly used. Sold, Rented, Exchanged. All subjects. Satisfaction guaranteed. Cash paid for used courses. Complete details and bargain catalog free. Send name, Nelson Company, L-237, Manhattan Building, Chicago.

PATENT ATTORNEYS

INVENTORS—Before disclosing your invention to any one send for Form "Evidence of Conception"; "Schedule of Government and Attorneys' Fees" and instructions. Sent free. Lancaster, Allwine & Rommel, 414 Bowen Building, Washington, D. C.

PATENTS—Advice and booklet free. Highest references. Best results. Promptness assured. Watson E. Coleman, Patent Lawyer, 724 9th Street, Washington, D. C.

PATENTS secured. Two valuable booklets sent free. Write immediately. Victor J. Evans & Co., 158-P, Victor Building, Washington, D. C.

AGENTS WANTED

SELL new, used clothing from home, auto, store. Men's suits 96c. Overcoats 66c. Dresses 21c. Ladies' coats 42c. Hundreds big bargains. Catalog Free. S & N, 440-T East 31st, Chicago.

RADIO ENGINEERING

RADIO Engineering, broadcasting, aviation and police radio, servicing, marine and Morse telegraphy taught thoroughly. All expenses low. Catalog free. Dodge's Institute, Elm St., Valparaiso, Ind.

RADIO

WE buy and sell used radio testing equipment. Harold Davis, Inc., Jackson, Miss.

TRADE C. W. transmitter for astronomical telescope. Box A, Radio News, 608 S. Dearborn, Chicago.

I.P.S. RUBBER Crystal and power pack (for 2.5 volt tubes). Less tubes and coils, \$22.50 for both units. Nation Wide Radio, 572 W. Randolph, Chicago.

ANY Radio Diagram 25c. Specify manufacturer, model. Radio magazine free. Supreme Publications, 3727 West 13th, Chicago.

*The Biggest Issue
in the History of*

Popular Photography

2 2 PAGES

crammed with the most imposing array of photos, features and articles ever gathered together for one big issue!

Including:

- ★ 58 pages of Prize Salon Prints.
- ★ Special 8-page insert of outstanding natural color photos.
- ★ An illustrated directory listing new photographic equipment.
- ★ Prize Winners of the \$3,700.00 Popular Photography Contest.
- ★ Interesting facts on war propaganda photographs.
- ★ John Paul Pennebaker's natural color photograph on the cover.

Plus . . .

Scores of regular features and articles, specially augmented for this **GIANT DECEMBER SALON ISSUE**.

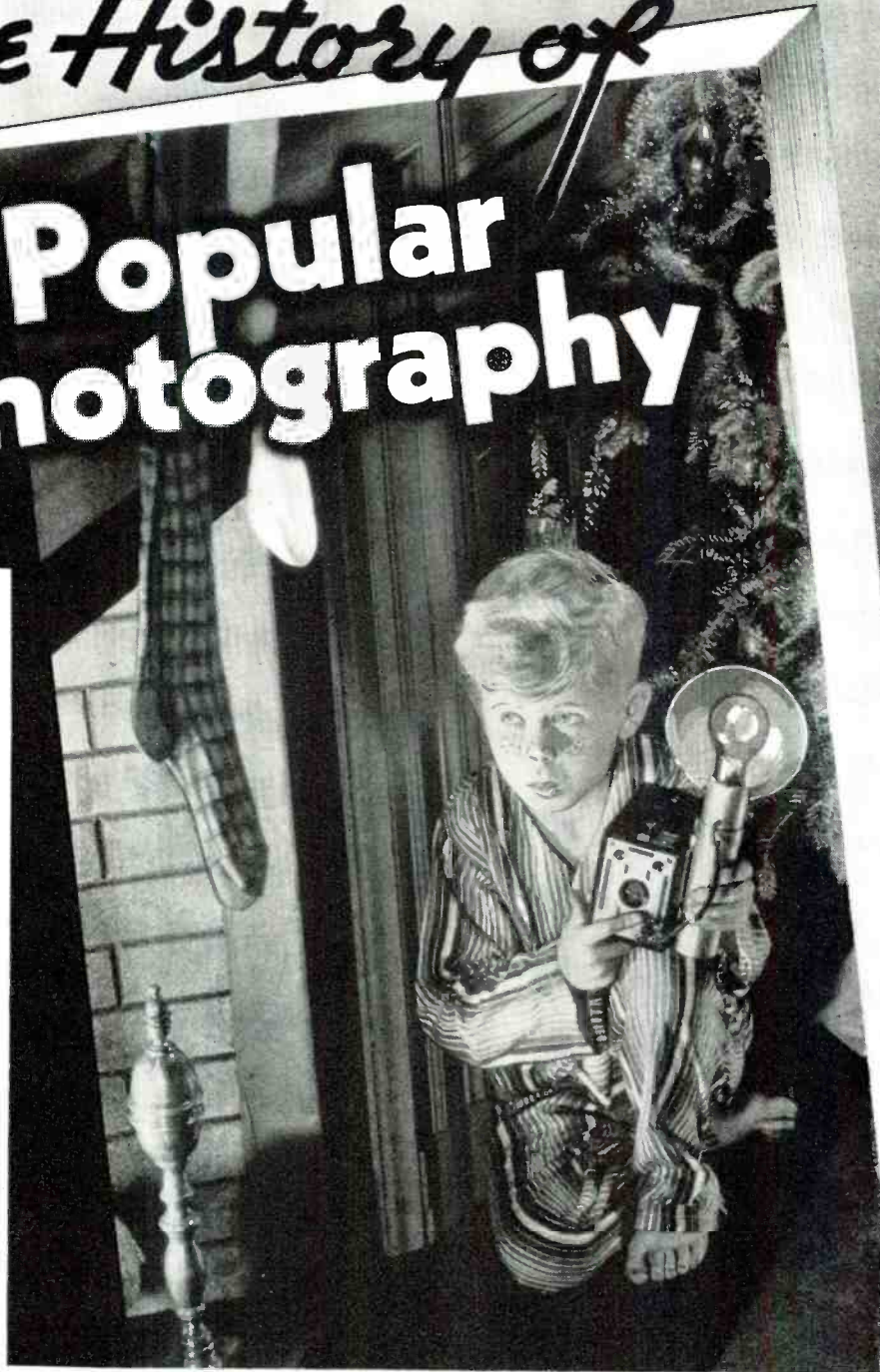

The GIANT ANNUAL SALON ISSUE

is the GREATEST photographic magazine ever published. No camera owner, amateur or professional, can afford to miss this magnificent issue! 212 pages . . . 379 outstanding pictures, 8 pages in full color . . . and 33 fascinating features, make the December Salon Issue of POPULAR PHOTOGRAPHY the greatest value in photographic magazines ever offered. Get your copy today! Remember—the price remains at only 25c!

NOW ON SALE At All Newsstands



★ Because those familiar yellow-and-black cartons dominate the condenser stock of most progressive jobbers, may be convincing enough. But if you want more reasons to make you "go" AEROVOX, just consider:

INDIVIDUALLY TESTED

★ AEROVOX originated the practice of individually-tested condensers. Despite the greatest jobbing business in its history, taxing the new giant plant's production capacity, AEROVOX continues to test each and every condenser, regardless whether it carries a ten-dollar or ten-cent list.

FULLY GUARANTEED

★ A guarantee slip packed with every condenser positively protects you against the remote possibility of a defective AEROVOX condenser. Prompt replacements are made on any unwarranted condenser failure.

ALWAYS ACCEPTED

★ When you install AEROVOX condensers in that new assembly or in servicing, there is that safe feeling of a job well done. General acceptance, always.

★ Ask for CATALOG . . .

Your jobber has a new catalog for you. Ask for it—or write us direct.



Bench Notes
(Continued from page 21)

"That settles it," the *Signal-Chaser* said, throwing down a pair of sidecutters, "if you're going to be sarcastic, find the trouble yourself!"

Cliff counted to ten. "I'm sorry," he said, "but what about the set? Is it the volume control?"

Pete was pacified. "Of course not—it's in the audio system. You don't need supernatural powers to tell you that. Give me a hand—let's hook it up."

As Cliff had reported, the set played with poor quality and with lower volume than usual. As Pete raised the volume control, the level increased to only about a third of the proper maximum, and then flattened out with poor quality over the rest of the track.

"It's not tubes," Pete reasoned, "because you've already tried new ones. A defective speaker on this model is as infrequent as a humming-bird with its motor shut off, but we'll replace it with a spare because it's the quickest way to check the output transformer that's attached to it."

The set, playing with the test speaker, remained the same.

"Now for the voltages," Pete announced. "We've eliminated most of the parts of the audio stages, so—"

"I told you the voltages were all okay," Cliff interrupted.

"Ah-ah!" Pete warned. "What did I tell you about being sarcastic? The voltages are *not* okay. When a serviceman says *that*, he means all the voltages *he can measure* are the right ones. Now—behave yourself!"

Cliff went into a steaming oral retirement.

"Plate voltages are proper," Pete announced, without glancing up from the set. Then: "What did you get between the filaments and grids of the output stage?"

"Forty-three volts."

"And the other voltages didn't average higher or lower than those shown on the chart?"

"They were about the same—so little difference you could hardly notice it."

"Then," Pete said, "there was no variation which might have been caused by a high or low line voltage, or by an off-size power transformer. Under such conditions, the two-volt difference between the forty-three you found and the forty-five on the chart becomes important! Where are those two volts?"

"I don't know," Cliff said, miserably, "you had them last."

"Tsk!" Pete taunted, "I hope you're not that impolite to your customers!" He began to disconnect the set and speaker. "Of course," he continued, "you couldn't be expected to follow the audio swing on the grids with a voltmeter—but you *could* have used your head when you came across two or three bits of incriminating evidence which all pointed to the one audio

component we haven't checked! Here—take it—finish the work yourself!"

"But—what should I do?" Cliff asked.

"Replace the only audio part we haven't tested," Pete replied impatiently, "the _____. The one in there now probably has a high resistance ground!"

Cliff was puzzled for a while, but got the set running by soldering a few connections and tightening two screws on the new part. The set was running normally within an hour, and the customer was well pleased.

What part did Cliff replace, and why did the evidence indicate that this part was at fault? —50—

Hamchatter

(Continued from page 37)

On a 6 by 12 chassis he put a 27 into a 45 into a pair of 2A5's in parallel. Communication was established and he kept his end of it up remarkably well until one of the local youths began a rag chew with one of his city cronies and poured a couple of hundred watts on top of PNX's frequency.

W6PJT, formerly of Phoenix, Arizona, has been transferred by Transradio Press to the bureau in Olympia, Washington. Henry Poole received his Private Pilot's License in Phoenix, and added a Seaplane rating to it in Olympia. Busily engaged in taking friends for a flight from the local airport and from Puget Sound.

W7HRP is new ham in Anaconda and expects to be on in about two months.

W7CUK will be on soon with a 6L6 and an 809, and a vertical antenna.

W7AYR will be on soon with 100 watts on 160 phone and 40 cw.

W7BHH will be on soon with a 33 ft. vertical antenna.

W7ACH is rebuilding his radio shack and has a new exciter using a 6L6 and an 807.

W7CRE is really going to town with his kilowatt and vertical antenna. He expects to have a new Howard by the first of October.

Conditions in Anaconda are not very good the year round but some of the hams are snagging some pretty good dx.

W7AQH is active in the N.C.R. even to the extent of going to Butte every Wednesday.

W7BUG has been inactive for the summer but expects to get on this winter some time.

[Tnx to Floyd Arthur Andrews for the above. —Ed.]

JACK WELLS sends in the following: You may be interested in a short summary of FSUE's dx activities. He's got 99 countries, 37 zones and WAC on phone; has been active 10 years, and is now off the air due to reasons beyond his control . . . hi.

WILNK sends in:

WIKTH has entered R. I. State College es doesn't find time fer radio nw.

WILQL has a new Howard 450 revr es claims he hears everything wid it.

W1JXQ is nw on the air wid a new eco es gets



Drawn by WILNK. How's abt urs?

all T-9x repts wid it. Fb! **W1LQE** has a transceiver up on 2 1/2 es has really worked a station. Watsamatter, Ernie, getting tired of 80?

W1LEX was recently on 5 but left the band when he failed to hear a station.

W1MCN is a new "ham" in Providence. Bob claims he is "going to town" wrking dx wid his 25 watts.

W1MBM has quite a few states toward W.A.S. but is very anxious to wrk Nevada es New Mexico. I wonder if Bob knows that Nevada is just about the toughest state to wrk?

W1KUF recently got his class "A" ticket es is now working out fb on 75 es 20 fone. —50—

THE NEW 1130-S SIGNAL GENERATOR WITH AUDIO FREQUENCIES



SPECIFICATIONS

Combination R.F. and Audio Signal Generator, R.F.—100 Kc. to 100 Mc., A.F.—100-7,500 cycles. All direct reading, all by front panel switching.
R.F. and A.F. output independently obtainable alone or with A.F. (any frequency) modulating R.F.
Accuracy is within 1% on I.F. and Broadcast bands; 2% on higher frequencies.
Audio frequencies in 5 bands; 100, 400, 1000, 5000, and 7500 cycles.
Giant airplane full vision, direct-reading dial.
Condenser and other leakages tested to 160 megohms.
All services on 90-130 volts A.C. or D.C. (any frequency).
Model 1130-S comes complete with tubes, test leads, carrying handle, instructions. Size 12"x9"x6 1/2". Shipping weight 15 pounds. Our net price. **\$11⁸⁵**

THE NEW MODEL 1280 SET-TESTER

Combines Models 1240 and 1250

A complete testing laboratory in one unit, the Model 1280 combines the Models 1250 Multitester and 1240 Tube Tester. (See specifications of each below.)

- ★ Instantaneous Snap Switches Reduce Actual Testing Time to Absolute Minimum.
- ★ Spare Socket and Filament Voltages Up to 120 Volts, Make the Model 1280 Obsolescence Proof.
- ★ Latest Design 4 1/2" O'Arsonval Type Meter.
- ★ Works on 90 to 125 Volts 60 Cycles A.C.



Even those servicemen who through past purchases know they can always get SUPER-VALUES from Superior, will be amazed and delighted when they read the specifications of this all-purpose instrument and then note the unbelievably low price. The Model 1280 features a 4 1/2" O'Arsonval type meter for easy reading of the various scales, and in line with our new policy of stressing appearance as well as serviceability in our new 1200 line of test equipment, our Model 1280 utilizes an aluminum etched panel, designed for beauty as well as ruggedness. The primary function of an instrument is, of course, to make measurements accurately and when designing test equipment this is our first thought. However, we also appreciate the important part the appearance of an instrument plays in the impression a serviceman makes on his customers, especially on home calls. We have, therefore, paid special attention to the outward design of all of our new instruments. For instance, the panel of this Model 1280 is made of heavy-gauge aluminum and etched by a radically new process which results in a beautiful, confidence-inspiring appearance.
Model 1280 comes complete with test leads, tabular data and instructions. Shipping weight 18 pounds. Size 13"x11"x6 1/2". Our net price **\$19⁷⁵**

Portable cover \$1.00 additional

THE NEW MODEL 1250 MULTITESTER

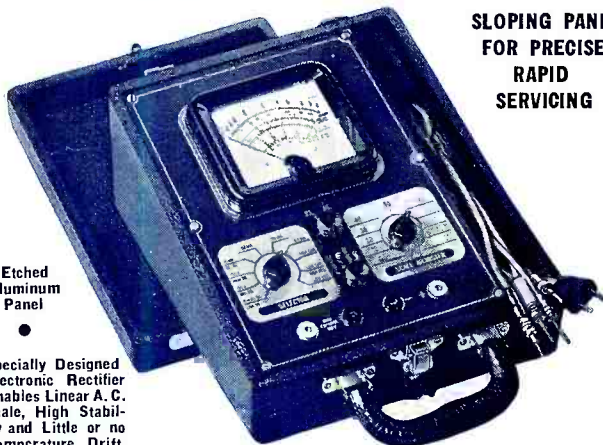

SLOPING PANEL
FOR PRECISE
RAPID
SERVICING

Etched
Aluminum
Panel

Specially Designed
Electronic Rectifier
Enables Linear A.C.
Scale, High Stability
and Little or no
Temperature Drift.

Here is an opportunity to acquire a Multi-Service, Precision Engineered Instrument, for less than you would have to pay for an ordinary Volt-Ohm Milliammeter. Besides making the usual volt, resistance and current measurements (both A.C. and D.C.) this unit accurately measures the CAPACITIES of mica, paper and electrolytic condensers, INDUCTANCE of coils, chokes and transformers, DECIBEL gain or loss, of power amplifiers and public address systems, WATTS output of amplifiers, receivers, etc.

SPECIFICATIONS

Complete A.C. and D.C. Voltage and Current Ranges	High and Low Capacity Scales
D.C. Voltage: — 0-15, 0-150, 0-750 volts	.0005 to 1 mfd. and .05 to 50 mfd.
A.C. Voltage: — 0-15, 0-150, 0-750 volts	3 Decibel Ranges
D.C. Current: — 0.1, 0-15, 0-150, 0-750 ma.	—10 to +19, —10 to +38, —10 to +53
A.C. Current: —0-15, 0-150, 0-750 ma.	Inductance: 1 to 700 Henries
2 Resistance Ranges	Watts: Based on 6 mw. at 0 D.B.
0-500 ohms, 500-5 megohms	in 500 ohms .006000 to 600 Watts

Model 1250 works on 90-120 volts 60 cycles A.C. Comes complete with test leads, tabular charts and instructions. Shipping weight 9 lbs. Size 9 1/2"x11"x6 1/2". Our net price. **\$11⁸⁵**

Portable Cover \$1.00 Additional

THE NEW MODEL 1240 TUBE TESTER

Instantaneous
Snap Switches
Reduce Actual
Testing Time
to Absolute
Minimum

Tests All Tubes
1.4 to 117
Volts

Sockets for All
Tubes—
No Adapters

Superior is proud to offer the newest and most practical tube tester ever designed. Unbelievably low in price—unbelievably high in performance.

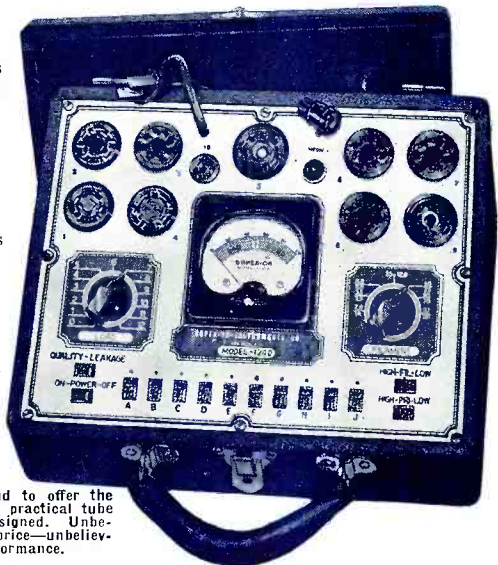

- ★ Tests all tubes, 1.4 to 117 Volts, including 4, 5, 6, 7, 7L, octals, octocals, Bantam Jr., Peanut, single ended, floating filament, Mercury Vajor Rectifiers, the new S series, in fact, every tube designed to date.
- ★ Spare socket included on front panel for any future tubes.
- ★ Tests by the well-established emission method for tube quality directly read on the GOOD ? BAD scale of the meter.
- ★ Jewel protected neon.
- ★ Tests shorts and leakages up to 2 megohms in all tubes.
- ★ Tests leakages and shorts in all elements AGAINST all elements in all tubes.
- ★ Tests BOTH plates in rectifiers.
- ★ Tests individual sections such as diodes, triodes, pentodes, etc., in multi-purpose tubes.
- ★ Latest type voltage regulator.
- ★ Features an attractive etched aluminum panel.
- ★ Works on 90 to 125 volts 60 cycles A.C.

Model 1240 comes complete with instructions and tabular data for every known type of receiving tube. Shipping weight 12 pounds. Size 6"x7 1/2"x10 1/2". Our Net Price. **\$11⁸⁵**

Portable Cover \$1.00 Additional

SUPERIOR INSTRUMENTS CO. 136 LIBERTY ST., DEPT. RN12
NEW YORK, N. Y.

SERVICE

With a Capital "S"

for Manufacturers and Buyers of Radio Equipment

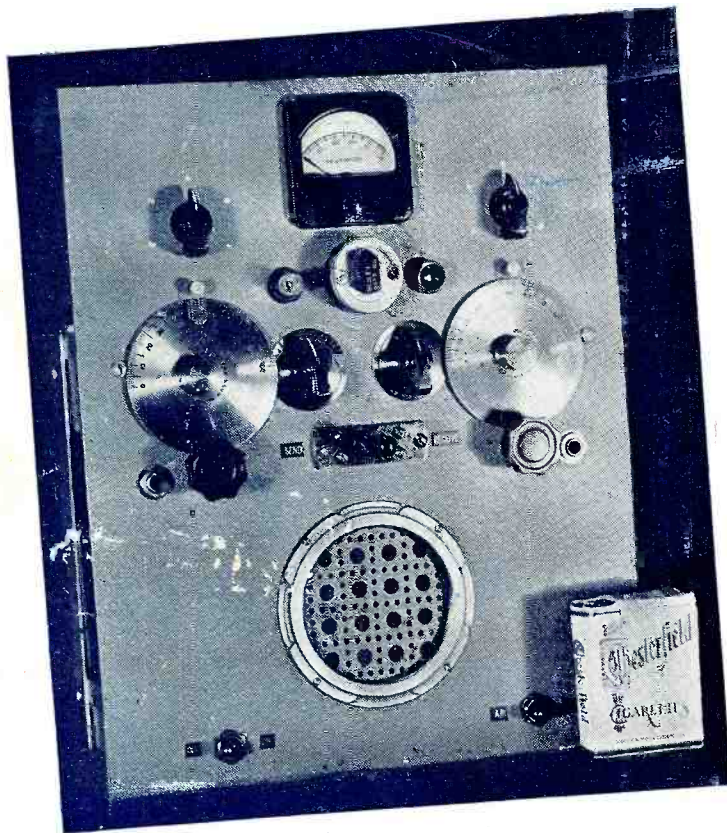

We know that there have been times when you have wanted to have the various transmitters, gadgets, units, receivers and whatnots which have appeared from time to time in RADIO NEWS, built for you. Or there have been problems which you wanted solved, and couldn't get done elsewhere.

NOW IT CAN BE DONE!

In establishing the ZIFF-DAVIS ELECTRONIC LABORATORIES the manufacturer, experimenter, tinkerer and amateur gets a real break. He can now get that equipment built for him at moderate prices. That means that he need not fuss around trying to get someone unfamiliar with the apparatus to build it for him, but the very men who designed it will build him the same unit.

As a starter, we are prepared to quote prices on:

- RADIO NEWS 1940 ALL-PURPOSE TRANSMITTER-RECEIVER
- RADIO NEWS DE LUXE DIALOMATIC RIG
- RADIO NEWS FULL-RANGE, DE LUXE P.A. SYSTEM
- RADIO NEWS TWO-BAND MIDGET RECEIVER
- RADIO NEWS DE LUXE KILOWATT TRANSMITTER
- RADIO NEWS 5-10 METER RECEIVER
- RADIO NEWS D.F. LOOP
- RADIO NEWS CONTROL CONSOLE
- RADIO NEWS 56MC PRESELECTOR
- RADIO NEWS "VOX" SYSTEM

... and the RADIO NEWS FIVE-BAND PORTABLE TRANSMITTER-RECEIVER pictured above as well as any other unit designed by the staff of, and appearing in RADIO NEWS for the past two years.

WE'RE HERE!



IF YOU HAVE A PROBLEM



SEND IT TO US.

ZIFF-DAVIS ELECTRONIC LABORATORIES

608 South Dearborn Street — Chicago, Illinois