

TRADE SHOW NUMBER

**RADIO
NEWS**

**JUNE
25 Cents**

SADLER BROS. RADIO STORE
1201 WEST ALLEMAN
CHICAGO, ILL. 60606

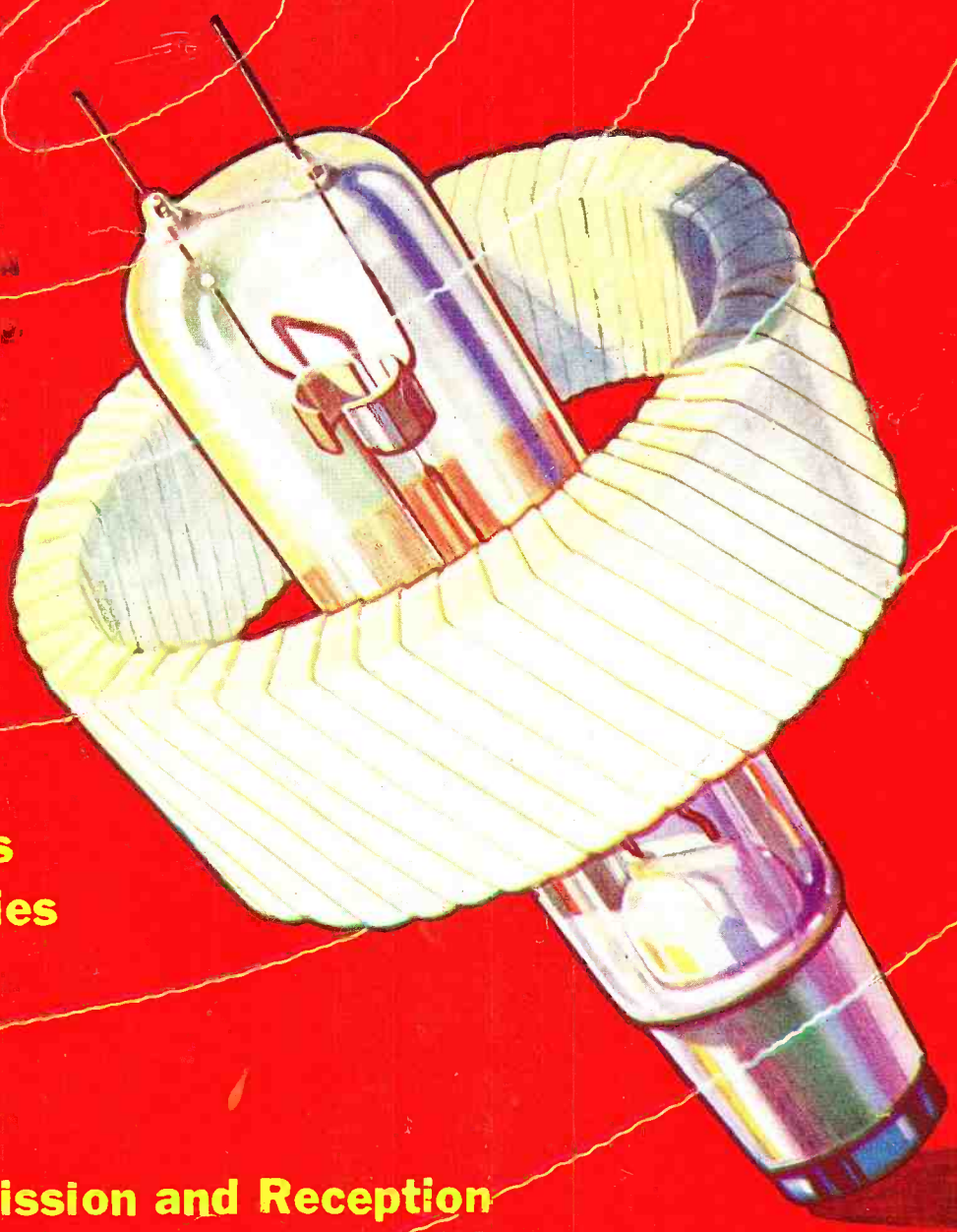

**Latest Tubes
Newest Receivers
Unique Accessories**

2 Meter Transmission and Reception

RADIO MEN

GET THIS
TIMELY BOOK
FREE
with
RADIO NEWS

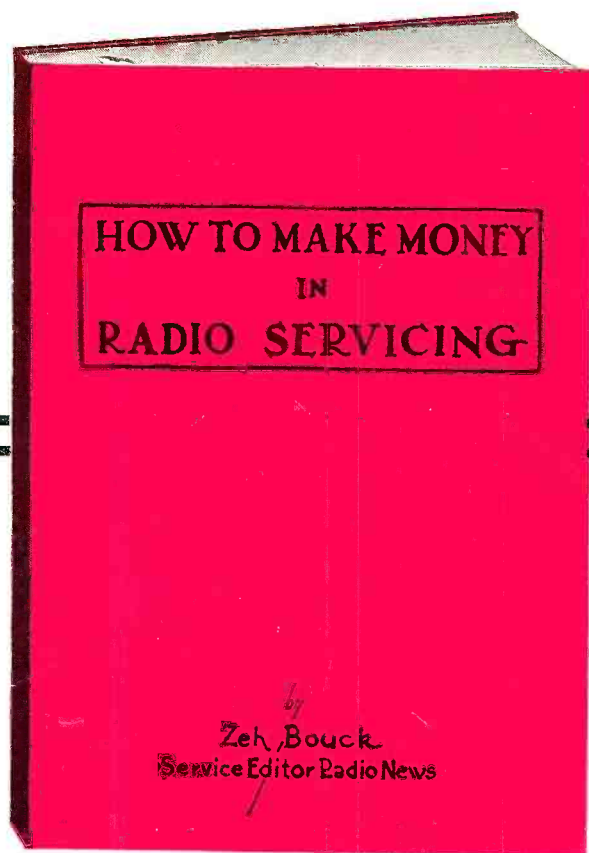

CONTENTS OF THIS GREAT BOOK

Introduction—Servicing as a Profession—Business Methods and Profits—The Technical and Economic Ends of Servicing.

Chapter One—Equipment—The Service Shop—Fitting the Equipment to the Pocket book—Truck Equipment.

Chapter Two—Contacts—Dealer Contacts and Contracts—The Local Lighting Company—Automotive Accessory Stores.

Chapter Three—Advertising and Publicity—Newspaper Publicity—Motion Picture Films and Slides—Billboards and Truck—The Shop Sign—Sample Publicity—Sample Advertisements.

Chapter Four—Circularization—A Good Letterhead—Mailing Cards—Sample Circulars—Stickers—Canvassing.

Chapter Five—Service Procedure—The Appearance of The Serviceman—Making the Service Call—Service “Don’ts”—Checking Over the Set—When to Take the Receiver to the Shop—Educating the Customer—Files and Records.

Chapter Six—The Service Salesman—Tub Sales—Set Sales—Shop and Store Displays—Impressing the Customer.

Chapter Seven—Off Season Business—Pepping Up Old Sets and Sales—Interference Location—Rural Possibilities—Extra Speakers—Special Baffles—Merchandising Tone Control.

Chapter Eight—Service Side Lines—Public Address Systems—Talking Movies—Aids for Hearing—The Telephone Booster—Picking Up Cash With Pick-ups—Electrical Side Lines.

Chapter Nine—The Business End of Servicing—Service Charges—Free Calls—Good Will—How to Bill and Collect—The Value of Trade-ins—Dunning Letters—Legal Points.

Chapter Ten—How To Buy—Where to Secure Parts—Replacement Substitutions—How to Get Best Discounts.

Chapter Eleven—Keeping Up To Date—How to Secure Manufacturer’s Literature—Valuable Service Literature—Service Books—Technical Publications—Service Organizations.

Clip Coupon and Mail Today

RADIO NEWS, Dept. 6
350 Hudson St., New York, N. Y.

Enclosed is \$1. Please send me absolutely FREE, postage prepaid, a copy of “How To Make Money In Radio Servicing,” and enter my subscription for the next 7 issues of Radio News.
(If renewal subscription check here)

Name.....

Address.....

City..... State.....

Canadian price, \$1.50, including Postage and Duty.
Foreign Postage 50c Extra.

“HOW To Make Money In Radio Servicing,” written by Zeh Bouck especially for Radio News, is the answer to the burning question of the hour! Prepared after months of effort and at great expense, it tells the radio service man how to make his business show a profit. And, what is more important in times such as the present?

Not only for the active service man, but also for the amateur and experimenter who desires to turn his knowledge and experience into practical money-making channels this book will prove indispensable. It tells you how, and when, and why to do things. It is *practical—up to the minute—and complete.*

For a limited time, Radio News is offering this money-making book absolutely FREE with a subscription for seven months for only \$1.00.

Save \$.75

And that is not all—in addition to securing the book FREE, you also save 75c on your subscription, as these seven issues purchased on the newsstands would cost you \$1.75.

All The Latest Developments In Every Branch of Radio

RADIO NEWS, edited by Laurence M. Cockaday, needs no introduction to radio men. From the very beginning it has led every publication in the whole field. It gives you all the radio news—while it is news. Hot from the laboratories—just out of the experimental stations—all the newest happenings in radio—direct to you in Radio News. Radio today is the fastest growing, fastest moving industry in the world. Greater expansion is just around the corner. Television—short-wave developments—electronics. Astounding new things are happening—you will want to know about them in detail. And you can—by reading Radio News.

Written By Foremost Authorities

Such outstanding authorities as Dr. Lee De Forest, Guglielmo Marconi, Laurence M. Cockaday, Dr. Irving Saxl, Ernest Lee Gahricke, Carl Dreher, McMurdo Silver, J. E. Smith, S. Gordon Taylor, Lieut. William H. Wenstrom, Dr. E. E. Free, and scores of others of equal prominence in the radio field—write regularly for Radio News. You have at your command the experience of acknowledged experts. You can use their researches—their results—to build your own future in Radio.

To make money today in radio service work, you must be well equipped. This book starts right at the very beginning, and tells you what equipment you will need to be successful. It tells you how to get customers, and how to build up a clientele by every known means of advertising and sales promotion. Numerous sample advertisements are included with instructions for their use. Full details are given regarding local contacts with dealers, as well as arrangements with manufacturers.

And remember you get seven issues of Radio News Magazine and this wonderful new book for less than thousands pay for the magazine alone.

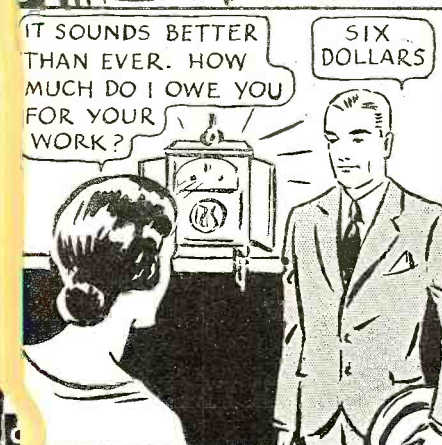
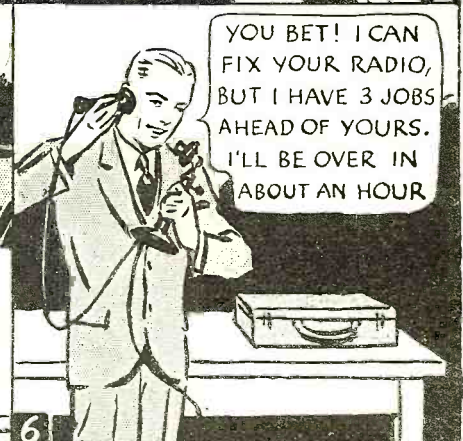
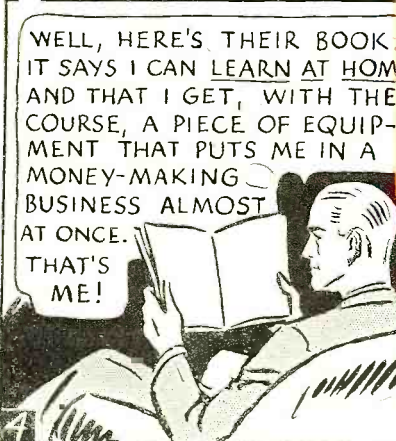

WORK FOR YOURSELF • SET YOUR OWN PAY BEGIN NOW • WE'LL HELP

If your pay has been cut—or, if you're slaving away on some hopeless job—*here's your chance to get on your feet in a hurry!* R. T. A.—one of the oldest, best known radio organizations in the world—offers you the opportunity to go to work for yourself—to name your own pay—and to start making money almost at once. R. T. A. is not just a school that teaches you and then lets you shift for yourself. Instead, R. T. A. makes you a Certified Radiotechnician and provides you with a wonderful service outfit that makes money for you just as soon as you get it. Real money too—up to \$20 a day! With R. T. A. Training and with the R. T. A. Set Analyzer and Troubleshooter you should be the most popular radio service man in town, and have all the business you want to take care of. No pay cuts—no worry about losing your job—nobody to boss you but yourself.



SEND COUPON for NO-COST MEMBERSHIP PLAN

We have worked out a truly wonderful plan whereby R. T. A. membership, the R. T. A. Course, and the R. T. A. Set Analyzer and Troubleshooter need not cost you a cent. The coupon will bring you full particulars. Clip—fill in—mail now! Today!

RADIO TRAINING ASSOCIATION OF AMERICA
4513 Ravenswood Ave., Dept. RNA6, Chicago
Send me full particulars of your No-Cost Membership Plan.

Name

Street

Town State

RADIO TRAINING ASSO. OF AMERICA
4513 RAVENSWOOD AVE. Dept. RNA6 CHICAGO, ILLINOIS

S. GORDON TAYLOR
Technical Editor
 WILLIAM C. DORF
Associate Editor



HOWARD S. PEARSE
Associate Editor
 JOS. F. ODENBACH
Art Editor

Edited by LAURENCE M. COCKADAY

VOLUME XIII

June, 1932

NUMBER 12

CONTENTS

(Cover Design by Morey)

Radio Future.....	PAGE 987	Below Ten Meters By James Millen.....	PAGE 1009
Short-Wave Experiments By Irving J. Savl, Ph.D.....	PAGE 994	Duplex Photo-Cell By Mernard J. Montyn.....	PAGE 1012
\$10,000.00 a Year for Service By Carlton H. Hess.....	PAGE 997	Graphs and Charts By John M. Borst.....	PAGE 1014
Triple-Twin Amplifiers By Sidney Fishberg.....	PAGE 998	Electric Filter Design By C. A. Johnson.....	PAGE 1016
Radio News A.C. Multi-Ear Aid By S. Gordon Taylor.....	PAGE 1000	The International Six By Allan C. Bernstein.....	PAGE 1018
Phenomena Underlying Radio By E. B. Kirk.....	PAGE 1002	What Tube Shall I Use? By Joseph Calcaterra.....	PAGE 1019
Mathematics in Radio By J. E. Smith.....	PAGE 1004	Quartz-Crystal Receiver By Zeh Bouck.....	PAGE 1021
The "Nook Midget" Chassis By Beryl B. Bryant.....	PAGE 1005	Broadcast and Short-Waves. By McMurdo Silver.....	PAGE 1023
Grid-Glow Tube By M. H. Brown.....	PAGE 1007	Vacuum-Tube Voltmeter By C. Bradner Brown.....	PAGE 1024

DEPARTMENTS

What's New at the Trade Show.....	PAGE 1026
The Service Bench.....	PAGE 1032
Latest Radio Patents.....	PAGE 1036
With the Experimenters.....	PAGE 1040
Radio Science Abstracts.....	PAGE 1042
Backstage in Broadcasting.....	PAGE 1043
News and Comment.....	PAGE 1044

Published Monthly by Teck Publishing Corporation, Washington and South Avenues, Dunellen, N. J.

OFFICERS

Lee Ellmaker, *President*
 Warren P. Jeffery } *Vice Presidents*
 Huston D. Crippen }
 William Thompson, *Treasurer*
 Wesley F. Pape, *Secretary*

EDITORIAL AND EXECUTIVE OFFICES

350 HUDSON STREET, NEW YORK CITY, N. Y.

Entered as second class matter at the Post Office at Dunellen, N. J., under the act of March 3, 1879. Copyright, 1932, by Teck Publishing Corporation. All rights reserved. Title Registered at the U. S. Patent Office. Printed in the United States of America. The contents of this magazine must not be reproduced without permission. We cannot be responsible for lost manuscripts, although every care is taken for their safety.

25c a Copy. \$2.50 a year,
 \$3.50 in Canada, \$3.50 in
 Foreign Countries. Sub-
 scribers are notified that
 change of address must reach
 us five weeks in advance of
 the next day of issue.

The Editor—to You

ANOTHER year has rolled around and here we are again at the Annual Radio Trade Show in Chicago to view new developments and latest designs in apparatus for both radio and television for the 1932-33 radio season.

As was promised, the editors have made this issue a summary of the developments that are to be shown to the trade for the first time. This issue of RADIO NEWS will therefore serve technicians, engineers, servicemen, experimenters as a four-day trip to the Show. You will find in these pages the opinions and forecasts of many eminent radio authorities that you might not be able to get even if you were at the Show. The first article in the magazine contains the best views of the future trends in radio of more than fifty of the leading men who are making radio history in the radio field. The 6-page department "What's New in Radio" gives you advance information on the many new

the recent pictures received by this system. These are reproduced on this page.

Hrs letter follows: "I have the pleasure to send you the pictures of our television experiments. Our television system was invented by Professors Kenjiro Takayanagi and the experiment was cooperated with me.

"Since last November 1, 1931, we have succeeded to transmit a figure of 10,000 picture elements at 20 pictures per second with 84.5 meters. We have demonstrated the system in the radio room of JOAK in the Fourth Exhibition of Invention, Tokyo, which will be opened

dent, and I have spent some time in looking through the book and we feel that it is well worth-while and the book in itself is worth what servicemen will pay for the seven issues of the magazine. Please understand that the Institute of Radio Service Men stands ready to cooperate with you at any time in anything that will aid the radio serviceman's profession."
—Ken Hathaway, Executive Secretary, Institute of Radio Service Men, Chicago, Illinois.

A MONTH or two ago we enclosed a request from Mr. E. H. Anderson, of the New York Public Library, asking if one of our readers could supply them with a copy that was missing from the library files. It seems that, due to this request, many of our readers generously sent the missing issues to the New York Public Library, and the director writes: "Your request on our behalf has brought us a number of issues of RADIO NEWS,

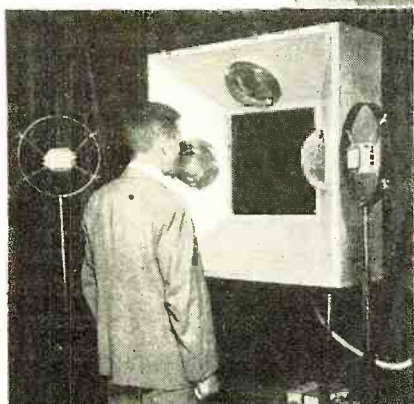
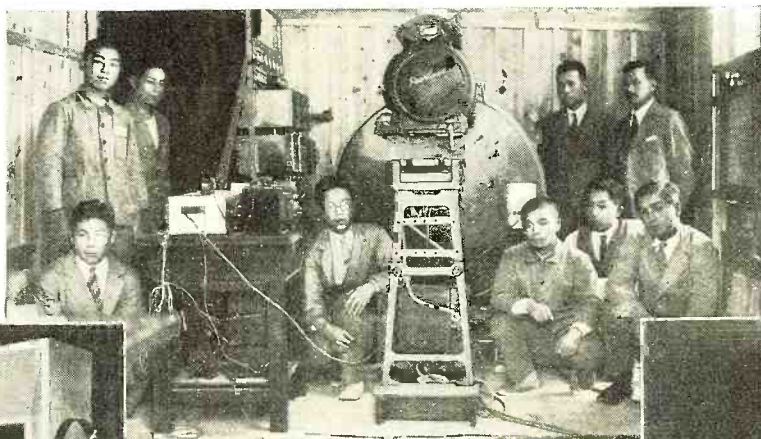

from 20th of March to 10th of May, 1932."—Professor Tomomasa Nakashima, Hamamatsu Technical College, Hamamatsu, Japan.

As already noted, we shall be glad to publish, on this editorial page, names of readers of RADIO NEWS who would like to correspond with other readers. Mr. Charles Youshian, 1103 W. Columbia Avenue, Philadelphia, Pennsylvania, has requested that his name be placed in this category. Also, we have been asked to include the name of T. E. Fevyer, 3a Margravine Gardens, Barons Court, London, W6, England.

MR. W. J. WHERRY, of Newark, N. J., writes a suggestion that: "After a series of articles like 'Electric Filter Design,' 'Using Graphs and Charts in Modern Radio Practice,' 'Mathematics in Radio,' 'Radio Physics Course' have been completed, they be published as a complete series in pamphlet form."

The editors have had this in mind and intend to do just this thing. We have already done so with our two books, "23 Lessons in Radio" and "How to Make Money in Radio Servicing."

IN regard to the latter book, Kenneth Hathaway, Executive Secretary of the Institute of Radio Service Men, writes: "I have your letter of March 18th and also the book, 'How to Make Money in Radio Servicing.' Mr. Hinson, our Vice Presi-

items to be displayed at Chicago. All of the newest patents and inventions are included in the 4-page installment of the department "Latest Radio Patents." Servicemen who are looking for new things, new methods of getting business, will be aided by the enlarged "Service Bench" department, as well as by a number of articles throughout the magazine packed with information of particular importance to them at this time.

TELEVISION is taking up, this year, an increased space at the Radio Show and the developments of many radio laboratories will be on view. America is progressing in television, although other brains are also being attracted to this important field. In Japan, Professors Takayanagi and Nakashima have been working on the general problems of television and have recently transmitted pictures from the radio station JOAK in the Fourth Exhibition of Invention at Tokyo. Professor Nakashima writes us the following letter and sends the photographs of his staff, the transmitter in operation and a photograph reproduction of one of

and I take this opportunity to thank you again for your courtesy."—E. H. Anderson, Director, New York Public Library.

THE editor thanks those who so kindly came to the assistance of this meritorious public institution.

HERE are some other encouraging letters that came to the editor's desk:

"THE new feature, 'Radio Science Abstracts,' I read with great interest. It is very useful to anyone who wants to develop new ideas."—Carlos Raggio, Buenos Aires, Argentina.

"I HAVE taken RADIO NEWS regularly for three years, and I must say that for general information over all classes of radio work your book is unequalled."—George R. Cooper, Radio Research, Cliffside, Mundesley, Norwich.

Sturcell Lockaday

They say you CAN'T, but
I say you
get Enjoyable Programs
Every day of



E. H. SCOTT

Pioneer Designer of 'round the world broadcast receivers.

Seven years ago, newspaper and magazine editors gave columns and columns of space to the amazing performance of a theretofore unknown receiver. They heralded the advent of transoceanic reception, on the broadcast band (200-550 meters) as the greatest radio achievement of the age. They named the receiver "World Record Super," because it brought in 117 programs from 19 stations, ALL OVER 6000 miles away, and WITHIN THE SHORT SPACE OF 13 WEEKS.

This receiver was the work of E. H. Scott, who believed that a radio set designed in accord with certain advanced ideas of his own, and engineered to micrometric precision, would do things no other receiver was ever able to do. These sets were built in the laboratory. Not even a screw was touched by an unscientific hand, and the radio industry was given a new target.

During the following years, E. H. Scott set still higher standards for radio's performance. Today, as the culmination of these efforts, he offers the Scott All-Wave, a hand-built instrument of scientific precision that is sold with a guarantee of regular, 'round the world reception, or YOUR money back.

MANY prominent radio engineers STILL contend that dependable daily reception of extremely distant foreign stations is impossible.

"It can't be done!" they shout. They insist that the distance is too great—that atmospheric conditions are too variable—that signal strength is insufficiently constant—that if foreign reception is to be obtained at all, an ideal location must be had—and, last, that there is no receiver generally available today that is sensitive enough to bring in foreign stations regularly.

Many of those making these statements are receiver manufacturers; men who have been forced to conclude that mass production methods cannot

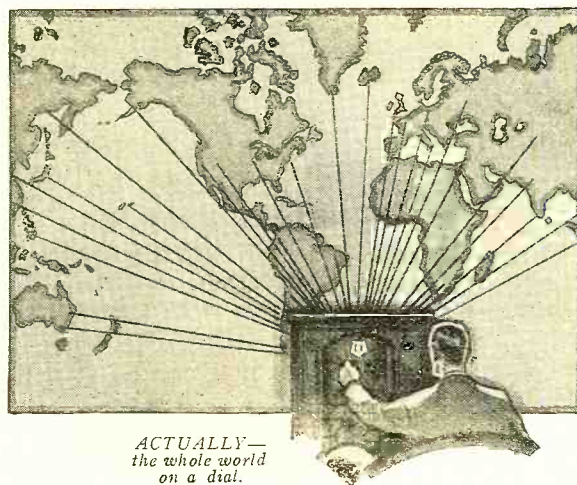

ACTUALLY—
the whole world
on a dial.

produce receivers capable of regular foreign reception. Seeming disbelief in the practicability of foreign reception is therefore the result of someone's failure. The only reason for sincere disbelief is ignorance of the facts.

You are entitled to the truth. It is your privilege to know the FACTS, because the most interesting—the most enjoyable world of radio is to be found

between 15 and 200 meters. Hence, I have written this answer to disbelievers and to the unadvised, and I am spending my own money to publish these four pages of FACTS.

You will find in them a full explanation of what foreign reception is; how regularly it comes in; what the programs are and how they sound. In addition—you'll find undeniable PROOF that the Scott All-Wave 15-550 meter Superheterodyne is certain to give you enjoyable round the world reception every day of every month of the year. Yes, EVERY day, even during the summer months! I say, "You CAN do it!" *E. H. Scott*

CAN



4 Pages of
PROOF

from dozens of Foreign Stations Every month of the Year



Reception from VK3ME sent back to Melbourne, Australia, by telephone from Chicago by E. H. Scott.

The AUSTRALIAN TEST *first proved regular reception possible*

For a considerable period, short wave broadcasts from England, France and Italy have been picked up by the broadcasting chains in this country, on highly developed laboratory-type short wave receivers and re-broadcasted on the 200-550 meter band to listeners in America. The fact that these broadcasts were always planned, weeks in advance, convinced us that their reception was contemplated with absolute certainty. Why, then, couldn't *all* foreign broadcasts be depended upon? To ascertain whether or not they could be, we selected the station farthest from Chicago that broadcasted regularly, and set out to see how many of its programs we could pick up with the Scott All-Wave.

All Programs Recorded

VK3ME at Melbourne, Australia, is 9560 air miles from Chicago. This station broadcasts two times a week on a wave length of 31.55 meters. The reception test was begun June 6th, 1931. Ten months have elapsed, and *every* broadcast (excepting three) was received with sufficient loud speaker volume to be clearly heard and logged. The three programs were missed only because an illegal code transmission interfered.

Each broadcast from VK3ME has not only been clearly heard, and its reception verified by the station, but they have all been recorded just as they came from the amplifier of the Scott All-Wave on aluminum discs. These recordings are available to anyone who wishes to hear them.

Program Returned to Australia by Phone

The engineer of VK3ME was curious to know with what quality his program was received in Chicago. He realized, of course, that clarity was sufficient to permit logging of details, but beyond that he was skeptical. So on January 23rd, 1932 Mr. Scott telephoned VK3ME from Chicago, and while VK3ME's program was being received, the telephone mouthpiece was pointed toward

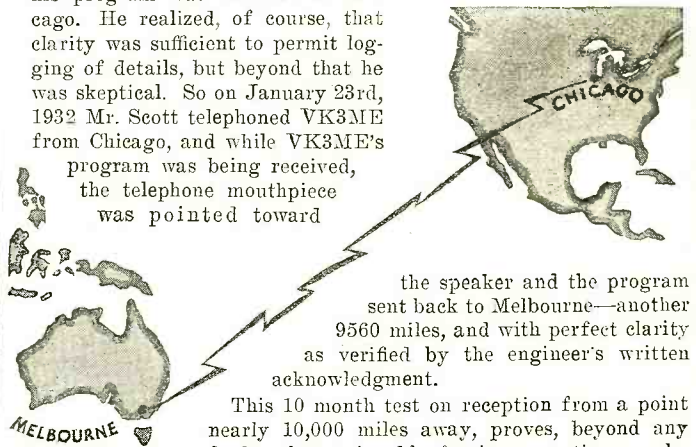

the speaker and the program sent back to Melbourne—another 9560 miles, and with perfect clarity as verified by the engineer's written acknowledgment.

This 10 month test on reception from a point nearly 10,000 miles away, proves, beyond any doubt, that enjoyable foreign reception can be depended upon. IF the receiving equipment is competent. It PROVES that DISTANCE is *no* obstacle! And it PROVES that variable conditions of the atmosphere are not insurmountable obstacles! To further substantiate our contentions we began a test of VK2ME at Sydney. VK2ME's acknowledgment of this reception is reproduced below. Both of these tests PROVE that there IS a receiver having more than enough sensitivity to detect and reproduce the broadcast from foreign stations regularly and with adequate volume!

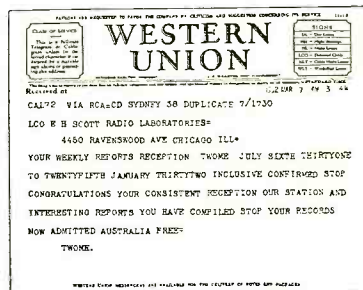

Other Owners Do Even Better

This remarkable performance was not a stunt. It was not a freak happenstance occurring to one

Scott All-Wave ideally located and installed. To the contrary, it appears as mediocre performance when compared to the 9,535 logs of foreign reception sent to us during January, February and March from Scott All-Wave owners located in all parts of the country! These logs, constituting further proof of the practicality of foreign reception, are discussed on the next two pages.

(Turn the page, please)

9535 Detailed Logs

by SCOTT

tell *What You hear*

and prove the absolute

Dependability of the Scott All-Wave



See preceding pages



Clarity

THE detail contained in this log, submitted by Mr. Roye Bilheimer of Pennsylvania, demonstrates the clarity with which the Scott All-Wave brings in foreign stations 10,000 miles away. This log was made Feb. 28, 1932, and while only 30 minutes of it are shown here, the log, as submitted, covered the entire 2 consecutive hours of the broadcast.

6:00 a.m. E.S.T.—Chimes are heard striking the hour of 9:00 p.m., and you say, "Just 9:00 o'clock, Sunday evening." You go on to say, "VK2ME, 47 York Street, Sydney, Australia, would be pleased to receive reports from those overseas relating to the reception of these programs. Our next record is rather an interesting broadcast. I am going to play for you, a record recorded in Chicago. This record was picked up by Mr. Scott of Chicago, an ardent listener of VK2ME. It was then recorded on his home recording set, on aluminum discs, and then sent to VK2ME, and we will now play this record over for you, which will give you some idea of the reception in the United States, especially in Chicago. This is a musical selection by the Band of His Majesty's Guards. Stand by a second, please."

6:05 a.m. E.S.T.—VK2ME, Sydney, Australia. The record you have been listening to was one made in Chicago by Mr. Scott, an ardent listener to VK2ME. The original recording was transmitted some time ago and Mr. Scott received that recording, and cut in the record on his home recording set, and forwarded this to VK2ME. That was the record which has just arrived in Sydney and we have just played it for you, to see how you will receive it. I shall now play for you the laugh of the "Kookaburra," that was also picked up in Chicago by the same gentleman.

6:06½ a.m. E.S.T.—Laugh of the "Kookaburra." Now you say, "That was the laugh of the 'Kookaburra,' reproduced in Chicago again after receiving the original recording from VK2ME. We should be glad to receive reports from other listeners as to how they receive these recordings." A talk of the day is entitled "Australia Commences the Travel Idea," prepared by Charles Holmes, Director of the Australian National Travelers' Association. Now you continue with the talk:

"Set in the sunshine of southern seas, Australia is the world's littlest continent. Australia is a continent that is different from other lands in its appearance, its geographic formation, and its strange animals, as well as its age-old peoples. Then, too, the remainder of the native race that originally inhabited Australia are a stone-age people, but now I wish you could see them in the Government Reservations, and in the far-back places of the continent, where many still lead their primitive lives.

6:12 a.m. E.S.T.—They were entertained by Australian aborigines who are located in a settlement there. They were amused to see them throw their boomerangs, that strange wooden weapon which, when thrown by a person, returns to the thrower, and the visitors had an amusing time practicing among themselves. Rudolph Friml gazed at a group of black fellows who were playing a tune with the leaf of the eucalyptus tree, "Rose Marie," from the famous play he had written.

6:14 a.m. E.S.T.—You are now speaking of native bears, and say: "Here the visitors saw the quaint and lovable little bears. 'Living toys,' one visitor called them. One gentleman wanted to buy them outright, so enthused was he by these little native animals. Some of the ladies brought honey and candy, and were greatly disappointed when their gifts were refused by the bears. They prefer to get their own sweets from the eucalyptus tree.

"Australia welcomes the visitor. We want the world to know us better, and we, ourselves, seek a greater knowledge of people of other lands. In these days, travel is more than a great pleasure maker—it is a great peace maker, and that is what the world today is most in need of. This concludes my short talk, entitled 'Australia Commences the Travel Idea,' prepared by Charles Holmes, Director of the Australian National Travelers' Association."

6:15 a.m. E.S.T.—The Band of His Majesty's Air Force will play "Washington Braves," arranged by Victor Herbert.

6:18 a.m. E.S.T.—VK2ME, Sydney, Australia. You now give the time as 18 minutes past 9:00 Sunday evening. Contralto solo, "God Shall Wipe Away All Tears," by Sullivan.

6:22½ a.m. E.S.T.—VK2ME, Sydney, Australia. An organ solo, "Just Imagine," by Leslie James. This is coming through with fine tone and clarity. Although the weather here is very bad. It is very foggy and rainy.

6:25 a.m. E.S.T.—VK2ME, Sydney, Australia. The time is 26 minutes past 9:00 Sunday evening. You now announce the next selection, a waltz.

6:30½ a.m. E.S.T.—VK2ME, Sydney, Australia. The band of His Majesty's Guards directed by R. G. Evans, playing "Intermezzo," by Reeves

9,535 Detailed logs of foreign programs have been sent to us since January 1st, 1932. All of these logs are complete—proving that the reception was not only heard, but that the clarity was perfect. Two of these logs are reproduced (in part only, for lack of space) on these pages. Think of it! 9,535 logs from 186 stations in 40 different foreign countries! It is difficult to understand, how anyone after reading these logs, could believe that dependable, day in, day out foreign reception is anything but a complete, and thoroughly satisfactory actuality.

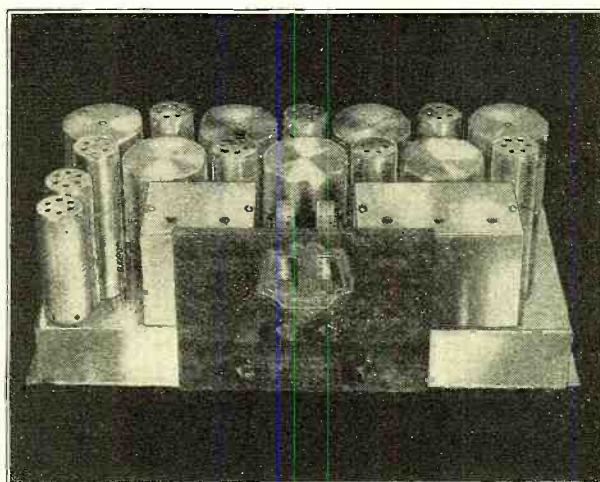

What Countries Will You Hear?

Any Wednesday, Saturday or Sunday morning you can tune in the Australian stations and listen to a three hour program, in English, of course. Then if you wish something with a decidedly foreign flavor, you can dial Saigon, Indo-China, and listen to the weirdest, Eastern music you have ever heard.

Right after breakfast, most any morning, you can tune in the Radio Colonial at Paris, France—or Chelmsford, England, from which station comes an English version of the World's latest news.

From 11:30 A. M. until 5 P. M. you have your choice of musical programs, talks, plays, etc. from Italy, France, Germany or England. In the late afternoon, the offerings from Portugal will be found very entertaining.

In the evening you may have your choice of a dozen or more different stations including Colombia and Ecuador in South America. Then, too, there is Spain, and Cuba.

Is this all?—Indeed not!—These are just a few of the many foreign stations that will be found on the dial of the Scott All-Wave. A complete list showing the exact time to tune dozens of foreign stations, is furnished with the receiver.

What Will You Hear?

From a large number of these foreign stations you'll hear news in English, and you'll delight in the variety of aspect the different countries give to an item of international interest.

You'll hear music from everywhere. Weird chants from Indo-China, and in contrast, a tango from the Argentine. From Rome you'll hear the real Grand Opera—you'll hear the voice of the Pope, the Vatican Choir and solo voices mellowed in Italian sunshine. From Germany you'll hear political speeches, music and news. From France, Spain and Portugal you'll hear a wonderful musical program that will thrill you hour after hour. From England you'll hear plays—drama—comedy and musicales; delightful presentations, refreshingly different from those to which you are accustomed. You'll never tire of foreign reception, because it never loses its novelty.

Will the Reception Be Clear?

Foreign stations are tuned easily and smoothly with a Scott All-Wave. As the dial is turned to the correct spot, the station comes on, in most cases, with the same naturalness, clarity, and roundness of tone that characterizes domestic reception.

of Foreign Reception Owners and *How You hear it*



Usually, you can have more volume than you wish, which means simply that the sensitivity may be lowered beneath the noise level, thereby permitting the program to come through with truly enjoyable bell-like clarity. There's no doubt about it. Dependable foreign reception is here; yours to thrill to; yours to enjoy as you have never enjoyed radio before.

Read These Logs*

The log reproduced at the right represents one day that E. B. Roberts of Massachusetts spent with his Scott All-Wave. During the day he journeyed from France to England, to Italy, back to France and in the evening to South America. The other log is that sent in by Mr. Royce Bilheimer of Pennsylvania who made a point of logging every word put on the air by VK2ME, Sydney, Australia, February 28, 1932. If you have any doubt concerning the authenticity of these two logs or the others sent to us, see the auditors' report herewith. Read these logs—then consider that 9,533 more detailed logs bear witness to the new world of radio pleasure opened to YOU by the Scott All-Wave 15-550 meter Superheterodyne.



THE SCOTT WELLINGTON

Typical of the many excellent models of Scott Consoles, the Wellington is a beautiful example of deluxe cabinet artistry. Fashioned from burl walnut and finished to go with the finest furniture. The center drawer contains the optional phonograph equipment, which, when wanted, is supplied with an automatic ten record changer.

*Prove to yourself the
practicability of
Short Wave
foreign reception*

These four pages have told the story of short wave foreign reception in no uncertain terms. They have PROVED that clear, enjoyable reception of foreign stations can be enjoyed by anyone irrespective of the state or country in which he lives. And we want to prove to you, right in your own home—that YOU can tune 'round the world whenever you choose and enjoy every program you hear. To do that, we'll build a Scott All-Wave 15-550 meter superheterodyne to your order; we'll test it on reception from London, Sydney or Rome—and give you the exact dial readings. If you don't get enjoyable foreign reception from these stations—if the receiver does not eclipse every statement made for it, you may return it and your money will be refunded. The coupon below will bring full particulars of this offer—also the technical details of the Scott All-Wave. Clip the coupon—mail it now.

The E. H. SCOTT RADIO LABORATORIES, INC.
4450 Ravenswood Ave., Dept. N62, Chicago, Ill.

The E. H. Scott Radio Laboratories, Inc.,
4450 Ravenswood Ave., Dept. N62
Chicago, Ill.

Send me full particulars of the Scott All-Wave Superheterodyne.

Name

Street

Town State

***AUDITORS' REPORT**

We hereby certify that we have examined and counted 9,535 logs of programs reported by purchasers of Scott All-Wave Receivers from 186 stations, foreign to the country in which received, during the months of January, February, March, 1932.

CHESNUTT, MURPHY, POOLE & Co.
Certified Public Accountants

News and Music From Four Foreign Countries Received in One Day

THESE logs, made March 7, 1932, and submitted by E. B. Roberts of Massachusetts, indicate the variety of foreign programs that may be heard with a Scott All-Wave. For lack of space, only a portion of each log appears here.

- NEWS FROM FRANCE**
STATION RADIO COLONIAL—PONTOISE
- 8:44½ a.m. E.S.T.—"This is Radio Colonial from Paris calling. Wavelength 19.68 meters."
News in English from the Continental Daily Mail, Great Britain—The financial recovery of Great Britain has aroused the interest of the world.
 - 8:45 a.m. E.S.T.—Chimes.
From N. Y., Sunday—The U. S. view is that the world economic crisis is behind. Sterling reflected by rising to a new high.
From Geneva, Sunday—Small nations are not willing that the League's authority be flouted even if the larger nations are.
 - 8:51½ a.m. E.S.T.—From Berlin, Sunday—Speeches regarding the election next Sunday. Will Hindenburg or Hitler be elected only question.
 - 8:55 a.m. E.S.T.—From N. Y., Sunday—The Lindberghs have turned to the underworld for help as the authorities seem helpless.

- NEWS AND MUSIC FROM ENGLAND**
STATION G5SW—CHELMSFORD
- 1:15 p.m. E.S.T.—Chimes.
 - 1:15½ p.m. E.S.T.—This is the British Broadcasting Corp. calling short wave listeners of the British Empire through G5SW. G5SW broadcasts on a wave of 17,550 kilocycles or 25.53 meters.
 - 1:16 p.m. E.S.T.—Programs to be radiated today.
 - 1:17 p.m. E.S.T.—Programs to be radiated tomorrow, March the 8th.
 - 1:18 p.m. E.S.T.—News Bulletins for the Middle Zone. World copyrighted.
Brind died today. An ardent advocate of peace.
Bulletin regarding the Indian Budget.
Far East Bulletin—Dr. Yen announced that China is ready to enter negotiations to restore peace. The Japanese have no intention of advancing further.
Bulletin regarding the kidnaping of the Lindbergh baby—no news as yet.

- NEWS AND MUSIC FROM ITALY—STATION I2RO**
ROME
- 2:49 p.m. E.S.T.—Telling in Italian of the results of the six-day bicycle race in Madison Square Garden, which was won by the team of McNamara-Peden.
 - 2:52 p.m. E.S.T.—Now talking about Primo Carpera and Young Scribling.
 - 2:54 p.m. E.S.T.—"Raddio Roma-Napoli."
News bulletins from the U. S. A. Shanghai and Tokio.
News regarding the Lindbergh baby.
 - 2:59 p.m. E.S.T.—Announcement.
 - 3:01½ p.m. E.S.T.—Announcement. Gave names of Italian cities. Music by orchestra between announcements.
 - 3:02 p.m. E.S.T.—Orchestra selection.

- MORE MUSIC FROM FRANCE**
STATION RADIO COLONIAL—PONTOISE
- 3:57 p.m. E.S.T.—"The Marseillaise."
 - 3:59 p.m. E.S.T.—"Hilo, Hilo, Ici. Parea. Station Radio Colonial."
 - 4:00 p.m. E.S.T.—Piano and violin selection.
 - 4:06 p.m. E.S.T.—Announcement.
 - 4:08 p.m. E.S.T.—Instrumental selection.
 - 4:15 p.m. E.S.T.—Announcement.
 - 4:16 p.m. E.S.T.—Cello solo.
 - 4:21 p.m. E.S.T.—Announcement.

- MUSIC FROM SOUTH AMERICA—STATION HKF**
BOGOTA, COLOMBIA
- 8:25 p.m. E.S.T.—Vocal solo. Man singing native selection.
 - 8:28 p.m. E.S.T.—Announcement.
Baritone solo, with choruses singing.
 - 8:33 p.m. E.S.T.—Announcement.
Vocal duet.
 - 8:46 p.m. E.S.T.—Announcement.
 - 8:47 p.m. E.S.T.—Native instrumental selection.
 - 8:50 p.m. E.S.T.—Announcement.
 - 8:53 p.m. E.S.T.—Dance music. Waltz.
 - 8:57 p.m. E.S.T.—Announcement.
Baritone solo.
 - 9:02 p.m. E.S.T.—Announcement.
 - 9:03 p.m. E.S.T.—Native dance selection.
 - 9:06 p.m. E.S.T.—Announcement.
 - 9:00 p.m. E.S.T.—Station announcement. "HKF, in Bogota, Colombia, South America."
 - 9:10 p.m. E.S.T.—Instrumental selection.
Volume very good. Some fading.

RADIO NEWS LIBRARY SPECIAL OFFERS

SAVE UP TO 50%

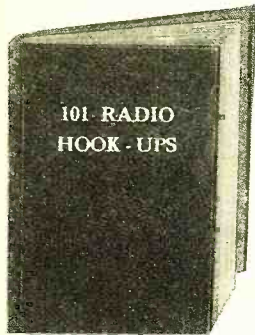

101 RADIO HOOK-UPS

Former Price 50c

(Offer No. 1) **NOW 25c**

Here's a big, attractively bound (Red Bristol) edition of the book that every man interested in radio has been eagerly looking for! As its name implies this book contains complete diagrams and descriptions of the most popular types of receivers, short wave transmitters, test apparatus and amplifiers or units thereof used in virtually every field of radio activity. Popular demand has resulted in the publishing of this new edition, priced to meet the current market.

(Offer No. 2) THIS Book FREE with Subscription for RADIO NEWS for next 5 issues for \$1.

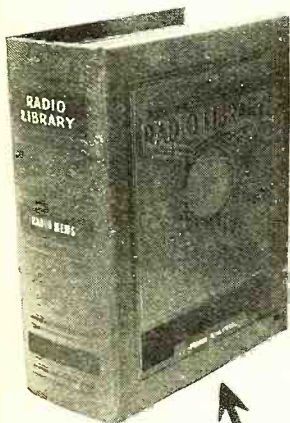

File Your Copies of Radio News

In this Beautiful Magazine Binder FREE with

2 Year Subscription \$4

(Offer No. 3)

This handsome binder is manufactured to hold 24 copies of Radio News. A complete two-year file of issues.

Strongly made, durably covered in washable tan pigskin fabrikoid, embossed in gold, with all metal parts plated, this binder is built to give a life-time of service.

It is a binder which you will be proud to add to your "Radio Library" shelves.

For a limited time, we are offering one of these handsome binders FREE with a 2-year subscription for RADIO NEWS for \$4. (Saving of \$2.00 over newsstand price—Regular annual subscription price \$2.50.)

Your Name Here in Gold 25c EXTRA

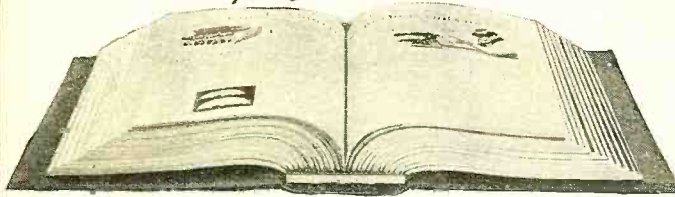

RADIO NEWS, Dept. 6-B, 350 Hudson St., New York, N. Y.

Enclosed find \$..... to cover the cost of the offers I have checked below:

- Offer No. 1—101 Radio Hook-ups—25c
- Offer No. 2—101 Radio Hook-ups, with 5 issues of Radio News—\$1
- Offer No. 3—Radio Library Binder FREE with 2-year subscription for Radio News for \$4 (Name stamped 25c extra)
- Offer No. 4—"Short Waves," by Leutz—\$1.50
- Offer No. 5—1001 Radio Questions and Answers—25c
- Offer No. 6—1001 Radio Questions and Answers with 5 issues of Radio News—\$1
- Offer No. 7—Short Wave Manual—25c
- Offer No. 8—Short Wave Manual with 5 issues of Radio News—\$1
- Offer No. 9—23 Lessons in Radio, with 5 issues of Radio News—\$1

Name.....
 Street.....
 City..... State.....

Begin subscription with issue. If renewal check here
 Add 50c extra on 5 issue subscriptions for Foreign or Canadian postage. Add \$2 extra on 2-year subscription.

"SHORT WAVES"

Regular Price \$3

(Offer No. 4) **NOW \$1.50**

This is the most complete book on short waves yet issued, published by Charles R. Leutz and Robert B. Cable.

The chapters on the propagation of short waves and directional antennas with their applications to the transatlantic radio links are the most complete of any yet available in book form. Skip distance, useful range and how they are affected by day, night or season, are exhaustively treated. Amateur and broadcast equipment, airplane radio, television and medical applications are among the other subjects covered. All the latest systems for the guiding of airplanes in fog, American and European television systems, the bloodless electric knife and many other late developments have here been brought together for the first time in a single volume.

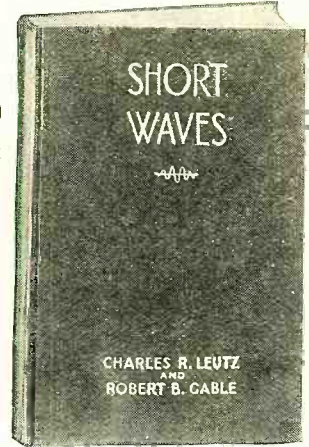

384 Pages (6½ x 9¼)

1001 RADIO QUESTIONS AND ANSWERS

Regular Price 50c

(Offer No. 5) **NOW 25c**

If you own a radio, you need this book. Everything you want to know about radio is in it, from "How to Kill Outside Radio Noises," to a clear description of the newest tubes and how to use them. If you have a question on radio, here is your answer and a thousand more. 96 illustrated pages. Large, 9 by 12 inch size. Beautiful colored cover.

(Offer No. 6) THIS Book FREE with Subscription for RADIO NEWS for next 5 issues for \$1.

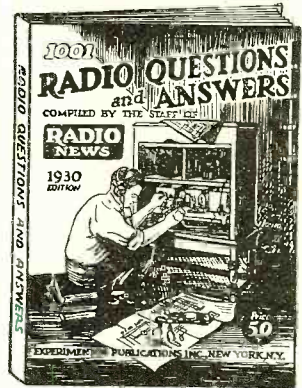

SHORT WAVE MANUAL

Regular Price 50c

(Offer No. 7) **NOW 25c**

Experience the thrills of the Short Waves—of hearing Europe, Africa or Australia direct as clearly as native stations. This big book, replete with illustrations and How-to-Build diagrams and plans, crowded with 28 chapters by foremost S-W authorities, represents the last word in authentic S-W data. Brings you more information than books selling at ten times its price.

(Offer No. 8) THIS Book FREE with Subscription for RADIO NEWS for next 5 issues for \$1.

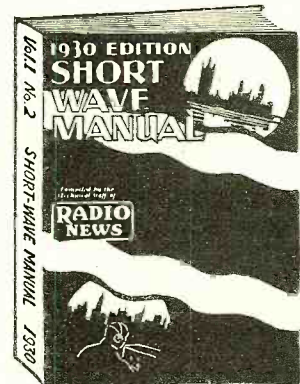

23 LESSONS IN RADIO

FREE with 5 Issues of RADIO NEWS \$1

(Offer No. 9)

A Few of the Subjects Covered:

Elementary Radio Theory—The Detector Tube—Construction of a two-stage audio-frequency amplifier—How the Radio-Frequency Amplifier Works—A Short-Wave receiver—Principles of transmitting and receiving—Complete Chart of Standard Radio Symbols—How to Build K F Tuner—A 3-stage resistance coupled audio-frequency amplifier—The How and Why of B-Power Units—Breaking into the Amateur Game—A code test outfit—Circuit, constructional and operating details of a Low-Power Transmitter—How the Vacuum Tube Works—Battery construction details—How to Analyze Receiver Circuits.

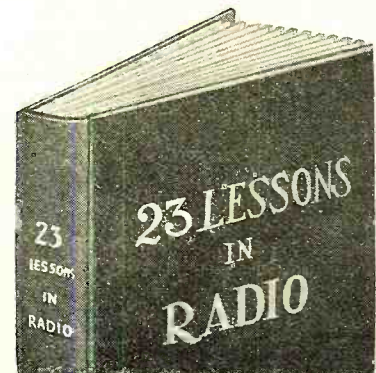

only \$37.50 11-TUBE Super-Het!

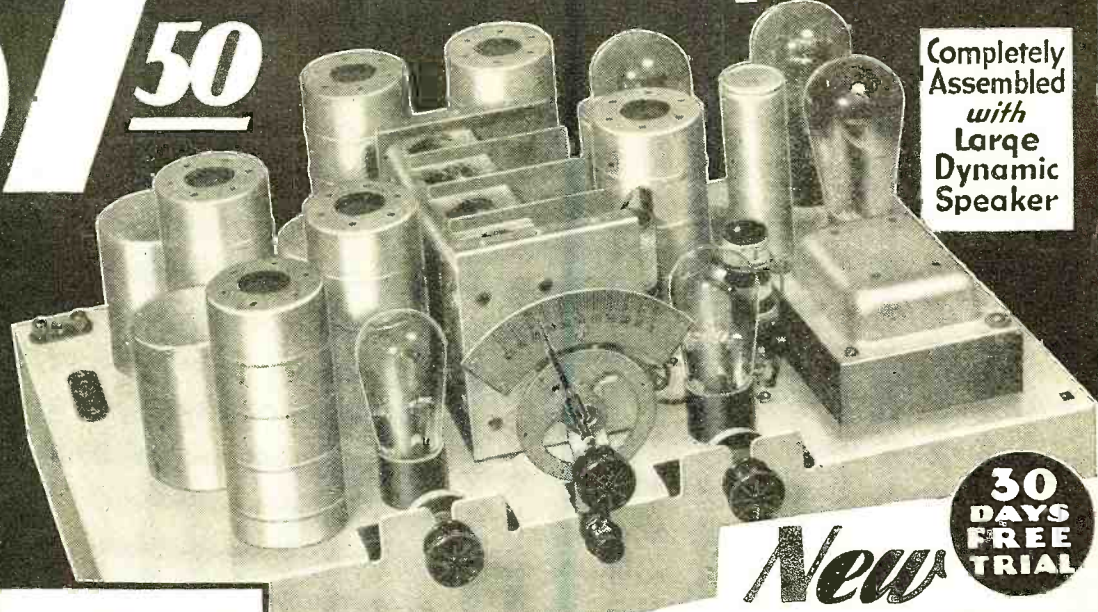

Completely Assembled with Large Dynamic Speaker

Pentode Variable-Mu and Real Automatic Volume Control

30 DAYS FREE TRIAL

New

13-Tube and 15-Tube ALL WORLD-ALL WAVE COMBINATIONS!

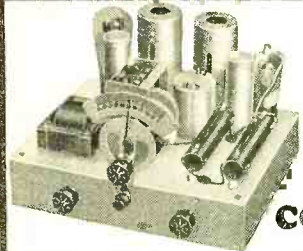

MIDWEST 4-TUBE SHORT-WAVE CONVERTER

World-Wide Short-Wave Reception

Converts any A.C. set of adequate sensitivity into a short-wave receiver for reception of police calls, airplane conversations, ships at sea, and broadcasts from foreign stations.

This amazing new short-wave converter employs 4 tubes, self-powered. It uses one 280, one 224, and two 227 tubes. In combination with a 9-tube Super-Het, it gives you a 13-tube ALL-WORLD, ALL-WAVE combination. When used with the very latest model Midwest 11-tube super-heterodyne, shown above, it gives you a total of 15 powerful tubes, and ALL-WORLD, ALL-WAVE reception unbeatable even in receivers costing several times as much.

Don't confuse this 4-tube self-powered converter with cheap one- and two-tube converters that are not self-powered. The Midwest Converter actually gives better performance than many converters costing twice as much.

Now you may get SHORT-WAVE broadcasts—airplane calls—police signals—foreign stations—standard long-wave broadcasts—all with one combination set. Hear U. S. stations from coast to coast, and from Canada to Mexico. Hear the Canadian stations, Mexico, Cuba, South America, Europe, Asiatic and other foreign stations and ships at sea. A Midwest 13-tube or 15-tube combination gives you ALL that's desirable in radio. These wonderful new combinations are sold at amazingly low direct-from-factory prices. When you receive our big new catalog and note the low prices, 30-day free trial offer, terms as low as \$5.00 down, you'll be positively amazed. Mail the coupon right now—get the surprise of your life.

Deal Direct with Factory SAVE UP TO 50%

Never have such powerful sets been offered at Midwest's amazing low direct-from-factory prices. You save the middle-men's profits. Your outfit will reach you splendidly packed, rigidly tested, with everything in place ready to plug in. No assembling! Entertain yourself for 30 days absolutely FREE—then decide. And don't forget—every MIDWEST outfit is backed by an absolute guarantee of satisfaction. You take no risk. Mail the coupon now!

TERMS
as low as
\$5.00 DOWN

AIR CELL BATTERY 8-Tube Sets

For homes without electricity. The amazing new Air Cell battery does away with all battery troubles. Never needs recharging. Just add a few drops of water occasionally—that's all. It's "Self-charging." No trickle charger—no battery troubles of any kind. Brings the joys of radio to any home, anywhere, any time. 8-tube battery chassis completely assembled (less tubes), now only \$19.95.

Read These Letters From Midwest Owners:

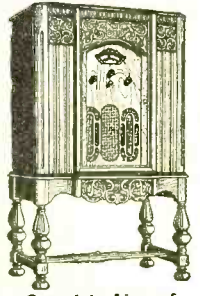

Complete Line of Consoles

The big FREE catalog beautifully illustrates the complete line of gorgeous Midwest Consoles. "Deluxe," Highboy and Lowboy models.

Holds VK2ME Two Hours

"I heard VK2ME, Australia, this morning and held them for over two hours. The volume was ample to hear this station all over the house. Have received amateurs all over the U. S. from Maine to California. I have also picked up CBS and stations in Colombia, S. A., two in Argentina, one in Indo-China and one in Canada, VE9DR, which comes in at all hours."—E. Applebaum, 334 Johnson Ave., Newark, N. J.

Gets Germany, Italy, France

"Received converter—am well pleased with it. March 2nd I picked up Germany, France and Italy. On the following day I got Italy again clear and loud. From 2:45 till 6:40 P.M. I heard all of the music from the Royal Opera House."—A. Mosconi, 7122 Paschall Ave., Philadelphia, Pa.

Hears League of Nations Speeches

"I raised Honduras at 7:52 on middle switch; at 3:34, a European station at 10 o'clock E.S.T., broadcasting League of Nations speeches. Around 11 A.M. I picked up another European station at 48 broadcasting a fine program of music, the announcing being in German."—A. Battalgeon, 6009 Notre Dame East, Montreal, Canada.

Bermuda, Philippines, Switzerland, Rome

"I am very well satisfied with my Midwest and have picked up the following: Vancouver, B. C.; Hamilton, Bermuda; Geneva, Switzerland; Philippine Islands. Two-way conversation between airports and airplanes. Police radio from every direction, Rome, Italy. It was announced as Italia, Roma, and came in about

the position on the dial which would indicate 12 RO, Rome."—Geo. E. Kuhr, 218 Division St., Bellevue, Ky.

Gets Sydney, Australia

"On February 28th at 4:30 A.M., Sunday, I picked up VK2ME, Sydney, Australia, which I think is good, as I have a poor location for radio."—S. M. Bevenue, 1815 Dolman St., St. Louis, Mo.

Mail this Coupon for Complete Details and Big FREE Catalog!

Midwest Radio Corp., Dept. 79, Send me SPECIAL USER AGENTS' PROPOSITION, Cincinnati, Ohio

Without obligation send me your new 1932 catalog and complete details of 13 and 15-tube All-World, All-Wave Combinations, 4-tube Converter, 9 and 11-tube Superheterodynes, low factory prices, easy terms and liberal 30-day free trial offer. This is NOT an order.

Name.....

Address.....

Town.....

State.....

MIDWEST RADIO CORP.
Dept. 79 (Est. 1920) CINCINNATI, O.



Radio's Unique Qualities in Public Information

Radio is indissolubly associated with education, particularly if education is viewed in its broader sense. Even in its narrower application to the schools, radio must be looked upon as providing outstanding opportunities. Just what proportion of radio time should go for general education, as distinguished from commercial broadcasting, is still to be determined. We hope that with time and the spirit of cooperation, the fullest advantage can be taken of the unique qualities of radio in public information.

Rafael G. Hillman

Secretary of the Interior,
Washington

Radio News

VOLUME XIII

June, 1932

NUMBER 12

COMING DEVELOPMENTS FORECAST A BRILLIANT RADIO FUTURE

An authoritative forecast of future trends in radio development and activity. These pages contain the predictions of some of the leading men who are making radio history in advancing the art and industry of radio

I FIRMLY believe that radio will become more and more one of the dominant factors in uniting American citizenship to work out the common problems which now face us all.

Radio broadcasting during the coming year will develop along lines already indicated in 1931, pursuing the path of increased service to the public in the fields of entertainment and education.

DESPITE the industrial depression, radio development continues along so many novel lines that there is no single trend of development, but rather a number of lines of work, each of which indicates an impending accomplishment and a new branch of the radio field.

Radio transmitting equipment is becoming more powerful, of better quality, of greater reliable coverage, and is being interconnected by network lines of widened frequency response.

Receiving equipment is developing along certain lines of increased convenience, more faithful quality which may require somewhat larger, more effective, and higher-priced sets than have been current for the last two years. Concurrently, factory economies and

A FEATURE of radio nowadays is utilization of by-products. In the science of sound, for example, notable progress has been made through the possibilities of exact measurement provided for the first time by such radio devices as vacuum-tube amplifiers, microphones, standard sound sources and electric filters.

Embodied in modern noise meters, frequency analyzers and simi-

AN ambitious schedule of broadcasting, probably including coverage of the Olympic games at Los Angeles and the major political conventions in Chicago, has been drawn up in full guarantee that there will be no leanness in radio's summer fare.

The close of 1931 and the dawn of 1932 saw Metropolitan Opera carried direct from the stage into millions of American homes with radio sets. As the national conventions of the major political parties approach, and through the fall campaign, radio will be alive with the exciting contests which are now under way.—*M. H. Aylesworth, President, National Broadcasting Company.*

novel methods of chassis and parts construction will enable giving the radio purchaser more for his money.

Television remains the great question mark of the year, with excellent progress reported from the laboratories, but no commercial plans as yet worked out to the satisfaction of the radio leaders. Further improvements in electric phonographs and corresponding records may be confidently expected. The field of 16 mm. sound pictures appears due for a considerable expansion along industrial, educational and home lines. All in all, radio and its allied arts are still in youthful and healthy condition and with an apparently satisfactory future ahead of them.—*Dr. Alfred N. Goldsmith, Vice-President, Radio Corporation of America.*

lar instruments, these by-products of radio already have revolutionized acoustic science. Significant practical progress has been made in noise reduction, in improving auditoriums, in making better musical instruments and in other directions. Further value from these quantitative measurements in acoustics is certain.—*Dr. E. E. Free, Consulting Physicist.*

Aside from these special events, it may be said that the general quality of all broadcasting will continue to advance and that every listener will find on his dial the type of entertainment he prefers.

Because of the steady progress in program building and trans-



M. H. AYLESWORTH



DR. A. N. GOLDSMITH



DR. E. E. FREE



WILLIAM S. PALEY



WILLIAM DUBILIER



LEVERING TYSON



R. H. MANSON



H. E. YOUNG

mission it devolves upon the listener to take advantage of the most modern receiving sets available. Obviously, what is up-to-date in broadcasting is most appreciated through the use of an up-to-date receiver.—William S. Paley, Pres., Columbia Broadcasting System.

Tubes First, Condensers Second in Radio

By William Dubilier

Dubilier Condenser Corp.

RECENT developments in the condenser industry indicate that the condensers have found their place in the electrical sciences and arts as well as radio.

The electrical art divides itself into three sections: capacity, inductance and resistance. Devices developed during the last fifty years have mostly utilized resistances or inductance or both. Only recently has capacity begun to take its place, seriously, with inductance and resistance.

Condensers are being used extensively with motors. Condensers are being used extensively in furnaces and in power-factor correction. With the improvements made by our organization recently, capacitors using different types of dielectric have eliminated the doubtful manufacturing factors which have made large production unprofitable and unstable in the past.

Mica condensers are used in practically every broadcasting and radio station of the world. It is the most important development, next to the tube, that made the present broadcasting possible. Without the development of the mica condenser, present types of broadcasting would have been impractical and probably impossible. It is the development of the condenser that made the a.c. set practical, for without it smoothing would have been impossible, and if the older types of units were utilized the expense would have been prohibitive.

225,000 Students—by Radio

By Levering Tyson

Director National Advisory Council on Radio in Education

THE National Advisory Council on Radio in Education has had an excellent opportunity during the winter to experiment with the actual broadcasting of educational programs on a nation-wide basis. Since October, under our auspices, there has been broadcast over the National Broadcasting Company's red network of fifty-four stations a series of programs on psychology and economics, and since February, over a Columbia network of more than sixty stations, a series of lectures and dramatizations on Vocational Guidance.

It is relatively easy to get speakers for an educational program, but the Council believes this is only a very small part of the job. It is also necessary to stimulate a de-

sire on the part of the listener to read and study further on the subjects of the broadcasts. With this idea in mind, the committee in charge of these programs have prepared listener's notebooks, handbooks and reading guides to accompany the series. These, as well as the individual lectures, have been published for the Council by the University of Chicago Press, and distributed, at cost, to listeners. To date 225,000 copies of this material have been distributed.

Future Trends in Receiving Set Design

By Ray H. Manson

Chief Engineer Stromberg-Carlson Telephone Mfg. Co.

FROM the standpoint of overall performance, broadcast receivers of the near future will not be greatly improved over the best designs of the past year. New tubes, announced this spring, will, however, allow for more efficient circuit design. Class "B" amplification (push-pull audio) will allow greater output, but this system presents some unsolved problems which require further study before it can be adopted for general use in a.c. electric sets. Twin speakers, all-range sets or converters, new designs of automatic phonograph units and "concealed" receivers, with arm-chair control, will be featured this year. The radio public will get more for its money, although quality of performance will be determined by the price classification as in the past.

Radio Increasing Its Service to Humanity

By H. E. Young

General Commercial Engineer, Western Electric Company

IN granting high-power broadcasting licenses the Federal Radio Commission has taken a most important step in serving the public. This regulation and its companion compelling closer frequency adherence will result in improved reception for millions of listeners in rural and suburban areas throughout the country. Due to the increased signal strength, improved quality and the elimination of the audible beat notes which

were so annoying, there will be an increasing demand for receiving sets capable of faithful reproduction.

In other fields radio will continue to render increasing service to humanity. Its usefulness in specific applications, such as air transportation and police work, is already established. New fields will constantly appear, presenting great obstacles at first, but eventually yielding to the high order of engineering skill which has been developed.

Radio Dollar Value to Rise

By F. A. D. Andrea

President, F. A. D. Andrea, Inc.

THE remarkable economic trend in radio which has manifested itself during the past two years, resulting not only in an improvement in the appearance and performance of the higher-priced sets, but also offering the purchasing public substantial increase in dollar value on lower-priced sets, will unquestionably continue to be a factor in the industry.

This past trend, however, will be modified substantially by the elimination of the extreme low-price craze which has resulted in considerably inferior products being placed on the market, and the so-called lower price range will show a substantial advance in the dollar value of the unit sale, accompanied of course by substantial improvement in appearance and performance.

Radio Helps the Deaf

By Charles H. Lehman

President, Hearing Devices Co.

THE talking pictures, radio and bridge are sharply bringing home the fact that deficient hearing is as common as deficient eyesight. The progress in the art of making hearing aids is keeping pace with the development in other lines of electrical sound transmission. The using of hearing aids is becoming more general and will soon cease to cause embarrassment and will excite no more comment or attention than the use of eyeglasses.

The marvelous development of radio, through the genius of De Forest and others, has enabled much improvement to be made in the tone qualities of hearing aids. With the progress of metallurgical art and better knowledge of magnetic metals, even smaller and more powerful earpieces will be made.

The hearing aids of the future will employ smaller microphones than those now in common use. It will be feasible to use two such microphones, one on each side of the person, to give wider pick-up range and possibly directional qualities.

I believe that eventually miniature vacuum tube devices similar to the ones described in the January, 1932, RADIO NEWS, but much smaller and compact, will be devised and used, with much smaller battery consumption, and small pocket cases will eventually be made which will contain the vacuum tube and miniature dry cells which will be easily replenished or replaced. Theatres,



F. A. D. ANDREA



C. H. LEHMAN



D. N. DULWEBER



McMURDO SILVER

churches and public places will be wired in many locations and even homes will have outlets at convenient places so arranged as to enable the hard-of-hearing to plug in their portable devices and hear with as much ease as if they had normal hearing.

Powerful influences are at work in spreading information to the deafened children or those potentially hard-of-hearing. Preventive means will be more widely used and those with hearing already impaired will eventually find means of relieving their impairment through the magic of radio, the vacuum tube and the marvelous powers of the electric microphone.

Radio Service Work Important to the Industry

By D. N. Dulweber
Supreme Instruments Corp.

THE entire industry has come to recognize that, with the constantly expanding production of receiving sets, ever widening markets must be created, which can only be accomplished through still further popularizing radio. Unquestionably, this can best be attained through the enthusiastic satisfaction of present users, which depends entirely upon obtaining for them the maximum and most pleasurable service from the sets now in operation.

The future of the radio industry is, therefore, largely dependent upon the development of radio servicing that will guarantee such results to the radio public. Unless such results can be attained, the full rewards cannot be realized from the engineering ingenuity and sales efforts employed in the production and distribution of radio equipment.

Short-Waves, Multiple Speakers—Stressed

By McMurdo Silver
President, Silver-Marshall, Inc.

THE 1932-33 radio season will see a number of new design trends, not necessarily along revolutionary lines. Summarizing, these new developments will be the wider offering of combination short-wave and broadcast receivers, the use of multiple speakers, new tubes and class B audio amplification.

In the combination field, the public has realized the DX possibilities of short waves, and an ever-increasing interest will result in much wider offering of such sets by manufacturers.

Multiple speakers will be used both for pure sales appeal and the somewhat improved tone they give over a single speaker.

Ultra Short-Waves for Television

By E. F. W. Alexanderson
General Electric Company

THE apparatus for transmission and reception of television has already been



E. F. W. ALEXANDERSON



C. W. HORN



K. A. HATHAWAY



C. F. JENKINS

developed to a high degree of perfection. But much experimentation will still be required in exploring the wave medium for transferring the signal from the transmitting to the receiving station. That some ultra-short-wave will be used is now taken for granted, but whether this ultimately will be a wavelength of meters, centimeters or millimeters is yet to be determined.

Future Trends in Short-Waves for Broadcasting

By C. W. Horn

General Engineer, National Broadcasting Co.

UP to date our short-wave international work has been in the pioneer field. At present we are improving equipment and circuits. The immediate future will see the general extension of international program circuits so that within a few years events may transpire where they will, and the radio audience will participate. Thus, this great world of ours will again shrink considerably in dimensions when we consider communications.

Broadcasting will have more program material available, and the engineers will naturally contribute by solving the problems of fading and synchronization, with the result that the rural listener will greatly benefit by obtaining a consistent and definite signal.

The engineer, during the next few years, will solve many of the major problems confronting the industry; he will create additional facilities which will overcome the crowded conditions of the broadcast spectrum and permit a more equal distribution of facilities with our neighbors to the north and south of us. With the aid of pure scientists he will make television a practical thing, and then will continue to improve that new field until it becomes comparable to other broadcasting services.

Improved Service to Aid Industry

By K. A. Hathaway

Executive Secretary, Institute of Radio Service Men

SERVICE men are coming to realize that their success depends upon obtaining re-

peat business and that there is little if any profit on the first call, because of the cost of getting the customer originally. It is apparent, therefore, that the serviceman must be well trained, courteous, reliable and fair, in order to guarantee satisfaction on all calls so that future business will be forthcoming.

Progressive servicemen have seen the necessity for banding together in a co-operative spirit as a means for building up their profession. Their co-operation one with another, personally as well as through the medium of an organization, will benefit the entire industry, not only because of the establishment of confidence brought about by the unification of action, but by the finding and development of markets for new and untried merchandise.

The effect of providing a high order of satisfaction to radio listeners will not only give the members of the radio service profession a greater return on their investment in training and equipment, but will also result in a more widespread use of radio, greater turnover of merchandise, and a larger audience for the already well-developed program emanating from the broadcasting stations of the country.

Television Perfection Increasing

By C. Francis Jenkins
Television Pioneer

TELEVISION, like all new arts, must of course have its ups and downs during its development period. Fifteen years ago, in my early work on motion pictures, I recognized a fixed source of light which would, when shuttered by a slide or a film at a speed fast enough to deceive the eye, be the ideal system for the projection of moving pictures on the screen.

Today, I believe the same principle will eventually be used to establish television, namely, to shutter a local fixed source of light with a slide whose density is in proportion to the picked up, transmitted television picture. There is much to be accomplished before this can be an actuality, and in the meanwhile the lens disc, cathode rays, all offer methods of approaching the ideal of television broadcasting.

I look for a general increase in the perfection of television offerings during 1932, with confidence that a television service, when properly organized, will open up various and many entertainment, educational, political and commercial avenues of progress that can at present be only dimly realized.

Short-Waves Developing Rapidly

By James Millen
Vice-President, National Company, Inc.

WITH the ever-increasing use of the frequencies between 3 and 20 megacycles for international broadcasting, aviation, va-



JAMES MILLEN



W. H. HOLLISTER



U. A. SANABRIA



E. H. SCOTT



E. A. NICHOLAS



K. P. ROYCE



ARTHUR MOSS



E. V. AMY

rious types of communication and other such commercial applications, the true experimenter is being crowded out of the short-wave field in which he only so recently pioneered.

Under 10 meters, however, lies a vast band of little-used frequencies about which little actual scientific data is as yet generally available. This ultra-short-wave field will undoubtedly receive the same attention during the coming year from the readers of RADIO NEWS as did the so-called short-wave field just a few years ago.

In our laboratory at Malden we have been conducting researches in this new field for many months and as a result have developed a complete line of the highly specialized components required by the ultra-high-frequency experimenter. These new products will be exhibited for the first time at the annual radio trade show to be held in Chicago this spring.

DX Reception Demanded!

By W. H. Hollister

President, Lincoln Radio Corp.

THE romance of radio has taken a new lease on life, and the public today is getting the old thrill of the one-tube set in the modern receiver, capable of world-wide reception.

The present receiver is reaching the low ebb of cost, and the public, in the near future, is going to demand better-made receivers. They must live up to new standards of range and tone, with more intrinsic value in construction, to insure reliability and performance. More power to less distorted advertising and more real value in radio!

Definition Important in Television

By U. A. Sanabria

Television Expert

A DEFINITION of five thousand lines per picture seems necessary in order to make television a national power. The present transmitting and receiving cathode-ray methods, though faced by severe engineering obstacles, can and will probably force their way into a commercial article. I have been encouraged by the recent trend of development, producing some fine schemes that can result in television without scanning, or without the necessity of transmitting and receiving with an elemental system, and I expect that the real success in television will be obtained with the method of this latter type.

Foreign Broadcast Reception

By E. H. Scott

President, E. H. Scott Radio Laboratories, Inc.

UNDOUBTEDLY this fall there will be many changes in radio receiving sets as the public now know them. The most im-

portant development will, I believe, be in the designing of receivers for the reception of foreign broadcasting stations as well as domestic broadcasting stations. That is, sets that will tune from 15 to 550 meters.

I also believe that, although the tone of the majority of the sets available today is good, this will be still further improved by those manufacturers who in their engineering researches are studying the acoustical properties of the speaker, amplifier and console as a whole.

Hearing Aid Advances

By K. P. Royce

Graybar Electric Co., Inc.

IN my opinion, the trend in the design of hearing aids is fourfold: reduced size, improved appearance, greater power, greater clarity. The new Western Electric audiphones exemplify all four of these trends.

Each of these advances increases the "consumer acceptance" which portends another important trend, a little further in the future—lower prices, resulting from increased sales. It is estimated that 80% of the hard-of-hearing do not use a hearing aid at present. Many have objected to the size and appearance; others have not found one sufficiently powerful; still others (particularly those suffering from nerve deafness) have found that hearing aids make speech audible but not intelligible. All of these difficulties are being overcome by research, and it is my belief that the use of aids to hearing will increase in the next ten years just as the use of aids to vision increased in the first decade of this century.

Modern Features in Receiver Design

By E. A. Nicholas

Vice-President, RCA-Victor Co., Inc.

CERTAINLY you would not think of purchasing your new car without raising the hood and inspecting the motor. For the same reason, no one should think of purchasing a new radio set without inspecting the chassis and giving careful consideration to its design and construction.



J. E. SMITH



M. B. SLEEPER



A. M. FLECHTHEIM



A. H. LYNCH

The engineers of my company have perfected a ten-point synchronized tone system, which, in their opinion, every modern receiver should embody.

We are teaching people to turn radio sets around and look into the back, and consequently doing much to protect the purchaser from inferior equipment hidden behind show cabinets. Chassis quality alone is not sufficient in these days of high-quality radio, but rather a perfect synchronization of all chassis parts with each other, and these in turn perfectly synchronized with the type of cabinet in which they are put.

It is not enough for a radio set to have fair tone quality without good selectivity; nor is unusual selectivity which cuts out valuable side-bands desirable. There must be no undue cabinet vibration from the loudspeaker, for that introduces distortion. The tone color control must permit gradual shading of tone instead of three or four limited positions.

Class B Amplifiers

By Arthur Moss

President, Electrad, Inc.

THE present trend in audio-frequency amplification seems to be toward greater power, with smaller tubes. The pentode output tube and the new tubes recently announced for Class B amplifiers are highly efficient electrically, and when used in circuits suited to their characteristics will give high output in audio power with comparatively small input from the power line.

That this electrical efficiency must be obtained by some sacrifice in the quality of the audio output is regrettable, especially in view of the fact that the public is educated to expect the very best in tone quality. However, we can leave it to the engineers to hold this inherent distortion to a minimum, or to compensate for it by circuit design.

Trends in Radio Development

By Ernest V. Amy

Consulting Engineer

WHILE the trend in radio development for the immediate future may be somewhat slower than in the past, now is the time for continued research and carefully directed experimental work. The best stimulant for radio buying is the development of new and worth-while products. The remote-control feature for the operation of radio sets in the home will receive more attention and general acceptance by the public.

Television, while still in the experimental and development stage, is slowly but surely emerging from the laboratory into a system which, with some refinements, will be the basis of the future home receiver. There is no fundamental obstacle to the development of television.

In the tube industry, there is already a general tendency towards greater undistorted

audio output and increased sensitivity with flat frequency response. Many present output tubes have the disadvantage of varying their power output with impedance, consequently causing frequency discrimination and distortion.

More Knowledge for Service Work

By J. E. Smith

President, National Radio Institute

NEW refinements in radio receivers and modern standards of performance have caused a distinct change to take place in the field of radio service. The listening public can no longer be satisfied with mediocre reception. Present-day trends require that the radio serviceman, to do satisfactory work, must have more training and more knowledge than ever before. Men already engaged in service work, as well as those who are planning to enter this field, must not understand only the fundamental principles of radio, but must become familiar with the modern tools and instruments that are used by the up-to-date trouble-shooter to diagnose trouble and to aid in its correction.

Accelerated Research and Engineering

By M. B. Sleeper

Assistant Sales Manager, Pilot Radio and Tube Corp.

RADIO is answering the challenge of new conditions with an accelerated research and engineering program to create finer sets with new features and improved performance.

We believe that the day of the assembly shop has passed, for only radio manufacturers who have complete manufacturing machinery and who are equipped to make their own tools, dies, and molds can afford to give the quality demanded at current prices, and can control production accurately enough to prevent overproduction from wiping out each season's profits.

The new Pilot Dragon receiver, covering 18 to 555 meters with a single tuning adjustment, out-performing at a far lower price the converter combination introduced last year, is an outstanding example of successful merchandise achieved by engineering effort. We believe that new standards of design are established by this receiver.

Amazing Radio Developments Coming

By A. M. Flechtheim

President, A. M. Flechtheim & Co., Inc.

NO more is radio in its infancy. Yet, we will see the time, not far off, when we can aptly say that by June, 1932, "the surface was not more than scratched." The amazing developments to come—in radio broadcasting, in television, in radio remote control and in the great field of elec-



BOND GEDDES



H. G. KNOX



TOBE DEUTSCHMANN



D. E. REPLOGLE

tricity—will further astound and lead to prosperity. Even condensers, as a single entity, will share in the honor of returning us to better times.

With specific reference to fixed condensers, as used in the radio industry and allied phases of the electrical industry, their use will always be on the increase, what with the numerous new developments constantly being made.

We have consistently improved our products—paper-dielectric condensers exclusively—with the result that today we enjoy business from many of the country's leading manufacturers. Outstanding among our achievements is the fact that more than 450 of the broadcasting stations in the U. S. A. employ Flechtheim condensers. Most of the aircraft-radio manufacturers use the new highly developed type HSM, the smallest, most dependable high-voltage condenser made. Its perfection required more than four years of intensive research—an example of the great lengths to which it is necessary to go in order to keep abreast of the field.

Trade Show to Reveal Improvements

By Bond Geddes

Executive Vice-President, Radio Manufacturers Association

THERE are unusually good prospects for business during the 1932-1933 season. The weaker radio firms have been eliminated from the field and the industry is entering the new season with renewed strength and bright hopes. During the past year many manufacturers sold sets at below cost. This practice has been curtailed and a profitable sales year of new and better merchandise is ahead.

Marked technical advances have taken place during the past year. Modifications in receiving-set design feature improved quality. Tremendous engineering strides were made in the development of new tubes. The development of the "all-wave" receiver was another important stride. Important improvements have been made in loud-speakers, and improvements also have been made in automobile receivers. The rural listener has benefited by improvements in battery receivers and the production of long-

life batteries. Automatic tuning and clock control for receivers are added features of many sets. The demand for remote-control tuning devices has increased.

We expect many R.M.A. members to reveal new and greatly improved television lines at the Chicago Trade Show. Technical strides in visual broadcasting have been tremendous, and many receivers will be introduced at the show. Large television sales are anticipated, but volume sales cannot be expected until commercial television stations are in operation—and this should be in the near future.

Short-Waves, Television to Be Important Sales Factors

By Arthur H. Lynch

Merchandising Counsel

THERE is no question whatever but that short-wave transmitters, receivers and television developments of all kinds will continue to provide the novelty which, in my mind, has always been an extremely important sales factor in the radio business.

There is no question about the radio business being temporarily chaotic. The mortality of radio companies has brought about a very serious reduction in price. Good radio receivers and accessories of most reliable manufacture are now obtainable at prices which are ridiculously low. In most cases, the present prices are below the actual cost of manufacture. This condition cannot exist for long. By next fall the entire industry should be purged of a great many of its parasites and be on a much more even keel. Radical changes in our merchandising methods as well as economies in manufacturing, distribution and collections, are bound to be important trade considerations.

Condensers Conquer Interference

By Tobe C. Deutschmann

President, Tobe Deutschmann Corp.

THE paper-dielectric electrostatic condenser, without which the broadcasting systems of the world would never have reached their present stage of development, is destined to receive increased recognition in the coming season. Power—in radio—is synonymous with the paper-dielectric condenser. Increased field strength, greater coverage, higher amplification, improved quality of reproduction, all these demand the high voltages which necessitate the use of electrostatic condensers as the heart of the plate power supply. These condensers are also essential in all applications where absolute safety is of paramount importance. The exacting requirements of industrial applications are filled only by the time-tested, reliable, paper-dielectric condenser. The increasing realization that this product is fundamental to the radio and electrical industry is bound to bring this condenser back to its own, even among those who seem to have



H. C. LEWIS



H. L. OLESEN



A. S. MOHAUPT



D. O. WHELAN



A. J.
KENDRICK



P. L.
JENSEN



H. S.
BAIRD



O. B.
HANSON

abandoned it in favor of other types. The paper-dielectric condenser is recognized as vital to the operation of radio interference filters now being widely used to reduce the present rapidly increasing noise level. Man-made static cannot override properly designed units in which this condenser is used either alone or in combination with suitable inductance.

Studio Acoustics and Electrical Transcription

By H. G. Knox

Vice-President, Electrical Research Products, Inc.

WHILE continued research further improves radio broadcast transmission and reception, the acoustic problems of the studios are of equally vital importance in affecting the quality of all broadcasts. Marked increase in quality has been achieved by proper acoustic treatment of studios in relation to new pick-up techniques. Further research in, and application of, the science of acoustics is destined to improve to an even great extent the quality of all broadcast programs.

Another development sponsored by this company, electrical transcriptions, is bringing better quality of programs especially to audiences of the smaller stations hitherto unable to secure fine artists. This development is growing in popularity, and research in this field has produced electrically transcribed programs equal in quality to the best direct broadcasts and superior in sound quality to the average present-day microphone broadcasts.

Television to Accomplish Wonders

By D. E. Replogle

Vice-President, Jenkins Television Corp.

TELEVISION has seized the present time for a breathing spell. New developments, particularly in the transmitting end, are opening up amazing new fields; engineers can now see their way through the technical problems toward a reasonably satisfactory television service. Recent technical advances, including use of ultra short-waves for satisfactory television transmission, the new camera-television pick-ups and the new cathode-ray receivers, will undoubtedly be noted by those with finances and will, by far-sighted industrial leaders, be used to make television accomplish wonders as soon as the financial clouds are somewhat lifted. Then television will re-emerge all the better for the extra amount of time that it has been forced to stay in the laboratories.

Economically, the immediate horizon still seems cloudy. Who will pay for the transmitter, for the talent, for developing the studio technique to support a broadcast service is still unknown.

It is my opinion that as soon as general business conditions appreciably begin to improve, television will be one of the first

industries to emerge and make a real place for itself in American life.

Future Trends in Radio Service

By Harold C. Lewis

President, Coyne Electrical School

THE field of radio service offers splendid and increasing opportunities to really well-qualified servicemen, either in good-paying jobs for dealers, factories, etc., or in a service and sales business of their own.

The home radio market is far from being saturated, as some people seem to think. There are still millions of homes without radios, and millions more with old, obsolete sets that should and will be replaced. And before long millions of home radio owners will learn the convenience of having two or more receivers in different rooms of the house. Servicemen can sell this idea best!

The auto radio field is hardly scratched and many millions of these sets will be sold and installed during this and the next several years, making a greatly increased need for top-notch servicemen. Aircraft radio is providing another increasing field, and the very critical service requirements on this equipment will demand thoroughly trained expert servicemen.

The increasing popularity of short-wave and all-wave receivers, and the tremendous field that will be opened up by television, will require a higher grade of serviceman with a thorough knowledge of fundamental principles of electricity, radio, vacuum tubes, circuits, etc.

Every good serviceman should, in addition to securing this knowledge, keep up-to-the-minute on new tube developments, latest test equipment, methods and data.

The move now under way and being fostered by various servicemen's associations to raise the standards of servicemen by disqualifying and eliminating many of the put-terers and dabblers who have posed as such will make the opportunities and remuneration much better for those who are really qualified and those who are ambitious and far-sighted enough to secure the necessary thorough practical training for this great and growing field.

Those who have not the proper knowledge and neglect to get it will be left far behind and "out-of-the-picture" by the rapid developments in radio during the next few years. Those who do study and train and keep up to date will be well repaid for their efforts and investment and will find their profession growing brighter, more enjoyable and more profitable month by month.

Stabilizing Fair-Price Levels

By Harold L. Olesen

*Manager, Radio Sales Division,
Jewell Electrical Instrument Co.*

THE last radio season saw the start of an active campaign to properly merchandise radio tubes. A good foundation has been laid. The 1932 season will see a con-

tinuation of this effort and a beginning of the very profitable returns obtainable therefrom.

Price has been the governing factor for the past year or so, but is gradually giving way to quality. Very low prices have been reached only at the expense of quality, which in many instances has not been generally acceptable. 1932 will see a tendency to stabilize around fair-price levels, where good quality can be obtained. These price levels will be somewhat higher than those in demand during 1931.

Attractive Opportunities in Service Work

By Arthur S. Mohaupt

President, Radio Training Association

WITH the ever-increasing commercial applications of the radio and electronic principles, there are many attractive opportunities constantly being offered to the wide-awake and ambitious man. However, quick money today lies in radio service work, service work that is rendered with a satisfaction guarantee. The gyp and shyster will soon fall by the wayside.

Realizing the need of the industry for a thorough and practical servicemen's training course, the Radio Training Association of America, located at Chicago, has concentrated its efforts along these lines and is in a position to offer the serviceman just the type of training he needs. The course of training has been examined and endorsed by thirty prominent manufacturers and organizations.

Higher Qualifications for Servicemen

By Dow O. Whelan

President, R. C. A. Institutes, Inc.

THERE is vast difference in the qualifications required of a serviceman today, from what was necessary a decade ago. The increasing complexity of radio circuits and the manner in which radio has entered new fields makes it imperative that the 1932 serviceman be prepared to deal with an almost endless variety of practical problems.

The transition that has already come gives a clear indication of the future. Only those who keep abreast of new developments can hope to survive in such a rapidly moving art, which assumes increasing importance with each passing year. Radio service offers much more than the mere practice of a trade; it offers also the opportunity to participate in the romantic development of an amazing new industry.

Electrical Transcription

By A. J. Kendrick

President, Sound Studios, Inc.

UNDER present business conditions, the expenditure of the sales and advertising dollar probably has been given more intensive analysis than ever before. It is encouraging, therefore, that this study has resulted in a consistent increase in the use of electrical transcriptions as the most effective and economical means of reaching a group of important markets selected to meet the individual needs of each advertiser.

We feel that such a tribute to the soundness of radio broadcasting by electrical transcription holds great promise for the future expansion of this branch of advertising.

Speakers for Greater Power

By Peter L. Jensen

President, Jensen Radio Mfg. Co.

THE design of 1932-33 loudspeakers will depend upon the trend in radio receivers and output tube standards. The trend in

receiver design is toward more undistorted electrical output, whether accomplished by the use of class B amplifier and -46 tubes or by the use of more powerful triodes. This necessitates the employment of speakers capable of handling a greater amount of power. The trend in speakers will therefore be toward the use of a more rugged single speaker, or, what is more probable, the use of multiple speakers. Two speakers, with their natural period slightly staggered will increase the undistorted acoustical output from four to six times. The use of three or more speakers will further improve conditions in the same proportion.

Future of Television in the Cathode-Rays and Ultra-Short Waves

By Hollis S. Baird

Chief Engineer, Short Wave & Television Corp.

THE screen receivers which have come into use during the past few months should be considered only a stepping-stone to home television using cathode-ray tubes. The ultra-short-wave bands and the cathode-ray tube form the only foundation for a successful television system which can compare with our present broadcasting system. In the former we have sufficient channels for the number of stations and in the latter we can go to any reasonable number of scanning elements for detail to compare with home movies.

The accompanying sound will also be sent on the ultra-short-wave band so that the home television will be entirely separate from the present broadcast receiver, and both sound and picture will be operated by one dial.

Widening Radio Horizon

By J. Clarke Coit

President, Radio Manufacturers Association, Inc.

LAST year the radio industry thought it had reached the maximum to give the public the best and most radio for the least possible expenditure. This year we have found, as usual, that we are wrong. It seems demonstrated that in mechanical genius and achievement new progress flows unceasingly from our engineers and laboratories. Progress is notable in new tubes and in the adaptation of short-wave, dual reception, with definite trend toward one-dial, all-wave control. In the development of tone fidelity through improved loudspeakers there is also marked progress notable. All this and more is being achieved and given to the public without a comparable increase in cost. I feel that despite what has been accomplished, radio is still in its infancy and that a widening horizon is opening to those manufacturers who satisfactorily serve the public.

Vertical Broadcast Antennas

By E. K. Cohan

Technical Director, Columbia Broadcasting System

NO longer are the double latticed-work steel towers, which dot the country from coast to coast, exclusively symbolical of a broadcasting station.

Since the middle of 1931 WABC, the 50,000-watt key station of the Columbia Broadcasting System in New York, has made radio news through the exclusive use of a new type of antenna for broadcast transmission purposes: a single vertical steel mast, 7 inches in diameter at the base, 27 feet in diameter at a height of 280 feet, and 665 feet high, over all.

After many months of practical experience with this radical departure from con-



G. J. KELLEY



J. C. COIT



J. F. RIDER



E. K. COHAN

ventional antenna design, the excellent results and increased efficiency obtained justify the prediction that the single mast vertical antenna will become the symbol of the modern broadcasting station.

Direct-Coupled Quality Amplifiers

By Gerard J. Kelley

Consulting Designer

NOW that the public has had its fill of small radio sets, loaded with sacrifices in provisions for good tonal characteristics in order to make possible the low prices that have prevailed, I foresee as inevitable a future public insistence on decidedly better reproduction quality, just as better performance and appearance was demanded after the opening up of the low-price era in the automobile field. From my association with the field, I conclude that serious thought is being extensively given to seeking much of the needed improvement in the use of the most effective direct-coupled amplifier systems now available.

Accurate Analysis in Service Work

By John F. Rider

Engineering Consultant

THE trend of radio servicing presents a very interesting picture, one which indicates that the present radio serviceman will lose his identity as a repair man and become a technician and salesman.

Future radio service will follow in step with modern changes in engineering and the prophecy is made that within a very short time, new methods of radio receiver analysis and service will be introduced. What with the modern idea of speed and the demand for accuracy, radio service work will progress toward more rapid and accurate methods of analysis with less possibility of error and guesswork.

Fewer Tubes, Added Efficiency

By J. J. Steinharter

President, Cable Radio Tube Corp.

MORE than ever before, the trend of 1932 is toward added efficiency in receivers with fewer tubes employed.

The leading tube makers have met this demand, directing development work through two different channels: first, the creation of new-purpose tubes, such as the Speed Triple-Twin, and, second, the redesigning of popular types, resulting in the production of such tubes as the Speed 282, 239 and 248.

New-purpose tubes of increased efficiency eliminate several stages in the conventional chassis with resultant economies in receiver construction. Certain of these types are also especially welcome to manufacturers of sound equipment, public address systems, etc.



J. F. RIDER



E. K. COHAN

Redesigned popular types not only meet the need of space economy, especially in automobile and aviation sets, but afford greatly increased power within their smaller bulb dimensions.

Greater diversification in the use of radio tubes is also increasingly evident this year, in such applications as elevator control, remote control of mechanical apparatus, alarm systems, etc.

Television-Electric Phonograph to Bolster Radio

By Dr. H. H. Sheldon

Chairman, Psychics Dept., New York Univ.

IMPROVED home records with good reproduction and long duration will stage a comeback for the old phonograph.

Television is the only thing that will lure back the large number of persons who no longer tune in because of cheap, blatant advertising. The door is now wide open for good home sound records and will remain so until television is further improved and the air cleared for good picture-program stations.

Increase in Tube Replacement

By E. A. Tracey

Vice President, National Union Radio Corp.

THE presidential election this year should create a sharp increase in replacement tube purchases.

Undoubtedly there are today more sets in use operating with old and inferior tubes than ever before. It is therefore more than likely that the increased use of these sets during the election campaign will burn out many old tubes and emphasize the need of replacing the weak ones.

A great profit opportunity thus exists for manufacturers, jobbers, dealers and servicemen. A sales plan specifically pointed toward this market should be highly productive, and the ability of each unit of the industry to devise a strong contemporaneous sales appeal will, in a large measure, determine their degree of success in this most profitable division of the tube market.

Future Trend of Electrolytic Condensers

By G. C. Mercer

Sales Manager, P. R. Mallory & Co., Inc.

WHEN the radio industry first felt the need of a less expensive and more compact filter unit, the wet electrolytic condenser was brought forward and filled the immediate demands.

The wet electrolytic has been displaced rapidly by the dry type, which is more adaptable to the mechanical layout of the radio chassis and has superior electrical characteristics.

Even though the dry electrolytic is the best obtainable at the present time, its development is by no means at a standstill.

(Continued on page 1046)

BECOMING VERSED IN RADIO TRANSMISSION

SHORT WAVE

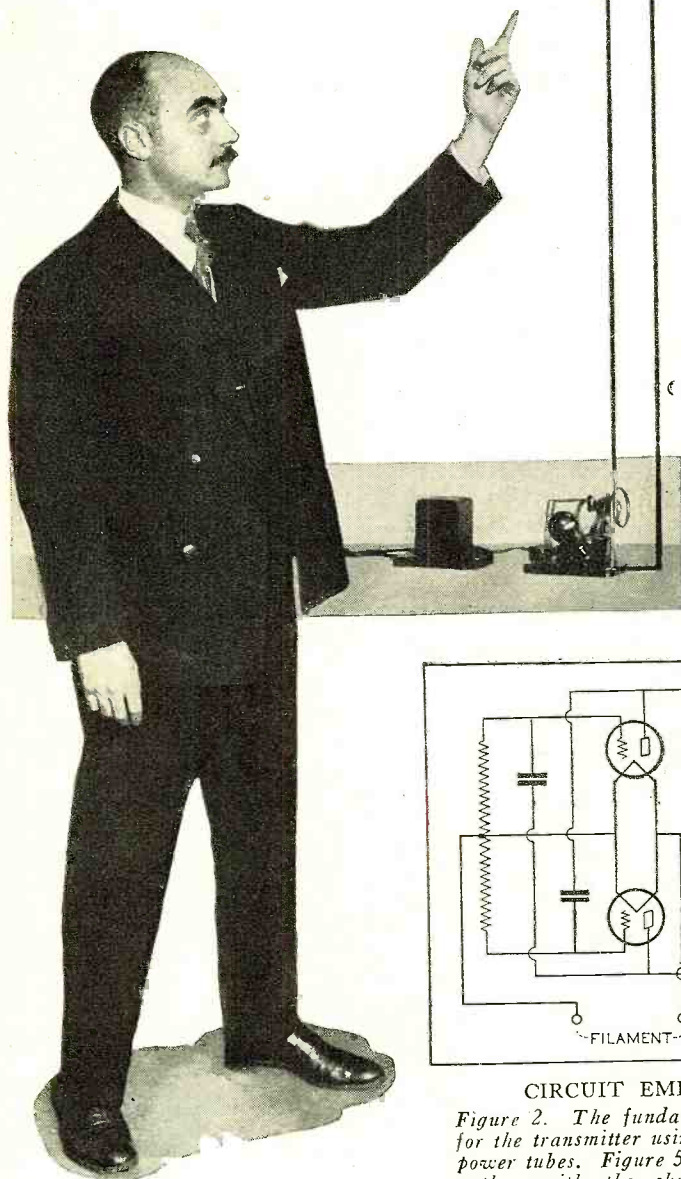

The increasing recognition of the ultra short-waves makes it important the fundamental principles involved and these frequencies. The author points be made in the home or school laboratory illustrate short-wave operation and be invaluable to both

As there is, electrically and mathematically, a close relation between the electromagnetic waves of ordinary radio-frequency ranges and this latter type of ultra-short electromagnetic waves, it is possible to make an almost direct analogy study of radio phenomena in the broadcast band and for general communication purposes.

Efficient short-wave apparatus for experimenters and lecturers has been built in different sizes and upon a number of different physical principles. One of these types of apparatus shows the action of radio waves in interrelation with the phenomena of physics, especially optics; it was designed and built with standard parts of experimental equipment by the Central Scientific Company of Chicago. Figure 1 shows a close-up of this apparatus which is used as a transmitter.

Simple Transmitter Unit

The electromagnetic oscillations are impressed upon one single winding of copper ribbon, about $3\frac{1}{2}$ inches in diameter, strong enough mechanically so as to stand without mechanical support. These oscillations are generated in this winding by two tubes of the 210 type which are wired in push-pull. The voltage is applied to the plates of the tubes through a choke coil which taps the center of the above-mentioned single winding. Between 20 and 30 turns of insulated copper wire, wound around the outer surface of an average test tube (for chemists) is used in this particular case as a choke. One end of the test tube is closed by a cork which is fastened to the panel of the apparatus so that the choke stays erect.

Figure 2 shows the wiring diagram of the above-mentioned short-wave apparatus.

The grids are connected by a leak which is tapped in the center and connected at one side to the filament and on the other side to the filament winding. This transformer can be plugged into any house circuit of 110 volts alternating current. The secondary delivers the plate voltage of about 500 volts and the filament current for the tubes. In the actual experimentation, however, it is important to remove this transformer away from the vicinity of the short-wave generator! The voltages are carried to the latter by about six feet of insulated wire. Great metal masses have to be avoided in the neighborhood of the ultra-short-wave generator, as they would interfere with the high-frequency electromagnetic field. This holds true even in a more general way. Make sure, in working with a short-wave transmitter in this frequency range, that you have no metal parts in the neighborhood of the transmitter. For instance, in the drawer of the table upon which the transmitter is placed often are metal tools. They are sometimes an unsuspected source of trouble in this kind of experimentation.

The electromagnetic wave energy can be radiated by a bi-pole antenna which is connected to the self-induction winding.

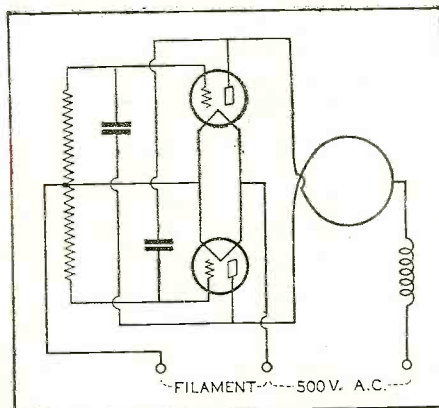

CIRCUIT EMPLOYED

Figure 2. The fundamental diagram for the transmitter using two type -10 power tubes. Figure 5, at the left, the author with the short-wave set-up pointing to a Lecher-Wire system

By Irving J. Saxl, Ph.D.

THE advance of the radio sciences depends largely upon the fact that the fundamental principles of radio are fully understood and so thoroughly known by experimenters and engineers that a background is given for the design of new and improved types of apparatus. In bringing about this deeper understanding of the basic underlying facts of radio transmission and reception, the teacher has heretofore been confronted with the difficult problem of bringing to the understanding of the pupil experiments which were too complicated for an average experimenter to make or for a lecturer to show in a classroom of usual size. This has been especially true with experiments in the laboratory with actual radio waves.

Now the development of an efficient ultra-short-wave outfit makes possible conducting those experiments within a limited area and, at the same time, to show the actual facts which are necessary to a clear demonstration of the nature of radio phenomena.

PHENOMENA BY PERFORMING THESE ULTRA

EXPERIMENTS

possibilities for communication on the that radio men in all fields understand the characteristics of transmission on out how a number of experiments may or in the lecture room that will clearly transmission. The set-up described will experimenters and teachers

In Figure 1 the two rolls of copper sheet metal are clearly visible and the bipolar antenna can be plugged in simply in these cones. They are inserted opposite each other so that one rod comes out at the left side of the transmitter and the other rod out of the right side.

First we have to know something about the frequency or wavelength with which we are working. In Figure 1 there also is shown a wavemeter which measures these ultra-short wavelengths. It consists, mainly, of a coil which has only one single winding of copper wire which is rigid enough to keep it firm. In series with this coil a little variable condenser is connected, thus making a simplified oscillating circuit which can be brought into resonance with the transmitter by turning the dial of the condenser and so varying its capacity. Attached to the loop is a small flashlight bulb, the second terminal of which is attached to the copper turn about 90 degrees apart from the first connection to the winding. By turning the condenser carefully so that the little lamp indicator shows a maximum of light, we can find easily the point of resonance.

Lecher-Wire Wavemeter

In Figure 3 is shown a calibration chart for this wavelength. On the horizontal axis the scale divisions of the panel are marked. At the corresponding point of the vertical axis the wavelength can be read directly.

Another method of measuring the wavelength directly and making visible the voltage and current maximum is by the Lecher-Wire method.

The waves are propagated along a pair of practically parallel wires which, as shown in Figure 4, are attached to the wall or ceiling support by means of insulators. The distance between the two wires has to be small in comparison with the wavelength and, naturally, the diameter of each wire has to be small too in comparison with the wavelength to be experimented with. The oscillator is coupled to the antenna system by one single loop as shown. These parallel wires are bridged at a definite distance from

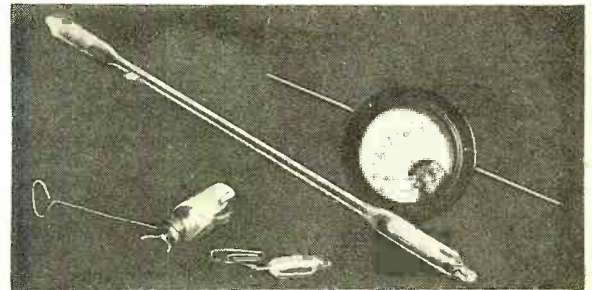

DEMONSTRATING EQUIPMENT

Figure 6. Here is the wave-demonstrating equipment necessary for the experiments. At center is the long neon glass tube. At right is the meter for indicating current waves. Below at the left is an incandescent lamp and a neon lamp for picking out nodal points

the oscillator by a metallic conductor. The waves traversing the wires are reflected back from this conductor and thus "standing" waves are generated.

In Figure 5 the actual arrangement is shown. The wires were extended through the length of the RADIO NEWS laboratory and insulated from the walls by proper insulators. The author points to a little neon tube which has been moved along and between these two wires until it shows light at a certain point. Several of these lighting positions can be found along the parallel wire system. The distance between these points will be always equal if we have to deal with a pure sinusoidal wave form. The point where the neon bulb lights up corresponds to a maximum of voltage. In attaching a tape, parallel to those wires, and putting down the points where the lamps glow brightest, corresponding to the voltage maxima in numeric readings, we are able to determine by actual measurement the wavelength of the particular radiation we are using.

Instead of a single little neon bulb connected to the wire, a longer tube filled with diluted gases can be used which connects without metallic conductance both of the wires. Such a larger bulb is shown in Figure 6. In the same picture are shown also several other apparatus for finding out about the voltage and current characteristics of these electromagnetic waves. We see, at the right side, a thermogalvanometer for measuring the high-frequency currents of small amperage. Protruding from both sides of the galvanometer are metallic wires. With these two wires which are connected to the binding posts of the thermo-galvanometer, this instrument can be

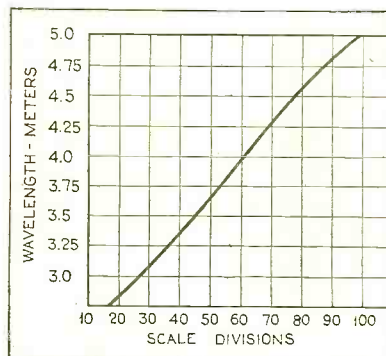

CALIBRATION CURVE

Figure 3. Shows wavelength of meters plotted against scale divisions on the dial of the wave meter

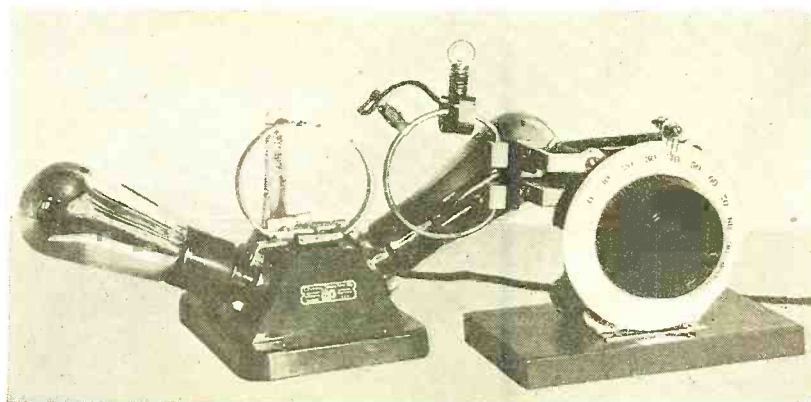

A CLOSE-UP OF THE TRANSMITTER

Figure 1. Shows the transmitter at left and a simple wave meter at the right for making short-wave experiments. The wave meter is calibrated for wavelengths between 3 and 5 meters, as shown in Figure 3

WAVE SET-UP

Figure 4. At right is the set-up, including generator, Lecher antenna, wave meter, galvanometer, neon indicating lamps and equi-potential link

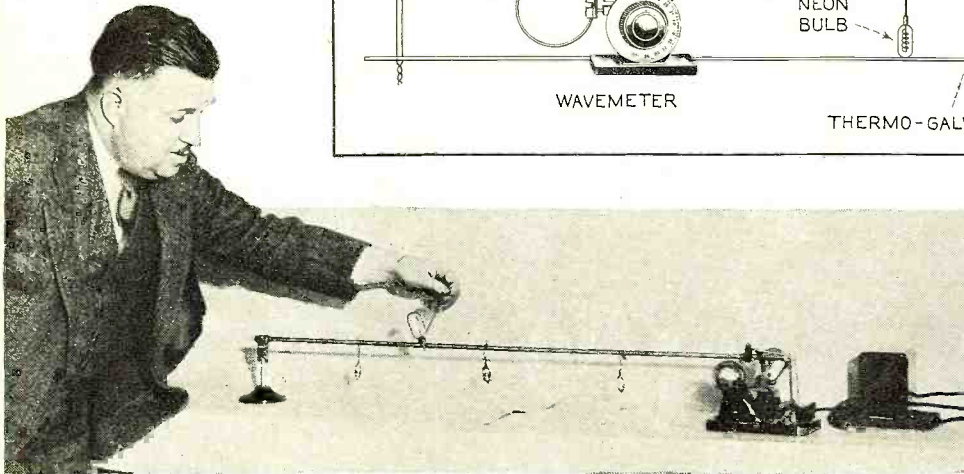
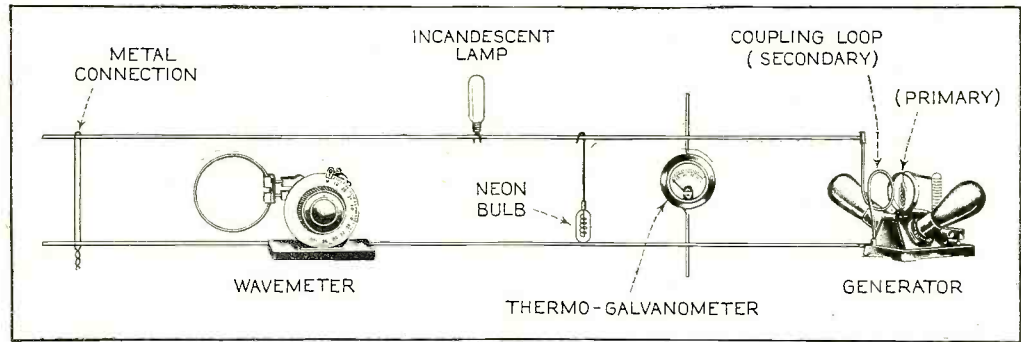

MEASURING WAVES

Figure 7. At left is an actual experiment with a "shortened" antenna with the small neon bulbs glowing brightly at voltage peaks

slid along, contacting the two antenna wires at various points. It will then show differences in its deflection, the maximum current being indicated just half-way between the points where the neon bulbs lighted up. In the foreground of this picture is also shown one of the little neon bulbs which have to be connected by wire to the Lecher system. With the aid of the neon bulbs and the galvanometer we can find out exactly about the distribution of the current maximum and voltage maximum between the wires. Where the voltage is a maximum, we do not find any high-frequency current and where the current is a maximum, we have a minimum of voltage. Instead of the galvanometer we can use a less expensive instrument which also gives a clear determination for the purpose of general demonstration. This is a small incandescent lamp. One side of its filament is connected to the wire by a sliding attachment; the other end of the filament can be attached to the other wire or simply held in the hand, the capacity against ground building the second connection for the flow of electric current through the bulb. The lamp glows where we have to deal with a current maximum.

"Seibt" Coil Antenna

This is shown clearly in the experiment, Figure 7. In this set-up only one single wire is used instead of the Lecher wire. For shortening the actual distance of this wire and for increasing its self-induction, the wire is wound around an insulating body (a glass tube), thus condensing into a more handy dimension the whole length which the Lecher system would have. Coils for this type of demonstration were used first by Seibt. Instead of the second wire, the capacity of the first wire against ground is used. We see little neon bulbs hanging at equal distances from the "wound-up" antenna wire, indicating by their glow the "voltage" maxima. In the center between the neon bulbs the incandescent lamp is held by Mr. Cockaday. The filament of the incandescent lamp glows at this point, indicating that we have to deal at this point with a "current" maximum.

With these two experiments, the experiment along the Lecher wire and along the Seibt coil, it is possible to make clear to a large audience the distribution of voltages and current at high-frequency oscillations along metallic conductors and as standing waves. How are these oscillations, however, radiated into space?

Figure 8 tells us something about this point in wave distribution. The author is holding in this picture two bipole antennas, each acting as a separate receiving system. Connected in the middle of each of these antennas is a flashlight bulb. If current is generated in this "receiver," the bulb lights up. The energy for lighting up this lamp is transmitted "free" through space and there is no wired connection to the transmitter. Nevertheless, the received energy is strong enough so that sufficient current is provided for the lamp to give it a brilliant glow.

Reception Demonstration

If the lamp lights up, it is an indication that current is going through the receiver. By observing the light intensity of this bulb at different positions of the receiving bipole antennas, interesting facts can be found about the distribution of radiant energy in space. In the experiment pictured above, the high-frequency oscillations had to travel partly through the body of the experimenter. Nevertheless, the lamp glowed intensively if the bipole was held parallel to the receiving bipole. The body of the author had absorbed only very little of the radiated energy of this high frequency. The same waves, however, are absorbed to a large extent by the bipole held in the hand which is brought into resonance by adjusting it to the proper length. These bipolar antennas consist of hollow tubing, and within the tubes rods slide in and out so that the length of the antenna can be varied. Thus the length can be adjusted to the wavelength where the lamp glows strongest, indicating that it is in "resonance." In this case the length of the bipole corresponds to half of the entire wavelength. (Continued on page 1051)



EFFECT OF POLARIZATION

Figure 8. The author holding at right angles two similarly constructed bipoles. Each bipole has at the center of its length a small lamp which lights when current flows in the circuit. Notice that the lamp in the horizontal bipole is glowing, while the lamp in the vertical bipole does not glow. This is because the transmitter on the laboratory table is sending out horizontally polarized waves which cannot be picked up nearby with a vertical antenna

\$ 10,000.00 a Year for SERVICE



FOUR years ago, Bill Benson was playing with radio. He still is, but he gets paid for it to the tune of \$10,000 a year! Bill is just an ordinary fellow with a genius for being practical and resourceful. When he found his service business slipping with the depression, he immediately cast about for new sources of income and hit upon one of the most profitable stunts of his short business career. A friend of Bill's, the owner of a small tobacco shop on one of the main stems of a large Western city, complained about bad business. Bill suggested a remedy—a remedy that only a serviceman could provide.

Placing a grid-glow tube in the store window and connecting it to a small relay, a power relay and a fractional horsepower motor with a multi-colored wheel on its shaft, Bill produced a powerful advertising medium. Responding to a sign over the grid-glow tube, passersby placed their hands near the grid-glow tube and thus started the motor. It was not long before the mysterious performance of this gadget attracted scores of people and the little tobacco shop began to do a better business than it had done even in normal times. There was always a curious crowd before the window, and when several nearby merchants began to inquire about this business-producing experiment, Bill got his big idea.

Why not, he argued with good business sense, build up a

By Carlton H. Hess

How an Alert Serviceman Keeps His Business Buzzing with New Ideas and New Sources of Income

few of these machines with different sorts of motor-driven devices, and rent them to business men by the week on a contract basis? He "went to it" and before he had the second one put together he had eleven rental contracts signed for a total of twenty-six weeks at \$35.00 a week. But that was only a modest beginning, for Bill now has fourteen of these simple little machines working for him and he has spread his business so that he now works the smaller towns in the outlying districts. Bill figures that this one idea, which is certainly not beyond the average serviceman, nets him about

\$6,000 a year. This in view of the fact that he also employs two expert helpers and gives them decent salaries.

In the town where Bill lives there are two large brokerage offices. Putting on his best suit, Bill called on the office manager of the largest house and offered,

free of charge, to place a public address system in the board room for trial and at no obligation. This, Bill argued, would be invaluable in announcing special pieces of news that came over the ticker. It was—so much so, indeed, that the manager of the office would not permit him to remove it. Bill collected a neat check for \$225.00 and waited. Just what he thought would happen did happen. A few days after he had sold this outfit he sent a note to the other two brokers and told them that he was able to install P.A. systems at very reasonable rates. Just as soon as these fellows (Continued on page 1059)

THE MOST RECENT DEVELOPMENTS IN Triple-Twin Amplifiers

The introduction of the Triple-Twin tube has created an interest comparable with that aroused by direct-coupled audio circuits two or three years back. Information of a practical nature concerning the use of the new tube is presented here

By Sidney Fishberg*

THE Triple-Twin tube offers excellent possibilities as a power amplifier tube, possessing, as it does, a very high-power sensitivity and requiring only a 250-volt plate supply. The high gain of this tube allows of unusually small input voltages. Looking at Figure 4, for instance, we see that only a 5-volt grid swing is necessary to obtain an output of 4500 milliwatts, whereas the -50 type tube requires an 84-volt grid swing for an output of 4600 milliwatts. It is therefore evident that by using this new type -95 tube in place of a -50 tube, the input need be only 1/17 as large to obtain the same output. Besides, the plate power supply can be smaller and cheaper, since the plate voltage of the -95 tube is only 250 volts. A third desirable feature of this tube is the fact that the load impedance is 4000 ohms, a standard value. This means that there is no need for special apparatus. In fact, very little apparatus of any type (excluding power supply equipment) is required in Triple-Twin amplifiers.

A newly developed amplifier using the Triple-Twin tube and intended for use as a phonograph and speech amplifier is illustrated in Figures 1 and 2, and shown in schematic form in Figure 3. It will be seen that in this amplifier a -27 tube precedes the -95 tube. This tube is used to obviate the necessity for carefully matched input transformers. The output of the average high-quality microphone or phonograph pick-up is approximately .25 to .50 volt. In order to raise this level to that required for maximum output, either a matching transformer or a stage of

amplification is necessary. In this amplifier a stage of amplification was chosen because matching transformers, especially phonograph-matching transformers, are quite expensive and often hard to obtain. The utility of a single stage of amplification preceding the -95 tube may easily be seen from the curves shown in Figure 4. An ample reserve of voltage amplification is furnished by this tube; in fact, a .5-volt signal fed directly to the grid and cathode of the -27 tube will produce more than rated output. When a matching transformer is used, the input voltage for maximum output may be much lower, even if the impedance match is not exact.

Referring to the schematic diagram, Figure 3, it is seen that the input to the amplifier is direct to the grid and cathode of the -27 tube. This "universal" type of input permits the use of any input device, whether it be phonograph pick-up, microphone or radio detector. When using a microphone, a 500-ohm resistor should be connected across the input terminals in order to afford a closed circuit for the microphone current. When using a detector tube as input, transformer coupling is desirable.

The grid and plate circuits of the -27 tube are thoroughly by-passed by means of resistance-capacity filters to prevent degenerative effects, so that the fidelity in the -27 stage may be comparable to that in the output stage. The effectiveness of this filtering may be seen from a comparison of the overall fidelity curves of this amplifier and the fidelity curves of the -95 tube itself. The -27 tube is coupled to the -95 tube by means of a 2:1 audio transformer of high primary impedance. The

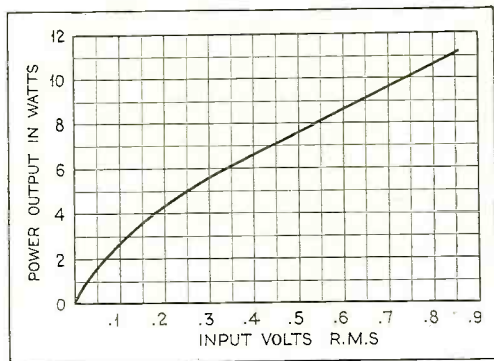

POWER OUTPUT CURVE--PUSH-PULL -95 AMPLIFIER

Figure 9. Power output for various voltages applied to -27 tube grid

*Chief Engineer, Baltimore Radio Corp.

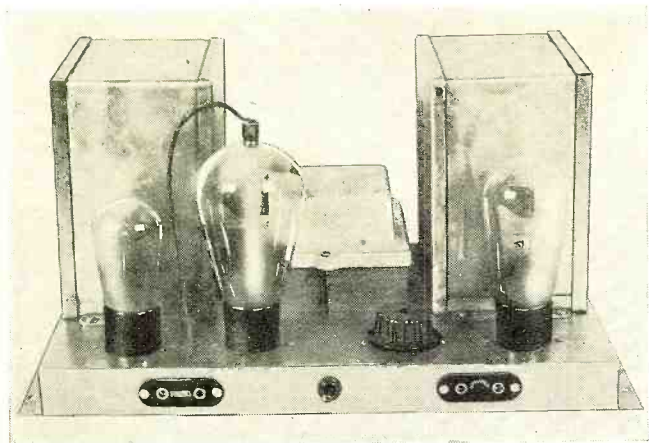

THE SINGLE TRIPLE-TWIN AMPLIFIER

Figure 1. This unit is compact and simple, yet constitutes the equivalent of a three-stage amplifier of the conventional type

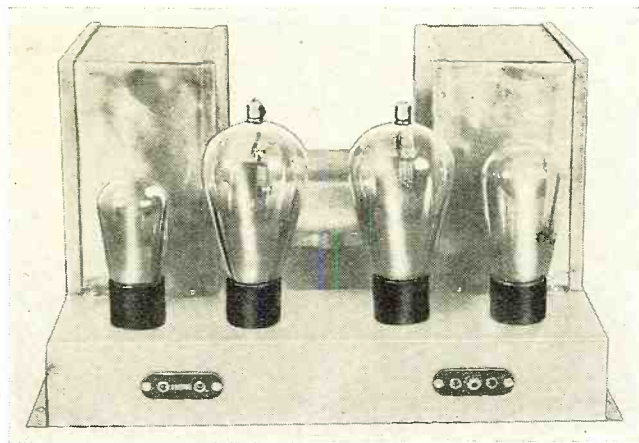

A PUSH-PULL TRIPLE-TWIN AMPLIFIER

Figure 8. When compared with an amplifier using type -50 tubes and having the same power output-to-signal-input ratio, this unit is unusually compact

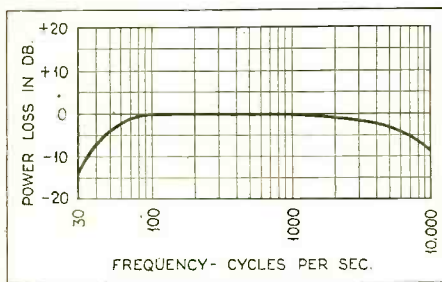

FIDELITY CURVE

Figure 5. This curve represents actual measurements with resistance input and resistance output

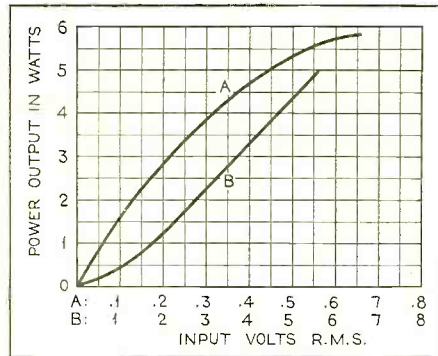

POWER OUTPUT CURVES

Figure 4. The curve "A" read against scale "A" represents the output power with input voltage applied to -27 tube grid. Curve "B" shows output for voltages applied to grid of the type -95 triple-twin tube

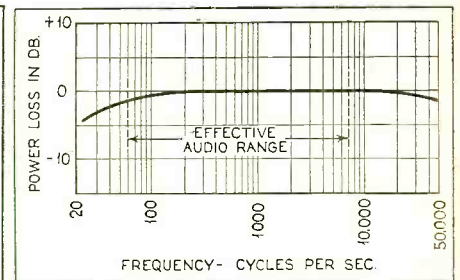

CURVE OF TUBE ALONE

Figure 6. Here also measurements were made with resistance-coupled input and resistance load

overall gain of tube and transformer is approximately 14 times, or 23 db.

The -95 tube is used as in the amplifier circuit described in the March issue of RADIO NEWS. The constants of the various components are given in Figure 3. The capacities of C1 and C2 are 2 mfd. each. While the recommended value of C2 is 25 mfd., the loss of low frequencies due to decreasing its capacity to 2 mfd. is not at all discernible to the ear. The value of C1 is not critical and may vary from .5 to 2 mfd. The by-pass choke L1 has an inductance of 15 henries and a d.c. resistance of 200 ohms. It is desirable to have the resistance of this choke as low as possible so that the voltage drop in it will be low and the bias of the first section of the Triple-Twin not increased too much.

The power supply is conventional in most details. It is worthy of note that the inherent hum level of the Triple-Twin tube is exceedingly low. The filter system consists of a heavy 50-henry choke shunted by two 4 mfd. condensers. The adequateness of this simple filter is shown by the fact the hum level is 43 db. below the maximum

signal level of the complete amplifier.

The Triple-Twin tube may be used in a push-pull circuit when it is desired to obtain large power outputs with low distortion. Two of these tubes connected in push-pull are capable of delivering up to 15 watts with less than 3% distortion. A consideration of the Triple-Twin circuit shows that the ordinary push-pull circuit, in which the input transformer has a grounded center-tap, cannot be used because the signal circuit of the input section is connected between cathode and ground. In order to keep this circuit separate in the two tubes it is necessary to use a circuit completely symmetrical about the ground line. This, of course, demands a transformer with a split secondary winding. The circuit of such an amplifier is shown in Figure 7, while the amplifier itself is shown in Figure 8. The values of the various components are the same as for the single circuit, with the exception of R6, which is now half of its previous value. Resistor R6 and the tube filaments are the only elements which are common in the push-pull circuit. The output

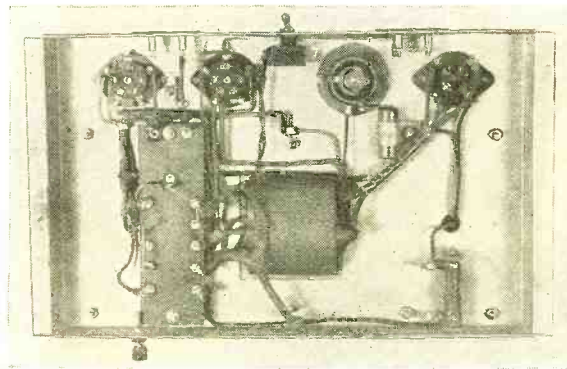

BOTTOM VIEW OF AMPLIFIER

Figure 2. This view provides a good idea of the simplicity of this new amplifier

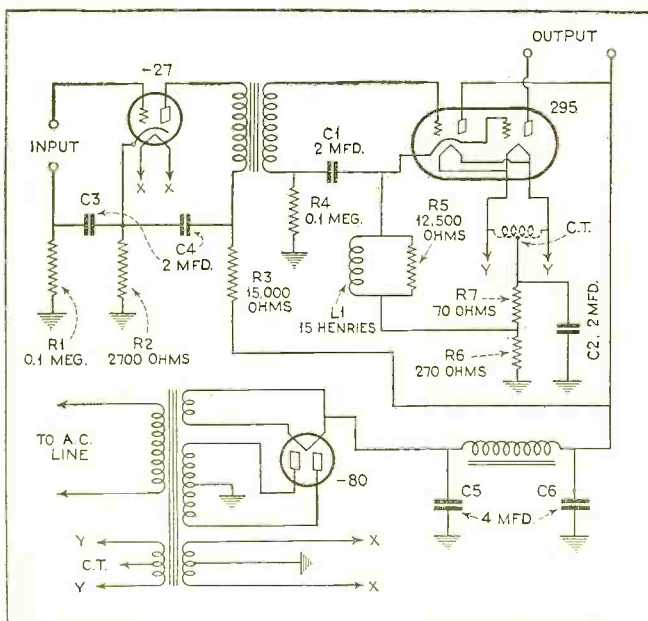

CIRCUIT OF -95 PUSH-PULL AMPLIFIER

Figure 3. The -27 tube is used as a universal coupling tube and permits the use of phonograph pick-up or microphone inputs without the usual matching transformers

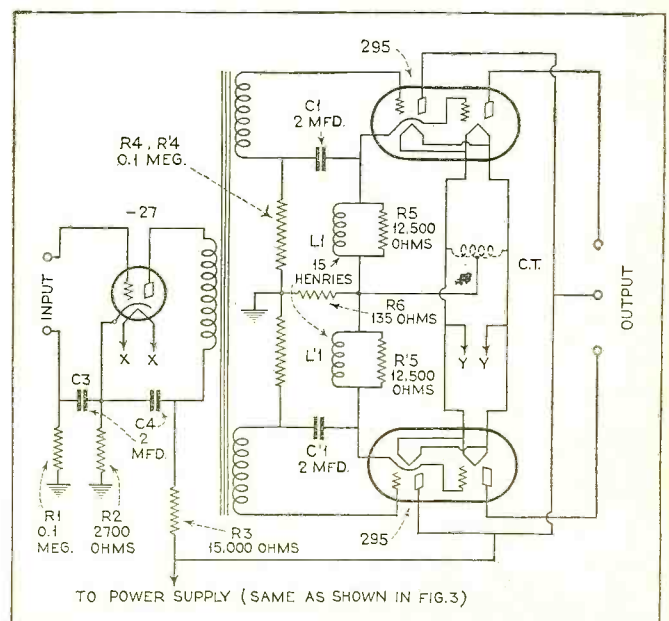

CIRCUIT OF THE -95 AMPLIFIER

Figure 7. Note that the push-pull input transformer requires a split secondary; for reasons explained in the text a center-tapped secondary cannot be used

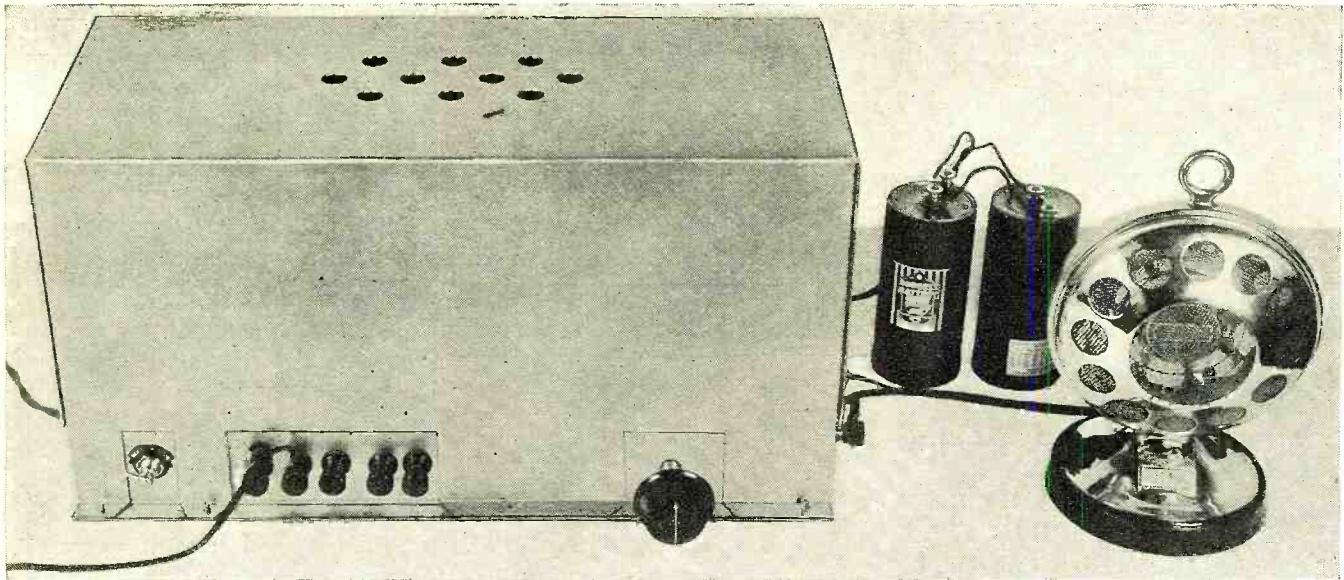

THE COMPLETE A.C. AMPLIFIER AND MICROPHONE EQUIPMENT

The amplifier and power supply are completely enclosed in a rust-proof metal case 14¾ inches long, 7½ inches high and 6½ inches deep. This provides an unusually neat appearance and complete protection against tampering

RADIO NEWS

A. C. MULTI-EAR AID

The group hearing aid field offers unusually profitable opportunities for the serviceman and radio builder. The new equipment designed by the author and described in this article is ideal for the purpose and can be installed at a surprisingly low cost. It also constitutes an excellent individual hearing aid of the non-portable type for those who are extremely hard of hearing

THE equipment described in this article was designed primarily for installation in churches, meeting rooms of the hundred-odd leagues for the hard-of-hearing in the United States, theatres, lecture halls or, in fact, in any location where it is desired to provide accommodations for deaf persons to enable them to hear speeches, sermons or music. The equipment is powerful enough so that more than a hundred headphones can be operated at a volume level that will permit even the extremely deaf to hear clearly, yet is so flexible that a single person can use the microphone, amplifier and a single headphone as an individual hearing aid of the non-portable type for permanent installation in home or office. In the design of the equipment every effort was made to provide an ideal device for these purposes, and the tests conducted during and after the completion of the design indicate an extremely close approach to this standard.

The prime requirements for an efficient device for these usages are listed as follows:

(1) Quality of voice reproduction must be excellent, preferably with some

By S. Gordon Taylor

emphasis on the higher frequencies where hearing loss is likely to be greater.

(2) The volume level at the headphones must be high enough to be easily audible—even to a person with such an extensive hearing loss that one must shout in his ear to be heard.

(3) Individual control of volume at each headphone is essential in order that each listener may adjust the volume level to meet his requirements, yet the arrangement must be such that varying the volume control at one outlet does not effect the volume at others.

(4) The headphones provided for the listener must be light in weight, comfortable to wear and capable of handling high volume without rattling or distortion.

(5) The entire system must be dependable and should require the minimum of operating and maintenance attention.

(6) The entire system must be easy to install, avoiding series-parallel wiring arrangements in the output system, etc.

(7) The cost must be kept down to a reasonable figure.

(8) Where alternating-current lighting supply is

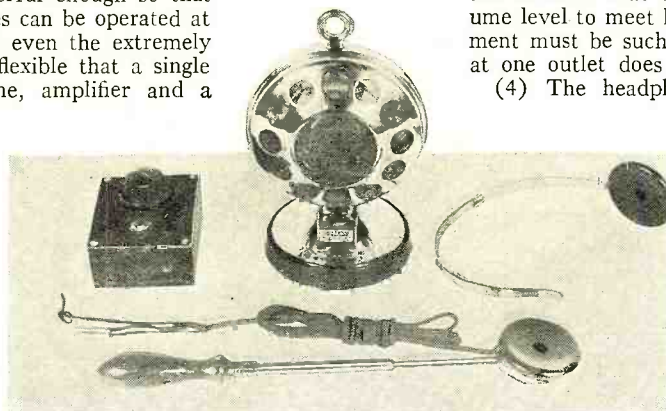

INPUT AND OUTPUT ACCESSORIES

A single microphone serves the entire installation. One outlet box, a headphone, with handle or headband, and a phone plug (not shown) constitute a complete individual outlet. The amplifier has ample power to operate well over a hundred such outlets

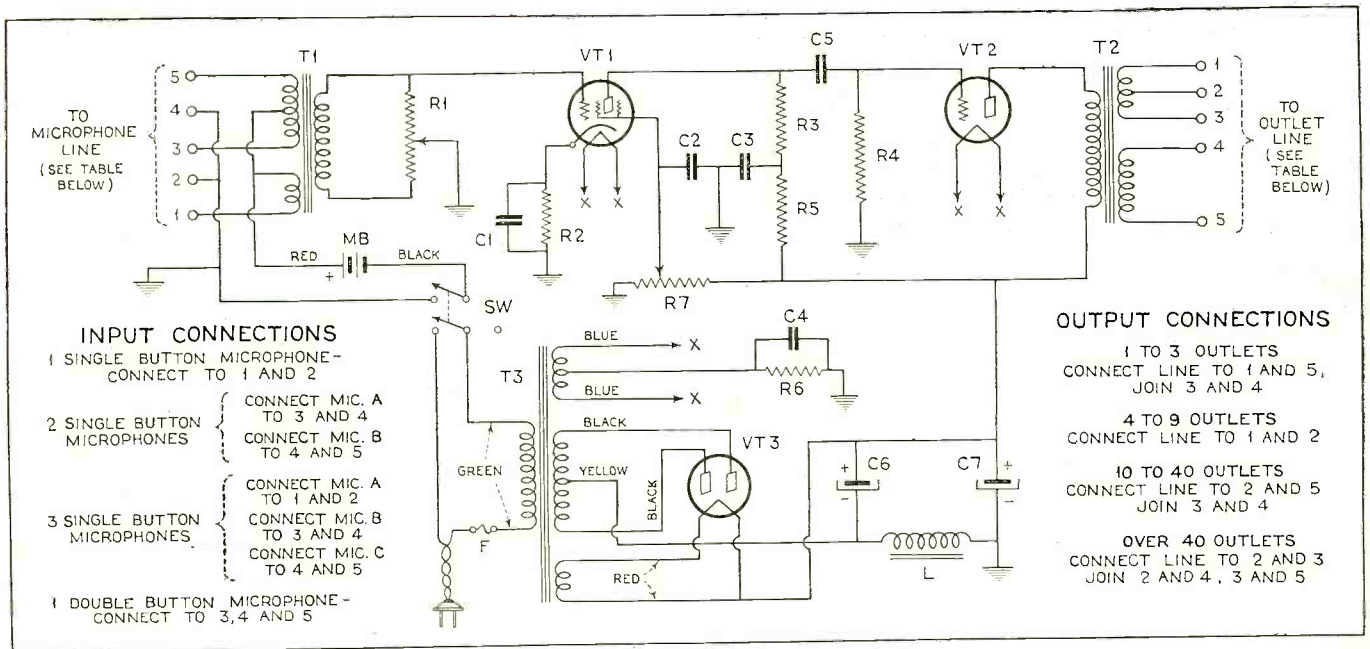

THE SCHEMATIC CIRCUIT OF THE AMPLIFIER

Figure 1. The input transformer (T1) has a universal primary to accommodate one, two or three microphones, the proper connections being shown in the table at the left. Table at right shows proper output connections for any number of headphones. Note that the filter choke (L) is in the negative side of rectifier output. This placement provides absolute stability

available, the system should use this for operating power, eliminating batteries.

(9) If a.c. operated, the hum must be eliminated entirely, or at least kept down to a point where it is not noticeable even to a person of normal hearing and is not at all perceptible to a person of sub-normal hearing.

(10) All parts of the equipment must be neat in appearance and so designed as to prevent tampering by unauthorized persons.

It would seem that these qualifications would be hard to meet in any single device, especially in one of low cost. Yet they have been met almost 100% in the A.C. Multi-Ear Aid, as follows:

(1) The quality of reproduction is such that it is easy to recognize a person's voice and the characteristics of individual speech. The sibilants, such as the "S" sounds, are brought out brilliantly, whereas they are too often lost in ordinary hearing devices for the deaf.

Musical reproduction is pleasing. To a person of normal hearing it would be rated at least "good," while to the average hard-of-hearing person it is likely to rate an "excellent" mark because of the slightly increasing emphasis on the higher frequencies.

(2) With a hundred headphones in the output circuit the volume level is still sufficiently high to permit a hard-of-hearing person to hear the rustling of paper three feet from the microphone who, with the unaided ear, hears nothing of ordinary conversation and who cannot hear a sermon from the front seats in a church. This same subject can also understand a whisper at three feet from the microphone which with his unaided ear against the speaker's lips he could not understand at all. With only a half dozen headphones connected in the output circuit, one subject who normally can barely hear words shouted directly into his ear could understand

(Continued on page 1054)

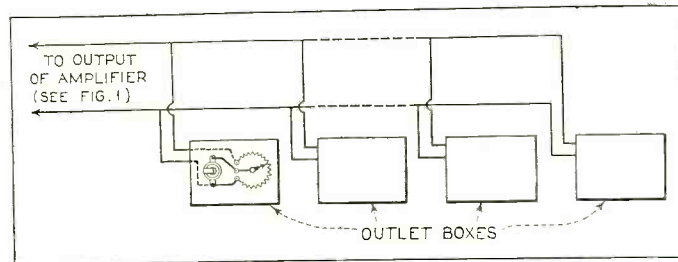

THE OUTPUT LINE

Figure 2. This line may be of any desired length to permit most convenient location of outlet boxes. All boxes are connected in parallel to the line. Each box includes a phone jack and volume control and is connected to the line as indicated by the broken line in the detail drawing

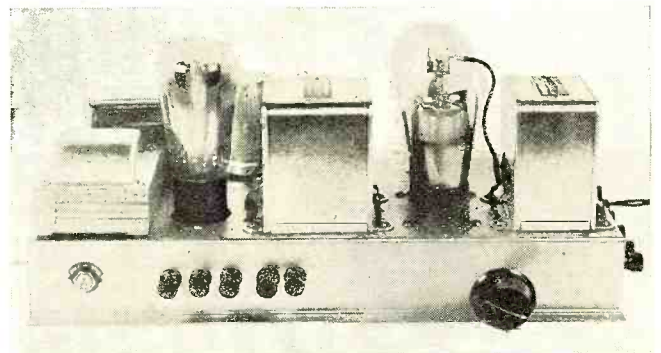
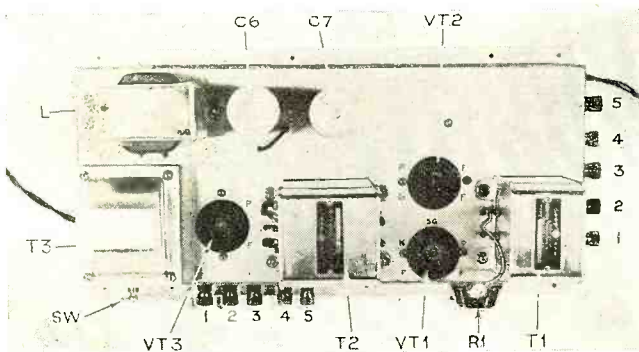

THE TOP AND FRONT VIEWS WITH COVER REMOVED

A simple and attractive layout with the power equipment well isolated from input circuit to eliminate hum. With cover and baseplate in position, all parts are inclosed and secure from tampering

AN INTRODUCTION TO THE VARIOUS PHYSICAL Phenomena Underlying Radio

Radio apparatus of today, including television, uses practically all of the physical phenomena capable of being controlled by science. Devices which can be assembled within the space of a few cubic feet involve actions and energy transformations ranging over the whole domain of physics. Sound, heat, light, electro-static and electro-magnetic changes, as well as the dynamics of moving parts, are linked together in a chain of interactions which require study if we are to understand them

BEFORE passing to a detailed discussion of hot filaments, cathode streams of electrons, the production of light in neon tubes which are used in television, the polarization of light and its modification in light valves such as the Kerr and the Karolus cell,

By E. B. Kirk
Part Two

magnetic actions used in special apparatus, crystal oscillators, and certain chemical effects, a tabulation of some of the ways in which heat and electricity can be produced may be useful. Tabulations of light, sound, and magnetic actions will be given later, together with a list of special effects.

Actions Which Liberate or Absorb Heat

Mechanical: Transformation of mechanical work into heat.

1. *Friction:* The rubbing of one body against another. Davy melted ice by rubbing two pieces together while both were many degrees below zero.
2. *Internal Friction:* Due to the relative motion of the molecules or parts of a fluid (liquid or gas). Water, if stirred, gets warm. Joule determined the mechanical equivalent of heat in this way.
3. *Bending or Twisting:* An automobile tire heats appreciably at high speeds.
4. *Shearing, Tearing and Boring:* Metal turning from a machine lathe may become red hot. The boring of a cannon gave Rumford the idea that heat and work were connected in a quantitative way.
5. *Compression and Stretching:* Air, if compressed, becomes heated. Sound waves are alternate compressions and rarefactions.
6. *Impact:* A piece of iron, if hammered, becomes heated.

Radiation:

Energy in the form of waves, such as light, ultra-violet, X-rays, gamma rays. If radiant energy of any wavelength falls upon a body, some of which, at least, is absorbed and which appears as heat.

Electrical:

1. *Flow of a current* usually results in the liberation of heat. Under some special conditions heat can be absorbed, as when a current is sent from the cold to the hot part of a piece of copper.
2. *Induction:* Eddy currents cause heating in transformer cores. Cathodeless ring discharges: high potentials induced in a gas cause luminescence with the liberation of heat.

3. *Impact* of a stream of electrons: heating of the target of an X-ray tube.
4. *Magnetization: hysteresis;* friction due to the rapid internal rearrangements of the atoms or molecules of a magnetized substance when placed in a fluctuating magnetic field.
5. *Electrostatic changes* produce heat in the dielectric of condenser.

Physio-chemical:

1. Melting, freezing.
2. Evaporation, condensation, liquifaction.
3. Crystalization.
4. Dissolving, precipitation.
5. Electrolysis: as in electro plating.
6. *Luminescence* (as distinguished from pure temperature radiation).
 - a. *Fluorescence:* as in a cathode ray tube.
 - b. *Phosphorescence:* material stimulated by light continues to glow after stimulating light is removed.
7. The fracture of certain crystals results in the production of light and heat (Tribo-luminescence) and electric charges—laminae of mica when separated—sugar when broken in the dark produces flashes of light.
8. Radioactivity gives rise to the liberation of large quantities of heat.

Chemical Changes:

1. Combination, separation and rearrangement of atoms or molecules: combustion, rusting of metals, chemical actions within the living organisms.

In fact, *no change* in the physical or chemical state of a body can take place *without* the appearance or disappearance of heat. In the interchange of one form of energy into another there is always a portion of the energy which fails to follow the desired conversion and appears as molecular or radiant heat. There is always a quantitative relation between the disappearance of one form of energy and its reappearance as another; these relationships are expressed in different units

for the different transformations that are being considered.

Since all energy tends to take the form of heat, it seems that the world as we know it is slowly dissolving into heat. Physicists have said that if a perfectly efficient process (which we do not know of) of turning heat back into higher forms of energy is not taking place somewhere, the universe must eventually "run down" to a dead level of a perfectly uniform distribution of heat, a perfectly homogeneous field of warmth.

Actions Which Produce Electrons or Ions

Mechanical Action:

1. *Contact*: similar or dissimilar substances. Simply touching dissimilar substances or even two pieces of the same substance in dissimilar states (heated, magnetized for example) will give rise to electric charges.
2. *Strain*: change in the form of a body. Bending, twisting, shearing, tearing, boring, compressing and stretching of a material gives rise to electric charges.
3. *Impact*:
 - a. One body against another.
 - b. Atoms against each other—thermal agitation.
 - c. Electrons against atoms—cathode rays, beta particles, ions moving under the influence of a magnetic or electric field will tend to produce additional (secondary) electrons and ions.
4. *Friction*:
 - a. Dissimilar substances—rubber and fur, etc. Snowflakes passing through the air may become electrified so as to cause an antenna to become highly charged, giving sparks several inches long. Escaping steam carries a positive charge.
 - b. Same substance in different or the same state. Air currents give rise to atmosphere electricity.

Heat:

1. *Thermo-electric Effects*:
 - a. Within the same material—Thomson effect.
 - b. Between different materials—Seebeck, Peltier effects.
2. *Thermionic Effects*: Emission of ions and electrons from hot bodies.
3. *Pyro-electric Effects*: Potentials developed on crystals when heated.
4. *Thermal Agitation*: Production of electric charges on heated bodies.

In these lists we see many actions which are common to both. Theoretically as we have seen before, whatever produces heat produces electrical changes, for both actions involve the electrons, and what has been said for heat can be repeated here: any change in the physical or chemical state of a body tends to liberate electrons. In any electrical change

Light: Radiant energy is capable of liberating electrons.

1. *Photoelectric Effects*—as employed in photoelectric tubes.
2. *Photoconductive Changes*: A change of resistance, as in the Selenium cell.

Magnetism:

1. Magnetizing or de-magnetizing a substance will give rise to electric charges.

Physio-chemical Reactions:

1. Melting, freezing, solidification.
2. Evaporation, condensation, liquification.
3. Crystalization.
4. Luminescence (as distinguished from pure temperature radiation)
 - a. Fluorescence.
 - b. Phosphorescence.
5. *Photochemical Reactions*: Combination, separation or rearrangement of the atoms or molecules induced by the action of radiant energy. Photosynthesis taking place in living plants—photovoltaic cells, chemical action in the cell, resulting from the stimulation of the incident light.
6. *Radioactivity*—Alpha, beta and gamma rays.

Chemical Actions:

1. Combination, separation and rearrangement of atoms or molecules; giving rise to electric charges, for example, combustion—the action taking place in electric batteries—actions within living organisms, as in the electric eel

some energy will be lost as heat, a lower form of energy toward which all other forms tend to transform. These actions which are given in both lists are capable of being measured, and we can see from a casual perusal that many of them are in every-day use and are being constantly employed, beneficially and otherwise.

Suggested Reading

The reader will find in the material referred to below, in most part non-mathematical and popular in presentation, the development of the ideas which have led to the concepts of modern physics. As we proceed to a detailed study of certain phenomena and effects, specific references will be given.

1. *Encyclopædia Britannica*. Article on atoms.
2. *Cajori*, "A History of Physics."
3. *Dampier-Whetham*, "A History of Science." An excellent critical presentation.
4. *Darrow, Floyd L.*, "The New World of Physical Discovery." A popularly written review of the history of physics.
5. *Heyl, Paul R.*, "Fundamental Concepts of Physics." A very readable review of the theories since Newton's time.
6. *Millikan, R. A.*, "The Electron." A classic work on the electron, mathematical in certain parts.
7. *Mills*, "Within the Atom." In popular form.
8. *Radio-physics Course* (RADIO NEWS).
9. *Slosson*, "Easy Lessons in Einstein." A popular exposition.
10. *Sullivan*, "Atoms and Electrons." Written in popular form.

Mathematics in Radio

Calculus and Its Application in Radio

By J. E. Smith*
Part Sixteen

A STUDY of the plate resistance of a vacuum tube is essential to the efficient design of the apparatus associated with such a tube. Thus, in the design of radio-frequency transformers placed in the output circuits of the various tubes, the proper impedances of these transformers is dependent upon the plate resistance of the tube. Again, the power output of a power amplifier is dependent upon the plate resistance of the power tubes that are used.

In order to study the application of the differential calculus to determine the plate resistance of a vacuum tube, reference is made to the schematic circuit of the two-element tube of Figure 1. In order to obtain a current flow through the tube it is necessary to heat the filament and supply a plate battery in the circuit such that the plate is positive with respect to its filament. It can be readily appreciated that the tube must have some resistance, otherwise the current drawn from the battery would be very large.

The resistance of the tube varies and for low plate voltages it is relatively high, and as the plate voltage is increased the resistance decreases quite rapidly at first and then more slowly. When the plate voltage is increased to large values, the plate resistance may again increase.

This is shown graphically by means of the formula which has been derived for the plate current of a two-element tube, i.e.:

$$i = aE^2$$

"a" is a constant dependent upon the design of the tube and we shall assume that it has a value equal to .00006. Plotting this equation for various values of E up to 40 volts, we have:

E	E ²	i (in amperes)	i (ma.)
5	25	.0015	1.5
10	100	.006	6.0
15	225	.0136	13.6
20	400	.024	24.0
25	625	.0375	37.5
30	900	.054	54.0
35	1225	.0738	73.8
40	1600	.096	96.0

*President National Radio Institute.

Plotting these values, it is noticed from Figure 2 that the current is not directly proportional to the applied voltage, otherwise it would be a straight line. If we were considering the d.c. internal resistance of this tube, it is noticed that at point A it would be simply determined

from Ohm's law, i.e., $R = \frac{15}{.013} = 1158$ ohms. Again, at point B, it would be equal to $\frac{30}{.054} = 557$ ohms.

HEREWITH is presented the fifteenth of a series of instruction articles on mathematics, emphasizing especially its application to radio. The articles which have appeared thus far are:

WHAT HAS GONE BEFORE

Article	Page	Date
Arithmetic	542	Dec., '30
The Slide Rule	630	Jan., '31
Algebra in Radio	722	Feb., '31
Algebra in Radio	826	Mar., '31
Algebra in Radio	920	Apr., '31
Algebra in Radio	1004	May, '31
Geometry in Radio	1088	June, '31
Geometry in Radio	63	July, '31
Geometry in Radio	230	Sept., '31
Trigonometry in Radio	288	Oct., '31
Trigonometry in Radio	292	Nov., '31
Trigonometry in Radio	491	Dec., '31
Trigonometry in Radio	589	Jan., '32
Calculus in Radio	687	Feb., '32
Calculus in Radio	779	Mar., '32

The d.c. internal resistance of a tube is not as important to the designer as its a.c. resistance, for it is noticed from Figure 3 that a.c. voltages are set up in the circuit and, as a result, a.c. currents flow through the tube. With reference to Figure 4, it is evident that for small changes in plate voltage WV, the resultant change in plate current UV would be different than if a linear relation existed between voltage and current. In Figure 4, WV represents the changes in plate voltage ΔE_p , and UV, the corresponding change in plate current ΔI_p .

Applying the Differential Calculus, and with reference to Figure 4, the constant potential is $E_p = 10$, the direct current is $I_p = .006$ (amperes) and is expressed as follows:

$$(A) I_p = aE_p^2$$

Now the a.c. resistance of a tube can also be considered as the ratio of the voltage change ΔE_p to the resultant current change ΔI_p and is expressed in the limit as:

$$(B) R_o = \frac{dE_p}{dI_p}$$

Applying the mathematics:

$$(A) I_p = aE_p^2$$

$$(C) \frac{dI_p}{dE_p} = 2aE_p$$

This results from the formulas (3) and (5) under the Standard Forms of Differentiating. Here, $E_p = v$, the exponent $2 = n$, and "a" = c.

From (C) above (from algebra):

$$dI_p = 2aE_p \times dE_p$$

or

$$\frac{dI_p}{dE_p} = \frac{1}{2aE_p} \quad (\text{Cont'd on page 1047})$$

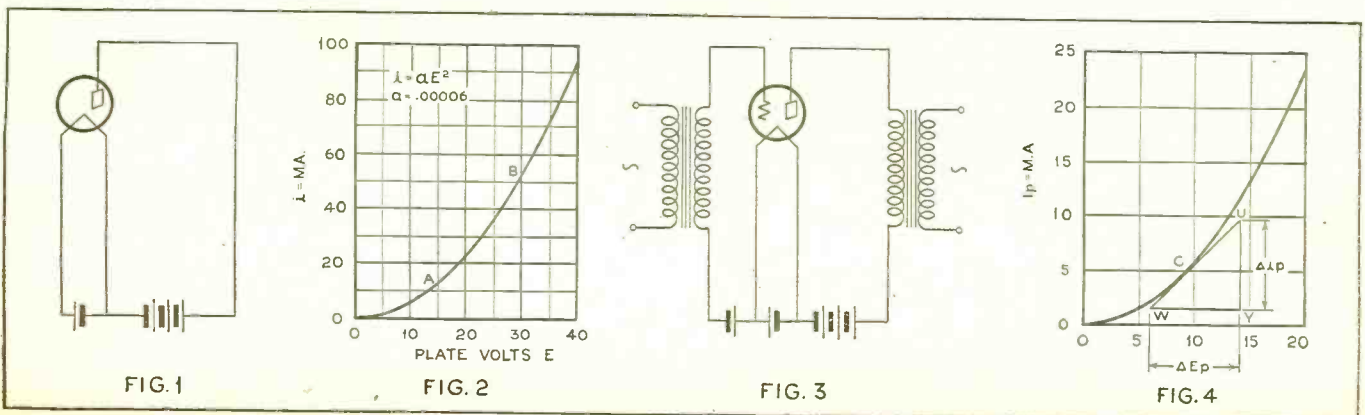

The "Nook Midget" Chassis

The tiny receiver described here is ideal for building into any piece of furniture. It is small enough to fit in almost any nook or corner, is surprisingly low in cost and is easy to build

THE idea of having two or more radios in the home is growing in popularity and is certainly far more practical than was the idea of "two cars in every garage," toward which we were working before the smash came during the latter part of 1929. The "Tired Business Man" upon arriving home at night is certainly in a position to appreciate this when he is forced to listen to an hour or two of bedtime stories, tuned in for the benefit of the children, when he would much prefer to listen in on some of the grown-up programs available at that time.

A small, inexpensive receiver in the children's room will enable the older members of the family to select their own program fare on the living-room radio and the children to have their own selection in their own room. At other hours of the day, a small receiver in the kitchen or one of the upstairs rooms would permit the lady of the house to enjoy her chosen programs wherever she might happen to be engaged in her household duties. Or, if the "T.B.M." is fortunate enough to have a den where he can isolate himself on occasions, a receiver installed there will oftentimes hold much enjoyment for him.

This idea, of course, is not by any means new. In fact, it was the demand for extra receivers in the home that resulted in the development of the present-day midget receivers. The only trouble is that many of these midget receivers are too large and too expensive to properly serve the purpose for which they were intended.

The receiver described in this article is far better adapted to this type of service than are most of these commercial midgets. In fact, it seems to represent a close approach to the ideal, inasmuch as the cost for all parts complete, less tubes, is in the neighborhood of \$15.00, and in size the chassis is only $9\frac{1}{2}$ inches long, $6\frac{1}{2}$ inches deep and $6\frac{3}{4}$ inches high (with the tubes in position). But before going into a detailed description of the receiver there is another point that can well be emphasized.

Dealers and servicemen are getting into the off season and the progressive ones are looking for profitable side-lines with which to keep themselves and their employees occupied. Building and installing miniature receivers such as the one described here offers one real possibility because of the low cost at which these receivers can be sold. In many cases the construction and sale of the chassis itself would be only part of the job. Many purchasers would want to have the chassis installed in some piece of existing furniture. The receiver is so small that it can readily be installed in a drawer of a

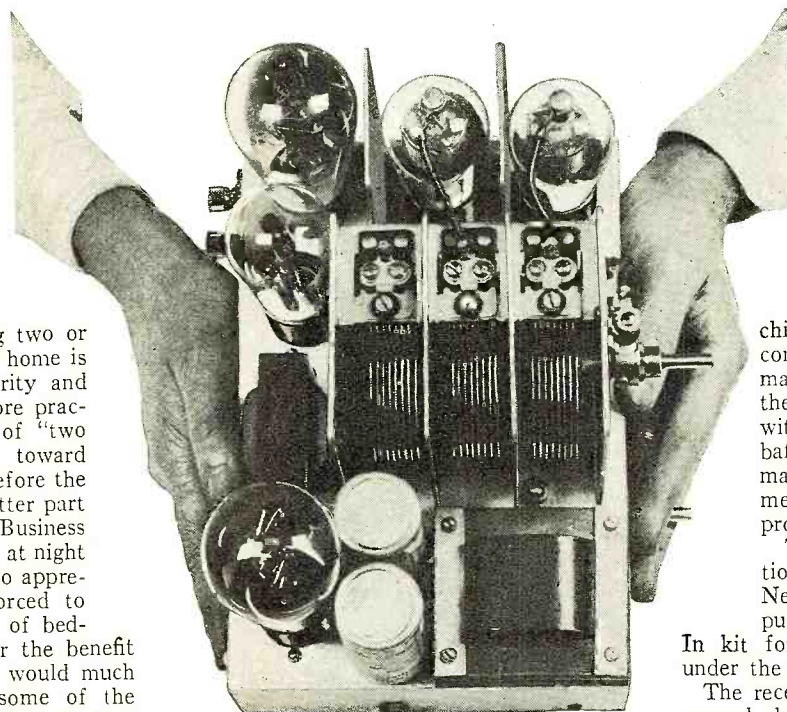

THE COMPLETE CHASSIS
Some idea of the size can be obtained by comparison with the hand holding the chassis

chiffrobe or dresser, or in a compartment in a desk, or it may even be suspended from the underside of a table top with the speaker on a small baffle suspended in the same manner, facing downward. This means an added installation profit.

The cost of \$15.00 was mentioned above, but there is one New York distributor who is putting out the complete kit. In kit form, the price is somewhat under the amount mentioned above.

The receiver is a 5-tube unit of advanced design. The tubes used are two -51's for the r.f. stage, a -27 detector, a -47 pentode for the power stage and a rectifier tube of the -80 type. The cost of the receiver may be further reduced by the elimination of the filter choke and one of the electrolytic condensers. It is felt that the slight cost of these parts is more than justified by the hum elimination. Still, for those that are not annoyed by a slight hum this is one way of still further reducing the cost.

The r.f. stages of the receiver are of conventional design, employing compact coils which, with their copper shield cans, help greatly in eliminating instability.

The detector and audio systems employ a type of direct coupling that is especially adaptable to midget receivers. This circuit is not original with the writer, having first been suggested by Mr. Joseph Heller. Mr. David Grimes also developed a similar circuit for push-pull amplification some time ago.

The advantage of this type of direct-coupled circuit for midget receivers lies in the lower plate voltage required, as compared to other direct-coupled systems, and in the positive grid-swing compensation. This latter is accomplished by the control on the grid of the -27, as the bias resistor of that tube is also the grid leak of the power tube. When the grid of the -47 goes positive and grid current flows, the bias on the -27 is increased, thus compensating for the grid current flow and reducing distortion.

For those who wish to make the chassis, all details are given in Figure 2. It is recommended that aluminum be used, as it will be easier to work. However, sheet iron, copper or brass may be used if desired. A sheet $10\frac{1}{2}$ inches by $13\frac{1}{2}$ inches by $\frac{1}{16}$ inch thick is required. A rectangle $6\frac{1}{2}$ inches by $9\frac{1}{2}$ inches is marked on the metal. This is accomplished by measuring in two inches from each edge. The square corners are now cut out and the metal bent along the lines. This forms the chassis, which should be $9\frac{1}{2}$ inches long, $6\frac{1}{2}$ inches wide and 2 inches deep.

By Beryl B. Bryant

The socket wells and the rectangular well for the power transformer are now cut and filed to smooth the edges. The mounting holes for the remaining components are marked on the chassis. These are checked against the components by placing the latter in position. After the constructor is assured that the holes are in the proper position, they are drilled and burrs removed. If the chassis has been made of aluminum, copper or brass, it is well to rub the metal down with fine steel wool. To preserve the satin finish, a coat of thin transparent lacquer may be applied to the top surface and allowed to dry. If iron is used, it may now be sprayed with black or brown lacquer.

Assembly

To expedite fast assembly, it is recommended that the sockets be mounted first, then the power transformer. Next in order the inverted type electrolytic filter condensers on the top of the chassis. Next the 10 mfd. by-pass condenser, C10, is mounted, followed by the volume control and the power switch. Care should be taken that the volume control is well insulated from the chassis. Should this short to ground, the bias on the r.f. tubes will be short circuited, resulting in decreased volume and broad tuning.

Before mounting the tuning condenser, the extending shaft should be removed to within 1/2 inch of the condenser frame. The condenser is provided with three right-angle mounting brackets, two on the front-end plate and the third on the rear-end plate. This condenser is now mounted, and at the same time the bottoms of the coil shields, after having been removed, are fastened into position. The filter choke L4 is next mounted in position. Before proceeding with the wiring the antenna and ground binding post plate is mounted on the rear of the chassis. The remainder of the parts, which consist of the pig-tail type filter condenser C8, the by-pass condensers and the resistors, are mounted as the wiring of the receiver progresses.

Wiring

In wiring the receiver, it is recommended that the filament

circuit be completed first. It will be noted that the sockets are so mounted that the filament prongs are near to the sides of the chassis. Upon the completion of the filament circuit, the power circuit is wired. This includes the socket for the -80, the power transformer, the speaker socket, the filter condensers and the filter choke. The balance of the wiring of the receiver is now completed. This consists of the screen-grid circuits, the cathode circuits and the plate circuits. After these have been completed, the triple by-pass condenser C4 is mounted and wired into the circuit. Next the by-pass condenser C5 is mounted and wired. The resistors R5 and R6 are then wired into the circuit, using the terminals of C5 to anchor the resistors. The balance of the resistors are now wired into the circuit, anchoring them to convenient points.

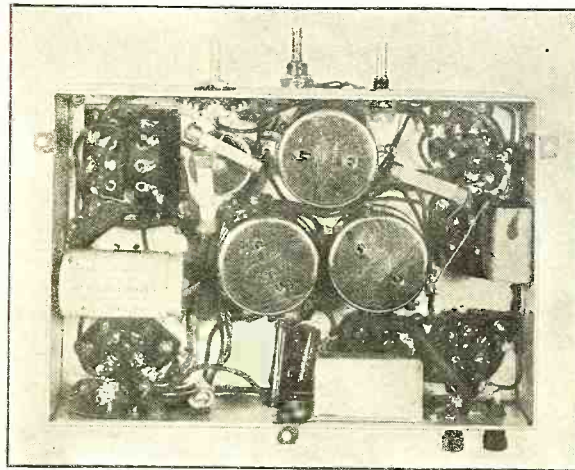

UNDER THE CHASSIS

In spite of the compact layout, the parts and wiring are not unduly crowded

Placing the Receiver in Operation

After the receiver has been completely wired and the circuit checked, the tubes are placed in their respective sockets, the antenna and ground connected, the speaker plug inserted into the speaker socket on the rear of the chassis and the power connected to the receiver. After the tubes have warmed, the voltages should be checked. The plate voltages of the r.f. stages should be 250 volts at 3 volts bias. The screen voltage should be 90 volts. The voltages on the plate of the -27 and the -47 should be approximately 250 volts. Measuring the cathode of the -27 to ground should read 35 volts, while the bias voltage of the -47 should read 50 volts. This will give a net bias voltage on the grid of the power of 15 volts. It will be noted that the second r.f. stage has a fixed bias. If desired, a -24 may be substituted here with slight increase in gain. The volume is amply controlled by varying the r.f. bias.

List of Parts

C1, C2 C3—General Instrument r.f. type 3-gang .000366 mfd. variable condenser

(Continued on page 1050)

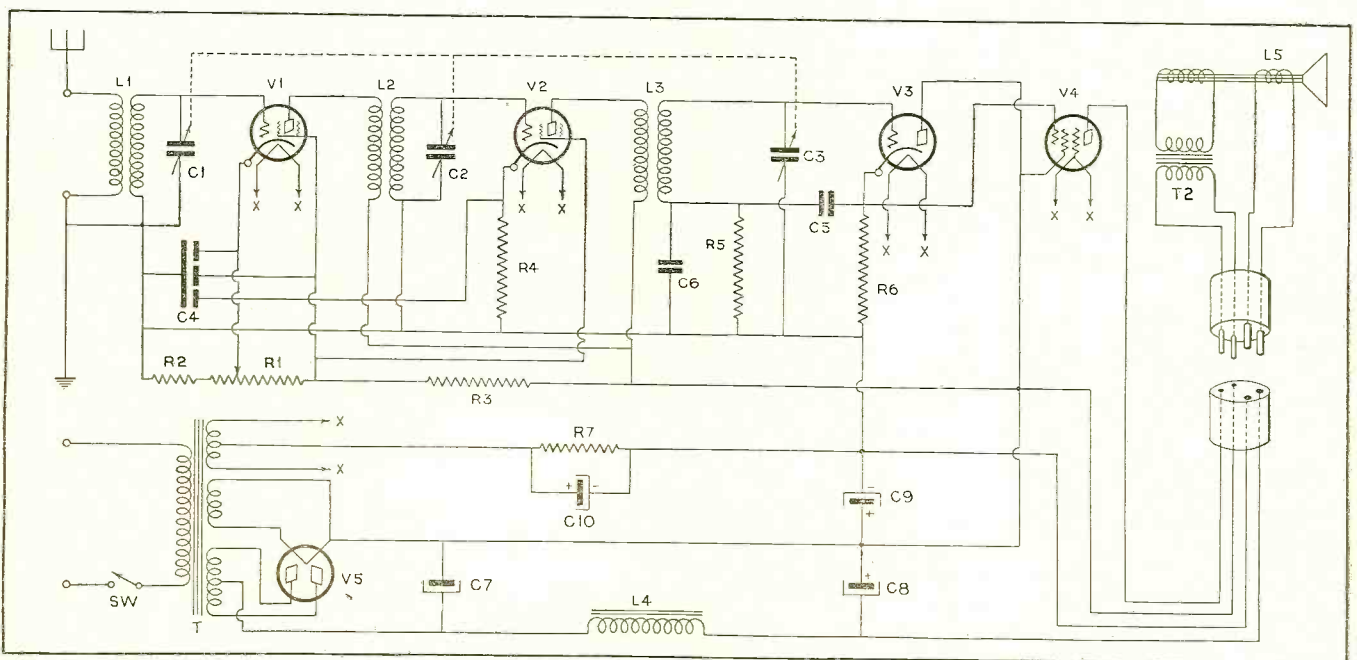

THE COMPLETE CIRCUIT DIAGRAM

Figure 1. The type of direct-coupling employed between the detector and power stages, while not new, is rather unusual and highly effective

SOME CONTROL CIRCUIT USAGES OF THE GRID-GLOW TUBE

|| *A wave of the hand and this apparatus can be used to control the operation of large electrical machinery*

By M. H. Brown



ELECTRICAL conduction in gases has been the subject of investigation by scientists for many years, but commercial importance of devices utilizing this physical phenomenon has not been particularly outstanding until the last few years, when development has been rapid.

Of the many devices of this type that are now in use, none are more interesting than the grid-glow tube invented by Mr. D. D. Knowles several years ago. It is the product of modern research in vacuum and gas-tube devices and has won a place for itself in the laboratory and in industrial applications by virtue of its simplicity and extreme sensitivity to delicate electric currents.

Conduction of Electricity in Gases at Low Pressure

The majority of the applications for the tube utilize it as a relay, sensitive to feeble stimuli, operating mechanical contacts that are in turn the control for larger electrical devices. The feeble stimuli may be photoelectric currents, currents passed between electrodes in a flame, charging currents to very small condensers, current flow through high resistances, charges picked up by conductors in a strong electrostatic field, or conduction of current through a very thin film of moisture.

Since the grid-glow tube employs neon gas, at low pressure, to carry the current between electrodes in the tube, an explanation of the conduction of electricity through gas is necessary to understand its operation. In general, devices that depend on the conduction of electricity through gas are called glow-dis-

charge devices. This name is derived from the fact that a glow is present when there is an electrical discharge through the tube. Mercury-vapor lamps, neon signs and glow-tube rectifiers are in this class of devices.

In Figure 1, a simple gas tube is shown. Two electrodes are sealed in a glass bulb that contains gas at a low pressure. The electrode of large area is the cathode and it is connected through a microammeter and resistor to the negative side of a battery. The anode is connected to the arm of a potentiometer that varies the voltage across the tube. If a curve is plotted, of voltage across the tube against current through the tube, the result will be a curve which is as shown in Figure 2. The current starts from zero (at zero voltage) and gradually increases to a nearly constant value of a fraction of a microampere for all voltages up to the "breakdown" voltage. This small initial current is carried by the "free" electrons in the gas. The origin of these electrons is not known, but it is believed that they are caused by the action of invisible cosmic rays which release electrons from the gas atoms. When the voltage reaches a value such that these free electrons, in travel towards the anode, are accelerated to a velocity sufficient to drive other electrons out of the atoms of the gas, the electrodes then are at breakdown potential, the ionization of the gas then becomes very intense and current in the order of milliamperes may be carried through the tube. Ionization of a gas

by this process is called "ionization by collision" and it is readily detected by the glow that results.

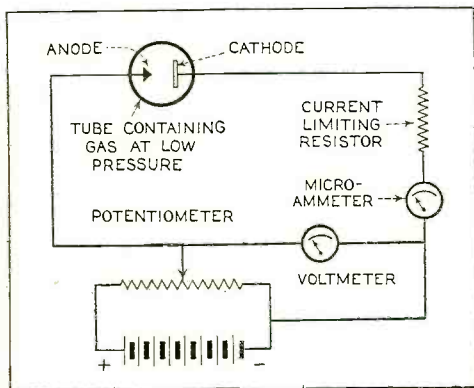

GLOW TUBE CIRCUIT

Figure 1. Simple circuit for employing a gas discharge tube, including a limiting resistor and meters

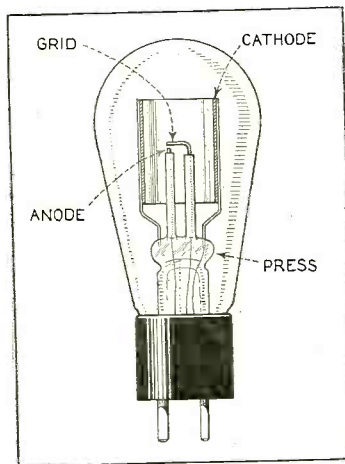

GRID-GLOW TUBE

Figure 3. Sketch showing the cross-section of a cold-cathode, grid-glow tube

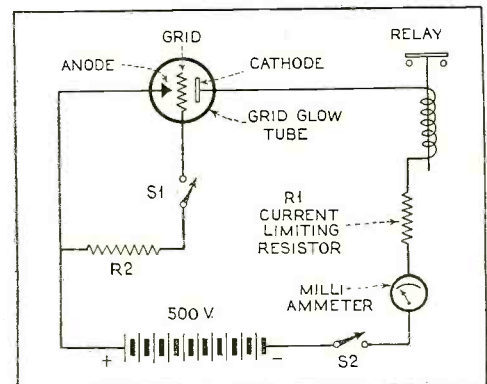

GRID-LEAK CIRCUIT

Figure 4. Shows the connections for the relay and limiting resistors for a grid-leak circuit

After the ionization by collision has started, the voltage required to maintain ionization is much less than that required to cause breakdown. The voltage that must exist across the tube electrodes to maintain ionization after breakdown is called the tube "drop." Since the tube would draw excessive current if it tended to maintain a drop lower than the applied voltage, a resistor must always be used in series with a glow-discharge tube to furnish a voltage drop equal to the difference between the tube drop and the applied voltage.

The difference in area of the electrodes in the glow tube of Figure 1 makes it easier for the tube to conduct current from the anode, of small area, to the cathode, of large area, than in the opposite direction. This fact makes rectifiers of all glow tubes of unequal electrode area.

The Cold-Cathode Grid-Glow Tube

The cold-cathode grid-glow tube is a glow-discharge device, essentially the same as the one described in the previous paragraph but in addition to the anode and cathode there is also a grid electrode. This electrode is used to control only the starting of the grid-glow tube and it has no control over the magnitude of the current flowing from the anode to the cathode. After the glow discharge has started in the tube, however, the grid is powerless to stop it.

The actual construction of the grid-glow tube is shown in Figure 3. The tube is slightly larger than the familiar -27 type radio tube. The electrode structure consists of three main parts, the cathode, the anode, and the grid. The anode is a wire extending from the "press" upward into the tube. With the exception of the end of this wire, which is of small area, the anode is completely surrounded by a glass tube which is fused to the press. The grid is also a wire that extends upward into the tube. It is parallel to the anode and is bent at the end to extend over the exposed end of the anode so that it is very close to it. It, also, is covered with a glass tube for nearly the full

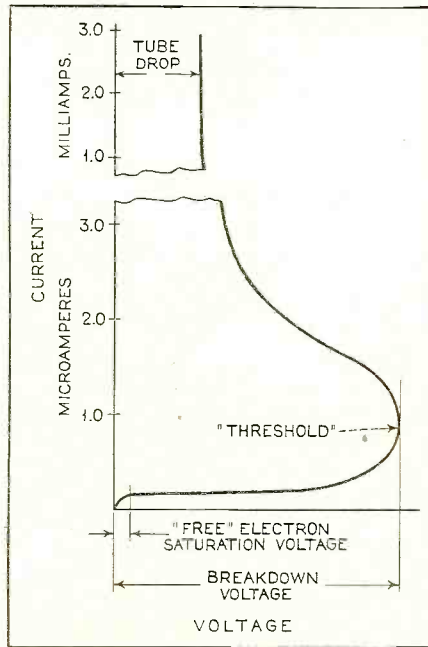

OPERATION CURVE
Figure 2. Characteristic curve for the circuit shown in Figure 1

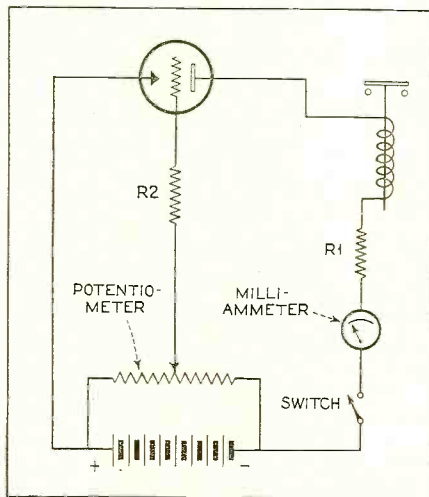

POTENTIOMETER CIRCUIT
Figure 7. Connections for a potentiometer control grid-glow tube

length of its straight portion. The cathode is a metal cylinder that surrounds the grid and anode structures. It is supported by two stiff wires that are sealed into the press.

In Figure 4, the grid-glow tube is connected in a circuit similar to that of Figure 1. A resistor that limits the current through the tube to 8 milliamperes, and a relay that will pick up at 6 milliamperes or less, are connected in the cathode circuit. With the grid unconnected (or free) it is impossible to get a breakdown in the tube even though voltages up to 900 volts are applied between the anode and the cathode. This condition is the result of the grid obtaining a negative charge from the free electrons in the gas which are attracted towards the positive anode. Since the grid is very close to the anode and as it has no electrical connection to remove the charges brought to it by the electrons, it attains a negative potential that repels any additional electrons that would otherwise travel to the anode.

In order to start the grid-glow tube it is necessary to remove this charge from the grid. This may be done several ways. One simple method is to connect the grid to the anode through a high-resistance leak. This is accomplished in Figure 4 by closing switch S1. The result is that the negative charge is replaced by a positive charge obtained from the positive anode. The value of the grid leak to just start the tube is given in the curve of Figure 5. Proper values of limiting resistance, for various anode-cathode voltages, is given by the curve of Figure 6.

After the tube has started, the grid no longer has any control over the current and it will not stop the glow discharge regardless of how negative it may be. It will be necessary to open the cathode or anode circuit of the tube, such as by opening switch S2 in Figure 4, to stop the glow.

Alternating-Current Operation

On alternating current the glow is automatically shut off toward the end of each cycle when the instantaneous voltage of the a.c. wave becomes less than the tube (Continued on page 1064)

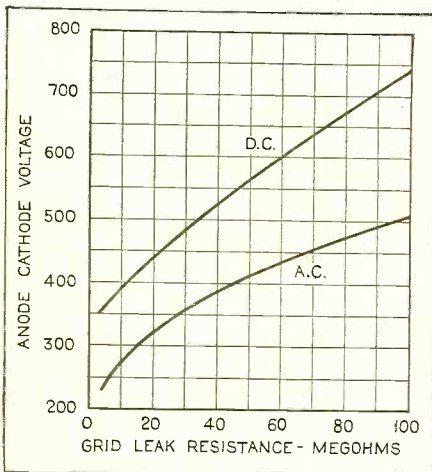

CURVES FOR A.C. AND D.C.
Figure 5. Grid-leak curves for the circuit shown in Figure 4

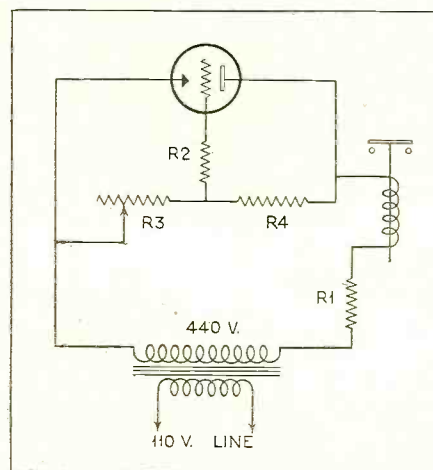

VARIABLE RESISTOR CIRCUIT
Figure 8. Circuit control by changing the resistance R3

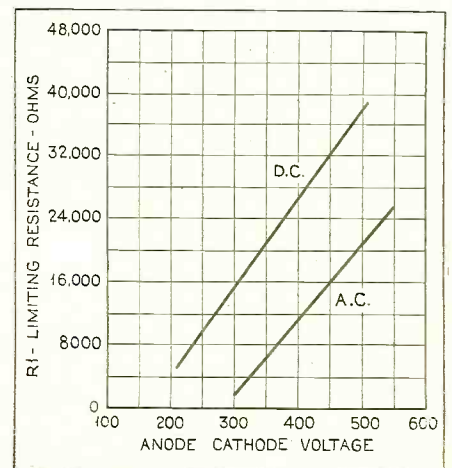

CURRENT-LIMITING RESISTORS
Figure 6. The values for the resistors in both a.c. and d.c. circuits

Q Professional investigators and radio amateurs have opened a new field for experimenters—the ultra short-wave range below ten meters. This is the first of a series of articles by Mr. Millen providing practical data—the real dope—on transmitters and receivers for operation on quasi-optical waves

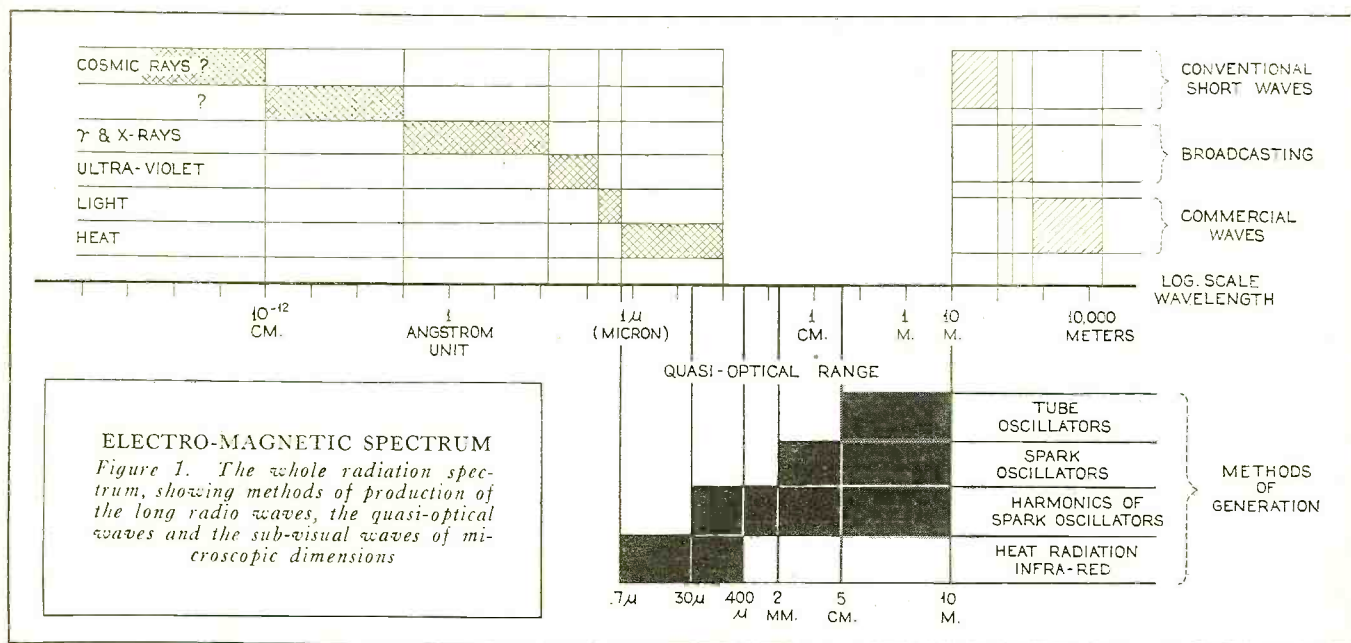

TRANSMISSION AND RECEPTION

BELOW TEN METERS

By James Millen*

A FEW years ago, when radio broadcasting first attained its highly commercialized status, the old-time experimenter shifted his activities to the so-called short-wave field. The renewed experimental possibilities stimulated his interest, and individual pioneering was both profitable and educational for some years. Today, however, the conventional short waves are as commercialized as the broadcast frequencies, and the availability of high-grade, ready-made short-wave equipment leaves little justification for further efforts on the part of the veteran experimenter. Like Alexander of old, he seeks new worlds to conquer—and finds them in the realm of still shorter wavelengths.

Short Waves Increasing in Usage

Until several years back, two hundred meters was considered a short wave. As a matter of fact, it was thought to be the minimum wavelength practical for radio communication. Today, the bulk of the world's wireless transmission is carried on between 10 and 150 meters! As short waves became still shorter, a limit was placed again on the highest useful frequency, and it was generally conceded that wavelengths under 10 meters would be useless for signal-carrying purposes. But last year, with the opening of a new "nether region," the International Technical Consulting Committee on Radio not merely recognized the utility of still shorter wavelengths, but circumvented the possibility of another temporary limitation by including all frequencies, between 30,000 kc. and those of heat waves, in a possibly useful category. These frequencies have been designed as "quasi-optical"—wavelengths of radiated energy which behave more or less like those of light.

Wavelengths below 10 meters are "optical" in the sense that, like light, they follow more or less a straight line and

cast definite shadows of relatively small objects. They do not bend around obstacles or readily follow the curvature of the earth as do the broadcast frequencies with which we are familiar. Also, they possess a greater power of penetration, and, therefore, are not reflected or refracted to any great extent by the Kennelly-Heaviside layer, and communication is almost limited to points between which it would be possible to transmit light under perfect weather conditions. However, unlike light, these short waves are quite independent of weather and will readily penetrate clouds and fog. This, too, is a familiar optical phenomenon, as the general tendency toward diffusion increases with the frequency. For instance, the sky appears blue due partly to the fact that the blue light of high frequency in the visible spectrum is diffused in the atmosphere.

When an arc of incandescent lamp is lighted, only a small amount of the power is radiated as light. Most of it is dissipated as heat that cannot be used for communication purposes. However, with the very short radio waves, a considerably greater portion of the power input is radiated, and low powers can be used for consistent communication purposes. The shorter radio waves are also fairly amenable to reflection by optical methods, thus greatly increasing the effectiveness of low powers. Communication has been carried on across the English Channel on a wavelength of a few centimeters with a power that would barely light a flashlight bulb!

10-Meter Tests in Berlin

Nature finds it difficult to generate these quasi-optical frequencies and, therefore, reception on these low waves is remarkably free from static and similar noises. In 10-meter tests in Berlin the noise level was only one-tenth that experienced on regular broadcast frequencies.

Due to the fact that there is no varying reflection from the Kennelly-Heaviside layer, reception being the result of a

*The National Company.

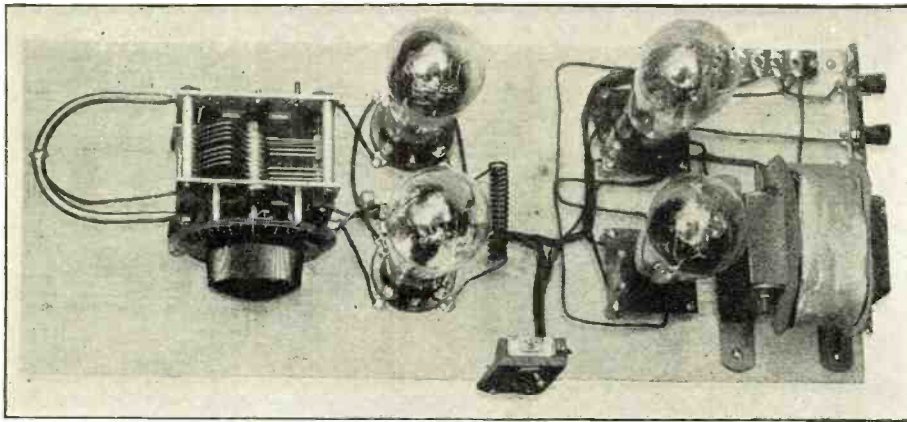

RADIO TELEPHONY SET-UP FOR USE ON FIVE METERS

Figure 5. The two pentode tubes shown at the right are used to modulate the two push-pull oscillator tubes in this five-meter radio telephone transmitter

direct ground wave without interference patterns, the usual sort of fading is conspicuous by its absence.

While it is mathematically and physically convenient to think of broadcast and conventional short wavelengths in terms of equivalent frequency, we shall, for similar reasons, revert to the old-fashioned wavelength system in considering quasi-optical phenomena.

Figure 1 shows the entire electromagnetic spectrum, arranged in a logarithmic extension from the longest radio waves down to the shortest sub-optical manifestations. Wavelengths within various ranges are conveniently handled by a variety of units. Very short wavelengths are generally considered in Angstrom units, which are one ten-thousandth of a millionth of a meter long. The micron is one millionth of a meter or 10,000 Angstrom units. The usual metric units, the millimeter and centimeter, are next in convenience. The entire spectrum is most readily handled mathematically, by negative powers of 10 times the centimeter.

Generating Quasi-Optical Waves

Figure 1 also indicates the method by which the quasi-optical frequencies are generated. It is of particular scientific interest to note the overlapping of the two possible systems for generating wavelengths between 30 and 400 microns. This was, in effect, a no-man's land of science, and the fact that the phenomenon it covers can be produced either by electrical or optical methods is additional evidence of the continuous nature of electromagnetic manifestations.

We are, for the time being, interested in the tube oscillating systems. While shorter wavelengths can be obtained by

as well as the Columbia System, has been experimenting with portable 5-meter transmitters which may be carried by announcers and used for mobile broadcasting of sporting events.

Experimental work of a semi-commercial nature is being conducted in the Empire State tower, New York City, on an ultra-short-wave television system. The possibilities of such an arrangement are considered particularly promising, due to certain simplicities in modulation associated with quasi-optical transmission. Signals from this experimental station have been picked up fifty miles away, with excellent intensity and tone quality, on an inexpensive and simple receiver, details concerning which will be given in a following article in this series.

A strictly commercial application of the quasi-optical waves is responsible for the consistent telephonic communication between various islands in the Hawaiian group over distances as great as 200 miles. While the transmitters and receivers are installed well up on the mountains, they are by no means within optical range of each other, and advantage is taken of the slight refractive effect to which reference has already been made. Reception is clear and staticless and is "piped" down to the usual insular telephone systems.

Tube Oscillators

The tube oscillators of practical utility in the generation of quasi-optical wavelengths fall into three categories—the familiar regenerative oscillating arrangement, the Barkhausen-Kurz systems and the magnetron.

These systems will here be considered in the order indicated. Figure 2 shows a short-wave transmitter, complete with power supply, designed to operate at 2

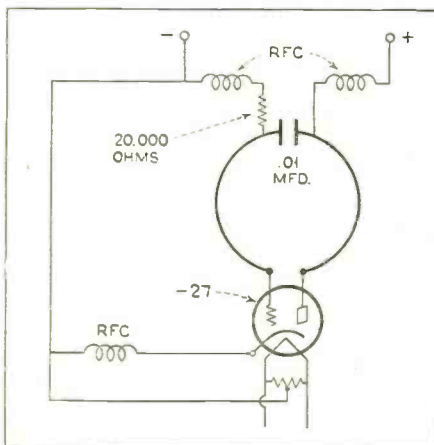

SIMPLE CIRCUIT

Figure 3. The schematic diagram for the complete two-meter transmitter shown in Figure 2 at right



FOR TWO METERS

Figure 2. Photograph of a complete transmitter for work on a two-meter wavelength complete with power supply, oscillator tube and other essentials

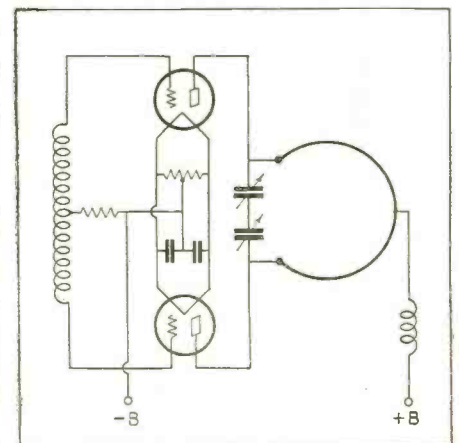

PUSH-PULL CIRCUIT

Figure 4. Diagram of the push-pull circuit using standard tubes in transmitters shown in Figures 5 and 6

meters. The tube used is a standard -27 type and the base has *not* been removed. The wiring diagram is shown in Figure 3. It is interesting to note, in conjunction with this transmitter, that the shunting of the condenser directly across grid and plate did not reduce the wavelength appreciably. However, the energy output at 2 meters was increased 75 percent by the substitution of low-loss insulation "R-39" for the standard bakelite tube base and condenser molding, along with an isolantite socket in place of the bakelite. This indicates the importance of low-loss design in ultra-high-frequency work.

In the range of from 4 to 10 meters almost any of the standard triodes can be used successfully, especially in the push-pull circuit shown in Figure 4. Figure 5 shows a 5-meter radio-telephone transmitter employing -10 type tubes with pentode modulators. Where higher power is required, the 852 is probably the most satisfactory, and Figure 6 shows a highly effective 5-meter transmitter employing two of these tubes in a push-pull arrangement. For transmission below 2 meters, special tubes and circuits become necessary. The usual triode, with base removed, is still effective between 1 and 2 meters, but its power output falls off rapidly as the wavelength is decreased. For still shorter wavelengths the Barkhausen-Kurz and magnetron oscillators are more effective.

The Barkhausen-Kurz Oscillator

The frequency at which the regenerative oscillators, heretofore considered, have oscillated, has been determined by the inductance and capacity of the circuit elements in the usual way. However, as the wavelength becomes shorter and shorter, the time required for the electrons to perform their customary transits approaches the "period" of the circuit, making it difficult or impossible to maintain the phase relationships essential to stable oscillation. The circuits previously described have also functioned with the conventional distribution of potentials among cathode, grid and anode.

The Barkhausen-Kurz oscillators function as a result of the natural tendency of an electronic stream to oscillate about an axis of potential, at a period determined by the velocity and distance traveled—the effect that contributes to the inefficiency of regenerative oscillators at centimetric waves. The Barkhausen-Kurz circuits upset not only our conventional theory of how oscillators

work, but likewise our practice of maintaining the anode at a positive potential in respect to the cathode and grid. In the B-K circuits, the grid is highly positive to both cathode and plate, and the anode may often be negative in respect to the filament. A typical Barkhausen-Kurz circuit is shown in Figure 7.

Without recourse to higher technical considerations, the functioning of such a circuit may be explained as follows: Electrons leaving the hot filament are attracted to the grid by the high positive potential. Many of them stick to the grid, while others, impelled by their momentum, speed through the meshes. The escaped electrons are rapidly de-accelerated, particularly if the plate is negatively charged with respect to the grid, and are again attracted to the grid. Once more some electrons stop at the grid while others continue through, to reverse again with the new electrons leaving the filament, recommencing the cycle. The time required for a complete oscillation is obviously governed by the distance the electrons travel, which is partially determined by the spacing of the tube elements and by the velocity of the electrons which is a function of the potential at which the tube is operated. It is therefore apparent that the wavelength of such a circuit may be altogether independent of the values of inductance and capacity and can be varied over quite a range merely by changing the grid and plate voltages.

However, it has been discovered that the output of the Barkhausen-Kurz oscillator is increased considerably when the natural period of the circuit, as determined by L and C, corresponds to the relaxation (Continued on page 1053)

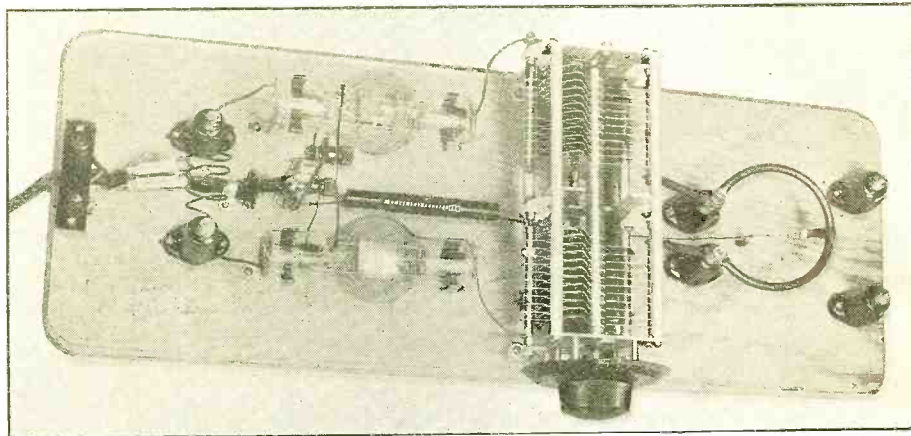

POWERFUL FIVE-METER C.W. TRANSMITTER

Figure 6. This layout contains the same oscillator circuit as shown in Figure 5, but using the more powerful 852 type tube for higher output



ULTRA SHORT-WAVE RECEIVER
Figure 9. A view of a five-meter receiving set with the top shield removed to show simple layout

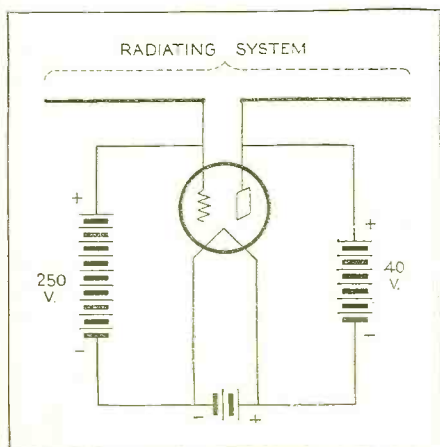

BARKHAUSEN-KURZ CIRCUIT

Figure 7. This is the fundamental B-K hookup for the high-frequency oscillator of extreme simplicity for ultra short waves

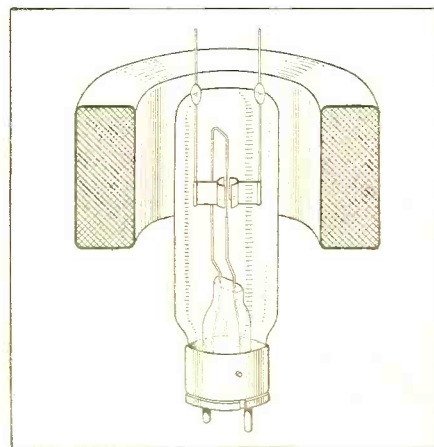

THE MAGNETRON OSCILLATOR

Figure 8. In this sketch of the magnetron oscillator tube a field coil is shown, partly cut away, for controlling ultra high-frequency oscillation

SOME APPLICATIONS FOR A Duplex Photo-Cell

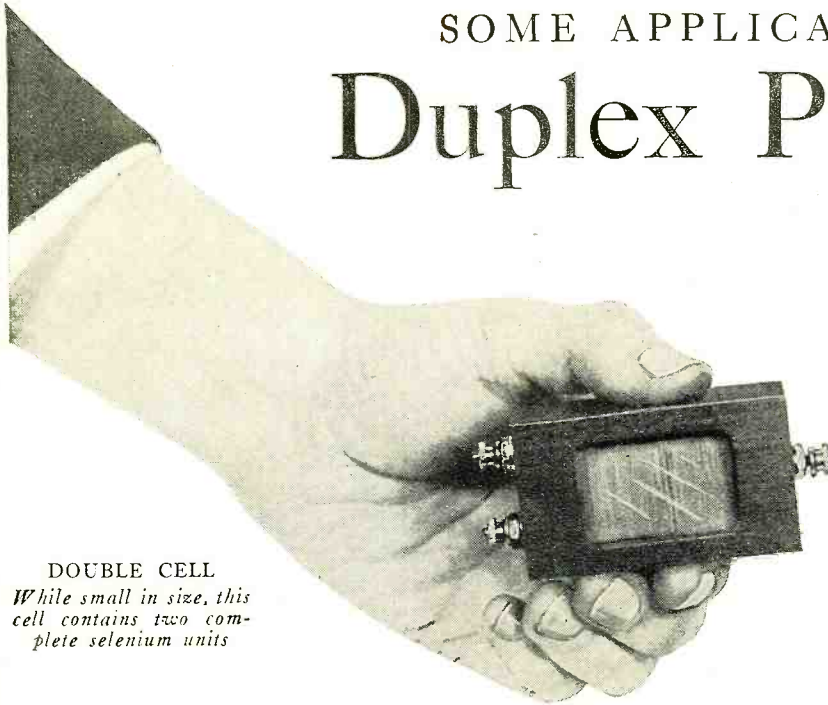

DOUBLE CELL
While small in size, this cell contains two complete selenium units

Last month we described a new type of selenium cell, especially suitable for relay operation. A new, double selenium cell has now been made available; it is called the "Duplex" cell. This article describes the new unit, its characteristics and outlines a few applications

By Bernard J. Montyn

ANOTHER new photo-electric device is now available to the experimenter. It contains two selenium cells in a case similar to that described last month. Three connections are brought out to the case terminals. For convenience these have been marked A, B and C (see Figure 1). The two sections of the new Luxtron unit are joined at B and the two other terminals come out at A and C. The hook-up permits the use of the two sections in series, in parallel or each separately.

Curves of the duplex cell performance are shown in Figures 3, 4 and 5. These were made by Prof. R. T. Dufford of the University of Missouri.

Illumination Curves

The first group of curves shows the current plotted against the applied voltage for different amounts of illumination. If the resistance of the cell remained constant for a certain illumination, these lines should be straight. These curves reveal, therefore, that the resistance varies slightly with the voltage.

According to simple arithmetic, the current of the two sections in parallel should equal the sum of the two sections, taken separately, all other conditions remaining the same. This checks reasonably well. The second set of curves shows the variation of the resistance with voltage for different illuminations. This set shows clearly what a variation in resis-

tance is introduced between the parallel and series connection. The third set of curves represents the relation between current and illumination. These will probably be of the greatest interest to the experimenters. The approximate form of these curves is that of a logarithmic one. When they are plotted on semi-logarithmic paper, the lines become nearly straight. The resistance, however, does vary practically in proportion to the illumination except at values over 1000-meter candles (100-foot candles approximately).

Sensitive at Low Intensity

All curves show that the greatest slope (greatest current variations for unit light variation) is at the lower light intensities. A Luxtron relay which trips at $\frac{1}{2}$ ma. is now available. This enables the experimenter to work with lower light intensities, and cancelling the dark current as explained in last month's article. A variation of $\frac{1}{2}$ ma. is easily obtained and the relay will attract and release its armature without difficulty.

A word of warning may not be amiss. Selenium exists in many allotropic forms. Crystalline gray selenium B is the only one which is light-sensitive. It melts at 217° C. and then transforms itself into an amorphous form which is not light-sensitive. The ST cell and the Duplex cell take 25 volts, no more! Some experimenters, accustomed to applying high voltages to metal-oxide cells, have done the same with the

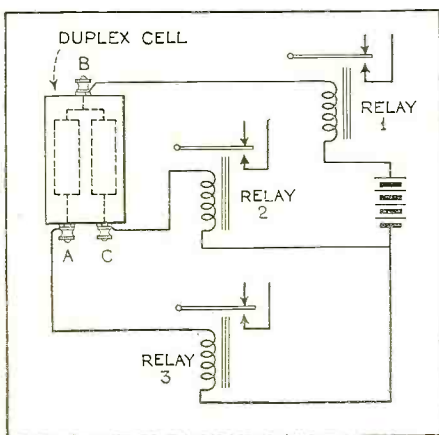

OPERATING THREE CIRCUITS
Figure 1. Besides permitting series or parallel connections, the "Duplex cell" enables one to operate three relays independent of each other

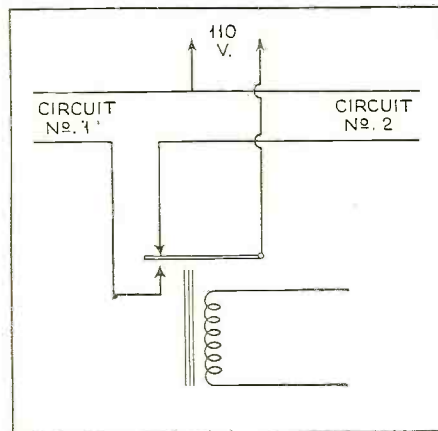

TWO CIRCUITS, ONE RELAY
Figure 2. In certain cases, where one circuit has to be opened when another is closed, the change can be made with one relay

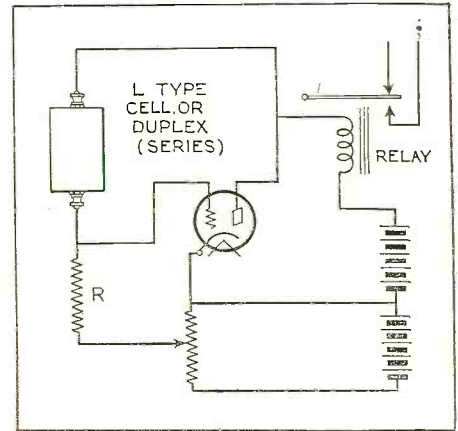

TUBE AMPLIFIER FOR D.C.
Figure 6. When necessary, this simple hook-up will provide ample gain for the operation of relays in the plate circuit

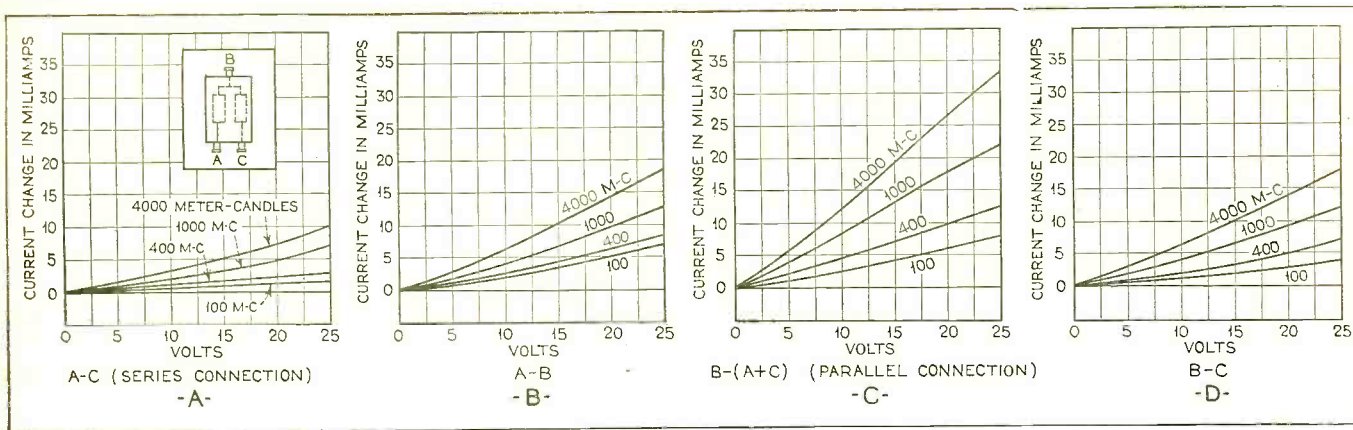

RESISTANCE VARIES WITH APPLIED VOLTAGE

Figure 3. The fact that these lines are curved shows that the selenium cell does not follow Ohm's law

selenium cell. The heat developed causes the chemical change referred to above. This procedure makes the cell useless. Once more, do not apply more than the rated voltage! Do not over-heat the cell!

The measurements that were made to plot the curves in this article were obtained with meter-candles as a unit of illumination. To many of our readers this unit may be unfamiliar. A meter-candle, or lux, is the illumination from one international candle falling perpendicular on a surface at one meter distance from the light source. A foot candle is the illumination of the same candle at the shorter distance of one foot.

The illumination is inversely proportional to the square of this distance. Since one meter equals 3.281 feet, the foot-candle equals $3.281^2 = 10.76$ meter-candles. For approximate values, divide the number of meter-candles by ten in order to get foot-candles.

Sometimes in photo-electric work one encounters the unit of light quantity—the lumen. The lumen is defined as that quantity of light or luminous flux which is emitted by a point source of light of one candle intensity in unit solid angle. The unit of the angle is the radian. In other words, the lumen is the quantity within a cone of one radian apex. There is a total of 4π of such angles all around, which means that a one-candlepower source emits 4π lumens. Since the area of a sphere is also $4\pi r^2$, a sphere of one-foot radius around a one-candlepower source of light would receive one lumen per square foot, which is also defined as a foot-candle. Also, a meter-candle equals one lumen per square meter.

The quantity of light falling on a surface is obtained by mul-

tiplying its area with its illumination. If the surface is not illuminated uniformly, the product is obtained by integral calculus, simply dividing the surface into an infinitely large number of elements, finding the light quantity falling on each and adding all these products.

The unit of brilliancy, the candlepower, is more or less familiar to everyone. It is the brilliancy or luminous intensity of a candle of a particular composition. In America, one uses what is known as the "international candle." In Germany and some other European countries, the "Hefner" candle is the standard. It is nine-tenths of the international candle.

Mean Spherical Candles

Incandescent lamps used to be rated in candlepower, but now they are rated in watts—the power consumed. A Mazda lamp or any light source does not emit an equal amount of light in all directions. An old-time 100-candlepower lamp had this brilliancy in one favorable direction only. Nowadays one averages the brilliancy and speaks of a lamp having a brilliancy of 74 "mean spherical candles." This means that in some directions it has a larger and some a smaller brilliancy, but the total is the same as that of a lamp emitting 74 cp. in all directions. This 74 mean spherical candlepower is approximately equal to 100 candlepower of the old rating.

The fourth unit of light is the unit of brightness, the lambert, but this is outside the scope of this article.

This little device can be connected in many different ways which make it possible to control (Continued on page 1052)

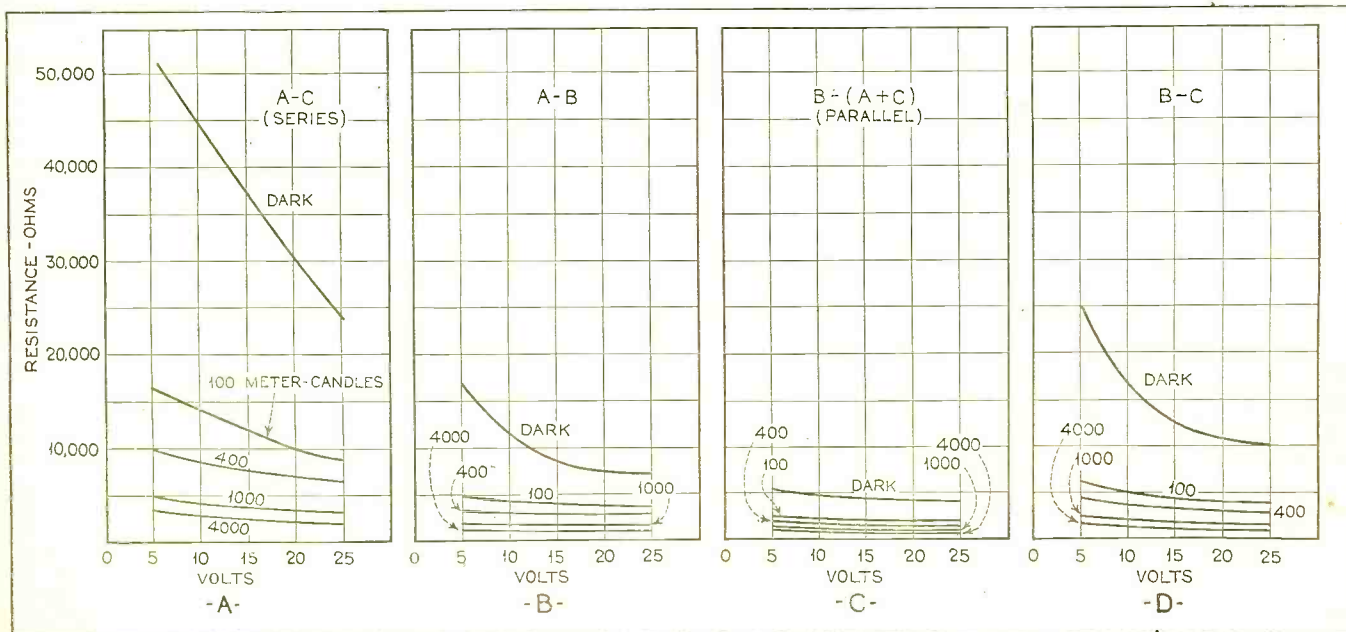

VARIATION IN RESISTANCE

Figure 4. These curves show the drop in resistance when the cell is illuminated

MODERN RADIO PRACTICE IN USING GRAPHS *and* CHARTS

Calculations in radio design work usually can be reduced to formulas represented as charts which permit the solution of mathematical problems without mental effort. This series of articles presents a number of useful charts and explains how others can be made

WHAT is the reactance of a 1 mfd. condenser at 100 cycles? It is surprising how long it takes many radio men to figure this out and how many more—who do not figure—that use a wrong value.

Since every up-to-date radio receiver contains filtering circuits and by-pass condensers, it is essential that everyone engaged in radio work should have some accurate quantitative idea of the magnitude of condenser and of coil reactances at different frequencies. Even if he does not intend to do any designing of his own, such knowledge helps the reader to understand someone else's design and it is a great help in determining which parts can be used for replacement in a certain receiver.

As is no doubt known to most readers, reactance is found by means of the simple formulas:

$$X_L = 2\pi fL \qquad X_C = \frac{1}{2\pi fC}$$

Even though these expressions are relatively simple, they seem to be cumbersome enough to prevent their frequent use. The chart of Figure 1 has been prepared to do away with all calculations and permit the reactance to be found with a ruler. Its range is large enough to be of use in all practical cases, as it is designed to find the reactance of any condenser between 100 mfd. and 1 mmfd. and of any inductance between 100 to 1 microhenry at frequencies varying between 10 cycles and 10,000 kilocycles. The ranges can be extended with a little ingenuity.

The Problem of Ranges

To design a chart for these simple formulas is easy enough; the difficulty is in covering the large ranges required and in still having the results accurate over the entire range.

The only type of chart that has the same percentage of accuracy over its entire range is the logarithmic one; even then the accuracy varies with the angle of intersection. If the above-named ranges are to be covered in a single chart on one page of RADIO NEWS, it is necessary to reduce the scale so as to get 14 cycles on the reactance scale. This has been done in Figure 1 and the three scales, marked B, form the chart covering this wide range.

It will be seen that the B chart consists of repeated sections, or cycles, which differ from each other only in the position of the decimal point. In other words, a chart covering one cycle would be sufficient for all calculations, but then the decimal point must be placed according to mental calculation in the same way as is done when using the slide rule. The one cycle could now be made to occupy the full page and thus permit greater accuracy.

The determination of the correct place for the decimal point might offer difficulties for the reader, and therefore we show

By John M. Borst
Part Six

in Figure 1 two different charts, A and B, for the solution of the same formulas.

The chart B solves these equations, giving the answer in two places, by interpolation and also shows the decimal point. For those cases where this is not accurate enough, the A chart then supplies one or two figures more, giving all the precision that would ever be required in practice.

In most cases the problem can be solved with the aid of the B chart, for most practical problems deal with quantities in round numbers. If, however, it is required to find the answer accurate to within three figures, it can be obtained with the aid of the A scales after the approximate values and the number of zeros already have been found on chart B. This arrangement eliminates any mental calculation and all chances of making errors in the location of the decimal point, which would otherwise be so easy to make, for this type of problem often requires working with numbers involving many zeros.

Examples

Let us answer the question asked at the beginning of this article (see Figure 1). A straight-edge laid along the 100-cycle mark on the frequency (B) scale and along the 1 mfd. mark on the L, C (B) scale indicates a capacitive reactance of approximately 1600 ohms. This line has been marked 1B in the Figure.

Supposing that greater accuracy is required, let us repeat the same operation, using the A scales everywhere—line 1A. The reactance is found to be 1592, with no indication of the decimal point. However, it was already determined that the reactance was approximately 1600 ohms so that this indicates an exact value of 1592 ohms. With the aid of the A chart one can obtain the result, accurately, to three places.

Taking another example: Let it be required to find the reactance of a 10-millihenry choke coil at 550 kc. Using all the B scales again and connecting the known values with a straight line—2B—the value of the reactance is found on the inductive reactance scale as somewhat over 34,000 ohms. By repeating the procedure on the A scales, additional figures can be obtained which show the reactance to be 34,540 ohms—line 2A.

Besides inductance, the choke has distributed capacity of unknown magnitude. This quality lowers the reactance considerably and the reader should be warned to take this into consideration when determining the size of the by-pass condenser.

In cases where one wants a by-pass condenser which shall have a certain reactance at a particular frequency, the work is done backwards. For instance (see Figure 2), a -27 tube has a bias resistor of approximately 2700 ohms. If the usual rule, that the by-pass condenser C3 shall have a reactance of 1/10 of this, is to be followed, a (Continued on page 1049)

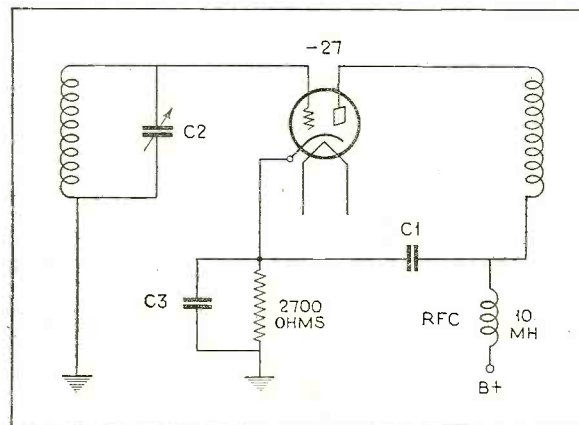

CHOKES AND BY-PASS CONDENSERS

Figure 2. The values of filtering chokes and by-pass condensers can be determined with the aid of the chart in Figure 1 as explained in the text

Reactance of Condensers and Coils or Chokes

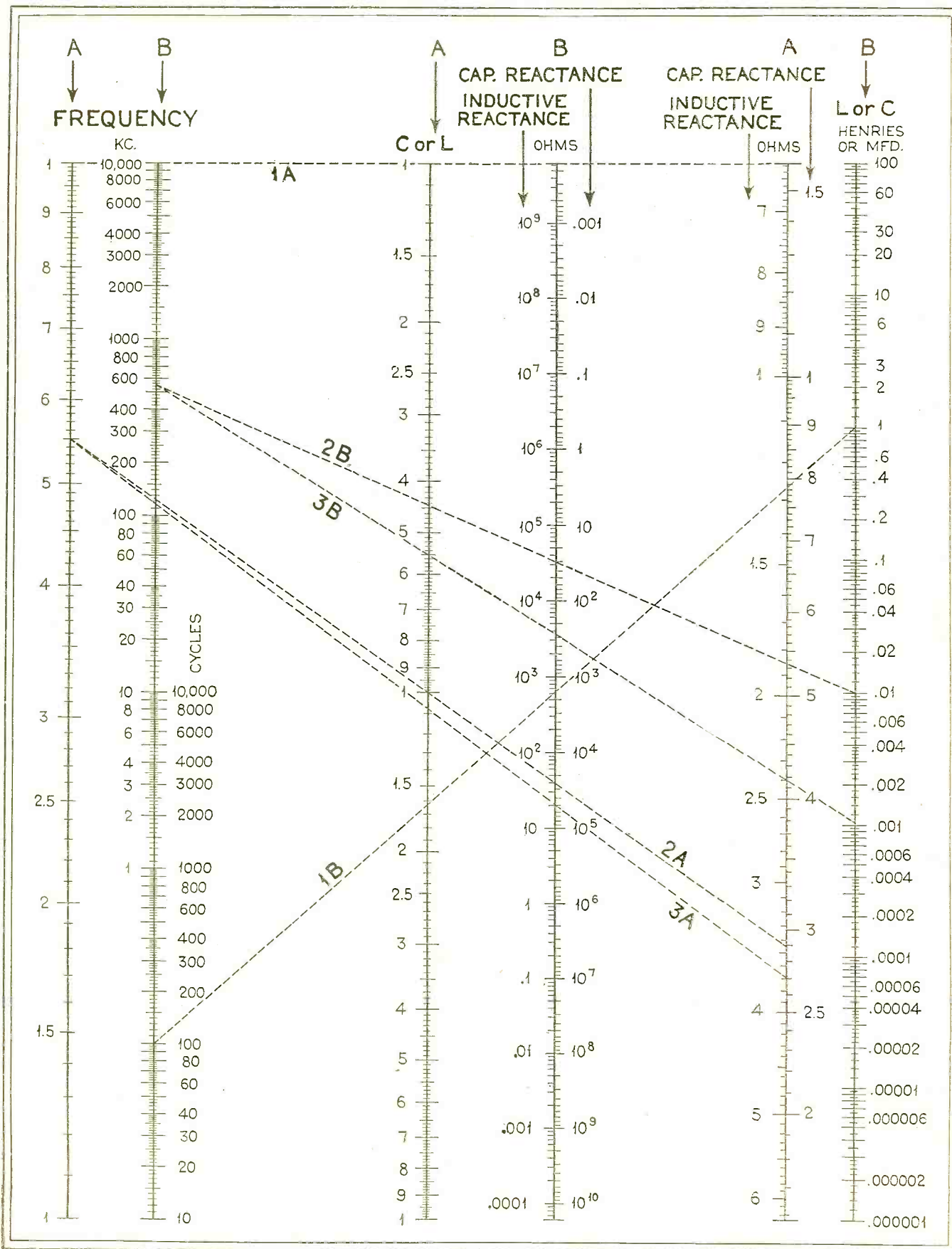

YOU NEED NOT KNOW THE FORMULA

Figure 1. Lay a ruler or straight edge along the proper divisions and the three quantities, frequency, inductance (or capacity) and reactance are on a straight line. When two are known the third one is found automatically.

Electric Filter Design

The fourth of a series of articles on filters. These articles should be of particular interest to engineers and advanced experimenters because of the ever extending use of various types of filters in the radio field

As an illustration of the design methods recommended in Part Three, we shall assume that a low-pass filter is required for use in a 500-ohm transmission line. The insertion loss requirement at each frequency is given in Table I.

In addition to the loss requirements, the impedance to very high frequencies must be as low as possible. This last requirement calls for a mid-series termination of either the constant-k or the shunt derived m-type filter. This can readily be seen by studying the symbolic image-impedance characteristics shown in the low-pass filter design chart.

Filter Requirements

As suggested in the design procedure, we shall next plot the requirements on a frequency scale. This is shown in Figure 2 by the straight lines. A tentative cut-off frequency $f_c = 5000$ c.p.s. will be selected, and an attenuation peak frequency $f_\infty = 6250$ c.p.s. Next the U's and V's corresponding to the ratio of the series to the shunt impedances must be computed and the transfer attenuation loss determined from the charts given in Part Two. The equations for these quantities are given in the low-pass filter design chart. The transfer loss, α_k , for a full section of the constant-k low-pass filter section and the transfer loss, α_m , for a derived type low-pass filter section having an "a" equal to 1.25 is shown in Table II.

It will be noticed that the requirement at 5000 cycles will not be met unless the total insertion loss is different from the total transfer loss. Experience has shown that we can usually expect a reflection gain at the theoretical cut-off frequency owing

*New York University.

By C. A. Johnson*
Part Four

to the mismatch of impedances at this point. The non-dissipative impedance at the theoretical cut-off is, of course, zero, but the actual impedance looking into the filter shown in Figure 1 is $131.7 + j212.3$ ohms at 5000 c.p.s., so that the ratio of the impedance of the line to the actual impedance looking into the filter is approximately 1.4 at an angle of 58° . We might expect by consulting Figure 3 to obtain a reflection gain of about 1 db. at each end of the filter so that it is perfectly safe to work out the element values for a section of the constant-k low-pass filter with a theoretical cut-off frequency at 5000 c.p.s. and also for a mid-shunt m-derived low-pass section with a cut-off at 5000 c.p.s., and a peak of attenuation at 6250 c.p.s.

Element Values

Before we can compute the element values for these sections, however, the question arises as to what value of "R" to use in the formula for the element values. This question requires a study of how the image impedance of low-pass filter sections vary with frequency across the transmission band of the filter, as shown in Figure 4. In order to keep the distortion over the transmission band as low as possible, it is desirable to use a value of R which is somewhat lower than the impedance of the transmission line, in case a mid-series termination is used. This is evident from a study of the image-impedance characteristic shown in Figure 4 for an "a" equal to 1.25 section. It will be noted that the image impedance is fairly constant over the transmission band up to about .85 of the theoretical cut-off frequency. Hence we shall use the mid-series termination and $R=490$ ohms will be used in computing the values of our coils and condensers.

FREQUENCY (CYCLES PER SECOND)	INSERTION LOSS IN DECIBELS	
	MAXIMUM	MINIMUM
4000 AND BELOW	2	
5000	4	
6250		60
7000		35
8000		30
11000		30
15000 AND ABOVE		30

f	U_k	V_k	α_k (db)	U_m	V_m	α_m (db)	α (db) TOTAL
4000	-.64	.0064	-	-.390	.0066	-	-
5000	-1.00	.0100	3.4	-.999	.0278	2.17	5.75
6250	-1.56	.0156	12.1	-.563	56.25	47.0	59.1
7000	-1.96	.0196	14.9	2.77	.109	19.1	34.0
8000	-2.56	.0256	18.8	1.44	.0226	17.6	36.4

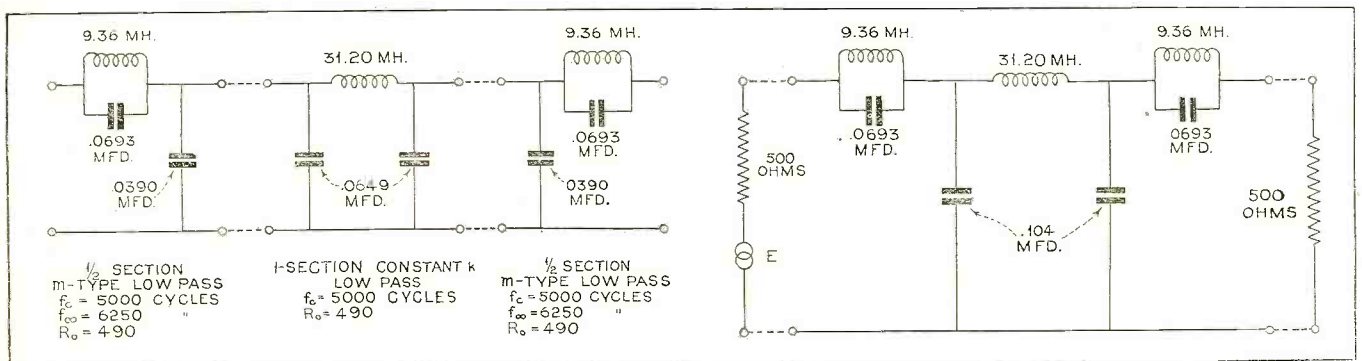

LOW-PASS FILTER

Figure 1. The method of arriving at the values shown is described in this article

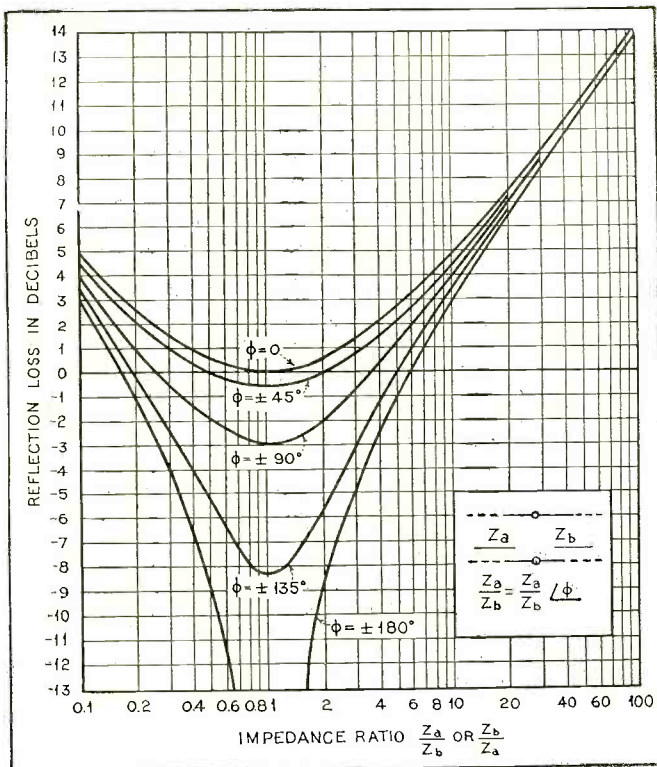

REFLECTION LOSS

Figure 3. The reflection loss, resulting from mismatch of impedances at a junction, is here plotted against the ratio of impedance

For the constant-k section, we have:

- $L_k = 31.2$ millihenries
- $C_k = .130$ microfarads.

For the mid-shunt m-type section:

- $L_i = 18.7$ millihenries.
- $C_i = .0346$ microfarads.
- $C_e = .0779$ microfarads.

The above values are those for a full section filter, so that where we wish to use a half-section filter the series impedances should be halved and the shunt impedances should be doubled as shown in Figure 1. The series coils for the half section are half the values given above and the series condensers are twice the values given above. It will be observed that the full constant-k section is inserted between two m-derived half sections so that the sections are put together on an image impedance basis and the impedance looking into the filter at high frequencies will be low. After the filter sections were put together as shown in Figure 1, it was mesh computed as explained in Part 3.

Result of the Calculations:

The results of this mesh computation are shown by the computed insertion loss curve of Figure 2. It is seen that the requirements have been met with very little margin, and if constructed of coils and condensers having the values shown in Figure 1, tests would show that the loss would be exactly as computed. However, it is usually

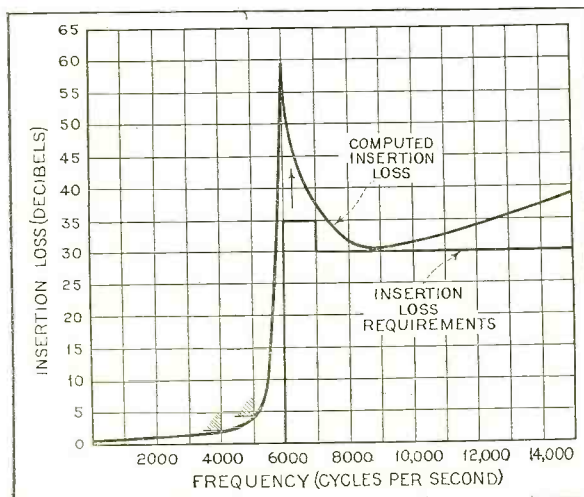

INSERTION LOSS CHARACTERISTIC

Figure 2. The insertion loss requirements as set up in the example given in the text are shown here, as is the computed insertion loss of the filter shown in Figure 1

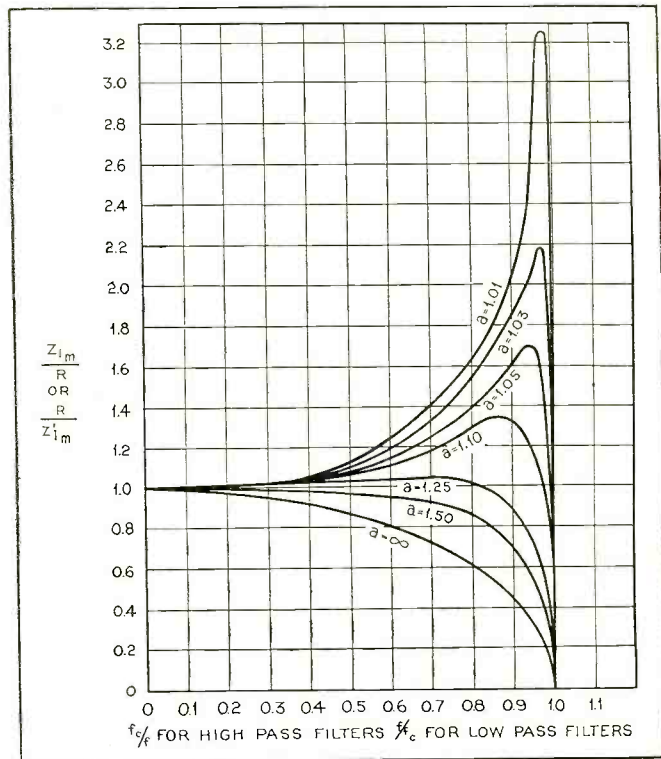

VARIATIONS IN IMAGE IMPEDANCE

Figure 4. Variations of the mid-series and mid-shunt image impedance for various values of "A" in the transmission band

very difficult to obtain the exact theoretical values of inductances and condensers called for by the design, and in case the coils or the condensers do not have their theoretical values it is quite important to adjust one or the other so that the resonance point is approximately correct. In this particular design, no difficulty should be experienced in meeting the insertion loss curve, even with elements off as much as 5%, if the series coil (9.36 millihenries) or series condenser (.0693 mf.) is adjusted so that their resonance frequency is 6250 c.p.s.

Future Articles in this Series

The next article will feature a discussion of high-pass filters, including the insertion loss and element values of a filter having an effective cut-off at about 150 cycles per second. This will enable the reader to build a band-pass filter which will transmit all frequencies from 150 to 5,000 cycles, by using the low-pass filters described in this article, in series with the high-pass filter to be described in the next issue. If the two filters are used in parallel, a band-elimination filter will result, which will eliminate all of the voice frequencies but will pass other disturbances in the transmission line such as low-frequency hum and high-frequency static.

Future articles will explain the design and construction of the many different kinds of band-pass filters, band-elimination filters and attenuation equalizers. Starting with the constant k, band-pass filters, it will be explained how m-type filters are derived, and how they degenerate into the simpler forms. The advantages and disadvantages of the mu-type filters will be pointed out, with cautions to be taken in using them.

*These illustrations are taken from "Transmission Networks and Wave Filters," by Mr. T. E. Shea. (D. Van Nostrand Co., Pages 108 and 299 respectively.)

Some New Variations for The International Six

Pentode output circuits for this receiver enable the owner to get added amplification. The necessary changes for this, for adding a phonograph pick-up, for home recording, and for increasing radio-frequency sensitivity, are discussed by the author

By Allan C. Bernstein

SINCE the first article on the International Six appeared in the November, 1931, issue of

RADIO NEWS, many fans have inquired about using a pentode tube output in this receiver. The necessary changes are simple and inexpensive to make. The output volume is almost doubled, the increase being from 1.5 to 2.5 watts. The quality is only slightly inferior, from an electrical measurement standpoint, but even a trained ear cannot detect the difference. The overall amplification is increased somewhat, although the full possible amplification of the pentode is not utilized, to avoid introducing undesirable harmonics.

The output transformer on the dynamic speaker must be changed to accommodate the high output impedance of the pentode tube. It is best to obtain this transformer directly from the speaker manufacturer, since in this way you will be sure to match, accurately, the impedances of both the voice coil and the pentode. Unless these impedances are closely matched, distortion will be evident, especially at high volumes. An output transformer designed for a -45 tube presents an impedance of only 2,000 ohms, against the 7,500 ohms actually required, introducing considerable distortion. Conversely, a pentode matching transformer will not give good results on a -45 tube.

The total current drawn by a -47 tube is 39.5 mils, 32 for the plate and 7.5 for the screen grid. This is to be compared to 32 mils for the -45 tube. The grid bias must also be reduced from 50 volts, the value used for a -45 tube, to 16.5 volts. This requires certain changes to be made in the direct-coupled audio-amplifier circuit. The 25,000-ohm resistor R11 is to be replaced by a 50,000-ohm resistor of 1/2-watt capacity. Then a 20,000-ohm fixed resistor, with a sliding tap RX, is to be connected from the mid-tap of the power-tube filament winding, on the transformer, to the chassis.

Now measure the d.c. resistance of the output transformer primary and the r.f. choke. A fixed resistor, RY, of a little more than four times this value is to be connected from the screen grid to the output terminal, away from the plate of the tube, as shown in the diagram. If no facilities are available for measuring these resistances, a value of about 1,000 ohms may be used in this position. The purpose of this resistor is to reduce the screen-grid voltage to the same value as the plate po-

tential and its size is not very critical. After these changes have been made, a five-prong socket having been substituted for the four-prong socket, the set may be placed in operation. Measure the plate current of the pentode tube with a milliammeter placed in series with the output transformer, with the volume control set at minimum volume. The plate current should be less than 32 mils. Turn off the switch and decrease the resistance of R3, and again test. After two or three adjustments you should be able to get the correct plate current.

Now readjust the hum-bucking potentiometer for minimum hum. If an objectionable amount of hum is still present, disconnect condenser, C15 (the insulated electrolytic condenser), and replace it with an uncased 1 mfd. condenser of at least 300-volt rating. Then connect the insulated electrolytic condenser, which was formerly C15, in parallel with condenser C10, as shown at CX. This procedure will effectively eliminate any hum which may have been present, although it will not be necessary in most cases. The extra 1 mfd. condenser may be put in any convenient position and held in place with friction tape.

When these changes have been made it will be found that the range of the set has not been increased appreciably, but those stations which previously came in weakly will now come in with much greater volume. The total output volume available will also be increased.

There are many other refinements which can be added to the receiver. The most useful is the attachment of a phonograph pick-up, either temporarily or permanently connected into the circuit. For temporary connection get a pin-jack terminal strip with two pin-jacks on it. To one terminal solder a screen-grid clip and to the other terminal solder the cap removed from an old screen-grid tube. If no old screen-grid tube is available, solder a small battery clip to this terminal. Now lift off the lead to the -24 tube grid, slip the pick-up jack over the top of the tube and reconnect the lead to the other end of the jack, as shown in the sketch, Figure 1. Now connect the phonograph pick-up to the jack, set the receiver volume control at a minimum, and you are ready to operate the set. A constant-impedance volume control should be used to regulate the energy input from the pick-up to the receiver. If

(Continued on page 1059)

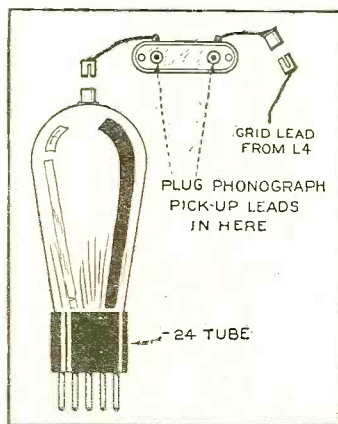

ADDING PHONOGRAPH LINK

Figure 1. A tip jack connector inserted in the grid lead of the -24 tube for accommodating the pick-up

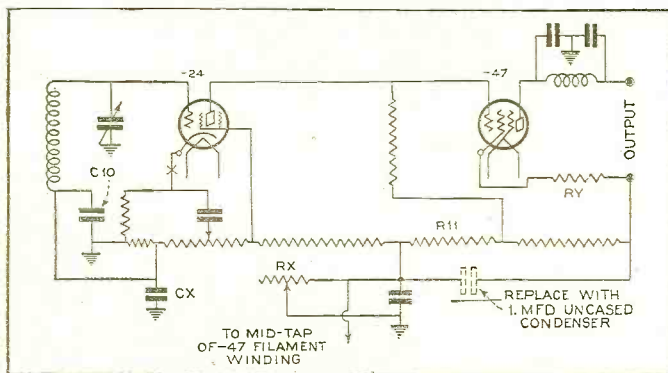

THE PENTODE OUTPUT CIRCUIT

Figure 2. This schematic diagram shows the final arrangement using the -47 type pentode as an output power tube. The point marked X on the diagram is an alternative position for inserting the phonograph pick-up unit

What Tube Shall I Use?

This month the author discusses the considerations involved in selecting tubes for use in the intermediate audio-frequency amplifier stages, and provides complete data on all tubes generally available for this service

ONE of the most important factors in obtaining efficient amplification and distortionless reproduction is that of operating tubes at the proper points of their characteristic curves.

By Joseph Calcaterra
Part Three

of a tube, the higher the amplification that can be expected of it.

This simply means that the filament, grid, screen-grid and plate voltages should be of proper values. Also the signal input to the tube should at no time exceed the maximum signal voltage which the tube can handle without overloading.

In the design of tubes, the choice of amplification factor determines, to a very considerable extent, the plate resistance of the tube, an increase raising the resistance and vice versa.

So much was said in the early days, when negative grid bias was first used with amplifier tubes, about the economy in plate current drain effected by the negative grid bias that many experimenters still believe that the grid bias is used only to reduce the plate current drain. The effect of limiting the plate current drain is merely an incidental and, in these days of ample B supply capacity, an unimportant function of the grid bias.

The plate resistance of a tube does not remain constant, but changes under varying conditions of plate and grid bias voltages. The plate resistance of a tube, within certain limits, decreases as the plate and grid bias voltages are increased, so that lower plate resistances can be obtained for a given tube by using the higher plate and grid bias voltages recommended for that tube.

The main function of the grid bias is to bring the tube to its proper operating point to handle the signal input to the tube without producing distortion.

All other things being equal, low plate resistance tubes give better amplification and frequency characteristics because the ratio of impedance of the transformer primary coupling impedance or resistor to the plate resistance of the tube is higher, thus causing less loss and better response at the lower frequencies.

A consideration of the tube characteristics which determine the suitability or unsuitability of a tube for use as an audio amplifier will help materially in selecting the proper tube for any given audio application.

Matching Tube to Load

Considerations in Selecting Audio Tubes

The load resistance used in the plate circuit of the tube has an important bearing on the operating efficiency of the tube as an audio amplifier. As a general rule, the higher the load resistance, the better the results that can be expected in amplification and quality reproduction.

The effect of amplification factor, plate resistance, load resistance, mutual conductance and input resistance of a tube on its operating efficiency as an audio amplifier may be judged from the following considerations:

To take full advantage of the output of a tube, the load resistance (primary of transformer, impedance coil or plate coupling resistor) must be large as compared to the plate resistance of the tube at all frequencies in order to obtain maximum transfer of energy into the grid or input circuit of the next stage.

The mutual conductance of a tube is a measure of the change in plate current produced by a change in grid-bias voltage. For any given type of tube, the mutual conductance depends on the conditions under which the tube is operated.

When using transformer-coupled amplification, the primary of the transformer must have high inductance, first to provide a high impedance load and secondly to assure maximum transfer of energy (minimum leakage) to the secondary of the transformer.

Tubes having high values of mutual conductance are usually better amplifiers, but it is important to guard against fallacious conclusions in this respect by making mutual conductance comparisons only between tubes designed for similar service and having similar characteristics.

For the average type of low mu, low plate resistance tubes having plate resistances of from 5000 to 15,000 ohms, the primary of the transformer should have an inductance of 100 henries (an impedance of nearly 63,000 ohms at 100 cycles per second).

The amplification factor (mu) of any given type of tube remains practically constant under all the conditions under which the tube is ordinarily used. In general, and under proper circuit conditions, the higher the amplification factor

TABLE IV
TYPE NUMBERS OF SIMILAR TUBES MADE BY DIFFERENT MANUFACTURERS

RADIO NEWS TYPE NUMBERS	401	-01A	-12A	-22	-24	-24A	-26	-27	-30	-31	-32	-36	-37	-40	-99
ARCTURUS	-	101A	012A	122	-	124	126	127	-	-	-	136A	137A	32*	099
CECO	-	201A	112A	222	224	-	226	227	230	231	232	236	237	240	199
CUNNINGHAM	-	CX-301A	CX-112A	CX-322	C-324	C-324A	CX-326	C-327	CX-330	CX-331	CX-332	C-336	C-337	CX-340	CX-299
DeFOREST	-	401A	412A	422	-	424	426	427	430	431	432	-	-	440	499
GOLD SEAL	-	6SX-201A	6SX-112A	6SX-222	6SY-224	-	6SX-226	6SX-227	6SX-230	6SX-231	6SX-232	6SY-236	6SY-237	6SX-240	6SX-199
KELLOGG	401	-	-	-	-	-	-	-	-	-	-	-	-	-	-
KEN-RAD	-	UX-201A	UX-112A	UX-222	UY-224	-	UX-226	UY-227	UX-230	UX-231	UX-232	UY-236	UY-237	-	UX-199
NATIONAL UNION	-	NX-201A	NX-112A	NX-222	NY-224	-	NX-226	NY-227	NX-230	NX-231	NX-232	NY-64	NY-67	-	NX-199
PILOT	-	P-201A	P-112A	-	P-224	-	P-226	P-227	-	-	-	P-236	P-237	-	-
RAYTHEON	-	ER-201A	ER-112A	ER-222	ER-224	-	ER-226	ER-227	ER-230	ER-231	ER-232	ER-236	ER-237	ER-240	ERX-199
RCA RADIOTRON	-	UX-201A	UX-112A	UX-222	UY-224	UY-224A	UX-226	UY-227	RCA-230	RCA-231	RCA-232	RCA-236	RCA-237	UX-240	UX-199
SPEED	-	201A	112A	222	224	-	226	227	230	231	232	236	237	X-140	199
SYLVANIA	-	SX-201A	SX-112A	SX-222	-	SY-224	SX-226	SY-227	SX-230	SX-231	SX-232	SY-236	SY-237	SX-240	SX-199
TRIAD	-	T-01A	T-12A	T-22	T-24	T-24	T-26	T-27	T-30	T-31	T-32	T-36	T-37	-	-

* NOTE. CHARACTERISTICS DIFFER FROM GENERAL AVERAGE. SEE MANUFACTURERS CHART OF CHARACTERISTICS. THE ABOVE CHART SHOWS GROUPING OF SIMILAR TUBES IN EACH CLASS. TUBES OF DIFFERENT MANUFACTURERS MAY DIFFER IN SOME CHARACTERISTICS. FOR ACCURATE DATA, CONSULT MANUFACTURERS' TUBE CHARACTERISTICS CHARTS.

TABLE V
AUDIO AMPLIFIER TUBES FOR TRANSFORMER COUPLED CIRCUITS

RADIO NEWS GENERAL TYPE DESIGNATION	FILAMENT OR HEATER RATING		NUMBER OF ELECTRODES NOTE *	CATHODE TYPE	NEGATIVE GRID BIAS VOLTS BETWEEN-			PLATE VOLT.	PLATE CURRENT MA.	A.C. PLATE RESISTANCE OHMS	MUTUAL CONDUCTANCE MICROMHOS	VOLTAGE AMP. FACTOR (mu)	BASE TYPE	TUBE DIMENSIONS		AVER. LIST PRICE
	VOLTS	AMPS			G & -F	G & FIL. C.T.	G & CATH.							L	D	
GROUP 1: A.C. TUBES: "A" "B" AND "C" SUPPLY FROM A.C. LIGHTING LINES.																
-27	2.5	1.75	3	HEATER	-	-	6.0	90	2.7	11,000	820	9.0	UY	4 1/16"	1 13/16"	1.00
					-	-	9.0	135	4.5	9000	1000	9.0				
					-	-	13.5	180	5.0	9000	1000	9.0				
					-	-	21.0	250	5.2	9250	975	9.0				
-26	1.5	1.05	3	FIL.	-	6.0	-	90	3.8	8600	955	8.2	UX	4 1/16"	1 13/16"	.80
					-	9.0	-	135	6.3	7200	1135	8.2				
					-	13.5	-	180	7.4	7000	1170	8.2				
401	3.0	1.0	3	HEATER	-	-	6.0	90	2.5	13,300	750	10.0	UX	-	-	-
					-	-	9.0	135	3.9	11,700	850	10.0				
					-	-	12.0	180	5.8	10,500	952	10.0				
GROUP 2: D.C. STORAGE BATTERY TUBES: "B" AND "C" SUPPLY FROM DRY BATTERIES OR "B" AND "C" ELIM'S.																
-12A	5.0	.25	3	FIL	4.5	-	-	90	5.2	5600	1500	8.5	UX	4 1/16"	1 13/16"	1.50
					9.0	-	-	135	6.2	5300	1600	8.5				
					13.5	-	-	180	7.6	5000	1700	8.5				
-01A	5.0	.25	3	FIL.	4.5	-	-	90	2.5	11,000	725	8.0	UX	4 1/16"	1 13/16"	.75
					9.0	-	-	135	3.0	10,000	800	8.0				
GROUP 3: D.C. TUBES FOR AUTO. OR D.C. DISTRICT USE: "B" AND "C" SUPPLY FROM DRY BATTERIES OR "B" AND "C" ELIM'S																
-37	6.3	.3	3	HEATER	-	-	6.0	90	2.6	11,500	780	9.0	UY	4 1/4"	1 9/16"	1.75
					-	-	9.0	135	4.3	10,000	900	9.0				
GROUP 4: LOW VOLTAGE (DRY CELL) D.C. TUBES: "B" AND "C" SUPPLY FROM DRY BATTERIES.																
-31	2.0	.13	3	FIL.	4.5	-	-	135	6.8	4950	760	3.8	UX	4 1/4"	1 9/16"	1.60
-30	2.0	.06	3	"	4.5	-	-	90	1.8	13,000	700	9.3	"	"	"	"
-99	3.3	.06	3	"	4.5	-	-	90	2.5	15,500	425	6.6	"	4 1/8"	1 3/16"	2.50

NOTE *: THIS REFERS TO ACTUAL ELECTRODES AND NOT TO NUMBER OF TERMINALS OR PRONGS

This will provide a high enough ratio of load to plate resistance for all general purposes except where very high quality reproduction is required.

The use of a high inductance in the primary limits the step-up ratio of the transformer to about 3 or 4 to 1, since the use of higher ratios would require the use of a large number of turns on the secondary resulting with troubles due to distributed capacity in the secondary. High distributed capacity in the secondary windings is likely to result in trouble from resonance peaks and also impairment of the response at the higher frequencies.

Selecting Transformers

In deciding which ratio transformer to use in the first and second stages, it is usually best to use the low-ratio transformer between the detector and the first audio tube and the higher-ratio transformer between the first and second audio tubes. The determining factor in such a choice, as between two similar transformers of different ratios, is not the ratio, but the fact that the lower ratio transformer usually has a higher

inductance primary which is better suited for use in the plate circuit of the detector, since the detector tube usually has a higher plate resistance than the amplifier tube.

To obtain the highest quality possible, the audio transformers should do more than merely provide a means of transferring the signal voltage. The impedance and turns ratio of the windings should be such as to properly match the output of one tube to the input of the next.

When using impedance and resistance-coupled amplifier circuits, the lack of any voltage step-up in the coupling circuits makes it desirable to use tubes which provide a higher amplification. For this purpose, the special high-mu tubes and some of the screen-grid tubes are most suitable.

In impedance coupling, the use of high-inductance chokes for plate coupling is important. In resistance coupling, the plate-coupling resistor, the coupling condenser and the grid leak should have the recommended values which have been found to work best, in order to avoid troubles from loss of amplification and from instability (motor-boating).

The grid resistance should not be (Continued on page 1057)

TABLE VI
AUDIO AMPLIFIER TUBES FOR RESISTANCE AND IMPEDANCE COUPLED AMPLIFICATION

RADIO NEWS GENERAL TYPE DESIGNATION	FILAMENT OR HEATER RATING		NUMBER OF ELECTRODES NOTE *	CATHODE TYPE	SCREEN GRID VOLTS	NEGATIVE GRID BIAS VOLTS BETWEEN-			RESISTANCE COUPLING		IMPEDANCE COUPLING		PLATE CURRENT MA.	A.C. PLATE RESISTANCE OHMS	MUTUAL CONDUCTANCE MICRO-MHOS	VOLTAGE AMP. FACTOR (mu)	BASE TYPE	TUBE DIMENSIONS		AVER. LIST PRICE	
	VOLTS	AMPS				G & -F	G & CATH.	PLATE VOLT. NOTE †	RECOMMENDED PLATE COUPLING RESISTOR, OHMS	PLATE VOLT.	RECOMMENDED PLATE CHOKE, HENRYS	L						D			
GROUP 1: A.C. TUBES "A" "B" AND "C" SUPPLY FROM A.C. LIGHTING LINES																					
-24 -24A	2.5	1.75	4	HEATER	25	-	1.0	250	200,000	135	500 ‡	.5	2,000,000	500	1,000	UY	5 1/4"	1 13/16"	\$ 1.00		
						-	1.0	250	200,000	135	500 ‡	.5	2,000,000	500	1,000	UY	5 1/4"	1 13/16"	1.60		
-35	2.5	1.75	4	HEATER	25	-	1.0	250	200,000	135	500 ‡	.5	2,000,000	500	1,000	UY	5 1/4"	1 13/16"	1.60		
GROUP 2: D.C. STORAGE BATTERY TUBES: "B" AND "C" SUPPLY FROM DRY BATTERIES OR "B" AND "C" ELIM'S																					
-40	5.0	.25	3	FIL.	-	1.5	-	135	250,000	135	250 ‡	.2	150,000	200	30	UX	4 1/16"	1 13/16"	3.00		
					-	3.0	-	180	250,000	180	250 ‡	.2	150,000	200	30	UX	4 1/16"	1 13/16"	3.00		
-22	3.3	.132	4	FIL.	22.5	1.5	-	180	250,000	180	500 ‡	.3	2,000,000	175	350	UX	5 1/4"	1 13/16"	4.50		
GROUP 3: D.C. TUBES FOR AUTO. OR D.C. DISTRICT USE: "B" AND "C" SUPPLY FROM DRY BATTERIES OR "B" AND "C" ELIM'S																					
-36	6.3	.3	4	HEATER	22.5	1.5	-	180	250,000	180	500 ‡	.5	-	-	-	UY	4 1/16"	1 9/16"	2.75		
GROUP 4: LOW VOLTAGE (DRY CELL) D.C. TUBES: "B" AND "C" SUPPLY FROM DRY BATTERIES																					
-32	2.0	.06	4	FIL.	22.5	1.0	-	180	250,000	180	500 ‡	.25	-	-	-	UX	5 1/4"	1 13/16"	2.30		

NOTE ‡ SHUNTED WITH 200,000 OHM RESISTOR

NOTE † PLATE VOLTAGES ARE VALUES APPLIED THROUGH RECOMMENDED PLATE COUPLING RESISTORS.

NOTE * THIS REFERS TO ACTUAL ELECTRODES AND NOT TO NUMBER OF TERMINALS OR PRONGS.

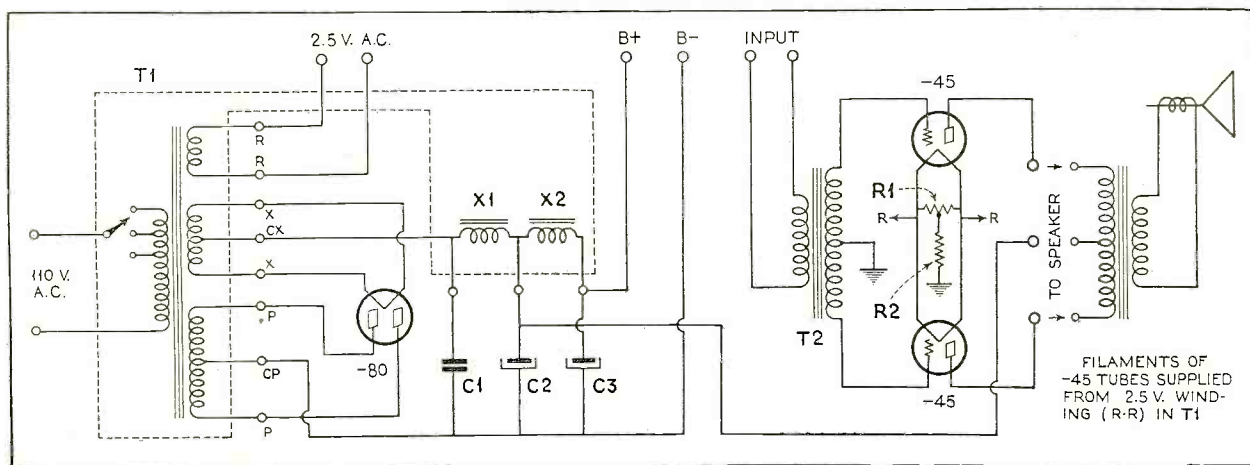

THE CIRCUIT OF THE AMPLIFIER—POWER UNIT

Figure 1. As will be seen here, the circuit is a conventional one. This unit supplies the filament and plate voltages for the tuner, the voltage divider being in the tuner

ADJUSTMENT AND OPERATION OF THE STENODE Quartz-Crystal Receiver

The Stenode's super-selectivity makes the lining-up process somewhat critical, but detailed instructions are given here, together with data on the Stenode power pack

THE Stenode receiver described in the April and May issues of RADIO NEWS can be operated in conjunction with any standard amplifier and power supply combination capable of taking care of the voltage and current requirements of the tuner. While the standard Stenode tuner is so adjusted that the correct plate voltages are applied to the tubes when the tuner "B" potential is 275 volts (measured with the tubes lighted and the volume control at zero), reasonable variations from this voltage can be employed providing the resistor network in the tuner itself is varied to maintain the correct tube voltages as indicated on the wiring diagram accompanying the May article.

For the benefit of those who may not care to make the necessary modifications in an otherwise unsuitable amplifier, or who for any other reason prefer constructing a special amplifier and power supply, the Stenode power unit is recommended as economical and effective. This amplifier-power supply receives detailed consideration in the Stenode books, and will be treated here only in a general way, and in an effort to indicate the elasticity of design and the permissible variations in individual construction.

The wiring diagram of the power amplifier and power supply combination is shown in Figure 1 and the layout in Figure 2. This unit has been designed as a companion chassis to the Stenode tuner. The general appearance and height of the base are the same, and the binding posts are so arranged as to facilitate connections with the tuner. Inspection of Figure 1 will indicate that the unit is

By Zeh Bouck
Part Three

conventional in every respect, and includes a power supply using a type -80 rectifying tube and two -45's in push-pull with an input transformer. It is assumed that the output will be connected with the speaker through an output transformer integral with the speaker assembly.

The primary of the power transformer (T1) is tapped, providing compensatory regulation for line voltage variations. There are three secondaries—the high-voltage secondary, the winding supplying the filament potential for the rectifying tube, and the 2.5-volt heater-filament winding for the tuner and power tubes. T2 is the push-pull input transformer. The push-pull tubes are biased through the center-tap resistor R1 and the series biasing resistor R2 across the tube filaments.

Parts List for Power Pack

- T1, X1, X2—Amertran 245 power block
- T2—National P-50 input transformer
- Three 4-prong wafer sockets
- C1—Flechtheim 4 mfd., 1000-volt filter condenser
- C2, C3—Aerovox 8 mfd. electrolytic condensers
- R1—Electrad c.t. resistor, 40 ohms
- R2—Electrad type B, 750-ohm resistor
- Nine Eby binding posts.
- Chassis material

The total list price of the parts, as listed at the end of this article, is \$69.25 and subject to the usual discounts of at least 40%, and even this can be bettered by many constructors. Obviously, the cost can be still further reduced by intelligent substitution, but no compromise should be made with quality, and the substitutions should be



COMPLETE POWER AND AMPLIFIER UNIT

Figure 3. A less expensive unit can be made by the use of intelligent parts substitutions

carefully selected after due consideration of voltages, loads, etc.

There are available at cut rates from many mail-order houses various replacement transformers and chokes which can be used in this power unit at a considerable saving. However, in addition to the requirements of the power tubes, the filament winding must be capable of supplying at least 12 amperes to the tuner without overheating or a serious voltage drop. Similarly, in reference to the efficiency of the chokes, it should be borne in mind that the two -45 tubes draw 65 milliamperes, and about the same consumption must be allotted to the tuner.

Due to the high heater drain, it is essential that the tuner be connected to the power pack with very heavy 2.5-volt leads, which should be as short as possible. Twisted cable, the equivalent of a number 8 wire, and not more than two and a half feet long, is recommended.

The photographs in Figures 3 and 4 provide additional constructional details on the power and amplifier unit. The resistors, condenser C1, and a fuse if desired, are mounted under the base.

The Stenode being fundamentally a superheterodyne, the procedure of lining up the tuning, oscillator and intermediate-frequency stages follows the general method. However, the extreme sharpness of the crystal circuit, and the fact that the crystal frequency is not variable, complicates the adjustments slightly and justifies detailed description of the various maneuvers. Also, as the Stenode incorporates an oscillator tracking condenser, the method of lining up differs somewhat from that of padding circuits with which the average superheterodyne expert is familiar.

It is essential that the intermediate-frequency amplifier be tuned to the crystal frequency, which will be within a hundred cycles or so of 175 kc. The adjustments are made on the semi-fixed capacitors across the i.f. windings. There are two methods of lining up the intermediate-frequency circuit, depending on whether or not the experimenter possesses a 175 kc. oscillator. Needless to say, every serviceman and superheterodyne enthusiast should possess an intermediate-frequency oscillator, and details concerning the construction and calibration of such a unit are contained in *The Service Bench* in this issue of RADIO NEWS.

Using a 175 kc. oscillator, the adjustments are made with the receiver switched over for straight superheterodyne operation. The first detector should be isolated from its usual input

circuit and coupled to the output of the oscillator, and the i.f. units adjusted for the greatest deflection on the tuning meter. If the oscillator is modulated, the audio output of the speaker may be used for resonance indication. Should it be impossible to peak any one of the i.f. circuits, this condition will almost invariably be caused by an undue amount of circuit capacity, and fifty to a hundred turns can be unwound from the associated coil. This will generally be the secondary of the first i.f. or bridge input unit.

The first detector is then reconnected in accordance with the receiver circuit diagram, and the high-frequency end lined up. This operation is also effected with the balance control switch on the super side. A standard broadcast-frequency oscillator should be employed unless there are local stations conveniently available over the entire tuning range.

The trimmers on all four condensers should be set at about half-way between maximum and minimum capacities, and the oscillator adjusted to a convenient frequency close to 1500 kc. The tuning dial should then be set at the division corresponding to this frequency, in accordance with the tuning curve of Figure 5, and the trimmers on all condensers adjusted for maximum signal response. The circuit will now have been compensated to the correct value of lumped capacity for tracking over the tuning scale. However, slight variations necessarily associated with the quantity production of variable condensers will usually make it necessary to bend the outside plates of the four rotors, at different tuning points, to maintain the true tracking curve.

The frequency should next be decreased to about 1120 kc. (again the exact frequency must be known) and the dial reset by reference to the tuning curve. The trimmers are now re-adjusted, noting carefully the direction and the exact amount of change to a fairly close fraction of a turn. The trimmers are then returned to the former position determined as effecting the correct lumped capacity, and the plates in mesh are bent to duplicate the effect secured when the trimmers were adjusted. Proceed to another tuning point at about 900 kc. and repeat the operation, this time bending the second slit sectors. Repeat these adjustments at 760 kc., 620 kc. and 520 kc., in each case bending only the last sector in mesh. These points are chosen because they represent the intermeshing of the rotors and stators by slit sectors, each of which can be bent in or out without disturbing (Continued on page 1058)

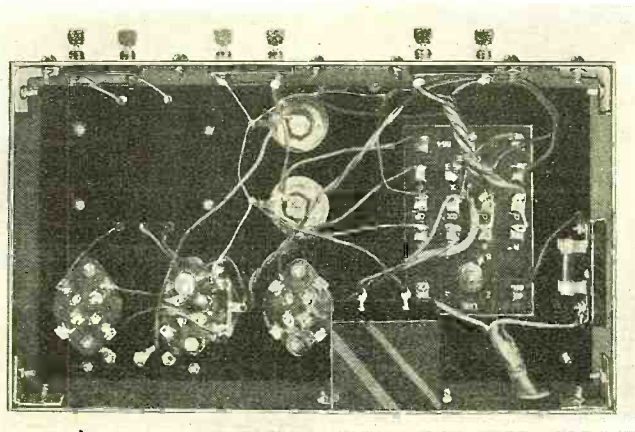

UNDER THE CHASSIS

Figure 4. Showing the simple connections under the base of the Stenode amplifier and power unit

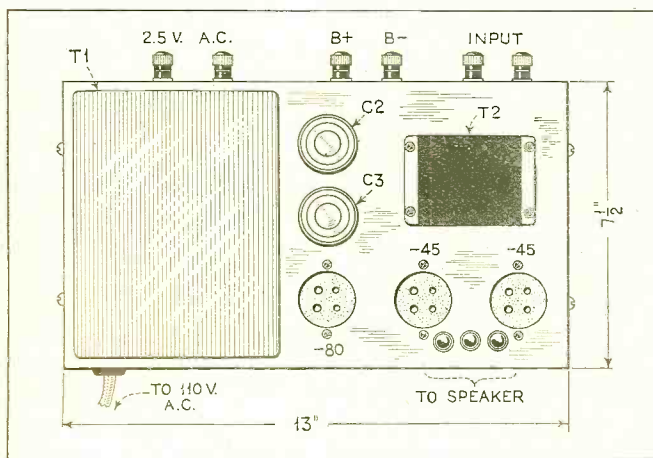

AMPLIFIER-POWER COMBINATION

Figure 2. The order of the binding posts follows the arrangement on the tuner chassis

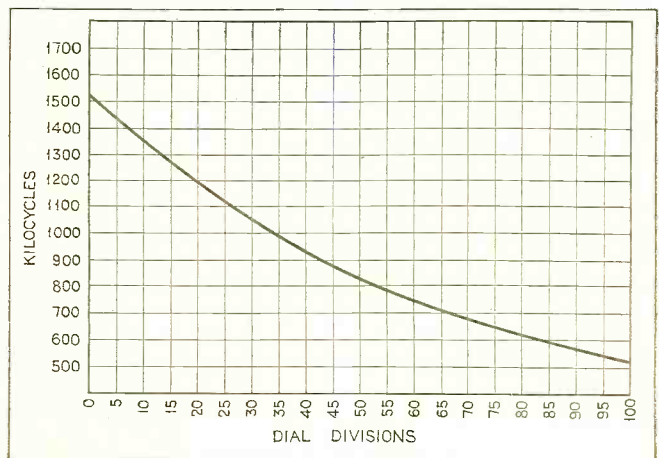

THE TUNING CURVE

Figure 5. This curve of the Stenode tuner should be used for accurate lining-up

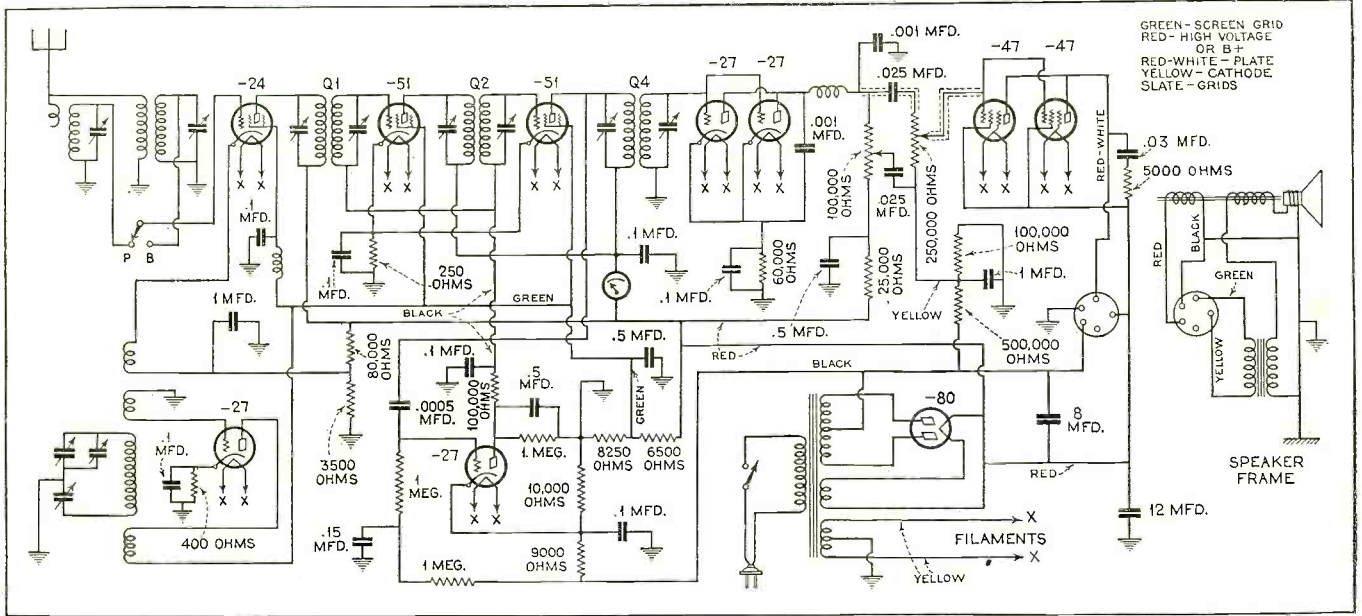

THE SCHEMATIC CIRCUIT DIAGRAM

Figure 2. In addition to its dual tuning range, the receiver includes such modern features as automatic volume control, visual tuning, parallel detection and parallel output pentodes

NOVEL SUPERHETERODYNE DESIGN FOR THE Broadcast and Short Waves

This ten-tube super is primarily a highly sensitive broadcast receiver, but it has the added advantage of an extended range that includes the police band and the higher television and amateur bands

THIS new receiver, known as the S-M 727, not only covers the broadcast frequency range of 550 to 1500 kc., but by an ingenious circuit arrangement this range is extended up to 2470 kc., this extra range serving to permit reception of police stations and some of the amateur phones and television stations. It is, therefore, really more than merely a broadcast receiver—it is a short-wave receiver in addition, except that it does not cover the frequency range of any short-wave broadcast stations, either domestic or foreign.

The receiver itself is illustrated in Figure 1, with its circuit diagram in Figure 2. No operating curves are given here, since they are exactly the same as those for the 727SW receiver described by the author in the April, 1932, issue of RADIO NEWS. In fact, the basic circuit arrangement is exactly that of the broadcast portion of the 727SW, except for a number of interesting changes having to do with simplicity and economy.

Examining Figure 1, the tube arrangement from right to left is -27 oscillator, -24 first detector, two -51 i.f. stages, -27 automatic volume control tube, two -27's as paralleled audio detectors, two -47 pentodes in parallel, and an -80 rectifier. All tubes except the -47 pentodes and -80 rectifier are shielded by a sectional partition having a removable rear and top

By McMurdo Silver*

for access to all radio-frequency tubes.

The control shafts seen at the bottom of Figure 1 are five in number, being, left to right, volume control and on-off switch, tone control, tuning, police call trimmer and switch to select between police call and broadcast band reception. The dial scale has two sets of calibrations, the right-hand one being from 550 to 1500 kc. and the left from 1500 to 2470 kc. Between these two scales is a blank strip on the dial for writing in station call letters, if desired. Above the dial is the visual tuning meter connected in the plate circuit of the second i.f. amplifier tube. The power transformer is at the left of the dial, and the i.f. transformers can be partially seen behind the dial scale. The large shield box at the right front houses only the gang condenser and the rather large high "Q" antenna coil.

At the left of Figure 1 is the 11¼-inch specially compensated electro-dynamic speaker, with its quite large input transformer (necessary because of the additional plate currents of the parallel pentodes) visible behind the right side of the cone frame.

The most interesting part of this receiver is not so much, however, the mechanical layout, but its circuit arrangement. Its schematic diagram appears in Figure 2 and is worthy of careful study.

A cursory examination indicates that it utilizes but one tuned circuit ahead of the -24 first detector, freedom from image-frequency (Continued on page 1048)

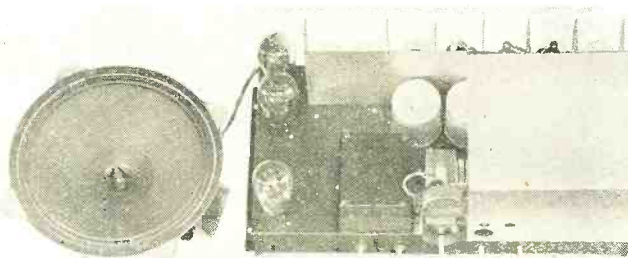

THE COMPLETE RECEIVER

Figure 1. The large shield at the right houses the input tuning circuits, while the i.f. coils are in cans immediately behind. Note the partitions shielding the individual tubes

*President, Silver-Marshall, Inc.

HOW TO CONSTRUCT AND OPERATE A Vacuum-Tube Voltmeter

Most constructional articles on vacuum-tube voltmeters give little information on the use of the completed instrument. The present article is an exception, inasmuch as it also covers the detailed use of such a meter

By C. Bradner Brown

THE checking of noise levels and gain per stage in multistage amplifiers offers a considerable problem. The first thing which is necessary is the construction of a vacuum-tube voltmeter. This piece of equipment reads peak voltages without drawing any current from the circuit, which is the same as though its resistance were infinitely high. Figure 1 shows the basic circuit for such an instrument.

The voltage V is balanced against the positive signal peak, as is shown in Figure 2.

(a) shows the action of the vacuum-tube circuit with the impressed signal voltage V . The grid bias V_2 is such that the tube acts as a detector, thus causing an increase in plate current shown by the dotted line. The extra grid voltage V_1 is then applied until the plate current returns to normal.

(b) shows the extra voltage V_1 balancing the signal voltage V . It is evident that only the positive peak will be read, as it is the positive peak that is detected. In order to make the meter direct reading, it is only necessary to supply a voltmeter V_1 to read the balancing voltage. Since this is a null or balancing method, the voltage of the plate battery and the grid bias need be no more accurate than in the average radio set using grid-bias detection. Figure 3 below shows the schematic diagram of the actual set-up used. The resistor values are as follows: R is a voltmeter multiplier, R_1 is a 200-ohm potentiometer, R_2 a 35-ohm potentiometer, and R_3 a 1000-ohm potentiometer.

The use of two voltmeters and two potentiometers for obtaining the balancing voltage was made necessary by the large range covered by the instrument (0.05-150 volts). The 0.8-volt meter was constructed by revamping an 0-8 volt Weston model 301. The original scale reading was 0-8 volts with a resistance of 500 ohms. The resistance coil was removed and a $47\frac{1}{2}$ -ohm resistance inserted, the moving coil having a resistance of $2\frac{1}{2}$ ohms. This made the total resistance 50 ohms, which caused a full-scale deflection on 0.8 volt, producing an 0-0.8-volt range. This

was necessary for reading voltages below 1 volt.

In order to simplify the action of the circuit, it was rewired to eliminate switches and to make the change-over from the 0-7.5 volt scale to the 0-150 volt scale automatic with the insertion of the extra voltage V_x . The final circuit is shown in Figure 4.

The constants for Figure 4 are the same as Figure 3, except that the operation is now much simpler. The cam switch C lights the filament and connects the potentiometer circuits. As long as the voltage is below 8 volts, it is possible to measure it with the batteries in the cabinet. When the voltage exceeds 8 volts, it becomes only necessary to plug into jack J the extra voltage, taking care that the positive and negative terminals are as shown. This action automatically shifts from low to high scale on the 0-150 meter. The jack switches were remodeled from filament-lighting jacks, which almost every experimenter has in his junk box.

In measuring the gain per stage, the following procedure is carried out. A constant signal of some given frequency is applied to the amplifier. The input to the stage in which the measurements are to be taken is found as shown in Figure 5. The terminals of the circuit marked V are connected as shown, depending on the type of amplifier. Voltage readings are then obtained as follows, using the voltmeter shown in Figure 4. With the plug out of jack J and the terminals V shorted, switch C is turned on and all potentiometers placed at the end of the scale so as to indicate zero voltage on both meters. The plate current is then adjusted to 0.1 ma. by

varying potentiometer R_3 . Having made this setting, the terminals are connected to the source to be measured, as above, and the potentiometers R_1 and R_2 adjusted so as to return the plate current to 0.1 mil. When this point is reached (it may be necessary to insert more voltage at J) the sum of the meter readings is equal to the positive peak voltage. The grid voltage on the next stage can now be measured and the gain per stage calculated as shown in Figure 6. If the audio output value of the plate circuit is wanted, it is necessary

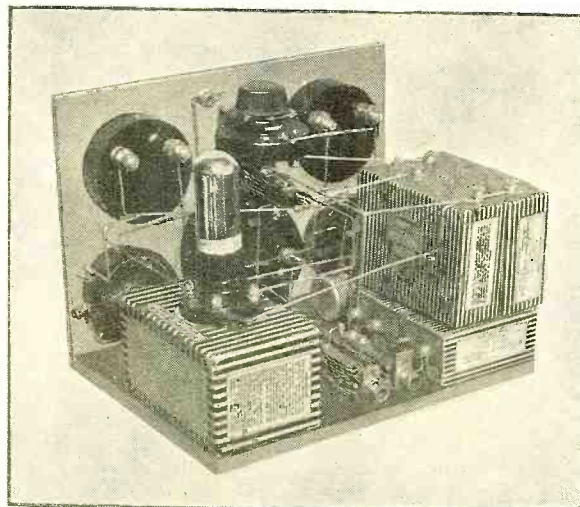

THE COMPLETED METER

In this particular type of meter exact battery voltages are unimportant. Also its small physical size and wide voltage ranges are an advantage. The circuit is shown in Figure 4

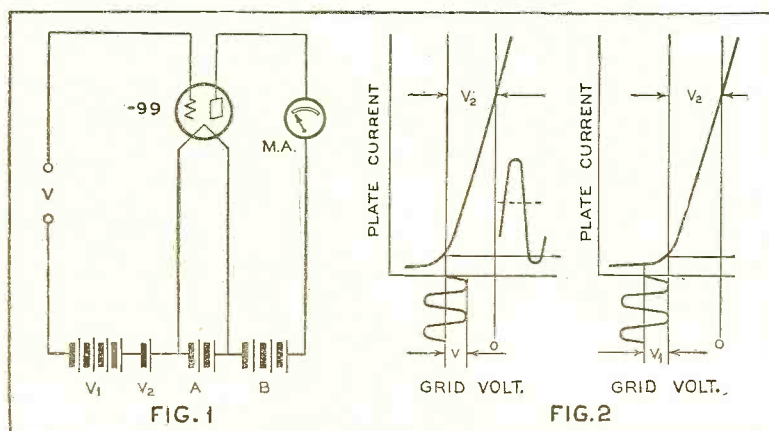

THE BASIC CIRCUIT AND MEASUREMENT PRINCIPLE
Figure 1. This is the fundamental circuit in which the C bias is varied to balance out the applied signal voltage, as in Figure 2. The C voltage required to do this equals the applied peak voltage

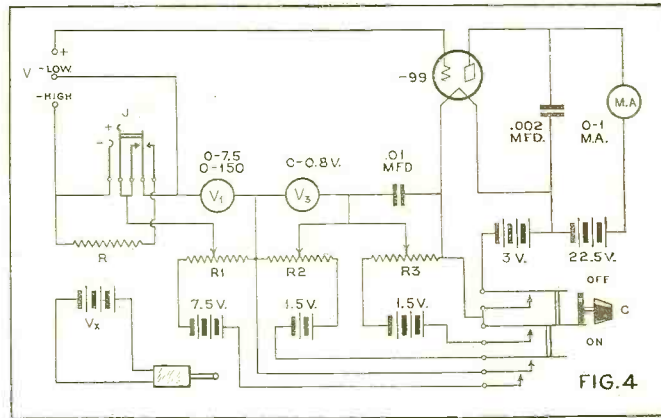
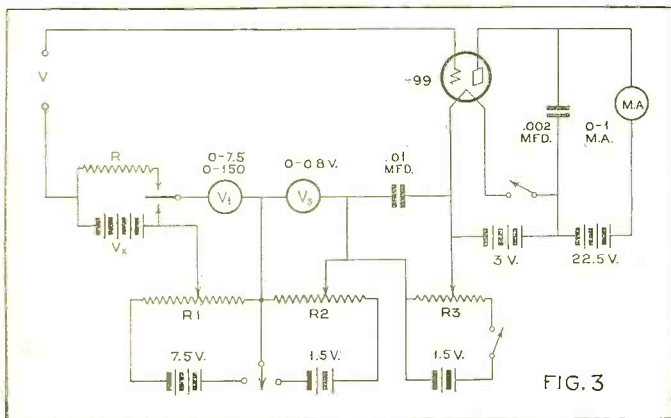

THE FINAL CIRCUITS

Figure 3. This shows the circuit of Figure 1, with refinements and a rather complex arrangement of switches.
 Figure 4. The ultimate circuit in which switching becomes largely automatic

to read the output voltage with and without a signal and subtract the readings to get the total signal swing, half of which is the positive peak, or use the coupling device shown in Figure 7. This will measure only the audio part of the signal, and only the positive peak of this. Its use is advisable in most cases, as it obviates the need for calculations.

Shooting Trouble With a V. T. Meter

In this manner it is possible to go from stage to stage and determine where the trouble, if any, lies. If a high gain over any particular stage appears to be unreasonable, it should be rechecked and the trouble remedied before proceeding. In case the positive swing exceeds the negative grid bias, or the negative swing goes off of the straight part of the curve of the mutual characteristic curve, it should be remedied, for this will cause distortion.

The measuring of noise levels is done by measuring the grid or plate audio voltage with and without a signal. The ratio is then an indication of the noise level at that particular stage.

$$\frac{\text{Voltage without signal}}{\text{Voltage with signal}} = \text{noise level ratio}$$

Since the noise level or background noise may or may not be particularly harmful, depending on the frequency of the signal, it is difficult to set an absolute value to this ratio. However, at any time when the ratio exceeds .2 in television amplifiers distortion will result which will ruin the definition

of the picture. In sound-film equipment a little more leeway is allowed, as our ears are not quite as sensitive as our eyes. A ratio of about .3 may be found in the form of a high-frequency "hiss" without seriously damaging the results obtained. Public address systems quite often have a noise level of about .3 at 60 cycles which is apparently unnoticeable. Any more than the values given show that improvements should be made, as it is generally possible to keep the noise level below this figure with proper care.

In case resistance coupling is used, a steady voltage across the grid with the previous stage disconnected, as shown in Figure 8, may be due to faulty blocking condensers and may result in a current flow through the grid leak, which will be noticed as a roar in the sound output. Any steady voltage of this sort should be investigated.

Tracing Down Noises

This vacuum-tube voltmeter has been used by the author in checking the gain per stage in an 8-stage resistance-coupled amplifier. It proved especially valuable in hunting down noise levels and locating the particular stage in which the noise originated. The only expensive meter needed for the average experimenter is the 0-1 milliammeter. If you have an old 1000-ohms-per-volt meter, the movable coil will serve excellently by removing the resistance. In fact, it has been suggested that the arrangement in Figure 9 be used to allow the use of the meter as a high-range (Continued on page 1064)

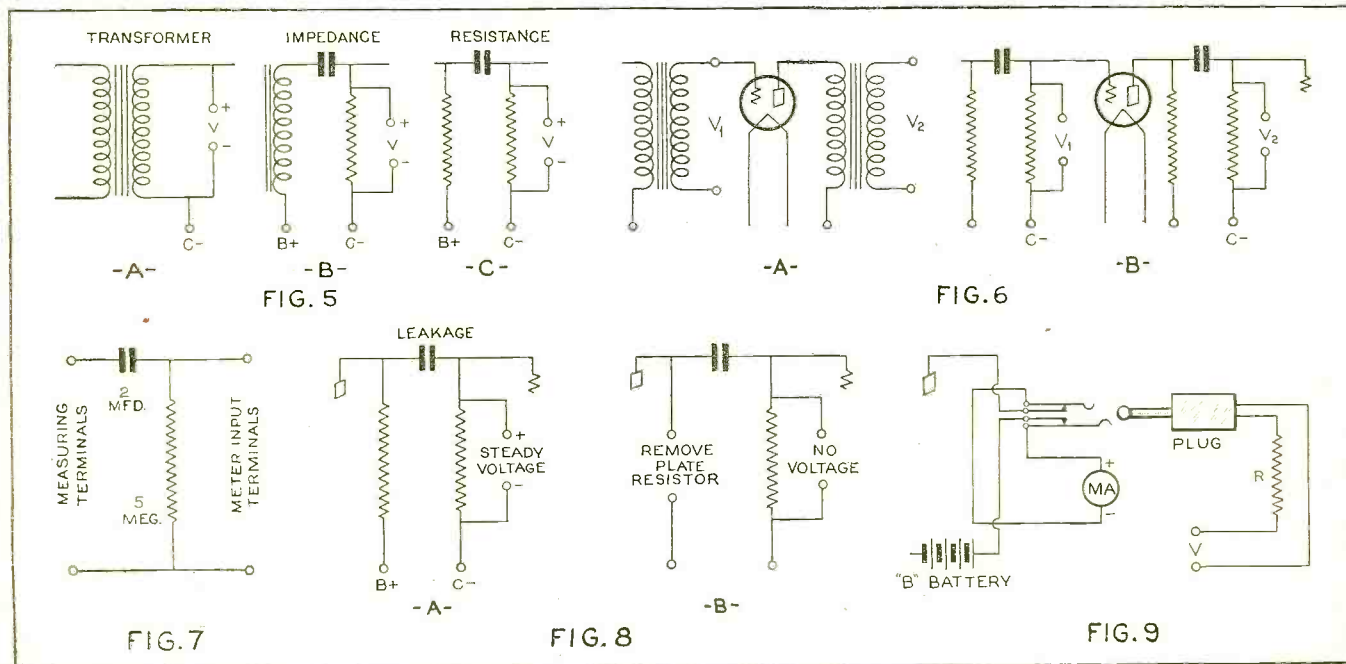

HOW TO USE THE V. T. VOLTMETER

Here are shown various amplifier and auxiliary apparatus circuits referred to in the text

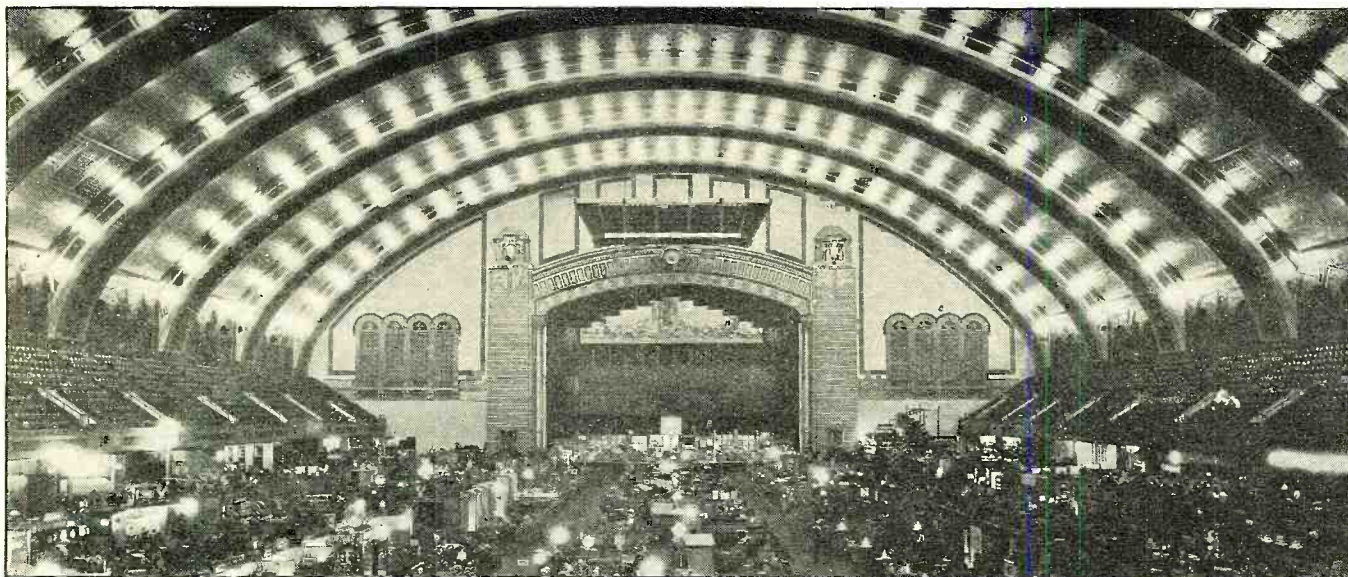

What's New *at the* Trade Show

As a service to dealers and servicemen, the following pages are devoted to descriptions of new radio apparatus displayed at the Chicago Show

Unique Superheterodyne Receiver

Description—The Philco model 112X is an eleven-tube superheterodyne receiver featuring a new method of cabinet design and mounting for the reproducer, so as to provide the utmost in quality reproduction. The improved electro-dynamic speaker is mounted on a baffle-board of large area, which is sloped in such a way as to throw the sound upward and not along the floor.

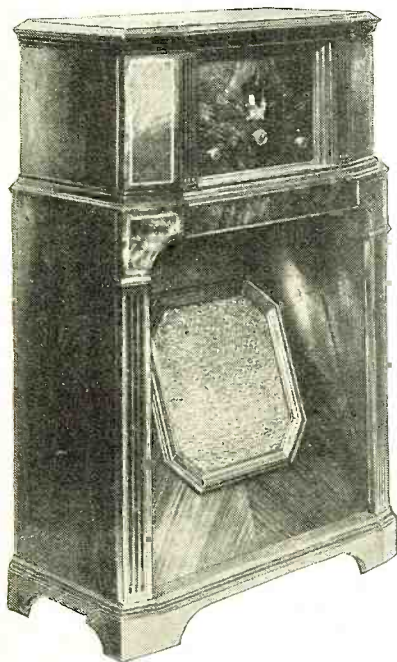

An echo-absorbing screen is installed at the back of the speaker chamber, to prevent any echo or blur effect. The baffle-board is made of extra heavy laminated hardwood and it is securely anchored to the cabinet to prevent vibration. The receiver is

By The Technical Staff

equipped with two pentode power tubes, automatic volume control and a four-point tone control.

Maker—Philadelphia Storage Battery Co., Philadelphia, Pa.

Midget Receiver

Description—The Lafayette mantel type set illustrated here is a seven-tube superheterodyne circuit and is provided with a tone modifier and an acoustic compensator. The tubes employed are two -24 type, one -27 type, two -35 type, one -47 pentode and one



-80 rectifier. The receiver chassis and dynamic speaker are enclosed in an American walnut cabinet measuring 18 inches high by 15 inches wide by 11 $\frac{1}{8}$ inches deep.

Maker—Wholesale Radio Service Company, 100 Sixth Avenue, New York City.

Console Receiver

Description—This model RAE-59, ten-tube superheterodyne radio-phonograph combination is enclosed in a hand-rubbed walnut cabinet measuring 46 inches high by 29 $\frac{3}{8}$ inches wide by 19 13/16 inches deep. This combination features automatic volume control, micro-tone control, a low impedance pick-up unit, a new type inertia tone arm, a

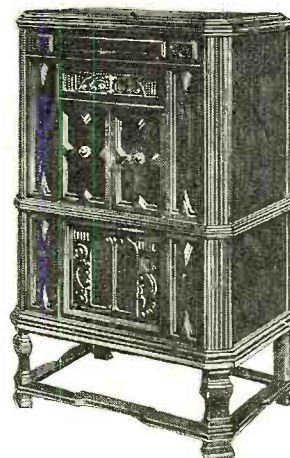

studio microphone for home recording and an automatic record changer. The phonograph drive is also provided with a 33 $\frac{1}{3}$ r.p.m. clutch. The following tubes are employed: three -35 type, three -27 type, one -24 type, two -47 type pentodes and one -80 type rectifier.

Maker—RCA-Victor Co., Inc., Camden, N. J.

Condenser for Automobile Radio Receiver

Description—A new type condenser, No. 1120, which is impregnated with a high melting-point compound and encased in a leak-proof metal cylinder measuring 1 $\frac{1}{4}$ inches in

diameter by 2 1/8 inches high. This condenser is available in .5, .75 and 1 mfd. capacities and is rated at a working voltage of 150 volts d.c. It is capable of withstanding a



temperature of 160 degrees Fahrenheit. In addition to its use in the suppressor systems of automobile radio installations, it is suitable for interference and spark suppressor applications on electrical machinery.
 Maker—Acrovox Wireless Corp., 70 Washington Street, Brooklyn, N. Y.

Television Receiver and Radiovisor

Description—The table type model JD-30 eight-tube receiver shown in the accompanying illustration has a wavelength range of 80 to 550 meters. The radio-frequency tuning circuit is of special design to provide



broad-band tuning for television signals and the required selectivity for reception on the broadcast band. The audio-frequency system is said to provide uniform amplification at all frequencies from 20 up to 30,000 cycles. The following type tubes are utilized: four -24 type, one -27 type, two -45 type and one -80 type. The cabinet measures 21 inches high by 12 inches wide.

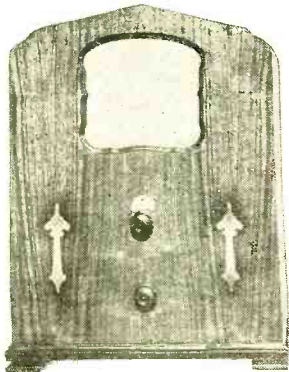

The second illustration shows the Jenkins model R-400 projector type television radiovisor. It comprises a 60-line, lens type

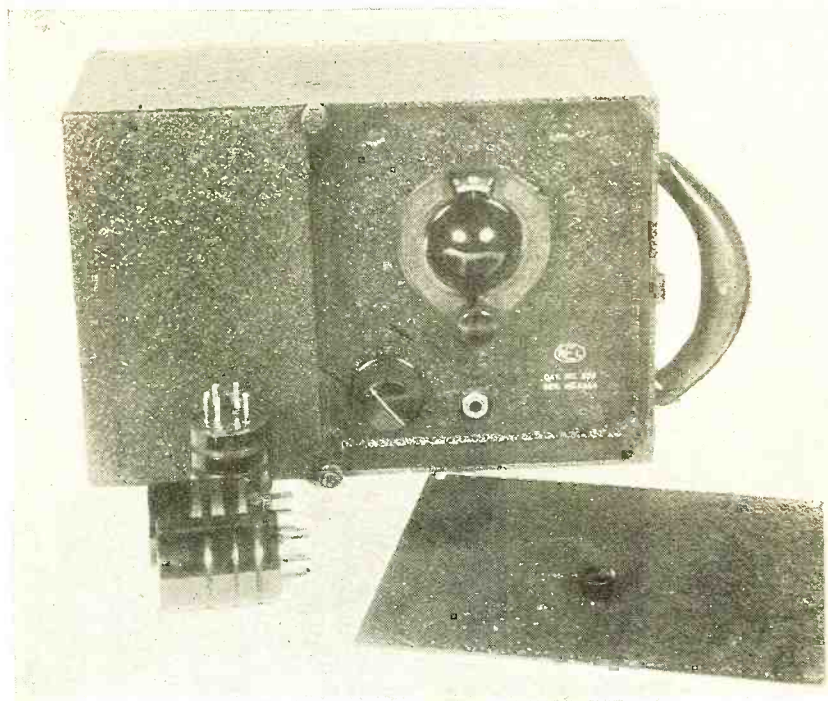

TWO-TUBE SHORT-WAVE RECEIVER

A member of the RADIO NEWS staff tested this receiver in his home and reported excellent amateur phone and code reception

A Compact Two-Tube Short-Wave Receiver

Description—A portable short-wave receiver employing two -30 type two-volt tubes. The set is supplied with three plug-in type coils, covering a wavelength range from 20 to 100 meters. Additional plug-in coils are available to cover a tuning range up to 600 meters. With the complete set of coils, it is possible to receive both code and broadcast signals in the amateur short-wave

band, also police and aeronautical signals and regular broadcast reception in the broadcast range from 200 to 550 meters. It makes use of two small-size B batteries and one C battery to furnish the filament and plate voltages to the tubes. The receiver chassis and all three batteries are enclosed in a neat crystallized lacquer-finished metal case, measuring 11 inches long by 7 1/2 inches high by 4 1/4 inches wide. With complete equipment it weighs 12 pounds.

Maker—Radio Engineering Labs., Inc., 100 Wilber Ave., Long Island City, N. Y.

scanning disc with motor driving equipment, a fixed mirror, a crater type lamp and a ground-glass screen. The attractive cabinet containing the apparatus measures 24 inches high by 16 inches wide.

Maker—Jenkins Television Corp., Passaic, N. J.

Tube Tester

Description—An inexpensive tube tester capable of testing all tubes, including the new power and radio-frequency type pen-

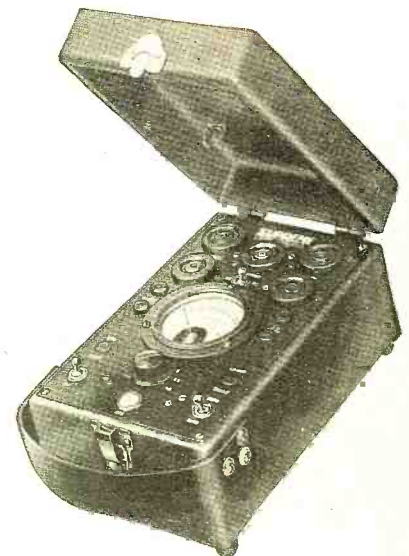

Transmitting Condenser

Description—The type VM transmitting condenser is a popular unit for filter circuit requirements in broadcasting stations. It is rated for continuous operating voltages up to 5000 volts d.c. (3300 r.m.s., rectified a.c.)



and is available in 1, 2 and 4 microfarads capacity. The connecting posts are mounted within heavily bushed, glazed porcelain insulators. This company manufactures a complete line of paper dielectric condensers, ranging from .0001 mfd. to a 4 mfd. transmitting condenser rated at 7000 volts d.c.

Maker—A. M. Flechtheim & Co., Inc., 136 Liberty Street, New York City.

ode tubes, without adapters. It has provisions for filament or heater potentials of 1.5, 2.0, 2.5, 3.3, 5.0, 6.3 and 7.5 volts to any of the five sockets mounted on the panel. It incorporates a grid shift test, a

gas test for amplifiers, a cathode-heater short test for heater type tubes and it can test both plates of full wave rectifier type tubes. This instrument employs a large $3\frac{1}{2}$ -inch D'Arsonval type meter with two calibrated scales of 0-8 and 0-80 milliamperes. The meter has a removable cover, permitting the glass to be easily replaced in case it is broken.

Maker—Supreme Instruments Corp., Greenwood, Miss.

Antenna Transformer

Description—In city apartment houses it is often necessary to employ a long lead-in from the aerial installation on the roof, with a resultant loss in signal strength. To meet this condition the Aeroformer, recently in-

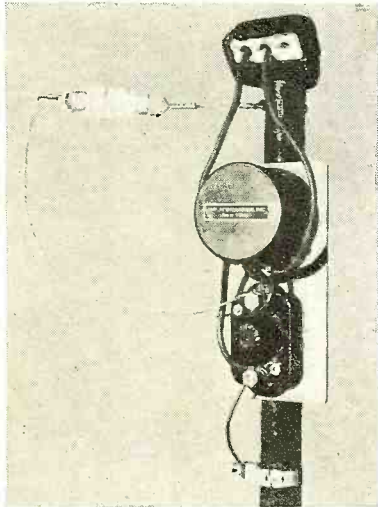

roduced, is a specially designed radio-frequency transformer to match the impedance of the average broadcast receiving antenna to any long lead-in of forty or more feet in length. This device is designed to provide increased pick-up and will help to eliminate radio interference. It also compensates for losses where a shielded lead-in wire is employed. The unit is installed on top of the roof and is connected between the antenna and the beginning of the down lead. The illustration shows a neat-appearing installation with the device and a lightning arrester mounted on a pipe standard.

Maker—Amy, Aceves & King, Inc., 11 W. 42nd St., New York City.

Portable Horn

Description—The compact No. 3220-N folded air-column horn is particularly adapted to sound-amplifying equipment for small theatres and outdoor public-address installations where it is desired to mount the horns on a pedestal or tower. It weighs



33 pounds and is equipped with a cast aluminum throat section and stand. The oval bell measures 27 inches by 35 inches, with a depth of 27 inches. The air column is slightly less than seven feet.

Maker—Racon Electric Co., Inc., 18 Washington Place, New York City.

Combined Television and Broadcast Receiver

Description—A combination receiver that should have popular appeal to all types of radio enthusiasts. This attractive cabinet of upright design contains a short-wave

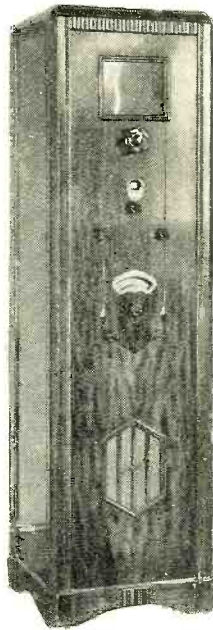

chassis to receive television signals and a superheterodyne receiver to provide reception on the broadcast wavelengths (200-550 meters). The television screen measures 8 inches by 7 inches. A lens scanning disc driven by a synchronous type motor and a Taylor neon arc lamp are employed to project the television images.

Maker—Trav-Ler Manufacturing Corp., 1818 Washington Ave., St. Louis, Mo.

A Flashlight with a Revolving Head and a New Type Snaplite

Description—The first illustration shows a unique flashlight with a double reflector sys-

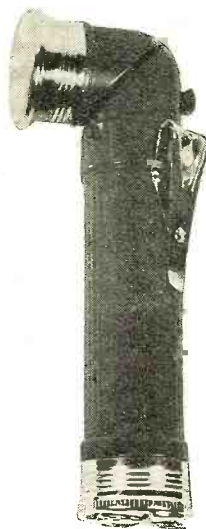

tem and a focusing, revolving head. In addition to its popular appeal to campers and its many industrial applications, this flashlight should prove of valuable assistance to the radio serviceman. The revolving head feature permits him to light up many inaccessible places, often encountered in service work. It is equipped with a choice of garter ring or bell hook for fastening to one's belt, pocket or coat-button, allowing the

operator free use of both hands.

This company also announces a new flashlight in a small pocket design which is

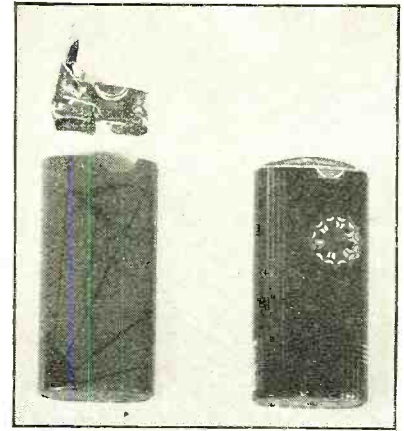

known as the "Snaplite." The illustrations show the Snaplite with cover closed and with the snapper top removed. This new design permits easy and quick battery renewals. It is inexpensive and a convenient size flashlight for all types of radio enthusiasts.

Maker—Burgess Battery Co., 111 W. Monroe St., Chicago, Ill.

An Attractive Radio-Phonograph Combination

Description—The Sparton Model 30-A combination radio receiver and automatic phonograph can play automatically and consecutively twelve of either the 10 or 12-inch size phonograph records. The turntable mechanism can revolve at a speed of 78 revolutions per minute for the standard type record or at $33\frac{1}{3}$ revolutions per minute for the new 30-minute records. The radio receiver is a ten-tube superheterodyne circuit, employing the following tubes: Four -35 type, three -27 type, two -45 type and one

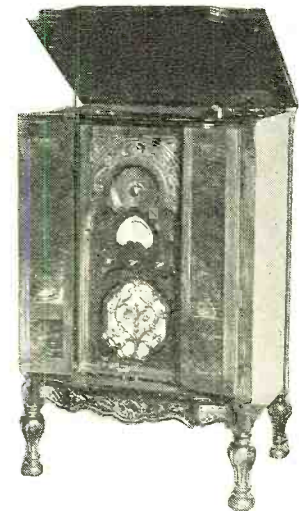

-80 type rectifier. This set features automatic volume control and a tone control.

Maker—The Sparks-Withington Company, Jackson, Mich.

Long Playing Phonograph Record

Description—This new type of long playing phonograph record recently introduced, is made of durium, a synthetic resin which is extremely tough and at the same time flexible. A fibre board is coated with a shell of durium five one-thousandths of an inch thick, on which the recording impression is made. A new method of recording

known as the micro-channel process permits twice as much music or speech to be impressed on a disc as heretofore recorded.



Due to the durability of durium, these long playing records are made possible by reducing the thickness of the walls between the needle grooves, thereby providing twice as many channels as on an ordinary record. The manufacturer states that long tests show these records will last three times as long as the old-style record. They are inexpensive and are to have a wide distribution.

Maker—Durium Products, Inc., 460 W. 34th St., New York City.

Unique Superheterodyne Receiver

Description—The Ozarka Model V-16 receiver employs 16 vacuum tubes of the following types: four -35 multi-mu, three -45 power tubes, seven -27 general purpose and two -80 type rectifiers. This set features



automatic volume control, tip-jack provisions for phonograph or television, color tone control, matched tubes for the particular set in which they are to be used, two Rola speakers, one 10-inch size for the bass and

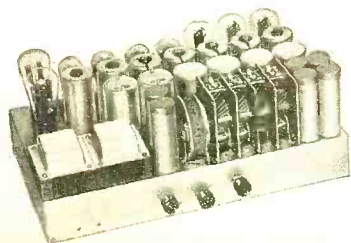

one 8-inch size for the treble register. The reproducers are matched to separate amplifiers, pitched respectively for low and high range. The baffle-board for the speakers is made of 1/4-inch solid walnut lined with soft wood.

Maker—Ozarka, Inc., 1257 Fullerton Avenue, Chicago, Ill.

Triple-Twin Tube

Outstanding Features—Designed to replace both the detector and audio-frequency amplifying tubes. It has three times the output

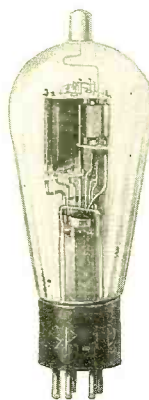

of a -45 type tube and twice the output of a -47 pentode type tube.

Usage—Amplifier and a combined detector and amplifier.

Type Number—295.

Heater Voltage—2.5 volts.

Heater Current—4.0 amperes.

Amplifier

	Input Section		Output Section	
	180	250 max.	180	250 max.
Plate volts.....	180	14.0	-2.5	-3.0
Grid bias (volts).....	10.0	14.0	32.0	32.0
Plate current (ma.).....	3.0	4.0	13.0	13.0
Amp. factor.....	14.4	14.4	3550	3000
Plate res. (ohms).....	12500	12000		
Mutual cond. (microhms).....	1150	1200	3650	4350
Power output (watts).....			2.25	4.5
Signal volts (full power—r.m.s.).....	4.0	5.0		
Load impedance (ohms).....	12500	12500	4600	4000
Input capacity (mmf.).....	3.5			

Detector-Amplifier

Plate volts.....	180	250 max.
Input grid bias (volts).....	12.0	-16.0
Input plate current (ma.).....	1.0	2.0

Note—Output characteristics remain as listed above.

Overall length.....	6 9/16 inches
Overall diameter.....	2 11/16 inches
Cap.....	0.346 inch-0.369 inch
Bulb.....	S-21
Base.....	Standard 5-pin UY

Maker—Cable Radio Tube Corp., 84 No. Ninth St., Brooklyn, N. Y.

A New Line of Controls with Switch-Cover Plates

Description—A new line of wire-wound potentiometers that can be used with or

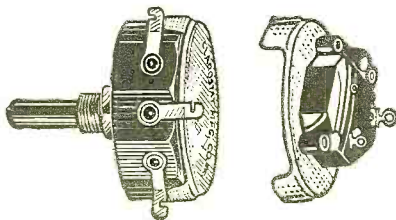

without the line switch. This new Ad-A switch line eliminates the necessity of stocking duplicate sets of controls. The standard dust-guard cover plate of the control unit can be easily pried off and the cover plate with the built-in switch snapped on in its place. This switch is approved by the Underwriters for 3 amperes at 110 volts. The

wire-wound potentiometers are available in any taper and in resistance values up to 50,000 ohms.

Maker—Clarostat Mfg. Co., Inc., 285 N. 6th Street, Brooklyn, N. Y.

Condenser Microphone

Description—The model 44 condenser microphone is especially adapted to sound recording, radio broadcasting and sound measurement work. It is designed for high sensitivity and to be free from background noises. The microphone is connected to a two-stage amplifier employing two -30 type tubes. The transmitter head is 3 1/8 inches in diameter and is mounted on a swivel supported by two strong pillars, so that it may be inclined at any angle to face the sound

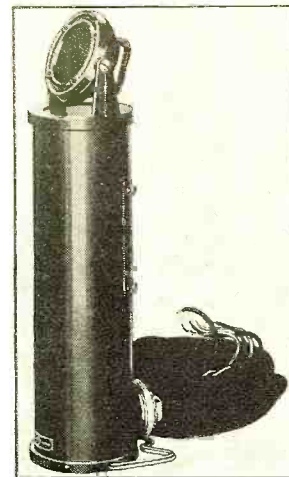

source. The diameter of the case is 3 3/4 inches and its length 12 3/16 inches. The instrument can be mounted in any one of three ways, on a table or a desk, suspended by a rope or on a floor stand.

Maker—Shure Brothers Co., 337 W. Madison Street, Chicago, Ill.

Low-Boy Console Receiver

Description—This inexpensive four-tube superheterodyne console set—the "Bonni-boy"—is equipped with a full-floating moving coil dynamic speaker and a balanced, image suppressor pre-selector, to eliminate double-spot reception. The circuit makes use of a -24 type tube as an oscillating detec-

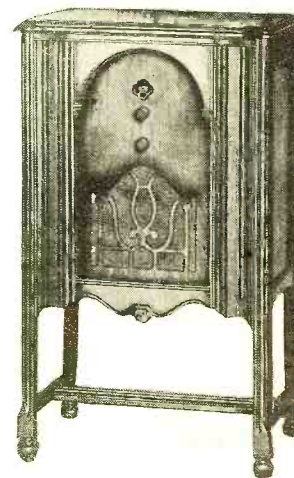

tor, one -35 multi-mu type tube in the intermediate-frequency stage, one -47 pentode type tube as a second detector and amplifier. The -80 type tube is used for rectification. The dimensions of the cabinet are: 35 inches

high by 20½ inches wide by 12¼ inches deep.

Maker—The Crosley Radio Corp., Cincinnati, Ohio.

Console Receiver

Description—A ten-tube superheterodyne receiver equipped with matched twin speakers to provide improved quality and a wider range of tone reproduction not possible with



a single speaker. The receiver chassis and the two speakers are enclosed in an attractive six-leg cabinet measuring 42¼ inches high by 24¾ inches wide by 14¾ inches deep.

Maker—U. S. Radio & Television Corp., 1504 N. Michigan Ave., Chicago, Ill.

Electro-Dynamic Unit

Description—A new giant electro-dynamic horn unit, type GAC-4, for sound-reproducing systems, designed to operate on an output of 10-30 watts. This unit is said to



have a frequency response from 50 to 8000 cycles. It weighs 15 pounds and requires a field supply of 1.6 amperes at 6 volts d.c. The impedance of the voice coil is 16 ohms.

Maker—Macy Electrical Products Co., Inc., 1451 39th Street, Brooklyn, N. Y.

Audio Amplifier

Description—A four-stage audio amplifier especially made for theatre use. This sound system is capable of serving an audience up to 1000 people, and it is designed to work with either sound-on-film or sound-on-disc equipment. It employs the following tubes: One -35 type, two -27 type, two -50 type and two -81 type. It is 110 volts, 60-cycle, a.c. operated, and can provide all the auxiliary voltages to the photo-cell, exciter lamp,

monitor speaker and microphone. This amplifier features a combined, fade-over control and a volume control. Accessories comprising a mounting stand, a pick-up and

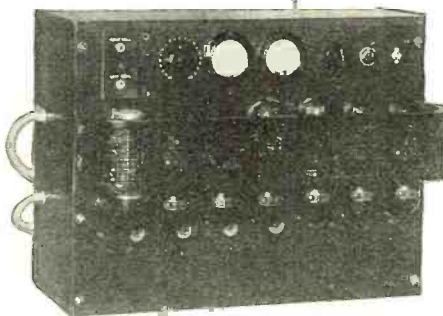

microphone control unit, and a monitor speaker, are available for use with this audio amplifier.

Maker—Webster Electric Co., Racine, Wisconsin.

Oscillator

Description—This model No. 550 oscillator should have popular appeal for the radio experimenter as well as the serviceman and dealer. It is a direct-reading instrument with an adjustable output covering both broadcast and intermediate-frequency wave bands from 130 to 1500 kilocycles. The parts are heavily shielded and the complete equipment is contained in an



attractive leatherette-covered carrying case.

Maker—Readrite Meter Works, 20 College Avenue, Bluffton, Ohio.

Electro-Dynamic Unit

Description—An electro-dynamic unit for sound reproduction which incorporates a new design in diaphragm action. The voice coil and diaphragm are located for maximum effective influence of the field poles. The diaphragm is only .002 inch thick and it is so molded and shaped that it forms its own core for the voice coil. This new type of construction and design permits the op-



erator or serviceman to quickly and easily replace an impaired diaphragm. This dynamic unit has a capacity of 25 watts on the input, not to exceed 15 volts at 2 amperes alternating current. The impedance of the voice coil is 16 ohms. The exciting voltage of the field coil is 6 to 8 volts at 1½ am-

peres. This voltage can be obtained from the standard 6-volt storage battery or the manufacturer's specially designed dry rectifier.

Maker—Fox Amplifying Company, 625 Board of Trade Bldg., Toledo, Ohio.

Resistor Assortment

Description—This convenient serviceman's resistor kit offers an economical method for stocking resistance units for all types of replacement work. The kit contains ten assorted metallized resistors of 1 or 2-watt rating, in resistance values most commonly required for repair and replacement service.



Thousands of different resistance values may be had by connecting two or more resistor units in parallel or series. Two simple formulas with complete instructions for obtaining an infinite variety of resistance ranges accompany each kit.

Maker—Lynch Manufacturing Co., Inc., 1775 Broadway, New York City.

Direct-Coupled Amplifier

Description—This model D-250 audio amplifier provides an undistorted power output of 14.4 watts. The tubes used are: one -24 type, one -27 type, two -50 type and two -81 type rectifiers. The approximate overall gain of this amplifier is 76 deci-

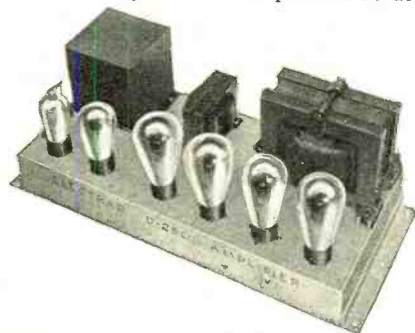

bels. It measures 22 inches long by 10½ inches high by 9 inches wide.

Maker—Electrad, Inc., 175 Varick Street, New York City.

Indoor Aerial Device

Description—A new device known as the Aerostat to replace the outside antenna. To

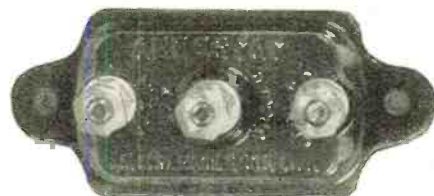

install this unit it is only necessary to connect the antenna and ground terminals of the receiver to the binding posts on the

Aerostat marked "Set A" and "Set Ground." A good ground lead, preferably from a cold water pipe, is connected to the end binding post marked ground "X." This unit measures 4 inches long by 1 3/4 inches wide by 1 3/4 inches high.

Maker—M. M. Fleron & Son, Inc., Trenton, N. J.

Variable Resistance

Description—The Eli type potentiometer employs a new type of construction and as-

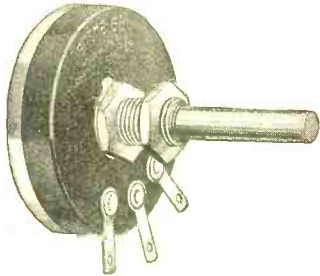

sembly whereby the shaft and bushing are insulated from the resistor and contacting parts. This control is available in different values ranging from 100 ohms up to several megohms. It measures 1 1/2 inches in diameter. The Centralab potentiometer is also available with a line switch assembly. If desired, these resistors may be had with a definite fixed resistance at either end of the resistance strip.

Maker—Central Radio Laboratories, 900 E. Keefe Avenue, Milwaukee, Wis.

Midget All-Wave Receiver

Description—This table type superheterodyne receiver is capable of tuning from 18

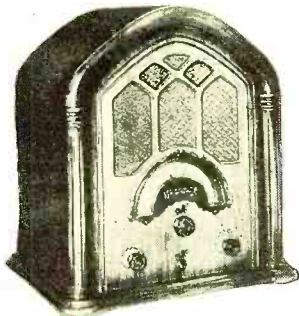

to 555 meters without using plug-in coils and with only one tuning adjustment control, Four tuning units, comprising nine coils, three for the broadcast band and six for the short wavelengths, are mounted in a catacomb assembly which contains the band selector switch. The switch has 46 contacts that are fitted with 125 silver points. This all-wave receiver is also available in a console style cabinet.

Maker—Pilot Radio & Tube Corp., Lawrence, Mass.

Isolantite Socket

Description—The material known as isolantite, said to approximate the insulating qualities of fused quartz, is employed in a



new low-loss socket made in either sub-panel or base mounting type and available in four, five and six-prong models. Its electrical efficiency is not affected by either tempera-

ture or humidity. The socket is constructed with reinforced side-gripping contact springs and measures 2 1/4 inches long by 1 5/8 inches wide with standard 1 27/32 inches mounting centers.

Maker—The Hammarlund Mfg. Co., Inc., 424 W. 33rd St., New York City.

Aerial Equipment

Description—The accompanying illustra-

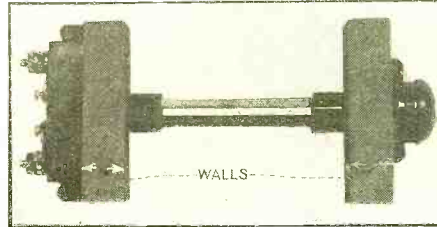

tion shows a wall section of a house with this new complete radio aerial and ground entrance fitting installed. With this type of antenna entrance fitting it is possible to make a neat and convenient connection installation to the aerial and ground terminals of the radio receiver. This equipment includes a resistance type lightning arrester, a bakelite molded receptacle plate and the connection plug. The plug is of special design and will not fit the regular electric light outlets. Also it is impossible to reverse the ground or antenna connections.

Maker—Woodruff & Co., Meridian, Miss.

Feather-Weight Headphones

Description—These inexpensive, light-weight headphones should find wide application among the hard of hearing, amateur transmitting fans and wherever headphones are worn for long periods of time. The total weight of both receivers is only six ounces. The outside diameter of the receiver is 2 3/8 inches and the thickness 3/8 inch. Aluminum shells with bakelite tops explains the unusual light weight of these

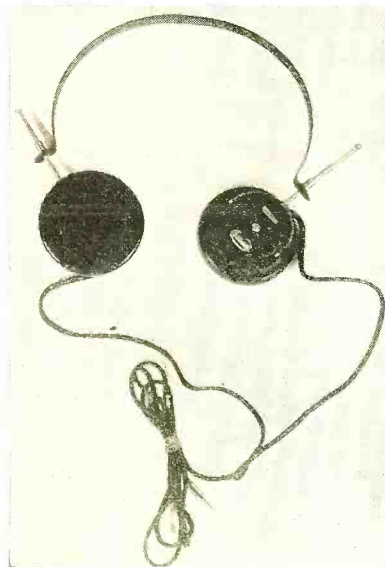

headphones. They are rated at 2000 ohms each, or a total of 4000 ohms for both receivers.

Maker—The Winchester Company, 36 East 22nd St., New York City.

An Electric Clock for the Radio Receiver

Description—A midget type self-starting electric clock, especially designed for easy

installation in any radio set, electric cooking range or other equipment where accurate time is desired. The diameter of the clock is 3 3/4 inches and the overall dimensions from the panel face to the back of the movement is 2 1/4 inches. For any interruption in the power, a little red signal appears in the opening under the figure 12, notifying that the clock is wrong and should be reset. To

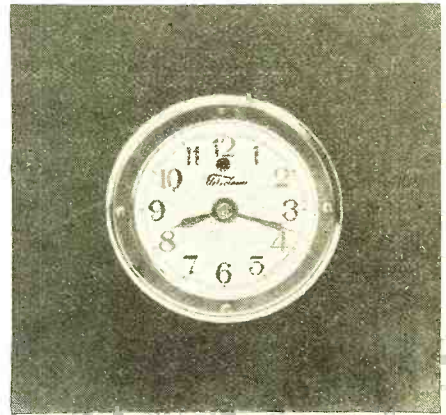

set the hands of the clock, the resetting knob on the lower part of the bezel is pulled out and turned for the desired time.

Maker—The Warren Telechron Co., Ashland, Mass.

A Compact Filter Analyzer

Description—This filter analyzer contains three different filter circuits. The instru-

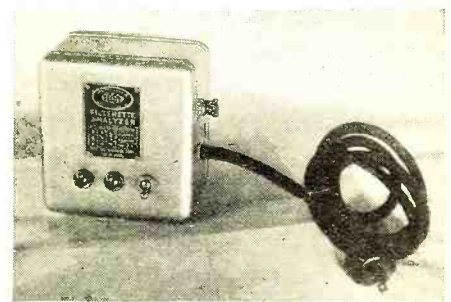

ment is easily installed and by operation of the three switches, which cut in and out the various filter circuits, the operator can quickly select the proper type of filter for any particular requirement. This device should prove a convenient filter analyzing instrument for the serviceman and radio dealer.

Maker—Tobe Deutschmann Corp., Canton, Mass.

Tone-Control

Description—The Octave Tone Condenser unit consists of seven condensers and a fan-

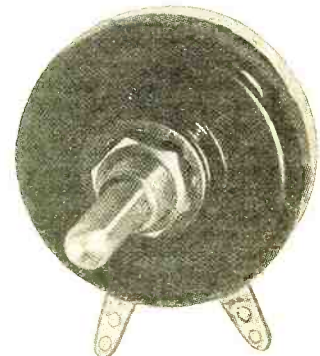

type switch which permits any number to be connected in the circuit by means of the

(Continued on page 1067)

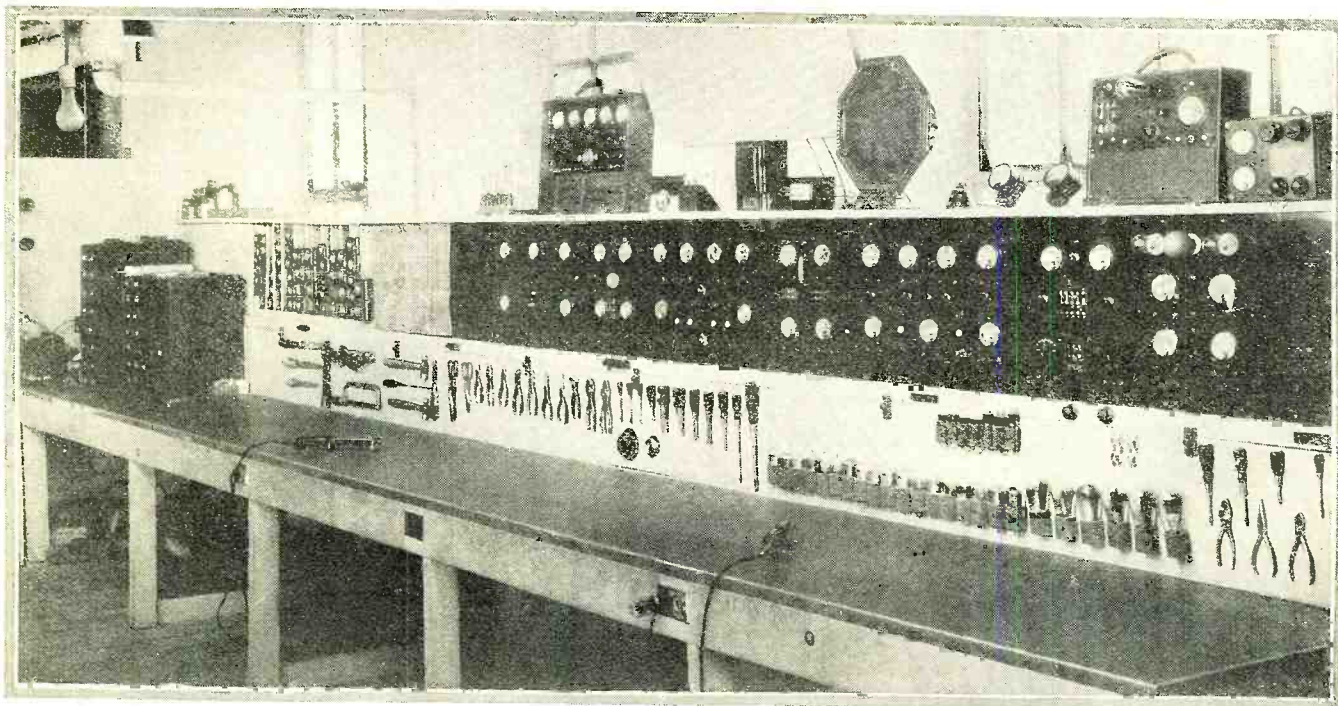

The Service Bench

Off-Season Profits, Auto and Camp Radios, Utilizing Trade-ins, Summer Rate Inspection, S. W. Receivers, P. A. Systems, A 175 k.c. Oscillator, Service Shops, Service Publicity, Service Kinks, Receivers Serviced: Majestic, Sparton, Atwater Kent, DeForest, Crosley, Fada, Day-Fan, Silver-Marshall, Radiola, Stewart-Warner, Service Equipment, Interference Diagnosis

IN the spring a young man's fancy turns to everything but radio, and the same goes for most of the serviceman's customers. In the early days of broadcasting there was adequate reason for this. With only a few low-power stations on the air, enjoyable reception was impossible for the majority of listeners during other than the cooler months of the year. In recognition of the depleted audience, the broadcasting stations lowered the already mediocre standard of program fare, and even those serviced by local stations put slip-covers over their radios along with the rest of the furniture.

Today there is no appreciable let-down in program excellence. As a matter of fact, the quality is somewhat improved! Quite a few of the commercial programs are withdrawn, their sponsors still haunted by the paling ghost of a summer bugaboo, and the blatant hawking of this or that product is replaced with various out-of-door orchestras and bands. Super-power stations, relatively unaffected by the lowered transmission characteristics of the summer, and maintaining an adequate signal to static ratio, blanket the country. And short-wave reception contributes still further to the pleasurable possibilities of summer radio.

These facts are generally appreciated by the listening public, and account for its reluctance to relinquish radio entertainment during motor and camping trips, and vacationing in general. Advertising and publicity may be employed further to promote the idea that summer is *the* radio season, emphasizing the excellence of the programs, consistency of reception and the recreational possibilities in vacation time! This advertising and publicity may take any of the

Conducted by
Zeh Bouck

various forms suggested in the *Service Bench* for May, with short news items, tie-up advertisements and appropriate circulars being recommended as the most advantageous media. Such propaganda will prove of double

THE status of the serviceman has improved greatly in the last two years. Thousands of dealers have discovered that a contract with an independent serviceman is the only economical solution to the service problem. This has resulted in a wider recognition of the serviceman by the set manufacturer. Relevant sidelines and sound merchandising methods have added to his profits. With higher standards in servicing we have a finer standard in servicemen—members of a guild emphasizing technical prowess of a high order.

—The Service Editor

value in stimulating set sales of a strictly seasonal nature—camp and auto radios—while tending to maintain the volume of your usual service business.

Automobile Radio

Summer is definitely the motoring season—as it was once the off-season for radio.

There are relatively few automobilists who are not radio enthusiasts, and the comparatively small number of automobile radio installations is suggestive of a very profitable market at this time of the year. The serviceman's own car should be used as a demonstrator and employed to advantage on every service call. Everyone who is sufficiently interested in good radio reception to keep his home set in operation will welcome the opportunity to step out to the curb and give a favorable ear to your auto installation.

Many servicemen may not possess a closed car suitable for persuasive demonstrations—or any car at all, as was the case of Robert Murphy, of Albany, New York. Mr. Murphy's solution to this very serious problem is original and practical. He writes:

"Appreciating the possibilities for early summer money in automobile radio, but not owning a car for demonstration purposes, I made a deal with our family doctor, whereby I installed a receiver in his car free of charge which he displays (quite proudly!) on every occasion. I installed this receiver seven weeks ago, at a net cost of \$37.50 and three hours' labor. Subsequent sales of six receivers at \$80 each give a net profit of \$217.50 on seven installations. I picked on our doctor because he is rather a close friend. A public garage owner, high school principal, president of the local bank and several other prominent citizens should make equally effective 'salesmen.'"

There are available to the serviceman, from the various mail-order houses, automobile radio installations priced from \$29.50 up. These include tubes, speaker, chassis, tuning, unit, B battery and suppressors.

There is an excellent opportunity here for a contract between the serviceman and a local dealer in second-hand cars. The installation of an automobile radio greatly enhances the resale value of a car, offering consistent work for the serviceman with increased profits and more ready sales to the automobile dealer. The sale of second-hand cars is greatest during the months of May and June, and no time should be lost in approaching the livest wire auto dealer in your territory with this mutually profitable proposition!

In many instances the automobile radio will serve a double function, and the mellow notes of a distant orchestra will vie with the mosquitoes at the roadside camp. However, the opportunity for a separate sale will often present itself, and a midget or a good portable may be recommended as a camp receiver. If necessary, an inexpensive midget may be purchased and rewired for battery tubes. Here, too, is the chance to dispose of the numerous battery type receivers which the average serviceman is forced to accept as trade-ins. These sets should, of course, be subjected to thorough modernization, including changes in the audio-frequency circuits and modification to permit the use of the recently developed and more economical tubes. Many receivers, hitherto collecting dust as a total loss, may thus be renovated into readily salable camp sets.

In many permanent camps 110 volts a.c. is available, and in such cases several of the good inexpensive standard receivers may be recommended. The Ansley Universal a.c.-d.c. portable is more readily stowed away in the car than a midget, and is quite effective on almost any kind of an aerial.

There is also a possibility here for the use of any standard small receiver from a six-volt storage battery in conjunction with one of the new non-rotary 110-volt a.c. converters, which are being more or less widely circularized at the present time. To date the *Service Bench* has been unable to obtain one of these for test purposes, but we understand that at least one well-known manufacturer of generating equipment will place such a unit on the market in the very near future. A development of this nature is logical and practical.

However, the serviceman is advised to investigate the device thoroughly before investing money in a sample. Literature describing one of these units is such as to recommend little faith in the product. This particular converter is guaranteed to operate a 60-watt radio while consuming only 36 watts from the battery! Regardless of the elementary laws of energy transfer and efficiency, this phenomenon is accounted for by the statement that no ammeter is sufficiently delicate to make a correct reading of the drain, which, due to the fact that it is intermittent, appears higher than it really is! The device apparently is of the vibrator

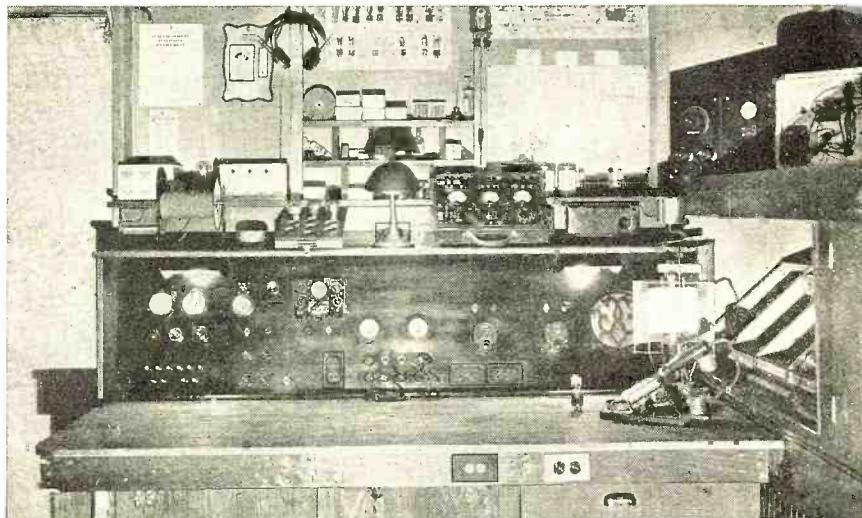

Figure 3. The service shop of the Radio Electric Store, Springfield, Ohio

type, and if the current consumed by the apparatus is actually different from the ammeter reading, it is probably more. Under a current of varying strength, the usual d.c.

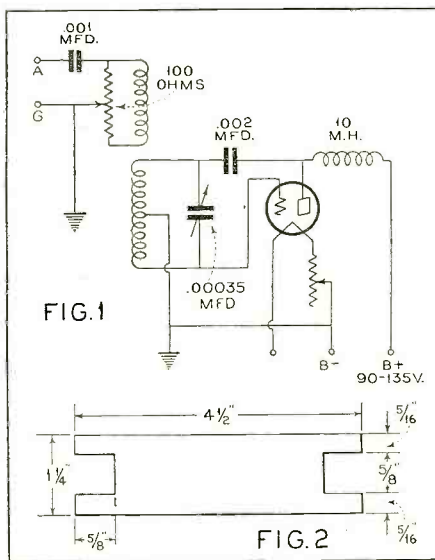

Figure 1. Simple parallel feed circuit of the 175 kc. oscillator. Figure 2. Winding for the 175 kc. oscillator coil

meter will read average values only, which will be less than the effective or r.m.s. values indicated on a hot-wire meter—the correct method of determining such currents.

Cut-Rate Inspection

As we have already indicated, there is no good reason why your regular service business should suffer during the summer months to an extent greater than explainable by the usual vacation time exodus. This natural decline is all the more reason for stimulating business among the stay at homes. Taking a tip from the garage owner who makes special offers during his slow winter months, the serviceman will find it worth while to get out a circular or form letter along the following lines:

"My dear Mr. ———: Summer is here, and with it some of the finest radio programs you will ever listen to! The Philharmonic Orchestra from the New York Stadium—baseball games—open air boxing—dance music from the world's most famous hotels to liven up your evening lawn parties!

"Let us look over your receiver for you—to make certain that your radio reception this summer will be all that it should be. We are able to make you the following special service offer during the months of June and July—

"Check all tubes and replace any two of them.

"Check antenna and ground, and repair.

"Check and clean volume control.

"Tighten all connections, and resolder defective joints.

"Clean condenser bearings.

"Check all voltages, and adjust for maximum response.

"Clean all shield joints.

"Calibrate dial for eight important stations.

"This would ordinarily be an \$8.00 to

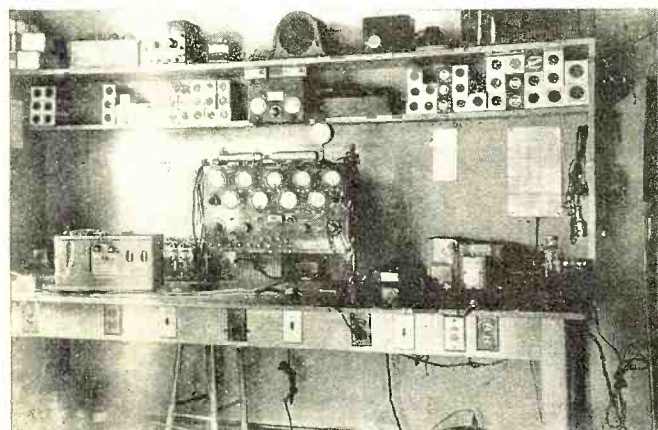

Figure 4 (Left). The main bench in the service shop of the Radio Service Company, Springfield, Mo. Figure 5 (Right). Another corner in the Radio Service Company's shop

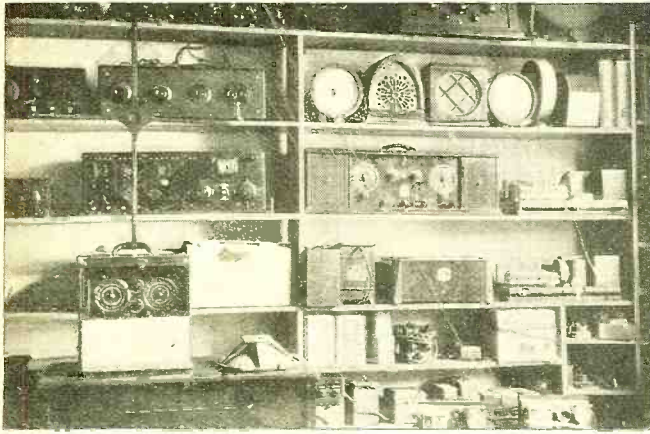

Figure 6. This company's motto is "Day and night service." Receiving and shipping department

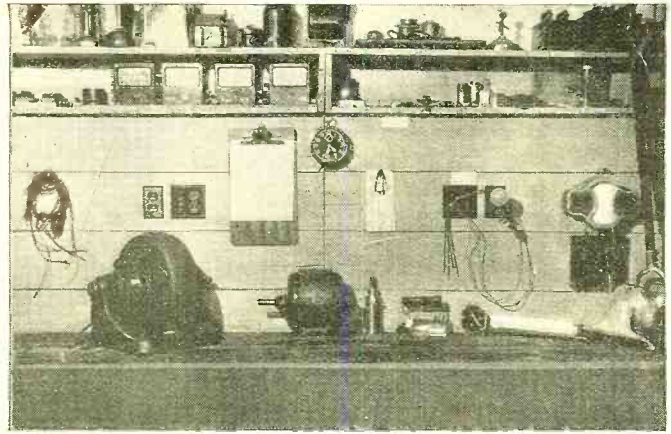

Figure 7. Where the heavy work is done. Delicate instruments are isolated from jars

\$10.00 service job. For this limited time the price is only \$5.00! We shall do the work either in your own home, or in our well-equipped shops—as you designate. A 'phone call will bring our expert."

While the serviceman can, of course, do nothing in the way of static reduction, there is no reason why he should not take advantage of its presence. All noises are static to the average fan, and the serviceman can eliminate or reduce many similar disturbances. The following letter will net a few extra dollars:

"My dear Mr. ———: Has your radio been noisy of late? Why let these annoying scratches and crackles spoil the fine summer programs? Let us inspect your receiver. If we can help matters, fine and dandy. If we can't, we'll tell you so quite frankly, and there'll be no charge."

Short-Wave Receivers and Converters

To the distance chasing fan alone does summer bring an appreciable curtailment of radio pleasure. True, he will still be able to tune in distant stations, but they will not be plentiful enough to satisfy his omnivorous spirit, and the noise level will be up. Check over the out and out fans among your clients, and approach them with the possibilities of a short wave receiver or a converter. While short wave operation suffers from similar limitations during the summer, the unusual results possible on the higher frequencies will in many instances supplement the hot weather deficiencies of the broad-

cast receiver. A high grade five-tube converter, carefully matched to the receiver input, is preferable to a short-wave set.

Public-Address Installations

The summertime offers unusual possibilities to the wide-awake serviceman in the way of out-of-door P. A. systems. This service sideline has already been covered, in a general way, in previous issues of the *Service Bench*, and in the *Radio News* book "How to Make Money in Radio Servicing." The accompanying photographs suggest two logical summertime installations—in the public park and at the swimming pool. The Wright-DeCoster Company, by whose permission these photographs are reproduced, will be glad to send the serviceman illustrations and details of many similar installations. Prospects include golf and country clubs, baseball parks, amusement parks, flying fields, band stands, race tracks, fair grounds, picnic grounds, street dances, etc.

SERVICE EQUIPMENT

A 175 KC. Oscillator

Many inquiries to the *Service Bench* have requested data on the calibration and construction of an oscillator suitable for lining up intermediate-frequency amplifiers at exactly 175 KC. It is important that the correct intermediate frequency be very closely approximated, because some superheterodyne oscillating systems are designed to track only at that frequency difference. The design of the i. f. oscillator itself presents no difficulties, but the manner of accurate calibration has stumped many servicemen. A standard broadcast frequency oscillator is readily calibrated by cross reference to various stations of known frequency. However, such facilities are not generally available in the neighborhood of 175 kilocycles, and a precision wavemeter runs into well above one hundred dollars.

As a matter of fact an intermediate-frequency oscillator can be easily calibrated by reference to the same broadcasting stations used in plotting a curve on the higher frequency generator. But matters are facilitated if the broadcast-frequency oscillator is used, rather than the stations from which it has been calibrated.

First of all we shall describe briefly a simple i. f. oscillator, the circuit of which is shown in Figure 1. This is of the familiar parallel feed type. All values are given on the diagram, with the exception of the coil and the rheostat. This latter will be determined by the available tube and battery supply. Practically any triode can be used.

The coil is wound on the bobbin form shown in Figure 2, with number 20 double cotton-covered wire. There are 14 layers with 14 turns to a layer, the center-tap being taken at the 98th turn. The coupling coil is wound with 4 turns of wire over the main coil.

Harmonic Calibration

Set the tuning condenser at about the midway position, and locate a harmonic of the oscillator on a sensitive broadcast receiver. Unless the oscillator is modulated, for instance, by applying a. c. to the plate, it may be necessary to have the receiver oscillating in order to pick up the oscillator. This latter method is productive of more accurate results and is advised. Any t. r. f. receiver can be made to oscillate by adequate coupling between a grid and plate circuit, or, in some cases, merely by increasing the screen potentials. Also, by following a non-oscillating tuner closely with the broadcast oscillator it will not be difficult to beat the i. f. oscillator and locate the whistle.

The local oscillator (broadcast frequency) should now be adjusted for zero beat with the i. f. oscillator, and the exact frequency of the intermediate-frequency harmonic noted. Proceeding in the same manner, locate an adjacent harmonic—either up or down, the direction being suggested by the greatest available tuning range. Note the exact frequency of this last harmonic. As harmonics are merely multiples of the fundamental, the difference between any adjacent

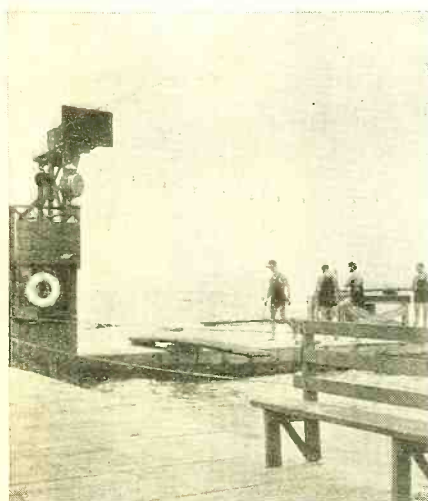

A serviceman made money on this P. A. installation at Venice Beach, Mich.



Another summer job for the serviceman. Loudspeakers installed in Liberty Park, Salt Lake City

harmonics will be the frequency at which the i. f. oscillator is functioning. Simple! If this frequency is lower than 175 KC., reduce the value of the tuning condenser, if higher, vice versa, continuing these adjustments until the difference between two convenient adjacent harmonics is exactly 175 kilocycles. It is, of course, possible to calibrate the i. f. oscillator, in this manner, over quite a range of useful frequencies. As a matter of fact, by means of the harmonics, this single oscillator can be employed for both i. f. and r. f. purposes. The method of complete calibration is described in detail by John F. Rider in his "Servicing Superheterodynes," by whose permission much of the data given above has been summarized.

THIS MONTH'S SERVICE SHOPS

The service equipment shown in Figure 3 is one of the neatest and most efficient layouts we have seen. It is owned by Mr. A. V. Ditty, of the Radio Electric Store, Springfield, Ohio. A shop of this sort is in the nature of a display, and service customers should be extended a cordial invitation to visit it. The usual equipment is on hand, and all test leads are brought out from the back of the bench, conserving profanity and facilitating good workmanship. The soldering iron rack at the right is of particular interest. The tip of the iron rests in a cup containing melted solder, preventing the iron from overheating, by supplying an additional surface for heat radiation. The iron rarely pits, and is always clean and ready for use.

The four photographs of Figures 4, 5, 6 and 7 are of the most elaborate service shop that has found its way to the *Service Bench*. This shop has been engineered and constructed by Harvey Wilson of the Radio Service Company of Springfield, Mo. The first photograph is of the main service bench, and incorporates the conventional test equipment. Figure 5 shows an auxiliary bench. One item of interest is the Dictaphone which has been worked over into a coil-winding machine. Figure 6 is a portion of the office



The Ansley portable Universal receiver en route to the summer camp. This receiver can be operated from a six-volt battery in conjunction with a non-rotary converter, from 110 volts a.c. or from 110 volts d.c.



Running down the interference racket and racketeers! The Tobe-Deutschmann interference inspector badge

INTERFERENCE DETECTIVES TO AID INDUSTRY

Badges Worn by Trained Men Able to Arrest Thieves of Radio Entertainment

A concerted drive is being made throughout New England to rid cities and towns of radio interference. The drive radiates from the plant at Canton of the Boston-listed Tobe Deutschmann Corp., where devices are made that do away with such interference.

These devices have to be placed at the source of the trouble—no other method suffices. And, of course, the source of interference must be located. Trained men, representing the Canton plant, formerly home of the once famous Rising Sun stove polish, travel throughout New England, on receipt of complaints, to locate the various sources of trouble.

They wear badges to identify their authority and are said to be able to arrest all the bad geni who steal our radio entertainment. Suppression of interference is expected to prove very helpful to the radio industry.

Servicemen publicity! Home-town papers, please copy

where sets and parts are received from either the customers or the shops, awaiting repair or delivery. Figure 7 shows the heavy work bench. The large motor apparently is from one of these remote control tuning devices. All in all, an impressive and effective layout.

SERVICE NEWS

Tobe-Deutschmann, pioneer in running down artificial static, is organizing squads of electronic police, recruited from the ranks of the servicemen. These servicemen are

identified as experts in noise detection by badges, and a complete course of instruction is offered them by Tobe. Appreciating that most interference of this type can be eliminated or reduced to a satisfactory degree by filters placed either in the lines to the set or in the power supply to the device giving rise to the disturbance, Tobe-Deutschmann has designed an interference analyzer which determines with a minimum of effort the best type of device to be used in specific cases. Considerable publicity is being given to this enterprise, and the wide awake serviceman will find it more than worth while to cash in on the project. Inquiries may be directed to Tobe-Deutschmann, Canton, Mass.

Resistor Replacement Handbook

Among the various replacement handbooks being issued by manufacturers of associated apparatus, the most complete and attractively published volume we have yet seen has been brought out by Electrad. In addition to the usual resistor and circuit data, considerable information is given relative to volume controls and direct coupled amplifiers. It is bound in a durable fabrikoid cover and is accompanied with the usual card which, when mailed, entitles the serviceman to supplementary sheets. The price is one dollar.



Clarostat (285 North Sixth Street, Brooklyn) is also circulating a valuable "control handbook," containing data on volume controls, attenuators, constant impedance controls, faders, tone controls, line ballasts, and related circuits. This booklet may be obtained free by servicemen requesting it on their letterhead, either directly to Clarostat or to the *Service Bench*.

Supplement to Trouble Shooter's Manual

The Radio Treatise Company, at 1440 Broadway, New York City, announces a new monthly and quarterly supplementary service to John F. Rider's 1000-page "Trouble Shooter's Manual." This supplementary data will average over 1000 pages a year and is being sold at a very reasonable subscription price. It is suggested that servicemen write to the publishers for further details.

New Switches Announced

The Best Company, of Irvington, N. J., have announced a new line of sectional rotary switches which should be of particular interest to the serviceman. Various custom switching requirements of the serviceman, from automatic tuning down, are easily effected by possible combinations which can be arranged to switch as many as 600 circuits!

Data on Brunswick and Bremer-Tully

Complete circuit and parts replacement details on these receivers can now be obtained from the Brodco Radio Corporation, at 142 Liberty Street, New York City. Ac-
(Continued on page 1060)

Latest Radio Patents

A description of the outstanding patented inventions on radio, television, acoustics and electronics as they are granted by the United States Patent Office. This information will be found a handy radio reference for inventors, engineers, set designers and production men in establishing the dates of record, as well as describing the important radio inventions

1,834,229. AMPLIFYING SYSTEM. ALBERT H. TAYLOR, Washington, D. C., assignor, by mesne assignments, to Federal Telegraph Company, a Corporation of California. Filed Nov. 7, 1927. Serial No. 231,591. 4 Claims.

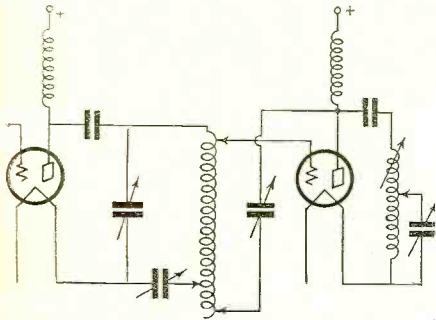

3. An amplification system comprising a plurality of electron tubes each having grid, filament and plate circuits, the output circuit of one electron tube having two parallel branches, one of said branches comprising a capacity and the other branch comprising an inductance and capacity in series, said last named capacity providing a nodal point of voltage intermediate the ends of said inductance, a connection from said inductance on one side of said nodal point to the grid of a succeeding electron tube and a connection from said inductance on the opposite side of said nodal point through a capacity to the plate circuit of said succeeding electron tube.

1,834,233. HARMONIC FREQUENCY SELECTOR AND AMPLIFIER CIRCUIT. ROBERT H. WORRALL, Washington, D. C., assignor, by mesne assignments, to Federal Telegraph Company, a Corporation of California. Filed Nov. 7, 1927. Serial No. 231,590. 2 Claims.

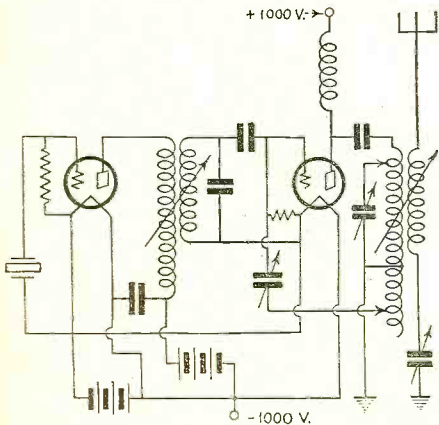

2. In a transmitter system, the combination of a signal transmission circuit, a piezo electric crystal element, an electron tube having input and output circuits, the input circuit of said electron tube connected to said

Conducted by
Ben J. Chromy*

piezo electric crystal element, said electron tube having means connected into its output circuit for selectivity and independently sustaining a plurality of harmonics of the fundamental frequency of said piezo electric crystal element, an amplification system, a tuned circuit coupling said amplification system with said aforementioned means and adjustable to selectively amplify any one of the harmonic frequencies of said piezo electric crystal element selected and sustained by said aforementioned means, and connections between said amplification system and said transmission circuit for impressing the selected harmonic frequencies of increased amplitude upon said transmission circuit.

1,837,413. INDUCTIVE COUPLING DEVICE. ELLSWORTH S. DOBSON, Millburn, N. J., assignor to Bell Telephone Laboratories, Incorporated, New York, N. Y., a Corporation of New York. Filed Oct. 6, 1930. Serial No. 486,677. 7 Claims.

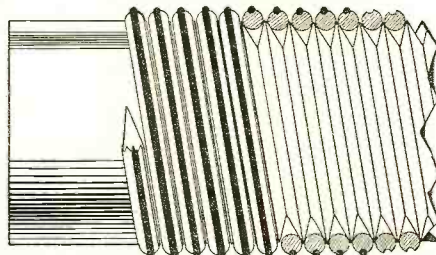

1. An inductive coupler comprising an inner winding consisting of a conductor having a groove in its surface and an outer winding consisting of an insulated wire wound in the groove in said inner winding.

1,839,130. ELECTROSTATIC LOUD-SPEAKER. ADOLPH A. THOMAS, New York, N. Y. Filed Mar. 7, 1929. Serial No. 345,177. 15 Claims.



1. An electrostatic telephone instrument comprising a pair of plates having permanently interfitting corrugations and separated by an elastic dielectric, at least one of said plates being vibratory.

1,836,839. OSCILLATION GENERATOR. ROY E. CORAM, Newark, N. J., assignor to Western Electric Company, Incorporated, New York, N. Y., a Corporation of New York. Filed Sept. 11, 1926. Serial No. 134,777. 5 Claims.

1. The method of generating a wave of a given frequency, utilizing a frequency determining circuit comprising a variable inductance and capacitance in resonant relation,

and amplifying means for regeneratively supplying oscillations to said circuit and receiving oscillations therefrom, which consists in setting the inductance at a given value, adjusting the capacitance to the largest value at which oscillations persist, varying the in-

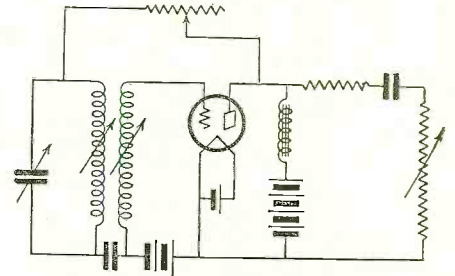

ductance in such direction as to cause the oscillation frequency to more nearly approximate the desired value, readjusting the capacitance as before to the corresponding new limiting frequency, and making repeated readjustments of inductance and capacitance in the above order until the desired oscillation frequency is achieved.

1,836,569. ELECTRIC TRANSLATING DEVICE. JOHN C. BENJAMIN, New York, N. Y., assignor to Bell Telephone Laboratories, Incorporated, New York, N. Y., a Corporation of New York. Filed Dec. 21, 1927. Serial No. 241,714. 5 Claims.

1. A translating device comprising an enclosing vessel, a cathode at one end of said vessel, a pair of collector elements at the other end of said vessel, said elements being in a plane at right angles to the axis of said cathode, means to focus an electronic stream from said cathode toward said collector elements, and sound responsive means including

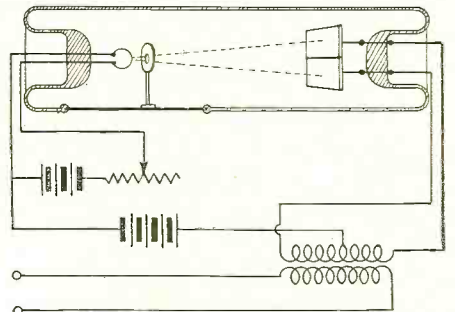

a diaphragm for controlling said stream to shift said stream to variable portions of said collector elements.

1,837,144. ELECTRIC PIANO HARP. JOSEPH BETHENOD, Paris, France, assignor to Compagnie Generale de Telegraphie Sans Fil, a Corporation of France. Filed Feb. 25, 1931. Serial No. 518,236, and in France Feb. 28, 1930. 8 Claims.

3. Apparatus for producing a damped musical sound comprising in combination a gen-

*Patent Attorney, Washington, D. C.

erator of sustained oscillations of inaudible frequency, a generator of damped waves of inaudible frequency comprising a thermionic tube oscillator means for supplying the anode

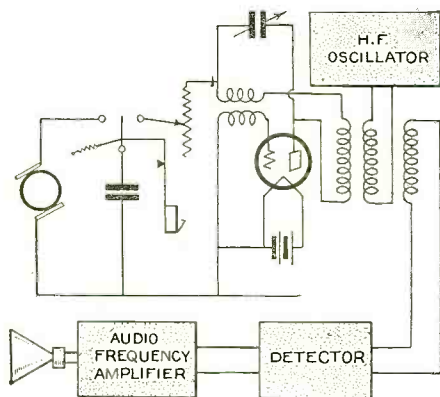

of the said tube with a rapidly decreasing potential, means for regulating the rate of decrease of said potential, means for combining the oscillations supplied by said generators, and means for transforming into sound the resultant of combining said sustained oscillations and said damped oscillations.

1,830,240. ELECTRIC WAVE LIMITING DEVICE. EUGENE PETERSON, New York, N. Y., assignor to Bell Telephone Laboratories, Incorporated, New York, N. Y., a Corporation of New York. Filed May 18, 1929. Serial No. 364,226. 8 Claims.

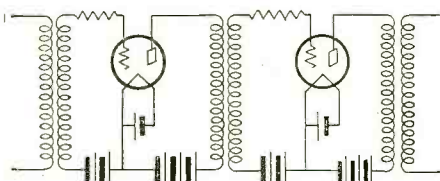

1. In a voltage limiting device, means for limiting voltage peaks of both polarities in successive stages, said means comprising a plurality of space discharge devices connected in tandem relation, and means in the input circuits of said devices for preventing the voltages impressed upon the input circuit of said devices from exceeding a predetermined value.

1,834,117. KERR CELL AND CONTROL MEANS THEREFOR. GEORGE MAURICE WRIGHT, Great Baddow, Chelmsford, England, assignor to Radio Corporation of America, a Corporation of Delaware. Filed May 18, 1928, Serial No. 278,687, and in Great Britain May 26, 1927. 3 Claims.

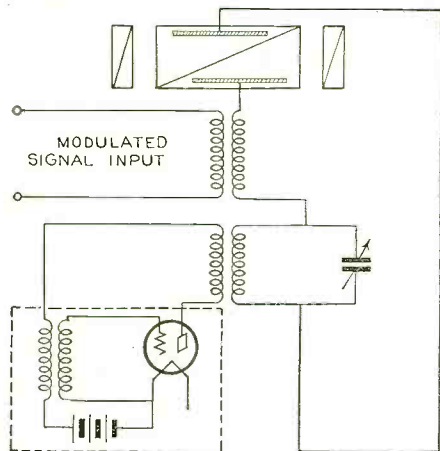

1. A light control system for picture telegraphy and the like, comprising a Kerr cell

having the electrodes thereof separated by a liquid dielectric, means for applying signal voltages to the electrodes of said cell, and means for superimposing upon said signal voltage a separate relatively high-frequency voltage for preventing the collection of deposits upon the cell electrodes.

1,838,871. GLOW DISCHARGE AMPLIFIER. JOHANNES MICHAEL SCHMIERER, Lichterfelde, near Berlin, Germany, assignor to Radio Patents Corporation, New York, N. Y., a Corporation of New York. Original application filed Dec. 24, 1924. Serial No. 757,854, Patent No. 1,720,352, dated July 9, 1929. Divided and this application filed Dec. 6, 1927, Serial No. 238,189, and in Germany Jan. 23, 1924. 14 Claims.

1. An amplifying circuit comprising a cold operating glow discharge tube, electrodes in said tube, power supply connected to said tube, means for conducting a potential to be amplified to said tube, a potentiometer connected across said power connections, and a

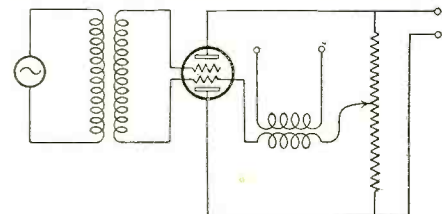

circuit from a point intermediate to said power connections of said potentiometer and said tube to carry the amplified control potential.

1,830,175. THERMIONIC TUBE CIRCUIT. ILIA PODLASKY, Paris, France. Filed Mar. 17, 1927, Serial No. 175,998, and in France Mar. 17, 1926. 9 Claims.

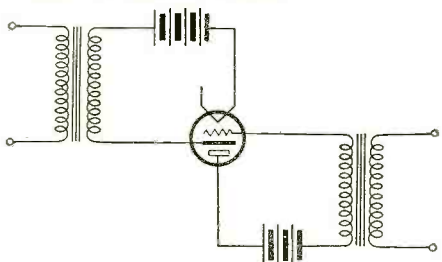

1. An electron discharge device comprising an electron-emitting cathode, a control electrode, a main anode and an auxiliary anode, said control electrode, main anode and auxiliary anode being arranged in substantially circular symmetry around said cathode, said auxiliary anode being arranged externally of the main anode.

1,837,746. PHOTO-ELECTRIC TUBE. VLADIMIR K. ZWORYKIN, Swissvale, Pa., assignor to Westinghouse Electric & Manufacturing Company, a Corporation of Pennsylvania. Filed Mar. 3, 1928. Serial No. 258,706. 8 Claims.

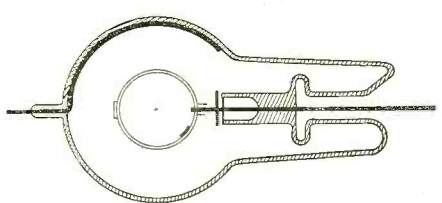

1. A photo-sensitive device comprising a vacuum-type container having a surface therein covered with a metal of the alkali earth group and a metal of the alkali metal group superimposed on said first metal to form a cathode, and a cooperating electrode therefor.

1,834,051. MICROPHONE. LEE DE FOREST, New York, N. Y., assignor to General Talking Pictures Corporation, New York, N. Y., a Corporation of Delaware. Filed Oct. 2, 1929. Serial No. 396,642. 6 Claims.

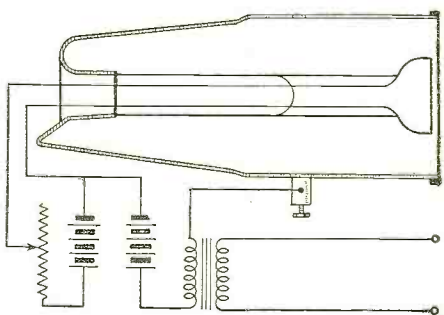

1. A microphone device of the type described, comprising a glass portion and a metal portion hermetically sealed together, a conducting flexible portion hermetically sealed to the metal portion to form an anode and a cathode within said vessel supported adjacent the flexible portion, said vessel being exhausted.

1,837,364. SIGNALING APPARATUS. HERBERT E. IVES, Montclair, N. J., assignor to Bell Telephone Laboratories, Incorporated, New York, N. Y., a Corporation of New York. Filed Aug. 20, 1925. Serial No. 51,310. Renewed Mar. 26, 1931. 8 Claims.

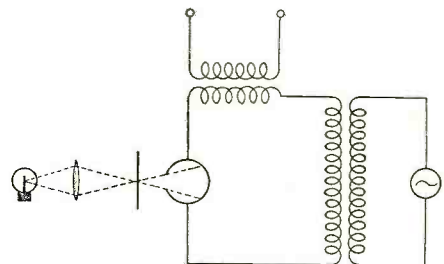

1. In combination, a source of signaling current, a light-sensitive cell having electrodes each of which is adapted to act both as an anode and as a light-sensitive cathode, means comprising said source of current for rendering each of said electrodes alternately an anode and a cathode, and means for controlling the amplitude of the photo-electric current in said cell in accordance with light rays of varying intensity.

1,830,322. METHOD OF PRODUCING OSCILLATIONS FROM PIEZO ELECTRIC PLATES. AUGUST HUND, Bethesda, Md., assignor, by mesne assignments, to Federal Telegraph Company, a Corporation of California. Filed Sept. 30, 1925. Serial No. 59,675. 9 Claims.

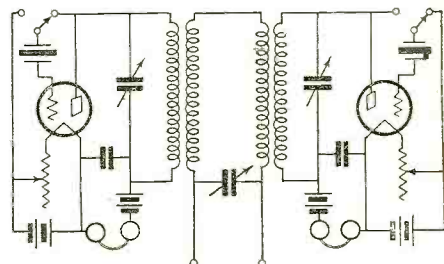

9. A generator of low-frequency oscillations comprising two high-frequency oscillator networks of each, including a space discharge tube and a piezo electric frequency controlling device, and a circuit co-operatively controlled by the two said networks for deriving their different frequency.

1,839,481. **CIRCUIT ARRANGEMENT FOR GENERATING ELECTRIC OSCILLATIONS**, GILLES HOLST, BALTHASAR VAN DER POL, and KLAAS POSTHUMUS, Eindhoven, Netherlands, assignors to Radio Corporation of America, a Corporation of Delaware. Filed Apr. 6, 1927, Serial No. 181,421, and in The Netherlands Apr. 9, 1926. 6 Claims.

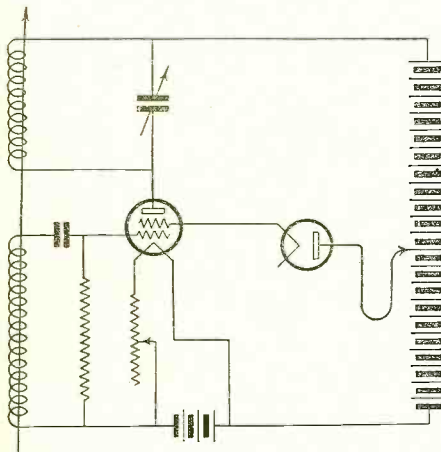

4. In a circuit arrangement for a discharge tube having a plurality of grids and an additional electrode, a diode connected between one of the grids and the additional electrode.

1,839,361. **IMAGE PRODUCING SYSTEM**. ALLAN WEAVER, Brooklyn, N. Y., and DAVID E. BRANSON, Bloomfield, N. J., assignors to American Telephone and Telegraph Company, a Corporation of New York. Filed Dec. 19, 1923, Serial No. 681,593. Renewed June 26, 1930. 17 Claims.

1. The method of transmitting and reproducing a picture in substantially its original colors, which consists in filtering the light from successive points of the picture substantially according to the color sensitivity of the human eye, applying the component rays

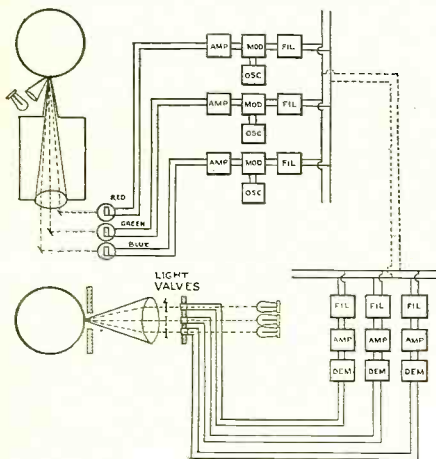

of primary colors to modulate respective carrier currents, and at the receiving end applying each of said currents to control one of a plurality of light valves to synthesize rays of light in the respective colors.

1,839,455. **SIGNALING**. ERNST F. W. ALEXANDERSON, Schenectady, N. Y., assignor to Radio Corporation of America, a Corporation of Delaware. Filed June 16, 1928, Serial No. 285,927. Renewed Aug. 23, 1929. 8 Claims.

1. The method of transmitting pictures which includes modulating electrical energy in accordance with the light intensity of the picture, superimposing alternating interrupter

energy of constant frequency and amplitude on the modulated energy, and radiating sig-

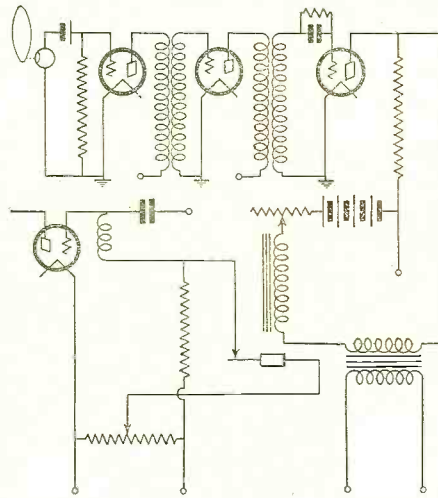

naling energy only when the superimposed wave exceeds a predetermined mean value in amplitude.

1,840,043. **MULTIPLE-UNIT TUBE**. SIEGMUND LOEWE, Berlin, Friedenau, Germany, assignor to Radio Corporation of America, a Corporation of Delaware. Filed Jan. 19, 1927, Serial No. 161,999, and in Germany Mar. 8, 1926. 1 Claim.

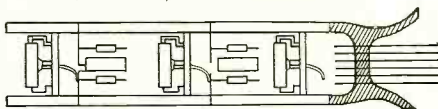

A multiple unit tube comprising a base, two parallel members extending therefrom, and a plurality of amplified units and coupling units mounted on said members, each of said amplifier units comprising a cylindrical plate, a filament at the axis thereof, a grid between the filament and plate and a rod of insulating material for holding the leads to the grid, plate and filament in spaced relation, each of said coupling units comprising a condenser and a pair of resistances, and leads to the condenser supporting said resistances and engaging said parallel members for supporting the coupling unit comprising the condenser and resistances, on said parallel members.

1,840,776. **FILTERING ARRANGEMENT FOR DIRECT CURRENT**. HARRY W. HOUCK, East Orange, N. J., assignor, by mesne assignment to Dubilier Condenser Corporation, New York, N. Y., a Corporation of Delaware. Filed Oct. 24, 1924. Serial No. 745,659. 2 Claims.

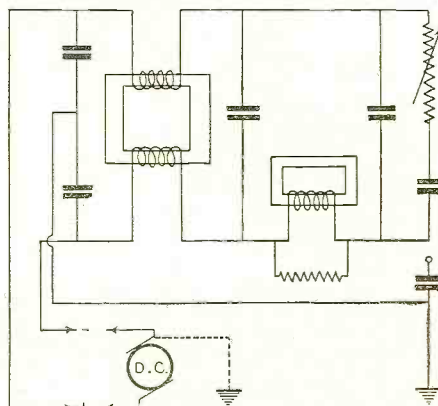

1. In combination with a radio receiving set, a source of unidirectional power supply having one side normally grounded, a filter connected between said source and the re-

ceiving set to smooth out fluctuations in the power supply to the set, a ground connection for the filter and a terminal connected to the receiving set to provide a ground therefor, and a condenser connected between said terminal and ground connection to prevent a conductive connection between the receiving set and ground.

1,841,101. **LOUD SPEAKER**. PAUL B. FLANDERS, East Orange, N. J., and HENRY C. HARRISON, Port Washington, N. Y., as-

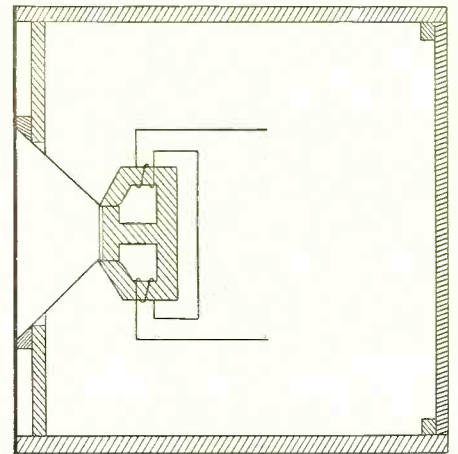

signors to Bell Telephone Laboratories, Incorporated, New York, N. Y., a Corporation of New York. Filed Mar. 6, 1930. Serial No. 433,590. 9 Claims.

1. The method of reducing cancellation effects in the air waves set up by direct radiating diaphragms which consist in confining a portion of the air displaced by one side of the diaphragm and altering the phase of the motion of that portion of the air not confined.

1,840,121. **VACUUM TUBE**. LEON McCULLOCH, Pittsburgh Pa., assignor to Westinghouse Electric & Manufacturing Company, a Corporation of Pennsylvania. Filed May 20, 1926. Serial No. 110,547. 5 Claims.

1. In a method of providing a thermionically-emissive cathode, the step of heating a mixture caesium trinitride and barium trinitride.

1,841,639. **COUPLING**. OMMO SCHMIDT, Berlin, Germany, assignor to Telefunken Gesellschaft fur Drahtlose Telegraphie m.

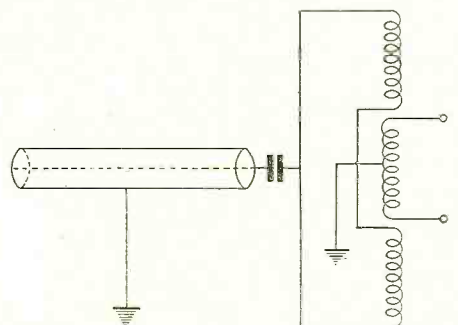

b. H., Berlin, Germany, a Corporation of Germany. Filed Aug. 31, 1929, Serial No. 389,648, and in Germany Sept. 2, 1928. 2 Claims.

1. In a radio frequency transmission system an input circuit comprising a transmission line, an output circuit, a pair of parallel primary transformer coils connected at their midpoint to ground and at their other common connection point to the input transmission line, and a secondary coil connected to the output circuit and symmetrically coupled to said primary coils.

1,840,580. CRYSTAL-CONTROLLED OSCILLATOR. RAYMOND A. HEISING, Millburn, N. J., assignor to Bell Telephone Laboratories, Incorporated, New York, N. Y., a Corporation of New York. Filed July 25, 1927. Serial No. 208,225. 4 Claims.

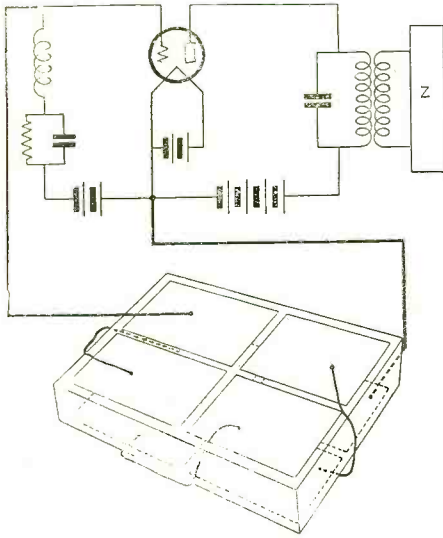

1. A wave translating system comprising a piezo-electric crystal device adapted to elastically vibrate as one crystal at one frequency, pairs of electrodes for said device, a different portion of said device being interposed between each pair of said electrodes, and means including said electrodes for connecting said portions in series with each other.

1,841,571. ELECTROSTATIC CONDENSER. BENJAMIN J. BUTLER, Somerville, Mass., assignor, by mesne assignments, to General Electric Company, a Corporation of New York. Filed Apr. 30, 1926. Serial No. 105,655. 5 Claims.

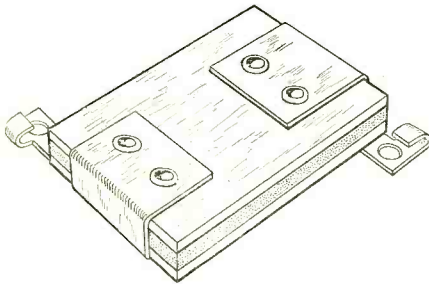

1. An electrostatic condenser comprising a stack of dielectric and armature sheets, a plate face to face with an end face of such stack; and a metal clamp embracing said stack and plate; said plate spacing apart said stack and clamp; and a portion of the metal of said clamp which faces said plate being extruded into said plate, and a separate terminal lead interposed between the end plate and clamp and held in firm electrical and mechanical engagement with the stack by said extended portions of the clamp.

1,841,582. ELECTRICAL CONDENSER. PRESTON E. GILLING, Haddon Heights,

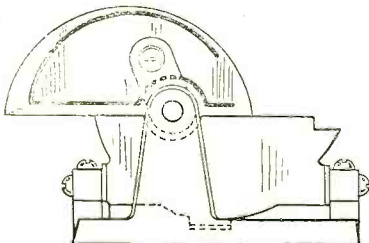

N. J., assignor to Radio Condenser Company, Camden, N. J. Filed Feb. 27, 1929. Serial No. 343,196. 5 Claims.

1. In an electrical condenser including a stator and a rotor, each composed of a group of plates spaced for interleaving relationship as the rotor is operated, and means for altering the capacity curve of the condenser, said means comprising a single segment forming part of and cut from the outer plate of one of said groups with means for positively adjusting the position of the segment.

1,841,452. RECORDING SYSTEM. RICHARD HOWLAND RANGER, Newark, N. J., assignor to Radio Corporation of America, a Corporation of Delaware. Filed Feb. 4, 1930. Serial No. 425,768, 23 Claims.

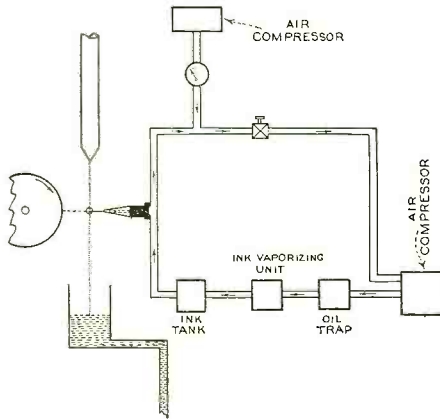

1. The method of recording signals which comprises continuously projecting a recording fluid toward a record surface, projecting a second fluid at an angle to said first named fluid for normally blocking the said first named fluid from the record surface, and altering the path of the second fluid so as to permit varying amounts of the first fluid to reach the record surface in accordance with desired received signals.

1,842,558. AMPLIFIER ENERGIZING SYSTEM. BENJAMIN F. MIESSNER, Short Hills, N. J., assignor, by mesne assignments, to Radio Corporation of America, New York, N. Y., a Corporation of Delaware. Filed July 20, 1929. Serial No. 379,673. 16 Claims.

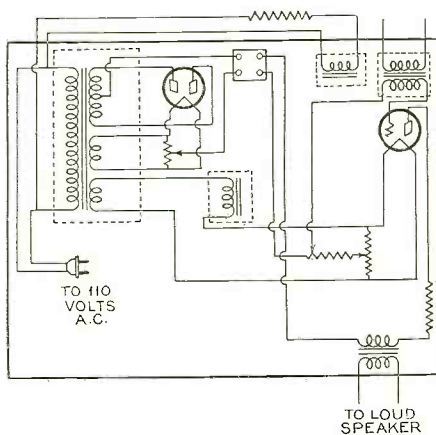

1. In an amplifying system the combination of a chassis, an alternating current energy supply transformer mounted upon said chassis, an audio frequency transformer forming part of an amplifying system carried by said chassis, and means operatively associated with said supply transformer and in close proximity to said audio transformer for neutralizing the flux induced in said audio transformer by flux flowing through said chassis from said supply transformer.

1,843,018. INPUT SYSTEM FOR ELECTRICAL AMPLIFIERS. FREDERICK H. DRAKE and WILLIAM D. LOUGHLIN, Boonton, N. J., assignors, by mesne assignments, to Radio Corporation of America, New York, N. Y., a Corporation of Delaware. Filed June 16, 1928. Serial No. 285,886. 2 Claims.

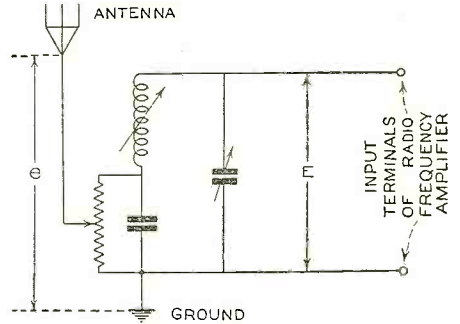

1. A tunable input system for an audion amplifier comprising the combination with a tuned circuit including in series of fixed condenser, an inductance and a variable condenser, of a resistance shunted across said fixed condenser, and a variable tap on said resistance, said tap and the junction of said fixed and variable condensers serving as terminals across which is impressed the incoming alternating current voltage that is to be amplified, and terminals of said variable condenser serving as output terminals across which said amplifier may be connected.

1,842,624. ELECTRON DISCHARGE TUBE. MONTFORD MORRISON, Chicago, Ill., assignor, by mesne assignments, to Westinghouse Lamp Company, a Corporation of Pennsylvania. Filed Feb. 25, 1928. Serial No. 256,916. 7 Claims.

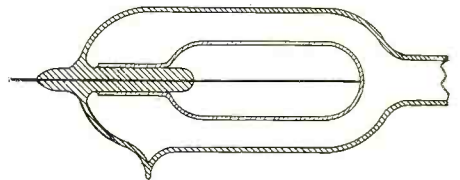

1. A gasoline conduction discharge device comprising an enclosing envelope, an inert gas filling and a plurality of electrodes, at least one of said electrodes having means to distribute the electrical discharge uniformly over the electrode surface and a sealed-in lead-in conductor constituting a support for said electrode.

1,844,177. RESISTANCE-COUPLED AMPLIFIER. KLAAS POSTHUMUS, Eindhoven, Netherlands, assignor to Radio Corporation of America, a Corporation of Delaware. Filed June 6, 1927, Serial No. 196,725, and in the Netherlands Aug. 16, 1926. 12 Claims.

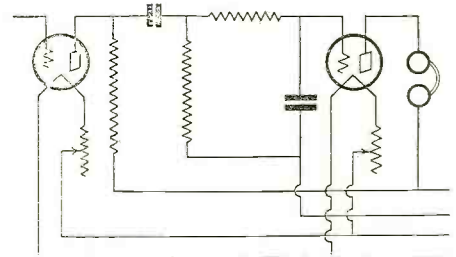

1. A resistance coupled oscillation amplifier comprising a series of triodes, means to lead oscillations from the plate of one triode to the grid of the next succeeding triode comprising two partially separate paths, one

(Continued on page 1072)



With the Experimenters

Combination Meter, Police Signals on a Broadcast Receiver, D. C. Meter as Output Meter, Hints on S. W. Reception, Crystal Detector, Depth Gauge for Drills, Transmitter Coil Mounting, Handy Coil Winder, Radio Time Switch, Eliminating Man-made Static, Home-made Voltage Divider, Radio Index System, Improved Ground System

A Combination Ohmmeter, Milliammeter and Voltmeter

Conducted by
S. Gordon Taylor

HAVING on hand an 0-1 milliammeter and an 0-5 d.c. voltmeter, and desiring to get the fullest benefit from them without undue complication, the writer finally decided on an instrument that serves as:

- (1) A quick reading, accurate ohmmeter, with ranges from 100 to 250,000 ohms, that can be read much closer than the average commercial meter and does not require the use of calibration curves or recalibrated dials.
- (2) A high resistance voltmeter with ranges of 0-50, 150, 300 and 500 volts.
- (3) A milliammeter with two ranges of 0-1 and 0-10 milliamperes.

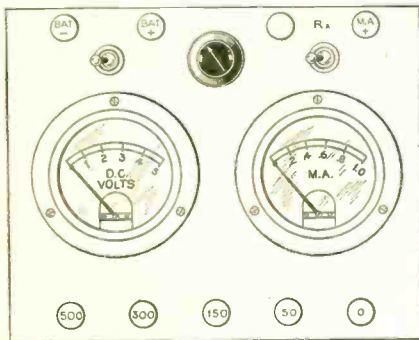

The meters and associated parts were mounted on a bakelite panel and installed in a box 6½ x 8 x 2¾ inches. In this case a mahogany cabinet that had housed a Radiola IIIa was cut down for the purpose, and the result was a neat, compact job. The high-resistance voltmeter is made as

usual, by using a number of high resistances (R2, 3, 4 and 5), wired in series with the positive side of the milliammeter. The resistances used in this case were Shallcross Super-Akrohm, which are accurate within 1% of rating. Of course, only high-grade meters should be used, such as Weston or Jewell.

There is a 10 ma. shunt for the milliammeter which is disconnected by the associated toggle switch when the 1 ma. range of the meter is to be used. This shunt can be readily made from a section of an old rheostat.

Inspection of the wiring diagram will show that the ohmmeter consists simply of a potentiometer and voltmeter across a battery, with the milliammeter and two binding posts for the unknown resistor, in series. The resistor R1 is used as a multiplier to increase the range of the voltmeter to 25 volts, in order to be able to measure resistances up to 250,000 ohms. A toggle switch is provided to cut this resistance in or out of the circuit. The writer used an Electrad wire-wound resistor of 2000 ohms, with adjustable terminals. In order to adjust the multiplier, the potentiometer was adjusted until the voltmeter showed a full-scale 5-volt reading; the multiplier was then cut in the circuit and adjusted until the meter read one volt.

For the benefit of those not familiar with this type of ohmmeter, the following procedure is given:

For measuring resistors that have no pig-tails a standard resistor clip should be provided, with a short piece of bus bar soldered

at each end, in such a manner that they may be inserted in the binding posts marked R_x. Connect a battery at the proper terminals. A 22½-volt dry battery answers most purposes. Set potentiometer so that no reading is shown on voltmeter. Insert resistor at binding posts R_x and advance potentiometer slowly until a reading of 1 ma. is obtained; note reading on voltmeter and multiply by 1000. For example, if voltmeter reading is 4.3 volts, the resistor value is 4300 ohms.

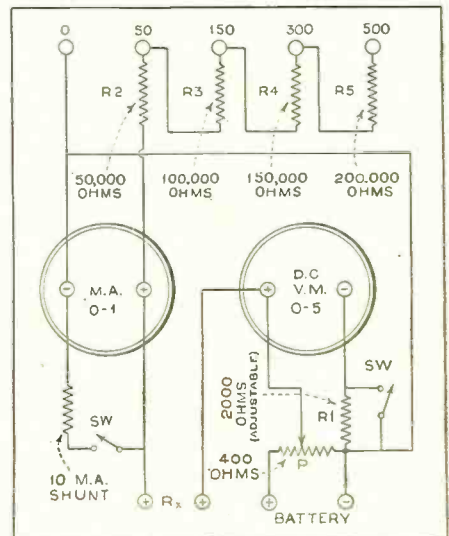

If the milliammeter reads 1 ma. before sufficient reading is obtained on voltmeter, the resistance is of low value and the switch should be thrown to put the 10-mil. shunt across the meter, in which case the voltmeter

reading should be multiplied by 100, when full-scale reading is obtained on the milliammeter.

To check resistances over 50,000 ohms, the 25-volt scale is used and the milliammeter adjusted to a .1 ma. reading. In this case the voltmeter reading is multiplied by 10,000.

This method is simply an easy application of Ohm's law, *i.e.*, $E/I = R$. It differs from the usual method in that the voltage is varied to provide a determined current.

It is not claimed, of course, that any of the above features are new ideas, but their combination in one case affords the user a compact instrument of many uses.

R. K. WHEELER,
Dayton, Ohio.

Extending Broadcast Receiver Wavelength Range

There are many battery and electric sets of the Browning-Drake type using one neutralized or screen-grid r.f. stage, followed by a regenerative detector.

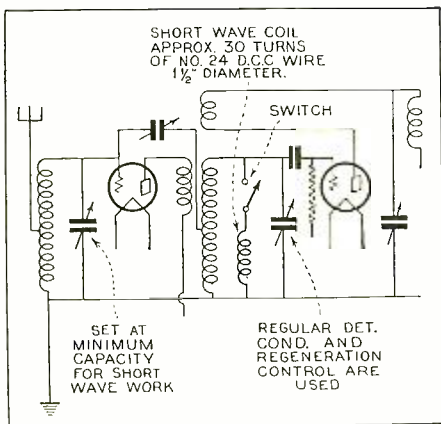

With the addition of a small coil and switch across the detector coil secondary, as shown herewith, these sets will bring in the police, aircraft and even the 80-meter amateur 'phones.

In making this change-over keep leads from the switch to the grid circuit as short as possible—the smaller the switch the less the detuning effect of the switch on the standard circuit. A 1500 kc. station may be off the dial if the capacity is too great. Get the short-wave stations first before operating on the secondary coil. I use an a.c. snap switch set back from the panel and connected with a bakelite shaft. I will be glad to answer readers' questions concerning this by mail if stamps are sent to cover postage.

FRANK J. FAULKNER,
Brigham City, Utah.

An 0-1 Milliammeter as an Output Meter

I have needed more than one output meter at various times, so I set about making my own.

Just about every service shop has a discarded Westinghouse Rectox unit lying around. Even one with a shorted unit can be used, as only one section of the unit will be needed. Disassemble the rectifier, being careful not to scratch the oxide surface nor to cut the lead discs.

Next cut from thin paper four discs a little larger than the lead washers. In each of these cut a small slot as indicated. In mine, an 0 to 1 ma. meter was used, so only a small slot was necessary. With a larger meter a larger slot is required, but the size illustrated is plenty large and will even work a 10 ma. meter. Reassemble the unit,

using only four of the copper discs with the oxide on them. Place the paper discs on the oxide side of the copper discs, having a lead washer on the back side of the cop-

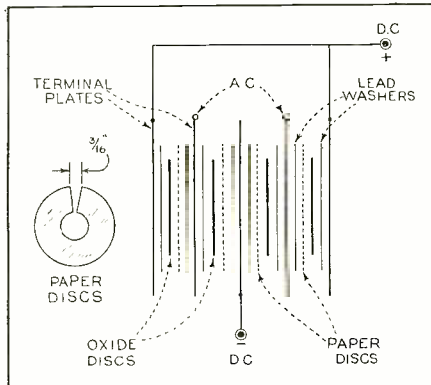

per discs and against the paper. The brass terminal may be used or terminals can be made of copper sheet. A bolt shorter than the original one will also have to be used. Pull the bolt up as tight as possible; the tighter the better. In connecting the unit the center terminals go to negative of the meter and the two outside terminals to positive. The two in between are a.c.

As an output indicator a variable resistance is used in series with the rectifier.

This is fine for balancing a set in a cabinet, as you can set the meter without having to reach around a cabinet in case the volume is too great. With fixed resistors it can be used as an a.c. voltmeter, although a slight percentage of error is present.

V. F. MUNSON,
Kewanee, Ill.

Portable Handy-Light

I am submitting a drawing and description of a little device that I have found indispensable in radio service work.

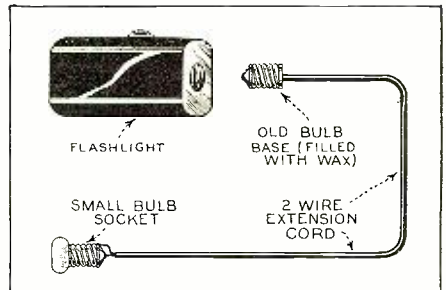

Take a small flashlight, remove the lens and screw an extension cord (made by soldering a double wire into an old bulb base and having a miniature socket, such as used in a radio set) in series with the rectifier.

(Continued on page 1062)

DX'ers Corner

*M*ANY experimenters are DX fans—either chronic or occasional. There are a number of organized activities in this field in which such fans would be interested, but which unfortunately receive relatively little publicity, with the result that those who would be most interested are likely not to know of them at all.

"With the Experimenters" will therefore give more attention to this absorbing field by frequently including a "DX'ers Corner," in which will be given information on current activities in long-distance reception. It is felt that this activity on the part of RADIO NEWS will help to foster development work on highly sensitive receiver design and will therefore serve a real purpose in the forward march of radio, in addition to making an interesting hobby even more interesting.

—The Editors.

Paste These Rules on Your S.W. Receiver

The following twelve suggestions, taken from the operating instructions which accompany all Hammarlund "Comet" receivers, are worth the careful reading of anyone interested in short-wave reception and should be particularly valuable to beginners in short-wave reception.

1. Don't expect to find stations on all parts of the dials. Short-wave stations are widely separated except in a very few places.
2. Don't expect broad tuning. Most distant stations tune very sharp.
3. Don't expect to hear the world the first day you tune. It requires some knowledge of tuning to get excellent results.
4. Don't expect to hear a station simply because it is on the air. Many things govern short-wave reception.
5. Don't get discouraged. If reception is poor one day, it may be fine the next.
6. Don't skim over the dials. Tune slowly.
7. Don't pass up any weak signals. Ofttimes a weak program can be brought out plainly by careful tuning.
8. Don't tune for stations when they are not on the air. Use a good station list.

Refer to timely schedule information appearing in short-wave magazines, such as the International Short-Wave Club periodical.

9. Don't tune haphazardly. Learn where stations should be found on the dials of your particular receiver.

10. Don't expect wonderful results with a poor receiver. A good receiver is necessary for good results.

11. Don't tune above 33 meters for distant stations in daylight.

12. Don't tune below 25 meters for distant stations after dark.

1250 Miles with a Crystal Detector

Suggest to those who have built the Byrne crystal set (RADIO NEWS, January, 1932, "With the Experimenters" department) that they try adding a lead from the dead end of the first coil, the one the slider works on, to the rotor of the variable condenser.

With this freak connection I get a surprising increase in volume on local stations.

I would be pleased to hear from any one who tries this out.

A. NEAL,
Denver, Col.

(Continued on page 1066)

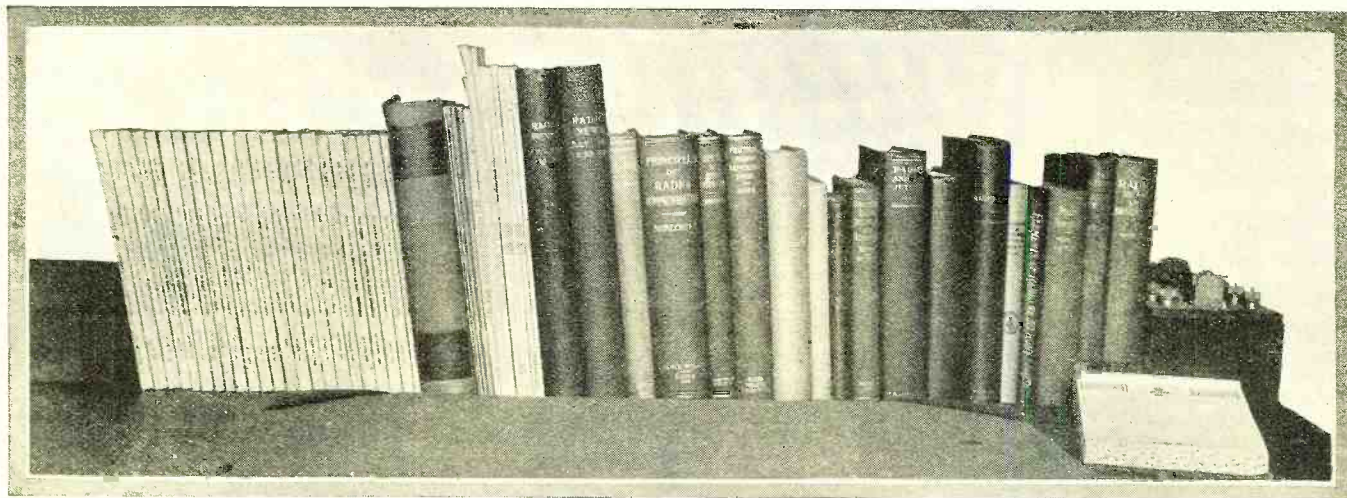

Radio Science Abstracts

Radio engineers, laboratory and research workers will find this department helpful in reviewing important current radio literature, technical books and Institute and Club proceedings

Review of Articles Published in the April, 1932, Issue of the Proceedings of the Institute of Radio Engineers

A Simple Harmonic Analyzer, by M. G. Nicholson and William M. Perkins. The authors review the various methods of determining the harmonic content of complex wave forms. It is pointed out that the more generally used methods involve oscillographs, beat frequency systems, tuned circuits, or balancing-out methods. All of these methods, while accurate, usually suffer because of inflexibility and slowness in operation. The authors describe a new method which is simple, inexpensive, and direct reading. This new method involves the use of a dynamometer type meter, having its zero point in the middle of the scale. Leads from the moving coil and stationary coil are brought out separately and connected so that the current to be analyzed flows through the stationary coil. The moving coil is connected to a variable frequency oscillator which is tuned to approximately the frequency of the harmonic to be measured. Under these conditions the pointer of the meter will oscillate slowly and the readings of swing to the left and to the right are averaged to get the value of the current. From this reading the value of the harmonic being measured can be determined.

An Examination of Selectivity, by R. H. Langley. The first part of the paper reviews the more important recent contributions on the subject of selectivity with a view to indicating the necessity for coordination of the results and clarification of the definitions. The relation of the selectivity curve of a receiver as it is now measured is discussed and the central portion of the selectivity curve is compared mathematically with the fidelity characteristics.

Empirical Standards for Broadcast Allocation, by A. D. Ring. This paper by a member of the engineering division of the Federal Radio Commission explains the methods used in determining empirical standards of

Conducted by Howard Rhodes

reception, interference, and service area. The paper considers the good average service area of a 100-watt local channel, 250 to 1000-watt regional channel, 5000 to 10000-watt high-power regional channel and 5000 to 50000-watt clear-channel station, with reference to the voltage intensity ratio of the desired signal to the undesired signal, incidental to specific mileage and frequency separations between stations. It is pointed out that the standards are empirical and will be changed when justified by further development in the suppression of sky-wave radiation, synchronization, improvements in reception conditions, etc. The paper includes graphs of field intensity, both calculated and observed with respect to the distance in miles from the station. Tables also indicate what field intensities are considered to give good service and the service areas of stations of various powers.

Mica Condensers in High-Frequency Circuits, by I. G. Maloff. This is an excellent paper on characteristics of mica condensers. It describes, in considerable detail, the construction of typical units. Of more importance is the discussion by the author of the rating of mica condensers. The author works out several typical examples for the calculation requirements of a tank condenser bank, the calculation of the rating of a given mica condenser, and the calculation and choice of a proper bank of condensers for a tank circuit.

Some Effects of Topography and Ground on Short-Wave Reception, by R. K. Potter and H. T. Friis. This paper contains some results of an experimental study of the effects which ground and ground irregularities have upon short-wave signal reception. The results illustrate the signal strength advantages to be gained in the selection of suitable ground or topographical conditions and show the influence of antenna types and vertical angle of signal arrival upon such an

advantage. Although the tests were confined to reception, the conclusions are probably applicable in general to the case of transmission. The agreement between measurement data and theory seems to justify the application of plane wave optical theory to the calculation of vertical plane directivity of antennas. Such an application suggests, according to the data obtained, that signals from South America are normally received at much lower vertical angles than those from England.

Review of Contemporary Periodical Literature

The Cathode-Ray Oscillograph, by J. B. Johnson. The Bell System Technical Journal, January, 1932. An excellent article on the development and use of the cathode-ray oscillograph. The author considers various types of tubes, such as the high-voltage type with the fluorescent screen, the high-voltage tube with internal photographic equipment and the low-voltage tube. The operation of these tubes is discussed from the standpoint of both theory and practice, with particular reference to the low-voltage type of tube. The article is illustrated with numerous diagrams and photographs, timing circuits, and reproductions of actual oscillographs. The article should prove of interest to all those whose work requires that they make use of the cathode-ray tube.

The Operation of Vacuum Tubes as Class B and Class C Amplifiers, by C. E. Fay. The Bell System Technical Journal, January, 1932. A simple theoretical development of the action of a vacuum tube and its associated circuit when used as a Class B or Class C amplifier is given. An expression for the power output is obtained and the conditions for maximum outputs are indicated. The way in which the tuned-plate circuit filters out the harmonics in the pulsating plate-current wave is illustrated by an hypothetical example. The Class B dynamic curves are found to give a better approximation to a straight line than the Class C
(Continued on page 1071)

I Chatty bits of news on what is happening before the microphone. Personal interviews with broadcast artists and executives. Trends in studio technique.



THE PICKENS SISTERS

Backstage *in* Broadcasting

By Samuel Kaufman

OHMAN and Arden, the snappy piano team heard on numerous NBC features, are finds of S. L. Rothafel (Roxy).

They did their first broadcasting from the Capitol Theatre in New York and later became fixtures of Roxy's Gang. Since then they have been heard on many NBC sponsored features. Phil Ohman hails from New Britain, Connecticut. Victor Arlen was born in Wenona, Illinois. Ohman was once employed in the piano department of a New York department store and Arden's early efforts were confined to making piano recordings. Since their appearance under Roxy's auspices in 1922, they have appeared in many Broadway musical comedies.

IT is a rare case, indeed, when an entertainer or group of entertainers with no previous microphone experience secures a network contract. Yet that's just what happened to the Pickens Sisters, vocal trio from Georgia, now signed to an exclusive NBC contract. Within two weeks after their first program the sisters were placed on a daily schedule. This is a goal that some radio entertainers of long experience never attain. The sisters, namely, Jane, Helen and Marla, are in program effect, a

sort of cross between the Boswell Sisters and the Mills Brothers; they have the harmonizing liveliness of the former and the "vocal orchestral" feature of the latter. The Pickens Sisters gained their contract on their first audition. They have been harmonizing together since Marla was four, Helen six and Jane eight. That was seventeen years ago. The musical background of the trio is in the South. Before moving to Atlanta, they lived in a small Georgia town, and the singing of Negroes impressed them strongly.

NORMAN BROKENSHERE, veteran radio announcer who spent the past few seasons making talking pictures and recorded radio programs, is again back in the fold of the CBS, being featured on two new series of radio programs. His initial return engagement was on a Tuesday night feature on which he is billed as "Society's Playboy." Shortly after this program got under way he secured the additional feature spot of master-of-ceremonies of the daily "Music That Satisfies" program. On the latter series he is co-featured with the Boswell Sisters on Mondays and Thursdays;

Alexander Gray, barytone, and Nat Shilkret's orchestra on Tuesdays and Fridays, and Ruth Etting, musical comedy songstress, on Wednesdays and Saturdays. As "Society's Playboy" he is co-featured with Welcome Lewis, contralto, and Nat Brusiloff's orchestra. As a minister's son, Brokenshere first lived in small towns in Canada and New England. He was once a schoolboy janitor earning twenty-five dollars a year. His varied career included the tasks of printer, mechanic, truck driver, secretary, doughboy, business man, college student and charity campaign organizer.

AMONG the program "hits" on the air is the recently introduced "Eveready Radio Gaieties," starring Belle Baker, singing comedienne, and Jack Denny's Orchestra, which was brought to New York from Montreal for the Sunday radio series. Belle Baker brings to the air her extensive repertoire popularized throughout her twelve-year vaudeville career. She has been starred in musical comedy and talking pictures. She was previously heard over the air on certain occasions as a guest artist, but never as a regular weekly feature. Jack Denny, whose musical career has been constantly

(Continued on page 1051)



NORMAN BROKENSHERE



OHMAN AND ARDEN



BELLE BAKER

News and Comment

A page for the news of the whole radio industry, including important trade developments, new patent situations, comments by leading radio executives, notes, rumors and opinions

Array of Events at R.M.A. Trade Show

CHICAGO, ILL.—Prominent speakers, a "national clinic" on important radio industry problems and considerable entertainment as well as business are to be features of the big annual radio gathering at Chicago during the R.M.A. convention and trade show.

The program for the industry conclave May 23-26 at the Stevens and Blackstone hotels was outlined at a meeting in Chicago March 9th of the R.M.A. Convention and Reception Committee, of which Mr. Leslie F. Muter of Chicago is chairman. The committee includes President Coit of the R.M.A., Vice-President A. S. Well, Directors Henry C. Forster, R. T. Pierson and E. N. Rauland, and Messrs. Thomas A. White, Harry Olson, Clarence Clago, Harry Simpson, Mortimer Frankel, P. V. Galvin, J. T. Beatty and Colonel George B. Gaw, official "greeter" of Chicago civic interests.

The R.M.A. annual convention is scheduled for Wednesday morning, May 25, with prominent speakers being invited. For the thousands of radio jobbers and dealers in attendance, there is planned the open "clinic" with other prominent speakers on Tuesday morning, May 24, together with other important group meetings to consider special subjects before the radio industry. Joint meetings of directors and others of allied radio organizations also are being arranged.

Chairman Muter and his committee will meet the special trains and other delegations on their arrival at Chicago. For social diversion and entertainment a program, including an "open" golf tournament for the entire radio industry, is being arranged by Henry C. Forster, chairman of the Entertainment Committee.

Ultra-Short Waves Can Reach Mars

EAST PITTSBURGH—At different times certain people have interested themselves in the possibilities of communication with possible inhabitants of Mars. If anything of this sort is ever to be accomplished, it will probably have to be done by means of ultra-short radio waves, according to I. E. Mourmoutseff, research engineer of the Westinghouse Electric and Manufacturing Company.

Some 25 years ago certain known facts of radio communication convinced Dr. A. E. Kennelly, professor of electrical engineering at Harvard, and Professor Oliver Heaviside, English scientist, that there must be a sort of cushion or atmospheric layer 100 or more miles from the earth's surface. This has since been known as the Kennelly-Heaviside layer.

First Television National Art Exhibit

NEW YORK—Radio's first television art exhibit went on the air recently when Malcolm Vaughn, noted art authority, brought his pertinent comments on the Loan American Portrait Exhibit by contemporary artists to the radio audience via Station WINS, New York, and at the same time reproduc-

Reported by

Howard S. Pearse

tions of the canvasses were shown the sight audience via Station W2XCR, New York.

The exhibit, held at the Anderson Galleries, was for the benefit of free coffee stations for the unemployed, a division of the free milk fund.

Robot Battleship Controlled by Radio

WASHINGTON, D. C.—Uncle Sam's newest Radio Frankenstein, the decommissioned battleship *Utah*, condemned under the London naval treaty but kept afloat for radio experimental purposes, steamed out of the Norfolk Navy Yard recently for trial runs which will precede its assignment to the fleet in Pacific waters.

One of the earliest American ships of the dreadnaught type, the vessel has been stripped of its armaments and equipped with



U. S. S. UTAH

a complete system of radio control that will enable naval observers to maneuver it from a distance without the aid of a crew aboard. It has been outfitted by naval radio experts to be operated as a "robot" man-o'-war from another vessel or even from an airplane.

Repeating similar radio-control experiments conducted with the battleship *Iowa* during fleet maneuvers off Panama in 1923, the Navy will use the *Utah* as a target vessel to test its latest developments in bombs, guns and fire control. Ultimately, like the *Iowa*, it will be sunk.

The relay control of a battleship by radio is completely practicable, according to naval experts, but much remains to be learned from the *Utah* experiments, which will involve the newest types of radio apparatus available. Everything on the ship is operated by radio impulses sent out by a controlling ship using a special keying system on a regular radio transmitter. It is possible to use this same "switchboard" arrangement aboard an airplane to control the movements of the "robot."

Provision is made for steaming the radio-controlled ship at varying rates of speed, changing its course, laying smoke screens, and, in fact, maneuvering it nearly in all respects like an enemy ship in battle. The *Utah's* electric motors, operated by signals sent out from the controlling ship, will open and close the throttle valves, move the rudder and regulate the supply of oil to the

boilers for smoke screens. The Sperry "metal mike," or gyro pilot, will keep the ship on its course.

It is a simple matter to install the "switchboard" control apparatus on a ship or airplane. In the target practice, the *Utah* will often be out of sight of the controlling craft, but an airplane will observe the effects of bombs or gunfire and will radio the information back to those in control.

For the most part, the radio and relay-control apparatus that has just been installed on the *Utah* is the product of the genius of John Hays Hammond, Jr., radio inventor of Gloucester, Mass., whose radio-controlled torpedoes were introduced during the war. Similar apparatus developed both by Mr. Hammond and by research scientists of the Naval Research Laboratories is also available for operating "pilotless" airplanes.

Batteryless Radio Patents Held Invalid; Lowell & Dunmore Lose

WASHINGTON, D. C.—Unless the United States Supreme Court reverses the decision of the Circuit Court of Appeals at Philadelphia last week, holding that the "socket power unit" now commonly used to eliminate batteries in radio receiving sets has not been infringed by the Radio Corporation of America, dreams of vast riches for the two men claiming to be the inventors of the device appear to have gone glimmering.

Royalties on practically every radio ever produced which derives its power from house alternating current lighting mains would have been due Percival D. Lowell, Francis W. Dunmore and the Dubilier Condenser Corporation had they won the suit. It has been estimated that \$10,000,000 was involved.

New Showrooms Feature Free Institute for Radio Servicemen

NEW YORK—Wholesale Radio Service Company, formerly at 38 Vesey Street, New York, are now installed in their new location at 100 Sixth Avenue, New York City. The new quarters are said to have about five times the floor space of the older ones.

The successful history of this company mirrors quite closely the unparalleled growth of the radio industry. From a very modest start, the Wholesale Radio Service Company has expanded constantly until now it is one of the largest and best-known concerns of its kind in the radio business.

U. S. Spends \$310,000,000 for Radios in 1931; General Motors Leaves Field as Kolster Enters Westinghouse Deal

NEW YORK—Although the radio manufacturing industry has not escaped the effects of the general depression, the American public purchased about \$310,000,000 worth of sets, tubes and parts in 1931, according to reliable retail trade statistics. This is a far cry from the figures of the peak years of 1928, 1929 and 1930, which approximated

\$800,000,000, but it shows that the radio industry is still one of some magnitude.

Radio sets sold last year, including phonograph combinations and auto receivers, numbered 3,420,000, valued at \$212,040,000. This is exclusive of the 472,000 sets exported last year, when exports were nearly double those of 1931. It is exclusive also of tubes, 53,500,000 of which, value at \$69,550,000, were marketed. The sets sold in the American market in 1931 almost equal the total number of licensed radios in Great Britain or Germany.

That the battery market still exists is shown by the fact that \$15,100,000 worth of batteries were sold in 1931. Miscellaneous accessories brought in \$8,580,000 and other parts \$6,000,000.

Many formerly well-known names have dropped out of the radio trade, unable to stand the strain of the times. The latest to decide to leave the radio field is General Motors, which formerly marketed a set under its own brand but manufactured by R.C.A. under an arrangement whereby the latter company owned 49 percent of General Motors Radio. On the other hand, expansion of trade effort is seen in the new agreement between Westinghouse and Kolster Radio, whereby the latter will manufacture and sell Westinghouse receivers. Formal announcement of this arrangement has not yet been made, but it is expected that Westinghouse will terminate its manufacturing arrangement with R.C.A., despite the fact that it owns about 20 percent of R.C.A. stock. Kolster is a subsidiary of the International Telephone & Telegraph Corp.

Radio to the Strathosphere

VIENNA, AUSTRIA—Emulating Prof. Piccard's ascent by balloon to the strathosphere last year, two scientists here, Herr Hans Braun and Count T. Vichy, making secret preparations for a like exploit, planned to carry a short-wave transmitter in order to keep a ground crew informed of their progress. German and Austrian broadcasting stations may rebroadcast their reports.

U. S. Bars Baird Television Because of Alien Identity

NEW YORK—Introduction of the Baird system of television, developed by John Logie Baird, British inventor, has been barred from the United States by a decision of the Federal Radio Commission. Reversing the recommendation of Examiner Ralph L. Walker, the Commission has denied the application of Station WMCA, New York, to erect a 1000-watt visual broadcasting station, proposing to use the Baird system and to operate in the 2850 to 2950 kilocycle band.

The Commission held that, though the application was in the name of WMCA, an American company, the proposed station would be operated jointly with Baird Television Corp., Ltd., a British concern. Mr. Baird himself was one of the witnesses at the hearing on the application, and it is understood that practically all of the equipment has already been delivered to WMCA in the confident expectation that the station would be authorized.

More Work at Kolster

NEWARK, N. J.—Production of Kolster International radio receiving sets has been speeded up materially since the completion of arrangements to distribute the Kolster 1932 line. In the last week more than 100 employees have been added to the working force at the Kolster plant at 360 Thomas Street, Newark, and the daily output of all models has mounted steadily.

New Radio Horizons

Pioneer the Ultra Short Waves

with NATIONAL!

NATIONAL Ultra Short-Wave Parts



MIDGET ULTRA SHORT-WAVE R-39 FORMS AND COILS

Made of R-39 wonderful low-loss dielectric, these insure highest efficiency, maximum flexibility, stability and fixed calibration in ultra short-wave circuits. Diameter is such as to give best average form-factor. Give best results when used with NATIONAL Isolantite Coil Sockets. Available in 4-prong style only.



NATIONAL ISOLANTITE COIL-SOCKETS

These Reduce losses to a minimum in ultra short-wave work. For regular or sub-panel mounting. In standard 4, 5 and 6 prong style and special 6-prong for NATIONAL standard size R-39 forms.



TYPE BM 3" MIDGET VELVET VERNIER DIAL

A smaller dial with the famous V.V. Mechanism for small receivers and transmitters. Fixed ratio only. Type BMD dual range 0-100-0; type BMC 200-0 clockwise.

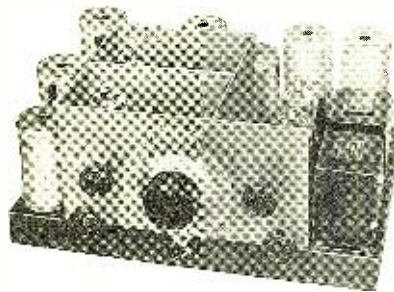

NEW NATIONAL 5-METER RECEIVER KIT

Complete set of parts for newly designed receiver covering range 334 to 7½ meters. Coils also furnished for use on amateur 20 and 80 meter phone bands. Receives ultra s.w. transmissions now on the air, including television programs, experimental airplane beacon signals (U. S. Navy), amateur phone transmitters. Extremely high signal-to-noise ratio. Single-control tuning. Volume control, sensitivity control, push-pull Pentode power output for loud-speaker operation. Employs above listed new NATIONAL Ultra Short-Wave parts.

Made for full AC operation.

Send coupon below for more complete information on this new and entirely different kit.



SPECIAL ULTRA SHORT-WAVE CONDENSER TYPE SEU

Isolantite insulation. Heavy 270° plates, double spaced, insulated front bearing, constant low impedance pigtail, standard capacity 18 mmf. For ultra short-wave tuning or neutralizing in low-power transmitters.

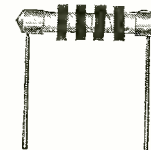

ULTRA SHORT WAVE RF CHOKE TYPE 100

Universal wound in four narrow spaced sections on Isolantite form. Has extremely low distributed capacity. Fits in grid-leak clips or can be mounted with stiff leads, directly in the circuit. DC resistance 50 ohms, distributed capacity 1 mmf., inductance 2½ mh., current rating 125 ma.



TYPE EMP SPLIT STATOR CONDENSER

For short-wave receivers and low-power push-pull transmitters—special Isolantite low-loss insulation. 1200 volt breakdown. Plates are single spaced. Standard size 100 mmf. per section, but furnished up to 350 mmf. on order.

Send for this Entirely New and Authoritative Manual on Ultra Short Waves; Just Printed

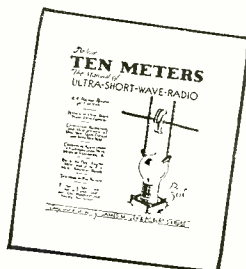

"BELOW TEN METERS" A HANDBOOK OF ULTRA SHORT-WAVE RADIO

First and only book of its kind. Compiled by James Millen and Robert S. Kruse. Full of new and highly interesting information "How to Build," etc., etc. Send stamps, coin or money order.

PRICE 50¢

NATIONAL Company, Inc.

61 Sherman St., Malden, Mass.

Gentlemen:

Enclosed please find 50c for your Ultra Short-Wave Manual. (Vol III of NATIONAL "Short-Wave Series.")

Please send me full information on your new 5-Meter Receiver Kit.

Name.....

Address.....

Don't Fail to Read

**IMPORTANT
ANNOUNCEMENTS**

on

Page 1056 and Page 1071

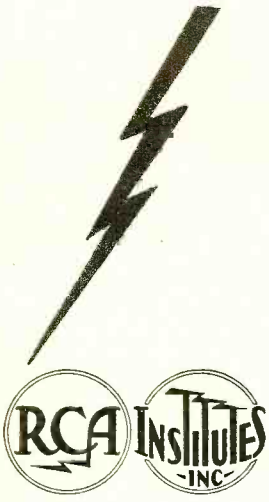

The NEW STENODE

All for \$5 **3 Big Books—**
 One Containing all the Scientific Reasons for this Remarkable Receiver.
 The Second Containing Complete instructions for Building It.
 The Third is the Complete Description of the 1932 Stenode, by Zeh Bouek.
9 Complete Blue Prints

Prepared by Stenode Engineers in personal co-operation with
Dr. James Robinson
 (Former Chief of Wireless Research British Royal Air Force and Inventor of the Stenode)
 All in a sturdy mailing container, originally made to sell at \$10. Now, because of their popularity—only **\$5**

STENOTUBES

The special, 175 K.C. quartz crystal, mounted in vacuum tube form, necessary for the Stenode. Imported from England and carrying the approval of Dr. Robinson, at the very low price of **\$15**

Send checks or money orders to
ARTHUR H. LYNCH Garden City, N. Y.

SHORT WAVE SUBMARINER	CONVERTER \$12.50
ACROCYCLE OSCILLATOR	\$17.50
AUTO-DIAL (Auto Radio) \$40.00 Send for Free Circular	
J.M.-P. MANUFACTURING CO., Inc. 3426 Fond du Lac Ave. Milwaukee, Wis.	

ALUMINUM BOX SHIELDS
 Genuine "ALCOA" stock, silverdip finish, 5x6x6 \$1.89
 —Cabinet size \$4.65. 10x6x7 Monitor size \$3.25. 5x6x5 Coil Shield (like picture on the right) \$1.00. Any size to order.
 "BUDDY" Test Prods. Always sharp point. ed using phonograph needles. \$1.50 pair. We can furnish all parts for the SET TESTER DELUXE described in October Radio News.
SELENIUM CELL, \$3.50
 Television Lenses, 13/16" .12c | Conoid Coil.....38c
 Grater Neon Lamps.....\$5.95 | 3/8" to 1/2" Coupling.....25c
 We specialize in parts exclusively. We can furnish everything described in this magazine. Give us a trial. Please include postage.
BLAN, the Radio Man, Inc., Box 96, New York City



Radio Future

(Continued from page 993)

The possibilities offered by its use in industrial equipment are unlimited, and the hearty approval accorded the dry condenser in the radio industry has paved the way for its adoption in other fields.

Refinements that are being made for industrial application will be reflected in the radio units, improving their service in a like manner. Research indicates that higher voltage dry electrolytic condensers with very low power factor will be available for radio use in the near future. These units will have all the desirable characteristics of paper condensers combined with small size and economical price.

New Television Systems

By George Gruskin

Executive Director, Sanabria Television Corp.

I AM of the opinion that the public has become educated—by the high standard of radio and talking-picture service currently disseminated—to the point where television must at least approximate the present-day home talkies in pictorial quality and entertainment value before it will be acceptable commercially, before there will be a sizable market for home televisions.

To conceive of the many thousands of lines inherent in a modern motion picture in terms of the ordinary mechanical and cathode-ray systems which allow us images composed only of from 2000 to 50,000 picture elements is to face pessimistically a very long-drawn-out period of development endeavor.

For this reason, and since the radio industry is in vital, immediate need of such a rejuvenating influence as perfected television, I believe necessity will again become the mother of invention and a new television system will appear on the horizon which will dispense with the usual mechanical and cathode-ray scanning methods in favor of devices capable of transmitting and receiving images comparable to home movies, accomplished, perhaps, by means which will not—in traditional fashion—break the image down into picture elements prior to transmission and piece it together again at the televisor.

Receiver-Tube Manufacturers Must Work Together

By J. M. Spangler

Manager, Radio Tube Division, National Carbon Company

IT appears that the future trend in radio tubes will be determined largely by the engineering problems arising chiefly from the keen desire of radio receiver manufacturers to pass on to the public the very latest in radio. If this is a fact, it would indicate that future radio tubes must of necessity be designed for the particular applications involved.

It would seem, therefore, that a closer relationship must be maintained between receiver and tube engineers in order that the public may derive these benefits.

Radio Aids the Deaf

By Betty C. Wright

Executive Secretary, American Federation of Organizations for the Hard of Hearing, Inc.

IN these modern times, new worlds are opening up for the hard-of-hearing, through electrical hearings aids, the radio, group phone equipment in churches and theatres. In the future, people with defective hearing who do not avail themselves of the

joys to be obtained through the use of a satisfactory hearing device may be classed with people who do not believe in any of the modern conveniences. Hearing aid manufacturers can make it as natural for hard-of-hearing people to use hearing aids as for people with defective sight to wear glasses, by providing inexpensive, effective and attractive hearing instruments.

Rapid Test Methods Important

By A. E. Thiessen

Engineer, General Radio Company

THERE is unquestionably a growing sentiment in favor of real quality in radio reception. The public is gradually becoming educated to better performance and demands receivers that will provide it. This shifting picture changes the emphasis in radio design. Where once the problem was to make them as small as possible, it is probable that the old question of quality will again receive attention. Technical improvements of this nature are only possible by better testing methods, both in the laboratory and on the production line.

Laboratory measurements on receivers from the antenna through to the sound output from the loudspeakers are the real indication of how they will perform in the user's home. The production testing problem is to invent rapid methods for holding production within the laboratory limits.

Larger Size, Better Quality Loudspeakers

By Stanley S. Sondles

Sales Manager, Magnavox Co., Ltd.

IT is our company's opinion that the trend in loudspeakers for the coming season will be for larger size and better quality with greater power-handling ability.

The present trend in set development incorporating the class B audio system in better quality sets seems to point to the need for larger and better quality speakers instead of smaller speakers with quality compromises because of a price situation which was pretty much general through 1931.

While the dual speaker arrangement is successful, its greatest value seems to be from a sales point of view, and it is believed that a genuine quality speaker will eventually take the place of the present dual arrangement.

Our company, pioneers in the dynamic speaker field, as can be expected, are taking definite steps to meet this demand and will exhibit new developments at the R.M.A. Trade Show on May 23rd.

New Tubes, Short-Waves, Television

By A. G. Hoffman

President, Midwest Radio Corp.

FUTURE trends in receiving set design, in my opinion, will be built around the several new tubes recently announced and new circuits developed to obtain more efficiency from existing tubes. Short-wave reception is at last coming into popular use and engineers are devoting much of their time to simplifying the tuning below the regular broadcast band, as we all realize that once more we are capturing the listeners' thrill for distance. Short-wave reception is the real big feature in the new receivers. Television for the masses is not as yet a reality.

Better Speakers for P.A. Work

By Horatio H. Burt
Sales Manager, Best Mfg. Co.

ONE of the important needs in loud-speaker design is the improvement of the type of speakers used in school rooms, hotel rooms and wherever programs are distributed from a centralized amplifier. For this purpose is required a speaker with a high sensitivity and wide range which will reproduce harmonics in their proper relative intensity to the fundamental, resulting in greater realism.

Such a speaker which has a greater efficiency than commercial type dynamic speakers will soon be available for centralized radio systems, air-cell battery sets, automobile sets and wherever a speaker is needed which does not require any field power.

The Future of Insulating Materials in Radio

By D. J. O'Connor
Vice-President, Formica Insulation Co.

PRESSURE for reduced costs has led to the use of progressively smaller, flimsier and cheaper insulating parts in many radio sets built in large quantity. In my opinion, this movement has gone too far; there is bound to be a reaction. This reaction will be stimulated by the fact that the best insulating materials are now selling at prices lower than any previously suggested—lower than any of us would have thought possible a few years ago. Nothing is more important than good insulation to dependability and durability in electrical devices. The cost of quality insulation is so much less than the cost of even a small amount of trouble that to use it is the best possible economy.

Better Quality at Lower Prices

By Romeyn B. Scribner
President, Thomason Laboratories, Inc.

SINCE the advent of theatre amplifiers new uses for voice and music fortification have appeared almost daily. So far only those applications showing immediate financial returns have been promoted to any extent.

The future holds two important fields. First, improved quality in these applications already made. Second, installations in churches, hospitals, institutions and homes that have withheld up to now because high quality systems have been too expensive. Manufacturers must produce better quality at lower prices to crack this important market.

Mathematics in Radio

(Continued from page 1004)

Therefore, from (B):

$$R_o = \frac{1}{2aE_p}$$

The numerical value of R_o can now be computed, since $a = .00006$ and $E_p = 10$.

$$R_o = \frac{1}{.0012} = 835 \text{ ohms}$$

It is noticed that this value of a.c. resistance is about one-half the value of the corresponding d.c. resistance.

Thus, by means of the characteristic curve of a tube, its a.c. internal resistance is shown to be easily and accurately calculated by the use of calculus.

DEPENDABLE—PERMANENT—EFFICIENT



Improve your present equipment with a Bud Speaker

BUD LOUD SPEAKERS are an outstanding marvel in construction and performance. With the use of **BUD SPEAKERS** such disturbances as distortion under pressure, overheating unbalanced tone and background noises are eliminated. The exclusive diaphragm and voice coil assembly embodies every essential for positive, permanent and dependable performance. Unaffected by temperature or humidity.

BUD ALUMINUM TRUMPET HORNS have already established new records in sound quality; nothing has been developed, as yet, to equal their general satisfaction. Their importance cannot be over-estimated. Clear, bell-like, and astonishingly realistic in tone—light in weight—and free from all the dangers of exposure and atmospheric changes. Overall length of 6 feet with 32-inch bell. Pole mountings are necessary in many sound-projection installations, such as football stadiums, ball parks, arenas, airports, etc. Special throats carrying two or more **BUD SPEAKERS** can be supplied. Write for descriptive literature.

BUD SPEAKER COMPANY

625 Board of Trade Building
Toledo, Ohio, U. S. A.

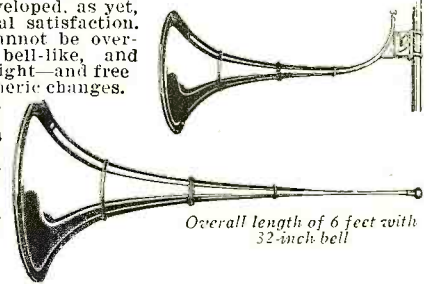

Overall length of 6 feet with 32-inch bell

DEAF!

The new DeForest Audiphone is the most efficient pocket hearing aid—Price only \$40.

Ten Days' Free Trial.

We also make the DeForest Transmitter used in the Radio News Hearing Aid. (January issue.)

Circulars and circuit free.

The Theatrephone is the simplest of all group hearing aids. Servicemen, this is a good field!

HEARING DEVICES CO., INC.
2463 Times Bldg., Times Square, New York

FOR FIXIT SHOPS



FREE FOTO GUIDE and Vacuum Cleaner Parts Catalog. Most complete ever published. Lists over 800 items and special tools. 32 pages. Illustrated. Standard material at lowest cost. Valuable source data on obsolete parts. Big help to all repair shops.

WASHING MACHINE PARTS

Combined washer, vac. and small motor servicing attracts trade and reduces operating expense. We can supply most replacement parts. Uniformity to highest standards guaranteed. Lowest known prices with saving on transportation and trouble. Consolidated orders earn maximum discounts. Instructive catalog free.

Uron Industries, Inc.

1235 West Sixth St., Cleveland, Ohio



The ELECTRAD Resistor Replacement HAND BOOK

A PERPETUAL GUIDE — \$1.00 a year.

SERVICE MEN

Everywhere Praise

THIS BOOK

A PERPETUAL guide to correct resistor and volume control values—with diagrams, charts, set specifications and other valuable data.

Prepared by authoritative engineers, and published by Electrad as a service to service men.

Loose-leaf pages, genuine Fabrikoid flexible cover. Kept up to date by supplements four times a year.

A small dollar investment that pays BIG dividends.

Mail the Coupon.

175 Varick St., New York, N.Y.
ELECTRAD
INC.

ELECTRAD, INC., 175 Varick St., New York, N. Y.
Enclosed \$..... (check, currency or M. O.) for.....
copies and supplements (as published) of RESISTOR
REPLACEMENT HAND BOOK (\$1.00 single copy;
75c each for 6 or more).
Name.....
Address.....

RN-6

A New Tone Quality in Heavy Duty Units

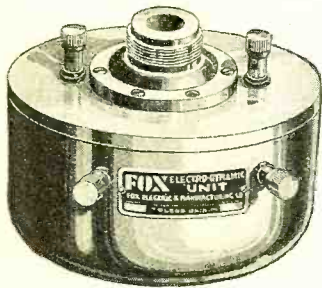

FOX

Fox Units are guaranteed for accuracy, realism, and brilliancy—and are absolutely free from distortion under pressure. High sensitivity factor, exceptional tone balance. Unaffected by moisture or atmospheric conditions. List \$49.50.

Fox Horns—Authentic in design—superior in construction. Types for all indoor and P. A. purposes, including rams horn, exponential air column, and standard trumpet.

Investigate the new 4 ft. and 6 ft. All-Aluminum Fox Trumpets, with their brilliancy and tremendous range.

Fox Units and Horns not only command attention for their output volume and tone value—they offer definite and exclusive engineering and physical features found nowhere else. The combination out-demonstrates anything on the market.

FOX ELECTRIC & MFG. CO.
3118 Monroe St. Toledo, O.

AERO WORLDWIDE SHORTWAVE RECEIVER

\$6.45

Listen in DIRECT to London, Paris, Berlin, Buenos Aires and other broadcasting stations throughout the world via short waves. Your ordinary receiver cannot tune in these low wave stations. **WORLD-WIDE RECEIVER gets 14 to 550 meters.**

AERO SHORT WAVE CONVERTERS

Convert Your Present Set into a Short Wave Super-Heterodyne
A. C. Model \$12.50—D. C. MODEL \$11.50
AT LAST! The perfect Auto Radio—ONLY \$20.00

Built by pioneers in the manufacture of Auto Radio. We guarantee 1000 miles radius of reception. A masterpiece of Radio Engineering. Latest model 6 Tube Aero Pentode Auto Radio. Price of set only \$20.00. Set complete with tubes, batteries, dynamic speaker, antenna equipment and noise suppressors, \$39.50. SEND FOR COMPLETE CATALOG.

CHAS. HOODWIN CO., 4240 LINCOLN AVENUE Dept. T-30 Chicago, Ill.

NEW CATALOG

of the most complete test and connector line for radio, electrical, sound and servicemen, etc.

Sent Free on Request

International Air Research Laboratories
4808 47th St., Woodside, L. I., N. Y.

IMPROVED ALUMINUM BOXES

Remove any side without affecting rigidity; brass corner posts; silver finish; cost no more than ordinary boxes. The boxes you have long wanted. Shipped KD.

1/16": 5x6x9, \$1.90; 10x7x6, \$2.95; 12x7x8, \$3.95; 14x7x9, \$4.65; 1/8": 5x6x9, \$3.85; 10x7x6, \$5.15; 12x7x8, \$6.35; 14x7x9, \$7.25.

Remit \$1.00 on C.O.D. orders. We invite your inquiries.

JOHN R. SKRONDAL
82 Mt. Vernon Street Ridgefield Park, N. J.

Broadcast and Short Waves

(Continued from page 1023)

interference being secured first by the use of a 465 kc. intermediate amplification frequency, and secondly through the very good high-Q antenna-coupler. Analysis of the image-frequency problems indicates that such interference can only occur at twice the intermediate frequency away from any signal. For example, the band to be covered is 550 to 1500 kc., with the oscillator operating always above the signal frequency. Obviously, the oscillator range is therefore 550 plus 465 kc. to 1500 plus 465 kc. or 1015 to 1965 kc. Adding the i.f. of 465 kc. again to find the possible image or repeat spots in the broadcast band, only three are found, 1480, 1490 and 1500, in the broadcast band. These three points in themselves are not serious, but are of no importance, anyway, due to the more than adequate rejectivity of the high-Q antenna circuit.

A two-point switch is seen in the first detector grid lead, which permits choice of either the high-Q broadcast band antenna-coupler with its section of the two-gang tuning condenser, or the antenna-coupler for the police-call band. This second antenna-coupler need not be as efficient a coil as that required for the broadcast band. Consequently, it is wound on a smaller tube and is tuned by a mica compression condenser actuated by a knob on the front of the chassis.

In this police band the image-frequency interference is quite noticeable in larger cities and proves definitely the worth of the high-Q broadcast band antenna-coupler. It will be noticed that if a local broadcast station is tuned in and the switch thrown to the police range it will still be heard—in fact, almost as well as with the switch in the broadcast position, due to the inadequate rejectivity of the police-call antenna circuit. This, however, is of little importance, as there are few police-call frequencies, and there is no difficulty in finding them even between the image points found in an extremely good reception location just outside Chicago. For example, taking the Chicago police calls at 1712 kc., their image point in the broadcast band will be at 1712 minus 930 kc. (twice the i.f.) or 782 kc. No local station is on this frequency (considered as 780 kc.) and as it is occupied only by relatively weak distant stations much weaker than the local police station, no trouble is had in getting police calls. However, at a distant point where both the 780 kc. broadcast station and the 1712 kc. Chicago police station are of about equal field strength, some trouble would be had in receiving this Chicago police call, but careful tuning would do the job, since even the 2 kc. separation between the two signals would permit of practically interference-free reception of the Chicago police calls by slight detuning. In this connection it must be realized that the 727 is primarily a broadcast set, with police call possibilities practically thrown in at no extra cost.

It will be noted that the broadcast band antenna-coupler has the customary primary, while the police call antenna-coupler is shown with an open-ended primary. Actually this is only a capacity turn, the antenna being capacitatively coupled to the first detector grid circuit for the police band.

The balance of the first detector circuit is not unusual, except the method of obtaining C bias—automatically, and in addition by having current bled through the bias resistor from the B supply to insure a desirable and constant value of bias for this tube.

The oscillator circuit is the usual S-M tank-tuned system having two padding capacities in addition to the tuning capacity

to insure accurate tracking at all broadcast frequencies.

The i.f. amplifier utilizes three high-gain 465 kc. transformers. These are dual tuned and having Litz coils to insure both high gain and high selectivity, a combination usually hard to obtain at such a high frequency. The two -51 vario-mu i.f. tubes are initially biased by means of a 250-ohm resistor shunted by a .1 mfd. condenser, and are additionally and variably biased by the action of the automatic v.c. tube—not as a volume control means, but as a sensitivity control, volume being controlled in the audio circuit.

The function of the a.v.c. tube is to establish a balance point for different signal levels such that the voltage delivered to the second or audio detector will be just sufficient to produce a full five to six watts undistorted power output from the pentodes when the volume is turned full on, and similarly to maintain constant power output for all signals at the level determined upon by the setting of the manual volume-control knobs. It does this by rectifying the carrier signal voltage appearing in the second i.f. plate circuit and applying it as a d.c. voltage to the control grids of the i.f. tubes, its action being so proportioned that all signals from 30 microvolts absolute on up will result in a bias on the i.f. tube sufficient to lower their gain to just that sufficient to get the desired constant signal voltage on the audio detector grids.

The 1-megohm resistor in the plate circuit of the automatic volume control tube is also in the i.f. grid return, and it is the d.c. voltage developed across this resistor that provides the variable bias, the grid circuit of the a.v.c. tube (a simple rectifier) being fed signal carrier voltages from the second i.f. plate. To remove the signal modulation from the carrier, resistance and capacity filtration is included in the a.v.c. circuit. The 100,000-ohm resistor connected from i.f. secondaries to a.v.c. plate and the .1 and .5 mfd. condensers around this resistor to ground are part of this filtration. The two 1-megohm resistors in the a.v.c. grid and -B supply circuits, plus the .15 mfd. condenser connecting them to ground are additional filtration, and also serve as a balancing arrangement to prevent any possible a.c. ripple in the power supply from affecting the a.v.c. operation.

The paralleled -27 type second detectors really have more purpose than simply making two tubes do the work of one. They increase the handling capacity of the audio detector, which is desirable where it feeds directly through resistance and capacity coupling to the output pentodes, and it reduces the effective detector output impedance to a point where large r.f. plate by-pass capacities (desirable for stability) do not cut treble response too badly.

The audio detector is coupled to the paralleled pentodes by a 100,000-ohm plate resistor, .025 mfd. grid condenser and 250,000-ohm grid leak. A tap on the plate resistor allows a .25 mfd. condenser to progressively short the plate circuit, thus serving as a tone control or high-frequency attenuator of variable effect. Volume is controlled by running the pentode grids up and down the grid leak, the signal voltage across which is constant for all antenna inputs from 30 microvolts absolute on up due to two a.v.c. action. The 25,000-ohm resistor and .5 mfd. condenser in the detector plate circuit is for isolation or filtration.

The reason for paralleled rather than push-pull pentodes is quite simple, but not one of pure economy, since power supply regulation must be better than for the same

tubes in push-pull, because when in parallel their plate currents are additive. Paralleling them reduces their effective input and output impedances, making the effect of necessary circuit capacities far less detrimental to treble response—in a word, paralleling them improves high-frequency response and simplifies circuit compensation necessary in any highly selective type of receiver.

At first it may appear that paralleling the output tubes will reduce their undistorted output, and this is true of triodes, but is not so of pentodes, where the second harmonic canceling effect of push-pull operation is of no benefit since from a pure power output standpoint the pentode third harmonic distortion factor, which push-pull does not help, is the most serious. The undistorted power output of pentodes is therefore as great in parallel as in push-pull.

The 5000-ohm resistor and .03 mfd. condenser across the pentode plates is an equalizing circuit preventing a rise of load impedance with frequency so great as to introduce second harmonic distortion, and also serves to prevent hiss which is sometimes observed in pentode output circuits. The output transformer connecting the pentodes to the speaker is of extra large size—much bigger than would be a push-pull output transformer for the same tubes, since its core must not become saturated by the additive plate current of the two tubes.

The power supply is quite interesting, having but two filter condensers (a total, however, of 20 mfd.) and but one choke (the speaker field). By careful balancing and resistance-capacity filtration the hum is kept down to as low a level as would be present with a much more expensive filter—so low as not to be noticeable with one's ear against the speaker. The speaker field is in the negative filter lead instead of in the positive lead, and, peculiarly enough, bias for the pentodes is taken from a bleeder circuit across it! This bleeder in itself, however, is no mean filter, since it consists of one 500,000 and one 1-megohm resistor with a 1 mfd. condenser. Likewise, some of the a.v.c. operating voltage is taken from another bleeder across this filter choke. The whole scheme is quite new, and considerably more complicated than appears from the circuit diagram, since much depends upon careful proportioning of the circuit constants for additional filtering and balancing action over and above the brute-force filtration provided by the speaker field acting as a choke. It is felt to be rather a contribution to economical filter design.

The set has a sensitivity of two to three microvolts absolute, or less than 1 microvolt per meter, absolute 10 kc. selectivity, and five to six watts undistorted output for all signals from between 20 to 30 microvolts absolute input on up. Its fidelity is flat to a very few db. from 40 to 4000 cycles.

Graphs and Charts

(Continued from page 1014)

condenser is needed which shall have 270 ohms reactance at the lowest frequency: 550 kc.

Referring to the B chart, line 3B passes through 550 kc. on the frequency scale through 270, on the capacitive reactance scale and the capacity is somewhat over .001 mfd. The A chart supplies the more accurate figure of .00107 mfd.

The capacity and inductance which will resonate at a desired frequency can be found also. Simply find the reactance of one component at that frequency and choose the other one so that it has the same reactance.

For the Radio Builder Who Wants— QUALITY

HERE are four new Hammarlund developments which are a delight to careful short-wave set builders.

A wonderful Midget Condenser of high capacity and wide range. Isolantite insulation. Single and dual models. 20 to 325 mmf. per section.

Isolantite Coil Forms, Non-slipping surface. No drilling. Four, five and six prongs.

Isolantite Sockets. Top and sides glazed. Four, five or six perfect contacts through side-gripping reinforced springs.

Shielded Polarized Choke. Minimum external field.

Mail Coupon for Details

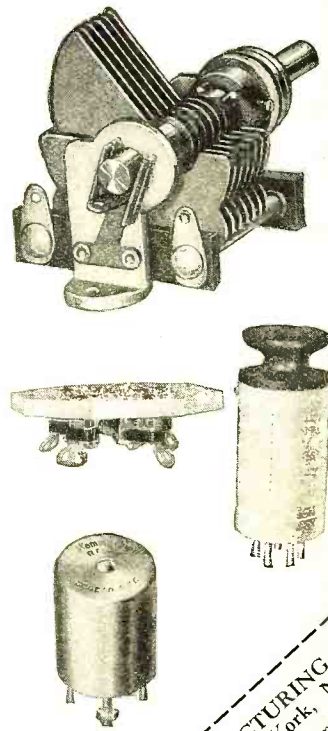

For Better Radio
Hammarlund
PRECISION
PRODUCTS

HAMMARLUND MANUFACTURING CO.
424 West 33rd Street, New York, N. Y.
Send details of complete line of Hammarlund Precision Products.
Name..... Address.....
RN-6

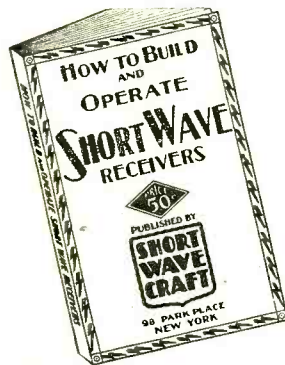

JUST OFF THE PRESS!

THE greatest book of its kind ever published. HOW TO BUILD AND OPERATE SHORT WAVE RECEIVERS is the best and most up-to-date book today.

The book has been edited and prepared by the editors of SHORT WAVE CRAFT, and contains a wealth of material on the building and operation, not only of typical short wave receivers, but short wave converters as well.

Dozens of short wave sets will be found in this book, which contains hundreds of illustrations; actual photographs of sets built, book-ups and diagrams galore.

WE SAY—AND REPEAT IT—THAT NOTHING LIKE THIS HAS EVER BEEN PUBLISHED BEFORE.

The book comes with a heavy

colored cover, and is printed throughout on fine-class paper. No expense has been spared to make this the outstanding volume of its kind. The book measures 7½ x 10 inches.

This book is sold at such a ridiculously low price, because it is our aim to put this valuable work into the hands of 50,000 short wave enthusiasts during the first few months of 1932.

Published by the publishers of SHORT WAVE CRAFT magazine. This alone will be your guarantee that it is a really worthwhile publication.

We know that if you are at all interested in short waves you will wish to do without this book. It is a most important and timely new radio publication.

This Book Is Not Sold On Newsstands.

Mail fifty cents in stamps, money order or check to
SHORT WAVE CRAFT, 94 Park Place, New York, N. Y.

CONCOURSE

(DRY)

Electrolytic
Condensers

save time and profit for
service men



Smaller and lighter than wax paper condensers, yet same mfd. equivalent. Working voltage 450, peak voltage 600. 20% more capacity than rated; very low power factor. An established condenser with a solid reputation for performance. Replaces cumbersome paper blocks in a jiffy. Easier servicing; more profit for you; customer satisfaction assured. Types for every specification. Get the complete story at once!

Write or wire for our complete descriptive catalogue

CONCOURSE
ELECTRIC COMPANY
387-411 Wales Ave.
New York City



The R. T. I. C. LAPEL-MIKE

Diameter 1¼ in. Wt. 1¼ oz.

A Real Working Instrument

Carbon granule type microphone, absolute fidelity, rugged, operates with any standard microphone amplifier. No equalization. Performance comparable to any carbon mike.

Not a Toy

Write for information on this and other microphones of the complete R. T. I. C. line.

RADIO TELEVISION INDUSTRIES CORP.

Dept. B-1

130 West 42nd St. New York City



LEARN RADIO

this easy, practical way

WRITTEN by two widely known radio engineers, these three books cover every phase of building, repairing and "trouble-shooting" on modern receiving sets. The books include complete instructions for building short-wave and TELEVISION receivers.

Radio Construction Library [NEW Edition]

Including Television Receivers

This practical Library includes: PRACTICAL RADIO—The fundamental principles of radio, presented in an understandable manner. Illustrated with working diagrams. RADIO CONSTRUCTION AND REPAIR—Methods of locating trouble and reception faults and making workmanlike repairs. RADIO RECEIVING TUBES—Principles underlying the operation of all vacuum tubes and their use in reception, remote control and precision measurements. The Library is up-to-the-minute in every respect and is based on the latest 1931 developments in the design and manufacture of equipment.

Three Volumes,
6 x 9—1087 pages,
605 illustrations.

See this Library FREE!

No Money Down

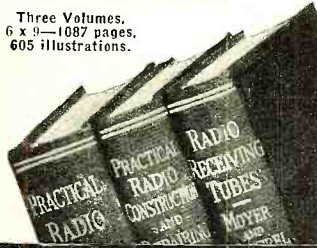

FREE EXAMINATION COUPON

McGraw-Hill Book Company, Inc.
330 West 42nd St., New York

Send me the new RADIO CONSTRUCTION LIBRARY, three volumes, for 10 days' free examination. If satisfactory I will send \$1.50 in ten days, and \$2.00 a month until \$7.50 has been paid. If not wanted I will return the books.

Name

Home Address

City and State

Position

Name of Company

SEND FOR OUR

NEW CATALOG

listing complete stocks, replacement parts, standard radio apparatus, full line of amateur equipment.

HAM SPECIALS

- 866 Rectifiers, guaranteed first quality \$2.95
- 280M Rectifiers, special— \$1.39
- Type 888—The new half-wave mercury vapor rectifier—2½-volt filament—7500 volts inverse peak— \$1.95

Complete line of

PUBLIC ADDRESS EQUIPMENT

Send us your specifications for estimates.
New American double button microphone—\$7.50

RADIO ELECTRIC SERVICE CO.
N. E. cor. 7th & Arch Streets
Philadelphia, Pa.

PATENTS TRADE MARKS COPYRIGHTS

"Little Ideas May Have Big Commercial Possibilities" PROTECT THEM BY PATENTS
Send for our Free book, "HOW TO OBTAIN A PATENT" and "Record of Invention" blank.
Prompt Service—Reasonable Charges—Deferred Payments.
HIGHEST REFERENCES

VICTOR J. EVANS & CO.

Registered Patent Attorneys—Established 1898
622-F Victor Building, Washington, D. C.

ALUMINUM SOLDER

Recent discovery! Alumaweld! Solders aluminum, pewter, cast iron, and any metal. Ten times as strong as ordinary solder. Enough solder for 20 jobs only 5¢. Money back guarantee. Agents, dealers write for details.

ALUMAWELD CO.

Dept. 16, 710 E. Broadway Glendale, Calif.

The "Nook Midget" Chassis

(Continued from page 1006)

- C4—Sprague by-pass condenser, three .1 mfd. sections
- C5—Acratest .5 mfd. by-pass condenser, No. 2872
- C6—Micamold bakelite fixed condenser, type A, .006 mfd.
- 1 Acratest No. 5126 knob, ¼-inch shaft, 1⅜ inch diameter, two-tone walnut
- 2 Acratest No. 5127 knobs, ¼-inch shaft, 1-inch diameter, two-tone walnut
- 1 Acratest No. 4076 pilot light socket with mounting bracket

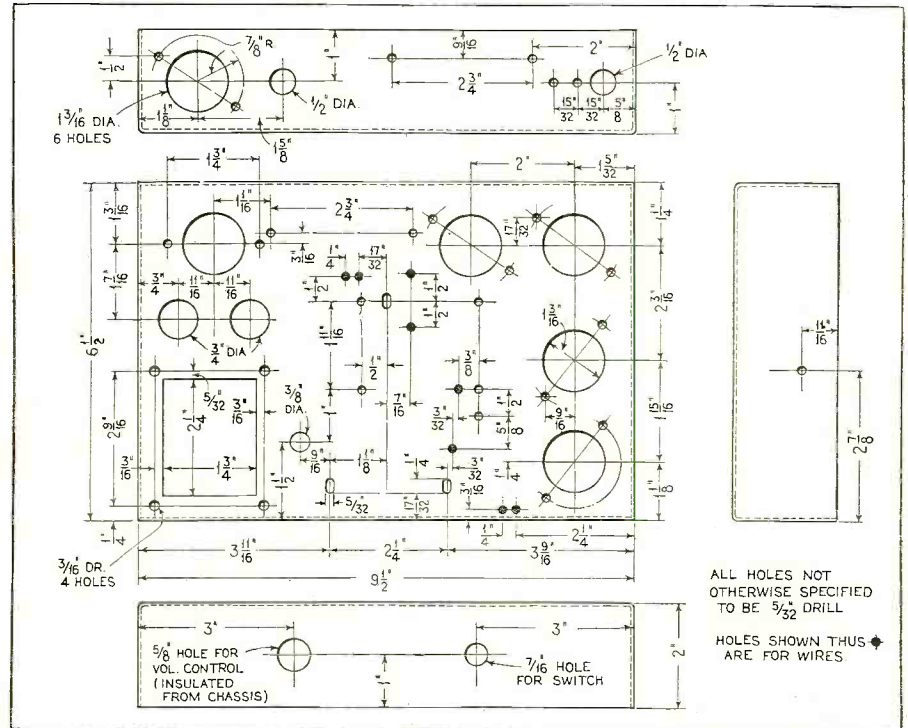

BASE SPECIFICATIONS

Figure 2. All details are shown for those who prefer to make the base

- C7, C9—Acratest electrolytic filter condensers, No. 5304, 4 mfd., inverted can type, 500 volts
- C8—Acratest electrolytic filter condenser, No. 6665, 2 mfd., tubular pigtail type, 400 volts
- C10—Acratest electrolytic filter condenser, No. 5310, 10 mfd., 50 volts
- L1, L2, L3—Acratest matched set of 3 "Conoid" coils with shield cans, type 3217
- L4—Acratest filter choke, No. 2533, 25 henries at 150 ma.
- R1—Frost 10,000-ohm tapered volume control
- R2—Acratest 350-ohm resistor, No. 3500, 1 watt
- R3—Acratest 15,000-ohm resistor, No. 3500, 1 watt
- R4—Acratest 1000-ohm resistor, No. 3500, 1 watt
- R5—Acratest 250,000-ohm resistor, No. 3500, 1 watt
- R6—Acratest 30,000-ohm resistor, No. 3500, 1 watt
- R7—Acratest No. 5900 wire-wound 5-watt resistor, 2000 ohms
- SW—Acratest power switch, rotary snap type, No. 4122
- SP—Acratest speaker plug, 4-prong, No. 5868
- T—Acratest power transformer, No. 6027, rectified output 375 volts at 70 ma., 5 volts at 2 amps., 2½ volts at 8¾ amps.
- V1, V2, V3, V4—Acratest 5-prong wafer sockets, No. 4063, markings 2-51, 1-27, 1-47
- V5, V6—Acratest 4-prong wafer sockets, No. 4062, markings 1-280, 1-blank
- 1 Eby molded twin terminal, marked Ant. and Gnd.
- 1 Acratest full-vision dial and pointer, No. 5737, clockwise scale
- 1 ⅜-inch to ¼-inch Acratest reducing bushing for variable condenser
- 1 chassis, 9½ inches by 6½ inches by 2 inches, Blan (aluminum) or Acratest (iron)

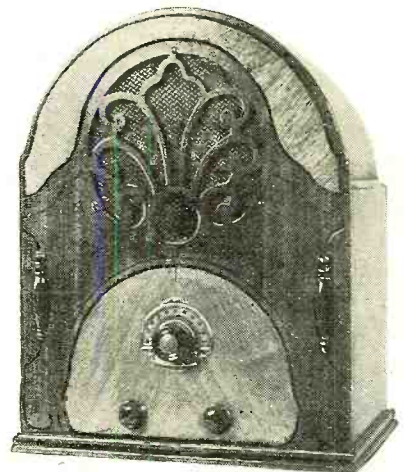

THE RECEIVER IN A CABINET
The unit is shown here in a small midget cabinet

- 1 Operadio "reflex field" dynamic speaker chassis, single -47 tube output, 2500-ohm field
- 2 aluminum or iron tube shield partitions, 2¼ inches wide by 4½ inches high with ⅜-inch turned-over edge at one end for mounting
- 1 cabinet of type selected, Blan or Acratest
- Assorted screws and nuts for assembly

Short Wave Experiments

(Continued from page 996)

It is interesting to note that the oscillating circuit of the "receiver" shows current only when the receiving bipole is held parallel with the transmitting bipole. If it is turned around to a vertical position, the lamp does not glow up.

In Figure 7 the author is holding the two bipole antennas in his hands. One is parallel to the sending antenna, the other is at 90 degrees to it. The parallel system shows a brilliant light, meanwhile there is no light in the normal system, indicating that no current was received by this system. What does this mean? It means that at small distances from the transmitter at least, the propagation of the electromagnetic radiation is not distributed equally over the entire globe in the center of which the receiver might be imagined to be placed. One of the important laws for propagation of short waves is that they can be received best in a plane cutting through the receiving system and the transmitting antenna. This is because the radiation is polarized.

This effect of polarization can be shown readily in bringing a grating with parallel metal wires between the transmitting and receiving antenna. Electric radiation will be propagated through the grating only when the wires are parallel to the receiving

and transmitting antenna. If they remain in the imaginary plane connecting receiving and transmitting system, no energy is passed through the grating.

We thus have here something similar to the effect of optical polarization with Nicol prisms. After all, light is an electromagnetic radiation as well as short waves, as shown first by James Clerk Maxwell's investigation and formulas.

It is possible to demonstrate many other applications of the electromagnetic wave phenomena with short-wave outfits of this type. From the longest radio waves used for transatlantic communication down to these ultra-short waves and light rays, and even for radiation shorter than this, there is only one set of physical laws.

An excellent means is thus given the teacher to bring about a better understanding of the phenomena of the radio sciences. It is possible, at the same time, to generalize these experiments in such a way that laws, for the fields which connect physics with the other sciences, might be abstracted.

Thus this short-wave demonstration outfit may become a valuable asset for the teaching of the phenomena of the radio sciences, optics and the deeper understanding of the basic facts of radio phenomena.

Backstage in Broadcasting

(Continued from page 1043)

linked with radio, gave up his affiliation with the Mount Royal Hotel in Montreal and brought his orchestra to New York for the new CBS feature. Broadcasting from a Broadway club back in the early days of radio, Denny's music reached the ears of Canadian listeners and he was soon signed by the Montreal Hotel. Then, in turn, his broadcasts from Montreal were heard by his present sponsors in New York and brought him the new contract.

to the CBS. Radio features are often shifted from one chain to another, but it is certainly rare to see one transferred back to the original network.

ARTHUR BAGLEY has the largest gymnasium class in the world. According to NBC officials, he is the gym instructor for some 2,500,000 listeners. For the past nine years he has been exploiting the cause of physical culture over the air. His present setting-up exercises are heard every weekday at 6:45 a.m., Eastern Daylight Saving Time, and he has never been late for a broadcast. He has three alarm clocks set to ring at five-minute intervals, starting at 5:45 a.m. In addition, a hotel clerk rings his apartment at 5:40 and 6 o'clock. When he arises, he does not turn off any of the alarms, lest he'll relax for a moment and fall asleep again. Bagley often does all the gymnastic exercises as he announces them during programs. Bagley began his professional career in the Y.M.C.A. at Rahway, New Jersey. He conducted gym classes in Newark, New Jersey, and Taunton and Lawrence, Massachusetts, before beginning to broadcast health exercises over a Newark station.



LANNY ROSS

THE Maxwell House Ensemble, featuring Lanny Ross, tenor, and a dance orchestra formerly heard over the NBC, is now on the CBS on a thrice-weekly schedule of Mondays, Wednesdays and Fridays. Ross graduated from Yale three years ago. He was a stellar member of the college glee club and soloist during the organization's European tour. On the running track he was a member of Yale's one-mile championship team, a record-holder for the quarter-mile and national 300-yard champion. While he was first striving for radio fame, he found time to acquire a law degree from Columbia University. He recently received a fellowship from the Juilliard Graduate School of Music, and at present is devoting his spare time to the study of operatic music and languages. With the switching of Ross to the CBS, George Frame Brown's "Real Folks" skit was shifted back to the NBC. Sponsored by General Foods, Inc., the same parent organization as Ross' feature, "Real Folks" was but a few months before transferred

IN 1929 the Paramount-Publix Corporation, one of the nation's leading motion picture and theatrical firms, caused somewhat of a sensation in broadcasting circles when it acquired a 50 per cent. interest in the Columbia Broadcasting System. The deal was widely accepted as an indication of a closer alliance between the radio and the theatre. Now, after the three most progressive and lucrative years in broadcasting, the stock has been sold by Paramount and the CBS is completely owned by William S. Paley and his associates, with no interests represented external to the company. Mr. Paley expressed regret at the

(Continued on page 1052)

He made it himself—easily—
from our instructions.



"I Saved over
\$200 in 1931 by
building my own
test equipment
with your resistors"

Excerpt from letter received from Serviceman.

You can do the same. Mail coupon today for FREE CHARTS giving complete instructions.

INTERNATIONAL RESISTANCE CO.
PHILADELPHIA TORONTO

IRC
RESISTORS

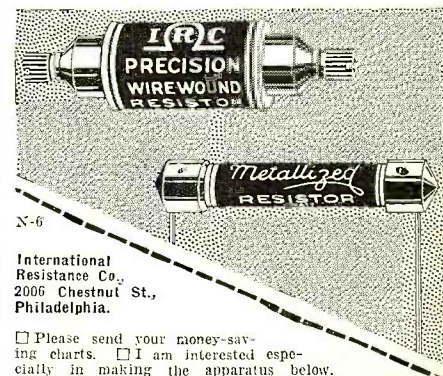

International Resistance Co.,
2006 Chestnut St.,
Philadelphia.

Please send your money-saving charts. I am interested especially in making the apparatus below. (Name the equipment you wish, below coupon.)

Name.....

Address.....

City..... State.....

EFFICIENT PHOTO CELLS CAN NOW BE BOUGHT AT LOW COST

THE NEW LUXTRON KIT HAS THOUSANDS OF OTHER PRACTICAL APPLICATIONS IN ADDITION TO THOSE DESCRIBED BY **BERNARD J. MONTYNE**

In the May issue of Radio News \$3.50

Fire Alarms—Burglar Alarms—Smoke Indicators—Counting—Sorting—Color Matching—Automatic Sign Lighting Switches

COMPLETE KIT only \$9.50 (Never Before Sold for Less Than \$60)

REQUIRES NO AMPLIFIERS

This Includes:

- 1 Light Sensitive Lux-Tron Cell, type "ST"
- 1 Relay, Controlling 110-Volt Circuit, type R-1
- 1 Gum-Wood Relay Cabinet
- 1 Complete Set Instructions and Diagrams, showing How to Make Automatic Parking Light Control for Automobiles



Size 6" x 3 1/4" x 3 1/2" deep. LUX-TRON R-1 RELAY (shown above in case)

ONLY \$4.00 (Less case)

Send \$1 Only For Interesting Instructions and Diagrams.

LUXTRON MFG. COMPANY, INC.
Pioneers in Photo-Cell Devices Since 1900
241 Lafayette St., Dept. RN, New York, N. Y.

Duplex Photo-Cell

(Continued from page 1013)

three or even more circuits with the one cell. These circuits are independent; every one can be adjusted to trip the relay at a different illumination. Each relay should have its own biasing battery and rheostat. Or the little unit described in the previous article can be used.

If it were necessary to operate two relays from one cell, relays should be connected in series. In some cases two operations can be performed with one relay (breaking one

How three different relays can be connected to the duplex cell, each with a different adjustment, can be seen in Figure 1.

When the two cells are connected in parallel, then the combination becomes more sensitive, since the current increase is doubled. Sometimes a high resistance is desirable and the two sections are connected in series.

For greater sensitivity the output of the selenium cell can be amplified by means of

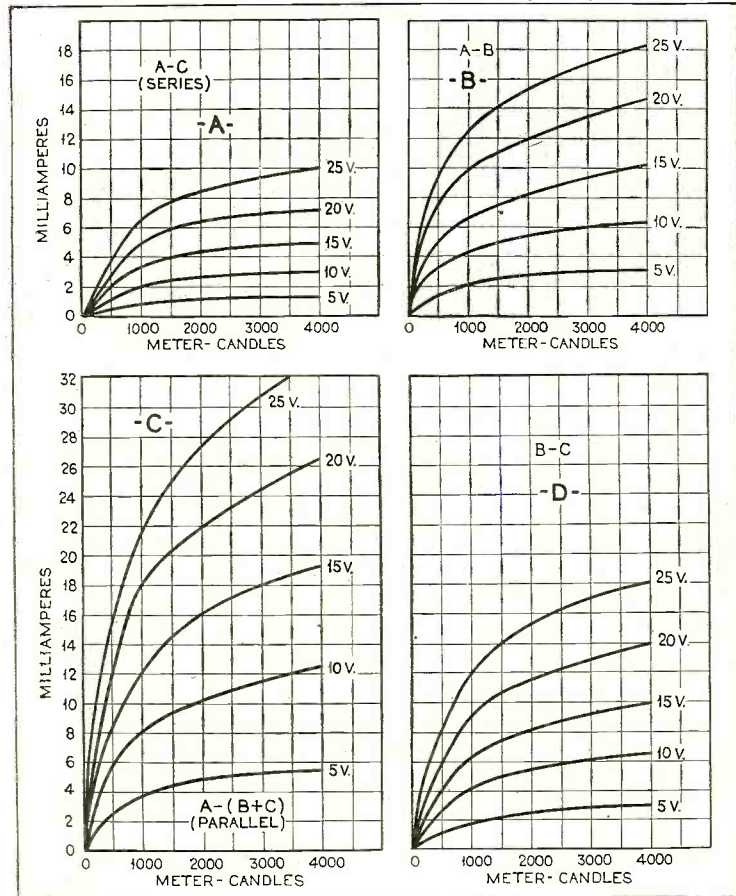

FIGURE 5

circuit and closing another); but then, both are operated at the same light-intensity. The connections are shown in Figure 2.

a vacuum tube. A single-stage amplifier is shown in Figure 6. This is called a "forward" connection. When the light increases, the plate current increases.

When a second stage might be required, it would have to be a direct-coupled amplifier because it is desired to amplify d.c. The resistance-coupled amplifier becomes less and less efficient at very low frequencies and will not amplify a steady voltage at all.

In the October, 1931, issue of Radio News a short item appeared in "With the Experimenters" department. Mr. Bradner Brown described a direct-coupled amplifier for this purpose. For vacuum-tube work the L type Luxtron cell is best suited, because of its high resistance. When you employ a Duplex unit, connect both sections in series.

The resistance R in Figure 6 should be between 50,000 and 200,000 ohms for the L-type cell and from 20,000 to 100,000 for the Duplex type with the two sections in series.

When a "reverse" amplifier is needed, the cell and the resistor R should change places.

Applications of photo-cells have become more and more numerous during the last few years. Most of these are in specialized fields of science and industry, which prob-

Backstage in Broadcasting

(Continued from page 1051)

severance of relationship with Paramount, but, simultaneously, made known his gratification that the CBS will continue its development under single control.

In commenting on the status of broadcasting, Mr. Paley said: "While broadcasting is now thoroughly established, I do not believe that even yet we can foresee its whole destiny. We do know that throughout the industrial crisis commerce and industry have found it an indispensably strong weapon and that it is now assured of sufficient revenues to meet the vast sums required to serve its public and to leave a fair margin for profit. This healthy stabilization has put broadcasting in a strong position to grapple with its ever new problems and to develop to a degree in America that it does not seem possible for it to attain anywhere else."

DAYRAD

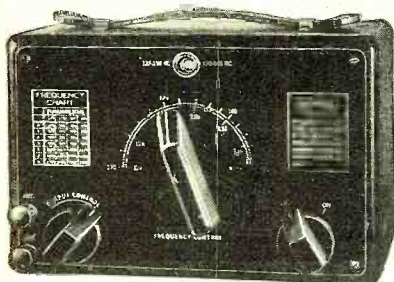

Type 175 Oscillator

For accurate adjustments on I.F. or R.F. stages. Covers 170 to 185 KC—127 to 133 KC—254 to 266 KC and complete harmonics in broadcast band. Cast aluminum case—complete leak-proof shielding.

Direct Reading—Compact—Self Contained

Less Battery and Tube \$1.975 NET PRICE

See Your Jobber Today—or Write

THE RADIO PRODUCTS CO.
DAYTON, OHIO

WRITE AT ONCE

for complete information on the most powerful receiver known. Used by MacMillan Polar Expedition. Tune in this summer on a Lincoln De Luxe Super Powered Receiver with amplification to bring any distance at any time with loud speaker volume. Laboratory built—15 to 550 meters.

LINCOLN RADIO CORPORATION
Dept. N-6
329 South Wood St., Chicago, Illinois

ably accounts for its slow adoption by the average experimenter.

Some of the most interesting applications are those where the cell is used as watchdog. Ordinary burglar alarms, consisting of wires along doors and windows do the job only half-way. A photo-electric cell can be set up in a room with a light source shining upon it. If desired, this light is made invisible (infra-red or ultra-violet). Any person interrupting the light beam will then set off the alarm, unknown to himself.

The work can be done still better than this, however. If a cell is set up so as to detect anyone entering a door or passing through a narrow passageway, a camera can be focused at that point. The relay is then arranged to open the shutter and ignite a flashlight, taking a picture of the intruder.

Recent events in America have made many a citizen concerned about the safety and protection of his home against undesired intruders. One might even go so far as to protect the entire property, to surround the house with a wall of light beams. This is not as impossible as it sounds. Four pillars could be placed at the corners of an imaginary rectangle which surrounds the house. Electric lamps in or on one pillar could shine onto a cell, hidden in another pillar, and so protect the entire space between them.

An important consideration is the height of the beam. One certainly does not want it so low that the alarm goes off when a cat prowls. Yet if the height is above, say, three feet, a person might stoop under it.

Another example of application is to use the cell as an electric lock. A small hole is made in the door, or any convenient place, with the photo-electric cell behind it on the inside. The relay is connected in a circuit which can release the catch on the door. The door can be opened only when a light shines upon the cell through the hole.

A flashlight or a match is then your key and the knowledge of the location of the

hole is the combination. Anybody who does not know about it would have a hard time opening the door. This system, of course, may be employed in addition to the regular lock.

These are just a few illustrations of uses for the photo-cell. The number has become so large that it is impossible to name them all. It is interesting to note that a New York manufacturer of weighing equipment has perfected a system for weighing and adding the weight of all material passing a certain point on a conveyor belt. This system uses a photo-electric cell for the counting process.

Here is another example of what can be done with photo-electric cells. Many years ago this idea was worked out by Meissner and by Hammond. It was called the electric dog. A small car on three wheels was supplied with an electric motor and battery. In front it had two eyes (two selenium cells). Each cell could energize an electromagnet when it was illuminated. These electromagnets attracted the steering rod. When both cells were illuminated equally, the magnets pulled on the steering wheel with equal force and it had to stay midway; in other words, the car would go straight towards the light.

If the light was off towards one side, one cell would receive more light and consequently the car would turn until it faces the light. In fact, if one walked ahead of the car with a flashlight, it would follow every turn, no matter how involved the route. This system was a step in the development of a self-steering torpedo. It was reasoned that ships focused their searchlights on a torpedo so they could find its path and steer clear of it.

If a torpedo could be made which was attracted by the light, it would follow the ship if it changed its course, provided they shined their searchlight on it. At the present time this system has been replaced by radio-controlled steering mechanisms.

Below Ten Meters

(Continued from page 1011)

period (the time required for an electron to leave and return to the grid) of the tube.

The Magnetron Oscillator

The magnetron oscillator may be described as a Barkhausen-Kurz tube operating under the influence of a magnetic field. The field is produced by a coil surrounding the tube, as suggested in the drawing, Figure 8. The efficiency of the tube is increased considerably as a critical value of field strength is approached, thus making possible relatively large outputs at wavelengths as short as 3 centimeters!

Full constructional details on Barkhausen-Kurz and magnetron oscillators will be given in future articles in this series and will feature a $\frac{3}{4}$ -meter amateur-band, radio-telephone transmitter.

Antennas and Wavemeters

The antenna systems employed on ultra-short waves are simple examples of the "dipole" or Lecher wire type. As the dimensions seldom exceed a single wavelength, they are very small and instantly portable. The use of Lecher wires makes it possible to measure the radiated wave with great accuracy, even on the shortest practical wave, while between 1 and 10 meters, modifications of conventional wavemeters provide satisfactory methods of wavelength determination.

Ultra-Short-Wave Receivers

Where the field strength is adequate, the

crystal detector provides a simple and effective receiving system. A tube may also be used, often in a slight variation of the transmitting circuit. At the present time radio-frequency amplification is almost impossible at quasi-optical wavelengths, but it is logical to presume that special tubes, suitable for this purpose, will be developed in the not distant future. Simple regenerative circuits may be used, with a distinct gain in sensitivity, but superheterodynes will not be practical until extremely stable ultra-short-wave oscillators are developed. However, the super-regenerative circuits offer distinct possibilities, as the gain can be increased in this system to an extent not achieved by any other method of reception. Constructional details on highly efficient receivers will be given in succeeding articles. Such a receiver is shown in the photograph, Figure 9.

Bibliography

In preparation for the articles to follow, the serious experimenter will find it more than worth while to review the development of the quasi-optical waves as presented by W. H. Wenstrom in the *Proceedings of The Institute of Radio Engineers* for January, 1932. Single copies of this issue can be secured from the Institute, at 33 West 39th Street, for \$1.00. In addition to an excellent general review, Mr. Wenstrom concludes his paper with a comprehensively detailed bibliography of 54 references pertaining to this particular field.



In the Great Shops of COYNE

Don't spend your life slaving away in some dull, hopeless job! Don't be satisfied to work for a mere \$20 or \$30 a week. Let me show you how to make REAL MONEY in RADIO—THE FASTEST-GROWING, BIGGEST MONEY-MAKING GAME ON EARTH!

Jobs Leading to Salaries of \$50 a Week and Up

Jobs as Designer, Inspector and Tester,—as Radio Salesman and in Service and Installation—as Operator or Manager of a Broadcasting Station—as Wireless Operator on a Ship or Airplane, as a Talking Picture or Sound Expert—HUNDREDS of Opportunities for fascinating, BIG Pay Jobs!

10 Weeks' Shop Training AT COYNE IN CHICAGO

We don't teach you from books. We teach you by ACTUAL WORK on a great outlay of Radio, Broadcasting, Television, Talking Picture and Code equipment. And because we cut out useless theory, you get a practical training in 10 weeks.

TELEVISION Is Now Here!

And TELEVISION is already here! Soon there'll be a demand for TELEVISION EXPERTS! The man who gets in on the ground-floor of Television can have dozens of opportunities in this new field! Learn Television at COYNE on the very latest Television equipment.

Talking Pictures A Big Field

Talking Pictures, and Public Address Systems offer golden opportunities to the Trained Radio Man. Learn at COYNE on actual Talking Picture and Sound Reproduction equipment.

Earn As You Learn

You get Free Employment Service for Life. And if you need part-time work while at school to help pay expenses, we'll help you get it. Coyne is 32 years old. Coyne Training is tested—You can find out everything absolutely free. JUST MAIL the Coupon for My BIG FREE BOOK.

H. C. LEWIS, President
Radio Division, Coyne Electrical School
500 S. Paulina St., Dept. A2-3C, Chicago, Ill.

Send me your Big Free Radio Book and all details of your Special Introductory Offer. This does not obligate me in any way.

Name.....

Address.....

City..... State.....

**GREATEST MAGAZINE
IN SHORT WAVES**

150 Hook-Ups,
Illustrations and
Photographs



Hugo Gernsback,
Editor

Sample Copy, 15c
(see coupon)

THE thrills of a life-time are now yours. A twist of a knob, now brings DIRECT into your home world-wide short-wave radio—London, Rome, Tokio, Sydney (Australia). Or listen to the thrilling American police reports on the air at all times via short waves.

You now can build your own up-to-the-minute short wave set or converter from instructions and plans printed in profusion every month in SHORT WAVE CRAFT.

"THE RADIO EXPERIMENTER'S MAGAZINE"
SHORT WAVE CRAFT also publishes the most complete and accurate short wave station list of the world. SHORT WAVE CRAFT is exclusively a short wave magazine for the experimenter, the radio constructor and the serious radio fan.

INTERESTING ARTICLES IN THE CURRENT ISSUE NOW ON NEWSSTANDS
\$500.00 in Prizes to S. W. Set-Builders.
Simple Transmitters and Receivers for Ultra Short Waves.
A Police Short Wave "Thrill-Box" That Works! Announcing the SHORT WAVE LEAGUE by Hugo Gernsback.
A 5 Meter Transmitter.
Dead Spots—Their Cause and Cure.
A Crystal Detector. Band Pass Super-Het For Short Waves.

SHORT WAVE CRAFT
99 Park Place N. Y. C.

SPECIAL OFFER COUPON
SHORT WAVE CRAFT RN-6
99 Park Place, New York, N. Y.

GET ACQUAINTED OFFER

- As per your Special Offer, I enclose \$1.00 (Canada and foreign \$1.20) for which enter my subscription to SHORT WAVE CRAFT for 8 months. (I understand that your regular rate for a year's subscription is \$2.50).
- Mail me a sample copy of SHORT WAVE CRAFT for which I enclose 15c (U. S. Stamps or coin accepted).

Name.....
Address.....
City..... State.....

Make a PROFIT

Service men make \$90 to \$110 extra per month, installing AMPERITE. Send \$1.62 to Dept. RN-6, for dealers' sample and sales helps.

AMPERITE Corporation
561 BROADWAY, NEW YORK

AMPERITE
Self-Adjusting
LINE VOLTAGE CONTROL

An advanced radio course for radio men! Only one of its kind. Write us at once for free catalog and full details.

CAPITOL RADIO ENGINEERING INSTITUTE, Inc.
14th St. & Park Rd., N. W. Dept. F-11 Washington, D. C.

A. C. Multi-Ear Aid

(Continued from page 1001)

**T
H
R
I
L
L
S
!**

stand ordinary conversation at a distance of three feet from the microphone and could understand a radio speech with the microphone three feet from the radio set while with his unaided ear placed directly in the mouth of the dynamic loudspeaker in the radio set he could not understand a word of the same speech.

(3) The design provides for an outlet box at each headphone, and this includes a volume-control knob which provides continuous variation of volume—not just a few steps of variation. The individual outlets are so independent of one another that when the volume controls at 25% of the outlets are simultaneously varied from minimum to maximum the effect is not noticeable at the other outlets. This represents a far more extreme variation than would be met in actual use, of course.

(4) The specified headphones weigh 3 1/4 ounces each, with cord and headband. When it is realized that an ordinary unlined felt hat weighs four ounces or more, this light weight can be easily appreciated. Certainly the wearing of these headphones does not constitute a burden. Both the headphone itself and the headband are shaped to fit comfortably, the headband being adjustable for this purpose. The handle is somewhat heavier than the headband, but the total weight of the headphone, cord and handle is well under five ounces. Even when using a single one of these headphones in the output of the amplifier there is no evidence of rattle or distortion.

(5) All parts employed in the amplifier are over-size. The only wearable parts are the tubes and the microphone battery. The tubes should provide 1000 hours of actual service and the battery should last for about a year even if the installation is in use two or three hours daily.

(6) Installation is as simple as it is possible to make it. The output circuit is designed to permit all outlets to be connected in parallel. Also the output line is of the low-voltage type and as such the underwriters permit the insulation of the wire to provide all the protection necessary. Ordinary insulated wire such as that used in electric light wiring may be tacked along walls, floors or seats, without conduit, insulators or other wiring protective devices. Even in cases where it is desired to employ more than one microphone the universal type of input circuit included in the amplifier makes impedance matching and connections extremely simple.

(7) The complete amplifier kit, microphone with desk mounting stand and covers, tubes and battery costs only \$85.00, at list prices. The outlet equipment, including outlet box and headphone, lists at about ten dollars per outlet. Thus the parts and equipment for a ten-outlet installation, complete, costs slightly under \$185.00, list prices. This figure is, of course, subject to the usual discounts to radio servicemen and dealers. In this connection it is interesting to note that commercial types of group hearing equipment that have come to our attention, even those which consist only of a group of microphones, a battery and headphones, without an amplifier of any type, cost from \$225.00 up, without installation, for systems providing ten headphones.

These facts of cost are extremely important to the radio serviceman or dealer who may contemplate the sale and installation of this equipment, because it means that A.C. Multi-Ear Aid is in a class by itself and is without competition in its effectiveness, particularly at anywhere near the price for which it can be sold and installed by the serviceman.

(8) The entire system is a.c. operated, with the exception of the microphone, and this is battery operated, because a.c. microphone operation has a tendency to cause hum. In a system which employs headphones in its output hum cannot be tolerated.

(9) A.C. hum has been reduced to a point where it is inaudible, even to persons of normal hearing. This has been accomplished by providing ample filtration and complete shielding.

(10) So far as appearance is concerned, the photographs accompanying this article speak for themselves. To make the amplifier fool-proof, it has been completely inclosed in a ventilated metal case which is attached to the chassis by means of machine screws. All high-voltage parts are thus completely inclosed. The only external controls are the dual "on-off" switch, which breaks both the a.c. and microphone battery circuits, and the input volume level control.

Universal Input and Output Matching

The foregoing, together with the accompanying drawings and photographs, constitutes a rather comprehensive description of the A.C. Multi-Ear Aid. However, there are a few points concerning the construction of the amplifier which deserve attention.

Both the input and the output transformers are provided with universal windings which allow a wide variety of impedance matching. As indicated in Figure 1, the input transformer has two primary windings, one of them being center-tapped. Each of the three sections has the same impedance and each matches the impedance of a single-button microphone. Three microphones of this type can therefore be connected simultaneously, or a double-button microphone may be connected to the three terminals of the center-tapped winding. It is suggested, however, that where more than one microphone is to be used a switch be incorporated in the circuit to each so that those not actually in use can be cut out. This is not essential but is desirable in order to avoid picking up background noise through unused microphones.

The output transformer secondary is tapped to provide impedance values of 25, 100, 500 and approximately 1000 ohms. These values provide a wide enough variety to match any number of headphones. The approximate connections for any number of headphones are shown in Figure 1. These can be checked in making an installation by connecting the outlet system to different terminals to determine which give the best results.

Hints on Constructing the Amplifier

Where the chassis is purchased, the construction of the amplifier is extremely simple, because all holes for mounting and wiring are already drilled. For those who prefer to make the chassis, the specifications will be found in Figure 3. The wiring of the amplifier follows standard practice and requires no detailed description. The chassis is considered as "ground" potential and all grounded connections shown in the diagram, Figure 1, can be made direct to it. This means that the input binding posts numbers 2 and 4 need not be insulated from the chassis as are the other eight.

There are just two points unusual enough to warrant special mention. The filter choke, L, is in the negative side of the rectifier output instead of the positive side. Among

other advantages, this variation from common practice provides absolute stability. Because of this arrangement, one of the filter condenser cans must be insulated from the chassis, which explains why one insulated type condenser, C6, is specified.

The other point is in the design of the power transformer specified. This transformer is made with the center tap of the 2½-volt heater winding connected to the transformer core. The circuit employed in this amplifier makes it necessary to break this connection and connect the center tap to the chassis through the resistor R6 to provide the grid bias for the power tube. This is a simple matter. Examination of the transformer will show an uninsulated wire coming out of the transformer winding and clamped under one of the core laminations. Simply cut this wire at the core and connect it to R6 instead. The bias applied to the -45 filament is likewise applied to the -24

and in operation, this can be readjusted and left in the position which provides the greatest output volume.

Installing the Complete System

A good deal of information on installation was given in the article last month, covering the battery-operated Multi-Ear Aid. Space does not permit repetition here, particularly as the same input and outlet equipment was employed in that device. The only difference is that the connections to the input and output of the amplifier are different this month, inasmuch as different transformers are employed. However, complete information on these connections is given in Figure 1. Also, the method of connecting the outlet boxes to the output line is shown in Figure 2.

It will be noted that in Figure 1 instructions are given for connecting one, two or

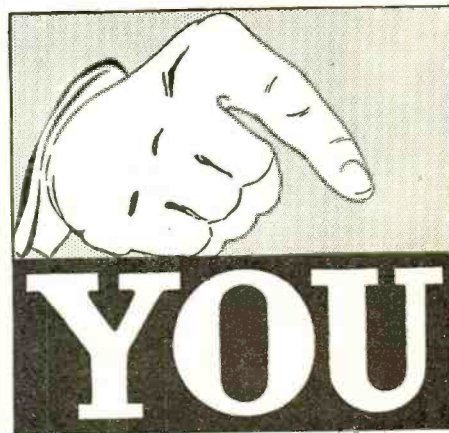

Are in a "radio show" Every Day!

THE older the radio, the more service calls, and the better the judgement of the owner in analyzing service skill. To win out in the daily "radio show" you need modern testing equipment, and it's more economical to have the best, particularly the most efficient and positive instrument in radio development—



SUPREME DIAGNOMETER AAA-1 \$147.50

5 ultra modern testing instruments in 1 for the price of **1**

You can't afford to decide on any instrument until you have sent the coupon for information on AAA-1 and the other new SUPREME INSTRUMENTS, namely

- Model 90 Supreme Set Analyzer \$7850
- Model 60 Supreme Oscillator \$3000
- Model 70 Supreme Oscillator \$4975
- Model 40 Supreme Tube Tester \$3000

All-Dealers' net prices F.O.B. Greenwood, Miss. Ask your jobber to demonstrate.

SUPREME INSTRUMENTS CORPORATION
 434 Supreme Bldg., Greenwood, Miss.
 Please send me full particulars on _____
 (Here specify those interested in)
 Name _____
 Address _____
 City _____ State _____
 Jobber's Name _____
 City _____ State _____

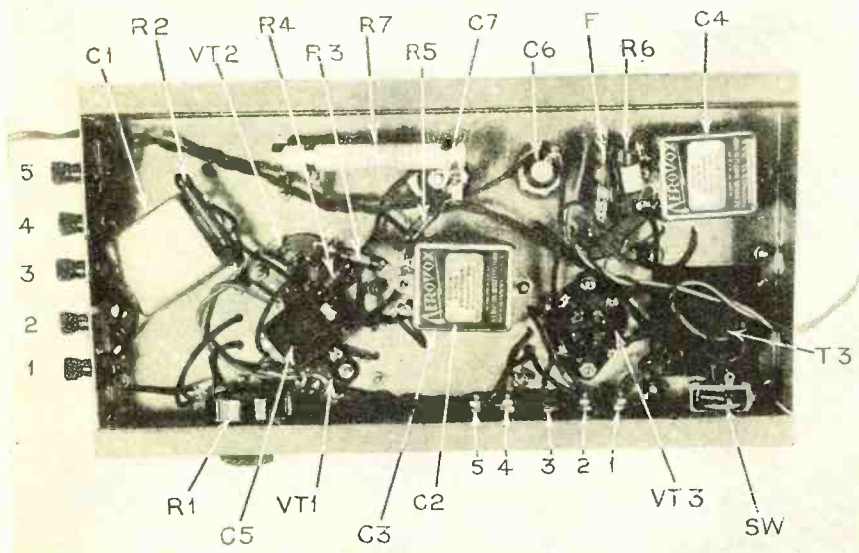

THE BOTTOM VIEW WITH BASEPLATE REMOVED

All wiring is simple and direct with resistors and by-pass condensers so located as to avoid long leads

heater, inasmuch as both operate off the same filament winding. This does not affect the operation of the -24 tube, however, because its heater is not a part of the tube circuit.

The switch, SW, includes two separate circuits, controlled by a single knob. The one contained within the frame is the a.c. switch and is of the single-pole, double-throw type. On the outside of the frame is the battery switch. Both are used in this case as single-pole, single-throw switches. Care should therefore be exercised in the wiring to make sure that when the switch is turned "on" both circuits will be closed. In wiring the d.c. portion of the switch, incidentally, the chassis should not be employed as one side of the battery circuit. Instead, the two wires from the battery and input transformer should be twisted together and carried to the switch as a pair. This prevents any possibility of picking up a hum from the power transformer which is mounted close to the switch.

The voltage divider, R7, is mounted with one of its terminals fastened under a screw in the chassis. The other end terminal is then soldered directly to the positive terminal of one of the electrolytic condensers. This makes the necessary connections and at the same time provides secure mounting. The adjustable tap on the divider should be loosened and moved to about ½ inch from the grounded end terminal. This will provide a screen voltage of approximately 50 volts. When the amplifier is completed

three microphones to the input. Actually, a single microphone will be sufficient for most installations. There are some conditions under which two or three microphones are to be preferred, however. In certain churches, for instance, portions of the service may be delivered from three different points, such as the pulpit, the lectern and the altar.

If these three points are rather widely separated, individual microphones at each may offer the best solution of the pick-up problems. In other similar cases, but where the three points are within a few feet of one another, a single microphone mounted or suspended midway between the three points will usually provide adequate pick-up. It is therefore apparent that whether more than one microphone is necessary depends entirely upon the conditions encountered in any particular installation.

The important point is that the amplifier provides input connections for more than one microphone should extra ones be required. If more than one microphone is used, it is recommended that each be provided with a simple "on-off" switch so that as the speaker moves from one to another he can turn off the one he is leaving and turn on another as he approaches it. The reason for this is that if there is any background noise in the room it will be picked up threefold by three microphones, whereas the speaker's voice will be picked up primarily by only one, thus increasing the noise ratio if the unused microphones are not cut

COME TO AMERICA'S oldest RADIO SCHOOLS



... RCA Institutes offers complete radio training in four big resident schools

NO matter what branch of radio interests you, it is taught at one of our schools—either in New York, Boston, Philadelphia or Chicago. All equipment is modern... instructors are men with practical experience. The schools were founded nearly a quarter century ago—are America's oldest radio schools. You can learn such adventurous branches as sound... aviation and marine radio... broadcast operating, and servicing—to mention but four.

You learn on actual equipment, solve practical, every-day problems. Come to any of our schools. There is no better way to learn radio. The tuition is moderate, classes start about every six weeks. The coupon below may mean the stepping stone to a highly interesting career. Mark and mail it without delay, to nearest school: New York, 75 Varick St.; Boston, 899 Boylston St.; Philadelphia, 1211 Chestnut St.; Chicago, 1154 Merchandise Mart.

A Radio Corporation of America Subsidiary

RCA INSTITUTES, INC.
Home Office, Dept. RN-61
75 Varick St., New York City

Please send me your General Catalog. I am checking below the phase of radio in which I am interested.

Radio Broadcasting (New York only)
 Radio Servicing (all schools)
 Advanced Service (New York and Phila.)
 Sound Motion Picture (New York and Chicago)
 Aviation and Marine Operating (all schools)

Name..... Age.....
 Address.....

John F. Rider's \$1.00 Radio Service Library

Every one of these books is the latest word upon the subject. Timely—up to the minute and accurate. Start a service library of beautifully cloth-bound, type-set books. Keep up to date on all service problems and have your own radio service reference library.

For a small sum you can have an indispensable and highly valuable library. Add to it as you go along. Every one of these works by Rider is practical, easy to read and understand. The Best Sellers in the radio service field.

- Servicing Superheterodynes.....\$1.00
- Practical Testing Systems..... 1.00
- Radio Service Questions and Answers, Vol. 1... 1.00*
- Radio Service Questions and Answers, Vol. 2... 1.00*
- Servicing Receivers by Means of Resistance Measurement..... 1.00*
- Useful Radio Tables for Service Men..... 1.00*
- Servicing Auto-Radio Receivers..... 1.00*

*Now being printed. Other books are immediately available.
 Every book of 144 or more pages. Sold with a Money Back Guarantee.

RADIO TREATISE CO., INC.
 1440 Broadway New York City

Group Hearing Aids
 Selling and installing group equipment for the deaf in churches, theatres, etc., opens a new field to enterprising servicemen—a field which is not highly competitive and is unusually profitable. Write for Bulletin 11-3 which points out its possibilities in detail. Also for price lists on all parts for

The Radio News' A. C. Multi-Ear Aid
 and all other individual and group hearing aids described in recent issues of Radio News.
 Complete parts in stock. Discounts to bonafide servicemen and dealers.

WILLIAM H. BRODERICK
 40 East 49th Street New York, N. Y.

THE MOST COMPLETE LINE OF CONDENSERS AND RESISTORS FOR EVERY RADIO USE



out. Where the background noise is negligible, there will be no harm in leaving all the microphones in the circuit.

The foregoing ideas are offered as suggestions which will enable the installation man to determine the best pick-up arrangement for any installation he is making.

Operation

The operation of the equipment is so simple that it really calls for little consideration. It has been made this way purposely so that no technical knowledge or practice would be required on the part of whoever is to be in charge of the system

sists of a single 1½-volt cell (which will usually be found adequate), there is little possibility of overloading. In general, the volume level should be kept only as high as necessary to somewhat more than meet the demands of the most deaf person who is likely to use the system. Then each listener can cut this down to his requirements at his individual outlet.

The Specified Parts

It is strongly urged that the special parts for the installation, such as the microphone, input and output transformers, headphones and outlet boxes, as specified in the follow-

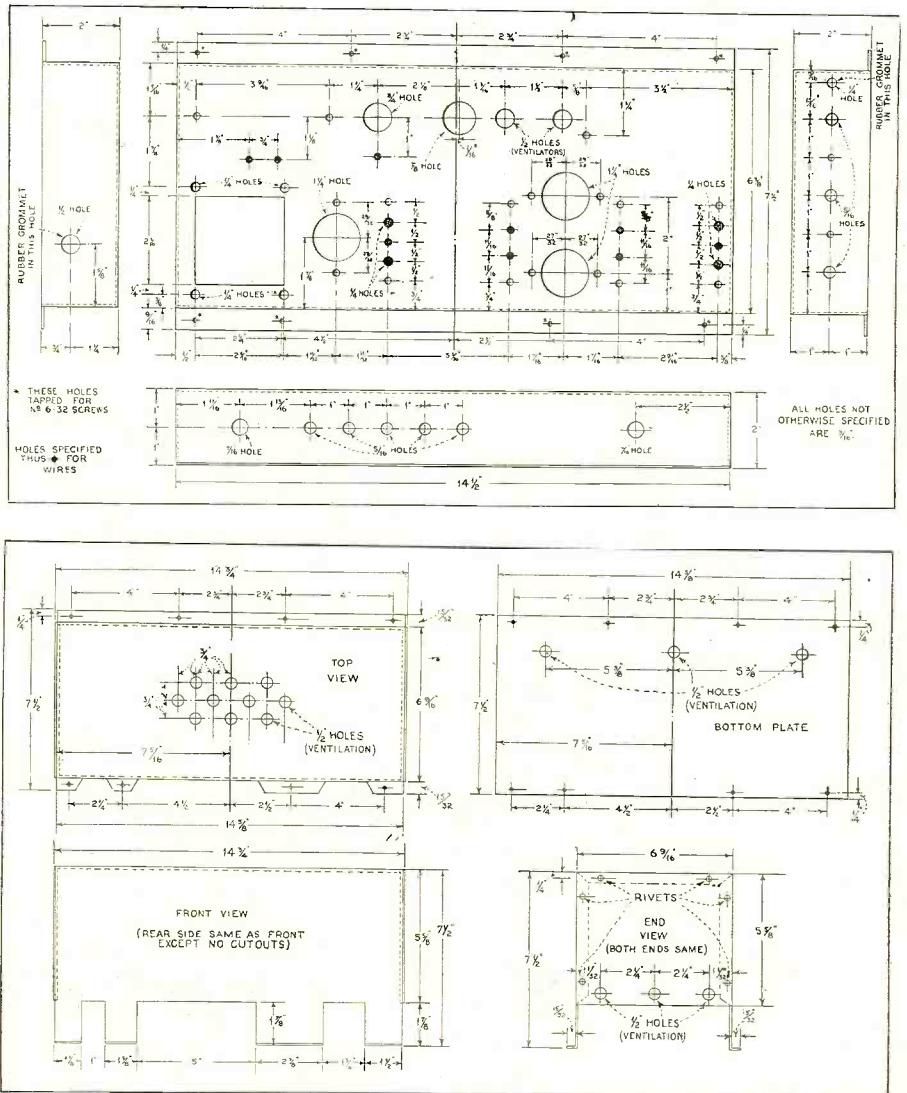

Figure 3. Specifications for Chassis and Cover

after it has been installed. The entire system is turned on and off by means of the switch SW. The volume level control, R1, can in most cases be properly set when the equipment is installed and left in that position indefinitely, because volume is controlled at each individual outlet anyway. However, if, as in some cases, the microphone is to be moved around to different points and is to be used by different speakers, simple instructions should be given to the operator by the serviceman making the installation to enable him to adjust this to provide an approximately constant output level.

The adjustment of this volume control is not at all critical. Its dual purpose is to keep the noise level low and prevent the input level being high enough to overload the tubes. If the microphone battery con-

ing list of parts, be adhered to inasmuch as these units were selected to provide a balanced ensemble, both electrically and acoustically.

The List of Parts

(Power Amplifier Equipment)

- C1, C2, C4—Aerovox type 261 by-pass condensers, 1 mfd., 200 v.
- C3—Aerovox 361 by-pass condenser, 1 mfd., 300 v.
- C5—Aerovox type 1450 mica condenser, .02 mfd., molded bakelite
- C6—Aerovox type ISD-2 electrolytic condenser, 2 mfd., 500 v., insulated mounting
- C7—Aerovox G5D-2 electrolytic condenser, 2 mfd., 500 v., grounded case
- F—"Littlefuse" 1 ampere fuse with insulated mounting

- L—Kenyon type KC-350 filter choke, 30 henries, 75 ma.
- MB—2 Burgess type 44 microphone batteries or 2 Burgess standard No. 6 dry cells
- R1—Clarostat type P5-500A volume control potentiometer, 500,000 ohms, with shaft 1/2 inch long
- R2—Aerovox type 1094 carbon fixed resistor, 3000 ohms, 1 watt
- R3, R4—Aerovox type 1095 carbon fixed resistor, 250,000 ohms, .5 watt
- R5—Aerovox type 1095 carbon fixed resistor, 25,000 ohms, .5 watt
- R6—Aerovox type 992 Pyrohm fixed resistor, 1500 ohms, 3.75 watts (cool)
- R7—Electrad type C-300 wire-wound voltage divider, 30,000 ohms with one adjustable tap
- SW—Carter type 115 dual a.c.-d.c. toggle switch, with "on-off" name plate
- T1—Kenyon type BLG input transformer with split universal primary
- T2—Kenyon special type 3480 output transformer with split universal secondary (especially designed for this amplifier)
- T3—Kenyon type K-54 power transformer
- VT1—Eby wafer type 5-prong tube socket
- VT2, VT3—Eby wafer type 4-prong tube sockets
- 1 Broderick rustless alloy metal chassis, base plate and ventilated cover, drilled ready for use
- 10 Eby binding posts
- 1 type -80 rectifier tube
- 1 type -45 power tube
- 1 type -24A screen-grid tube

1 clip for control grid terminal of -24 tube
 8 one-half-inch extruded insulated washers with hole to pass 6/32 binding post screws
 8 One-half-inch flat insulating washers with holes to pass 6/32 binding post screws
 Screws, hook-up wire, solder, etc.

(Input Equipment)
 Universal (special adjustment) model A single-button carbon microphone
 *Universal type K desk mounting microphone stand, chromium or bronze, with eight suspension springs
 Universal covers, chromium or bronze, for type K microphone stand
 Microphone cord, two-wire, equipped with spade-tip terminals; length as required
 *If microphone is to be suspended from ceiling, a Universal five-inch suspension mounting ring, with springs, is required in place of the desk mounting. The microphone covers specified above fit this type of mounting also.

(The following equipment required for each outlet)
 Broderick type A outlet box with universal type mounting plate. Includes phone jack and volume control potentiometer, built in and wired
 Trimm "Featherweight" headphone, 1000 ohms, with headband or telescope handle
 Carter No. 2 flat type phone plug
 In addition to the above, wire and wiring accessories will be required. Numbers 14 or 16 twisted pair, as used for wiring electric light circuits, is recommended for this use.

What Tube Shall I Use?

(Continued from page 1020)

too high, as otherwise the accumulations of electrons on the grid will interfere with the proper working of the tube along the best operating range of its characteristic curve and will cause blocking and distortion.

The trouble often encountered in resistance and impedance-coupled circuits from this source can be overcome by proper design and filtering of the circuits and by the use of the proper tubes and circuit constants.

The input resistance of a tube depends upon the plate voltage, grid bias voltage and the mechanical construction (size and spacing of the grid and cathode) of the tube. The input resistance of a tube is increased by increasing the plate voltage or the grid bias voltage or by increasing the distance between the grid and cathode or decreasing their size. The input resistance of a tube can be lowered by connecting a resistance across the secondary of the transformer. Resistors used for this purpose should have values of from 50,000 to 2,000,000 ohms.

Better frequency response, at the sacrifice of some amplification, can be obtained from transformer-coupled stages by shunting such resistances across the secondary windings. This results in lowering the input resistance of the tubes and has the effect of flattening the response curve and giving more uniform amplification over the whole range of frequencies.

During the past few years the tendency has been to include the volume control in the radio-frequency stages, on the theory that the proper place for the volume control is ahead of the detector, to prevent any possibility of detector overloading.

While the location of a volume control in the radio-frequency stages is important, most experimenters and engineers have lost sight of the fact that the use of a variable resistance shunt across an audio transformer secondary has the effect of flattening the

response curve so that at the lower volume settings the low-frequency response is actually brought up, in effect, thus eliminating the loss in naturalness due to loss of low-frequency response when the ordinary type of volume control is turned down.

While the use of a volume control in the radio-frequency stage is important, to prevent any possibility of detector overloading, better results can often be obtained if an additional volume control, in the form of a variable high-resistance shunt, is used across the transformer secondary.

It is unfortunate, but true, that high amplifying efficiency and quality reproduction do not go hand in hand. In arriving at the best operating conditions, some compromise must be made between the two.

It can be demonstrated, for instance, that greatest amplification is realized when a tube of low plate resistance is worked into a tube of high input (grid to cathode) resistance.

On the other hand, best quality reproduction (flat frequency characteristic) is obtained when a tube of low plate resistance is worked into a tube of low input resistance.

Highest amplification is also obtained when the load resistance is very high and the transformer ratio is high, while best quality reproduction is obtained if the load resistance is kept high but the transformer ratio is low.

Again highest amplification is obtained with high plate resistance tubes which usually have high amplification factors while better quality of reproduction is obtained with low plate resistance tubes which usually have lower amplification factors.

In designing an audio amplifier to provide the voltage step-up required between the output of the detector and the input of the power output tube, it is therefore important to take into consideration the use of

(Continued on page 1058)

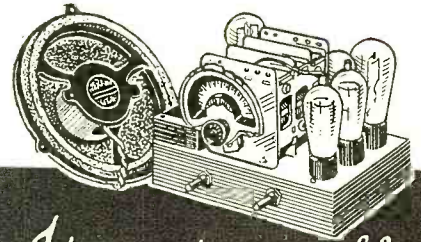

It's easy to assemble the popular new "Nook Midget" with SPECIFIED Acratel parts

21 Out of 26 Essential Parts Are Specified Acratel—the Standard of Quality Radio Parts.

Use This Convenient Order Form

Federated Purchaser, Inc. Date
 25 Park Place, N. Y. C.
 Please send me the following parts for the "Nook Midget" receiver:

Quant. No.	Cat. Description	Price
1	5360 3-Gang Condenser	\$2.50
1	2404 3-T/10 Mfd. condenser	.39
1	2872 .5 Mfd. condenser	.15
1	3148 .006 Mica condenser	.24
2	5304 4 Mfd. electrolytic condensers @ .60	1.20
1	6665 2 Mfd. electrolytic condensers	.35
1	5310 10 Mfd. electrolytic condensers	.30
1	Set 3217 Conoid Coils (3)	.98
1	2565 25 h. 150 mil. choke	.65
1	5134 Frost 10,000 Ohm Volume Control	.45
5	3500 1 Watt Carbon Resistors	
	1—350 Ohm, 1—1000 Ohm	
	1—15,000 Ohm, 1—30,000 Ohm	
	1—250,000 Ohm	.10
1	5900 2000 ohm 5 watt resistor	.20
1	1129 Rotary switch	.14
1	5885 Speaker plug, 4 prong	.20
1	6027 Power Transformer	1.35
4	4063 5-Prong Wafer Sockets @ .06	.24
2	4062 4-Prong Wafer Sockets @ .06	.12
1	6658 Eby Twin Post "ant.-gnd."	.12
1	5737 Pull Vision dial and pointer	.25
1	5126 Knob	.10
2	5127 Knob @ .10	.20
1	4076 Pilot light socket	.13
1	6754 3/8" to 1/4" shaft reducer	.15
1	6811 Metal Chassis	1.00
1	191 Operatic Dynamic Speaker	2.45
2	6812 Tube shield partitions @ .15	.30
1	4495 25 ft. coil of hook-up wire	.11
1	3682 Screw and nut assortment	.19

Total Value of Parts—\$14.96

SPECIAL PRICE FOR COMPLETE KIT—\$13.50 including Instruction Sheet and Schematic Diagram

PLEASE NOTE: 20% deposit must accompany all C. O. D. orders.

Send me your FREE 100-page catalog listing over 3,000 items. I am a dealer Serviceman Experimenter

Name

Address

City and State

ACRATEST CONDENSERS, ACRATEST TRANSFORMERS, ACRATEST RESISTORS, ACRATEST VOLUME CONTROLS, ACRATEST PUBLIC ADDRESS EQUIPMENT

Distributed Exclusively by

Federated Purchaser Inc.

25 Park Place, Dept. A, New York, N. Y.

Acratest is standard

Quartz-Crystal Receiver

(Continued from page 1022)

the previous adjustments, thus maintaining the correct tuning alignment over the entire tuning range.

Next tune in the oscillator or a powerful station at about the center portion of the dial. Turn up the volume until unbearably loud and switch the balance control over for Stenode operation, turning it to about the half-way point. This maneuver should be accompanied with a pronounced loss in signal strength. Set the clutch on the dial for rough tuning, and operate the dial rapidly back and forth across the station, decreasing the volume until the signal is just audible as the carrier is crossed. Now make the final adjustment on the i.f. transformers as the dial is wiggled. The signal will of course be loudest when the i.f. amplifier is tuned exactly to the crystal frequency. As this point is approached, the adjustment becomes more and more delicate and the volume should be maintained at a very low level. These adjustments must be made as the dial is wiggled across the carrier, otherwise the i.f. amplifier may be tuned to a frequency slightly different from that of the crystal.

When correctly adjusted, a distinct "chirp" should be heard as the station is passed. This is described as the "crystal chirp." When the carrier is tuned in slowly, the chirp becomes a high whistle, almost like a beat note, when slightly off resonance. The chirp is explained by the fact that as the tuner oscillator is tuned slightly to one side of a 175 kc. difference from the desired carrier, only the sidebands representing the higher audio frequencies are tuned to the crystal intermediate frequency, and these, beating with the attenuated but still present carrier, are demodulated as high audio frequencies.

Adjusting Without an I.f. Oscillator

When a 175 kc. oscillator is not available,

the procedure is somewhat reversed, and the high-frequency end is first lined up roughly. With telephone receivers in the plate circuit of the first detector tube, either the oscillator or a powerful local station is tuned in, and trimmers on all but the oscillator section are adjusted for maximum response. If greater pick-up appears desirable, the antenna can be tapped directly to the grid of the r.f. tube. The oscillator trimmer is then set at half way between maximum and minimum capacity, and the telephone receivers removed from the circuit. Screw all i.f. trimmers down to within two turns of maximum, with the exception of the bridge circuit secondary, which should be adjusted to minimum capacity. With the volume control well up, and the balancing condenser set for Stenode operation, it should be possible to hear the signal as the trimmer on the oscillator section is adjusted. Having located the signal, adjust the i.f. units as described before, until they are tuned to the crystal frequency. Readjust the high-frequency trimmers (but not the oscillator) and return to the i.f. trimmers for a final touch. The i.f. circuit should now be perfectly tuned, and the four gangs of the tuning condenser can be lined up in accordance with the previous directions, with the receiver operating either as a Stenode or as a super.

Operation

The operation of the Stenode when used as a straight superheterodyne is conventional in every respect. However, a few lines on the tuning technique as a Stenode are in order.

Until familiarity is acquired, it is suggested that stations be first tuned in as an ordinary super. The volume should then be advanced slightly, and the balance control turned until the signal is weakest. This will usually approximate the balance point. The clutch button on the dial should be pulled out, throwing in the 250 to 1 ratio, and the station tuned very carefully. Tune visually, not by ear, resonance being indicated by the greatest deflection on the meter. Volume should then be adjusted to suit, and the balance control varied for the lowest noise level and best bass response. In ordinary reception, the balance control can be varied considerably and employed as a tone control. The balance point is the same for all stations, and this control need not be touched except for tone variation or better discrimination against heterodyne or side-band interference.

It will take the operator only a few minutes to acquire the knack of tuning stations without first locating them on the straight super adjustment. Complete Stenode operation is desirable, as there are many distant stations that cannot be located through locals except when the crystal tuned intermediate frequency feature is employed.

Heterodyne Elimination

Even a bad heterodyne whistle can be eliminated on the Stenode by adjusting the balancing condenser. Similar adjustment will also eliminate the blasting effect of side-band interference of a local on a distant station which is often experienced with or without heterodyne.

An entirely new order of selectivity, with fine quality, is to be expected on the Stenode, and reception of distant stations, through local and distant interference, of even only 5 kc. separation—for instance, a U. S. station between a Canadian and a Mexican—is consistently possible.

Write for this book

FREE

You cannot possibly afford to be without this valuable book it is not just another CATALOG—it is indeed a VERIFIABLE ENCYCLOPEDIA of the RADIO INDUSTRY

WHOLESALE PRICES

LATEST ISSUE! JUST RELEASED!

All that is new in Radio is listed in this money-saving **SPRING 1932 SUPPLEMENT**

HERE ARE A FEW OF THE NEW APPARATA WE FULLY DESCRIBE THEREIN: Single Dial ALL-WAVE 10 to 550 Meter Super-Heterodyne Receivers; Automobile "B" Eliminators and "Auto" Motor Generators producing 110 volts, 60 cycles A.C.; Automobile Public Address Amplifiers (Ideal for Political Campaigns); Class "B" Amplifiers; 8 tube Auto "Super-Het" Kit; Universal A.C.-D.C. Weston Meters and Analyzers; "Super-Het" Short Wave Receivers, Converters, Coils, Switches; 14 tube "Super-Het" ALL-WAVE 10 to 550 Meter Single Dial Kit; "Super-Het" Essential Tuner Kits; Combination 33 1/3 and 78 R.P.M. Elec. Phon. Motors and Pick-Ups; Class "B" Amplifier R.C.A. Tubes, Transformers, Chokes, etc.; Universal Bracket Noms 171-245-247-250 A.C. Power Replacement Transformers; Neon Flashlight Radio Set Troubleshooting; Columbia Automatic Record Changer Phonograph and Amplifier; and thousands of other items; all quoted at **WHOLESALE BOTTOM NET PRICES!**

See Also Specializing in **AUDITORIUM-SOUND TRUCK-AUTOMOBILE PUBLIC ADDRESS CLASS "A" and "B" AMPLIFIER INSTALLATIONS.**

Investigate our **13 WATT Seven Tube THREE STAGE DUAL PUSH-PULL 250 AUDIOPHONIC** (see illustration, which we sell for only \$29.50)

By all means, consult our Engineering Staff before you purchase any public address amplifier or associated equipment. . . for . . . WE CAN SAVE YOU BIG MONEY . . . and furnish you with the most modern and most efficient apparatus! Our Amplifiers are available in semi-assembled OR FACTORY WIRED FORM in 8 to 7 tube models, 1 to 50 WATTS undistorted output! Let us know your requirements, and we will cheerfully give you single and double button microphones, stands, shielded microphone cable, Control Boards, Pre-Amplifier Stages, Faders, R.C.A. Photo Phone Dynamic Speakers (A.C. or D.C.), Racon Products, etc. etc. WRITE US TODAY!

COAST-TO-COAST RADIO CORPORATION

123 N West 17th St., New York N.Y.

M A C Y

HORNS AND UNITS

Are now obtainable for small as well as for large public address installations. We illustrate a few of this year's outstanding models which are suggestive of the complete Macy line.

"STANDARDIZE ON MACY"

PRICES HAVE BEEN REDUCED in keeping with the trend of the times, but Macy quality has been rigidly maintained.

ROUND TRUMPET **GIANT ELECTRO DYNAMIC UNIT** **FIELD EXCITER**

Write for Literature and Price List on Our Latest Improvements

MACY ELECTRICAL PRODUCTS CO., INC.
1451 39th St. Brooklyn, N. Y.

G.E. PHONOGRAPH MOTOR

Synchronous 110 Volt, 60 Cycle, 80 R.P.M. Motor

Can be installed in place of old-fashioned hand winding spring motors. Also many other uses. These G. E. motors are all brand new.

original factory cartons. Fully guaranteed. \$12.00
value only \$3.95. Shipped Prepaid. Manufacturers and dealers write for Special Quantity prices.

Only \$3.95
12¢ VALUE

National Jobbing & Export Co., 109 W. Lake St., Dept. 156, Chicago

BUY THESE Great Books!

Radio Physics Course
by Alfred A. Ghirardi \$3.50

Radio Servicing Course
by Ghirardi & Price \$1.50

Send for FREE circular at once!

THE RADIO TECHNICAL PUB. CO.
80 Fifth Ave. Dept. RN-6 New York City

What Tube Shall I Use?

(Continued from page 1057)

a power output tube which requires a low value of signal input voltage to provide the required undistorted output, and the use of a detector which gives a comparatively high a.f. signal output for a given r.f. signal input, so that the amplification required between the detector output and the power tube input is as low as possible.

The requirement of low amplification will then make it possible to use low plate resistance, low input resistance tubes and low step-up ratio transformers for transformer-coupled circuits, and comparatively low plate resistance and low input resistance tubes for impedance and resistance-coupled circuits with consequent improvement in the frequency characteristics and quality of reproduction of the amplifier, even when comparatively low load resistances are employed.

With these facts in mind we can analyze the characteristics of the tubes listed in Tables V and VI, which show the generally available tubes which are suitable for transformer, impedance and resistance-coupled audio amplification.

These tubes have been listed in groups according to the power supplies from which they are designed to operate, since any choice of tubes is limited primarily by the source of power supply.

\$10,000.00 a Year for Service

(Continued from page 997)

found out that one of their large competitors was so equipped, they rushed Bill into the installation of two more.

Bill has one of the best portable P.A. systems that I have ever seen, and he sure does know how to make money with it. It cost him about \$200.00 to build and he has netted over \$600.00 a year with it for three years. When he first built it, he immediately started a mail-order campaign and sent circular letters to every fraternal and political organization in town, as well as all of the owners of auditoriums and the ministers of all the churches. He got a lot of business from these sources. During the last political campaign, Bill loaded his outfit on his little Ford truck and collected \$25.00 a night, for ten nights straight!

Bill runs his servicing business on the basis of "no results, no charge." If he fixes a radio set, he makes sure that it will stay fixed. One of his most ingenious tricks is that of leaving a new radio receiver in a house while he carts the old one off to the shop for repairs—repairs that he could often make on the spot if he really wanted to. However, it is no hardship on the part of the customer, nor does this practice contain any element of unfairness. Last year it was responsible for the sale of no less than eleven new receivers.

Of late Bill has been keeping his eye on the new and ever-expanding field of electronics—that is, the practical application of grid-glow tubes, photoelectric cells, thyatrons, etc. Being an alert serviceman, he is not overlooking the opportunities that lie here. Already he has "feelers" out and already he has begun to make installations. A large estate on the outside of the city has had him make installations in connection with the gates on the bridge path that circles its three hundred acres. During the week-ends this path is used a great deal by guests. For this reason the owner has had automatic control of the gates installed. Formerly the guests had to dismount, but now their horses simply interrupt a beam of light and a counter weight helps a fractional horsepower motor to do the rest. The motor simply lifts the weight and then releases it, and the falling weight closes the gate.

Bill had a friend in a paper-box factory

and he "sold" him the idea of placing photoelectric counters on all of his paper machines. This is an easy thing to do, and any young man acquainted with radio principles could do the same trick. On each one of these machines Bill netted a profit of about \$60.00. As matters stand at the time this article is written, Bill has a number of prospects in connection with photoelectric installations, many of them counters. Of course, the depression has greatly interfered with this sort of thing, but Bill is seeing great things ahead in this phase of his business, and he is watching the new developments with an eagle eye.

Bill is a great fellow to keep records, and that is something that the average radio serviceman does not do. Every time Bill fixes a radio set, he leaves a printed slip in it that contains his name and address and a record of what was done with the machine and also the price. A carbon copy of all records is filed at the little office, which is capably managed by his wife, who keeps all the records and attends to the telephone calls. Incidentally, Bill's wife also solicits business over the 'phone. She watches the newspapers closely and keeps tabs on big public meetings and other functions. A few days before each one, she calls up the management and tries to sell it the idea of installing a P.A. system. Only a few months back, she not only sold a night's rental, but a permanent installation. The customer was so pleased with the night's result that he ordered a 50-watt system.

Bill watches the surrounding farm land like a hawk. A friend in the local power company's office tips him off when a new power line is being run down a road that never had such a line before. It offers Bill a big opportunity to sell a farmer an electric set in place of the old battery set—if he has a radio. This has proven to be a profitable thing to do. Bill waits until the new line is open and then stops at each house connected to it.

This bright and cheerful fellow is not doing anything that any serviceman cannot do if he is not a chair-warmer. There is plenty of business to be had and to be made, but one has to burn up the old "gray matter" to do it.

The International Six

(Continued from page 1018)

one is not supplied with the pick-up, purchase one separately and use it between the pick-up and the jack.

If you desire to connect the phonograph pick-up permanently to the receiver, this method cannot be employed, since it would involve inserting a switch with long leads in the grid circuit of the detector tube. Therefore the pick-up must be inserted in the cathode lead. Break the circuit at the point marked X in the diagram (Figure 2) and connect your phonograph pick-up at this point. Connect a switch across the phonograph pick-up so that it may be short-circuited when it is desired to use the radio. This switch may be mounted on the front panel or at any convenient point, although the leads to it should not be over one foot in length. If trouble is experienced when using the radio after a phonograph pick-up has been installed, shield the leads to the cut-out switch, grounding the shields. Excellent volume and quality will be had with the regular 245-volt output. With pentode-tube output the volume

will be quite sufficient to fill a small hall.

Home recording can be successfully accomplished even with 245-tube output, although the pentode output gives much more satisfactory results. At first, it will be best to try recording a program broadcast from a powerful local station. Connect the pick-up directly to the output terminals of the set in place of the dynamic speaker, having previously tuned in the station for maximum volume, without overloading. It is best to make this connection with a d.p.d.t. switch so that the change from speaker to pick-up can be instantly accomplished. Use a special steel needle in the pick-up and place a fairly heavy weight on the head. Make sure this weight is not so heavy that it slows down the machine. This trouble will probably not be encountered if an electric motor is used, although great care must be exercised when using the old type spring motor. Aluminum discs specially cut for home recording will give the best results.

If you desire to make your own records,



**"I find it Pays
to use JEWELL
professional equipment"**

Experienced radio servicemen find that the high degree of accuracy, convenience and thoroughly dependable operation of Jewell Service Instruments results in profits that more than offset any saving to be gained by using obsolete or inexpensive make-shift equipment.

These instruments enable servicemen to work more rapidly and more accurately—saving time on jobs, thus doing a greater number of jobs each day and also reducing complaints and repeat calls to a minimum.

Jewell 444 Set Analyzer



Socket current and voltage tests on all sets, including those using output and r.f. pentodes. Twenty-four measuring ranges for use with test leads. Triple range output meter. Two range capacity test. Non-shatterable meter glasses. Test cord detachable at analyzer panel. Simplified switching system separates A.C. and D.C. tests. Large easy to read meter with 2-5/16 inch long scales. Panel and over fifty other parts molded of bakelite to assure permanence.

Jewell 563 Test Oscillator



Three frequency bands: broadcast 550 to 1,500 K.C.; low intermediate 125 to 175 K.C.; and high intermediate 160 to 280 K.C., covered by fundamental waves. Calibration curves carried in cover. Entire unit, including batteries, shielded by heavy metal carrying case. Separate output for neutralizing.

Furnished complete with shielded output lead, batteries, and one '30 type tube.

**Jewell Electrical Instrument Co.,
10 Haynes Ave., Newark, N. J.**

Please send me literature on the Jewell Instruments checked below:

- | | |
|--|--|
| <input type="checkbox"/> Jewell 444 Set Analyzer | <input type="checkbox"/> Jewell 540 Portable Tube-Seller |
| <input type="checkbox"/> Jewell 563 Test Oscillator | <input type="checkbox"/> Jewell 538 Counter Tube-Seller |
| <input type="checkbox"/> Jewell 581 Professional Combination | <input type="checkbox"/> Jewell Panel Instruments |

Name.....

Address.....

MARQUETTE

AUTO RADIO

Sensational all Wave
9 TUBE SUPER-HET.



MARQUETTE SNAP ON MOUNTING STEERING POST MOUNTING

NO TOOLS REQUIRED (PAT. APPLIED FOR) ELECTRICAL REMOTE CONTROL (MARQUETTE PAT. APPLIED FOR) ALL WAVE RECEPTION (15 to 55 METERS - PENTODE (RF AND AF) LATEST CUNNINGHAM TUBES - ELECTRO DYNAMIC SPEAKER - PUSH PULL PENTODE - AUTOMATIC VOLUME CONTROL - FULL VISION DIAL MONEY BACK GUARANTEE 10 DAY FREE TRIAL PRICE COMPLETE

WITH CUNNINGHAM TUBES AND EVERY READY BATTERIES

\$49.50

MARQUETTE RADIO INC.

110 West 18th St. NEW YORK

DISTRIBUTORS - DEALERS WRITE for TERRITORIES NOW

a microphone will also be needed. This microphone may work well in the cathode lead without any input transformer, control box or external source of voltage. Again it may be necessary to use a small battery and input transformer, or a control box may also be needed. Better results may be obtained by using the microphone in the grid circuit as described above. Experimentation will show just which method works best with the particular apparatus you have available. Do all your testing with the dynamic speaker before attempting to use the phonograph pick-up. If a freeback howl is evident, put the microphone and speaker in different rooms, closing the door between them.

Now that we are in the heart of the summer, with DX stations rolling in, some fans may desire a trifle more sensitivity than is available for extreme distance work, although the present arrangement is very sensitive when operated with a good aerial and ground. The r.f. amplifier can be improved by balancing each stage separately instead of balancing all stages simultaneously by the gain control, as is done in the present hook-up. This may be accomplished by using 10,000-ohm, semi-variable resistors in each screen-grid lead for the three r.f. tubes. With these resistors set for maximum resistance, balance the receiver as described in the sec-

ond article so that the set is just below the oscillator point, when the volume control is turned on full. Now decrease one of these resistors until the set spills over, then increase the resistance slightly and fasten the semi-variable adjustment. Adjust the other two resistors in the same manner. These adjustments compensate for the differences in tubes and should be therefore repeated once a year or as often as tubes are changed. The added sensitivity will be found worth-while when working extremely weak signals and will even improve the selectivity slightly.

List of Parts

- Conversion to Pentode Operation
- R1—Lynch type LF-4½, 50,000-ohm, ½-watt resistor
 - R2—Lynch type LF-4½, about 1,000-ohm, ½-watt resistor (see text)
 - R3—Electrad type B-200, 20,000-ohm, 13-watt resistor
 - 1 Eby type 247, wafter socket, 1 27/32 mounting holes
 - 1 Output transformer (see text)
- For Phonograph Operation
- 1 Audak Musicchrome, electric turntable, pick-up and volume control complete
 - 1 Eby twin-jack, labeled "Phono"
 - 1 A.C. switch

The Service Bench

(Continued from page 1035)

According to an announcement "a limited supply of hard to get Brunswick circuit diagrams are available and will be sent free of charge to servicemen." Requests may be sent either to the address given or to the *Service Bench*.

can do a quick, thorough repair job, he inspires the confidence of his client and has a better chance eventually to sell him a new receiver. Most of these receivers require a

GET THIS

Free New No. 23. Edition of our greatly enlarged **RADIO SERVICE TREATISE**. Every radio man must have it. Contains some 75 new hook-ups, circuit diagrams, over 350 illustrations. **POSITIVELY THE GREAT-EST BOOK EVER PUT OUT BY ANYONE.** Editorial contents: VACUUM TUBE THEORY; VACUUM TUBE CHARACTERISTICS; Chart; How to Take Care of Your Tubes. How to Connect Phonograph Pick-ups. Improving Tone Quality of Old Sets; Connecting Additional Loud Speakers; all fully illustrated with diagrams. Other articles: Modernizing Old Radio Sets; How to Convert Battery to Power Sets; Selection of Tubes; Push-Pull Amplifiers; Replacing Audio Transformers; Phone Attachments; How to Choose Power Transformers; Voltage Dividers; Wattage of Power Transformers; Selecting and Installing Replacement Parts in Radio Sets; Filter Condensers; Repairing Eliminator, etc.

WRITE TODAY. Enclose 2 cents for postage. Treatise sent by return mail.

RADIO TRADING CO.
27 West Broadway New York City

ALL IN THE DAY'S WORK

In tabulating the complaints indicated in our general service correspondence a significant number of letters bring forth an indictment against "intermittent reception." Writes Robert Schofield, of Cambridge, Mass.:

"In servicing several of the early a. c. receivers, I have run across a common cause of intermittent reception. The symptoms were good reception when the current was turned on, followed by a rapid weakening of the signal until finally it was barely audible, with a pronounced hum. Turning the receiver off for a moment, and turning it on again, cleared matters up for a minute or two, when the trouble reappeared. The trouble was finally located in the grid circuit of the detector. The old type gridleak arrangement was used, in which the cartridge leak was clipped between two prongs. The metal cap on the leak, as well as the prongs, had become oxidized, resulting in a very poor contact, which became even more highly resistive with probably some polarizing effect caused by the grid current. Scraping these contacts eliminated the difficulty, and a permanent cure was immediately effected by installing gridleaks of the pig-tail type."

Similar action on another old-time receiver located an entirely different source of trouble, as described by Roger Burns, Louisville, Ky., specialist in Silver-Marshall, Pilot and Hammarlund receivers.

"While receivers employing B battery eliminators and trickle chargers are certainly antiquated, many of them are still in use, and require a lot more servicing than the more modern sets. Also, if the serviceman

RADIO SERVICE

Our four years experience plus manufacture's data sheets have taken the guess work out of repairing any make of radio set. Flat rates prevail so you know the cost before you call us.

- \$1.00** will entitle you to a maintenance service call which gives you a complete check of your receiver from aerial to ground, set, tubes, batteries, speaker, etc.
- \$2.00** will cover our charge for time spent on repairing any set you bring to our shop.
- \$4.00** will be our charge for having to bring your set to the shop for repairs. These charges cover travelling time and labor spent on the job. Parts, of course, will be extra. All work unconditionally guaranteed for sixty days.
- \$8.50** erects any type aerial that conforms with city regulations.

Radio Tubes Tested Free (mutual conductance method)

Batteries Charged Gramophone Repairs
Prest-o-Lite Service Station
Burgess and Eveready Batteries

Car, mantle and portable radios. Short wave sets built to order. Phonograph pickups installed. Sets modernized. General Radio Consultants. Tubes, Batteries, parts, etc. carried on hand.

WILKINSON'S RADIO SHOP

PHONE 157, UNITY
RADIO AS YOU WOULD LIKE TO HAVE IT

Telling the whole story; and eliminates any possible post-mortem quibble about the bill

C battery, which, on ageing is responsible for many complaints of intermittent reception. The receiver plays all right when it is first turned on, but the response drops after a minute or so until finally it is barely audible. Turning the receiver off and then on effects a very temporary relief. Peculiarly enough, there is little or no distortion.

Get Started in RADIO



Write for free booklet telling about this growing and most promising industry. The radio operator is an officer aboard ship. His work is light, pleasant and interesting. He has many opportunities to travel to all parts of the world.

A new course in TELEVISION now under way. Full information on request.

EDUCATIONAL DEPARTMENT
WEST SIDE YMCA 17 W. 63d St. New York



UNIVERSAL MODEL "X" 2-Button Microphone

Advanced 1932 superiority at rock bottom prices. Pure gold contacts. Duralumin diaphragm. Exceptionally rugged. Same high standard at a price that defies competition. Price \$10.00.

Universal Microphone Co., Ltd., 425 Warren Lane, Inglewood, Calif., U. S. A.

"The explanation seems to be that there is a certain amount of voltage left in the battery, which is sufficient for bias purposes when the receiver is first turned on. However, when the grid is thrown positive on a very high swing, the grid current has a polarizing effect on the battery, permitting the grid current to build up until the cells are effectively polarized. In this state the grid circuit is practically open and next to no signal results. The signal is gradually weakened as the circuit resistance is increased, so that the grid swing is never enough to cause bad distortion."

Exactly the same symptoms have been reported on all electric sets in which an electrolytic condenser is employed as the first filter capacitor—i.e., immediately following the rectifier tube. In this position it receives the peak voltages, which may cause a rapid and cumulative break-down. In a minute or so the d. c. resistance of the capacitor, having decreased slowly, is sufficiently low as to cause a marked reduction in the output of the rectifier circuit, with resultant loss in signal response.

Permit us to introduce our representative Mr. Clyde D. Kiebach. With your kind permission he will call on you on—

Mr. Kiebach is an expert on Radio servicing, building and repairing. You no doubt have a Radio that needs a little tuning up. Mr. Kiebach will tell you just what ails it or what improvements it may need.

We will appreciate any courtesy you may show him.

KIEBACH RADIO HOSPITAL
1429 MOSS STREET

Authorized Silver Merchants Service Station
Endorsed by National Radio Institute Washington, D. C.

Introducing the serviceman. An inexpensive and effective circular

Robert Freeman, of Adel, Iowa, comments upon an entirely different source of similar trouble in Majestics—

"A device known as an automatic sensitivity control is incorporated in the later Majestic models. It consists of a variable resistor attached to the rotor of the condenser gang so that the bias on the r. f. tubes is varied as the stations are tuned in, thereby maintaining the circuit just under the oscillating state throughout the tuning range. A faulty resistor will show up as blank spots as the dial is rotated. The set will either be dead at these points, or the sensitivity will suffer considerably. If the correct replacement resistor is not immediately available, a temporary repair may be made by removing the resistor from the shaft, leaving it supported by the metal bracket by which it is attached to the chassis. Care should be observed that no other part of the resistor comes in contact with the chassis."

Roger Hertel, of Hertel's Radio Store, Clay City, Nebraska, has contributed two previous articles to the *Service Bench* on the merchandising and advertising end of servicing. Fearing to be stigmatized as a theoretical economist, rather than a practical serviceman, he sends along the following dope, just to show that he knows the alpha omega of servicing as well as the abc's of business.

Trouble with Spartons

"The Sparton Equisonne circuit seems to be one which requires a considerable amount of servicing after being in use for some time. The Equisonne circuit itself is rather simple being an almost perfect example of untuned r. f. amplification. Once the Equisonne circuit has been serviced by an incompetent serviceman, then the fun begins. One of these Spartons was brought in to us for repair, the owner stating that he had taken it to two other servicemen, with the result that each previous service job had

made the receiver worse rather than better. The set had a very bad a. c. hum, with pronounced distortion. We analyzed the set, and everything checked okay. The voltages were correct, the tubes excellent. Finally, the receiver was completely unbuttoned. The Sparton Equisonne circuit is broken up into four units—the power-pack; the condenser unit; the r. f. amplifier and detector unit, and the volume control with station selector. The trouble was soon evident. The first serviceman had evidently been careless and had left unconnected, part of the grounding system between each of the four units. This was the cause of the bad hum and distortion, and could only be located by checking for ground on each separate unit.

"Often the ground connection on the panel of the Sparton becomes disconnected or partly broken, resulting in the same condition, or in noise resembling static. Sometimes it sounds like electrical interference. The serviceman will do well to check the entire ground system when any of these symptoms put in their appearance in a Sparton.

"This same model Sparton has the habit of burning out the r. f. plate filter condensers. This appears to be due to insufficient rating as the Sparton replacement condensers do not stand up any better than the original capacitors. Unfortunately most servicemen prefer to use the Sparton replacement unit because of the ease of installation and the fact that it is very difficult to locate a 400-volt .25 mf condenser which will fit in the same space. However, I make all our replacements with two .5 mf, 200-volt tubular condensers in series—all of which repairs have so far been permanent.

Atwater Kent Model 70

"This receiver causes but little grief, but we did run into a case of trouble that was unusually baffling. The set was DEAD. Not a sound of any kind when the switch was turned on. The r. f. detector and audio were checked thoroughly. The plate, grid and heated voltages were all normal. The speaker was tested for continuity, and the connection on the five prong plug tested okay. When the speaker was connected and the receiver turned on, the field was powerfully magnetized.

"Page Philo Vance! For no logical reason another speaker was tried, and the set worked! The Atwater-Kent service manual was secured and the matter investigated on paper. From the diagram of the speaker, and the previous tests, the trouble was readily deduced. The speaker field serves as a choke in the filter systems, and is connected to the five-prong plug. The voice coil, however, is not connected to the plug directly, but through a push-pull output transformer, integral with the speaker assembly. In other words, the voice coil could be open without effecting the continuity test at the plug terminals.

A Service Shop Kink

"The small bottles used in testing samples of cream come in very handy in the service shop. The lids of about a dozen of these jars can be fastened to the underneath side of the service bench, and the jars screwed into them, thus providing an out of the way and yet convenient storage for nuts, bolts, lock washers, soldering lugs, small condensers, resistors, etc."

Autodyning with the -24

"On the DeForest-Crosley not every -24 will work in the autodyne socket. If the volume falls off between 1000 and 1500 kc. look to the autodyne tube, and try one that has been tested in a good receiver (the 500 series).

"When the Fada mantle sets come in with

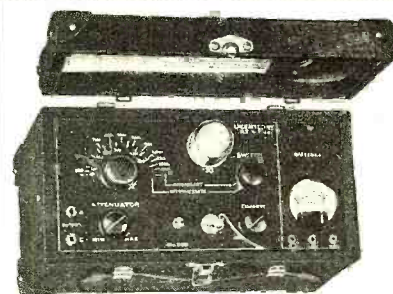

OSCILLATOR No. 550
(Licensed by A. T. & T. Co.)

Output adjustable to broadcast, low and high intermediate bands—130 to 1500 K.C. Direct reading—except for 200 to 550 K.C., which are obtained by sharp second and third harmonics.

Full instructions in cover. Heavy shielding throughout the attractive, leatherette-covered case. Dependable. Accurate. Sturdy. No. 550—\$21.00 Net. No. 551—less output meter \$18.00 Net. Complete with batteries and tube.



RADIO INSTRUMENTS

No service man can afford to be without these dependable servicing instruments. Low in first and last cost.

Locating servicing troubles with Readrite equipment cuts your costs and makes greater profit per call.

No. 600 Set Tester makes every necessary test of radio receivers using Pentode and all types of tubes. Resistance, capacity and continuity measurement charts furnished. Simple to operate. \$18.00 Net.



No. 600. SET TESTER

Readrite Meter Works
20 College Ave.
Bluffton, Ohio

Please send me information about Readrite Oscillator and No. 600 Set Tester. Also catalog of other servicing instruments.

Name

Address

City State

Readrite Meter Works
Established 1904
20 College Ave., Bluffton, Ohio

National AC or DC-SW-3

20-40-80 Meters
 Gives exceedingly high signal-to-noise ratio, using UX-235 tube. Has genuine single control, although there are two condensers and two sets of coils. AC or DC Models.

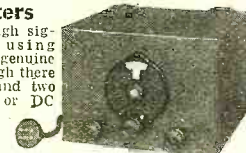

Write for our Special Price

"Chi-Rad" 2 Tube "Ham" Receiver

Great favorite with amateurs. Spreads 20-40-80 meter bands over 60 points on the dial.
 Volume equal to some very expensive receivers. Ask your "Ham" friends.

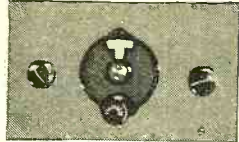

Easily built from complete kit of parts. **\$20⁷⁴**

2 Tube 18 to 190 Meters

Receiver described in "How to Become a Radio Amateur" Manual, 25c. Complete kit of parts, including headset (less tubes and batteries)... **\$11⁵⁰**

Send 10c for 110-Page Catalog of Short-Wave Supplies, Replacement Parts, Electric Clocks, etc.

CHICAGO RADIO APPARATUS CO.
 417 S. Dearborn St. Dept. RN-6 Chicago, Ill.

RACON Announces

... a new line of Acoustic Couplers for Dynamic Cones

Racon Acoustic Couplers for Dynamic Cones add brilliance and depth to reproduction, in addition to giving greater volume and projection power. Made in all sizes to fit any make dynamic cone. Racon Speakers for public address systems are incomparable.



RACON HORNS and UNITS ARE COVERED BY U. S. PATENTS NOS. 1,807,711; 1,501,432; 1,577,270; 73,217; 74,218; 1,722,448; 1,711,514; 1,781,489; 1,832,608; 1,834,327; 1,835,730.

Send for Complete New Catalog on Horns and Units
 Address Dept. R.N.-6

RACON ELECTRIC CO., Inc.
 18 WASHINGTON PLACE NEW YORK
 LONDON, ENGLAND TORONTO, CANADA

42-Strand Genuine Phosphor Bronze
Drum Drive Cables, Bands & Belts
Exact Duplicates of Originals
 We supply bands and belts for every standard make set on the market, ready for use, or by the foot.

Flexible Sleeve Shielding
 for Automobile Radios, Sound Equipment, Amateur Stations, etc. in all sizes.
Write for Samples and Prices

J. F. DISTRIBUTING CO.
(Wire and Cable Specialists)
 5024 Fort Hamilton Parkway, Brooklyn, N. Y.

A SHORT WAVE CHASSIS

The RELIABLE SW 2



A 2-tube set—one 232 Screen Grid Detector—one 233 Pentode Audio Power Tube—3 Low-loss Plug-in Coils reaching a band from 14 to 105 meters.
 Completely wired with a full vision open scale dial with pilot light.
 Panel 7 x 11. Base 6 x 10.
 Built with standard merchandise, including Hammarlund Isolantite Condenser. Guaranteed loud-speaker reception \$9.95
 Metal cabinet \$2.00 extra
 Sent C.O.D. charges collect. Order today.

Radio Surplus Corp.
 56 No. Vesey St. New York, N. Y.

BY-PASSES

A Complete Range of Types and Sizes at New Low Prices.



Distributed by
WHOLESALE RADIO SERVICE CO., Inc.
 100 Sixth Avenue NEW YORK, N. Y.

the complaint of distortion, check the blue resistor in the pentode center-tap filament circuit. Replacing it usually clears up the trouble.

"We find we can use the two-volt tubes in nearly every set, after we do a little balancing and cutting down on resistors. The regeneration idea works out very fine in neutrodynes, specially in the old style Day-Fan, of which there are quite a few around here.

"Wilkinson & Son, Unity, Sask., Canada."

Increasing Midget Salability

A. G. Murphy, of the Hilltop Radio Service, Columbus, Ohio, sends in a novel idea, interesting from both service and sales points of view:

"In the resale of trade-in midgets you can make them tune in the police broadcasting stations by tapping the grid coils so that only one-third of the turns are used. A simple rotary switch, working on the low potential side, makes it possible to tune either police or conventional broadcast.

"The same effect can be secured by cutting the grid wires at the tuning condensers, and inserting fixed .00025 mf condensers—again with a convenient switch for shorting purposes.

"The police broadcasts are often much more interesting than the commercial broadcast ballyhoo. It is very nice to sit in your own home and know that some drunk is strangling a woman down at 2643 South Wabash Street."

A Tip on the Silver 30

"When a Silver 30 comes in it is a good idea to replace all the porcelain type resistors in the set. These resistors consist of a rod of porcelain with two flues, each loaded with a rod resistor resembling 'metalized carbon,' connections to which are made by the metallic heads on the ends of the porcelain. They are about the size of the ordinary gridleak type resistor.

"The trouble with these resistors is that one rod breaks down first, leaving the entire load to the remaining resistor. Since they are in parallel, this changes the voltage drop, resulting in decreased sensitivity. If the break is not complete, the ends make and break contact as the set is warming up, causing considerable annoyance during this

period. When the remaining rod gives way, the noise is terrific until the set is thoroughly warmed. This trouble is readily identified, located and eliminated. The only thing is that this noise is often thought to be a part of the customary background noise before it gets bad enough to be identified as set trouble. If the break is complete in one rod, there is no noise, and the symptom is only lack in sensitivity. For this reason, in checking over a Silver-Marshall, it is a good idea to be certain that the voltage readings are in close agreement with those specified.

"Verne V. Gunsolley, Minneapolis, Minn."

Correcting Poor Alignment

"I have run across several Radiola's 16, that in the course of time have become deficient in sensitivity. Battery and tube renewals do not bring back the old time pep. Loosening up of the coils and the inevitable slight changes with use seem to have an accumulative effect, and the circuits are no longer in perfect alignment.

"I remedy this by connecting a small trimmer condenser across the middle variable condenser. One side of the trimmer is fastened to the back left screw that holds the tuning condenser in place and the other is soldered to the wire that grounds the condenser gang to the frame of the set. The condenser is held rigidly about 1½ inches above the contact strip on the back of the condenser gang. In some cases, two trimmers are necessary.

"E. N. Preston, Portland, Michigan."

Installing Dial Cables

Wayne Clay, of Springfield, Miss., blows taps on the day's work with the following service kink:

"When installing dial cables on Spartons, Majestics, Stewart-Warners and many other sets using the cable drive, I find it quite difficult to hold the cable taut in its proper position on the dial drum and winding shaft, and at the same time tighten all the set screws without aid. However, if a piece of soft wood is cut so that it can be wedged tightly between the frame and the shaft upon which the dial cable winds, so that the shaft will not turn, the job is easily finished without the use of a third hand."

With the Experimenters

(Continued from page 1041)

as used for Christmas tree lights, on the other end with a flashlight bulb in it) into the bulb receptacle. This enables you to get in very small places with a good clear light—for locating balancing condensers, etc.

H. B. CLOSSON.
 Philadelphia, Pa.

A Depth Gauge for Drills

In your RADIO NEWS for March, 1932, page 775, you mention, in connection with "The 'Complete' Service Unit," the drilling of the main panel (¼ inch thick) to a depth of 3/16 inch. The method which the author of that article suggests is to put a mark on the drill 3/16 of an inch from the point. Then by watching this mark the drilling can be stopped when the hole reaches this desired depth.

May I suggest that where holes of a specified depth are to be drilled a more simple and fool-proof arrangement is to cut a small hardwood block of such a length that when a hole is drilled through its center it will leave the required length of the drill projecting. If this block is slipped over the

drill it will be impossible to drill holes deeper than the projecting portion of the drill.

The drawing shown herewith illustrates

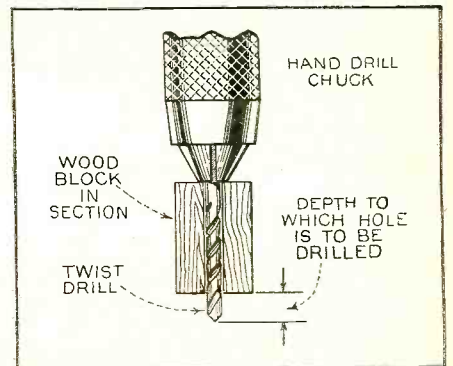

this idea. It will usually be found desirable to make the hole through the wood block large enough to permit the drill to slip through easily so that the block will not turn with the drill. To facilitate this idea

it may be found worth while to put a drop of oil on the top of the wood block next to the drill chuck.

ALGIE ROBINSON,
Niagara Falls, Ont., Canada.

A Simple Low-loss Inductance Mounting

Small copper tubing inductances, customarily used in circuits such as amateur radio transmitters, where only a few turns of copper tubing are used generally need no special support to make them rigid enough to avoid frequency change due to vibration or sagging of the coil. However, where a larger coil is desirable, requiring from ten to twenty turns, the tubing is not sufficiently rigid to support the coil when mounted by means of lugs at each end. Some kind of support is necessary to hold the center of the coil firm and yet not make so much contact with the winding as to cause losses due to leakage at these points.

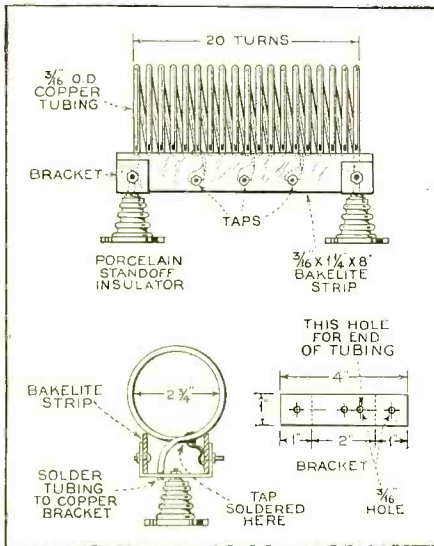

The writer, having constructed many such inductances and found most methods of mounting either too elaborate or costly to construct, hit upon the arrangement shown in the accompanying illustrations. The entire coil and mounting can be constructed at a cost of less than a dollar and the completed unit will have the finished appearance of a factory-made unit and will be every bit as efficient.

The particular coil described was made of twenty turns, 2 3/4 inches in diameter and wound with 3/16-inch outside diameter copper tubing. The parts used will be readily recognized by any experimenter.

In constructing a coil of this size for amateur radio use it is well to take off a few taps so that the coil will lend itself to use in other circuits than the particular one for which it is being constructed. The coil shown is tapped at three points, center and one-quarter distance from each end. The taps are taken off by means of copper strips 3/8 inch wide with one end bent three-quarters distance around the turn to be tapped and securely soldered in place, and the other end placed under the head of a number 8-10 machine screw to provide a convenient binding post. Strips forming these taps should be as short as possible. About 1 1/4 inches will be found to be about right for this size coil and mounting. For appearance sake the taps should be soldered to the portion of the turn between the two hard-rubber supports. If desired, these taps can be brought out on both sides of the coil by mounting the machine-screw binding posts on both supporting strips. This arrangement will be found particularly de-

sirable when the coil is to be used in intermediate amplifier circuits and will be found to be a great aid in obtaining neat circuit arrangement.

CARL D. SHORT,
Bronx, N. Y. City.

A Handy Coil Winder

Many of the short-wave sets built by amateurs and described in current magazines use coils wound upon the bases of discarded

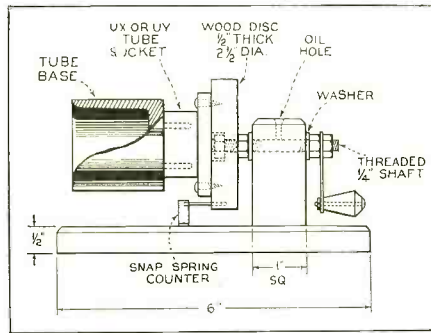

tubes. These forms make excellent coils if wound smoothly, and they look nice if they are laid in shellac and given an extra coat when completed. Winding them by hand is a messy job, however, unless a winding jig is used. The coil winder made by the author has been in use for some time and it has proved itself to be very satisfactory.

The essential parts are an old UX or UY socket, depending upon the type of tube base used, a few pieces of wood, and an old condenser shaft, threaded in a convenient size at both ends, with accessory nuts and washers.

A disc of soft wood about 1/2 inch thick and from 2 inches to 3 inches in diameter is cut, drilled through the center and countersunk to take the end of the shaft and a locking nut. This spindle turns in a hole drilled through one end of a piece of medium hard wood, 1 inch square, which is fastened to one end of the baseboard. A small oil hole drilled in the top of this bearing post gives the shaft sufficient lubrication. The handle is a piece of brass or steel, drilled, and locked to the end of the spindle between nuts. The socket is centered and secured to the disc as shown in the drawing.

The coil form is placed in the socket, shellaced and wound as usual.

DUANE MURPHY,
Uhrichsville, Ohio.

An Automatic Radio Time Switch

I have read the articles on simple radio time switches utilizing alarm clocks (RADIO

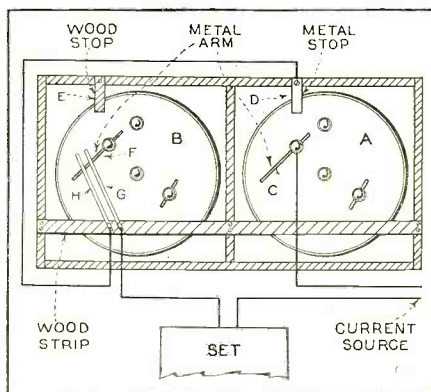

News for December and February). These devices are capable of automatically turning (Continued on page 1065)

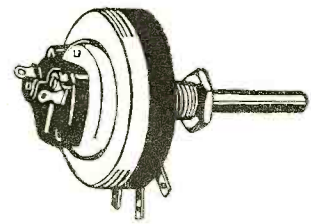

Order 5
Centralab Replacement
Volume Controls
and Get the New
50c Edition of Our
Volume Control Guide
FREE!

This new Guide is just off the press . . . it is yours with an order of only FIVE (5) Replacement Controls at new low dealers prices.

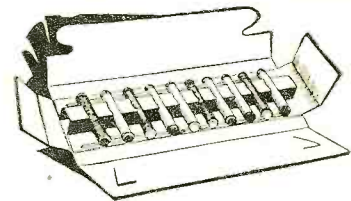

Now!
a service carton of
10 Centralab
Fixed Resistors

your own choice of resistance values. Dealers list price, \$3.00.

\$1.75
net

FREE: with every service carton we will include the NEW QUICK REFERENCE WALL CHART showing resistance combinations at a glance.

Centralab

Central Radio Laboratories
Milwaukee, Wis.



SHALLCROSS Wire-Wound RESISTORS

—Calibrated to an accuracy of 1%—
are standard equipment in the construction of the following circuits:

- Multi-Range Volt Meters
- Multi-Range Ammeters
- Wheatstone Bridge
- Capacity Bridge
- Radio Set Analyzers

and other high-grade test equipment.
Send 4c in stamps for our Bulletin 150-D, and let us know which circuit you are interested in.



FREE—FREE Wholesale Radio Catalog



"THE BIG BOOK"
(136 pages)

Write now, for your free copy chock full of radio and electrical bargains.

American Sales Company
Wholesale Radio Distributors
44 West 18th Street
New York, N. Y.

PATENTS

Write for Free Information, HOW TO OBTAIN A PATENT and RECORD OF INVENTION—or send drawing or model for examination.

MILLER & MILLER, Patent Attorneys
FORMER MEMBERS EXAMINING CORPS U. S. PATENT OFFICE
1006 Woolworth Bldg., Dept. H, New York
680 Earle Building, Washington, D. C.

RADIO SCHOOL

YOUNG MEN wanted to train as radio operators; we prepare for U. S. Govt. license; new classes now forming; call or write for 40-page catalog; established 1899.
MASS. RADIO SCHOOL, 18 Boylston St., Boston.

Radio Book SPECIALISTS SPECIAL OFFER

- "Theory of Radio Communication," by John T. Filgate\$1.50
 - Radio Experimenter's Handbook..... .25
 - The ABC of Vacuum Tubes..... .50
- We will get you the book you want on radio or television. Write for our circular and find out all about the service we offer.

RADIO PUBLISHERS' SERVICE
22 West 21st Street, New York City

Grid-Glow Tube

(Continued from page 1008)

drop. Because of this, the glow tube is more easily controlled on a.c. than on d.c.! The rectifying action of the grid-glow tube makes possible the use of direct-current relays and meters when it is used on a.c. as well as d.c. If an ordinary telephone relay of a few thousand ohms resistance is used, it must be shunted by a 2 mfd. condenser for 60-cycle operation or a 4 mfd. condenser for 25-cycle operation. A lag-loop relay does not need a condenser, as it is designed to have a slow decay of magnetic flux which tends to hold the relay closed on pulsating current.

The circuit of Figure 7 shows a potentiometer connected across the anode-cathode voltage supply. The grid is connected to the arm of the potentiometer through a grid resistor. It should be remembered that in a.c. circuits the grid should always have a limiting resistor in series with it or it will draw excessive current in the discharge, with ultimate injury to the grid. As the arm is brought from the negative end of the potentiometer, it will reach a point which is less negative than the grid, and the grid charge will drain off, thus starting the tube.

The difference between the voltage required for a.c. and d.c. operation is accounted for in that an a.c. voltage-wave has peaks 1.4 times the root-mean-square (r.m.s) voltage as read on an a.c. meter. Consequently, the peak a.c. voltage and the d.c. voltage which starts the grid-glow tube will have the same magnitude but the r.m.s. a.c. voltage will be less than the d.c. voltage. The value of the resistance in this potentiometer may be as much as 100 megohms, total.

Since the same effect of varying voltage, between grid and cathode, can be obtained by using a fixed and a variable resistance as in Figure 8, this circuit can be used to start the grid-glow tube, due to a change in resistance. If R3 is the variable resistance, then the tube will tend to start as its value is increased. If R4 is the variable resistance, then the tube will tend to start as the value of R4 is decreased. The following table gives approximate values of R3 and R4 for a.c. and d.c. to just operate the tube.

Table I

	R ₃ = 3 megohms	
	R ₃ megohms	R ₄ megohms
440 V. A. C.	1	1.2
500 V. D. C.	5	6.0
	10	12.0
	20	24.0
	50	60.0

The photograph at the head of this article shows a group of grid-glow tube apparatus. A transformer designed to give 440 volts, for grid-glow tube service, is on the extreme right. It is purposely designed to have high impedance, so that excessive current cannot be drawn by the grid-glow tube. A relay and condenser, suitable for grid-glow tube service, is on the left of the grid-glow tube. A milliammeter and current-limiting resistor are also shown.

Vacuum Tube Voltmeter

(Continued from page 1025)

voltmeter also. The meter is connected in the circuit with a double contact jack as shown. When the plug is inserted in the circuit, the resistance used as a multiplier (R) is in series and the terminals V may be used to measure voltages in the usual manner as of batteries or plate supply, etc.

STATEMENT OF THE OWNERSHIP, MANAGEMENT, CIRCULATION, ETC., REQUIRED BY THE ACT OF CONGRESS OF AUGUST 24, 1912,

OF RADIO NEWS, published Monthly at Dunellen, N. J. for April 1st, 1932.

State of New York } ss.
County of New York }

Before me, a Notary Public in and for the State and county aforesaid, personally appeared Lee Ellmaker, who, having been duly sworn according to law, deposes and says that he is the President of the RADIO NEWS and that the following is, to the best of his knowledge and belief, a true statement of the ownership, management (and if a daily paper, the circulation), etc., of the aforesaid publication for the date shown in the above caption, required by the Act of August 24, 1912, embodied in section 411, Postal Laws and Regulations, printed on the reverse of this form, to wit:

1. That the names and addresses of the publisher, editor, managing editor, and business managers are: Publisher, Teck Publishing Corporation, 350 Hudson Street, N. Y. C.; Editor, Laurence M. Cockaday, 350 Hudson Street, N. Y. C.; Managing Editor, None; Business Managers, None.

2. That the owner is: (If owned by a corporation, its name and address must be stated and also immediately thereunder the names and addresses of stockholders owning or holding one per cent or more of total amount of stock. If not owned by a corporation, the names and addresses of the individual owners must be given. If owned by a firm, company, or other unincorporated concern, its name and address, as well as those of each individual member, must be given.) Teck Publishing Corporation, 350 Hudson Street, N. Y. C.; Macfadden Publications, Inc., 1926 Broadway, N. Y. C.; Bernarr Macfadden, 1926 Broadway, N. Y. C.; Orr J. Elder, 1926 Broadway, N. Y. C.

3. That the known bondholders, mortgagees, and other security holders owning or holding 1 per cent or more of total amount of bonds, mortgages, or other securities are: None.

4. That the two paragraphs next above, giving the names of the owners, stockholders, and security holders, if any, contain not only the list of stockholders and security holders as they appear upon the books of the company but also, in cases where the stockholder or security holder appears upon the books of the company as trustee or in any other fiduciary relation, the name of the person or corporation for whom such trustee is acting, is given; also that the said two paragraphs contain statements embracing affiant's full knowledge and belief as to the circumstances and conditions under which stockholders and security holders who do not appear upon the books of the company as trustees, hold stock and securities in a capacity other than that of a bona fide owner; and this affiant has no reason to believe that any other person, association, or corporation has any interest direct or indirect in the said stock, bonds, or other securities than as so stated by him.

LEE ELLMAKER,
President.

Sworn to and subscribed before me this 30th day of March, 1932.

(SEAL) TERESA A. QUIGG,
Notary Public.

(My commission expires March 30, 1933.)

In Our June Issue— AMAZING STORIES

MASTERS OF THE EARTH, by John Edwards. The idea of interstellar travel, or for that matter, the idea that the moon might be inhabited by some form of intelligent life, does not seem altogether far-fetched any more. Although both are possibilities that may not be confirmed for many a long year, speculations about the scientific aspects of these ideas go on space. Here is an especially interesting story by an author in H. G. Wells' country that is entirely new and extremely well written.

POLITICS, by Murray Leinster. Politics is the all-pervading topic of conversation nowadays, no matter how you look at it. But Murray Leinster, about whose stories we need to say nothing to readers of AMAZING STORIES, interests himself only with the purely scientific possibilities of the future of politics in the realm of . . . but why tell you more? Mr. Leinster's tale is very vivid and convincing.

A MATTER OF NERVES, by William Lemkin, Ph.D. Of course, the effects produced by the doctor-scientist of this story are not entirely satisfactory, but that's because the doctor's motive was not altruistic. We can think of several ways in which this "reversal" invention could be applied to excellent advantage and you will probably think of many more when you finish reading "A Matter of Nerves."

THE LEMURIAN DOCUMENTS, by J. Lewis Burt. No. 4: Phaeton. Even in the ancient days, apparently, interplanetary travel was thought of, and even tried. How, is effectively told in this fourth of a series of modernized mythology stories.

THE METAL DOOM, by David H. Keller, M.D. It appears that only a small minority of our vast population could adapt itself to such a revolutionary change as Dr. Keller depicts—which assumption seems to us quite logical. How a thoroughly modern person, practically born in this age of miracles, will react in a sudden transition to a second stone age, is graphically set forth in the second instalment of this story.

And Other Unusual Scientific Fiction
NOW ON SALE AT ALL NEWSSTANDS

With the Experimenters

(Continued from page 1063)

the radio either off or on (but not both) at any predetermined time.

Recently I made a device, using the same principle, but incorporating some modifications so as to be capable of turning any electric appliance either on or off or both on and off at predetermined times, automatically. As such a device has wide uses, e.g., with neon or electric signs, washing or diathermy machines, radio in music houses of public parks, etc., the accompanying diagram and explanation may be of interest to fellow workers. The construction of this device was led up to by a friend's request for something to switch the electric signs of his shop on and off at some predetermined time. He used to switch the signs on at 5 p.m., the closing time of his shop, and off the next day when the shop opened, but operation from dusk to midnight was all that he actually required and he was therefore wasting much "juice."

As the preparation of the alarm clock and the wooden box has been clearly explained by Mr. Vernon W. Palen, and his explanation mainly holds for the construction of the present device, the reader is referred to page 493 of RADIO NEWS for December, 1931. The only difference is that here we have a second alarm clock, with a metal arm C attached to its alarm winding key.

In setting the device to turn a radio on and off, say at 8 p.m. and 12 p.m., respectively, it is necessary to set the alarm A for 8 p.m. and the alarm B for 12 p.m., leaving the metal arms C and F attached to the winding keys away from the stops D and E, i.e., in the position as shown in the attached figure. At 8 p.m. arm C will rotate until it strikes the metal stop D, thereby closing the circuit, and turning on the radio or other device. At 12 p.m. alarm B is released and arm F turns until stopped by wood block E, breaking the contact with the two springs G and H. Thus the radio is turned off.

To set the device for turning the radio on but not off, it is necessary to stop the working of alarm B by leaving its control at "Silent" position and set alarm A at the desired time, leaving the arms C and F as shown in the figure.

In setting the device to turn the radio off, alarm A is left with arm C at contact with D, and alarm B is set for the time it is desired to have the radio turned off, while arm F is left at contact with springs G and H. The radio will continue to operate until the set time arrives, when arm F will rotate and open the circuit.

LIU E. LO.
Newchwang, China.

Eliminator for "Man-made Static"

Usually the best remedy for radio interference is to locate the source and then rem-

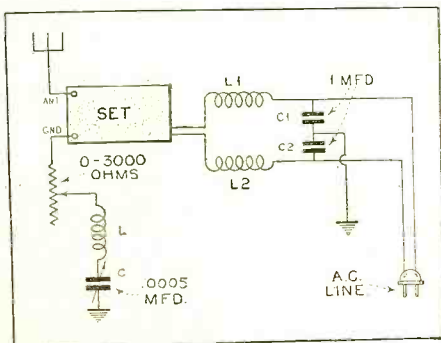

edy the cause or filter the troublesome device. In some cases, however, this is impos-

sible or at least impractical. A case of this kind has given me trouble for some years. An old transmission line which runs near me radiates a steady grinding, crackling noise for its entire length of about 20 miles and drowns out all but the most powerful local stations. After considerable experimenting, the following system was worked out and it removed the noise, although it is some trouble, as it has to be adjusted to every station separately.

Two grounds are necessary. The tuned circuit is not, as might be supposed by an inspection of the diagram, tuned to the frequency of the station being received, but is used to produce a phase balance in the interference, part of which enters through the antennae and part of which gets by the filter. The resistance R completes the balance. Actual data cannot be given on the parts, as they vary with the installation. Reversing the two grounds used is also necessary sometimes. An 0-3000 ohm resistor (R), C of 500 mmfd. and coils ranging from 100 to 500 microhenries have taken care of all conditions I have run into.

In the filter, C1 and C2 are 1 mfd. condensers, and coils L1 and L2 consist of 500 turns of No. 18 d.c.c. wire in a 4-inch roll.

This circuit has also been used to stop interference caused by a vibrating battery charger.

HARRY KENYON,
Berlin Heights, Ohio.

A Home-made Voltage-divider

A good voltage divider for use in B eliminators can be made from an old carbon-pile type variable resistance unit such as the Bradleyohm. Made as shown in the accompanying drawing, the voltage divider will prove to be a handy resistance unit.

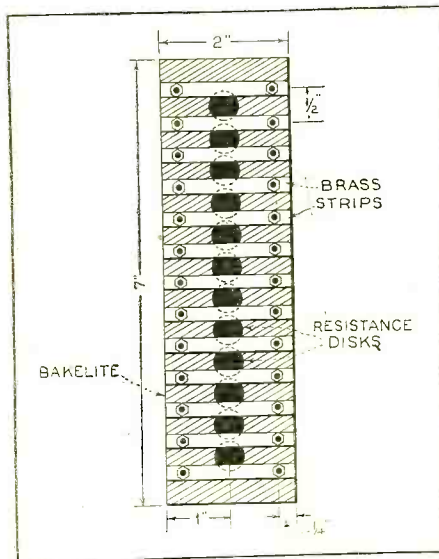

A strip of bakelite two by seven inches is used as a support for the twelve carbon-discs. Thirteen holes are drilled along each edge, one-half inch apart and one-quarter inch in from the edges, with a number 28 drill. Thin strips of brass two inches long and one-quarter on an inch wide hold the discs in position. Each brass strip has a hole drilled one-quarter of an inch from each end with a number 28 drill. The unit is assembled, as shown in the drawing, with 6/32 machine-screws and nuts.

Before assembling the unit, however, procure some tin or aluminum foil. Foil may be purchased at any large radio-supply house or it can be obtained from an old

READ WHAT THE BOSTON HERALD

says about the opportunity for **SERVICEMEN**

Famous Manufacturers cooperating

PLAN SERVICE TO STOP RADIO NOISES

Trained Men to Chase Down "Man-Made Static"

The eyes of the radio listener, radio manufacturer, dealer and jobber are centered on the work of the Tobe Deutschmann Corporation of Canton, Mass., who have been pioneering in this new business of the elimination of man-made static. Little does the public know of the vast amount of research and development work which has been going on in that Canton plant so that Mr. Radio Listener would be able to better enjoy the radio programs. At a time when no one thought of the problem of radio interference as amounting to anything at all, Tobe Deutschmann, head of the Tobe Deutschmann Corporation, quietly and systematically was gathering about him engineers to wage this battle. The work has commanded the respect of the entire nation.

"Static, the enemy of good reception, is not necessarily the result of thunderstorms, but may be coming from your next door," says Mr. Deutschmann.

"In fact, most of us are harboring potential manufacturers of static right in our own homes. A modern electrical radio receiver now gets its current from the power lines. This same power line, in turn, acts as an antenna and produces the noise—far and wide. This would be discouraging enough if nothing could be done about it, but it is an established fact that electrical equipment which creates radio interference can be quickly and inexpensively filterized so as to stop the static right where it is born and peace and quiet will come once more to your radio.

The Radio Manufacturers' Association together with the National Electrical Manufacturer's Association have started to go after this problem with vigor. Plan is now under way to engage the services of many thousand service stations, men who will be trained by the Tobe Deutschmann Corporation school.

These men will be appointed in districts in proportion to one man for every 10,000 inhabitants. These men will receive a course of training from Tobe Deutschmann Corporation, and radio interference complaints as received by such companies as Philco, RCA, Victor, Atwater Kent, Zenith, Crosley, Audiola, Clarion, Stromberg Carlson and many other radio manufacturers will be sent to them through Tobe Deutschmann Corp.

"These service stations will call on radio listeners and correct each case of interference if it is in his power to do so. In many cases these men will find that the interference complaint can be traced down to faulty appliances, connections, defective tubes or loose wiring."

Take advantage of this same opportunity in your own community. Wire to reserve your franchise.

Tobe Deutschmann Corp.
Franchise Director, Filterette Division
CANTON, MASS.

NOTICE TO PRESENT FILTERETTE STATIONS—The recently completed 21-page Man-Made Static survey report on Albany, Georgia, is now available to all Filterette Service stations upon request. It will help you in getting similar contracts to survey your community.

Our Goal...

THE CONTROL of

CANCER

Advances in knowledge of the nature of cancer and of its early symptoms have greatly increased chances of successful treatment. Surgery and radiation are the only recognized forms of treatment for cancer.

For free information write, call or telephone to the

NEW YORK CITY CANCER COMMITTEE

of the

AMERICAN SOCIETY FOR THE CONTROL OF CANCER

34 East 75th Street, New York • RHinelander 4-0435

If not a resident of the Metropolitan area, write to

American Society for the Control of Cancer, New York, N. Y.

IMPORTANT

TO

SERVICEMEN RADIO ENGINEERS TECHNICIANS
DEALERS REPAIRMEN CUSTOM SET BUILDERS

Without any obligation or expense to you, RADIO NEWS will list your name for reference purposes in our Service Bureau files.

Our Service Bureau functions without expense to either readers or manufacturers, to furnish information and contacts. Frequently we are requested by manufacturers to furnish lists of radio men who are interested in some specific branch of radio work.

If you want to be listed, send us your name on the coupon below.

Radio News Service Bureau, Dept. 6, 350 Hudson St., New York, N. Y.

List my name in the Bureau's files:

Name

Address

City State

Subscriber? Newsstand Buyer?

Occupation: Engineer Serviceman Dealer Technician

Connection with the Industry

Remarks: Our Service Department is considering the publication of a new volume for the Radio News Library. What subject would you suggest to be covered?
 Television Short Waves Servicing New Hook-Ups
 Mathematics in Radio

paper by-pass condenser. A wad of foil, about one-eighth of an inch thick and one-quarter of an inch wide, is placed under each brass strip at the point where the carbon-discs meet. If the unit be assembled without a wad of foil under each strip, the discs would crumble when the machine-screw nuts were tightened.

When using carbon-discs taken from an old-style Bradleyohm, care must be taken to use only the high-resistance discs. This type contains discs of plain carbon mixed with discs of high resistance to build up the piles to the proper height. Placing each disc in series with a voltmeter and battery provides an easy method of sorting the discs.

It is unnecessary to test the discs from the single-hole mounting Bradleyohm, as all the discs have approximately the same resistance. These discs are smaller in diameter than the discs in the old-style Bradleyohm; so, if these be used, it will be necessary to drill the holes in the bakelite strip closer together, as the spacing given above is based on the diameter of the larger discs.

When used as a voltage divider, one end of the unit is connected to the plus terminal of the filter and the other end is connected to the minus terminal. The machine-screws in between serve as taps for intermediate voltages.

SYLVESTER BRUZAS,
Chicago, Ill.

Another Radio Index System

I have just read the article "Indexing Radio News" on page 867 of the April issue and am describing herewith the system I use in the hope that it may prove helpful to others.

I number each magazine in the upper left corner, using large figures cut from a calendar. I have a card-index system arranged in alphabetical order and I enter each article in this record, showing magazine number and page, and as I have taken as high as six magazines, I also show the magazine name. For example, page 855, April issue, "Service Unit, the Complete . . . 19-855 R.N." I have a stack of radio magazines four feet high, all indexed that way, including five years of RADIO NEWS. As I do radio service work, I find use for a great number of the articles, especially service notes and wiring diagrams.

L. A. HARRISON,
Ellis, Kans.

DX'ers Corner

(Continued from page 1041)

A Highly Effective Ground System

We hear a lot about grounds of various types, but the average radio owner who appreciates good clear reception and a well-balanced aerial-ground combination is at a loss at times to know how to construct one that will work efficiently under all conditions.

A combination ground has been tested out and found to work very well, and here is how it was constructed: A 1/2-inch gas-pipe about 8 feet long was driven down into the soil and a hole some bigger than the pipe was dug around it for 3 feet down into the soil. This was well salted, with about 3 pounds of common rock salt, and a can of caustic potash was added to facilitate good chemical diffusion and draw dampness. This mixture was then well wetted with water and dirt filled around it to the top of the ground.

Another ground was constructed some 10

feet away from this, using the cells from two discarded B batteries. Holes were punched in each cell and they were then connected in series and laid in a trench dug a foot deep. The end wire from the group of cells was connected to a 4-foot metal rod which was driven into the earth, the other end of the wire from the cells was connected to the gas-pipe ground mentioned above, and then to the ground post of the set.

This combined pipe-chemical ground was well wetted down and covered with moist earth, and has proved a very simple and efficient combination. This ground can also be used as an aerial if attached to the aerial post on set, and KFI in Los Angeles was brought in with good clarity and no static on a hot July night, also CMC in Havana was picked up with good clarity when, switching to the outside antenna, it could not be heard at all. This type of combi-

nation ground is inexpensive and in my case has greatly improved reception.

The advantages of this ground system result from two things: First, there is a larger area of ground contact obtained from the two pies and the B battery cells; and, second, the chemicals employed attract moisture. They also filter into the ground, thus making the nearby ground a better conductor and in fact greatly increasing the size of the effective "ground" area.

For the information of others who may desire to construct a similar ground, I may say that I use one copper pipe and one iron pipe, but two pipes of either copper or iron, or any other metal for that matter, should prove equally satisfactory.

I use three different receivers, and this ground system proves to be highly effective with all of them.

RAY E. EVERLY,
Newton, Ill.

What's New at the Trade Show

(Continued from page 1031)

control arm. The condensers are circular in shape, stacked one upon the other, and are enclosed in a bakelite case, similar in size and design to the containers employed for variable resistance units. The case is backed by a metal dust-guard. This type of construction and design provides a small, compact tone-control and eliminates the resistance strip heretofore used in conjunction with condensers for tone-controls. The diameter of the case measures 1 5/8 inches and the length of the shaft is 1 1/8 inches.

Maker—Filtermatic Mfg. Co., 4458 Frankford Ave., Philadelphia, Pa.

Resistor Replacement Kit

Description—A handy resistor assortment, containing twenty 1-watt metallized resistor

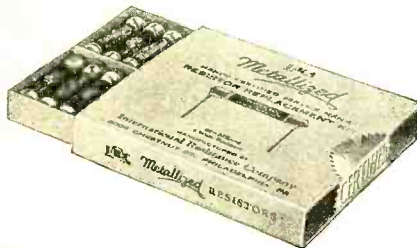

units of different values from 500 ohms to 3 megohms. The kit includes the resistor values most commonly used for replacement work. This assortment is complete with the manufacturer's resistor replacement guide and a Radio Manufacturers' Association standard color code chart.

Maker—International Resistance Co., 2006 Chestnut Street, Philadelphia, Pa.

Portable Public Address System

Description—The entire equipment of the Webster midget type PT-463 sound-amplifying system is designed to fit into a single

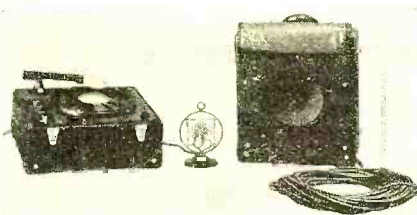

carrying case measuring 15 1/2 inches by 14 inches by 13 inches. The total weight of

the apparatus is under forty pounds. This address system supplies a real need for conventions, sporting events, and wherever it is necessary to distribute speech or music to a group of people. The equipment comprises a push-pull audio amplifier employing screen-grid and pentode type tubes, an electric phonograph turntable that plays either 33 1/3 or 78 r.p.m. records, a microphone, a dynamic speaker and the necessary microphone cable and extension speaker cord. It operates from either 110 or 220-volt, 50-60 cycle a.c. supply.

Maker—The Webster Co., 846 Blackhawk St., Chicago, Ill.

Television Tube

Description—A crater neon arc type television tube, recently announced for television receiving equipment, employing the lens type of scanning disc. The tube comprises two electrodes, mounted in the same plane and within a few thousandths of an inch from each other. Neon gas surrounds both electrodes and the word "crater," the designation of this type tube, is derived from the way the arc or ionization of the neon gas takes



place. The electrode known as the target has a hole of about .025 inch through it, and it is through this hole that the intense beam of light is projected on the lens scanning disc. The striking voltage for the tube is approximately 180 volts, the maximum current 40 ma. and the crater light source .030 inch.

Maker—Triad Mfg. Co., Inc., Pawtucket, R. I.

COME TO SUNNY CALIFORNIA

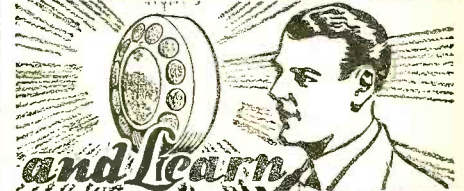

and Learn RADIO-TELEVISION TALKING PICTURES

Get your training in California where the great American Television Laboratories are located—where hundreds of trained sound Engineers and Mechanics are employed in the Studios of Hollywood. Scores of good jobs will be opening up—and you can prepare for them in 4 months of practical shop work in the great National School.

RAILROAD FARE ALLOWED

For a limited time we are including coach railroad fare to Los Angeles in our tuition, so the trip costs you nothing extra. Free Employment Service. Many earn while learning. Get the facts about this 25-year old Institution. Mail coupon for big Free Book.

National Television, Talking Picture and Radio School,
Dept. 6110, 4006 So. Figueroa St., Los Angeles, California.
Please send me your big Free Book on Television, Talking Pictures and Radio.

Name.....
Street No.....
City..... State.....

SERVICE MEN!

YOUR RESISTOR PROBLEM SOLVED

with the RADISTOR KIT CONTAINING EVERY Resistor That You Need!

Always on Hand for Quick Use Contains a Resistance Value for Any Service Job

Twenty-four of the finest quality, 1 watt, R. M. A. color-coded Carbon resistors that take care of practically every replacement need. Kit contains one, each, of the following: resistances: 100; 250; 400; 500; 800; 1,000; 2,000; 3,000; 4,000; 5,000; 6,000; 10,000; 15,000; 20,000; 25,000; 40,000; 50,000; 60,000; 75,000; 100,000; 250,000; 500,000; 1,000,000; 2,000,000 ohms. Can be hooked in parallel or series to provide great range of resistances. GUARANTEED accurate to within 10% plus or minus, most of them are within 5% plus or minus. Fine quality that insures a first class repair job and a satisfied customer. FREE COLOR CODE CHART included. Always valuable to a serviceman. No ohmmeter is needed to determine the value of resistors. GREAT TEST VALUE. Nothing ever before offered equals this your time using "add-it" resistors when you can get 24 of the very finest, select quality, carbon resistors obtainable for only \$2.75.

Place your order NOW. For the small purchase price of \$2.75 you will receive the finest kit of resistors ever offered. At no extra cost to you we will include the necessary simple formulas you need to find the value of resistors when hooked either in parallel or series. DON'T WAIT — SEND FOR THEM NOW!

Order direct from this Advertisement! CASH WITH ORDER OR C.O.D.



Please send RESISTOR KITS at \$2.75 Net, Plus Postage. Copy New 1932 Serviceman's Wholesale Price Guide (Attach your professional card).

Name.....
Street.....
City..... State.....

THE RADOLEK COMPANY
606 CANAL STATION CHICAGO, ILL.

F. & H. CAPACITY AERIAL



Price \$1.00 Complete postpaid

Every Instrument Tested on Actual 1127 Mile Reception A LARGE NUMBER ARE IN USE BY GOVERNMENT, IN NAVY HOSPITAL

The F. & H. Capacity Aerial Eliminator has the capacity of the average 75-foot aerial, 50 feet high. It increases selectivity and full reception on both local and long distance stations; is absolutely guaranteed. It eliminates the outdoor aerial along with the unsightly poles, guy wires, mutilation of woodwork, lightning hazards, etc. It does not connect to the light socket and requires no current for operation. Installed by anyone in a minute's time and is fully concealed within the set. Enables the radio to be moved into different rooms, or houses, as easily as a piece of furniture. 8,000 dealers handle our line. Dealers! Over 80 leading jobbers carry our line or order sample direct. Write for proposition.

SEND COUPON, IT PROTECTS YOU

Name

Address

City State

Send one F. & H. Capacity Aerial with privilege of returning after 3-day trial if not satisfactory, for which enclosed find check M. O. or dollar bill, or send C. O. D. Send Literature, Dealer's proposition.

F. & H. RADIO LABORATORIES
 Fargo, N. Dak. Dept. 19

TRIMM QUALITY PHONES

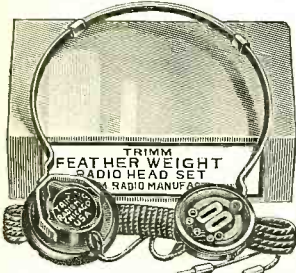

For the
Hard of Hearing
Church
Theatre
Amateur
Airplane
Servicemen
Scientist
Hospital
School
Office
Signal Service
Police Officer
Forest Ranger
Prospector
Mortician

Write for full information
TRIMM RADIO MANUFACTURING COMPANY
Headphone Specialists
1528-38 Armitage Avenue Chicago, Illinois

FILTERMATIC PRODUCTS

Help you to get the BEST possible reception from your RADIO set.

SUPER-FILTERMATIC The Modern Aerial (INDOOR OR OUTDOOR)

Thousands of satisfied users, praised by radio experts. Replaces all other aeriels, reduces static, and noises. Especially good on distance reception. Helps to separate stations, does not connect in light socket (therefore eliminating hum and line noises). It is very compact, measuring only 1 3/4 x 2 inches, is absolutely non-corrosive and non-directional, installed in one minute, no tools needed. Will never wear out. Eliminates trouble and expense of lightning-cresters. Can also be used in conjunction with your present aerial.

Price only \$2.00 postpaid.
Satisfaction guaranteed or money refunded.



ALL PROGRAMS Are Good with a FIL- TERMATIC. For all radios only \$1.00 post- paid.

Entirely automatic—no bothersome tuning. Improves tone, reduces static, brings in distance, increases volume, separates stations. Installed in one minute, no tools required, in series with your aerial or across your aerial and ground. Satisfaction guaranteed or money refunded.

Send check or money order. C. O. D. 25% with order. (No foreign C. O. D.) Money back guaranteed after 5-day trial. Service Men and Dealers Write for Particulars. Also information about Free local newspaper advertising.

FILTERMATIC MFG. CO.
(Dept. B-10) 4458 Frankford Ave., Philadelphia, Pa.

Grammar at a Glance

Speak and write correctly! Win business and social success. Here is a new method for simplifying English grammar that removes the mystery and makes learning easy. Self-testing system included. See improvement immediately. Written by Columbia University teachers. Send no money. Pay postman only \$1.25, plus postage. Refunded if not satisfied.

D. VAN NOSTRAND CO., 250-N 4th Ave., New York

Wrench Kit

Description—A handy set of seven midget type wrenches that should prove popular with the radio serviceman, dealer or me-

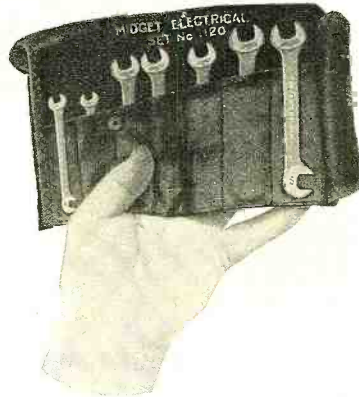

chanic. These wrenches are made of chrome-molybdenum material, which explains their small and light-weight design and the unusual strength of the tool. The wrenches have openings from 7/32 inch to 1/2 inch. The openings at both ends of the tool are of the same size, but are set at different angles, permitting a right-hand, left-hand or a head-on adjustment grip of the nut.

Maker—J. H. Williams & Co., 75 Spring St., New York City.

Short-wave Receiver

Description—The Reliable short-wave two-tube battery-operated receiver employs one -32 type tube and one -33 pentode tube

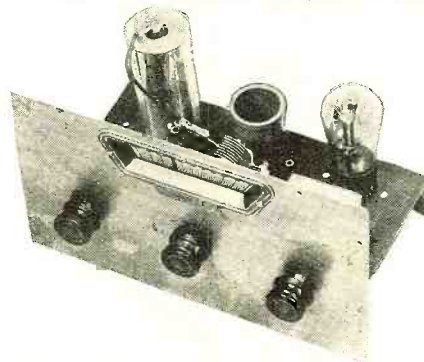

and is equipped with three plug-in type coils, covering a wavelength range of 14 to 105 meters. The set is constructed of standard parts, which includes the new Isolantite type tuning condenser. An attractive metal cabinet is available to enclose the complete receiver. The panel measures 11 inches long by 7 inches high.

Maker—Radio Surplus Corporation, 56 Vesey St., New York City.

Meter Shunts

Description—A recent announcement of importance to servicemen, dealers and all

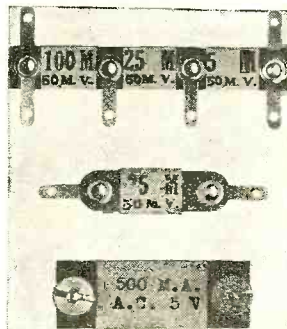

types of radio enthusiasts is the new line of "Van" meter dials, multipliers and a.c. (Continued on page 1070)

Read Classified Advertising—It Pays

Advertisements in this section twenty-six cents a word for each insertion. Name and address must be included at the above rate. Cash should accompany all classified advertisements unless placed by an accredited advertising agency. No advertisements for less than 10 words accepted. Objectionable or misleading advertisements not accepted. Advertisements for these columns should reach us not later than 1st of 2nd month preceding issue.

TECK PUBLISHING CORP.
350 Hudson St. New York, N. Y.

Corporation Service

INCORPORATE DELAWARE PREPARATORY financing invention, business. Retain perpetual control. Booklet, forms free. UNIVERSAL Incorporators, Dover, Del.

Correspondence Courses

Used correspondence school courses and educational books sold, rented and exchanged. Money-back guarantee. Catalog free. (Courses bought) Lee Mountain, Pisgah, Alabama.

CORRESPONDENCE COURSES—Sold, Bought, Exchanged, Rented. Bargain Catalogue Free. Hanfing, C-739 Broadway, New York.

Electrical

Build your own Fans. Twenty-inch aluminum propellers for aeroplane Fans, \$3.85. Will ship collect. Michael Electric Co., Ft. Worth, Texas.

For Sale

WESTERN ELECTRIC TRANSMITTER. 500 Watt with tubes, power panel and motor generator. For sale. Write Franklin McCoy, 203 Langley Road, Newton Centre, Massachusetts.

Inventions

INVENTIONS COMMERCIALIZED. Patented or unpatented. Write Adam Fisher Mfg. Co., 278 Enright, St. Louis, Mo.

Microphone Repairs

Guaranteed Microphone Repairs. Any make or Model. 24 hour service. Stretched diaphragm double-button repairs. \$7.50. Others \$3.00. Single-button repairs \$1.50. Write for 1932 catalog with diagrams. Universal Microphone Co., Ltd., Inglewood, Calif.

Patent Attorneys

PATENT YOUR IDEA NOW. Send for free book, "How to Obtain a Patent," and free "Record of Invention Blank." In business since 1898, specializing in patent matters, we have successfully served thousands of inventors. Little ideas may have big commercial possibilities. Delays are dangerous in patent matters—act at once and protect your idea. Reasonable fees. Confidential terms. Write us today. Victor J. Evans & Co., 616 F. Victor Bldg., Washington, D. C.

PATENTS, TRADE MARKS—All cases submitted given personal attention by a member of the firm. Information and booklet free. Lancaster, Allwine & Rommel, Suite 414, 815 15th St., N. W., Washington, D. C.

PATENTS—Advice and booklet free. Highest references. Best results. Promptness assured. Watson E. Coleman, Patent Lawyer, 724 9th Street, Washington, D. C.

PATENTS secured. Low cost. Write for book "How to Get Your Patent" and "Record of Invention Certificate." Personal skilful service assured. 35 years' experience. Preliminary advice free. L. F. Randolph, 343 Victor Building, Washington, D. C.

PATENTS—Time counts in applying for patents. Send sketch or model for instruction or write for free book, "How to Obtain a Patent" and "Record of Invention Form"; no charge for information on how to proceed. Clarence A. O'Brien, Registered Patent Attorney, 3094 Adams Bldg., Washington, D. C.

Photography

HAVE YOU A CAMERA? Write for free sample of our big magazine showing how to make better pictures and earn money. American Photography, 3105 Camera House, Boston, Mass.

Songwriters

COMPOSERS—VERSE OR MUSIC. Brilliant opportunity. Write at once. Van Buren, 2710 McClurg Bldg., Chicago.

Triple-Twin Amplifiers

(Continued from page 999)

transformer need not be split; the conventional center-tapped type being satisfactory. It will be seen that resistor R7 is omitted in the push-pull amplifier. As mentioned in March RADIO NEWS, the main purpose of this resistor is to cut down the hum level. In the push-pull amplifier the hum cancels out through phase difference in the two tubes, and hence R7 may be dispensed with. The by-pass condenser C2 may be omitted for the same reason.

The power output curve of this amplifier is shown in Figure 9. This curve shows that the maximum output is less than twice the output for a single tube. This discrepancy is explained by the fact that the overall ratio of the split transformer used in the push-pull amplifier whose power output curve is given is only 2-to-1. Since the

transformer in the single-tube amplifier also has a ratio of 2-to-1, it is evident that the grids of the push-pull tubes are receiving only half the voltage that they should in order to make a fair comparison with the single-tube amplifier. When a 4-to-1 or a 5-to-1 interstage transformer is used to feed a push-pull -95 amplifier, no difficulty is experienced in obtaining 12 to 15 watts. Incidentally, it is quite difficult to obtain a 4-to-1 push-pull input transformer with a split secondary, but doubtless such transformers will be available in the near future.

The power supply for this amplifier is similar to that of the single-tube amplifier except that it is capable of delivering 110 mils at 250 volts. The output transformer used with this amplifier must be capable of handling this current without saturation.

Radio News Technical Information Service

The Technical Information Service has been carried on for many years by the technical staff of RADIO NEWS. Its primary purpose is to give helpful information to those readers who run across technical problems in their work or hobby which they are not able to solve without assistance. The service has grown to such large proportions that it is now advisable to outline and regulate activities so that information desired may come to our readers accurately, adequately and promptly.

Long, rambling letters containing requests that are vague or on a subject that is unanswerable take up so large a portion of the staff's working time that legitimate questions may pile up in such quantities as to cause a delay that seriously hinders the promptness of reply. To eliminate this waste of time and the period of waiting, that sometimes occurs to our readers as a consequence, the following list of simple rules *must* be observed in making requests for information. Readers will help themselves by abiding by these rules.

Preparation of Requests

1. Limit each request for information to a single subject.
2. In a request for information, include any data that will aid us in assisting in answering. If the request relates to apparatus described in RADIO NEWS, state the issue, page number, title of article and the name of the device or apparatus.
3. Write only on one side of your paper.
4. Pin the coupon to your request.

The service is directed specifically at the problems of the radio serviceman, engineer, mechanic, experimenter, set builder, student and amateur, but is open to all classes of readers as well.

All questions from subscribers to RADIO NEWS will be answered free of charge, provided they comply with the regulations here set forth. All questions will be answered by mail and not through

the editorial columns of the magazine, or by telephone. When possible, requests for information will be answered by referring to articles in past issues of the magazine that contain the desired information. For this reason it is advisable to keep RADIO NEWS as a radio reference.

Complete information about sets described in other publications cannot be given, although readers will be referred to other sources of information whenever possible. The staff cannot undertake to design special circuits, receivers, equipment or installations. The staff cannot service receivers or test any radio apparatus. Wiring diagrams of commercial receivers cannot be supplied, but where we have published them in RADIO NEWS, a reference will be given to past issues. Comparisons between various kinds of receivers or manufactured apparatus cannot be made.

Only those requests will be given consideration that are accompanied by the current month's coupon below, accurately filled out.

JUNE, 1932

Technical Information Coupon
RADIO NEWS Laboratory
350 Hudson Street
New York, N. Y.

Gentlemen:

Kindly supply me with complete information on the attached question:

- I am a regular subscriber to RADIO NEWS and I understand this information will be sent me free of charge.
- I am not yet a subscriber to RADIO NEWS.
- I wish to become a subscriber to RADIO NEWS and enclose \$2.50 to receive the magazine regularly for one year, and to receive this valuable technical information service free of charge.

Name

Address

UPPCO-AC-DC

Constant Potential Motor Car Generators

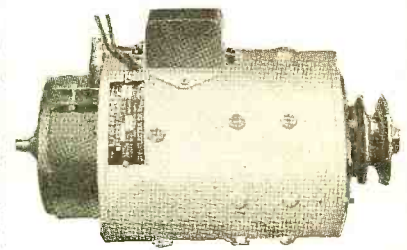

An Outstanding Achievement In Auto-Radio Installation

The new "Uppco" A.C. constant Potential Generator meets the requirements for operation of A.C. receivers and Sound Amplifying Systems.

FEATURES

Maintains 110 volts at variable speeds. No governors or other regulating device is used. All current control is within generator. All units supply 6 volts of D.C. for motor car battery charging. Models are available in different wattage ratings: Model A—110 watts, Model B—150 watts, Model C—300 watts.

For descriptive literature and prices write
UPP ELECTRIC COMPANY
303 N. Westport Ave., Kansas City, Mo.

A NEW Service Kit —and a NEW Service

Lynch Servicemen's HANDIPAKS contain a Resistor Assortment of one or two-watt Metallized Resistors. The two formulas contained in each Handipak make possible hundreds of additional resistance values to meet every emergency. \$1.00 Lynch Resistor Replacement Manual FREE with each Handipak.

To Service-	Your
men—	List
	Cost
1-watt Handipak	\$3.00 \$1.80
2-watt Handipak	\$4.00 \$2.40

Lynch Resistor Replacement Manual can also be bought for \$1.00.



Send order today for Handipak, including the Manual, or write for FREE RMA ColorCodeCard and complete catalogue.
LYNCH MFG. CO., Inc., 1775N B'way, N. Y. C.

Telegraphy

Step into this interesting—uncrowded—HIGHLY PAID Profession. Become a trained operator in Morse or Radio Code, easily, quickly, at home, with TELEPLEX, the Master Teacher. Used by the U. S. Government and leading schools. Entirely new code course in 12 rolls of tape. During last ten years TELEPLEX has trained more operators than all other methods combined.

Write for Folder E-6
TELEPLEX CO.
76 Cortlandt St., New York, N. Y.

Learn AT HOME With
teleplex





Insure YOUR WORK
with
CLAROSTAT Replacement VOLUME CONTROLS

CLAROSTAT Replacement Volume Controls are "Custom-made" to exactly suit the receivers for which they are offered. Not a makeshift job for idea.

The resistance, taper, shape and shaft are made according to the proper specifications. There is no delay in installing them. There are no comebacks when you use CLAROSTAT Products.

See the new CLAROSTAT CONTROL HANDBOOK AND CATALOG for 32 pages of dope for servicemen. Sent for your FREE copy.

CLAROSTAT Mfg. Co.
285-287 N. 6TH ST. BKLYN. N.Y.

SUPREME DRY ELECTROLYTIC CONDENSERS at NEW LOW PRICES



Servicemen Dealers and Manufacturers can save money by buying the **SUPREME LINE**

These condensers are made to give you quality satisfaction at low cost. Listed below are a few of the types for immediate delivery

Tot. Capacity	En. Anode	Price	Tot. Capacity	En. Anode	Price
1 MFD	24	\$.34	8-8-8	8	1.45
2	2	.44	8-8-8	8	2.10
4	4	.50	9-9-18	2	2.35
8	4	.60	8-18-18	3	3.50
12	6	.80	9-9-18-18	3	3.50
12	6	1.30			
8	4	.64	2	2	.30
8	4	.70	4	4	.35
8	4	.70	8	8	.48
14	2-4-8	1.34	Cartridge Type		
16	8-8	1.07	1/2		.20
18	6-9	1.17	1		.28
20	15-5	1.45	2		.33

ALL condensers 500 V. Peak. Guaranteed against any electrical defect. When ordering from this list send 20% cash with C. O. D. orders. 2% cash discount allowed when full remittance is sent with order. Write for Prices on all Special Sizes of Electrolytic Condensers Not Listed.

SUPREME SPECIALTIES CO.
136 Liberty Street New York, N. Y.

You Can Become a Fast, Capable RADIO OPERATOR at Home

CANDLER Scientific System

In less than half the usual time. Amazing results. Thousands of fast Radio operators taught by CANDLER. FREE advice if you're "stuck."

All questions answered personally. No obligation. If Radio operator, ask about **ADVANCED COURSE for SPEED and Copying Behind and "MILL"** Course. **FREE BROCHURE** will save you time and money. Tune in on Candler Short Wave Station!

CANDLER SYSTEM CO., Dept. RN-6
6343 So. Kedzie Ave., Chicago, Ill.

World's Only Code Specialist



E. J. Yarriss, Chicago, copied 8 wms with first lesson. C. Lane, Portland, Ore. does 20 words on third lesson.

COMPLETE TELEVISION SCANNER \$8.50

Driving motor, synchronous motor, double spiral 16-inch disc, adjustable lamp bracket, etc., completely assembled, ready to operate. Order now.

Short wave one-tube kit. All parts necessary to build a knock-out one-tube set. \$5.95
Two-tube receiver kit (with pentode). 6.75
Three-tube kit (with pentode). 8.20

HARRISON RADIO CO.
142 LIBERTY ST. Dept. N-6 NEW YORK CITY

What's New in Radio

(Continued from page 1068)

d.c. meter shunts for use with the d.c. or the rectified a.c.; -0 to 1 milliammeter and the new type of a.c.-d.c. universal meter. With this equipment it is possible to increase the range of these instruments and to permit their use as ohm and capacity meters. The a.c. and d.c. shunts as shown in the illustration are made of non-corrosive alloy wire with a temperature co-efficient of practically zero up to 900 degrees.

Maker—D. L. Van Leuven, 4323-54th St., Woodside, New York.

Motor Radio Receiver

Description—A compact seven-tube super-heterodyne automobile set, utilizing three of the new -39 radio-frequency pentode tubes

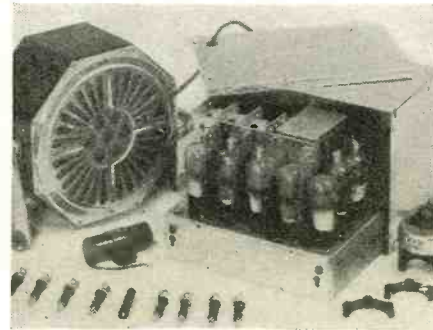

and two of the new -LA type power pentode tubes. The other tubes include one -37 type and one -38 type. The receiver chassis is enclosed in a dust-proof case and the remote control is so constructed as to eliminate backlash. This receiver makes use of either the Wright-DeCoster or Utah reproducer.

Maker—Universal Auto Radio Corp., 1223 S. Michigan Ave., Chicago, Ill.

Combination Home Recorder and Reproducing Device

Description—This Recordovox comprises a combined reproducer and recorder head with



a control box. This unit replaces the usual tone arm of the phonograph and with the proper connection by the aid of the adapters, the sound is reproduced through the audio amplifier system and loudspeaker of the radio set. No tools are required for installing this equipment. It is designed to work with



any type of receiver and phonograph. Provision is made for the connection of a hand microphone, to be used in speech recording.

Maker—Pacnet Electric Co., 91-7th Avenue, New York City.

INDEX TO ADVERTISERS

A	
Aerovox Wireless Corp.	1056
All American Service	1072
Alumaweld Co.	1050
American Sales Co.	1064
Amperite Corp.	1054
B	
Baltimore Radio Corp.	1071
Blan the Radio Man, Inc.	1046
Broderick, Wm. H.	1056
Bud Speaker Co.	1047
C	
Candler System Co., The	1070
Capitol Radio Engineering Inst.	1054
Central Radio Labs.	1063
Chicago Radio Apparatus Co.	1062
Clarostat Mfg. Co., Inc.	1070
Coast to Coast Radio Corp.	1058
Concourse Electric Co.	1049
Coyne Electrical School	1053
Classified	1068
D	
Deutschmann Corp., Tobe	1065
Dubilier Condenser Corp.	1072
E	
Eastern Rabbitry	1072
Electrad, Inc.	1047
Evans & Co., Victor J.	1050
F	
F & H Radio Laboratories	1068
Federated Purchaser, Inc.	1057
Filtermatic Mfg. Co.	1068
Fox Engineering Co.	1048
G	
Grant Radio Labs.	1072
H	
Hammarlund Mfg. Co.	1049
Harrison Radio Co.	1070
Hearing Devices Co., Inc.	1047
Hoodwin Co., Chas.	1048
I	
International Air Research	1048
International Correspondence Schools	1072
International Resistance Co.	1051
J	
J. F. Distributing Co.	1062
J. M. P. Mfg. Co.	1046
Jewell Electrical Instrument Co.	1059
L	
Lincoln Radio Corp.	1052
Luxtron Mfg. Co., Inc.	1052
Lynch, Arthur H.	1046
Lynch Mfg. Co., Inc.	1069
Mc	
McGraw-Hill Book Co., Inc.	1050
M	
Macy Electrical Products Co., Inc.	1058
Marquette Radio, Inc.	1060
Massachusetts Radio & Telegraph School	1064
Metal Cast Products Co.	1072
Mid-west Radio Corp.	985
Miller & Miller	1064
N	
National Co., Inc.	1045
National Electrical & Automotive School	1067
National Jobbing & Export Co.	1058
National Radio Inst.	3rd Cover
N. Y. City Cancer Committee	1066
R	
RCA Institutes, Inc.	1046, 1056, 1071
Racon Electric Co., Inc.	1062
Radio Electric Service Co., Inc.	1050
Radio Products Co., The	1052
Radio Publishers Service	1064
Radio Surplus Corp.	1062
Radio Technical Pub. Co.	1058
Radio Television Industries Corp.	1049, 1071
Radio Trading Co.	1060
Radio Training Association of America	977
Radio Treatise Co., Inc.	1056
Radolek Co.	1067
Readrite Meter Works	1061
S	
Scott Radio Labs., Inc., E. H.	980:1-2:3
Shallercross Mfg. Co.	1064
Short Wave Craft	1049, 1054
Silver-Marshall, Inc.	4th Cover
Skrondal, John R.	1048
Supreme Instruments Corp.	1055
Supreme Specialties Co.	1070
T	
Teleplex Co.	1069
Trimm Radio Mfg. Co.	1068
U	
Universal Microphone Co.	1060
Uron Industries, Inc.	1047
Upp Electric Co.	1069
V	
Van Nostrand Co., D.	1068
W	
West Side Y. M. C. A. Radio Inst.	1060
Wholesale Radio Service	1062

Radio Science Abstracts

(Continued from page 1042)

curves because of a reversed curvature which appears at the lower ends. It is pointed out that the screen-grid tube should function similarly to a high- μ three-element tube in this type of operation. The screen-grid tube as the three-element tube, but its dynamic characteristic tends to bend more rapidly at the upper end.

Constant Frequency Oscillators, by F. B. Llewellyn. The Bell System Technical Journal, January, 1932. The vacuum-tube oscillator has proven to be one of the most valuable tools available to the engineer. Such oscillators are used in large variety laboratory and commercial apparatus. This article discusses the manner in which the frequency of the vacuum-tube oscillator depends upon the operating voltage, is therefore important and timely. Experimental

data are cited which show the degree of frequency stability which may be expected as a result of application of the methods outlined in the theory, and also show that the best adjustment is in substantial agreement with that predicted by theory. With a carefully built and adjusted oscillator the effects of normal variations in the operating voltages are negligible in comparison with the effects of temperature variations resulting from the changed operating currents. Methods for preventing these latter effects are not discussed in the present paper. The appendix contains an analysis of the conditions under which the performance of an oscillator may be represented by the use of linear circuit equations.

Technique of Microphone Calibration, by Stuart Ballantine. The Journal of the

RADIO NEWS Export Service

AS a service to our readers in locations outside the United States of America, either commercial, professional or private individuals, RADIO NEWS will arrange to provide contact with leading American manufacturers of radio supplies and receiving equipment.

To utilize this service, clip and fill out coupon below and send it attached to your letter on which you list the types of apparatus you are interested in.

Our Export Service Department will refer your inquiries direct to the proper manufacturers, asking them to send you full particulars, catalogues, prices, etc.

* * *

ALS einen Dienst für unsere Leser, entweder Kaufleute oder Privatpersonen ausserhalb der Vereinigten Staaten von Amerika, kann RADIO NEWS mit den führenden Amerikanischen Fabrikanten von Radio Apparaten Kontakt herstellen.

Für den Gebrauch dieses Dienstes schneide man den Kupon aus und sende denselben mit einer Liste von Apparaten die für Sie von Interesse sind.

Unsere Export Abteilung wird Ihr Schreiben umgehend an die betreffenden Fabrikanten weiter befördern, mit der Bitte Ihnen Auskünfte, Preise und Kataloge zu senden.

* * *

COMME un service à nos lecteurs demeurant hors des Etats-Unis d'Amérique, soit établissements commerciaux, soit personnes privées, RADIO NEWS arrangerá de procurer le "contact" avec les usines les plus importantes des appareils de T. S. F. en Amérique.

Pour utiliser ce service, coupez, signez, etc., le coupon sur cette page et envoyez le attaché à votre lettre en énumérant les types des appareils qui vous intéressent.

Notre Département d'Exportation fera suivre vos requêtes aux manufacturiers directement en les priant de vous envoyer toutes informations, catalogues, prix, etc.

* * *

COMO un servicio especial a nuestros lectores que se encuentran fuera de los Estados Unidos de America, ya sean comerciantes, profesionales o personas privadas, RADIO NEWS tendra a bien ponerlas en contacto con los principales centros manufactureros de radio, de aparatos receptores y accesorios.

Para beneficiarse de tal servicio, sírvase recortar el coupón de esta página, enumere los tipos de aparatos que le interesen, y envíenlosla con su carta.

Nuestro Departamento de Exportación se encargará de ponerse en contacto directo con dichos centros, pidiendo le envíen información completa, catalogos, precios, etc.

* * *

RADIO NEWS Export Service Department

Kindly put me in contact with American firms manufacturing the class of radio apparatus noted on attached sheets.

Name.....

Address.....

Business.....

IS YOUR FUTURE

A Question Mark



Then learn what radio training can do for you.

If you are unsettled about your future—consider the future and opportunities in radio. Each of its interesting branches offer advancement, adventure, excitement! But you must be trained!

Get this training at RCA Institutes. America's oldest radio school, founded nearly a quarter century ago. Now has four big resident schools, New York, Boston, Philadelphia, Chicago.

Modern equipment throughout. Expert instructors. Association with radio's largest research laboratory. Elementary, advanced courses in every branch of practical radio. Tuition very moderate. Easy payment terms. Mark and mail coupon now—before you forget, to nearest school: New York, 75 Varick St.; Boston, 899 Boylston St.; Philadelphia, 1211 Chestnut St.; Chicago, 1154 Merchandise Mart.

A Radio Corporation of America Subsidiary



RCA INSTITUTES, INC.
Home Office, Dept. RN-6
75 Varick St., New York

Please send me your General Catalog. I am checking below the phase of radio in which I am interested.

- Radio Broadcasting (New York only)
- Radio Servicing (all schools)
- Advanced Service (New York and Phila.)
- Sound Motion Picture (New York and Chicago)
- Aviation and Marine Operating (all schools)

Name.....Age.....

Address.....



THE R. T. I. C. RIBBON MICROPHONE

To our complete line of lapel, carbon, and condenser types we add Dynamic Microphones.

Simplicity: Ribbon diaphragm driving magnetic pickup feeding two-stage amplifier.

Fidelity: Perfectly flat curve from 80 to 8000 cycles.

Non-Microphonic: Specially designed spring mounting.

Adaptability: Connects to usual input without circuit change.

Write for technical data on this and other microphones.

RADIO TELEVISION INDUSTRIES CORP.

130 W. 42 St., Dept. N-2, N. Y. City



NEW STRATFORD TRIPLE-TWIN AMPLIFIER

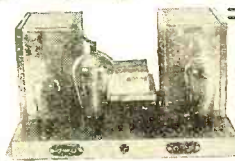

THIS AMPLIFIER HAS AN OUTPUT OF OVER 5 WATTS with only 3 tubes including the TRIPLE-TWIN. It is designed for use with a high-impedance pickup. It can also be used as a microphone amplifier in public address systems with the addition of a matching transformer.

Priced special at..... \$19.85

SPEED Tubes (227-295 & 280)..... \$3.30

Send orders or requests for catalog

BALTIMORE RADIO CORP.
725N Broadway New York City

LISTENERS' OFFICIAL RADIO LOG

World Short Wave Stations—Police—Aeronautical—Relay and Telephone Stations, also Aeroplane and Amateur Bands—Cross Tabulated by Call, Frequency, Location and Time of Broadcast. An accurate, up-to-date 32-page Call Book. Contains all broadcasting stations from 15 to 550 meters, with World Wide and U. S. Time Map. Jobbers, Dealers, Mrs., Service Men—write today on letterhead for sample and quantity price, others send 25c.

ALL AMERICAN SERVICE
5707 N. Clark St.
CHICAGO, ILL.



Tune in on This

New Radio Course

IT PROVIDES an easy way to prepare for a good position in radio work. It furnishes a broad knowledge of radio that applies to the job at hand, whether that job be the simple act of removing a tube or figuring on the most modern installation. It explains the technicalities of radio in clear, understandable language, first laying a fine mathematical background.

There is no better way for you to succeed in radio than to study this new course of the International Correspondence Schools. Every day new students are finding out its many advantages. The course is endorsed by leading radio experts and radio manufacturers.

Mark and mail the coupon today and let us tell you what the new Radio Course can do for you.

Mail the coupon for FREE booklet

International Correspondence Schools
Box 8281-L, Scranton, Penna.

Without cost or obligation, please tell me all about the **NEW RADIO COURSE**

Name _____
Street Address _____
City _____ State _____

Acoustical Society of America, January, 1932. The author considers here some of the more important methods of calibrating microphones. These methods are considered both theoretically and practically and comparisons are made of the calibrations obtained using various methods. In connection with the thermophone method, the author indicates loss of pressure due to leakage of sound through capillary ducts and to the spurious rise in pressure which occurs when air instead of hydrogen is used in the thermophone. Several curves are given showing the effect of cavity resonance and the variation in response with the angle between the source of sound and the axis of the microphone.

On the Loudness of Noise, by H. B. Marvin. The Journal of the Acoustical Society of America, January, 1932. The author points out, in the introductory paragraph of the paper, the fact that the ear sensitivity varies with frequency and that the curves which have been published, showing this variation, have nearly all been made using pure tones. In this paper is described the method of measuring loudness which involves adjusting the loudness of a noise until it appears to be equal to the intensity of a pure tone. Both the noise and the pure tone are measured with an audio noise-meter and the results compared. The noise-meter is corrected for frequency and intensity level.

Dual Loudspeakers for Broadcast Receivers, by W. Austin Ellmore. Radio Engineering, March, 1932. The last year has seen an increase in the number of receivers utilizing two loudspeakers with characteristics such that the lower and medium audio frequencies are reproduced by one loudspeaker and the higher audio frequencies by the other loudspeaker. This article makes no attempt to discuss the problem in any detail, but simply endeavors to point out the trend which has taken place and to indicate some of the factors, such as response characteristics, field-supply power and others, which must be considered in the development of receivers using dual loudspeakers.

Television Progress from an Engineering Viewpoint, by Dr. Paul G. Weiller. Radio Engineering, March, 1932. This article might be termed just a summary, since it is in effect a discussion of the various television reproducing systems such as those using a lens disc, cathode-ray tube, gas-filled tubes and neon tubes. A method is shown of applying a timing axis with cathode-ray tubes. A circuit is also given for the hot-cathode grid-controlled rectifier.

Latest Patents

(Continued from page 1039)

of which paths includes a large capacity and offers a high resistance to the oscillations to be amplified but which allows the passage of high frequency oscillations, the other of said paths including a lower capacity and offering a high resistance to high frequency oscillations and a low resistance to low frequency oscillations, a grid leak resistance, the said grid being connected to points of said leak resistance and said low capacity where the potential amplitude of the high frequency oscillations has already been substantially reduced but where the amplitude of the low frequency oscillations is substantially unweakened, said leak resistance being shunted by the large capacity.

STANDARD SINCE 1910

Dubilier announces—

ADVANCED ENGINEERING
Fresh blood, fresh ideas, fresh enthusiasm have been added to unparalleled Dubilier experience. Dubilier engineering was never more efficient.

ADVANCED PRODUCTION
Dubilier laboratory results are being translated into good products at lowest prices in the largest plant devoted exclusively to condensers, insuring better values than ever.

ADVANCED FEATURES
For the past six months the Dubilier staff has studied, refined and put into production improved types of condensers for every purpose. Type for type, Dubilier condensers are outstanding.

WRITE! The story is too long to be told here. So why not write for literature covering any types in which you are particularly interested. And if you seek added profits, why not handle the Dubilier line?



DUBILIER
Condenser Corporation
4377 Bronx Blvd. New York



START YOUR OWN BUSINESS
SPARE TIME OR FULL TIME
Casting Metal Toys and Novelties Offers You the Chance to Make Money

Big demand for 5 and 10c Store Novelties, Toy Soldiers, Animals, Ashtrays, etc., calls for additional production. High import duty and present conditions in Germany offer chance for an enormous business here.

We cooperate in selling goods you make, give you lists of dealers handling such Toys and Novelties and furnish you circulars to mail out and with which to get the orders.

NO EXPERIENCE or special place needed and we furnish casting forms for production of steady sellers. A chance of a lifetime for man with small capital to get into a new industry and with our backing build up a big and profitable business.

For full information write AT ONCE to
METAL CAST PRODUCTS CO., Dept. 12
1696 Boston Road, New York City
Established 1912



NEW Radio Handbook

CONTAINING: Sent postpaid
Technical Information. **25c**
Volume Control Guide.
Transformer and Condenser Guide.
Radio Replacement Parts Catalog.

Hard to Get Parts—We have them. Send us your repair work for estimate.

Grant Radio Laboratories
6521-N South Halsted St., Chicago, Ill.

MAKE \$10,000

A year raising rabbits for us. We pay up to \$12.00 each for all you raise. Send 25c for full information and contract, everything explained. Send at once and find out about this big proposition we have to offer you.

THE EASTERN RABBITRY
Route 1, Box 236 New Freedom, Pa.

AMAZING STORIES MAGAZINE

If you would live again the thrills you knew when reading Jules Verne for the first time—if you would know life from fifty to thousands of years from now—if you would revel in the most stimulating, vivid fiction of the day—read **AMAZING STORIES** Quarterly.

Fantastic, yet fascinating—incredible, yet probable—weird, yet somehow sane, these amazing stories fire your imagination, but never strain it!

Spring-Summer Issue
NOW ON SALE—50c

Will Show You Too

How to Start a Spare Time or Full Time

Radio Business of Your Own



J. E. SMITH, President
National Radio Institute

The man who has directed the Home-Study Training of more men for the Radio industry than any other man in America.

Here are a few examples of the kind of money I train "my boys" to make

Started with \$5 Now has Own Business



that is play." Howard Houston, 512 So. Sixth Street, Laramie, Wyo.

\$700 in 5 Months Spare Time

"Although I have had little time to devote to Radio my spare time earnings for five months after graduation were approximately \$700 on Radio, sales, service and repairs. I owe this extra money to your help during the time I studied and since graduation."—Charles W. Linsey, 537 Klatsi St., Denver, Colo.



\$7396 Business in 2 1/2 Months



business have been \$7,396.25. If I can net about 20% this will mean a profit of about \$1,500 to me."—John F. Kirk, Kirk Sales and Service, Union Block, Spencer, Iowa.

My Free book gives you many more letters of N. R. I. men who made good in spare time or full time businesses of their own

Without Capital

I give you instructions early in your Course for doing 28 Radio jobs common in every neighborhood. Many N. R. I. men begin making money soon after they enroll. I show you how N. R. I. graduates have built up good businesses of their own. I show you how to install and service all types of receiving sets. I give you Radio equipment and instructions for building circuits, testing equipment, and for making tests that will give you broad, practical experience. I give you a Money-Back Agreement and Lifetime Employment Service. Clip the coupon below and get my free 64-page book, "Rich Rewards in Radio"—it gives you a full story of the success of other N. R. I. students and graduates, and tells how you can start a spare or full time Radio business of your own without capital.

Many N. R. I. Men Have Made \$200 to \$1,000 in Spare Time While Learning

Many of the more than sixteen million sets now in use are only 25% to 40% efficient. I will show you how to cash in on this condition. I will show you the plans and ideas that have enabled many others to make \$200 to \$1,000 in spare time while learning. G. W. Page, 1606-B Fifth Ave., N., Nashville, Tenn., writes: "I made \$935 in my spare time while taking your course."

Get Ready Now for Jobs Like These

Broadcasting stations use engineers, operators, station managers, and pay up to \$5,000 a year. Radio manufacturers use testers, inspectors, foremen, engineers, service men, and buyers for jobs paying up to \$6,000 a year. Shipping companies use hundreds of operators, give them world-wide travel with board free and good pay besides. Radio dealers and jobbers employ hundreds of service men, salesmen, buyers, managers, and pay up to \$100 a week. Talking Movies pay as much as \$75 to \$200 a week to the right men with Radio training. My book tells you of the opportunities in Radio, Talking Movies, Set Servicing, Aircraft Radio, and other fields.

I Will Train You at Home in Your Spare Time

Hold your job until you're ready for another. Give me only part of your spare time. You do not need a high school or college education. Hundreds with only a common school education have won bigger pay through N. R. I. J. A. Vaughn jumped from \$35 to \$100 a week. E. E. Winborne seldom makes under \$100 a week now. The National Radio Institute is the Pioneer and World's Largest organization devoted exclusively to training men and young men by Home Study for good jobs in the Radio industry.

You Must Be Satisfied

I will give you an agreement to refund every penny of your money if you are not satisfied with my Lessons and Instruction Service when you complete my course. And I'll not only give you thorough training in Radio principles, practical experience in building and servicing sets, but also Advanced Training in any one of five leading branches of Radio opportunities.

My 64-Page Book Gives the Facts

Clip and mail the coupon now for "Rich Rewards in Radio." It points out the money-making opportunities the growth of Radio has made for you. It tells of the opportunities for a spare time or full time Radio business of your own, the special training I give you that has made hundreds of other men successful; and also explains the many fine jobs for which my course trains you. Send the coupon to me today. You won't be obligated in the least.

Get my new book
It points out
what Radio
Offers You



.. NEW Radio Equipment for Broad Practical Experience Given Without Extra Charge

With the aid of this equipment you can work out with your own hands many of the things you read in our text books. From it you get the valuable experience that tells an expert from a beginner. In a short time you have learned what it would take years to learn in the field. It's training like this that puts the extra dollars in your pay envelope. Some of the many circuits you build and experiments you perform are: Measuring the merit of a tube, building an ohmmeter, tube voltmeter, and a Grid dip meter for service work. You actually make experiments illustrating the important principles in the 25 best known sets.

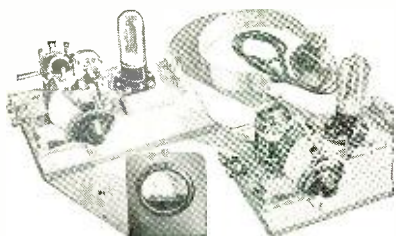

Apparatus for transmission and reception of an actual radio signal—one of the many experiments set up with my outfits.

Special Offer

Act now and receive in addition to my big free book, "Rich Rewards in Radio," this Service Manual on D.C., A.C. and battery-operated sets. Only my students could have this book in the past. Now readers of this magazine who mail the coupon will receive it free. Overcoming hum, noises of all kinds,

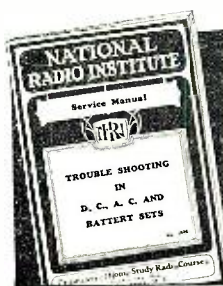

fading signals, broad tuning, howls and oscillations, poor distance reception, distorted or muffled signals, poor Audio and Radio Frequency amplification and other vital service information is contained in it. Get a free copy by mailing the coupon below. ACT NOW.

J. E. SMITH, President
Dept. 2FR
National Radio Institute
Washington, D. C.

THIS COUPON IS GOOD FOR ONE FREE COPY OF MY NEW BOOK

mail it TODAY

J. E. SMITH, President,
National Radio Institute, Dept. 2FR
Washington, D. C.

I want to take advantage of your Special Offer. Send me your two books, "Trouble Shooting in D.C., A.C. and Battery Sets" and "Rich Rewards in Radio." I understand this does not obligate me and that no salesman will call.

Name Age

Address

City State

"M"

SM

Beat This Record! 31 Countries and 5 Continents in One Month—with a 727SW



For the First Time
in Radio History—
the Best AND the
Cheapest

\$ **58** ⁵¹/_{NET}

The Silver-Marshall all-wave 727SW (550 to 18,000 kilocycles) is a receiver that cannot be outperformed station for station. It has 10 tubes that all operate on both broadcast and short-wave. Automatic volume control that eliminates fading on distance tuning. Meter tuning. Fractional microvolt sensitivity. 10kc selectivity. And it has an EXCLUSIVE S-M feature—COLOR TUNING. It is a dial on which ALL the bands are accurately calibrated. It is as easy to find HRB, Tegucigalpa, Honduras, as it is to find KDKA.

The price of the 727SW chassis and speaker (factory wired and tested under the personal supervision of McMurdo Silver) is \$58.51 NET.

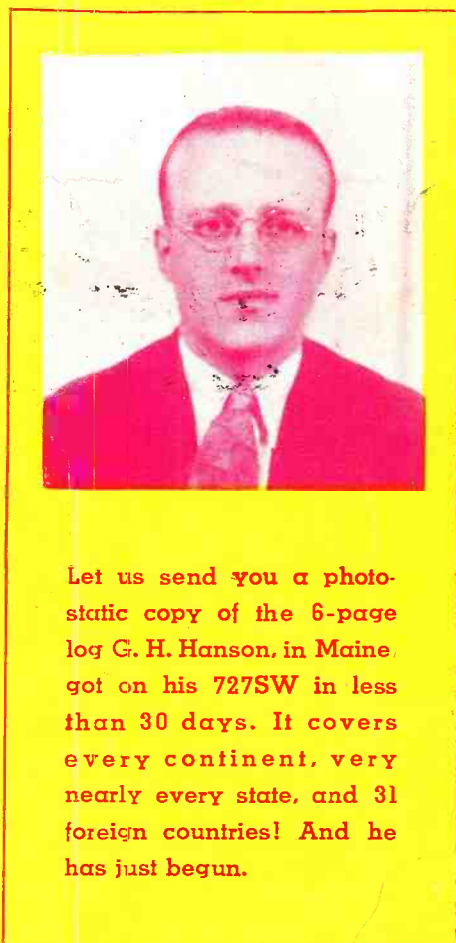

Let us send you a photo-static copy of the 6-page log G. H. Hanson, in Maine, got on his 727SW in less than 30 days. It covers every continent, very nearly every state, and 31 foreign countries! And he has just begun.

Tear out part of this page—pin a \$5 bill to it with your name and address, and the 727SW will be shipped balance C. O. D. Play with it for 10 days—give it every operating test. And if it is not the best receiver you ever tuned, return it and your money will be promptly refunded.

The 727DC (550 to 1500 kc) chassis and speaker for operation with the new Eveready Air-Cell battery is \$40.87 NET
Write for details.

SILVER-MARSHALL, Inc.

6405 W. 65th St.
Chicago, U. S. A.

Enclosed find \$5. Send 727SW balance C. O. D. for ten day trial.

Please send me FREE a copy of G. H. Hanson's log.

Send 727DC details.

Name.....

Address.....

SILVER-MARSHALL, Inc.

6405 West 65th Street Chicago, U. S. A