

RADIO NEWS

**JUNE
25 Cents**

**Writing
Sound's
Autograph**

**Auto Radio
Latest Radio Patents
New Superheterodynes**

NOTE: We have no connection with any company using a similar name.



EXPERIMENTERS, JOBBERS AND DEALERS

WRITE TODAY FOR OUR PRICES

Baird TELEVISION

THE MOST SIMPLE AND EFFICIENT SHORTWAVE AND TELEVISION KIT POSSIBLE

WE make no exaggerated claims, but we have a kit that is a pleasure to build and a delight to operate. Easy tuning. Single-dial control. Operates a dynamic or magnetic speaker. Quality equal to any high-class broadcast receiver. A.C. operated. **NO A.C. HUM INTERFERENCE, ESPECIALLY BELOW 50 METERS.** Earphone jack. Phonograph pick-up. All-aluminum chassis. Coils and screen-grid tubes individually shielded. Carefully shielded variable condensers. Two shielded stages of screen-grid radio frequency. Shielded screen-grid detector. Uses famous Octocoils. Highest quality resistance-coupled amplification. 245 power tube. Wave length range 15 to 550 meters.

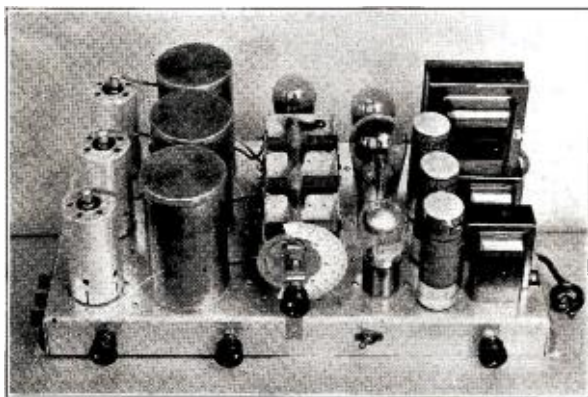

And most important of all, designed for TELEVISION.

Don't be misled. You cannot get satisfactory TELEVISION unless your receiver is built for TELEVISION. Your audio amplifier must cover a frequency band of 10 cycles to 40,000 cycles to get a good picture and regular shortwave sets only cover a frequency band of 100 cycles to 5,000 cycles. Tune in the world on your loud speaker or your favorite Television stations for pictures. A remarkable receiver for export trade. Our receivers now in use in foreign countries are giving wonderful results. **AND HOW THE PRICES WILL SURPRISE YOU!**

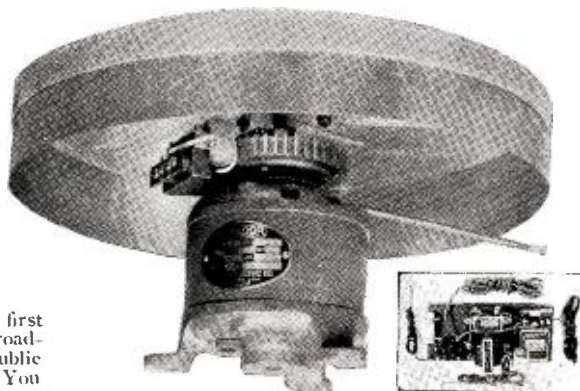

OUR Television Station W1XAV was the first station in the world to televise regular broadcast programs. So do we lead in offering the public the most simple television kit so far designed. You will be amazed at the simplicity of construction—the facility of operation. It will take you less than an hour to put it together and one minute to make it work and actually SEE TELEVISION PICTURES. In conjunction with the above receiver or kit you will be able to tune in Television stations and get the new and wonderful thrill of SEEING PICTURES. The only television kit offered which has horizontal scanning equipment covered by patents pending. This is the only satisfactory distortionless method of Television reception. Automatic synchronization of pictures. No fussing, no struggling to keep your picture in frame.

SHORTWAVE & TELEVISION CORPORATION
70 Brookline Avenue, Boston, Massachusetts

SHORTWAVE & TELEVISION CORPORATION,
70 Brookline Avenue,
Boston, Massachusetts.

Dept. B

Please send me the following for experimental purposes:

- No. 25 Complete Short Wave Kit, wave length range 15 to 550 meters, including 2 sets of OCTOCOILS, blue print and construction manual (Less tubes and cabinet).....\$56.25
 - No. 26 Television Kit complete with Lens, Television Lamp, Synchronizing Amplifier, Synchronizing Motor and Cabinet. Check 45-48-60 line.....\$60.00
 - No. 35 Short Wave Receiver, complete in metal cabinet, including 2 sets of OCTOCOILS (Less tubes).....\$82.75
 - No. 36 Television Receiver, completely assembled in cabinet. Ready to operate in conjunction with a No. 25 or No. 35 Short Wave Receiver.....\$75.00
 - OCTOCOILS, set of four coils, wave length range 15 to 200 meters.....\$3.75
- Diagram of 3-tube Tuner sent free on request with stamped self-addressed envelope.

Name Address

State City

Train *with* R.T.A. *for* Radio Service Work

Important and far-reaching developments in Radiocreatesudden demand for specially equipped and specially trained Radio Service Men.



With this
Radio Set Analyzer
(sent to every Member)
You Can Earn
\$3.00 an hour

THOUSANDS of skilled Radio Service Men are needed now to service all-electric sets. By becoming a certified R. T. A. Service Man, you can earn \$3.00 an hour full time or spare time, and fit yourself for the big-pay opportunities that Radio offers.

We will quickly give you the training you need to qualify as a Radio Service Man . . . certify you . . . furnish you with a marvelous Radio Set Analyzer. This wonder instrument will then put you on a par with experts who have been in the radio business for years. With its help you can quickly diagnose any ailing Radio set. The training we give you will enable you to make necessary analysis and repairs.

Serving as a "radio doctor" with this Radio Set Analyzer is but one of the many easy ways by which we help you make money out of Radio. Wiring rooms for Radio, installing and servicing sets for dealers, building and installing automobile Radio sets, constructing and installing short wave receivers . . . those are a few of the other ways in which our members are cashing in on Radio.

As a member of the Radio Training Association, you receive personal instruction from skilled Radio Engineers. Upon completion of the training, they will advise you personally on any problems which arise in your work. The Association will help you make money in your spare time, increase your pay, or start you in business. The easiest, quickest, best-paying way for you to get into Radio is by joining the Radio Training Association.

This amazing Radio Set Analyzer plus the instructions given you by the Association will transform you into an expert quickly. With it, you can locate troubles in all types of sets, test circuits, measure resistance and condenser capacities, detect defective tubes. Knowing how to make repairs is easy: knowing what the trouble is requires expert knowledge and a Radio Set Analyzer. With this Radio Set Analyzer, you will be able to give expert service and earn \$3.00 an hour. Possessing this set analyzer and knowing how to use it will be but one of the benefits that will be yours as a member of the R. T. A.

Special No-Cost Memberships Now Open

To any ambitious men, No-Cost Memberships that may not—need not—cost you a cent are available. The training and the valuable Radio Set Analyzer can be yours! Now is the time to prepare to be a Radio Service Man! By the time you're ready, demand will exceed supply. Bigger salaries, rapid promotion, bigger opportunities! For the sake of extra money made in your spare time, bigger pay, a business of your own, a position with a future, get in touch with the Radio Training Association at once. Send for No-Cost Membership Plan, and FREE Radio Handbook that will open your eyes as to what Radio has in store for the ambitious. Don't wait! Don't delay! Get started now!

RADIO TRAINING ASSOCIATION OF AMERICA
Dept. RNA-6 4513 Ravenswood Ave. Chicago, Ill.

Fill Out and Mail Today!

RADIO TRAINING ASSOCIATION OF AMERICA
Dept. RNA-6, 4513 Ravenswood Ave., Chicago, Ill.
Gentlemen: Send me details of your No-Cost Training Offer and information on how to make real money in radio quick.

Name.....

Address.....

City..... State.....

LAURENCE M. COCKADAY
Editor

ALBERT PFALTZ
Associate Editor



S. GORDON TAYLOR
Technical Editor

WILLIAM C. DORF
Associate Editor

VOLUME XII

June, 1931

NUMBER 12

CONTENTS

(Cover Designed by David Hymes)

Super Broadcasting on Long Waves <i>By Lieut. Wm. H. Wenstrom</i>	PAGE 1049	Capital of the Radio World <i>By Samuel Kaufman</i>	PAGE 1068
Radio As You Go <i>By Everett M. Walker</i>	PAGE 1052	A "Midget" Superheterodyne <i>By McMurdo Silver</i>	PAGE 1070
Giant Loudspeaker Has 15-Mile Range <i>By Hans H. Reinsch</i>	PAGE 1055	Receiver Equipment Now—and Then <i>By John F. Rider</i>	PAGE 1072
Writing Sound's Autograph <i>By E. E. Free, Ph.D.</i>	PAGE 1056	Tapping the Short Waves <i>By Zeh Bouck</i>	PAGE 1075
How to Build a Home Televisor <i>By Joseph Calcaterra</i>	PAGE 1059	Stepping Out for World-Wide Reception <i>By S. Gordon Taylor</i>	PAGE 1078
Policing the Ether Lanes <i>By Martin Codel</i>	PAGE 1062	Junior Transmitter—Part VI <i>By Don Bennett</i>	PAGE 1080
Electrical Eyes Keep Watch for Industry <i>By H. B. Stevens and M. J. Brown</i> ..	PAGE 1064	All Waves—Without Changing Coils <i>By Robert Hertzberg</i>	PAGE 1082
The New Ribbon Microphone <i>By Charles Felstead</i>	PAGE 1067		

DEPARTMENTS

The Service Bench.....	PAGE 1084
Backstage in Broadcasting.....	PAGE 1086
What's New in Radio.....	PAGE 1087
Junior Radio Guild.....	PAGE 1088
Manufacturers' Receiver Circuits.....	PAGE 1090
Home Laboratory Experiments.....	PAGE 1091
Latest Radio Patents.....	PAGE 1093

Published Monthly by Radio-Science Publications, Inc., Jamaica, N. Y.

OFFICERS

W. Z. Shater, *President*
G. L. Harrington, *Vice President*
Laurence A. Smith, *Treasurer*
Byrd D. Wise, *Secretary*

EDITORIAL AND EXECUTIVE OFFICES

381 FOURTH AVENUE, NEW YORK CITY, N. Y.

Entered as second class matter at the Post Office at Jamaica, N. Y., under the act of March 3, 1879. Copyright, 1931, by Radio-Science Publications, Inc. All rights reserved. Title Registered at the U. S. Patent Office. Printed in the United States of America. The contents of this magazine must not be reproduced without permission. We cannot be responsible for lost manuscripts, although every care is taken for their safety.

25c a Copy, \$2.50 a year,
\$3.00 in Canada, \$3.50 in
Foreign Countries. Sub-
scribers are notified that
change of address must reach
us five weeks in advance of
the next date of issue.



Broadcasting stations need trained men continually for jobs paying \$1,800 to \$3,000 a year.



Operators on ships see the world and get good pay plus expenses.



Aviation is needing more and more trained Radio men. Operators employed through the Civil Service Commission earn \$2,000 to \$2,800 a year.



Television—the coming field of many great opportunities—is covered by my course.



Talking Movies—an invention made possible only by Radio—offers many fine jobs to well trained Radio men.

You'll Get Thrills-Adventure BIG PAY in RADIO



J. E. Smith, Pres.

*Radio's Amazing Growth is Opening
Hundreds of Big Jobs Every Year*

**I will Train You at Home to Fill
a Fascinating Job in Radio**

You like action, romance, thrills! You'll get them in Radio—plenty of them! Big pay, too. That is why I urge you to mail the coupon below for my free book of startling facts on the variety of fascinating, money-making opportunities in this great, uncrowded field. It also explains how you can quickly learn Radio through my amazingly simple 50-50 method of home-study training, even though you may not now know the difference between a "Screen Grid and a Gridiron". Thousands of men who knew absolutely nothing about Radio before taking my course are today making real money in this growing industry.

**Thrilling Jobs That Pay
\$50 to \$100 a Week**

Why go along with \$25, \$30 or \$45 a week in dull, no-future work when there are plenty of good jobs in Radio that pay \$50, \$75 and up to \$250 a week? For instance, by taking my training, you can see the world in grand style as a Radio operator on shipboard. There are many splendid openings in this line with good pay plus your expenses. You'll also find thrills and real pay in Aviation Radio work. Broadcasting is another field that offers big pay and fascinating opportunities to men who know Radio. And think of the great, thrilling future

Travelled 75,000 Miles

"Dear Mr. Smith: I have worked as Junior Operator on board S. S. Dorchester and Chief Operator of the Chester Sun. I have travelled from 75,000 to 100,000 miles, visited ports in various countries, fished and motored with millionaires, been on airplane flights, etc. I am now with Broadcasting Station WREN." (Signed) Robin D. Compton, 1213 Vermont St., Lawrence, Kansas.

for men with Radio training in Television and Talking Movies. My free book tells all about these and many other branches of Radio that bring you in contact with interesting people, pay big money and make life pleasant for you. Without doubt, Radio training is the key that opens the way to success. And my training, in particular, is the only training that makes you a "Certified RADIO-TRICIAN"—the magic words that mean valuable recognition for you in whatever type of Radio work you take up after graduation. You'll see why, when you receive my interesting book.

Earn While You Learn

You don't have to quit your present job to take my course! You stay right at home, hold your job, and learn in your spare time. (Lack of high school education or Radio experience are no drawbacks.) I teach you to begin making money shortly after you enroll. My new practical method makes this possible. I give you eight big laboratory outfits that teach you to build and service practically every type of receiving set made. Many of my students earn \$15, \$20, \$30 weekly while learning. Earle Cummings, 18 Webster St., Haverhill, Mass., writes: "I made \$375 in one month in my spare time, installing, servicing, selling Radio sets." And let me emphasize right

\$400 a Month

"The Radio field is getting bigger and better every year. I have made more than \$400 each month and it really was your course that brought me to this." J. G. Dahlstead, 1484 So. 15th St., Salt Lake City, Utah.



here that a Radio business of your own is one of the money-making opportunities my training prepares you for in case you wish to settle down at home.

Get My Free Book

Send the coupon below for my 64-page book of opportunities in Radio and information on my home-study training. It has put hundreds of fellows on the road to bigger pay and success. It will tell you exactly what Radio offers you, and how my Employment Department helps you get into Radio after you graduate. I back my training with a signed agreement to refund every penny of your money if, after completion, you are not satisfied with the Lesson and Instruction Service I give you. Fill in and mail the coupon NOW!

J. E. SMITH, Pres., Dept. I-FR
National Radio Institute,
Washington, D. C.

*Act
Now*



Mail Coupon Today

J. E. SMITH, President
National Radio Institute, Dept. I-FR
Washington, D. C.

Dear Mr. Smith: Send me your book "Rich Rewards in Radio" giving information on the big-money opportunities in Radio and your famous 50-50 method of home-study training. I understand this places me under no obligation and that no salesman will call.

Name.....

Address.....

City.....

State.....

Occupation.....

Employment Service to all Graduates

The Editor—to You

LAST month was promised an announcement that would make short-wave enthusiasts happy. In the magazine you are holding in your hand there is included a wealth of short-wave material, including complete descriptions of two of the latest and finest short-wave sets, one a superheterodyne and the other an entirely new type of receiver. Both of these receivers may be used either on the short-waves or for the ordinary broadcasting wave-bands. In tests on these receivers, made by our technical editor, really remarkable results were obtained on distant reception on both receivers.

* * *

ANOTHER article, "Tapping the Short Waves," from the able pen of Zeh Bouck, is the first article of a series that gives an inspiring account of what can be accomplished on the short-wave bands that should interest every broadcast listener.

* * *

THIS IS the season of the year when we begin to think of the long, open highways and what we can do to our automobiles to get the most comfort out of them during the coming summer. One of the modern comforts for an automobile and at the same time a thing of real value is the new type of automobile radio receiver that can be installed and operated in the car even while it is moving at speed along the highway. Turn to page 1052 and read what you should do to get one of these sets in your car and what line of enjoyment you can expect from it if and when you do get it. There are many makes and designs and you will be able to pick one that will be best suited to your own needs. Many motorists are installing these sets in their cars to take to the summer camp instead of lugging portable radio sets by hand. By using an extension cord and a separate loud speaker, the set can furnish music where it is needed.

* * *

DID YOU know that Uncle Sam had a "radio policeman" keeping careful watch in the air over our home land? He resides at Grand Island, Nebraska, in a group of new buildings equipped with the latest types of receiving apparatus and direction finders. He is in constant radio communication with Washington and reports all infractions of the radio laws. Read the article, "Policing the Ether Lanes."

* * *

EVEN IN these days of multi-tube sets there are still a few people who stick to the old crystal type of receiver. Strange as it may seem, here is one person who goes on nightly DX jaunts with the crystal set. He is Lawrence Fesler, Jr., of Sioux City, Iowa. He says: "I want to say that there is nothing more inter-

esting than a good crystal set. I have constructed one that will bring in distant stations clearly. I have heard the following stations with it: WOW, Omaha, Neb.; WLW, Cincinnati, O.; WTAM, Cleveland, O.; KMOX, St. Louis, Mo.; WMAQ, Chicago, Ill.; WCCO, St. Paul, Minn.; KUSD, Vermilion, S. D.; WMAX, Yankton, S. D.; WFAR, Chicago, Ill.; WFAA, Dallas, Tex." Good work for a crystal! Next month we will describe this set and give the hook-up.

* * *

THE correspondence of the technical information service has been growing, lately, in leaps and bounds, and although the staff has been enlarged to take care of the increasing activity, it is now necessary to regulate the work systematically. There is an enormous amount of time spent by the staff in reading through the many long and sometimes rather indefinite letters sent to this department. On page 1095 will be found a statement and a set of regulations which our readers are requested to follow in making the greatest use of this department. By adhering to the regulations readers will therefore get increased benefit and a more prompt reply.

* * *

ARE YOU going to the Trade Show at the Stevens Hotel in Chicago on June 8th? This year promises some of the greatest developments in radio receiving apparatus, in new types of tubes and improved loud speakers, in amplifiers, television and electronics. Dealers and jobbers among our radio audience are urged to take in the show so that they may gain the proper information and make the proper contacts in order to start in full swing on the new merchandise in the fall. Of course, there are many dealers and servicemen who are not as fortunate as others and who will not be able to attend. The editor has completed plans for making the July issue of RADIO NEWS, which is also the twelfth anniversary of the magazine, the "eyes" and "ears" for those of our readers who have to stay at home. This special issue will contain a complete and enlarged section, "What's New in Radio," describing all of the new types of apparatus developed for use during the 1931-1932 season. This section will include the fields of radio receiving and transmitting apparatus, television, electro-acoustics and electronics. There also will be many articles of more than passing interest to the industry at large, as well as a greater amount of feature material for our regular readers than has ever been published between two covers.

* * *

MANY of the subscribers to RADIO NEWS, who reside in foreign countries, value each issue of the publication so highly that they do not hesitate to send

us long-distance radiograms immediately upon being advised that their subscriptions have run out, rather than trust to the mails carrying their renewal in time for the next issue. Only this week a communication was received from H. H. Crawford, amateur station W6TJ, who passed along a message from Adolfo Elias of radio station LU3FA, located at Rosario, Argentina. The message itself had to do with an immediate subscription renewal. Evidently Mr. Elias places full trust in amateur efficiency and reliability.

* * *

A WORD to advertisers—they, too, read our magazine from cover to cover. Importers of radio apparatus in foreign countries have requested that we ask our advertisers to mention the type of merchandise they manufacture which would be suitable for export. RADIO NEWS is becoming a considerable factor in the export of American radio products to foreign lands. During the last month alone there were held, by correspondence and over the editor's desk, a number of consultations with European and South American importers resulting in sales of advertiser's merchandise, abroad, estimated at more than \$50,000 in value.

* * *

READERS interested in the field of electronics will find articles in the present issue on the application of photoelectric cells, tubes and amplifiers to scientific fields other than radio, including fire control and sorting of production articles.

* * *

STUDENTS and engineers have not been forgotten in the following pages by any means. Articles on the future of broadcasting, the history of receiving circuit design, as well as a continuation of the mathematics of radio, form their share of the editorial contents of the magazine.

* * *

JOSEPH CALCATERRA continues his description of the television apparatus now being used in the Boston transmission and receptions and gives full constructional details for building a practical, though simple, televisor unit.

* * *

DR. E. E. FREE describes the cathode-ray oscillograph and its many uses in visualizing sound waves.

* * *

UNTIL the next issue, when the Editor will have completed the 145th number of the magazine—Happy Reading!

Stewart M. Lockaday

BIG PAY JOBS

open

for the Radio Trained Man

Don't spend your life slaving away in some dull, hopeless job! Don't be satisfied to work for a mere \$20 or \$30 a week. Let me show you how to make real money in Radio—the fastest-growing, biggest money-making game on earth.

JOBS LEADING to SALARIES of \$60 a Week and Up

Jobs as Designer, Inspector and Tester paying \$3,000 to \$10,000 a year—as Radio Salesman and in Service and Installation Work, at \$45 to \$100 a week—as Operator or Manager of a Broadcasting Station, at \$1,800 to \$5,000 a year—as Wireless Operator on a Ship or Airplane, as a Talking Picture or Sound Expert—HUNDREDS of Opportunities for fascinating, BIG PAY JOBS!

Learn Without Lessons in 10 Weeks

Coyne is NOT a Correspondence School. We don't teach you from books or lessons. We train you on the greatest outlay of Radio, Television and Sound equipment in any school—on scores of modern Radio Receivers, huge Broadcasting equipment, the very latest newest Television apparatus, Talking Picture and Sound Reproduction equipment, Code Practice equipment, etc. You don't need advanced education or previous experience. We give you - RIGHT HERE IN THE COYNE SHOPS—all the actual practice and experience you'll need. And because we cut out all useless theory, you graduate as a Practical Radio Expert IN 70 DAYS' TIME.

TELEVISION and TALKING PICTURES

And TELEVISION is already here! Soon there'll be a demand for THOUSANDS of TELEVISION EXPERTS! The man who learns Television now can make a FORTUNE in this great new field. Get in on the ground-floor of this amazing new Radio development! Come to COYNE and learn Television on the very latest, newest Television equipment.

Talking Pictures and Public Address Systems offer thousands of golden opportunities to the Trained Radio Man. Here is a great new Radio field just beginning to grow! Prepare NOW for these wonderful opportunities! Learn Radio Sound Work at COYNE on actual TALKING PICTURE and SOUND REPRODUCTION equipment.



No Books - No Lessons All Practical Work at Coyne

No Books! No Lessons! ALL ACTUAL, PRACTICAL WORK. You build radio sets, install and service them. You actually operate great Broadcasting equipment. You construct Television Receiving Sets and actually transmit your own Television programs over our modern Television equipment. You work on real Talking Picture machines and Sound equipment. You learn Wireless Operating on actual Code Practice apparatus. We don't waste time on useless theory. We give you just the practical training you'll need—in 10 short, pleasant weeks.

EARN as You LEARN

Don't worry about a job! You get Free Employment Service for Life. And don't let lack of money stop you. If you need part-time work while at school to help pay expenses, we'll gladly help you get it. Coyne is 32 years old! Coyne Training is tested—proven beyond all doubt. You can find out everything absolutely free. Just mail coupon for my big free book!

RADIO COYNE ELECTRICAL SCHOOL
DIVISION H. C. LEWIS, President Founded 1899
500 S. Paulina St. Dept. A1-8C, Chicago, Ill.

H. C. LEWIS, President

Radio Division, Coyne Electrical School
500 S. Paulina St., Dept. A1-8C, Chicago, Ill.

Send me your Big Free Radio Book and all details of your Special Introductory Offer. This does not obligate me in any way.

Name

Address

City State



STEVENS HOTEL
(HEADQUARTERS)

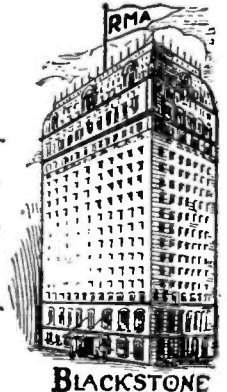

BLACKSTONE HOTEL

TO THE
FIFTH ANNUAL

RMA Trade Show

AND 7TH ANNUAL RMA CONVENTION

CHICAGO

JUNE 8 to 12th



BUSINESS\$ FOR YOU WITHOUT BALLYHOO

EVERYBODY WILL BE THERE.

Bu\$ine\$\$ will be the key-note during "Radio Week" of June 8th. This will be a "*bu\$ine\$\$*" show and *bu\$ine\$\$* for YOU, *bu\$ine\$\$* for everybody in radio.

The National Furniture Industry and the Music Industry also will be holding conventions and exhibits in Chicago, drawing thousands of visitors, during "Radio Week."

All the new radio products on display in the trade show. Every leading manufacturer of receiving sets, tubes, speakers and accessories has reserved exhibit booths in the trade show and demonstration rooms in hotels. There will be *more* new circuits, new tubes, new speakers, new cabinet designs, and new radio products, including home talkies, television, remote control, and other radio devices and products than ever before in one year.

Thirty thousand (30,000) square feet of radio exhibits in the Grand Ball Room and Exhibition Hall of the Stevens Hotel.

ADMISSION TO THE TRADE ONLY—NO VACANT BOOTHS—ALL EXHIBITORS REQUIRED TO SHOW THEIR MERCHANDISE.

Twenty-five thousand radio manufacturers, jobbers and dealers expected to attend.

Reduced railroad rates have been granted on all lines—one and one-half fare rate. Secure certificates from local railroad agents. RMA special trains from all sections.

Official hotels—Stevens Hotel (headquarters), Blackstone, Congress and Auditorium Hotels with demonstration rooms of manufacturers.

INDUSTRIES AND EXHIBITIONS

Radio industries, June 8-12—RMA National Federation of Radio Associations, Radio Wholesalers Association and National Association of Broadcasters.

Music industry convention and exhibits, Palmer House—June 8-10, during "Radio Week."

Institute of Radio Engineers annual convention, Sherman Hotel—June 3-6.

Annual national "Furniture Mart" with 25,000 furniture buyers, jobbers, dealers and manufacturers—June 1-15.

Business meetings and entertainment for visitors during entire "Radio Week"—June 8-12—RMA "stag" party Wednesday, June 10—Music Industry banquet, Tuesday, June 9.

Apply now direct to hotels for room reservations.

RMA invitation credentials mailed to the trade about May 1st. For information or credentials write to Bond Geddes, RMA Executive Vice-President, Stevens Hotel, Chicago, or,



CONGRESS HOTEL

RADIO MANUFACTURERS ASSOCIATION

11-W. 42ND ST. N.Y. CITY

32 W. RANDOLPH ST. CHICAGO

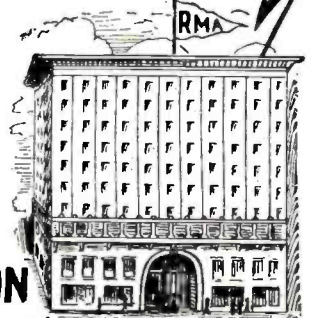

AUDITORIUM HOTEL



FROM 15 TO 600 METERS

'ROUND THE WORLD-CLEAR AS A BELL

SCOTT

ALL-WAVE

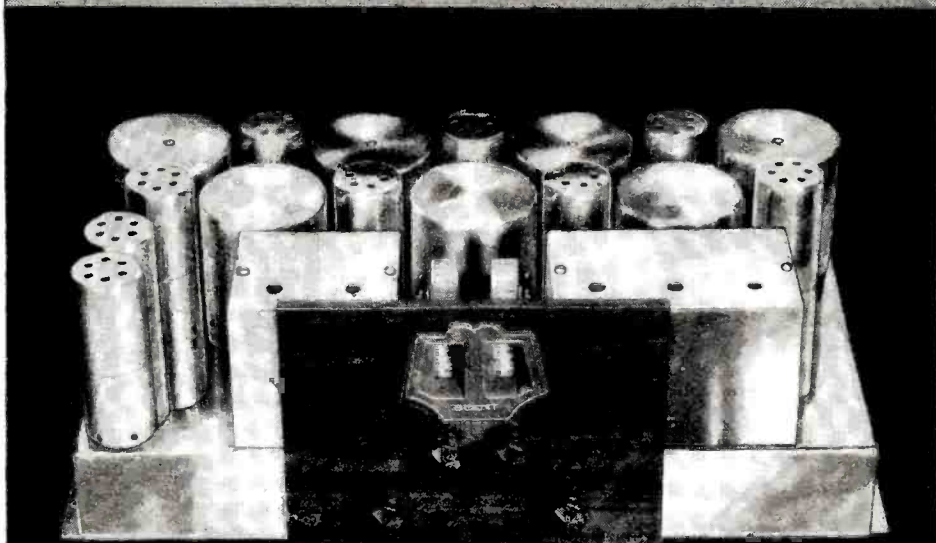

SUPERHETERODYNE

THE NEW SCOTT WORLD'S RECORD RECEIVER

It requires no exaggeration to create enthusiasm for the new Scott All-Wave Superheterodyne. A straightforward statement of the facts concerning this remarkable receiver is sufficient.

With the new Scott, Chicago listeners heard the Pope, direct from HVJ, Rome. They listen daily to VK2ME, Sydney, Australia; to KAIXR, Manila, P. I., to F31CD, Chi-Hoa, Indo China; to G5SW, Chelmsford, England, and to dozens of other short wave broadcasts including ship phones, airport stations, and police calls. Not code, but voice, and it's sharp, crisp, clean and clear like a local broadcast.

The Scott All-Wave is the only receiver that handles the short wave band equally as perfectly as the broadcast band. This is due to two things. First, the unique manner in which a set of .00007 tuning condensers are automatically cut into the circuit in place of the regular .0005's when the short wave band is desired to be worked. Secondly, the smoothness of this receiver's performance on the short wave lengths is due to the perfect stability of the Scott high-gain, four stage, intermediate frequency, screen-grid amplifier. The short wave stations slide in just as smoothly as those within the broadcast band of 200 to 600 meters.

What more can a receiver give you than the whole world of radio at the mere flick of a dial? The new Scott All-Wave gives you the one additional thing necessary to your complete satisfaction. Its fine construction gives you complete assurance of dependable 'round the world performance throughout the years to come.

SCOTT TRANSFORMER CO. 4450 RAVENSWOOD AVE., CHICAGO, ILL.

Sole Representative for New Zealand: CHAS. BEGG & CO., Ltd., 21 Princess St., Dunedin, N. Z. Sole Representative for Uruguay: ARMANDO I. LOPEZ, Chile 388 Cerro, Montevideo, Uruguay.

Chrome-Plated Rugged Metal Chassis

The Scott All-Wave is as bright a jewel of construction as it is a star of performance. It is all metal—heavy pressed steel that won't warp, twist, or impose strain upon the wiring. And it's put together like a modern bridge! Add to this superb construction, the beautiful, polished chromium plate that covers the whole chassis, and the Scott All-Wave Superheterodyne looks the thoroughbred it surely is.

Thrill to This New-Day Performance

Tune the new Scott All-Wave alongside of any other receiver in existence today. See for yourself how it tunes the whole broadcast band without concern for the miles that may exist between broadcaster and receiver, and with equal unconcern for proximity to local stations. Thrill to real 10 Kilocycle selectivity over the whole band! Thrill to the fact that there's a station at every dial point! Then cover the 15-250 meter band. Listen to stations in Europe, Asia, South America, Africa,

Australia. Enjoy a tour of the entire world, in your own living room. Then, and only then will you fully realize why all major world's records are held by Scott receivers and that the new Scott All-Wave is, in all truth, the greatest achievement in modern radio engineering.

The price of the new Scott All-Wave is amazingly low. You'll be agreeably surprised when you hear the low figure at which this remarkable instrument may be obtained.

MAIL this COUPON

SCOTT TRANSFORMER CO. 4450 Ravenswood Ave., Chicago. RN-6

Send me full particulars of the new Scott All-Wave Superheterodyne.

NAME

STREET

TOWN..... STATE.....

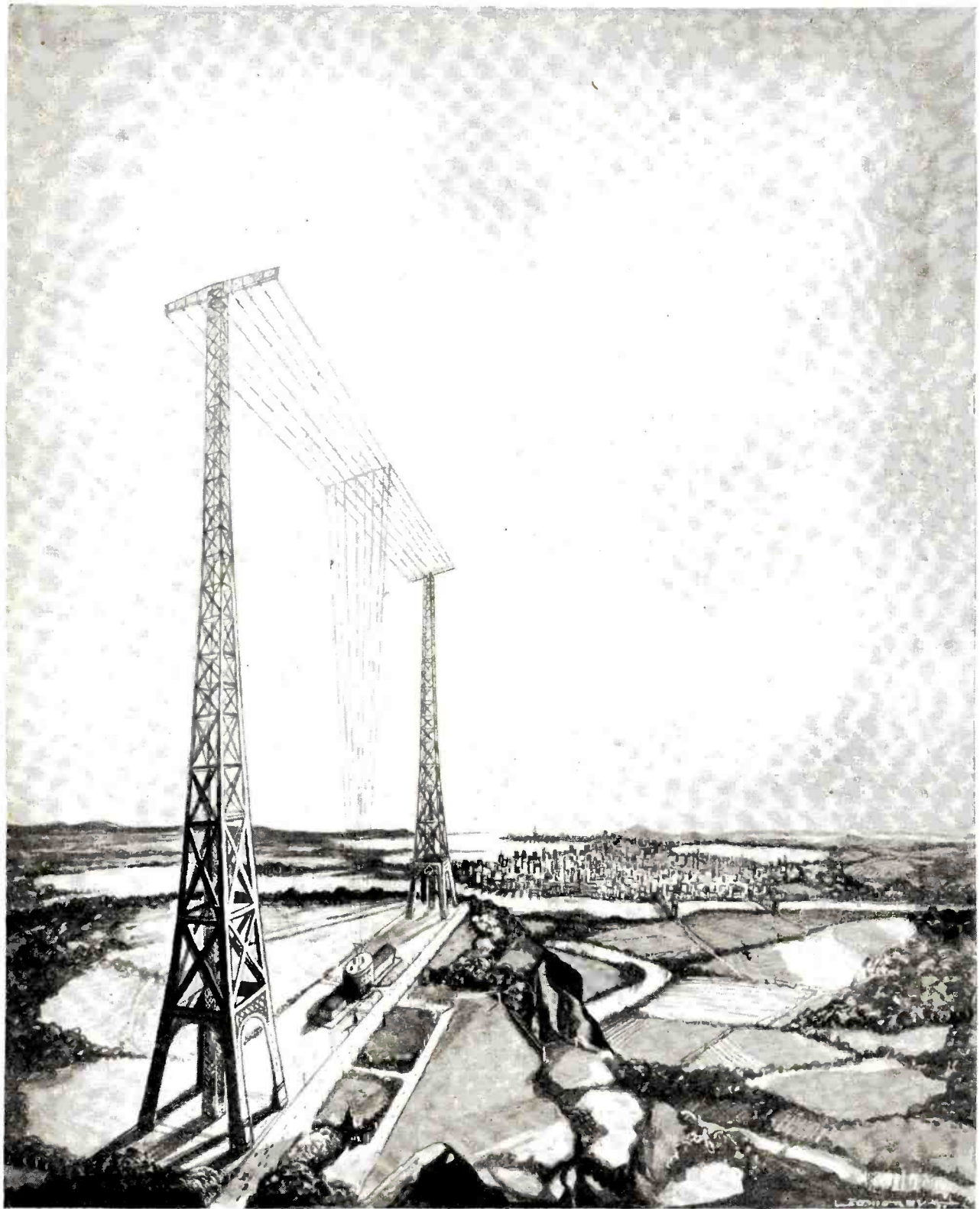

A Super-Broadcasting Station of the Future ?

To cover the whole country by direct waves, towering antennas 800 feet high, located in a central radiating position, would be fed by a 1,000-kilowatt transmitter operating on 1,500 meters, according to Lieut. Wenstrom's plan. This system would not rely on the sky wave with its effect in producing fading in distant receivers

Super Broadcasting on Long Waves

This month Lieutenant Wenstrom goes into a more detailed study of some of the problems involved in the system of long-wave super-power broadcasting which he proposed in the April issue

IN the April issue of RADIO NEWS we put forward a plan for the betterment of American broadcasting. It calls for something like seven national stations operating at power levels approaching one thousand kilowatts on wavelengths around 1500 meters. It is a foregone conclusion that some readers will oppose the plan as visionary and impractical, while others will support it as logical and promising. Few who are genuinely interested in broadcasting can regard it with complete indifference.

One can easily get too excited about a new and untried idea. On the other hand, one can also be so much in a rut that new and promising ideas are automatically shunted away from the mind. Human beings have thrown away their savings on schemes to extract gold from sea water, and other human beings used to stand around and laugh at Robert Fulton when he was building the first American steamboat, to say nothing of the early airplane experimenters. The formula for a reasonable middle course, so far as it can be stated in words, seems to be that everything must be examined on its merits.

The Long-Wave Super-Broadcasting Idea

Briefly summarized for the convenience of readers this month joining the discussion, the outline of our national broadcasting idea is as follows: On present broadcasting wavelengths signals begin to fade badly from sixty to one hundred miles from the transmitter, depending upon the wavelength and the type of ground over which the signals pass. This fading is erroneously ascribed to various causes even in the semi-technical press, but is probably due to amplitude equality between the constant-path ground wave and the variable-path sky wave and the phase differences between the two. Further out, where the sky wave predominates, fading is less severe but usually present in some degree. There is another type of fading called "hashing" which is caused by unequal fading of the two sidebands of a telephone signal. As neither kind of fading can be tolerated under improving standards of true broadcasting service, station service areas are arbitrarily limited by the occurrence of first fading rings and power increases are only useful (aside from extension of doubtful space-ray service) in so far as they extend reasonable signal strength out to these fading zones. The useful power limit at present broadcast frequencies appears to be around 50 kw.

Our present broadcasting system is laid out on metropolitan rather than rural or truly national lines, and the thirty-odd two-hundred-mile circles representing the possible service areas

By Lieut. W. H. Wenstrom

of our larger transmitters cover only a small fraction of the entire United States, as shown in Figure 4, page 880, of the April article. While the indefinite extension of synchronized 50-kw. transmitters would be a possible way to bring city reception to the country dwellers who need it most, it is in general much cheaper to cover a given area with few large stations rather than many small ones.

On 1500 meters the signals do not begin to fade until they are something like 400 miles out from the transmitter. This enormous non-fading area permits the efficient use of very high power (perhaps 1000 kw.) to distribute true service broadcasting to every isolated listener in half a million square miles of territory. About seven such stations should bring clear, loud and non-fading reception, night and day, summer and winter, to practically everyone in the United States regardless of location. Of course, the present largely metropolitan system would continue in undisturbed operation. While the plan entails such difficulties as receiver changes and wavelength assignments, the prospective benefits are probably great enough to justify them if experiment bears out our preliminary theory.

Far from glossing over the disadvantages of the scheme, we have been at some pains to discover them and point them out. In the same spirit we welcome criticism and discussion of the idea.

Preliminary Experimental Work

Even more important than discussion is experiment, particularly along two lines indicated last month. There is need of quantitative measurements of the intensity of static, in the seven districts of the United States: Northeast, southeast, north central, northwest central, southwest central, northwest and southwest. These measurements should run at least a year to determine seasonal variations. Longer studies would give the year-to-year changes, which might follow the trend of long-wave atmospherics as observed for some years at the Bureau of Standards. Observations should be made at 200 kc., at 750 kc. or other frequencies within the present broadcast band, and at some other frequencies as well. This research, aside from its value in the present discussion, would be an important contribution to the scientific background of radio transmission.

Such measurements are within the scope of any well-equipped radio laboratory. Probably the simplest and most efficient method is that used by the Bureau of Standards. An autodyne detector feeds several stages of audio amplification. An audio tone of definitely adjustable amplitude is introduced into the

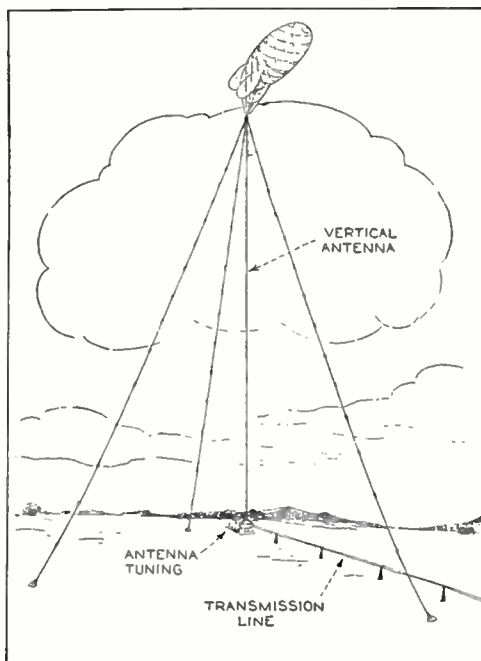

Figure 6. Shown above is a speculative design of the half-wave 1,500-meter vertical antenna supported by a triple-guyed balloon

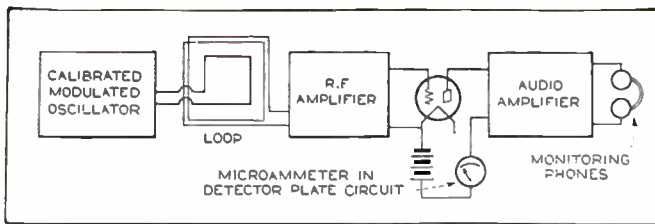

Figure 2. Essential parts of a field strength measuring set as used for measuring transmission from broadcasting stations, usually in portable form and mounted in an automobile

audio amplifier, and compared either visually or audibly at the amplifier output with the atmospheric picked up by the detector. A separate modulated oscillator is used to check the detector sensitivity, which remains fairly constant for long periods if filament and plate voltages remain constant. More complicated automatic recording methods have been described by H. T. Friis in the Bell System *Telephone Journal* for April, 1926, by E. H. Kincaid in the Proceedings I. R. E. for October, 1927, and by S. W. Dean in the Proceedings I. R. E. for July, 1929.

The other experimental field in which we should like to see our predictions verified is 200 kc. telephone transmission in various parts of the United States. While some of this has already been done in the northern Appalachian section, we need information particularly on the shape and size of the first fading ring not only along the eastern seaboard, but also in the flat mid-west, in the northern Rockies and southwestern deserts, and over the steep mountains and wide, flat valleys of the Pacific coast. For every transmitting station there must be several field strength measurement sets continuously in action.

Field measurements are now becoming standardized. Present methods are quite fully described in the *General Radio Experimenter* for January, 1931. Even a single set, costing as much as the automobile which carries it, is likely to be beyond the means of the average experimenter. The principle, however, is simple. A microammeter in the detector plate circuit, as in Figure 2, increases its reading in proportion to the strength of the received carrier wave. These increases are quite small compared to the no-signal plate current, which is balanced out in the more sensitive arrangements. For instance, at New Haven, with a normal plate current of 0.4 ma. or 400 μ a. WOR at Newark, N. J., produces about 10 μ a increase, while WEAJ at Bellmore, Long Island, produces a 100 μ a increase. Of course, a good radio-frequency amplifier is necessary in front of the detector, particularly for a portable set, which must use a loop antenna. The expensive part of the installation is a modulated

oscillator, which is used for calibrating the receiving system. Such a program of 200 kc. transmission tests as we suggest could be successfully completed only by some suitable agency such as a government department or a large electrical company. It is a logical and necessary step before the building of the first national long-wave transmitter.

Technical Possibilities

Most people with whom we have discussed the long-wave super-broadcasting idea have regarded it at first as "startling" and "upsetting to present notions." Others have termed it "radical." There is nothing radical or new about long-wave broadcasting—it has been done in Europe for years—but its application on so grand a scale to the United States is undoubtedly new. When one realizes how great a part thought-habits and even inertia play in our lives, these reactions can only be regarded as natural. In addition, however, the plan might be criticized from a transmitting viewpoint as idealized and not practical. It might be said that the system is on too grand a scale for present technical possibilities, that it would

cost too much to build and run, and that inasmuch as national advertisers care little about covering the less inhabited districts of Nevada or Alabama, no one would pay large amounts of money for such a system.

By way of answering some of these questions, let us first turn to the technical possibilities of broadcasting transmission as they are at present. The standard high-power broadcast transmitter of the present has an output of 50 kw. Figure 5 shows a block diagram of such a station. The crystal oscillator is followed by a buffer amplifier which feeds into a 50-watt amplifier tube. The radio-frequency currents in this 50-watt tube, called the modulating amplifier, are modulated by a 250-watt audio power amplifier which is fed by the audio speech amplifier. The audio tube is larger than the radio tube which it modulates so that modulation may be 100 per cent.—or, in other words, so that the steady radio-frequency carrier may be varied at audio frequency between twice its normal amplitude and zero.

The older broadcast transmitters used to step up the audio and radio currents to kilowatt levels separately, modulating the output stage. This design, of course, entailed duplication of amplifiers all the

way up the line, and a tremendous amount of audio energy in the modulator, which in the case of a 50-kw. transmitter consisted of twelve large water-cooled tubes in parallel modulating eight of these tubes connected as the final radio amplifier stage. Under this system, also, the modulation was not over 60-70 per cent.

The more modern 50-kw. transmitter shown in the diagram therefore does its modulating at an intermediate level

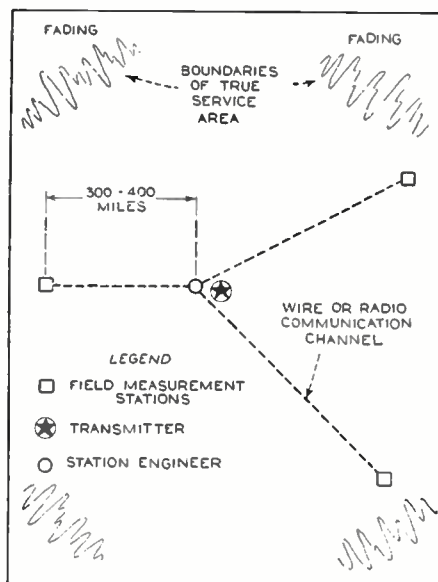

Figure 7. Possible wave economies in long-wave super-broadcasting. Field measurement stations continually report actual signal strength to station engineer, who regulates output power accordingly to maintain constant intensity

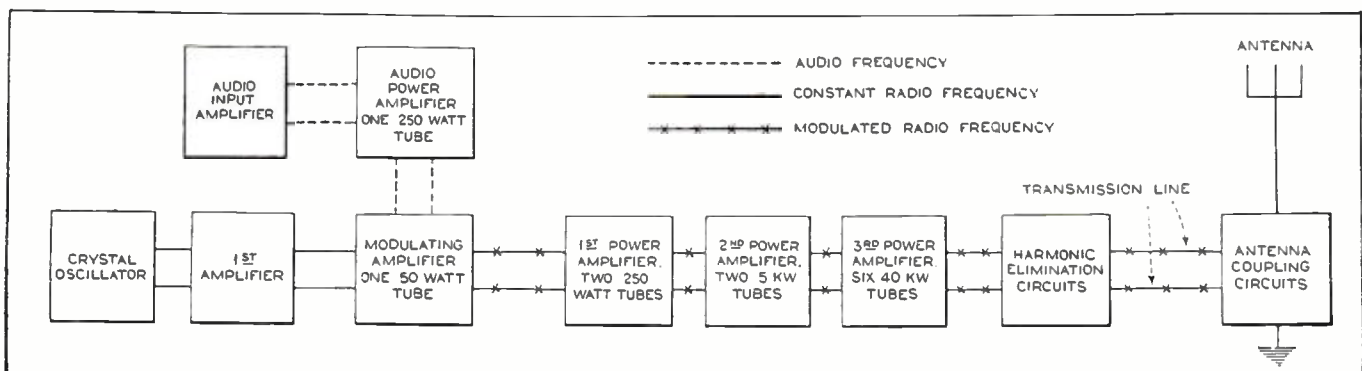

Figure 5. Block diagram of a typical 50-kw. broadcast transmitter, showing successively larger stages to handle increasing power. Modulation takes place in an early stage, thus eliminating the duplication of amplifiers and high-power modulator stages formerly required

represented by the 50-watt modulating amplifier tube. From here on the modulated radio frequency is amplified in exactly the same way that the incoming signal is amplified in the radio-frequency stages of a receiver; the only difference is that the receiver tubes are handling microwatts while the transmitter tubes must handle watts and kilowatts—the ratio is something like a billion to one. After the 50-watt modulating amplifier, then, comes a power amplifier consisting of two 250-watt tubes, which in turn feeds another stage consisting of two water-cooled 5-kw. tubes. If the energy at this point were fed directly into the antenna without further amplification, the whole array would be simply a 2 kw. broadcast transmitter. But the third power amplifier stage, consisting of six 40-kw. tubes, further steps up the energy and makes the ensemble a 50-kw. transmitter. As the carrier must reach peaks of twice normal value at 100 per cent. modulation, the total rating of the output stage must be at least four times the normal rating or 200 kw. Another make of 50-kw. transmitter uses two 100-kw. tubes in the output stage.

Fifty kw. transmitters are manufactured by two or three large electrical companies in the United States. They cost around \$300,000 each. So far about ten stations have actually put them into operation and some thirty more are ready to do so if their license applications are granted. There is, therefore, nothing prohibitive about a 50 kw. transmitter.

Radiating One Thousand Kilowatts

The step from 50 kw. to 500 kw. or 1000 kw. involves nothing more than the addition of a final 1000 kw. stage. The largest present tube, manufactured especially for the new KDKA station, is rated at 200 kw. Twenty of these tubes in parallel should make a 1000 kw. stage with a peak output of 4000 kw. A large number of tubes in parallel is likely to suffer from electrical troubles such as parasitic oscillations, it is true, particularly at high power. However, in the 1915 Arlington radiophone experiments 500 tubes were connected in parallel—a feat which shows what can be done along this line. The design of a 1000 kw. broadcast transmitter will be very far from plain sailing, but this is true of all electrical design problems. Difficulties are to be expected, but the probability is that they can be overcome.

The new KDKA station at Saxonburg, Pa. (thirty miles from Pittsburgh), is now actually completed and licensed for experimental operation between 1 a.m. and 6 a.m. at an output of 400 kw. While the exact design of the transmitter has not been made public, it is reasonable to suppose that it is a standard 50 kw. transmitter feeding a final power amplifier comprising about eight of the new 200 kw. tubes in parallel. These tubes are water-cooled, of course, six feet high and eight inches in diameter. The antenna is of unique design, being an eight-acre circular web supported on 100-foot wooden poles. This is in effect a great condenser, while most of the newer antenna designs are predominantly inductive.

The new KDKA transmitter is interesting in several ways. It shows for one thing that a 400 kw. broadcast transmitter is already an actuality. It should settle definitely the value of power increases in extending service areas on present wavelengths. If our theoretical reasoning is correct, 400 kw. KDKA will fade just as badly beyond 100 miles or so as 50 kw. KDKA does now, although the signal will be something like three times as strong. The new station may give fair service at 600 to 1000 miles, which at least will be no worse than that most rural listeners have to put up with now. But judged solely by true service within the fading ring, there is reason to predict that more than 75 per cent. of the radiated 400 kw. will be wasted. The experiment would become still more interesting if it were possible for KDKA to increase its wavelength to 1500 meters in addition to its power increase. The great difficulty here, of



A mobile broadcast transmitter. Such outfits are used to test proposed locations for broadcast stations

course, is that few 1500 meter receivers exist at present. But more of this in the next of this series of articles.

What we have shown so far is perhaps enough to indicate that there are no insuperable difficulties in the way of a 1000 kw. 1500 meter broadcasting station.

Another question is the amount of interference which such a powerful station would cause in receivers tuned to other wavelengths. Dr. Dellinger of the Bureau of Standards has recommended that stations using more than 5 kw. be located outside centers of population by minimum distances commensurate with the power transmitted. For a 5 kw. station this is 2 miles; for a 50 kw. station it is about 6 miles. Extrapolating from these values, we can assume that a 1000 kw. station is not going to cause much interference beyond a 30-mile circle.

and the few inhabitants of this circle can probably tune the station out by using wavetraps. No such station should be located within 30 miles of a city, of course. But with the tremendous service area which such power on 1500 meters provides, 30 miles, more or less, would make little difference in the entire coverage area.

Antenna Design

Another technical question to be solved in long-wave broadcasting is antenna design. The commonest type of antenna, named after Marconi, is the $\frac{1}{4}$ wave grounded type. The antenna itself may be a straight wire $\frac{1}{4}$ wavelength high, or a bent wire or group of wires having somewhat less height but more capacity to ground. At the average broadcasting wavelength of 400 meters $\frac{1}{4} \lambda$ is about 330 feet, and (Continued on page 1104)

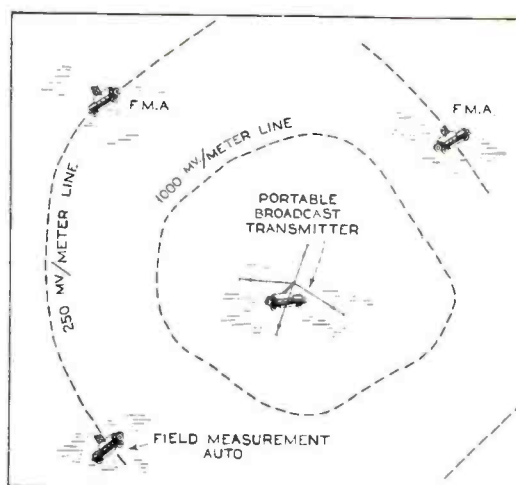

Figure 4. How field measurement sets are used to outline the field from a transmitter. The distances shown are shortened in relation to the size of the automobiles



Early Heinafone automobile set in the days before single control was demanded. Installation included a redesigned instrument board to accommodate the radio apparatus

THE automobile radio receiver is older than broadcasting. Indeed, the combination of the motor car and the radio set dates back long before the days of broadcasting, when all that could be heard over the ether were telegraph code signals.

With the inception of broadcasting the installation of radio sets in automobiles became more common, but did not meet with popular response, due to the number of intricate problems which could not be solved by the average listener.

The transition of automobile radio, however, has been rapid within the last two years. First attempts to solve the many problems of mobile reception were begun about four years ago when the Heinafone Corporation first developed an adequate receiver which met with the requirements of automobile reception.

This installation consisted essentially of a sensitive tuned radio-frequency set installed behind the dashboard of the automobile, with the necessary controlling instruments mounted on a reconstructed instrument board, which, in addition to containing all of the devices essential to the operation of the car, had two tuning dials, volume control and switches for the radio installation.

The problems encountered in conjunction with the operation of the radio receiving set in the automobile while in motion were numerous. The major difficulty was experienced with ignition system interference.

Automobile radio in its present state of development has been available to the motor car owner for about a year. Last spring saw no less than a dozen radio manufacturers enter the field. This widespread acceptance of the idea has contributed no small amount to the solution of the many problems involved, and today it is possible to choose between any one of a dozen makes of automotive radio sets and have them installed in any make of car for a nominal cost varying between \$100 and \$200. Moreover, a number of popular car manufacturers are incorporating as standard equipment a built-in antenna which materially simplifies the installation problem.

At one time it was felt that nothing short of a superheterodyne receiver was practical for reception in an automobile, because of the necessarily small antenna. Development of the screen-grid tube has, however, made tuned r.f. receivers entirely practical for this service.

Perhaps the greatest problem of an automobile radio has been to eliminate interference caused by the ignition system of the motor. Each spark plug in effect acts as a small trans-

Radio as

That auto radio has reached a from the fact that manufacturers stations throughout the country and radios in special models and others

By Everett

mitter. Each time one is discharged, it causes a buzz to be heard in the receiver. When the motor is running at normal speed, this buzz becomes continuous and makes reception practically impossible above the noise.

Several systems have been devised for elimination of this interference. By virtue of the fact that most sets utilize the automobile battery for supplying the power necessary to heat the filaments of the vacuum tubes, there is a more or less direct connection between the sparking plugs and the radio set. Tests have shown that interference from this source is greatest at the lower dial settings. Actually, oscillation from spark plugs takes place at about ten meters, but the interfering wave is extremely broad.

Engineers have largely solved this problem by suppressing the high frequency oscillating effect of the spark plugs. This is done by connecting high resistances in series with each spark plug, and on the top of the distributor. These resistances allow the high tension currents to flow to the plug points without materially impairing the power, but prevent the passage of the undesired high-frequency currents into the wiring and battery system. Interference from the ignition system has been reduced in modern automobile sets to the point where in the majority of cases it has a negligible effect on reception.

It is evident that the automobile receiver must operate with a very limited antenna, and yet deliver a moderately loud signal to the reproducer. Sensitivity must be equivalent to that of a good home receiver. The standard generally adopted by automobile set makers is sensitivity of about 20 microvolts input when the set is required to give an output of 80 milliwatts. This performance must be obtained with economy

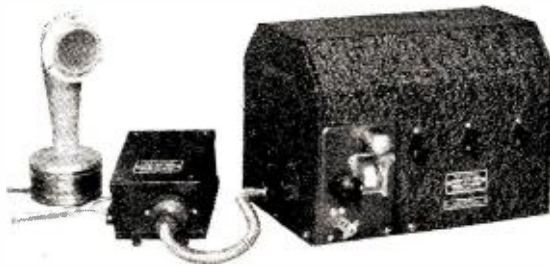

(Above)

The National set before installation. The unit at the right contains the receiver and all controls



Control unit for the Bosch automobile radio set. Tuning is accomplished by means of the knob on the left of the instrument, while the volume control is on the right. The "On-Off" switch is provided with a key.

You Go

highly practical stage is evident are organizing installation service several makes of cars are including as extra equipment on all models

M. Walker

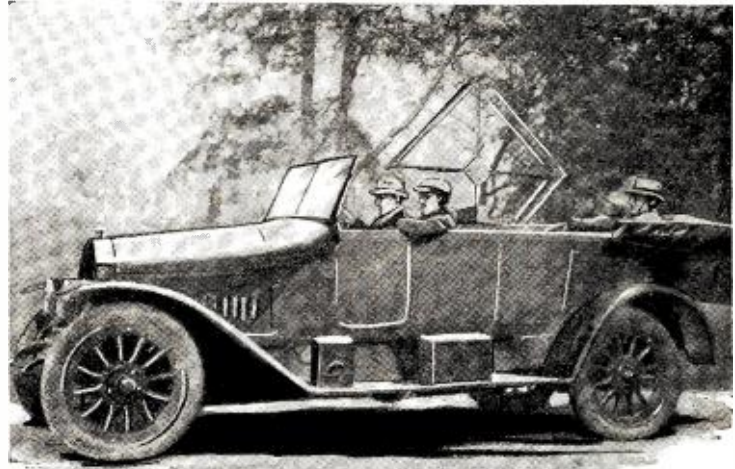

The modernists of two decades ago enjoyed(?) radio on the road, although it involved a massive loop and individual head phones

of space, weight and batteries. Construction must be rigid in order to stand up well under the tremendous vibration to which the set will be subjected, dust-proof, and must be simply controlled from the instrument board.

Naturally, with the limited antenna, the radio-frequency gain must be reasonably high to permit reception of stations up to a distance of at least fifty miles.

In considering antenna systems there are almost as many different types of aerials which may be installed as there are different types of cars. It has been found that the antenna which will perform most efficiently in one body type car will give entirely different results in another. Up to certain limits, a large antenna will give greater signal strength than a smaller one. The current flow in a receiving antenna is directly proportional to its length, to its effective height, and inversely proportional to the resistance of the antenna.

Simplifying this statement, it means that the greatest signal strength would be obtained with the antenna located at the highest point, which naturally would be assumed to be the roof of the car. The effective height of the antenna, however, is measured by its distance from the ground. In many modern cars, metal

construction is used throughout the body. In such cases the effective height would not be between the aerial and the earth, but between the wires and the nearest metal portions of the car. This is one of the most important factors considered in the installation of radio in the automobile.

In automobile radio, logically enough, it is impossible to secure a direct ground connection. Therefore, it is necessary to employ the car chassis as a counterpoise. This has the same effect as using a ground, by virtue of the capacity relation between the metal portions of the automobile and the ground over which it passes.

It cannot be concluded, therefore, that the ideal antenna is one made up of screening placed in the roof of the car.

The trend in modern car design is toward the use of all metal construction. In such cars, when the overall dimensions of the antenna are increased, the effective height is decreased. If the antenna approaches too close to the body of the car, or to the dome light, or associated apparatus, the efficiency of the antenna is apt to be rather low, unless adequate separation is provided.

Experiments conducted over a period of years have more or less established the fact that the antenna should be at least three inches from all metallic portions of the car.

However, it is practically impossible by force of circumstances, and it must run parallel and close to the metal side post of the car. This close relation offers a path of leakage between the antenna and chassis which should be reduced to a minimum. This capacity also has a tendency to destroy the electrical balance of the receiver. Practice has found that the best results are to be obtained with the lead-in run down the right front post of the car.

Antenna lead-in requirements are altered considerably in different types of cars. For instance, in the case of the limousine and town cars, the automobile is divided into two sections. It is then necessary to confine the aerial to either one section, or construct it in two sections, and link the two together.

In the case of the open car or roadster, where the top is a folding type, installation of the aerial in the roof becomes more difficult. This has been accomplished in most cases by using flexible wire run under the inside lining of the hood. About 100 feet of wire, run back and forward, each wire being spaced about three inches from the next, will suffice for such an antenna.

A type of antenna which virtually solves all these problems and which gives reliable results is the capacitor plate antenna mounted under the car chassis. Several automobile radio set manufacturers have adopted this type antenna. It completely avoids any necessity for ripping the top of the car off for

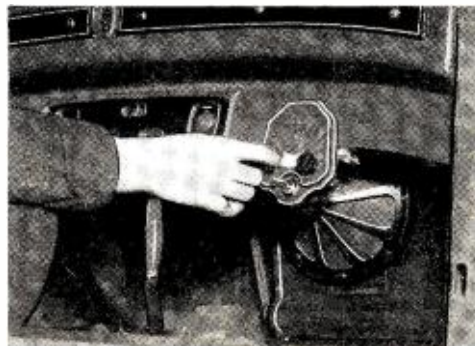

At the right is a Crosley radio set installed on the instrument board where the control unit can be seen. The set and loud speaker are mounted on the dashboard which separates the motor from the driving seat

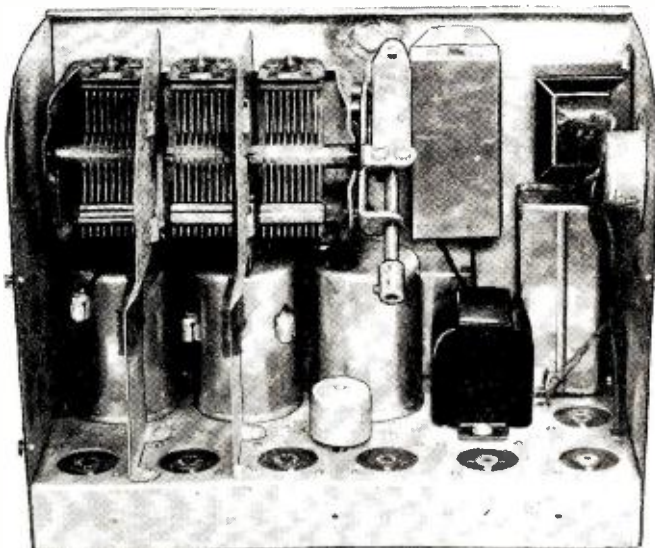

The Philco Transitone auto receiver with the case partly removed to show compact design. The oblique shaft in center of set leads to tuning dial on instrument board

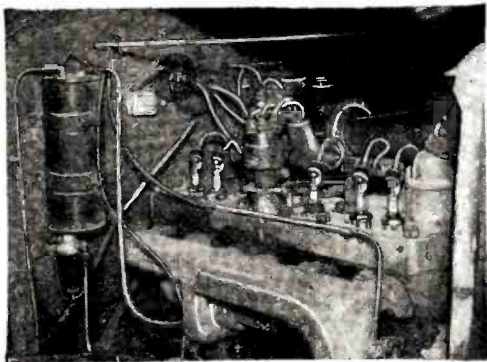

At the left is shown a method of installing ignition oscillation suppressors. One is used in series with the high tension lead at each spark plug and one in the main lead to the distributor

erection of the antenna, and then replacing it—a job which can be done only by an experienced automobile top worker.

Tests have shown that with this type antenna there is less tendency for pick-up of ignition noise. Unless the roof antenna is properly designed, it being located above the chassis, with the ignition system virtually in between antenna and counterpoise, it has a greater tendency to pick up ignition disturbance.

It can also be shown that the sub-car antenna can be designed so as to have even greater effective height than the roof aerial. The approximate capacity of such an antenna would be about 250 micromicrofarads. As shown in the diagram the capacity between the plate and the chassis, and the plate and the ground would serve to pick up the radio frequency current necessary to receive the broadcasting signals. Furthermore, it has the advantage of being located near the receiving set, and it is not necessary to run the lead wire adjacent to the car frame for any extended length.

So much for antenna design. Now for consideration of the receiving set itself. Practically all of those available on the market at the present time make use of screen-grid valves in a tuned-radio-frequency circuit. The popular type tube for this purpose is the 24 type. While this valve is designed for use in alternating current sets, it has a number of particular advantages which make it practical for automotive radio. It is rugged in construction, and above all is practically free from microphonic noises.

In order to obtain the necessary 2.5 volts for the filament circuit from the six volt storage battery used in the car, it is necessary to wire them in series. Three such valves are usually connected in this manner. This delivers approximately two volts to the heating filament of each tube, and has been found satisfactory under normal conditions. In other sets two such valves are connected in series, and the filament voltage is reduced to the proper value by means of a fixed resistance in the battery circuit.

In the automobile radio set, the amount of volume necessary is not great because of the small size of the automobile enclosure. If the average home set were installed in the automobile, adjusted at normal house volume, it would sound terrifically loud. One stage of audio frequency amplification is therefore usually adequate. High sensitivity is provided by the sensitive radio-frequency amplifiers employed.

Receivers in general are designed for mounting directly behind the dashboard which separates the engine compartment from the driving seat. They are controlled by means of a remote tuning device which attaches directly to the instrument board, usually in front of the seat to the right of the driver.

Tuning controls consist essentially of a station selector, volume control and "on" and "off" switch. Methods of tuning the variable condensers in the set vary somewhat but in principle of design are essentially the same. This tuning control is attached to the instrument board by means of a clamp. Control of the set is obtained by means of either a chain cable, similar to that used to drive the speedometer, or by means of a direct shaft with the necessary differential joint connections to drive the tuning shaft, which usually is at right

angles to the instrument board of the automobile.

Of the types used, perhaps the best control is obtained with the direct shaft. When properly adjusted it is not apt to have any lag motion, while the flexible chain contained in a flexible housing is apt to lag when the direction of turning the control is reversed. However, in sets where this system is used, lost motion has been reduced to a minimum.

Shielding of the set is important. In addition to shielding out motor interference, it protects the receiver from dust.

While power to operate the filaments of auto sets is obtained from the automobile storage battery, the necessary plate potential is obtained from conventional B batteries. Such batteries are usually contained in a metal battery box mounted under the rear floor boards.



Above is the complete Bosch equipment, which includes "B" batteries and battery box, shelf, tubes, the set and speaker and the tuning control at the lower right with its flexible shaft to receiver

At the right is an installation of the "B" battery box under the rear floor boards of an automobile. The container is assigned to hold three standard 45-volt batteries. A cover over the top fits flush with the floor



Connection to the set is made through wires contained in a shielded housing which eliminates any tendency for ignition pickup in the battery wire circuit.

While no automobile set manufacturer has attempted to develop other than the use of batteries as a means of obtaining the plate battery power, it might be suggested here that another means of obtaining such power would be by means of a dynamotor operated from the storage battery. Such a generator would require only a small amount of power to run. The plate power consumed by the average auto set does not exceed fifty milliamperes. A dynamotor designed to generate such power would take small drain on the battery.

Perhaps the major reason why automobile radio was not more widely accepted last year, when it was first introduced in its present practical state, was due to the installation problems. The merchandising problems also presented difficulties.

However, this year manufacturers are prepared to cope with this problem. In addition to designing less expensive sets, they are making preparations for the establishment of service stations throughout the country. A number of these set makers are in the battery service field, and are preparing to equip all service stations to make installations.

Among the manufacturers making automobile radio sets are: the Philco Radio Company, which is entering the field for the first time this year; The American Bosch Magneto Company, The National Company, the Crosley Radio Corporation, The Delco-Remy Company, Silver-Marshall, Inc., and others.

Philco is entering the field for the first time this year, and has incorporated Transitone, a pioneer automobile radio manufacturer, and will produce Philco-Transitone sets.

While older than broadcasting, engineers did not begin to attempt to solve the problems of installing sets in cars until four years ago. During this period tremendous progress has been made. Today it is possible to receive radio programs with reliability over distances between fifty and 100 miles while touring along the country highway—truly a remarkable achievement.

Giant Loud Speaker Has *Fifteen-Mile* Range

A mammoth German loud speaker, a product of Siemens and Halske, weighs 450 pounds, is built into a baffle board five yards square and covers a distance of fifteen miles without distortion of the high or low frequencies

By Hans H. Reinsch

A FEW months ago the residents of Berlin were given an extraordinary concert—one in which the music, curiously enough, seemed to emanate from the air itself. Thousands of people in the streets stopped and looked up, but it was quite impossible to discover the source of the music.

Publicity releases later announced the fact that this "concert from the clouds" had been broadcast from a new giant loud speaker installed on the roof of the research laboratory of Siemens and Halske, of Berlin.

The volume of this new type of speaker is so immense that music and speech can be heard over a distance of approximately 15 miles. In the case of the incident described, the volume actually obtained corresponded to that which can be produced by an orchestra of some 2000 musicians. It is claimed for this speaker that the quality of reproduction is not impaired at all by this tremendous volume but remains perfectly true to nature.

Due to certain technical and design features, the speaker has an equal response to high and low frequencies. This achievement has been made possible by producing a magnetic field of very great flux density in which all lines of force are at right angles to the vibrating conductors. The reproducer has a total weight of about 450 pounds and

is built into a baffle board which measures approximately 5 square yards.

A current of 120 amperes passes through the voice coil and the leads feeding the power current to the speaker unit, where it is converted into sound, are cables as thick as fingers. The diaphragm generating the sound waves is made of 1.5 mm. aluminum sheet to withstand the strain of the vibrations which will move the diaphragm a total distance of up to four-fifths of an inch.

The speaker unit is of the electro-dynamic type and will handle energy ranging from 600 to 800 watts, the radiated energy amounting to about 200 watts. This latter causes a large variation in the air pressure, which it was possible to notice as far away from the speaker as 55 yards.

One of the Siemens and Halske reproducers was installed on the tower of the Berlin transmitter during the recent Berlin exposition in the German capital. and it was on a Sunday morning that the speaker was first put into operation. Simultaneous with the ringing of church bells throughout the city, this giant speaker burst forth with the strains of a popular German song—now current in this country—"Oh, Donna Clara." The churchgoers were sufficiently upset by this to put in complaints at eleven police stations in different parts of the city. The (Continued on page 1098)

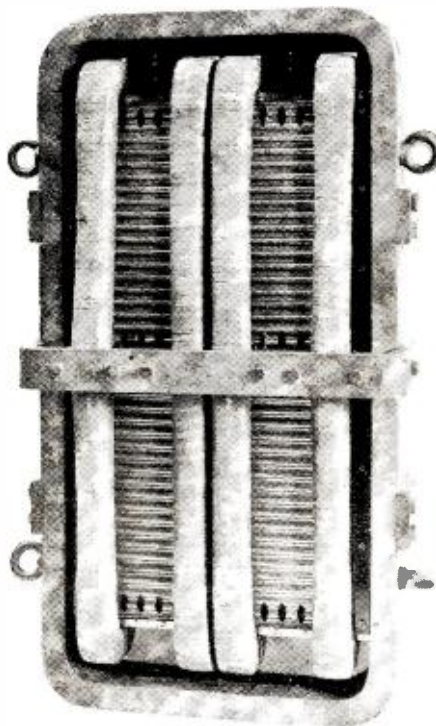

Above is a close-up view of the giant Siemens and Halske loud speaker unit described in this article



At the left is a loud speaker installed on the roof of the Berlin station, from which point the initial experiments were carried out

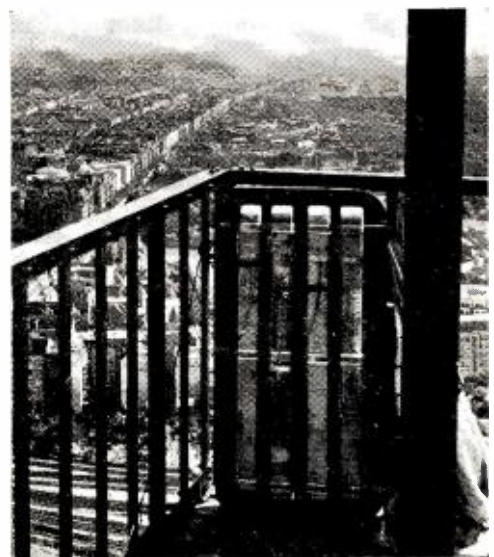

At the right is shown a panoramic view of the city of Berlin from the balcony on which the loud speaker was mounted. This glimpse gives some idea of the immense distance covered by the music broadcast through this speaker

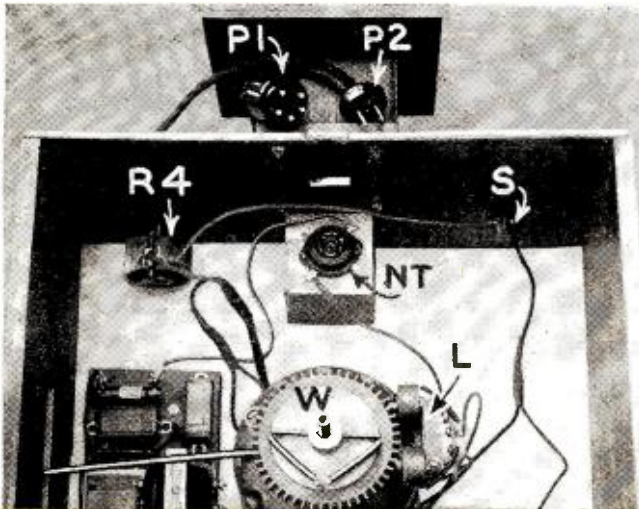

any later time, clockwise rotation should be desired, because of any change in the standard method of scanning, the direction of rotation of the motor can be changed very easily by reversing the connections of the red and blue leads of the motor.

The speed of the motor is varied by adjustment of rheostat R4. When the speed is adjusted to approximately the speed of the transmitter scanner, the synchronizing unit effectively locks it in step with the transmitter and keeps the picture in frame.

Assembling the Television Unit

The first step in building the television unit is to assemble the synchronizing phonic wheel and magnet mounting on the motor and mount the motor in the cabinet. The various elements used in the motor assembly are shown in Figure 1. The magnet mounting adjusting rod, LR, is screwed into the magnet mounting L and the assembled magnet mounting is then slipped over the shaft and centering boss of the motor frame. The shoulder on the upper part of the motor, over which the magnet assembly is fitted, will probably have to be sand-papered to remove the paint so as to allow the magnet assembly to move

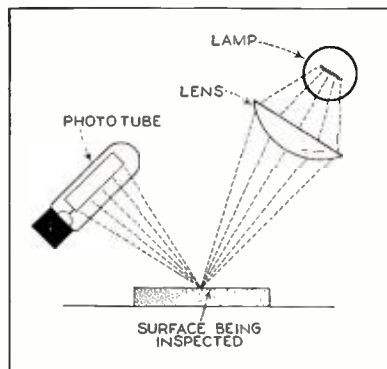
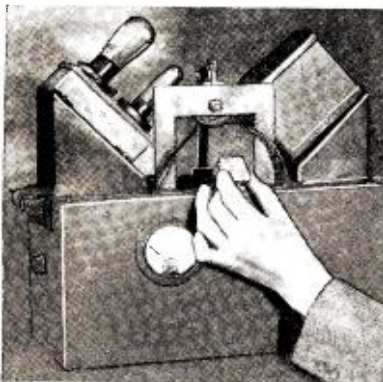

Figure 11. A photo-electric sorting device and, Figure 10, at right, a schematic arrangement of same. The method of operation is explained in the text

which is, in turn, utilized to decrease the bias of the second amplifier tube and increase its plate current. With this type of amplifier, the plate current of the second tube is at all times approximately proportional to the amount of illumination on the photo-electric cell, regardless of the rate of change of the applied light.

If it is desired to amplify a rapid change (*i.e.* of the order of audio frequencies) in light intensity, a somewhat higher amplification factor may be obtained by using transformer coupling as shown in Figure 6. It is obvious that slow changes in light intensity, or the initial light on the phototube will not affect the plate current of the second tube, as only rapidly-varying currents in the primary of the coupling transformer will induce a voltage in its secondary which is applied to the grid of the second tube.

Phototube Light Sources

The discussion, so far, has concerned the phototube and the methods of amplifying its energy. In order to make intelligent use of such amplifier schemes, it is necessary to consider the proper methods of directing light on the cell. Many devices operate from the interruption or partial interruption of a light beam from an artificial source. In constructing such a light source it must be borne in mind that it is only necessary to direct a small but intense spot of light on the light-sensitive tube. An incandescent bulb produces light from a heated filament which is heated to practically the same temperature for any bulb from the smallest to the largest. If the image of the filament of a large bulb is concentrated on a phototube it simply produces a larger spot of light of about the same intensity as a

much smaller bulb. This, of course, means that nothing will be gained in using a large bulb as a light source; in fact, it will be found wise to use an ordinary 21 c.p. automobile headlight bulb. Slight advantages for some applications may be gained by using a specially constructed bulb, with a straight filament instead of a coiled filament structure. The advantages, for most experimental uses, are so slight, however, that the extra cost of a special bulb is not always justified.

If the bulb is simply placed in the open, a sufficient light intensity for satisfactory operation will not reach the phototube except for extremely short spacings between the phototube and light source. For greater distances, a parabolic reflector, or simple convex lens placed at a distance from the bulb equal to its focal length, will concentrate the light into approximately parallel rays. If the scheme is to work

for distances more than a very few feet, it will also be necessary to use an additional lens in front of the phototube to collect and concentrate the light on the phototube. Figure 7 shows such an optical system. Plano-convex or double-convex lenses (2 to 6 inches in diameter) of a focal length of from two to six inches will be found satisfactory. A cheap reading glass will generally meet these specifications.

The lens in front of the light source should be so placed that a sharp image of its filament will be thrown on a flat surface at about the same distance as it is expected to work the phototube. It will be found that the distance from the bulb to the lens is the focal length of the lens except for extremely short operating distances. The collecting lens in front of the phototube should be similarly placed at its focal length so that the collected light is focused on a small, intense spot on the cathodes of the phototube.

Figure 8 illustrates a commercial form of light source, for industrial applications, where the bulb is mounted in a suitable box with means for adjusting its focus.

Detecting Smoke With the Phototube

If a light source is directed on a phototube as shown in Figure 7 and the phototube amplifier is connected to cause an increase of current with a decrease in light (Figure 3 of this article or Figure 8 of the April article, which is essentially the same circuit excepting for d.c. voltage supply), a comparatively small puff of smoke intercepting the light beam will cause an appreciable increase in amplifier-tube plate current. It is possible to adjust such a set-up so that a fairly strong puff of cigar or cigarette smoke will cause enough current change to operate an indicating lamp, an alarm bell or

driving collar member and the top face of the phonic wheel. It will then be found that the toothed wheel is free on the shaft of the motor but will be carried around when the shaft revolves by the flexible connection to the shaft through the springs which connect it to the ends of the driving collar rods.

Mounting the Motor Assembly

It would be found much easier to work inside the cabinet if the viewing chute or shadowbox at the front is left off until the other parts are completely assembled in the cabinet. It will also help considerably, in handling the cabinet and working in it, to unscrew the lid of the cabinet and lay it aside until all the parts in the cabinet are assembled and wired.

The next step in building the unit is to mount the motor assembly in the cabinet as shown in Figure 3, with the end portion of the magnet adjusting rod, LR, projecting through the slot provided at the side of the cabinet. The motor should be placed with its shaft exactly in the center of the cabinet. When this has been done, mark the center of the motor mounting holes with a center-punch. The motor can then be removed and the mounting holes drilled through the bottom of the cabinet. A No. 6 size or slightly larger hole will do.

Cushioning the Motor

In mounting the motor, slip a washer over the mounting screw. Then insert the mounting screw through the base of the cabinet from the bottom. Slip one of the rubber cushioning washers, provided for the purpose, over the screw after it enters the cabinet and then insert the screw through the mounting foot of the motor, placing another rubber washer over the screw. Then slip a metal washer over the screw, on top of the rubber washer and finally thread a nut on the end of the

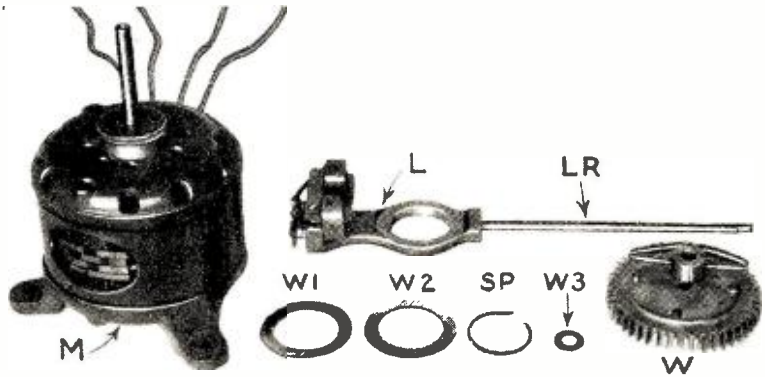

Figure 1. The motor with its auxiliary parts ready for assembly. Details of assembly are described in the text

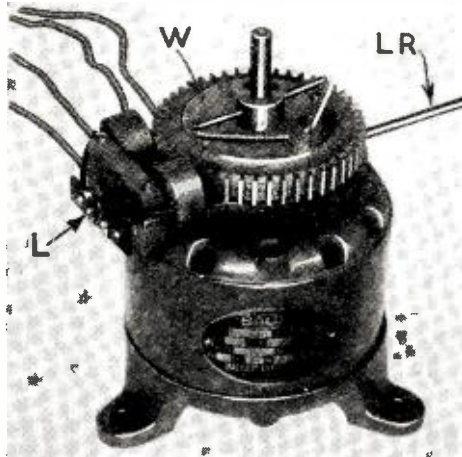

Figure 2. The motor assembly completed and ready for installation in the cabinet

screw. By using this method of mounting, the motor will be floated between the two rubber washers which will absorb any vibration created by the running motor.

The three screws should be tightened up evenly, after making sure that the center of the shaft is in the center of the cabinet. Otherwise the shaft may lean at an angle instead of being at right angles to the base of the cabinet.

Next place the 2 mfd. condenser, C4, in the corner of the cabinet as shown in Figure 3 and fasten it in place by screwing four 3/4" wood screws into the base, side and back of the cabinet. Then mount the snap switch, S, and the rheostat, R4, on the front panel as shown. The mounting nuts of the rheostat should be adjusted so that the rheostat resistance element is as far back from the panel as possible.

The scanning belt can now be assembled on the scanning drum.

Handle Scanning Drum and Belt Carefully

The importance of handling the scanning drum and belt carefully cannot be stressed too strongly. The drum and belt have been made with precision exactness and must be kept so to give good results. The belt will run true, the scanning holes keeping within five-thousandths of an inch of a straight line, provided the belt and drum are not bent out of shape by careless handling. Always pick up the drum by the heavy collar at its center. Bending the drum or belt is sure to result in the appearance of lines which will ruin the picture.

If you hold the closed circle belt up to the light, you will see a complete single turn spiral of very small, square holes. These are the scanning holes. The efficiency of the television receiver depends largely on the accuracy with which these holes are made and spaced and the true running of the belt.

Near one edge of the belt you will find five elongated holes, or slots, spaced to correspond with the five pegs projecting on the inside of the drum flange. To mount the belt in the drum, bend the belt into the shape shown in Figure 5 and place it inside the drum with the edge of the belt containing the (Continued on page 1094)

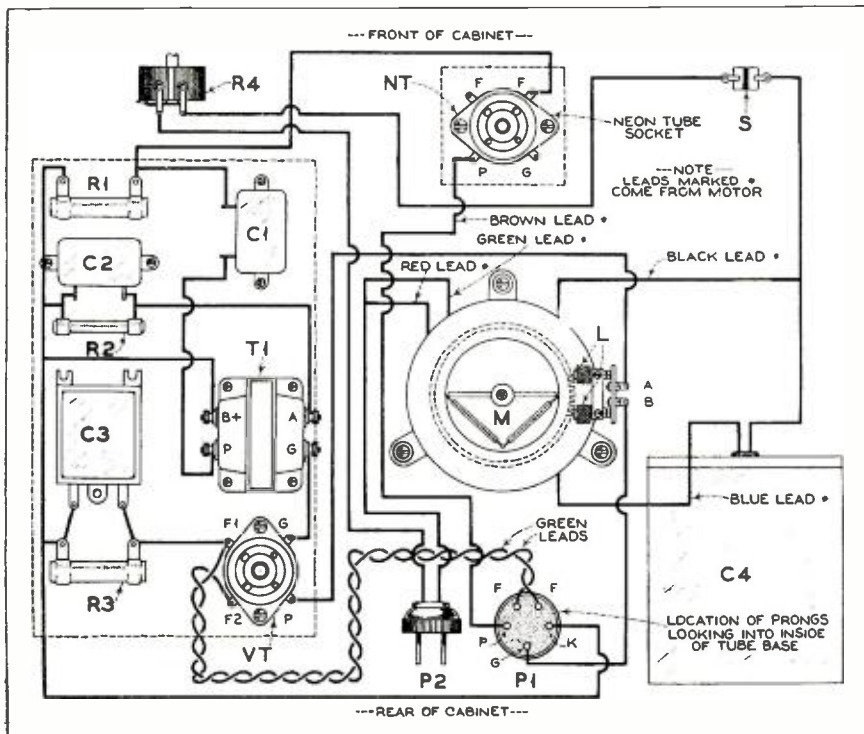

Figure 7. The picture wiring diagram of the complete unit, showing the detailed wiring of all parts. The symbols correspond with those in the other illustrations

Policing *the* Ether Lanes

Uncle Sam spent a quarter of a million dollars for his radio receiver, but it is no ordinary receiver. It reaches out to the ends of the world to check up on the transmitters deviating from assigned frequencies

By Martin Codel

OUT on the Nebraska prairie, not very far from the geographical center of these United States, stands radio's super-policeman—a sort of robot traffic cop of the ethereal wavelengths.

If you should detrain at Grand Island, Nebraska, and travel about seven miles westward along the Lincoln Highway, traversing a level sandy plain unusual for its lack of vegetation, you would come to a turn-off leading for a quarter mile or so to where this robot cop stands his lonely vigil.

Your eyes would behold a few innocent-looking, squat new buildings; all around them, covering 50 acres of the flat lands, they would also see a veritable forest of tall cedar poles looking for all the world like telephone poles but supporting a maze of wires strung in intricate patterns and stretching in all directions. (See Figure 1.)

You are at the standard frequency monitoring station of the Radio Division of the U. S. Department of Commerce. Those buildings and that jungle of wires figuratively constitute America's "policeman of the air." Radio's traffic cop is nothing more than a radio receiving system; but—

He has probably the most sensitive ears in the world, for there is hardly a radio station anywhere in the world, broadcasting or telegraph, that he cannot hear!

Enter the brick structure labeled "Main Building," Figure 3, and you will see panels and loops and loud speakers and gadgets galore, all shining new, all neatly and precisely arranged, all looking as though they mean business. They do mean business. They are there for a real purpose; otherwise the federal government would hardly have agreed to expend a quarter million dollars or more to have them there.

Over that maze of antenna wires come radio-frequency impulses from every nook on this earth of ours. By means of those instruments, trained men can tune in those impulses and hear what they are saying, whether they sputter forth dots and dashes or speak a native tongue. With those instruments, it is possible to measure to within one part in one million whether the radio frequencies are precise, *i.e.*, whether they are deviating or "wobbling" from their assigned positions in the wavelength spectrum.

Radio's traffic cop bellows forth no orders or abuse. He has a meek little voice, only 750 watts of power behind it, over which he telegraphs his findings by radio to Washington. More frequently he uses the wire telegraphs to inform Washington or to inform the station which he has been measuring. He is exacting as a scientist in his determinations; he is mild as that same scientist in his "human" relations with offenders. They are given every chance to come within standard. To stop wobbling off frequency, to make the ether channels safe for their own travels as well as for others to travel.

The measurement of frequencies according to precision standards fixed by the U. S. Bureau of Standards is, then, the purpose of our "policeman of the air." If you are a DX fan, the monitoring

man might let you have a few moments' thrill tuning in—well, Russia's Radio Moscow on the long waves with its constant flow of news and propaganda; that broadcaster in Malabar, Java; a broadcaster out in New Zealand; France's Tour Eiffel; Germany's Koenigwüsterhauser, and code stations all over the world. Or it might be Mukden, up in Manchuria, talking about an earthquake, as it actually happened to be a few months ago. That's easy, the monitoring man will tell you, very easy, if the station is using substantial power on a clear channel. Easier still to hear North American stations—though there has to be a lot of manipulating of antennas to catch the call letters of the stations on channels that are badly heterodyned because they are so crowded with a multiplicity of stations.

"We haven't gone after any station yet that we haven't been able to receive, at least to catch its call letters," says S. W. Edwards, supervisor of development and production of the Radio Division, the man who conceived and built the government's standard frequency monitoring station at Grand Island.

Glance over the list of stations heard up to the time of this writing, early in February, or before the station had gone into everyday operation, and it looks like a voluminous compilation taken whole from a gazetteer of the world. There are tricks to every trade, and there are certain little tricks whereby this remarkable station can be made to tune in even the stations wanted on the badly heterodyned channels. For measurement purposes, of course; it would hardly do to promise real entertainment on those channels.

The Grand Island development is Edwards' brainchild. He conceived it about five years ago while he was federal radio supervisor at Detroit. With his chief, William D. Terrell, director of the Radio Division, he went to the then Secretary of



S. W. Edwards, supervisor of development and production of the radio division, Department of Commerce

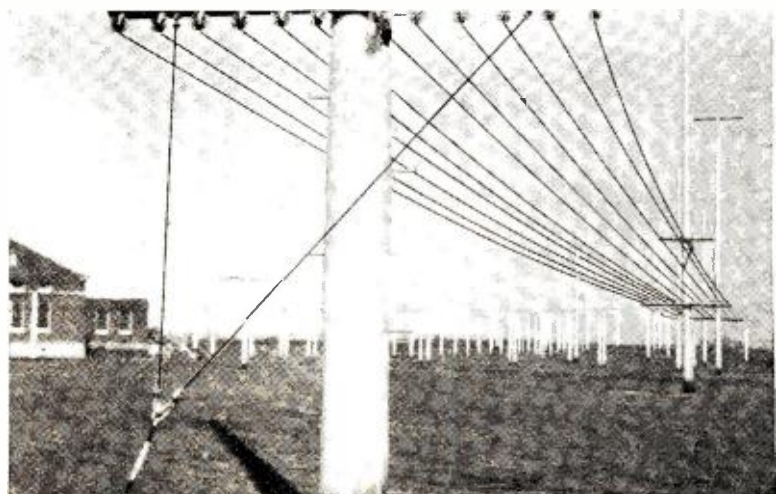

Figure 1. This photograph conveys some idea of the complexity of the antenna systems. The multitude of poles are only a part of those used

Commerce, Mr. Hoover, with the idea. The next step was to enlist the support of the country's leading radio engineers. They were wholeheartedly in favor of the project.

It was decided that the best place for the measuring station would be somewhere out in the Middle West. Extensive field strength tests were made throughout the Corn Belt. Reception conditions were found to be exceptionally good almost everywhere in the prairie regions. It then became a problem of elimination to choose one site over another.

The Grand Island site was chosen because of its central location, the nature of the terrain and the fact that neither radio, telegraph, telephone nor man-made interference were there to cause trouble. Grand Island is just about equidistant by air line between Boston and Los Angeles.

Congress appropriated first \$50,000 and then \$30,000 for the land, buildings, road and communications lines. Under earlier departmental appropriations, about \$200,000 was made available for the equipment for this and a group of secondary standards planned by the division. Fortunately for the government, the Grand Island Chamber of Commerce donated the 50-acre tract. By October, 1930, the plant was ready for operation, except for a delay in the arrival of the two Diesel engines needed for its independent power plant and for the delay in obtaining sufficient personnel to man the station.

The land was surveyed for the antenna layout before the buildings were planned. Eleven different antennas were led out on Great Circle bearings. Four were multiple doublets, each 312 feet long with the doublets in parallel every eight feet to build up bigger voltages. These antennas are not unlike those used by the Radio Corporation of America's long-distance receiving stations at Riverhead, L. I. They are exclusively used for high-frequency (short-wave) receptions and are so placed that their reception effect is directional.

One set of these doublet antennas, tuned to the range of from 25 to 75 meters, is pointed toward London and tunes in stations in eastern United States and Europe. The other set, tuned from 65 to 175 meters, is pointed to Porto Alegre, just north of Rio de Janeiro, to take in the continent of South America, all Central America, the West Indies and the southern part of the United States. To hear western United States and Asia on these frequencies, the station depends upon round-the-world impulses.

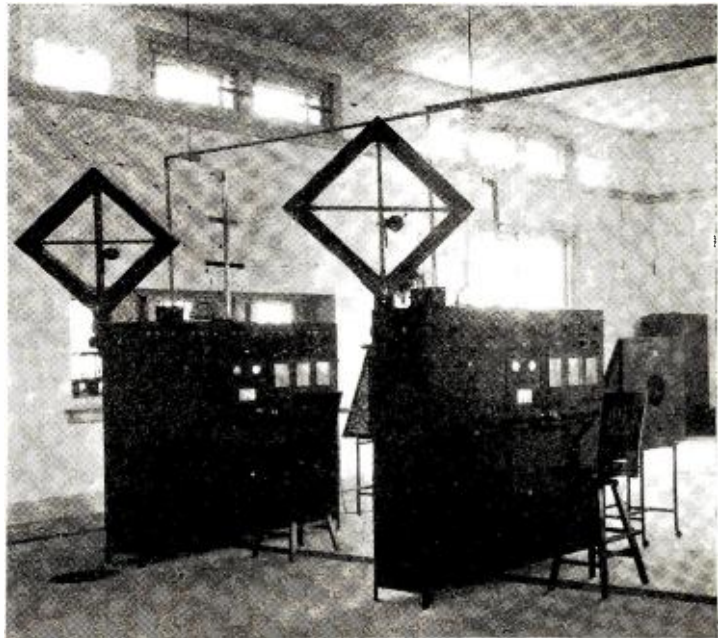

Figure 5. The two 200-3,000 meter receivers with their loops for use in emergencies

Two 200-foot single doublets covering the band from 100 to 225 meters and two 150-foot single doublets covering the band from 40-100 meters, non-directive and not as reliable as the multiple, complete the doublet set-up.

Next there is a so-called "general purpose antenna," which simulates as closely as possible conditions under which the average broadcast listener receives. It is tuned to the broadcast band from 200 to 550 meters, although it has considerable overlap.

Then there is a vertical antenna for tuning just below the broadcast band in the upper range of the high frequencies. It consists of a brass tube 65 feet long mounted on 8-inch stand-off insulators along the side of one of the 60-foot cedar poles which support all but the long-wave Beverage antenna. The vertical antenna is for general all-around high-frequency reception and ties in with one of the multiple doublets to lessen fading.

The eleventh antenna is of the Beverage type, consisting of one single strand of No. 12 hard-drawn copper wire 1440 feet long and running due east from the main building. While constructed for the broadcast band, it also is adapted to receive radio beacon signals on 1000 meters, and the monitor can consistently tune in aviation beacon stations as far away as Bellefonte, Pa., and Oakland, Calif.

Finally, there is the loop antenna, probably the largest of its kind in the world. It consists of two loops at right angles, each 500 feet long and 40 feet high on the sides. They, too, are mounted on 60-foot poles. They can tune the long waves between 3000 and 30,000 meters.

(Cont'd on page 1111)

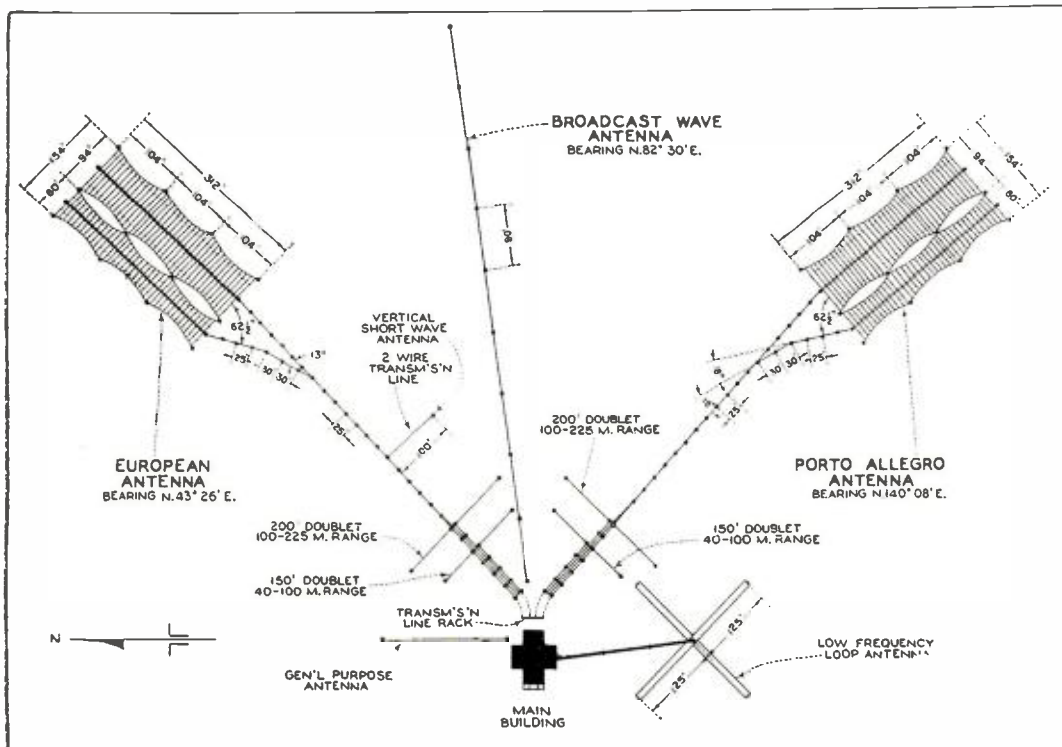

Figure 2. The layout of the antenna systems, which include eleven antennas, four of which are short-wave directional systems, indicated by the grid-like forms at the upper right and left

ELECTRIC EYES

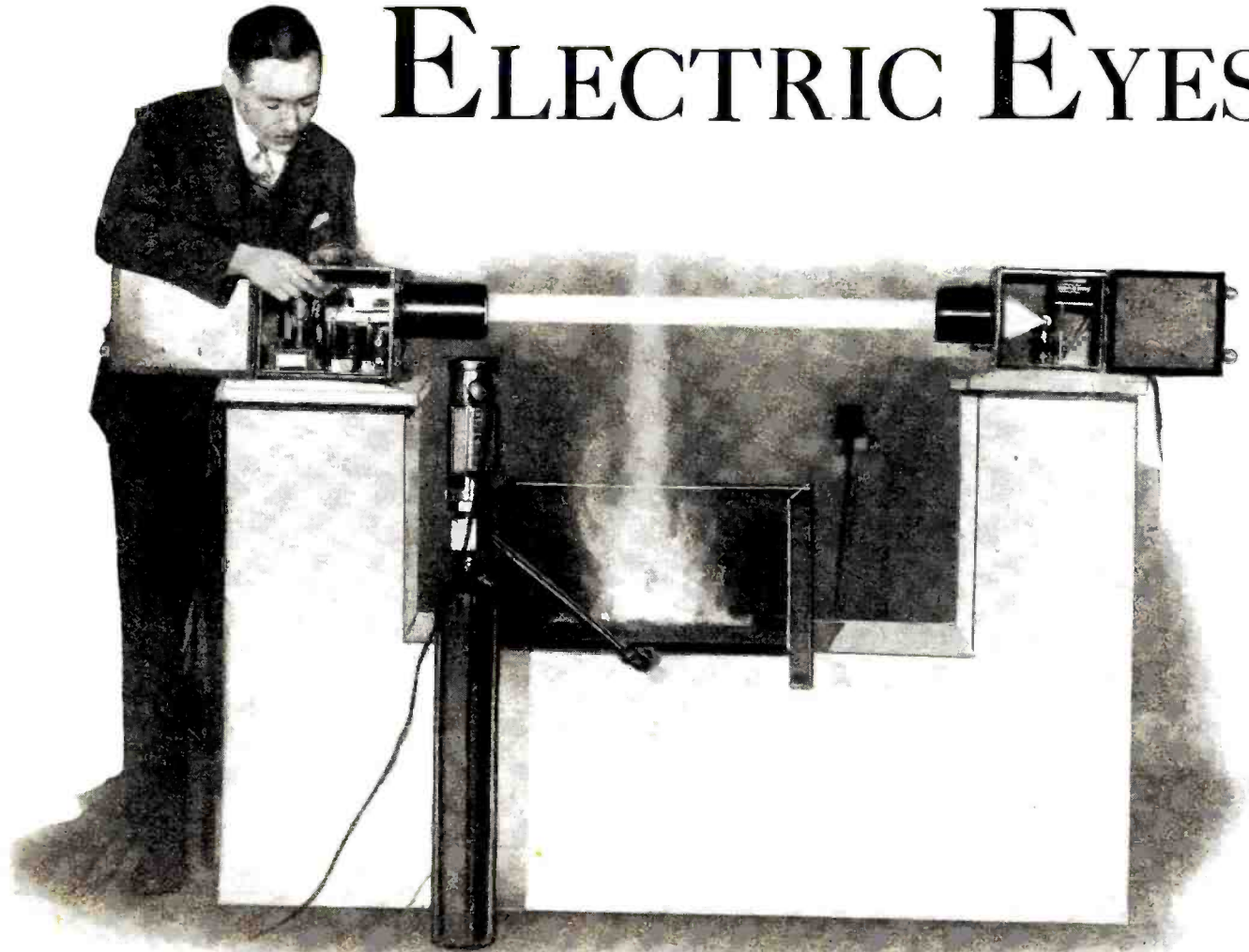

Figure 9. A model set up to demonstrate the action of an automatic phototube operated fire extinguisher system as described in this article

IT is frequently more convenient to operate a photo-electric cell and its amplifier from an a.c. voltage source than from "B" batteries. The characteristics of circuits given for d.c. operation are not appreciably changed if the amplifier tube filament is supplied with alternating current and the plate and bias voltages supplied from any standard "B" eliminator.

A circuit that is satisfactory for many applications, although somewhat less sensitive, may be obtained by utilizing "raw" alternating current as a plate and grid-bias supply. When an a.c. potential is impressed on a cell and its amplifier, an appreciable current will be conducted only during a portion of alternate half cycles—the result is naturally a lowered sensitivity than that obtained in a circuit where the current is flowing continuously.

An a.c.-operated phototube amplifier circuit arranged to give an increase in the amplifier tube plate current, with an increase in light on the phototube, is shown in Figure 1. The operation of the circuit may be better understood if it is remembered that the devices operate only during the period when the end of the transformer connected to the amplifier tube plate circuit has a positive polarity. When light strikes the phototube a current flows through the circuit indicated by the heavy lines of Figure 1. This current, flowing through the grid resistor, makes the grid more positive, which causes a rise in amplifier tube plate current.

Unless some precaution is taken, the same relay that is used in the plate circuit of a d.c.-operated amplifier cannot be used

THE previous article in the April issue discussed the construction and characteristics of the modern phototube and its use coupled with a single thermionic amplifier tube supplied with d.c. filament, bias, and plate potentials. This discussion takes up the use of the phototube in connection with a.c.-operated amplifiers, multi-stage phototube amplifiers, the selection and use of a proper light source, and some of the more prominent applications of phototube devices. THE EDITORS.

with an a.c. amplifier. Since with an a.c.-operated amplifier the plate current is flowing only half the time and even then does not reach a steady value, the relay will attempt to follow the current variations which will result in a pronounced "chatter." This condition may be prevented by connecting a fixed condenser across the coil of the relay of about 2 or 4 mfd. This condenser will become charged while current is flowing and then will discharge into the relay coil when current is not flowing, thereby holding the relay closed during the portion of each cycle when current is not flowing.

Another method of accomplishing the same result is by the use of a "lag-loop" type relay, such as the one illustrated in Figure 2. A comparison of this relay with the one recommended for use in d.c. circuits, illustrated in Figure 11 of the April article, will show that the lag-loop relay coil is fitted with a heavy short-circuited turn of copper. The short-circuited turn will tend to prevent the collapse of magnetic flux, in the iron core of the relay, during the time when current is not flowing and prevent chatter. This type of relay will remain closed for a fraction of a second after the current is shut off, which may or may not be a disadvantage, depending upon the characteristics of the device operated by the relay.

Figure 3 shows a circuit designed for a.c. operation, so arranged that a decrease in phototube illumination will cause an increase in amplifier tube plate current. The only difference between this circuit and that of Figure 1 is that the phototube is so connected that it draws current through the grid resistor,

Keep Watch for Industry

The applications of photo-electric tubes described in this article, and the close relationship between phototube work and radio, open a logical avenue for extending the activities of ambitious radio engineers and servicemen

By H. B. Stevens and M. J. Brown*

in the direction to make the grid more negative, thus depressing the amplifier tube plate current as long as the tube is illuminated.

The plate and bias voltages will depend upon the tube used, as well as the amount of maximum plate current desired. An increase of plate voltage, accompanied by a proportionate increase in bias voltage, will result in a higher maximum plate current. Naturally the plate voltage should be limited to the rating of the tube used.

Since the amplifier-tube grid resistors used in the amplifiers have a rather high value, it is important that the phototube circuit, proper, be so protected and wired that it will not be subjected to undue electrical leakage. A comparatively small amount of leakage will conduct as much current as a 100-megohm grid leak and thus upset the operation of the entire circuit. Figure 4 illustrates a commercial form of amplifier unit, so constructed that all circuits carrying currents of the order of microamperes are protected in a dust- and moisture-proof container, while all external circuits carry currents of the order of milliamperes or more and are, therefore, not so easily disturbed. Such a device is particularly to be recommended where the phototube devices are to be subjected to a considerable amount of dirt or moisture.

It will be found that many interesting experiments may be performed, using a single stage of amplification. It is only necessary to use additional amplification when working with extremely low light intensities, such as the reflection of light from a comparatively dull surface.

Multi-Stage Amplifiers

Figure 5 shows a two-stage resistance-coupled amplifier. When the photo-electric cell is subjected to light, a current flows through the grid resistor of the first amplifier tube (in exactly the same manner as in a single-stage amplifier) which makes the grid more positive and results in an increase in plate current. The plate current of the first amplifier tube flows through a resistor, producing a drop

*Engineers, Westinghouse Elec. & Mfg. Co.

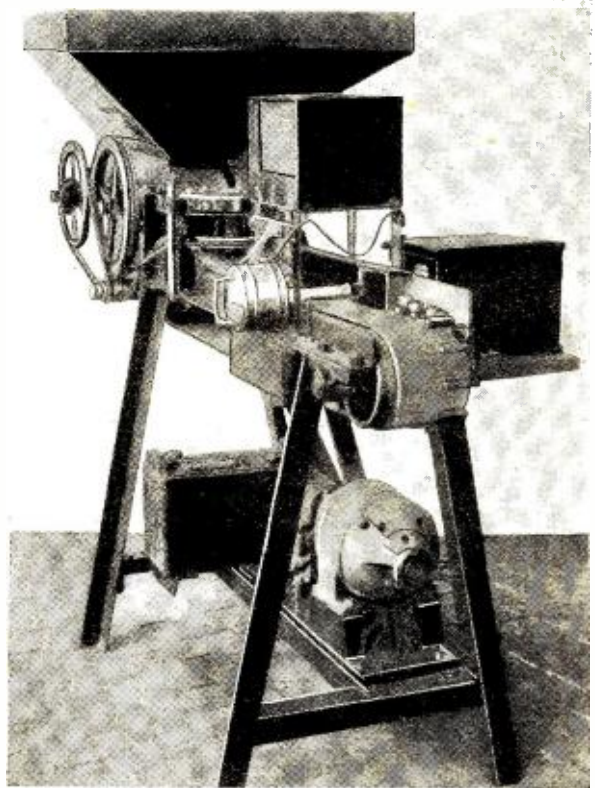
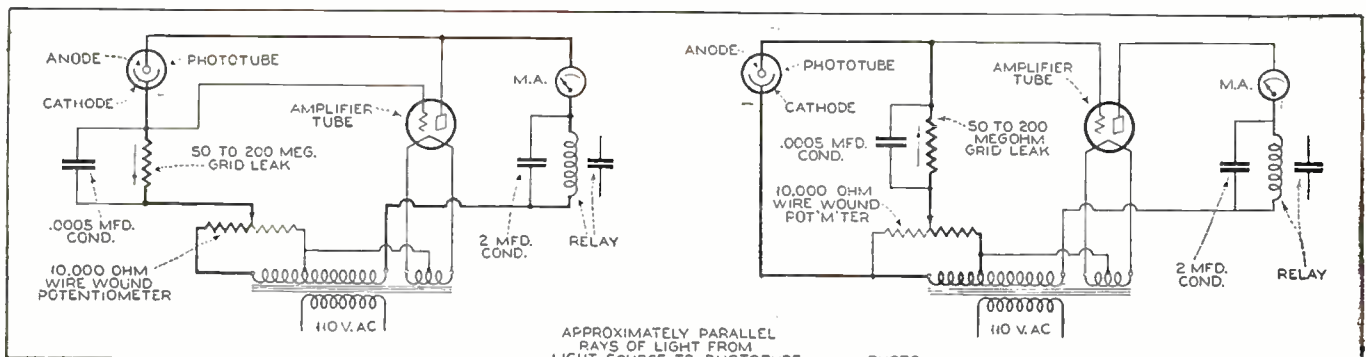

Figure 14. A photo-electric tube arranged to count the output of a machine as the units pass on the conveyor seen in the centre



Two a.c.-operated photo-electric amplifiers arranged to provide (above, Figure 1) an increase in plate current with an increase in light, and (above, right, Figure 3) a decrease in plate current with an increase in light

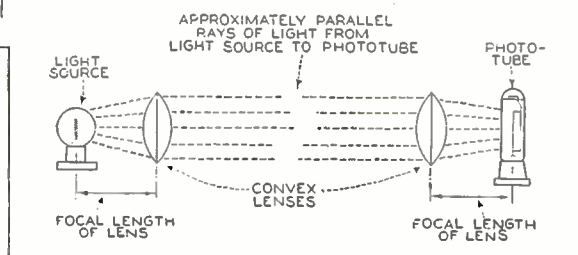

Figure 7 (left). Diagrammatic sketch of a simple optical system for use with photo-cell

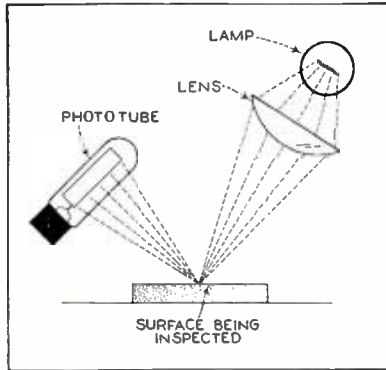
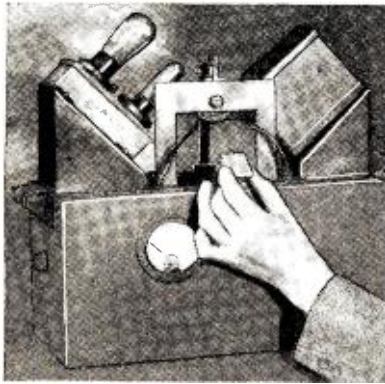

Figure 11. A photo-electric sorting device and, Figure 10, at right, a schematic arrangement of same. The method of operation is explained in the text

which is, in turn, utilized to decrease the bias of the second amplifier tube and increase its plate current. With this type of amplifier, the plate current of the second tube is at all times approximately proportional to the amount of illumination on the photo-electric cell, regardless of the rate of change of the applied light.

If it is desired to amplify a rapid change (*i.e.* of the order of audio frequencies) in light intensity, a somewhat higher amplification factor may be obtained by using transformer coupling as shown in Figure 6. It is obvious that slow changes in light intensity, or the initial light on the phototube will not affect the plate current of the second tube, as only rapidly varying currents in the primary of the coupling transformer will induce a voltage in its secondary which is applied to the grid of the second tube.

Phototube Light Sources

The discussion, so far, has concerned the phototube and the methods of amplifying its energy. In order to make intelligent use of such amplifier schemes, it is necessary to consider the proper methods of directing light on the cell. Many devices operate from the interruption or partial interruption of a light beam from an artificial source. In constructing such a light source it must be borne in mind that it is only necessary to direct a small but intense spot of light on the light-sensitive tube. An incandescent bulb produces light from a heated filament which is heated to practically the same temperature for any bulb from the smallest to the largest. If the image of the filament of a large bulb is concentrated on a phototube it simply produces a larger spot of light of about the same intensity as a

much smaller bulb. This, of course, means that nothing will be gained in using a large bulb as a light source; in fact, it will be found wise to use an ordinary 21 c.p. automobile headlight bulb. Slight advantages for some applications may be gained by using a specially constructed bulb, with a straight filament instead of a coiled filament structure. The advantages, for most experimental uses, are so slight, however, that the extra cost of a special bulb is not always justified.

If the bulb is simply placed in the open, a sufficient light intensity for satisfactory operation will not reach the phototube except for extremely short spacings between the phototube and light source. For greater distances, a parabolic reflector, or simple convex lens placed at a distance from the bulb equal to its focal length, will concentrate the light into approximately parallel rays. If the scheme is to work for distances more than a very few feet, it will also be necessary to use an additional lens in front of the phototube to collect and concentrate the light on the phototube. Figure 7 shows such an optical system. Plano-convex or double-convex lenses (2 to 6 inches in diameter) of a focal length of from two to six inches will be found satisfactory. A cheap reading glass will generally meet these specifications.

The lens in front of the light source should be so placed that a sharp image of its filament will be thrown on a flat surface at about the same distance as it is expected to work the phototube. It will be found that the distance from the bulb to the lens is the focal length of the lens except for extremely short operating distances. The collecting lens in front of the phototube should be similarly placed at its focal length so that the collected light is focused on a small, intense spot on the cathodes of the phototube.

Figure 8 illustrates a commercial form of light source, for industrial applications, where the bulb is mounted in a suitable box with means for adjusting its focus.

Detecting Smoke With the Phototube

If a light source is directed on a phototube as shown in Figure 7 and the phototube amplifier is connected to cause an increase of current with a decrease in light (Figure 3 of this article or Figure 8 of the April article, which is essentially the same circuit excepting for d.c. voltage supply), a comparatively small puff of smoke intercepting the light beam will cause an appreciable increase in amplifier-tube plate current. It is possible to adjust such a set-up so that a fairly strong puff of cigar or cigarette smoke will cause enough current change to operate an indicating lamp, an alarm bell or other device.

Figure 9 illustrates a photo-electric fire extinguisher constructed for demonstration purposes. A small fire built in the metal pan in the center of the table causes a cloud of smoke to rise and intercept (*Continued on page 1098*)

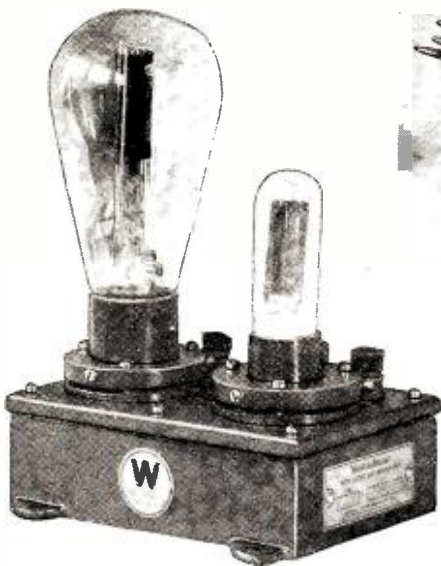

Figure 4. A commercial photo-electric amplifier unit. Figure 2 (above, right). A "lag-loop" relay suitable for use in plate circuits of a.c.-operated photo-electric amplifiers

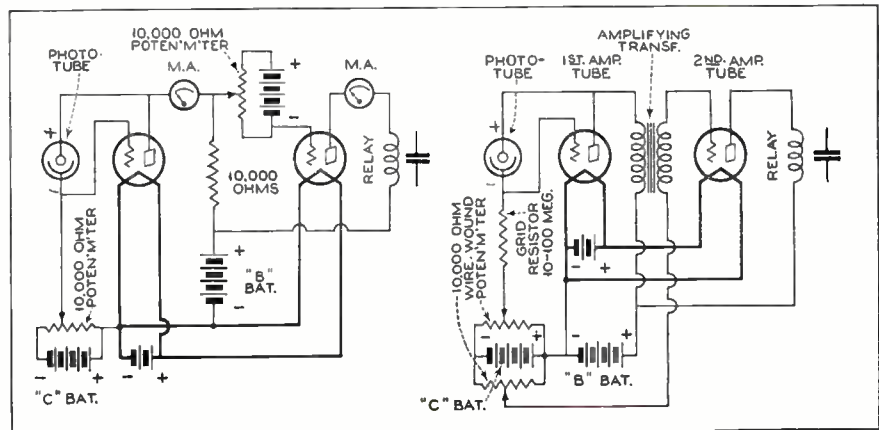

Figure 5 (below, left). Two-stage photo-electric amplifier circuit with resistance coupling. Figure 6 (right). Same, with transformer coupling

The New Ribbon Microphone

A new and radical development in microphones, the new ribbon type, because of its directional characteristics, may greatly simplify the recording of sound pictures. It offers interesting possibilities for the broadcast studio as well

WHEN operated as the pick-up device for certain types of sound transmission and recording work, the fault has always been found with ordinary microphones that they are not sufficiently directional. The regular one-button and two-button carbon microphones and the condenser microphone are sensitive in an almost equal degree to sounds coming from any direction. While this characteristic which most microphones possess may sometimes be of advantage under particular types of sound pick-up conditions, it has the disadvantage of making the microphone sensitive to all the extraneous and unwanted sounds and disturbances originating within range of the microphone. The ideal microphone for motion picture sound recording and public address systems would pick up only the sounds or speech coming from a certain direction to the almost complete exclusion of all other sounds. Many attempts, such, for example, as reflectors, concentrators, and other sound-focusing devices, have been made to overcome this non-directional quality possessed alike by carbon and condenser microphones; but these efforts have all either met with failure or have proved to be merely more or less unsuccessful substitutes for the truly directional microphone.

Working on an old principle, the RCA Photophone engineers have developed an extremely sensitive directional microphone, which they call the ribbon microphone because of its construction. This microphone operates under the electrical law that a conductor moving in a magnetic field has an electromotive force induced in it by its action in cutting the magnetic lines of force of the field. At any instant, the magnitude of the induced e.m.f. is equal to the rate of change of the magnetic flux through the circuit. It is the same effect that makes possible the operation of electrical generators

Photo courtesy RKO Radio Pictures

The ribbon microphone with the covers removed. Below the microphone and above the amplifier

Figure 1. The schematic circuit of the microphone and built-in amplifier

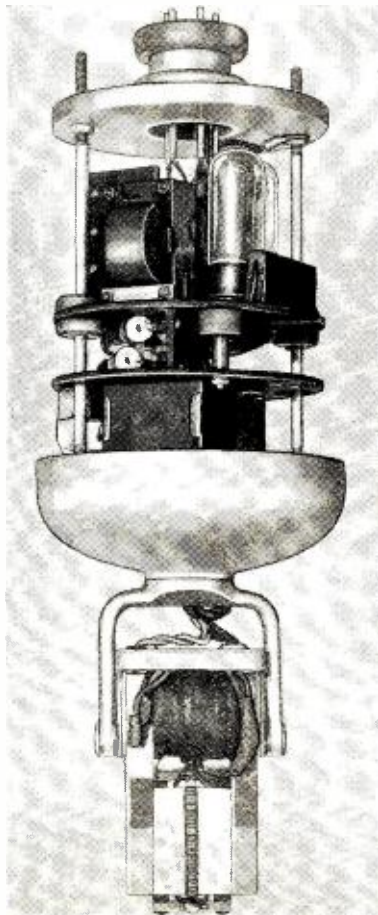

By Charles Felstead

and many other pieces of electrical equipment; although, in such machines, a larger number of turns of wire are used to obtain a greater cutting of the lines of force than would be possible with a single wire or loop of wire. Since only a single conductor is used in the ribbon microphone, it is necessary to increase the magnetic flux considerably so that a small movement of the conductor will cause it to cut a great many lines of force. For that reason, a small but powerful electromagnet takes the place of the permanent magnet which is employed in the classical electrical experiment that demonstrates this law, because the electromagnet provides a much greater magnetic flux; and that helps to compensate to a certain extent for the small size of the moving metal armature of the ribbon microphone.

In place of employing a round wire as the moving armature in the ribbon microphone, a very light piece of wide, flat metal ribbon is used because it presents more surface for the sound-pressure waves to act upon. The ribbon is supported directly between the two poles of the electromagnet and transversely of the magnetic field of force between the poles. The ribbon is suspended loosely; and there being no current flowing through it when it is not moving, it has no field of force of its own and so is not affected by the field of force with which it is surrounded. But when a sound wave, which is made up of alternate rarefactions and condensations in the air, impinges on the flat surface of the ribbon, it causes the ribbon to move forward and backward under the influence of the changing air densities caused by the sound wave. This movement of the ribbon armature causes it to cut the magnetic flux between the poles of the electromagnet, and that sets up a minute alternating current within the ribbon, which is fed through an input transformer to the grid circuit of the first tube in the microphone amplifier. Since the rapidity of the back and forth movement of the ribbon is dictated by the speed with which the rarefactions and condensations follow each other in the air, the movement of the ribbon and the current produced in it by that movement are of the same frequency as the frequency of the sound causing it. (Continued on page 1096)



Courtesy RCA Photophone

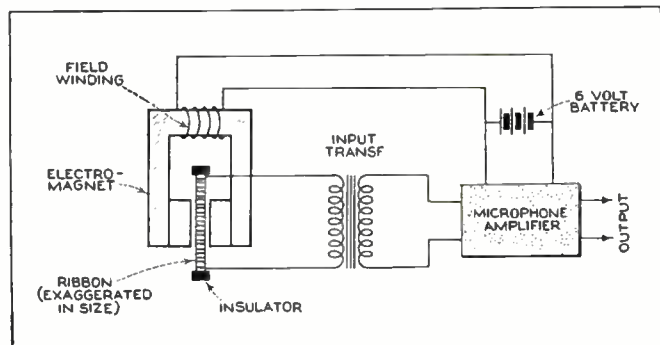

Hiram S. Brown, Merlin H. Aylesworth (at left) and Messrs. Todd, Robertson and Todd, architects, are shown examining the model of Radio City

Capital of the

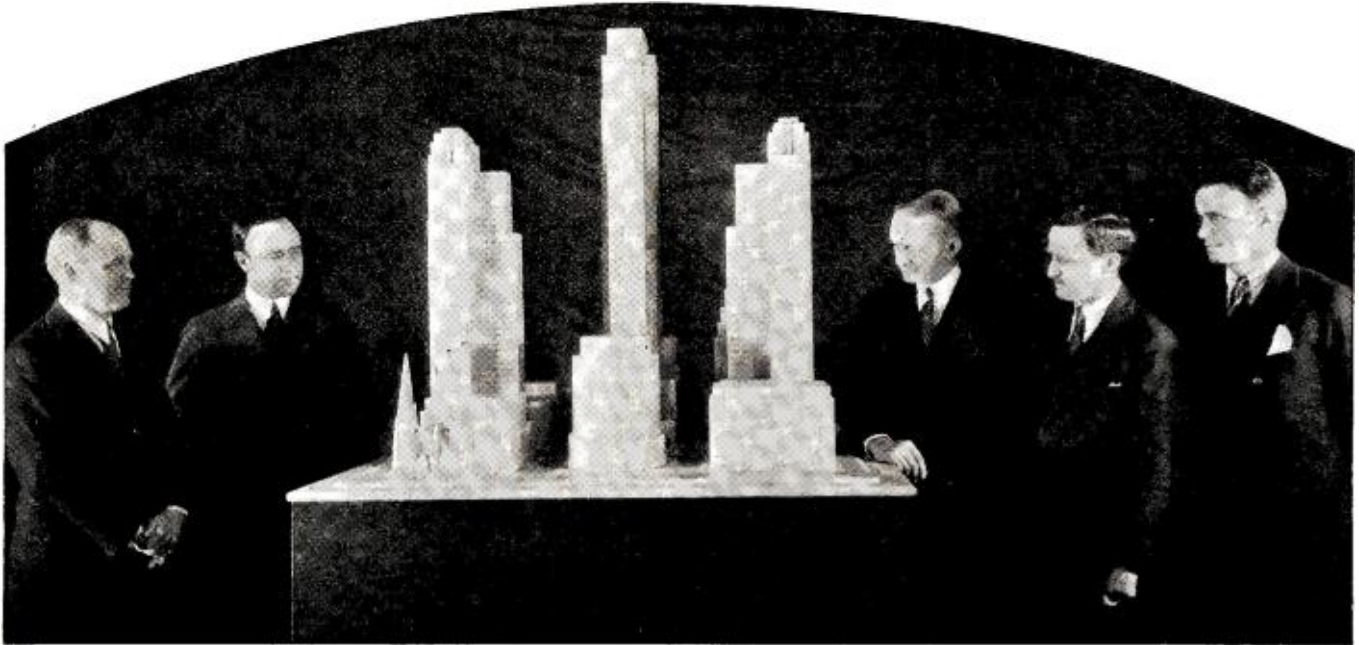

COVERING almost three entire blocks in one of the most fashionable sections of New York, a magic city of odd-shaped, towering structures will be completed within the next three years and dedicated to radio, music and entertainment.

Best known as Radio City, but frequently designated as Rockefeller City and Metropolitan Square, the largest group construction undertaking ever dedicated to American industry will be realized at an expenditure of \$250,000,000. John D. Rockefeller, Jr., heads the financial backers of the project. Mr. Rockefeller will virtually be the landlord of the "Capital of the Radio World."

The eminent tenants of Radio City will include the Radio Corporation of America, the National Broadcasting Company, the Radio-Keith-Orpheum theatrical and motion picture interests, the RCA-Victor Company and RCA Photophone, Inc. At this writing, the inclusion of the new Metropolitan Opera House in the project was contemplated. Two huge R-K-O theatres with respective seating capacities of 4000 and 6000 will be located in Radio City.

The site of the project, with a frontage on Fifth Avenue from Forty-eighth to Fifty-first Streets, extends all the way back to Sixth Avenue.

Until a plastic model of Radio City was recently exhibited to the press in the offices of the architects, no hint of the design of the structures was given out. The exhibit disclosed a beautiful group of structures of varied and unusual design. John R. Todd, chief building engineer, termed the design as "modern New York style," when asked for a name to describe it.

The central block, between Forty-ninth and Fiftieth Streets, will be the site of a sixty-eight-story office building. In area of floor space, this structure will be the largest in the world. Only the Empire State and Chrysler buildings will surpass it in height. Tentatively designated as "Office Building No. 1," this central structure will be partially taken over by the Radio Corporation of America for general offices and by the National Broadcasting Company for executive offices and broad-

casting studios. Facilities for the broadcasting of sight as well as sound will be provided in this structure, according to Merlin H. Aylesworth, president of the NBC. Some twelve floors will be reserved by the NBC. These will contain twenty-seven to thirty broadcasting chambers.

With a frontage on Fifth Avenue between Forty-ninth and Fiftieth Streets and separated from "Office Building No. 1" by an attractive plaza of gardens and fountains will be an imposing oval-shaped building to contain shops, a bank, show-rooms and a roof restaurant. On the Sixth Avenue side of the central block will be a building that will house general offices and recording facilities of RCA-Victor and RCA Photophone.

A motion picture theatre with a seating capacity of 6000 persons is planned for the block between Fiftieth and Fifty-first Streets. The theatre will be set off from Sixth Avenue by an office building that will house the general offices of the Radio-Keith-Orpheum organization. On the opposite side of Radio City, between Forty-eighth and Forty-ninth Streets, a combination vaudeville and motion picture theatre of 4000 seats will be erected. There has been some talk of reversing the position of the two theatres and thus al-

lowing the larger to have a frontage on Sixth Avenue. Provisions are made for the opera house facing on Forty-eighth Street. A frontage of 350 feet and the width of an entire block will provide for a very large structure. There will also be storage space for costumes and scenery used in the opera company's repertoire.

The Collegiate Church of St. Nicholas and another realty enterprise will still maintain a small portion of the block between Forty-eighth and Forty-ninth Streets. In addition to the vaudeville and opera-house structures planned for this block, another Radio City office building will be erected. Two additional office buildings will be erected on the Fiftieth to Fifty-first Street block. A large site in the centre of this block is as yet unassigned for any specified type of building.

In all, 2,000,000 square feet of rentable space will be available to tenants other than those in the RCA group, Mr. Todd claimed.

ACCORDING to the announcement now made public, S. L. Rothafel will direct the theatrical activities of the Radio City. Since television is expected to be a practical reality, it is believed that Mr. Rothafel's services, in addition to theatre management, will be employed in creating lighting and scenic effects for R-K-O and NBC television programs.

—THE EDITORS.

Radio World

Known as the Radio City, the quarter-billion-dollar home of broadcasting and entertainment will cover three square blocks in the heart of New York City. When completed, in 1934, it is expected that the gigantic undertaking sponsored by NBC, R.C.A., R-K-O, RCA-Victor, and RCA Photophone, Inc., will include a new Metropolitan Opera House, two large motion picture and vaudeville theatres and a television station

By Samuel Kaufman

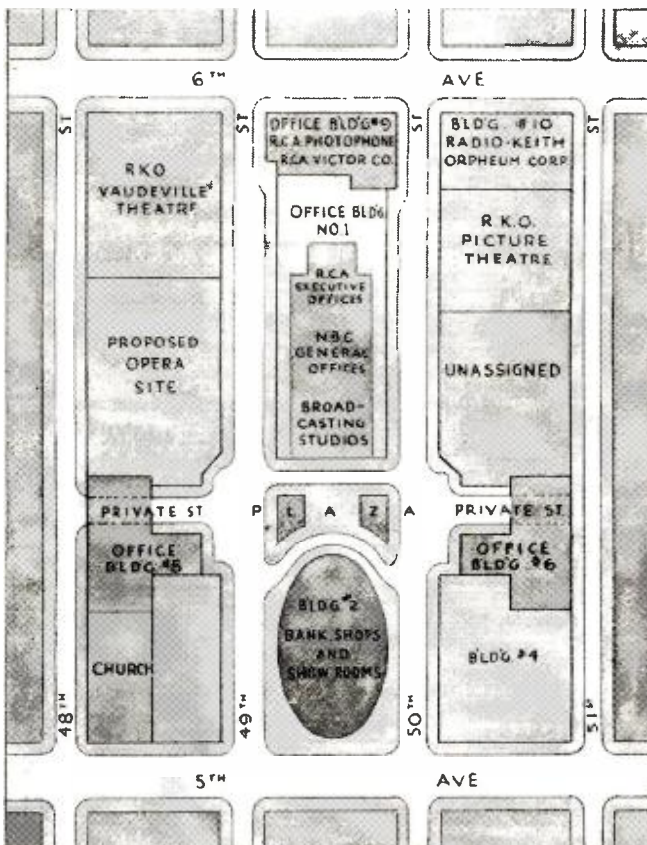

A diagrammatic layout of the plan for the Radio City, showing the location of the proposed opera site, the two theatres and the broadcasting studios

Hiram S. Brown, president of Radio-Keith-Orpheum Corporation, and Mr. Aylesworth remarked, during the model exhibition, that both theatres will be wired for the transmission of television programs. They indicated that the opera house will also be so provided if it is definitely included in the Radio City group.

Mr. Aylesworth said, considering rapid laboratory advances of television, that it can be expected that the practical transmission of sight and sound programs will be possible by the time Radio City is entirely completed in 1934. He considered it likely that the television station will be situated directly atop the central structure. He expressed the belief that broadcasting of sound alone will never be supplanted by television but will rather be supplemented by it.

In addition to two city streets, Forty-ninth and Fiftieth, running directly through the site, two private streets will run under arches from Forty-eighth and Fifty-first Street to reach the central plaza.

Shops throughout the area have posted removal

notices and house wreckers are busily engaged in the clearance work preliminary to the excavating which will start in June. The entire development will not be completed until 1934, but the central structure is expected to be ready for occupancy in 1932. Space will be gradually claimed by the various firms as their respective units are completed.

A novel feature of the project will be the provision of underground parking space for motor vehicles. Provision is also made for all trucking and shipping to be done on a subterranean level. These facilities will considerably eliminate any traffic congestion on the narrow streets above. A rampway to the parking and shipping levels will be situated on Forty-eighth Street, while an exit will be provided on the Fifty-first Street side.

At the model exhibition, Mr. Brown and Mr. Aylesworth jointly announced the acquisition of S. L. Rothafel (Roxy), former impresario of the Roxy Theatre, as director of the Radio City theatrical undertakings. He has officially been associated with the R-K-O since April 1. Although his detailed duties for the Radio group before the theatres are completed were not revealed at this writing, it was the general impression that he will be identified with the broadcasting periods sponsored by the R-K-O organization.

The large amount of rentable space will undoubtedly attract other radio, music and entertainment groups to Radio City.

A representative of the Columbia Broadcasting System, rival network of the NBC, emphatically stated that the CBS will not under any circumstances rent any space within Radio City. He claimed that the present Columbia building at 485 Madison Avenue—just two blocks from the Radio City site—are ample for the chain's needs in (Continued on page 1114)

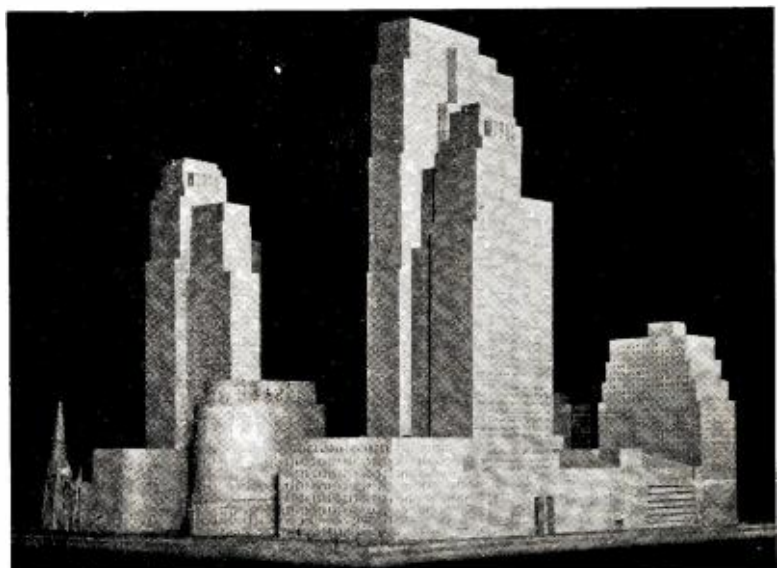

Another view of the recently completed model of the Radio City. Work on the giant enterprise will begin this month and is expected to be completed some time in 1934

A "MIDGET"

By McMurdo Silver*

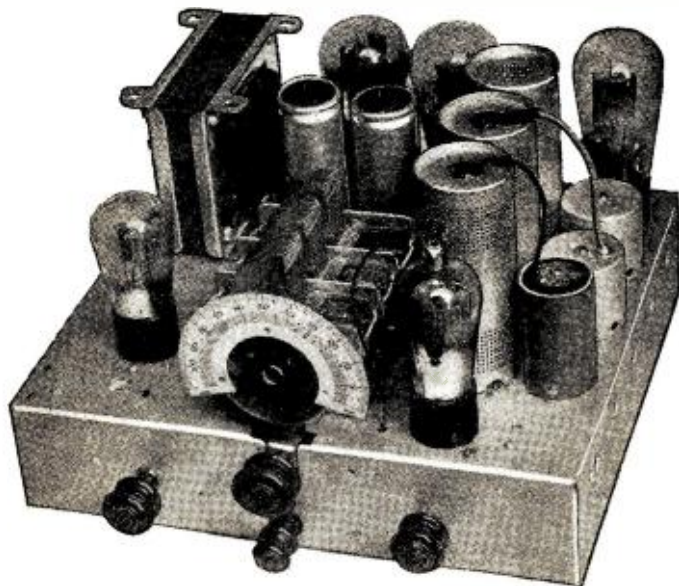

Comparing the size of the standard tubes visible in this chassis, some idea of its remarkable compactness is had. It is just 12 inches long, 10 $\frac{3}{4}$ inches deep and 8 inches high overall, yet is a full-fledged superheterodyne

Figure 2. This curve of the Silver midget superheterodyne indicates a high degree of selectivity with a certain attenuation of high audio frequencies which is compensated for in the loud speaker design

THE past eight months in radio have taught us the absolute and outstanding superiority of modern superheterodyne broadcast receivers. These eight months have also taught us something else—that in the t.r.f. field it is possible to so simplify design as to produce very good sets of low cost and low space requirements—in a word, midgets. With two such lessons before us the question immediately arises as to why the size and cost of modern superheterodynes may not likewise be reduced, without a sacrifice of tone, selectivity, or practically usable sensitivity.

It was to provide an answer to this question that the engineering laboratories of Silver-Marshall, Inc., have been at work for the past several months and the results of their work appear in the new Silver-Marshall type 783 superheterodyne described herewith—a midget in size, but in the phrase of the old-time ad-writers, "a giant in performance."

The obvious tendency in designing such a receiver would be to follow the trend of t.r.f. midget sets; that is, to cut out a tube here, a coil somewhere else, a few condensers, and so on, until the final result would be a true midget—midget in size, performance and price. The other alternative, and the one followed, simply but faithfully, resolved itself down to one of cutting costs and size without cutting performance. Therefore the circuit was first worked out on a bread-board, circuit values arrived at, and then by the aid of a very flexible shoe-horn, all of the parts were sandwiched into a chassis 12" long, 10 $\frac{3}{4}$ " deep and 2 $\frac{1}{2}$ " high—no mean feat, as the photos show, if any space at all to get at wiring and individual parts was to be left available.

The model employed the circuit of Figure 1, which is seen to consist of a dual selector circuit preceding a -24 screen-grid first detector, a -27 oscillator inductively coupled to this detector, two stages of -24 screen-grid i.f. amplification, a -27 second detector, two -45's in a single push-pull audio output stage, and an -80 rectifier. Before considering the design features of the receiver it would be well to examine its perform-

ance curves as shown in Figures 2, 3 and 4, Figure 2 depicting selectivity, Figure 3 fidelity and Figure 4 sensitivity.

Examining Figure 2, it is apparent that the band width 100 times down (or the points at which an unwanted station would have to be 100 times as strong as the wanted signal to produce equal output) is just 11 kc., while at 1000 times down the width is just over 20 kc. These figures show an order of selectivity never approached in the best of the tuned r.f. sets, even the famous Sargent-Rayment 710, which employed five of the best tuned circuits found in any broadcast receiver ever made. At 10,000 times down the band width is just 28 kc., or within about 15% of that of the Silver-Marshall 714. These figures indicate one thing quite positively—that the receiver will give absolute 10 kc. selectivity against even 50,000-watt stations within a few miles of the receiver, as a number of practical tests have conclusively demonstrated. Selectivity is uniform to within less than 10% over the entire broadcast band, since it is determined almost wholly by the i.f. amplifier selectivity and the "arithmetical selectivity" (see previous articles by the writer in RADIO NEWS). But with such selectivity, what about fidelity?

Figure 3 tells a deceptive story, since it shows only electrical fidelity, that is, antenna to speaker, while the true story is told by antenna to ear sound-pressure measurements which would include a compensated speaker. Figure 6 shows the progressive attenuation of the higher audio frequencies, about what would be

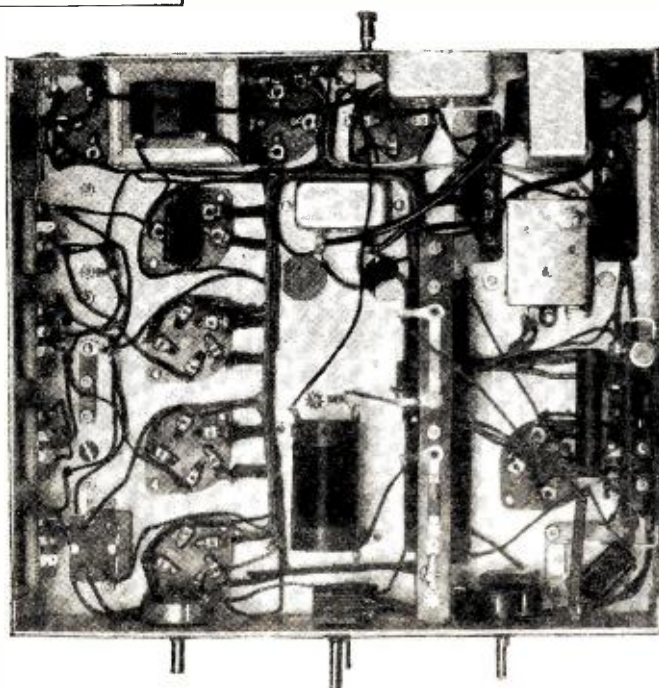
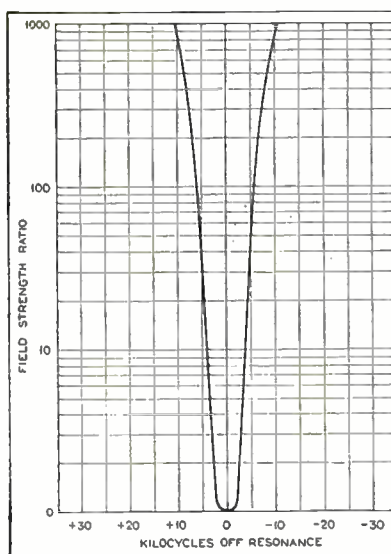

Despite the adroit use of a shoe horn to get all the parts under the chassis, there is still plenty of space to get at the individual parts for servicing and adjustment when necessary

*President, Silver-Marshall, Inc.

Superheterodyne

A nine-tube a.c. superheterodyne reduced in design to midget proportions, but with sensitivity, tone quality and selectivity which would hardly be looked for in such a small package

expected to go with such a selectivity curve as that of Figure 2. This curve is seen to be flat to less than 4 db. from 60 to 1000 cycles, and to fall off rapidly up to 4000 cycles. the limiting frequency necessary for faithful reproduction (actually a bit too faithful for the average ear). This fall off is compensated for by employing a speaker designed to have an exactly opposite frequency characteristic, and which nicely boosts the attenuated frequencies up to their original levels as far as the ear is concerned, and the ear, after all, is the final judge. A continuously variable tone control is a part of the audio circuit, and as it is turned down, the higher frequencies may be progressively attenuated until the final curve, antenna to ear, would look like the antenna to speaker curve of Figure 3.

From Figure 4, the sensitivity curve, the sensitivity is seen to vary from 6 to 10 microvolts per meter of effective antenna height (assuming the usual arbitrary height of four meters). Compared to the S-M 714, for instance, these figures appear low, but coupled with the extreme selectivity of the circuit, they translate into the ability to receive at entertainment volume and clarity practically every station that can be so received on the 714—and admittedly a radio set selling under \$85.00 complete can hardly be expected to exactly equal one costing \$250.00 and more. The practical difference, however, lies in the fact that the 714 was designed for really excessive image-frequency selectivity and to be operated right under a transmitter, while the 783 was designed for home use, assuming a distance of two or three miles between the set and the nearest broadcast transmitter.

As a matter of fact, the effective sensitivity of this superheterodyne of 6 to 10 microvolts per meter is far greater than that of any t.r.f. set of equal electrical sensitivity due to its far greater selectivity and consequently much lower noise level—which simply means that it will give a larger number of enjoyable programs than could be had from a 6- to 10-microvolts tuned r.f. set. For instance, in a test made in a semi-business, semi-residential location in Chicago, a stock model of this new receiver was placed on a table without antenna or ground connections, next to a very sensitive four-gang screen-grid t.r.f. set having a sensitivity of 1/2 to 1 mv. per meter, which used a thirty-foot antenna.

On the t.r.f. set just five out-of-town stations could be heard, such as Cincinnati, Nashville and other near-by points, this while using a thirty-foot antenna. The inability to bring in more out-of-town stations was not due to lack of sensitivity, but to the high noise level of the less selective t.r.f. set, and its poorer selectivity. On the super, using the same number of tubes, seventy-seven stations could be tuned in with one rotation of the dial, absolutely without interference or cross talk, with no antenna or ground, and with far less noise than on the t.r.f. set. These stations ranged from Canada to New England, Florida, Texas and California. Such, then, is what a good super should and will do, not in a very good location, but simply a fair one. Adding the 30-foot antenna of the t.r.f. set to the super merely boosted volume, and in no way effected selectivity.

Looking at the chassis from above, a three-gang (Continued on page 1096)



The "midget" screen-grid superheterodyne in a table console-cabinet complete with speaker—the local-distant switch is seen on the right side of the cabinet

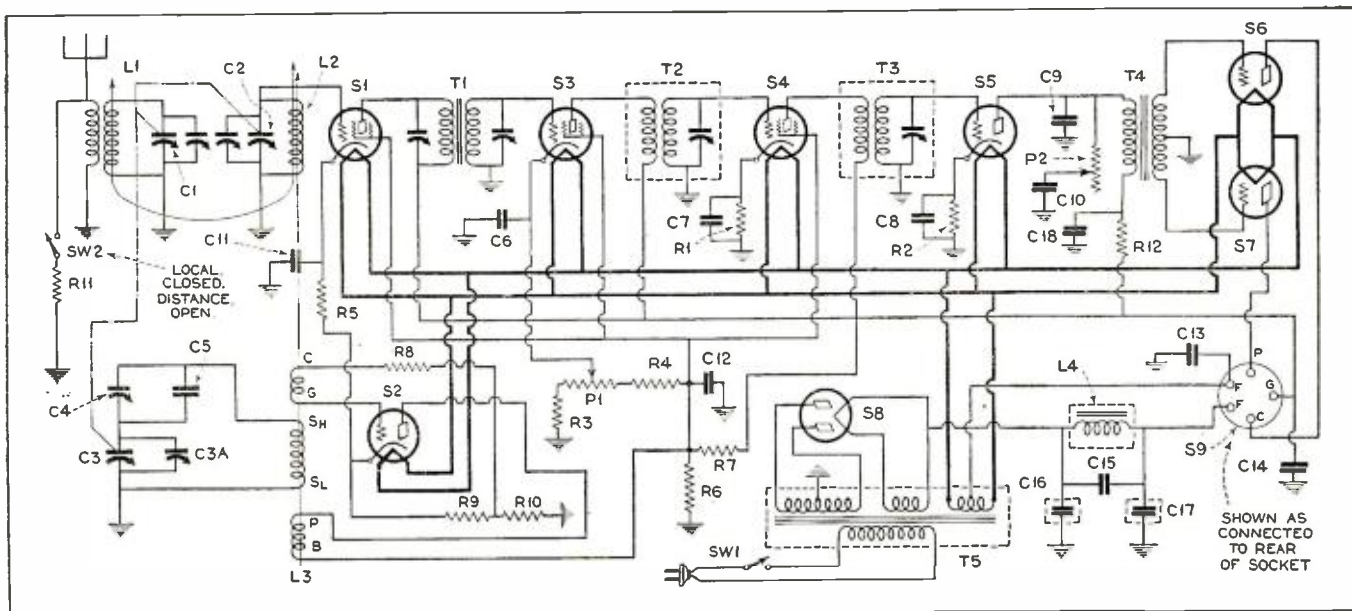

Figure 1. The final model of the circuit employed

BROADCAST RECEIVER

The development of a.c. tubes brought about the greatest improvement in radio receivers, and the complete adoption of radio by the American public, as proven by the vastly increased volume of receiver sales beginning with 1927 and 1928

THE era of greatest receiver improvement as demanded by a public who by this time had become aware of what should be expected from radio broadcasting, started with the year following the advent of the first a.c. tube. Research on the whole was prior to 1926 limited to the very largest of radio manufacturers. The organization which had been carrying on along research lines was now ready to announce the developments of their engineers. With battery form of supply as a basis, the improvements were more of the kind related to an individual part of a receiver than to the entire receiver. The advent of the a.c. tube required extensive and intense investigation in order to produce a receiver which would not only combine the convenience made possible by a.c. operation, but which would at the same time represent the expected yearly advance in electrical efficiency. Then, too, operation on a.c. called for rather extensive circuit modifications, including the problem of avoiding a.c. hum.

Shielding was one of the first improvements of the nature which was lasting. The great increase in sensitivity accom-

By John F. Rider

plished by the use of three and four stages of tuned radio frequency amplification and two or three stages of audio frequency amplification resulted in increased trouble from electrical interference or "man made static." This made necessary perfect shielding as one means of combating, or at least minimizing, the disturbance. The great increase in power used by a large number of broadcasting stations and the fact that so many stations started operation in close proximity to large centers of population made necessary the development of receivers which would provide the required degree of selectivity. The increased demand for tone quality made necessary such improvements in receiver design which would furnish sensitivity with minimum regeneration and selectivity with good quality of reproduction.

A.C. Operation Demanded

The first batch of a.c. tube receivers were far from satisfactory. The tubes were not uniform and the design of the receiver was not sufficiently advanced to combat the various evils which cropped up with the a.c. line as the source of power. On the other hand, the conveniences afforded by a.c. operation proved too tempting to the public and the demand for a.c. electric receivers was so overwhelming that the manufacture of battery receivers ceased almost over night.

With the greater need for extensive research more and more of the men who in the past had been connected with the telephone industry found their way into the radio field and more and more the artifices of telephone engineering began to manifest their presence. An example of an early model a.c. receiver is shown in Figure 14. It dates back to 1927. Six tubes were used with a -71 in the output stage. Despite the fact that push-pull output systems had been used in power amplifiers three years back, the first two years of a.c. receivers did not witness the wholesale application of the push-pull output system. The receiver shown in Figure 14 makes use of more bypass capacities than were to be found in the battery receivers of that and previous years, but not nearly the number to be found in present-day receivers. The necessity for radio-frequency chokes was also recognized in this receiver and they have been used extensively ever since.

One major fault of the average tuned radio frequency amplifier type of receiver for some time after its introduction was the uneven amplification over the wavelength band. Response at the lowest waves within the range was poor, with a rising characteristic as the wavelength was increased and a lowering as the upper limit was approached. Correction of this defect was one of the first problems when intense research started. Shielding and various forms of neutralization and stabilization has removed the bothers of excessive regeneration. The problems produced by the advent of the a.c. tube caused a general reduction in the amplification available with the complete receiver so as to minimize the hum in the output. As a



The new Silver-Marshall midget superheterodyne is typical of what the public has learned to demand of radio today. Compact size—fine tone quality and ease of operation

Back in 1923 simplicity of appearance and operation were considered unimportant, as is evident from this home-built model of the famous four-circuit tuner

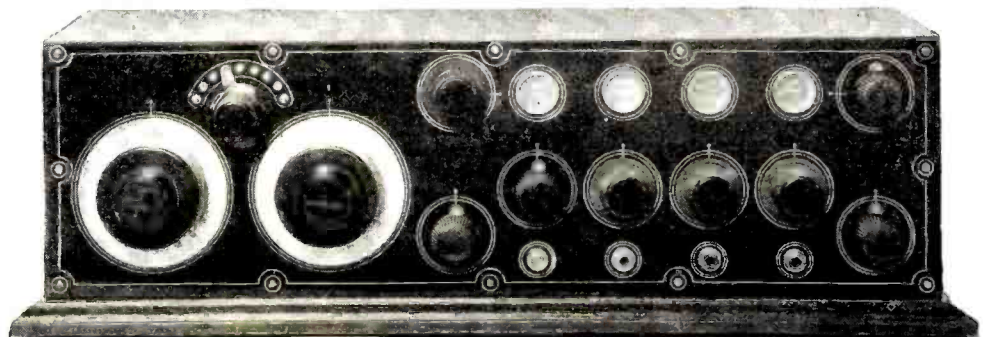

EQUIPMENT

Now— and Then

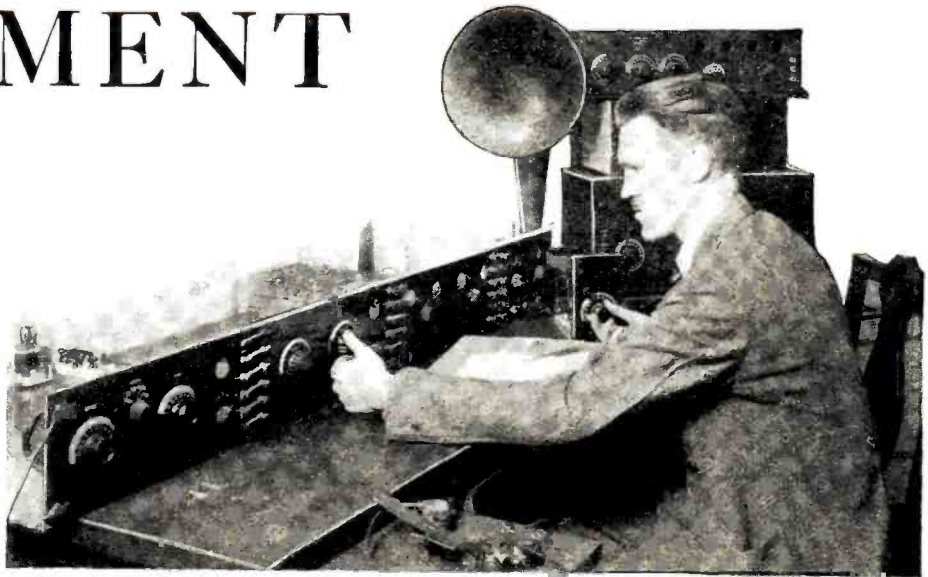

PART TWO

The first superheterodyne kit to appear on the market is shown here as it appeared in the Technical Editor's Laboratory back in 1922. When assembled it was close to five feet long and employed eight battery-operated tubes. Contrast this table full of equipment with the modern superheterodyne chassis shown on the next page

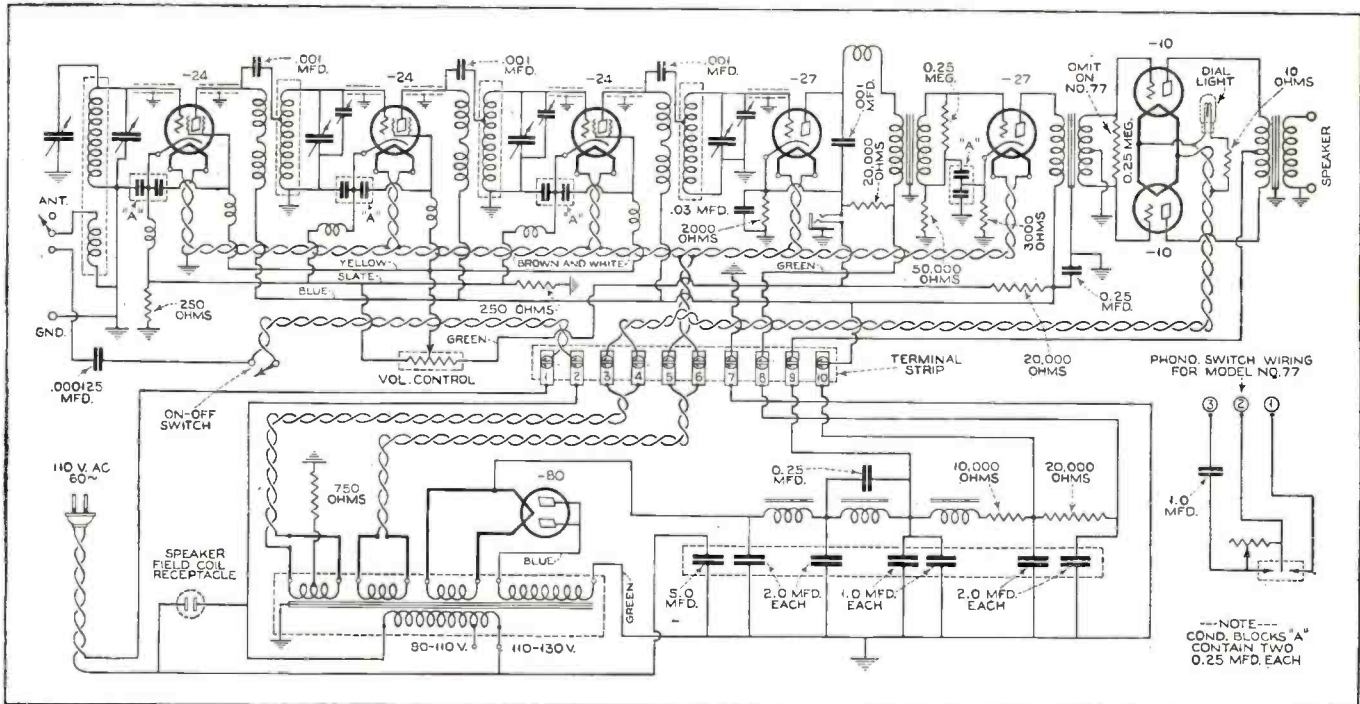

A modern receiver circuit is a far cry from the earlier a.c. circuits such as that on the next page

Quite a contrast in the number of controls on this 1931 Majestic model as compared with the old-timer just to the left

result, the first complaint heard in connection with a.c. receivers was that the sensitivity was not as great as with an equal number of tubes used in a battery receiver. This has since been corrected.

Simplifying Control

Accompanying the gradual advancement in the art of radio receiver design subsequent to 1925 was the reduction in the number of controls. The development of the automatic filament control unit such as the Amperite removed the need for individual or even a common variable filament rheostat. This development removed a few controls from the panel. The development of three and four stage tuned radio-frequency amplifiers made necessary unification of control because it was impossible to satisfactorily tune a three or four stage tuned radio-frequency amplifier with a separate tuning control for each stage. By 1927 and 1928 practically all receivers were equipped with single control and the greatest number of controls mounted upon a panel amounted to four, with three being most common.

The quality of reproduction obtained by the close of 1928 was generally classed as being a close approximation of fidelity and perfection, although the latter is not as yet available. The old type horn speaker had been superseded by the cone speaker of the magnetic type and this in turn finally gave way to the moving coil dynamic. The improvements effected during 1928 presented a situation which called for discussions of what further developments were possible upon radio receivers.

The period between 1925 and 1928 was productive of receivers which were more and more complex inside and more and more simple to operate. The status of the man who was called upon to repair such receivers was rising to a higher level. Cut-and-try methods of production gave way to scientific production. Cut-and-try methods of design gave way to scientific design based upon elaborate and thorough investigation. The radio receiver was becoming an engineering product, basically the same as in years gone by but nevertheless a distinct departure from the old.

Each improvement represented a technical advancement, not necessarily new to the science but new in its application to a product in use by the public. Such was the band-pass filter. Changes were made in the power pack filter system to improve the filtering action. Hum balancing or neutralizing systems were added to the audio amplifier. Provision was made for the correct matching of the phonograph pick-up unit for use with the radio set. Audio transformer primaries were wound with special taps for use with the electric pick-up. The correct location of the volume control device became an item of importance, based upon investigations which showed the detrimental effect of certain locations. Automatic volume control and automatic tuning were incorporated into receivers. Such improvements did not represent basic changes but were more in the nature of refinements.

Electrical interference was mounting with every increase in receiver sensitivity. Thereupon receiver systems were equipped with filters of various types to overcome such annoyances. The advent of the a.c. tube was beset by difficulties due to line voltage variation. Many new receivers were equipped with various forms of ballasts or line voltage reducing resistances so as to adapt the receiver power pack to various line voltages or to counteract the line voltage fluctuation and to keep the input voltage to the power pack transformer at a constant value. The use of ballast lamps or tubes intended to function in this manner are daily increasing in numbers. Also, power companies are endeavoring to maintain constant line voltage.

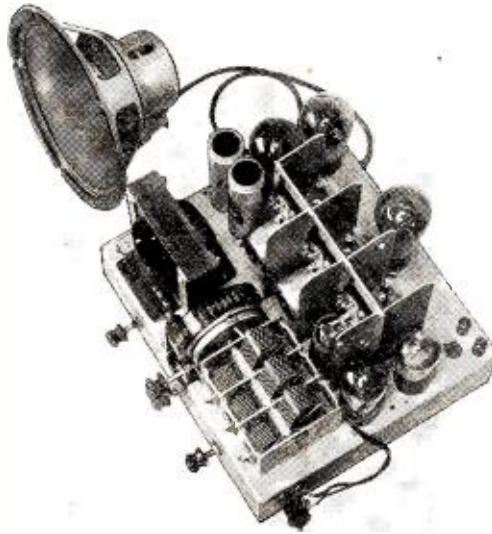

The chassis of the S-M midget measures only 12 inches, yet it is a full-fledged superheterodyne

More Resistors Used

Receiver design since 1928 has shown a marked tendency towards the use of many more fixed resistances. Whereas some of the old receivers made use of three or four fixed resistors, some of the modern units employ ten or twelve such units. They act to isolate the various circuits and thus minimize intercircuit reaction. What with the increased sensitivity and amplification produced by the screen-grid radio-frequency amplifier tube there arose a need for definite control of regeneration in order that the increased amplification, sensitivity and selectivity be unmarred by a high degree of regeneration which is ruinous to tone quality. Thus were born the grid filter resistance circuits and the plate filter circuits.

With the popularization of radio receivers came the gradual need for a receiving system which would be fool-proof and suitable for application wherever required. Individuality as expressed by peculiarities during operation was taboo. Catering en masse, it must be suitable en masse. The old type of receiver required weeks and weeks of diligent experiment and patience before one became sufficiently familiar with the various controls to secure satisfactory performance. The modern receiver requires no experience, no knowledge of radio on the part of the owner and operator, but a great deal more knowledge on the part of the man who is to repair the defect when it occurs.

Improvements Still to Come

Improvements Still to Come

Modern radio receiver design represents development of the old receiver rather than the application of many new discoveries. Electrically the modern receiver is close to its pinnacle of perfection. This, however, does not mean that there shall be no additional improvements. In fact, a new improvement in the form of a tube with a characteristic which varies with the signal voltage (not the conventional form of automatic volume control) has just been introduced and has been incorporated into one brand of radio receivers.

Remote control, although not generally applied now, is several years old. No doubt it will become more popular later. Remote form of volume control is inevitable. In fact, it is a necessity in order to conform with the changing requirement during an evening at home. There is no doubt about the fact that manual form of volume control is a nuisance when the character of the program changes during an evening.

Tone control represents an effort to (Continued on page 1113)

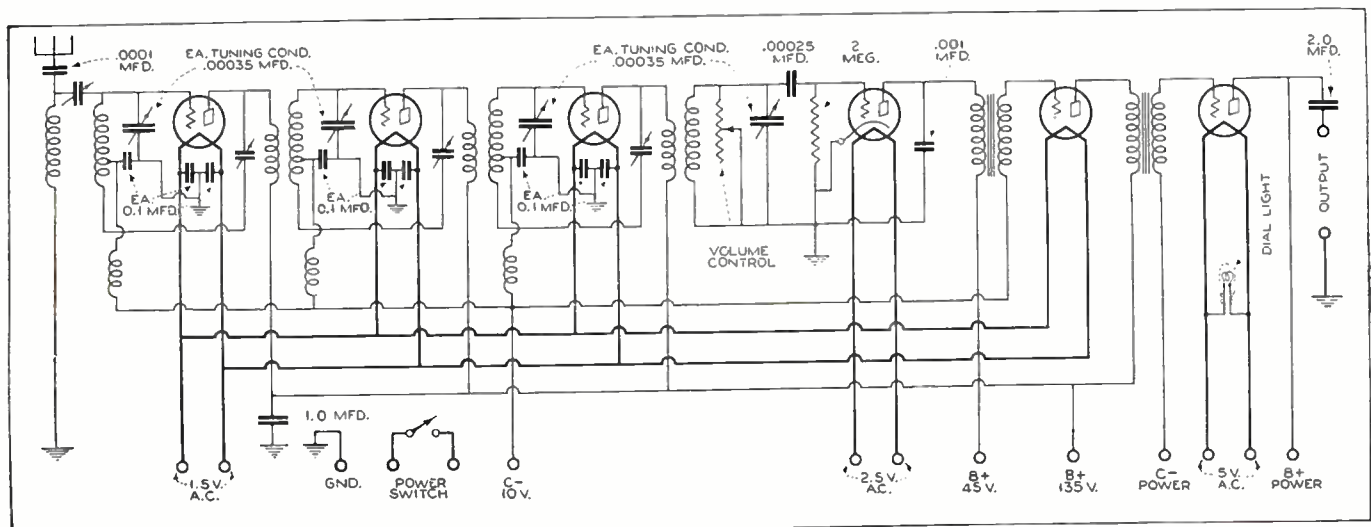

Figure 14. The circuit diagram of one of the early (1927) a.c. receivers. It shows little change from battery-operated receivers popular at the time



Tapping *the* Short Waves

Direct short-wave reception brings new entertainment to the parlor and a new thrill to the hobbyist

By Zeh Bouck

THE era of international broadcasting has definitely arrived. The repeated appearances of Ramsay MacDonald in England, Cosgrave in Ireland, Mussolini and the Pope in Rome before the international short-wave microphone, and the almost universal rebroadcast on long waves, have stimulated the interest of the average broadcast enthusiast in the high-frequency impulses that carry their voices across the oceans. It is almost paradoxical that the really quite excellent reception of the long-wave rebroadcasts on standard receivers should result in a desire to receive such programs on the more direct and original waves. However, there exists an admittedly greater fascination in receiving the voice of Senatore Marconi direct from HVJ, the Vatican City, Rome, Italy, than via the intermediary of a local station. And aside from the intriguing element of direct contact, it is occasionally possible to secure better reception from a foreign short-wave station than from a semi-local rebroadcasting the program. Also many interesting programs are being broadcast by domestic short-wave stations which may be received with fairly consistent excellence, and the short-wave receiver thus contributes to the possible sources of radio entertainment. In rural communities, isolated from long-wave coverage, the s.w. receiver often provides the only reliable reception. The short-wave receiver has definitely emerged from the laboratory. In simplicity, reliability, battery or light socket convenience, and appearance, it compares favorably with the conventional broadcast apparatus. It may take its place in the parlor with the long-wave receiver or in a "short-wave nook" where its offerings are reserved for the privileged ears of the real radio fans of the family and where one can concentrate on

its operation and programs without parlor distractions.

The expression "short waves," offhand, is self-explanatory, but on further thought requires qualification. After all, the term is relative. Two hundred meters was a short wavelength ten years ago. Indeed, it was considered just about the lower limit available for practical communication purposes. Today one hundred meters is hardly among the conventional short-wave bands which, in general parlance, include the wavelengths between ten and sixty meters. The larger part of short-wave communication is carried on at

present between fourteen and fifty-four meters, but successful experimental work has established two-way communication over short distances on wavelengths fifty centimeters long!

The wavelengths with which the broadcast listener is most familiar are those that bring to him his daily entertainment, generally comprising musical arguments for the purchase of some commodity. These wavelengths are between 200 and 550 meters.

Wavelength is a physical conception by means of which we are quite successful in representing how a radio signal travels along its route from the transmitting station to your receiver. A "wave form" is assumed, because a recording instrument placed anywhere

within the influence of the signal would show a wavy line on the recording paper or tape. Such an instrument would show that the signal, starting at zero, would attain a certain maximum positive strength, then slowly decrease to zero again, to build up on the negative side to a similar maximum, again dropping to zero to recommence the "cycle." This cycle occupies a certain definite time, which can be measured directly and indirectly. Also, radio waves travel from the transmitting

THIS is the first of a series of articles emphasizing the possibilities of short-wave reception to RADIO NEWS readers. As a designer and operator of short-wave equipment for the past eight years, Zeh Bouck is particularly qualified to present its attractions to the broadcast listener and the experimental enthusiast. In a succeeding article Mr. Bouck will consider code reception, opening a new field of fascinating entertainment to the legion of "dx-getters."

—THE EDITORS.



This Silver-Marshall short-wave receiver is a perfect complement to the usual broadcast equipment

Figure 1. A graphical conception of wavelength and frequency. This is the sort of a picture that a recording instrument would make of a passing wave train showing that length equals the velocity divided by the frequency. Figure 3. A simple form of wave filter that may be used effectively to reduce artificial static interference in short-wave reception

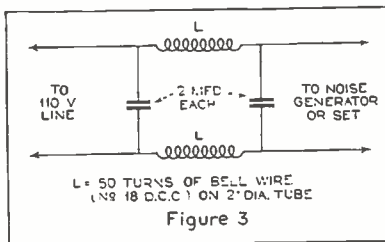
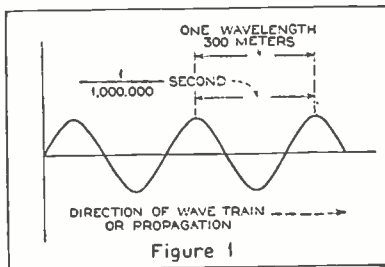

antenna to the receiving antenna with a speed that has been definitely established at about 300,000,000 meters a second. Now if a railroad train, or any other object, travels at a known speed past a given point in a known time, the length of that object can be determined by dividing the speed of the train (let us say) by the time interval. This relationship, in reference to a wave "train," is shown in Figure 1. The time element in this case happens to be one-millionth of a second, and the wavelength is therefore 300 meters. If the time consumed by one cycle is one millionth of a second the frequency that a cycle will repeat itself in one second will be one million—or we can speak of the frequency of 300 meters as one million cycles.

The relationship is more simply expressed in the equation:

$$F = \frac{V}{\lambda} \text{ or } \lambda = \frac{V}{F}$$

Where F is the frequency in cycles per second, V the velocity of propagation or 300,000,000 meters per second and λ the wavelength in meters.

Thus, if we know either the wavelength or frequency we can always compute the other determinant by means of one of the two equations.

For scientific purposes, it is often more desirable to work with frequencies rather than with their corresponding wavelengths, principally because, regardless of wavelength, a certain definite frequency band is considered necessary for the trans-

mission of radio telephone signals utilizing the systems employed today. This band is 10,000 cycles wide. That is, if a broadcasting station is transmitting on 300 meters, or one million cycles, it will occupy a band extending 3000 cycles on each side of the carrier frequency of one million cycles—i.e., between 995,000 and 1,005,000 cycles. In order that no other station can overlap or interfere, the carrier of a second station must not be within 10,000 cycles of the carrier of the first station.

Due to the existence of this desirable frequency band, a broadcasting station operating on a fundamental of 300 meters will spread over a wave range of about three meters, and at 600 meters about twelve meters.

In other words, the amount of space required by a broadcasting station, in wavelength spread, varies with the wavelength, becoming greater as the wavelength increases. But the frequency band of ten thousand cycles remains constant. Hence, it is more convenient to compute many radio calculations in terms of frequency rather than those of wavelength.

Long wavelengths are low frequencies; short wavelengths are high frequencies. When frequencies become very high, it is less clumsy to group them into thousands of cycles—the kilocycle or kc.—and into millions of cycles—the megacycle or mc.

A wavelength of ten meters is equivalent to a frequency of 30,000,000 cycles, or 30,000 kilocycles or 30 megacycles.

Let us try to think in terms of frequency rather than wavelength. If at first you are somewhat confused, you may readily translate frequency to wavelength by means of computation, or the conversion chart shown in Figure 2.

Characteristics of Short Waves

One of the principal advantages of short-wave communication lies in the multiplicity of available radio channels as contrasted to the congested conditions existing above 200 meters.

The frequency corresponding to ten meters is, as we have shown, 30,000 kc. Between this frequency and that of 1500 kc., corresponding to 200 meters, there exists a 28,500 kc. band of usable frequencies. Dividing this by 10 (10,000 cycles, the recommended band for a broadcasting station) we find that 2850 broadcasting stations within interfering power distances could be accommodated without interfering with each other on a well-designed receiver. Between 200 meters and 600 meters, there is room for only 1000 similar stations.

High frequencies are characterized by an uncanny carrying power, low powers on low wavelengths transmitting over distances that could be spanned on long wavelengths only by the expenditure of hundreds of times the same power.

Short-wave signals suffer from peculiar fading and absorption effects from which long-wave signals are relatively free. The most unusual of these is, perhaps, the so-called "skip-distance" effect. For instance, the direct wave from a fifty-watt transmitter operating on 7500 kc. may be so attenuated at a receiving station five hundred miles away, by absorption or deflection due to terrestrial conditions, that the signal is entirely lost. However, another portion of the signal, traveling more directly upwards, collides with the somewhat

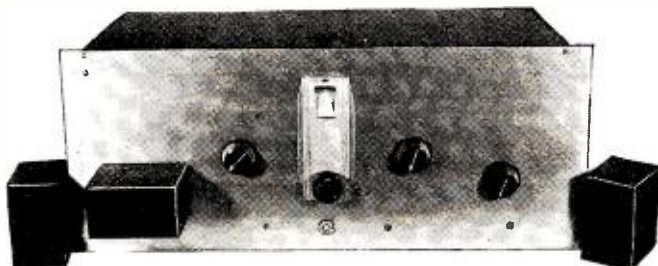

The short-wave superheterodyne designed by Wireless-Egert. The shielded coils plug in front of the panel

problematical Kennelly-Heaviside layer—a stratum of ionized gases high above the earth's atmosphere—and is reflected to the earth thousands of miles away from the transmitter. Thus a receiver in Australia might hear a transmitter in New York City, the signal from which is inaudible in New Orleans or Panama.

The tricks played by high frequencies vary with atmospheric conditions, the time of day and the frequency employed. But it is almost always possible, by making a shift in frequency, to pick out a short wavelength satisfactory for the communication desired. For instance, for consistent trans-oceanic telephone communication, three frequencies, approximating 20, 15 and 10 megacycles, are always available. During the day, the 20-megacycle frequency is generally used, shifting to 15 mc. in the evening and to 10 at night.

Short-Wave Telephone Stations

Only a small percentage of the available short-wave frequencies are given over to telephone transmission, but the actual number of such stations in regular operation exceeds the number of broadcasting stations in the United States. The average short-wave receiver will pick up several times as many telephone stations as the average broadcast receiver.

Short-wave telephone services may be divided into four classes—broadcast, amateur, trans-oceanic commercial and airplane. The broadcast stations are generally given over to the simultaneous transmission of long-wave programs and are operated in conjunction with a long-wave station. For instance, W2XE is the short-wave channel of WABC, New York City. The following are the international frequency allocations for short-wave broadcasting:

- 6000-6150 kc. (50-48.9 meters).
- 9500-9600 kc. (31.6-31.2 meters).
- 11,700-11,900 kc. (25.6-25.2 meters).
- 15,100-15,350 kc. (19.85-19.55 meters).
- 17,750-17,800 kc. (16.9-16.85 meters).

No satisfactory international short-wave radio-telephone call-book is available at the present time. However, a few of the more prominent and popular stations are given in the next column:

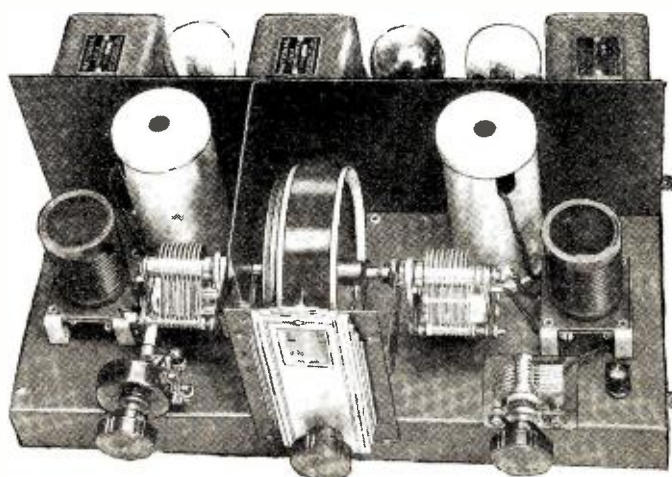

The chassis of the National tuned r.f. short-wave receiver—an efficient, medium-priced set available in both a.c.- and battery-operated models



At the left is the short-wave nook in the author's home. Equipment—one s.-w. receiver, electric clock, pencil, log and plenty of cigarettes

Station	Location	Approximate Frequency
W3XAL	Bound Brook, N. J.	6100 kc.
W2XE	New York City	15,150 kc., 11,880 kc., 6110 kc.
W2XAF	Schenectady, N. Y.	9530 kc.
W3XAD	Schenectady, N. Y.	15,160 kc.
HVJ	Vatican City, Rome, Italy	15,100 kc., 6000 kc.
W9XAA	Chicago, Ill.	6070 kc.
GBW	England	15,200 kc.
WSXK	Pittsburgh	6150 kc.
PCL	Holland	15,350 kc.
G5SW	England	11,850 kc.
GBS	England	17,750 kc.
HRB	Honduras	6160 kc.
HKC	Bogota, Colombia	6170 kc.

Amateur phones will be found on (Continued on page 1100)

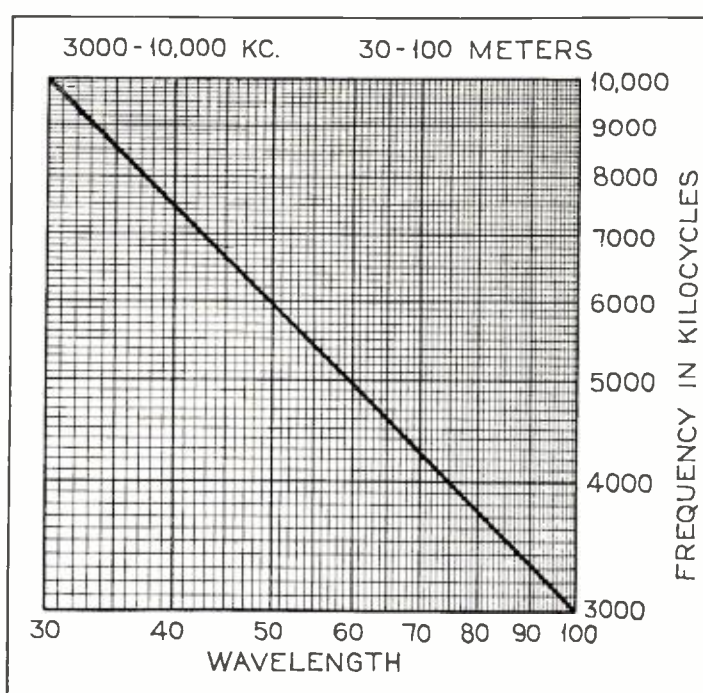
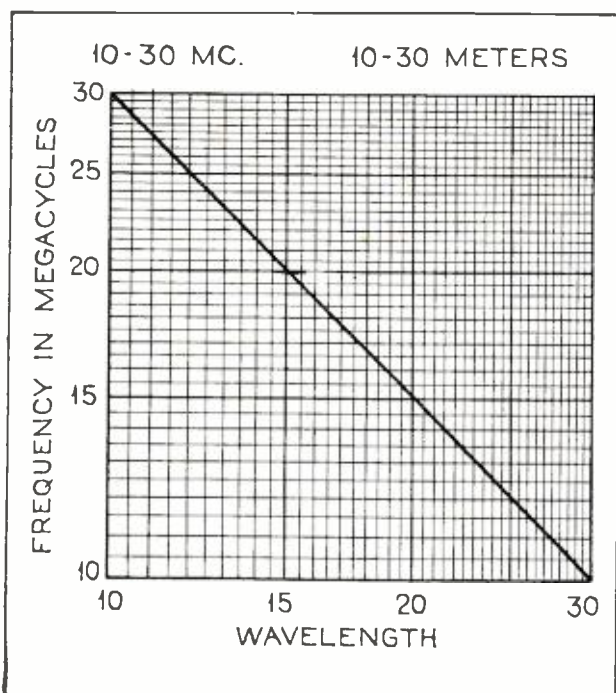

Figure 2. Wavelength-frequency conversion chart. This may be used for higher wavelengths and lower frequencies merely by shifting the decimal point

Stepping Out for WORLD-WIDE Reception

A twelve-tube, all-wave superheterodyne receiver in which exacting design has resulted in a degree of efficiency which fully justifies the use of so many tubes

By S. Gordon Taylor

RADIO fans whose experience dates back far enough will remember that about six years ago a mild sensation was caused in the radio world when a receiver operating in the midwest established four of what were claimed to be new world's records for long-distance broadcast reception. The designer and builder of the receiver was E. H. Scott, a Chicago radio engineer, who has since become well known as the designer of a long line of laboratory-built Scott receivers.

It was therefore with pleasurable anticipation that we packed the latest one of these receivers into a car and took it out into the suburbs of New York for a try-out. Even to one who has been professionally interested in radio for years there is still a thrill in occasionally going on a DX fishing expedition. At least this applies to the writer—providing the receiver employed actually produces results.

The location selected for the tests was not chosen because of any outstanding characteristics as a good radio location (although it is known to be at least average in this connection), but rather because it happened to be convenient and sufficiently isolated from neighboring houses to permit the set to be operated at full volume without fear of a visit from the neighborhood vigilance committee.

Along about nine o'clock, with dinner out

of the way, the receiver was set up and the try-out gotten under way. Even before the switch was turned on two interested but admittedly non-technical fans, who were sitting in, were enthused by the very appearance of the set. Some idea of its attractiveness can be gained from the illustrations. The whole set is completely shielded and the shielding and chassis of both the receiver and the power amplifier are plated and highly polished.

When the set was turned on, this enthusiasm instantly took a jump, because of the fine tone quality that was apparent with the first few bars of music tuned in. Although the loud speaker was set up without a baffle, the quality of reproduction was really impressive in its depth and timbre. Regardless of the setting of the volume control, this excellent quality persisted, due partly to the use of power detection in both first and second detectors and to a push-pull arrangement of tubes in both the first and second audio stages and not overlooking the complete shielding and the resulting stability in both the radio and intermediate-frequency amplifiers.

After listening a few minutes to this station, which we had assumed to be a local station, it was announced as WMAQ, Chicago. Of course, we had expected to bring in Chicago stations without any difficulty, but to have one come in without any back-

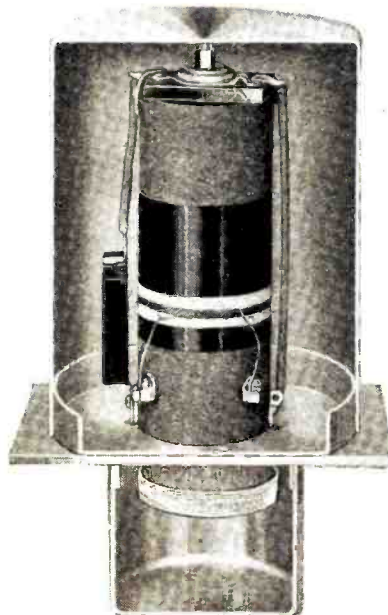

One of the unique intermediate-frequency transformers. The primary is completely shielded from the secondary, depending for coupling on a separate pick-up coil

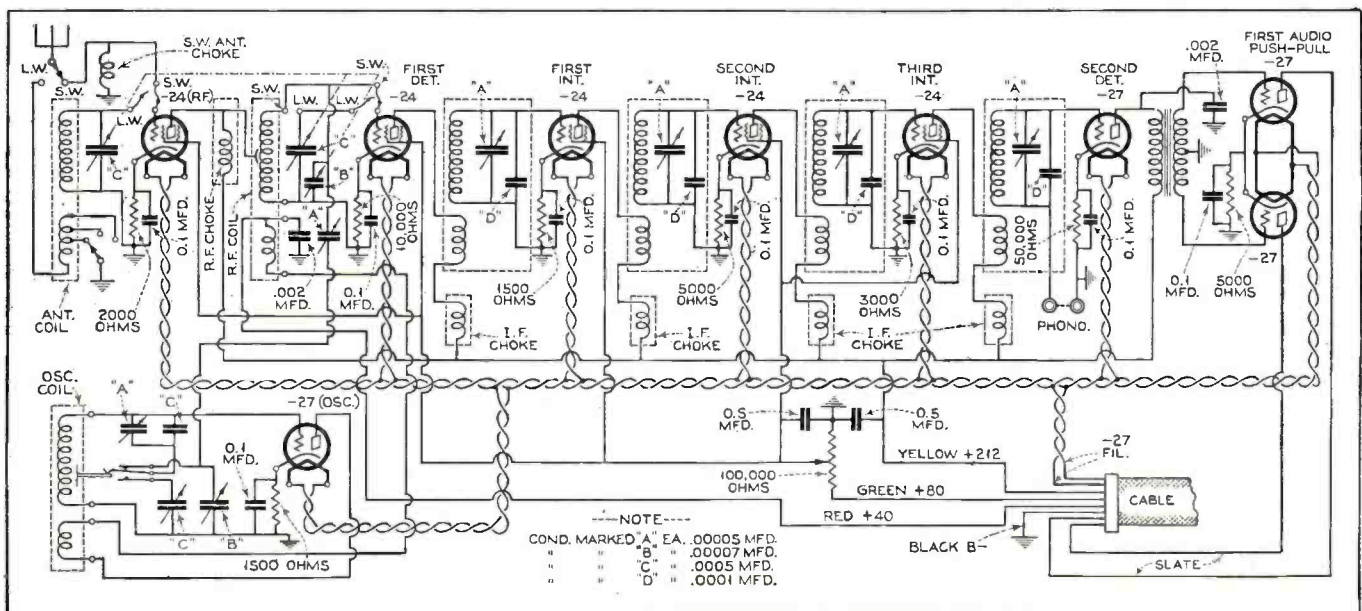

Figure 1. The complete circuit of the receiver chassis. This includes only the push-pull, first and audio stages. The power output stage is included in the separate power supply chassis

ground noise whatsoever, and with all the earmarks of a local station so far as both quality and volume were concerned, was a distinct surprise which provided thrill number three for those listening in.

The next step in the performance was to run up to the top of the dials and then drop down, channel by channel. Within a few minutes stations had been tuned in on thirty-five consecutive channels without a miss. On some of these channels heterodynes were encountered. Among the others there were only two or three channels on which reception was not comparable with that from local stations.

The downward run on the dials was stopped at this point to go back and pick up call letters in order to determine whether stations actually came in on the frequencies indicated by the broadcast band frequency calibration on the main tuning dial. Setting the dials for 660 kilocycles, the program was held until the station announcement was heard. It proved to be WEAF, to which this frequency is assigned. Shifts were then made to a few other frequencies and checked by call letters, with the result that the calibration proved surprisingly accurate.

Knowing that the calibration was accurate proved a big help, because, thereafter, in testing the sensitivity of the set on distant stations it was only necessary to select the broadcast station, set the dials for its frequency and there it would be found. Later on in the night four California stations were tuned in with the volume control set at zero, turning it up only after the dials had been set for the proper frequency, and each time this was tried the desired station was found to be there "on the dot," unless it happened to be "faded out." In this case a slight movement of the main dial would produce it again. This stunt was made possible by, first, the accurate calibration of the dials and, secondly, by the distinct ten-kilocycle band-pass characteristic of the receiver. This latter feature resulted in stations being heard even when the dials were set an appreciable fraction of a dial division off exact resonance. In tuning, the main dial could be moved perhaps a quarter division off exact resonance with little diminution of volume, but moving it a hair's breadth further would cause the station to drop out almost completely. Thus tuning was not critical, yet selectivity was very good. WLW could be brought in, for instance, without any interference from

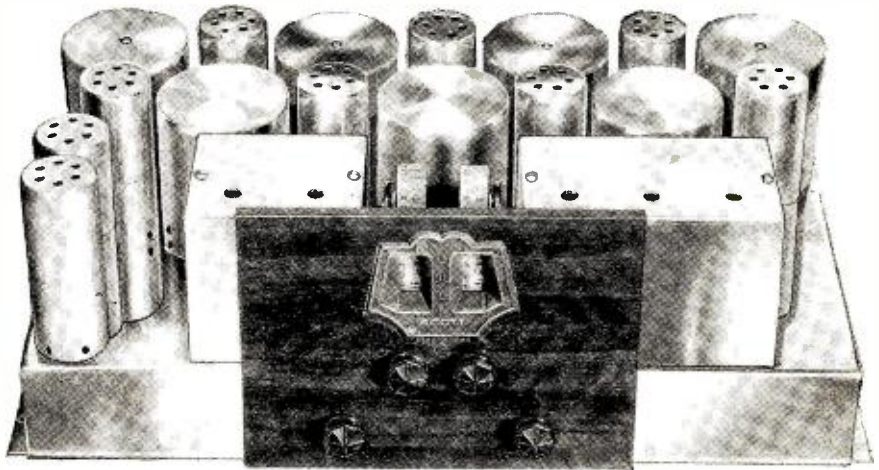

All shielding is plated and highly polished, giving an attractive appearance to the receiver

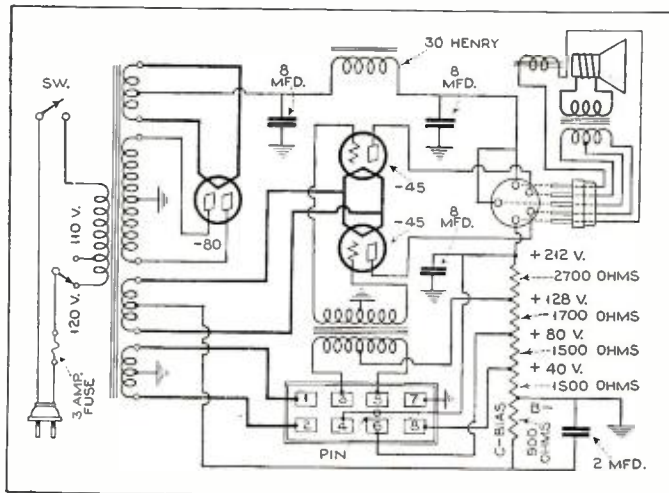
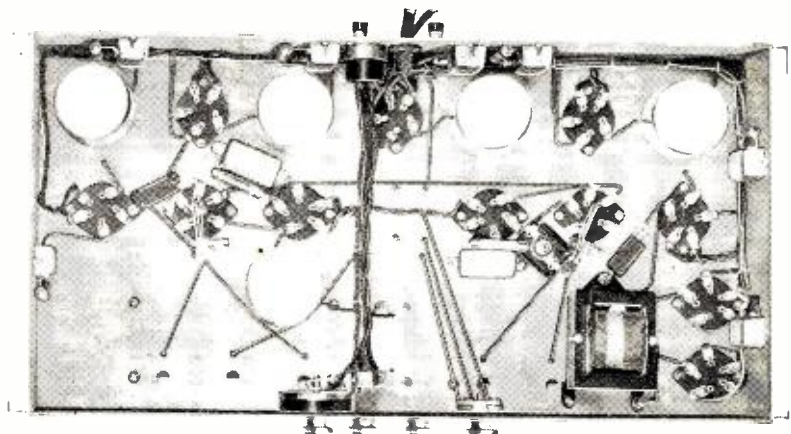
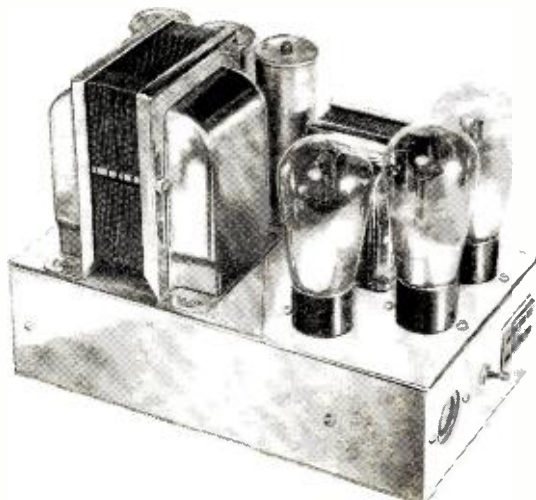

Figure 2. The circuit of the power supply unit which includes the power output stage. This unit is shown below

WOR. With the dial set exactly between the proper settings for these two stations both were heard more faintly. But moving the dial very slightly from this center point would bring in one or the other of the stations with normal volume and clear of interference from the other. These and other tests which were tried left the writer rather enthusiastic about the receiver. Space does not permit a detailed description of the whole evening's experience, but the foregoing summarizes in general the results obtained on the broadcast band. No log was kept including all the stations heard. In fact, no effort was made to get call letters except in those channels known to be occupied by far-distant stations. It is an interesting fact that among these latter channels, six produced west-coast stations—four in California and two in the state of Washington. Two of these at least could be heard all over the house above the barrage of accompanying static. Unfortunately, as the evening wore on, the static had increased until at the hour when west-coast stations should be coming in at their best the static was little less than terrific.

This mention of static brings back an incident of the evening. Later on when the short-wave coils had been plugged into the receiver an amateur in Springfield, Massachusetts, was heard in the 40-meter band, calling an amateur in California, on phone. Just by coincidence the answering Californian was tuned in a few minutes later, also (Continued on page 1115)



The under side of the chassis, with the bottom plate removed to show the layout

Planning the Amateur Station for the "JUNIOR TRANSMITTER"

Wherein Don with the able assistance of Gus makes a ship-shape layout of his amateur station which includes the transmitter and other equipment described in this series of articles

By Don Bennett

"SOME junk pile!"

"All right, Gus, call it a junk pile, but let's see you do your stuff in straightening it up. I've figured out one way I can put this stuff together to take up the least room and still be efficient. Maybe I'm wrong, but see what you think of it. Here's the idea—there's a lot of waste space in the air over this desk. Why not use it? These two-by-two's set up in the corner here and braced will form a skeleton for shelving to hold the transmitter, power supply, frequency meter and the receiver and monitor can go on top of the desk. I'll put the key on the desk and the switch for the power supply on the upright. I've got the two-by-two's already, so what say we apply a little sweat and intelligence to the job right now?"

"Yes, that's O.K., but how about the antenna leads? Your window is at the opposite end of the transmitter from the leads. What about that? Going to rebuild it in reverse?"

"Nope. I've got that doped out, too. I'll bring the leads down through the shelving and mount the meters underneath where they can be seen easily and then run the leads across the bottom of the shelf and down to the window."

"You're really developing faint signs of intelligence. How did you come to figure all that out? Guess you don't need me around here any longer."

"Easy, bo—I need that strong right arm and a small corner of your brains. Remember, you promised to show me how to take that chirp out. Also the thumps that enhance all the broadcast programs when I punch the key. Stick around."

"O.K. Here's the dope on the key click filter first. A key click filter is composed of an inductance, some resistance and a capacity in the keying circuit. The conventional method is to put the inductance in series with the

key and the condenser and resistance across it, like this—(Figure 1). The object of the whole arrangement is to introduce a lag in the keying—a split second lag, to be true, but a lag nevertheless. The idea is this—when the key is pressed (without a filter) a surge of current is put into the tube, and therefore into the oscillatory circuit, and as a result the transmitter starts to oscillating violently and if we could look at the wave radiated from the antenna, it would look like this (Figure 2a). When the key is released there is another surge of power (voltage surge) and the signal would look like this (Figure 2b). You can see from this that what we need is something that will apply the power gradually to the tubes and will also take it away gradually, but not so gradually as to introduce "tailing" (Figure 2c). A lag circuit accomplishes this, and the lag circuit is made up of the choke, L, condenser, C, and resistance, R1. When we have these at the proper values, the key can be pressed and the tubes will go smoothly into operation, the signal looking like this (Figure 2c), and when we raise the key the voltage will be gradually diminished so that the tube slips out of oscillation and the signal will look like this (Figure 2d). The only trick is finding the proper values. And they are never the same in two places. Why, I remember one time when I set up a filter in a haywire rig and it worked swell. After a couple of days' test I built it up in a permanent way and it didn't work at all. Worse, if anything, than the set without the filter in. I just switched a few things around, adjusted the resistance, added capacity, switched the choke to the other key lead and finally it worked O.K. again.

"The inductance I can be a regular filter choke of from 2 to 50 henrys inductance. When using an inductance of from 30 to 50 henrys it may be



Amateur station W2AMH is located in a closet. The power supply is on the shelf overhead and above that, but not showing in the photo, is the transmitter

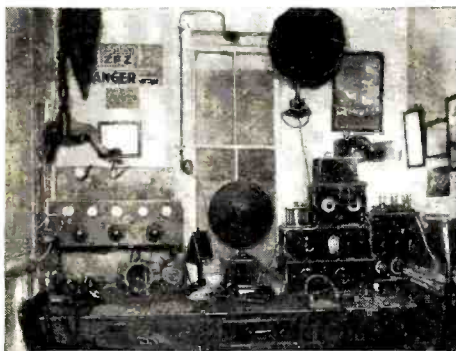

Even in the city all amateurs are not confined to closets and odd corners. 2FZ, for instance, has plenty of room . . . and needs it for the extensive apparatus shown in these two views of his station and power plant

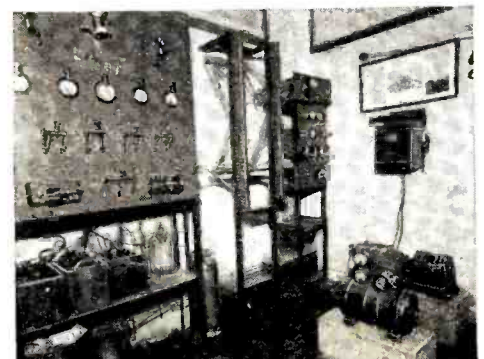

necessary to shunt it with a variable resistance (as shown by the dotted line as R2 in Figure 1) having a maximum value of 5000 to 10,000 ohms. A 1 mfd. fixed condenser fits in nicely at C. The voltage rating of the condenser should be at least half that of the plate voltage of the transmitter. The resistor R1 can be a General Radio 214 of a value between 200 and 500 ohms. Incidentally, the current rating of the choke should be at least 150 mils to take care of our normal plate current of 130 mils.

"But to get back to your layout—let's put up the shelving and then plot the rest of the equipment. Hand me the hammer—"

"It's a good thing, Gus, that every ham doesn't live in an apartment, where he has to hang his transmitter on the wall—hold that while I nail this end—what would a guy do who had all the space he wanted—this piece is too long—"

"Saw it off—the guy with plenty of room gets himself a good, solid table and mounts his stuff on it—no, he doesn't screw it down tight—he might get some vibration from the power supply that would modulate his signal with a 60- or 120-cycle note—cut this one off, too, make it 26 inches—if we get a modulation here, we'll just put the power supply up on rubber sponges of the five-and-dime type and maybe the oscillator, too—you screw the bracket on while I cut the other shelf—there, now let's put the desk back and plan the rest of the set-up."

"I thought we could put the receiver over here in the corner—let's try it."

"No good. You'd need a boarding-house reach to tune it. Put it here in the center—"

"But, Gus, I have to open the desk to raise the typewriter—the receiver will block that. I've got it—we'll put the receiver on a shelf high enough to let the typewriter pass it. Check. Where'll we put the monitor and the dynatron?"

"I think there's room alongside the receiver for the monitor and we'll put the dynatron up on the wall and fasten it rigidly. That wants to be steady, and speaking of that, did you wire it with good heavy wire like I told you? If you didn't, rewire it with bus-bar so that the frequency won't wobble all over the place."

"The next thing to do is to mount the transmitter and the power supply and wire them up. The Underwriters' Specifications call for BX from the meter to the input of the transformer. The builder put the BX from the meter up—you put it from the outlet to the transformer. Put a switch in at some convenient location near the operating position, and a pilot light wouldn't be a bad idea. Fuse the line at the transformer with 3 or 5 amp. fuses. Now to mount the meters—leave the filament voltmeter where it is. We'll make a bracket from a rotor condenser plate for the plate milliammeter and sling it under the shelf so that you can see it easily. Don't forget the r.f. choke between the meter and the transmitter. Now for the big stunt. Bolt the transmitter to the shelf and bore two holes about an inch in diameter through the shelf and the baseboard of the transmitter right where those two G. R. stand-off insulators were. Mount the stand-offs over these holes and mount two more under the shelf. A piece of 10-32 brass rod replaces the screws that were in the stand-offs



Mr. Bennett's station, shown above, the layout of which is described in detail in this article. At the left is a close-up of the author's station equipment. All of the apparatus has been described in constructional data given in the five previous articles of this series

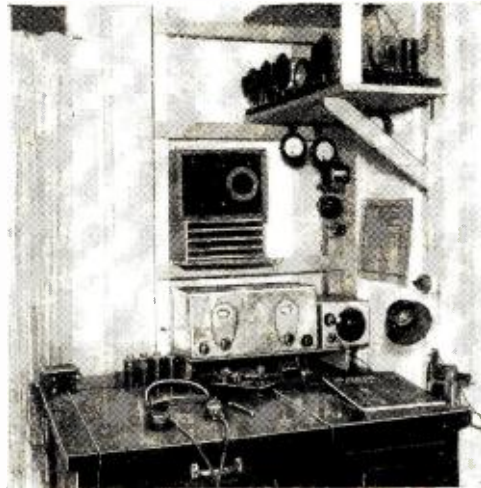

and we bring our antenna connections down where they do some good. Two right-angle brackets of brass fastened to the rod with a nut and to the connection on the meters will support the meters in a visible position. Then run the antenna leads, which should be at least No. 14, but which could better be 3/16" copper tubing, across under the shelf and down to the antenna lead in which can be two pyrex bowls or four General Radio stand-offs mounted two on each side with a large hole in the board (Figure 3).

"Bring your receiving antenna lead-in around in back of the desk and either fasten it in place so that if you have to move the receiver it won't drop in back, or else put a binding post near where the antenna post of the set will be. Run a ground lead around and bring it out to a binding post so that if you have any experimental set-ups at any time you will have a convenient ground connection. Now here's something else. Your layout should be such that you can shift quickly from receiver to monitor to check your signal. The easiest way to do that is by a change-over switch to which the phones are permanently connected and which will transfer them from the receiver to the monitor and vice versa. Some hams prefer continuous monitoring of the transmitter and some like to use a break-in (Continued on page 1112)

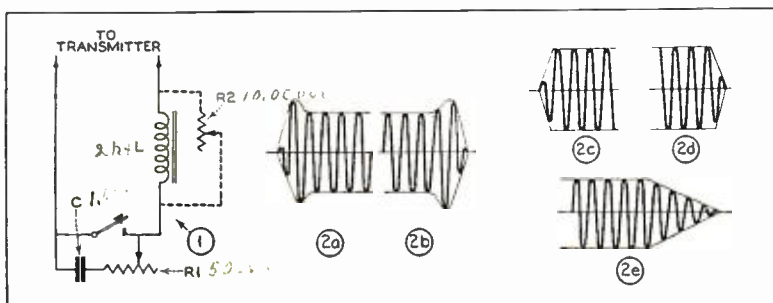
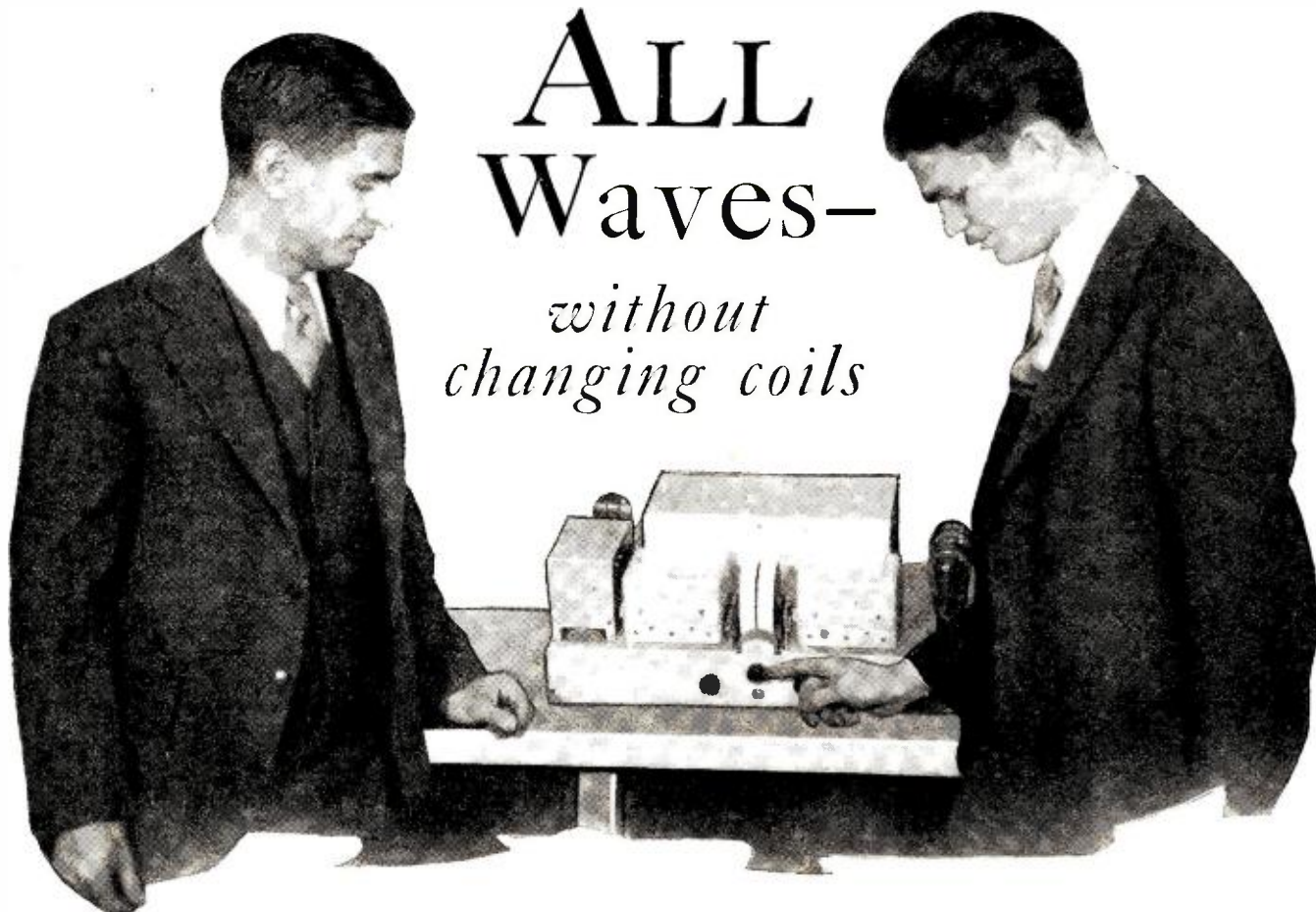

Figure 1 (at left). A key click filter. C is a 1 mfd. fixed condenser, R1 a 500-ohm rheostat and R2 a 10,000-ohm rheostat. L is a choke of 2 henries or more inductance. Figure 2. The key clicks are shown in graphic form in a and b. In c and d the filter has eliminated the click and in e the reverse, or tailing, is shown

ALL Waves— *without changing coils*



A new a.c.-operated receiver with a wavelength range of 15 to 650 meters, obtained without plug-in coils; all wave changing being accomplished by means of a multi-contact switch controlled by a knob on the front panel

SHORT-WAVE broadcasting, as distinguished from amateur short-wave telegraphy, began attracting the interest of radio experimen-

ters about two years ago, and is developing into an indoor sport of considerable proportions. It lured back to the radio fold many former DX fans of the 1920-1925 period, who had dropped out of the game because chain broadcasting and high power had robbed it of some of its early glamour. The mere possibility of hearing voice and music from Europe and the Antipodes is reviving some of the old DX fever.

At first people were satisfied with simple battery receivers possessing hand capacity and many of the other troubles associated with elementary regenerative sets. However, they had been spoiled by the efficient all-electric broadcast receivers already on the market, and they began to demand comfort with their thrills. In an effort to fill their needs, manufacturers worked on the receiver problem, and in quick succession there appeared a series of improved sets. First, the simple regenerative tuner took on an untuned screen-grid r.f. stage and a little shielding. Then a *tuned* screen-grid job with double shielding made its commercial appearance (the original "Super-Wasp"; see RADIO NEWS for June, 1929). Batteries still remained a nuisance to those customers who had outgrown the spilling-acid-on-the-rug stage, but a.c. short-wave operation, when successful at all, was usually a laboratory accomplishment and therefore unfit for the public. Finally David Grimes and John Geloso discovered the source of the mysterious "tunable" hums that cause so much trouble, wiped them out with a few simple expedients, and produced the a.c. Super-Wasp, the first completely a.c. operated short-wave receiver on the market. Brought out in September, 1929 (see RADIO NEWS for January, 1930), this set has enjoyed a phenomenal use throughout the world, its popularity strengthening its sponsor's conviction that the short-wave fan was maturing and that his

By Robert Hertzberg*

ranks were being increased by new converts who were never fans before but who were adopting the short-wave hobby.

There was still one feature of short-wave operation that caused concern, and that was the matter of plug-in coils. The early receivers used a maximum of three coils, which could be inserted and removed without much trouble because the sets were wide open. However, as the benefits of shielding became evident and the number of coils rose to as high as ten (five pairs to cover a range of from 15 to 500 meters), the coils themselves became a nuisance. Getting them in and out of necessarily tight shielding cans was an operation that tested the temper and bruised the knuckles, and left the set owner in no mood to make delicate adjustments on hair trigger dials. Anticipating a consumer reaction to this situation, and looking forward to increased markets, the new Universal Super-Wasp has been laid out as a short-wave or rather combination wave-receiver, possessing the following features:

1. No plug-in coils. The set remains closed, and all wave shifting is done from the front panel.
2. The minimum wavelength is around 15 meters, and the maximum not less than 550, to take in the regular broadcast band as well as all the short-wave channels. The experience gained from the previous Super-Wasps indicated the desirability of this coverage. Many people will use these sets for regular entertainment reception when the short waves are not obliging.
3. The detector regeneration control does not affect the tuning to any appreciable degree. A requisite to insure dependable logging.
4. The power pack is part of the chassis, not a separate unit dangling in the back.
5. The tuned screen-grid r.f. stage, having demonstrated its effectiveness, is retained.
6. The audio system is fully grown, using a respectable out-

*Pilot Radio & Tube Corp.

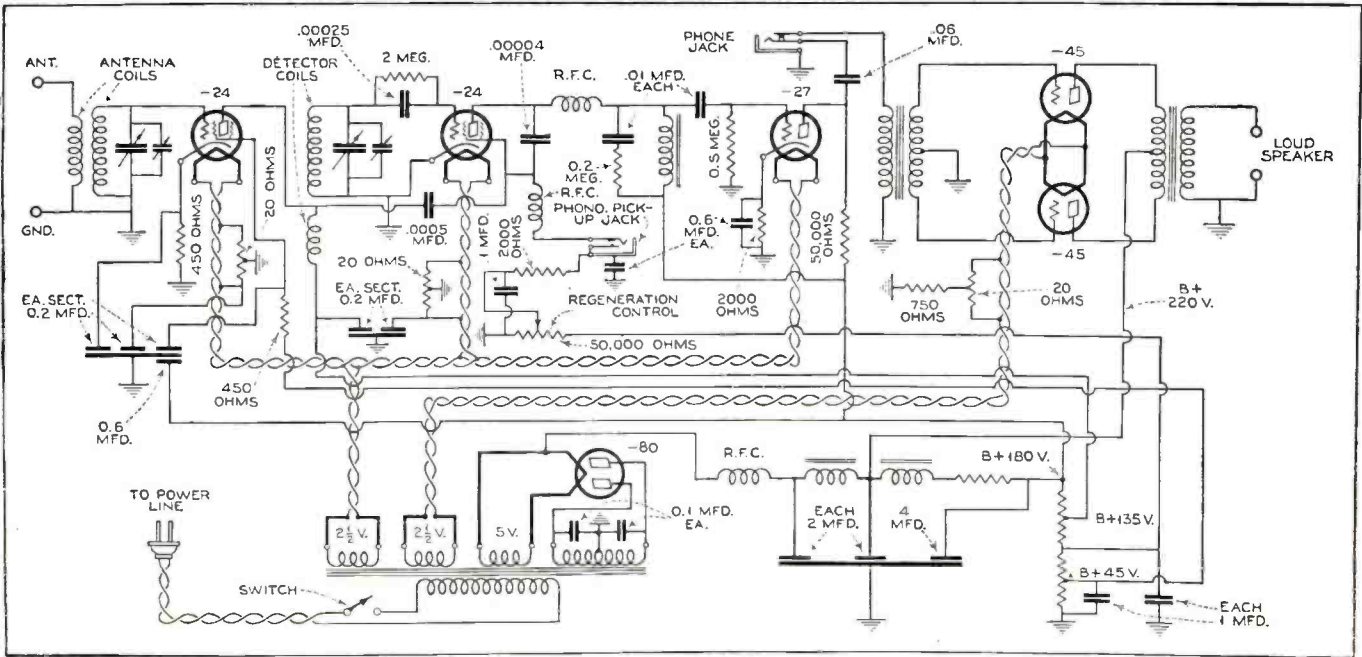

The complete schematic circuit of the Universal Super-Wasp with its built-in power supply

put stage that would do justice to a good dynamic speaker.

7. The laboratory "appearance," so closely identified with previous short-wave sets has been shaken off, and the new receiver is worthy of a place in the living room or at least in the corner of the library or reading room.

8. It is made both in kit form for easy home assembly, and in factory-built form for people who are somewhat dubious about their skill with a soldering iron.

The finished receiver, just emerged from the laboratory and ready for the hands of short-wave fans, more than meets the requirements originally laid down for it. It covers the unprecedented range of 15 to 650 meters, with all the coils fixed inside the chassis, and with any one of the seven overlapping ranges instantly available by the mere twist of a little knob on the front panel. It is difficult to describe the simplicity and convenience of the control, which does for short-wave reception what the self-starter did for the automobile. You merely turn the knob, you hear a sharp little click, and the range you are set for appears marked on a small scale. That's all there's to it; no wrestling with coils, no loosening of the shield tops, no pulling the set off the table.

The screen-grid r.f. amplifier stage and the screen-grid detector stages, respectively, are enclosed within a large common shield can having, of course, a partition in the center. Each is provided with four small

fixed coils mounted on the edge of a molded bakelite switch housing. This housing, a marvellous example of the bakelite molders' art, contains a shaft bearing fifteen thin cams, which are brought into play against fifteen plunger contacts. The two switches, alike except that one is left handed and the other right handed, are lined up on the aluminum chassis, their shafts terminating in a worm gear. This is driven by a smaller gear which is coupled to the control knob on the panel by a steel shaft and a universal joint.

The r.f. or antenna coils contain two windings apiece, a primary and a secondary. One end of each is left grounded, and the other ends terminate at the plunger contacts on the antenna switch. The detector or interstage coils also have two windings apiece: a combination primary and tickler, and a grid coil or secondary, arranged the same way.

The tuning condensers for each stage are split units, each consisting of a small section of 130 mmfd. maximum and a larger section of 415 mmfd. They have a common rotor but separate stator connections, the latter brought out to contacts on the switches. In addition, there is a fixed loading condenser of .0004 mfd. mounted inside each of the stage shields. If the small condenser sections are designated as A and the large as B, and the loading condenser as C; and the four coils, in the upward value of their inductance, as 1, 2, 3, and 4, (Continued on page 1103)

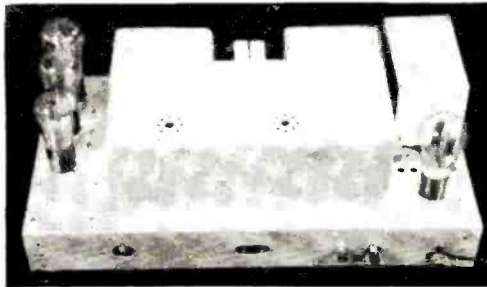

A rear view of the receiver, showing the complete shielding. Along the back are the phonograph loud speaker and antenna ground connections

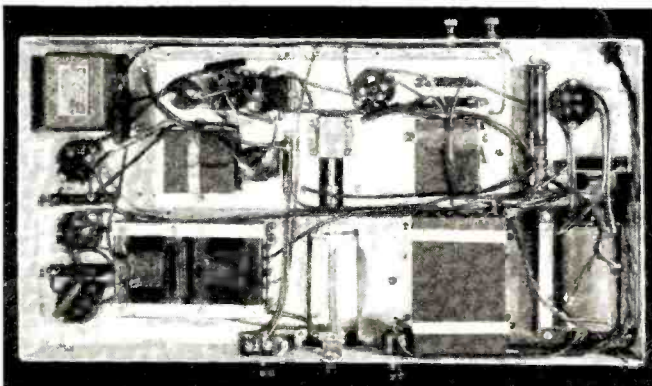

As shown in the view above, the power equipment is completely isolated below deck, with the audio and power transformers at opposite ends

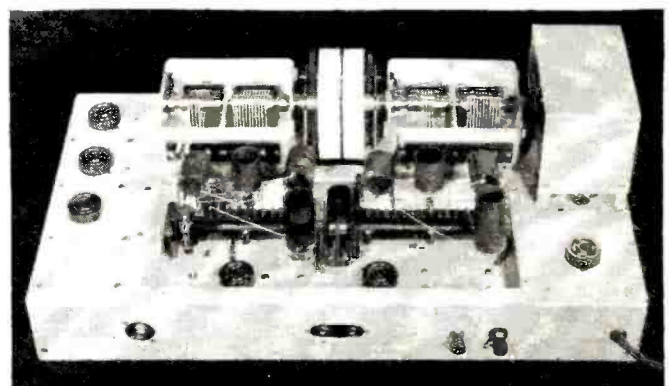

The shielding removed to show the arrangement of the tuned circuit components, including the coils and coil switching arrangement

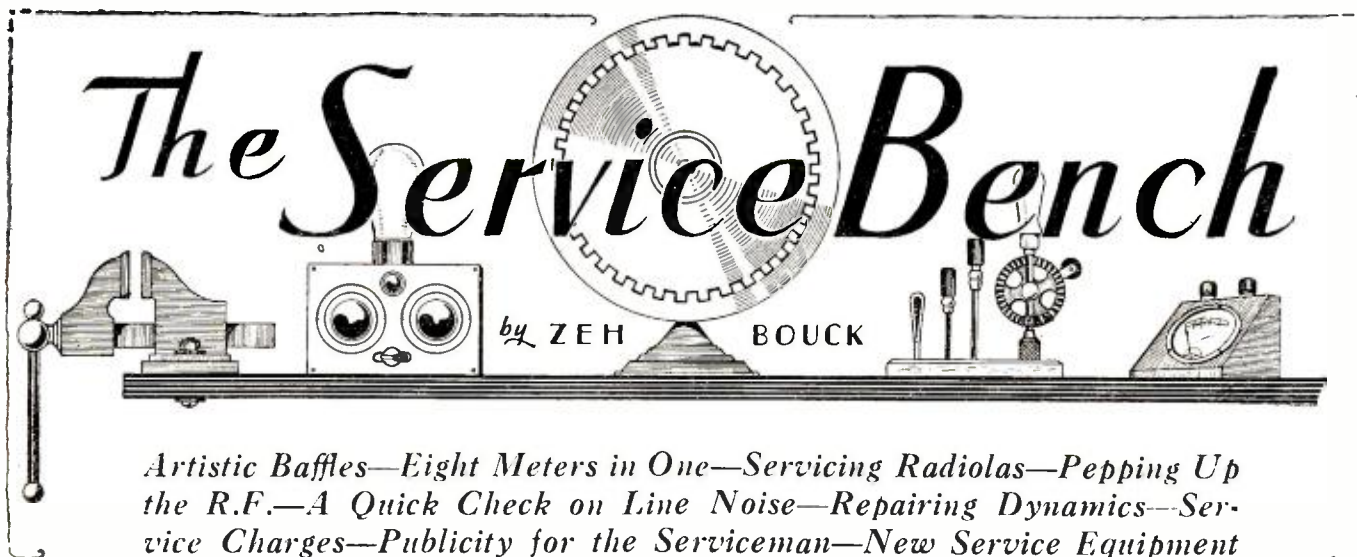

Artistic Solutions to the Baffle Trouble

THE problem of mounting a dynamic speaker so that its electric-acoustic efficiency is high and its esthetic aspects passable, confronts the serviceman on more than sporadic instances. The necessity for extra-cabinet mounting of a moving coil loudspeaker may be occasioned by several factors—insufficient baffling and unsatisfactory reproduction, howling with the speaker mounted integral with the tuning cabinet, the desirability of a second speaker in a different part of the house, and the custom built installation calling for a separate speaker. Numerous instances have also been brought to our attention where customers have evinced a desire for a separate speaker-amplifier combination used in conjunction with home talkies and phonograph reproduction.

As is generally appreciated, the dynamic speaker requires a large baffle area for good reproduction of the lower frequencies. As a matter of fact, it is seldom that sufficient baffle is provided in cabinet mounted designs, and the results of electrical compensation in the speaker or amplifier are not always desirable.

The simplest and most effective type of baffle consists of a heavy board having some fifteen square feet of area surrounding the opening against which the cone of the speaker is placed. This arrangement, however, is artistically crude, and the Service Editor has on various occasions so modified the baffle as to admit it into the polite society of the well appointed living room.

In private homes it is often possible to mount the speaker against the wall of an adjoining room, covering the opening with a bit of light tapestry, and employing the wall itself as a baffle. For instance, the speaker might be mounted in a pantry, against the wall separating the pantry from the living-room. This arrangement is ideal from an acoustic point of view, but of course is only practical in a private dwelling providing the necessary architectural convenience.

A somewhat similar system is suggested by McCory, the well-known news photographer of the *New York Daily News*, who mounted a speaker in the floor of the room above his library, using the ceiling of the latter as an excellent baffle.

It is a fairly simple job for a carpenter to mount a dynamic speaker against the walls and ceiling in the corner of a room, as suggested in Figure 3. This arrangement is equally well adapted to apartment houses and private homes, and combines perfect baffling with a pleasing appearance. The board, after being made

up and fitted, is fastened to the walls and ceiling with toggle bolts.

It will usually be found essential to cut the "S" shaped louvres in the baffle in order to prevent booming and unpleasant resonance effects on the low notes. Mounting the speaker about a half inch behind the opening—using wooden washers for spacers—is also effective in achieving the correct tone balance. Acoustic perfection is best determined by listening to announcers, and the amount of spacing and louvre openings should be varied until the voice is absolutely natural. Variation of the tone control, on receivers so equipped, will facilitate this adjustment.

None of the arrangements so far described is recommended for frame houses accommodating more than one family, as the low notes are effectively transmitted throughout the structure.

Figures 1 and 2 illustrate a method of camouflage that may be used universally, and which possesses the added advantage of being portable. The speaker and baffle board are mounted on an easel, and the baffle is covered with an oil painting on canvas. The size of the baffle will of course be determined by the painting available, but should be as large as possible. The shelf on which the painting rests is about two inches wide. The baffle is mounted behind the front supports. This spaces the canvas about three inches from the baffle opening, reducing the effect of the canvas on the sound to a negligible degree. The exact dimensions of the easel illustrated are given in Figure 1. This easel stands approximately five feet four inches high. Pictures painted on heavy board—such as beaver board—should not be used, as they tend to muffle reproduction.

The easel is preferably placed in a corner, and should be moved tentatively, until the best sound distribution and general frequency response are secured. As usual, make such tests on the voices of familiar announcers. When a small picture does not permit adequate baffling, the tone deficiency can be compensated somewhat by draping a heavy cloth over the back of the easel and speaker.

Many custom-built installations include loud speakers built into existing furniture such as bookcases. The hole cut in the front is covered with a silk or other grille. "Cabinet resonance" must be avoided in such an installation and is often overcome by cutting away the back of the compartment in which the loud speaker is placed.

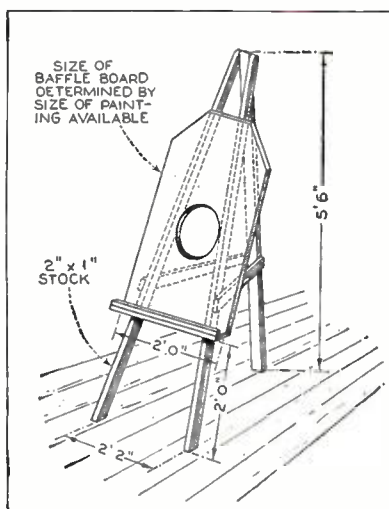

Figure 1. General specifications for the easel—baffleboard combination



Figure 2. (Left) The complete speaker installation, the baffle and speaker being hidden by the oil painting. This baffle is highly effective and the combination is portable



Figure 3. (Right) An attractive permanent speaker installation. If desired, the speaker hole may be covered with a light cloth. The louvres are important—not merely decorative

EIGHT METERS IN ONE

By Earl H. Miller

(First Lieut., U. S. Signal Corps Reserve)

(The serviceman's knowledge of meter technique is generally so extensive that we have hesitated to give space to many of the test equipment articles that have found their way to the service desk. However, Lieutenant Miller's contribution is the best we have seen on the subject and we recommend the instrument he describes as a most useful auxiliary to whatever service equipment the expert may have on hand.—THE SERVICE EDITOR.)

THE most important single item in a service or experimental laboratory is measuring equipment. Because of the cost of reasonably accurate instruments, any means of multiplying the usefulness of a single meter should relieve the budget. It is the purpose of this article to describe a useful d.c. meter of several volt, milliamper and resistance ranges which the serviceman may construct without straining the purse.

The foundation of the instrument is a Weston model 301 d.c. milliammeter having a full-scale reading of one milliampere. The following ranges are secured: 1, 10, 100 and 500 milliamperes, 10, 100 and 500 volts (all 1000 ohms per volt) and two continuity-resistance ranges.

The simple application of Ohm's law in the determination of the resistance values to be used as multipliers in converting a milliammeter into a voltmeter is perhaps familiar to the majority of experimenters, but will be treated briefly. The problem is to determine the resistance necessary to secure full-scale deflection of the meter with the full voltage of the desired value applied.

The resistance for the 10-volt range is determined as follows:

$$R = \frac{E}{I}$$

when R = Combined resistance of meter and multiplier

E = Voltage range desired

I = Current required to deflect meter to full scale

The meter resistance (27 ohms in the one used by the writer) is negligible. Applying the formula $E = IR$, the drop across the meter itself is found to be $.001 \times 27 = .027$ (Cont'd on page 1095)



THERE are many service customers who can be interested in short-wave reception. The advent of international broadcasting, with the attending publicity, has stimulated a desire to receive these services directly. A well-placed word of explanation showing that short-wave equipment compares with the broadcast receiver in appearance and ease of operation—that it has completed its incubation period in the laboratory—will often result in a sale of either an adaptor or receiver. The possibilities of a real financial return often justify advertising campaigns.

—THE SERVICE EDITOR

ALL IN A DAY'S WORK

DUE to the tendency of the average set owner to play his radio at close to maximum volume, even the best of dynamics will develop cone kinks after a period of service. These kinks form areas on the surface of the cone that are resonant to certain frequencies, resulting in a noticeable rattle or fringe on some musical notes.

Taking the Rattle Out of Dynamic Cones

The best way of remedying this trouble is by giving the affected areas repeated coats of rubber cement, permitting each coat to dry thoroughly before repainting. The tension of the rubber cement will be sufficient to dampen the resonant portions without stiffening the cone as a whole.

Do not use shellac unless the cone is of the fairly rigid or "stiff" type.

It is well, when making such repairs, to throw in gratis a lecture on the proper care of the speaker, warning the owner against tuning his receiver with the volume control on full, or making sudden changes in the volume adjustment when a local station is tuned in. This last process is particularly hard on the speaker when the volume control is slightly noisy. Most speakers are designed to output high volume. It is the sudden and explosive "plops" that do most of the damage.

A Quick Check on Line Noise

H. W. Koch of Trinidad, Colorado, remarks that three out of every five of his service calls are complaints of noise, the majority of which he readily traces to line irregularities within the house. He carries with him a fifty-foot extension cord with which he connects the radio directly to the line at the point where it enters the building (or as close to the meter as possible). If the noise disappears with the cutting out of the remaining house circuit by opening the switch or pulling the fuses, the job can be turned over to the local electrician.

He concludes with the following notes on besting the force of gravity—"By slipping on a pair of rubbers, one can walk around on roofs of all sizes and shapes as safely as a cat."

Notes on Radiolas

Fred Pitzer sends in the following pointers on Radiola technique:

"The tone in the Radiolas 33 and 41 may be compensated somewhat in favor of the bass notes by inserting a condenser of (Continued on page 1105)

Backstage in Broadcasting

Chatty bits of news on what is happening before the microphone. Personal interviews with broadcast artists and executives. Trends and developments of studio technique

THIS year, Billy Jones and Ernie Hare celebrate their eleventh anniversary in broadcasting. We visited the veteran song and comedy team in their office high above Times Square and heard them discuss their trials and tribulations. Currently known as the Interwoven Pair and in past programs as the Happiness Boys and the Flit Soldiers, Jones and Hare point out that Friday has always been their lucky broadcasting day and that they request all of their programs to be broadcast on that day. Billy and Ernie met in a phonograph studio where they both happened to be recording. They recognized each other's talents and decided to team up. A long series of combination recordings followed. These included several nursery rhymes put to music. Soon a letter from Tommy Cowan, program director of the early Westinghouse transmitter, WJZ, arrived requesting Jones and Hare to participate in "radiophone experiments." WJZ's studio was in a tent in Newark, and the boys traveled over and did their act before a microphone that bore striking semblance to a tin can. Jones and Hare broadcast with the speculation of having but a handful of experimenter-listeners.



Billy Jones

By



Samuel Kaufman



Ernie Hare

and Hare to participate in "radiophone experiments." WJZ's studio was in a tent in Newark, and the boys traveled over and did their act before a microphone that bore striking semblance to a tin can. Jones and Hare broadcast with the speculation of having but a handful of experimenter-listeners.

Radio grew and so did the team's popularity. Known as the Happiness Boys, Jones and Hare spread their sunshine and cheer to a rapidly growing army of listeners. Later, the team rose to new heights under various program designations. Today they sit in a cozy office at desks facing each other. Billy collects gags—bundles of them—and files them away until they can be suitably used in a program. Any joke, heard, conceived or suggested, is jotted down and filed until the opportune day they can be put to use on the air. The boys collect strange phonographs which they use to play their own recordings. Billy takes especial pride in a talking machine that completely folds away into an alarm-clock case.

Radio grew and so did the team's popularity. Known as the Happiness Boys, Jones and Hare spread their sunshine and cheer to a rapidly growing army of listeners. Later, the team rose to new heights under various program designations. Today they sit in a cozy office at desks facing each other. Billy collects gags—bundles of them—and files them away until they can be suitably used in a program. Any joke, heard, conceived or suggested, is jotted down and filed until the opportune day they can be put to use on the air. The boys collect strange phonographs which they use to play their own recordings. Billy takes especial pride in a talking machine that completely folds away into an alarm-clock case.

WERE it not for two desk microphones in Studio L of the National Broadcasting Company, visitors would never guess they were in a broadcasting chamber. It has the appearance and furnishings of a magnificent living-room. And that's just the purpose Gerard Chatfield, program supervisor, had in mind when he designed the studio. Mr. Chatfield thought that a cozy, homelike room would be just the thing for speakers new to broadcasting. The timid or inexperienced speaker may go on the air from these comfortable, luxurious surroundings



in an atmosphere that will psychologically improve the program, according to the supervisor's plans. The room contains a fireplace, a sofa, desks, chairs, paintings, pottery and many other items that would offhand be identified with a residence rather than a studio. There are no drapes on the walls or windows, but the entire room is invisibly treated for excellent acoustical results. We were astonished to find that an attractive cupboard with leaded glass windows was in reality a dummy front of the control room. A beamed ceiling, three beautiful windows overlooking Central Park, and special lighting effects add charm to the unique setting. The studio is claimed to be the first of its type and a duplicate was constructed in the new Chicago studios of the network.

DR. FRANK H. VIZETELLY, who, besides editing a dictionary, has long been an exponent of perfect English over the radio, recently inaugurated a bi-weekly class for announcers of the Columbia Broadcasting System.

Every second Tuesday, following his broadcast period, the Columbia staff is rounded up, herded into a studio and Dr. Vizetelly gives pointers on microphone diction.

"Our enunciation must be clean cut so that when we speak, we speak clearly and
(Continued on page 1120)

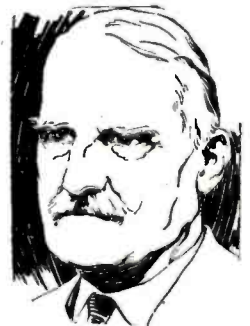

The new speakers' studio at NBC

What's New in Radio

A department devoted to the description of the latest developments in radio equipment. Radio servicemen, experimenters, dealers and set builders will find these items of service in conducting their work

Midget Receiver

Description: This midget eight-tube receiver offers several unusual features, heretofore encountered only in larger type receivers. Among these are a tone control, and a local and distance switch. The receiver employs four screen-grid tubes.



Two 45 type tubes are used in the push-pull power stage. The receiver is thoroughly shielded and its output is handled by the new Magnavox dynamic speaker. The receiver chassis and the reproducing unit are mounted in a concert grand cabinet measuring 19 1/4 inches high by 16 1/2 inches wide by 11 inches deep.

Maker: Jackson-Bell Company, Los Angeles, California.

A Handy Set of Test Prods

Description: Here is a convenient set of test leads for the radio experimenter and service man. When used in combination with a meter and a dry cell or a small "B" battery they are particularly adaptable for continuity testing of radio apparatus. The handles are of convenient



size, measuring 6 inches in length, and are well insulated. The prod points are phonograph needles inserted and held securely by small metallic chucks. This arrangement permits these needle points to be easily and quickly renewed. The sharp points are capable of puncturing the insulation of wires, which is an advantage in tracing and locating the par-

Conducted by The Technical Staff

ticular circuit under test. The leads are 50 inches long and are available with either spade tips or phone tips.

Maker: Blan the Radio Man, Inc., 89 Cortlandt Street, New York City, N. Y.

New Variable Mu Radio Tube



Description: E. T. Cunningham, Inc., has announced to set manufacturers a new screen-grid tube designed primarily for use in radio-frequency and intermediate-frequency amplifier stages. This tube is not ordinarily interchangeable with any other tube and must be used in circuits especially designed for its characteristics. This new tube, designated as C-335, is extremely effective in reducing cross-modulation and modulation distortion. Furthermore, its design is such as to permit easy control of a large range of signal voltages without the use of local-distance switches or antenna potentiometers, making the tube particularly adaptable to automatic volume control design. It is designed for a.c. operation and employs a cathode of the quick heater type. The remarkable ease of volume control obtainable with the C-335 is due to the gradual and smooth variation in mutual conductance over a wide range with change in grid voltage. The mutual conductance at -40 volts on the grid is nominally 10 micromhos, and at -1.5 volts 1100 micromhos. This gives a useful mutual conductance ratio of 110 for a single stage. With these characteristics the C-335 offers very attractive possibilities to designers in obtaining improved set performance with simplified circuits.

The tentative ratings and normal characteristics for the C-335 are given below:
 Filament voltage 2.5 volts
 Filament current 1.75 amperes
 Plate voltage (recommended) . . . 180 volts
 Screen voltage (recommended) . . . 75 volts

Grid voltage -1.5 volts
 Plate current 9 milliamperes
 Screen current Not over 1/3 of plate current
 Plate resistance 200,000 ohms (approx.)
 Mutual conductance 1100 micromhos
Approximate Interelectrode Capacitances
 Grid to plate 0.010 uuf. maximum
 Input capacitance 5 uuf.
 Output capacitance 10 uuf.

Overall Dimensions

Length 4 11/16—5 1/4"
 Diameter (maximum) 1 13/16"
 Cap 0.346—0.369"
 Socket C type (five-prong)

Maker: E. T. Cunningham, Inc., 370 7th Avenue, New York, N. Y.

Feather-Weight Headphone

Description—This headphone receiver weighs only 1 1/2 ounces. Its outside diameter is 1 13/16 inches and it measures three-quarters of an inch in thickness. The use of high grade cobalt steel for the magnets and bakelite for the shell of this unit explains its unusual light weight. It should find a wide application among the hard of hearing, who are forced to use headphones if they are to

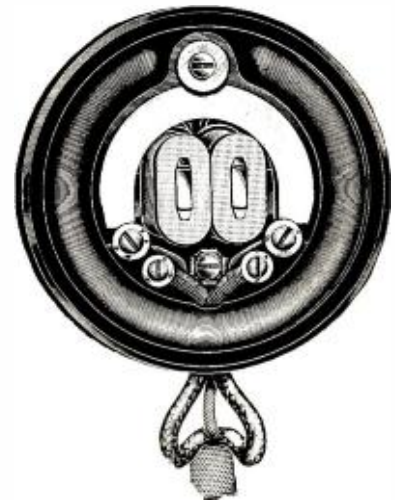

enjoy radio programs, sound movies and lectures. It will also materially reduce the discomfort of the headphones now commonly used in hospitals and hotel radio systems. These new headphones are also adaptable to airplane service as their small size permits them to fit readily into the pilot's helmet and their light weight is scarcely noticeable. The receivers can be wound to any desired impedance and each pair is equipped with a thin steel headband. They can be supplied with cords, three, six or twelve feet long.

Maker—Trimm Radio Mfg. Co., 947 West Harrison Street, Chicago, Ill.



The Junior Radio Guild



LESSON NUMBER TWENTY

Using Mathematics in Radio

Geometry and Its Application in Radio

PART SEVEN

IN the practice of radio engineering and the various investigations involved in the design and construction of radio apparatus it can be conceived that a knowledge of surfaces as applied to various geometric figures is of tremendous importance in the proper understanding of such designs.

Geometry teaches us the relation of plane surfaces, such as the triangle, square, rectangle and circle, to other geometric figures; and surface areas are also considered, which is probably the most important study of geometry as applied to radio designs.

Throughout apparatus design in radio engineering we encounter coils of various shapes, condenser plates of different dimensions and resistors of varying sizes. These are so constructed that a knowledge of their surface areas is essential to the successful application of fundamental electrical formulas.

It is interesting to review those theorems and propositions of geometry which are of practical application to the electrical engineer, and it is readily and early appreciated that this phase of mathematics is essential to the student of radio.

Engineers are constantly required to assist in the preparation of drawings, and are responsible to a great extent for the general layout of apparatus and the correct positioning of the various parts. Geometry is an aid in presenting the proper method of placing such ideas on paper in the form of lines, so that the dimensions of length, breadth and thickness can be shown.

It is of interest to investigate a few propositions in the construction of some geometric figures, as these will show the applications of the theorems of geometry.

Proposition—Problem

At a given point in a straight line, to erect a perpendicular to that line.

With reference to Figure 1, it is obvious that the given point may be anywhere between the extremities of the line, such as O in the line AC, or at the extremity of the line, such as B in the line AB.

1. Let O be the given point in line AC. (Figure 1 (a)).

Now lay out HO and OB equal.

With H and B as centers, and with equal radii greater than OB, describe two arcs intersecting at R. Join RO, and the line RO is perpendicular to the line AC.

The proof of this statement is that since O and R are two points each equidistant from

To beginners in radio the importance of the fact that the common ordinary garden variety of mathematics (the kind of mathematics which to some seemed so pointless when taught in the elementary and lower classes of high school) is quite necessary to the later assimilation of a knowledge of geometry, trigonometry and calculus cannot be stressed too much. For the truth of this it is only necessary to question those in the radio game who have been unfortunate enough to have slipped up on this part of their education and now wish that they had the opportunity to go back to school again.

RADIO NEWS is glad to present to its readers this seventh of a series of articles prepared by Mr. J. E. Smith (President, National Radio Institute) on the use of mathematics in radio. The first of the series appeared in the December, 1930, issue of RADIO NEWS.

THE EDITORS.

H and B, they determine the perpendicular bi-sector of HB.

2. Let B be the given point in line AB. Figure 1 (b).

Now take C, any point above AB, and from C as a center, with the distance CB as a radius, describe an arc intersecting AB at E.

Draw EC and prolong it to meet the arc again at D. Join DB, and then the line DB is perpendicular to the line AB.

The proof of this statement is shown by reference to the definitions and theorems in the study of the circle, a review of which will be of interest at this time.

We have the following definitions relating to the circle:

(a) The bounding line of a circle is called its circumference.

(b) The diameter of a circle is the straight line through the center, ending at the circumference.

(c) The radius of a circle is the straight line from the center to the circumference.

(d) The circumference of a circle is divided into 360 equal parts, called degrees.

With reference to the last definition (d), we can see that an angle at the center of a circle can be measured by the intercepted arc. Thus in Figure 2 (a) the angle A is measured by $\frac{1}{4}$ of the circumference or is equal to 90 degrees. In Figure 2 (b) the straight angle B is measured by $\frac{1}{2}$ of the circumference or is equal to 180 degrees.

Therefore, the proof of the second point of the above proposition is stated as follows:

Corollary

An angle inscribed in a semi-circle is a right angle. Figure 2 (c).

Note: The definition of a "corollary" is a truth that is easily deduced from known truths.

Thus, the line DB of Figure 1 (b) is perpendicular to the line AB at the given point B.

Proposition—Problem

To bisect a given arc.

With reference to Figure 3, having given the arc AB, the problem is to bisect it.

Draw the chord AB.

With A and B as centers, and with equal radii greater than one-half AB, describe arcs intersecting at D and E. Draw DE and then this line is the perpendicular bisector of the chord AB.

(Since D and E are two points each equidistant from A and B, they determine the perpendicular bisector of AB.)

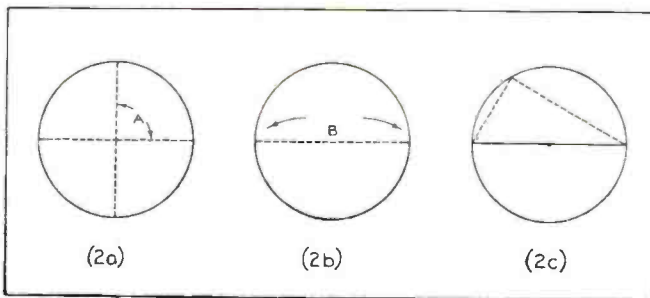
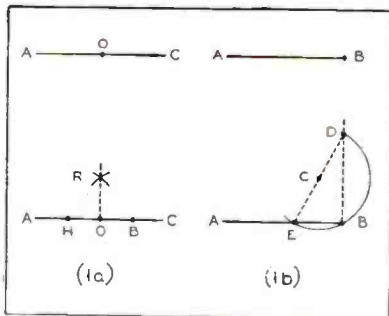

Figure 1 (above). Figure 2 (below)

Therefore, DE bisects the arc AB.
The proof of this is given by the following:

Corollary

The perpendicular bisector of a chord bisects the arc of the chord.

Proposition—Problem

To bisect a given angle.

With reference to Figure 4, having given the angle AEB, the problem is to bisect it.

From E as a center, and with any radius, say EA, describe an arc cutting the sides of the angle at A and B.

Now, with A and B as centers, and with equal radii greater than one-half the distance from A to B, describe two arcs intersecting at D. Draw DE and then this line bisects the arc AB at C (from the above proposition).

Therefore, since an angle at the center of a circle can be measured by its intercepted arc, and since arc AC equals arc CB, the angles are equal, and the line DE bisects the angle AEB.

The proof is also stated as follows:

(In the same circle, equal arcs subtend equal central angles.)

Proposition—Problem

To divide a given straight line into a given number of equal parts.

With reference to Figure 5, having given the straight line AB, the problem is to divide it into any given number of equal parts.

From A, draw the line AO, making any convenient angle with AB.

Let it be required to divide the straight line AB into three equal parts. Now, take any convenient length, as AC, and apply it to the line AO three times. Thus, AC, CD and DE will be equal. From E, the last point in the line AO, draw EB.

Now, by drawing GD and FC parallel to BE, these lines will divide AB into equal parts.

The proof of this statement is shown by reference to the definitions and theorems in the study of oblique lines and plane angles.

We have the following definitions and theorems relating to lines and angles:

(1) If one straight line intersects another straight line, the vertical angles are equal. Thus, with reference to Figure 6, angle a is equal to angle b, and angles c and d are equal.

(2) A straight line that cuts two or more straight lines is called a transversal. Thus, with reference to Figure 7, GD is called the transversal. The angles a, d, g and f are called interior angles and angles b, c, e and h are called exterior angles. The angles b and f, c and g, e and a, h and d, are called exterior-interior angles.

(3) If two parallel lines are cut by a transversal, the exterior-

interior angles are equal. Thus, with reference to Figure 8, angle c is equal to angle g, and angles h and f are equal.

Now, referring to Figure 5, and the following theorem, we can prove that the parallels FC, GD and BE divide the line AB into equal parts.

Proposition—Theorem

If three parallels intercept equal parts on one transversal, they intercept equal parts on every transversal. Thus, let us investigate Figure 9, where three parallels cut equal parts on the transversal AB.

By drawing lines CH and DJ parallel to AB, and from the fact that the exterior-interior angles a and c, are equal respectively to b and d; also that angle a is equal to angle c, we have that angle b is equal to angle d.

Now, since the exterior-interior angles e and f are equal, and the sides CH and DJ are equal, the two triangles CHD and DJE must necessarily be equal. Since these triangles are equal, side CD must equal side DE.

In like manner, AC can be shown to be equal to CD, and thus, for three parallels intercepting equal parts on the transversal AB, they intercept equal parts on the other transversal AE.

Examples

It is well for the student to construct all of the above problems with various degrees of magnitude.

Construct the following:

1. At a given point in a straight line, to erect a perpendicular to that line.
 - a. Given the line AB and with reference to the problem in the proposition, take the point C outside of AB but near A and construct a perpendicular at B.
 - b. Given the line AB, take the point C outside of the length of AB. The perpendicular is to be constructed at B.
 - c. Given the line AB, take the point C outside of AB but to the right of the perpendicular to be constructed at B.

2. To divide a given straight line into a given number of equal parts.

- a. Given the line AB, divide it into four equal parts.
- b. Given the line AB, divide it into six equal parts.

Applications to Radio

In studying the relations of the current and voltage in a simple series circuit consisting of an inductance and a resistance, as shown in Figure 10, we have learned that the vector representation of the voltage drops can be shown as indicated in (b). Here we have the voltage drop across the resistance R as being in phase with the current I, and the reactive voltage drop across the inductance L as being at right angles to I. In order to obtain the magnitude of the voltage E, we find that we have a geometric figure in the shape of a right triangle.

Geometry teaches us that there is a definite relationship existing between the three sides of a right angle triangle. Let us study the right triangle ABC of Figure 11, and let CF be drawn from the vertex C, perpendicular to AB.

In this figure we now have three (Continued on page 1102)

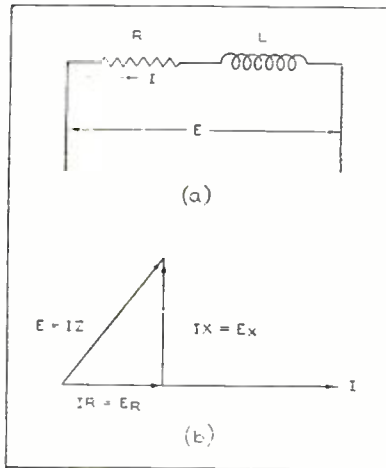
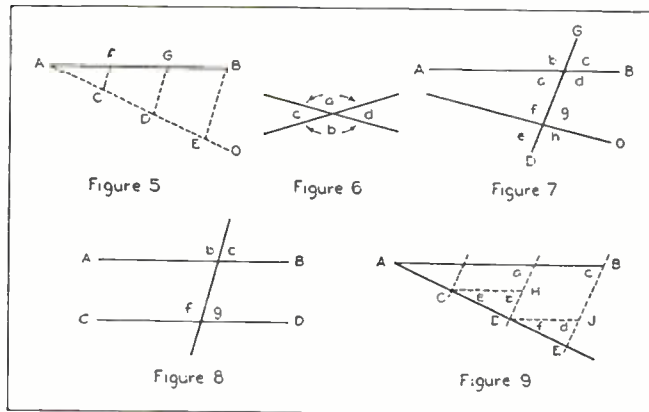
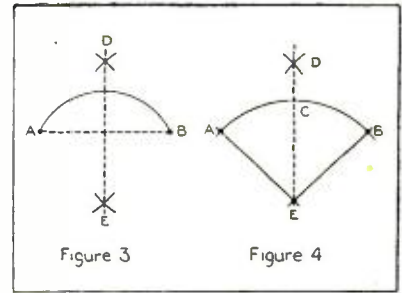

Figure 10

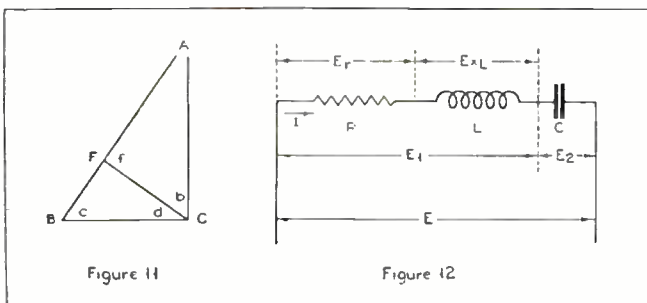
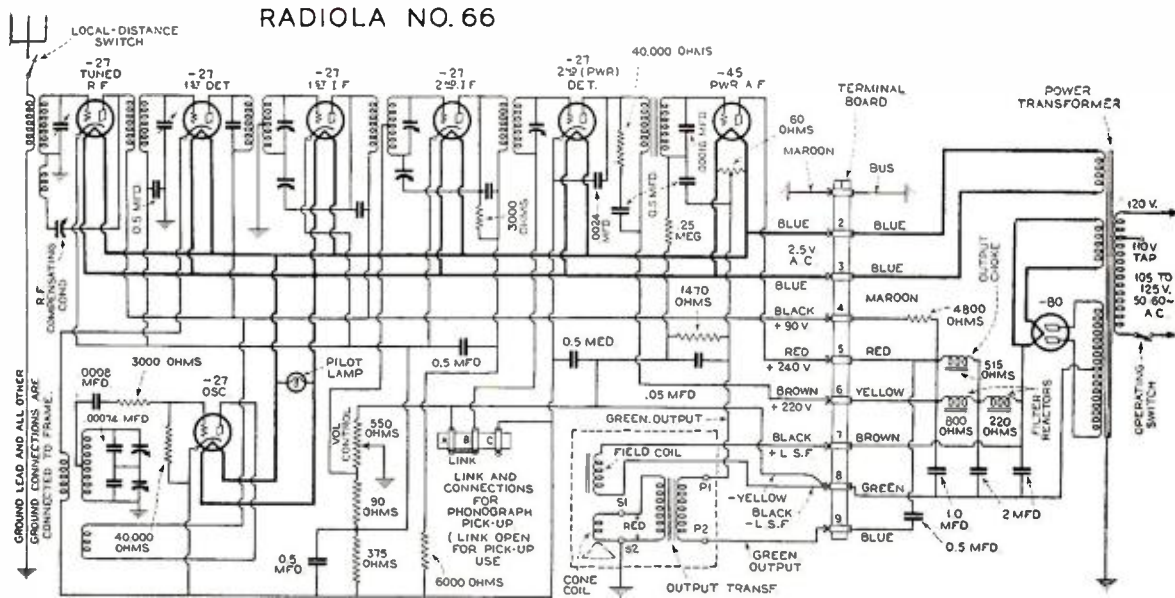

Figure 11

Figure 12

Radio News Manufactured Receiver Circuits



IN this eight tube Radiola No. 66 superheterodyne receiver, type -27 tubes are used throughout except for a single -45 type tube in the power output stage and a type -80 tube as a rectifier. The r.f. compensating condenser and coupling coil connected between the plate of the first -27 type tube and the lower end of the secondary inductance are a means for provid-

ing regeneration in the tuned r.f. stage. After this condenser has been set for best operation for the particular type -27 tube used it may be left untouched. Both the i.f. secondaries are of the bridge type, providing stable operation for the two i.f. tubes. The power supply is so designed as to supply the necessary current to the speaker field.

Radio News Manufactured Receiver Circuits

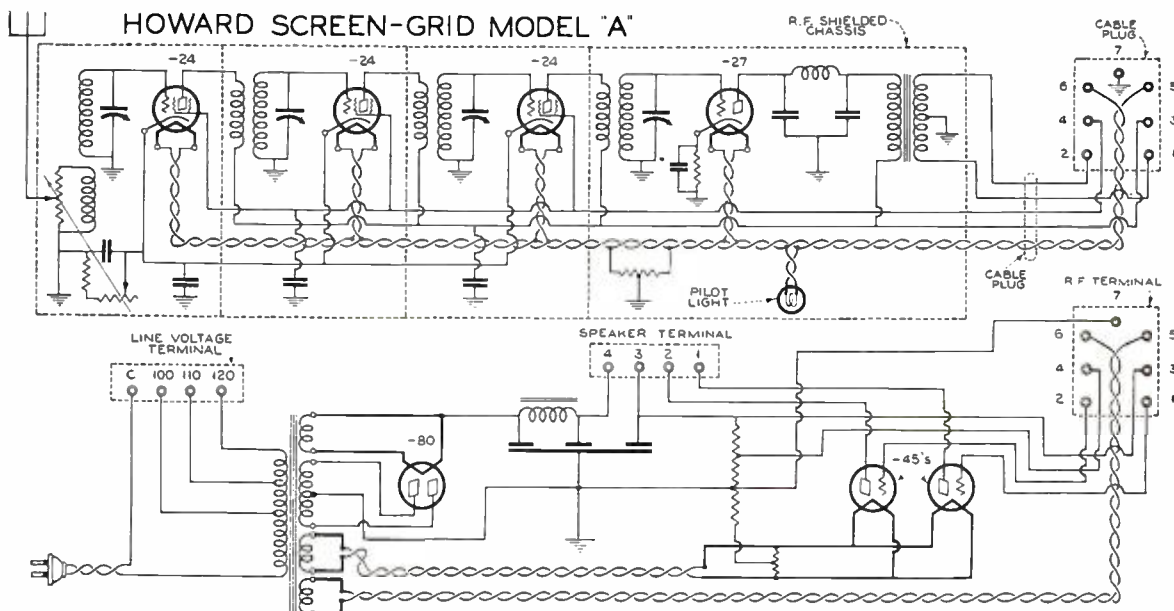

THE Howard Screen Grid Model A is a seven tube receiver in which the three r.f. stages use -24 type tubes. The detector is a -27 type tube followed by a push-pull audio stage with -45 type tubes. An -80 type tube is used in the power

supply. This receiver employs a dual volume control. Provision is made to operate the receiver from line voltages of 100 to 120 volts by taps on the primary of the power transformer.

~RADIO NEWS HOME LABORATORY EXPERIMENTS~

The Photo-Cell

MANY experimenters and engineers, giving most of their thought to specific radio problems, look upon the photo-cell not as a tube of somewhat unusual characteristics but as a special product of the physical laboratory and the physicist. Such it is, but it is also true that, in many ways, the cell functions in a manner similar to any ordinary tube and the operation of the cell in circuits can be analyzed in very much the same manner we use to work out the operating characteristics of a tube and its associated circuit.

In the ordinary three-element tube we have a filament which, when heated, is a source of electrons. So far as the fundamental operation of the tube is concerned the composition of the filament is not an essential factor so long as it is capable of emitting sufficient electrons. In the three-element tube we also have a plate which acts as a collector of the electrons which pass from the filament to the plate. Between the filament and the plate we place a grid which functions as a valve or gate to control the number of electrons reaching the plate from the filament. In the three-element tube the emission from the filament is essentially constant, the number of electrons reaching the plate being determined by the construction of the tube and the potentials on the grid and the plate.

It will be obvious that if we wished we could control the plate current by varying the filament current. At low currents the filament would be comparatively cool and few electrons would be emitted—and the plate current would be small. At high currents through the filament the heating effect would be greater, more electrons would be emitted and the plate current would be large. We don't use this method because the grid gives us a much more effective and efficient means of controlling plate current: but the important point is that it is possible to control the plate current by varying the number of electrons emitted from the source.

Now in a photo-electric cell, Figure 1, we have a cathode or source of electrons corresponding to the filament in an ordinary tube. In the photo-cell the cathode is composed of some substance which is affected by light so that when a light is shone on the cathode electrons are emitted, this corresponds exactly to the emission of electrons from a filament when it is heated. Many substances will emit electrons under the influence of light, but certain substances will emit many more electrons than others. In photo-cells the materials most commonly used are sodium, potassium and caesium. Other substances such as rubidium, strontium, barium and lithium also exhibit pronounced

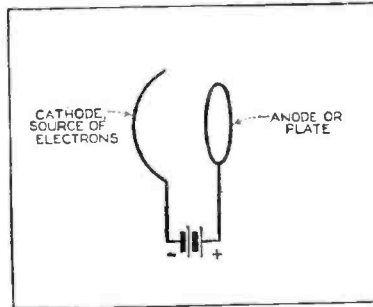

Figure 1. A schematic representation of a photo-electric tube

photo-electric properties, but the former three are by far the most effective materials we have found up to the present.

Now if we coat the inside of a glass bulb with one of these substances and throw a light on it, electrons are immediately given off, the number of emitted electrons depending upon the intensity of the light and upon its color. We therefore have a source of electrons and we can accurately control the number of electrons emitted by varying the amount of light shining on the cell.

Now we have to put into the tube some element which will attract these electrons, just like the plate attracts electrons in an ordinary tube.

Referring again to Figure 1, we note that in front of the cathode, or coating on the glass wall, we place an anode, which in most cells takes the form of a circular ring. Since the electrons are negatively charged, we can attract them to the anode ring by making the anode positive with respect to the cathode. This is simply done by connecting a battery in the circuit as shown in Figure 1.

Figure 1 shows, therefore, the fundamentals of any photo-cell circuit. Realize how similar it is to a three-element tube. In both cases we have a source of electrons, in both cases we have an anode or plate which attracts the electrons and in both cases we have a battery between the source of electrons and the plate to give the plate a positive charge.

There isn't any actual grid in a photo-cell, but in the circuit we have a control element which does just what the grid does in an ordinary tube. The grid of an ordinary tube is used to vary the number of electrons reaching the plate. In the photo-cell the number of electrons reaching the anode or plate is controlled by the amount of light falling on the cell; we can therefore consider that the beam of light is in effect the grid of a photo-cell.

Now the characteristics of an ordinary tube are defined almost completely by three characteristics. First, we have the plate resistance which represents the a.c. resistance to the flow of alternating currents between the plate and the filament. Secondly, we have the amplification constant which is a measure of the relative

effect of the grid and the plate on the plate current. Thirdly, we have the mutual conductance which indicates the amount of current which will flow in the plate circuit if the grid voltage is varied a certain amount.

The resistance between the anode and cathode of a photo-cell is exactly the same in effect and importance as the plate-filament resistance of a tube. If a tube has a high R_p the plate circuit coupling resistance must be much higher to realize any considerable voltage amplification. The voltage

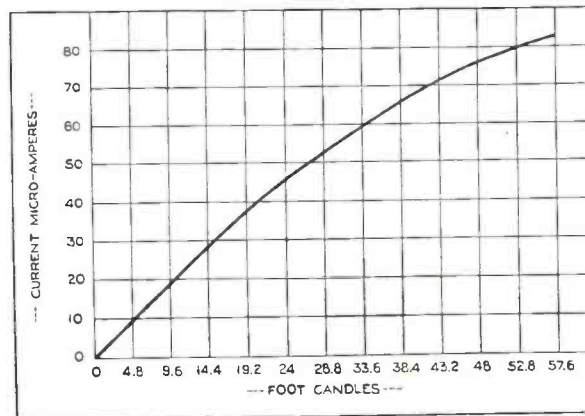

Figure 2. A curve showing the increase in the current output of a type P-4 cell with increasing light intensities

amplification obtained from a tube working into a resistance is proportional to

$$\frac{\text{Load resistance}}{\text{Plate resistance} + \text{load resistance}}$$

and the same formula applies to the voltage amplification from a photo-cell, the plate resistance being (in the case of the cell) the effective resistance between anode and cathode.

The mutual conductance of a tube can be considered as the a.c. current in the plate circuit per volt a.c. applied to the grid. With the photo-cell the equivalent characteristic is the a.c. current developed in the photo-cell circuit per lumen or per foot candle change in light on the cell.

The amplification constant of a tube can be considered as the a.c. voltage developed in the plate circuit of a tube per volt a.c. applied to the grid. In the photo-cell the equivalent constant is the a.c. potential developed in the cell per lumen or foot candle change in light on the cell.

So we have in the photo-cell characteristics essentially similar to tube characteristics and both tube circuits and photo-cell circuits can be analyzed in much the same manner.

Since the tube in its more general applications has an a.c. voltage applied to its grid and the engineer is concerned with the magnitude of a.c. voltage developed in the plate circuit, we are seldom concerned directly with the d.c. plate current produced with a certain value of grid voltage. Photo-cells are frequently used, however, in circuits where the current produced with a given light intensity is of considerable importance. Where the cell is to be used to operate relays, etc., the current with a given light intensity is of importance in determining how sensitive a relay must be used or whether the output from the cell must be amplified before it can be utilized.

Cells of the type shown in Figure 1 are made by a number of companies. Sometimes, to increase their sensitivity, a small amount of gas is placed in the cell and although the sensitivity is markedly increased in this manner the uniformity of response is not as great as in the case of the vacuum cell. Liquid cells are also being made. These cells contain an anode and a cathode, as do other cells, but the space between the two elements is filled with a liquid; one of the first liquid cells used sodium hydroxide for the liquid. Such cells frequently require no external battery for their operation, a potential being developed inside the cell under the influence of light.

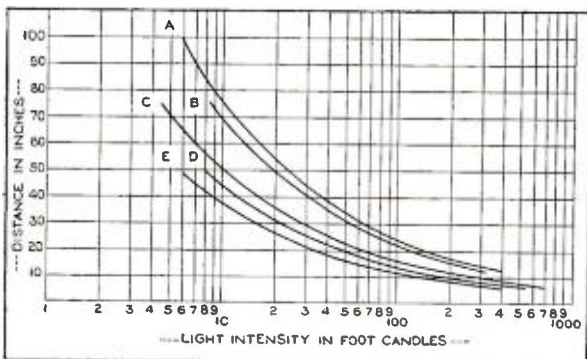

Figure 4. Light intensity curves of common types of incandescent lamps

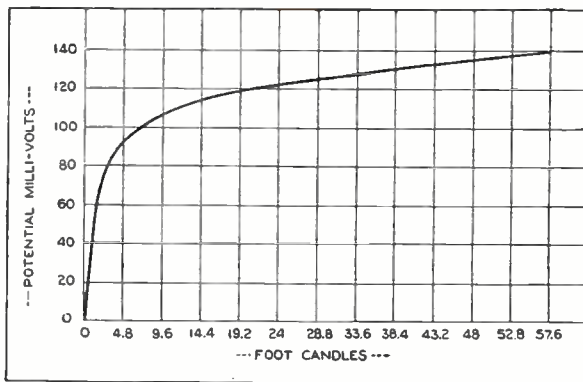

Figure 3. The voltage developed within the P-4 type cell varies with light exposure, as indicated by this curve

From the preceding discussion of the similarity of cells and tubes let us see if we cannot analyze the operation of a cell in a typical circuit. Obviously space is not available to discuss all types and makes of cells, so the following discussion is necessarily limited to one cell. We have taken for our example the Arcturus type P-4 cell, which is of the liquid type and which requires no external battery.

Let us see first if we cannot calculate the internal resistance of this cell. In Figure 2 is given a curve showing the current output at various light intensities from 0 up to about 60 foot candles; in Figure 3 is a curve, for the same range of light intensity, showing the e.m.f. developed by the cell. Now the a.c. internal resistance of the cell will be equal to

$$\frac{\text{Change in developed e.m.f.}}{\text{Change in output current}}$$

$$\frac{\text{Change in developed e.m.f.}}{\text{Change in output current}}$$

for the same change in light intensity.

From the curve of Figure 3 we can obtain the developed e.m.f. for two light intensities. Taking two representative points, we have:

Intensity in foot candles	Developed e.m.f. in millivolts
19.2	119
38.4	131

Therefore the a.c. internal resistance of the cell can be found by converting these figures in column two to volts and subtracting them and then dividing by the difference of the corresponding changes in current output at the same light intensities. The latter figures, obtained from the curve of Figure 2 are: At 19.2 foot candles I is 38 microamperes and at 38.4 foot candles the I is 66 microamperes. Changing these currents to amperes and substituting in the above formula we have:

$$\begin{aligned} \text{a.c. resistance} &= \frac{0.131 - 0.119}{0.000066 - 0.000038} \\ &= 430 \text{ ohms} \end{aligned}$$

And so we obtain one of the essential constants of the cell if it is to be used with varying (modulated) light, as for example in television or in talking movies.

Now let us see if we cannot determine the a.c. e.m.f. developed in the cell per foot candle change in intensity of light falling on the cell. For this purpose we must take two intensities and two developed e.m.f.'s from Figure 3 and divide them. (Continued on page 1118)

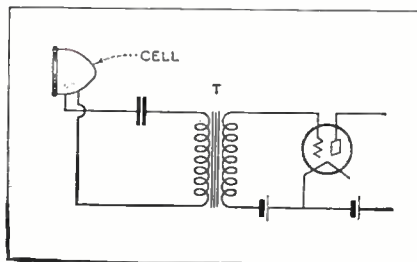
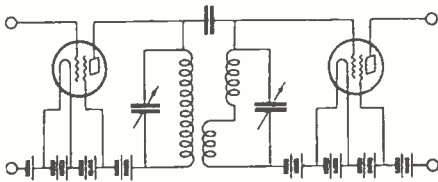

Figure 5. Adding an amplifier to the photo-tube circuit. The transformer is a special type for this purpose

Latest Radio Patents

A description of the newest patented inventions on radio, television, acoustics and electronics as they are granted by the United States Patent Office. This information will be found a handy radio reference for inventors, engineers, set designers and production men in establishing the dates of record, as well as describing the important radio inventions

1,792,274. AMPLIFYING SYSTEM. WENDELL L. CARLSON and RALPH S. HOLMES, Schenectady, N. Y., assignors to General Electric Company, a Corporation of New York. Filed Jan. 28, 1927. Serial No. 164,341. 10 Claims.



1. The combination of a pair of space discharge devices including input and output circuits, means for tuning the output circuit of one of said devices and the input circuit of the other of said devices, and capacitive and inductive couplings connected between said tuned circuits, said couplings being out of phase with each other and the capacitive coupling being between the high potential ends of said tuned circuits.

1,792,077. ELECTROMAGNET AND VOLTAGE DIVIDER. FULTON CUTTING, New York, N. Y. Filed Jan. 9, 1928. Serial No. 245,519. 5 Claims.

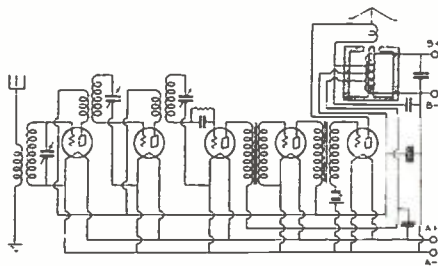

1. In combination with a radio receiver having vacuum tubes and an anode power source, an electro-dynamic loud speaking telephone having a field winding, said winding having taps and being connected to said anode source, said taps being connected to the anodes of the various tubes.

1,791,932. ELECTRICAL STETHOSCOPE. FRANK E. MILLER, New York, N. Y. Filed Feb. 24, 1928. Serial No. 256,658. 2 Claims.

1. In an electrical stethoscope an electromagnetic sound transmitting unit consisting of an electromagnet, a diaphragm free to vibrate, a short, flexible, hollow rubber sound conducting portion having an eccentric protruding cavity resembling the tympanum of the human ear adapted to make contact with the human body, in combination with an audio amplifier and a frequency filter and a visible oscillograph.

*Patent Attorney, Washington, D. C.

Conducted by
Ben J. Chromy*

1,793,588. MEASURING AND MONITORING CIRCUITS FOR TELEPHONE LINES. FRANK A. COWAN, East Orange, N. J., assignor to American Telephone and Telegraph Company, a Corporation of New York. Filed Sept. 25, 1929. Serial No. 395,046. 4 Claims.

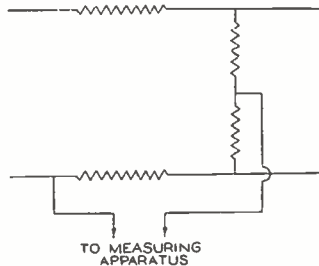

3. In a vacuum tube telephone repeater, an outgoing line and a measuring circuit in the output of said repeater and arranged in conjugate relationship.

1,792,144. RADIOSIGNALING. LOUIS COHEN, Washington, D. C., and AUGUST HUND, Battery Park, Md. Filed June 30, 1927. Serial No. 202,656. 7 Claims.

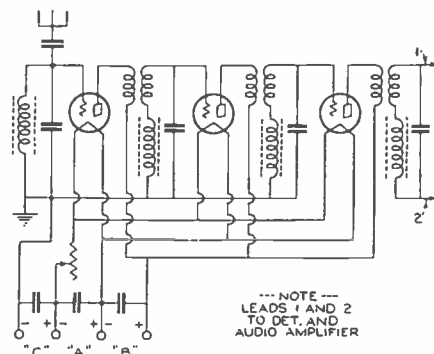

2. In a system for radio amplification comprising several three-electrode vacuum tubes, the grid and filament of each of the said vacuum tubes being associated with a tuned circuit which consists of a fixed condenser and inductance, a portion of the windings of which is wound in reversed direction to the main winding of the coil, a metallic cylinder slidable over the said main winding of the said inductance effecting tuning; the said portion of the winding as well as the said main winding of the tuning inductance coil being in inductive relation to the plate circuit of its corresponding preceding tube.

1,792,961. ELECTRICAL CIRCUITS FOR RADIO RECEIVERS. STUART BALLANTINE, Mountain Lakes, N. J., assignor to Radio Frequency Laboratories, Incorporated, Boonton, N. J., a Corporation of New Jersey. Original application filed June 17, 1924, Serial No. 720,708. Patent No. 1,760,871, dated June 3, 1930. Divided and this application filed Mar. 10, 1928. Serial No. 260,779. 10 Claims.

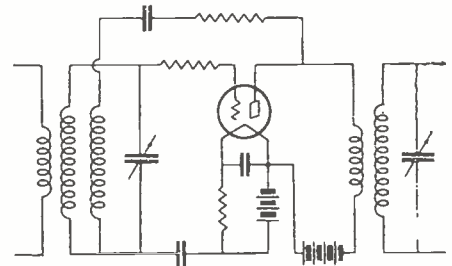

1. An electrical amplifier circuit comprising, in combination, a vacuum tube including at least anode, cathode, and control electrode elements; a tuned input circuit for said vacuum tube; an output circuit for said vacuum tube, a connection including a resistance between the high potential terminal of said input circuit and the control element of said vacuum tube; and means operative to reduce the effects of retroactive currents due to coupling between said input and output circuits.

1,792,683. TELEVISION APPARATUS. PAUL R. EGGER, Davenport, Iowa. Filed Mar. 22, 1930. Serial No. 438,004. 5 Claims.



1. In a television set, a scanning element comprising a revolvable shaft, and a plurality of narrow mirrors formed integral therewith extending transversely of the shaft parallel to and in line with the axis of the shaft.

1,793,772. APPARATUS AND METHOD FOR LOCALIZATION OF SOUND ON SCREENS. WIKKE BOUMA, Hollywood, Calif., assignor of one-third to Theo. M. Talley, Los Angeles, Calif., and one-third to Theo. M. de la Garde, Hollywood, Calif. Filed Feb. 26, 1929. Serial No. 342,808. 17 Claims.

3. The method of facilitating localization of sounds in sound-picture reproduction including making light impressions at zones on the negative film frame bars as determined by locality of sound origin in a filmed scene or performance concurrently with the filming of the scene.

7. Sound-record picture making apparatus
(Continued on page 1103)

A Practical Home Televisor

slots down in the drum. One of the slots should be slipped on to the peg located near the end of one of the radial ribs of the drum and held there while the rest of the belt is allowed to spring into place against the inside of the drum flange. It will be found that each slot in the belt will be opposite a corresponding peg on the inside of the drum flange.

A slight shifting of the belt is all that should be necessary to place the belt accurately in position. In some of the belts, large round holes will be found at the lower portion of the belt which fits into the drum. These holes can be disregarded entirely. Once the belt is properly centered on the pegs of the drum, it will be held firmly in place.

Now place the assembled scanning drum and belt over the shaft of the motor, with the scanning belt pointing down toward the base of the cabinet. Turn the drum and belt till the two scanning holes at the beginning and end of the spiral appear at the square hole on the front panel. Adjust the drum along the shaft until the upper and lower holes are centered in the square opening of the cabinet. Then tighten the drum in place by means of the set screw in the collar of the drum.

Mounting the Neon Tube

With a small ruler or scale, measure the distance between the surface of the scanning belt and the inside edge of the square opening in the front of the cabinet. Keep this dimension in mind and then remove the drum. Next place the neon tube in its socket, NT, and place the socket and tube on the mounting platform provided for it on the base and inside face of the front panel. This platform and socket is shown in Figure 3. The socket should be placed so that the F terminals are toward the front panel. The plate electrode of the neon tube itself will then face and be parallel to the front panel and be framed in the square opening in the front panel. When the tube is in this position, look through the square opening of the front panel and be sure that the square plate of the neon tube is approximately centered behind this opening. If necessary, build up the platform with a few pieces of thin wood or cardboard, or if too high, take out the platform and shave it down. The proper position of the plate of the tube in the center of the opening on the front panel is very important.

Then set the tube and socket so that the distance between the inside edge of the opening in the front panel and the glass of the tube is about $\frac{3}{16}$ " more than was the distance between the scanning belt and the edge of the hole and screw the socket down in this position. This placement of the tube and socket will provide the required clearance between the inside of the scanning belt and the neon tube and socket.

The next step is to assemble and wire the parts of the amplifier. The locations and connections of the various parts are so clearly shown in the illustrations that

(Continued from page 1061)

it is not necessary to give detailed instructions for the assembly and wiring.

When the amplifier unit is completed, it can be placed in the cabinet and fastened to the base by two 1" wood screws. It is important to place the unit as shown so that the type -45 tube is located inside of and clears the scanning belt.

The balance of the wiring which connects the amplifier with the other parts in the cabinet and the two plugs can then be completed.

Wiring for External Connections

A twisted pair of wires should run from the filament terminals of socket VT on the amplifier unit assembly to the filament prongs on the 5-prong tube base which serves as the 5-connector cable plug P1.

Another lead is run from R3 to the cathode prong of the plug.

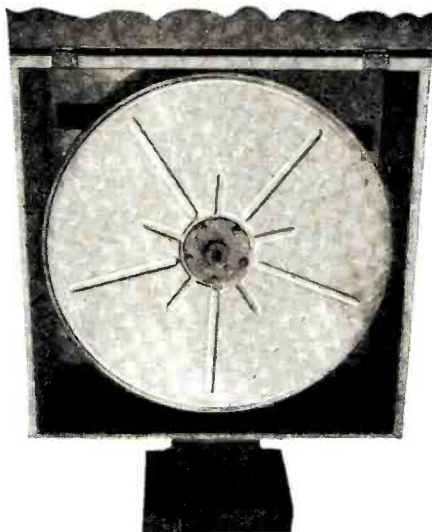

Top view of the televisor with scanning drum in place, ready for operation.

A lead is run from the synchronizing magnet assembly, L, to the grid prong of plug P1.

A lead runs from the P terminal of the neon tube socket to the plate prong of the plug. This wire can be run under the motor frame to keep it away from harm.

Wires of different colors should be used for these leads to permit tracing of the leads after they are braided into a cable. These wires should be braided together and run through the hole in the back of the cabinet before they are connected to plug P1. The leads should be long enough to make the connection between the television unit and the receiver.

Special Wiring

From the P terminal of socket VT, run a wire under the motor frame and up to the one terminal of the magnet assembly L.

The black lead from the motor should be spliced and soldered to the wire which runs from condenser C4 to switch S.

The blue lead of the motor should be spliced and soldered to the other lead of condenser C4.

Run the two wire cable from the a.c. plug, P2, into the cabinet through the hole at the rear of the cabinet and thence under the motor to the front of the cabinet. Solder one lead of this cable to one terminal of the rheostat R4.

Splice and solder the other lead from the two-wire cable to the green and red leads from the motor.

Splices Should Be Made Carefully

The splices should be carefully soldered and then insulated by wrapping rubber insulating tape around them, with a layer of friction tape over the rubber tape to hold it in place.

The rest of the connections are so clearly shown on the diagrams that it is unnecessary to describe them in detail.

When all the connections have been made, the neon tube can be inserted into its socket and a type -45 tube should be placed in the amplifier. The lid of the cabinet can now be replaced. Then mount the viewing chute or shadowbox on the front of the cabinet in the position indicated in the photograph, fastening it in place by means of the mounting holes and screws provided.

Mounting Scanning Belt and Drum

The scanning belt and drum assembly should now be mounted on the motor shaft and fastened firmly by means of the set screw. Before tightening the set screw be sure that the first and last scanning holes of the spiral are centered vertically in the square opening at the front of the cabinet.

The small lens should then be fitted at the mouth of the small section of the chute while the larger lens should be fitted at the mouth of the larger opening. The lenses can be held in position by wrapping several windings of ordinary rubber, or friction tape, around the edges and forcing them into place.

The television unit is now ready to be connected up to a suitable shortwave receiver.

It will interest readers to know that actual demonstrations of television reception employing the Baird equipment described in these articles are being given in Kresge Green Front stores in all localities which are within practical receiving range of television transmitting stations now in operation. This provides prospective builders of this television receiver an opportunity to not only witness the outfit in operation but also to study the equipment itself.

Type of Shortwave Receiver Required

For television reception, the shortwave receiver must be non-regenerative. The r.f. stages should pass a fairly wide band of frequencies (fairly broad tuning) and be very stable in operation. Its audio system must be capable of reproducing

(Continued on page 1119)

Eight Meters in One

(Continued from page 1085)

volts, an insignificant fraction of even the lowest range, 10 volts.

$$\text{Then } R = \frac{10}{.001}, \text{ or } 10,000 \text{ ohms, the}$$

value of the 10-volt multiplier resistance. Similarly, the values required for the 100-volt and 500-volt ranges are found to be 100,000 and 500,000 ohms, respectively. Shallcross type 6M resistors, having an accuracy of plus or minus 1%, were used in constructing the instrument described. A number of other manufacturers make excellent resistors for this purpose.

The resistors used as shunts to obtain the various milliampere ranges are home-spun. The cheapest and simplest plan is to determine the resistance required for a shunt for the lowest range to be used and then tap this shunt at the proper point, as described later, for the higher ranges. If the exact values of shunts were to be calculated, they could only be made with the use of a bridge, an instrument usually beyond the means of the experi-

shunts are calibrated as shown in the diagram, Figure 4.

The calibrating meter is connected in series with a battery and a rheostat and adjusted to read, in this case, 500 ma. Then with the 10 ma. shunt connected across the meter, connect the apparatus as shown. Since the switch forms part of the complete shunt, it must also be permanently connected in the circuit while calibrating. The connection indicated by an arrow should first be made at the extreme negative end of the shunt, then drawn *carefully* along the shunt until full-scale deflection of the shunted meter is obtained. The 500 ma. lead is then connected at this point. If this sliding con-

nection is first made at the end of the shunt opposite that to which the calibrating meter is connected the meter will probably be ruined.

The point at which 500 ma. will give full-scale deflection will be found less than an inch from the negative end. In the same manner the point of connection of the 100 ma. lead is determined.

Care is necessary in connecting these two leads to the shunt. If the solder is allowed to spread over part of the shunt its value will be changed and readjustment will be necessary. Only extreme patience here will insure accuracy.

A small two-cell flashlight battery is
(Continued on page 1109)

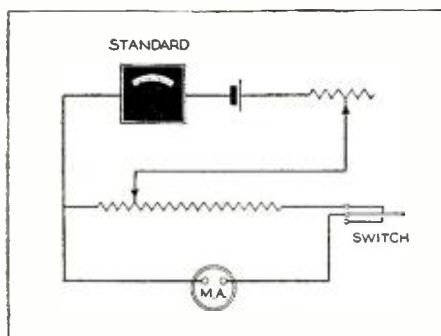

Figure 4. The connections for calibrating the universal meter against a standard milliammeter

menter and one requiring an expert to handle where such extremely small values are encountered.

An easy way to determine the value of the 10 ma. shunt is as follows: The meter-shunt combination will carry 10 ma. The meter alone carries but 1 ma., so the other 9 ma. must be flowing in the shunt. Since the same potential exists across the meter and shunt, and the shunt carries nine times as much current as the meter, its resistance must be 1/9 that of the meter, in this case, $1/9 \times 27 \text{ ohms} = 3 \text{ ohms}$. Any kind of wire whose resistance per unit length is known, and which will carry sufficient current without heating enough to change its resistance appreciably, may be used.

It will now be necessary to have access to a d.c. milliammeter of the required range and accuracy to calibrate the shunts. A piece of wire giving slightly more than the calculated resistance required for the 10 ma. shunt is shunted across the meter and its length gradually reduced until the meter needle sands at full-scale when the calibrating meter reads 10 ma. This cut-and-try process is somewhat tedious, but your trouble will be well repaid by the accuracy of the meter secured. The 100 ma. and 500 ma.

Radio News Technical Information Service

Scope of the Service

The Technical Information Service has been carried on for many years by the technical staff of RADIO NEWS. Its primary purpose is to give helpful information to those readers who run across technical problems in their work or hobby which they are not able to solve without assistance. The service has grown to such large proportions that it is now advisable to outline and regulate activities so that information desired may come to our readers accurately, adequately and promptly.

Long, rambling letters containing requests that are vague or on a subject that is unanswerable take up so large a portion of the staff's working time that legitimate questions may pile up in such quantities as to cause a delay that seriously hinders the promptness of reply. To eliminate this waste of time and the period of waiting, that sometimes occurs to our readers as a consequence, the following list of simple rules *must* be observed in making requests for information. Readers will help themselves by abiding by these rules.

Regulations Applying to the Preparation of Requests for Information

1. Limit each request for information to a single subject.
2. In a request for information, include any data that will aid us in assisting in answering. If the request relates to apparatus described in RADIO NEWS, state the issue, page number, title of article and the name of the device or apparatus.
3. Write only on one side of your paper.
4. Pin the coupon to your request.

The service is directed specifically at the problems of the radio serviceman, engineer, mechanic, experimenter, set builder, student and amateur, but is open to all classes of readers as well.

All questions from subscribers to RADIO NEWS will be answered free of charge, provided they comply with the regulations here set forth. Non-subscribers to

RADIO NEWS will be charged a nominal fee of \$1.00 for this service. All questions will be answered by mail and not through the editorial columns of the magazine, or by telephone. When possible, requests for information will be answered by referring to articles in past issues of the magazine that contain the desired information. For this reason it is advisable to keep RADIO NEWS as a radio reference.

Complete information about sets described in other publications cannot be given, although readers will be referred to other sources of information whenever possible. The staff cannot undertake to design special circuits, receivers, equipment or installations. The staff cannot service receivers or test any radio apparatus. Wiring diagrams of commercial receivers cannot be supplied, but where we have published them in RADIO NEWS, a reference will be given to past issues. Comparisons between various kinds of receivers or manufactured apparatus cannot be made.

Only those requests will be given consideration that are accompanied by the coupon attached below, accurately filled out.

Technical Information Coupon
RADIO NEWS Laboratory
381 Fourth Avenue
New York City, New York
Gentlemen:

Kindly supply me with complete information on the attached question:

- I am a regular subscriber to RADIO NEWS and I understand this information will be sent me free of charge.
- I am not yet a subscriber to RADIO NEWS and enclose \$1.00 to cover costs of the service.
- I wish to become a subscriber to RADIO NEWS and enclose \$2.50 to receive the magazine regularly for one year, and to receive this valuable technical information service free of charge.

Name

Address

A "Midget" Superheterodyne

condenser is seen at the center. at the left the -27 oscillator tube, and just in front of this tube. and accessible through a hole in the chassis, the oscillator low frequency (600 kc.) trimmer condenser. The oscillator high frequency (1400 kc.) trimmer is directly on the gang condenser, as are the selector circuit trimmers. On the right of the gang condenser is an unshielded -24 tube, the first detector which feeds into the first i.f. transformer. This transformer is dual tuned (tuned primary and secondary)

(Continued from page 1071)

which, however, is not at all serious at 175 kc., the frequency of the i.f. amplifier. The reason for the selection of the 175 kc. as the intermediate amplification frequency was fully covered in recent articles in RADIO NEWS by the writer— suffice it to say that 175 kc. is the ideal i.f. for superheterodynes designed for the American broadcast band of 550 to 1500 kc. from stability and selectivity standpoints.

The second and third i.f. transformers are single-tuned, each having its secondary tuned by mica compression condensers of from 100 to 120 mmfd. range,

similar to those used in the first i.f. circuit. Each of these condensers, located beneath the chassis, is individually shielded, and they are accessible for adjustment through the holes in the right side of the chassis. The slip-over shields are not shown in the under-chassis view, having been removed for clarity.

The i.f. amplifier feeds into a -27 linear power detector, which has been used instead of a -24 screen-grid detector to permit the inclusion of a variable tone control circuit. The volume of second detector plate by-pass condenser required in a super to insure stability and freedom from i.f. harmonic feed back is so large

(Continued on page 1107)

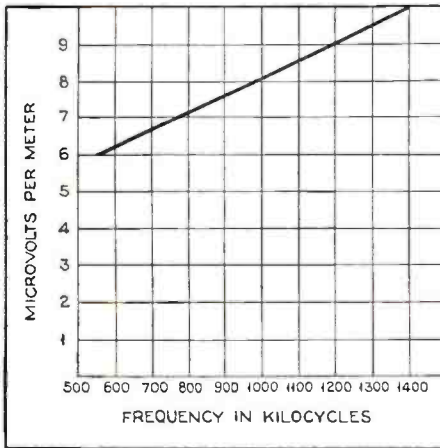

Figure 4. The sensitivity indicated by this curve is in effect increased by the reduced noise level resulting from the high selectivity of the circuit

and is unshielded, in order to give a very high order of selectivity and keep unwanted frequencies out of the i.f. amplifier. This transformer feeds the first -24 i.f. tube, directly behind the first detector, which in turn feeds the second i.f. transformer, which is shielded, as is also the third i.f. transformer. The reason for shielding the second and third i.f. transformers and the -24 i.f. and -27 second detector tubes is to prevent reaction which would cause instability, and, secondly, to prevent direct pickup,

The New Ribbon Microphone

(Continued from page 1067)

Likewise the amplitude of the oscillation of the ribbon is governed by the force of the physical manifestation of the sound wave in the air; and as a larger movement of the ribbon causes it to cut more lines of force, a greater current is induced in it by a louder sound. After being suitably increased by the micro-

phone amplifier, this current can be transmitted to another amplifier for further amplification and then supplied to the sound recording or reproducing device, or employed for any other purpose for which a faithful electrical copy of sound waves may be required.

A U-shaped core is used for the elec-

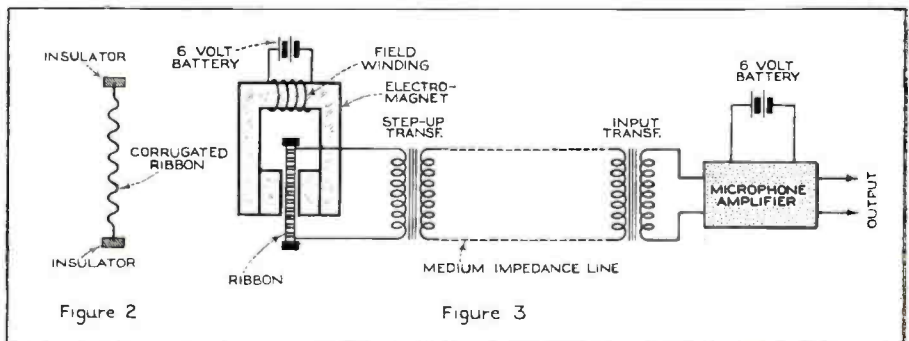

Figure 2

Figure 3

Figure 2. A sectional view of the metal ribbon

Figure 3. Circuit employed with a long transmission line between microphone and amplifier

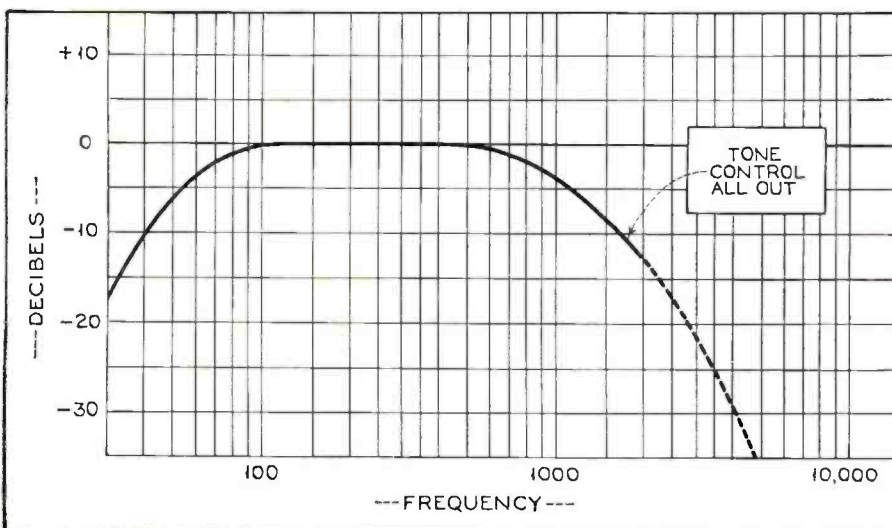

Figure 3. The rather sharp drop in amplification at the higher frequencies is offset by a rising characteristic in the loud speaker, with a close approach to a flat combination curve up to 4,000 cycles as the result

tromagnet with the two poles quite close to the sides of the ribbon. The field winding of the electromagnet is placed around the bottom part of the U. This will be evident from an examination of the accompanying illustration, Figure 1. This field winding is energized by a six-volt battery that also supplies current to the filaments of the tubes in the microphone amplifier. The light metallic ribbon that is employed in the microphone is of duralumin; and its dimensions are approximately three inches long by three-sixteenths inch wide and one-half mil thick. To prevent standing waves on the surface of the ribbon and to keep the natural frequency of the ribbon out of the frequency range that is nor-

(Continued on page 1118)

Champion

POWER PENTODE TUBE Champion

ENGINEERS' 1930
CREATION

PUBLIC 1931
ACCEPTANCE

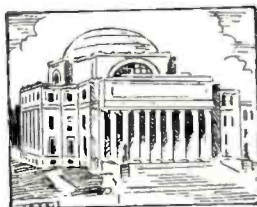

Columbia University,
New York City

Here, over a year ago on January 15, 1930, the Power PENTODE tube was first demonstrated by Champion engineers.



Champion Laboratory,
DANVERS, Massachusetts

Through the untiring efforts of Messrs. Briggs and MacLeod of Champion Engineering staff the Power PENTODE attained its present perfection.

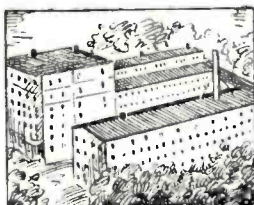

Home of Champion Radio
Tubes

DANVERS, Massachusetts

For more than a quarter-century, the name CHAMPION has stood for sterling worth and integrity.

ON January 15, 1930, Messrs. Briggs and MacLeod of Champion's engineering staff demonstrated before a distinguished gathering at Columbia University, the principles of a radically different radio tube—the POWER PENTODE. In the March 1930 issue of the "Proceedings of the Radio Club of America, Volume 7, No. 3," the following paragraph is noted. "Those who heard the demonstration of the Pentode Tube, which followed the presentation of the paper (demonstration of a Pentode by A. D. MacLeod and R. S. Briggs of the Champion Radio Works, Inc.) will recall that, etc., etc."

Then came months of study and experimenting . . . of laboratory tests . . . of intensive effort, day and night by the entire engineering staff of Champion to PROVE it's finding. Champion's new tube must meet the most rigid specifications of set manufacturers . . . it must be SUPERIOR in every way . . . greater in tone brilliance . . . more faithfully reproducing the high notes . . . duplicating every tonal inflection of the artist as though he stood before you!

Now the Power PENTODE Tube is ready! Ready for your most critical audition. Ready to demonstrate a depth of power, tonal beauty and brilliancy never before available in radio! Hear it. Decide for yourself! You'll admit—once more—Champion is FIRST.

CHAMPION
Radio Works, Inc.
DANVERS
Massachusetts



For Experimentation with the New STENODE

National Company now announces the following components for experimentation with the new Stenode system. These have been developed in co-operation with Dr. James Robinson's laboratory, and bear the endorsement of the American Stenode Corporation.



The Piezo—Electric Crystal Mounted in vacuo, with standard 4-prong U X base. Heart of the Stenode System.



Velvet Vernier Control A new patented dial mechanism with 250:1 and 5:1 reductions. No back lash. Essential for tuning the Stenode Circuit, with its new order of selectivity.



Balancing Condenser with Velvet Vernier Drive Compensates for electrostatic capacity of crystal holder and associated wiring.



Input Coupling System For crystal and associated capacity balancing network. Also intermediate Frequency Transformers—for use between the Stenode Crystal Control Amplifier and 2nd Detector, and for interstage intermediate frequency transformers where more than one stage of intermediate frequency is employed.



Compensated Audio Transformers Push-pull input and output transformers are also available for power stages.

Send for further details regarding the Stenode Radiostat and for catalog No. 146-N, fully describing precision built apparatus for all sorts of experimental and laboratory radio work.

NATIONAL

Company, Incorporated

61 Sherman Street, Malden, Mass.



Electric Eyes Keep Watch for Industry

(Continued from page 1066)

the light beam between the light source and light relay. This results in a relay action which actuates an electrical release, freeing carbon dioxide gas, which extinguishes the fire.

Sorting Devices

Small objects, having a decided difference in light-reflecting qualities, may be sorted by photo-electric means by the use of an optical system as shown in Figure 10. The articles to be sorted may be placed on a conveyor belt and moved



A light intensity meter which employs a photo-electric tube

into the light spot. The articles, which reflect a considerable amount of light, such as a tinfoil surface, will illuminate the phototube sufficiently to cause a relay action which may be caused to operate an electromagnet so arranged that it will discard such objects, while others having a dull surface such as a paper label, will not reflect light so readily and will



A lighting control unit which automatically turns on lighting systems when daylight drops below a predetermined level

pass through. In order to make such a scheme operate it will be necessary to use a d.c. (or properly rectified a.c.) voltage supply. The circuit of Figure 1 will not be sensitive enough for this application.

It is to be noted that such a device can only be readily constructed to sort objects having a very wide light-reflecting quality, such as tinfoil and paper. To distinguish between articles having a

somewhat smaller difference in light reflection is a problem requiring considerable study and experimental work.

Figure 11 illustrates a device constructed to sort small unlabeled packages from those that have properly been labeled in the manner just described.

Figure 12 illustrates a form of lighting-control unit designed to turn on sign lights, factory lights, or other illumination when natural lighting conditions are such as to require artificial illumination and automatically extinguish the artificial illumination when natural light makes it no longer effective.

A device designed to measure intensity of illumination is shown in Figure 13. The instrument is essentially a phototube, a battery, and a microammeter. Special insulation precautions have been taken in its construction to prevent leakage currents from flowing in the phototube circuit. As an accurate instrument for use by illuminating engineers and photographers, such a device is believed to have

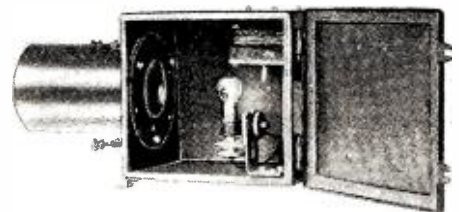

A commercial form of light source

marked advantages over many other present devices designed for light measurement.

A device which counts lamp bases as they interrupt a light beam in passing along a conveyor belt after having been produced on an automatic machine is shown in Figure 14.

Many new and interesting applications of photo-electric devices are constantly being made, and it seems that it is only a question of time until this new art will assume a commercial importance, placing it on the same scale with many staple electrical products with which we are more familiar.

Giant Loudspeaker

(Continued from page 1055)

matter, however, was soon cleared up when it was explained that the loud speaker had been put into operation by mistake that time.

To illustrate the range of application, it is noted that this giant speaker can be taken up in a balloon to an altitude of about 1000 yards and supply whole towns with music and speech. Due to this long range, it is also eminently suitable for the transmission of orders at sea when these are to be given in naval maneuvers or other similar events. It is also, of course, obviously valuable in all kinds of public address work and sporting events.

Writing Sound's Autograph

(Continued from page 1058)

will be another important field for the cathode-ray devices; for example, by attaching wires to an optic nerve and finding out just what kind of signal passes to the brain when the eye sees a flash of light, a line of investigation begun several years ago with less efficient apparatus by the late Dr. E. D. Adrian.

One problem of cathode-ray work remains to be solved; that of photographing the picture on the fluorescent bottom of the tube or of making some other per-

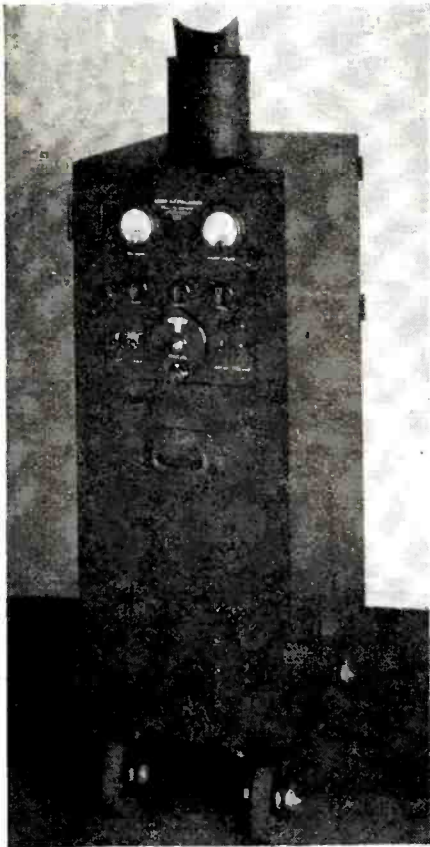

The front of the mobile cathode ray oscillograph. The controls are to adjust the tube focus and the sweeper circuit

manent record, conveniently and cheaply. Here is fame and fortune for some bright inventor. From Germany there comes, too, news of a new type of cathode-ray device, recently described by Dr. E. Bruche and Dr. W. Ende. in which the whole length of the electron pencil is made visible by a luminous gas in the tube, not merely the point where the pencil writes on the fluorescent screen. Thus the exact way in which the pencil bends under the action of a magnetic or an electric field may be observed and carefully studied.

With its inevitable improvements and its ever-growing uses, the electron pencil that writes faster than lightning is sure to be as much a necessity in future scientific laboratories of all kinds as things like microscopes or chemical balances have been in the laboratories of the past.

\$32.50

COMPLETE

With Six Tubes

RETAIL PRICE . \$69.50

Read These Specifications

THEY tell the story! They tell the kind of value you'll find in this little giant of a midget! 6 tubes, 4 screen grid, dynamic speaker—the volume, smoothness, tone control you will find in any fine console model. Fine workmanship, beautiful design, walnut piano finish cabinet—and all complete for \$32.50! There's not one cent more to pay for anything!

Read these specifications and judge for yourself. You know radios and you'll know what a marvelous bargain this is. You could not buy high-grade parts and make it yourself at such a price. Hundreds of people have paid the full retail price of \$69.50 for the Mascot. It's a radio you'll be proud of.

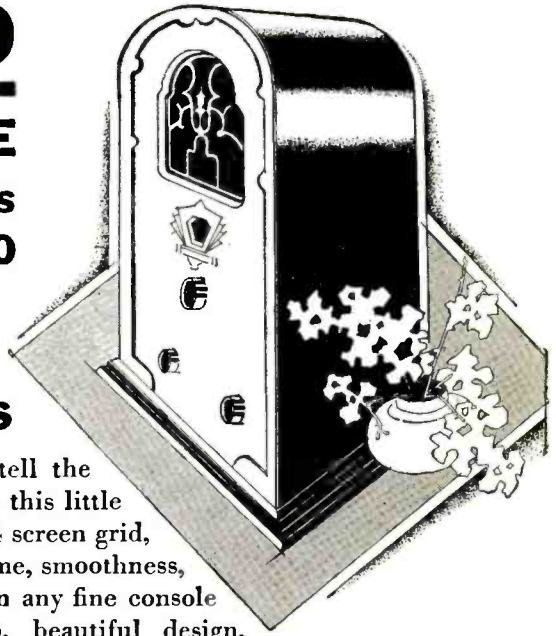

READ THESE SPECIFICATIONS

- 1 Six R C A licensed tubes, 4 screen grids No. 324, 1 power tube No. 245, 1 rectifying tube No. 280.
- 2 Three stages tuned R. F. 1 stage tuned detector necessitating the use of interstage shielded 4 gang variable condenser.
- 3 Linear power detection.
- 4 Resistance coupled audio.
- 5 Shielded R. F. coils of tuned plate and grid, giving greater tuning range and sensitivity.
- 6 Power pack, consists of high voltage power transformer of rugged construction with a large core, so as to prevent easy saturation. One thousand working voltage filter paper type condenser, whose capacity totals 14½ MFD. (No wet condensers are used.)
- 7 A phonograph pick up jack, giving sufficient amplification to equal the output of any auditorium type power amplifier.
- 8 A tone control. Superior in quality to any, giving a full range of the musical scale.
- 9 A combination of volume control and switch allows for simplification of tuning.
- 10 Speaker of the electro dynamic type designed to take the full load of the receiver and which properly matches its impedance.
- 11 A positive drive, easy visioned dial with pilot light detachable.
- 12 The gold lacquer finish of the chassis and shields, harmonizes with the artistic walnut piano finish of the cabinet.
- 13 Complete aerial equipment included.
- 14 Weight packed 33 lbs. Size 18½ x 14½ x 10.

Can be had in either A. C. or D. C. current. Specify which one you want.

MASCOT MIDGET RADIO

Backed by a Million Dollar Guarantee!

A corporation that does \$22,000,000 worth of business a year is back of the Mascot and guarantees your complete satisfaction.

Nothing to worry about! You take no chance with a small unknown radio concern—you deal with the biggest sellers of radio in the world! You can place absolute confidence in every word they claim. They would not dare to risk their reputation on a misstatement.

Send for it today. Play it for a week—day time and night. Get your favorite stations—your favorite program—and if you don't think it's the biggest value in a radio buy you ever saw, pack it up on the seventh day and send it back to us parcel post and we will mail you a check for every cent of the money you paid.

—SEND ONLY \$3—

with your order. Then when the postman brings you the actual radio itself, pay him the remaining \$29.50 plus whatever slight parcel post charge there may be. And if your whole family isn't enthusiastic about it, send it back by the end of one week and we'll cheerfully refund all the money you paid. And think what you save! A \$69.50 radio for \$32.50! \$37 to the good! More than 100%. That's what you get for being your own dealer! An opportunity you can't afford to pass up. Send in the coupon right this minute while the page is still before you.

Mail It NOW →

SAVE

\$ 37.00

CITY RADIO COMPANY
219 Varick Street, New York City

Enclosed is \$3 and I will pay the postman \$29.50 and his small parcel post fee when he delivers the beautiful MASCOT MIDGET RADIO. This will pay you in full. If I don't like it I will return it within a week and you will refund my entire payment.

Name

Address

City..... A.C. or D.C. current?.....



Individual Reception is the thing today!

INSULINE comes to the fore with the ICA Companion—a complete, portable, all electric receiver for AC or DC operation. Just attach a ground or aerial, plug into outlet and you're ready to tune in. The Companion is designed for headphone reception, but anyone with either a dynamic or magnetic amplifier can transform the

Companion into a powerful receiver by plugging the amplifier cords into the phone tip jacks. The AC Companion employs two '27s detector and rectifier; the DC a 112-A. Single dial sharp tuning. Complete with phones, it weighs less than 10 lbs. and is built into a handsome leatherette traveling case 13" x 14" x 7½". You'll want this set for your own. Listen to your own choice while the family is using the big set. Take it with you while traveling. Lend it to that friend in the hospital. Have one in the office. You can enjoy the Companion without annoying others.



List Price with phones
less tubes
AC or DC for 110 v,
50 to 60 cycles
\$25.00
for 220 v AC,
50 to 60 cycles
\$26.50

If your dealer does not stock the ICA Companion, order direct. We will gladly send free literature upon request.

INSULINE
CORPORATION of AMERICA
78 CORTLANDT STREET NEW YORK CITY

Tapping the Short Waves

(Continued from page 1077)

the 3,500-4,000 kc. and 14,000-14,400 kc. bands with the preponderance of traffic being handled on the first mentioned channel. While it is stretching the point somewhat to say that amateur radio telephone conversations are entertaining, they are occasionally interesting.

Commercial transoceanic telephony is generally conducted on the three fixed service bands from 17,800-21,450 kc., 15,350-16,400 kc. and 9,600-11,000 kc. These conversations are generally "inverted"—that is, intentionally garbled so that they sound to the casual listener exactly like Chinese. However, by beating the signal (permitting the receiver to squeal) at the correct frequency, it is sometimes possible to render inverted speech intelligible. The conversation between the technical operators is often carried on without garbling. On the occa-

system is the more sensitive and complicated. Before investing in an adaptor, it will be well to determine, by asking expert advice, whether it will work successfully with your receiver. The combination is not a felicitous one on some broadcast sets, notably super-heterodynes.

On the selection of a short wave receiver itself, the buyer will be guided by the same considerations that determined his choice of a broadcast band set—price, a.c. or d.c., design and appearance. The price range of short wave receivers is equally extensive and here, too, the super-heterodyne tops the list in price and efficiency. However, quite reliable round-the-world reception may be obtained with the medium priced receivers comprising one stage of screen-grid t.r.f. followed with a regenerative detector (preferably screen-grid) and the usual audio system.

Four sets of coils are generally required to cover the short wave spectrum in which we are interested—22 to 13 m.c., 14 to 7 m.c., 8 to 4 m.c. and 5 to 2 m.c. An interesting super has recently been developed by Wireless-Egert in which the shielded coils are plugged into the front of the receiver, making it unnecessary to open the cabinet in shifting bands.

The choice of an a.c. battery-operated receiver is not determined altogether by the existence or otherwise of the convenient power supply. The a.c. design, due to superiority of the tubes, is inherently more sensitive. It is, therefore, doubly affected by the limitations of line noise by sensitivity and the conductive coupling to the line. In some apartment house installations, the a.c. receiver will be unbearably noisy, and in such instances battery operation is obviously recommended. The use of a filter (Figure 3) between the line and the noise generating equipment, such as an electric refrigerator, will reduce the disturbance to within tolerable limits. When it is impractical to get at the source of the interference, the filter may be connected between the short wave receiver and the line with a grateful reduction in artificial static. The ideal apartment house installation comprises the a.c. receiver with the heater and plate potentials supplied respectively from a four volt storage battery and a "B" battery. This is somewhat hard on the "A" battery, but the superiority of the a.c. tubes is retained along with the isolated and relative quietness of d.c. operation.

The short wave receiver or adaptor should be installed as far away from any motor-driven electrical equipment—elevators, refrigerators, etc.—as possible.

An easily acquired knack of tuning contributes an artistry to short wave reception which is lacking on the broadcast band. The variation in technique may be attributed to the fact that the short wave receiver is generally tuned with the circuit oscillating—i.e., with the regenerative control so adjusted that a whistle is heard each time a carrier frequency is crossed. (Most of these whistles will be broken up into the characteristic dots and dashes of the code transmitter.) The typical short wave receiver has three controls—

(Continued on page 1101)



Mounted above the standard broadcast receiver, a simple switch connects either receiver to the loudspeaker

sions when commercial traffic is transmitted clearly, listening-in is quite as edifying as eavesdropping on a party wire.

Practically all airplane telephone traffic is handled on the 5,500-6,000 kc. band, including point-to-point flying field and mobile services. This is often fascinating, always interesting, and some very reliable weather reports may be picked up from local airmail terminals.

Adaptors vs. Receivers

Short wave signals can be received on a short wave receiver, or with an adaptor employed in conjunction with a broadcast range receiver. Where a suitable long wave set is available, the adaptor provides the most economical method of tapping the high frequencies. There are two types of adaptors—the simple regenerative design, which is merely a short wave receiver using the audio frequency channel of the broadcast set, and the super-heterodyne converter, in which the s-w signal is transformed into an intermediate-frequency within the usual broadcast range, and then applied to the r.f. amplifier of the standard receiver. This latter

Tapping the Short Waves

(Continued from page 1100)

the main tuning control, the regeneration or oscillation control, and the trimmer. These controls are much more closely interlocked than the comparable knobs on the broadcast receiver, and even a slight variation of one of them will appreciably alter the wavelength to which the receiver is tuned. In tuning, the regenerative control should be maintained just beyond the oscillation point. When the circuit is oscillating a distinct hiss is audible in the 'phones or speaker, the background noise is considerably intensified and a whistle will be heard whenever a carrier frequency is encountered. At the correct tuning point—with the circuit just oscillating—the background noise and signal response will be at a maximum. In other words the receiver is at its most sensitive adjustment. To maintain this condition while tuning, it will usually be necessary to vary the regeneration control for every ten degrees or so on the tuning dial. When a telephone carrier is crossed, readily identified by the steady whistle and generally modulated by voice or music, reduce the regeneration (retuning slightly with each variation in the regenerative control) until the circuit is no longer oscillating and the carrier is clear. A faint "swish" will now locate the carrier (if unmodulated) as the tuning dial receives its final adjustment. In some instances of very weak signals, it is desirable to "zero beat" the carrier, rather than stop oscillations. As the carrier is approached with an oscillating receiver, the pitch of the whistle becomes lower, vanishing at zero beat—the exact resonance or tuning point—trailing off again into a squeal on the other side. Occasional stations are best received at zero beat with the circuit just oscillating. In achieving this adjustment a slight body capacity effect may make it necessary to tune slightly to one side of zero beat, the beat becoming zero when the hand is removed from the tuning control.

Operating Hints

The short wave receiver will operate effectively on a very short indoor antenna. Ten to fifteen feet of wire are quite sufficient.

As already intimated, the efficacy of the various short wave bands varies with the time of the twenty-four-hour day. The greatest distances will be received on the three principal bands in accordance with the table given below:

22 to 14 m.c. daytime.

14 to 10 m.c. morning and evening twilight.

10 to 2 m.c. night.

It will often be interesting to log the stations, and the author suggests ruling off a sheet of paper to accommodate the following observations:

Date, Time, Coil, Dial, Frequency, Call Letters, Language, Remarks.

The station may be logged in local time, but in corresponding with the station for verification of transmission, the hour should be given in G.M.T.—which is

(Continued on page 1102)

It's Easy To Identify 1931 Tubes

Look for Robust Rectifiers

Ample and uniform current supply for every tube in the A. C. radio set—that is the function of the rectifier tube. De Forest engineers have insured that function with these latest refinements:

1. Special alloy hooks maintaining uniform tension on filaments.
2. Ingenious clamping to insure accurate plate dimensions for equalized full-wave rectification.
3. Carbonized plates insuring maximum heat dissipation at higher outputs demanded by latest sets.
4. Tabbed filament to insure low-resistance welds and prevent weakened filament due to spot welding.
5. Exhaust port positioned well below press to avoid leakage.

These and many other advanced features found in every type of fresh De Forest Audion, insure the 1931 performance of any radio set.

This is the fourth of a series of debunking messages dealing with 1931 radio tube features. The entire story can be sent to you immediately, if you so desire.

DE FOREST RADIO CO., PASSAIC, N. J.

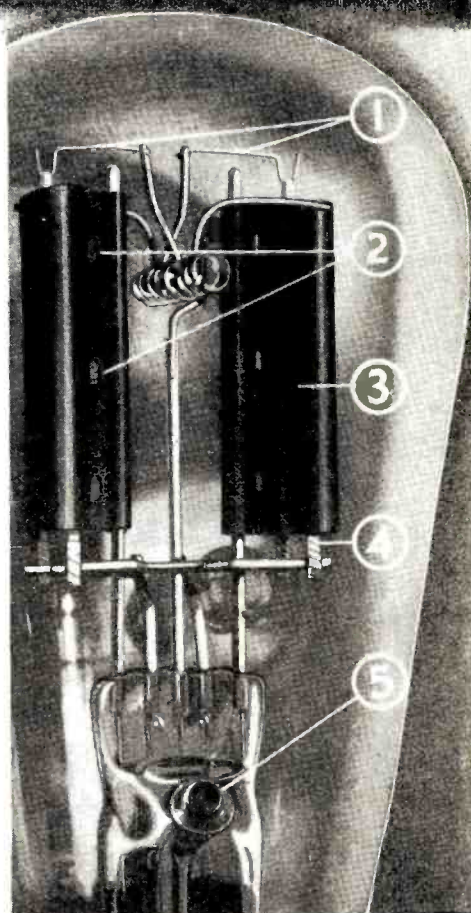

de Forest
AUDIONS
RADIO TUBES



After all, there's no substitute for 25 years' experience



New Pilot Universal Short-Wave Receiver
No Coils to Change

National—AC 55 W Short-Wave Receiver

In Kit or Completely Constructed

SEND 10 CENTS FOR LATEST CATALOG

CHICAGO RADIO APPARATUS CO.
415 S. Dearborn St., Dept. RN-6, Chicago, Ill.

RADIO TUBE INSURANCE THAT PAYS—

AMPERITE corrects line voltage variations. Lengthens tube life. Protects power equipment. Improves tone. Reduces noise. Saves money on set upkeep. You can install AMPERITE in your radio in 5 minutes. No chassis changes. A type for every set, including midgets. \$3 at your dealers.



Write Dept. RN6, giving make and model number of your set.



AMPERITE Corporation
561 BROADWAY, NEW YORK

AMPERITE
Self-Adjusting
LINE VOLTAGE CONTROL

I R C



The size you want
The type you want
The value you want
The accuracy you want

You'll find them all in the stock of any Wholesaler handling Type "K"

Metallized

RESISTORS

The *Metallized* line is not only more accurate, more dependable—it is more complete. Say *Metallized* to your jobber and you will get our new Type "K" Filament, now adopted by leading set manufacturers. Watch for this improved Resistor in sets at the Radio Show in Chicago.



I. R. C. PRECISION WIRE WOUND RESISTORS

Are supplied to make capacity bridge meters, ohmmeters, voltmeters and high-reading milliammeters. They are specified for laboratory standards by leading engineers. Write for free charts, showing how to make these meters.

INTERNATIONAL RESISTANCE CO.
2006 Chestnut Street Phila. Pa.

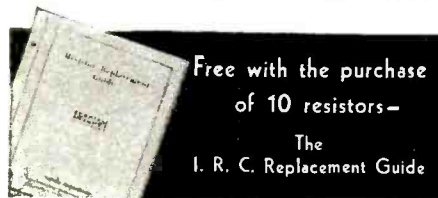

Free with the purchase of 10 resistors—
The I. R. C. Replacement Guide

The Junior Radio Guild

(Continued from page 1089)

right triangles, namely, ABC, AFC and BFC, respectively. Now, considering only the two right triangles ABC and AFC, we see that the angle "a" is common to both of them. Therefore, angles "b" and "c" must be equal. These equal angles are called homologous angles, and the sides opposite the equal angles are called homologous sides.

Continuing the relations of these triangles, we state that they are similar, for they have homologous angles, and we see that their homologous sides are proportional. Therefore, in the similar triangles

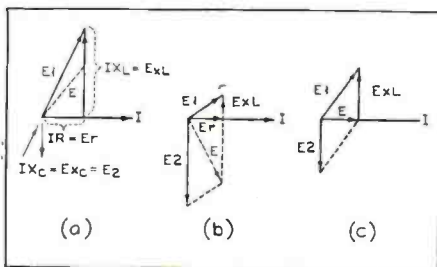

Figure 13

ABC and AFC, the side opposite the right angle "b + d" of triangle ABC is to the side opposite the right angle "f" of triangle AFC as the side opposite the acute angle "c" is to the side opposite the acute angle "b." Or, in other words, we have:

$$AB/AC = AC/AF$$

Recognizing this expression as a standard algebraic ratio, and simplifying, we have:

$$(1) AC^2 = AB \times AF.$$

In like manner, in the similar triangles ABC and BFC we can show that:

$$(2) BC^2 = AB \times BF.$$

By adding (1) and (2) we have:

$$(3) AC^2 + BC^2 = AB (AF + BF).$$

But since (AF + BF) is equal to AB, and substituting in (3) we have:

$$AB^2 = AC^2 + BC^2.$$

We have proven by geometry, then, that the square of the hypotenuse of a right triangle is equal to the sum of the squares of the two sides.

Therefore, in referring back to our vector representation of (b), Figure 10, we find that the magnitude of E can be found by taking the square root of the sum of the squares of the voltage drops across the resistance and the inductance, or:

$$E = \sqrt{E_r^2 + E_l^2}$$

In studying the relations of the current and voltages in a series circuit consisting of a resistance, inductance and capacity, as shown in Figure 12, we find that the use of geometric figures aids us considerably in determining the final phase relations existing in the circuit. First taking the case where the reactance of the condenser is small compared to the reactance of the coil, we have the vector representation of the voltage drops in the circuit as that shown in Figure 13 (a). The resistance drop is in phase with the current, the inductive reactance drop is at right angles to I and leading, and the resultant of these two is E1. The capacitive

reactance drop is at right angles to I and lagging, and the resultant of E1 and E2 is E. It will be found later that this resultant is the diagonal of the parallelogram formed by the sides E1 and E2, and it will be shown by the use of trigonometry that there is a definite relationship existing between the sides and the included angle.

Now, taking the second case where the reactance of the condenser is large compared to the reactance of the coil, we have the vector representation of the voltage drops in the circuit as that shown in Figure 13 (b). In this case, it is seen that the resultant voltage E, which is the diagonal of the parallelogram found by the sides E1 and E2 is such that the current I leads it by a certain angle.

Taking the third case, where the reactance of the condenser is equal to the reactance of the coil, we have the vector representation of the voltage drops in the circuit as that shown in Figure 13 (c).

(Continued on page 1109)

Tapping the Short Waves

(Continued from page 1101)

Eastern Standard Time plus five hours.

Harmonics of long wave broadcasting stations may fool you at first. However, such spurious short wave signals can generally be identified by their position in reference to international allocations and the very mushy quality of speech. Local short wave stations can be recognized without waiting for the quarter hourly signature, by checking for simultaneous broadcasts on the long waves—though this is not altogether reliable in these days of chain broadcasts. However, in the vicinity of New York City, W2XE is readily checked by listening to WABC.

A foreign language does not necessarily place a station beyond the confines of the U.S.A. The babel from W9XAA has been responsible for many fantastic tales of dx fish. But a station failing to sign at quarter hour periods may be tentatively logged as a foreigner.

In conclusion it is only fair to point out that this short wave bed of roses has its thorns and that its possibilities are more accurately described in this article than in the advertising and publicity matter prepared by some of the manufacturers of short wave apparatus. While there may be less static above 6,000 kc. than below, there is invariably more noise caused by artificial strays. Every passing automobile is a potential short wave transmitter in competition with every doorbell in the neighborhood. Short period fading finds its realm in the region of megacycles and signals often flutter with a disconcerting wobble.

But all in all, intelligently operated, with no more than reasonable optimism, the short wave receiver possesses a genuine entertainment value and contributes a fascination to radio reception unapproached in the more familiar bands.

All Waves

(Continued from page 1083)

the seven combinations are as follows:
Range 1, 15 to 23 meters: coils 1 and condensers A.

Range 2, 22 to 41 meters: coils 2 and condensers A.

Range 3, 40 to 75 meters: coils 3 and condensers A.

Range 4, 70 to 147 meters: coils 3 and condensers A and B.

Range 5, 146 to 270 meters: coils 4 and condensers A.

Range 6, 240 to 500 meters: coils 4 and condensers A and B.

Range 7, 470 to 650 meters: coils 4 and condensers A, B and C.

The primary and tickler windings of both coils 3 are each tapped in one place, part of the winding being used for wave range 3 and all for wave range 4. The primaries and ticklers of both coils 4 are tapped in two places, for use on ranges 5, 6 and 7.

Importance of Cam Switches

The entire operation of the set, it may be seen, depends on the smooth functioning of the cam switches. The sequence of the latter has been worked out very carefully, so that the shortest paths are made for the lowest wave ranges. Of course, there is some capacity between contacts, but this is far less troublesome than it would appear. Dozens of different switching arrangements were tried, and this one finally chosen because it worked so smoothly.

Examination of the schematic diagram of the Universal reveals that the method of coupling the r.f. tube to the detector is somewhat out of the ordinary. It was adopted after exhaustive research by Grimes and Messing, and is as reliable as it is simple. It was necessary to use a single winding for both primary and tickler in order to simplify the switching arrangement, and the present scheme works to perfection. The regenerative action of the detector is controlled by a potentiometer regulating the detector screen voltage, a method that does not alter the tuning.

The rest of the circuit is not unusual. The first audio tube, a -27, is impedance coupled to the detector, the earphone jack being connected in its plate circuit. The shunt system of feeding the plate voltage to this tube is employed to permit the use of a grounded earphone jack on the front panel, for the protection of the operator. The output stage uses a pair of -45's in push pull.

The power system uses a regular 230, which, being a rather prolific source of r.f. disturbance, is pretty well isolated by buffer condensers across the high voltage transformer secondary and an r.f. choke in the "B" plus lead. These help enormously in eliminating hum and other noises.

In kit form for home assembly, the Universal is supplied about 35 per cent. assembled and wired. The power transformer, filter chokes, filter condenser block and audio transformers are already

(Continued on page 1105)

The WORLD'S GREATEST All-Wave SCREEN GRID SUPER

ULTRADYNE

(This is the set that was described in the April issue, page 937)

MODEL L-32

Operates entirely from A.C. Line
Completely Shielded Throughout
Covers All Wavelengths from 15
to 600 Meters

Tunes as easily and smoothly on
the short wave as it does on
the broadcast band

10 K. C. Selectivity Over Entire
Band

Selectivity and Sensitivity so great,
distance range is unlimited

Power Detection

Push Pull Amplification

Full Natural Tone

Not a Trace of Hum or Distortion

Steel Chassis

Simplified Construction

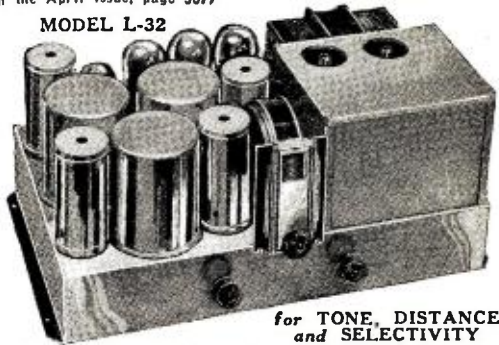

for TONE, DISTANCE
and SELECTIVITY

The model L-32 Ultradyn, with the Dynatron oscillator, works equally as well on short waves as it does on the broadcast band.

One of the Many Letters
From Ultradyn Enthusiasts

Traul Radio Co.,
1075 Atlantic Ave.,
Brooklyn, N. Y.

Gentlemen:
Received your Ultradyn Kit and Parts
and had same completely assembled four
hours later. It is really surprising how
simple it was to follow your instructions.
It may interest you to know that twenty
minutes after I completed the set I pulled
in 678W. (Eastman, England)
(Sign-4) MARTIN ZINK,
Gerard Ave., Bronx, N. Y.

ULTRADYNE BOOKLET

Send 25c for this booklet which tells how to construct and operate the Ultradyn MODEL L-32 Receiver. This booklet also contains life-size picture, diagrams and lay-outs of the entire set; also, life-size wiring diagram of the entire circuit showing every wire location and connection.

ULTRADYNE KIT

The kit contains 3 specially tested and matched Ultraformers with double compensating condensers in aluminum sealed cans, 1 special steel chassis drilled and pierced as per specifications, all ready for mounting, three rubber grommets and 4-coil mounting pillars and INSTRUCTION BOOKLET. List Price **\$32⁵⁰**

TRAUL RADIO CO., 1075 Atlantic Ave., Brooklyn, N. Y.

QUALITY for your Short-Wave Set



Hammarlund Short-Wave Plug-in, Space-Wound Coils, 20 to 215 meters.



Hammarlund Shielded Polarized Choke. High inductance, low distributed capacity.

Hammarlund Vibration-proof Midget Condenser, 20 to 225 mmf. Many new features.

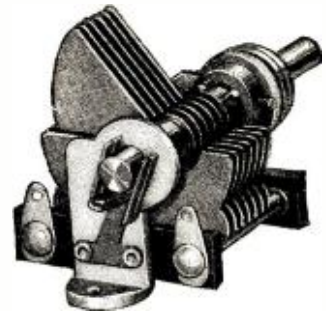

ONE thing which cannot be short in short-wave work is the QUALITY of parts you use.

Correct design is imperative. Good material and intelligent workmanship are equally important to insure success.

Hammarlund Condensers, Space-wound Coils and Polarized Chokes for Short-Wave Circuits are preferred by thousands of painstaking experimenters throughout the world.

And yet, with all of their inbuilt quality and wide reputation, their cost is attractively low.

Your dealer probably can supply you. If not, write direct to us. Mail coupon for helpful Short-Wave Data and advance information on the new

HAMMARLUND
SHORT-WAVE
SUPER-HETERODYNE

For Better Radio
Hammarlund
PRECISION
PRODUCTS

HAMMARLUND MFG. CO., 424-438 West 33rd St., New York.
Please send me data describing Hammarlund Short-Wave Products and their uses.
Name.....
Address.....
R.N.-6

Super Broadcasting on Long Waves

(Continued from page 1051)

Super Akra-Ohm Wire-Wound Resistors

are carefully designed to insure an accuracy of one per cent and a constant permanency of calibration.

They afford an inexpensive means to build test equipment for the measurement of resistance voltage and current with accuracy, and are sold by us either singly or in kits for those who desire to build their own

**Capacity Bridge
Wheatstone Bridge
Multi-range A.C. and
D.C. Voltmeters**

We have prepared separate bulletins fully describing the construction and use of the above circuits. If you will write us which ones you are interested in, we will gladly send copies without any obligation on your part. Address Dept. D.



HOME-STUDY BUSINESS TRAINING

Your opportunity can never be bigger than your preparation. Prepare now and reap the rewards in earlier and larger success. Free 64-Page Books Tell How. Write now for book you want, or mail coupon with your name and address in margin today.

- Higher Accountancy
- Mod. Salesmanship
- Traffic Management
- Law: Degree of LL.B.
- Commercial Law
- Industrial Mgmt
- Banking and Finance
- Telegraphy
- Rail. Station Mgmt
- Railway Accounting
- Paper Salesmanship
- Business Mgmt
- Business Corres.
- Credit and Collection
- Correspondence
- Modern Foremanship
- Personnel Mgmt
- Expert Bookkeeping
- C. P. A. Coaching
- Business English
- Commercial Spanish
- Effective Speaking

LASALLE EXTENSION UNIVERSITY
Dept. 694-R Chicago

SEND FOR **FREE RADIO CATALOG** **LOWEST PRICES**

COAST-TO-COAST RADIO CORPORATION

142 N. LIBERTY ST., NEW YORK

The CROSLEY ROAMIO

AUTOMOBILE RADIO RECEIVING SET

Get The Lowest Price-First!

on thousands of NATIONALLY ADVERTISED ITEMS

FROM THIS BOOK Write for it!

American SALES COMPANY
N-44 W. 18th St., N. Y. C.

FREE

most stations use a T type antenna supported between steel network towers 200 to 300 feet high.

As we mentioned last month a vertical half wave antenna radiates more strongly in a horizontal direction than the $\frac{1}{4} \lambda$ type, hence giving a relatively strong ground wave and extending the non-fading range by perhaps 50 per cent. WABC is building in Wayne, New Jersey, a $\frac{1}{2} \lambda$ antenna of this type; the steel tower itself, about 600 feet high, acts as the antenna. The tower, along with a new 50 kw. transmitter, should be ready for operation in May or June of this year. It will be interesting to see just where the first fading ring of this new station will fall, and to observe the other transmission characteristics of the $\frac{1}{2} \lambda$ antenna.

Now at 1500 meters even one-fourth wave is around 1200 feet. This means that we can leave half wave antennas out of the discussion entirely for the present, contenting ourselves with the more conventional $\frac{1}{4} \lambda$ type. A 1500 meter antenna proportionate in size to those of most present broadcast stations would require two steel towers about 800 feet high. These towers would, of course, be difficult to build from an engineering viewpoint and consequently expensive. However, the fact that they can be built for sufficient important uses is shown by the number of high antenna towers in use today. There are eight 820-foot towers at the Lafayette, France station, built by the United States Government during the war. There are no less than twelve 820-foot towers at the British Empire station near Rugby, England. There are ten 400-foot towers at Rocky Point, Long Island, and three even higher at Arlington, Virginia. So it goes. Where the importance of a proposed service is great enough, 800-foot towers are technically and economically possible.

At this point we might give some rein to imagination and picture a possible 1000 kw. 1500 meter broadcast station of the future. As we drive through sparsely settled country over the automobile road connecting the station with civilization, the first thing to attract our attention is two great steel towers in the distance, surmounted by crossarms between which stretches the yet invisible antenna. As we approach we can see the immense antenna fabric traced against the sky. Though we now seem directly under the towers, their bases are still a half mile away as we enter the self-supporting village known as Radio Northeast. It looks much like any other village, with a general store, a street or two of houses, and people going about their errands. On the far side of town and a quarter mile distant is the transmitting station where some 8000 kw. of electricity, arriving from a distant power plant over a high tension transmission line, are converted into radio waves and a necessary percentage of useless heat. Over wire lines, too, come the programs to a monitoring room in the station, whence they are passed on to the audio input amplifier. The building houses a complete 50-100 kw. transmitter,

and in addition a bank of giant vacuum tubes comprising the final output stage. These operate other monitoring devices, but pass most of their energy into a transmission line extending out under the towers to a small shack which houses the antenna tuning circuits.

Aside from the strictly practical antenna described above, there are some other systems which at present are little better than speculative possibilities. For one there is a single 1200-foot tower, insulated from the ground and used as a $\frac{1}{4} \lambda$ antenna. The guys of such a tower must, of course, be broken into comparatively short lengths by insulators. The new Empire State Building towering above the New York skyline gives a good idea of what 1200 feet means in the way of height. A single 1200-foot mast, if it could be economically built at all, would

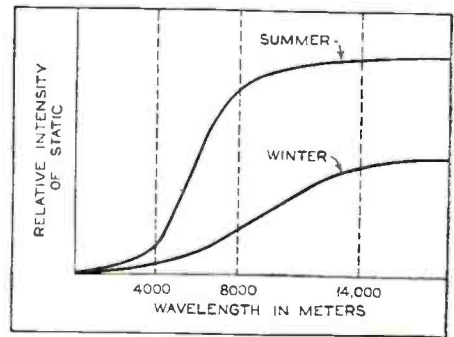

Figure 1

probably cost more than two 800-foot ones, though it might be more efficient.

Another speculative possibility is a balloon-supported antenna. These have actually been used in experimental transmissions both in America and in Europe. Medium power experimental transmitters, however, can be handled more roughly than a 1000 kw. broadcaster which must furnish true day and night service to half a million square miles. If the balloon blows around in the wind, changing the antenna capacity through wide limits, some thousands of dollars worth of tubes may go up in smoke, and even if the circuit breakers do their duty broadcast service may be interrupted. In this connection it is interesting to note that John Hays Hammond, Jr., has taken out a patent (U. S. No. 1,561,228) on a device to compensate antenna capacity changes due to antenna movement relative to the ground.

For a $\frac{1}{2} \lambda$ 1500 meter antenna, which must be 2400 odd feet high, a balloon appears to be the only practicable method of hoisting wire to such a height. By using three or four insulator-spaced guys, forming a pyramid with the balloon at the top, and a central conducting downlead for the antenna proper, the thing might possibly be done. However, the conventional two-tower support would probably prove more permanently satisfactory than any of these schemes.

The costs of the proposed national system
(Continued on page 1106)

All Waves

(Continued from page 1103)

mounted in place. The entire coil assembly is completely wired, at the factory, as this is an important job and simply *must* be correct. All the parts are accurately prepared and go together without trouble. A set can be assembled and wired complete in about three evenings with the aid of a few simple hand tools. A small false front panel is supplied, this fitting snugly into a handsome walnut table-styled cabinet, the purchase of which is optional. In this cabinet the Universal is fit for any room in the house, and not for the workshop alone. The various accompanying photographs give a better idea of the receiver than any mere description.

The wide wavelength range of the Universal makes it a versatile receiver that lives up to its name. It is first and foremost a short-wave set, and as such is highly sensitive and selective. The writer will not give the usual performance of short-wave authors by mentioning a string of foreign stations a yard long picked up on the set. Every radio man knows that short-wave reception is a gamble and involves patience, skill and a dash of luck. Used properly, the Universal will bring in most everything worth hearing on the short-waves.

On the regular broadcast band the selectivity with only one tuned r.f. stage naturally does not approach that of broadcast receivers having from three to seven such stages. However, it is enough to allow comfortable separation of local stations. Incidentally, the Universal really covers the very low and very high ends of the broadcast band, which most broadcast receivers do not. It will bring in funny little stations you never knew existed.

The receiver's coverage of the ship calling waves will endear it to the hearts of thousands of ex-operators, and to amateurs who like to hear a little *good* operating as a change from the CQ parties on the amateur bands. One thing is certain: the owner of such a set will never be lacking in radio signals. He can sweep the whole wide spectrum between 15 and 650 meters without raising his elbows, and he is bound to run into something that will amuse or interest him.

All in a Day's Work

(Continued from page 1085)

suitable size between the plate of the first audio tube and the grounded chassis. A .004 mfd. condenser is generally the correct value.

"The pickup in the 100,000 to 300,000 series of the models 44 and 46 can be improved as follows: Connect the 3350-ohm resistor (carbon rod) which is green and red in series with the red and black carbon rod 2000-ohm resistor. This is best accomplished by disconnecting the 2000-ohm resistor at the 540-ohm tap on the upper resistor (pack terminals to the left, nearest resistor, lug number 3); dis-

(Continued on page 1119)

The Two Greatest Books on RADIO SERVICING

Radio Service Man's Handybook

With Addenda Data Sheets

The RADIO SERVICE MAN'S HANDYBOOK contains a tremendous amount of authentic material and practical information on Modernizing old receivers; Servicing obsolete sets; Repairing power packs; Construction of test laboratory equipment; Vacuum tubes; Set testing with analyzers and hundreds of other similar subjects. Among the contributors are Bertram M. Freed, Leon L. Adelman, Paul L. Welker, Sylvan Harris, C. W. Palmer and others.

The HANDYBOOK enables service men to record notes, diagrams and charts on the special 48-page section of specially ruled sheets included in the book. Over 200 pages in all—size 9 x 12 inches—\$2.00.

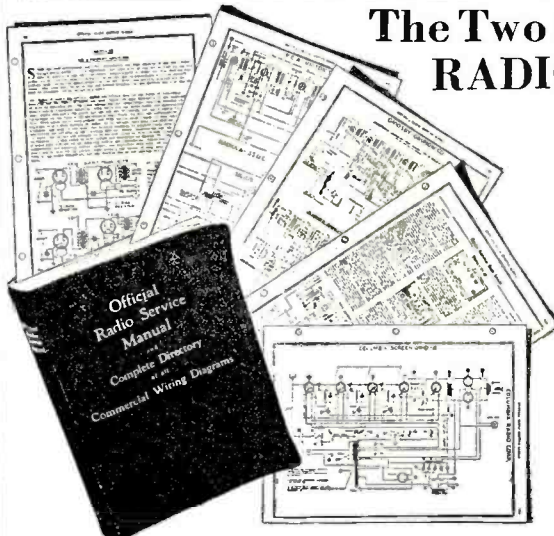
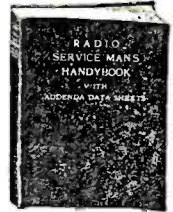

Official Radio Service Manual and Complete Directory of All Commercial Wiring Diagrams Edited by HUGO GERNSBACK

THE OFFICIAL RADIO SERVICE MANUAL is the greatest achievement ever attempted in the Radio Service Field. It is not only the OFFICIAL RADIO SERVICE MANUAL and Complete Directory of all Commercial Wiring Diagrams, but it contains a complete and comprehensive course of instruction for radio service men. Just off the press and more than 25,000 copies sold. And why not, when it fills such a universal need among Manufacturers, Jobbers, Dealers, Service Men and all interested in radio? The OFFICIAL RADIO SERVICE MANUAL is complete and gives you every circuit of every set manufactured of which there is any information. Its looseleaf and flexible leatherette covers enable additional servicing data to be added periodically. There are hundreds of time-saving kinks which will help to increase your business and profits.

Over 1,000 Diagrams and Illustrations
352 Pages—\$3.50—Size 9 x 12 in.

BOTH BOOKS for \$5.00

Mail Coupon TODAY!

GERNSBACK PUBLICATIONS, Inc. RN-6
96-98 Park Place, New York, N. Y.
I enclose herewith check or money order for \$..... for which you are to send me postage prepaid the
() Official Radio Service Manual\$3.50
() Radio Service Man's Handybook 2.00
OR BOTH BOOKS FOR \$5.00
Name
Address
City
State



CODE AT HOME RADIO AND TELEGRAPHY
LEARN WITH AUTOMATIC Has Helped Thousands NOW! On Land, Ships, and Air—Your Career
A WITH AUTOMATIC To Better Positions Future is Secure. Know Code. The Auto-Omnigraph teaches you easily and quickly. Learn by
ROMNIGRAPH U. S. Govt. Depts., Colleges, Scientists, and Schools use it Listening. Models \$15-\$40. Catalog Free.
N THE OMNIGRAPH MFG. CO., 810 E. 39th St., NS-1, Brooklyn, N. Y.

WORLD-WIDE SHORT WAVE RECEIVER
ONLY \$6.45
Span the World with this Set!

A new radio thrill for you! Listen in DIRECT to London, Paris, Berlin, Buenos Aires and other broadcasting stations throughout the world via short waves. Enjoy unique foreign programs from strange lands. Your ordinary receiver cannot tune in these low wave stations. WORLD-WIDE RECEIVER gets 14 to 530 meter stations with surprising clarity. SEND NO MONEY! Just write your name and address on a postcard and ask us to send you this wonderful guaranteed short wave set. Pay postman \$6.45 plus a small delivery charge. All orders West of Rockies must be accompanied by \$1.00 deposit. Price in foreign countries: \$7.75 delivered. Order today!

NEW RADIO BARGAINS
Low Power Transmitter adaptable for phone or code. With plug-in coils\$14.75
B Eliminator, Bone Dry, with 280 tube, 180 volts, will operate up to ten tube set, fully guaranteed. 6.75
AC—A B C power packs 8.75
Tubes: UX type, 30-day replacement guarantee, No. 210, \$2.25; No. 250, \$2.35; No. 281, \$1.65; No. 245, \$1.25; No. 224, \$1.25; No. 227, 75¢; No. 226, 65¢; No. 171, 75¢.
International Microphone, two-button, for public address systems and transmitters, speech or music \$9.75

WRITE FOR BARGAIN CATALOG
CHAS. HOODWIN CO.
4240 Lincoln Ave., Dept. F-3, CHICAGO

A NEW DEPENDABILITY IN SOUND EQUIPMENT

FOX units not only command attention for their output volume and tone value—they offer definite exclusive coil and diaphragm features that insure continuous service. The Fox Electro-Dynamic Unit and the Fox Rams Horn is a combination that out-demonstrates anything on the market.

Improve your present equipment with a Fox Unit.
Complete sound engineering service. Estimates free for special work.



Engineering Co.
388-392 Dorr St.,
Toledo, Ohio,
U. S. A.

The "EXPLORER" SHORT WAVE

PLUGLESS POWER CONVERTER



Price \$24.50

A sensational advance in short wave reception

NO PLUG-IN COILS
POWER RECEPTION

AUTOMATIC BAND SELECTION! Wave-length range 15 to 160 meters; automatic band selector changes wave-length bands in less than a second by turning a small knob on the panel—an original EXPLORER achievement.

The EXPLORER itself uses two tubes, greatly amplifying distant signals. Used with your broadcast receiver, it makes possible reception of stations all over the world with real loud-speaker volume.

With the EXPLORER you can obtain the best possible short wave reception at the lowest cost. Built on new principles of short wave design, it is full-sized, thoroughly shielded, and enclosed in a beautiful satin-finish aluminum cabinet.

A special vernier tuning condenser permits ease of tuning like a broadcast receiver's. Single dial tuning; and the regeneration control does not affect tuning. Results obtained are unsurpassed by expensive short wave receivers, and the elimination of plug-in coils makes the EXPLORER the most convenient of all short wave receiving apparatus.

Price \$24.50. Models for every receiver, including superheterodynes. Order now! Sent C. O. D. on receipt of \$2 or prepaid on receipt of price in full. Foreign, price \$25.50, remit in full with order.

Send for Free Literature

RIM RADIO MFG. CO.

695 GRAND STREET BROOKLYN, N.Y., U.S.A.

Dealers! Servicemen!
Send for Our Latest
Bargain Bulletin
RCA VICTOR Uncased
Condenser

1000 Volts D. C. Working Voltage



This genuine RCA Victor uncased condenser is composed of the highest grade materials. They are compact and moisture proof, impregnated in special heat resisting compound. Packed in individual cartons.

100% Replacement Guaranteed

1/2 Mfd. 25c.	\$2.50 dozen	2 Mfd. 50c.	\$5.50 dozen
1 Mfd. 35c.	3.60 dozen	4 Mfd. 85c.	9.00 dozen

BALTIMORE RADIO CORP.

725n Broadway New York City
Send for Our Latest Bargain Bulletin

WANTED MEN

To Manufacture Metal Toys and Novelties



Big demand for 5 and 10c store Novelties, Ashtrays, Toy Soldiers, Animals, Auto Radiator Ornaments, etc. We cooperate in selling goods you make; also buy these from you. Small investment needed to start and we help you build up. WE FURNISH COMPLETE OUTFIT and start you in well-paying business. Absolutely NO EXPERIENCE and no special place needed. A chance of a

life-time for man with small capital. Write AT ONCE if you mean strictly business and want to handle wholesale orders now being placed.
METAL CAST PRODUCTS COMPANY, Dept. 12
1696 Boston Road, New York City



New H-F-L Mastertone
—new in magnificence of tone—
—new in power with world-wide reach—
—new in quick tuning—
—new in sensitivity and selectivity with a station at every point on dial. A new price—America's finest radio at amazingly low cost. FREE Book explains all. Send for it and Special Offer now.
HIGH FREQUENCY LABORATORIES
A-136, 3900 N. Claremont, Chicago

Super Broadcasting on Long Waves

(Continued from page 1104)

tem will undoubtedly be large. There is the initial cost of the station itself, and the cost of large tube replacements. Probably the main running cost would be that of electric power. This can be purchased in large amounts at about one cent per k.w.h. It is reasonable to assume that a station radiating 1000 kw. will draw about eight or ten times this power from the supply mains—say 8000 kw.—and that it will operate on the average eighteen hours out of the twenty-four. At this rate the annual power bill for each station comes to, roughly, half a million dollars—a sizeable amount. However, the present broadcasting bill for technical facilities alone is around \$30,000,000 per year. In addition, we do not advocate starting the seven odd national stations at anything like 1000 kw. each. They should be placed in operation one at a time in accordance with increasing demands for long wave service, at power levels around 100 kw. each. Then, as true service benefits become apparent and results justify the expense, power can be increased.

It is probable that the use of such high broadcasting power will develop an entirely new transmitting power technique. Heretofore we have been running our transmitters at constant power levels, while the listeners' signals were anything but constant. With a transmitter drawing power at over \$1000 per day it would be worth while to operate constantly two or three field measurement stations in the outlying portions of its service area, so that power could be reduced under good transmitting conditions and increased under poor ones. It is even possible that all the patient research in correlations between sunspots, weather and radio transmission, now so seemingly removed from engineering problems, may enable station engineers to predict power requirements hours or days in advance.

It can be argued that the present cost of broadcasting is paid by advertisers with goods to sell, and that such advertisers, seeing scant possibility of sales in the great open spaces, would contribute nothing to the proposed national system. But the insistent selling talks of advertisers are a fairly recent arrival in radio, and to many an unwelcome one. Perhaps the advertiser who gets the most out of radio is the one who contents himself with a mere announcement of the full firm name every quarter hour or so, meanwhile dubbing the orchestra or artist with a brief commercial identification. Such an advertiser, valuing the permanent benefit of radio advertising in building up national good-will above immediate sales to a frenzied few or the overnight return of toothpaste cartons in exchange for horoscopes, should look favorably on national true service broadcasting.

This viewpoint raises questions too involved for discussion in a technical article already too long. It is true, however, that many people find much wrong with our present radio broadcasting and with the methods by which it is financed. More and more people are beginning to be annoyed by the blatant and insistent

selling talks which our loud speakers deliver in longer and longer installments. A survey by the Commonwealth Club of California, made a year ago when advertisers were less clamorous, showed that 63 per cent. of the listeners thought that there is something wrong with radio broadcasting. Further, only 43 per cent. ever bought anything as a result of radio advertising, while 54 per cent., or a clear majority, were annoyed by it. Still, many advertisers think it good business to alienate a hundred million people in order to sell a hundred thousand cartons of goods. Perhaps it is for the present, but how about the future?

The technical side of broadcasting is likewise far from rosy at the present time. The Federal Radio Commission is daily harassed by the inordinate demands, and the political influence, of thousands of publicity seekers who think that broadcasting exists rather for the boundless expansion of their egos than for the genuine entertainment and service of millions of listeners. As if the wavelength situation in the United States alone were not bad enough, Canada is making ready to demand a few more exclusive broadcasting channels than the six out of ninety-six which she has at present, while Mexico has begun to operate powerful transmitters on the same wavelengths that some of our transmitters now use.

All this goes to show that broadcasting as it exists today is far from perfect. There is no need to consign the national long wave plan summarily to the wastebasket because it does not fit in perfectly with an imperfect system of the present. It is also true that advertising is not the only way in which broadcasting can be paid for. There is always the possibility of an indirect tax on receiving sets or on the vacuum tubes which are the heart of a receiver, or even a direct listener tax as collected in Europe. These tax schemes appear less fantastic as the standard of broadcast service is raised.

There is the ultimate possibility, too, of radio endowments. Many men who have accumulated a surfeit of this earth's riches are genuinely looking for a chance to spend it in some way that will help people without spoiling them. Endowing universities has been considered as good a way to spend this money as any. When radio broadcasting transmission technique advances far enough to eliminate the will-o'-the-wisp vagaries of space ray service in favor of true broadcasting service for the whole nation, overgrown fortunes may be attracted to this great university and theater of the air.

Broadcasting may be financed eventually by any one of these methods, by a combination of all three, or possibly by others yet undiscovered. The expense of our proposed national long wave system, though considerable, is not excessive considering the possible benefits promised by the system. More to the point than gestures of horror at possible expenses, is the initiation of experimental work to determine definitely whether or not the benefits can be realized.

A "Midget" Super-heterodyne

(Continued from page 1096)

that when placed across the necessarily high impedance output circuit of a -24 detector the attenuation of high audio frequencies resulting (which is not the case with a -27 detector) is very serious. The better high response of the -27 detector with the value of plate by-pass capacity required for stability is such that a tone control may be used advantageously, whereas this cannot satisfactorily be done with a -24 detector. In the diagram, condenser C10 of .025 mfd. and variable rheostat P2 of 500,000 ohms comprise the tone control circuit, and C9, of .00075 mfd. capacity is the second detector plate by-pass. (For detector i.f. harmonic feed back problems, see articles referred to above.) The second detector feeds the -45 push-pull tubes through a 1/1 audio transformer having a substantially flat characteristic from 40 to 4000 cycles.

The power supply is conventional in that it employs a multi-voltage transformer for A, B and C voltage, two (wet or dry, optionally) electrolytic condensers of 8 mfd. each one filter choke and one section of the electro dynamic speaker field, the second section of the speaker field serving as the bias resistor for the 45 push-pull tubes. The filter choke is tuned to 120 cycles to improve filtration by condenser C15. Volume control is affected by varying the control grid bias on the first i.f. tube. In order to give entirely adequate control even on powerful local stations, the local-distance switch S2 is included. In the local position S2 shunts the antenna and ground with a 200 ohm resistor R11, this effectively reducing overall gain for local reception.

Oscillator Circuit

The oscillator circuit needs no special description other than to refer to previous articles in this publication by the writer, describing the system employed, which utilizes a tuned tank circuit arranged to track away from the first detector circuit by the i.f. frequency, or 175 kc. and compensated by a total of three "padding" or trimmer condensers, two variable (C3A and C4) and one fixed (C5). Some of the bias resistor for the -24 first detector has bled through it the plate current of the oscillator to insure a more constant and desirable bias than would obtain if first detector employed the automatic self-bias system employed for the other tubes.

In this, as in previous receivers described by the writer, certain precautions were necessary such as a very short path for by-pass condensers C9 and the grounding of certain circuits, not simply anywhere on the steel chassis, but at certain particular points to insure stable operation—precautions which an examination of several commercial super-heterodynes recently put on the market indicates are only too often neglected as unessential, which is apt to be a very serious oversight.

Special Band Spreading Coils



These new specially designed coils permit a spread of 50 dial divisions on the 20-40- and 80-meter amateur band, using the Standard NATIONAL SW-5 THRILL-BOX. Also available for other bands, on special order.

Just another reason for the outstanding superiority of the NATIONAL SW5 THRILL-BOX.

Send 50c in stamps or coin for new 64-page Short-Wave Handbook, Bulletin No. 146N is free.



NATIONAL

A.C. SW5 THRILL-BOX

NATIONAL CO. INC., 61 SHERMAN STREET, MALDEN, MASS.

**SHOCKED TO DEATH
FIXING RADIO AERIAL**

Surgeon and Police Fail to Revive Staten Island Man—Two Women Aids Recover.

A powerful electric current, which got into a radio aerial, killed Leo Hillstede today in the back yard of his home at 2390 Forest Ave., West

INSURE YOURSELF AGAINST THIS!

with

HOLYOKE

COMBINATION
AERIAL AND LEAD-IN WIRE

NO SPLICING OF JOINTS

NOW is the Time!
TO REPLACE YOUR AERIAL

No doubt your radio aerial which has faced severe storms throughout the winter is now badly in need of replacement.

But—bear in mind that you are liable to contact with live wires when making aerial installation and unless properly protected as Holyoke Aerials always are, you are easily susceptible to very serious personal injury which oftentimes proves fatal.

Holyoke Gutta Percha, insulated aerial protects you against such electric danger shocks, which do not penetrate Holyoke insulated aerials—Longer life, non-corrosive—insuring clearer signals.

Saves time and work—simply attach one end to tree, chimney, pipe, pole—anything—and the other end to radio.

NO SEPARATE LEAD-IN NEEDED

Holyoke Aerial is a stranded copper wire, cotton-wrapped, encased in Gutta Percha, Cotton-braided and damp-proof impregnated. No insulators needed. No window strips needed. Holyoke insulation is insurance against all trouble. Inside or outside—as clear a year after as the day it is installed. The Gutta Percha renders Holyoke Aerial moisture proof.

"The Transatlantic Cable is insulated with GUTTA PERCHA"

Holyoke Aerial is packed in boxes of 100, 150 and 200 foot coils; also on 1000 foot spools. Holyoke Perfect Aerials are on sale at all dealers or order direct from us. 75c will bring you one box containing full size 100-foot coil of Holyoke Combination Aerial and Lead-in wire.

Manufactured by
THE HOLYOKE CO., Inc.

621 Broadway
New York, N. Y.

WRITE AT ONCE

for description of the greatest practical development in broadcast and short wave reception. Learn what is possible in the most powerful, all wave receiver known. Built by engineer under strict laboratory methods.

Distributors: You can demonstrate any standard equipment known with Lincoln Super Receivers.

LINCOLN RADIO CORPORATION

Dept. N-6
329 South Wood St. Chicago

WANTED BUSINESS BUILDERS

By underselling all others by half in ten world famous electrical specialty, replacement supply and service lines we maintain a double monopoly and a business made to order for this day and age. No pinneering necessary. Products long established by millions spent in advertising. Only responsible workers seeking lucrative line free from traveling or expense and who are able to finance themselves in a small way are wanted.

U-R-O-N INDUSTRIES

1311 Engineers Bldg. Cleveland, O.

WELLSTON GOLD TEST AERIAL Gets Greater Distance!



Reduces Static & Hum

The World's Smallest Aerial 2 1/2 by 3 inches in Size

IMPROVES RADIO RECEPTION

EASY TO INSTALL

It is a simple matter to install the WELLSTON GOLD TEST AERIAL—even a child can do it in a few minutes' time. No extra tools are needed. Place it anywhere—inside on the back of the radio cabinet. Once installed no further attention is required.

IT WILL NEVER WEAR OUT

Made of emerald green genuine solid Condensite with binding posts to match this NEW AND IMPROVED WELLSTON GOLD TEST AERIAL is of the filtered type endorsed by radio engineers. Although small enough to fit the palm of your hand, it has a capacity equivalent to 54 ft. of best grade aerial wire strung 50 ft. high in the air.

IF YOUR DEALER CAN'T SUPPLY, ORDER DIRECT

Price \$2.50

WELLSTON RADIO CORP.
Dept. 118 St. Louis, Mo.

F R E E



JANUARY 1931 CATALOG NO. 22

RADIO SERVICE TREATISE

AND RADIO BARGAIN CATALOG

FOR RADIO SERVICEMEN—RADIO TECHNICIANS—RADIO DEALERS

RADIO TRADING CO.

NEW YORK CITY

We have just issued our new "RADIO SERVICE TREATISE." It's red hot all the way through. 52 new hookups and circuit diagrams. 110 illustrations. Partial contents: Modernizing old radio sets. How to convert battery to power sets. Selection of tubes. The detector tube. The power tube. Changes in grid or "C" bias circuits. Push pull amplifiers. Replacing audio transformers. Phone attachments. How to

choose power transformers. Voltage dividers. Wattage of power transformers. Selecting and installing replacement parts in radio sets. Filter condensers. Repairing "B" eliminators. ALL BRAND NEW DOPE—NOT A REPRINT. Send 2c postage. Catalog yours by return mail.

RADIO TRADING CO.
27 West Broadway, N. Y. C.

AMERTRAN TRANSFORMERS

For Every Radio Application

AMERICAN TRANSFORMER COMPANY

178 Emmet Street, Newark, N. J.

Massachusetts Radio and Telegraph School

18 Boylston Street, Boston

Send for Catalogue

Tel. Hancock 8184 Established 1905

The New Ribbon Microphone

(Continued from page 1096)

mally recorded, the ribbon is corrugated transversely by running it through a set of coarse gears. An edge view of the ribbon is shown in Figure 2. The ribbon is supported without tension by two small insulators attached to the ends. The whole microphone assembly is extremely light in weight, and is so small that it can be almost hidden by covering it with the two hands. It is enclosed in an aluminum case that is perforated on the sides to permit the free passage of sound. The light weight and small size are twin advantages of this microphone; as they make it possible for it to be hung on the end of a microphone boom that has been run out to its fullest extent without causing the boom to sag under the weight of the microphone and they simplify the matter of hiding it in a set where a microphone out in the open would be in view of the camera.

Low Impedance

Because the ribbon is short and straight, the impedance is naturally quite low; but it increases enormously with high frequencies. To match this low impedance to the high grid circuit impedance of the first tube in the amplifier, it is necessary to use the step-up input transformer which has already been mentioned. However, it is not always desirable, particularly when the microphone must be hidden on the set, to have the microphone and its amplifier close together. In such cases, a special transformer is used at the microphone and its output is transmitted through a medium-impedance line to the amplifier, where another transformer matches the impedance of the line to the impedance of the grid circuit of the first tube. This arrangement may be seen in Figure 3. The impedance of this transmission line is low enough so that it can be run for quite a distance without picking up extraneous electrical disturbances and causing serious trouble. This makes a very convenient arrangement and one that helps to solve many of the problems of the microphone and monitor men.

Amplifier

The amplifier is of three stages employing tubes of the 854 type. Its output is normally about twenty-five db. down, which is considerably higher than the output level of a condenser transmitter with a one- or two-stage amplifier. The frequency response curve of the ribbon microphone and its amplifier is approximately flat to 3000 cycles, at which point the curve is slightly humped to a value of about one and a half db. followed by a steady falling off in response as the frequency increases. This curve is not so very much different from the response curve of a condenser microphone. An equalizer that compensates for this falling off in response at the higher frequencies can be easily constructed.

It is evident that the ribbon will respond only to sounds coming from the two general directions toward which the

flat surfaces of the ribbon face. If the sound strikes the surface of the ribbon from a slight angle, the response, and naturally the voltage output of the microphone varies as the cosine of the angle of the incident sound. This means, of course, that the microphone is sensitive only to sounds whose sources fall within the confines of two narrow cones on each side of the flat ribbon. There is some question as to whether or not the directional effect is not too greatly emphasized in this microphone. Since the ribbon microphone is sensitive to sounds coming from just two directions, it follows that its response to random sounds is just one-half that of the response of a non-directional microphone, such as a carbon or condenser microphone. Because of that characteristic, the ribbon microphone can be used in a set having twice as much reverberation as the set in which an ordinary microphone can be used without the ribbon microphone picking up an excess of reverberation; and if it were used in a set having just the proper amount of reverberation for a condenser microphone, the ribbon microphone could be placed at twice the distance from the sound source as the non-directional microphone could without the ribbon microphone picking up more than the desired amount of reverberation. Due to the same effect, the articulation at a distance from a speaker is better with the ribbon microphone than with a condenser microphone because of the elimination of much of the undesired sound and excessive reverberation; but for close-up recording the two microphones are about equal. Another great advantage of this ribbon microphone is that camera gear noise, generator noise, and other distracting sounds can be excluded by proper orientation of the microphone. If the ribbon of the microphone is pointed at the object that is producing the disturbing noise, the noise will not be heard, except in so far as it is reverberated by walls or other hard surfaces against the flat faces of the ribbon. A line drawn through the length of the ribbon is said to constitute the plane of zero reception, and the two side directions from which sound can be picked up are called the reception zones. Even if this new microphone does prove to be too directional under actual working conditions, it represents one of the first steps in the evolution of directional microphones and is bound to be followed by other developments.

Patents

(Continued from page 1093)

including a camera having a means effective to indicate on picture film frame lines change of locations of source of sound in a scene or performance, concurrently with the exposure of the film to the scene and including selective devices to determine positional relation of the indications.

The Junior Radio Guild

(Continued from page 1102)

In this case, it is seen that the resultant voltage E, which is the diagonal of the parallelogram with sides E1 and E2, is such that the current is in phase with the voltage. Such a condition of the circuit is referred to as the resonant effect and occurs when the reactances of the condenser and the coil are equal.

The study of the above geometrical figures for a series circuit consisting of a resistance, inductance and capacity, indicates the phase relation of the current to the supply voltage. We have seen that this relation is shown by the diagonal of a parallelogram, and this diagonal will take one of three positions: (1) Such that the current will lag the voltage E, as shown in Figure 13 (a); (2) such that the current will lead the voltage E, as shown in Figure 13 (b); and (3) such that the current will be in phase with the voltage as shown in Figure 13 (c).

From the last consideration we can study further the relation of the triangles thus formed. Thus, considering Figure 14, if AB represents the resultant of the two vectors AC and AD, let us investigate the two triangles ABC and ABD. Immediately we know that AB is equal to AB and angle "a" is equal to angle "b," for since the lines AC and BD are parallel, we have from the following proof that these alternate interior angles are equal.

Proposition

If two parallel lines are cut by a transversal, the alternate interior angles are equal.

Let us prove this proposition, and we have, in Figure 15, two parallel lines EF and GH cut by the transversal BC.

To prove that angle "a" is equal to "b":

Let us draw the line AD, through O, the middle point of BC, so that it is perpendicular to GH. Then AD will also be perpendicular to EF. Now, the vertical angles c and d are equal (if one straight line intersects another straight line, the vertical angles are equal). Since the tri-

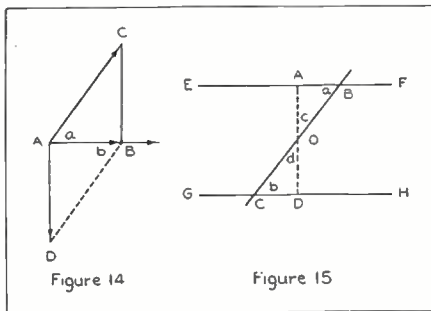

angles ABO and COD are right triangles, and angle "c" is equal to angle "d," it follows that angle "a" must be equal to angle "b."

Therefore, the alternate interior angles "a" and "b" are equal.

Referring to Figure 14, we have shown in the right triangles ABC and ABD that AB is equal to AB, and angle "a" is equal to angle "b." Therefore, these triangles are equal (two right triangles are equal if a leg and an acute angle of the one are equal respectively to a leg and the homologous acute angle of the other). Now, if these triangles are equal, side AD must equal side BC, and since these sides represent the reactances of the coil and condenser, we see that this sets the condition in order that the current will be in phase with the voltage.

Eight Meters in One

(Continued from page 1095)

connected to provide current for resistance and continuity tests. Since the current demand is small, the life of the battery should be several months. This makes it worth while to solder the leads to the spring terminals. If the voltage of this battery is 2.75 it will require 2750

$$\text{ohms } R = \frac{e}{i} = \frac{2.75}{.001} \text{ for full-scale}$$

deflection on the high range, 1 ma, and 275 ohms on the low range, 10 ma. The calibrating resistor recommended is the Electrad truvolt type B, 3000 ohms. This resistor was chosen because of the adjustable feature provided by the sliding terminals and taps.

The 275-ohm tap is located by connecting the full resistance in series with the shunted meter and test battery, then sliding the tap along until the needle stands at full scale. The same method is used for the high range with the shunt disconnected.

All that is now necessary is to connect the shunt, the three multiplier resistors

and the calibrating resistor in such manner as to make all ranges of the meter conveniently available for use. Figure 5 shows the connections. With the switch in the "V" position, it will be seen that the meter is connected to the three multiplier resistors. This makes the voltage ranges and 1 ma. range available and connects the full length of the calibrating resistor for high range resistance measurements.

In the "MA" position, the three ma. ranges are connected and part of the calibrating resistance cut out, making the low range resistance test available.

The resistance indicated at any position of the meter needle with the plug in the jack marked "CT" (continuity test) is

$$\text{determined by the formula } R = \frac{E}{I} - R_c$$

E is the voltage of the contained battery, I the current indicated by the meter and R_c the value of the calibrating resistor. This was calculated for about 20 points

(Continued on page 1110)

Get your

RADIO TRAINING

From America's finest Radio School

THE man who really wants to become an expert in radio . . . who knows that the better his foundation, the better his chances . . . and who is willing to spend a year preparing himself . . . such a man will make no decision until he has read the complete story of RCA Institutes, Inc.

A Good Foundation Vital

Like other professions, radio rewards only those who excel. The poorly trained will never rise higher than the place in which they started. Others will climb step by step to positions of power in radio telephony . . . broadcasting . . . sound pictures . . . aviation radio . . . radio merchandising. And among these will be those who planned years in advance . . . studied, worked, stuck to it.

You are making your decision right now, how well you will fit yourself. So decide wisely. To be a graduate of RCA Institutes stamps you as a man who knows the real worth of a good foundation. As one who knows that a year of training now, under America's finest radio instructors, is the surest way to acquire the knowledge and skill you must have.

You Can Study At Home

You do not have to give up your present position to enjoy the benefits of RCA Institutes training. You may study at home in your spare time . . . or at any of our resident schools throughout the country. The Home Laboratory Training Course includes a complete set of radio equipment of the most modern design.

Send For Our Free Book

If you have read this far . . . you have already indicated that you are the type of man who should study radio. This may be the big turning point of your life. You will not rest until you have sent for our free book that tells you the complete story of what RCA Institutes offers you. Fill in and mail the coupon below right now. There is plenty of time for investigation . . . but no time for delay in getting all the vital facts.



RCA INSTITUTES, Inc.

RCA INSTITUTES, Inc.
Dept. EN-6
75 Varick St., New York, N. Y.

Gentlemen: Please send me your FREE book which tells about your laboratory method of radio instruction at home.

Name.....

Address.....

Occupation.....

SERVICEMEN

Here is a positive way to
INCREASE PROFITS

Install the
**Multicoupler
Antenna System**

as specified by leading archi-
fects. Apartments so equipped
increase your service sales.

Wide awake service men and
service organizations can cash
in on real profits.

Write us on your letterhead
for prices and detailed in-
formation.

*Positive in operation—
easily installed*

Amy, Aceves & King, Inc.
Consulting Engineers
55 West 42nd Street
New York City



Wood-Supersonic Short Wave Converter



No Coils to Change

Complete A. C. operation. Uses 4
tubes—2-224, 1-227, and A. C. Recti-
fier Tube. Solid Mahogany Cabinet
6 1/2 x 6 1/2 x 12.

Foreign stations with room vol-
ume when attached to antenna
and ground post of good Radio.
Models as low as \$18. No fussy
regeneration controls.

Power pack for your home-
made converter Filament sup-
ply for 3 heater tubes. 150 volts
for B supply. Price \$15.00.

Manson Wood & Co. Wakefield, Mass.

Help

For the RADIO MAN

ELECTRAD Resistors, Voltage,
Controls, Amplifiers and Sound
Systems are used and praised by ex-
perts throughout the world. The products
of long experience—highly perfected and
moderately priced.

Write Dept. RN-6 for Complete,
New 36-page Catalog.

175 Varick St., New York, N.Y.

ELECTRAD

INC

Eight Meters in One

(Continued from page 1109)

on the scale and a curve drawn. This
curve is pasted inside the cover of the
box containing the instrument. A single
curve suffices for both ranges, as the low
range, having a sensitivity of 10 ma., in-
dicates just 1/10 of the high range at any
setting. A range of from 30 to 30,000 is
easily readable, and while not highly ac-
curate, suffices for most service needs.

In operation, the switch is thrown so
that its handle points toward the row of
jacks connecting to the measurements de-

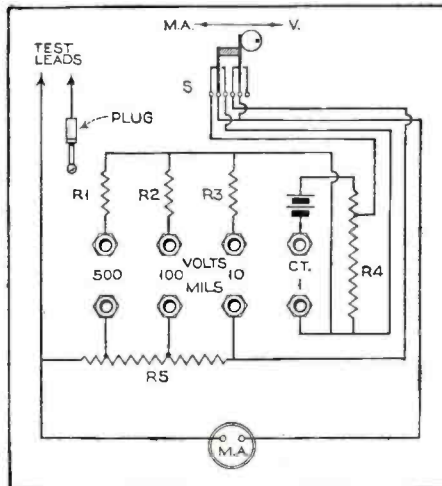

Figure 5. Permanent circuit arrangement

sired and the plug is inserted in the
proper jack. A pair of leads, equipped
with clips or prods, connects the instru-
ment as desired. A bi-polar switch would
simplify operation somewhat but require
more room, and then parts from one's
junk box are always cheaper.

The whole assembly is mounted in an

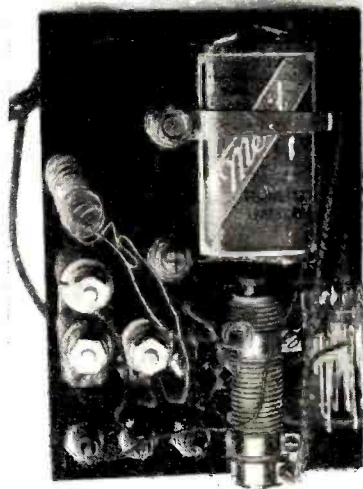

Figure 6. The compact behind
panel layout, showing resistors,
battery and switch

oak box which was intended as a file for
3" x 5" index cards. A panel 3 1/2 x 5
inches provides space for meter, switch
and jacks. The crowding of the parts
necessary to mount them in such small
space makes a neat wiring job difficult,
(Continued on page 1120)

RACON PRODUCTS

FOR SOUND REPRODUCTION!
..... ARE UNSURPASSABLE!

Newest Storm-proof Horn



TRUMPET HORN
(Illustrated)

Bell 22 inches round, length 40 inches. Equipped
with cast aluminum ferrule and suspension ring.
For Public Address and all Outdoor use. This
horn has been perfected after years of exhaustive
research in Racon Laboratories. Will withstand all
weather conditions. Requires no replacements or
servicing after heavy rainstorms. . . . Guaranteed
for one year. Prices slightly higher than regular
horns.

Racon horns and units are covered by U. S.
Patents Nos. 1,507,711, 1,501,032, 1,577,270,
73,217, 73,218, 1,722,448, 1,711,514, 1,781,489

Write for Catalog Containing Complete Line
RACON ELECTRIC CO., INC.
The largest horn speaker manufacturers in the world
18 WASHINGTON PLACE, NEW YORK
England and Canada

Volume Control GUIDE

By Engineering Staff of
CLAROSTAT

FREE to all those who write and mention this
magazine.

Here is a real help for Service Men, Dealers and Ex-
perimenters. Sent without any charge or obligation.

Clarostat's many years' experience manufacturing Volume
Controls and other variable resistors has made it possible
for us to compile this very useful and instructive piece
of literature which should be handy to all those who
work on radio and sound equipment.

Write today. Be sure to mention this publication.

CLAROSTAT MFG. CO., Inc.
285 North 6th St. Brooklyn, N. Y.

IN SCIENCE AND INVENTION for June

Bali—A Volcano-Fed Eden—A remarkable ac-
count of this miniature Garden of Eden, where
the inhabitants leisurely live their lives in
peace and plenty, with practically no labor on
their part. By Hickman Powell.

**Unseen Menaces Behind Mississippi Flood
Control**—The building of dams to prevent the
banks of the Mississippi from overflowing
may cost us not only money, but the fertility
of the soil we are trying to protect.

Why Is the Sun Hot?—A discussion of this
much-mooted question by Dr. Donald H.
Menzel, of the Lick Observatory.

Aerial Bombs will Decide the Next War—Will
the U. S. Army Air Force prove the de-
termining factor in our next war?

**The World's Super Amusement Center—Radio
City**—Details of the New Rockefeller \$250,000,000
Project.

Multitude of How to Make Its, including:
New Tools You Can Easily Make; A Drum
Sander, A Nine-Hole Golf Course for Your
Smoker, An Electric Floor-Waxer, A Work-
bench from an Old Bedstead, An Outboard
Trailer, and a Self-Bailer for a Racing Hydro-
plane.

Dealers and Service Men Send for the
Latest Issue of



It contains hundreds of Radio and Electrical bargains
Have You Received Your Copy?
NUBOR RADIO CO., 14R Warren Street, New York City

Figure Quickly

THESE SHORT CUTS
SAVE YOU TIME AND
PREVENT ERRORS

Quick methods of addition,
subtraction, division, fractions, interest and discount,
percentage, calculating powers and roots, and every arith-
metical problem. Just the help you have always needed.

RAPID ARITHMETIC by T. O'CONNOR
SLOANE, Ph.D., LL.D.
Send no money—just pay postman \$1.50 plus few cents
postage. Refunded if not satisfied.
D. VAN NOSTRAND CO. 250N 4th Ave., New York

Policing the Ether Lanes

(Continued from page 1063)

By an arrangement of the apparatus, the various antennas enable the receivers to tune anywhere in the spectrum between 10 and 30,000 meters, and it is a simple matter of coil arrangement to make them go below 10 meters for the ultra-high frequency development that is now taking place.

These antennas lead into the main building to a transmission line rack in the rear of the building. Thence they go to a lightning arrester rack, each antenna having its own arresters. All of the arresters are connected to ground through a heavy copper strip.

After passing through the lightning arrester, the transmission lines from the antennas lead into the main instrument room as shown in Figures 4 and 5. All lines are transposed to prevent antenna effect, or the picking up of extraneous signals.

There are receivers for each frequency band, and indoor loops to be used in case heavy snows, winds or sleet storms break down the outside antennas. The receivers are built for three frequency bands and the antennas connected accordingly. There are two type C receivers to handle the frequencies from 10 to 200 meters; two B receivers for 200 to 3,000 meters, and one A receiver for 3,000 to 30,000 meters.

These receivers, built by Westinghouse under specification drawn up by the Department of Commerce, are among the most sensitive in the world, if they are not the most sensitive. They are so constructed that by changing coils they cover wide ranges of frequencies with maximum effect. The A receiver has three stages of tuned r.f., two or untuned r.f., a regenerative detector and a power amplifier; the B receivers have four stages of tuned r.f., a regenerative detector and a power amplifier; and the C receivers have three stages of tuned r.f., using screen-grid tubes, a regenerative detector, a power amplifier and a balanced radio frequency amplifier of two stages put on ahead of the first r.f. stage to heighten the sensitivity and match the impedance of the transmission lines to the impedance of the first r.f. stage.

So much for the technical equipment. A monitoring man sits at each receiver. He tunes throughout the bands, and asks the two men stationed in the measuring booth to measure the frequency of the stations he receives. Their primary standard is obtained from a clock with a seconds pendulum of invar metal, electrically driven and with temperature and vacuum control. This clock, which is checked twice daily against Arlington time signals, is used to ascertain whether a 5,000 cycle tuning fork, the basis of all the measurements, is fast or slow. The tuning fork is then checked against standard frequency transmissions from the U. S. Bureau of Standards.

The booths also contain secondary standards as auxiliary equipment in case 36 radio engineers are required. The accuracy is one part in 100,000.

To maintain 24-hour watches, at least there is trouble with the primary. Their

Radio Division was literally begging Congress for the necessary personnel when this was being written; with only six men available early in February, monitoring work at the Grand Island station was almost at a standstill.

Why monitor radio stations? Let Edwards answer: "We have international agreements and national assignments covering wave band allocations and wave length assignments. These agreements are based on scientific needs. Frequencies are reserved and assigned with the object in view of obtaining the best results with the least amount of interference. We all know how badly congested the wave lengths have already become, nationally and internationally. We all know how tremendously important to the commerce of nations radio communications are.



View of monitoring equipment, showing highly sensitive and selective receiving apparatus

"Off frequency operation would be bad for all concerned—the party using a particular frequency no less than the parties on frequencies adjoining. No one gains from interference; everyone stands to lose.

"Nowhere else in the world can accurate checks of frequencies be made in accordance with accepted standards."

For strategic purposes, the Grand Island station has a tremendous military value. For radio intercept work in time of an emergency, it could be called into play to act as the ears of the military. If our diplomats want to know the nature of the propaganda a foreign government may be transmitting via radio, it would be a simple matter to put a shorthand reporter at the receiver. Even in peace time it has a social value other than technical. When the Columbia Broadcasting System wanted to rebroadcast the ceremonies attending the exchange of signatures of the naval disarmament conference last autumn, it was a simple matter for Grand Island to tune in J1.A. Tokyo, and have the Japanese end of the service relayed to the network via the usual telephone lines.

Withal the splendid jobs that are being accomplished at the incomparable Grand Island station, there are greater plans for the future. More and improved antennas will be needed from time to time; right now they could well use some new directional layouts. Several hundred acres more of antenna space will be needed. America's "ear" may be the most sensitive in the world today; but, even that isn't sensitive enough.



METERS

must be

DEPENDABLE

To be worth buying or to be worth using, a meter must be dependable. You must be able to rely on its readings and know that they show a true picture of the circuit conditions. No matter the size or the use, meters must be dependable.

Dependability is built into an electrical measuring instrument only by careful, intelligent design, selected materials, and precision manufacturing, such as you get only in Weston instruments.

For your own information, look inside of a Weston instrument. Compare it with other makes. Weston's superiority in construction and its resultant dependability is evident.

Weston's popular line of 3 1/4" and 2" panel meters may now be procured with Bakelite cases at no additional cost.

WESTON ELECTRICAL INSTRUMENT CORP.

615 Frelinghuysen Ave., Newark, N. J.

Planning the Amateur Station

(Continued from page 1081)

NOW READY!
The New 1931 Trouble Shooter's Manual
 By **John F. Rider** with the **FREE Question and Answer Service.**
More than 800 pages! More than 1500 diagrams!
 This is the most complete book ever offered to the radio service men. Nothing has been left undone to furnish every bit of radio service information which may be of value to the radio service man. The wiring diagrams are complete with socket layouts, set analyzer, voltage data, electrical constants, color code, chassis layout... Commercial broadcast receivers, short wave receivers and adaptors, kit receivers, midset receivers, set analyzers, public address systems, power amplifiers, power packs, tube data, a complete Radio Service Course in Trouble Shooting, principles and application of the set analyzer, a separate section devoted to the peculiarities in radio receivers.
Complete!!! Complete!!! COMPLETE!!!!!!
 Modern up-to-date in every respect. Hot off the press! If you do service work you must have this book. It is sold with a money back guarantee. ... One successful repair job pays for the cost of the book.
 More than 800 pages and more than 1500 diagrams
 Price \$5.00 Postpaid
 We will send the book C.O.D. if you want it so.
RADIO TREATISE CO., Inc.
 1440 Broadway New York City

F. & H. CAPACITY AERIAL



Price \$1.25 Complete

Every Instrument Tested on Actual 1000 Mile Reception
 The F. & H. Capacity Aerial Eliminator has the capacity of the average 75 foot aerial, 50 feet high. It increases selectivity and full reception on both local and long distance stations. Absolutely guaranteed. It eliminates unsightly poles, guy wires, mutilation of woodwork, lightning hazards, etc. It does not connect to the light socket and requires no current for operation. Installed by anyone in a minute's time and is fully concealed within the set. Enables the radio to be moved into different rooms or houses, as easily as a piece of furniture. The F. & H. Capacity Aerial will be mailed C. O. D. or upon receipt of M. O. or check for \$1.25, and you may return it after three-day trial for refund, if not entirely satisfactory. **WE PREDICT THIS TYPE OF AERIAL WILL BE USED PRACTICALLY ENTIRELY IN THE FUTURE.** 8,000 dealers handle our line. Dealers! Over 80 leading jobbers carry our line, or order sample direct.

F. & H. RADIO LABORATORIES
 FARGO, N. DAK., DEPT. 10

A New Member of the "QRQ" Universal Family
ONLY \$5 COMPLETE Including 3-ft. Cord
 Just what the amateur and experimenter has been praying for. Genuine carbon single button microphone, 200 ohms resistance. Bronze case with suspension eyelet. Life-like voice reproduction. Built by microphone specialists! Only \$5 complete.
UNIVERSAL Microphone Co. (LIMITED)
 1163 Hyde Park Blvd. ♦ INGLEWOOD, CALIF.
 Other models \$7.50, \$15, \$25, \$50, \$75. Also cables, plugs, transformers, mountings, etc. Get catalog.

ALUMINUM BOX SHIELDS
 Genuine "ALCOA" stock, silver-plate finish, 5x8x6 \$1.89
 —Cornet size \$4.65, 10x8x7 Monitor size \$3.25, 5x5x5
 Coil Shield (like picture on the right) \$1.00.
ANY SIZE TO ORDER
 Coil Shields, Coil Hole Covers, Intermediate frequency coils for Radio News Superhet 600 pair.
"BUDDY" Test Prod
 Always sharp pointed, using phonograph needles, 4-ft. wires, spade or phone tips. Colored nipples identify each lead, \$1.50 each.
BMS Speed Bug \$10.00
 We specialize in parts exclusively. We can furnish everything described in this magazine. Give us a trial.
BLAN, the Radio Man, Inc., 89 Cortland St., Box N6, New York City

system. You can't very well use both. "You remember I told you about putting the jacks on the back of the receiver so that your phone cords would not be in the way? Well, here's what you do—bring your phone cords down in back of the desk and through to the front. On one side of the leg opening of the desk put a panel with two or three jacks and one of these new General Radio 339-B double pole, double throw "anti-cap" type switch. Connect the phones to the two center poles and the receiver to one of the outside sets, the monitor to the other (Figure 4).

"The next thing is to place your key. When using a straight key, the proper location for it is with the knob approximately eighteen inches from the edge of the table. This is the most comfortable position for periods of extended sending. I'm using one of the new BMS Speed "Bugs" and you can slide that all over the

try to hog the air with a lot of CQ's and long calls. The good operator is not the one who sends the most CQ's or even the one who burns up the most juice. He's the guy who makes the most QSO's (contacts) and the ones that mean something. I'll bet you we can turn on the receiver right now and pick up a bunch of kids, up to and including the age of seventy who will send CQ forty or fifty times before signing and when they do sign it is usually so garbled you can't read it. Listen for the fellow who calls five or six times and signs not over three. He's the fellow who does the most effective work. And another thing. Every time you go on the air, **CHECK YOUR FREQUENCY!**

There's going to be an International Conference in 1932 and a lot of these foreign governments that don't like hams anyway are going to shout about off-frequency operation. Unfortunately, a few misguided persons don't know how to measure frequency or if they do, they don't bother and as a result all hamdom gets a black eye. Ham stations have been logged as far out of the band as 200 kilocycles, and for that there's no excuse. Get inside the band and stay there. With the measuring equipment you have you should not only be able to get in the band but get on a definite frequency. Careful calibration of your dynatron and careful adjustment of your transmitter make this a simple problem.

"Off band operation doesn't simply mean jamming a few commercials, it might mean loss of life. Impossible? Not at all. The aircraft service frequencies are near the ham bands and a ham wobbling over into those bands might prevent a pilot from receiving a storm warning in time to reach an emergency landing field. The trans-Atlantic telephone has been interfered with, the Navy and various commercial stations. Outside of being illegal, it's not good operating, not the kind of operating that made the ham game what it is today.

"Amateur regulations call for a well-filtered power supply free of mush. They also proscribe key thumps and key clicks. Besides being illegal it's not very courteous to clog up our narrow bands with a broad, interfering note just because your transmitter is improperly adjusted or your power supply isn't right. It's up to every ham who goes on the air today to see that his note is clean, his signals are steady and that he is on the proper frequency.

"As far as steady signals go, you have as good a self-excited transmitter as you can build. The best is a crystal controlled oscillator with buffer and amplifier stages. If you don't want to go into crystal control, which really isn't as tough as it sounds, build yourself an oscillator amplifier rig which can be quickly and easily converted to crystal. One advantage of the oscillator amplifier is that your signals are steadier because small changes in the radiating system do not kick back into the oscillator and

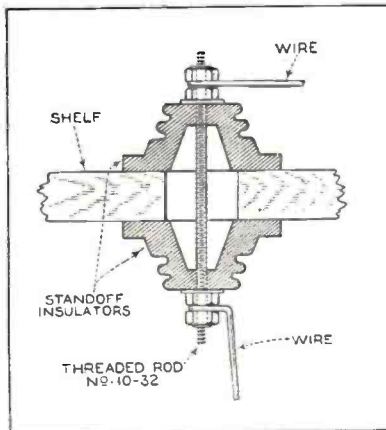

Illustrating the use of standoff insulators to carry r.f. leads through shelf

table until you find the most comfortable positions. That's the nice thing about a bug, the sideways motion is much easier on the arm, and if you know how to use one properly there is no prettier fist than the bug. But it is absolutely essential that you use it properly. The nice thing about a "Bug" is that you can start slow and grow up with it. It can be adjusted down to below seven words per minute and up to forty or thereabouts. But listen here—don't put it on the air until someone who knows checks you and tells you that you know how to use it properly—then practice some more. So much for that.

"Let's put a shelf here above the receiver to hold a message file, a little box with four shelves, one shelf each for messages destined North, South, East and West. Fasten the file to the shelf and on top of it put the dynatron (which you should have in a box by this time). Frame your station and operator's licenses and hang them on the wall. Put your call book handy somewhere within easy reach and you're all set.

"Now listen to me a minute. When you open up, remember that a ham should always be a gentleman. Don't

(Continued on page 1113)

Planning the Amateur Station

(Continued from page 1112)

change the frequency. A swinging feeder is not as serious a problem when it is hooked up to a m.o.p.a. (master-oscillator, power-amplifier). More of that later—but remember this—use your monitor and frequency meter unsparingly. You've invested good money in them—realize a return in your investment and keep out of trouble.

"Here's another thing—don't be a 'rubber stamp' ham with all your QSO's sounding like this—'Ur sigs FB hr in Hohokus OM QSA4 R8 tnx es cuagn 73's'" (Your signals sound fine here in Hohokus, Old Man, strength QSA4, readability R8, thanks and see you again, best wishes). What in the name of the pink-tailed rhin—rhinoc—aw hell—elephant,

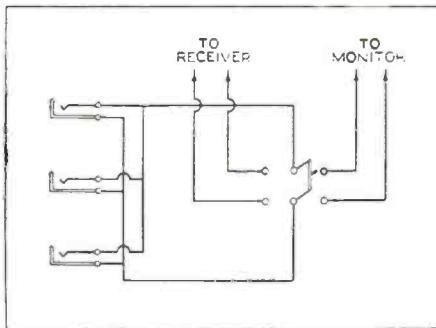

The switching circuit for changing headphones from receiver to monitor circuits

good is that kind of a message. If you can't at least handle some messages and get some real fun out of the game, at least swap some interesting information."

"O.K. Gus—I'll be a good boy and try to act like a gentleman. But how about the other guy, will he?"

"It's up to you to help and try clear up the air by setting an example. And that reminds me—setting an example—your speed in receiving isn't all it could be. Don't get that bug warmed up to 35 per when you can only read twenty. Send your stuff at the same speed you want it sent to you. Then the fellow at the other end will give you stuff you can copy. If he doesn't like your slow speed he will tell you to QRQ (send faster). Then if he forgets himself you can tell him to QRS. Well, I guess that's enough for now. You've a good station here, a nice layout and you should have a lot of good QSO's. I guess I can't do any more for you for awhile."

"Well, thanks Gus for all you have done. I'm sure tickled with it. I've been thinking about that oscillator-amplifier rig you mentioned a few minutes ago. That sounds interesting. Tell me some more about it."

"You have the symptoms."

"What symptoms?"

"Feel like tearing this down and building the m.o.p.a?"

"Sure, if it's so much better."

"You've got it."

"What?"

"The radio bug—and let me warn you—it's incurable. All I hope is that you have a station on the air most of the

time, not in the process of being torn down and built up again. Maybe you'd better keep this for a reserve rig and build the m.o.p.a. from the ground up. Well, if it must be it must be. I'll be around shortly and go over the oscillator-amplifier with you. So long."

(Now Gus has Don all hot and bothered about a transmitter of the master-oscillator, power-amplifier type and if we can judge by past experience it is likely that Don will have a revamped transmitter ready to describe next month.

TECHNICAL EDITOR).

Broadcast Receiver Equipment— Then and Now

(Continued from page 1074)

comply with the public demand of years' standing. The present-day systems by no means represent the ultimate. The modern simple capacity systems are not modern. They were used several years ago, in fact as far back as 1925, at which time the character of the transmission and interest on the part of the public did not require any such refinement. This is evidenced by the fact that it was seldom employed until 1930, when it became a talking point and a feature. Some of the present-day systems as applied to radio receivers do not represent tone control in the real sense of the word, but better days are coming.

Improvements in Receivers

To outline every minute improvement available in a present-day receiver would take more space than can be devoted to the subject. The best evidence is a schematic diagram of a modern screen-grid radio receiver of conventional nature, one which is representative of the millions of radio receivers in use. Compare this system with the three-tube outfit of 1923.

Popularization of such things as home recording, available with some of the modern receivers, tends to make for a scientific public. It widens the scope of knowledge of things scientific. What with the start of this electronic age, we may find the time not far distant when a radio receiver will be started by the wave of a hand and the tuning of the receiver carried out by a clockwork mechanism adjusted at the start of the evening to shift stations at a predetermined time.

The one disadvantage of the present-day radio receiver is its size. No doubt there will be a gradual return to smaller receivers. The popularity of the midget receiver shows the favor displayed in that direction. The limitations imposed by midget construction will no doubt be overcome, at which time there will be no need for large receivers. Let us hope that that day is not in the too far distant future.



No. 700

A new tester designed to meet the servicing needs for all types of receiving sets. Checks all voltages at the socket. Tests all the different tubes, including screen-grid and rectifier. Continuity of circuits, resistance and capacity measurements are made with this complete analyzer. The three meters give readings 0-60-300-600 d.c. volts, 0-10-140-700 a.c. volts and 0-20-100 ma's. Selective switch simplifies operations. Accurate. Compact. Dependable. Full instructions and charts furnished. Attractive leatherette case. Cover is removable.

\$15 NET to Dealer
\$25 List Price
No. 700

If not at your jobbers', remittance must accompany order for direct shipment.

Readrite



No. 600

Same as No. 700 except testing equipment is all contained in a removable tray placed in top of the carrying case. Space below for tubes and tools. Panel arrangement is convenient for shop testing also. Strong case, leatherette covered with handle, lock and clasps on each side.

\$18 NET to Dealer
\$30 List Price
No. 600

Catalog contains many other instruments for servicemen and dealers.

Readrite Meter Works

Established 1904

19 College Ave.

Bluffton, Ohio

Capital of the Radio World

(Continued from page 1069)

SERVICEMEN
YOU need this EX-STAT Kit
of PRECISION Resistors



... because it contains 24 different values of guaranteed resistors from 100 ohms to 2 megohms in values most needed. Conservatively rated as to power; units vary not more than plus or minus 10% of rated value; quiet in operation; long life; RMA color code. Of the same type as those accepted as standard by more than 72% of the radio receiver manufacturers. Packed in a handy, light weight, steel box that fits your pocket. **List Price \$12.00**
 Attractive discounts upon request.

EX-STAT Ignition Filter Systems
 Completely eliminate interference from the ignition system of any car. No automobile radio has a 100% chance to do its job without this ingenious System developed by careful research and proved by universally satisfactory performance in actual installation. Fully guaranteed. Send for complete literature at once.
TILTON MANUFACTURING CO., Dept. RN6
 15 East 26th St. New York, N. Y.



VARION
A & B
Eliminators
\$19.50

"A" only \$10.50
 "B" only 9.00

All DRY. NO HUM
 Completely electrify your battery set from 110 volt A.C. 25 or 60 cycle line and 110 and 220 volt D.C. lines. Delivers 6 volt "A" at 2 1/2 amperes maximum with a filament rheostat to control the "A" side for sets using as low as 3 tubes or as much as 10 tubes. Uses Benwood Lenz Dry Rectifier.
 180 volt "B", tapped at 45 volts for detector. 90 volts for R.F. and 180 volts for power.
 Uses a 280 Tube
 Send 20% with order. Balance C. O. D.
VARION PRODUCTS CO., INC.
 402 West Broadway, New York City
 Made by manufacturers of Varion Antenna Filters

AUTO RADIO
Long Distance Receiver

Amazing Low Price!
Quality Performance



Six tube triple screen-grid using 3-224, 2-227, and 1-245 power tube. Easy to install. Will fit any car. Single dial control. We guarantee that this set will pull in stations within a radius of 1,000 miles and that it will deliver the volume and tone qualities of an electric set, or your money refunded.
PRICE OF SET ONLY \$20.00
 Price Complete, including tubes, batteries, dynamic speaker and suppressors, all ready to install and use, \$39.50. Send \$5.00 deposit with order, balance C. O. D. On foreign orders remittance in full required. **ORDER TODAY.**
CHAS. HOODWIN CO.
 4240 Lincoln Avenue, Dept. F. 30 Chicago, Illinois

ACME WIRE PRODUCTS

Parvolt Filter and By-Pass Condensers, Aerial Wire—Stranded and Solid, Varnished Insulations, Coils.

THE ACME WIRE CO.
 NEW HAVEN, CONN.

the present and for the near future. The representative stated that the chain's seven studios were ample for present broadcasting needs and can be adapted to television when the occasion arises. The C. B. S. also plans to erect its television transmitter atop its building, it was said.

Television Advances

Mr. Aylesworth, when queried as to whether his plans for television broadcasting were based on any advances in the design of television receivers, said that the R. C. A. and other companies were making sufficient strides in that field to warrant his plans for sight transmission.

The annual report of the R. C. A. on March 10 stated that highly scientific and research development in television had been made in 1930 but that no attempt will be made to market such equipment commercially in 1931. The laboratories will pursue this phase of radio aggressively this year, however.

Before the first plans for Radio City were formulated, the R. C. A. made plans for the construction of its own forty-eight story building on the corner of Lexington Avenue and Fifty-first Street—three blocks east of the present Radio City site. The subsequent crystallization of plans for the construction of Radio City made it apparent that the opportunity for occupancy of the Lexington Avenue structure should not be sacrificed. The R. C. A., therefore, planned to move last month from its offices in the Woolworth Building to its own structure known as the R. C. A. Building.

Work on the R. C. A. Building was carried forward with the original intention and the building will be partially occupied by the R. C. A. until the completion of its still newer quarters in Radio City. The building is owned by a realty subsidiary of the R. C. A. and will be maintained as an investment through the leasing of office space.

Studio Design

Many new ideas in studio design and construction are planned by NBC engineers. Some broadcasting chambers will be more than three stories in height and will virtually be radio auditoriums rather than radio studios. Elaborate facilities for visitors' galleries from which program presentations may be observed through soundproof plate glass will also be provided. Pending advances in television, final and definite studio details were not announced. Progress in this field will be closely observed by NBC engineers and studios will be equipped accordingly.

All of the studios will be constructed with special emphasis on perfect acoustics. Many advances in the field of sound insulation are expected to be introduced in the Radio City development.

Radio City, already termed a "community of sound and vision," will be a memorable tribute to the industry which, in little more than a decade, established itself in a commanding position of entertainment and utility.

The stage, the screen, the concert hall and the microphone will be grouped into closer proximity than ever before and a constantly growing interchange of talent is anticipated.

Radio, the industry that greatly abetted the screen by making talking pictures practical, the industry that aided the stage by creating new standards in auditorium acoustics and sound amplification, the industry that aided the concert hall by creating widespread interest in good music, will now join forces with all of its contemporary fields to establish television presentations from Radio City.

Radio City is ideally situated for the interests of its tenants. It borders on the established theatrical, music, art and shopping centres of New York.

It is but four blocks from the present NBC building at 711 Fifth Avenue. St. Patrick's Cathedral, famous Catholic edifice, is directly opposite. Prominent churches of other denominations are also in the immediate vicinity. Numerous theatres, concert halls, hotels and night clubs are in close proximity. Many neighboring points are remote control pick-up locations.

Broadcast-Theatre Alliance

One interesting phase of the R-K-O tenancy of Radio City is the fact that the old Keith-Albee theatrical interests, now absorbed by R-K-O, were strongly opposed to radio broadcasting and for a long period refrained from permitting its contracted performers to approach a radio microphone. The R-K-O now, without doubt, heads the list of amusement enterprises advocating broadcasting affiliations. Mr. Brown stated that he did not fear any box-office losses through the broadcasting of both sound and vision from R-K-O stage presentations.

It is believed that Roxy's services, in addition to theatre management, will be employed in creating lighting and scenic effects for R-K-O and NBC television programs.

The opinion exists in radio circles that the erection of Radio City will draw many other radio firms to the vicinity, if not directly within the development. The neighborhood is expected to become a center of radio retail shops as well as music stores. The music publishing industry, now dependent on radio and the talking screen as the most powerful exploitation mediums for song hits, is also expected to be represented within the boundaries of Radio City. The possibility also exists that some of New York's smaller broadcasting stations will move close to the development.

Largest Industrial Undertaking

Never before has any American industry, no less a single group of firms, entered a project of such magnitude. It is a gigantic undertaking and has aroused world-wide interest and comment.

Broadcasting, not yet eleven years old, is moving into a quarter-billion dollar home. We wonder what it will demand when it becomes of age!

Stepping Out for World Wide Reception

(Continued from page 1079)

on phone, so that both sides of the conversation could be followed. We easterners have been led to believe that California residents talk of nothing but weather—and sure enough this west-coast “ham” brought up the subject of “radio weather” almost immediately. But for once the comments were unfavorable, because he reported severe static. Presumably he was complaining about the static as it affected the 40-meter band, but his signals were received in New York with practically no static at all—in contrast to the bad static prevailing on the broadcast band at the time.

Quite a number of broadcast stations were also heard on the short waves, but

The loud speaker constitutes the third unit. It is only the work of a moment to connect up the three units, all connections being provided in the form of cables and plugs. Once connected up, the power supply to all units is controlled by a separate switch, also provided, which can be attached to the outside of a cabinet.

Tuning

Tuning is accomplished by means of two drum dials. One controls the r.f. and first detector tuning condensers, which are ganged. The other tunes the oscillator. For short-wave reception plugging in the proper coil for a given band

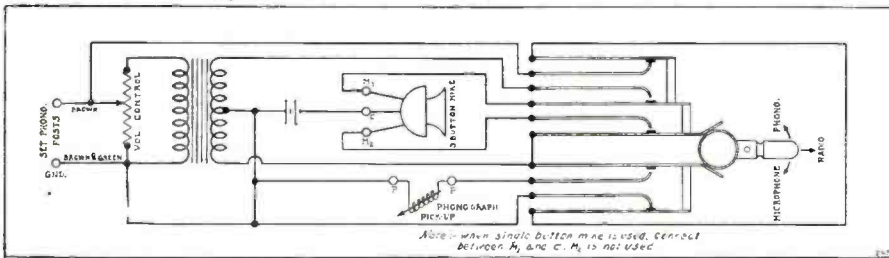

The circuit of the power supply unit, which includes the power output stage

time would not permit anything like a complete test of the receiver on the short-wave channels. Another test is to be made with special attention to the bands from fifteen meters up and the story will appear in the July issue.

The Scott receiver employs a total of twelve tubes. As indicated in the circuit diagrams, Figures 1 and 2, five are of the -24 type and are employed in the r.f.

automatically connects in the short-wave tuning condensers to correspond with the coils. To avoid the complications and inaccuracies of ganged condensers on the short waves the r.f. stage is tuned only in the broadcast range. For the short-wave bands the r.f. stage is untuned and is coupled to the antenna by means of a choke coil, thus leaving only one tuning condenser to be controlled by each dial. This results in maximum efficiency and precision in tuning, features which are of the utmost importance in short-wave work.

Other Controls

Two other controls are provided on the front panel. The one at the left provides three degrees of antenna coupling as indicated by the tap switch on the antenna coil primary in the circuit diagram, Figure 1. As a means of providing any desired degree of selectivity this arrangement works out to excellent advantage. Normally the center tap provides ample selectivity under practically all conditions, but where interference is particularly severe, as in the immediate vicinity of a powerful station, the lower tap provides the super-selectivity required.

The other knob is a volume control which is extremely smooth in operation and provides very gradual variation—an important feature.

Provision is made, in the form of two binding posts on the rear edge of the chassis, for connecting in a phonograph pick-up or microphone. A separate control box for phonograph and microphone switching is available, as shown in Figure 4. The circuit is shown in Figure 3. This control box is connected to the two bind-

(Continued on page 1117)



All shielding is plated and highly polished, giving to this receiver a highly attractive appearance

stage, first detector and three intermediate amplifier stages. Four -27's are used for the oscillator, second detector and the push-pull first audio stage. In the output power stage two -45's are used and a type -80 rectifier is included in the power unit.

The receiver chassis includes the receiver up to and including the first audio stage while the power output stage is included in the separate power supply unit.

- - Just published - -
Moyer and Wostrel's

RADIO HANDBOOK

HERE at last is a handbook that meets the need for a complete digest of authoritative radio data, both theoretical and practical, in one logically arranged and thoroughly indexed volume. From the fundamentals of electricity, magnetism and electron theory right down to full details on latest commercial and industrial applications, this book covers the whole field of radio, with descriptions, definitions, design data, practical methods, tables and illustrations in profusion.

886 Pages of
Latest Data on:

- television
- sound motion pictures
- modern transmitters
- latest vacuum tubes
- applications of vacuum tubes in industry
- photo-electric cells
- short wave apparatus
- broadcast receivers
- Pieze crystal, 100% modulation, etc.
- marine radio equipment, etc., etc.

See this book **FREE**
Send this coupon

McGraw-Hill
FREE EXAMINATION COUPON

McGraw-Hill Book Company, Inc.
370 Seventh Avenue, New York

Send me Moyer and Wostrel's Radio Handbook, post-paid, for ten days' free examination. I will send \$5.00 within ten days of receipt or return the book.

Name

Home Address

City and State

Position

Name of Company RN-6-31

1931 RADIO BARGAINS

Radio CATALOG WHOLESALE DISCOUNTS
LOWEST PRICES

REGULAR WHOLESALE TRADE DISCOUNTS!

Nationally-advertised, guaranteed radio merchandise, including the sensational **BONDED LAFAYETTE ALL ELECTRIC RADIO RECEIVER** with tone control. Write at once for **FREE 1931 Radio Bargain Catalog**, showing complete selection. Don't buy until you see this wonder catalog!

WHOLESALE RADIO SERVICE CO.
Dept. F-12; 38 Vesey St., New York

FREE!

ACCOUNTING LESSON

FREE

New Revised Course
Now Ready!

Find out about it by
trying it free

Send for our new book, "The Accountant—Who he is, What he does, How to become one," and the first lesson free of charge.

In reply please state age and position

INTERNATIONAL ACCOUNTANTS SOCIETY, INC.
A Division of the
ALEXANDER HAMILTON INSTITUTE
Dept. 366, 3411 So. Michigan Ave., Chicago

Servicemen—Dealers

Dial Cable Replacements

Genuine Bronze Dial Cable at Money-saving Prices

50-ft. coil, 7c. foot	100-ft. coil, 5c. foot
250-ft. coil, 4c. foot	500-ft. coil, 3c. foot

Standard size used by leading manufacturers of radio sets having drum type dials. Mailed C. O. D.

Address **MULLINS DIAL CABLE**
136 So. Mason Ave. Chicago, Ill.



ALL PROGRAMS Are Good With a FILTERMATIC FOR ALL RADIOS
 ONLY \$1.00 POST PAID
 Entirely Automatic
 No Bothersome Tuning
 Improves Tone—Reduces Static
 Brings in Distance
 Increases Volume
 Prolongs Life of Tubes
 Separates Stations
 Send Cash or P. O. Money Order
 Satisfaction Guaranteed or Money Refunded
AND NOW! THE SUPER-FILTERMATIC \$2.00 AERIAL OF THE FUTURE Post-paid

The Filtermatic Mfg. Co. wishes to introduce a remarkable invention named the SUPER-FILTERMATIC, which takes the place of all present type Aerials, in addition to having all the wonderful features the Filtermatic has, such as improving tone, reducing static, bringing in distance, eliminates lightning dangers, increasing volume and separating stations. The SUPER-FILTERMATIC will never wear out due to its rugged construction. It is very compact measuring only 1 1/2 inches, is absolutely non-directional, non-corrosive. It does not connect in the light socket; all A.C. hum and line noises are eliminated, it is easy to install (one minute time required), no tools needed, once installed no further attention required. It is the equivalent of an outside aerial 75 feet long and 50 feet high, more than sufficient for the modern set. The SUPER-FILTERMATIC is being introduced at the special low price of only \$2.00 post-paid. Satisfaction guaranteed or money refunded. Just stop and think, of the trouble and expense the Super-Filtermatic will save. If used to replace the expensive, unsightly dangerous outside aerial, THE SUPER-FILTERMATIC IS THE AERIAL OF THE FUTURE.

SERVICE MEN & Dealers Write for Our Attractive Offer
FILTERMATIC MFG. CO., Dept. B-10
 4458 Frankford Ave. Philadelphia, Pa.

Retable SERVICEMEN'S SET ANALYZER

- TESTS
- LINE VOLTS
- GRID-BATT.
- SCREEN-GRID TUBES
- CA-PACITY
- FILAMENT-VOLTS
- "C" BATT. VOLTS
- CATHODE-VOLTS
- PLATE-VOLTS
- GRID-TEST



WITH BATT.—CONTINUITY—RECTIFIER TUBE-TEST.
 Heretofore a set analyzer instrument making every possible accurate test to properly check all radio circuits and tubes has been sold for \$30.00 to \$70.00 wholesale—realizing the tremendous market open for a similar product, at a more modest price, we are manufacturing the instrument herewith illustrated in huge quantities, thereby enabling us to offer same to you at a fraction of its actual value. However, quality has not been sacrificed—\$14.70 NET. We guarantee 100% accuracy. Specially priced.

Free Catalog on Request
Radio Surplus Corp.
 56 Vesey St. No., New York, N. Y.

RADIO'S STANDARD TEXTBOOK

RADIO PHYSICS COURSE
 By Alfred A. Ghirardi, E.E.
 Instructor of Radio Communication and Applied Electricity in a Technical High School in New York, well-known author, formerly Consulting Engineer Pilot Radio & Tube Corp. and Associate Editor "Radio Design." Mr. Ghirardi is a rare combination of author and authority, with the added knack of making complicated things seem simple.

RADIO, TELEVISION, TALKIES
RADIO PHYSICS COURSE covers every phase of the radio and allied arts, including television and the talkies. 362 pages, 350 illustrations. Thoroughly up to date, it is used as a text book by a large number of Radio Schools, High Schools and Colleges all over the world.

Send cash, check or money order for \$2.50 direct to the publishers and **RADIO PHYSICS COURSE** will be sent postpaid.

Special Note: Mr. Ghirardi has consented to the publishers and **RADIO PHYSICS COURSE** personally a **autograph** of the **FIRST 500 books ordered from this announcement.** Order Now!

RADIO TECHNICAL PUBLISHING CO.
 Dept. B 22 West 21st Street New York City

Send for Your FREE **RADIO TROUBLE FINDER**
 (See Inside Back Cover)

INDEX TO ADVERTISERS

Acme Wire Company.....	1114
Aerovox Wireless Corp.....	1116
Alexander Hamilton Institute.....	1115
American Sales Company.....	1104-1117
American Transformer.....	1108
Amperite Corp.....	1101
Amy, Acheves & King.....	1110
Automatic Radio Co., Inc.....	1119
B	
Baltimore Radio Company.....	1106
Blan the Radio Man, Inc.....	1112
C	
Candler System, The.....	1116
Allen D. Cardwell Mfg. Corp.....	1118
Central Radio Laboratories.....	1117
Champion Radio Works, Inc.....	1097
Chicago Radio Apparatus Co.....	1101
City Radio Company.....	1099
Clarostat Mfg. Co., Inc.....	1119
Classified Advertising.....	1118
Coast to Coast Radio Corp.....	1104
Coyne Electrical School.....	1045
Crosley Radio Corp.....	1104
D	
De Forest Radio Co.....	1101
E	
Electrad, Inc.....	1110
Electric Soldering Iron Co.....	1117
Ellis Electrical Laboratory.....	1118
Excello Products Corp.....	1119
Experimenters Radio Shop.....	1117
F	
F. & H. Radio Laboratories.....	1112
Federated Purchaser.....	1118
Ferranti, Inc.....	1117
Filtermatic Mfg. Co.....	1116
Fox Engineering.....	1105
G	
Gernsbach Publications, Inc.....	1105
H	
Hammarlund Mfg. Co.....	1103
High Frequency Laboratories.....	1106
Holyoke Company.....	1107
Hoodwin Co., Chas.....	105-1114
I	
Insuline Corp. of America.....	1100
International Resistance Co.....	1102
J	
J. M. P. Mfg. Co., Inc.....	1116
L	
La Salle Extension University.....	1104
Lincoln Radio Corp.....	1107
Ludy Hotel.....	1120
Lynch Mfg. Co., Inc.....	1116
M	
Manson, Wood & Co.....	1110
Mason, Fenwick & Lawrence.....	1116
Massachusetts Radio & Telegraph School.....	1108
McGraw-Hill Book Co., Inc.....	1115
Metal Cast Products.....	1106
Midwest Radio Corp.....	1119
Mullins Dial Cable Co.....	1115
N	
National Co., Inc.....	1098-1107
National Radio Institute.....	1043
Nubor Radio Co.....	1110
O	
Omnigraph Mfg. Co.....	1105
R	
R. C. A. Institutes, Inc.....	1109
Racon Electric Co., Inc.....	1110
Radio Mfg. Association.....	1046
Radio Surplus Corp.....	1116
Radio Technical Company.....	1116
Radio Trading Co.....	1108
Radio Training Assn. of America.....	1041
Radio Treatise Co., Inc.....	1112
Readrite Meter Works.....	1113
Rim Radio Mfg. Co.....	1106
S	
Scott Transformer Co.....	1047
Shallcross Mfg. Co.....	1104
Short Television Lab., Inc.....	Second Cover
Sillman Company.....	1118
Silver-Marshall, Inc.....	Fourth Cover
T	
Telex Company.....	1119
Tilton Mfg.....	1114
Trans Radio Company.....	1103
U	
Universal Microphone Company.....	1112
U-R-O-N Industries.....	1107
V	
Van Nostrand Co., Inc., D.....	1110
Varion Products Co., Inc.....	1114
W	
Wellston Radio Corp.....	1108
Weston Electrical Instrument Corp.....	1111
West Side Y. M. C. A. Radio Inst.....	1120
Wholesale Radio Service Co.....	1115
Workrite Radio Corp.....	1120

SHORT WAVE WITH YOUR PRESENT RADIO



"THE SUBMARINER"

Short wave reception from all parts of the world is enjoyed by many users of "Submariners."
 No need to buy a special short wave receiver, as the "Submariner," attached to your receiver in a few seconds, will bring in reception for only a fraction of the cost.
 "Submariners" are available designed for operation with each type of receiver. They are priced from \$17.50 to \$27.50, with fixed wave band of 19-50 meters, or interchangeable coils of 13-145 meters. The "P" feature an exclusive "Submariner" achievement, enables you to get superior results with all of the newest receivers. The models JAT7, 19-50 meters, at \$22.50, or the JAT7, 13-145 meters, at \$27.50, have a tremendous wallop when attached to the
NEW SCREEN GRID SUPER-HETERODYNE receivers.
ORDER TO-DAY
 Sent postpaid upon receipt of price, or C. O. D. if \$1.00 accompaniment order. Foreign—Cash with order.
J-M-P MANUFACTURING CO., INC.
 3417 Fond du Lac Ave. Milwaukee, Wis., U.S.A.

BECOME A RADIO OPERATOR QUICKLY AT HOME BY CANDLER SCIENTIFIC SOUND METHOD

We teach you CODE in less than half the usual time. We've taught thousands in past 20 years, including former champion McElroy, whose speed was 56 1/2 wpm. Our methods originated by world's foremost CODE SPECIALIST, who instructs you personally. Endorsed by officials and 45000 Morse and Radio operators. Take up this great profession where steady jobs and rapid promotions are assured. BIG demand for CANDLER trained operators. Make a start TO-DAY! Send for FREE Brochure.
THE CANDLER SYSTEM CO., Dept. N-6
 6343 So. Kedzie Ave., Chicago, Ill.

Build Your Receiver with the Aid of BLUEPRINTS

A limited supply of blueprints still available on the following receivers:
 The Junk Box Short Wave Receiver..... 25c
 A Two Tube Reflex Receiver..... 25c
 How to Construct the Pre-Selector..... 25c
 A Bloopless One-Dial Two Tube Set... 25c
 Write to **RADIO NEWS, Blueprint Dept.**
 381 Fourth Avenue, New York City

MASON, FENWICK & LAWRENCE PATENT LAWYERS

New York City Washington, D. C.
 Established 70 years. Send sketches.
 Electrical, Aeronautical, Refrigeration and Chemical Inventions carefully handled. Practice before the U. S. Courts and the Patent Office. Prompt and careful service. Write us. Protect your inventions.
TRADE MARKS REGISTERED

THE MOST COMPLETE LINE OF CONDENSERS AND RESISTORS!



DEALERS AND SERVICEMEN!
 Standardize on Metallized
LYNCH RESISTORS
 Write for Special FREE Offer of \$3.50 Official Radio Service Manual (352 pages)
 Lynch Mfg. Co., Inc., Dept. N. 1775 B'way, N. Y.

Stepping Out for World-Wide Reception

(Continued from page 1115)

ing posts mentioned and thereafter a changeover from radio to microphone or phonograph involves simply flipping the control box switch.

A study of the receiver circuit diagram, Figure 1, and the power-unit circuit, Figure 2, will provide detailed information on the many worth-while features incorporated in the design of which space does not permit a detailed discus-

15 meters to	21 meters
21	27
27	38
38	84
84	184
200	550

The tuning capacity employed with the short-wave coils is much smaller than that employed with the broadcast coils. In the case of the coils for the lowest wave-

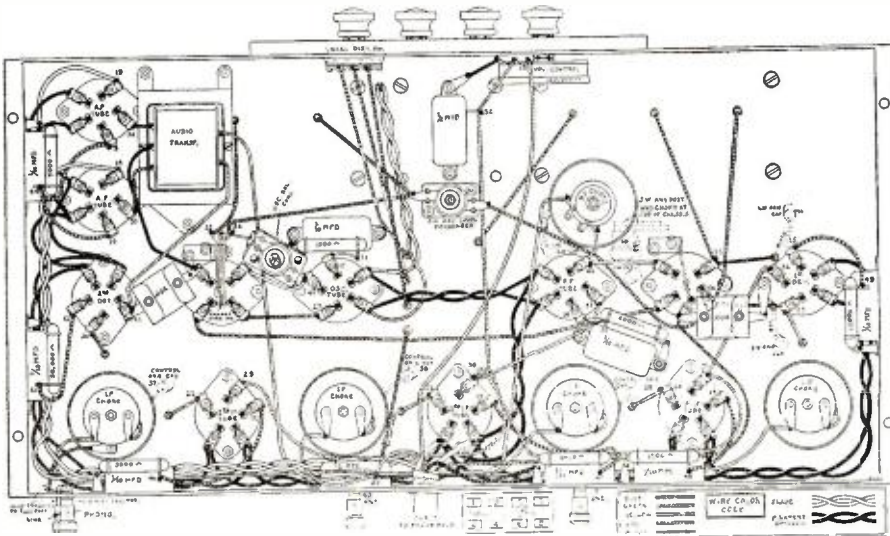

The under side of the chassis with the bottom plate removed, showing the layout

sion. One feature especially worthy of mention, however, is the design of the intermediate-frequency transformers. One of the complications of screen-grid circuits is the necessity for providing high impedance transformer primary circuits in order to approximate the output impedance of the tubes—that is, if good efficiency is to be obtained. On the other hand, a large primary winding, or a tuned primary is likely to provide a degree of coupling that mitigates against adequate selectivity.

In the Scott receiver this problem of obtaining high efficiency and ample selectivity at one and the same time is solved by inclosing the primary and secondary of the transformer in separate, individual shield cans, providing complete shielding from one another. The coupling between the two is accomplished by winding a relatively small coil directly over the secondary winding. This winding is then connected in series with the primary. The degree of coupling thus may be small, depending on the size of this pick-up coil and its location on the secondary winding, without sacrificing the desired high primary impedance. This design, in addition to providing any desired degree of selectivity, also tends to increase stability.

The receiver covers the entire broadcast spectrum, from 15 meters up to 550 meters, except for a small gap between 184 meters and 200, which contains nothing of interest for the broadcast fan. Six pairs of plug-in coils are used for the purpose. These cover the following ranges:

bands still smaller tuning capacities are employed. The shift from one set of tuning capacities to another adds no complications in operation, however, because the changes are made automatically. Each coil as it is plugged in makes its own connections to the proper capacities.

One of the features stressed by the manufacturer is the treatment of coils to protect them from the effects of moisture. Along the seaboard and particularly in some tropical areas this feature is an important one. The unusually complete shielding of the whole receiver is another safeguard against damage resulting from exposure to humidity, of course, but the coils not in use and therefore not in position within the shields need the protection provided by the special process of dehydration and impregnation to which all Scott coils are subjected.

The article covering the short-wave tests of this receiver which are to be made by the author within the next few days, and are to be reported in the July issue, will undoubtedly provide some real thrills. Authentic reports from Chicago indicate reception *daily* of short-wave broadcasts from England, Italy and South America. It is hoped that the article will also include a description of the new Scott short-wave station finder, an extremely simple device which has just been developed. This unit is intended to take the guesswork out of short-wave tuning, enabling the operator to determine instantly the wavelength to which the receiver is tuned.

its Popularity
DEMANDS
a SECOND
EDITION



Send for the 2d edition of this famous **VOLUME CONTROL Guide**, showing how to service most all old and new sets with a mere handful of **CENTRALLAB** controls. Contains a mine of practical information for the serviceman.



MAIL COUPON NOW

CENTRAL RADIO LAB.
922 Keefe Ave., Milwaukee, Wis.
Here is 25c. Send me new **VOLUME CONTROL GUIDE**

Address.....
Name.....
City..... State.....
Radio News

Get The Lowest Price-First!
on thousands of **NATIONALLY ADVERTISED ITEMS**
FROM THIS BOOK
Write for it!
AMERICAN
SALES COMPANY
N-44 W. 18th St., N. Y. C.

FREE

BETTER AMPLIFYING EQUIPMENT . . .

especially for exacting amplification requirements. **SPECIAL MATCHING TRANSFORMERS** giving flat response curves . . . built in U. S. A. shipped in 48 hours.

FERRANTI, Inc., 130 West 42nd Street
New York City

ESICO "Junior"
Reg. U. S. Pat. Off.



Does the work of a high priced electric iron. A high grade, durable 80-watt tool for the amateur or professional radio worker. Length 13 3/4 in., wt. 1 lb., 0 oz. cord, complete, \$2.75. At better hardware and electrical dealers or send direct to us if they can't supply you.
Electric Soldering Iron Co., Inc., 135 W. 17th St., N. Y.

MILLION PARTS

*7 mf. Splitdorf cond. block 1000 V. \$2.75, Farand Inductor dynamic unit \$1.59, High impedance r.f. choke coil 25c, Carbon wire wound strip or flexible resistances 12 for \$1.00, Brass pulley 25c. Variable resistances 50c, 245 voltage divider 50c.

EXPERIMENTERS RADIO SHOP
Dept. R.N.
129 West St., New York City Catalog Free

Anywhere

PPOINT your finger at the globe—anywhere. If Radio is known there—so, most probably, are CARDWELL condensers. Countless "Cardwell condensed" installations, the pride of their designers, cover every wave band and reach every corner of the earth. That outfit you contemplate building, if worth building at all, deserves

CARDWELL CONDENSERS

Send for Literature
THE ALLEN D. CARDWELL
 Mfg. Corp.
 89 Prospect Street, Brooklyn, N. Y.

FREE!



New Number Just Out
Over 2,000 BARGAINS
 IN EVERY MONTHLY ISSUE.

8 Pages

OF VALUABLE SERVICE DATA

Federated Purchaser
 20 HUDSON ST. N. Y. C.

RADIO PARTS

We carry one of the largest stocks of standard and replacement parts in the country. Our prices are lowest and all orders shipped the same day as received.

SEND FOR CATALOG

SILMAN CO.

614-620 Grant Street
 PITTSBURGH PA.

ELLIS MICROPHONES AND ACCESSORIES

WRITE FOR DETAILS



ELLIS ELECTRICAL LABORATORY

337 WEST MADISON ST. CHICAGO, ILLINOIS

Home Lab. Experiments

(Continued from page 1092)

Just as well as not we can take the same figures we used before. We then have:
 a.c. e.m.f. per foot candle
 Change in e.m.f.

Corresponding change in light

0.131 — 0.119

38.4 — 19.2

= 0.00064 volts
 = 0.64 millivolts

This means that every time we change the intensity by one foot candle the developed e.m.f. changes by 0.64 millivolts.

By means of the two constants just calculated we are able to calculate many interesting things. Suppose, for example, that we place the cell at a distance of 30 inches from a 100-watt type C Mazda bulb. The light intensity in foot candles can then be determined from Figure 4 (this figure gives intensity curves of a number of common types of lamps). In this case the intensity would be 30 foot candles approximately. Now if we modulated this light (caused its intensity to vary) from its normal up to 50 per cent. and then down 50 per cent. the foot candle intensity at the cell would vary 50 per cent. of 30, or 15 foot candles. The a.c. e.m.f. developed in the cell would therefore be:

A.C. e.m.f. in cell
 = variation in foot candles × e.m.f. per foot candle
 = 15 × 0.64
 = 9.6 millivolts

Now if we wanted to amplify this small a.c. voltage we would connect the cell to a transformer and a tube as shown in Figure 5. If we assume the input of the tube to be say 250,000 ohms then the impedance ratio of the transformer T would be:

$$Z \text{ ratio} = \frac{\text{Input resistance of tube}}{\text{Internal resistance of cell}}$$

$$= \frac{250,000}{430}$$

$$= 600 \text{ (approx.)}$$

The turns ratio will be the square root of the impedance ratio. Therefore

$$\text{Turns ratio} = \sqrt{600}$$

$$= 24.5$$

Half of the developed voltage will be lost in the tube, the other half will appear across the primary of the transformer. The primary voltage will therefore be 9.6 divided by 2 or 4.8 millivolts. The voltage across the secondary will be the primary voltage times the turns ratio, which gives

Secondary voltage
 = 4.8 × 24.5
 = 117.5 millivolts (slightly more than one-tenth of a volt)

This voltage would then be amplified by the tube. If a single tube could not give sufficient gain a two- or three-stage amplifier could be used to build up the voltage to a sufficiently large value. The above notes will, however, give a good idea of the procedure followed in designing amplifiers and photo-cell circuits.

Read Classified Advertising—It Pays

Advertisements in this section twenty-six cents a word for each insertion. Name and address must be included at the above rate. Cash should accompany all classified advertisements unless placed by an accredited advertising agency. No advertisements for less than 10 words accepted. Objectionable or misleading advertisements not accepted. Advertisements for these columns should reach us not later than 1st of 2nd month preceding issue.

Agents Wanted

Guaranteed Genuine Gold Leaf Letters anyone can put on store windows. Large profits, enormous demand. Free samples. Metallic Letter Co., 422 N. Clark, Chicago.

Business Opportunities

ARTIFICIAL MARBLE. Beautifully colored glossy tiles. No polishing, almost uncanny. Saws and planes, or hacksaw proof. Cheap, fireproof, enameled wood. Cement composition. Make tabletops, floors, base, bookstands, mantelpieces, novelties, imitation lumber, garden furniture. Astonishing samples with particulars. Mr. John B. Payne, 945 Grande Vista Drive, Los Angeles, Calif.

FREE "UNHEARD OF BOOKLET" (Describes Daily Problems). Increases income 300%. Art-Craft Publishers, Kossuth Ave., New York.

Correspondence Courses

Used correspondence school courses sold on repurchase basis. Also rented and exchanged. Money-back guarantee. Catalog free. (Courses bought.) Lee Mountain, Pisgah, Alabama.

CORRESPONDENCE COURSES—Sold, Bought, Exchanged, Rented. Bargain Catalogue Free. Hanfling, C-799 Broadway, New York.

Detectives

DETECTIVES. Work home or travel. Experience unnecessary. Particulars free. Write George Wagoner, 2190-X Broadway, N. Y.

For Inventors

INVENTIONS COMMERCIALIZED. Patented or unpatented. Write Adam Fisher Mfg. Co., 278 Enright, St. Louis, Mo.

Miscellaneous

"Resistances, Condensers, Transformers, Choke-Coils, Etc." Write for sensational low price list. BRONX WHOLESALE RADIO COMPANY, 5 West Tremont Avenue, New York.

USED CORRESPONDENCE COURSES. reference libraries, bought, sold. Fair prices and guaranteed savings. On radio, business, industrial, technical, professional and music courses. Write today: Educational Service, Box R-28, Wales, Wis.

Old Coins Wanted

OLD MONEY WANTED. \$5.00 to \$2,500.00 each paid for old coins. Buying catalogue 10c. Einar Cohen, Box 483, Muskogee, Okla.

Patent Attorneys

PATENTS—Write for Free Information, HOW TO OBTAIN A PATENT and RECORD OF INVENTION—or send Drawing or Model for Examination, MILLER & MILLER, Patent Attorneys (former Patent Office Examiners), 1006-D Woolworth Building, New York, 262 McGill Building, Washington, D. C.

PATENTS, TRADE MARKS—All cases submitted given personal attention by a member of the firm. Information and booklet free. Lancaster, Allwine & Rommel, 269 Ouray Building, Washington, D. C.

Inventors—Should write for our Guide Book, "How to Obtain a Patent," and Record of Invention Blank, sent Free. Send model or sketch of inventions for our inspection and instructions free. Radio, Electrical, Chemical, Mechanical and Trademark Experts. Terms Reasonable. Victor J. Evans & Co., 922 Ninth, Washington, D. C.

PATENTS—Advice and booklet free. Highest references. Best results. Promptness assured. Watson E. Coleman, Patent Lawyer, 724 9th Street, Washington, D.C.

Salesmen Wanted

Screw-holding screw drivers! Non-magnetic. Remove, insert screws inaccessible places! Factories, garages, electricians, carpenters, mechanics, auto, radio owners buy on sight! Free trial! Jiffy, 1810 Winthrop Bldg., Boston.

Short Wave Receivers

Build Latest Shortwave Receiver, \$10; operates Loudspeaker; European Stations Easy; AC or Battery operation. Plans, 65c; Transmitter, \$8; Plans, 60c; Both, \$1 Bill; Adapter Plans, 35c. DELFRADIO, 524 Fairbanks, Oakland, California.

Song Poem Writers

SUBMIT THEME SONG POEMS. Hollywood Composers. Box 387 EX, Hollywood, Calif.

SONGWRITERS: Read "Song Requirements of Talking Pictures, Radio & Records", and explanatory, instructive book SENT FREE to aspiring writers of words for songs. We compose, arrange and secure copyrights. Write today. Newcomer Associates, 1674-VV Broadway, New York.

SONG-POEM writers. We compose music. Guarantee publisher's acceptance. National, 1475 WK, Broadway, New York.

COMPOSERS—VERSE OR MUSIC. Brilliant opportunity. Write at once. Van Buren, 2351 McClurg Bldg., Chicago.

Telegraphy

LEARN WIRELESS (Radio) and Morse Telegraphy. School, oldest and largest; endorsed by Telegraph, Radio, Railway and Government officials. Expenses low—earn part. Catalog free. Dodge's Institute, Cour St., Valparaiso, Ind.

A Practical Home Televisor

(Continued from page 1094)

faithfully, audio frequencies of from about 15 to 30,000 cycles. This makes it necessary to use a receiver with a well-designed resistance-coupled audio amplifier.

In the next issue, the construction of an inexpensive and highly efficient receiver, designed especially for use with the television unit discussed in this issue, will be described.

The receiver mentioned is not limited for use as a shortwave television receiver. It has been so designed that by simply changing the plug-in coils it becomes a highly efficient receiver covering a wave band of from 545 to 20,000 kilocycles (550 to 15 meters), enabling the operator to use it not only for television but also for all shortwave and broadcast program reception.

In the July issue will be described the construction of a special wide-channel, short-wave receiver to be used with this televisor unit.

List of Parts for Television Unit

- 1 Baird television cabinet, equipped with viewing chute and lenses.
- 1 Baird type 121 synchronizing magnet unit (L).
- 1 Baird adjusting rod for magnet unit (LR).
- 1 Baird type 122 synchronizing phonic wheel (W).
- 1 spring washer for magnet unit assembly (W1).
- 1 retaining washer for magnet unit assembly (W2).
- 1 retaining spring for magnet unit assembly (SP).
- 1 bearing washer for phonic wheel (W3).
- 1 Baldor type MC2R motor (M).
- 6 rubber washers for cushion mounting motor.

- 6 metal washers for mounting motor.
 - 3 mounting screws for motor.
 - 3 nuts for motor mounting screws.
 - 1 Baird type 123 scanning drum (SD).
 - 1 Baird type 124 scanning belt (SB).
 - 2 Aerovox type 260, .25 mfd. condensers (C1, C2).
 - 1 Aerovox type 200-S, 1 mfd. condenser (C3).
 - 1 Aerovox type BAL, 2 mfd. oil-impregnated condenser (C4).
 - 1 Aerovox type 992, 3000-ohm pyrohm resistor (R1).
 - 1 Aerovox type 1094, 50,000-ohm carbon resistor (R2).
 - 1 Aerovox type 992, 1000-ohm pyrohm resistor (R3).
 - 1 Centralab type GR-150, 150-ohm giant rheostat (R4).
 - 1 110-volt a.c. "on-off" snap switch (S).
 - 1 Apollo 6-to-1 ratio audio transformer (T1).
 - 2 Pilot type 216, 4-prong sockets (NT, VT).
 - 1 5-prong tube base to serve as 5-prong plug (P1).
 - 1 standard 2-prong lighting plug (P2).
 - 1 wood baseboard for amplifier unit, 7½" x 4" x ½".
 - 1 type -45 power tube for socket "VT."
 - 1 1" plate neon tube for socket "NT."
 - 15 ½" No. 5 or ½" No. 6 round-head wood screws.
 - 8 ¾" No. 5 or ¾" No. 6 round-head wood screws.
 - 2 1" No. 5 or 1" No. 6 round-head wood screws.
 - 10 feet Corwico braidite hook-up wire.
 - 6 feet standard 2-wire lamp cord (length depends on distance of television unit from outlet).
 - 8 feet rubber-covered wire.
 - 4 feet rubber-covered wire.
 - 4 feet rubber-covered wire.
 - 4 feet rubber-covered wire.
- } Preferably of 4 different colors

All in a Day's Work

(Continued from page 1105)

connecting the 3350-ohm resistor connection to the 1000-ohm tap on the lower resistor (the resistor farther away from you, lug number 1); and soldering together these two disconnected bus wires. Disconnect the wire from the 3600-ohm tap on the lower resistor (lug number 2). The other end of this wire connects to the fourth terminal on the terminal strip. Reconnect to the extreme left tap on the lower resistor (1100 ohms). Connect the 80 and 500 ohm sections of the upper resistor in parallel by connecting a jumper between lugs 1 and 3, still counting from left to right, with the terminal strip to the left. This change increases the voltage applied to the screen grids, with improved reception. The three line-up condensers on the panel side of the chassis should now be readjusted for best response on some low wave signal and rechecked at a lower frequency. If it is found necessary to alter the line-up condensers for the higher waves, leave the adjustment set for the low waves, and bend the end plates of the condenser until no adjustment of the line-up capacitors is required for high and low-wave stations.

Radio Conference to Meet in Copenhagen May 27th

With Chairman Charles McK. Saltzman back at his desk at the Federal Radio Commission this week, after nearly a month's vacation and after the Commission's one-week Easter recess, attention of the radio world turns to the conference of international radio engineers scheduled to begin in Copenhagen on May 27.

This conference, devoted entirely to the engineering aspects of radio, brings together the government experts formed as the International Technical Consulting Committee on Radio Communications. Meeting under the provisions of the Washington radio convention, these experts lay the technical groundwork for the treaty-making conference of all the world's radio-using nations held every five years, the last in Washington in 1927 and the next in Madrid in 1932.

President Hoover recently named Dr. C. B. Jolliffe, chief engineer of the Federal Radio Commission, to head the American delegation to the Copenhagen meeting next month, although it had been generally assumed that General Saltzman, who headed the same delegation last year, would again be chosen.

EXCELLO RADIO



MIDGET

Quadruple Screen Grid with Tone Control

An ideal set that will meet the most exacting conditions and has every modern feature to insure fine performance.

Complete catalog free on request

EXCELLO

Products Corporation

4832 West 16th Street, Cicero, Illinois

THE NEW AUTOMATIC MOTOR CAR RADIO

Is your answer for the Spring and Summer Radio Business.

NEW AND FINER PERFORMANCE DESIGN PRICES

Write for Full Particulars

Automatic Radio Mfg Co., Inc.
118 Canal St., Boston, Mass.

Fascinating-Profitable LEARN TELEGRAPHY This Easy Way —



CARNEGIE—world-famous at telegrapher

Thomas A. Edison—Andrew Carnegie—most of the presidents of railroads and other world leaders got their start as telegraphers. Today—on land—sea—in the air, men who know the code are commanding big money—in the world's most fascinating profession. Learn At Home —with TELEPLEX—the Master Teacher. Write for Folder E-6.

Teleplex Co. 76 Cortlandt St., New York



Teleplex



SUPER Screen Grid \$4.95 Complete less tubes

All styles of latest cabinets

TRY IT 30 DAYS FREE BEFORE YOU BUY

Factory to you. Save to 50% on latest Screen Grid Electric or Battery Radio. Get 'Send No Money' Offer.

MIRACO Radio

Amazing bargains direct from big, old reliable factory. Don't buy unless 30 days' use proves entire outfit unbeatable at up to twice our price for tone, selectivity, distance, power, 1 yr. guar.

FREE! Send for BIG SPECIAL OFFER—No obligation.

Midwest Radio Corporation
11th Successful Year
804-DJ, Miraco Dept., Cincinnati, Ohio

GEORGE W. WALKER SUPER-CONVERTER



(Model No. 4)

Convert Your Present Radio Receiver Into a Short-Wave Super-Heterodyne

Listen to Foreign Programs with Pleasing Volume

WALKER SUPER-CONVERTER FEATURES

Four A.C. Tubes, including Screen Grid and No. 180 Rectifier. All A.C. operated.

Truly Single Dial Tuning

No changing of coils for the popular Short-Wave Band.

Adaptable for use with either battery or A.C. receivers.

Attractive in appearance with its neat and compact two-toned moire finished metal cabinet, which measures but 7"x7"x12" long.

The Walker Converter represents the result of several years of experience in the design of Short-Wave equipment.

Each device tested in actual operation at the factory, insuring uniform efficiency in performance.

COMPLETELY WIRED AND ASSEMBLED
(Less Tubes)

\$65.00

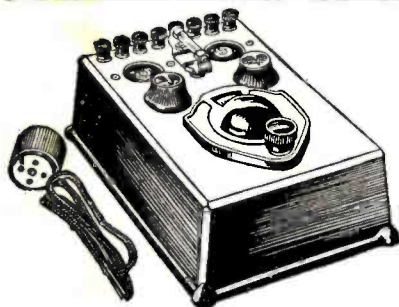

Showing No. '01 Adapter

Efficient reception of the entire wave band of 15 to 550 meters. Can be used with either A.C. or Battery receivers, or as an individual single tube receiver for short or long waves. Serves many purposes. Indestructible! Simple to operate—and inexpensive.

Write for Free Literature—Liberal Discounts to Dealers and Service Men

One of America's Pioneer Radio Manufacturers

THE WORKRITE RADIO CORP.

1806 E. 30th St. Cleveland, Ohio

FLEXI-UNIT A Flexible Radio Device of Unlimited Application—

Short-Wave Receiver, Short-Wave Adapter, Regular Broadcast Tuner, R.F. Pre-Amplifier (Booster), Radio "Experimental" Unit, Oscillator and Wave-trap. USE THIS UNIT AHEAD OF YOUR SHORT-WAVE TUNER AS AN R.F. BOOSTER.

Should your dealer be unable to serve you promptly—Mail your order direct to factory. **List Price \$16.00** including coils

No. '01 Adapter Plug (Battery)...\$2.00
No. '27 Detector Plug (A.C. Set)... 2.50
No. 27 R.F. Adapter Plug (A.C. Set). 3.00

Eight Meters in One

(Continued from page 1110)

but results in a very compact instrument. The constructional details are suggested in Figures 6 and 7.

The total list price of all parts used, except the panel, which was cut from scrap, is \$21.15. This may be considerably bettered by any experimenter with a "nose" for bargains, without sacrificing

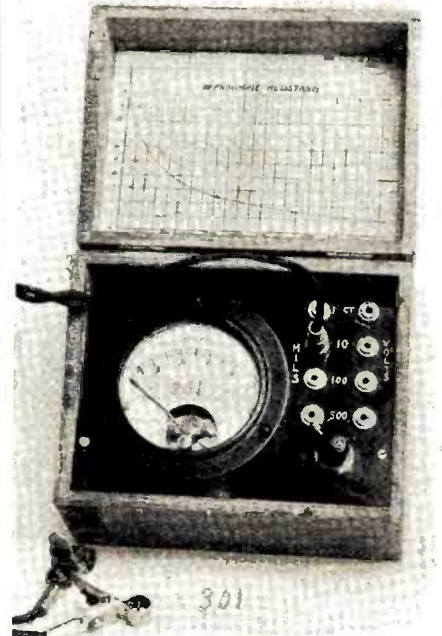

Figure 7. The finished meter

quality. The list price of separate meters of equal range and sensitivity would exceed \$100.00.

Following is the list of parts used. The symbols in parenthesis are those employed in Figure 5. Any parts with the proper values may, of course, be used:

- 1 Weston Model 301 Milliammeter, 0-1 (MA).
- 1 Shallcross Super Akra-Ohm, Type 6M, 10,000 ohms (R3).
- 1 Shallcross Super Akra-Ohm, Type 6M, 100,000 ohms (R2).
- 1 Shallcross Super Akra-Ohm, Type 6M, 500,000 ohms (R1).
- 1 Electrad Truvolt, Type B, 3000 ohms, with taps (R4).
- 1 Yaxley Midget Switch, No. A-760, DPDT (S).
- 1 Yaxley Pup Plug, No. 415.
- 8 Yaxley Pup Jacks, No. 416.

Backstage in Broadcasting

(Continued from page 1086)

naturally," Dr. Vizetelly tells his class. "Our o's should be rounded; our dentals dented; our labials lipped; our r's trilled; our b's and p's exploded; our ow's, iu's and simple u's harmonized; our h's aspirated in their proper places, and our final g's go unbobbed. Our words should drop from the lips like beautiful coins freshly issued from the mint, deeply and accurately impressed, neatly struck by the proper organs, distinct and sharp, in due succession, and of due weight."

RADIO OPERATORS WANTED



Radio operators are officers aboard ships. Well paid, pleasant work, travel. You can qualify in a short time in our well-equipped school under expert instructors.

Write now for free booklet on "Opportunities in Radio."

**West Side YMCA
Radio Institute**

113 West 64th St., New York, N. Y.

HOTEL LUDY
SOUTH CAROLINA AVE. AT THE BOARDWALK
ATLANTIC CITY'S
NEWEST CENTRALLY LOCATED FIREPROOF HOTEL
\$5.00
DAILY AND UP
AMERICAN PLAN
WIRE PHONE OR WRITE R.B. LUDY M.D.

Find Radio Troubles in 30 Seconds



FREE

Send for Your Gift Copy **NOW**

The Easiest Way to Learn Radio!

HAVE you ever invited friends to listen to a good radio program and then been keenly embarrassed because your radio wouldn't work? Has your radio reception ever been distorted or imperfect just when you wanted to hear every word distinctly? Most of us *have had* such experiences, and most of us *will have them* for years to come.

That's why our staff of expert radio engineers has especially prepared this RADIO TROUBLE FINDER volume for you. In times of need, it's worth its weight in gold. In simple words and easy-to-understand pictures and diagrams, it shows you just how to find and correct any radio trouble *quickly*.

Simple Charts Show You How

In the fastest form of reading—*by charts*—you learn at once what to do when tubes do not light; when tubes light and you get no reception; when your reception is weak. What to do when



A PROFITABLE RADIO REPAIR BUSINESS

This book will help you lay the foundation for a radio repair business in which hundreds of men earn as high as \$3.00 an hour. In many cases such a profitable side line has grown into a worthwhile full-time business. If you'd like to be your own boss, if you're searching for financial independence, send for this book today. It's FREE!

you get a hum or whistle; when your reception fluctuates; when your reception is distorted; when your power device overheats; etc.

After you have read this RADIO TROUBLE FINDER volume, you will know how to locate any kind of radio difficulty, and how to repair it in a jiffy!

Over a hundred thousand set owners already have the RADIO TROUBLE FINDER constantly at their elbows. They know that with it at hand they can depend on getting whatever radio programs they want, *when they want them!* Thousands have used the knowledge gained from this handy volume to make marked improvements in the reception of their sets, and in repairing the sets of friends. In many cases it has been the basis for starting a very profitable radio repair business.

These people have gladly paid real money for the RADIO TROUBLE FINDER. BUT, we have set aside a copy to be shipped to you, prepaid. ABSOLUTELY FREE!

A Gift from RADIO NEWS

We are offering you this remarkable volume FREE as an unprecedented reward for your merely accepting a six months' cut-rate introductory subscription to RADIO NEWS, the world's greatest radio magazine that no set owner should be without.

Do you want to know all about new sets and latest improvements? Would you like to know what goes on behind the scenes of the big broadcast stations and the inside stories of broadcast programs and artists? Do you know how to tell a good loud-speaker from a bad one? How to construct the latest power-supply unit? How to save money in servicing your set? *It's all in RADIO NEWS!*

If you are a DX fan, you'd probably like to have a list of every broadcasting station in the world. Or perhaps you'd like to experience the thrill of hearing foreign continents direct with a modern short wave receiver. Or perhaps it's television, auto radios, aviation radio telephony, or the projection and filming of talkies that interests you? *Frankly, whatever it is, if it's radio news you will find it in RADIO NEWS!*

That's why RADIO NEWS has practically twice as many readers as any other radio magazine. That's why you should read it too!

Send for Your FREE TROUBLE FINDER Volume TODAY!

Simply mail the coupon on the left and we will ship you your copy of the complete TROUBLE FINDER volume by return mail ENTIRELY FREE—at the same time entering your subscription to RADIO NEWS for the next six months at only \$1, saving you 50c on its regular newsstand value!

RADIO NEWS.

Dept. 2406, 381 Fourth Avenue, New York, N. Y.

Gentlemen: Ship me ENTIRELY FREE, postpaid, a copy of your RADIO TROUBLE FINDER volume—at the same time entering my subscription for the next 6 big issues of RADIO NEWS at only \$1 which I enclose. (Regular newsstand value \$1.50.)

Name

Address

City and State

Are you a serviceman Dealer Engineer Experimenter Radio Enthusiast

SM

YOU

Can Make Money as a Silver-Marshall Service Station!

If you are an agent, a radio dealer, a service man, or merely interested in radio from a technical standpoint, you should join the world-wide organization of 4,000 money-making Authorized Silver-Marshall Service Stations.

Special Discounts

They receive unusual discounts on superheterodyne chassis, cabinets, short-wave sets, converters, speakers, amplifiers, test equipment, replacement parts, and one hundred and forty other parts and sets.

Exclusive Receivers

The S-M superheterodyne Bearcat is handled only by Service Stations. There is unlimited profit and no competition. Sell them at list or at a discount to all your friends and acquaintances; or carry them as a plus-profit line in your store.

Special Offers

From time to time each Service Station receives special offers on certain Silver-Marshall equipment.

Latest Information

They are among the first to get full details on new equipment as it comes from the great S-M laboratories. They are given permanent subscriptions to the Silver-Marshall magazine, *The Radiobuilder*, and every new technical Data Sheet is supplied free as it comes from the presses.

Insignia of Authorization

Each Service Station is supplied with a certificate of authorization, an identification card, and is empowered to use the world-famous S-M trade-mark.

Consultation Services

Every Service Station, as an agency, is a part of the Silver-Marshall organization and is at liberty to consult at any time with our technical and merchandising staffs at no charge.



BEARCAT
\$84.50
LIST

The S-M Bearcat is an eight-tube superheterodyne receiver designed by the Silver-Marshall laboratories for the discriminating few who will have only the best. It is obtainable only from Authorized S-M Service Stations.

Superheterodyne Circuit.
Extension Speaker Jack to operate additional speakers in remote parts of the house.

Tone Control.
Three Screen-grid tubes—eight tubes in all.

Positive Ten K.C. Selectivity even on powerful local stations.

Sensitivity—fifty or more different station programs in an evening.

SILVER-MARSHALL, Inc.
6405 W. 65th Street
Chicago, U. S. A.

Please send me full details on becoming an Authorized Service Station.

Name.....

Address.....



No Obligation!

There are no strings attached to becoming an Authorized Service Station. There is no limit to the profits you can make—depends entirely upon the amount of time you spend operating your agency. Just send the coupon NOW and you will immediately receive full details.

SILVER-MARSHALL, Inc.

6405 West 65th Street • Chicago, U. S. A.