

# **RADIO NEWS**

**MAY  
25 Cents**

**Gauging  
"BLACK LIGHT"  
by Radio**

**Television  
Beam Radio  
Latest Circuits**

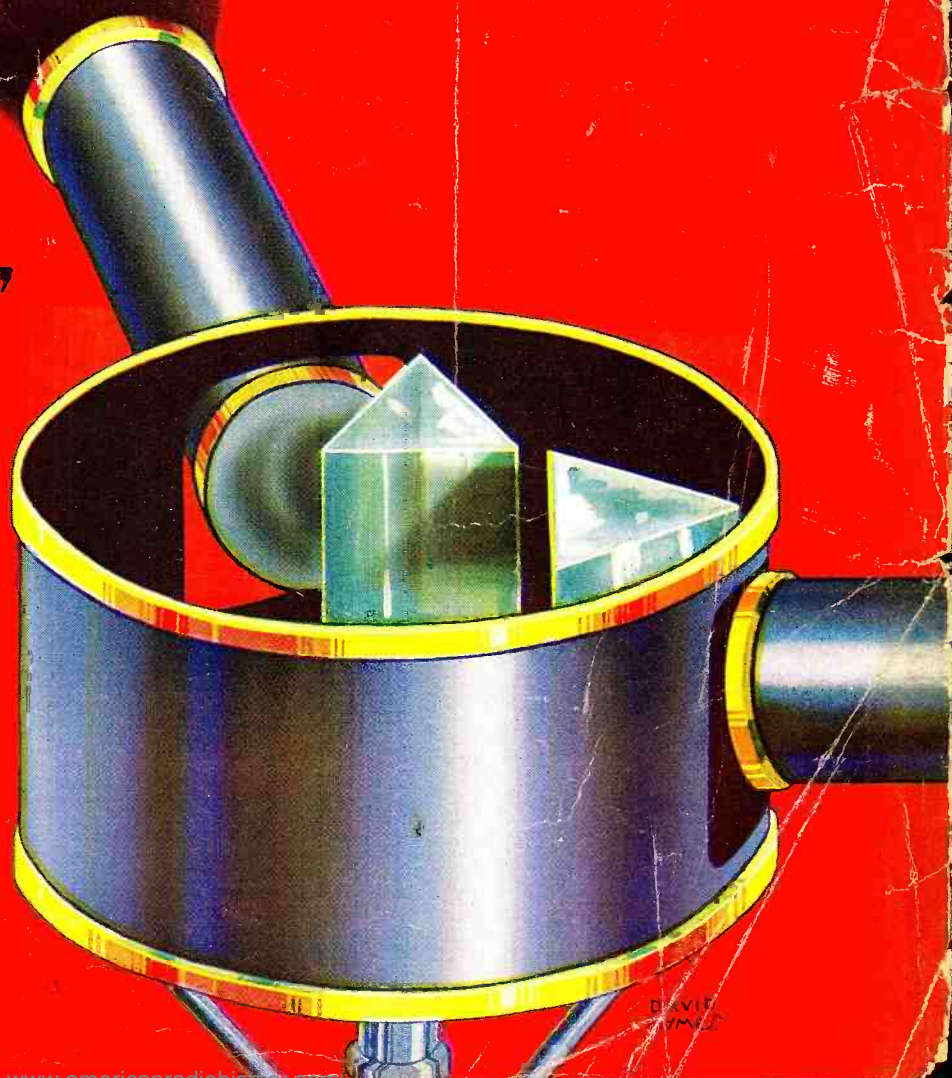

and **NOW** You can tune from  
**15 to 550 Meters**

A Brilliant *Engineering Feat* Enables the New  
**Lincoln DeLuxe**

S.W.-31.

to get-

**TELEVISION  
RE BROADCAST  
AMATEUR PHONE  
FOREIGN RECEPTION  
TRANS-ATLANTIC PHONE  
CODE·POLICE·AIR MAIL**

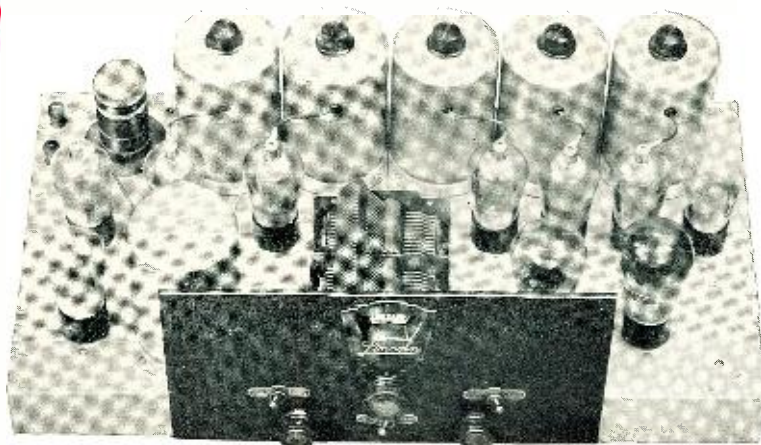

**One Dial Control—Tuned as Easily as Broadcast**

*Here is What Lincoln Engineers Have Achieved in the New SW-31*

1. Tremendous amplification sufficient to amplify a weak distant signal to local volume.
2. Sensitivity to pick up very weak signals.
3. Fidelity to reproduce perfectly all musical frequencies.
4. Daylight range to cover unlimited distance.
5. A simplified and stable method of receiving short wave transmission.
6. A new and simplified method of changing from short-wave to broadcast.
7. Perfect rejectivity on a 10 K.C. band.
8. A daylight range of 7000 miles in the Broadcast band.
9. A possibility of registering every channel in the Broadcast band.
10. A combination of broadcast reception, short-wave reception, and phonograph reproduction in one receiver.

LINCOLN ENGINEERS have at last perfected a new system which makes short-wave reception as easy to get as a local broadcast station.

**NO SHIELDS TO REMOVE  
NO CONNECTIONS TO CHANGE**

Tests, covering months, have consistently brought in to the Lincoln Laboratory reception on all short wave channels in daytime with local volume. The success of this marvelously new feature is augmented by the tremendously high amplification and extreme selectivity for which LINCOLN EQUIPMENT has been universally accorded. On Broadcast reception the LINCOLN DELUXE 31 has consistently outperformed any known receiver in the hands of the user. Claims made are not our statements but are unsolicited reports from individual owners.

**7000 MILES RECEPTION IN BROADCAST BAND**

is the report of one Lincoln owner in Shamrock, Texas. Quoting from his letter,—“I listened to 2YA, Wellington, New Zealand; heard their quartet numbers, soprano numbers and three band numbers. I heard the names of several numbers and some of the continuation of announcer besides the station announcement and sign off, or ‘shut down’ as they call it.” “I hear the Japs on 750, 770, 790 K.C.—Osaka, Sendai, and Kumamoto. I have verification by letter from KCMB, 500 watts, from Honolulu. I could hear a lecture being given by a woman over 2BL, Sydney, Australia on 855 K.C.” “Fifty stations received 100 watts and under. From Vancouver, B. C., CKMO, 50 watts.”

**SHORT WAVE IN AC AND DC MODELS**

Utilizing the same unique system both the Lincoln DeLuxe SW-31 and Lincoln D.C.-SW-8 are now available with the register from 15 to 550 meters. The D.C. model uses the new 2 volt low drain tubes with air cell “A” supply, requiring no charging, and with average use need be replaced but once a year. All equipment is strictly laboratory constructed by competent engineers who actually do every operation of construction. Parts used throughout are of the finest material, and design covers a period of years of intensive study of ultra performance.



*Send, Today,*

*for*

**LINCOLN RADIO CORPORATION**  
329 SOUTH WOOD ST., CHICAGO, ILL.

Complete information on Lincoln equipment to  
Dept. N5



**Train**  
with the R.T.A. ---where  
*Radio Employers*  
**Hire!**

**RADIO** NEEDS  
TRAINED  
MEN

LET US TRAIN  
YOU AT HOME  
FOR BIG PAY JOB

GET into the rich field of Radio via the Radio Training Association. Radio manufacturers, distributors, dealers are all eager to employ our members because we train them right, and qualify them for the positions that require better trained men.

Would you like to work "behind the scenes" at Hollywood, or for a talking picture manufacturer? R. T. A. training qualifies you for this work. Television, too, is included in the training. When television begins to sweep over the country, R. T. A. men will be ready to cash in on the big pay jobs that will be created.

So great is this demand from Radio employers that positions offering good pay and real opportunity are going begging. If you want to cash in on Radio quick, earn \$3.00 an hour and up spare time, \$40 to \$100 a week full time, prepare for a \$10,000, \$15,000, \$25,000 a year Radio position, investigate the R. T. A. now.

**Expert Supervision  
Lifelong Consultation Service**

As a member of the Association you will receive personal instruction from skilled Radio Engineers. Under their friendly guidance every phase of Radio will become an open book to you. And after you graduate the R. T. A. Advisory Board will give you personal advice on any problems which arise in your work. This Board is made up of big men in the industry who are helping constantly to push R. T. A. men to the top.

**Special Attention to Radio  
Service Work**

Thousands of trained Radio Service Men are needed now to service the new all-electric sets. Pay is liberal, promotions rapid. The experience you receive fits you for the biggest jobs in Radio. The R. T. A. has arranged its course to enable you to cash in on this work within 30 days!

Because R. T. A. training is complete, up-to-date, practical, it has won the admiration of the Radio industry. That's why our members are in such demand—why you will find enrolling in R. T. A. the quickest, most profitable route to Radio.

**Mail Coupon for No-Cost Training Offer**

Memberships that need not—should not—cost you a cent are available right now. The minute it takes to fill out coupon at right for details can result in your doubling and trebling your income in a few months from now. If you are ambitious, really want to get somewhere in life, you owe it to yourself to investigate. Learn what the R. T. A. has done for thousands—and can do for you. Stop wishing and start *actually doing something* about earning more money. Fill out the coupon and mail today.

**Radio Training Association of America  
Dept. RNA-5, 4513 Ravenswood Ave., Chicago, Ill.**

**Fill Out and Mail Today!**  
Radio Training Association of America  
Dept. RNA-5, 4513 Ravenswood Ave., Chicago, Ill.  
Gentlemen: Send me details of your No-Cost Training Offer and information on how to make real money in Radio quick.

Name \_\_\_\_\_  
Address \_\_\_\_\_  
City \_\_\_\_\_ State \_\_\_\_\_

# THERE'S A BIG PAY For the Trained Man in RADIO

Dissatisfied with your job? Not making enough money? Then let me show you how to get into Radio, the liveliest, biggest money-making game on earth. Thousands of opportunities for jobs leading to salaries of \$60 a week and up! Jobs as Designer,

Inspector and Tester paying \$3,000 to \$10,000 a year; as Salesman and in Service and Installation work at \$45 to \$100 a week; as Operator or Manager of Broadcasting Station at \$1800 to \$5000 a year—as Wireless Operator on Ship or Airplane, as Talking Picture or Sound Expert. Thousands of Big Pay opportunities for you to choose from!

## LEARN RADIO TALKING PICTURES By Actual Work in Great Coyne Shops -

Come to Coyne and learn all branches of Radio in ten short, pleasant weeks. NOT BY CORRESPONDENCE, but by actual work on scores of modern Radio Receivers, huge Broadcasting equipment, the very latest Television transmitting and receiving apparatus, Talking Picture equipment, etc. Broadcast yourself in our sound proof studio room!

Put on your own Television program! Learn Radio the practical way—by actual radio work on actual radio equipment!

You don't need advanced education or previous experience. I don't care if you are 16 years old or 46. Come to Coyne and I'll prepare YOU for a good paying Radio job in 10 weeks' time!



## TELEVISION IS NOW HERE!

And Television is already here! Soon there'll be a demand for thousands of Television experts. The man who learns Television now can make a fortune in this great new field. Get in on the ground-floor of this amazing new development! Mail coupon on the opposite page for full information—absolutely free!

Radio Division **COYNE**  
H. C. LEWIS, President  
500 South Paulina Street,

# JOB

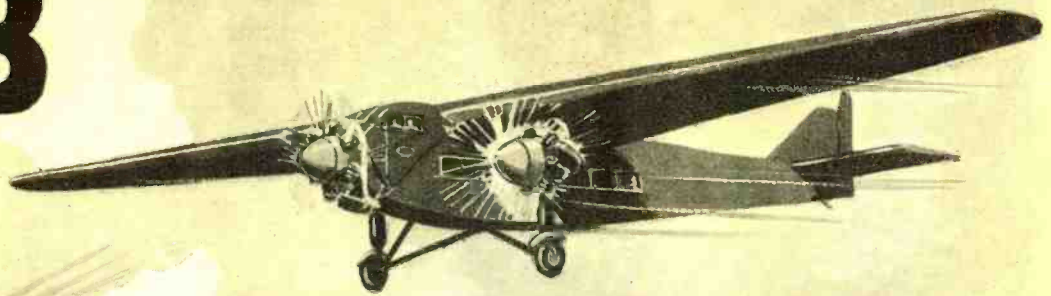

## Free Employment Service EARN AS YOU LEARN

You get free Employment Service as long as you live. And if you'll need part-time work while at school to help pay expenses, we'll gladly help you get it. Many of our students pay nearly all of their living expenses that way. Mail coupon below for full details.

# TELEVISION IN 10 WEEKS

## Not by Correspondence!!

Don't let anything keep you out of Radio! Start now, and after just ten short weeks of fascinating work in the great Coyne Radio Shops, you'll be all set for the best job and biggest pay you ever had in your life!

## Coyne is 32 Years Old!

Coyne Training is tested, proven beyond all doubt. You can find out everything absolutely free—how you can prepare for a good Radio Job or how you can go into business for yourself and earn \$3,000 to \$15,000 a year. It costs nothing to investigate!

## Mail Coupon for My Big Free Book

Fill in this coupon, tear it out and mail it to me at once. This will not obligate you in any way and positively no salesmen or agents will call on you. It will bring you—ABSOLUTELY FREE—a copy of my big Radio and Television Book, telling all about jobs, salaries, opportunities, etc. MAIL THE COUPON—NOW!

**Electrical School**  
Dept. 51-8C Chicago, Illinois

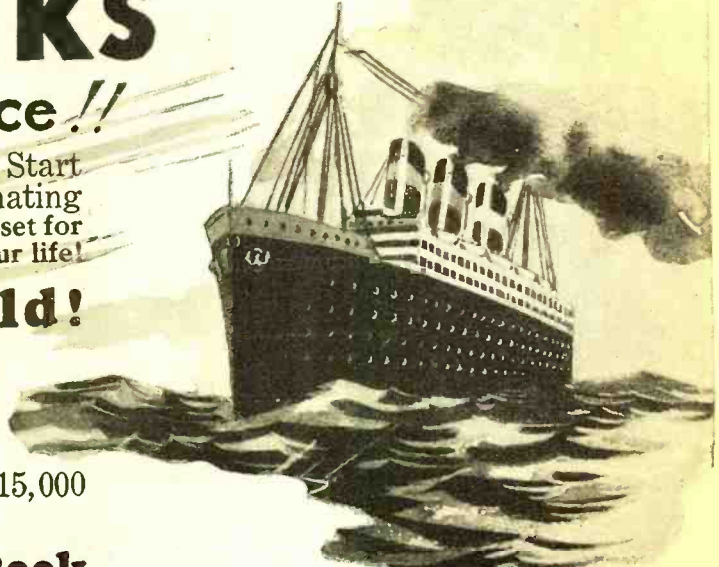

H. C. LEWIS, President  
**Radio Div. Coyne Electrical School**  
500 S. Paulina St., Dept. 51-8C, Chicago, Ill.

Send me your Big Free Radio Book and all details of your Special Introductory Offer. This does not obligate me in any way.

Name.....

Address.....

City.....State.....

LAURENCE M. COCKADAY  
*Editor*

ALBERT PFALTZ  
*Associate Editor*



S. GORDON TAYLOR  
*Technical Editor*

WILLIAM C. DORF  
*Associate Editor*

VOLUME XII

May, 1931

NUMBER 11

## CONTENTS

*(Cover Designed by David Hymes)*

Do the Planets Affect Radio? By <i>E. E. Free</i> .....	PAGE 969	The Boston Television Party By <i>Joseph Calcaterra</i> .....	PAGE 986
Europe on the Wire By <i>Zeh Bouck</i> .....	PAGE 971	Testing Power Transformers By <i>Herbert M. Isaacson</i> .....	PAGE 989
15 to 550-Meter Superheterodyne By <i>W. H. Hollister</i> .....	PAGE 974	Transmitter and Receiver = 9 Pounds By <i>Samuel Egert</i> .....	PAGE 990
Producing a Radio Drama By <i>Albert Pfaltz</i> .....	PAGE 976	Junior Transmitter—Part V By <i>Don Bennett</i> .....	PAGE 993
Music from Radio Tubes By <i>Louis F. Leuck</i> .....	PAGE 979	Solving the Band-Spread Problem By <i>James Millen</i> .....	PAGE 996
Gauging "Black Light" by Radio By <i>C. C. Clark and C. A. Johnson</i> ..	PAGE 980	"Scanning" Without a Disc By <i>Arthur H. Halloran</i> .....	PAGE 998
History of Receiver Design By <i>John F. Rider</i> .....	PAGE 983	Radio-Frequency Chokes By <i>Donald Lewis</i> .....	PAGE 1000

## DEPARTMENTS

The Service Bench.....	PAGE 1002
Junior Radio Guild.....	PAGE 1004
Backstage in Broadcasting.....	PAGE 1006
What's New in Radio.....	PAGE 1007
Home Laboratory Experiments.....	PAGE 1008
In the RADIO NEWS Laboratory.....	PAGE 1010
Latest Radio Patents.....	PAGE 1012

*Published Monthly by Radio-Science Publications, Inc., Jamaica, N. Y.*

### OFFICERS

W. Z. Shafer, *President*  
G. L. Harrington, *Vice President*  
Laurence A. Smith, *Treasurer*  
Byrd D. Wise, *Secretary*

### EDITORIAL AND EXECUTIVE OFFICES

381 FOURTH AVENUE, NEW YORK CITY, N. Y.

Entered as second class matter at the Post Office at Jamaica, N. Y., under the act of March 3, 1879. Copyright, 1931, by Radio-Science Publications, Inc. All rights reserved. Title Registered at the U. S. Patent Office. Printed in the United States of America. The contents of this magazine must not be reproduced without permission. We cannot be responsible for lost manuscripts, although every care is taken for their safety.

25c a Copy, \$2.50 a year, \$3.00 in Canada, \$3.50 in Foreign Countries. Subscribers are notified that change of address must reach us five weeks in advance of the next day of issue.

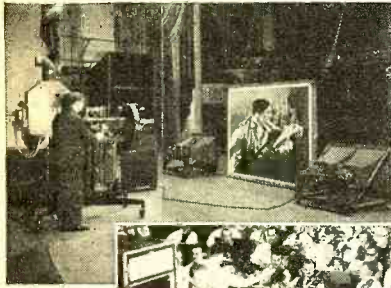

Television--the coming field of many great opportunities--is covered by my course.

Talking pictures--an invention made possible only by radio--offers many fine jobs to well trained radio men.



**YOU MUST HAVE NRI TRAINING to be a CERTIFIED RADIO-TRICIAN**

My course is the ONLY one that makes you a "Certified RADIO-TRICIAN." The U. S. Government grants me exclusive right to give that distinctive title to all who complete my training. It will mean valuable recognition to you in whatever branch of Radio you follow and will help open the door to bigger pay. Even before you graduate I give you business cards and a "JUNIOR RADIO-TRICIAN" card, which many of my students find helpful in earning money in spare time. My course has helped hundreds of men. It will help you. Send for my free book and you'll see why.

**Seldom Under \$100 a Week**



"Dear Mr. Smith: For the month of November I made \$577 and for December over \$645, and January, \$465. My earnings seldom fall under \$100 a week. I'll say the N. R. I. (National

Radio Institute) course is thorough and complete. — letter from graduate, E. E. Winborne, 1267 W. 48th Street, Norfolk, Va.

**Unlimited Consultation Service**

You can keep yourself posted on new developments without extra cost. Radio's change and growth bring new opportunities for the man who understands them. You'll have our whole Staff at your service to keep you informed.

# The One Sure Way to BIG PAY in RADIO

## Send for my Free Book See how Quickly I Train You at Home to Fill a Big-Pay Radio Job

In Radio more than in any other field, the surest, quickest way to get ahead is through training! For Radio is in crying need of more well-trained men. Competition is keen among the untrained fellows but the way is wide open for men who know Radio! Moreover, there are plenty of opportunities to earn while you learn—many of my students make \$200 to \$1000 in their spare time while learning. That is why I urge you to mail the coupon below for my free book. It tells about the great money-making opportunities that Radio offers trained men—and how you can learn at home to become a Radio Expert.



J. E. SMITH, Pres.



Broadcasting stations offer fascinating jobs, paying from \$1800 to \$6010 a year.

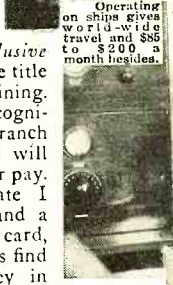

Operating on ships gives world-wide travel and \$85 to \$200 a month besides.



Radio factories employ thousands. Salaries for well trained men range from \$1800 to \$6000 a year.



Spare-time service is paying N. R. I. men \$200 to \$1000 a year.

### Many Earn \$50 to \$100 a Week

Many of my graduates are earning \$50 to \$100 a week. After completing my training you, too, should earn as good or even better pay. Hundreds of fine jobs are opening every year. Broadcasting Stations pay \$1,800 to \$5,000 a year to Radio engineers, operators, and station managers. Radio manufacturers continually need testers, inspectors, foremen, engineers, service men, buyers, for jobs paying up to \$15,000 a year. Shipping companies use hundreds of operators, giving them good pay plus expenses. Radio dealers and jobbers pay \$30 to \$100 a week to trained service men, salesmen, buyers, managers. Talking Movies pay as much as \$75 to \$200 a week to men with Radio training. Another way to make big money is to open a spare time or full time Radio sales and service business of your own. And any day now Television may open the way to a new world of opportunities to men who know Radio.

### My Free Book Tells All

Get the whole story. Send for my 64-page book of facts on the many opportunities for trained men in Radio today. It has put hundreds of fellows on the road to bigger pay and success. It also contains full information on the "Eighteen Star Features" of my home-study training, including Lifetime Employment Service to graduates. I back my course with a signed agreement to refund every penny of your money if, after completion, you are not satisfied with the Lessons and Instruction Service I give you. Don't let lack of complete training keep you down. Fill in and mail the coupon NOW!



**J.E. Smith, Pres., NATIONAL RADIO INSTITUTE Dept. 1-ER. WASHINGTON D. C.**

**FREE 64 page BOOK**



## Mail Coupon Today

J. E. SMITH, President National Radio Institute, Dept. 1-ER Washington, D. C.

Dear Mr. Smith: Send me your free book. I want to know exactly what Radio offers trained men—and what you offer in home-study Radio training. I understand this places me under no obligation and that no salesman will call.

Name.....  
Address.....  
City..... State.....

# The Editor—to You

WITH THIS issue of RADIO NEWS there begins, on page 1012, a new department listing and describing briefly the latest radio, television and acoustical patents as they are issued by the United States government. Wherever possible these descriptions include schematic drawings that illustrate the inventions. The department is conducted by a well-known patent authority and will contain what are considered to be the most important inventions of the month. Engineers and inventors, as well as other technical workers in the designing and manufacturing radio fields, will thus find in the future issues complete references to patent developments as time goes on. No radio laboratory or factory can afford to be without this valuable information.

Do you know just what physical factors in the universe combine to make good radio transmission and reception? Cold weather? Freedom from electrical disturbances in the atmosphere? Yes, it is true that these do play their part but the scientists now tell us there are "extenuating circumstances" far out in the solar system itself which make our radio weather for us.

Read what Dr. E. E. Free has to say about the effects of the planets upon terrestrial radio transmission and reception.

WHILE on the subject of transmission, readers who are interested, but have never experimented along this line, will find an article in this issue describing a tiny but efficient portable short-wave transmitter and receiver that they can build to help them break into the amateur game.

It is truly remarkable what vast distances can be covered on the short waves, with a tiny amount of power. The editor has just received a communication from Elias J. Pellet of Barranquilla, Republic of Colombia, South America, regarding his short-wave broadcasting station there. Mr. Pellet, a young Colombian engineer who studied at the University of Santa Clara, California, in 1927, built his station over a year ago. The station has been heard practically all over the United States during the early part of 1930, although it uses only 7 watts of power. It now broadcasts on a wavelength between 41.1 and 42.9 meters or 7000 or 7300 kc.

THE call letters of Mr. Pellet's station are HKD and the circuit used is of the tuned-grid tuned-plate variety, with a -10 tube as oscillator and two -50 tubes used in a 100% modulation system. The antenna is a half-wave voltage-feed Hertz Zep. HKD is on the air regularly every Monday, Wednesday and

Friday between 8:30 and 10:30 p.m. Eastern Standard Time. Mr. Pellet writes: "Since 1925 I have never missed a copy of your wonderful and interesting magazine. I like it more and more every day and keep all the past issues for reference. If any of your readers hear my station and will write to me, they will receive a beautiful souvenir from the station. Address all communications to radio station HKD, Box 715, Barranquilla, Republic of Colombia, South America."

RECEPTION of short-wave signals from American amateur stations was reported to the editor, recently, from London, England, by B. M. Holbrook. In a letter, Mr. Holbrook said: "Reception on the 40-meter wave-band last night, February 18th, was exceptionally good. I was successful in receiving the under-mentioned 'hams' from your side of the pond and I think they would like a QSL of their good DX. Hence I enclose rough cards, if you would be so good as to forward them to W2CCY, W3CGA, W2AMA, W1ALA and W1FT." Thank you, Mr. Holbrook. The cards are being forwarded.

RADIO NEWS has always realized and accepted its responsibilities in giving aid to radio servicemen and the present staff is determined to keep up this tradition and to improve its helpfulness as far as possible. Clifford E. Howard of Portland, Oregon, writes: "I have been a reader of RADIO NEWS since the days of the *Electrical Experimenter*. I find it better each year and have become a subscriber. Your constructional articles on testing instruments have been of inestimable value to me in the servicing of receivers of various types." Here is proof, from an "old-timer," of the high regard our servicemen readers have for RADIO NEWS.

CONSIDERABLE interest has been awakened among the broadcasting authorities by the article appearing in the April issue, from the pen of Lieut. Wm. H. Wenstrom. This article dealt with a suggested plan for broadcasting over the whole country, from a superpower high-wave station. Lieut. Wenstrom is continuing the second article of this series in the June issue. He then takes up the design of the transmitter and the antenna equipment for such a station. In his third article he will discuss the receiver details and the trends of design that will lead up to this development.

THE editor has always been keenly interested in the development and progress made in television. He believes that large groups of his readers also consider this subject of great importance. Two articles, appearing currently,

tell of the latest experiments in television broadcasting and of the newest technical developments in this latest offspring of the radio science.

BROADCAST listeners who are interested in receiving short waves as well as the regular wave-bands will be interested in the description on page 974 of a new superheterodyne that can be shifted from one wave-band to the other by merely turning a switch. Short waves and broadcasting on the same set!

IN THE June issue there will appear a constructional article on the new Universal Super-Wasp short-wave receiver which covers the range from 15 to 650 meters, without plug-in coils. The wavelength change is accomplished with a pair of ingenious cam switches. This new receiver is a development of the original Super-Wasp short-wave set which already has a well-established DX reputation. A set of this kind will bring in distant programs at practically any time during the day and night.

STUDIO men and the artists who broadcast will be interested in the story of "Producing a Radio Drama," appearing on page 976. They will also find the new department, Backstage in Broadcasting, newsy, informative and valuable in keeping in touch with what is going on, out in front of the microphone. This department is conducted by Samuel Kaufman, formerly radio program editor of the New York *Herald-Tribune*, who is personally acquainted with the bright lights among the artists, the producers and the executives, and who writes in a chatty, intimate style.

THE editor wishes to thank the many old friends he has discovered among the readers of RADIO NEWS, who have written him letters of encouragement and friendly suggestion. That we are following out a popular plan of increasing helpfulness to our readers seems to be substantiated by the fact that the newsdealers have reordered heavily the last two issues of the magazine, and many new subscriptions are coming in as the result of readers missing the last copy on the newsstands.

SHORT-WAVE enthusiasts will be happy to learn that in the June issue there will appear—but no, the editor thinks it may be more of a surprise if he reserves this announcement for the coming issue. Don't forget to be sure of your June copy.

Samuel Kaufman



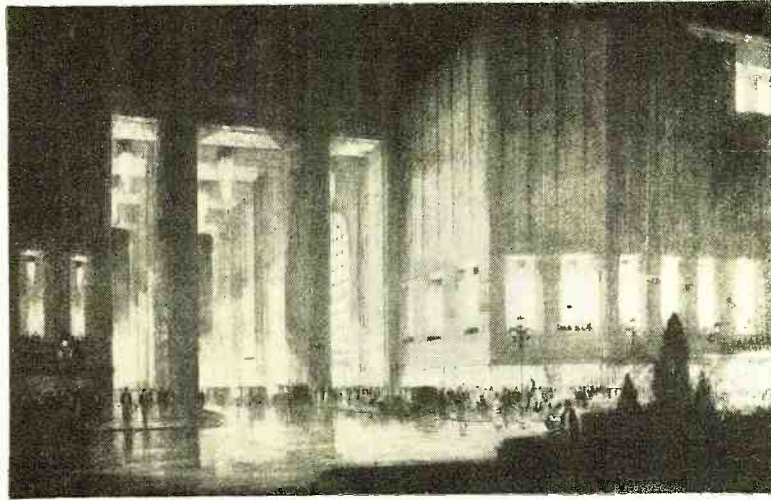

## A Radio Metropolis of the Future

An artist's conception of the view, from the Plaza, of the \$250,000,000 amusement center that is to occupy three square blocks in the heart of New York City. The radio metropolis will house complete broadcasting and television studios, as well as vaudeville and motion picture theatres and possibly an opera house. Work on this new giant radio enterprise, which will combine, in one area, a complete musical and broadcasting center, is to start this month and may be completed in 1934.

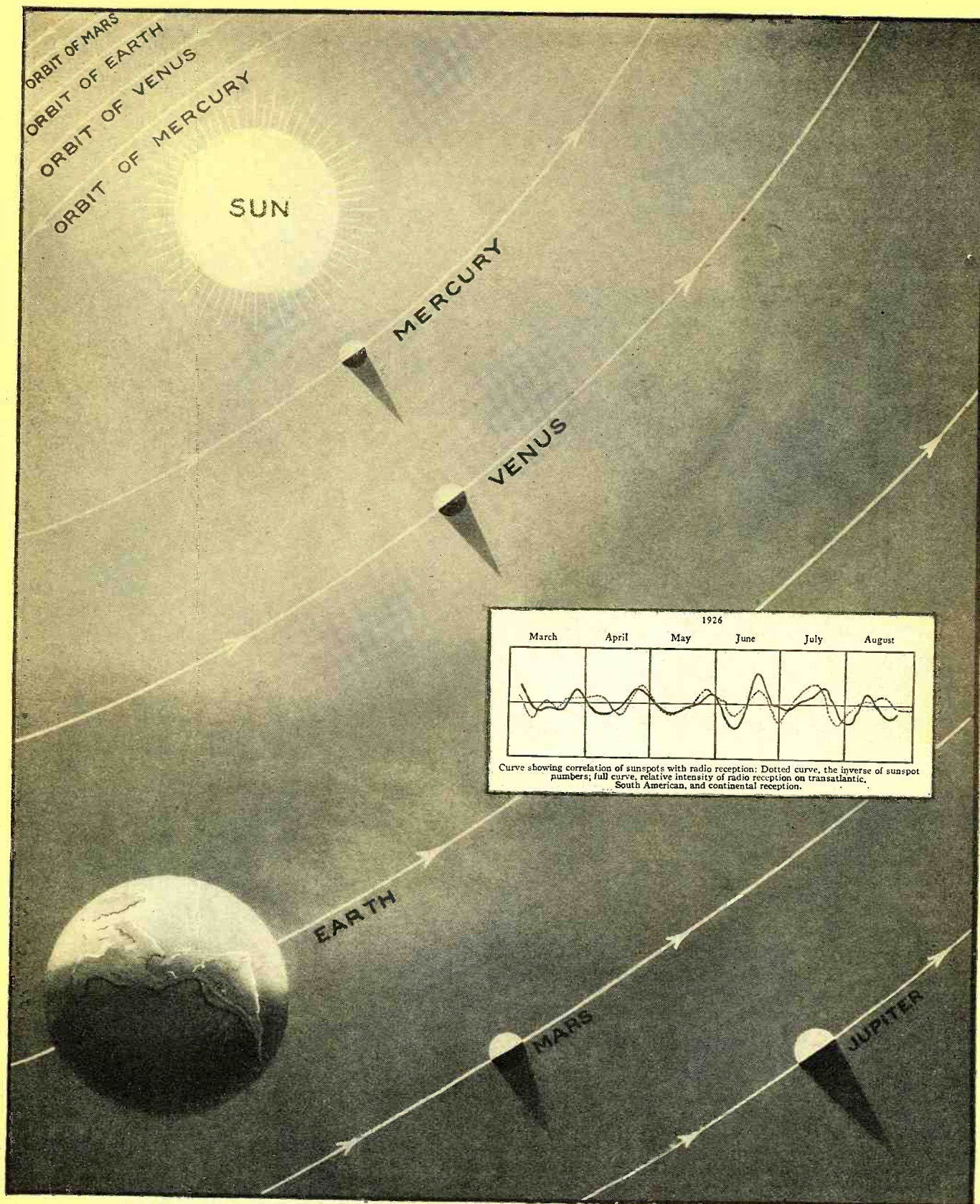

**W**HEN three planets get in line so that their enormous gravitational pulls act together on the sun, even that giant luminary feels something happen. (The gravitational force that keeps the earth in its orbit instead of flying off into space equals the combined strength of millions of steel cables each eleven inches thick and one attached to each exposed square foot of the planet's surface. Pulls by other planets are equally gigantic.)

This diagram shows how Mercury, Venus and Jupiter may come at long intervals to be in one line and how they act when this happens to lift greater tides on the sun. Tides and orbits are somewhat distorted in scale to get everything on one page. Such effects of planets on the sun have been found to affect the number of sunspots, as well as other phases of the sun's activity. The solar changes, in turn, influence our radio reception.

# Do the Planets Affect Radio?

*That radio conditions vary from year to year has long been recognized, as has also the fact that these variations follow more or less regular cycles. Scientists are casting about for the reasons and Dr. Free's suggestions as given in this article are well worth careful weighing*

**T**HE newest branch of radio science might be called radio "astrology." It has been many years since any competent scientific man put the slightest faith in the supposed effects of the movements of the planets on human lives or cast himself a horoscope to predict success or to decide whom he should marry. But within the past few months scores of perfectly sane and sober physicists, astronomers and radio engineers have turned hopefully to the stars to predict what radio reception will be like for the next twelve months.

They are thinking, of course, of very different relationships than were in the minds of ancient astrologers and casters of horoscopes. Yet that the place of the planets in their orbits does influence terrestrial things like radio now seems unmistakable, however little these same planets may have to do with wars or marriage or the characters dealt out to babies as they are born.

At the meeting of the American Association for the Advancement of Science a few weeks ago at Cleveland, Ohio, no less an authority than Professor Harlan T. Stetson, director of the astronomical observatory at the Ohio Wesleyan University, joined the new radio "astrologers" with a report of year-long studies in which radio disturbances were detected whenever the two inner planets of the solar system, Mercury and Venus, were in line with the sun, an event which recurs approximately every fifteen months. The connec-

By E. E. Free, Ph.D.

tion is due, Professor Stetson suspects, to powerful electric actions of the two planets on the sun, followed by similar electric influences of the sun on the earth.

Professor Dinsmore Alter of the University of Kansas, who has attained world-wide reputation by his studies of sunspots and of their terrestrial effects, agrees that radio may be affected by the positions of the planets, but traces the connection through sunspots instead of by some more direct electric link. The movements of the planets, Professor Alter believes, affect the condition of the sun so that sunspots are few or many. Side by side with this goes a variation in the intensity of sunlight, especially in the sun's

emission of the invisible ultra-violet rays. These rays are known to alter the upper layers of the earth's atmosphere in the region of the Heaviside layer. This is believed to be what affects earthly radio.

That correspondences between the number of sunspots and good or bad radio conditions actually exist has been proved, definitely enough to satisfy anybody, by the distinguished American radio engineer, Dr. Greenleaf W. Pickard; so this part of the theory may be taken as unquestionable. And the more strictly astronomical parts, like the assumed effects of planets on the conditions of the sun which is indicated by sunspots, has the support of equally high scientific authority, especially of Professor Ernest W. Brown of Yale, acknowledged world authority on the motions of earth, sun, and moon.

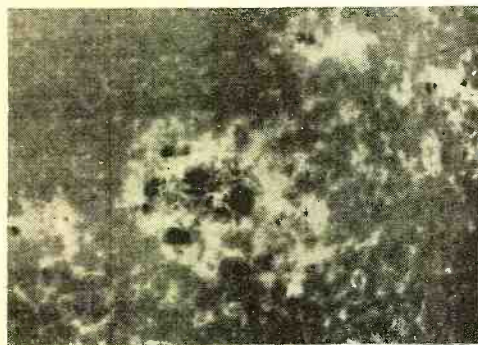

Above is a close-up of a sunspot group, photographed by the light emitted from one kind of atom. The white flecks are spots of more intense heat and solar activity surrounding the cooler areas of the sunspots themselves. Below are flaming "prominences" on the sun's surface caused by jets of hot hydrogen gas. The white dot is the size of the earth

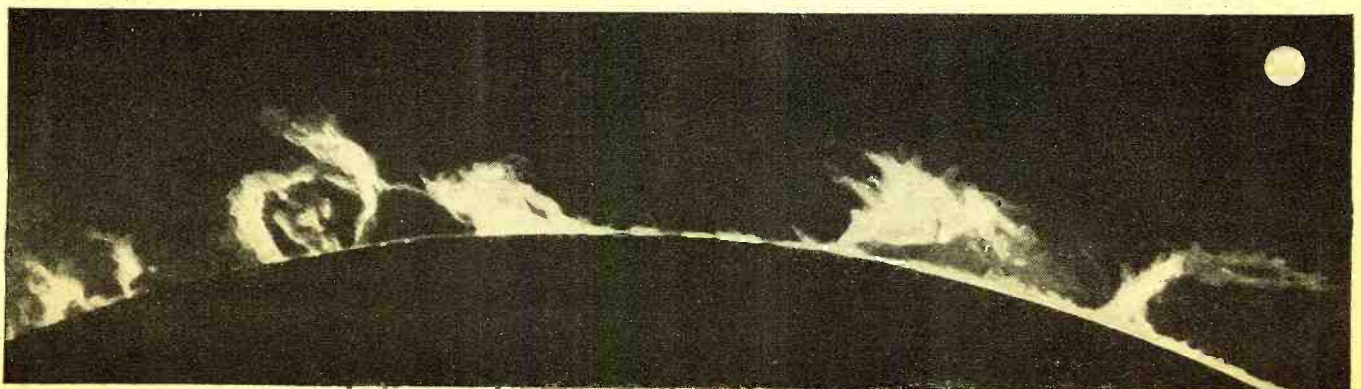

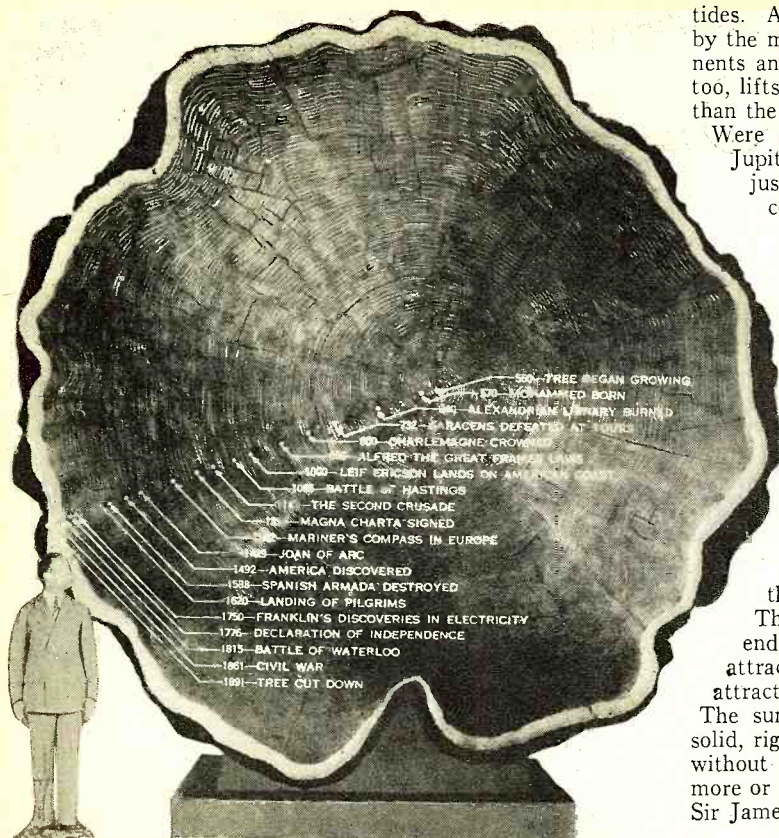

(Above) Annual rings in the trunk of a big tree from California, providing a weather record for over a thousand years. These tree rings also show the sunspot cycle. (Right) Clay layers millions of years old from an ancient lake bottom in Wyoming also show the sunspot cycle



No mystical relationships or unknown physical forces need be dragged in to explain how planets can influence sunspots. Nothing more mysterious is involved than the force of gravitation, and while science still knows little or nothing about the cause of gravitation there is no longer any doubt, thanks to Kepler and Sir Isaac Newton, about how gravitation works.

It is the gravitational attraction of the sun, of course, which holds each of the planets in its orbit. Otherwise each world would go careening off by itself in space, like a water drop shot from the rim of a spinning flywheel. It is possible to think of the sun's gravitational pull very much as one thinks of the string which restrains a child's toy ball whirled rapidly around one's head. Were it not for the string the ball would fly off at a tangent. Were it not for the cable-like attraction of gravitation between planet and sun the planet would do exactly the same thing. Only the planetary cable, were it a real rope of steel or hemp, would need to be gigantic, for the attraction between the sun and even a small planet like the earth equals the weight of nearly four billion billions of tons.

You cannot pull very hard on a rope attached to anything without deforming that thing by at least a trifle. This is true, too, of the imaginary ropes but perfectly real forces by which gravitation holds the members of the solar system in their paths. The moon's gravitational pull on the earth, for example, is responsible for the deformation of the oceans that we call

Dr. L. B. Aldrich, of the Smithsonian Institution, testing a series of special thermometers which are to be used for measuring the intensity of sunlight at weather observatories and observing stations. Small variations in the intensity of sunlight are believed to be responsible for the weather changes. The Smithsonian Institution maintains special observatories in the United States and in Africa for the daily measurement of the amount of energy in sunlight

tides. A similar, although much smaller, "earth tide" is raised by the moon's gravitation even in the solid crusts of the continents and can be measured by delicate instruments. The sun, too, lifts tides in both sea and land, although these are smaller than the moon's tides because the sun is so much farther away.

Were observations possible on other planets, like Mars or Jupiter, similar sun tides would be encountered, doubtless, just as they are on earth, plus a much greater and more complicated series of local tides on such a globe as Jupiter, which possesses no less than nine separate moons, each with its own tide-raising proclivities.

But the point of interest for terrestrial astronomy and especially for the new radio astronomy or radio "astrology" is not what tides are raised by the sun on the planets, but what tides these planets generate in the sun.

The imaginary cables that hold sun and planets together resemble real cables in possessing two ends and the necessity for two anchorages. The cables that hold up the span of a greater suspension bridge, for example, need to be anchored at their shore ends by enormous weights, larger than the weight of the bridge, so that the bridge weight will not pull out the cable ends and fall. Just so with the gravitational connection of the sun and a planet. This is "anchored" at one end to the planet, at the other end to the sun. Whatever billions of tons of weight this attraction exerts on the planet, it exerts precisely this same attraction on the sun.

The sun, astronomers long have known, is by no means a solid, rigid body on which such enormous attractions would be without effect. What may exist deep inside the sun is still more or less of a mystery about which famous astronomers like Sir James Jeans and Sir Arthur Eddington still come to verbal

fisticuffs, but the visible surface of the sun and the layers of that luminary which display sunspots and emit the ultra-violet rays effective on earthly radio certainly are not solid but a raging sea of white-hot, flaming gases in which every chemical compound known on earth is disintegrated into its constituent atoms and even the majority of these atoms are stripped of some of their electrons.

It would not be surprising if the gravitational attractions of the planets on the sun, even though the sun is so much larger than they, acted in some way to disturb the currents and movements in these gaseous layers. How such disturbances might affect sunspots

is less evident, since the real causes of these solar blemishes are unknown. The work of the famous American astronomer, Dr. George Ellery Hale, proved long ago, however, that sunspots are really vast whirling storms in the sun's gaseous surface, not unlike earthly cyclones (Continued on page 1026)

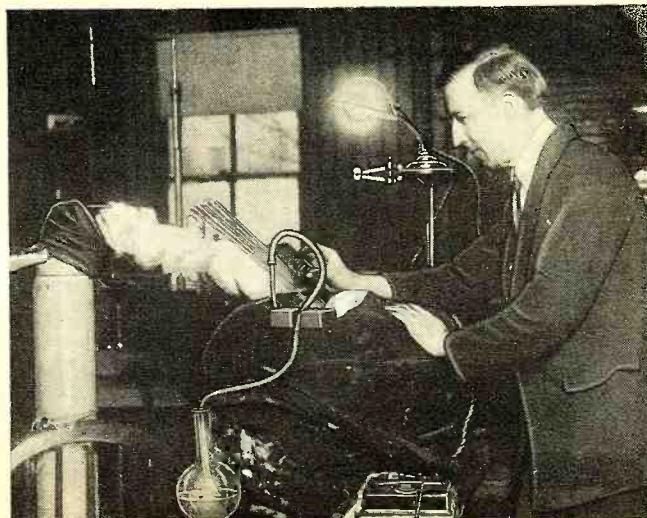

# EUROPE on the Wire



*How the telephone subscriber, sitting at the telephone in his own home, can put through a call to Europe or South America and talk over the short-wave "beam" searchlights aimed at these continents, encountering no more difficulty than he would in making a domestic toll call*

By Zeh Bouck

The ship-to-shore telephone booth on board the *S. S. Leviathan*—where passengers may call up their homes from mid-Atlantic with the ease of making the usual long-distance call

"Vodas" relay and telephone repeater equipment at Walker Street, New York. Trans-oceanic, ship-to-shore and South American calls all pass through this office



**I**T IS INTERESTING to note that the early radio investigations were carried out on short waves. Many of Hertz's classical experiments involved waves less than one meter in length. It was in the course of these experiments that Hertz, in 1888, demonstrated that electrical radiations can be readily concentrated or focused in a beam, laying down the principles that are today basically responsible for the achievement of transoceanic telephony.

From the inception of Marconi's experiments, ten years later, the preference for longer and longer wave lengths was definitely established in the trend of transmitter and receiver design. This was due principally to the relative ease of generating and controlling higher powers at lower frequencies, and the fact that two decades of research were destined to intervene before adequate short wave receiving apparatus could be developed. For instance, it was a simple matter twenty years ago to develop 50 kilowatts in an Alexanderson alternator at 50 kilocycles, but the field would have blown to pieces had an attempt been made to double the frequency by turning the disk twice its normal speed of 20,000 r.p.m.!

While it is today a matter of engineering simplicity to generate large amounts of power at high radio frequencies by means of the vacuum tube oscillator, the difficulties of controlling it still place limitations on the power economically available for commercial purposes. For example, the displacement currents between any conductors increase with the fre-

quency. These displacement or capacity currents heat every dielectric, with the exception of a perfect vacuum, causing a molecular wear and tear which may eventually result in breakdown. The effectiveness of an air dielectric at 30,000 k-c drops to one-tenth its strength for a direct current potential of the same value as the a.c. peaks. An air gap that is a satisfactory insulator to a 60 cycle alternating potential of 12,000 volts will break down with a 1000 e.m.f. oscillating at 30,000 kc!

But the limitations imposed by the complications attending further power and frequency increase are of theoretical rather than practical significance. The utility of still higher frequencies has yet to be demonstrated, and the powers easily controllable at the most effective frequencies are quite sufficient for transoceanic transmission due to the peculiar characteristics of electric wave radiations between 6 and 30 megacycles (50 to 10 meters) namely, unusual carrying or penetration power and the efficient adaptability to concentrated or directional transmission.

Optimum high frequencies corresponding to a particular time of the twenty-four hour day possess an uncanny ability to

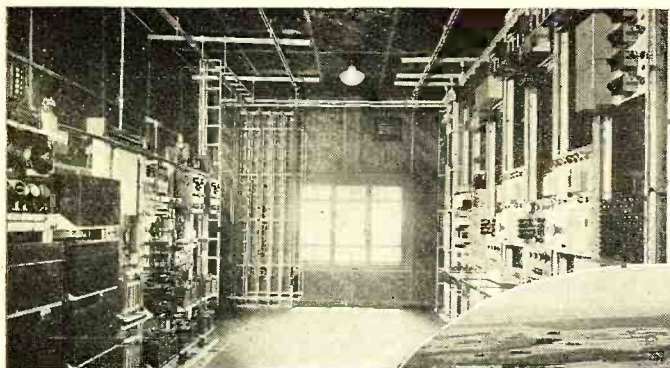

Voice frequency apparatus at Platinos, Argentina. This room is entirely shielded with number 20 B and S gauge sheet copper. The windows are covered with a fine copper mesh

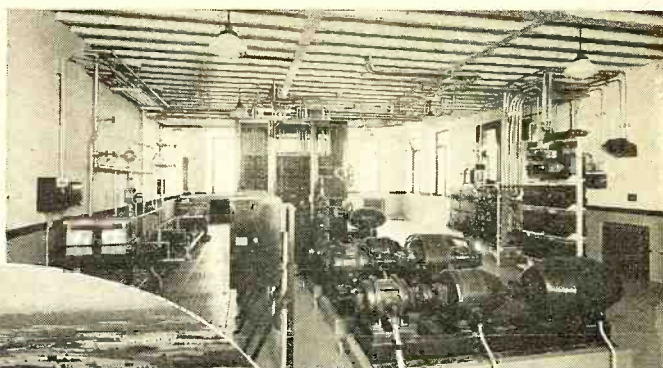

Pumps, motor generators, filament filters and the automatic battery charging plant at Hurlingham, Argentina



General view of the Bell Telephone transmitting towers at Lawrenceville, N. J. (Courtesy Fairchild Aerial Surveys, Inc., N. Y.)

travel long distances under the impulse of relatively small amounts of power. The maximum terrestrial distance has been spanned by amateurs putting far less power into their antennas than is consumed by the average Mazda lamp. As has been intimated, the efficacies of various frequencies vary between day and night. On the frequencies with which we have been most familiar for many years, and describing wave-lengths above two hundred meters, radio signals show a consistent drop of signal strength and range during the day time. Distant broadcast stations are best received during the night. Commercial stations having an effective night range of six thousand miles, drop to four and five hundred miles for consistent daylight communication on frequencies under 500 kilocycles. A similar effect is to be observed as high as 10 megacycles, but above 6 megacycles this characteristic is gradually reversed, and between 15 and 30 megacycles we have a band that is highly effective in the day time, but quite ineffectual at night. This variation is believed

to be due to altitude changes in the Kennelly-Heaviside layer—electrified strata of rarefied gaseous matter existing from fifty to several hundred miles above the earth's surface—which reflects the radio waves to their destinations with varying angles of incidence.

Three frequencies are employed in the long distance telephone channels we are describing. Daytime communication is carried on at frequencies in the neighborhood of 20 megacycles, with a shift to 10 megacycles at night. During the transition periods of evening and morning, 15 megacycles is generally more effective than the higher or lower frequencies.

*The Transmitting Antennas*

The advantage of a directional transmitting antenna is best considered from the point of view of achieving a desired result with the expenditure of less power. As we have intimated, the amount of power economically available for high frequency transmission is somewhat limited by problems of control, the possibilities of directional s-w transmission are doubly important. Assuming ideal conditions for the purpose of illustration, the distribution of energy about a broadcasting antenna may be described as circular. That is, the locus of a point at which an arbitrary signal strength is received (or any line of constant signal strength) describes a circle about the antenna. In other words, a receiving station one hundred miles away from the transmitter will receive a signal of the same strength regardless of whether it is north, south, east or west. If we concentrate the power of the transmitter over a sector of the circle 15 degrees wide (Figure 1), including the receiving station, and reduce the power into the transmitting antenna until the signal strength is the same as it was with the non-directional antenna, we will find that the reduction in power is proportional to the reduction in area. In other words, only one-twenty-fourth as much power will now be required to provide the same signal as before. Another way of looking at it is to say that the effective power has been increased twenty-four times by the concentration.

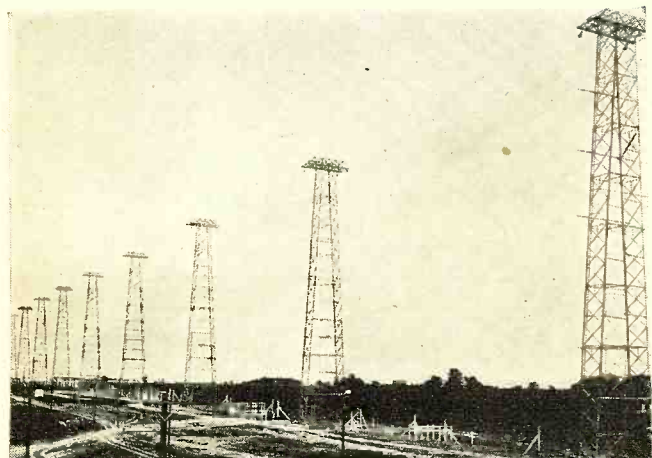

The transmitting antenna or curtains at Lawrenceville. When complete there will be twelve antennas, each five hundred feet long

Figures 1, 2 and 3. Graphic illustrations of the advantages of the beam system for transmission and reception, as explained in the text

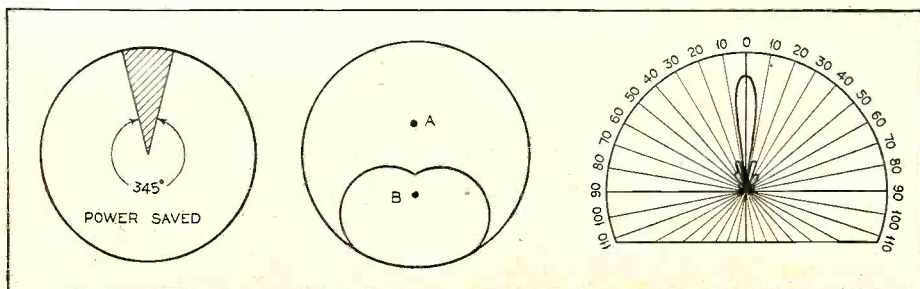

There are several possible ways of effecting this concentration. If two antennae are located one-quarter wave length apart and are simultaneously excited, one of them ninety degrees out of phase with the other, directivity will be achieved, and the field distribution will follow the curve of Figure 2. Assuming the antenna B to lag, the action is as follows:

The field of the upper antenna, A, requires one-quarter period to catch up with the field of the lower antenna, by which time the field of the two antennae will be in phase, and assisting. A doubly powerful signal will be propagated in this direction. However, by the time the field of the antenna, B, reaches antenna, A (one-quarter period later) it will be 180 degrees out of phase, and the fields will cancel each other in this direction.

The second or upper antenna therefore has the action of a screen or reflector. It is not necessary to excite this antenna separately, as energy in the correct phase difference can be induced in it by the radiating aerial.

The antennae employed for long distance point to point telephony are of the array or curtain type, equivalent to four Hertz antennae connected together by what may be described as non-radiating feeder lines. A reflecting curtain is hung behind the radiating portion, so that the direction of propagation is concentrated in a narrow beam broadside or perpendicular to the plane of the antennae. (The efficacy of this reflector was definitely demonstrated in the course of the author's airplane transmission and reception experiments in Buenos Aires, and has been detailed in the March, 1931, issue of RADIO NEWS.)

As the directional effect is determined by the accuracy with which the antenna dimensions and the spacing of the curtain conform with the wave dimensions of the frequency employed, three antennae, one for each wave length, are required for trans-oceanic channels employing three frequencies. The transmitters of the American Telephone and Telegraph Company are located at Lawrenceville, N. J., where four channels are used for communication—three with Europe and vessels en route between American and European ports, and one to South America. The twelve antennae have a total length of six thousand feet. Eight hundred acres of ground are available for present and future antennae. The gain of any one of these aerials is in the neighborhood 10 decibels—in other words, only one-tenth the power is required to lay down the same signal at a given distance in comparison with an ordinary antennae

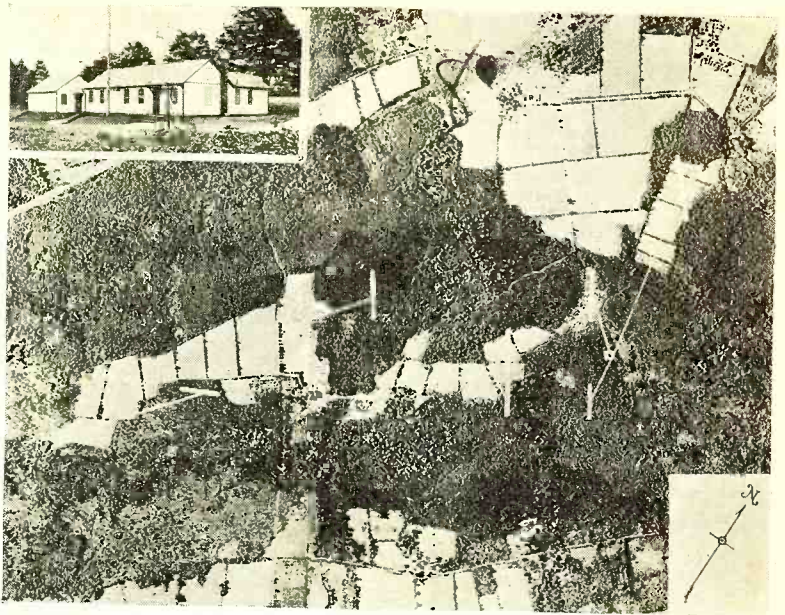

Aerial view of the receiving station at Netcong, N. J. There are four groups of antennae—three being trans-Atlantic and one for South America. There are three antennae in each group, one for each frequency. The heavy lines indicate the antenna arrays, the light lines the r.f. transmission lines and the squares the receiving stations

which radiate power in all directions. But employing more radiating sections it would be possible to increase the gain to a maximum of twenty decibels. (An interesting effect is to be observed in the shifting of the beam from Hurlingham, Buenos Aires, to Netcong, N. J., about ten degrees clockwise. This seems to be due to a variation in the Heaviside layer influenced by the earth's magnetic field.)

It would be obviously impractical to employ the same directional system on waves of much greater length than fifty meters. A 20 decibel antenna operating effectively on 500 meters would be ten wave-lengths or about fifteen thousand feet long, one-quarter wave length or about 400 feet wide, and two wave lengths or three thousand feet high.

As may be imagined, the possibility of sleet suggests adverse mechanical and electrical effects particularly serious in an antenna of this type. Aside from the mechanical strain, the difference between the dielectric constants of air and ice may be sufficient to detune the circuit. By (Continued on page 1030)

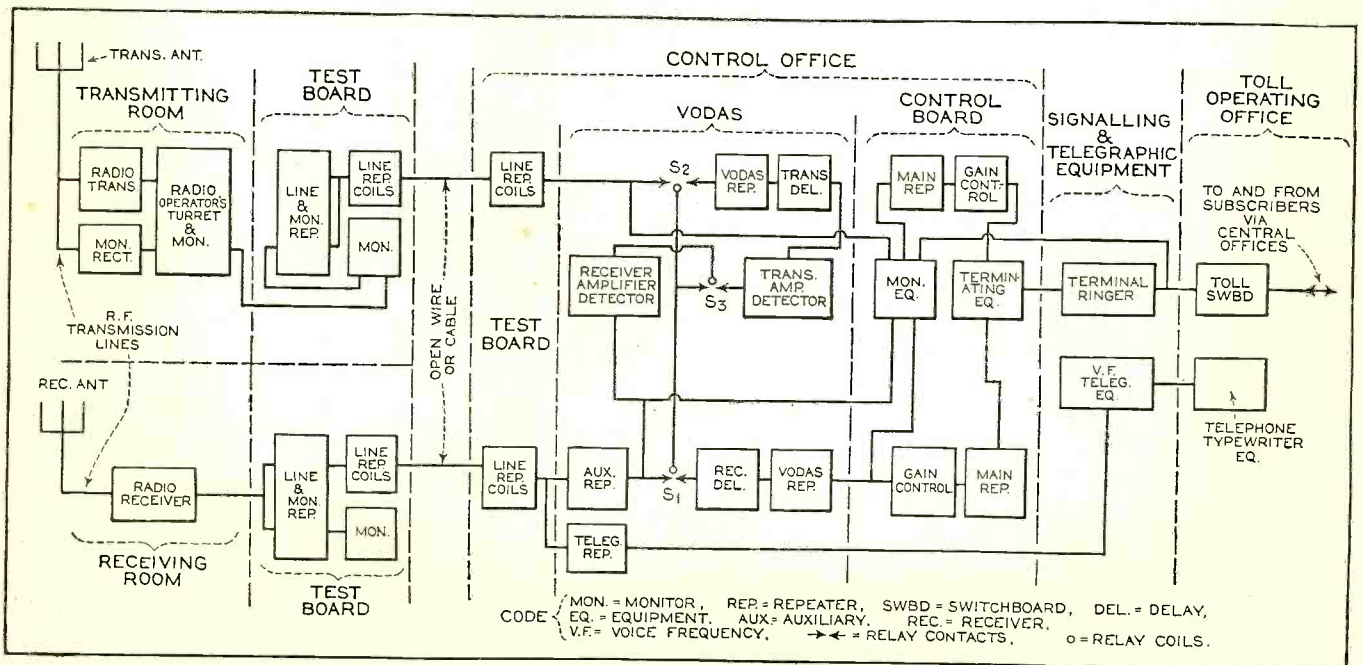

Figure 4. The general layout of a trans-oceanic beam telephone system. The complicity of the arrangement may be well imagined when it is considered that any one of the boxes may represent an installation such as photographed on the first page of this article

# SHORT WAVES AND THE 15 to 550 Meter

*The new Lincoln superheterodyne receiver employs four stages of tuned intermediate amplification to provide unusual sensitivity and selectivity. A.C. operation, phonograph switch, all wave coverage with total of five plug-in coils are some of the features*

**R**ADIO today is advancing more rapidly than one realizes. The possibilities of short-wave reception open up a vast field for reception of stations from almost unlimited distances.

In view of this new and steadily increasing field, intensive study was given to the development of simple, yet efficient, methods of receiving signals from 17,000 kc. to 1500 kc. in the short-wave bands, and also registering from 1500 to 550 kc. on the broadcast band. Simplicity of operation being paramount in a receiver designed for the drawing room of a home, it would be very desirable to have a simple, quick way of shifting from broadcast to short-wave and vice versa. With this thought in view, many different arrangements have been tried. Due to inter-coupling, etc., always experienced in the higher frequencies, any mechanical switching of coils was found to be very unsatisfactory, however convenient it would be to the operator. Complete removal of the oscillator and antenna coils and substitution of other coils of the plug variety worked more satisfactorily and this method is featured in the set described here.

By using a pick-up coil inductively coupled to the grid and plate windings of the oscillator, and in series with the negative end of the antenna coil, an ideal system has been worked out for the Lincoln SW-31 receiver whereby the antenna coil was shorted out by a two-way switch located on the front panel, allowing only the pick-up coil to be used as a combination pick-up and short-wave antenna coil. The two-way switch at the same time opens the main antenna tuning condenser circuit, thus using the small trimmer condenser (used in bringing the antenna circuit to resonance on broadcast bands) as a main tuning condenser for the short-wave bands.

By this simplified method a frequency range of from 20,000 kc. to 540 kc. is covered with a total of only five plug-in coils, the coil socket being conveniently located at the rear of the chassis and easily accessible in a console or other cabinet.

The individual coil ranges, as shown on the accompanying graph, are 15-32 meters; 28.5-47 meters; 46.5-84 meters; 81-231 meters (double range coil); and 190-540 meters (broadcast).

To change from broadcast to short-wave, or vice versa, it is only necessary to change one coil and throw one switch.

## Calibration of S.-W. Coils

To accurately calibrate the s.-w. coils, a

carefully designed oscillator was constructed and accurately calibrated in one meter steps by a standard wave-meter throughout the complete short-wave band. Operating in a shielded room, the s.-w. coils are calibrated so that the dials of the receiver can be set on a frequency of a short-wave station, and the station will come in with a slight adjustment of the antenna condenser.

A great deal of thought has been given this part of the design in view of the fact that heretofore there has been a large degree of uncertainty in just where to try to pick up a distant short-wave signal even if the frequency of the signal was known.

## General Description of SW-31 Receiver

Upon the panel of the SW-31 are mounted three controls and three switches. At the right is the combination switch and volume control; in the center, the main tuning control; and at the left, the trimmer to bring the antenna circuit into resonance. The switches enable the operator to change at will from local to distant reception; from radio to phonograph; or from broadcast to short-wave.

## R.F. Transformer Design

The transformer has proved to be the most practical and efficient means of coupling vacuum tubes in cascade amplifiers.

The control panel arrangement showing the purpose of each control

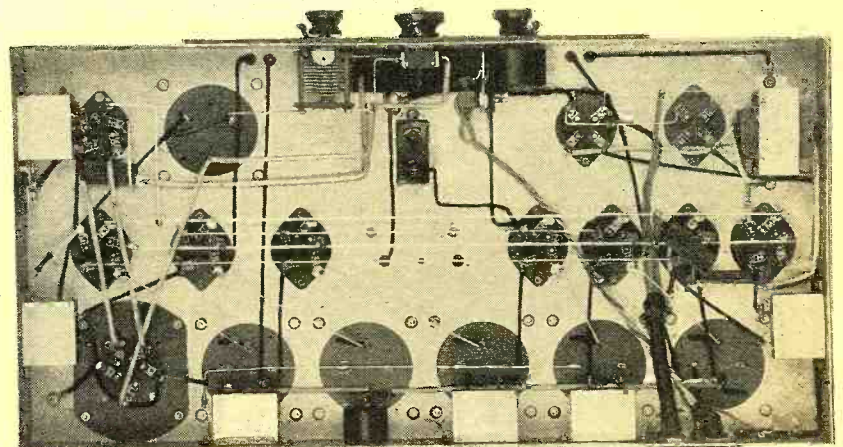
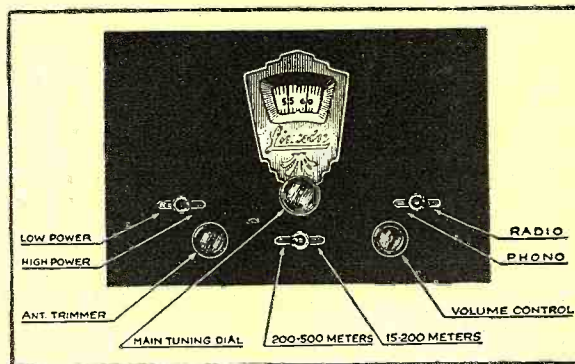

All neat and ship-shape "below deck," where practically all wiring is confined

\*President, Lincoln Radio Corp.



# BROADCAST BAND ON A Superheterodyne

By W. H. Hollister\*

There are four variations of transformer coupling; namely, untuned, tuned primary, tuned secondary, and tuned primary and secondary.

The untuned transformer is successful in low frequency amplifiers, but at high frequencies little gain can be obtained because of the short-circuiting effect of the input and output impedance of the vacuum tube. The effect of tuning either the primary or the secondary of a coupling transformer is to remove the effect of either the input capacity or the output capacity of the tube. The removal of either of these two capacities has a remarkable effect upon the gain of a stage, for the input impedance of a three-electrode tube at a frequency of 500 kilocycles is about 30,000 ohms.

When the primary is tuned, the plate to filament resistance of the tube, which is in parallel with the tuned circuit, has the effect of a small series resistance placed in the tuned circuit. This, of course, tends to reduce the sharpness of resonance or selectivity, as well as the gain of the stage. The effect of the parallel resistance increases as the plate-to-filament resistance decreases. Since the plate-to-filament resistance of a three-electrode tube is in the order of 10,000 to 20,000 ohms, the tuned-primary transformer, coupled between three-electrode tubes, would have an equivalent series resistance of sufficient value to have a measurable effect upon the selectivity and gain of the transformer.

A tuned circuit has a high impedance to the flow of a current of the same frequency to which it is tuned in the external circuit to which it is connected. At a frequency of 500 kilocycles it is possible to get an impedance of several hundred thousand ohms from a tuned circuit. This impedance increases with both the efficiency as well as the inductance of the coil.

It is not possible to get all of the gain out of a transformer when used between three-electrode tubes for a condition of instability and tendency for oscillation appears when the gain reaches a certain value per stage. The maximum gain, of course, would be reached with good shielding, by-passing of each stage to eliminate coupling by common impedance, and neutralizing.

The four-electrode shield-grid tube, however, has radically different properties from the three-electrode tube. The presence of a shield between the grid and the plate reduces the capacity between the grid and the plate. The shield does not greatly change the input capacity, which is the grid-to-filament capacity, but the plate to filament capacity is considerably increased. This means that the short-circuiting effect of the output capacity of a shield-grid tube is several times the short-circuiting effect of its input capacity. Since tuning either the primary or the secondary of a transformer has the effect of removing either the output capacity or the

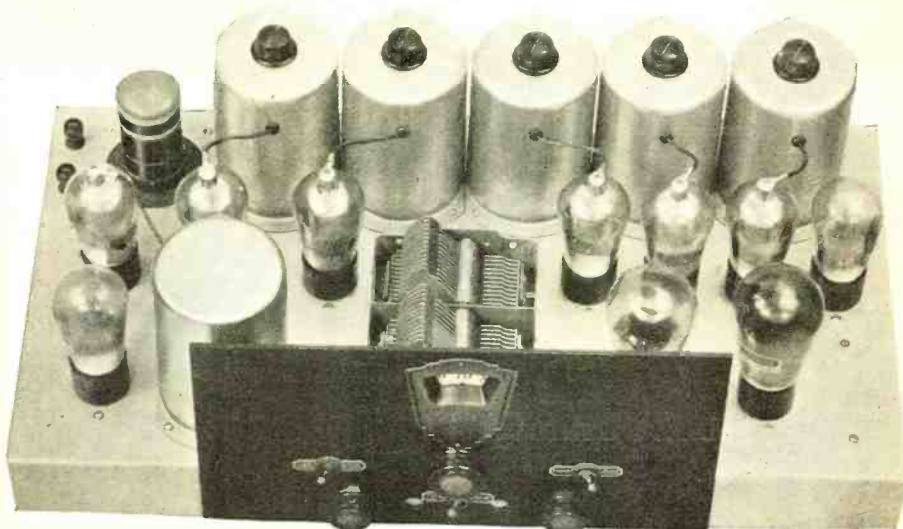

The chassis of the Lincoln SW-31 superheterodyne receiver. The power supply is provided by a separate unit

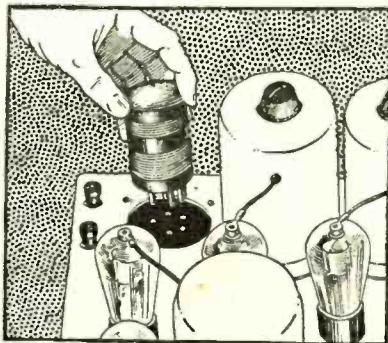

The receiver provides coverage from 15 to 550 meters by means of a single plug-in coil for each of the five bands in this range

input capacity respectively, the idea is immediately suggested to tune the primary.

A tuned primary has a high impedance and makes it possible to get a much larger proportion of the voltage generated in the tube across it. It is evident that if the primary impedance of the transformer is equal to the plate-to-filament resistance of the tube, that only one-half of the voltage will appear across the primary. From this consideration it is easily seen that if maximum amplification is to be obtained the primary of a transformer used with shield-grid tubes must be tuned.

In the case of the shield-grid tube, the plate-to-filament resistance is so high that its effect upon the tuned primary, in producing an equivalent series resistance, is negligible. This means that there would be no loss in selectivity in tuning the primary, but a considerable increase in voltage amplification would be effected.

After determining that the primary of the transformer must be tuned, there is still left one remaining possibility, namely: tuning both the primary and the secondary. Tuning the secondary, of course, would eliminate the short-circuiting effect of the input capacity of the tube. When both the primary and secondary are tuned, a maximum transfer of energy no longer takes place with close coupling. The condition for maximum transfer of energy is, to the contrary, a very loose coupling. Since space limitations eliminate the possibility of separating the primary and secondary by a space of 6 or more inches, depending upon the type of coil used, it was necessary to turn one of the coils so that it was practically at right angles to the other. It was found, however, that there is no such thing as *perfect* shielding. The gain which can be obtained with the tuned primary transformer is more than can be successfully used. The tuned primary transformer gave a gain of 75 per stage at a frequency of 480 kilocycles with complete aluminum shielding and by-passing. It was found, however, that this gain had to be reduced for (Continued on page 1037)

# Producing a

*The producers, as well as the writers of radio dramas, technique is still in the process of development and limit. The successful direction of a radio play demands script, microphone technique, sound effects, monitoring, dramatic production in the theatre of the air and undoubtedly develop a greater radio drama of*



William S. Rainey, who heads the production department at the National Broadcasting Company. At the right is a scene from a play "S O S" being enacted by company engineers who staged the production. As is quite evident, numerous sound effects were employed



**T**HE radio drama is still an experiment. As a separate and distinct art form, the drama written only for the medium of broadcasting has scarcely been born.

When one makes a brief and necessarily hasty survey of the history of broadcasting these statements appear somewhat less astonishing. In the first place, radio is a mere infant of ten, but it has a world-wide voice and a coast-to-coast physique. The rapid growth of radio engineering, crowded as it has been with achievement after achievement, has almost precluded any attempt to maintain the art of producing in the theatre of the air at a similar pace. And though radio is ten years old this year, the first plays were not put on the air until 1926! Worse than that—radio programs had no prepared continuity until 1926!

Radio was very much a novelty in the early days. It would be difficult to say whether some of the programs were more of a novelty to the listener or to the announcer and artists in the studio. The few announcers, whose initials have gone down in broadcast history, were artists in the art of ad lib. They "doubled"—sometimes literally in brass—but more often as readers of "Gunga Dhin" or singers of such familiar ditties as "The Road to Mandalay." WEAf had one or two small studios in those days and that guiding genius, the announcer, would often congregate there with his little flock of artists, with not much more than a good idea of what they would do during the broadcast. Sometimes they did what they thought they were going to do—and sometimes they didn't. At any rate, they made as merry as possible until the clock gave silent permission for them to "cease firing."

One of the first writers for the new medium of broadcasting was Katherine Seymour, who is today assistant head of NBC's continuity department. Miss Seymour gives us a fascinating story of those hectic days which later evolved the "continuity script," the radio play and the production technique of the present. "Back in the Dark Ages of radio—in 1925—none of

us was sure just where radio was headed, but we were sure it was going somewhere pretty fast. When our programs ran short or when broadcasters did not arrive at the studio, our cry of 'Help!' was usually answered by the switchboard operator who deserted her post for the piano—and jazz. Quite often I would have to read speeches or special announcements. It was not until late in 1925 that WEAf took the step that served as the basis of our present-day broadcasting.

"The post of special sales representative was created for Roosevelt Clark, who believed that advertisers could be sold prepared programs based on a central theme or program idea. I assisted Mr. Clark and we soon found that the task of supplying clients with scripts was going to develop into a much greater one than we imagined. The Clicquot and Ipana hours were among the first to be written. Writing for radio was evidently destined to be a big job. The idea of calling Mr. Clark a continuity writer was obtained from the movies.

"It was not until the middle of 1926," continued Miss Seymour, "that we thought of producing a radio drama. Among the earliest dramatized programs was Henry Carlton's feature, *Great Moments in History*, based on various episodes in American history. Then came William Manley's *Bible Stories*. Both of these followed the same general pattern—about half of the script was actually dramatization and the other half was given over to expository material delivered by a narrator. In the first series, the narrator was made the father of two inquisitive children.

"There were no production men in those days," Miss Seymour remarked, with a slight smile. "In the case of my own dramatization of *Scheherazade*, which ran eight or nine weeks, we had no production man and consequently had quite a time trying to get a proper balance between the music and the singers. The orchestra, deciding that they had been hired to play, were equally sure that they ought to be heard. So they played that way. There was one microphone. The orchestral accom-

# Radio Drama

*are dealing with a new and unique medium whose whose artistic possibilities are apparently without more than adequate rehearsals, interpretation of the In this article are outlined some of the problems of the encouraging spirit of experimentation that will tomorrow on the basis of today's knowledge*

By Albert Pfaltz

paniment was not faded down. Occasionally the single control-room man would dash into the studio to make some minor change, but we had neither the understanding of the necessity for maintaining a properly balanced effect on the air nor the technical facilities for doing so."

Speaking of the same program, William S. Rainey, production manager of the National Broadcasting Company, said, "The script was excellent, but the production of it was not. They hadn't learned, in those days, how to balance speaking voices against an orchestra, with the result that the music and actors indulged in a sort of cat-and-dog fight." Mr. Rainey went on to tell of some of the early radio dramatizations—the *Retold Tales*, in which Carlton and Manley dramatized O. Henry, de Maupassant, Hawthorne and others, adaptations of Shakespeare and an occasional one-act play. These few attempts made up the dramatic record of the primitive days.

"Sound effects were sparingly used—and rightly so—because most of them came through the loud speaker as unidentified noises," Mr. Rainey continued.

"Then came the *Melodrama Hour* in which the famous old thrillers were revived. At first these were 'spoofed' and deliberately overplayed for laughs, but the audience resented this, especially in

Vernon Radcliffe, who produces the "Radio Guild," "Real Folks" and "Harbor Lights" hours. His views on the radio drama are presented in this article



Shown above is Raymond Knight directing a scene in the "Empire Builders"—one of the regular dramatic weekly programs. The others are Harry Edeson and Virginia Gardiner

The Radio Guild has presented in the past year more than a hundred of the world's great plays. Adapted for broadcasting and directed by Vernon Radcliffe, they are heard each Friday at four o'clock on the Blue network. At the left is a scene from one of the Guild's plays. Included in the cast are (left to right) Charles Warburton, Sheila Hayes, Jeanne Owens, Florence Malone, Charles Webster, Leo Stark, Harry Neville and Vernon Radcliffe, who is timing the action of the play



Above is a scene from the "Rise of the Goldbergs." Left to right are Roslyn Silber, James Waters, Gertrude Berg and Alfred Corn

At the right is C. L. Menser, one of the outstanding radio producers. He directs the "RCA-Victor" hour and "Campus" and is also narrator on the former



the metropolitan areas, so that they were played straight. after that, to relatively small but enthusiastic audiences. I say a relatively small audience because the drama audience three or four years ago was just that. It has taken a long and intensive training in listening to build up the wide and greatly interested audience of today. Amos 'n' Andy taught people the art of listening to talking programs."

Radio today has three general types of broadcast plays—adapted stage plays, adaptations of novels, and plays written for broadcasting.

During the past year some of the more important offerings of the first group known as the Radio Guild, were *Journey's End*, on Armistice Day, with the cast from the Henry Miller Theatre; *Iphigenia in Aulis*, with Margaret Anglin; *Second Mrs. Tanqueray*, with Mrs. Pat Campbell; *Milestones*, with Tom Powers; *Doll's House*, with Eva Le Gallienne and Dudley Digges; *Servant in the House*, with Charles Rann Kennedy; *Jane Clegg*, with Margaret Wycherley, Ernest Cossart and Henry Travers.

Included in the second group, the *Penrod* series and the dramatizations of Conan Doyle's *Sherlock Holmes* are outstanding.

The third, and of course the most significant group, includes plays written for broadcasting—some of the most successful of these, all belonging to the episodic-series pattern so dear to the radio auditor: *Mystery House*, by Finis Farr; *Silver Flute*, by Gregory Williamson; *Soconyland Sketches*, by Carlton and Manley; *Big Guns*, by Lawrence Holcomb; *Jolly Roger*, by George P. Ludlam; *Wayside Inn*, by Burke Boyce, and one of the most successful of all, *Moonshine and Honey-suckle*, by Lulu Vollmer.

And another interesting experiment that should be noted—the six-day murder trial—*The Trial of Vivienne Ware*—aroused unusual interest.

Who are the men directing these plays and how do they work? Today the National Broadcasting Company has a producing staff of some eighteen or twenty men. Their names and the hours they direct are listed elsewhere in this article.

The radio production man is, of course, somewhat analogous to the director of the legitimate theatre. In the theatre of the air, however, the producer solves the problem of casting a show in an entirely different way. He must be "ear-minded." Radio types are determined solely by their voices, so it makes not the slightest difference what the actor or actress looks like.

Some women in their thirties have the voice of an eighteen-year-old girl; some youngster may sound like an advertising account executive or a racketeer. In either case, the voice must determine the choice for the rôle.

While each of the production men at NBC has his own ideas, production methods follow certain general rules. When a script has been received the producer's first problem is casting. Although auditions sometimes number well over a hundred a week, they are seldom productive of any real talent. The result is that production men have a group of well-established, trained and competent actors and actresses to call upon whose voice types are definitely marked and who are accustomed to broadcasting in several shows each week.

When the cast has been assembled the first rehearsal usually takes the form of a "play-reading" session. The producer gives his interpretation of the script and indicates how each of the scenes is to be handled. The actors then read through the show.

The dress rehearsal for each play is held immediately preceding the broadcast and in the same studio to be used when it goes on the air. Sound effects are "cued" into the script at this rehearsal for the first and only time. The producer also times the show, making whatever cuts may be necessary or arranging for longer musical interludes if they are indicated. (Cont'd on page 1018)

While the law-breakers were trying to escape across the ice during a thunderstorm these boys in the studio of a Canadian broadcasting station gave listeners a first ear-account of how the Northwest Mounted sound when getting their man



# Setting the "Feed-Back" Whistle to Music

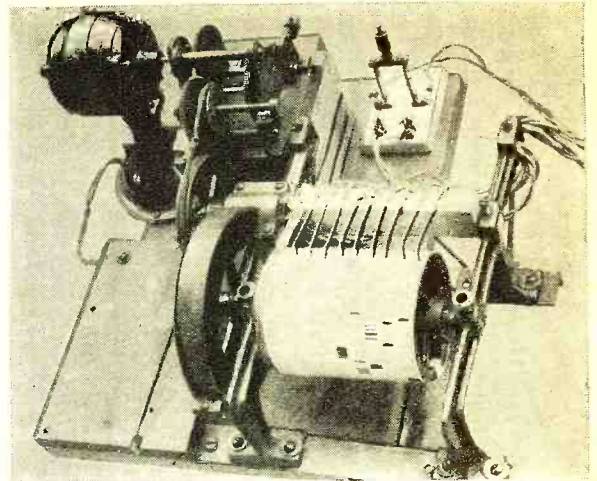

An ex-sign flasher serves as an automatic player for the electric organ

*With the simple apparatus described in this article the much maligned feed-back "peanut" whistle becomes music and provides the principle upon which this vacuum tube organ with its one-octave range is built*

By Louis F. Leuck

**A** HOWLING audio frequency amplifier is seldom encountered in modern, factory built receivers. That could not be said with any degree of truth until recently, and as to homemade audio amplifiers—well some of them still want to howl. This howl has now been successfully converted into music. An "electric organ" that did this very thing was built at the University of Nebraska for display on Engineers' Night and it was a "howling" success, literally and figuratively. Not only did a meager musical education suffice to pick out tunes on its eight keys but an automatic player attachment, built with an old sign flasher as a foundation, ground out the University song in fine shape. And the strange part of it is that the tones emitted from this "organ" are not harsh but actually full, rich, and pleasing. This is because they are rich in harmonics, containing practically all of them as will be discussed more fully later.

### The "How" and "Why"

If a two tube resistance coupled amplifier is built and the output from the plate of the second tube is coupled back to the grid of the first, as indicated by the dotted line in Figure 1 a, the result will be a one tone "electric organ." Only one plate battery is actually necessary but the diagram is given in this simplified form not only because it is easier to understand but because it can readily be arranged in the form shown

in Figure 1 b. The two circuit arrangements are exactly the same. Note that there is really no "first" and "second" tubes as far as amplification is concerned. Either tube has just as much right to be considered "first" as the other. Each tube occupies an exactly similar position in the circuit with respect to the other.

Due to its many harmonics this circuit is useful in laboratories for the calibration of frequency meters. In this case it is usually drawn in the form of Figure 1 b and is called a multivibrator.

Suitable arrangements must of course be made to couple the output to a loudspeaker. Figure 2 shows how this was done by means of a third tube which also served as a step of amplification. A good audio frequency transformer was a necessity to prevent the quality from suffering due to suppressed or over emphasized harmonics. A fixed condenser was required in series with the transformer primary as the apparatus will not function if d.c. is permitted to flow in this path.

The "organ" covers one octave. The figure also shows the arrangement for securing the eight different tones. C1 of Figure 1 has been replaced by a group of (Continued on page 1039)

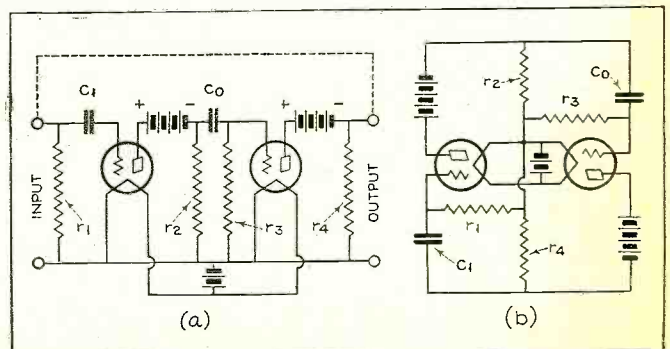
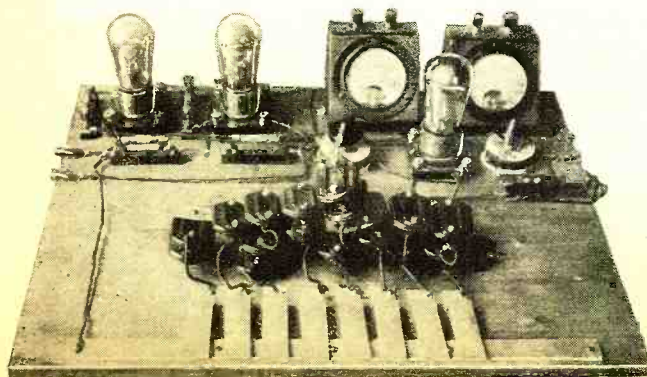
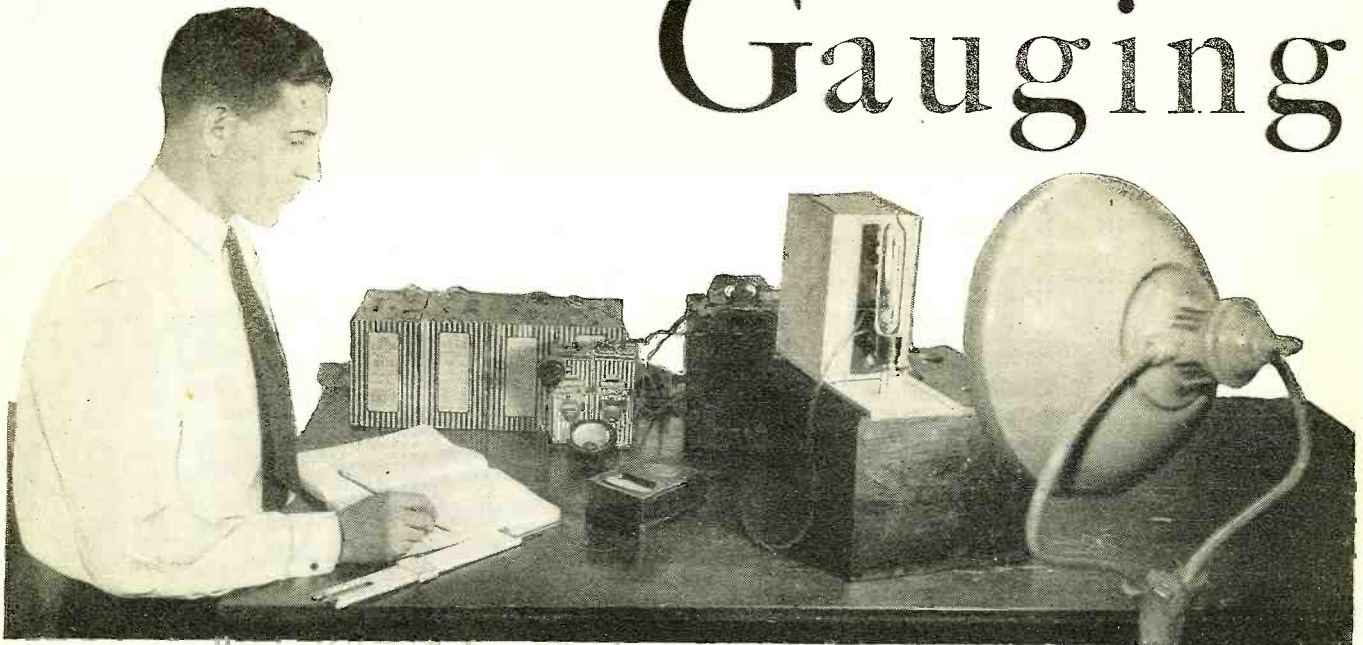

Figure 1. These two circuits are identical and both represent the fundamental circuit of this "electric organ"

Here is the complete electric organ with the one octave keyboard in the foreground

# Gauging



One of the authors making laboratory measurements of ultra-violet radiation, employing the photo-electric cell and amplifier shown at the right

**T**HE time approaches when no science can do without radio or radio engineers. To the already well-known services rendered by radio engineering in the handling of sound, the measurement of distance, the precise determination of time and many other scientific tasks, there have been added recently substantial contributions to one of the most difficult problems of practical physics, the precise measurement of ultra-violet rays now so important in maintaining health, in the treatment of foods and in scores of other industrial jobs.

As these uses of ultra-violet radiation have become extensive and widespread, there is an increasing demand for precise and dependable instruments to measure such radiation. Such ultra-violet meters must meet the practical requirements of industry and commerce. At the same time they must approach the precision and constancy of laboratory measurements. Several types of such instruments now are available, using photo-electric cells, vacuum-tube amplifiers and other devices developed by radio engineers and familiar to radio science.

Until recently it has been the practice to measure the amount and kind of ultra-violet radiation by means of its effect on a photographic plate, its effect in producing certain chemical changes, the fluorescence or glowing properties of certain materials or by means of a thermopile connected to a galvanometer. The first three methods scarcely meet the requirements of an accurate measuring device. They are not sufficiently precise nor sufficiently constant in their results. Also, they are apt to be too slow and to require too much technical skill in use. The latter criticisms apply, also, to the thermopile method, especially for use in such immediate practical activities as the industrial uses of ultra-violet radiation, in the sterilization of water, the production of vitamin D in foods, the treatment of cigarette tobacco to increase "mildness," and others.

In the majority of such instances it is necessary to determine not only the amount of radiation but also the exact "band" or wavelength being used. Usually only certain parts of the total range of ultra-violet radiation produce the desired effects. This is true, for example, of the present extensive use of ultra-violet radiation for its therapeutic and health effects, as employed by the medical profession or by the general public in the form of the large number of "sun lamps" or "health lamps" which are now available on the market. These uses again demand a measuring instrument with which the physicist can determine the amount and kind of radiation available from the lamp used so that he may know accurately what exposure is necessary for the proper "dosage." Even

laymen can use an ultra-violet meter to judge the effectiveness of his "health lamp."

A fully satisfactory ultra-violet meter for modern uses requires the following characteristics: (1) It must be sufficiently rugged and light to be portable; (2) it must read accurately the amount of energy which is present in a given band of wavelengths; and (3) it must measure directly, in acceptable units on an indicating meter, the energy present in the source; (4) it must be sufficiently sensitive to detect small amounts of radiation. Only two general methods now known can be imagined able to meet these requirements.

One of these employs the thermopile-galvanometer combination. This method has certain inherent drawbacks which are difficult if not impossible to overcome. The thermopile is a device which converts radiation into electric energy. The thermopile is sensitive not only to all ultra-violet radiation, but to visible and heat radiation also. This necessitates either the use of ray filters or of a spectroscope in front of the thermopile. Because filters never have a sharp "cut-off," their use requires complicated correction factors, whether used in front of a photo-cell or thermopile. When used in front of a thermopile, moreover, they may become secondary sources of radiation and thereby introduce a serious error. A spectroscope is expensive and impractical for the average commercial meter. A galvanometer, sensitive enough to detect electric

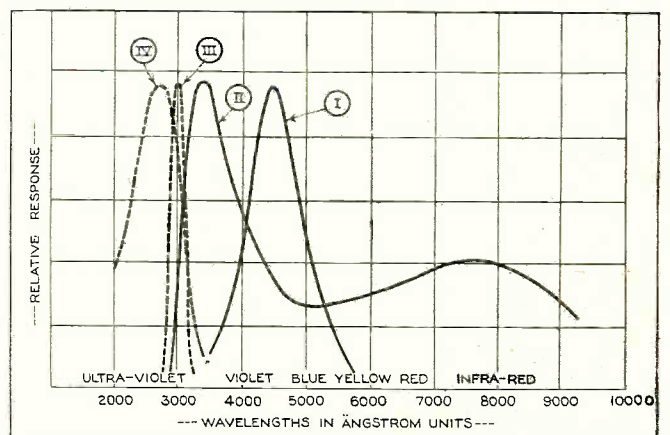

Figure 1. Current response of different photo-cells to radiation of various wavelengths. (I) Potassium, reproduced from Pohl and Pringsheim; (II) cesium-oxide, from Killer; (III) uranium in Corex, from Rentschler; (IV) cadmium in quartz, from Griffith and Taylor

\*New York University, School of Commerce.

# “Black Light” by Radio Circuits

*The new art of Electronics, or the application of radio principles and apparatus including vacuum tubes, photo-cells, relays and meters to other sciences, offers great opportunity to the informed radio technician. In this article are described some practical methods and circuits for measuring ultra-violet light intensities with sensitive photo-tubes*

By C. C. Clark  
and C. A. Johnson\*

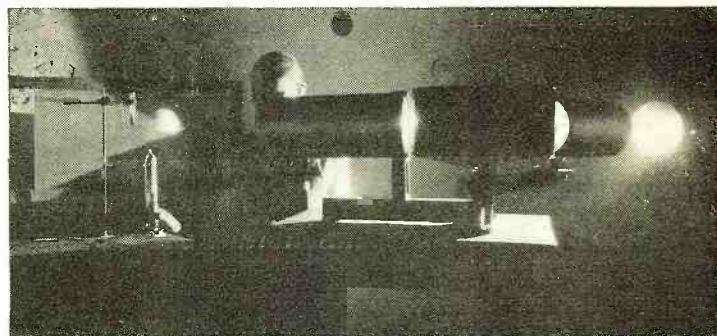

Measuring monochromatic ultra-violet rays in the laboratory. At the left is the photo-cell. At the right is the large quartz spectroscope adjusted to the ray source

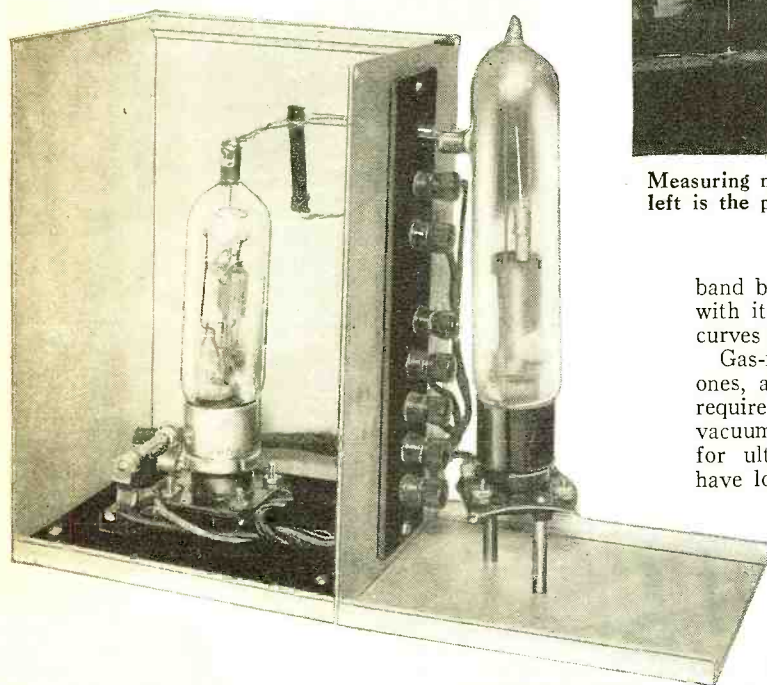

The photo-cell-amplifier unit on the next page with the shielding partly removed to show amplifier stage

band between 2800 Angstrom units and 3200 Angstrom units, with its peak at about 3000 Angstrom units. The sensitivity curves of these cells are given in Figure 1.

Gas-filled cells, while much more sensitive than vacuum ones, are sometimes unstable in their response and therefore require frequent recalibration. For this reason none but vacuum cells may be used in a commercial measuring device for ultra-violet radiation. Since these vacuum photo-cells have low-current outputs, it is necessary to employ especially sensitive recording apparatus, such as an electrometer, or to amplify the low output and use a less sensitive and more rugged meter. The latter method promises to be much more practical and is notable for using relatively simple extensions of well-tested radio technique.

As before considered, a practical method of measuring the relatively feeble currents from the photo-cell must combine reasonable accuracy and speed in taking readings with ruggedness and portability. In the case of the uranium cell, cells which are selectively sensitive to ultra-violet, the current to be measured may be  $10^{-10}$  amperes or even less. This requires a current amplification of 10,000 times or more in order that an instrument even as rugged as a micro-ammeter may be used. In field work it is often inconvenient and frequently impossible to use any type of laboratory galvanometer less rugged than such a micro-ammeter.

One solution of this problem is the device worked out by Dr. H. C. Rentschler, which does away with the use of any direct indicating meter. In place of the meter, the current passed by the photo-cell charges a condenser at a rate determined by the intensity of the cell. When this condenser is charged to a certain potential, a glow-discharge tube spills over and discharges through a relay winding, thus operating a counter. The number of counts per “unit time” is proportional to the intensity of the radiation entering the photo-cell. A device on the counter breaks the discharge circuit when the counter operates, so that the condenser and the circuit is ready to receive the next cycle of charge and discharge. The sensitivity of this meter may be adjusted by varying the capacity of the condenser.

The ordinary three-electrode vacuum tube has been used in a variety of ways to amplify the output of a photo-electric cell for use in photometry. Figure 2 is a com-

current from an average thermopile, is too delicate for use in a rugged portable meter.

The other method consists of a photo-electric cell to detect the radiation and some kind of a reading device to indicate the amount of electric energy generated in the photo-electric cell by the ultra-violet rays. This promises to be the best type of measuring instrument for a commercial ultra-violet meter.

There are two general types of photo-cells: vacuum and gas-filled. In each of these general groups there are many kinds of cells having various values of response, per unit of radiant energy, at different wavelengths of radiation. For example, a gas-filled photo-cell with a cathode of potassium hydride is very sensitive to visible light, with its peak of sensitivity in blue light at about 4500 Angstrom units. The caesium cell developed by the General Electric Company is sensitive both to visible light and to infra-red radiation, with two peaks of sensitivity at about 3300 Angstroms and at 8000 Angstrom units, respectively. Other photo-cells are sensitive chiefly to ultra-violet radiation. A cadmium cell with a quartz window, for example, is sensitive to the wavelength band between 2000 Angstrom units and 3000 Angstrom units. The uranium cell in Corex glass, developed by Dr. H. C. Rentschler of the Westinghouse Lamp Company, is sensitive over the

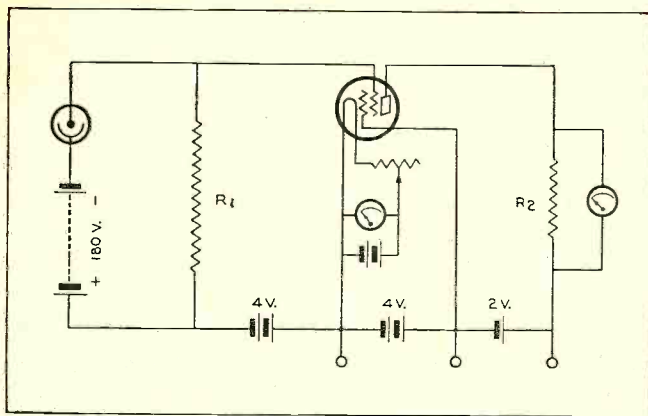
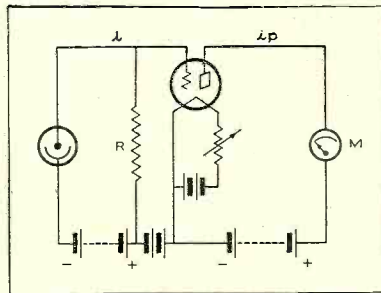

Figure 4. (Above) The new FP-54 amplifier tube and its circuit. This tube is far more sensitive than the usual three and four-element amplifier tubes

Figure 2. (Right) An ordinary three-element tube used to amplify the output of a photo-electric cell



mon type of hook-up for this purpose. The changes in grid potential are proportional to the IR drop across the resistor, R, and accordingly, the change in plate current  $I_p$  is directly proportional to the photo-electric current, I, over the straight-line part of the grid-volts-plate-current characteristic of the tube. Exact linear amplification is not extremely important, as the system can be calibrated with a standard light source. It is evident, from the circuit, that the sensitivity of the hook-up is proportional to the value of the resistor, R. For high amplification, therefore, R should have the highest possible value. There are at least two practical limitations to the amplification which can be obtained. In the first place, resistors of a value higher than 10 or 15 megohms are not ordinarily obtainable commercially, although some manufacturers will supply them up to 100 megohms on special order. However, any ingenious experimenter can devise ways of getting higher values if that is the only thing lacking.

The second, and much more serious limitation, is the problem of current leakage. Obviously, it is useless to increase the resistance of the intended path of the photo-electric current until it is of the same order as the parts of the circuit intended as insulators. A simple application of Ohm's law will show that the current will leak off through all parts of the circuit. This can be prevented or at least minimized at some points by the proper precaution. For example, the grid resistor mounting should be supported in the air by the leads.

It is sometimes advantageous to cut out the bottom of the tube base and fill in the space around the prongs with sulphur or similar insulating material. Considerable leakage may also take place where the leads enter the glass press of the tube itself. This can be eliminated, of course, by bringing the grid lead out at the top of the tube, although it practically means constructing a special tube. It is then necessary to keep the tube very clean and dry to prevent leakage over the surface of the glass.

Instead of attempting to obtain so much amplification from one tube, it is possible to use a multi-stage, direct-current amplifier. Everyone who has worked with them knows, however, that they are apt to be unstable and that it is almost necessary to use a separate battery supply for each stage. This is a serious limitation for a portable ultra-violet meter.

The introduction of the screen-grid tube made possible certain advances in the application of the photo cell to ultra-violet photometry. Figure 3 shows a circuit using type -32 vacuum tube for amplifying the output of a uranium cell. The control grid-bias is adjusted by means of the potentiometer for zero plate current. The deflection of the micro-ammeter is then proportional to the light on the photo-cell, and, since the uranium cell is sensitive only to the part of the spectrum in which we are interested, this hook-up makes a quite satisfactory portable meter for measuring ordinary levels of ultra-violet light. This circuit has been applied by Harris (*Journal of Scientific Instruments*, volume 6, page 2, 1929) to the measurement of the output of a cadmium photo-cell using a type -22 vacuum tube as the amplifier in place of the type -32 shown in Figure 3.

This circuit, however, is not always sufficiently sensitive for some of the work in ultra-violet measurement which is often necessary in the laboratory and sometimes in field work.

One of the most recent contributions to the problem of photo-cell amplification was the development of the FP-54 plectron by the vacuum tube engineering department of the General Electric Company. This tube is sometimes referred to as the "low grid-current" tube, because every precaution has been taken in its design and construction to minimize grid current. The result is that the grid current is of the order of  $10^{-13}$  amperes. Since the ordinary triode, under the best conditions, will have a grid current of

perhaps  $10^{-10}$  amperes, it cannot be used to accurately detect currents of that order or less. Ultra-violet photometry, on the other hand, may involve the problem of accurately measuring currents down to  $10^{-12}$  amperes.

Figure 4 is a schematic circuit for using the type FP-54 tube for this purpose. The resistance R2 should be large compared to the resistance of the detecting galvanometer, so that the galvanometer measures the plate-current change directly. As before, the larger the value of the photo-cell resistor R1, the greater will be the sensitivity of the instrument.

The mutual conductance of the tube is  $25 \times 10^{-6}$  amperes per volt. Accordingly, the value of resistor needed may be

found from the relation  $R = \frac{I_p}{I_{gm}}$  where I is the current to be

detected in the photo-cell and  $I_p$  is the change in plate current to be detected by the meter. For example, a current of  $10^{-10}$  may be measured with a micro-ammeter (*Cont'd on page 1023*)

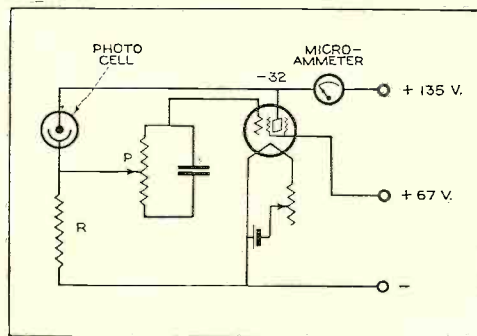
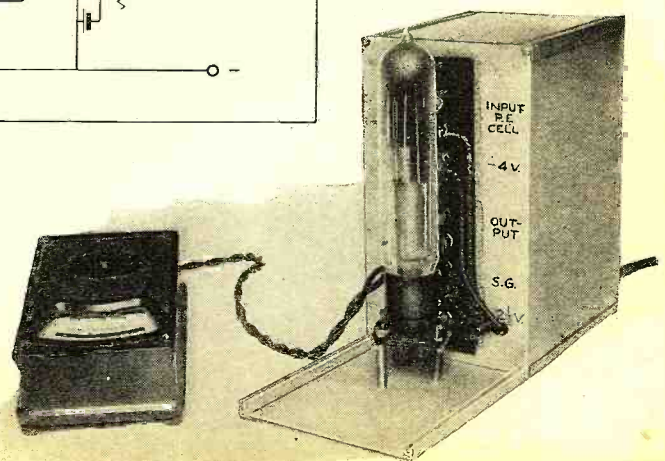

Figure 3 (at left). The -32 type tube offers advantages over the three-element tube for photo-electric amplifier use



A photo-electric cell and its shielded amplifier, the circuit of which is shown in Figure 4



# Broadcast Receiver Equipment Now— and Then



By John F. Rider

*Fundamentally the difference between radio receivers of today and those of a decade ago is largely a matter of refinement in detail. But what magnitude these details have assumed in producing the modern radio from the embryo of a decade ago*

**R**ECOGNIZING the fact that radio fundamentals have changed very little if at all during the past 15 or 20 years, it is interesting to note the remarkable changes and improvements effected upon commercial radio receivers and power amplifiers. This is particularly true when we realize that many of the modern basic structures are practically identical with the basic structures of many years ago.

About 23 years have elapsed since the patent covering the three-element vacuum tube was granted to De Forest. The original circuit as specified in that patent bears a very close resemblance to the systems in use today, as is evident in Figure 1. The only thing missing in this illustration is the grid leak.

If we probe still further we note that very little if any change was effected in vacuum tube receiver design, that is, basically, since the development of the earliest tube receiver, the Ultratone, by De Forest. A schematic wiring diagram of this receiver as used in 1913 is shown in Figure 2. The receiver as shown was popular for almost 10 years and was still in use, although not very popular, later than 1923.

We do not intend this article as a historical description of the radio development during the last two decades. Its primary purpose is to show that while the fundamentals have not changed, the modern receiver actually differs from the old. About ten years have elapsed since the advent of commercial radio broadcasting as we understand the term today. However, the first six or seven years subsequent to the start of popular broadcasting saw very few changes, that is, with respect to the receiver develop-

## PART ONE

ments of the years between 1913 and 1920. One major exception, or perhaps two, are the development of the neutrodyne and the super-regenerative receivers. In the case of the former, however, the application of neutralization to radio-frequency amplifiers was based upon prior developments to accomplish the same effects in tuning systems. A more extended discussion will follow shortly.

The development of the vacuum tube receiver was accompanied by the development of the audio-frequency amplifier for the purpose of magnifying the signal. This was back in 1913. Reference to records of that date shows that the circuit structure of a two-stage audio amplifier was like that used today (in battery models) with the exception of such things as bypass condensers and filter resistances. The major difference between an audio amplifier of old times and the modern unit is the available quality of reproduction. Contrast an old audio transformer with a *hard rubber rod as the core* with the modern iron alloy core units. Audio-frequency amplification in

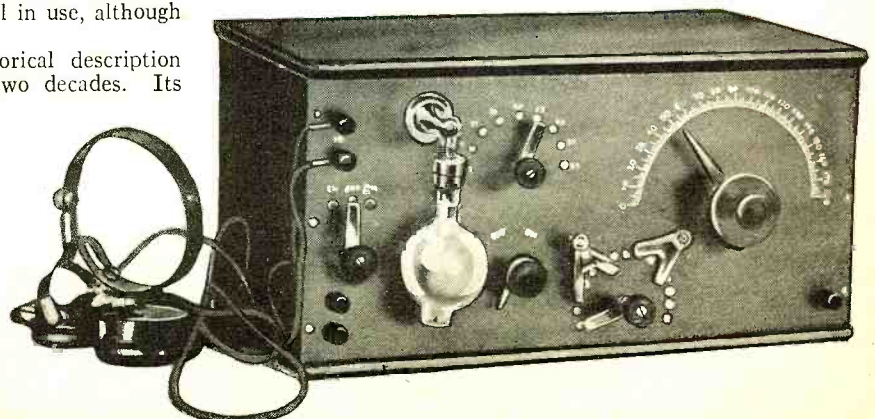

Figure 3. One of the earliest vacuum tube receivers, employing one of the original De-Forest audion tubes. Quite a contrast to the modern receiver shown above

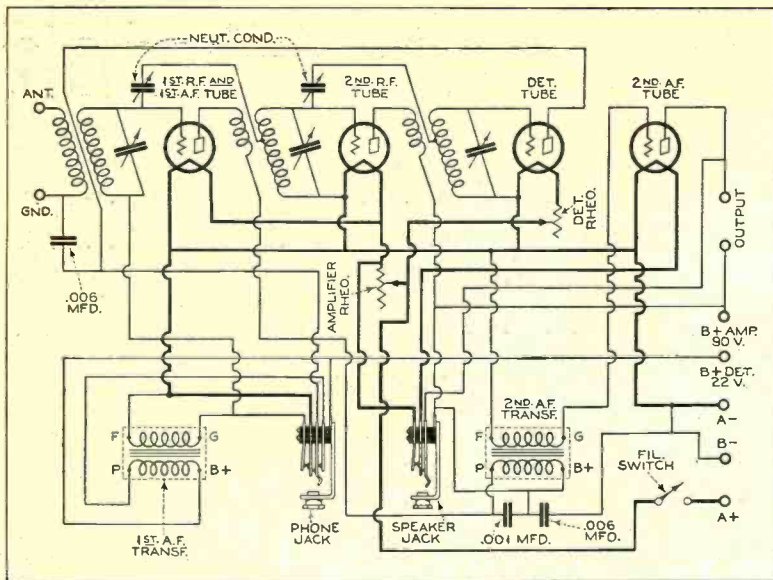

Figure 10. The Fada 160, one of the first neutrodyne. For the sake of economy the first tube was reflexed, serving both as an r.f. and a.f. amplifier

days of old was usually of two types, choke and transformer coupling. We recall experiments with five and six-stage choke-coil coupled audio amplifiers back in 1915. The intensity of the speech heard was plenty, but the quality was horrible, that is, in comparison with the modern units.

The major differences between the old and the new receivers may be expressed in a few words: quality of reproduction, selectivity and convenience of operation. The reference to selectivity is based upon the design of the respective receivers rather than upon the fact that selectivity was not available 10 and 15 years ago. Considering the number of stations in operation at that time, very little if any trouble concerning selectivity was encountered. The greatly increased degree of sensitivity available with the

modern radio receiver is a matter of tube design and circuit refinements, but let it not be said that some of the receivers used prior to the start of the popular broadcasting stations lacked in sensitivity.

The recent popularity of the superheterodyne receiver has created the impression in the minds of many that this receiver is new. Such an idea is far distant from the truth. The superheterodyne principle of operation had been considered and worked upon by many radio investigators prior to the advent of broadcasting and the general circuit structure of this type of receiver remains the same today as then, although tremendous improvements have been made in details.

Referring once more to sensitivity and selectivity, some very enviable records of the time were created by the type of receiver shown in Figure 4. Such receivers were available prior to 1919 and were used for several years subsequent to 1920. Alone, or when used with an audio amplifier of one, two, three or more stages, they accomplished wonders in the hands of the experienced operator. The popularity of the regenerative detector system waned when the subject of tone quality became of moment, but even today one does not hear anything but complimentary comment about the old single-tube regenerative detector systems.

Convenience of operation was a matter of fifth or sixth importance—perhaps tenth importance. That such a condition should exist is shown by the appearance of a popular tube receiver of the days around 1913 and later as shown in Figure 3. Everything but the batteries are mounted upon the front of the panel. Each and every circuit was equipped with a variable control in the effort to secure utmost sensitivity. Several recent receivers announce multi-wavelength ranges. Such receivers were used many years ago, and one example of a receiver which functioned marvelously upon the 150- to 20,000-meter band is shown in schematic form in Figure 5. It was known as the Weagant "X" circuit, popular for long-wave operation, but it also performed well upon the low waves. Examine this circuit and you will find three independently

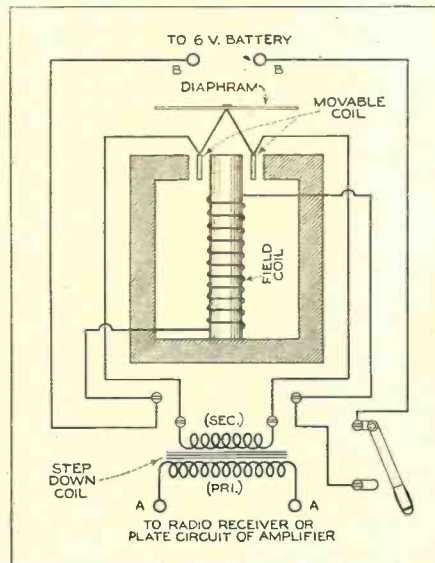
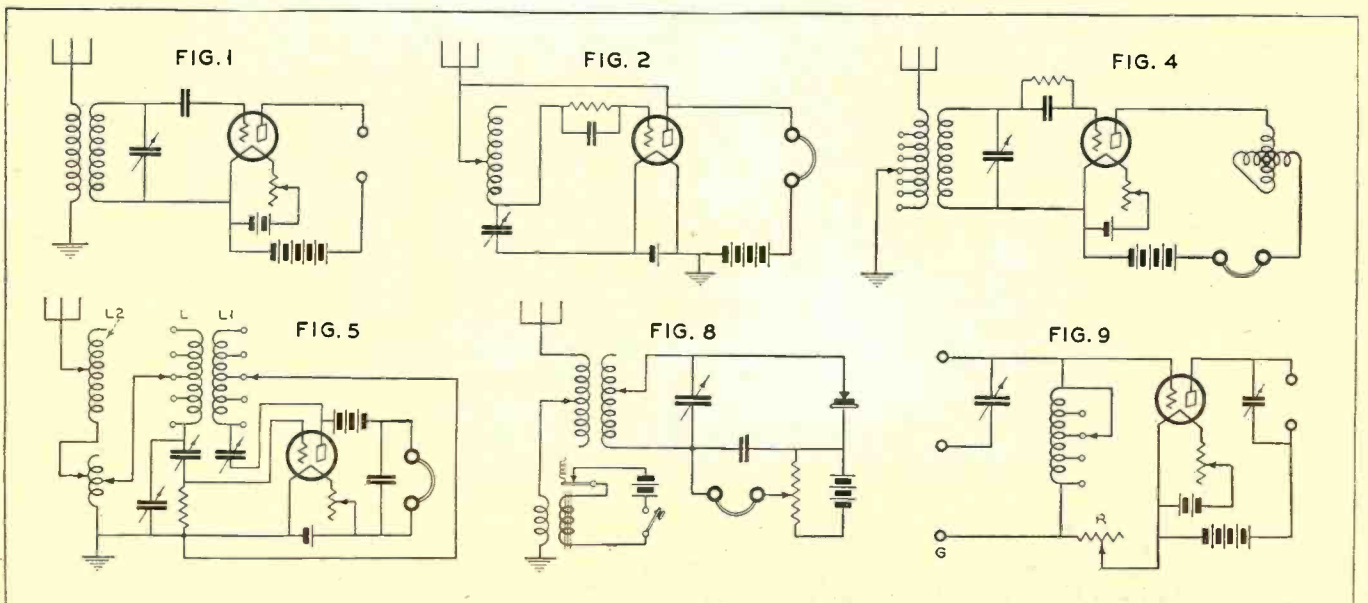

Figure 12. The circuit of the Magnavox, a dynamic speaker popular as early as the year 1919



Some of the circuits in vogue during the earliest days of broadcasting, all of which are touched on in this article

controlled tuning condensers and four separately tuned inductances. The coils designed as L, L1 and L2 were from 24 to 30 inches long and stood upright upon the table. These coils were finally replaced by the honeycomb type of inductances.

The modern receiver with its single tuning control for four or five stages represents an infinite advance over the old system, as is shown by the panel view of a receiver manufactured during the first few years subsequent to the start of broadcasting. The Grebe CR-8 afforded a wavelength range of from 500 to 24,000 meters and the panel view appears as shown in Figure 7. A typical broadcast receiver with a wavelength range of from 170 to 580 meters, the Grebe CR-6, is shown in schematic form in Figure 6. This receiver consisted of a regenerative detector system and two stages of audio. Each tube in the receiver was equipped with its own filament control unit. Grid bias was not used upon any of the audio stages and distortion as we know it today was rampant. Plenty loud but poor quality, although it was good for those times. In contrast to the long-wave CR-7, the CR-6 was known as the Grebe short-wave receiver. Short waves as we know them today are wavelengths below 150 meters, or the range between 40 and 150 meters. assuming that the waves below 40 meters are called ultra-short waves. Each stage was equipped with a filament and plate circuit control jack. Insertion of the plug connected to the headphones or to the loud speaker into any one of the jacks automatically extinguished the filaments of the succeeding tubes.

The start of broadcasting saw the popularization of the crystal receiver. The models manufactured at that time were even then much more crude than the crystal receivers in use for the ten years previous to 1920. The circuit diagram of a then de luxe type of crystal receiver is shown in Figure 8. The aerial and secondary circuit were tuned and a potential was applied to the carborundum crystal so as to secure best operation. A buzzer system was a part of the receiver and was used to enable pre-adjustment of the crystal contact. A crystal of this type was far more stable than the usual run of light contact crystals such as Galena. Strong bursts of static or signal interfered with the response of the Galena type of crystal. The required contact was very light



Figure 7. The Grebe CR-7, a high-grade one-tube receiver of 1922, had about everything on the panel but the kitchen sink

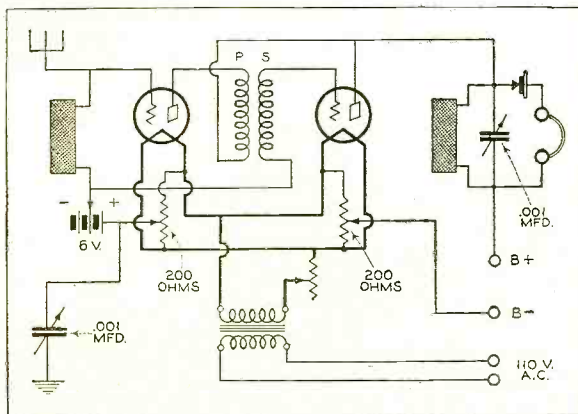

Figure 11. One of the first receivers to draw its filament supply from the a.c. lines. This circuit was published in RADIO NEWS 'way back in the dim past of December, 1922

and many a program was completed without some loss of time and program because of required readjustments. The modern receiver owner complains if an SOS signal interferes with his program. What would he have done in the past if a slight jar interrupted the program and perhaps ten minutes were required to locate another sensitive spot upon a crystal used in the open and subject to oxidation?

The number of incorrectly operated regenerative detector receivers multiplied with leaps and bounds. So much so that within two years subsequent to 1920 more miniature transmitters (although not intended as such) than receivers were in use. The heterodyne interference caused by these receivers mounted to such proportions that it was practically impossible to listen to a complete program without a series of shrieks, howls, growls and whistles emanating in some other receiver perhaps a mile away. The condition of the air today is sublime silence by comparison. The present-day form of electrical disturbance was unknown in years gone by because of insufficient sensitivity, few sources of such disturbance and the lack of power line operation.

The interference caused by regenerative detector systems became so great that more than one publication discussed the possibility of licensing the owners of such receivers. Agitation was started and one of the earliest types of radio-frequency amplifier units intended as a blocking as well as amplifier stage for use between the aerial and the oscillating detector was announced in 1922. The circuit of the Grebe RORO, a single-stage, tuned radio-frequency amplifier is shown in Figure 9. R in this illustration is the equivalent of the modern grid suppressor.

Hazeltine, early in 1923, announced the neutrodyne receiver, with the result that the tuned radio-frequency amplifier offering increased selectivity, made necessary by the fact that about 570 broadcasting stations had been licensed in the United States and about 60 in Canada, greater sensitivity and freedom from excessive regeneration, quieter operation and more friendly attitude toward one's neighbor, started the decline of the regenerative detector system. In a sense this invention constituted one of if not the greatest contribution towards the complete acceptance of radio broadcasting by the public. A (Continued on page 1032)

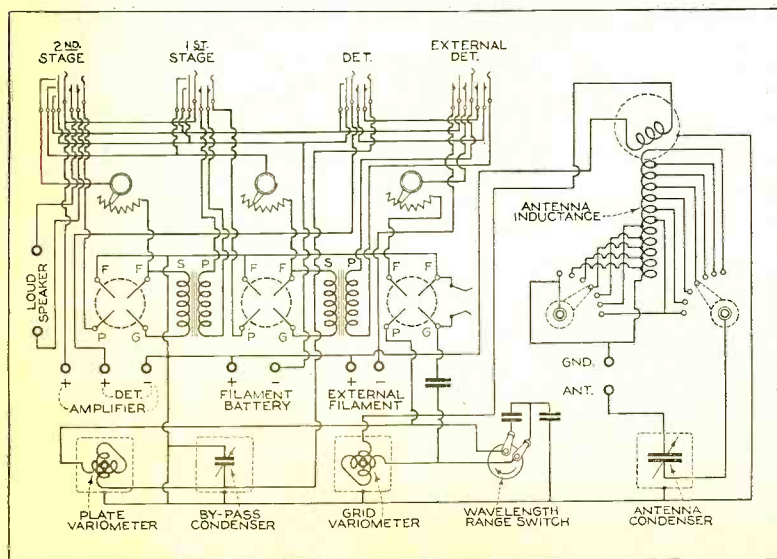

Figure 6. The circuit diagram of the Grebe CR-6 broadcast receiver, 1922 model. It had four tuning dials plus numerous rheostats and switches to keep the operator amused

# The Boston Television

*The increase in the number of transmitting stations, regular program schedules, practical demonstrations and the appearance of moderately priced television receivers are all helping to hasten the day of television in the home*

By Joseph Calcaterra\*

IT IS a curious fact that while other inventions have literally had to batter down almost impregnable walls of public opposition, television, on the other hand, has aroused such keen interest in an expectant public that it has been welcomed with open arms.

The fact that television is so closely allied with radio, an art which has made remarkable strides in a few short years, is no doubt responsible for this attitude on the part of the general public. There is a feeling that nothing is impossible to the minds that brought radio into being as one of the most entertaining and educational mediums the world has ever known.

Most of the television demonstrations up to the present, while interesting and promising, have had very serious drawbacks in that they required the expenditure of rather large sums of money for equipment capable of giving satisfactory results.

The results attained by the laboratory staffs of the General Electric Co., the Radio Corporation of America and the Bell Telephone Laboratories have been truly remarkable but the equipment required has been so elaborate as to make its use, by the average experimenter or in the average home, quite out of the question.

### Television Not Yet Perfect

That television is far from being perfect at present is admitted by the most ardent television enthusiasts, but little is to be gained and much may be lost by keeping television in the laboratory, awaiting the day when it can emerge full-grown.

All previous experience shows that no art can reach its highest development unless it is brought out into the open so that the cooperation and support of all classes can be enlisted in bringing it to perfection.

The progress of radio is a shining example of this fact. Radio has made far greater progress in the last ten years than it did in the previous twenty years, simply because the public has been interested in its development and has contributed, in a large measure, the interest and support necessary to push it ahead.

Whether or not television is practical has been argued pro and con for the past few years. As is the case with most "de-

bates," however, the arguments for and against it have usually been based on the individual's own conception of what constitutes "practical" television.

Today we do not consider an automobile "practical" unless it can go at least forty or fifty miles an hour for long stretches and provide comfortable riding qualities at such speeds. Only thirty years ago, a "gas buggy" that could crawl along at fifteen miles an hour, with many a pause for roadside repairs, was considered "practical," for it enabled its owner to travel along at a fair speed.

Placing the present television equipment in the hands of experimenters and the public will do for television what experimentation and testing in the hands of the public has done for the automobile. Most of the "impossible" things of yesterday have become the realities of today.

That television has now reached the stage where it is practical for the use of the type of experimenter who was thrilled by a few bars of music picked out of the air in the early days of radio, is beyond question. The days when stage presentations, prize fights or pageants can be viewed in the television receiver are still in the future,

the amount of detail of a face which can be received has sufficient entertainment value to justify the small expenditure necessary to construct and install a television receiver.

Just as the engineers who have made their mark and fortune in the radio industry are the experimenters who "played" with



Hollis Semple Baird, whose research work has produced the television system described in this article

### SCHEDULES AND DATA ON

Call Ltrs	Location	Operated by	Carrier Frequency (Kilocy.)	Freqcy Band Allocation (Kilocycles)	Power (Watts)	No. of lines to picture	Pictures per Second	Ratio of Height to Width
W1XAV	Boston, Mass.	Short Wave & Televis'n Corp.	2870	2850-2950	500	48	15	5 to 6
W2XBS	New York, N.Y.	Nat. Broadcasting Co.	2150	2100-2200	5000	60	20	
W2XCD	Passaic, N. J.	De Forest Radio Co.	2035	2000-2100	5000	48	15	5 to 6
W2XCR	New York, N.Y.	Jenkins Television Corp.		2000-2100	5000	48	15	5 to 6
W2XCW	Schenectady, N. Y.	General Elec. Co.		2000-2100	20000	48	20	
W2XR	L. I. Is. Cy., N.Y.	Radio Pictures Inc.	2910 2150	2850-2950 2100-2200	500	48	15	
W3XK	Sulphur Spgs., Md.	Jenkins Television Corp.	2065	2000-2100	5000	48	15	5 to 6
W8XAV	E. Pittsburgh, Pa.	Westg'se Elec. & Mfg. Co.	2150	2100-2200	20000	60	20	
W9XAO	Chicago, Ill.	Western Television Corp.	2050	2000-2100	500	45	15	1 to 1
W9XAP	Chicago, Ill.	The Chicago Daily News	2150	2100-2200	1000	45	15	1 to 1
W9XG	W. Lafayette, Ind.	Purdue Univ.	2800	2750-2850	1500	Variable	15	5 to 6

\*Aerovox Wireless Corporation.

# Party

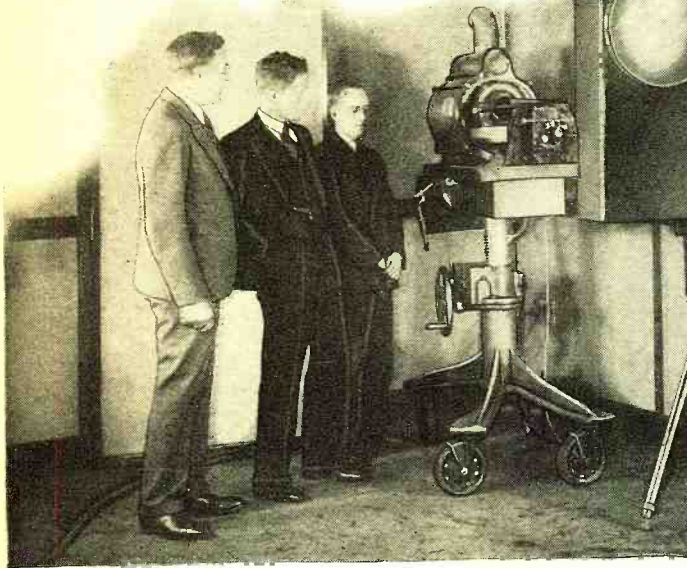

The television transmitter in the studio is being shown to Rudy Vallee by A. M. Morgan, president, and Hollis S. Baird, chief engineer, of the Short-Wave and Television Corporation

radio several years ago, so also the experimenters who build and experiment with the present comparatively crude television outfits of today will be the television experts of the next few years. They are the ones who will be responsible for the many revolutionary developments which are bound to come.

One of the most encouraging factors in the merchandising efforts made by concerns which are building and selling television receivers and kits is the fact that they are carefully concentrating their efforts in those localities where tests and experience have definitely proved that satisfactory television reception can be attained. The quality of television reception in any given locality has been determined in a general way by field tests conducted either with portable receivers or through reports of television reception by owners of television receivers.

Much helpful assistance can be rendered by television receiver owners if they report on reception to the stations.

## Do You Know That

regularly scheduled television programs are now available throughout a fair portion of the country to those equipped with receiving equipment? This article tells more about them.

The scanning belt, synchronizing unit and synchronous motor which form the heart of the Baird Television System. The motor and synchronizing unit keep the scanning belt at the receiver in perfect step with the scanner at the transmitting station

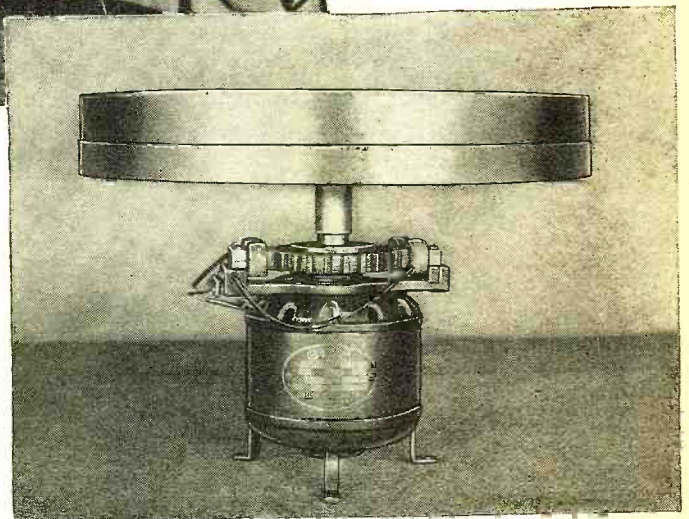

The television art is as yet too young and the number of television receivers too few to permit a definite estimate of the distances which can be covered by television signals of any given strength.

However, as the number of receiving stations increases and reports of reception are received, accurate estimates of probable areas which are covered by transmitting stations will be mapped out, just as in earlier days, reports from listeners-in and field strength tests conducted by mobile testing stations made it possible to estimate with a fair degree of accuracy, the areas over which a broadcast station of any given power could be expected to be heard satisfactorily.

### ACTIVE TELEVISION STATIONS

Scanning Characteristics	Television Broadcasting Schedules (Weekdays Only)	COORDINATED SOUND PROGRAMS		
		Through Stations	Frequency (Kc.)	Schedule
Left to right, top to bottom	12 M. to 1; 3:30 to 4; 7:30 to 10:30 P. M.	WNAC, WEAN, WNBH, WLBY, WORC, WICC, WDRC	1230, 780, 1310, 620, 1200, 1190, 1330	2 M to 1; 3:30 to 4 P. M.
Same as above	2 to 5; 7 to 10 P. M.			
Same as above	10 A. M. to 12 M. 3:30 to 5; 9 to 10 P. M.	W2XCD	1604	9 to 10 P. M.
Same as above	3 to 5; 8 to 10 P. M.	N. Y. stations		
Same as above	4 to 10 P. M. 5 to 7 P. M.	W2XAR	1604	8 to 9 P. M. Thursdays 7 to 9 P. M. irregularly on other weekdays
Same as above	7 to 9 P. M.			
Same as above	Experimental. No regular schedule	WSXK	6140	Sound programs. Experimental and irregular
Right to left, top to bottom	1:45 to 2; 4:30 to 5; 7:30 to 8 P. M.	WIBO	560	1:45 to 2; 4:30 to 5; 7:30 to 8 P. M.
	12:15 to 1; 3 to 3:20; 4 to 4:30; 7 to 7:30; 8 to 8:45 P. M.	WMAQ	670	Irregularly during television schedules
Left to right, top to bottom	Experimental. No regular schedule			

### Television Programs Improving

Another encouraging feature of the television situation is the fact that television stations are realizing that in order to keep their hold on both the experimenter and the general public,

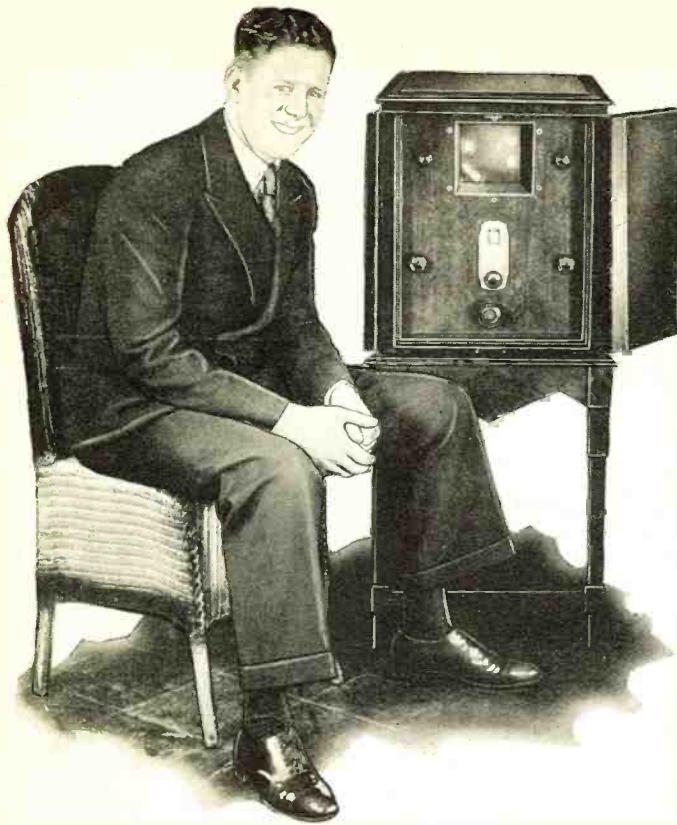

Rudy Vallee, popular stage and radio entertainer, "looks in" on a television feature coming in through the television receiver

### Features of the Baird Television System

1. Small in size. Panel is only 15" x 15", permitting installation in a console no larger than a standard radio cabinet.
2. Universal in its application. Can be adapted quickly and easily for reception of 24, 45, 48 or 60 line pictures at speed of 15 or 20 pictures per second.
3. Synchronization on signal instead of on power line, making the speed of the scanner independent of variations in the power line frequency, voltage or load.
4. Receiver portion of the outfit may be used for both short-wave and broadcasting wavelengths by means of interchangeable plug-in coils.
5. Uses a resistance-coupled audio amplifier giving a comparatively low gain per stage, but free from interstage coupling and distortion, thus eliminating the need for expensive filtering arrangements.

the best of the material available. Broadcasts of singers, talkers and other features are being arranged which take full advantage of the fact that in such transmissions the face and voice of the performer are the most important features. The time is not far off when these features will be transmitted on the same regular schedules as radio broadcasts.

Some people who scoff at the entertainment value of television broadcasts mention the fact that there are comparatively few stations which are broadcasting television programs. Such people might be reminded of the fact that in the beginning only two or three stations were broadcasting radio programs on the limited wavelengths of 360 and 400 meters, with programs limited for the most part to talks and phonograph reproductions. As soon as the interest in television increases, the number of stations will increase and the programs will improve.

worthwhile programs must be put on the air. In this they are following in the pioneering footsteps of some of the early radio stations.

Many of the old-timers can remember when the "program" from a broadcasting station consisted simply of remarks such as "Do you hear me now?" "How am I coming over now?" and other such choice testing phrases, interspersed with an occasional reading from a book or a snatch of a song. Gradually, however, program material improved until now the entertainment value of radio is unquestioned.

The same evolution is taking place in television broadcasting. Instead of simple facial movements, actual synchronized voice and visual broadcasts are now being put on the air.

Just recently a number of combined voice and visual broadcast programs have been transmitted from the studio of Station W1XAV of the Shortwave and Television Corporation. The combined transmission of sound and pictures was accomplished by transmitting the pictures direct from the aerial of Station W1XAV and the sound from a near-by station transmitting on a broadcasting wavelength. A telephone line connected the microphone at the television studio with the sound broadcasting station.

The voice was broadcast over the aerial of the sound transmitting station simultaneously with the transmission of the picture from station WEXAV. At the receiving end the voice was received on a standard broadcast receiver while the picture was received on the combination shortwave and television receiver. Voice and picture were perfectly synchronized.

The entertainment and educational value of the transmission of the voice and face of a prominent speaker such as the President of the United States or of a popular entertainer such as Rudy Vallee is obvious.

Television programs are being planned which make

### Type of Image Received

The images received with equipment now available are somewhat coarser than the halftone illustrations seen in the average newspaper. The maximum field of vision or limit of area which can be transmitted and received with good detail includes the face and part of the bust of a man or woman or any other object of similar proportions, with all the light tones which bring out the features. Under favorable conditions, the features of a known person can be recognized. The movements of the lips, eyes and other features are easily discernible.

It is interesting to note that merchandisers of television outfits are anxious to avoid any semblance of misrepresentation in selling their products. The Shortwave and Television Corporation, for instance, has made arrangements to install television demonstration outfits in all Kresge Green Front 25c. to \$1.00 Stores located within the transmitting range of existing television stations. In this way per- (Continued on page 1028)

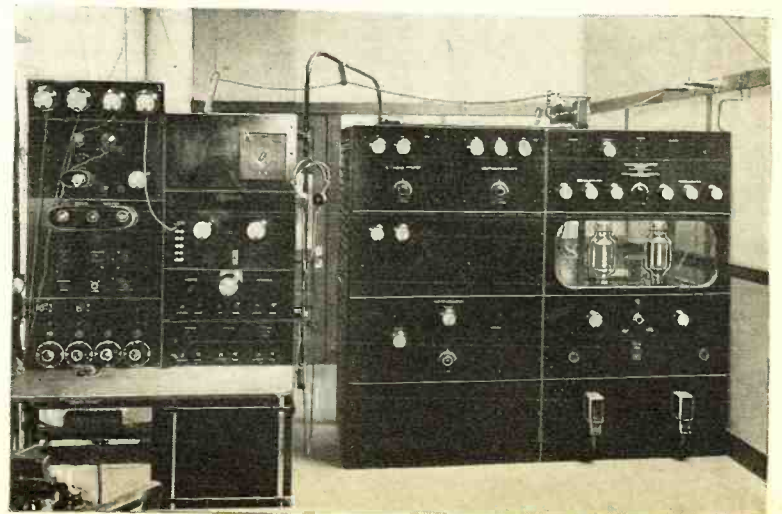

The transmitter room at W1XAV. The first panel at the left is the speech amplifier and next to it the television modulator and amplifier. At the right is the power amplifier with a 500-watt output stage

# Testing Power Transformers

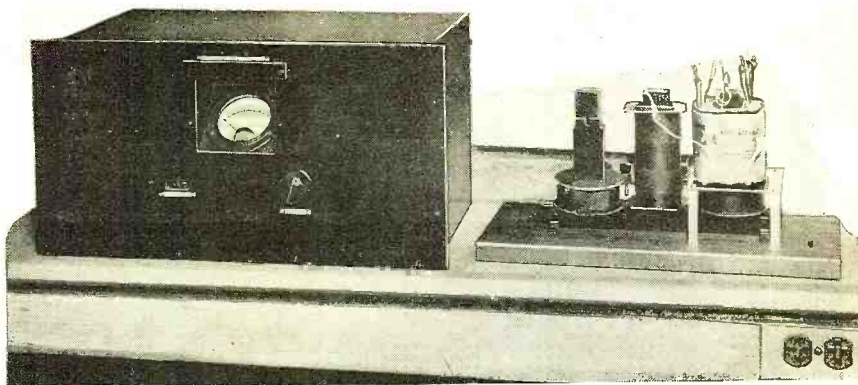

A view of the test set-up employed by the author for detecting shorted turns in transformer coils

*This simple apparatus provides an accurate and effective means for detecting shorted turns in power transformer windings and should be of interest to engineers and others engaged in inspection and production work*

THE engineering department of most well-planned radio manufacturing organizations is composed of two divisions. First, there is the research and design division, which is concerned with the development of new models embodying the fructification of advanced knowledge, and, second, there is the test engineering division. It is among the duties of the latter to see that the set in production conforms to the specifications set down by the design division. To do so it must devise test equipment which is sensitive enough to find minute and elusive faults, rapid enough in operation to be practical for production purposes, and yet simple enough to be handled by the average factory operator. Often this is an ingenuity-taxing job.

By Herbert M. Isaacson

### Shorted Turns

For illustration, we shall consider the matter of shorted turns in coils. In some pieces of apparatus the presence of shorted turns has no deleterious effect, in some it is desirable, but in others it is disastrous. Filter choke coils may have a comparatively large percentage of shorted turns with no more serious effects than a decrease in inductance and a resultant decrease in the effectiveness of the filtering—usually not enough to be detected by ear. A certain percentage of shorted turns in an audio-frequency transformer will flatten out peaks in its amplification *vs.* frequency curve and are therefore rather desirable. On the other hand, a single shorted turn in a power transformer may result ultimately in its destruction.

Consider, for a moment, the design of the average power transformer. It probably has five turns per volt, a high-voltage secondary of No. 30 enamel wire and a rated temperature rise under load of about 40° Cent. The average length per turn in the high-voltage secondary is 6 inches. It has a resistance at normal operating temperature of approximately

0.065 ohm. Assume this turn to be shorted on itself through a negligible contact resistance—it becomes practically a unity-power-factor load of 0.065 ohm across a 1/5-volt supply. The current flowing will be

$\frac{0.2}{0.065}$  or 3 amperes. This is 30 times normal current and the

heat generated will be 900 times normal. This heat from the single shorted turn will be conducted to adjacent turns, and their insulation will be broken down. (Enamel insulation will not withstand a temperature much in excess of 100° Cent.) The action is progressive—a vicious circle being created—shorted turns generating heat which causes more shorted turns which in turn generate still more heat, until the entire transformer is destroyed.

### Detection of Defects

A wattmeter or ammeter might be used to detect the presence of this initial shorted turn by the added primary power or current. However, variation in the core material or assembly might account for the increase of a half watt in power as easily as would the shorted turn. Further, if the contact resistance is not of negligible value, as assumed in our illustration (and it usually is not), then the increase of power would be so slight as to render its detection by a wattmeter altogether impossible. Even if a wattmeter did detect the shorted turn, there would be the expensive waste of having completely assembled the

transformer, and then rejecting it and reassembling it with a perfect coil. The ideal test method would detect the shorted turn in the coil before it was assembled into a transformer.

### A Better Method

Such a method is herein described. It is stable, simple to use and capable of testing 2000 coils per day. It can be made to have almost any degree of sensitivity desired. However, with a single-stage amplifier, as shown in Figure 1, holding a single loop of No. 30 wire, 6 inches in diameter, a distance of one inch above the top (Continued on page 1025)

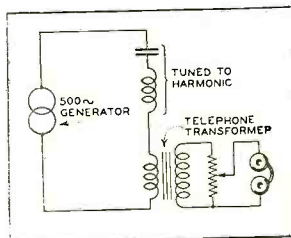
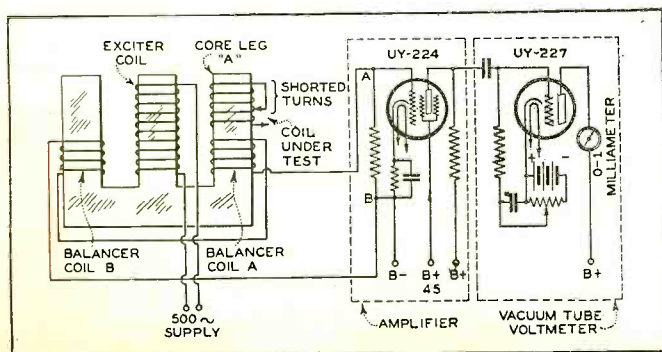

Figure 2. A method for determining the relative amplitude of harmonic frequencies in the output of a generator

Figure 1. (At left) The schematic circuit of the apparatus shown at the top of the page

# Radiophone

By  
Samuel Egert



The receiver and transmitter set up for operation

Figure 1. The receiver circuit is a conventional one. The use of a screen-grid detector provides unusually smooth control of regeneration by means of the resistance R2

WHEN the average person thinks of portable receivers and transmitters it is usually in connection with some expedition, an exploring party or something of the kind. Few persons view such equipment in connection with their own activities, yet there is scarcely anybody who has not at one time or another wished for something of the kind—some means of communication from an isolated spot where ordinary communication means such as the telephone, for instance, were not available.

There are many occasions when a compact and easily portable radio telephone or even a CW (continuous wave, code) transmitter could be used to excellent advantage to maintain communication from remote points such as those in which vacationists, who have a flair for getting back to nature, are likely to find themselves.

Exploring parties, movie companies on location, surveying parties all have real use for radio equipment with which to keep in touch with their headquarters or bases of supplies. Even construction gangs are often in need of this kind of radio equipment, particularly those engaged in large operations covering large tracts of land such as dam sights, water work projects, lumbering operations and the like. Many of these get along somehow with messenger service, especially during the earlier part of the operations while ground is being cleared. Real savings in time, dollars and cents could be effected if means were provided for more prompt communication service such as that provided by the equipment described in this article.

Some of the conditions suggested above really call for equipment more pretentious and of higher power than the outfit to be described here. But many requirements will be met by this simple equipment. In fact where the distance over which communication is to be maintained is only a few miles, this little set can be depended upon for voice transmission. For code transmission, under ordinary favorable conditions at night the set will reach out to forty or fifty miles and upward without difficulty.

It is not at all unknown for a low-power transmitter such as this to reach out hundreds or even thousands of miles with CW, but such ranges cannot be depended upon day in and day out, especially with the more or less uncertain qualities of the antennas that are likely to be employed with portable equipment.

For use on board a pleasure boat, cruising not too far off shore, a small transmitter is not only a convenient thing to have around but may, in case of emergency, help to avert a catastrophe. There are many boats that have come to grief

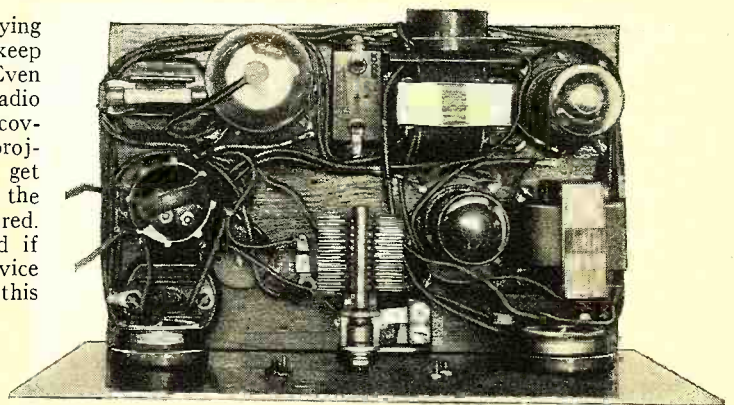
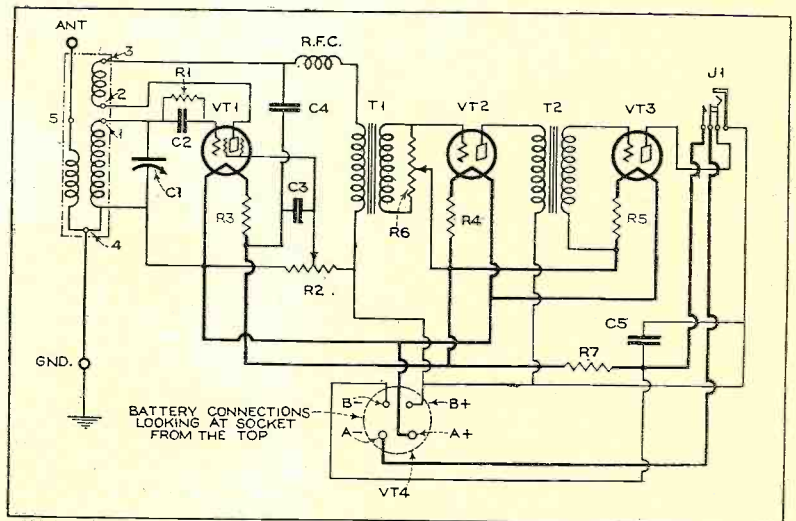

This top view of the receiver with its metal case removed gives a good idea of the layout of the parts, with the detector and tuned circuits confined to the left half and the audio amplifier to the right

within a few miles of shore due to a squall coming up before a "run to cover" could be made and when no means of communication were available for summoning help.

One may voice the objection that there must be two ends to the line in order to establish communication and that there is no advantage in having a radio transmitter on board when there is no one on shore with whom communication can be established. Actually there is always more than a fair chance of there being a receiver not far distant in the form of an amateur radio station. These stations are sprinkled over



# Transmitter and Receiver=9 Lbs

*For automobile, boat, camp or hike a truly portable short-wave transmitter-receiver offers many attractive possibilities to the amateur operator. The battery-operated outfit described here provides for both 'phone and code transmission and is designed to meet the most drastic limitations of weight and space, as well as to stand up under the hard wear of transportation*

the country—thousands of them, each a potential point of contact; willing to relay messages and to render any service that can be fairly expected.

But so much for the possible uses for low-power, portable radio equipment. Everyone can think of a dozen experimental and practical uses for it. There is just one bit of explanation required before the description of the equipment. Every radio transmitter, no matter how low its power, can be operated in the U. S. only under a license from the Department of Commerce. Amateurs who are already provided with amateur station licenses know the ropes and to such of them as are interested in the outfit described here, no suggestions regarding licensing are needed. But to others who may not be familiar with the requirements of the Department of Commerce the suggestion is hereby made that they apply to the office of the Radio Inspector for their districts for information as to the requirements; or if the location of the Radio Inspector's office is unknown a communication addressed to

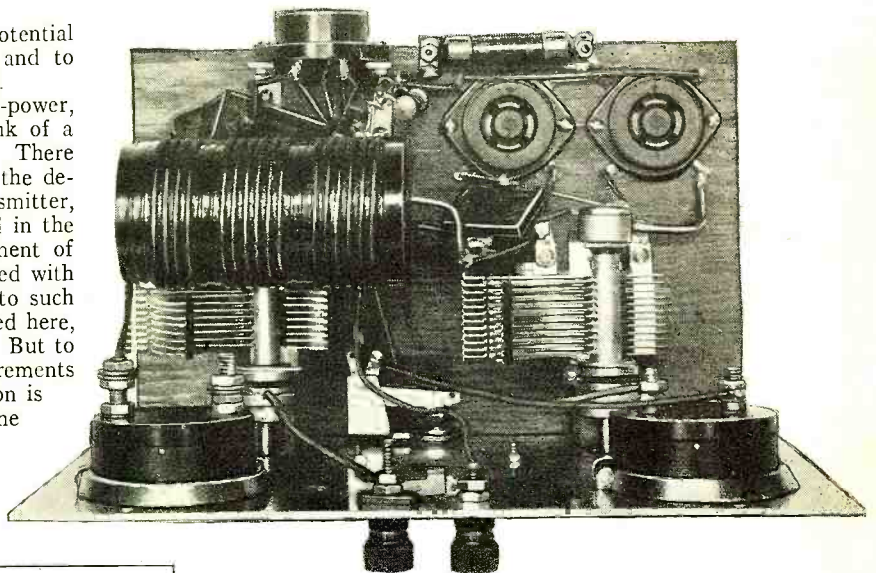

Top view of the transmitter. The antenna and ground binding posts are located at the top center of the front panel, as shown in the foreground

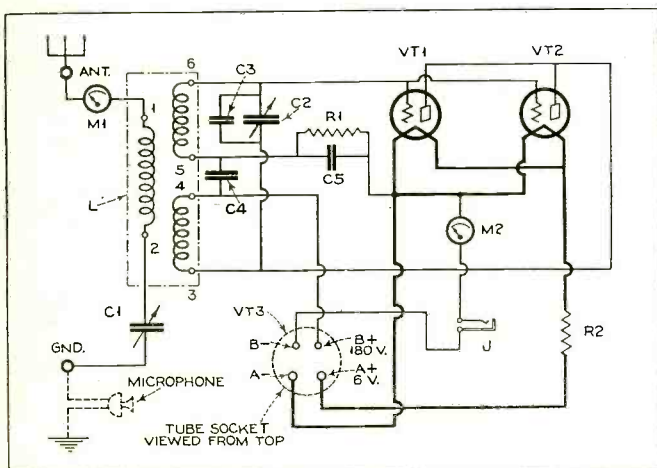

Figure 2. The circuit of the transmitter, which may be employed for either code or voice transmission. For the latter a microphone may be connected in series with the ground lead, as indicated by the broken line

the Radio Division, Department of Commerce, Washington, D. C., will bring the desired information.

Portable radio equipment, if it is to be really practical, is called upon to meet several requirements. It must be light in weight and small in size. It must be simple to tune and to operate. It must be simple to set up and dismantle. It must be designed for battery operation and in many cases will have

to depend on "B" batteries for the plate supply. In addition to all this it must be sufficiently rugged to stand up under the wear and tear of transportation.

The outfit described here was designed to meet these requirements. It consists of a receiver in which are incorporated a regenerative detector and two stages of transformer-coupled audio-frequency amplification; and a transmitter which consists of two type -12 tubes, in parallel, and which provides for either voice or code transmission.

Both the transmitter and the receiver are built into metal boxes, identical in size and also in appearance, except for the difference in the panel layouts. The two together, in their cases, weigh only nine pounds and occupy a total space of 10 inches by 16 inches by 6 inches. Both operate on batteries. They are planned to employ a storage "A" battery, although by substituting other resistance values for those in the filament circuits they can be readily adapted for dry-cell operation. It will be noted that dry-cell tubes are employed in the receiver. These require 2 volts for their filaments and 3 volts of the surplus voltage from the storage battery provide the "C" bias. The high voltage for the plate supply may be obtained from the smallest sizes of "B" batteries. The transmitter plate-current drain is rather high for these tiny batteries, however, and for that reason, except where the utmost economy in space or weight is essential, the medium sizes of "B" blocks are recommended.

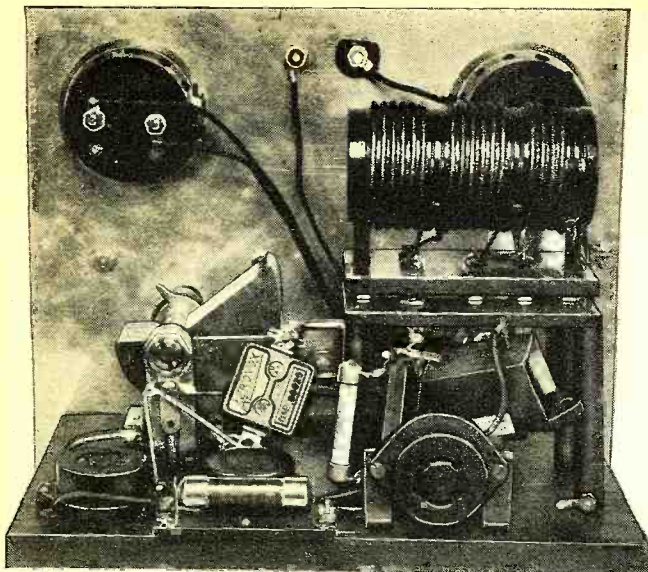

The transmitter from the back shows the method of coil mounting. The antenna tuning condenser is immediately in front of the coil and above it is the antenna meter

Figure 5. (At right) The specifications for the transmitter coil and mounting socket complete for those who desire to build their own

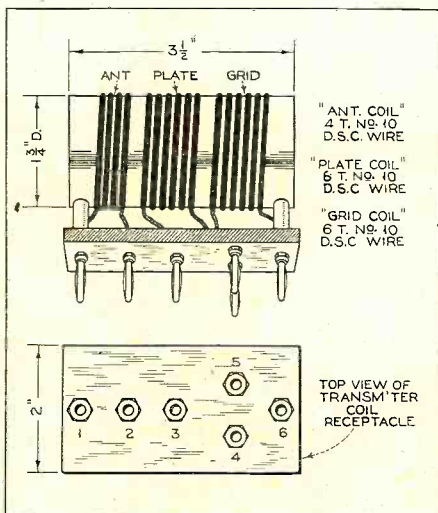

### The Receiver Design

The receiver utilizes a screen-grid type -32 tube in the detector stage and two type -30 tubes in the audio stages. Each of the three tubes draws its filament supply through a 50 ohm resistor connected in its individual circuit to provide a 3 volt bias for the grid. There is also a 5 ohm resistance (R7) in the common negative line. For operation from dry cells the 50 ohm resistors might be eliminated and a "C" battery used to provide the 3 volt grid bias. In that case a hand-operated rheostat in the common "A" negative lead would provide the necessary regulation to compensate for the battery voltage drop. The size of this rheostat would depend upon the total battery voltage employed.

There is nothing tricky about the receiver circuit, the most unusual feature being the use of a screen-grid tube for the regenerative detector. For those who have not tried this, there is a surprise in store in the smooth control provided over regeneration. There is no tendency for the tube to spill over, absolutely no fringe-howl and no "plop" when the tube goes into or out of oscillation. As shown in the schematic diagram of the receiver, Figure 1, control of regeneration is accomplished by means of a potentiometer connected across the "B" battery and with its contact arm going to the screen-grid. In other respects the detector circuit and the circuits of the two audio stages are quite standard practice.

As a matter of convenience, and of comfort when wearing headphones, a volume control is provided in the form of a potentiometer connected across the secondary of the first audio transformer. This control and the knob of the regeneration control resistor are both on the front panel, of course, and represent the only controls, other than the single tuning control. There is no filament switch but, instead, the jack into which the headphones or loudspeaker are connected is of the filament-control type which automatically turns on the filaments when the plug is inserted and turns them off again when the plug is

Another view of the receiver. The antenna and ground binding posts are mounted on the rear wall of the metal cabinet

removed.

Connections to the batteries are made by means of a plug and socket arrangement. A regular UX type tube socket is mounted on brackets within the receiver case but projects slightly through a hole provided in the back of the metal case. The battery cable terminates in a four-prong plug for which purpose an old tube base will serve. The connections for the socket are indicated in Figure 1.

This particular receiver was intended for use only on one band and is therefore provided with only a single coil. This is of the plug-in type, however, and other bands can be readily covered with suitable coils. The coil form used is the Pilot five-prong type, with a standard UY type socket as the base. The coil consists of five turns of No. 24 DSC wire for the antenna coil, 24 turns of No. 22 DSC for the secondary and 15 turns of No. 22 DSC for the tickler. All details are given in Figures 3 and 4. This coil, together with the 100 mmfd. tuning condenser, covers a range of from 60 to 100 meters.

### The Transmitter Design

The transmitter employs one of the simplest type circuits and is inductively coupled to the antenna. It is no more complicated to construct than a one-tube regenerative receiver.

In fact, it is much like such a receiver, except that it employs two tubes, in parallel, instead of one. Tuning of both the closed circuit and the antenna circuit are provided for in the form of variable condensers mounted on the front panel. The main difference in design between this and a receiver lies in the use of built-in meters. One is a d.c. milliammeter, connected in the "B" negative lead, to show the plate-current drain. The other is the antenna meter, a thermo-milliammeter with an 0-500 range.

The transmitting inductance is also of the plug-in type, designed to work in the 80 meter band. It is wound on a 1 3/4 inch form and consists of the following windings; Antenna coil 4 turns of No. 10 DSC wire; plate coil 5 turns of No. 10 DSC wire; grid coil same as plate coil.

Provision is made for filament operation from a storage battery and the 2 ohm filament resistor (R2) is correct for this service. Should dry cells be used, this can best be a hand-operated rheostat. As in the receiver, the battery connections are made by means of a plug and socket, the latter being mounted on the rear of the transmitter. No battery switch is included in the transmitter. The batteries are (Continued on page 1033)

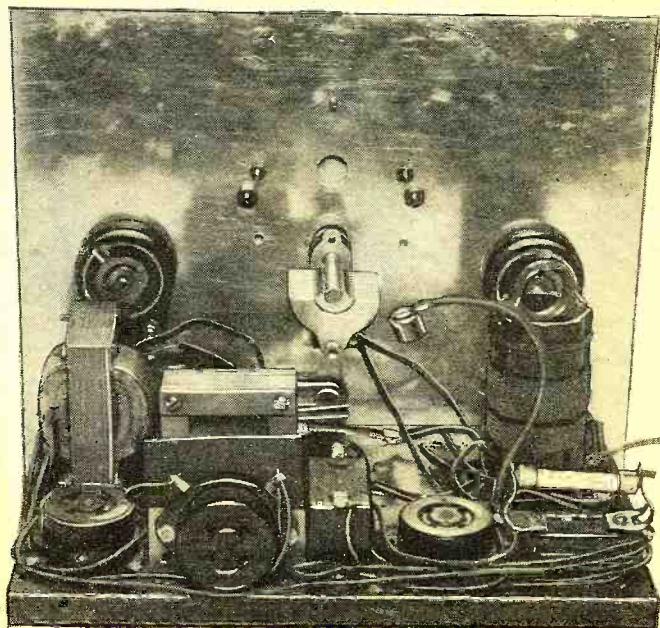

# A "Ham" Receiver

*to go with*

# The Junior Transmitter

*The articles thus far in Mr. Bennett's series on "The Junior Transmitter" have concerned themselves with transmission equipment. But no amateur transmitter can "do its stuff" unless it has as a mate a dependable receiver, so this present article of Mr. Bennett's is most timely*

By Don Bennett

"HOW'S the transmitter working, Don?"  
 "Pretty good, Gus. I'm getting pure d.c. reports and from what my monitor tells me, I believe them. One fellow told me I had a little chirp in the note but outside of that the reports are good."

"We'll fix that chirp later. I know a few stunts that will take care of it. I'm coming around here some day soon and straighten up this mess that you call a station. When I do that I'll also get you a better note. How you ever hope to operate efficiently with things running all over the place this way I don't know. I'm going to help you clean house but I'm too lazy to do it right now. Anything else wrong?"

"Yeah. This receiver. I'll be darned if I can get much of anything outside the second district on it. I think if I could hear something besides the Bronx I might find that the transmitter is reaching out into far places, but the way it is—blooie."

"A receiver you want—a receiver you'll get. Johnny Kulik has an ultra-modified circuit that is the berries, except for a few little things. He gave me the circuit, look—(Figure 1). There are two things about it that I don't like, the way he mixes up his tubes and the impedance coupling in the detector.

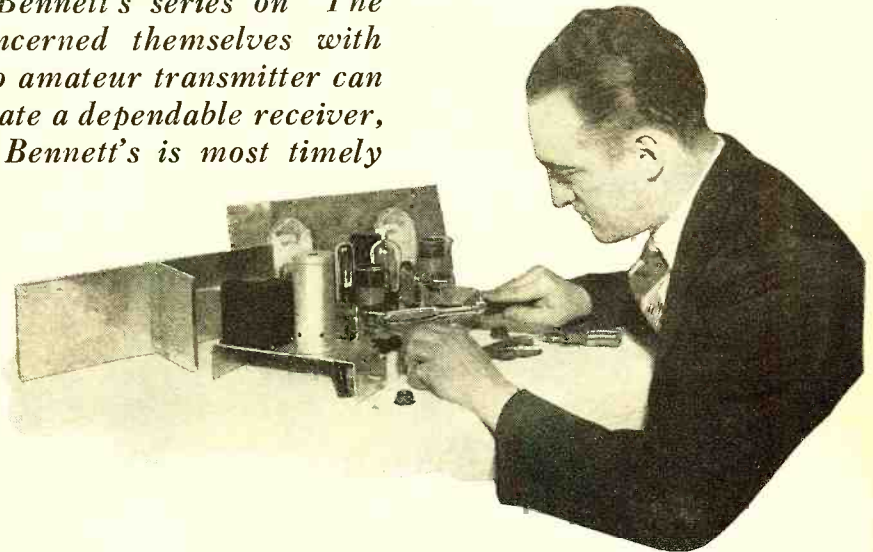

The author putting the final touches on the wiring job. Note that all parts are mounted on the sub-panel which permits assembly and wiring to be completed before partitions and front panel are mounted

The circuit was originally one used by commercials. It was modified by the boys on the Byrd expedition to suit them and Johnny got it from them and made some more modifications. Now I'm going to modify it again!

"My first modification is to use all two-volt tubes. A 432 in the radio frequency stage and one in the detector, a 430 in the first audio and a 431 output tube. The 432 detector is much more sensitive than the 112-A that Johnny used, but unless you have the proper plate coupling, you don't gain a thing. A National Impedaformer, S-101, serves excellently as a plate coupling device. Oh, say, that reminds me. I have a copy of the National SW-5 circuit, and I think that if we combine the good points of Johnny's set and the National we'll have a darn good outfit. The main trouble with Johnny's set is the impedance coupling in the detector stage. See here, (Figure 1) the plate of the r.f. tube goes to the tuning coil of the detector stage and the high voltage for the plate of the first tube is fed into the bottom of the coil. This means that he has 135 volts of direct current impressed on the grid condenser. Theoretically, that's O. K., but production condensers are not theoretical, they have a certain amount of leakage through the insulation and the dielectric. You may think that this leakage would be unimportant but if the d.c. resistance of the condenser is, say, 20 megohms, the leakage currents across it will amount to about six

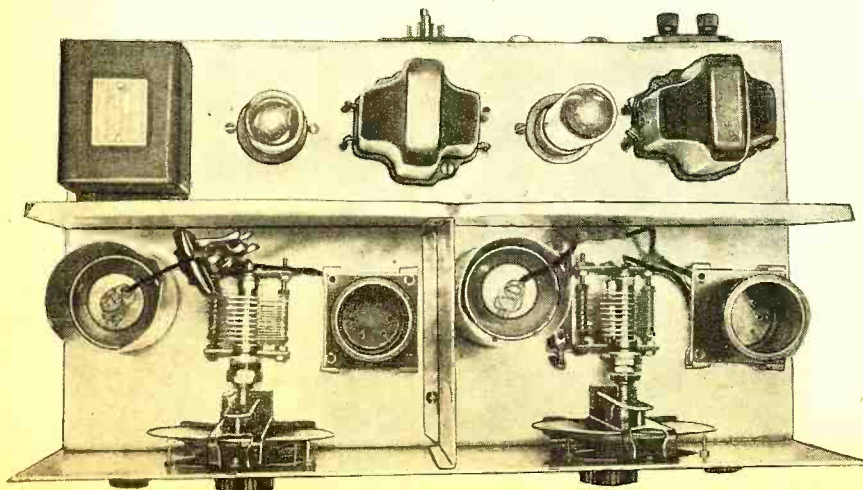

This top view shows the simple, clean-cut layout employed, making for simplicity of construction and efficiency in operation

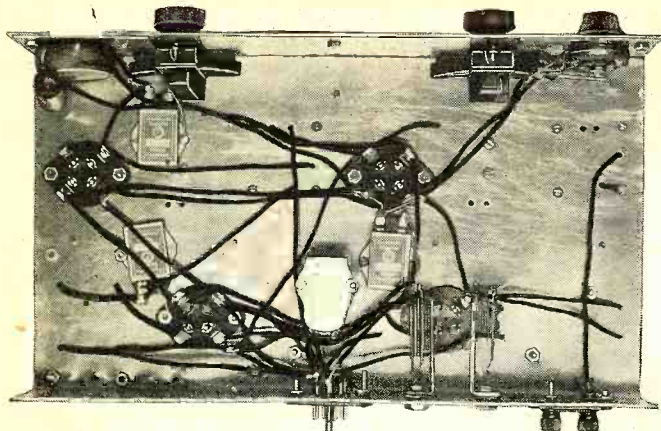

All wiring is confined to the under side of the chassis. Here all the main wiring is shown prior to installing and wiring the chokes and by-pass condensers

your r.f. and detector stages shielded from each other and from the audio. Enclose the whole works in an aluminum cabinet. Breadboards are passé except for experimental work. No set works well when the parts are full of dust and dirt. Use a cabinet every time. If you lay the job out right you can arrange it in a very intelligent way, not only electrically but mechanically as well. If I were you, I'd fasten everything to the base and have the panel separable as well as the enclosing cabinet.

"Look, bend a piece of aluminum like a U, fasten your parts to it, do your wiring underneath as much as possible and you'll have a good solid job."

"But listen, Gus. How about the dials and the volume control? They are mounted vertically on the panel."

"Put the dials on the panel but line them up so that they will slip off the condenser shafts easily. The volume control and rheostat can be mounted on the chassis and a clearance hole drilled in the panel to take care of the nut that holds them in place. The knob will cover the extra large hole the same as it covers the nut when mounted on a single panel.

"Look, here's the layout—put your r.f. stage to the right.

The tuning on that is broad and you don't need to tune it to hold a station when you are copying him in case he is swinging. Put the detector on the left where you can use your left hand for tuning while you write with your right. The same way with the volume control. Put that on the left also so that it won't interfere with your pencil hand. (Left-handed amateurs reverse everything.) Put the first a.f. in back of the detector and the second a.f. to the right. I'd put the phone jacks in the back of the set so that the leads can be brought down through the table and up under the front edge. That keeps them out of the way. Put the filament rheostat at the right because you don't adjust that much and it will make the panel balance up.

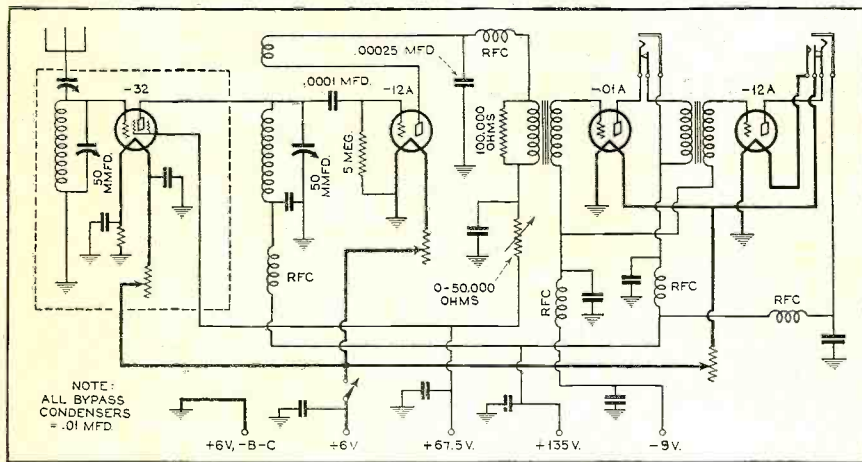

Figure 1. An ex-commercial short-wave circuit with modifications was one of the models used in designing the new circuit

Figure 2. The National SW-5 circuit which contributed many of the features included by Mr. Bennett in the receiver described in this article

microamperes at 135 volts. This current is larger than the average incoming signal. Now take this National circuit (Figure 2). They use transformer coupling, the d.c. for the plate of the first r.f. tube being fed through the primary of the transformer coupling and only the induced radio frequency currents are impressed on the grid of the detector. Also the direct current does not flow through the tuning circuit.

"Another stunt that National has is the method of controlling regeneration. Instead of using a series resistor, they put a potentiometer across the B battery and by means of the variable arm, pick off the desired voltage for the screen grid. The only thing I don't like about the National job is the gang-tuning. And I'm old fashioned enough to feel the need of separate tuning for the r.f. and detector. If you like ganged condensers go ahead and get one of their kits as is. One thing I think should be adopted from Johnny's circuit is the by-passing he uses. That and all the r.f. chokes. That's a darned good stunt and Johnny told me it doesn't work at its best until the chokes and by-passes are in."

"You'd recommend combining the two circuits then, Gus?"

"Yes, I think I would."

"I think I'll build a new receiver. Gus, and believe me I'm going to use your dope. How about mounting it? Would you use a breadboard layout?"

"Absolutely no! Use aluminum and shield everything. Have

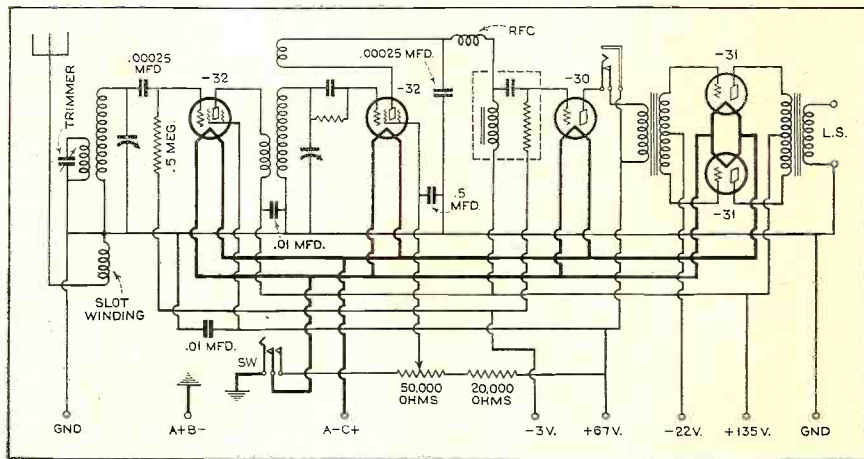

"Figure on a shield to run the length of the chassis between the r.f. and audio stages. A shield partition should be put between the r.f. and detector. If you use sub-panel sockets you need not put any holes through the shield to run the inter-stage leads. In fact, if you lay it out right, the only long leads will be those carrying the battery voltages.

"You'll find it necessary to notch out the front of the chassis in order to fit the dials properly. Do this before bending the front and back edges or you might find it a tough job to cut out the notches cleanly. For that matter, I'd lay out the whole chassis except the mounting holes for the tuning condensers before I did any bending. Drill and tap all the holes and wire brush the surface of the aluminum after you have finished your work. Wire brushing will make the aluminum less susceptible to finger marks and scratches, at least they won't show up as badly as if the surface were bright.

"After the chassis is all drilled and bent to shape, lay out

the panel and fasten the dials to it after the panel has been scratched with the wire brush. Fasten the panel to the chassis with three round head screws and put the tuning condensers in place. Mark off the mounting holes for the tuning condensers and drill them oversize. Your layout may be a little off and oversize holes will permit mounting the condenser so that the shaft will not be under any strain whatever.

"Next mount all your parts, remembering to put the shield cans in place at the same time you mount the sockets. Place the sockets so that the filament prongs are parallel to the front and back edges and away from the edges. That is, the r.f. and detector sockets should be mounted so that the filament prongs are to the rear and the audio stage sockets should have these prongs toward the front. This permits the shortest possible leads to grid and plate as well as the filament.

"The by-pass condensers are mounted under the chassis, as are the radio frequency chokes. The r.f. chokes should be mounted as close as possible to the point where the lead in which they are incorporated goes through the sub-panel. The leads to the coils are run straight down through the chassis except those that run to the tuning condensers and the control grid. These are kept inside the can. The grid by-pass condenser in the r.f. stage is mounted at the rear of the tuning condenser and if stiff enough wire is used in connecting up, no further support is necessary. A small bracket, however, wouldn't do any harm. The grid leak type resistor in the r.f. stage is mounted between the condenser and tube shield and you must be careful to see that the terminals are well insulated from the chassis. The easiest way to mount the grid condenser in the detector is to use a piece of bus wire connected to the control grid cap and to the condenser. This makes the lead as short as it

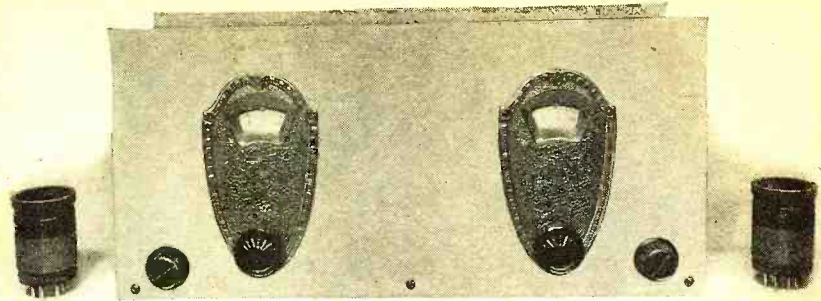

The front panel with its two main tuning controls, the regeneration control at the left and the filament rheostat at the right

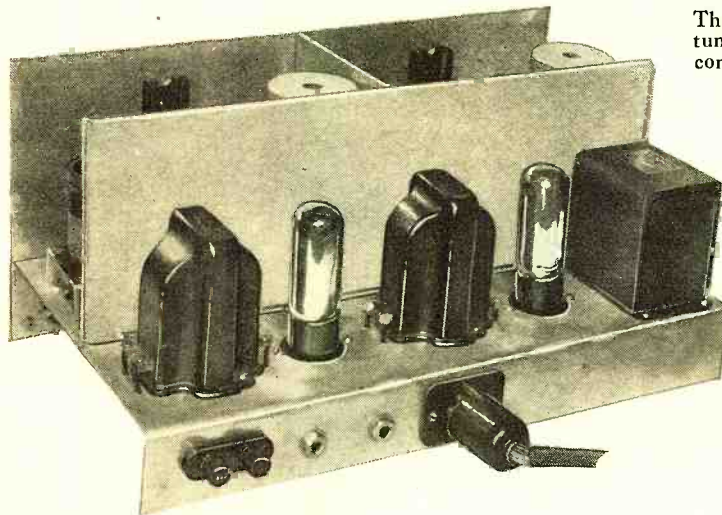

The rear of the sub-panel with the audio amplifier in a straight-line layout. The rear edge of the sub-panel provides for all connections

possibly can be and is plenty rigid enough. Remember to leave enough slack in the wire connected to the other end of the grid condenser to enable you to put the cap on the tube.

"Make all battery connections to a Yaxley cable plug at the rear of the set. Bring out your aerial and ground posts here too. Between them mount your two phone jacks. It might be a good idea to leave a speaker permanently plugged into the last jack in case you want to listen to short-wave phone or broadcasts. Pulling your phone plug out will connect the speaker automatically.

"Your cabinet can be made so that by removing a few screws it can be lifted bodily off the set in case repairs are necessary. Likewise, that is the reason for having your panel removable. The shielding can be made the same way."

"What size aluminum should I use, Gus?"

"Well, I think 16 gauge is about right for the panel and chassis; in fact, you can use that (Continued on page 1016)

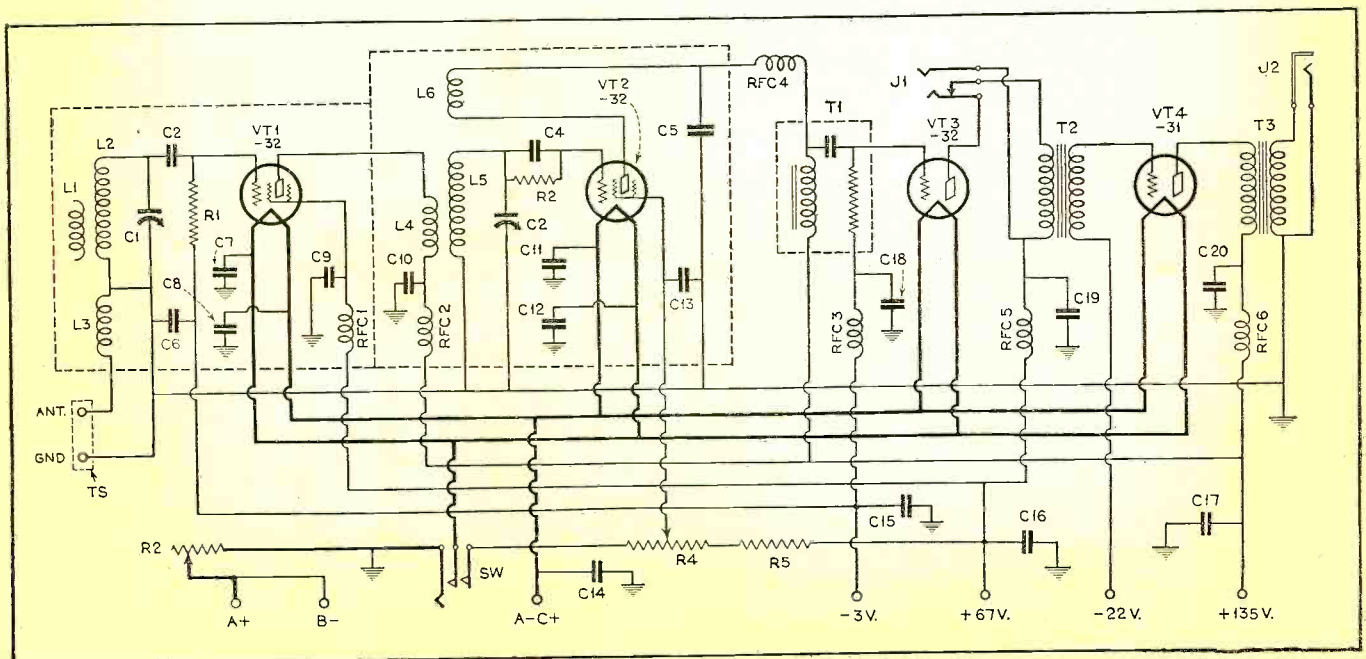

Figure 3. This is the circuit finally adapted for the receiver. It represents the designer's effort to combine in one circuit the best features of the two circuits shown in Figures 1 and 2

# Solving The Band-Spread

*A new and simple coil unit for short-wave receivers which allows stations in a given band to be "spread out," so to speak, over more than a mere few dial divisions. This new band-spread principle permits more accurate tuning and greatly improves opportunity for real DX work. It may be easily applied to any home-built short-wave receiver*

**A**LTHOUGH it is said that comparisons are odious, in this case the comparison serves quite well to illustrate a point which, up to now, has received little or no attention in spite of its importance.

In a broadcast receiver we expect the condensers and coils attached to the dial to tune it over a range of from 550 meters to 200 meters, or, in kilocycles, from 550 kilocycles to 1500 kilocycles, a total spread over the tuning dial of less than 1000 kilocycles.

Yet, in short-wave reception, in our endeavor to satisfactorily cover from 15 meters to 150 meters, or, in kilocycles, from 20,000 kilocycles to 2000 kilocycles, we are confronted with the fact that there exists a tremendous spread of 18,000 kilocycles.

Obviously, it is out of the question to expect that a condenser dial will be able satisfactorily to cover this enormous range in one-half of its revolution and still permit station separation. And so we have become used, in short-wave work, to employing as many as three or four sets of coils, so that this staggering total of 18,000 kilocycles may be covered by the one tuning condenser. Thus we have become used to talking about the 20-meter or the 40-meter or the 80-meter coils.

### Critical Tuning on Short Waves

While this arrangement solves the problem of covering all of the wave bands, each coil having a slight overlap over the next smaller size so that there will be no "holes" in the wave-band covered, there is set up one disadvantage which, although quite serious, has received little or no attention up to the present time.

This disadvantage has to do with the crowding of the dial for a particular wave-band. Let us suppose that for the 40- and 80-meter bands ample spread of the tuning response is obtained over the tuning dial. Yet when the 20-meter coils are plugged into the coil sockets the whole band might be bunched together within a few divisions of the dial. And this in spite of the fact that sound engineering principles had entered into the design of the receiver as in the case of the National SW-5 Thrill Box, where not only 270° straight frequency line tuning condensers were used but also a special vernier drum dial with large-scale diameter and high-reduction ratio.

### The Old-Fashioned Remedy

To overcome this evident crowding on the 20-meter band, some experimenters resorted to the expedient of removing plates from the tuning condenser, but this procedure had a detrimental effect on the tuning for other wave-bands.

It was in an effort to develop some ready means for wide band spread at any frequency without impairing the general purpose qualities of the SW-5

that the special band-spread coils were developed. These new coils are merely plugged in in the same manner as the standard coils and without making any changes in the receiver itself.

The result, in the case of the 20- and 40-meter amateur bands, is a 50-division spread, located right in the center of the dial.

Unfortunately it is impossible to spread the tuning out on the dial and still have the same wave range completely covered by a given number of coils. If it is desired to cover the same range but

have the tuning opened up it can only be done by using a larger number of coils and lower tuning capacity or something else which will be the equivalent. However, it may be that the owner of a short-wave receiver is interested only in certain portions of the band between 20 meters and 200 meters. An amateur, for instance, may be interested only in the American amateur bands. All he wants is to cover a narrow band at 20 meters, another at 40 meters and another at 80 meters. The wavelengths in between hold little interest for him.

### The Principle Employed

It is in cases such as these that the new band-spread coils will be most useful. Instead of the entire winding of a coil being shunted by the tuning condenser, only a part of it is so shunted. The range of the coil is therefore accordingly reduced and the tuning is opened up proportionately. In order to shift this particular desired band to the most suitable place on the dial the trimmer condenser included in the coil is once adjusted and thereafter requires no attention unless some further movement of the band is desired at a later date. In other words, the trimmer condenser permits the operator to select the particular portion of the band to be included within the tuning range.

One consideration involved in shunting a tuning condenser across only a part of a coil is that when the condenser is adjusted for minimum capacity the coil is tuned close to its natural period. Unfortunately, the circuit resistance increases rapidly as the frequency approaches the natural period of the

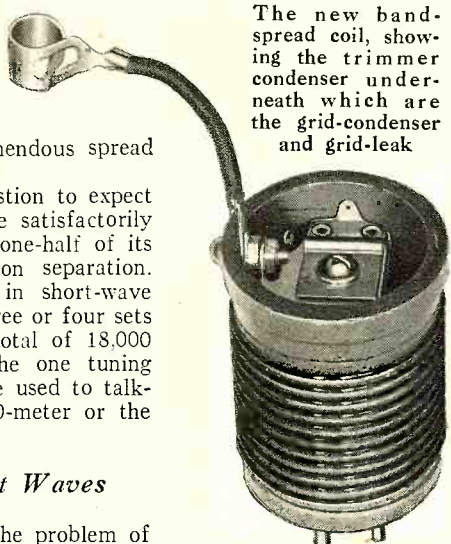

The new band-spread coil, showing the trimmer condenser underneath which are the grid-condenser and grid-leak

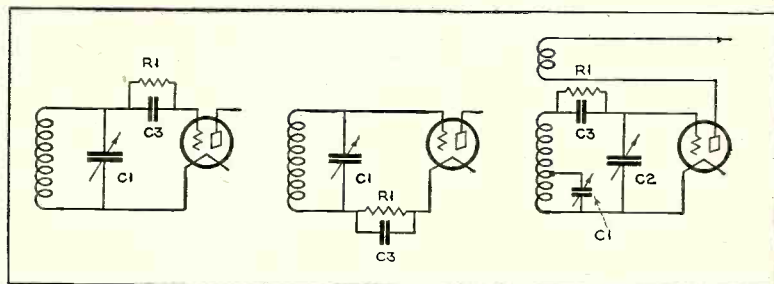
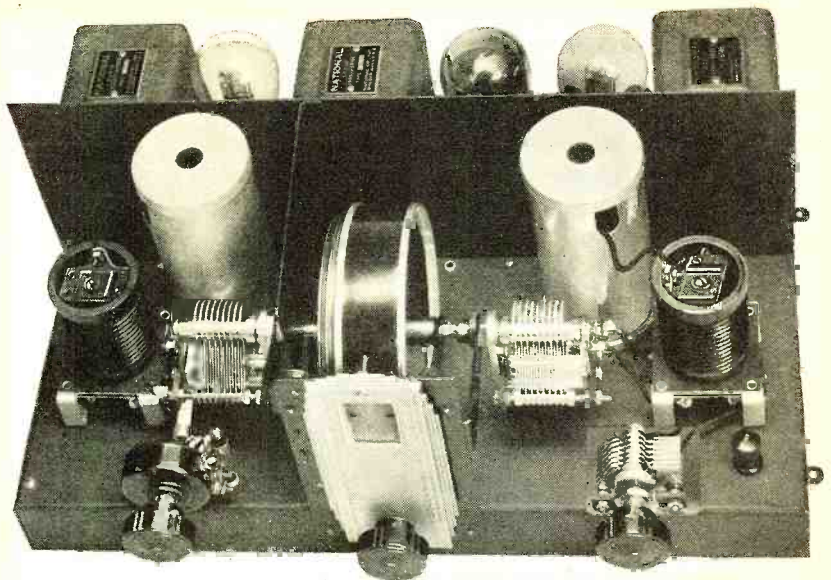

Figure 1. (Left) The conventional detector circuit with grid-leak and condenser at the top of the coil between it and the grid of the tube. Figure 2. (Center) Here the grid-leak is located in the grid return to filament, providing same results as Figure 1. Figure 3. (Right) The band-spread circuit showing the grid-leak and condenser in a new position. C1 is a 100 mmfd. tuning condenser; C2, adjustable mica condenser in parallel with tube capacity (about 3 mmfds.); C3-R1, grid-leak and condenser located inside coil form

\*National Company.

# Problem in Short-Wave Reception

By James Millen\*



The SW-5 short-wave receiver with the new coil substituted for the old. This substitution does not involve any changes in receiver wiring

coil. But in the case of the band-spread coils the shunt capacity furnished by the trimmer condenser plus the capacity of the tube itself keep the circuit well below the natural frequency of the coil. The variation in circuit resistance with an approach to the natural period of the circuit is illustrated in Figure 5.

### Efficient Design

In general appearance, as will be seen from the accompanying photographs, the new band-spread coil differs from the conventional s.w. coil only in that a lead comes out of the top for clipping directly to the cap of the screen-grid tube in place of the lead and clip built into the receiver. Inside the coil form, however, will be found a small grid leak and grid condenser as well as an adjustable low-capacity trimmer condenser. The coil form itself is made of R39, the low-loss short-wave coil material developed for use in this receiver by the Radio Frequency Laboratories of Boonton, New Jersey. The material in this coil form differs from regulation bakelite in that no coloring material, filler, or wood flour, the latter the ingredient that introduces the high-frequency losses, are used. Instead, the pure bakelite resin is mixed with finely ground mica.

To better understand the function of the new band-spread coil arrangement it is well to review briefly the circuits which have been universally employed.

In Figure 1 is shown the conventional tuned circuit for a detector stage. Here a coil is shunted by a variable tuning condenser, the top end of the coil connecting to the grid of the tube through a grid leak which is shunted by a grid condenser, while the lower end of the coil is brought directly to the filament. A variation of this circuit is shown in Figure 2, where the grid leak and condenser are located in the grid-to-filament return.

Figure 3 shows the new band-spread arrangement. It will be seen that C1, the regular variable tuning condenser, now shunts only a portion of the total inductance while the grid

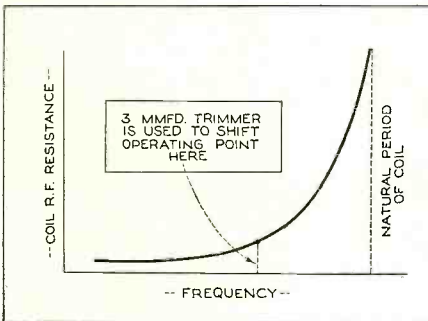
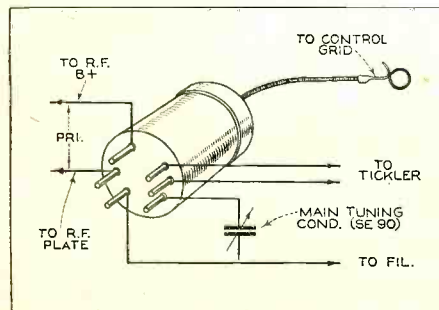

Figure 5. An r.f. resistance curve, indicating the rise in resistance as the natural period of the coil is approached and how the operating point is shifted to a low resistance value by the use of the 3 mmfd. trimmer

leak R1 and the condenser C3 connect directly to the top of the coil. Finally, the trimmer condenser C2 shunts this whole arrangement and is in parallel with the tube capacity, connecting directly from the grid to the filament.

### Prong Connections and Screen-Grid Lead

Figure 4 shows a sketch of the coil and indicates how the prongs of the coil are connected, together with the disposition of the screen-grid lead which comes out of the top of the coil.

The particular L/C ratio arrived at in this arrangement results in a circuit of a high order of sensitivity. This, with the other advantageous features outlined here, make these new band-spread coils a happy addition to the short-wave receiver art.

Although the general theory concerning the use of this band-spread principle may be applied to practically all types of short-wave receivers, the design and construction of the coil units employing this feature is due to the efforts of the engineering staff of National Company to provide their a.c. short-wave receivers with this desirable quality.

### Technical Details

Full technical details concerning the design, construction and operation of this receiver appeared in an article in the June, 1930, issue of RADIO NEWS, by Robert Kruse, well-known consulting engineer on matters pertaining to short-wave transmitter and receiver design, and the writer.

The photograph at the top of this page shows an SW-5 receiver, in which the original coils have been replaced by the new band-spread type. No alterations in the receiver itself or the wiring were required to make this substitution. With the new coils the frequency band covered by one will not overlap the bands covered by the next larger and the next smaller coils. Thus complete coverage of all short-wave bands is not obtainable with four sets of coils as with the older types. But with the new type the amateur can tune within the American amateur bands much more comfortably than heretofore. If he wants to tune in stations falling between these bands he can always use the old type coils interchangeably with the new. The main advantage of the band-spread coils will therefore be offered to the amateur and to short-wave fans who are interested in listening on the amateur bands.

Figure 4. Bottom of coil form, showing proper connections for use in SW-5 Thrill Box

Philo T. Farnsworth and a television transmitter employing the electrical system which he invented and which is described in this article

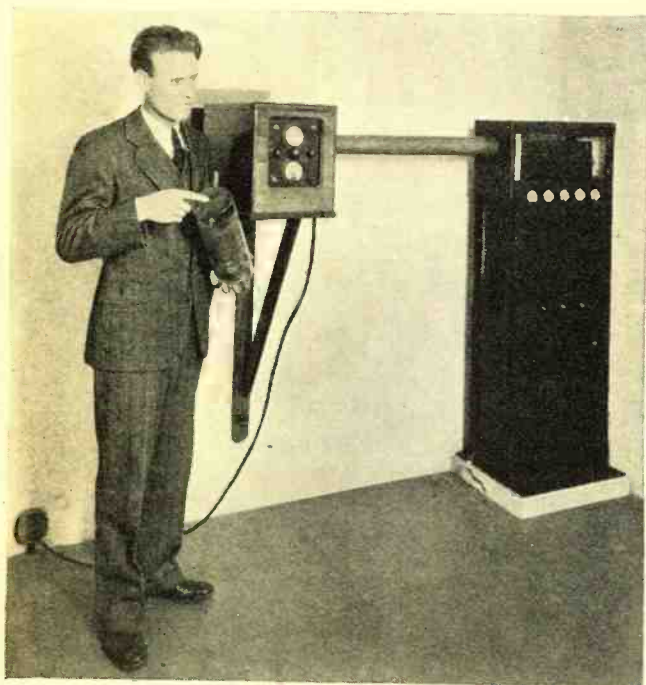

# “Scanning” WITHOUT a DISC

*Much interest has been evinced in the Farnsworth system of television because of its many unusual features. The Farnsworth system probably offers television experimenters more food for thought and study than any of the other systems to date, for which reason this article should be of more than usual interest*

By Arthur H. Halloran

**F**OLLOWING his announcement before the Federal Radio Commission that he is actually transmitting a 200-line moving picture along a 6-kilocycle channel, Philo T. Farnsworth has now authorized this explanation of the principles which he employs.

A youthful chief engineer of Television Laboratories, Inc., backed by a group of financiers at San Francisco, Philo T. Farnsworth has made what some have termed greater progress in solving the basic problems of television than has any other research investigator in the world. Discarding the revolving disk scanner as being too clumsy and too crude for the job, he scans a scene at the transmitter and at the receiver with a cathode ray beam. The two rays are kept in exact step by means of a control current which is transmitted along with the currents which reproduce the moving picture. Whenever a ten-kilocycle channel is allocated for his work, he can readily transmit a 400-line picture.

When this feat, which is accomplished with inexpensive equipment, is compared with the 72-line picture for which contemporary experimenters require a 40-kilocycle channel, it may be realized that television is progressing rapidly. Negotiations which are now under way may result in the availability of this receiver system for home use before the end of this year. Consequently the readers of RADIO NEWS will want to know how and why it works.

Perhaps the easiest way to acquire this knowledge is to follow through the simplified circuit diagram shown in Figure 1. This diagram illustrates a specialized and limited case which has been set up to facilitate an explanation. It by no means defines the entire procedure nor shows the various other means whereby Mr. Farnsworth is able to transmit radio movies without the necessity of modulating a carrier. So with the understanding that it merely typifies one of a great variety of methods, let us follow it through.

An optical image of a moving object 5 is focused through a lens 3 on to a silvered mirror 6, this being coated with a material which emits electrons when exposed to light. These parts constitute a sensitive photo-cell of a vacuum type, enclosed in a cylindrical glass tube 1. The mirror 6 is the cathode. Closely adjacent and parallel to it is an anode 7,

which is maintained 500-volts positive with reference to 6, by means of a direct-current source 8. The anode consists of a finely-woven wire cloth through whose interstices the liberated electrons are projected into the equi-potential space formed by the shield 10.

Sweeping across the equi-potential space are two electromagnetic fields which are set up by “saw-tooth” alternating currents, in two sets of coils placed at right angles around the tube. When one set of coils, diagrammatically represented by 15, is supplied with a 16-cycle current from an oscillator 16, it causes a magnetic field to sweep vertically across the tube 16 times per second. When the other set of coils, which is not shown in the diagram but which can be seen in the perspective view in Figure 2, is supplied with a 3000-cycle

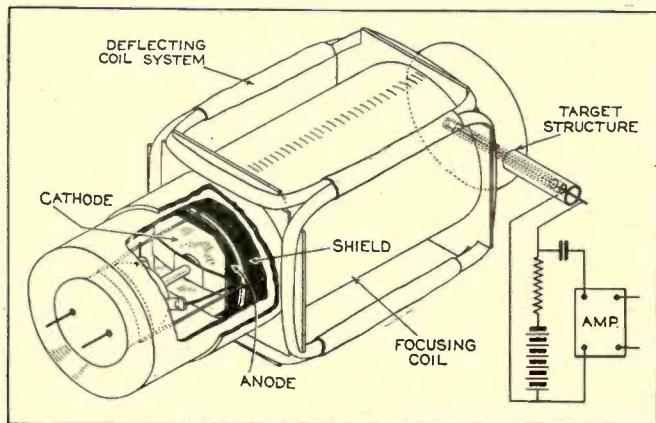
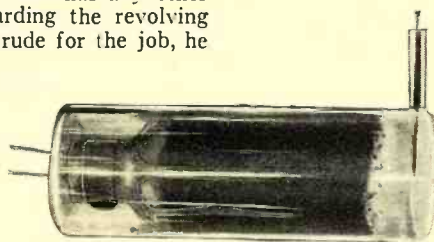

Figure 2. The actual appearance of the “Dissector Tube” employed in the Farnsworth system and, below, a perspective drawing of the tube showing the design details



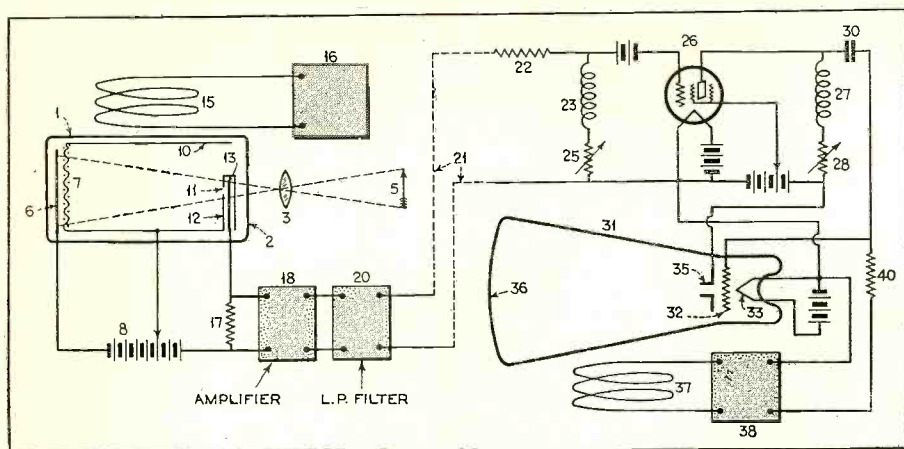
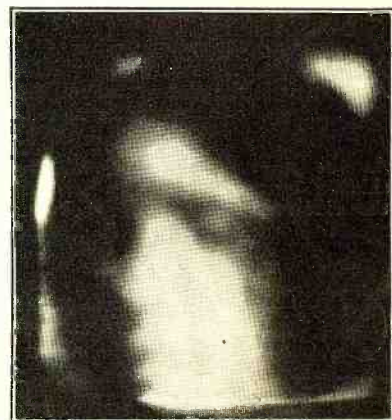

Figure 1. The simplified schematic layout of the Farnsworth system for narrow band transmission of moving pictures. The portion to the left of the dotted connecting lines is the transmitter while the receiver is to the right

*THE Farnsworth developments mark another step in the forward march of television, bringing still closer the practical reality of television in the home*



current a magnetic field is swept horizontally across the tube 3000 times per second. Their resultant effect upon the electrons in the equi-potential space is to form them into a cathode ray image which successively issues from each tiny element of picture area. This cathode ray is then magnetically focused through the small aperture 11 onto the target or electron collector 13.

Hereon is produced a random series of electrical pulses, each having a square front wave  $(200)^2 \times 16 \div 2 = 320,000$  cycles in width. Each pulse corresponds to an instantaneous change in light intensity in each element of area which is successively scanned by the cathode ray. The variations in light intensity are thus converted into corresponding variations in current intensity. These current pulses are passed through a 5-stage admittance-neutralized amplifier (18) which is capable of passing a 600-kilocycle wave-band, with a practically straight frequency characteristic. (No small feat in itself.)

Neglecting for the moment the filter 20 and the intervening network 21-40, and assuming that a 320-kilocycle distortionless channel were available to transmit the amplified current through the receiver, let us see what happens. The receiver is another cathode-ray tube through which sweep two sets of magnetic fields, one vertically and the other horizontally. The currents to establish these fields are 16-cycle and 3000-cycle "saw-tooth" components of the 320-kilocycle band. Because of their peculiar shape they are readily extracted from among the other frequencies and are used to locally generate or amplify, through oscillators 38, sufficient current to induce the required magnetic fields which cause a cathode ray to sweep across a fluorescent screen 36, thus reproducing a moving picture in exact synchronism with the original moving object 5.

In this vacuum tube, or oscillite, the electron-emitting element is a hot filament 33. The emitted electrons are attracted to and projected through the aperture of a plate 35, the

number of projected electrons being controlled by the current pulses on the grid 32. The intensity of these current pulses, it will be remembered, depends upon the intensity of the light which initiates them. Consequently as they emerge from the plate into the space through which the two magnetic fields are sweeping, they are formed into a cathode ray which rapidly scans the area of the fluorescent screen 36, thereby forming the moving picture.

But our assumption of a 320-kilocycle distortionless channel is not justified for either radio or wire transmission. In the entire 960-kilocycle spectrum, used by American broadcasters of speech and music, there are only three such channels possible. So the greatest problem in television, and the one which Mr. Farnsworth is probably the first to solve in a practical manner, is how to utilize a narrow channel for the production of a moving picture which has sufficient clearness and detail.

The manner in which he accomplishes this seemingly impossible feat is an interesting story in itself, entirely aside from his remarkable success with the cathode-ray tube. His work is based upon a painstaking study of the Fourier integral theorem, one of the most complex and baffling of all mathematical conceptions. In his study of this theorem he discovered an error and in its correction realized the possibility of suppressing all frequencies beyond the limits of a very narrow band, and then to supply the missing frequencies from derived components of the distorted pulse which is received.

As it would take an accomplished mathematician to understand Mr. Farnsworth's analysis, no attempt will be made to present it here mathematically. Yet it is possible to give an interpretation which can be understood by any student familiar with trigonometry.

Mr. Farnsworth starts with the fact that the abrupt changes in light intensity during the scanning of a picture cause corresponding abrupt changes in the pulses of electric current into which the picture is converted by the scanning process. Each signal wave is characterized by an abrupt square front which suddenly increases from zero to a maximum value, or likewise suddenly decreases from a maximum to zero, in an instant of time. These are the changes that correspond to an instantaneous change from black to white, or vice versa, in a picture. For less intense changes in light intensity there are less intense changes in current. But always each (Continued on page 1015)

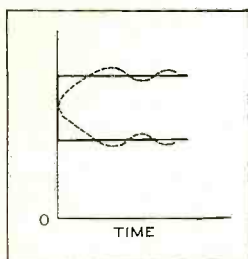
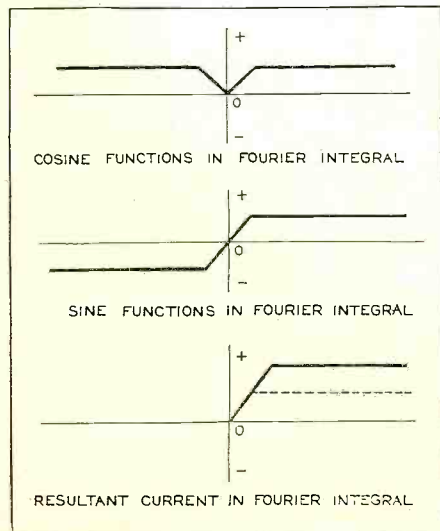
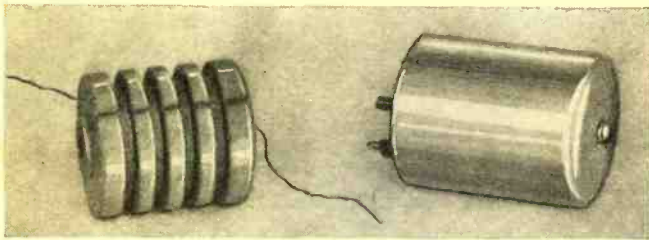

Figure 3. (Above) Form of wave from single pulse. Heavy line shows desired vertical wave front. The broken line indicates sloping wave front from filter. Figure 4. (At left) Sine and Cosine functions in Fourier Integral showing cancellation and addition

# The Why and Wherefore of Radio



Above, at the right, is a new shielded choke. At the left is the slot-wound coil ready to be enclosed within its shield

At the right is the standard type of unshielded type of r.f. choke. This differs from the shielded type only in the material of which the case is made



*The utility and importance of r.f. chokes but less general is knowledge about the are to effectively serve their*

By Donald

CONSIDERING the large number of uses to which small radio-frequency choke coils may be put in the construction and repair of radio receivers and in the construction of laboratory apparatus, it is perhaps somewhat surprising that more data on their characteristics and the conditions under which they should be used has not been published. To understand how, when and where to use these choke coils one must know exactly how they work; the following paragraphs are devoted therefore to a discussion of r.f. chokes with particular reference to their characteristics and manner in which they can be put to practical use.

A good r.f. choke cannot be made simply by winding a bunch of turns of wire on a spool. The capacity and resistance of the winding must be considered, and thought must also be given to the arrangement of the leads and whether the choke should be shielded. In the manufacture of r.f. choke coils these factors are studied and in addition thought is given to dehydration (removal of moisture) and impregnation of the winding so as to make the operation of the coil independent of weather conditions, for if the coils are not protected from moisture they may fail to function in certain climates.

But even giving heed to these facts an r.f. choke appears to be, so far as the electrical circuit is concerned, just a coil of wire of a certain inductance. If such were the case it would be a very simple matter to calculate the effect of a certain choke coil. Actually, however, the effectiveness of a choke coil depends largely on its effective capacity and resistance at the frequencies at which it is to be used.

Let us see why this is so. Every coil of wire possesses inductance—but it also has resistance and capacity. The radio-frequency resistance depends upon the type of winding, upon the size of wire and its insulation, the completeness with which the coil is dehydrated and the material with which it is impregnated. The effective capacity depends upon type of winding, the impregnation, insulation, shielding and manner in which the leads are

connected. Consequently an r.f. choke is *not* "just a coil of wire," but is much more, and if we are to know how a particular choke will function we must understand the effect of the coil capacity and resistance on its operation.

If we want to draw a complete "electrical" picture of a choke coil we cannot do it therefore just by showing a coil of wire, but we must represent it as shown in Figure 1. Here we have a coil *L* which represents the actual inductance of the coil; it is the inductance which we could measure at a very low frequency where the effect of the coil capacity would be negligible. Across the coil, Figure 1, we show a number of small capacities representing the

capacity between turns and in series with the coil *L* we show a resistance which represents the r.f. resistance of the coil, the value of this resistance being due, as indicated above, to many factors besides the ordinary d.c. resistance of the wire.

Instead of showing a number of small capacities we can simplify the picture by realizing that Figure 1 really shows a number of small capacities all connected in series; we can therefore represent the total capacity by a single condenser as shown in Figure 2. As soon as we look at Figure 2 we realize that we have a tuned circuit, and all such circuits have the characteristics of functioning sometimes as an inductance, sometimes as a resistance, and at other times as a capacity.

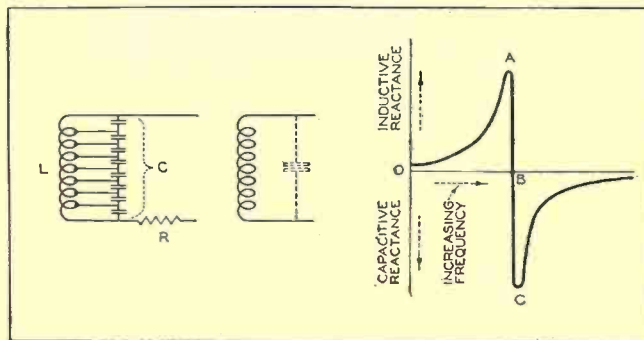

Figures 1, 2 and 3 (at left). The distributed capacity and resistance of any coil are indicated at C and R, or the equivalent capacity is as shown in the center. The curve represents the characteristic of a choke if all resistance were eliminated

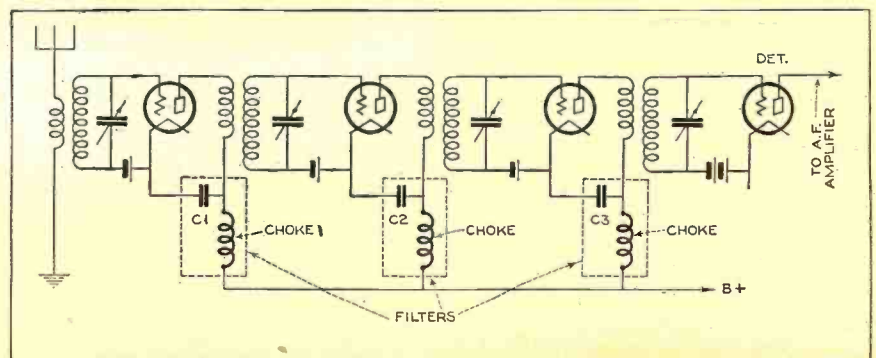

Figure 4 (below). The filters shown in the plate leads confine the r.f. output of each tube, thus avoiding undesirable coupling

# Frequency Chokes

are, of course, generally recognized, characteristics they should have if they intended purposes in radio circuits

Lewis

The design of a good r.f. choke involves so proportioning the capacity inductance and resistance (remember it's not the d.c. resistance but the r.f. resistance) that the coil will have no pronounced resonance but will have a high impedance at all frequencies at which it is designed to operate. And so the design of an r.f. choke is not a simple matter but a rather complicated problem of engineering.

If we neglect the resistance of the circuit and measure the reactance of a choke coil at various frequencies we obtain a curve like that shown in Figure 3. At low frequencies the choke acts like an inductance, but as we approach the point where the capacity becomes important the reactance rapidly increases to point A. Then quite suddenly the reactance becomes zero (point B) and immediately after the coil has a very large capacitive reactance, as indicated at C, this reactance gradually decreasing as the frequency is raised. The point where the reactance of the coil becomes zero (point B) is the "natural period" of the coil. The natural period is determinable from the formula:

$$f = \frac{1}{2\pi\sqrt{LC}}$$

If we substitute in this formula the characteristics of the Hammarlund type RFC-85 choke, for example, we find that it has a natural period of 316 kc., since its inductance is 85 millihenries and its capacity 3 micromicrofarads. The type RFC-250, with an inductance of 250 millihenries and a capacity of 2 micromicrofarads has a natural period of 225 kc. In order, however, that these chokes will not show pronounced resonance their effective resistance is made to vary in such a manner that the coils will have a high impedance over a very wide band of frequency. For this reason these chokes, in common with other well-designed coils, can be used at all frequencies, from the low radio frequencies used in the intermediate amplifiers of super-heterodynes to the high frequencies found in the short-wave receiver, although the type RFC-85 is somewhat preferable for use at broadcast frequencies and the 250-millihenry coil preferably at short waves due to its smaller distributed capacity.

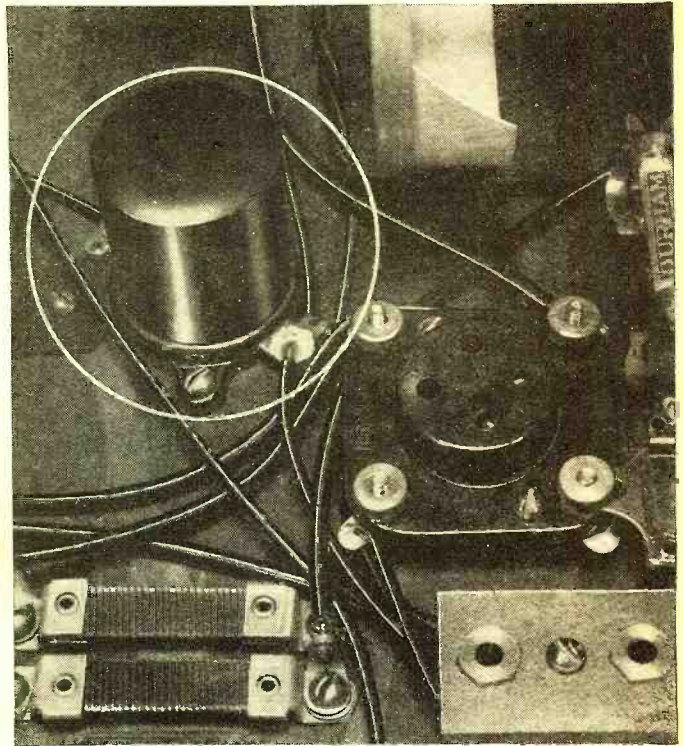

Above is shown the r.f. choke used in S-W set plate circuit. The new shielded chokes suggest a worth-while improvement for modern high gain r.f. amplifiers

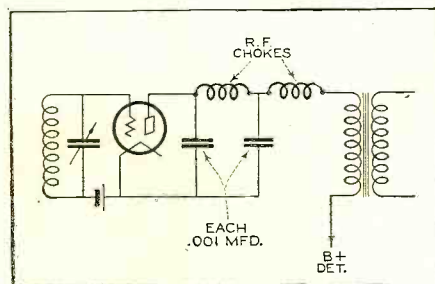
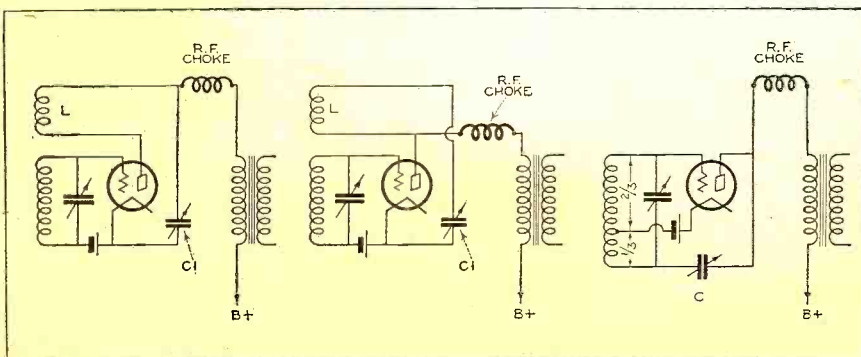

Figure 8 (at left). The proper connections when sometimes it becomes desirable to employ two chokes to insure maximum r.f. filtering

Since an r.f. choke, like any coil, produces a magnetic field about it when a current flows through it, it is sometimes desirable to use a shielded choke coil so as to prevent the field produced by the choke from coupling with the fields from other chokes or with the fields produced by the tuning coils. If such coupling is not prevented it is not possible to build high-gain, table receivers. The choke coil can be shielded by mounting it inside an aluminum can, as is done, for example, with the type SPC coil, a picture of which appears in this article. When shielding is used the coil should be "polarized"; i.e., the terminals should be marked to indicate which should be connected to the high potential and which should be connected to the low potential sides of the circuit. If this is not done the capacity between the shield and the leads inside the can may be sufficient to destroy the effect of the shield or lower the efficiency of the choke.

Radio-frequency chokes are used almost exclusively for the purpose of isolating circuits so as to keep the r.f. currents out of the (Continued on page 1034)



Figures 5, 6 and 7 (at left). Three common types of regenerated circuits which depend on effective r.f. chokes for proper operation

# The Service Bench

by ZEH BOUCK

Universal meters—New service fields—Trade-in values—Matching impedances—Auto radio tube tests—Receivers serviced: Atwater Kent—The new Victor—Crosley

## A UNIVERSAL METER FOR BENCH MOUNTING

By Charles Felstead

(Sound Engineer, Universal Pictures)

THE essential meters in a radio service shop are: a d.c. milliammeter for reading plate currents, a d.c. voltmeter for determining d.c. filament and d.c. and a.c. tube plate voltages, and an a.c. voltmeter for reading the filament voltages in alternating current operated receiving sets. If the serviceman is willing to devote a few minutes to the computation of two simple arithmetic examples involving Ohm's law, one meter can be used for all direct current readings. The algebra of voltage multipliers and current shunts is understood by the average serviceman, and will be reviewed here only briefly in the description of a meter and resistance combination arranged to be particularly useful as a permanent shop installation.

A direct-current voltmeter is a sensitive milliammeter connected in series with a suitable resistance. The range of the voltmeter depends upon the current capacity of the milliammeter and the resistance of the series resistor. In a low-reading voltmeter, the resistor is incorporated in the meter base; but voltmeters having ranges above 500 volts generally employ external resistors, called multipliers. The average medium-range voltmeter has a resistance of about 100 to 125 ohms per volt. This means that a voltmeter with a range of from 0 to 5 volts has a resistance of about 500 to 625 ohms. High-resistance voltmeters are employed in measuring the output of "B" battery eliminators and usually have resistances in the neighborhood of 1000 ohms per volt.

Ohm's law states

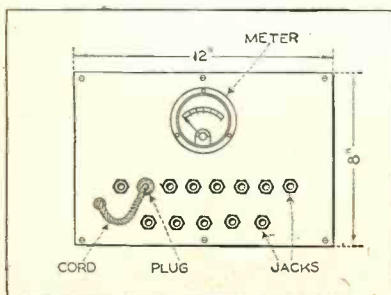
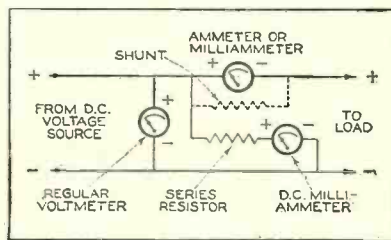

Figures 1, 2 and 3. Circuit and constructional details on the universal meter adapted to bench mounting. A portable design is, of course, equally practicable

that the voltage is equal to the current in amperes multiplied by the resistance in ohms; i.e.,  $E = IR$ . For example, let us apply this rule to the calculation of the resistance required to give a range of from 0 to 200 volts in a milliammeter reading from 0 to 10 milliamperes. If the number representing the desired voltage range is divided by the current rating of the meter in amperes, the result will be the ohmage of the series resistor necessary for that voltage range. Since 1000 milliamperes equals one ampere, the equivalent amperage for any number of milliamperes is found by dividing the number of milliamperes by 1000. In the case of 10 milliamperes, the corresponding amperage is found to be .01. Now, dividing 200, the required voltage, by .01, the range of the meter in amperes, the answer is 20,000—the correct resistance of the series resistor.

The minimum wattage rating can be figured from the statement,  $W = I^2R$ . In the case under consideration the current flowing through the resistor at maximum needle deflection is .01 ampere. This value squared is .0001. Multiplied by the value of the series resistor, 20,000, gives 2 watts.

With the meter and series resistor indicated, each milliampere division on the meter scale will now be equal to 20 volts (200 divided by 10). Different values of resistors for different ranges, with the same or other meters, may be calculated similarly.

The various volt-ammeter connections should not be confusing, and are indicated in Figure 1.

The current range of the same milliammeter may be increased by the use of suitable shunts. While it is possible to calculate the correct values for these shunts when the internal resistance of the meter is known, it is generally easier to determine the proper values by the cut-and-try method. The milliammeter is connected in series with a load (such as a variable high resistance) which is adjusted to draw the maximum current indicated on the meter (Continued on page 1014)

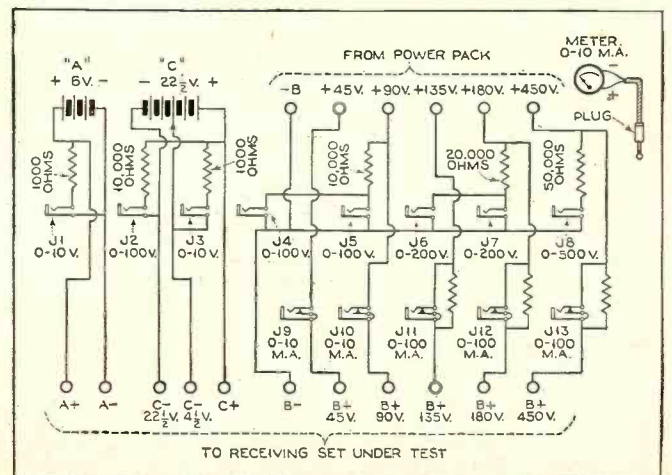

ALL IN A DAY'S WORK

WITH our test kit packed and such of our tools as have not been forgotten, we'll take our monthly round of service calls. Our first stop is with Robert Freeman, authorized Silver-Marshall station in Adel, Iowa. The S-M's give him no trouble, but he runs into a jam with an

Atwater Kent

"Most cases of failure in the early Atwater Kent electric models may be traced to the voltage dividing resistors in the power pack. Model 37 is especially weak in this respect. Removing the twelve hex nuts on the terminal plate will expose the power pack sub-panel. The resistors are the two glass cartridges on the end nearer the loud speaker terminals. The sub-panel can be raised sufficiently to permit resistor replacement without disconnecting any of the wires.

"Another source of trouble in these models is a shorted audio-frequency by-pass condenser. This is located in the filter condenser block of the power-pack. It is connected to the two white wires, one of which leads to the center tap of the first a.f. filament supply. The other wire goes to the a.f. terminal on the pack, connecting to the black with red tracer wire on the terminal plate of the cable on the set. Cutting this wire near the filter block will eliminate the faulty condenser, and the set seems to work equally well without it. The filter block is an expensive proposition, and repairing in this manner effects a considerable saving to the set owner. There is, of course, no reason why an external condenser cannot be inserted in the gap in the wire, though, as before intimated, results do not seem to justify the replacement. One symptom of this fault is excessive heating of the r.f. resistor cartridge, and, quite naturally, considerable reduction in volume."

The New Victor Jobs

By far the most prevalent of all radio complaints is that of noise, a symptom which, to put it mildly, covers a multitude of sins. With George S. Ballinger carrying our bag for us, we'll visit one of his clients in the warm but bustling metropolis of Gainesville, Florida. The set is a late model Victor. Trouble in a new set? Definitely so, and in this instance a bad case of noise, microphonic, evidencing itself with every truck that passes the house. Probably a tube, considering that the set is a new one, and probability points a finger at the detector socket. Sure enough, a simple replacement does the trick.

"But it's not always so easy," declares Mr. Ballinger. "And just because the set is a new one doesn't mean that the trouble invariably is the tube. I have run into exactly similar symptoms in Victors 35 and 57 (which sets, by the way, are alike in many respects). The installation of laboratory tested tubes did no good whatsoever, locating the trouble in the set itself. The noise would become evident whenever the set was jarred, either by hand or merely through the vibration imparted by a loud, low note. Walking across the floor was equally effective. I finally spotted the trouble in the second r.f. coil and condenser assembly under the chassis. There is a metal-covered condenser mounted with no great degree of rigidity on the end of this coil, and the slightest vibration was sufficient to make a contact between the condenser can and the shield, with resultant noise.

"This trouble has been eliminated in some of the newer sets by modifying the mounting.

(Cont'd on page 1014)

SERVICE NOTES

JACK HOWARD, who, by the way, is serviceman with the Fayette Electric Ice and Coal Company (no off-season here!), also passes on to us a scheme for soldering in tight corners where the use of the usual electric iron is impractical.

"In such instances I use a simple apparatus consisting of three battery clips, a few feet of heavy lamp cord and a carbon rod originally the positive terminal in a flashlight cell. The carbon rod is pointed, taped at the other end for a handle, and connected to one of the lamp cord leads. When the delicate soldering job presents itself, I clip the wires onto a six-volt storage battery, the free clip to the portion to be soldered, and touch the joint with the tip of the carbon rod. The carbon is almost instantly heated above the temperature necessary to flow any good rosin-core solder. This makes a very neat job, with the heat efficiently applied exactly where it will do the most good."

Matching Input and Output Circuits

Karl F. Oerlin, service consultant and instructor in physics at the Upper Darby Senior High School, in Upper Darby, Pa., sends us the following notes on matching up the impedance of a loud speaker with the output of the receiver when a variable tap coupling transformer is available (such as the Ferranti OPC4).

"Much has been written and said about matching impedances. We read about matching the impedance of a loud speaker to that of the set, matching a microphone with its transformer, and, in general, output with input. The serviceman is often called upon to do this matching, and he usually depends upon his ability to 'hear' the proper match. In my work on public address systems I have found the following method simple and easy to apply. All that is needed is an a.c. milliammeter and an ordinary toy transformer.

"Impedance is really a.c. resistance. Unlike d.c. resistance, however, a.c. resistance depends upon the frequency of the current at which the resistance is measured. This means that, if we know the impedance of a unit at, say, 1000 cycles, we do not necessarily know anything of the impedance at 100 cycles. But if two units are matched at one frequency (say 60 cycles) they will not be very far off at other audio frequencies.

"If we apply a source of ordinary 60-cycle current to a unit the impedance of which we desire to measure, and measure the current flowing through it by means of an a.c. milliammeter, we can obtain the impedance by substituting in the following equation:

$$Z = \frac{E}{I}$$

where E is the voltage used,

"I is the current read on the milliammeter, divided by 1000, and

"Z is the impedance in ohms at 60 cycles.

"In this way you can measure the impedances of various units at 60 cycles. If you can arrange them to match at this frequency, they will be close enough together at higher frequencies for good efficiency. Try different combinations and different taps on the output units until the impedances of the input and output are the same, or nearly so.

"When the impedance of a unit is very low, as will be the case of a voice coil in a moving coil loud speaker, and the secondaries of transformers designed to work into them, 110 volts should not be used directly, because it would burn out either the windings or

(Cont'd on page 1029)

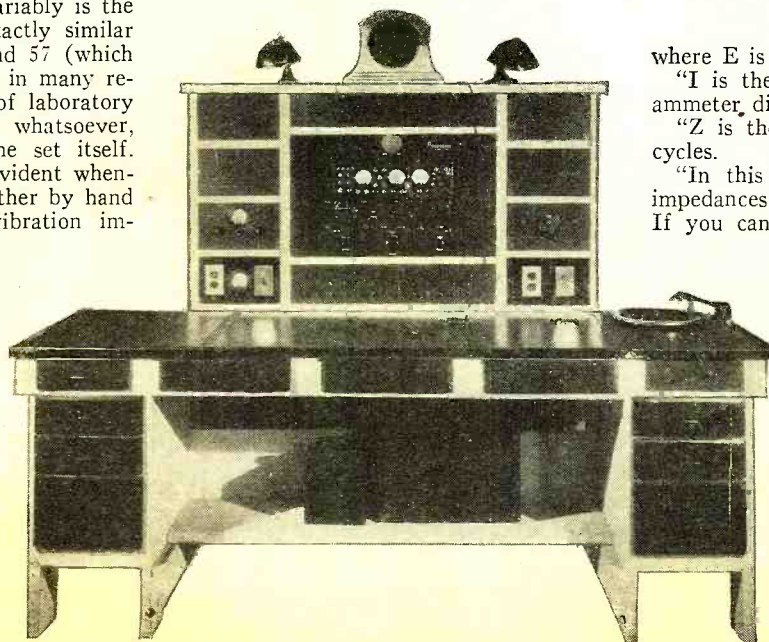

The service bench of the Mabry Radio Shop, of Beaumont, Texas. This is one of the neatest installations brought to our attention. The test panel is constructed around a Supreme Ohmmeter, incorporates a modulated oscillator and a direct reading ohmmeter, with plenty of room left for expansion



# The Junior RADIO Guild



LESSON NUMBER NINETEEN

## Using Mathematics in Radio

### Algebra and Its Application to Radio Engineering

#### PART SIX

**T**HE study of imaginary quantities in algebra aids the understanding and teaches the fundamentals of a very practical and important principle of alternating current theory.

#### Imaginary Quantities

Imaginary quantities deal with the letter "j" and the operator  $\sqrt{-1}$ , which will be shown to be one and the same thing. Again, it is well to remember that mathematics play a vast part in teaching the correct and easiest methods of obtaining certain results, and there is nothing real difficult in its understanding. It presents many new ideas, and when these are learned and appreciated, a better knowledge of various subjects is obtained.

As a preliminary beginning to this very interesting subject, let us investigate the possible positions of a point P, in the plane of the paper, as indicated in Figure 7.

This point is fully determined when we know its distance and direction from the reference lines, ox which is termed the x axis and oy which is termed the y axis, these lines being at right angles to each other. It is readily seen from Figure 8 that the point P1 is located at a distance out along the x axis equal to  $x^1$ , and at a distance up along the y axis equal to  $y^1$ . These distances,  $x^1$  and  $y^1$ , are called respectively, the abscissa and ordinate of the point P1.

But there are obviously four (4) points which would satisfy the conditions of being located at similar distances from the origin o, and this is corrected by assigning definite positive and negative directions to the abscissas and ordinates of the respective points. Thus, referring to Figures 9 and 10:

- P1 is said to be located at  $+x^1$  and  $+y^1$ ;
- P2 is said to be located at  $-x^1$  and  $+y^1$ ;
- P3 is said to be located at  $-x^1$  and  $-y^1$ ;
- P4 is said to be located at  $+x^1$  and  $-y^1$ .

Therefore, we see that all "y" points up above the horizontal axis are positive (+) and below are negative (-). In like manner, all "x" points to the right of the vertical axis are positive and to the left, negative.

Now, instead of locating a point by referring it to two intersecting lines, a point P1, Figure 11, is fully determined when we know its distance OP1 from the origin O, and the angle P1OX this line makes with the reference line ox. We see from Figure 12 that such a line OP1 = r is the hypotenuse of a right triangle and we know that the relation of the three sides of a right angle triangle is expressed as:

$$r^2 = a^2 + b^2$$

or

$$r = \text{the square root of } a^2 + b^2$$

Let us investigate and apply a method of analysis which teaches us the use of the operator "j." Referring

*TO beginners in radio the importance of the fact that the common ordinary garden variety of mathematics (the kind of mathematics which to some seemed so pointless when taught in the elementary and lower classes of high school) is quite necessary to the later assimilation of a knowledge of geometry, trigonometry and calculus cannot be stressed too much. For the truth of this it is only necessary to question those in the radio game who have been unfortunate enough to have slipped up on this part of their education and now wish that they had the opportunity to go back to school again.*

*RADIO NEWS is glad to present to its readers this sixth of a series of articles prepared by Mr. J. E. Smith (President, National Radio Institute) on the use of mathematics in radio. The first of the series appeared in the December, 1930, issue of RADIO NEWS.*

THE EDITORS.

to Figure 13, let a vector be represented by a line r in the direction of the x axis. In order to rotate this vector around to the left in a counter clockwise direction, let us state that it is to be multiplied by "j," which will place it along the y axis, as indicated. Continuing, let us further rotate this vector, now jr, around to the left. Multiplying by j, we see that it takes the position j<sup>2</sup>r. Again rotating the vector j<sup>2</sup>r, we obtain j<sup>3</sup>r, and further rotation places the vector at j<sup>4</sup>r shown in Figure 14. We see that performing this operation on the vector r places it at a position 90 degrees away to the left. Now, let us state that:

$$j = \sqrt{-1}$$

If the vector  $\sqrt{-1}r$  in Figure 15 is rotated to the left, we find that  $j^2 = -1$  and the vector will take the position  $-r$ . Again, further rotation places it at  $-r\sqrt{-1}$  and continuing, we find that  $j^4 = j^2 \times j^2 = -1 \times -1 = 1$ , and the vector takes the position r.

Referring to Figure 12 again, we can refer to the vector r by an expression known as the complex method and give an algebraic expression of the vector as

$$r = a + jb$$

in which a is the component along the x axis, and where j is a sign indicating that component b is to be laid out at right angles to a.

Another method presents itself then of indicating a point in a plane. Thus, in Figure 16:

- P1 is said to be located at  $a + jb$ ;
- P2 is said to be located at  $-a + jb$ ;
- P3 is said to be located at  $-a - jb$ ;
- P4 is said to be located at  $a - jb$ .

The algebra textbook referred to above, by Hall and Knight, contains a chapter on imaginary quantities ( $\sqrt{-1}$ ). The treatise of such quantities, and of such general expressions as  $a + b\sqrt{-1}$ , forms a basis of some very important mathematical discussions of electrical circuits.

#### Applications to Radio

Practically all mathematical discussions pertaining to alternating current circuits deal with the operator j, as it is an aid in showing the relations of currents and voltages throughout a system.

In a circuit having resistance and inductance reactance in series, as indicated in Figure 17, the current is the same throughout the system, and we show the vector I along the Ox axis as the reference vector. Since the resistance drop is in phase with the current and the reactance drop at right angles to it, the current lags the voltage E

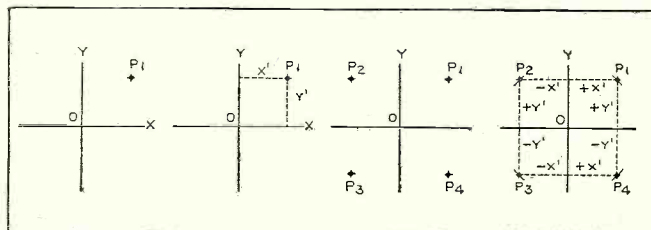

Left to right—Figures 7, 8, 9 and 10

and we state symbolically that

$$\dot{E} = Ir + jxI$$

Simplifying:

$$\dot{E} = I(r + jx)$$

Now, since  $Z = \frac{\dot{E}}{I}$ , we have a symbolic expression for the impedance, as:

$$Z = r + jx$$

The dot over the letter indicates that the algebraic expression is taken symbolically.

In a similar manner, in a circuit having resistance and a capacity reactance in series, as indicated in Figure 18, the resistance drop is in phase with the current, and the reactance drop at right angles to it, the current leads the voltage E, and we state symbolically that

$$\dot{E} = Ir - jxI$$

and we have for the impedance

$$Z = r - jx$$

*Note:* The reactance x for the inductance is equal to  $2\pi fL$ , while the resistance x for the capacitance is equal to the reciprocal to  $2\pi fC$ , or  $\frac{1}{2\pi fC}$ . The form  $2\pi f$  is often designated as " $\omega$ ."

**Simultaneous Equations**

The design features of audio-frequency transformers and their relations in radio tube circuits probably presents as wide an application of alternating current theory and mathematical analyses as any other single radio apparatus. Thus, let us study the application of an output transformer with its primary winding connected into the plate circuit of a power tube and its secondary feeding into a loud speaker. This circuit is represented in Figure 19. We have learned that such a circuit can be resolved into the equivalent one of Figure 20, where the input voltage  $E_g$  working through the tube can be shown as a voltage  $\omega E_g$  working into the plate circuit having a resistance  $r_p$ . The primary and secondary windings of the transformer will have resistances  $r_1$  and  $r_2$  and inductances  $L_1$  and  $L_2$  respectively, and the loud speaker will have a resistance  $r$  and inductance  $L$ .

**Kirchoff's Laws for A.C. Circuits**

These laws for direct current circuits we have studied, and similar applications of them can be made for alternating current circuits when a few important points are noted. An alternating current cannot be said to flow in one definite direction, but it is permissible to assume a specified direction at a particular instant. Thus, in Figure 20, the direction is taken as clockwise for the current in the primary circuit. Thus:

(a) In any closed alternating current circuit of sine wave form the vector sum of the electromotive forces and the potential drops is equal to zero.

*Note:* A very instructive analysis of Kirchoff's laws as applied to alternating current circuits is given in the following

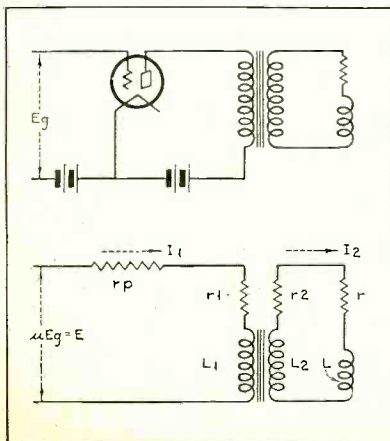
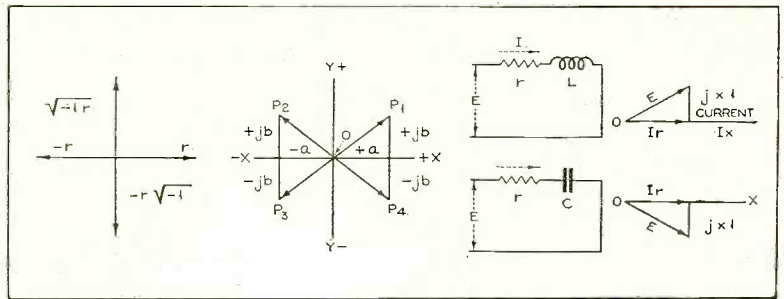

Figure 19. (Above) A typical output circuit

Figure 20. The electrical equivalent used as a basis of calculations shown in the text



Left to right—Figures 15, 16, 17 and 18

article: "Alternating Current Vector Algebra," by E. G. Reed, *The Electric Journal*, August, 1929, page 375.

In referring to Figure 20, we find that in the primary circuit the electromotive force is  $\omega E_g$ . The potential drops are those occurring across the plate resistance  $r_p$ , the reactive drop across the primary of the transformer, and in addition we have the effect of an electromotive force due to the mutual inductance  $M$ , between the primary and secondary windings. That such a mutual relation exists can be seen as follows: With a current flowing in the primary circuit, a voltage  $E_2$  is induced in the secondary winding. This voltage will produce a current in the secondary circuit which in turn will induce a voltage in the primary winding.

We have seen that an inductance and its resistance can be expressed as a vector quantity,  $r_1 + j\omega L_1 = Z_1$ , and if large  $R_1$  represents the sum of the resistances  $r_p$  and  $r_1$  in the primary circuit, we have the following value for large  $Z_1$ :

$$Z_1 = R_1 + j\omega L_1$$

Applying Kirchoff's law where the electromotive forces are respectively  $\omega E_g$  and  $j\omega MI_2$  for the primary circuit and  $j\omega M I_1$  for the secondary circuit, we have:

- (1)  $E + j\omega MI_2 = I_1 Z_1$
- (2)  $j\omega MI_1 = I_2 Z_2$

where  $Z_2 = R_2 + j\omega L_2$ ;  $R_2 = \frac{1}{2} + r$  and  $L_2 = L_2 + L$ . The above two equations are solved by the methods of simultaneous equations.

**First Method—Elimination by Addition or Subtraction**

By rearranging equations (1) and (2), we have:

- (1)  $E + j\omega MI_2 = I_1 Z_1$
- (2)  $I_2 Z_2 = j\omega MI_1$

Now, multiplying (1) by  $Z_2$  and (2) by  $j\omega M$ , we have:

$$EZ_2 + j\omega MI_2 Z_2 = I_1 Z_1 Z_2$$

$$j\omega MI_2 Z_2 = j^2 \omega^2 M^2 I_1$$

It is convenient here to subtract these two equations. Thus:

$$EZ_2 = I_1 Z_1 Z_2 - j^2 \omega^2 M^2 I_1$$

Simplifying, and remembering that  $j^2 = -1$ , we have:

$$EZ_2 = I_1 (Z_1 Z_2 + \omega^2 M^2)$$

$$\text{Therefore: } I_1 = \frac{EZ_2}{Z_1 Z_2 + \omega^2 M^2}$$

**Second Method—Elimination by Substitution**

The following method shows how very important the application of the various algebraic forms must be understood.

$$\text{Form (2): } I_1 = \frac{I_2 Z_2}{j\omega M}$$

Substituting this value of  $I_1$  in (1), we have:

$$E + j\omega MI_2 = \frac{I_2 Z_2 I_1}{j\omega M}$$

Simplifying:

$$j\omega MI_2 - \frac{I_2 Z_2 I_1}{j\omega M} = E$$

Multiplying each term by  $j\omega M$ , we have:

$$I_2 \{ j^2 \omega^2 M^2 - Z_1 Z_2 \} = j\omega ME$$

$$\text{Therefore: } I_2 = \frac{j\omega ME}{Z_1 Z_2 + \omega^2 M^2}$$

Since  $I_2$  is the current going (Continued on page 1014)

# Backstage in Broadcasting

*Chatty bits of news on what is happening before the microphone. Personal interviews with broadcast artists and executives. Trends and developments of studio technique*

## FREDDIE

**RICH**, conductor of several C. B. S. studio orchestras, is a rare type of leader. Dropping in on a recent program he conducted, we were impressed by his jovial demeanor throughout the broadcast. He entered

the studio with a broad smile which he retained until the "sign-off." We always thought it was a conductor's right to scowl at his men whether or not they were playing their parts well. But going back over Freddie's history, we find that he earned the right to smile. He hails from New York's East Side where he sampled the bitter taste of poverty. He studied the piano when a boy and at the age of twelve got a job in a cheap movie house where he played the piano ten consecutive hours each day. He worked himself out of this environment and studied at a fashionable conservatory. In 1922, at the Hotel Astor, he broadcast some of the first "remote control" dance programs. Thence onward to the present when he is devoting his entire time to radio.

"A RECESS from the microphone will undoubtedly do radio listeners and ourselves lots of good," S. L. Rothafel (Roxy) remarked to this reporter at the start of the nationwide tour of his famous "Gang" sponsored by the National Broadcasting Company.

We met the impresario backstage on the occasion of the only New York performance on the tour schedule. The seventy musicians, vocalists and novelty performers of Roxy's company were taking their stage positions and it was but a few moments before the curtain was raised.

"This is the first extensive tour we're



## By Samuel Kaufman

taking and it will give us the invaluable opportunity of personally meeting the vast audiences we've reached for several years via the microphone," Roxy continued. "However, the Gang will return to the air with me as shortly after the conclusion of this tour as we can catch our breath."

Roxy's remarks definitely indicated that his departure from the Roxy Theatre will not affect the radio audience. "Roxy and His Gang" is a permanent radio billing and it will be of no radical difference to the air listeners to hear the programs directly from a network studio than from the theatre studio in the past. As a matter of fact, "Roxy and His Gang" was an established radio feature years before the Roxy Theatre was built.

The Gang came into being back in the days of crystal detectors and headsets—not so long past in years but a great length of time in radio development. The first of Roxy's programs came from the Capitol Theatre, the first Broadway theatre to go on the air. When Roxy left the Capitol to manage the affairs of the world's largest theatre, the headliners of the Gang went with him and the famous air troupe continued their broadcasting. In turn, the Roxy Theatre was another transcendental step in Roxy's career. He will continue as the head of his radio troupe regardless of what other duties he is assigned in his affiliation with the National Broadcasting Company and the Radio City interests, we understand. He expressed his anxiety to return to air at

the end of his tour, but added that the brief absence of the Gang from the microphone would be giving both the radio audience and the Gang "an appreciative rest."

The Roxy Gang road company included such distinguished artists as Madame Ernestine Schumann-Heink, Beatrice Belkin, Frank Moulan, Harold Van Duzee, Josef Stopak and Viola Philo. The troupe traveled from city to city in a special train and made one or two appearances each day. Capacity audiences met the "Gang" throughout the itinerary of the tour.

Roxy's final and crowning achievement at the Roxy Theatre was to inaugurate the Sunday morning series of "dollar" concerts by a symphony orchestra of 200 pieces for the benefit of unemployed musicians. Erno Rapee conducted the series which was broadcast over the combined N. B. C. networks and rebroadcast in Germany. At the last Sunday concert under Roxy's supervision, an audience of 6,000 persons rose in tribute to the master showman-broadcaster. We also witnessed the final Gang program in the theatre studio when his associates gathered to bid him Godspeed in his new radio undertakings.

## AMERICAN

radio listeners are growing tired of the "I-love-you" theme of music and are turning towards a "Continental" taste in song-fare, says Vincent Lopez, director of several N. B. C. dance music programs. The maestro tells us that listeners are showing keen response to imported compositions. We were reminded that many adaptations of

*(Continued on page 1038)*



Here are some of the Roxy Gang, with their famous maestro. From left to right are Frank Moulan, Madame Ernestine Schumann-Heink, S. L. Rothafel, Beatrice Belkin and Harold Van Duzee



# What's New in Radio

*A department devoted to the description of the latest developments in radio equipment. Radio servicemen, experimenters, dealers and set builders will find these items of service in conducting their work*

## Portable Group Address System

*Description*—This portable address system supplies a real need for schools, churches and wherever it is necessary occasionally to distribute speeches or music to a group of people. The units and accessories are matched and designed so they will operate together as a unified system. The microphone two-stage am-



plifier is complete with carrying case, tubes, two-button microphone, adjustable microphone desk stand, fifteen feet of microphone cord and twenty-five feet of wire for connection to the speaker-amplifier. A leatherette carrying case houses the speaker-amplifier, which is complete with dynamic speaker and amplifying tube. In addition to its function in the address system, this speaker-amplifier can be used by itself as an

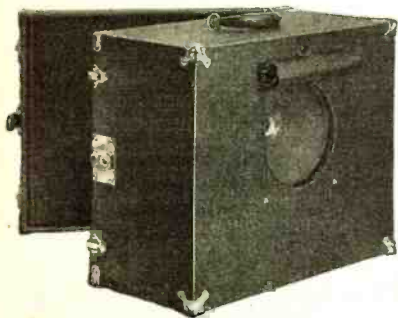

audio-amplifying system for a r.f. tuner or an electrical phonograph pick-up. It is provided with an extra set of output terminals for connection to a recording cutting head for making amateur phonograph records. The address system requires no batteries of any kind, it operates entirely from the 110 volt a.c. supply. The two units together weigh less than seventy-five pounds and can be set up and ready for operation in five minutes.

*Maker*—Samson Electric Co., Canton, Mass.

## Conducted by The Technical Staff

### Test Oscillator

*Description*—The increasing popularity of superheterodyne receivers makes this oscillator a timely addition to the service kit for use in properly peaking the intermediate stages of this type receiver. It offers i.f. of 130 kc., and 170 kc. to 180 kc. By means of a variable tuner it is possible to vary these frequencies over a considerable band so that amplifiers may be "flat topped," thereby meeting the requirements of some receivers for improved tone quality. This unit also pro-



vides any desired frequency over the broadcast band. It is adequately shielded and provision is made to operate it from the 110-volt line, either a.c. or d.c., or from a battery supply. It utilizes a -30 tube and calibration charts are furnished with the instrument. It is mounted in a hard wood case measuring 11¼ inches by 4¼ inches. This case has a carrying handle and provides space for accessories. The oscillator is available with or without an output meter.

*Usage*—For peaking i.f. stages of superheterodyne and for use in neutralizing and aligning tuned radio frequency amplifiers.

*Maker*—Supreme Instruments Corporation, Greenwood, Miss.

### Condenser Cartridges for Quick Replacement

*Description*—Heretofore, a broken-down condenser in the filter circuit of a radio power supply, has generally meant the replacement of a complete new filter condenser block. Due to the develop-

ment of this cartridge type of condenser it is now a simple matter, once the broken-down section has been located, for the repairman to replace the defective condenser with this new cartridge type

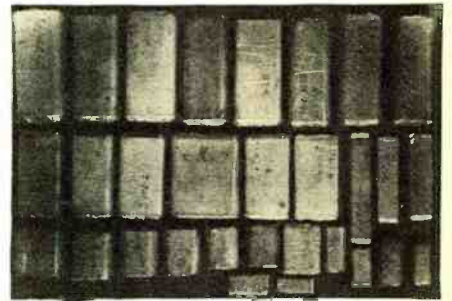

condenser. The replacement can be made within the condenser case, or externally, whichever is most practicable for the particular unit under repair. These condenser cartridges are supplied in large sizes for filter block replacements and are available in capacities of 0.5 to 2.0 mfd. with d.c. voltage ratings of 200 to 1,000 volts. They are paraffin impregnated, wax dipped and are furnished with two six-inch leads. Condenser cartridges for by-pass repairs are also available in capacities of 0.25 to 1.0 mfd. and have a d.c. working voltage of 200 to 400 volts.

*Usage*—Economical and handy replacement condensers for the serviceman.

*Maker*—Dubilier Condenser Corporation, 4377 Bronx Boulevard, New York City, N. Y.

### A Filter Device for Dial Telephones

*Description*—Here is a filter that will eliminate the objectionable interference in radio reception caused by some automatic dial telephones. This filter is so

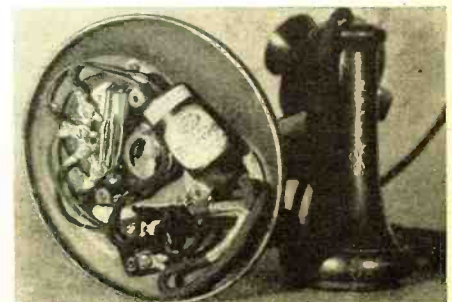

designed as not to affect the operation of the telephone or the quality of speech transmission. The unit is mounted in

*(Continued on page 1038)*

# ~RADIO NEWS HOME LABORATORY EXPERIMENTS~

## The Tuned Circuit

EVERY modern radio receiver depends largely for its selectivity and sensitivity upon the characteristics of tuned circuits. It is important, therefore, to know upon what factors depends the performance of such circuits. In this Home Experiment Sheet we have therefore discussed why a tuned circuit possesses the characteristics it does and the factors affecting these characteristics.

The circuit of Figure 1 represents the essentials of a tuned or resonant circuit, for in every circuit of this type there must be capacity C, inductance L; and of course every circuit will have some resistance R, since circuits of zero resistance cannot be made.

Now the a.c. impedance of such a circuit is

$$Z = \sqrt{R^2 + \left( 6.28fL - \frac{1}{6.28fC} \right)^2}$$

where Z is the total impedance in ohms  
 R is the resistance of the circuit  
 f is the frequency of the current  
 L is the inductance in henries  
 C is the capacity in farads

Now it will be noted that f appears in two parts of this impedance formula. It

appears in the quantity  $6.28fL$  and in  $\frac{1}{6.28fC}$ ; the first quantity therefore increases as f is raised and the second quantity decreases. At a certain value of f they will be equal to each other. Since they are subtracted the entire quantity inside the brackets becomes zero at this value of f and the formula for impedance becomes:

$$Z = \sqrt{R^2} = R$$

The frequency at which  $6.28fL$  becomes equal to  $\frac{1}{6.28fC}$  is the *resonant frequency* of the circuit and at this frequency the total impedance of the circuit is equal to R, the resistance of the circuit.

The current flowing through the circuit is at all times equal to  $\frac{E}{Z}$ . Therefore when Z is large the current is small. When the frequency impressed on the circuit is the resonant frequency of the circuit the total Z is a minimum and is equal to R, as shown by the preceding equation. Consequently at this frequency the current flowing through the circuit will be a maximum and may be very large if R is small.

Let us see how we can determine the resonant frequency of such a circuit. We have pointed out that the resonant frequency is that value which makes the two quantities in the brackets equal to each other—

$$6.28fL = \frac{1}{6.28fC}$$

Transposing this equation and solving for f we have

$$f = \frac{1}{6.28\sqrt{LC}}$$

This is the fundamental equation for resonance, and by solving this equation we can determine the resonant frequency of any circuit. Suppose, for example, that L has a value of 25 henries and C a capacity of 2 mfd. and the resistance of the circuit is 20 ohms. The resonant frequency will be

$$\begin{aligned} f &= \frac{1}{6.28\sqrt{LC}} \\ &= \frac{1}{6.28\sqrt{25 \times 2 \times 10^{-6}}} \\ &= \frac{1}{0.044} \\ &= 22.8 \text{ cycles} \end{aligned}$$

Note:  $10^{-6}$  appears in the above example to convert microfarads into farads, one farad being equal to one million microfarads.

The resonant frequency of such a circuit would therefore be 22.8 cycles. At this frequency the current will be  $\frac{E}{R}$ . If

E had a value of 100 volts and R a value of 20 ohms, then the current would be 5 amperes. Though the voltage remains constant, the current at all other frequencies will be much smaller. For example, at 500 cycles the impedance of the circuit would be

$$\begin{aligned} Z &= \sqrt{R^2 + \left( 6.28fL - \frac{1}{6.28fC} \right)^2} \\ &= \sqrt{400 + (78,500 - 160)^2} \\ &= 248 \text{ ohms} \end{aligned}$$

Therefore at 500 cycles the current would be  $\frac{100}{248}$  or 0.403

amperes. It will be realized therefore that in a resonant circuit the current is large if the resonant frequency is applied to the circuit but that at all other frequencies the current is small in comparison with its value at resonance. Here we have one of the fundamental characteristics of resonant circuits; they are sensitive to the resonant frequency and relatively insensitive to other frequencies. If we calculate or measure the currents at a number of frequencies we obtain the familiar type of resonance curve shown in Figure 2. Since the current at resonance is determined solely by the ratio of the voltage to the resistance

$\left( \frac{E}{R} \right)$  it follows that the

value of the current at resonance is directly proportional to resistance; doubling the resistance halves the current, halving the resistance doubles the current, one-tenth the resistance gives ten times as much current, and so on. Obviously, if we want a resonant circuit to function efficiently we must design it to have a low resistance.

In many cases we are not interested so much in the current at resonance as we are in the voltage across

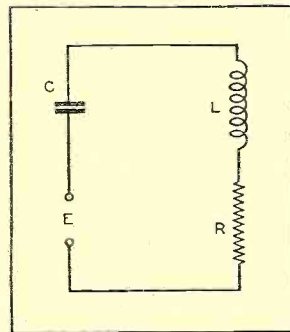

Figure 1. The essential components of every tuned resonant circuit

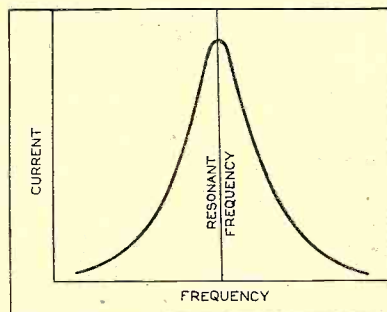

Figure 2. A typical resonance curve

the inductance coil. A common example of this is the simple antenna coupling circuit shown in Figure 3. A voltage is induced in the antenna circuit by the signals from the broadcasting station and as a result current flows through the antenna circuit. These currents build up a voltage across the antenna coil L1 and induce a voltage in the coil L2. Now the circuit of the secondary, consisting of L2, the tuning condenser C and the resistance of the circuit, constitutes a resonant circuit of the same type shown in Figure 1.

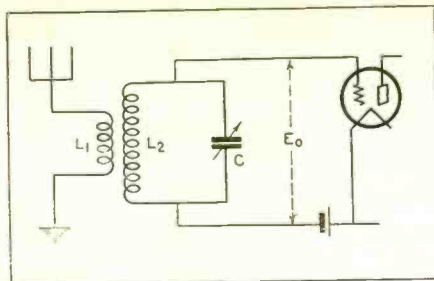

Figure 3. The secondary circuit, including L2 and C, also includes inherent resistance and is the equivalent of Figure 1

Now we want this secondary tuned circuit to do two things. First, we want it to respond readily to induced voltages which have a frequency of that signal to which we wish to tune. As the preceding discussion has shown, such an effect will be produced if the secondary circuit is resonated to the desired frequency. If this is done the currents at the desired frequency will be large in comparison with the currents at all other frequencies.

We also want this tuned circuit to create as large a voltage as possible across the coil L, for it is this voltage that is applied to the tube. Let us determine the relation between the voltage induced in the secondary and the voltage generated across the coil L. The ratio between the induced voltage and the voltage across the coil is usually referred to as the "gain" of the circuit. Therefore

$$\text{Gain} = \frac{\text{Voltage induced in the tuned circuit } E_o}{\text{Voltage across coil L } E_i}$$

Now the voltage across the coil L will be equal to the current through it times its reactance. That is:

$$E_o = 6.28fL \times I$$

and the current flowing in the tuned circuit will be, as previously shown,

$$I = \frac{E_i}{R}$$

Therefore, by combining these two equations and solving for Eo/Ei we have

$$\frac{E_o}{E_i} = \frac{6.28fL \times I}{IR} = \frac{6.28fL}{R}$$

This means that the voltage across the coil and the induced voltage will be in the same relation as the ratio of the reactance of the coil (6.28fL) to its resistance. For example, if we had a tuned circuit working at a certain frequency such that the reactance of the coil was 1000 ohms and its resistance was 10 ohms. then if we induced say 1 volt in the coil and tuned the circuit to resonance the voltage across the coil would be

$$\frac{1000}{10} = 100 \text{ volts}$$

In other words, we are able, simply by making use of the characteristics of a resonant circuit, to build up a voltage from 1 volt up to 100 volts. Such a coil would be described as having a gain of 100. Actually the coils used in a radio receiver must function at all frequencies from 550 up to 1500 kc. (the broadcast band), and since they have a different resistance at various frequencies they do not have a constant gain over the entire broadcast band. This was one of the factors which caused old-style radio sets to have non-uniform sensitivity, a difficulty that has been at least partially overcome by designing the entire

r.f. transformer so as to compensate for the variation in gain of the tuned circuits. A resonant circuit has therefore two essential characteristics: (1) It responds very readily to currents of the resonant frequency and responds very poorly to all other frequencies. (2) The voltage across the coil (across the condenser also) may, at resonance, be much larger than the voltage induced in the circuit. The two characteristics depend upon the resistance of the circuit and the relative values of the coil and the condenser. If the resistance is low the currents at resonance are large in comparison with what they would be if the circuit had a high resistance. Also the impedance of the circuit to some frequency off resonance will be larger the greater the ratio between the inductance of the coil and the capacity of the condenser. For best results we should therefore use low-resistance circuits consisting of large coils and small condensers. Of course, in practice we find that the larger the coil the greater its resistance and it is therefore not advisable to make the coil so large that its resistance becomes excessive. The governing factor is the gain formula 6.28fL/R and the coil we use should be one which gives the greatest gain.

In many cases it will be found that the gain continually increases as we increase the size of the coil. In such cases we find a new limiting factor—the distributed capacity of the coil. There is a small but definite capacity between turns of a coil and as we increase the size of the coil a point will be reached where these capacities have a value such that they will make the coil resonant; it is useless, therefore, to increase the coil size beyond the point where the coil inductance and coil distributed capacity resonate at the desired frequency. The frequency at which the coil and its capacity resonate is termed the "natural period" of the coil.

The coil and its distributed capacity can be represented as in Figure 4. The many small capacities between turns can be considered as a number of small capacities connected in series as shown in Figure 5.

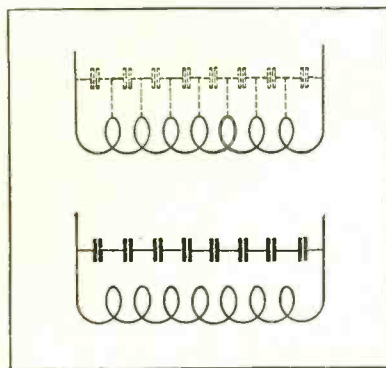

Figures 4 and 5. Every coil has distributed capacity as shown here

Every time we double the number of turns on the coil we multiply the inductance of the coil by approximately four times; at the same time we double the number of small condensers in series and this causes the overall capacity to be halved. But since the resonant frequency is

$$f = \frac{1}{6.28\sqrt{LC}}$$

and doubling the number of turns causes  $\sqrt{LC}$  to become  $\sqrt{4L} \times \frac{1}{2}\sqrt{C}$  it follows that the natural period of the coil is reduced by a factor of the  $\sqrt{2}$  or 1.4. As a result continually adding turns to the coil gradually decreases its natural frequency relatively.

Many of the coils used in old type sets were poorly designed and would have a natural period around 250 meters. As a result, it was impossible to tune such sets to any wavelengths below 250 meters and in many cases the wavelength range was even more limited because of the added capacity due to the wiring and minimum capacity of the tuning condenser, both of which are of course added to the distributed capacity of the coil.

The principles set forth above should be borne in mind constantly by the experimenter because of their manifold applications in all radio work.



Presenting this month:

Direct Reading Ohmmeter—Quartz Crystals—35c Each!—Automatic Volume Control

Conducted by  
S. Gordon Taylor

### Direct Reading Ohmmeter

**C**ONVERTING an 0-1 milliammeter for use as an all-range voltmeter or an all-range milliammeter seems to be the latest form of indoor sport. In fact, our own RADIO NEWS has given directions for making a milliammeter do about everything except to wind the clock and put the cat out. The result has been that the low-range milliammeter has become one of the most useful devices in the laboratory and the service kit.

Considerable has been written about the conversion of a milliammeter to use as a combination milliammeter and direct-reading ohmmeter, but judging from readers' inquiries there is still a considerable demand for information on the subject.

To start with, the basic circuit is shown in Figure 1. The equipment required consists of an 0-1 d.c. milliammeter, a resistance and a dry-cell battery. The value of the resistance depends on the battery voltage employed and this in turn is determined by the resistance range to be covered by the meter. The table in Figure 2 shows the battery voltages and

fixed resistance values required to cover various measurement ranges up to 1,500,000 ohms.

To describe the functioning of the ohmmeter, let us assume that a range of 0 to 50,000 ohms is desired. According to Figure 2, the calibrating resistance should be 1500 ohms and the battery a 1.5-volt cell. With these values the meter will show full-scale deflection if the terminals at x are shorted, but any resistance connected at x will, of course, reduce the

amount of current flowing and therefore the reading of the meter. The higher the resistance, the lower the meter reading will drop. This is the principle upon which the meter works and the meter scale can be recalibrated accordingly.

Ordinarily the calibration of the direct-reading ohmmeter scale is a tedious job and is accomplished either by calculation or by measuring resistances of known values. Even when the data are obtained, the actual marking of the scale is likely to show sloppy results. For the reader who uses either a Weston or a Jewell meter all this effort can be saved and neat appearance guaranteed by cutting out the scale shown in Figure 3, if the meter is a Weston, or Figure 4 if a Jewell, and attaching same to the original meter scale. This is accomplished by first removing the meter from its case and then removing the screws holding the old scale. The new scale is next attached to the old, the screws which hold the scale replaced and the meter put back into the case.

(Continued on page 1024)

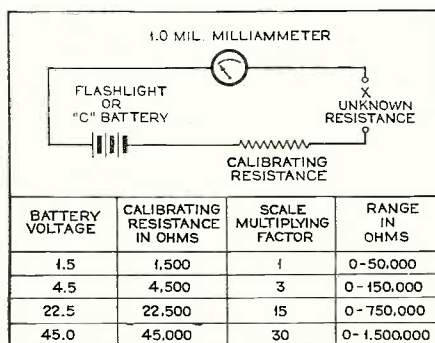
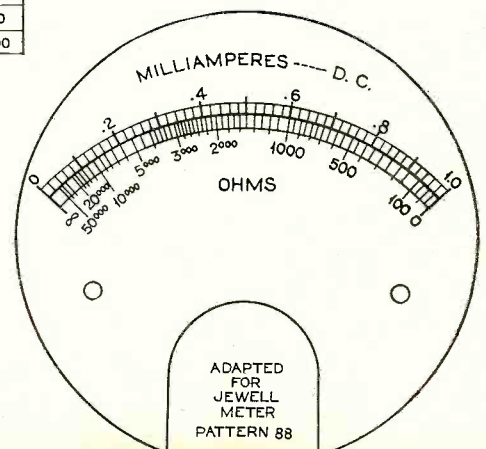
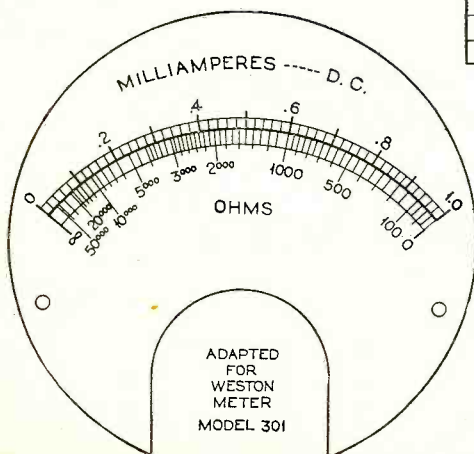

Figure 1. (Above) The basic circuit employed in converting a milliammeter to an ohmmeter

Figure 2. Here are shown the values of voltage and "calibrating resistance" for each range

Figure 3. (Left) Cut out this scale and attach it directly to the old scale of a Weston meter

Figure 4. (Right) If a Jewell meter is used, this scale will fit it exactly. These scales are provided through courtesy of the International Resistance Co.



**Automatic Volume Control**

In the December edition of RADIO NEWS you ask in the Laboratory Section for ideas on automatic volume controls. Last year I designed and built one for use with a Radiola 28 battery model set. As this should be readily adaptable to any set in which the volume can be controlled by varying the grid voltage of the r.f. tubes, I am giving a diagram of it (Figure 5). The diagram should be self-explanatory.

I am also giving a diagram (Figure 6) of an adaptation of the Loftin-White amplifier for this work which you may be able to develop for use with those sets in which grid control of volume is not feasible, that is, if the material required

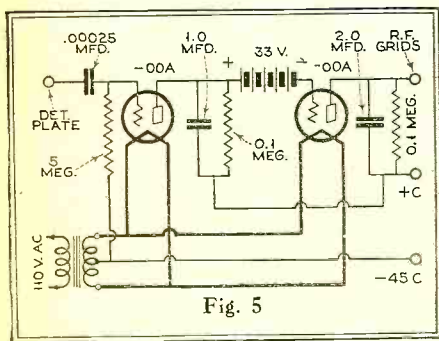

Figure 5. Automatic volume control as applied to the Radiola 28 battery model by Mr. Sevin

does not make it too expensive for your needs.

DOUGLAS B. SEVIN,  
Norwich, Conn.

**Quartz Crystals—35c Each!**

(The following article by Mr. Harold Jay Sullivan, amateur station W1AAD, of Pawtucket, R. I., will be of more than ordinary interest to owners of amateur transmitters.—TECHNICAL EDITOR.)

More and more amateurs are going in for crystal control and many others would join the "big parade" if it weren't for the expense of good crystals and their associated apparatus. This method of controlling the transmitter is, indeed, a step toward the solution of the "Ham" dilemma of QRM. Everyone admits this, but, like so many solutions, it appears, to the non-millionaire amateur at least, to be not for him. Most of these fellows would gladly buy a crystal, even a twenty-five dollar one, but the apparatus required to make this bit of quartz useful is quite beyond their budget. Well, why not use just a crystal oscillator and cut out the cost of frequency doublers and amplifiers, bias batteries and tubes? Foolish? Can't put any "soup" into the antenna? Well, most amateurs use a 210 with an input of about 30 watts, and, using a 210 in a crystal oscillator here at W1AAD many contacts have been effected for the past nine months, with an input of 54 watts. This transmitter has 600 volts on it and the original crystal is

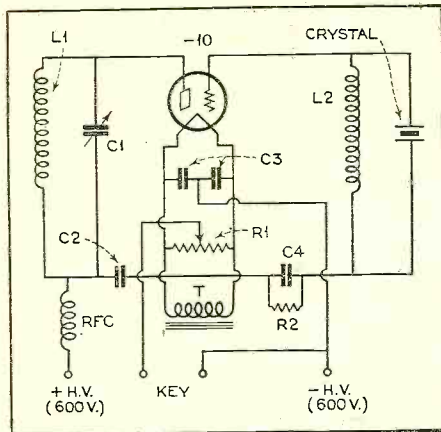

Figure 7. The circuit of the crystal controlled amateur transmitter at W1AAD

still in use. The complete outfit, including the crystal, cost about \$10.00.

Interesting, is true? Well, here's the how of it.

It all began when the "beginners" set in the December, 1929, issue of "QST," struck the writer as being ideal for a portable. This set was constructed in compact form, the complete oscillator measuring 10 inches long by 7 inches high by 4 inches deep, with the plate tank inductance mounted on the top "deck." This transmitter worked fine on the 20-40-80 meter bands and was exhibited with much pride to all visitors, most of whom looked once and snickered. One visitor, however, did not snicker. He, Mr. F. S. Huddy, W1II-W1ZS, looked, and was struck by the possibility of adapting this "peewee" set to what, he said, the English amateurs call "lock-in" crystal. He agreed to furnish the crystal, so, naturally, I had no objection. The result was a note such as anyone has a right to be proud of. Thus the lowly portable became a haughty 80 meter "xtal." When asked the price of the bit of quartz, Mr. Huddy said, "Well, it cost me 35c!"

These crystals, he said, are not what is commonly referred to as such, but are known to oculists as "Quartz Pebble" lenses. They are not ground to any particular frequency and any attempt to do so is more apt to result in failure than success. They came about through the ancient Chinese belief that glass of this type was beneficial to failing eyesight, a belief that modern science has proven false. Some of the older firms of opticians still have a few of these lenses on hand and will very gladly "unload" for a nominal sum. The only drawback is, that, like their more legitimate brothers, these "crystals" have a habit of either not oscillating at all or oscillating outside the desired band of frequencies. The frequency of the suspected eyeglass lens can be determined by laying the lens on the stator plates of the regeneration condenser of a receiver that is oscillating in the desired band. When the receiver is tuned to the crystal frequency a "plurp-plurp" will be heard in the earphones. This indicates that this particular crystal is oscillating at this frequency. Some of these lenses will control only one frequency in the band, while others will control on more than one frequency in

the same band, and a few may be found that will control on either the 40 or the 80 meter band. (A big saving in doublers and amplifiers.) These lenses are very thick, the one in use at W1AAD is an eighth of an inch. This is fortunate, in that it permits the use of a voltage on the crystal oscillator that would be used on the same transmitter minus the crystal. Plate voltages up to 700 volts have been tried with success and the transmitter here uses 600 volts of half wave rectified AC. Sometimes the crystal jumps around in the holder, but it is still "perking."

The exact amount of controlling that such a crystal does may be debatable, but, there is no doubt that it improves the tone 100 per cent; it produces a "rock steady" note and considerably sharpens the wave.

The circuit shown in Figure 7 is the one in use at the writers' station and is

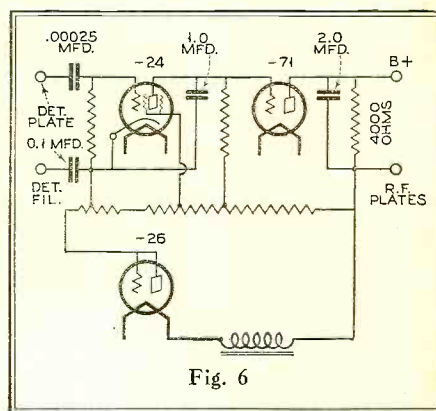

Figure 6. Mr. Sevin's suggestion for using Loftin-White amplifier as an automatic volume control

a modified Armstrong. The modification being that the grid coil is not tuned by a condenser and consists of a few turns of very small wire wound on an inch diameter tube. The crystal, as can be seen in the diagram, is connected directly across this coil. This circuit was used only because it was already built up and not because it is the only one in which such a system can be used. There is no reason why a Hartley, or, in fact, any of the present day, high frequency transmitters couldn't be adapted to some such system, but, remember that the crystal won't stand much over 75 watts!

The values of the parts shown in Figure — are as follows:

- C1—.0005 mfd. receiving condenser, variable.
- C2—.002 mfd. receiving condenser, fixed.
- C3—.001 mfd. receiving condensers, fixed.
- C4—.00025 mfd. receiving condenser, fixed.
- R1—200 ohm potentiometer.
- R2—10,000 ohm resistor.
- RFC—R.F. choke coil.

**COILS**

- Band. 3500 Kc. L1—12 turns of 1/4" copper tubing on a 2 1/2" diameter.
- L2—48 turns of No. 28 wire

(Continued on page 1024)

# Latest Radio Patents

*A description of the newest patented inventions on radio, television, acoustics and electronics as they are granted by the United States Patent Office. This information will be found a handy radio reference for inventors, engineers, set designers and production men in establishing the dates of record, as well as describing the important radio inventions*

Conducted by  
**Ben J. Chromy\***

1,787,582. SIGNAL RECEIVING SYSTEM. FREDERICK A. KOLSTER and GEORGE G. KRUESI, Palo Alto, Calif., assignors to Federal Telegraph Company, San Francisco, Calif., a Corporation of California. Filed Nov. 26, 1928. Serial No. 321,831. 4 Claims. (Cl. 179-171.)

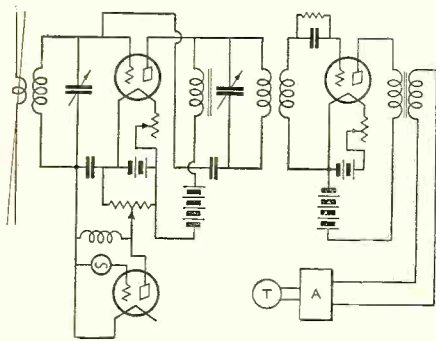

1. A signal receiving system comprising a source of signal energy of radio frequency, an electron relay having grid, cathode and anode electrodes, a reactive input circuit connected across the grid and cathode of said relay and coupled to said source, and a reactive output circuit connected across the grid and anode of said relay, said circuits being oppositely reactive with respect to a given frequency of operation and affording a network resonant as a whole to said frequency of operation in conjunction with said relay.

1,789,912. TUNING DEVICE. HAROLD A. SNOW, Boonton, N. J., assignor to Radio Frequency Laboratories, Incorporated, Boonton, N. J., a Corporation of New Jersey. Filed Oct. 17, 1924. Serial No. 744,095. 14 Claims.

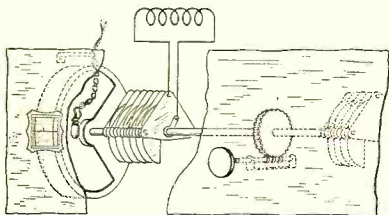

1. A radio receiving apparatus comprising a variable reactive element, a shaft operative to vary said element, an indicating drum operated by said shaft, a translucent portion of the curved surface of said drum, a scale upon said translucent surface, and a source of illumination whereby said scale is illuminated from behind said translucent surface.

1,790,120. LOUD SPEAKER. ADOLPH A. THOMAS, New York, N. Y. Filed May 24, 1926. Serial No. 111,149. 48 Claims.

1,789,416. NEUTRALIZED VACUUM-TUBE CIRCUITS. RALPH K. POTTER, New York, N. Y., assignor to American Telephone and Telegraph Company, a Corporation of New York. Filed Nov. 3, 1927. Serial No. 230,910. 7 Claims.

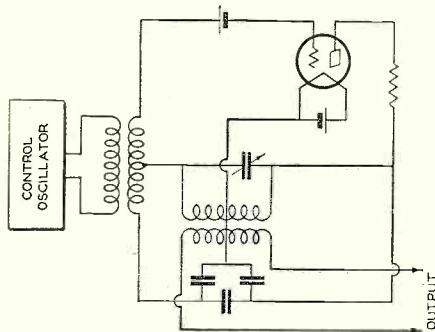

6. In an electrical system, a vacuum tube oscillator, a control oscillator associated with the input circuit thereof, means for balancing the vacuum tube inter-electrode impedances, and means for neutralizing the feed-back currents in the input circuit of the oscillator to prevent reaction of said currents on the control oscillator.

1,790,903. RADIO COLOR ORGAN. RICHARD M. CRAIG, San Antonio, Tex. Filed Sept. 23, 1929. Serial No. 394,692. 10 Claims.

6. A color attachment for radio receiving sets comprising colored electric lamps, means for mounting the lamps adjacent the sound-emitting element of a radio receiving set, vibratory elements in circuit with the lamps and responsive to different tone variations of the sound-emitting element, certain of said vibratory elements being operated to cause some of the lamps to be brilliantly lighted, and other of the vibratory elements being operable to cause other of the lamps to be dimly lighted.

1,789,673. AMPLIFIER COUPLING. HAROLD POTTER DONLE, Meriden, Conn., assignments, to Radio Inventions, Inc., a Corporation of New York. Filed Mar. 30, 1926. Serial No. 98,451. 2 Claims.

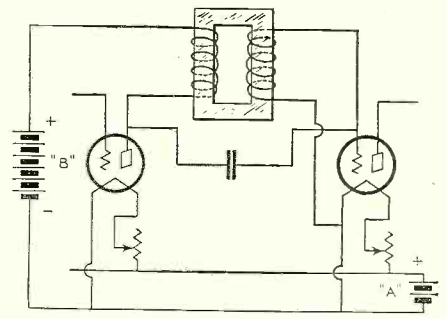

1. An audio frequency amplifier having vacuum tubes with a coupling device between them comprising an inductance inserted in the plate-cathode circuit of one tube, an inductance inserted in the grid-cathode circuit of the following tube, a closed magnetic core common to both inductances for producing a substantial mutual inductance between said circuits, and a condenser connected directly between the plate and grid terminals of said inductances, the second mentioned inductance being connected at one end between the condenser and the grid of the second tube and at its other end to the filament of the second tube whereby a substantial capacity coupling is produced, said inductances having low ohmic resistance and impedance sufficiently high to insure an efficient transfer of energy from one inductance to the other at audio frequencies.

1,791,435. AMPLIFYING APPARATUS. BROWDER J. THOMPSON, Schenectady, N. Y., assignor to General Electric Company, a Corporation of New York. Filed Dec. 24, 1927. Serial No. 242,475. 9 Claims.

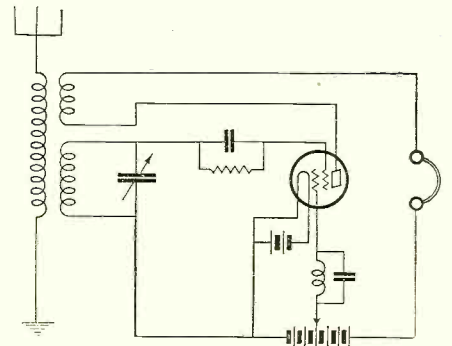

1. The combination with an electron discharge device having an electron emitting cathode and anode and two grids which are successively passed by the electron stream of separate circuits connecting the cathode with each of the other electrodes, and two

\*Patent Attorney, Washington, D. C.

separate means for producing regenerative amplification by the action of one of said grids, one of said means being most effective at the higher frequencies and other means being most effective at the lower frequencies at which the circuits are intended to operate.

1,791,030. RADIO RECEIVING SYSTEM. LESTER L. JONES, Oradell, N. J. Filed Mar. 6, 1928. Serial No. 259,451. 14 Claims.

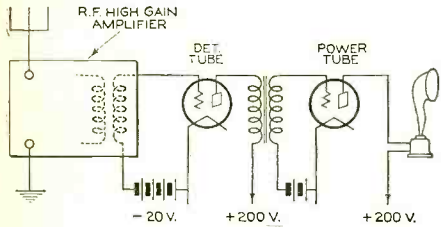

1. An electron discharge tube radio receiving circuit comprising a multi-tube radio frequency amplifier, a grid biased tube detector, a single stage audio frequency amplifier, and a loud speaker all arranged in cascade, means to impress a high biasing voltage on the grid of the detector tube, a source of high plate voltage therefor, the grid and plate voltages being sufficiently high to give the detector characteristic a linear portion so large that if substantially fully utilized the detector output need only be amplified by the single stage audio frequency amplifier to produce full volume operation of said loud speaker and the gain in the multi-stage radio frequency amplifier being high enough to provide an input for the detector tube of sufficient magnitude to utilize substantially the full linear portion of the detector characteristic thereof.

1,788,219. WAVE-METER CIRCUIT. EDWIN L. WHITE, Fort Shafter, Territory of Hawaii, assignor, by mesne assignments, to Federal Telegraph Company, a Corporation of California. Filed Apr. 21, 1927. Serial No. 185,539. 5 Claims.

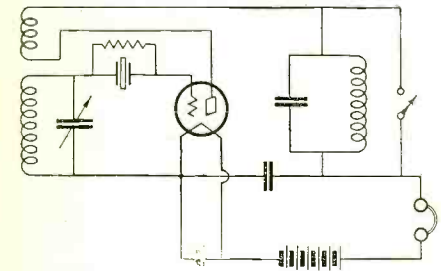

1. A frequency meter comprising an electron tube having grid, cathode and plate electrodes, input and output circuits interconnecting said electrodes, a piezo electric crystal element including in said input circuit and ground to a predetermined frequency, means coupling said input and output circuits, and a branch circuit included in said output circuit and means for rendering said branch circuit effective to sustain oscillations corresponding to the fundamental frequency of said piezo electric crystal element or effective to permit oscillations corresponding to the harmonic frequencies of said piezo electric crystal element independently of the fundamental frequency of oscillations sustained by said input and output circuits.

1,788,543. SWITCHING APPARATUS FOR SOUND-REPRODUCING SYSTEMS. JOHN LOUIS REYNOLDS, Long Island City, N. Y., assignor, by mesne assignments, to

Electrical Research Products Inc., a Corporation of Delaware. Filed Apr. 1, 1927. Serial No. 180,324. 2 Claims.

1. In a transmission system, two sound records, means for producing series of electrical variations from said records, each series corresponding to a separate message to be transmitted, said records being so related that the end portions of the first record corresponds with the beginning portion of the second record, a device for translating said electrical variations into sound waves corresponding thereto, an adjustable potentiometer interconnecting said means and said translating device, and means to operate said potentiometer to render increasingly effective the electrical variations corresponding to the beginning of one of said records and simultaneously to render decreasingly effective the electrical variations corresponding to the end portion of the other of said records, to produce in said translating device the effect of an uninterrupted series of electrical variations.

1,788,553. MEANS FOR AND METHOD OF AMPLIFYING ELECTRIC IMPULSES. ADOLPH A. THOMAS, New York, N. Y. Filed June 18, 1927. Serial No. 199,649. 10 Claims.

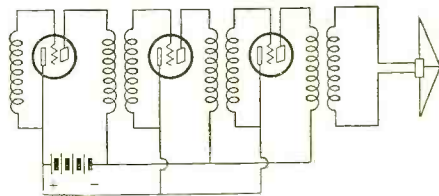

1. In a system for amplifying electric impulses, a plurality of operatively connected vacuum tubes having each a pair of spaced electrodes and an interposed grid, one electrode of each pair being adapted to emit electrons under the action of light, and a single source of light so arranged in relation to said vacuum tubes as to illuminate the photoelectric elements of all tubes with substantially the same degree of intensity.

1,787,689. GLOW-DISCHARGE LAMP. ERNEST ANTON LEDERER, Bloomfield, N. J., assignor to Westinghouse Lamp Company, a Corporation of Pennsylvania. Filed July 9, 1924. Serial No. 724,991. 8 Claims.

8. A discharge lamp comprising an envelope containing a gas at a low pressure, a hollow open-ended insulating member sealed to and forming a chamber within said envelope, a pair of electrodes, each having small effective discharge areas, disposed in said chamber for ionizing the gas within said

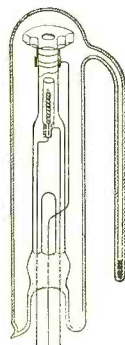

envelope, said hollow member being reduced to form a constricted passage at its open end and a third electrode having a relatively large effective discharge area disposed outside, in alignment with, and adjacent said

constricted passage to produce a positive column discharge in said chamber when a variable potential is impressed between the third electrode and at least one of the ionizing electrodes, said third electrode having an aperture in alignment with said constricted passage.

1,787,690. RECTIFIER. ERNEST ANTON LEDERER, East Orange, N. J., assignor to Westinghouse Lamp Company, a Corporation of Pennsylvania. Filed Nov. 13, 1924. Serial No. 749,593. 8 Claims.

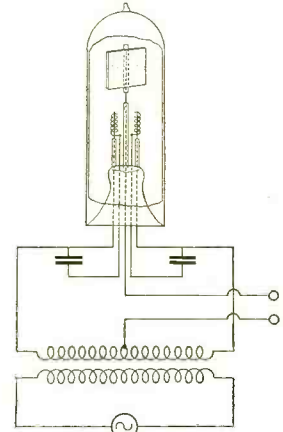

1. A gaseous discharge device comprising a casing containing an ionizable gas, a cathode and a pair of anodes within said casing and a conductor disposed adjacent each of said anodes for suppressing the discharge in one direction between the anodes and the cathode, said conductors having openings therein between the anodes to permit a discharge to pass from one anode to the other.

1,787,911. SOUND-REPRODUCING MECHANISM. WILLIAM D. LA RUE, Philadelphia, Pa., assignor to Victor Talking Machine Company, a Corporation of New Jersey. Filed May 1, 1926. Serial No. 106,073. 52 Claims.

47. In a sound-reproducing machine, in combination with a record support, a diaphragm, means for vibrating said diaphragm from a record on said support, means providing a column of fluid in contact with said diaphragm, a second diaphragm of substantially the same area as said first diaphragm and adapted to be vibrated by the changes of pressure in said fluid column, a cabinet for said elements, a relatively large diaphragm in the wall of said cabinet, a lever between said second diaphragm and said large diaphragm, and a joint between said second diaphragm and first diaphragm whereby said first diaphragm may move relatively to said record support.

1,790,505. CONDENSER TRANSMITTER APPARATUS. JOHN ELLIOTT JENKINS and SAMUEL E. ADAIR, Chicago, Ill., assignors to Jenkins & Adair, Inc., Chicago, Ill., a Corporation of Illinois. Filed July 30, 1928. Serial No. 296,252. 20 Claims.

1. In transmitter apparatus of the class described, a frame for supporting a condenser type transmitter, a unitary amplifier supporting means adapted to be detachably associated with the frame in juxtaposition with respect to a supported transmitter without the necessity of disturbing the position of said transmitter and a complete amplifier unit on said supporting means.

# The Junior Radio Guild

(Continued from page 1005)

through the speaker winding, we have an expression for the determination of the magnitude of the loud speaker current by substituting the known values of the various resistances and impedances which are previously obtained by laboratory methods.

There is a third method used in the solving of simultaneous equations which is of equal importance.

### Third Method—Elimination by Comparison

Again, in this method, further important steps of algebra are considered:

$$\text{From (1): } I_1 = \frac{E + j\omega MI_2}{Z_1}$$

$$\text{From (2): } I_1 = \frac{I_2 Z_2}{j\omega M}$$

Placing these equal to each other, we have:

$$\frac{E + j\omega MI_2}{Z_1} = \frac{I_2 Z_2}{j\omega M}$$

Simplifying, remembering that this is similar to the expression  $\frac{a}{b} = \frac{c}{d}$  where

$ad = bc$ :

$$\text{Thus: } I_2 (\omega^2 M^2 + Z_1 Z_2) = j\omega ME$$

$$\text{Therefore: } I_2 = \frac{j\omega ME}{Z_1 Z_2 + \omega^2 M^2}$$

We see that this expression is the same as that obtained by the method of substitution.

### Examples in Simultaneous Equations

Solve the equations:

Note: In solving these equations, use the three methods, that is:

(a) Elimination by Addition or Subtraction.

(b) Elimination by Substitution.

(c) Elimination by Comparison.

$$1. 3x + 4y = 10$$

$$4x + y = 9$$

To indicate the method:

(a) Solve by the method of elimination by subtraction.

Multiplying the second expression by 4, we have:

$$\begin{array}{r} 3x + 4y = 10 \\ 16x + 4y = 36 \end{array}$$

subtracting  $-13x = -26$

Therefore  $x = 2$  Ans.

(b) Solve by method of substitution:

From the second expression,  $y = 9 - 4x$ ; substituting this value of  $y$  in the first expression, we have:

$$3x + 36 - 16x = 10$$

Simplifying:

$$-13x = -26, \text{ therefore, } x = 2 \text{ Ans.}$$

(c) Solve by method of comparison:

We have, from the first expression:

$$4y = 10 - 3x, \text{ then } y = \frac{10 - 3x}{4}$$

We have, from the second expression:

$$y = 9 - 4x$$

$$\text{Therefore: } \frac{10 - 3x}{4} = 9 - 4x$$

$$\text{Simplifying: } 10 - 3x = 36 - 16x$$

$$13x = 26$$

$$x = 2 \text{ Ans.}$$

$$2. x + 2y = 13$$

$$3x + y = 14$$

$$3. 4x + 7y = 29$$

$$x + 3y = 11$$

$$4. 2x - y = 9$$

$$3x - 7y = 19$$

$$5. 5x + 6y = 17$$

$$6x + 5y = 16$$

$$6. 8x - y = 34$$

$$x + 8y = 53$$

$$7. 15x + 7y = 29$$

$$9x + 15y = 39$$

$$8. 14x - 3y = 39$$

$$6x + 17y = 35$$

$$9. 35x + 17y = 86$$

$$56x - 13y = 17$$

$$10. 5x - 7y = 0$$

$$7x + 5y = 74$$

$$11. 5x = 75 - 21$$

$$21x - 9y = 75$$

$$12. 6y - 5x = 18$$

$$12x - 9y = 0$$

### Quadratic Equations

Quadratic equations deal with the solution of algebraic expressions containing the square of the unknown quantity.

Up to the present time we have been interested only in studying the various forms taken by algebraic expressions and the solution of quantities containing single powers only.

The following example will indicate readily the application and solution of quadratic expressions:

$$4x^2 + 5 = x^2 + 17$$

Simplifying:

$$4x^2 - x^2 = 17 - 5$$

$$3x^2 = 12$$

$$x^2 = 12 = 4$$

$$\sqrt{\quad}$$

$$x = \pm 2 \text{ Ans.}$$

The above equation  $x^2 = 4$  is, of course, the simplest form of a quadratic equation, but further study of this subject will indicate that more complicated methods can be employed for the solution of such expressions.

Time will not be taken here to discuss these methods, but it is suggested that reference be made to the chapter on Quadratic Equations, pages 235-244, inclusive, in Hall and Knight's textbook, and the examples solved which are included.

## A Universal Meter for Bench Mounting

(Continued from page 1002)

scale—.01 ampere in the case of the meter we are using for an example. A shunt of resistance wire is then connected across the terminals of the meter, and the length of the wire shunt adjusted until the reading on the meter is reduced to 1 milliampere (or any other fraction of full-scale deflection as may be desired). The range of the meter has now been increased ten times, and 100 milliamperes are required to give full-scale deflection. Each milliampere division on the meter now represents 10 milliamperes. (If any other fraction of full-scale deflection is chosen, this fraction holds good for any reading on the scale.) The resistance wire shunt should be wound on a small porcelain tube, or other refractory material, and a mounting made for it.

The meters and various shunts and multipliers can be conveniently mounted in the service shop to facilitate voltage and current measurements, along the lines suggested in Figures 2 and 3. The meter is mounted on a bakelite panel at the back of the test bench. Eight two-prong and five three-prong jacks are arranged in two rows just below the meter. The upper jacks permit readings to be taken of the supply voltage, while the lower row is used for current measurements. This arrangement will permit the testing of almost every type of receiving set.

The circuit diagram of the meter panel

is shown in Figure 3 and is almost self-explanatory. In the wiring of the eight voltage jacks, J1 to J8, it will be noted that in several places one resistor is made to serve two jacks. This is practical, because the meter is never plugged into more than one jack at a time. The "A" and "B" batteries or power pack are mounted under the bench or behind the meter panel. Current shunts increase the range of the 10 milliampere meter to 100 milliamperes, and are used on only three of the jacks, J11, J12 and J13, it being unlikely that more than three voltage taps to the set will exceed the natural range of the meter. The meter must of course be connected correctly to the plug in order that the polarity follows through in the right sequence.

Variations of this arrangement will suggest themselves to the ingenious serviceman.

### All in a Day's Work

(Continued from page 1003)

"I have run across quite a number of mechanical rattles due to the second r.f. assembly shield not seating properly. A file and a spintite will cure this.

"Some folks are also having trouble  
(Continued on page 1038)



# “Scanning” Without a Disc

change is characterized by a vertical wave front.

But the straight wave front, as indicated by the heavy lines in Figure 3, becomes distorted in the electrical system and also in the transmitter aperture, so that the pulse which arrives at the receiver has a sloping wave front, somewhat as indicated by the dotted lines of Figure 3. It causes a badly blurred picture. Only by filling in the gap of missing frequencies can the oblique front be changed to a vertical front and the blurred picture converted into one whose details are clear and distinct.

This filling-in can be done in various ways. The general idea can be understood by considering one method which happens to be applicable to the wire transmission of a moving picture. This method uses a low-pass filter in the transmitter as shown at 20, Figure 1. Incidentally it is of interest to know that a band-pass filter, calculated to pass frequencies in the neighborhood of 2100 kilocycles, would enable the pulses to be radiated directly without the necessity of modulating a separate carrier.

Assume that a low-pass filter, such as an audio-frequency transformer, suppresses all frequencies above 6 kilocycles, and that a distorted wave pulse of the general form shown in curve 47 of Figure 5 enters the network defined by 21 in Figure 1. At this stage of the explanation someone may well ask why the distorted wave pulse has the form shown. In order to answer this question, as well as to explain the corrective action of the network, it is necessary to digress for a moment.

All communication engineers agree that a random pulse with a vertical wave front, such as that used in television, can be represented by the Fourier integral theorem. This theorem defines the current as a function of time, during infinite time before and after zero time. Zero time denotes the start of something, in this case the beginning of an electron attack on a fluorescent screen. During the World War the zero hour marked the beginning of an attack from the front-line trenches.

Anyone who understands the integral calculus recognizes this particular integral as being the summation from minus infinity to plus infinity of an infinitely long series of sine and cosine functions of  $\omega t$ , where  $\omega$  is equal to 6.28 times each infinitesimal frequency. For negative time, *i.e.*, for all time prior to zero time, the

(Continued from page 999)

sum of the sine functions is numerically equal and algebraically opposite to the sum of the cosine functions. Consequently, they cancel each other, and there is no actual current prior to zero time.

During positive time, *i.e.*, all time after zero time, the sine functions are equal to the cosine functions both numerically and algebraically. Therefore the current resulting from their super position is equal to twice that represented by the sum of the sine functions. These several relationships are graphically illustrated in Figure 4.

By evaluating this integral and plotting the values for different values of  $\omega t$ , the sine wave form of the current pulse shown in curve 47 of Fig. 5 is obtained. It will be noted that at zero time it rises obliquely from a zero value and continues as a series of decaying oscillations along a straight line.

The mathematical derivative, of an integral which involves sine functions, is also a sine function which lags 90 degrees behind the integrated sine function. A plot of its successive values shows zero value for negative time and an instantaneous rise from zero to a maximum at zero time and then a gradual falling back to zero through a series of damped oscillations, 90 degrees behind those of the original pulse, as shown in curve 48 of Figure 5.

The mathematical derivative of this second sine function is a cosine function whose value is zero prior to zero time and then at zero time it rises instantaneously to infinity and instantaneously falls back to zero, finally dying out through a series of damped oscillations 180 degrees behind those of the original pulse, as shown by curve 49 of Figure 5.

By superposing the first derivative  $I'$  and the second derivative  $I''$  in proper proportion on the original pulse  $I$ , a wave is obtained which for all practical purposes is the desired square wave front form.  $I'$  compensates for the sloping cut-off due to frequency attenuation in the filter and  $I''$  compensates for aperture and other distortion in the original pulse.

The electrical equivalent of obtaining the mathematical derivative of a sine function which represents an electrical current is to pass the current through an

inductance. Similarly the electrical equivalent of integration is performed by a condenser. These facts are indicated in the elementary expression for voltage drop through an impedance.

So finally, after many digressions, we are at last ready to consider the differentiating network which is installed in the receiver. Connected in series with the

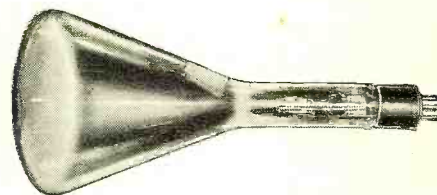

The cathode ray tube employed for “scanning” in the Farnsworth receiver system, illustrated at 31 in Figure 1

line is a resistor 22 which feeds a shunt circuit consisting of an inductance 23 and a variable resistor 25. The resistive impedance of 22 is of sufficiently high value to control the current independently of the effect of the inductive impedance 23. The flow of current  $I$  through 25 causes a voltage drop  $e = IR$  and through inductance 23 a voltage drop  $e''$  which is proportional to the rate of change of current  $I$ . It thus becomes the first derivative of  $I$ .

The sum of the two voltages  $e + e'$  is impressed upon the grid of a vacuum tube which has a high output impedance. Its plate current, which is an amplification of  $I$  and  $I'$ , in flowing through resistor 28 causes a voltage drop  $e''$  which is proportional to  $I$  and  $I'$ . The same currents in inductance 27 cause a voltage drop proportional to their rates of change, thus producing the differentiated currents  $I'$  and  $I''$ , which are fed into the condenser 30 which stores or integrates the pulses fed to it, converting part of the second derivative back to the first derivative and part of the first back to the fundamental.

The pulses which are fed to the grid 32 control the intensity of the cathode ray which creates the picture, as already explained. Resistors 25 and 28 are variable so that the values of the several components can be adjusted until the picture has the best appearance.

It should be remembered that this example merely defines one case of Mr. Farnsworth's invention. His entire idea cannot be fully understood, without greater recourse to mathematics than is here possible. But it is hoped that this qualitative analysis of how the warp and woof of the moving picture is first formed by a cathode ray, then cut into a mere scrap of the original, and finally patched so as to reproduce the original pattern, may pave the way for an understanding of the quantitative analysis that will probably be available as soon as the transmitted pictures are ready for reception in the home.

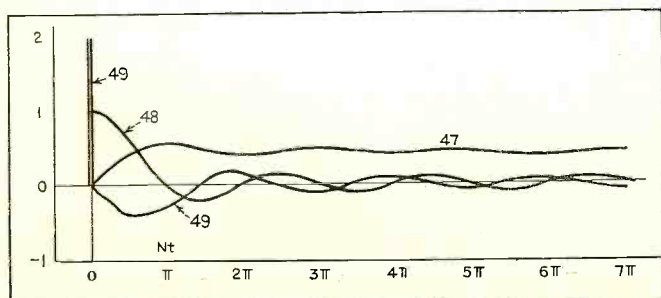

Figure 5. Plotted values of original and derived pulses

# The Junior Transmitter

(Continued from page 995)

all the way through. You could use anything down to 24 gauge and reinforce it for stiffness. Bending the edge over all around will do this. However, by using these milled corners and "T's" they have for sixteen gauge stuff, you can assemble the whole thing very easily. If you use this type of construction, have a "T" strip at each end of the interstage shield, one in the center of it, with the shield in two parts, and one at the panel. Mount these from the bottom with a tapped hole in the end of the T. Then you can lift the shielding right out, a section at a time if you want to work in the set. The sides can be fastened with one or two screws to the T strips at the ends of the shield. The back and sides could be bent out of one piece or built up with angles at the corners and the back fastened to the chassis with a couple of screws in the rear apron. A lid, hinged at the back, should be put on and may have a small knob fastened to it for convenience. Cut-outs must be made of course for the battery cable, the jacks and the antenna and ground posts."

"There's only one more thing you can

do for me, Gus. Come over and build it actually instead of verbally! But all joking aside—you haven't specified any particular method of band-spreading."

"Well—that's up to you, but I think I'd build the straight circuit, use the new National coils for the ham bands, and have the old coils in case you want to listen in the rest of the spectrum. You might want to listen to broadcast or airways stuff and the new style coils don't reach into that band. Suit yourself and your pocketbook though."

"That's a good idea, Gus; I'm going to do it. The order goes off tonight. Incidentally, are there any tricks to getting the set working properly?"

"Only the usual ones. You might have to change the grid leaks around a bit to get one that is the right value, but you'd have to do that anyway. Outside of that I can't think of anything out of the ordinary that would happen. Oh! yes. If there should be any difficulty in getting proper regeneration a capacity of .0005 mfd. instead of .00025 mfd. at C5 will do the trick.

## List of Parts for the Bennett Receiver

(of Figure 3)

- L1, L2, L3, National short wave coils. (Note: L3 is the slot winding. L1 is not used.)
- L4, L5, L6, National short wave coils. (Note: L6 is the slot winding.)
- C1, C2, National short wave tuning condensers type SE-90.
- C3, C5, .00025 mfd. Flechtheim Midget Condensers (Fixed).
- C4, .0001 mfd. Flechtheim Midget Condenser (Fixed).
- C6 to C12, .01 mfd. Flechtheim Midget Condensers (Fixed).
- C13, .5 mfd. Flechtheim Midget Condenser (Fixed).
- C14 to C20, .01 mfd. Flechtheim Midget Condensers (Fixed).
- CP, Yaxley 7 wire cable connector with plug.
- J1, BMS Fantail closed circuit jack.

(Continued on page 1024)

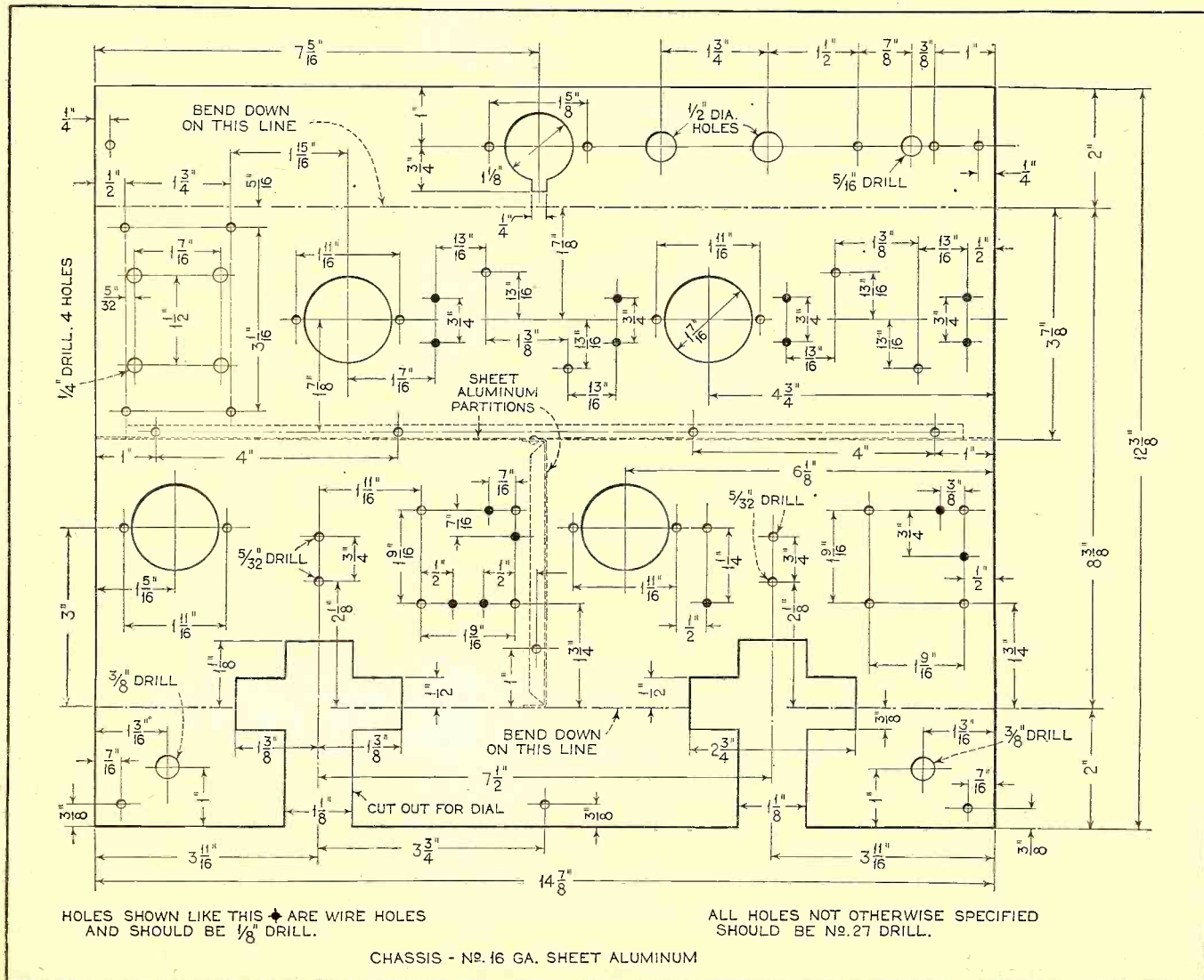

The complete drilling layout for the Bennett receiver

# SM

## From a Whisper to a Brass Band—Perfectly with S-M Sound Equipment

### A Tuner and a 50-Watt Amplifier

S-M 714 Superheterodyne tuner is the finest piece of radio equipment it is possible to build today. Hundreds of broadcasting stations are being logged consistently by 714 owners all over the country. There is no commercial receiver that can compete with it. It contains eleven tuned circuits—two in a dual pre-selector before the first r.f. tube. Ideal for PA installations. Tubes required: 4—'24, 2—'27. Size: 16½" long, 8½" high, 9½" deep.

The 714 Tuner, wired and tested, less tubes and ABC Supply \$87.50 List

674S Power Supply furnishes all A, B and C current for 714 and similar tuners. Should be used where amplifier with which tuner is to be used does not supply necessary current. Uses 1—'80 rectifying tube. Wired, tested and licensed. . . . . \$32.50 List

677B Amplifier was designed for use with 714 Tuner for home reproduction. . . . . \$82.50 List

PA-22A is a three-stage 50-watt power amplifier that uses any 105-120 volt, 50-60 cycle a.c. circuit as a power source. Curves from independent laboratories show a flat curve (within 4 d.b.) from 30 to 10,000 cycles, and ear tests prove an absolute fidelity of reproduction from bass drum to soprano voices. Most amplifiers cut off badly at 5,000 cycles and are poor for voice amplification.

The PA-22A has a universal input of from 0 to 100,000 ohms and is furnished with output impedance for both 200 and 500 ohm lines—can be supplied instead to match impedance of dynamic voice coils without additional cost.

The panel contains two on-off switches, one (with ruby pilot light) turns on the amplifier and one is for high or low line voltages. Jacks for checking plate currents of three audio stages, a meter with rheostat control for filaments of 845 tubes, and an adjustable hum control are also built into the front panel.

Necessary line impedance matching transformers and individual speaker volume controls can be furnished, on order, to use with the PA-22A. Size: 21" wide, 20" high, 12" deep. Tubes required: 2—866, 2—845, 1—245, 1—224, 1—280.

PA-22A, complete as described above, factory wired and tested, less tubes \$290.00 List

### Three Auditorium and Utility Amplifiers

692 is a 15-watt auditorium-type power amplifier with perfect fidelity of reproduction all the way from 30 to 10,000 cycles. The low-frequency end is exceptionally good and with good speakers the curve goes below 30 cycle range.

The 692 has a voltage amplification of 4000 (72 d.b.). Its input is "universal" and will operate directly out of 200-10,000 ohm pickups. The output is designed to operate into 3 to 125 ohm circuits, although it will operate into 900-7200 ohm circuits by using the primary of the output transformer as a choke. Size: 16½" long, 9¼" high, 11" deep. Tubes required: 1—'24, 1—'45, 2—'50, 2—'81. Wired, less tubes, \$245.00 List.

PA-32A is the single-stage "lower deck" of the PA-22A and is available for connecting to the output of standard

15-watt amplifiers like the S-M 692, to obtain 50 watts for larger outdoor installations. One or more PA-32A's can be used to parallel the output of the PA-22A to obtain 100 watts or more for airplane and similar installations. Tubes required: 2—866, 2—845.

PA-32A, 50-watt Single Stage Amplifier, complete less tubes. . . . . \$240.00 List

The PA-31A is a single-stage push-pull 250 auditorium-type power amplifier for doubling up with the 692 to obtain 30 watts output. Also is ideal to hook onto a Lofton-White amplifier (with single '45 tube in output) to deliver 15 watts, with very high gain for the combination. Tubes required: 2—'50, 2—'81.

Price, completely wired, less tubes. . . . . \$150.00 List

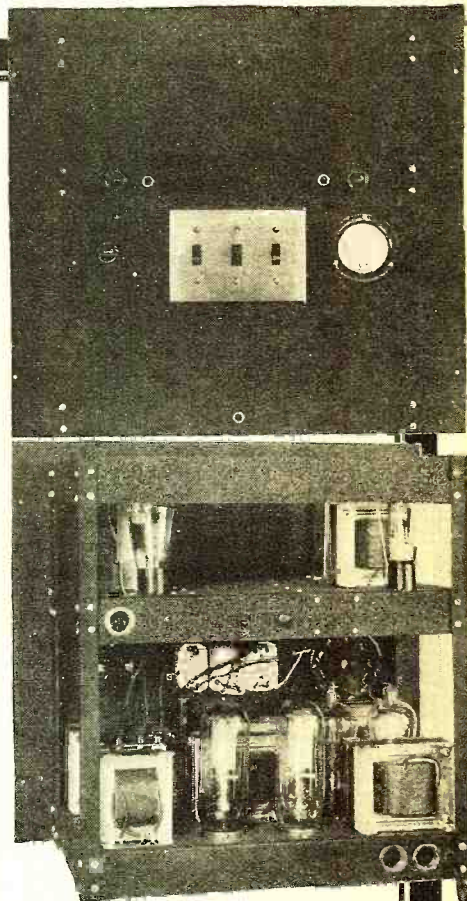

Front and rear views of PA-22A with rear shielding dust cover removed.

The Silver-Marshall Sound Department is at your service for planning sound systems. Send full particulars including blueprints to Chief Sound Engineer.

**SILVER-MARSHALL, Inc.**  
6405 West 65th Street • Chicago, U. S. A.

Silver-Marshall, Inc., 6405 W. 65th St., Chicago, U. S. A.  
 . . . . . Send me, free, your NEW 1931 CATALOG with sample copy of the RADIOBUILDER. Also Data Sheets as follows: (Enclose 2c for each Data Sheet desired.)  
 . . . . . No. 25. 714 Screen-Grid Superhet Tuner.  
 . . . . . No. 20. 677B Amplifier.  
 . . . . . No. 19. 692 Amplifier

Name \_\_\_\_\_  
 Address \_\_\_\_\_

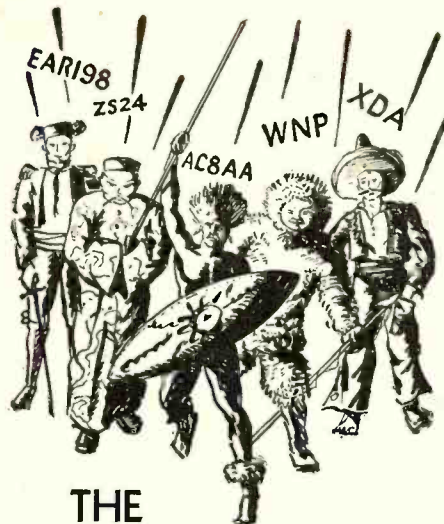

## THE CONQUEROR\*

### Brings Them All In!

\*Short-Wave and Broadcast Receiver, 14 to 600 Meters. A.C. or Battery Operated.

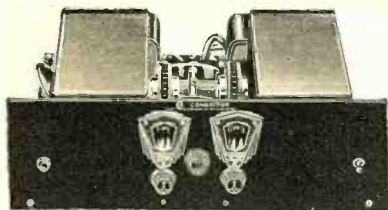

**WHAT** a job, this ICA Conqueror! It will bring you the stations you only wished for up to now. Performance is what counts in Radio and the Conqueror sure does perform!

No special tubes—just a 224 screen grid R.F., one 227 (A.C.) detector and two 227's and a 245 in the transformer—resistance—transformer audio.

The Kit is complete with the famous ICA Plug-in coils (14 to 157 meters) and by utilizing coils for the broadcast bands (up to 600 m.) you have a marvelous, all-purpose, receiver. We know that this kit cannot be surpassed at any price, surely it cannot be approached at a lower price.

See for yourself. Examine every part that goes into the Conqueror, then compare it with other sets. We will be glad to mail you more complete information upon request.

**List Price \$65.00**

Complete with S. W. Coils  
Power Pack—\$34.50

Price to dealers and pro set builders less 40%

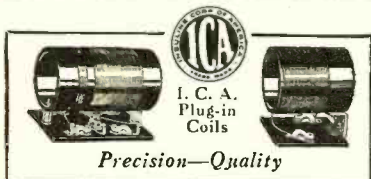

**INSULINE CORPORATION of AMERICA**  
78 CORTLANDT STREET NEW YORK CITY

## Producing a Radio Drama

(Continued from page 978)

Let us look in at the dress rehearsal of *Campus*. This is one of the half-hour sustaining features of NBC, written by Wade Arnold, that goes on every Saturday night from 9 to 9:30. C. L. Menser, who directs this hour and the RCA-Victor, is in the control room. The time is 7 o'clock on a Saturday evening. The players are in the studio, some walking about, others chatting in a little group. Ray Kelly, the genial young maestro of shouts and murmurs, is tinkering with one of his non-descript sound effects over in the corner.

At 7 o'clock Mr. Menser says, "All ready, children," into the mike placed before him on the table, and the rehearsal is on.

The story this week is of a college freshman who is meeting his girl friend at the railroad station. She is to be his guest at a frat dance.

For the next two hours Mr. Menser rehearses the show, stopping it for occasional suggestions of interpretation or

his headphone. Tiny green and white lights glow on the panel before him. "Thirty seconds."

Mr. Menser is in the studio with the actors. The noises in the studio die away. Mr. Menser, who also acts as announcer, steps around the kettle-drums and takes his place before the mike. He is watching the control room man. The atmosphere has become alert but not tense. In a moment comes the signal that they have the network. Mr. Menser begins his opening announcement.

And the cast gives a fine performance—an example of intelligent direction and the unflinching coordination that every radio dramatic script demands.

Speaking of rehearsals and sound effects reminds us of some rather amusing anecdotes. Getting the right sound is not always an easy matter. Sounds, like their less discriminating cousins, "noises," sometimes lurk in strange places. And, by the way, NBC makes all its own



A scene from "Harbor Lights," one of the outstanding NBC dramatic productions, written by Burr Cook and directed by Vernon Radcliffe

placing of the characters with reference to the mike. Then they take time out while Ray Kelly and his assistants experiment to get just the right sound for an automobile motor and a train approaching the station. The actors run through their lines again, this time with the sound effects. The bulky apparatus necessary for the train effect is placed in a small adjoining studio. Teamwork is required here, as Kelly has to "chug-chug" on a kettle-drum with a pair of wire brushes, blow a whistle and signal by nodding to his assistant in the other studio when the train is supposed to slow down and come to a stop.

Sometimes it is possible to run through the show completely just before the actual broadcasting, but, more often than not, there is only time to work on the hard spots. Six or seven musicians trail in at the last minute. They run through a couple of dance numbers. Several actors try a scene again to get just the right effect—fading their voices in or back, as the case may be. A taxi motor starts up. A train whistle blows. It is a minute before nine and everyone seems to be busy and quite oblivious to the hour.

The man at the control board adjusts

sounds—most of them come from Ray Kelly's perambulating factory. There are no phonograph records of trains, automobiles or chickens in a barnyard. The remarkable train effect used in the Empire Builders program is produced by elaborate apparatus mounted on the roof of the Chicago studios building.

Then there are simpler sounds but not necessarily easier to achieve. How would you reproduce the sound of a dog thumping his tail on the floor? Easy, you say? Well, the problem phased Ray Knight and several others recently. Mr. Knight, who is station KUKU's moving spirit, cogitated on the question and spurred his brain on to greater effort by tapping his head with a pencil. The control room man, hearing the sought-after "thump, thump," rushed out into the studio shouting, "Just what we want!"

Strange—but there are more Ripley-like occurrences than that in broadcast studios. For example, there is the sound that is not a sound. A stream of air directed through a hose vibrated the diaphragm of the mike and produces the sound of an airplane motor. Salt poured on cellophane or tissue paper sounds like

(Continued on page 1019)

## Producing a Radio Drama

(Continued from page 1018)

rain. Or, "When it rains it pours," as Wade Arnold of the publicity department remarked, neatly dodging our upper-cut with the machete.

One of the most amusing incidents that the boys at NBC recall occurred in one of the early rehearsals of a medieval mummer's play about Christmas. This was at one of the first rehearsals, without sound effects, in which the actors sang certain verses in chorus, begging the noble lords and ladies to thrown down money. To imitate the resulting sound of money falling, one of the actors—who "doubled" for the sound effects man, was accustomed to say, "chink-chink-chink-chink" at that particular point in the script. The following line, also in chorus, was "God Almighty, bless you all." When the show was on the air, the actor who had "doubled" for the sound effects man in the rehearsal burst forth with his "chink-chink-chink-chink" and everyone was so astounded that instead of the following chorus of "God Almighty, bless you all," only one man yelled "God-a-mighty" and, realizing that he was alone, clapped his hand over his mouth and did not say another word.

But to return to the radio drama and its interpretation. The medium of broadcasting is unique both from the standpoint of its mechanical possibilities and its artistic possibilities.

Take the Radio Guild hour, for example.

Each Friday afternoon, from four to five, this theatre of the air gives the listeners of more than forty stations an excellent play, admirably produced with as good cast as it is possible to assemble in New York. This network has an estimated audience of 8,000,000. Let us be conservative—more than that—let us be cautious and say that the audience is actually 2,000,000. A little arithmetic and we are confronted with the astounding fact that a Radio Guild play has a six years' run in one hour! Sounds absurd, doesn't it? It isn't, though, as you can readily find when you divide 2,000,000 by 1,000, which is the approximate seating capacity of a Broadway theatre.

A six years' run in one hour! A new medium. A new technique. A new theory of the drama. An invisible scene . . . just voices . . . sounds.

In short, the entire problem is new. One of the first to recognize the untold possibilities of the art and, in his work as a producer, to give us consistently fine radio dramas, is Vernon Radcliffe, director of the *Radio Guild* hour, *Real Folks* hour and *Harbor Lights*.

Vernon Radcliffe is sensitive to life. His undoubted achievement in the theatre of the air is due to that sensitivity, for without real feeling and understanding there can be no intelligent, convincing interpretation of the drama. It would be almost axiomatic to say that he is an idealist. His idealism, however, is but the driving force behind a thorough knowledge of the technique of dramatic production—a combination that has made for consistently fine performance.

(Continued on page 1020)

# TRUVOLT RESISTORS

ENAMELED WIRE

RESISTANCE WIRE WOUND ON ASBESTOS COVERING

ASBESTOS COVERING

CORE

## Save TIME WORRY and EXPENSE

U. S. Pat. 1676869 and Pats. Pend.

ADJUSTABLE SLIDING CLIP

TRUVOLT RESISTORS are "double-wound." The resistance wire is first wound around an asbestos-covered enameled copper core. This is then wound around a grooved fire-clay base. Only with this distinctive winding, patented by Electrad, can there be secured the greater air-cooling which has made TRUVOLT world-famous as the Perfect Performing Resistor.

**E**XPERIENCED radio designers know all of the "short-cuts" that may be taken in the selection of parts—but they don't dare "short-cut" on resistors.

Every function of modern radio receivers depends so much on the quality of the resistors used, it may be said truthfully that, "A radio can be no better than its resistors."

Radio experts in every corner of the civilized world have proved the dependability of Electrad Resistor design and workmanship. And they have proved that no other type of resistors offers so many worth while features as TRUVOLTS.

The free, open air-cooled winding of the resistance element—the adjustable sliding clips that may be removed or shifted for exact adjustment make TRUVOLT the handiest form of resistor for service work or the experimental laboratory.

TRUVOLTS are made in all usual resistance values and voltage ratings. Also 22 stock sizes of TRUVOLTS with handy knob-control adjustment.

Electrad manufactures a complete line of resistors and voltage controls for every radio and power supply requirement, including Television. Order from your dealer.

175 Varick St., New York, N.Y.

**ELECTRAD**

INCORPORATED

Mail Coupon for New Electrad Catalog  
 ELECTRAD, INC., Dept. RN5, 175 Varick Street,  
 New York, N. Y.  
 Enclosed 10c (stamps or coin) for new complete Electrad  
 Catalog. 36 pages of helpful Radio Information.  
 Name: \_\_\_\_\_  
 Address: \_\_\_\_\_

The WORLD'S GREATEST All-Wave SCREEN GRID SUPER

# ULTRADYNE

(This is the set that was described in the April issue, page 937)

**ULTRADYNE BOOKLET**

Send 25c for this booklet which tells how to construct and operate the Ultradyne Model L-32 Receiver. This booklet also contains life-size picture diagrams and layouts of the entire set; also life-size wiring diagram of the entire circuit showing every wire location and connection.

**ULTRADYNE KIT**

The kit contains 3 specially tested and matched Ultratrons with double compensating condensers in aluminum sealed cans, 1 special steel chassis drilled and pierced as per specifications, all ready for mounting, three rubber grommets and 4 coil mounting pillars and INSTRUCTION BOOKLET.

List Price ..... \$32.50

The model L-32 Ultradyne, with the Dynatron oscillator, works equally as well on short waves as it does on the broadcast band.

An Ultradyne receiver operating in New York City, easily tunes out WOR, Newark, and brings in WLW, Cincinnati, without a trace of interference. Likewise, WMAQ, Chicago, is brought in without interference from WEAF, New York; KGO, Oakland; KSL, Salt Lake City; KFJ, Los Angeles; KOA, Denver; XEN, Mexico City, to mention a few, have been logged regularly. Short wave stations from all over the world have been copied on the Ultradyne Receiver.

The Super-sensitive Plio Dynatron system of radio reception responds to weaker signals than the conventional method having far greater selectivity and providing tuning ease that is unmatched. Ultradyne performance is the envy of the radio industry.

Mr. H. W. Duley of Brooklyn, N. Y., reports he logged 74 stations in one night.

**LIST PRICE ..... \$32.50**  
**TRU RADIO CO., 1073 ATLANTIC AVE., BROOKLYN, N. Y.**

**Super**  **Akra-Ohm**  
Wire Wound  
**Resistors**

are carefully designed to insure an accuracy of one per cent and a constant permanency of calibration.

They afford an inexpensive means to build test equipment for the measurement of resistance voltage and current with accuracy, and are sold by us either singly or in kits for those who desire to build their own.

**Capacity Bridge**  
**Wheatstone Bridge**  
**Multi-range A.C. and D.C.**  
**Voltmeters**

We have prepared separate bulletins fully describing the construction and use of the above circuits. If you will write us which ones you are interested in, we will gladly send copies without any obligation on your part. Address Dept. D.



**JOBBER SERVICE DEALER**

We repair all makes power units, dynamic speakers, sets, etc. Try our service. We manufacture new condenser, choke and transformer replacement units for jobber—dealer. Repairs on all makes.

**MOE VERITAS METALLIZED RESISTORS**  
**2 Watt 30c (Any Resistance) 5 Watt 50c**

National distributors of the famous ACME Replacement Power and Audio Transformers—for all radios.

New merchandise—not surplus left over  
**MOE MFG. CO., MELROSE, MASS.**  
Largest Radio Repair Service in U. S. A.  
Write for Free Catalog

**A New Member of "QRQ" the Universal Family**

**ONLY \$5 COMPLETE** Including 3-ft. Cord

Just what the amateur and experimenter has been praying for. Genuine carbon single button microphone, 200 ohms resistance. Bronze case with suspension eyelet. Life-like voice reproduction. Built by microphone specialists! Only \$5 complete.



**UNIVERSAL Microphone Co. (LIMITED)**

1163 Hyde Park Blvd. ♦ INGLEWOOD, CALIF.  
Other models \$7.50, \$15, \$25, \$50, \$75. Also cables, plugs, transformers, mountings, etc. Get catalog.

**SERVICEMEN—DEALERS**

Just Out—Our Latest 1931 Catalog—Write for One

Latest Jensen D-8 D.C. Dynamic Speaker, with push-pull Transformer—2500 ohms. List, \$27.50. Special \$8.95

**S. HAMMER RADIO CO.**

140 Liberty St. New York City

**Producing a Radio Drama**

(Continued from page 1019)

Anyone who has met this man cannot fail to be impressed with the quality of the work he is doing and catch something of the fire of his enthusiasm for the radio drama.

Here is a man who says, "Radio can do everything that the legitimate stage and the movies do—and do it better."

Here is a man who says, "I believe that the average man is intelligent. I would rather play to an audience of farmers, miners, clerks, than an audience of sophisticates or the speakeasy crowd. The latter group, supposedly well versed in the drama, is so encrusted with a sense of its own importance that it cannot be reached by real drama."

Which thoughts we hasten to greet with three rousing cheers.

When one understands the purpose and

achievement of radio as a means of conveying drama to an audience the medium takes on a new significance. Radio is not just another way of presenting a play. It is more than that.

"Radio is a new, vital, personal medium," to quote Mr. Radcliffe again. "The visual sense in the theatre slows up the real drama, which is always a direct thing . . . psychic. For example, the ghost in *Hamlet*, which should motivate the entire play, is poor on the stage. In radio the ghost is intensely real and does motivate the drama.

"We are faced with a brand-new medium in which we can achieve the best drama because we are dealing with sound alone. The imagination of the listener—if he has any imagination at all—is more intuitive than the best scenery could possibly be in realizing the essential values that lie in the drama.

"The radio drama must be swift and, for the very reason that it is swift, what we do with sound effects, or pauses, may make or ruin a production. Spacing is terribly important. Unfortunately, there are numerous 'spirit exits' in radio. 'Well, goodbye,' says the character. Slam . . . goes the door at almost the same second. It must sound as if the actor flew through it. This matter of timing cannot be stressed too much. . . . It is often one of the imperfect—but always important—phases of dramatic production technique."

On the occasion of our talk with Mr. Radcliffe at NBC we had an opportunity to watch him work. All the phrases of "timing," "getting focus in each scene," "a dominant character," "sound perspective," "microphone technique," came to life. They are indispensable parts of the show.

We happened to be present at the three-hour rehearsal and the broadcast which followed Oscar Wilde's "The Importance of Being Earnest," which was given on the Radio Guild's hour. Mr. Radcliffe, who makes the adaptations of these plays, was in the control room following the script as the actors ran through their lines. There were not many corrections to be made. The actors were perhaps as fine a group as can be obtained in radio. Furthermore, they were accustomed to working together each week on this hour and consequently better able to give a coordinated interpretation. At the first rehearsals Mr. Radcliffe reads the script with the cast and discusses in detail its questions of characterization, reading, values to be stressed. At the dress rehearsal the actors are thinking more of effects, of sound perspective—sometimes called microphone technique.

As Mr. Radcliffe explained, "If they had the entire production toned up to the final pitch in this rehearsal they would not get the production right when they were on the air."

Three microphones were used. Mr. Radcliffe prefers the multiple-mike system of broadcasting for reasons of convenience. The mikes are adjusted to suit the height of the actors. Some directors

(Continued on page 1021)

**The NBC Producers**

*Joseph Bell* directs *Sherlock Holmes* and *Silver Flute*. Narrator on *Sherlock Holmes*, also acts on *Death Valley Days*.

*Frank Curran* directs the Nestlé program, and the *Radio Playbill*, which is his particular pet. It is a dramatic program on which hitherto unpublished material is used.

*Arthur Daly* directs *General Motors* and the *Rise of the Goldbergs*. Hopes to write some day.

*Paul Dumont* directs *Olds Company* and *Davey Tree*. Wrote and played a part in *Dutch Masters Minstrels*.

*Edwin Dunham* directs *Blackstone* and *Palmolive*. Plays the organ on *Silver Flute*, and has his own morning sustaining programs of *Hits and Bits* four mornings a week.

*William Hanley* directs *Niagara Hudson* and *Wayside Inn*. Writes continuity and is master of ceremonies on *Tetley Tea*. Supervisor of musical comedy group.

*Bennett Larson* directs *Fleischmann* and *Mobiloil*. Writes *Jolly Junketeer* and plays part of *Junket Dessert Man* on that program. Youngest production representative.

*Kenneth MacGregor* directs *Maxwell* and *Cities Service*. Was connected with *Floyd Gibbons' Literary Digest* broadcast for almost a year.

*C. L. Menser* directs *RCA-Victor* and the *Campus*. Also narrator on *RCA-Victor*.

*Vernon Radcliffe* directs *Radio Guild*, *Real Folks* and *Harbor Lights*. Acts on *Death Valley Days*.

*Gerald Stopp* directs *Moonshine* and *Honeysuckle* and *Careless Love*. Supervisor of the *Dramatic Group*.

*Madge Tucker* directs *Children's programs*. Plays and writes *Lady Next Door*. Originator of *NBC Children's Hour*.

*Edwin Whitney* directs *Music Appreciation Hour* and *Colliers*. Plays *Judge Whipple* and *Bill Perkins* on *Real Folks*, and *Captain Jimmy Norton* in *Harbor Lights*.

*John Wiggin* directs *Camel* and *Interwoven*. Composes music and is authority on modern dance idiom. Supervisor of musical group.

*Gregory Williamson* directs *Edna Wallace Hopper's programs* and *Chase and Sanborn*. Writes *Silver Flute*.

*Raymond Kelly* is sound effects technician. The sound effects division serves eighty-nine programs weekly.

## Producing a Radio Drama

(Continued from page 1020)

prefer the opposite system of studio pick-up—employing only one mike and working their actors at a considerable distance from it.

Regardless of the excellence of an actor's microphone technique in fading his voice in or fading it back from the mike, there are no two voices quite identical in carrying strength and quality. It is the job of the engineer in the control room to balance voices in a play to obtain the proper effect. The importance of monitoring cannot be overstated, in the opinion of Mr. Radcliffe, who warmly praised the work of Mr. Clements of the



And here is Phil Cook—radio's "one-man show." Have you ever wondered how he managed "exits" and "entrances"? The answer is "voice perspective" or microphone technique. We used to think that Phil raced around the studio to get certain effects of distance, but, like his characterizations, it's all in the voice and how he directs it while calmly sitting beside the mike

engineering staff of NBC, who has handled all of his Radio Guild productions.

A well written and well produced radio drama—one that is keyed intimately and sincerely—achieves the effect of "eaves-dropping" on life. This, in the final analysis, is the most it can achieve.

Today the cry is for better writing. In this opinion all the producers to whom we talked—Messrs. Rainey, Stopp, Menser and Radcliffe—concur.

Mr. Rainey was emphatic on this point. "It is always the writing that matters most in a radio play, and the greatest problem radio drama has today is to attract able writers," said Mr. Rainey. "It is axiomatic that playwriting is difficult. The comparatively few good plays written in a year is proof of this—we have novels and short stories galore, but only a handful of plays worth doing. A good playwright is a *rara avis*. A good radio dramatist is a *multa rara avis*. This is why so much time on the air is given to adaptations of stage plays and novels. But radio must develop its own writers—writers who realize that they must maintain a swift pace in their radio plays, who will say what they have to say,

(Continued on page 1022)

## It's Easy To Identify 1931 Tubes

### Look for Practical Quick Heaters

A radio set should start up in a few seconds. But are you willing to pay the usual price of short tube life and uncertain performance? De Forest engineers have eliminated the gamble by unique design:

1. Full-length cathode sleeve, minimizing hum and crackle. One-thirtieth usual hum level.
2. Notched insulator (patent applied for) reducing bulk yet retaining twin-hole insulator advantages.
3. Special hair-pin filament for neutralized A. C. field. Lower operating temperature than coiled type with freedom from brittleness.
4. Filament supported at twelve points. Cannot vibrate to cause microphonic noises. Cannot short circuit.

These and many other advanced features found in every type of fresh De Forest Audion, insure the 1931 performance of the 1931 radio sets.

*This is the third of a series of debunking messages dealing with 1931 radio tube features. Would you like the entire story at this time?*

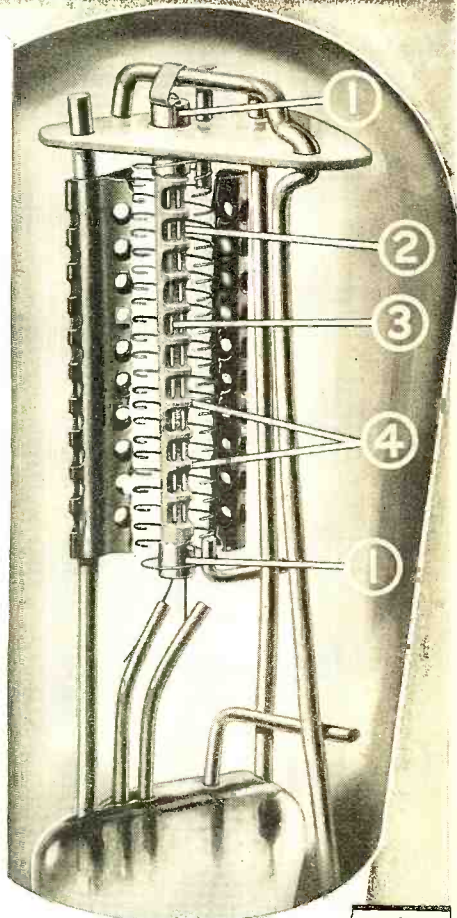

**de Forest**  
AUDIONS  
RADIO TUBES



DE FOREST RADIO CO., PASSAIC, N. J.



After all, there's no substitute for 25 years' experience



### BECOME A RADIO OPERATOR QUICKLY AT HOME BY CANDLER

SCIENTIFIC SOUND METHOD



*This Machine and 10 Special Tapes Furnished at Wholesale Price.*

We teach you CODE in less than half the usual time. We've taught thousands in past 20 years, including former champion McElroy, whose speed was 56 1/2 wpm. Our methods originated by world's foremost CODE SPECIALIST, who instructs you personally. Endorsed by officials and 45000 Morse and Radio operators. Take up this great profession where steady jobs and rapid promotions are assured. BIG demand for CANDLER trained operators. Make a start TO-DAY! Send for FREE Brochure. THE CANDLER SYSTEM CO., Dept. N-5 6343 So. Kedzie Ave., Chicago, Ill.

### RADIO OPERATORS WANTED



Radio operators are officers aboard ships. Well paid, pleasant work, travel. You can qualify in a short time in our well-equipped school under expert instructors.

Write now for free booklet on "Opportunities in Radio."

**West Side YMCA**  
Radio Institute

113 West 64th St., New York, N. Y.

Servicemen . . .  
Dealers . . .

**Introductory Offer  
of Varion  
ANTENNA FILTERS**

Regular Price \$2.50 Now

**ONLY \$1.00**

**New Field Open for Dealers and Servicemen!**

NOW we offer for the first time, the famous Varion Antenna Filter, which permits the use of any number of sets up to 40 from a single aerial. Particularly useful for apartment house hook-ups; large homes with more than one radio; hotels, etc. Install one good aerial and hook up all the sets to it, using the Varion Antenna Filter. For individual use the Varion Antenna Filter eliminates noisy low wave-lengths. Also lessens static noises on most of the other points of the dial. Can be mounted inside the receiver, if you wish. Clip and use the money-saving coupon today!



Made by the Manufacturers of Varion A and B Eliminators.

**Coupon Saves  
You \$1.50**

Varion Products Co., Inc.  
402 West Broadway, New York City

Gentlemen: I enclose \$1 for which please send me the Varion Antenna Filter. (Reg. Price \$2.50), and also send me literature and descriptive material.

Name .....

Address .....

Please send me literature on the Varion A and B Eliminator

**RACON PRODUCTS**

FOR SOUND REPRODUCTION!  
..... ARE UNSURPASSABLE!

Newest Storm-proof Horn



**TRUMPET HORN  
(Illustrated)**

Bell 22 inches round, length 40 inches. Equipped with cast aluminum ferrule and suspension ring. For Public Address and all Outdoor use. This horn has been perfected after years of exhaustive research in Racon Laboratories. Will withstand all weather conditions. Requires no replacements or servicing after heavy rainstorms. Guaranteed for one year. Prices slightly higher than regular horns.

Racon horns and units are covered by U. S. Patents Nos. 1,507,711, 1,501,032, 1,577,270, 73,217, 73,218, 1,722,448, 1,711,514, 1,781,489

Write for Catalog Containing Complete Line

**RACON ELECTRIC CO., INC.**

The largest horn speaker manufacturers in the world  
18 WASHINGTON PLACE, NEW YORK  
England and Canada

**Fascinating-Profitable  
LEARN TELEGRAPHY  
This Easy Way -**



Thomas A. Edison—Andrew Carnegie—most of the presidents of railroads and other world leaders got their start as Telegraphers.

Today—on land—sea—in the air, men who know the code are commanding big money—in the world's most fascinating profession.

Learn At Home with TELEPLEX—P. D. K.—the Master Teacher. Write for Folder C-2.

76 Cortlandt St., New York



**Teleplex**

**Producing a Radio Drama**

(Continued from page 1021)

briefly, who can make an asset out of the difficulty of invisibility and who can take advantage of the peculiar advantages radio offers—the appeal to the imagination, the freedom from the cumbersome mechanics of the theatre, the opportunity to use subtle effects that would be lost on the stage, and an intimacy impossible to achieve in any other medium. From such writers will come the radio drama of the future.”

One of these is undoubtedly Lawrence Holcomb, a member of the continuity department of NBC. In his “Skyscraper,” which was originally produced on the *Playbill Hour*, Mr. Holcomb has given radio one of the first outstanding scripts to be specially prepared for this interesting medium.

**“Skyscraper”**

We attended the dress rehearsal and broadcast of *Skyscraper* and found it so interesting that we believe it would be well worth while to present a brief outline of its plot in order to explain wherein a radio play of this caliber provides an indication of future development in dramatic writing and especially wherein it incorporates certain features that could not be handled effectively in any other medium, if at all.

*Skyscraper* is a triangle play. Two friends, *Lefty* and *Steve*, have been working for years as a riveting team. Steve is in love with *Dolly*, Lefty's wife. Lefty does not suspect this and believes that Steve is his best friend. While they are working on the thirtieth floor of a building, Steve purposely miststhrows a rivet to Lefty, causing him to lean out from his position on the girder to catch it in his bucket. The second throw is still worse and Lefty loses his balance and topples from the building.

It is at this point that Mr. Holcomb ingeniously makes use of his medium. We hear Lefty scream as he starts to fall. His voice fades into a pitiful groan. For a second there is only the whistle of air as his body hurtles downward, then supernatural voices come in, pounding out, “You're falling!” “You're going to die!” “You're falling!” “You're going to die!” “Thirty floors!” “You've only a second to live!” “You're falling!” “You're falling!” “You're going to die!”

By the last speech the voices have accelerated the hammer speed. Lefty calls, as if for help, “Mother! Mother!”

At this point a boy's voice—about that of an eight-year-old child—substitute's for Lefty's, and continues to call. Then the mother's voice comes in and there is a conversation between the two. This fades out with the supernatural voices, again repeating, “You're dying!” etc. Then another boy's voice fades in and there is a scene between the first boy and the new one in which one is trying to bully the other. This is substituted for a transitional second or two of the supernatural voices telling Lefty that he is “dropping,” “dropping,” “dropping,” and is immediately succeeded by the sound of continuous firing of heavy guns in the

great war. Through this scene, Lefty, whose mind has gone back to the time when he was a soldier, has a conversation with his war-time buddy.

Again the supernatural voices come in and are succeeded by flashes in which all of the characters participate—the mother, the two boys, Lefty, Steve, the foreman of the construction gang, Dolly—and in which the falling man's mind is dramatically portrayed.

Then the body strikes the pavement. The crowd closes in. A policeman's whistle blows. There are screams, excited shouts—and the whole scene fades out to a complete silence. After about a four-beat pause a door-bell is heard ringing. It is Steve, who has come back to see Dolly. He tells her that Lefty is dead. He pleads with her that he was trying to throw the rivets straight, that it was not his fault that Lefty fell. She will not talk to him and in just a few lines the play concludes on a most intensely dramatic note with Dolly demanding that Steve go. We hear the door slam as he leaves and Dolly sobbing softly to herself, “Lefty! Lefty!”

**The Radio Drama of  
the Future**

We have given this much of an idea of the script for the one reason that it presents so clearly the use that may be made of radio dramatic technique and clearly indicates some possibilities for future development. In the first place, the scene in which Lefty is falling to the ground is capable of production only in the medium of broadcasting and in that medium acquires an intensely swift and dramatic pitch. Obviously it could not be done at all on the legitimate stage or even in the talkies. Again, Mr. Holcomb has made an excellent use of pauses to separate his scenes. Incidental music is not employed in this script and it would certainly be out of place if it were.

The play received so much favorable comment that it was produced a second time—in the evening on a large network of the National Broadcasting Company.

When we say that *Skyscraper* indicates a possible trend in the development of the exclusive radio drama, we must hasten to point out that we do not mean that radio plays must be limited to such occurrences as people falling off a skyscraper, or something similar to that, which could not be mechanically reproduced in other media.

Obviously, a play of this kind is packed with problems for the producer. Any writing done especially for this new medium—such as this on the *Playbill Hour*, which is NBC's contribution to the development of the art in radio writing—is apt to be.

Although dramatic production technique and radio writing have not yet done more than establish the basic lines for future progress, it is indeed hopeful to note the spirit of intelligent experimentation which characterizes the vast majority of the NBC offerings.



## Gauging "Black Light"

(Continued from page 982)

using a resistor of 1000 megohms. For work in the laboratory, by substituting a galvanometer of the sensitivity of  $10^{-8}$  amps/mm, it is possible to measure as low levels of the ultra-violet as any engineer will ordinarily encounter.

It is necessary, of course, to exercise some care in assembling and operating such a circuit. All of the precautions against external leakage in the photo-cell and resistor circuit apply the same as in the use of a triode. If the cathode terminal of the cell is attached at the top (as in the case of the uranium cell used), it is advisable to wash the bulb surface with absolute alcohol to reduce surface leakage. The amplifier tube itself should be shielded electrostatically, and, if worked near alternating current, electromagnetic shielding should be provided as well.

The lead from the cathode of the photo-cell to the control grid should be very carefully insulated where it passes through the shield. For best results an amber tube or sulphur plug should be used, although for ordinary work a quartz tube will suffice. It is desirable that this and other leads passing into the shield be sealed in reasonably air tight, because when the relative humidity is high it may be necessary to put some drying agent, like calcium chloride, inside the shield to prevent leakage on the surface of the amplifier tube.

Freshly charged storage batteries make the best sources of potential for A, B and C supply, although dry cells may be used if the voltage is carefully checked.

Following is a list of the parts used for constructing this meter:

### Parts List for FP-54 Circuit

- 1 FP-54 pliotron
- 1 Westinghouse uranium photo cell in quartz or suitable ultra-violet transmitting glass
- 2 Eby cushion sockets.
- 1 aluminum shield,  $9\frac{1}{2}'' \times 6'' \times 4\frac{3}{4}''$
- 7 Eby binding posts
- 1  $6 \times 4\frac{3}{4} \times \frac{3}{8}''$  bakelite base.
- 1  $8 \times 1\frac{1}{2} \times 3/16''$  bakelite terminal strip
- 1 Aerovox plate resistor about 2000 ohms
- 1 Aerovox plate resistor mounting.
- 1 Aerovox grid resistor about 100 to 1000 megohms
- 1  $6'' \times 4\frac{3}{4}''$  aluminum shield
- 2  $4\frac{3}{4}''$  corner pieces
- 1 6-wire shielded battery cable.

To avoid moving the batteries around with the unit, while making measurements, a flexible shielded battery cable of any desired length may be attached to the amplifier so that the latter may be placed in whatever relation to the light source is convenient.

It is advisable to operate the tube for several minutes before readings are actually taken. The apparatus may be calibrated in absolute units of light intensity, for the wavelength range of the photo cell used, with a standard source of ultra-violet light. However, since many measurements consist of simply comparing one source with another, such a calibration may not be necessary.

# "SUPREME BY COMPARISON"

## SUPREME OSCILLATOR MODEL 70



THE Oscillator eagerly awaited by hundreds of engineers, dealers and servicemen knowing the Supreme standard—"Supreme by Comparison." Supreme Oscillator Model 70 sets a higher standard in Oscillator efficiency.

An Oscillator designed and calibrated for universal application for all intermediate and broadcast frequency requirements with multiple tuning of all frequencies between 100 and 1500 kilocycles; adaptable to all present commercial intermediate frequencies, as well as such frequencies between 100 and 550 kilocycles as may be designed into future radios, thereby greatly lessening the probabilities of obsolescence. A design in radical contrast to the earlier types which provide tuning at only one or two intermediate frequencies and which will become more or less obsolete, as new intermediate frequencies are chosen and announced by Super-Heterodyne manufacturers.

An Oscillator individually calibrated for an accuracy of  $\frac{1}{2}$  of 1 per cent. at all frequencies, provided with a switch for applying external 110-volt A.C. or D.C. power supply potentials for the filament, plate and grid circuits, or for applying the required potentials with batteries which may be included within the completely shielded Oscillator case of  $\frac{1}{8}$ -inch cast aluminum.

Only one Oscillator will satisfy the serviceman who prides himself on the highest type of equipment—Supreme Oscillator Model 70. Write for the complete, convincing narration of advantages.

### A COMBINATION OUTPUT-OHMMETER

An ingenious combination, providing a 4000-ohm constant impedance output meter of the rectifier type, and also calibrated as a high range ohmmeter for resistance measurements up to 1 megohm and will indicate circuit continuity of even higher resistance values. The attenuated output meter range is also useful for adjustments for minimum hum in A.C. radios, and for accurate neutralizing adjustments "by meter" instead of "by ear."

Carrying case of handsome hardwood for combined Oscillator, Output-Ohmmeter and Accessories provided at small extra cost.

### SELF-SATISFYING SELF-PAYMENT PLAN

Write for it! "Everything to Gain and Nothing to Lose."

### SUPREME INSTRUMENTS CORP.

401 Supreme Bldg., Greenwood, Miss.

Distributors in all Principal Cities

Service Depots in New York, Philadelphia, Pittsburgh, Chicago, Kansas City, Seattle, Toronto, San Francisco.

Foreign Division: 130 West 42nd St., New York City. Cable Address: LOPREH, New York.

Supreme Oscillator Model 70. Less Batteries and tube. Dealers' net price **\$49<sup>75</sup>**  
Supreme Output-Ohmmeter. Dealers' net price **\$30<sup>00</sup>**

F. O. B. Greenwood, Miss.

## SUPREME

Testing Instruments

"Supreme by Comparison"



**L CODE AT HOME**  
WITH AUTOMATIC ROMNIGRAPH

## RADIO AND TELEGRAPHY

NOW! On Land, Ships, and Air—Your Career Future is Secure. Know Code. The Auto-Omnigraph teaches you easily and quickly. Learn by Listening. Models \$15-\$40. Catalog Free.

THE OMNIGRAPH MFG. CO., 810 E. 39th St., N-12, Brooklyn, N. Y.

# TYPEWRITER

## NOW 1/2 PRICE

All Standard Makes Lowest Prices and easiest terms on World's best makes—Underwood, Remington, Royal, etc. Save over 1/2 Mfr's. original price. Your choice sent on 10 days FREE! EASIEST TERMS EVER OFFERED—PAY ONLY 12c A DAY. All standard size—late models. Fully Guaranteed. Also Portables at reduced prices. Send No Money—Big Free Catalog fully describing and showing actual photographs of each beautiful machine in full colors tells of our refinishing methods making each machine like new. Also tells of our direct-to-you savings and easy-payment plan. Lowest Prices now offered. Send for Free Catalog at once, also 10 day trial offer. No obligation. INTERNATIONAL TYPEWRITER EXCHANGE 231 W. Monroe St. Department 593 Chicago



## BE A Traffic Manager

Big Pay—Big Opportunity

Big business needs trained traffic men and pays them well. Train in your spare time for this highly profitable, growing profession. Low cost; easy terms.

Write now for valuable, interesting 64-page book—FREE.

LASALLE EXTENSION UNIVERSITY  
Dept. 594-T, Chicago

# DUBILIER

Inverted

## Hi-Mike Condenser



For sub-panel wiring, Dubilier engineers have developed the Dubilier Inverted Hi-Mike Condenser as a fitting companion for the standard type, with the same general characteristics.

Aluminum can  $4\frac{1}{2}$  by  $1\frac{3}{8}$  inches, interchangeable with usual units. 8 mfd. capacity with highest effective capacity. Working voltage of 400; peak of 430; capable of withstanding 500. Fastest self-healing. Lowest leakage—approximately 0.2 milliamperes at 430 volts after 100 hours. Lowest power factor—less than 10 per cent. Life expectancy in excess of usual radio assembly. Compact, clean, non-spillable, efficient, inexpensive, reliable.

WRITE for data regarding Dubilier Hi-Mike Condenser as well as complete line of Dubilier products.

# DUBILIER

Condenser Corporation

4377 Bronx Blvd.

New York City

**DOES THE WORK OF A HIGH PRICED IRON**

The ideal electric soldering iron for the radio worker. Heats quickly and stays hot. Long tapered copper tip gets into the hard-to-reach places. The "little brother" of Esico Industrial irons, used by leading radio factories and the U. S. Navy. Highest grade nickel chrome heating element; 85 watt. Heat insulated handle, dark mahogany. Weighs only 1 lb. Length  $12\frac{3}{4}$  in. Plugs in on any current; 6 ft. cord. Complete, \$2.75. Sent direct if your dealer can't supply you.

**ELECTRIC SOLDERING IRON CO., INC.**  
135 W. 17th St., New York, N. Y.

**ESICO "Junior"**  
REG. U.S. PAT. OFF.

### An Extension Loud Speaker Attached To Your Set in a Jiffy

Connect additional loud speakers, either magnetic or dynamic, to your radio set without rewiring or making any soldering connections. Our special protective device makes this unit absolutely safe. It does not endanger the radio in any manner. You can use our Extension-Speaker Coupler on all radios using two power tubes. Merely insert the coupler under the tubes and have an extra loud speaker in your kitchen, bedroom or anywhere else in your house.

Price \$2.50

Ditmas Electrical Co.  
1340 Nostrand Ave.  
Brooklyn, N. Y.

Mail coupon today

Please send me one Ditmas Extension-Speaker Coupler. Enclosed is \$2.50.

Name .....  
Address ..... City .....

# Direct Reading Ohmmeter

(Continued from page 1010)

The scales in Figures 3 and 4 are calibrated for the 1500 ohm-1.5 volt combination, but the other voltage-resistance combinations may still be used to provide a higher range by multiplying by the factors given in the last column of Figure 2.

If an ohmmeter of smaller range is desired and which will permit more accurate readings of low resistance it can be obtained by using a milliammeter with a greater range such as 0-10 milliamperes. The calibration scales in Figures 3 and 4 may still be used by dividing all resistance values by 10 (for an 0-10 meter). The calibrating resistor for use with a meter of this range and a 1.5 volt battery should be 150 ohms.

Before leaving the subject the necessity for using precision type resistors for the "calibrating resistances" should be stressed. If ordinary resistors manufactured to a tolerance of plus or minus 10% are employed the calibration will be thrown off accordingly. For this and all other similar purposes resistors of the

precision type and guaranteed to be within 1% of rated value are the only safe kind to use.

## Quartz Crystals— 35c Each

(Continued from page 1011)

- on a 1" diameter tube.
- 7000 Kc. L1—6 turns of  $\frac{1}{4}$ " copper tubing on a  $2\frac{1}{2}$ " diameter.
- L2—20 turns of No. 28 wire on a 1" diameter tube.
- 14000 Kc. L1—3 turns of  $\frac{1}{4}$ " copper tubing on a  $2\frac{1}{2}$ " diameter.
- L2—10 turns of No. 28 wire on a 1" diameter tube.

If you would like to hear an example of this unique method of crystal control, listen in on the 80 meter band, to either W1II, W1ZS or to W1AAD, and see if you don't agree that such a rig goes a long way toward helping matters in the amateur frequencies.

# The Junior Transmitter

(Continued from page 1016)

- J2, BMS Fantail open circuit jack.
- RFC1 to RFC6, National receiving type radio frequency chokes.
- R1, R2, 5 megohm Lynch grid leaks.
- 2 Screen grid clips.
- 2 National tube shields.
- Miscellaneous, 6-32 machine screws  $\frac{1}{4}$ " and  $\frac{1}{2}$ " long.

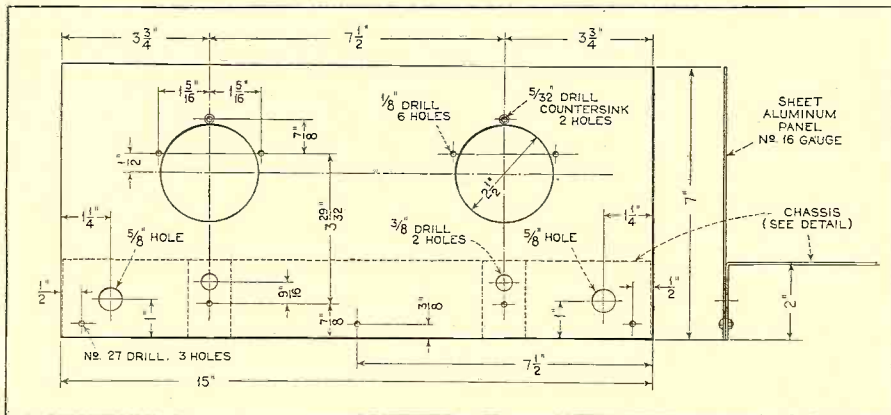

The drilling specifications for the front panel

- R3, 10 ohm rheostat with DPST switch.
- R4, 50,000 ohm Centralab potentiometer.
- R5, 20,000 ohm Lynch fixed resistor.
- SW, See R3.
- T1, National S-101 Impedaformer.
- T2, General Radio audio transformer.
- T3, General Radio output transformer.
- TS, Eby Antenna-Ground binding post block.
- VT1 VT2, VT3, VT4, Eby UX type tube sockets.

### Unkeyed Parts

- 2 Special six prong National coil sockets.
- 2 National VEC Dials.
- Blan Aluminum cabinet and shields.

### Correction

In Mr. Bennett's article in the March issue, pages 783, 784 and 785, there were two errors. In the diagrams Figures 2A, 2B, 3, 4 and 4A the grids and plates of the tubes were reversed. This error was so obvious it is hardly probable that any readers were misled. The other error was in stating Windom's formula for computing the radiator length for a transmitting antenna to operate at a given wavelength. The figure 2.07 credited to Windom (bottom, right-hand column, page 783) is actually the factor he employs for converting radiator length in meters to wavelength in meters. The factors credited to Schnell and Lamb were correctly given, as 1.56 and 1.57 respectively.

## Testing Power Transformers

(Continued from page 989)

of core leg A will cause a deflection of the vacuum-tube voltmeter. If the wire is brought flush with the top of the core, a 0-01 ma. meter is driven off scale. Figure 1 shows the circuit of the apparatus. If the two balancer coils have the same constants and the magnetic paths from the exciter through each of them has the same reluctance, then the voltage induced in balancer coil A will be equal to and 180 degrees out of phase with that induced in coil B and no potential difference will exist across A B.

The coil to be tested is slipped over core leg A. If it is perfect, there is no deflection of the vacuum-tube voltmeter. However, if there is a shorted turn present, the induced current will generate flux which by Lenz's law is 180 degrees out of phase with the flux causing it. If it were not for the leakage flux all of this counter flux would thread back through the primary, lowering its counter e.m.f. and thereby increasing its current just enough to offset this counter flux. The net result then would be that the flux through core leg A remains constant. However, because of the high reluctance of the path between the primary (the exciter coil) and secondary (the shorted turn), all of the counter flux set up by the shorted turn which threads coil A does not thread back through the primary. Considerable of it goes through the shunt air path. The primary current is not increased sufficiently to offset it and there is a resultant decrease in the flux through leg A. The net voltage induced in balancer coil A is reduced, and a voltage is generated across A B. This voltage is amplified and causes a deflection of the vacuum-tube voltmeter, thus giving the operator visual evidence of the presence of shorted turns.

The deflection is proportional to the current flowing in the shorted turn. If the contact resistance is appreciable, it limits the current. For this reason the exciter coil should have about one-third as many turns as has the transformer coil primary. The induced voltage will then be sufficient to break down contact resistance and give positive indication of a shorted turn.

The two balancer coils should have as many turns of wire as possible in order that a small change of flux due to a shorted turn will cause a large voltage difference between them. Sensitivity is further increased by an increase in frequency of the exciter voltage. The reason for this is rather interesting. If the shorted turns are few in number, the resistance component of their impedance will be large in comparison with the reactance component. The current then will be fairly independent of frequency. Since the flux is proportional to the number of turns and the current flowing through them, the flux they generate is independent of frequency. The voltage induced in balancer coil A by shorted turns is a function of the number of maxwells which thread it (but do not thread the exciter coil) and of the frequency, from the well-known equation,  $E =$

(Continued on page 1027)

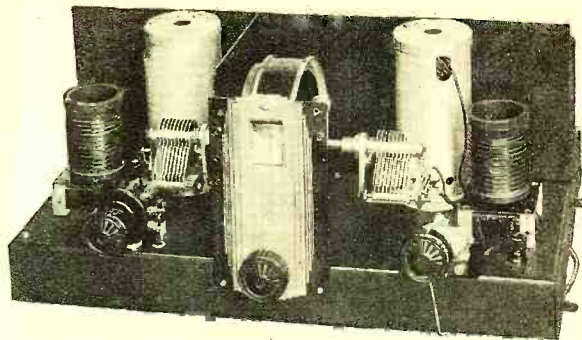

## TRUE SINGLE-CONTROL ON THE SHORT WAVES

No two-knob tuning grief with this modern single-control short wave receiver! By the use of the NATIONAL SE100 Tuning Condenser specially designed for short wave work only, coils that keep their original electrical constants, and the Volver Vernier Projection Dial, and because of other special designs, ganging and single control is a reality in the THRILL-BOX.

Note: New Band-Spreading Coils are now available which spread the 20 and 40 Meter Amateur Bands over 50 Divisions.

Just another reason for the outstanding superiority of the NATIONAL SW5 THRILL-BOX. (Send 50c in stamps or coin for new 64-page Short Wave Handbook, giving details of all modern S.W. circuits. Bulletin No. 143 is free.)



# NATIONAL

## A.C. SW5 THRILL-BOX

NATIONAL CO. INC., 61 SHERMAN STREET, MALDEN, MASS.

# Yes!

THERE IS SOMETHING NEW IN RADIO

NOW YOU CAN VASTLY IMPROVE TONE AND DISTANCE

ADJUSTABLE

## Level Glides

RUBBERIZED

AMAZING NEW IDEA! SUSPENDED-IN-AIR effect on your radio. No more vibrations. Adjustable for uneven floors. You get ALL the program instead of part of it.

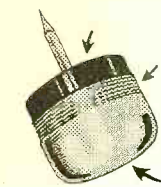

Patent Pending

Simply attach to legs of radio. The rubber vacuum cup, guaranteed for twelve years, is imbedded in the threaded band which fits threaded cap of .035 High Carbon Steel to allow desired adjustment. (Variation over one-half inch.)

Your set rests on resilient rubber. Tone improvement is marvelous. Tubes last longer. Set becomes "quieter". The heaviest radio moved with ease. EVERY RADIO NEEDS A SET OF "LEVEL-GLIDES" TODAY—NOW!

A MONEY-MAKER FOR EVERY RADIO DEALER AND SERVICE MAN

We desire retail representatives. Largest New York stores now selling LEVEL-GLIDES. Send 75c for trial set of four and learn about our special dealer sales plan. Radio owners buy on sight. Big sales opportunity.

STANDARD CUSHION COMPANY  
P. O. Box 753, Bridgeport, Conn.

## LEARN RADIO this easy, practical way

WRITTEN by two widely known radio engineers, these three books cover every phase of building, repairing and "trouble-shooting" on modern receiving sets.

### Radio Construction Library

This practical Library includes: PRACTICAL RADIO—The fundamental principles of radio, presented in an understandable manner. Illustrated with working diagrams. PRACTICAL RADIO CONSTRUCTION AND REPAIR—Methods of locating trouble and reception faults and making workmanlike repairs. Discusses modern Short Wave Receivers fully. RADIO RECEIVING TUBES—Principles underlying the operation of all vacuum tubes and their use in reception, remote control and precision measurements.

The Library is up-to-the-minute in every respect and is based on the very latest developments in the design and manufacture of equipment.

Three Volumes, 6 x 9—993 pages, 561 illustrations.

See this Library FREE!

No Money Down

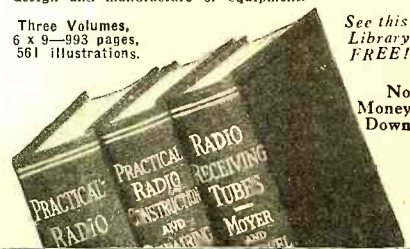

## FREE EXAMINATION COUPON

McGraw-Hill Book Company, Inc., 370 Seventh Avenue, New York

Send me the new RADIO CONSTRUCTION LIBRARY, three volumes, for 10 days' free examination. If satisfactory I will send \$1.50 in ten days, and \$2.00 a month until \$7.50 has been paid. If not wanted I will return the books.

Name .....

Home Address .....

City and State .....

Position .....

Name of Company.....RN-5-31

# The "Explorer" SHORT WAVE PLUGLESS POWER CONVERTER

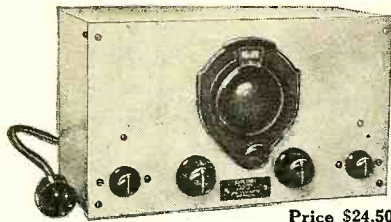

Price \$24.50

A sensational advance in short wave reception

## NO PLUG-IN COILS POWER RECEPTION

**AUTOMATIC BAND SELECTION!** Wave-length range 15 to 160 meters; automatic band selector changes wave-length bands in less than a second by turning a small knob on the panel—an original EXPLORER achievement.

The EXPLORER itself uses two tubes, greatly amplifying distant signals. Used with your broadcast receiver, it makes possible reception of stations all over the world with real loud-speaker volume.

With the EXPLORER you can obtain the best possible short wave reception at the lowest cost. Built on new principles of short wave design, it is full-sized, thoroughly shielded, and enclosed in a beautiful satin-finish aluminum cabinet.

A special vernier tuning condenser permits ease of tuning like a broadcast receiver's. Single dial tuning; and the regeneration control does not affect tuning. Results obtained are unsurpassed by expensive short wave receivers, and the elimination of plug-in coils makes the EXPLORER the most convenient of all short wave receiving apparatus.

Price \$24.50. Models for every receiver, including superheterodynes. Order now! Sent C. O. D. on receipt of \$2 or prepaid on receipt of price in full. Foreign, price \$25.50, remit in full with order.

Send for Free Literature  
**RIM RADIO MFG. CO.**

695 GRAND STREET BROOKLYN, N. Y., U.S.A.

## RADIO TUBE INSURANCE THAT PAYS

By automatically regulating line voltage fluctuations, up and down, to exact requirements between 100 and 140 volts—

AMPERITE saves tubes, prevents overloading, improves tone and reduces set up-keep. Pays for itself over and over. A type for every set, including "midgets." Installed in five minutes without chassis changes. \$3.00 at your dealers.

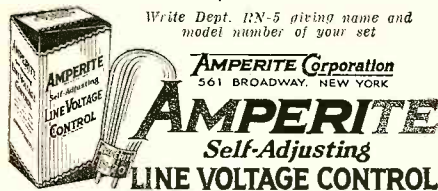
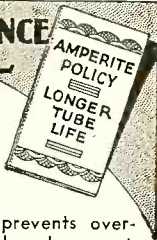

Write Dept. RN-5 giving name and model number of your set

AMPERITE Corporation  
561 BROADWAY, NEW YORK

**AMPERITE**  
Self-Adjusting  
LINE VOLTAGE CONTROL

## SHORT WAVE TONE

Here is a new kink for the S. W. enthusiast. Cut out background noises and mushy tone with the Clarostat Tone Control panel mounting type.

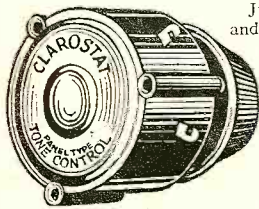

Just drill one hole and run two wires to audio transformer—that's all.

Regularly supplied without wire or adapters, \$1.80

Extra for pair of adapters and flexible wire, .50.

CLAROSTAT MFG. CO., Inc.  
285 N. 6th St., Brooklyn, N. Y.

# Do the Planets Affect Radio?

(Continued from page 970)

but so enormously larger that the whole earthly globe would be tossed around, if it fell into a sunspot, like a sparrow in a tornado. And a distinguished Norwegian mathematician and weather expert, Dr. V. Bjerknes, has formulated a widely accepted theory which regards sunspots



The author measuring intensity of U. V. radiation from the sun with the Beck portable spectroscope. This radiation varies with the sunspots

came interested in the possible existence, then asserted by some astronomers, of an unknown planet in the solar system, not outside the others where Pluto was discovered recently, but inside the rest, between Mercury and the sun. Mysterious black dots had been seen a time or two crossing the sun's face. Probably these were mere meteorites or even high-flying birds which astronomers chanced to catch in their telescopes when watching the sun. Occasionally someone still sees a dot like this but astronomers no longer take them very seriously.

Herr Schwabe was less certain. To see whether he could identify such a planet if it did appear he began to count every few days the number of sunspots. Seventeen years later, in 1843, he announced that he had found this sunspot number to vary from year to year in what seemed to be a regular cycle. As happens so often with important discoveries if they are really extraordinary, nobody believed him. It was not until the great Baron von Humboldt, whose lightest word was law to the scientific world, so vast was his authority, accepted Schwabe's results and called attention to them that the obscure and patient genius who had counted sunspots for a quarter century and had discovered their cycle got the recognition which was his due.

Thanks to the painstaking counts now kept unremittingly by more than a dozen observatories in all parts of the world, the year by year variations of sunspot numbers are now well known. A late student of the subject, Mr. William A. Luby, concluded that the average length of the cycle from one year of maximum sunspots to the next similar maximum is about 11.3

merely as the visible ends of far greater, tube-like whirls existing in the sun's deeper layers.

Such disturbances in the sun undoubtedly would stir its surface and probably would affect the radiation of light and of the ultra-violet rays; which is just what we observe that times of many sunspots bring about, for when the sun is much spotted its general surface seems to be hotter than usual. More heat, light and ultra-violet radiation are sent out. It would not be surprising, either, if relatively tiny forces like the attractions of distant planets affected these things, for such great whirling vortices as Dr. Bjerknes suspects to be the causes of sunspots usually are very delicately balanced and might be swayed or even destroyed by very slight disturbing forces, as the hand of a child can swing the famous Balanced Rock.

Professor Alter's theory is that the gravitational attractions of the planets actually do this, that tidal pulls from Mercury, Venus, the Earth or Jupiter, small as these are when compared with the vast mass of the sun, nevertheless are large enough to alter the shapes or course of the vortices imagined to exist in the sun and to be responsible alike for sunspots and for the effects on earthly radio.

The proof of any theory is to test it by unmistakable facts, and there is at least one set of facts which strongly support this tidal idea of the cause of sunspots. These are the facts about the now well-known sunspot cycle.

Over a century ago, in 1826, a German astronomer, Herr Heinrich Schwabe, be-

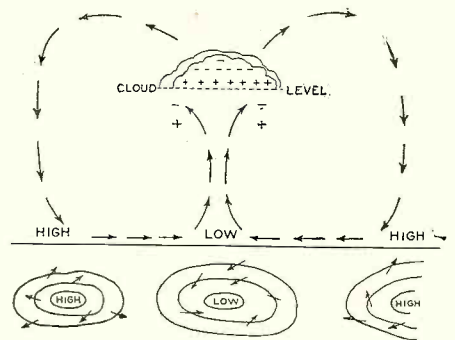

Formation of a thunderstorm is analogous to the formation of a sunspot. Note the vertical whirls about "High" and "Low" pressure areas

years. This figure is important to the new theory of planetary influences, as is also the fact that the cycle is not exactly 11.3 years but varies considerably in length from one sunspot period to another. During the two centuries or so, for which there are reasonably good records, there have been occasions, Mr. Luby records, when the time between sunspot maxima was as short as eight on nine years and other times when it was as long as fifteen years. A careful Italian student of the

(Continued on page 1027)

## Do the Planets Affect Radio?

(Continued from page 1026)

same records, Dr. Luigi Taffara of the Astrophysical Observatory at Catania, has come to similar conclusions.

The period of 11.3 years is only an arithmetical average but it is a striking one since it is very close to the time which the greatest of the planets, Jupiter, needs for one orbital revolution around the sun, the so-called Jovian "year." This time, according to the latest astronomical calculations, is 11.862 years; a correspondence so close as to be certainly a curious coincidence if it is no more.

The radio "astrologers" maintain, however, that it is more; that it indicates a real influence of the rotation of Jupiter around the sun on the sun's surface and thence on sunspots and on earthly radio. The very variability of the sunspot cycle and the fact that it does not correspond precisely with Jupiter's year reinforce this idea, for the tidal effect of the planets on the sun, while largest from Jupiter, because that planet has by far the largest mass, is complicated by the attractions of other planets also, especially of those much nearer the sun like Mercury and Venus.

The relative tide-raising forces on the sun have been calculated by Miss Hazel Marie Losh of Mount Wilson Observatory, who found that of Jupiter the greatest, with an effect 2.3 times that of the earth; that of Venus next with an effect of 2.2 times larger, and Mercury next with 1.2 times the earth's effect. Tidal forces of all other planets except the earth were found to be negligible.

Each of these planets traverses its path about the sun at its own speed and in its own time. That is why the planets occupy each according to its own rule the successive parts of the sky identified in ancient times by the signs of the zodiac. The directions from which the forces of the different planets are exerted on the sun vary similarly. At rare intervals all of the four planets important for tidal pulls may be on one side of the sun and almost in a straight line. At other times they will be scattered widely. On still other occasions the two main forces, those of Jupiter and Venus, may be directly opposed.

It must be expected, say the radio "astrologers," that these variations will obscure and modify the simple tidal variation due to Jupiter's movement around the sun so that the approximate eleven-year cycle will be now longer, now shorter. Sometimes the planetary gravitations will reinforce each other so that the sunspot maxima may be higher. Other years of maxima may encounter opposing planetary forces so that the expected number of sunspots is not produced. In a recent statement Professor Alter expressed the belief that the numbers of sunspots and their effects on radio and other earthly affairs must be followed week by week for at least fifteen years longer, until Jupiter has more than completed another circuit of the sun, before the truth or falsity of these theories can be decided.

Meanwhile there is another theory, scarcely a rival but a possible alternative, as to the mechanism by which planetary motions affect the sun, the sunspots and radio. It was first stated, I believe, by Professor Fernando Sanford of Stanford University, California. It assumes that the attractions, acting between the planets and the sun to produce sunspots, are not gravitational but electric. It is a variant of this theory which Professor Stetson uses to explain his fifteen-month cycle of both sunspots and radio effects ascribed to the electric forces of Mercury and Venus.

For Professor Sanford this idea of electric attractions extends to all of the planets. Jupiter and the earth would be almost as effective as Mercury and Venus. The effects of the electric attractions would interact with each other just as is imagined for the tidal pulls due to gravitation. This electric theory would require that all of the planets, the earth included, carry large electric charges, but since we know the potential of the earth merely as that assumed zero value which we call the "ground" we have no way of knowing whether this is the same as the potential of the sun or thousands of volts higher or lower.

Whether it be gravitation or electric attraction that is the effective force, there now seems little doubt that planetary forces of some kind are acting on the sun, have something to do with the cycle of sunspots and affect the corresponding radio cycle on earth. The last maximum of the sunspot cycle was due in 1927. As has happened before, it proved to be a broad, double maximum, with the numbers of sunspots high in 1927, a little lower in 1928 and high again in 1929. Since 1929 sunspots have been decreasing. Most of the experts expect this decrease to continue to a minimum somewhere about 1933.

Few sunspots mean a quiet sun and, in general, good radio conditions on earth with relatively easy transmission and a minimum of static. The best prediction of the radio "astrologers" for the rest of 1931 is that static will be below the average of the past few years and that reception will average better. This improvement should continue for about two more years.

## Power Transformers

(Continued from page 1025)

$4.44fN\phi \max 10^{-8}$ . Since the flux is constant, as just shown, the voltage induced in balancer coil A will increase with frequency.

The distributed capacity of the coil limits the frequency which may be used, since any current flowing through the coil under test due to capacity sets up counter flux just as shorted turns do. It seems that current having a frequency of 500 cycles is near the upper frequency limit with the average power transformer coil.

## SIX RANGE VOLT-OHMMETER

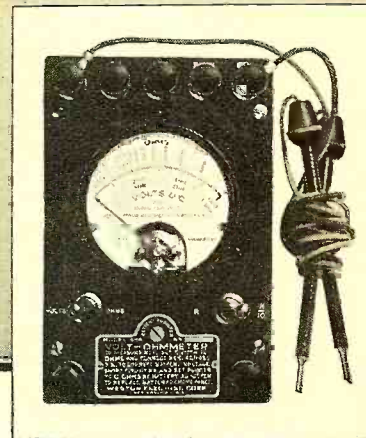

### WESTON MODEL - 564 -

*Checks voltages, resistances  
and continuity of circuits*

**A**LTHOUGH relatively new, Weston model 564 Portable D.C. Volt-ohmmeter has been bought by thousands of radio service men, transmitting amateurs and radio laboratory technicians. It has proved invaluable for checking continuity of circuits, resistances, chokes, speaker coils, primary and secondary transformer windings, etc., and filament, plate and grid voltages. It is an unusually handy, compact, serviceable instrument, completely self-contained.

Model 564 has six ranges of 3/30/300/600 volts (1,000 ohms per volt) and 0-10,000/0-100,000 ohms. Two toggle switches permit quick and easy change-over from voltmeter to ohmmeter and selection of low or high resistance range. Voltage ranges are selected by connecting test prods to correct binding posts as indicated on the instrument. New style test prods, with specially designed replaceable tips and 50" cables are supplied with each model 564.

Size (excluding binding posts): 5½" x 3¾" x 2½".  
Weight (including self-contained "C" battery): 2.3 pounds.

*Write for Circular HH*

**WESTON ELECTRICAL  
INSTRUMENT CORP.**

615 Frelinghuysen Avenue  
Newark, N. J.

# EXCELLO RADIO



## MIDGET

Quadruple Screen Grid  
with Tone Control

An ideal set that will meet the most exacting conditions and has every modern feature to insure fine performance.

Complete catalog free on request

EXCELLO  
Products Corporation

4832 West 16th Street, Cicero, Illinois

Readrite AEROVOX Faradon Webster de Forest

**EXTRA**  **EXTRA**

**American**  
SALES COMPANY

19-21 Waverly Street NEW YORK CITY

RADIO & ELECTRICAL WHOLE-  
SALE BARGAIN BULLETIN  
NO. 67

**Experimenters! Servicemen!**  
**!! NOW READY !!**

New 96-page Wholesale  
Catalog No. 67 full of real  
low prices on: Condens-  
ers, Transformers, Speak-  
ers, and other numerous  
items including replace-  
ment parts.

**GET COPY NOW**

Craybar KOLSTER SUPRA-AUTOMATIC  
WESTERN ELECTRIC POWERIZER FLECHTHEIM  
JOSWELL

**American Sales Company**  
N-44 West 18th St., N. Y. C.

## ACME WIRE PRODUCTS

Parvult Filter and By-Pass Con-  
densers—All insulations, Aerial  
Wire—Stranded and Solid,  
Varnished Insulations,  
Coils.

**THE ACME WIRE CO.**  
NEW HAVEN, CONN.

## The Boston Television Party

(Continued from page 988)

sons interested in television reception will be able to see and hear what may be expected from a television installation of this type before they buy the receiver or the parts necessary to construct it.

### Commercial Outfits

The fact that the parts necessary to build the complete outfit are now available of these Kresge stores, would seem to be proof enough that this particular receiver has been brought to a really practical level for the experimenter or person who wishes to make a start in this field, either for his own amusement or with the idea of possibly improving the system.

The Shortwave and Television kit makes it possible for any handy experimenter to build a practical shortwave and television receiver for less than \$125.00, exclusive of cabinet and tubes.

For those who do not care to bother with the construction of such an outfit, the Shortwave and Television Corporation is manufacturing a factory-built receiver of high sensitivity, consisting of two stages of screen grid radio-frequency amplification, a screen grid detector and three stages of resistance coupled audio frequency amplification feeding into a 245 power stage. The loudspeaker and neon tube are connected in the output of the 245 power tube. The entire installation, consisting of the receiver and the television unit, takes up a space no larger than a standard radio console.

A very important feature of the receiving equipment designed by Mr. Baird is the fact that the receiver itself both in the commercial factory-built model and in the kit consists of two distinct units, the receiver used to bring in the signals and the television unit which translates the signals into an image.

Less than \$50.00 of the total cost of the installation can be attributed to the television unit, so that this cost can be considered as the investment in the television feature.

### A.C. Operation

The whole unit operates direct from the a.c. lighting outlet and requires no batteries of any kind.

The circuit of the kit for the home-builder consists of one stage of screen grid radio frequency amplification, a screen grid detector and two stages of resistance coupled audio frequency amplification feeding into a 245 power stage. The output of the power stage is made to feed either a loudspeaker or a neon tube depending upon whether sound or television reception is desired.

The receiver is fitted with plug-in coils to cover any range of frequencies required. The detector can be made regenerative for shortwave and broadcast wavelength reception of sound programs or non-regenerative for the reception of television programs.

The picture appears on a lens about six inches square, placed at the rear of a shadowbox located at the front of the cabinet.

The television receiver is no more difficult to operate than many of the standard radio receivers now in use.

It is well to explain here that there is no fixed standard for the transmission of television signals. While the Radio Manufacturers' Association standardization committee on television has recommended a 48-line picture with 15 complete pictures per second (the system used at Station W1XAV), the stations which are actively engaged in transmitting regular television programs are using 24-, 45-, 48- and 69-line picture at speeds of 15 and 20 pictures per second.

The number of lines to the picture depend on the number of holes perforated in the scanning disc, drum or belt. The number of pictures per second depends on the number of revolutions per second of the motor which drives the scanner.

With the Baird system, the method of changing the number of lines to the picture and the number of pictures per second is extremely simple. The scanning belt of the system is supported on a spider frame in such a way that it can be easily removed and another belt having a different number of holes substituted in its place within a few seconds. It is thus possible to use a 24-, 45-, 48- or 60-hole belt depending on the number-of-lines picture being sent out by the television transmitter. The belts are very simple in construction and therefore inexpensive.

To change the speed from 15 to 20 pictures per second, or vice versa, all that is necessary is to adjust the rheostat on the panel.

### Employs Horizontal Scanning

The scanning belt used in the Baird system provides a means of obtaining much greater freedom from distortion than is possible with the usual type of scanning disc, since it gives a square or rectangular picture made up of straight lines instead of the curved lines and keystone shape effect produced by the disc scanners.

In the Baird system, the scanning "spider" on which the scanning belt is mounted, is so light in weight as compared with the heavy two-foot discs used in most television outfits, that a small 1/15 hp. motor is sufficient to provide the necessary power. Another important advantage of the lighter construction is that due to the lower inertia, the motor responds more quickly to speed adjustments required to bring it into synchronism with the transmitter.

### Synchronization

One of the most important factors in successful television transmission and reception is synchronization of the scanning arrangements used in the transmitter and receiver.

If the scanning discs, drums or belts used for scanning the subject at the transmitter and reconstructing the image at the receiver are not absolutely in step with each other, hole for hole, reception

(Continued on page 1029)

## Boston Television Party

(Continued from page 1028)

will consist simply of blurry lines of light and shade instead of a recognizable picture.

To obtain this important result, synchronous motors, accurately made to run constantly at a required speed, determined by the number of complete images to be transmitted and received per second, have been used at both the transmitter and receiver.

This adjustment of the motor speed at the receiver constitutes one of the most important "tuning" adjustments.

The motor used in the Baird system is a variable speed type which makes use of a special synchronizing unit which is operated by the incoming signal and acts to keep the receiver motor in step with the transmitter motor in spite of any variation in frequency or voltage between the power sources which drive the transmitter and receiver motors.

### Constructional Data in June

Because of the entertainment value resulting from experimenting and viewing the television programs now being broadcast many readers will feel the expenditure of the small amount now necessary to construct a television receiver is justified. A complete description of the construction of an efficient, inexpensive television receiver designed by Hollis S. Baird for the Shortwave and Television Corporation will therefore be given in the June issue of RADIO NEWS.

## Service Notes

(Continued from page 1003)

the meter. In such instances the voltage should be stepped down by means of the toy transformer. In selecting a voltage, start with the lowest available on the

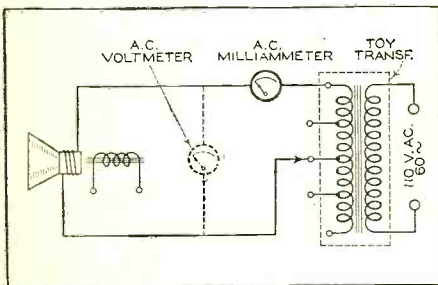
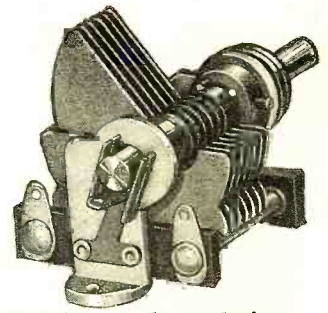

Figure 4

transformer. Figure 4 indicates how the apparatus is arranged for making this measurement.

"If an a.c. voltmeter is available, the line voltage should be checked. This definitely established voltage will of course provide an accurate determination of the impedance at 60 cycles. However, for simple comparing or matching impedances, this is not necessary, and the readings of the ammeter are all that are required."

# Short-Wave INSURANCE!



Hammarlund Vibration-proof Midget Condensers. 20 to 325 mmf. Many new features.

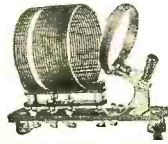

Hammarlund Short-Wave Plug-in, Space-Wound Coils. 20 to 215 meters.



Hammarlund Shielded Polarized Choke. High inductance, low distributed capacity.

THE experimenter soon learns that the one thing which cannot be short in short-wave work is the QUALITY of parts he uses.

Correct design is imperative, of course, but good material and intelligent workmanship are equally important to insure success.

Hammarlund Condensers, Space-wound Coils and Polarized Chokes for Short-Wave Circuits are preferred by thousands of painstaking experimenters throughout the world.

And yet, with all of their inbuilt quality and wide reputation, their cost is attractively low.

Your dealer probably can supply you. If not, write direct to us. Mail coupon for helpful Short-Wave Data and advance information on the new Hammarlund Short-Wave Super-Heterodyne.

For Better Radio  
**Hammarlund**  
PRECISION  
PRODUCTS

HAMMARLUND MFG. CO., 424-438 West 33rd St., New York.  
Please send me data describing Hammarlund Short-Wave Products and their uses.  
Name.....  
Address.....  
RN-5



### ALL PROGRAMS Are Good With a

### FILTERMATIC FOR ALL RADIOS

ONLY \$1.00 POST PAID

Entirely Automatic  
No Bothersome Tuning  
Improves Tone—Reduces Static  
Brings in Distance  
Increases Volume  
Prolongs Life of Tubes  
Separates Stations

Send Cash or P. O. Money Order

Satisfaction Guaranteed or Money Refunded

AND NOW!  
THE SUPER-FILTERMATIC \$2.00 Post-paid  
AERIAL OF THE FUTURE

The Filtermatic Mfg. Co. wishes to introduce a remarkable invention named the SUPER-FILTERMATIC, which takes the place of all present types Aerials, in addition to having all the wonderful features the Filtermatic has, such as improving tone, reducing static, bringing in distance, increasing volume and separating stations. The SUPER-FILTERMATIC will never wear out due to its rugged construction. It is very compact measuring only 1 1/2 x 2 inches, is absolutely non-directional, non-corrosive. It does not connect in the light socket; all A.C. hum and line noises are eliminated, it is easy to install (one minute time required), no tools needed, once installed no further attention required. It is the equivalent of an outside aerial 75 feet long and 50 feet high, more than sufficient for the modern set. The SUPER-FILTERMATIC is being introduced at the special low price of only \$2.00 postpaid. Satisfaction guaranteed or money refunded. Just stop and think, of the trouble and expense the Super-Filtermatic will save, if used to replace the expensive, unsightly dangerous outside aerial. THE SUPER-FILTERMATIC IS THE AERIAL OF THE FUTURE.

**SERVICE MEN & Dealers Write for Our Attractive Offer**  
FILTERMATIC MFG. CO., Dept. B-10  
4458 Frankford Ave. Philadelphia, Pa.

Dealers and Service Men Send for the Latest Issue of

## NUBOR FLASHES

It contains hundreds of Radio and Electrical bargains  
Just You Received Your Copy!  
NUBOR RADIO CO., 14R Warren Street, New York City

## WORLD-WIDE SHORT-WAVE RECEIVER

ONLY \$6.45

Span the World with this Set!  
A new radio thrill for you! Listen in DIRECT to London, Paris, Berlin, Buenos Aires and other broadcasting stations throughout the world via short waves. Enjoy unique foreign programs from strange lands. Your ordinary receiver cannot tune in these low wave stations. WORLD-WIDE RECEIVER gets 14 to 550 meter stations with surprising clarity. SEND NO MONEY! Just write your name and address on a postcard and ask us to send you this wonderful guaranteed short wave set. Pay postman \$6.45 plus a small delivery charge. All orders West of Rockies must be accompanied by \$1.00 deposit. Foreign countries must remit in full. Order today!

### NEW RADIO BARGAINS

Low Power Transmitter adaptable for phone or code. With plug-in coils ..... \$14.75  
Auto Radio—Uses 3—224, 2—227 tubes and 1—245 power tube, single dial, tremendous volume. Compact. Fits any car. We guarantee this set to perform better than sets selling up to \$150.. 20.00  
B Eliminator, Bone Dry, with 28u tube, 180 volts, will operate up to ten tube set, fully guaranteed. 6.75  
AC—A B C power packs ..... 8.75  
Tubes: UX type, 30-day replacement guarantee, No. 210, \$2.25; No. 250, \$2.35; No. 281, \$1.85; No. 245, \$1.25; No. 224, \$1.25; No. 227, 75c; No. 226, 65c; No. 171, 75c.  
International Microphone, two-button, for public address systems and transmitters, speech or music ..... \$9.75  
WRITE FOR BARGAIN CATALOG  
CHAS. HOODWIN CO.  
4240 Lincoln Ave., Dept. E-3, CHICAGO

## NEW KIND OF RADIO

New H-F-L Mastertone  
—new in magnificence of tone—  
—new in power with world-wide reach—  
—new in quick tuning—  
—new in sensitivity and selectivity with a station at every point on dial. A new price—America's finest radio at amazingly low cost. FREE Book explains all. Send for our Special Offer now.  
HIGH FREQUENCY LABORATORIES  
A-135, 3900 N. Claremont, Chicago

# Europe on the Wire

(Continued from page 973)

**NOW READY!**  
**The New 1931 Trouble Shooter's Manual**  
 By **John F. Rider** with the **FREE Question and Answer Service.**  
**More than 800 pages! More than 1500 diagrams!**  
 This is the most complete book ever offered to the radio service men. Nothing has been left undone to furnish every bit of radio service information which may be of value to the radio service man. The wiring diagrams are complete with socket layouts, set analyzer, voltage data, electrical constants, color code, chassis layout. . . Commercial broadcast receivers, short wave receivers and adapters, kit receivers, midjet receivers, set analyzers, public address systems, power amplifiers, power packs, tube data, a complete Radio Service Course in Trouble Shooting, principles and application of the set analyzer, a separate section devoted to the peculiarities in radio receivers.  
**Complete!!! Complete!!! COMPLETE!!!!**  
 Modern up-to-date in every respect. Hot off the press! If you do service work you must have this book. It is sold with a money back guarantee. . . One successful repair job pays for the cost of the book.  
 More than 800 pages and more than 1500 diagrams  
**Price \$5.00 Postpaid**  
 We will send the book C.O.D. if you want it so.  
**RADIO TREATISE CO., INC.**  
 1440 Broadway New York City

**All-Wave Converter**



THE Polo de luxe all-wave converter, designed by J. E. Anderson and Herman Bernard, is completely A.C. operated and tunes from 10 to 600 meters with any broadcast receiver. Only two connections to make — aerial to converter input, and set antenna post to converter output. Extremely sensitive triple screen grid circuit, with rectifier circuit built in. Total, four tubes. Users consistently get Europe.  
 Complete parts, with four precision plug-in coils wound on air (less three 224 and one 227 tubes, less cabinet). Order Cat. DX-4K, at. . . \$26.00  
 Wired model (less tubes and cabinet). Cat. DX-4-W at . . . \$31.00  
 Walnut-finish cabinet, order Cat. CRT at. . . \$ 5.00  
**POLO ENGINEERING LABORATORIES**  
 125-C West 45th Street, New York, N. Y.

**New National Short-Wave Receiver**

ACSW5—NATIONAL complete set of parts for 5-tube AC Short-wave Thrill Box. List \$79.50 **NET \$46.75**  
 DCWS5—NATIONAL complete set of parts for 5-tube Battery operated Short-Wave Thrill Box. List \$75.00 **NET \$44.10**  
 We can have either of the above sets of parts wired up for you at an additional list price of \$10.00 **NET \$5.88**  
 When desired completely wired add the letter (W) to our catalog symbols.  
 Type 5880 AB Power Supply (less tube) for use with above AC Short-Wave Thrill Box. List \$34.50. **NET \$20.30**  
 (Licensed under R.C.A. patents)  
**1931 CATALOG FREE**  
 Write for your copy. Complete line of transmitting and receiving short-wave supplies.  
**CHICAGO RADIO APPARATUS CO.**  
 415 S. Dearborn St., Dept. RN-5, Chicago, Ill.

an ingenious unbalancing of impedance values, it is possible to melt sleet on the Lawrenceville aerials with a 150 ampere current while the transmitter is in operation.

## The Transmitter

The transmitter is crystal controlled, and outputs a carrier power of fifteen kilowatts into the antenna system. One hundred per cent modulation is employed, the power on peaks being sixty kw. With the antenna gain already mentioned the output is approximately equivalent to 150 kilowatts into a non-directional antenna system—three times the power of our largest broadcasting station.

It is of course impractical to operate the crystal at the high frequencies to which the antenna is tuned. (The thinness to which a crystal may be ground is limited by the mechanical strain imposed upon it while oscillating.) The frequency of the crystal is subjected to two step-ups. The plate circuit of the first amplifying tube is tuned to the third harmonic of the crystal frequency and the plate circuit of the second tube to double the frequency of the input circuit. A frequency of 3333 kc. is thereby transformed to 20 megacycles at the same time that the amplitude of its vibrations is amplified sufficiently to control a push-pull oscillator employing two 250 watt tubes. This oscillator is modulated with four similar tubes, and finally amplified by water-cooled radio frequency tubes.

The power to the transmitters is furnished by filtered filament supply generators and six phase water cooled rectifiers operating at 12,600 volts. All units are, of course, in duplicate, and for the greater part may be used interchangeably by manual or automatic switching, only a few seconds being necessary to make an emergency shift. The switches are interlocking, making it impossible to cut in the different units in a sequence that might be injurious to the apparatus.

## On the Receiving End of the Circuit

The receiving antennae are located at Netcong, N. J., where 400 acres are provided for present equipment and future expansion. These aerials are of the array or broadside type, similar in many respects to the transmitting curtains. They exhibit approximately the same directional effects, a descriptive polar diagram of which appears in Figure 3. Each antenna is six wavelengths long, and consists of a series of resonant sections so connected that the induced currents from the desired or broadside direction are in phase while those resulting from signals in the plane of the antenna neutralize each other. This results in a two directional system with points of maximum response 180 degrees apart. The arrangement is analogous to the connection of a series of say four dry cells. When the battery is connected in series, the voltages are additive, and represent sig-

nals arriving from the broadside direction. If the cells reconnected plus to plus, minus to minus and plus to plus, the potentials will buck and no current can be drawn from the battery, a condition describing the effect of a wave arriving longitudinally. With this antenna system, an intermediate degree of attenuation is evidenced between the maxima and minima directions.

Finally a screen is placed behind the array, and so connected that broadside signals from the undesired direction neutralize each other in the receiver while those from the transmitter are unaffected. The antenna system is thereby rendered uni-directional in accordance with the polar diagram to which reference has already been made.

The antennae are connected to the receiver by radio frequency transmission lines. One receiver is used for each channel, and three antennas for each receiver corresponding to the three operating frequencies. Each of the three antennas is coupled to the input of the receiver through separate tubes and circuits, making it possible for the operator to select any one of them with the throw of a switch.

As it is undesirable to place unnecessary metallic systems in the immediate fields of the aerials, the individual receivers and their associated antennae are well separated. The accompanying aerial photograph shows the arrangement of the American Telephone and Telegraph receiving layout at Netcong, N. J. The heavy white lines indicate the receiving arrays, the light lines the transmission lines to the receiving stations located by the small squares. It will be noted that three of these arrays present their broadsides to Europe and one of them to Buenos Aires, South America.

The gain of these aerials is in the neighborhood of 16 decibels, which, considering static to come from all directions and the signal from the favored sector, increases the signal to static ratio about forty times. The effects of static are still further reduced by the fact that quite a portion of these natural strays arrive from definite quarters. The greater part of the static experienced in the eastern section of the United States comes from the direction of Mexico which is on the repelling side of the European arrays. Another center of static distribution is South Africa, and the attenuated strays from this part of the globe arrive in the neutralizing plane of three of the four Netcong aerials.

A reasonable amount of frequency discrimination is also contributed by this type of receiving aerial. With the author flying close to Platinos, Argentina, (the receiving station for B. A.) an effort was made to receive signals from the airplane on one of the regular beam arrays of the I. T. & T. The airplane was transmitting about 300 kc. off frequency (corresponding to about one meter at thirty meters). The signals could not be

(Continued on page 1031)



# Europe on the Wire

(Continued from page 1030)

heard, until recourse was made to field strength measuring equipment operating from an open aerial.

The receivers and aerials are located away from established automobile and airplane routes to eliminate interference from the ignition systems. Horses and wagons are used for general transportation in the vicinity of the receiving installations. Definite zoning has been prescribed for automobiles not equipped with ignition shielding.

## Reliability of Beam System

The combined gain of the transmitting and receiving antennae approximates twenty-five decibels. The significance of this is best understood when the reliability of the beam system is considered in terms of an ordinary broadcast transmitter located in England and sending a program directly to the average American home in New York City. Such a transmitter would have to have a power of at least 5000 kilowatts—one hundred times as powerful as the largest broadcasting station now in operation! And, at the same time (to justify the comparison on all points) you must imagine yourself receiving this super-super power station without fading, with about one-fiftieth the amount of static you now experience and without artificial QRN or interference!

Though the line terminal equipment and its associated apparatus is considerably more complicated than the radio units, it presented fewer problems to the designing engineers, due to the fact that the necessary equipment had been in service for some years over regular long distance channels. The toll-station-radio-toll-station circuit is suggested graphically in Figure 4. With the exception of the vodas, this arrangement is self-explanatory. The vodas (short for "voice operated device anti-singing") is one of the most ingenious contributions to the technique of long distance telephony, and its function is adequately indicated by its name.

## Echoes

Any long telephone line has a tendency to sing, due to the presence of echoes. Echoes exist whenever the effect of a current variation can be returned to its source. They are not serious in short lines (unless the telephone receiver is held against the mouthpiece, in which case a pronounced instance of singing will result) due to the fact that the returned disturbances are attenuated and, traveling practically at the speed of light, return to their source in phase with the original sound. However on delayed lines involving cables and in circuits where several definite sources of feedback exist (such as radio channels) singing becomes a serious problem, not merely because of the time element providing a genuine echo, but due to the amplification in the repeaters which returns the

echo with sufficient strength to set up recurrent oscillations.

The vodas consists of a series of voice actuated relays opening and closing the two transmitting circuits. Consider a conversation between A and B. When A is talking, B's transmitter is cut off, and vice versa, eliminating the source of feedback. However, in an elementary vodas arrangement, both transmitters would be on when neither A nor B were talking. This would permit singing to build up until one vodas operated. The line would then be silent for a short period—until the vodas opened and the singing built up again. An intermittent singing would result which would be quite annoying. To prevent this, one transmitter is cut off until the party on that end speaks. His voice actuates the vodas, and the line carries his speech. But it requires an appreciable time for the vodas to operate—say eight thousandths of a second—which would be sufficient to chop off part of the first syllable of his first word. This possibility is circumvented in an ingenious manner. The fraction of the first spoken syllable is used to operate the vodas, but the actual speech transmission is shunted through a delayed circuit, which actually holds back the speech that the party on the other end hears for a few thousandths of a second—long enough for the vodas to open!

## Flawless Operation

The vodas works flawlessly in spite of the fact that its action involves the opening and closing of relays in a certain sequence at time intervals measured in the thousandths of a second. Speech is transmitted instantaneously as far as the ear is concerned. Of course A and B cannot talk to each other at the same time for both vodases will close, and nothing will be heard at either end. This, however, is an advantage, for it eliminates unnecessary jawing which is not understandable to either party.

The various points in the connecting links between subscriber and radio transmitters are connected by telephone, telegraph and automatic typewriters, often operated in the course of dispatching and official business over the communication channels during quiet periods. The terminating equipment includes the usual test boards and associated apparatus, and the technical operator can monitor the transmission at all the points indicated in Figure 4. All voice frequency equipment at the transmitting terminal is housed in a completely shielded room to eliminate the possibility of r.f. pick-up.

From the point of view of the subscriber the functioning of this equipment is simplicity itself. He has merely to give the number to the regular long distance operator to call any party in the service areas which included practically all of western Europe, and the South American countries of Argentina, Uruguay and Chile.

A new and remarkable Resistor

## TYPE K METALLIZED

Rugged  
Noiseless  
Greater Load  
Accurate  
Moisture Proof

Now in the hands of all jobbers and dealers. You can obtain these superior units only by asking for I. R. C. Metallized Resistors.

A guarantee of quality—

A guarantee of uniformity—

can be given only by makers of standard merchandise. Establish a reputation for using dependable resistors. Always buy them by name—**I. R. C. Metallized.**

For conversion of meters—as voltage multipliers—ask for *I. R. C. Precision Wire Wound Resistors*. They are calibrated to an accuracy of 1% or better. They possess features found in no other wire wound units. Used as laboratory standards by the foremost engineers. Write for charts.

Don't risk your reputation with cheap resistors—follow the lead of the leaders and standardize on **I. R. C. Units.**

INTERNATIONAL RESISTANCE COMPANY

2006 Chestnut St. Philadelphia



*Metallized*  
and  
**PRECISION WIRE WOUND RESISTORS**

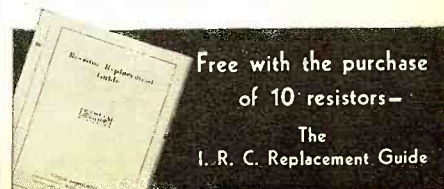

Free with the purchase of 10 resistors—

The I. R. C. Replacement Guide

# Balkite & Abox

## RADIO POWER UNITS

Magnavox Speaker Parts  
Eastern Factory Service Station

**TRANSFORMERS**  
90-135 & 180 Volt...\$1.10 to \$1.75  
Choke Coils ..... 50c to \$1.25  
Condenser Blocks \$.1.00 to \$4.00

Write for our latest Price Sheet on Sets, Eliminators, Electrical Appliances. Parts at the **LOWEST PRICES**. Special Discount to dealers and service men. Repairs on all eliminators and radio sets.

**MARTHENS-SCHROTER & CO., INC.**  
54 Dey Street New York City

**ACCOUNTING LESSON FREE**

New Revised Course Now Ready!

Find out about it by trying it free

Send for our new book, "The Accountant—Who he is, What he does, How to become one," and the first lesson free of charge.

In reply please state age and position

**INTERNATIONAL ACCOUNTANTS SOCIETY, INC.**  
A Division of the  
**ALEXANDER HAMILTON INSTITUTE**  
Dept. 166, 3411 So. Michigan Ave., Chicago

**FREE! FREE!**

Send today for a copy of our latest Radio Bargain Bulletin full of real Bargains.

**BALTIMORE RADIO CORP.**  
725 Broadway, Dept. "N", New York City

**ELLIS Microphones for TONE**

**ELLIS ELECTRICAL LABORATORY**  
337 W. MADISON ST. Sales Corporation CHICAGO

**ALUMINUM BOX SHIELDS**

Genuine "ALCOA" stock, silverclad finish. \$2.95 \$1.89  
—Cornet size \$4.65. 10x8x7 Monitor size \$2.25. \$2.85  
Coil Shield (like picture on the left) \$1.00.

**ANY SIZE TO ORDER**

Coil Shields, Coil Hole Covers, Shielded Wire, Intermediate frequency coils for Radio News—Super 950 pair, 70-MMF Hammarlund equalizer condenser 1pc, National Drum Dial, list \$4.50. Special \$1.50. National Eoutune, 500 MUF condenser excellent for denser. List \$3.00. Special \$1.50. Aerovox .01 Bakelite condenser. 31c.

We specialize in parts exclusively. We can furnish everything described in this magazine. Give us a trial.

**BLAN, the Radio Man, Inc.,** 89 Cortlandt St., Box 15, New York City

**SEND FOR FREE RADIO CATALOG LOWEST PRICES**

**COAST TO COAST RADIO CORPORATION**

HEADQUARTERS ALL RADIO REPLACEMENT PARTS

**142 N. LIBERTY ST., NEW YORK**

## Receiver Equipment Now—and Then

(Continued from page 985)

schematic diagram of one of the earliest neotrodynes, the Fada 160 is shown in Figure 10. The receiver employed four tubes to do the work of five, the first audio stage being reflexed to also function as the first audio-frequency amplifier. Contrast this circuit with a modern tuned radio-frequency receiver. It is much simpler in every respect and its advantages were found in its extreme simplicity. It was sufficiently sensitive to afford satisfactory distance reception. All in all, it performed to the king's taste, his palate having not as yet been whetted by modern receiver design.

Mutterings about a.c. filament operation were heard back in 1922 and an example of a suggested receiver using honeycomb coils, a crystal detector with a two-stage untuned radio-frequency amplifier with a.c. filament operation is shown in Figure 11. This diagram appeared in the December, 1922, issue of RADIO NEWS.

A.C. filament operation was not popularized until some time in 1926, but it had been used for quite a few years prior to that time in connection with amateur transmitters. The modern "B" battery eliminator did not appear upon the market until some time in 1925, but a.c. form of plate voltage supply had been used for many years. In fact, that modern "B" battery eliminator as a part of a complete a.c. receiver is almost identical with the old plate supply systems used in transmitters. One change is the use of the tapped filter choke or the parallel resonated filter choke.

The dynamic speaker so popular during the last two years was used back in 1919 and the schematic layout of this type of speaker as made by the Magnavox Company is shown in Figure 12. It was d.c. operated, employing a 6-volt battery to provide the excitation current for the voice coil. The output transformer was self-contained. The horn was made of metal. The diaphragm was small in contrast to the present-day large-size cones.

Basically the modern dynamic speaker is identical with the one shown, but as far as reproduction is concerned, the old style unit operated over a frequency range which represents but a small portion of the present-day range.

Accompanying greater selectivity, greater sensitivity and the gradual decline of regenerative receivers was an increasing interest in tone quality. More and more numerous became the discussion pertaining to tone quality. The intensity of the received signal was sufficiently great, but the haphazard methods of making these sounds audible to a group of listeners created interest in loud speakers. One of the earliest of these was simply a horn to the base of which a pair of headphones were clamped to serve as the loud speaker unit.

Push-pull amplifiers were of interest because of the Western Electric two-stage audio amplifier, battery-operated with push-pull output. This power amplifier

(Continued on page 1033)

## Amazing Discovery Resoles Shoes-9¢

**Pays Agents up to \$90 Weekly**

This amazing new shoe re-soling discovery—**SAVASOLE**—makes old shoes good as new for a few cents. A scientific substance made of ingredients imported from three continents. Fills in all cracks and breaks. Looks like leather—wears like iron. Re-builds worn heels. Spread on in a minute with an old knife. Dries hard and smooth overnight. Parents wild over it for children's shoes. Agents earning up to \$90 weekly. Fastest selling and most profitable specialty in America.

**SATISFACTION GUARANTEED OR MONEY BACK!** **OR SAMPLE FREE**

Without experience and starting in spare time you too can enjoy profits like Lewis, Kansas, who made \$30.10 his first morning. Berkeley, Illinois, made \$129 a week. Write now for details and **FREE SAMPLE**. **WE'LL PAY YOU 50c CASH TO TEST SAVASOLE!**

**THE PERFECT MFG. CO., Dept. R-593 Cincinnati, O.**

**Summer Days Are Comfortable... Here**

SUMMER days in Chicago are comfortable...at **THE DRAKE**. Pleasant... spacious... airy rooms and an ideal location... overlooking Lake Michigan... Beach, bridle paths... Lincoln Park... and other attractions immediately accessible. Rates begin at \$5 per day. Permanent Suites at Special Discounts.

**THE DRAKE HOTEL, CHICAGO**  
Under Blackstone Management

"AN ADDRESS OF DISTINCTION"

**BIG 3 FT. TELESCOPE**

Five Sections. Brassbound. Powerful Lenses. 10-Mile range. Special Eye Piece for looking at the sun, included FREE. Can be used as a Microscope. Guaranteed. Big value. Postpaid \$1.75. C.O.D. 15c extra.

**BENNER & COMPANY, T-68, TRENTON, N. J.**

**The CROSLLEY ROAM O**

**AUTOMOBILE RADIO RECEIVING SET**

**CICO CELL**

PRACTICAL PHOTO-SENSITIVE CELL OF MERIT  
SMALL ~ UNBREAKABLE ~ POSITIVE  
A SWITCH THAT IS OPERATED BY A BEAM OF LIGHT.  
SUITABLE FOR COUNTING, SORTING, TRAFFIC CONTROL, ALARMS & ETC.

PRICE \$ 5.50 - POSTPAID

**CLARK INSTRUMENT CO.**  
119 N. 4th ST., CAMDEN, N. J.

# Transmitter and Receiver=9 Lbs.

(Continued from page 992)

disconnected by withdrawing the plug from its socket. Also the "B" batteries are only connected into the circuit when the transmitting key is plugged into the jack, J, and is depressed. Thus there is no drain on the "B" batteries except when actual dots and dashes are being sent, or when the key is locked to provide a constant carrier for microphone modulation in voice transmission.

Voice transmission is accomplished through simply connecting the microphone in series with the ground lead. This simple method has proven surprisingly effective with this low-power transmitter. A suitable microphone may be one of the inexpensive type sold especially for amateur transmission work. When connected in this position no microphone battery is required.

It is scarcely necessary to go into the details of antenna design and transmitter adjustment here, as these are subjects that have been covered at length in recent issues. Moreover, with a portable transmitter it is necessary to use whatever type of antenna conditions will permit, so suggestions for "the ideal an-

tenna" would be quite superfluous. Worth-while information on these subjects will be found in articles beginning on page 783 of the March, 1931, issue and page 518 of the December, 1930, issue.

It is impossible to provide an accurate estimate on the distance a given transmitter will cover. To try to estimate the distance which a portable transmitter will cover is doubly futile because of the varying conditions under which it is likely to be used. Experience with this transmitter under different conditions indicates that with conditions favorable, the range of phone should be up to ten miles. The CW range may be anywhere from 25 miles to thousands of miles at night. While the latter figure is not an impossible one, a conservative estimate of dependable operating coverage would be from 25 to 100 miles.

### LIST OF PARTS

#### Portable Short-Wave Receiver

C1—Hammarlund MC-100-M tuning condenser, 100 mmfd.

(Continued on page 1034)

# Receiver Equipment Now—and Then

(Continued from page 1032)

was classed as the king of all audio amplifying systems. In contrast with the modern form of volume control the amplifier in question made use of a tapped secondary winding upon the input transformer, as shown by the movable contact illustrated in Figure 13.

Subsequent to the development of the

The demand for greater convenience accompanied the demand for greater quality. The gradual increase in the number of tubes used in receivers made necessary more frequent recharging of the storage battery form of filament power supply. The 1-ampere tube was replaced by the dry-cell tube and the .25 ampere

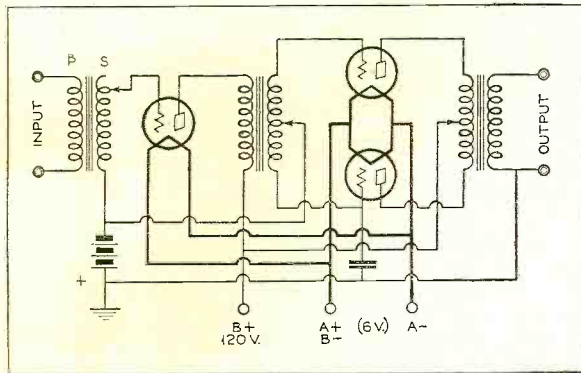

Figure 13. The Western Electric power amplifier in 1923 introduced the push-pull stage now so popular

neutrodyne receiver very little improvement was noted in receiver design for several years. It is true that several reflex receivers made their appearance, but they were short-lived. The major interest was devoted to improvements in tone quality. The requirements as presented by the musical scale were topics of discussion. Resistance coupling made its appearance late in 1924 and many heated arguments relating to the respective advantages of resistance, choke and transformer forms of audio-frequency amplifier are recorded in print in some of our leading radio journals.

tube. Vibrating and vacuum-tube chargers made their appearance. They were applied to plate and filament power supply units. The bulk of the "wet" storage "B" battery limited its sales, but the elaborate receiver was equipped with a storage "B" as well as storage "A" system and a charger, thus making the complete system and an electrified arrangement. In fact, this form of operation presented such an improvement over the ordinary form of operation that it was at one time considered one of the paramount reasons for the dislike of the first batch of a.c. tube receivers.

# AD made easy to learn AT HOME



**R**ADIO is a fascinating profession. Now you can become an expert in any one of its twenty different branches. Simply by studying in your spare time at home or at any of the four resident schools operated by RCA Institutes, Inc.

It is not hard to study radio the way it's taught by RCA Institutes. You learn radio by actual experience on the latest type of radio equipment. And you need not give up the position you now hold. You can study an hour a day or any number of hours a day, at home in your spare time.

The RCA Institutes' Home Laboratory Training Course teaches you in a most thorough manner. You learn about servicing, operating, radio telephony and telegraphy... also instruction in sound motion picture installation, maintenance and repairs. And you receive at no additional cost the complete RCA Institutes' home laboratory equipment, a modern outlay of apparatus furnished to every student, enabling you to easily solve radio problems.

Send for our FREE BOOK Today!



### RCA INSTITUTES, Inc.

RCA INSTITUTES, Inc.,  
Dept. EX-5  
75 Varick St., New York, N. Y.

Gentlemen: Please send me your FREE book which tells about your laboratory method of radio instruction at home.

Name.....  
Address.....  
.....  
Occupation.....

**RADIO DEALERS and SERVICEMEN**  
**GENUINE**  
**Now! GOLD TEST**  
**Replacement Condensers**  
**Transformers & Resistors**

GOLD TEST Replacement Parts, which are designed to allow the largest amount of safety in the space allowed, are manufactured to duplicate the original parts as to hook-up and external size.

GOLD TEST Parts are guaranteed. All parts used in assembling Gold Test Replacement Parts are manufactured and tested in the Wellston Radio Corporation factory. We specialize in the manufacturing of replacement parts, and by means of our large production, are enabled to quote prices as low as possible, consistent with our high grade material and workmanship. Our apparatus are made of new material. We do not use surplus or salvaged condensers, therefore, do not confuse our replacement parts with those that are made from salvaged and obsolete radio material.

**GOLD TEST**  
**Replacement Block**  
**For Atwater Kent**  
**No. 37**



This unit contains the proper chokes and high voltage condensers. All flexible wire colored leads identical to the original. Fully Guaranteed \$4.95 Each.

USE NOTHING BUT GUARANTEED PARTS

Manufactured by the Makers of the Sensational

**GOLD TEST AERIALS**

**WELLSTON RADIO CORP.**

Dept. 116 St. Louis, Mo.

**1931 Radio BARGAINS**  
**Radio CATALOG** **WHOLESALE DISCOUNTS**  
**LOWEST PRICES**

**RADIO CATALOG 1931**  
**WHOLESALE**

**REGULAR WHOLESALE TRADE DISCOUNTS!**  
 Nationally-advertised, guaranteed radio merchandise, including the sensational **BONDED LAFAYETTE ALL-ELECTRIC RADIO RECEIVER**, with tone control. Write at once for **FREE 1931 Radio Bargain Catalog**, showing complete selection. *Don't buy until you see this wonder catalog!*  
**WHOLESALE RADIO SERVICE CO.**  
 Dept. E-12; 38 Vesey St., New York

**FREE!**

**FLAT RESPONSE CURVES**

required by Broadcast Stations, Laboratories and in Speech Transmission, supplied by Ferranti Audio Frequency and Special Impedance Matching Transformers. Now built in U. S. A., shipped in 48 hours. **BETTER AMPLIFICATION** for Educational and Special Commercial Needs, furnished by Ferranti Amplifiers.

**FERRANTI, Inc.**  
 130 W. 42d St., New York

**BRISTOL DOUBLE BUTTON MICROPHONE TRANSFORMERS**  
 An excellent input transformer for all standard microphones. Primary impedance is 100 ohms per button. Use one side for single button mikes. This unexcelled transformer is equal in efficiency to others selling at many times our special low price of **\$1.95**  
**FREE** Send NOW for a copy of our latest Bargain Bulletin **FREE**  
**HARRISON RADIO CO.**  
 189 Franklin St., Dept. "N", N. Y. City

**Transmitter and Receiver = 9 Lbs.**

(Continued from page 1033)

- C2—Sangamo fixed condenser, .0001 mfd., with grid leak clips.
- C3, C5—Aerovox by-pass condensers, .5 mfd.
- C4—Sangamo fixed condenser, .0005 mfd.
- J1—Yaxley double-circuit jack, No. 704.
- L—Pilot short-wave coil form with UY type tube socket as base.
- R1—Lynch grid leak resistor, 5 megohms.
- R2—Electrad potentiometer, type E—0 to 500,000 ohms.
- R3, R4, R5—Electrad pig-tail resistors, 50 ohms each.
- R6—Electrad potentiometer, type B—0 to 100,000 ohms.
- R7—Electrad wire-wound resistor, 5 ohms.
- RFC—Egert choke coil, 85 mh.
- T1, T2—Egert audio-frequency transformers.
- VT1—Eby UX type tube socket equipped with type -32 tube.
- VT2, VT3—Eby UX type tube socket

- J—Yaxley double-circuit jack, No. 704.
- L—Egert plug-in transmitting coil and mounting base.
- M1—Weston thermo-milliammeter, 0 to 500, model 507.
- M2—Weston milliammeter, 0 to 50, model 506.
- R1—Lynch resistor, 10,000 ohms.
- R2—Amperite No. 112.
- VT1, VT2—Eby UX type tube sockets equipped with type -12A tubes.
- VT3—Eby UX type tube socket used as cable connector socket.
- 2 Eby large size binding posts for antenna and ground.
- 2 Kurz-Kasch tuning dials.
- 1 Polymet fixed condenser, .002 mfd.
- 1 4-wire cable connector plug.
- 2 1½-inch brass right angles for mounting connector socket.
- 1 wooden baseboard 9 inches by 5¾ inches by ½ inch thick.
- 1 aluminum panel 10 inches by 8 inches by 1/16 inch thick.
- 1 metal cabinet 10 inches long by 8 inches high by 6 inches wide.

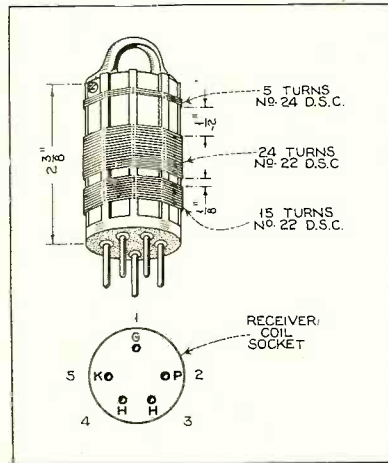

Figure 3 (above). The winding specifications for the plug-in receiver coil. Below, Figure 4, the connections for the coil mounting socket; the numbers represent connections as shown in Figure 1

- equipped with type -30 tubes.
- VT4—Eby UX type tube socket (used for cable connector).
- 2 Eby binding posts
- 1 4-wire battery cable equipped with UX type plug.
- 1 Kurz-Kasch tuning dial.
- 2 1½-inch brass right angles for mounting connector socket.
- 1 wooden baseboard 9 inches by 5¾ inches thick.
- 1 metal panel 10 inches by 8 inches by 1/16 inch thick.
- 1 metal cabinet 10 inches long by 8 inches high by 6 inches deep.

**LIST OF PARTS**

**Portable Short-Wave Transmitter**

- C1—Hammarlund type ML-11 variable condenser, .00025 mfd.
- C2—Hammarlund type ML-17 variable condenser, .00035 mfd.
- C3—Aerovox fixed condenser, .00025 mfd.
- C4—Aerovox by-pass condenser, .5 mfd.

**Radio Frequency Chokes**

(Continued from page 1001)

isolated circuit. For example in a radio frequency amplifier it is essential that the r.f. currents in the plate circuits of the various tubes be prevented from flowing through any part of the receiver circuit where they might cause coupling with other parts of the circuit and cause the amplifier to become unstable or to oscillate. For this reason we find r.f. choke coils in each plate circuit of many radio frequency amplifiers. The manner in which they are connected will be evident from the circuit of Figure 4, which represents the arrangement of a typical r.f. amplifier. Since each choke coil represents a high impedance to the r.f. currents, these currents will not pass through the choke but will instead flow through the condensers marked C1, C2, C3, each of which should have a capacity of about 0.1 mfd. The choke in combination with its by-pass condenser forms a filter because the circuit functions to filter the r.f. currents out of the circuit supplying plate voltage and to make the r.f. currents return directly to the tube filament or cathode. And it follows therefore that if the filter is to really be effective the leads connecting the choke and condenser into the circuit should be as short as possible. This means that the arrangement of the parts in the amplifier should be such that the r.f. choke and its by-pass condenser can be mounted close to the socket and radio-frequency transformer. The chokes in the r.f. amplifier circuit may be the shielded type with the shield connected to ground and with the high side of the choke connected to the r.f. transformer and with the low side connected to the B plus supply. The by-

(Continued on page 1035)

# Radio Frequency Chokes

(Continued from page 1034)

pass condenser should preferably be of the non-inductive type.

In regenerative circuits, both broadcast and short wave, the r.f. choke is used in the plate circuit of the detector tube to keep the r.f. currents out of the audio amplifier and force them to go through the feedback circuit. For example in Figure 5, in which regeneration is obtained by means of a midjet variable condenser, C1, connected between one side of the feedback coil L and the filament, the choke is placed between feedback coil and audio transformer. If the choke were not used the capacity of the audio transformer winding would be sufficiently high to cause the detector tube to oscillate without regard to the adjustment of the feedback condenser C1.

need for more complete filtering of the detector plate circuit is indicated if it is found that the set is quite stable with the antenna disconnected but unstable with the antenna connected; such a difficulty is due usually to a small amount of coupling between the antenna and the plate circuit of the detector tube and can be eliminated by using more complete filtering in the detector circuit. If two chokes are used they should be arranged as indicated in Figure 8.

We cannot leave this discussion of filtering in the plate circuit of the detector tube without pointing out that such filtering is always desirable but almost an essential when the detector is followed by a resistance coupled amplifier.

Some experimenters have constructed,

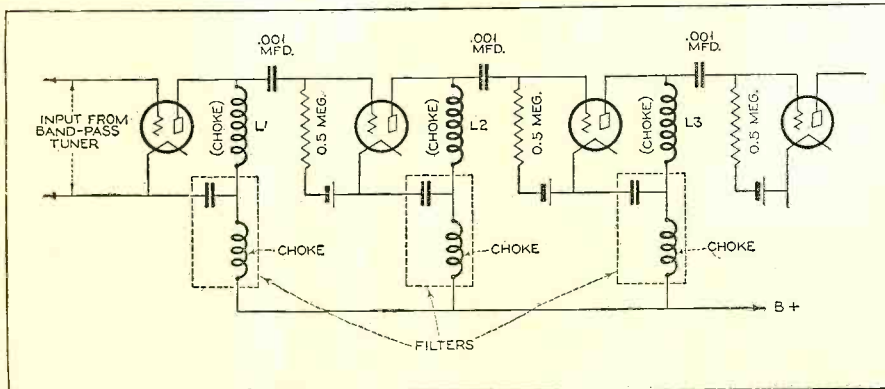

Figure 9. Some of the earliest superheterodyne receivers employed impedance-coupled intermediate amplifiers, using chokes as the plate impedance coils

In Figure 6 we show a shunt feed system for the plate circuit of a regenerative detector. In this circuit the feedback coil L and the regenerative condenser C1 are connected in series between the plate of the detector and the filament. In parallel with this feedback circuit is connected an r.f. choke coil and the primary of the first audio transformer. If the r.f. choke is a good one this circuit arrangement will be found very satisfactory. If not, the feedback current will be by-passed by the capacity of the audio transformer primary and little if any regeneration will be obtained.

In Figure 7 is shown another system of feedback control which makes a Hartley circuit. The secondary of the r.f. transformer is tapped at about one-third the distance from one end and the regeneration condenser C1 is then wired between detector plate and this end of the secondary, the tap on the secondary being connected to the filament. The r.f. choke is connected as shown in the drawing.

These circuit arrangements are applicable to either broadcast or short-wave receivers, although, as mentioned previously, the 250 millihenry choke should be used for the short wave circuits and the 85 millihenry choke for the broadcast receiver. In high gain receiver it may be found necessary to use two r.f. chokes in series in the detector circuit to completely eliminate coupling from the detector circuit and preceding r.f. tubes. The

with quite good results, impedance coupled r.f. amplifiers using r.f. choke coils as the coupling units. The circuit of such an amplifier is shown in Figure 9 where the coils L1, L2, and L3 are the r.f. choke coils, the remainder of the coupling system consisting of the 0.001 mfd. coupling condensers and the 0.5 megohm grid leaks. Since such an amplifier is of the untuned type and will amplify all signals, even some outside of the broadcast band, it must be used with some type of band-pass pre-selector unit to obtain the necessary separation between stations.

An examination of the various circuits given in this article will indicate that the r.f. choke coil is seldom used by itself—it almost invariably is used with either a variable or fixed condenser, the choke functioning to force the r.f. currents through the condenser circuit.

The fact that an r.f. choke coil represents a high impedance to r.f. currents is the idea that must be kept in mind in making use of these units. We can use them wherever we need a high impedance r.f. circuit or where we need to keep r.f. currents out of a particular part of the receiver system. Where they are used as parts of r.f. filter systems the connecting leads should be as short as possible. If the set has a high gain the chokes should preferably be of the shielded type so as to eliminate any possibility of coupling between the chokes and the other coils in the various circuits.

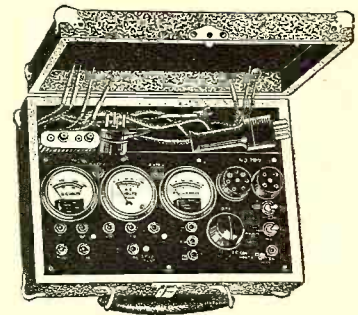

No. 700

A new tester designed to meet the servicing needs for all types of receiving sets. Checks all voltages at the socket. Tests all the different tubes, including screen-grid and rectifier. Continuity of circuits, resistance and capacity measurements are made with this complete analyzer. The three meters give readings 0-60-300-600 d.c. volts, 0-10-140-700 a.c. volts and 0-20-100 m.a's. Selective switch simplifies operations. Accurate. Compact. Dependable. Full instructions and charts furnished. Attractive leatherette case.

**\$15** NET to Dealer  
\$25 List Price  
No. 700

If not at your jobbers', remittance must accompany order for direct shipment.

# Readrite

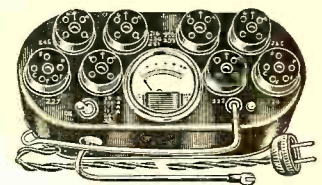

No. 400

## Counter Tube Tester

A new tester that gives dealer and customer the required tube value information. Mutual conductance test all tubes, including the new 2-volt tubes. Simple to use. Accurate. Dependable. Connects to A.C. supply. Attractive baked enamel finish. All parts shielded. Complete with up-to-date tube chart.

**\$12** NET to Dealer  
\$20 List Price  
No. 400

Send for catalog. Order your testers now.

**Readrite Meter Works**

Established 1904

19 College Ave. Bluffton, Ohio

### SHORT WAVE WITH YOUR PRESENT RADIO



#### "THE SUBMARINER"

Short wave reception from all parts of the world is enjoyed by many users of "Submariners".

No need to buy a special short wave receiver, as the "Submariner" attached to your receiver in a few seconds, will bring in reception for only a fraction of the cost.

"Submariners" are available designed for operation with each type of receiver. They are priced from \$17.50 to \$27.50, with fixed wave band of 19-50 meters, or interchangeable coils of 13-145 meters. The "J" feature, an exclusive "Submariner" achievement, enables you to get superior results with all of the newest receivers. The models JAT, 19-50 meters, at \$22.50, or the JATV, 13-145 meters, at \$27.50, have a tremendous waltop when attached to the

**NEW SCREEN GRID SUPER-HETERODYNE**

**ORDER TO-DAY**

*Sent postpaid upon receipt of price, or C. O. D. if \$1.00 accompanies order. Foreign—Cash with order.*

**J-M-P MANUFACTURING CO., INC.**  
3417 Fond du Lac Ave. Milwaukee, Wis., U.S.A.

## RELIABLE SERVICEMEN'S SET ANALYZER



**TESTS**  
LINE VOLTS  
GRID-BATT.  
SCREEN-GRID TUBES  
CAPACITY  
FILAMENT-VOLTS  
"C" BATT. VOLTS  
CATHODE-VOLTS  
PLATE-VOLTS  
GRID-TEST  
WITH BATT.—CONTINUITY—RECTIFIER TUBE-TEST.

Heretofore a set analyzer instrument making every possible accurate test to properly check all radio circuits (and tubes) has been sold for \$50.00 to \$70.00 *wholesale*—realizing the tremendous market open for a similar product, at a more modest price, we are manufacturing the instrument herewith illustrated in large quantities, thereby enabling us to offer same to you at a fraction of its actual value. **HOWEVER, QUALITY HAS NOT BEEN SACRIFICED**—we guarantee 100% ACCURACY.

**Radio Surplus Corp.**  
56 Vesey St. No., New York, N. Y.

## See the Craters in the MOON!

**Astronomical and Terrestrial  
TELESCOPE**

Own a genuine Astronomer's Telescope. See thousands of miles away. Make Sun, Moon Planets, Stars your next door neighbors. Moon Craters, Sun Spots, Eclipses, Comets. Only enlarged 30 times. Strange Spectacle!

Hours of fun looking at scenery, scenes, bathing beauties. Great for trips and vacations. Made like telescopes used in observatories. Gerding wrote, "Moon seemed 10 yards away."

**Only \$3.95**

**Five Days' Free Trial**  
Rush only \$1.00 now. Pay balance (\$2.95 plus postage), when postman delivers. Keep 5 days. If not delighted, return telescope and money will be refunded.

**ROLL-O SPECIALTY CO.,**  
Dept. Y-401  
220 E. 3rd St., Cincinnati, O.

### WANTED MEN

**To Manufacture Metal Toys and Novelties**

Big demand for 5 and 10c store Novelties, Ashtrays, Toy Soldiers, Animals, Auto Radiator Ornaments, etc. We cooperate in selling goods you make; also buy these from you. Small investment needed to start and we help you build up. **WE FURNISH COMPLETE OUTFIT** and start you in well-paying business. Absolutely **NO EXPERIENCE** and no special place needed. A chance of a life-time for man with small capital. Write **AT ONCE** if you mean strictly business and want to handle wholesale orders now being placed.

**METAL CAST PRODUCTS COMPANY, Dept. 12**  
1696 Boston Road, New York City

### INDEX TO ADVERTISERS

<b>A</b>	
Acme Wire Company	1028
Aerovox Wireless Corp.	1036
Alexander Hamilton Institute	1032
American Sales Co.	1028
American Transformer	1036
Amperite Corp.	1026
<b>B</b>	
Baltimore Radio Company	1032
Benner & Co.	1032
Blan the Radio Man	1032
<b>C</b>	
Candler System, The	1021
Central Radio Laboratories	1039
Chicago Radio Apparatus Co.	1030
Clark Instrument Co., Inc.	1032
Clarostat Mfg. Co., Inc.	1026
Classified Advertising	1038
Coast to Coast Radio Corp.	1032
Coyne Electrical School	962-963
Crosley Radio Corp.	1032
<b>D</b>	
DeForest Radio Co.	1021
Ditmas Electrical Co.	1024
Dixon Radio & Elec. Corp.	1039
Drake Hotel	1032
Dubilier Condenser Corp.	1024
<b>E</b>	
Electrad, Inc.	1019
Electric Soldering Iron Co.	1024
Ellis Electrical Laboratory	1032
Excello Products Corp.	1028
Experimenters Radio Shop	1036
<b>F</b>	
F. & H. Radio Laboratories	1037
Federated Purchaser	1037
Ferranti, Inc.	1034
Filtermatic Mfg. Co.	1029
<b>H</b>	
Hammarlund Mfg. Co.	1029
Hammer Radio Co., S.	1020
Harrison Radio Co.	1034
High Frequency Laboratories	1029
Hoodwin Co., Chas.	1029
<b>I</b>	
Insuline Corp. of America	1018
International Resistance Co.	1031
International Typewriter Exchange	1023
<b>J</b>	
J. M. P. Mfg. Co., Inc.	1036
<b>L</b>	
La Salle Extension University	1023
Lincoln Radio Corp.	Inside Front Cover
Ludy Hotel	1036
Lynch Mfg. Co., Inc.	1036
<b>M</b>	
Marthens-Schroter & Co., Inc.	1032
Mason, Fenwick & Lawrence	1037
Massachusetts Radio & Telegraph School	1039
McGraw Hill Book Co., Inc.	1025
Metal Cast Products	1036
Midwest Radio Corp.	1039
Moc Mfg. Co.	1020
<b>N</b>	
National Co., Inc.	1025
National Radio Institute	965
National Radio Trade Directory	1040
Nubor Radio Co.	1029
<b>O</b>	
Omnigraph Mfg. Co.	1023
<b>P</b>	
Perfect Mfg. Co.	1032
Polo Engineering Labs.	1030
<b>R</b>	
R.C.A. Institutes, Inc.	1033
Racon Electric Co., Inc.	1022
Radio Surplus Corp.	1036
Radio Trading Co.	1036
Radio Training Assn. of America	961
Radio Treatise Co., Inc.	1030
Readrite Meter Works	1035
Rim Radio Mfg. Co.	1026
Roll-O Specialty Co.	1036
<b>S</b>	
Shallcross Mfg. Co.	1020
Silver-Marshall, Inc.	1017
Standard Cushion Co.	1025
Supreme Instruments Corp.	1023
<b>T</b>	
Teleplex Company	1022
Traul Radio Co.	1019
<b>U</b>	
Universal Microphone Co.	1020
<b>V</b>	
Van Nostrand Co., Inc.	Back Cover
Varion Products Co., Inc.	1022
<b>W</b>	
Wellston Radio Corp.	1034
Weston Electrical Instrument Corp.	1027
West Side Y. M. C. A. Radio Inst.	1021
Wholesale Radio Service	1034

# FREE

JANUARY 1931 CATALOG No 22

## RADIO SERVICE TREATISE

AND  
RADIO BARGAIN CATALOG

FOR RADIO SERVICEMEN—RADIO TECHNICIANS—RADIO DEALERS

### RADIO TRADING CO.

NEW YORK CITY

We have just issued our new "RADIO SERVICE TREATISE." It's red hot all the way through. 52 new hookups and circuit diagrams, 110 illustrations. Partial contents: Modernization of old radio sets. How to convert battery to power sets. Selection of tubes. The detector tube. Changes in grid or "C" bias circuits. Push pull amplifiers. Replacing audio transformers. Phone attachments. How to choose power transformers. Voltage dividers. Wattage of power transformers. Selecting and installing replacement parts in radio sets. Filter condensers. Repairing "B" eliminators. **ALL BRAND NEW DOPE—NOT A REPRINT.** Send 2c postage. Catalog yours by return mail.

**RADIO TRADING CO.**  
27 West Broadway, N. Y. C.

## HOTEL LUDY

SOUTH CAROLINA AVE. AT THE BOARDWALK  
**ATLANTIC CITY'S**

NEWEST CENTRALLY LOCATED FIREPROOF HOTEL

**\$5.00**  
DAILY AND UP  
AMERICAN PLAN

WIRE PHONE OR WRITE R. B. LUDY, M. D.

### THE MOST COMPLETE LINE OF CONDENSERS AND RESISTORS!

**AEROVOX WIRELESS CORP.**

78 Washington St., Bklyn, N. Y.

**PRODUCTS THAT ENDURE**

## AMERTRAN TRANSFORMERS

For Every Radio Application

AMERICAN TRANSFORMER COMPANY  
178 Emmet Street, Newark, N. J.

### MILLION PARTS

The New Screen Grid coils 1 1/4 diam. .... 4 for \$1.75  
Screen Grid Intermediate coils, ..... 3 for 4.50  
Test plug 4 or 5 prong, ..... 2 for .49  
Federal power supply (1 1/2, 2 1/2, 5V) ..... 5.95

Experimenters, Repairmen ask for new Price List

**EXPERIMENTERS RADIO SHOP**  
129 West St. New York City

### DEALERS AND SERVICEMEN!

Standardize on



**LYNCH**  
METALLIZED  
RESISTORS



For Permanent Replacement—Accurate—Guaranteed  
Write for descriptive catalogue "N"

**LYNCH MFG. CO., INC., 1775 B'way, N. Y.**

# 15- to 550-Meter Superheterodyne

(Continued from page 975)

stable operation. For this reason the tuned primary and tuned secondary transformer was found to offer no advantages from a standpoint of the amount of amplification which could be used in the set, and had the distinct disadvantages of an additional adjustment for each stage.

Amplification is of little value unless it is accompanied by selectivity. The intermediate frequency of 480 kilocycles was chosen because the selectivity is much better at a higher frequency than at a low frequency, and because this frequency gives one-spot reception throughout the broadcast band. Selectivity is determined not only by the frequency of the intermediate but by the ratio of the inductance of the tuned circuit to the tuned circuit resistance. At a frequency of 480 kilocycles it was found that a single layer solenoid has the highest ratio of inductance to effective resistance of any type of winding. For this reason solenoids for both primary and secondary are used.

The final conclusions were that for maximum usable gain the tuned primary transformer using single layer solenoids for both primary and secondary coils mounted in fully enclosed aluminum shielding and operating at a frequency of 480 kilocycles, gave maximum amplification combined with maximum selectivity. The condensers which tune these i.f. transformers are of the rotor-stator type and their adjustment is not affected by atmospheric conditions or locality.

The frequency changer comprises a tuned-grid oscillator, a single-tapped antenna coil and a screen-grid first detector. Following are five tuned-plate, high-gain i.f. transformers, providing enormous amplification with 10 kc. selectivity. The second screen-grid power detector feeds into an audio amplifier consisting of one stage of resistance-coupled and one stage of -45 push-pull amplification with enormous output.

The power equipment is a separate unit. A heavy type of transformer is used, delivering all the voltages for the chassis; the windings supplying "A" power for heater-type tubes are wound of exceptionally large cable, insuring against any possibility of burn-out. The paper-type condenser bank is of sufficient over-voltage limits to eliminate shorting by high-voltage surges.

The chassis is of heavy cadmium-plated, satin-finished steel, with welded corners.

The two-gang tuning condenser is of large rugged construction, the rotor operating on a ball-bearing shaft. Plates are designed so as to give the most desirable spacing of stations on the dial.

The simplicity in tuning short-wave stations is at once apparent in the fact that the station desired can be brought in with only one selector dial. No regeneration is used, therefore no regeneration controls are necessary. When tuning stations from 15 to 35 meters, the antenna must be brought into resonance by adjusting the antenna trimmer or left-hand control on front panel. From 35 meters to 200 meters, the automatic tuning of the antenna circuit eliminates the use of the antenna trimmer and all stations can be picked up by the main dial and brought to full resonance by slight adjustment of antenna trimmer.

In view of the accuracy of calibration of short-wave coils, a new desirable feature is at once noted. For instance, if you wish to listen to Schenectady, W2XAD, 19.56 meters—15340 kc., simply select the coil marked 15 to 32 meters and it would be apparent at once just where the Schenectady station would fall on the dial.

The same rule would hold true with all foreign reception. For instance, Chelms-

(Continued on page 1038)

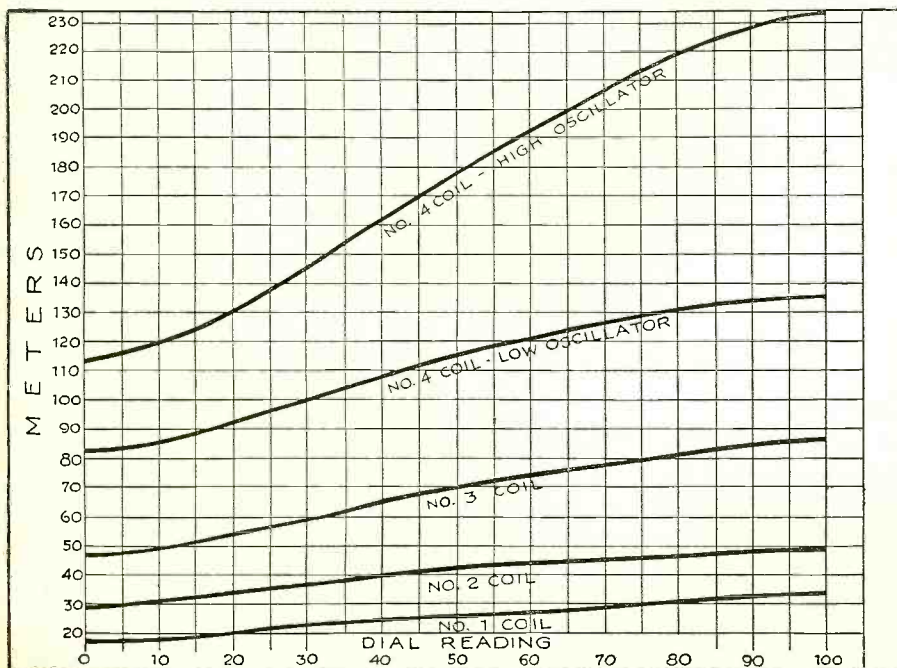

As an aid in locating any station of known frequency the receiver dial setting is carefully calibrated throughout, as shown here

## USE REESONATOR for Sharp Tuning Distance and Power



Now Only \$3.95

**NO**—The Reesonator is not new—it is an instrument which has been on the market for over three years and we have over 40,000 satisfied customers throughout the United States, Canada; in fact, the Reesonator is in use throughout the entire world. Its principle is used in most high powered, modern sets of today. The Reesonator will increase the selectivity and power of your machine to the equivalent of two extra tubes. The Reesonator will enable you to play distant stations with dance volume, that were barely audible without it. It is connected across aerial and ground wires, and can be done by anyone without tools in a minute. The Reesonator is only recommended for sets having an untuned antenna or floating tube, such as: Atwater Kent models 30, 32, 35, 37, 38, 43 and 49; Radiola models 16, 17, 18, 33, 51 and 333; Crosley Bandbox and Jewelbox and several models in Victor, Temple, Silver-Marshall, General Electric, Westinghouse, Apex radios and many others.

### F. & H. CAPACITY AERIAL



Price \$1.25 Complete

**Every Instrument Tested on Actual 1000 Mile Reception**  
The F. & H. Capacity Aerial Eliminator has the capacity of the average 75 foot aerial 50 feet high. It increases selectivity and full reception on both local and long distance stations and is absolutely guaranteed. It eliminates unsightly poles, guy wires, mutilation of woodwork, etc. It does not connect to the light socket and requires no current for operation. Installed in a minute's time by anyone. Enables set to be moved into different rooms with practically no inconvenience. We predict this type of aerial will be used practically entirely in the future. Return in three days if not satisfied. 8,000 dealers handle our line. Dealers! Over 80 leading jobbers carry this line; or order sample direct.

#### ITEMS SHIPPED POSTPAID

Name .....

Address .....

City ..... State .....

Inclosed find  check  M. O. for \$.....  
or send C. O. D. items checked, under three-day trial money-back guarantee.

REESONATOR  
 F. & H. Capacity Aerial Eliminator  
 Literature  Dealers' proposition

**F. & H. RADIO LABORATORIES**  
FARGO, N. DAK., Dept. 10

**Radio Bargain News**

Write for Your FREE Copy of this Big Catalog 40 PAGES OVER 1,000 ITEMS OF REPLACEMENT PARTS FOR ALL STANDARD SETS

**DEALERS AND SERVICEMEN SEND FOR IT**

**Federated Purchaser**  
20 Hudson Street New York City

**MASON, FENWICK & LAWRENCE**  
**PATENT LAWYERS**  
New York City Washington, D. C.  
Established 70 years. Send sketches. Electrical, Aeronautical, Refrigeration and Chemical Inventions carefully handled. Practice before the U. S. Courts and the Patent Office. Prompt and careful service. Write us. Protect your inventions.  
**TRADE MARKS REGISTERED**

## Read Classified Advertising—It Pays

Advertisements in this section twenty-six cents a word for each insertion. Name and address must be included at the above rate. Cash should accompany all classified advertisements unless placed by an accredited advertising agency. No advertisements for less than 10 words accepted. Objectionable or misleading advertisements not accepted. Advertisements for these columns should reach us not later than 1st of 2nd month preceding issue.

### Agents Wanted

Guaranteed Genuine Gold Leaf Letters anyone can put on store windows. Large profits, enormous demand. Free samples. Metallic Letter Co., 422 N. Clark, Chicago.

### Business Opportunities

**FREE BOOK.** Start little Mail Order Business. Hadwilt, 38-A, 74 Cortlandt Street, New York.

### Correspondence Courses

Used correspondence school courses sold on repurchase basis. Also rented and exchanged. Money-back guarantee. Catalog free. (Courses bought.) Lee Mountain, Pisgah, Alabama.

**CORRESPONDENCE COURSES**—Sold, Bought, Exchanged, Rented. Bargain Catalogue Free. Handling, C-799 Broadway, New York.

### Detectives

**DETECTIVES.** Work home or travel. Experience unnecessary. Particulars free. Write George Wagoner, 2190-X Broadway, N. Y.

### For Inventors

**INVENTIONS COMMERCIALIZED.** Patented or unpatented. Write Adam Fisher Mfg. Co., 278 Enright, St. Louis, Mo.

### Miscellaneous

**JOSEF DE LILLE,** Radio Dealer, MALDEGEM (Belgium), asks representation for Belgium of the best standard American Radio Receiving Set. Bank Reference—Société Generale Belgique.

Used correspondence courses, reference libraries, trade guides bought, sold. Write today. Sell your used course, library, guides. Or take advantage of our many money saving offers. Send your request regarding study matter you have, need or want. Educational Service, Box 28, Wales, Wis.

### Patent Attorneys

**PATENTS**—Write for Free Information. **HOW TO OBTAIN A PATENT and RECORD OF INVENTION**—or send Drawing or Model for Examination, MILLER & MILLER, Patent Attorneys (former Patent Office Examiners), 1006-D Woolworth Building, New York, 262 McGill Building, Washington, D. C.

**PATENTS, TRADE MARKS**—All cases submitted given personal attention by a member of the firm. Information and booklet free. Lancaster, Allwine & Romel, 269 Ouray Building, Washington, D. C.

**PATENTS**—Advice and booklet free. Highest references. Best results. Promptness assured. Watson E. Coleman, Patent Lawyer, 724 9th Street, Washington, D. C.

**Inventors**—Should write for our Guide Book, "How to Obtain a Patent," and Record of Invention Blank, sent free. Send model or sketch of inventions for our inspection and instructions free. Radio, Electrical, Chemical, Mechanical and Trademark Experts. Terms Reasonable. Victor J. Evans & Co., 922 Ninth, Washington, D. C.

### Patents

**PATENTS**—Write to B. P. Fishburne, Registered Patent Lawyer, 587 McGill Building, Washington, D. C. Honorable Methods.

### Radio

Earn \$7 to \$10 spare time evenings servicing receivers. (No selling scheme.) Radio Doctors, Inc., 132 Essex St., Salem, Mass.

### Song Poem Writers

**SONGWRITERS!** Advance royalty payments, new talking picture song requirements, etc., fully explained in our free instructive booklet. Write today. Song poems examined free. Newcomer Associates, 1674-VV Broadway, New York.

**SONG-POEM** writers. We compose music. Guaranteed publisher's acceptance. National, 1475 WK, Broadway, New York.

### Wireless

**LEARN WIRELESS** (Radio) and Morse Telegraphy. School, oldest and largest, endorsed by Telegraph, Radio, Railway and Government officials. Expenses low—can earn part. Catalog free. Dodge's Institute, Cour St., Valparaiso, Ind.

## Backstage in Broadcasting

(Continued from page 1006)

British, German and Cuban numbers had been finding their way to prominent places on American broadcasting schedules. At luncheon, recently, we discussed the same subject with L. Wolfe Gilbert, the song writer, and found that he also realizes a change in the musical demands of the American radio public. Gilbert says that the radio has been suffering from too many saccharine love songs and is turning to the more serious vein offered by compositions of foreign origin. Lopez and Gilbert may be partially right, but we doubt whether the old-fashioned "I-love-you" song can be permanently displaced by the American public which dotes on sentiment. After all, the "I-love-you" theme means the same thing in any language. Looking over literal translations of foreign lyrics, we find that our popular song lyrics are mild indeed.

**T**HE battle for the radio control of the more important names in the concert world reached its height when the C. B. S. recently merged seven of the largest concert bureaus into a single subsidiary known as the Columbia Concerts Corporation.



George Engles

The N. B. C. retaliated by announcing the acquisition of the managerial rights to all recording artists contracted by the Victor Talking Machine Division of the Radio Corporation of America. These moves gave each network many of the most prominent names in the concert field. The acquisitions do not seem to make any material difference to the radio listeners who had already been hearing the renditions of the world's greatest artists. At this writing, we are experiencing the paradox hearing Columbia-controlled artists over the N. B. C. and N. B. C. artists over the C. B. S. There is, however, the prestige of billing artists in the concert halls as "Management, N. B. C. Artists' Service" or "Management, Columbia Concerts Corporation." Radio's monopoly of concert stars is practically complete. It is true that there are still some prominent artists who have eluded the radio microphone. But they are in the minority and it will only take time, abetted by the purses of commercial program sponsors, to bring these stray sheep into the radio fold. Arthur Judson, prominent concert manager, has been named president of the Columbia Concerts Corporation, while George Engles, N. B. C. vice-president, continues as head of the N. B. C. Artists' Service.

## What's New in Radio

(Continued from page 1007)

the base of the telephone and an ordinary screw-driver is the only tool necessary to accomplish the installation. The instructions furnished with the device show clearly the simple connections to be made.

**Usage**—To eliminate radio interference caused by the operation of dial telephones.

**Maker**—Tobe Deutschmann Corp., Canton, Mass.

## All in the Day's Work

(Continued from page 1014)

with the home recording feature—such as poor quality, no volume, and so forth. In the majority of instances these troubles may be laid to the inexperience of the parties trying out home recording for the first time. I cured several complaints by scraping off the red paint on the recording needle, and seeing that it was tight in the chuck. Also the mike must be held straight. If the carbon has packed due to improper handling, it may be loosened by a gentle tap.

### Moderate Tone Most Effective

"In making recordings, it was found in several instances that a moderate tone of voice, or radio volume, was more effective than an excessive amount. In recording several voices, a horn, roughly rolled from a piece of cardboard and placed in front of the microphone, is effective. Always be sure to disconnect the mike after using, or it may become permanently packed and definitely injured.

"The use of good carbon volume controls has done much to eliminate this part as a source of trouble. However, I've run into several 15's in which the side of the volume control affecting the bias became noisy in spots. The obvious replacement cured this."

## 15- to 550-Meter Superheterodyne

(Continued from page 1037)

ford, England, G5SW on 25.53 meters, which is frequently received in the eastern part of the United States, would fall around 60 on the dial when the 15-32 meter coil is used.

One of the outstanding advantages of short-wave reception in the DeLuxe SW-31 is its ability to bring in distant reception in daytime. The high amplification and sensitivity which has been so valuable in bringing in distant stations on the broadcast band is again augmented by the fact that the higher frequencies from 15 to 49 meters can be brought in with far greater intensities from extreme long distances during the daylight hours.



# Setting the "Feed-Back" Whistle to Music

(Continued from page 979)

condensers, which provides a different capacity for each tone. Keys were arranged so that the capacity giving the desired pitch could be cut into the circuit by depressing the proper key. The correct value of capacity for each tone was originally determined by the trial and error method. A decade condenser box, a small stack of fixed condensers and a musical ear were at hand for the tuning process which

from a tuning fork for example, and to which we are more accustomed, but it really isn't so very different after all.

Figure 3c shows the kind of wave shape given by the "organ" in actual practice. This is because the circuit is out of "balance" more or less for all of the tones. The one coupling condenser is varied to secure the various tones while the other (C0) is left fixed at an intermediate value.

Figure 3. (a) A sine wave (tuning fork). (b) Rectangular wave (electric organ with condensers equal and resistors equal). (c) Trapezoidal wave (electric organ with condensers unequal or resistors out of balance)

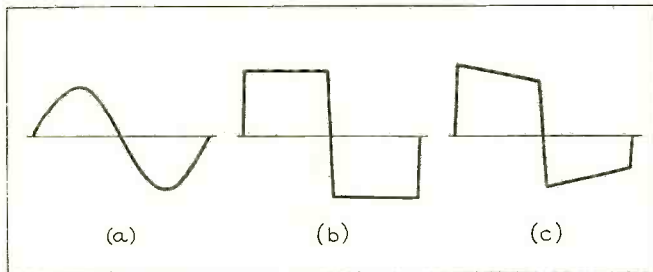

turned out to be fairly simple. Because of greater ease of capacity variation the condenser box was used first to get the various tones, and it was then replaced by fixed capacities in each case. The condenser values given in the figure are not exact but within about 10%.

### Determining Pitch

The pitch of the tone emitted by the "organ" is determined by the capacities of C1 and C0 and the values of r1, r2, r3 and r4 in Figure 1. It can be lowered by increasing either the capacity or the resistance values. If these condenser values are equal to each other and the resistance values are all equal the wave shape produced by the "organ" will be rectangular as shown by an oscillograph, which is merely a piece of apparatus for taking a picture of an electrical wave. See Figure 3b. It looks quite a bit different from a sine wave, Figure 3a, such as emitted

The effect of the "unbalance" on quality is hardly noticeable to the ear.

### Automatic Playing Device

The automatic playing device consists of a small a.c. motor which revolves a large metal drum through a set of reduction gears. Contacts were made of six-inch lengths of springy wire, one of which touches the drum continually. A music roll was made by cutting properly located holes in a wide piece of tape which was then placed on the drum. Each of the contacts for the eight different tones has its own row of perforations.

That much desired tremolo effect can even be produced. The body capacity of the player will cause it if a light varying contact is made with a finger of one hand on any part of the circuit while the other plays the aluminum keys, encased in a glove for insulation purposes.

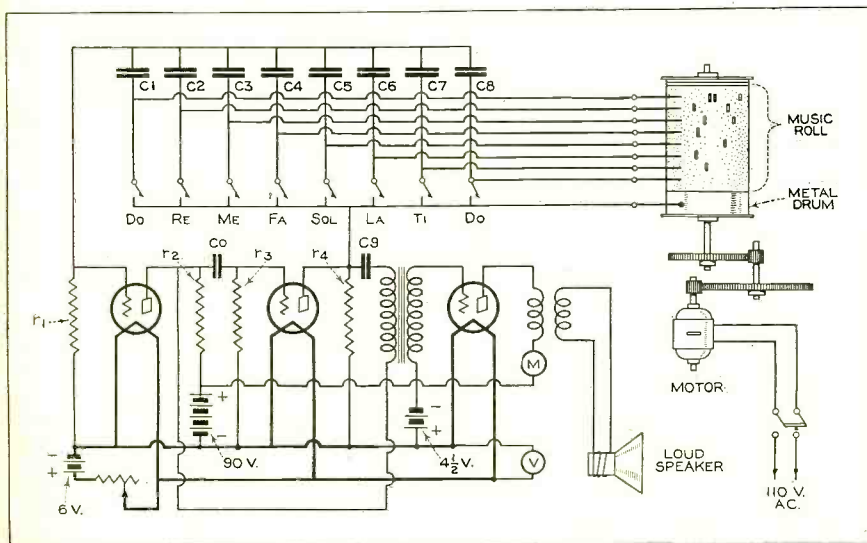

Figure 2. The complete electric organ.  $r_1 = r_2 = r_3 = r_4 = 100,000$  ohms.  $C_0 = .004 \pm 10\%$ ;  $C_1 = .006 \pm 10\%$ ;  $C_2 = .005 \pm 10\%$ ;  $C_3 = .0041 \pm 10\%$ ;  $C_4 = .0035 \pm 10\%$ ;  $C_5 = .003 \pm 10\%$ ;  $C_6 = .00285 \pm 10\%$ ;  $C_7 = .0025 \pm 10\%$ ;  $C_8 = .00215 \pm 10\%$ ;  $C_9 = 2$  mfd.

## Its popularity DEMANDS A SECOND EDITION

THE radio industry moves by leaps and bounds. New circuits and new refinements call for additional information. The NEW VOLUME CONTROL guide incorporates these additions. Send 25c for the second edition, which shows how a mere handful of CENTRALAB volume controls enables you to service practically any old or new set. Mail the coupon today.

## Centralab



CENTRAL RADIO LAB.  
922 Keefe Ave., Milwaukee, Wis.

Here is 25c. Send me new VOLUME CONTROL GUIDE.

Name .....

Address .....

City ..... State ..... R. News

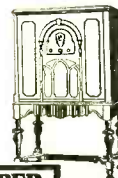

TRY IT 30 DAYS FREE BEFORE YOU BUY

Factory to you. Save to 50% on latest Screen Grid Electric or Battery Radio. Get "Send No Money Offer."

### MIRACO Radio

Amazing bargains direct from big, old reliable factory. Don't buy unless 30 days' use proves entire outfit unbeatable at up to twice our price for tone, selectivity, distance, power, 1 yr. guar.

FREE! Send for BIG SPECIAL OFFER - No obligation.

Midwest Radio Corporation  
11th Successful Year  
804-DM, Miraco Dept., Cincinnati, Ohio

SUPER Screen Grid \$49.88 Complete less tubes

## Massachusetts Radio and Telegraph School

18 Boylston Street, Boston

Send for Catalogue

Tel. Hancock 8184 Established 1905

### DEALERS AND SERVICEMEN

Have you received your copy of our latest 1931 WHOLESALE RADIO CATALOG, showing Superior Radio Values?

Every Item a Special  
Send for it today

DIXON RADIO & ELECTRIC CORP.  
110 East 23rd Street New York City

# What's NEW in RADIO?

How would you like to be posted on the new things and new developments in radio, just as soon as they come out? How would you like to receive mail from the country's leading radio manufacturers, wholesale radio mail order houses and publishers in the radio industry? How would you like to have access to the most complete radio data files ever compiled, containing all the important facts in every phase of radio progress? How would you like to receive regularly, catalogs, folders, circulars, price lists, bulletins, samples galore, etc., keeping you in close touch with the happenings in the radio industry for an entire year? This is only part of our complete service to you.

Would you like to locate a manufacturer of a certain product? Would you like to know the name of a jobber near you handling some particular item you may be interested in? Let us solve these questions for you.

No live radio dealer, fan, amateur, experimenter or professional can afford to be without our comprehensive service.

**This Handy Practical Portfolio  
FREE!**

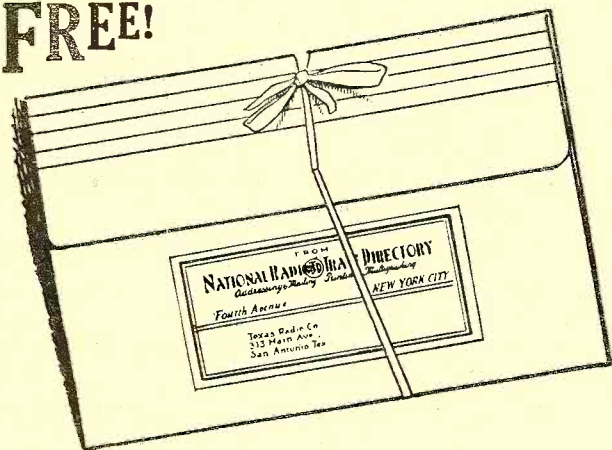

Our business is the nerve center of the radio industry, reaching out everywhere, collecting data from every available source, maintaining the most complete of its kind in the world.

**all \$1  
for**

You will realize that the amount we spend for postage alone does not cover the charge for our service. The \$1 subscription fee barely pays the necessary expenses entailed in mailing.

A subscription to our service will actually save you many times the small cost of \$1.00.

If there is any additional information you may require before subscribing, write for further details.

Every subscriber to our service receives one of these 10 by 12 inch accordion portfolios made of a durable material, in which to save the valuable data we send you.

**National Radio Trade Directory**  
23rd Street and Fourth Avenue  
New York

**Just Pin  
Dollar  
Bill to this  
form, fill  
in and  
mail at  
once!**

NATIONAL RADIO TRADE DIRECTORY  
303 Fourth Ave., Dept. N  
Gentlemen:

Date.....

Enclosed please find \$1.00 for one year's subscription to your "Big Mail" and "Radio" Information Service. It is understood that you are to put my name on your stencil list to receive mailings, including catalogs, bulletins, price lists, samples, etc. I am also to receive free a 10 by 12 inch accordion portfolio.

NAME ..... ADDRESS .....

CITY ..... STATE .....

The Most Fascinating Radio Book of the Year!



The Latest Most Authoritative Information Available on **SHORT WAVES**

5 Big Months of **RADIO NEWS** for **\$1.00** and this valuable book **Free**

**T**HE thrill of the Short Waves! It's like the invention of radio all over again. If you've ever decoded messages straight from South Africa or Australia—if you've ever known the kick of getting Europe or Little America direct—if you've ever had SW chats with friends hundreds of miles away, then you know what we mean.

The Short Waves are opening up a tremendous new field of amazing possibilities. An entirely new world of experimenting, of thrills, of new experiences with these miraculous SWs lies ahead.

Because you and thousands of other radio men want to keep posted on all the latest wrinkles on Short Waves, the Technical Staff of RADIO NEWS has especially prepared a complete new, up-to-the-minute SHORT WAVE MANUAL.

Its twenty-three chapters, replete with illustrations, diagrams, charts and plans, bring you the results of years of research work by the foremost authorities in the field—the last word in authentic SHORT-WAVE data. Many of the chapters were especially written by that famous

SW expert, Lieut. W. H. Wenstrom. You will be fascinated with such features as:

- Breaking Into Amateur Transmitting SW Transmitter for the Average Home and Purse
- A Portable SW Transmitter and Multi-wave Receiver
- For Real Thrills Get Down in the Amateur Wave Bands
- Ready for a Short-Wave Chat
- Getting the Most from Your SW Transmitter
- Some Experiments on Ultra-High Frequencies
- Short-Wave Stations of the World

It is one thing to pound the key of a short-wave transmitter and hope to high heaven that your signals are "getting out." It is another thing to understand intelligently the conditions under which perfect results are secured and how to get the most out of Short Waves.

Here is the book that explains everything—that describes and illustrates all the new inventions and improvements—that gives you the complete and latest SW data. In short, here's just the book you want!

Many radio men have paid a substantial price for this book, but you may have it **FREE!** And besides save on your special 5 months' subscription to RADIO NEWS!

**FREE**

You may secure the SHORT WAVE MANUAL without cost with a subscription to RADIO NEWS. See coupon below.

**Mail Coupon TODAY!**

RADIO NEWS, Dept. 2405  
381 Fourth Avenue, New York, N. Y.

Ship me ENTIRELY FREE the new SHORT WAVE MANUAL and enter my subscription for the next five big issues of RADIO NEWS at the special price of only \$1.00 which I enclose (regular newsstand price \$1.25).

Name .....

Address .....

City and State .....

Are you a Serviceman ? Engineer ? Dealer ? Experimenter ?

Present subscriptions will be extended from expiration.

## Follow the Direct Road to Success

Do you want a better position and a larger pay envelope? There is just one way to win success—be head and shoulders above your fellows by gaining a broader basic education. Mathematics is the basis of all education. Not a day passes in which you do not have to use mathematics in your work. Do you make your own calculations, or are you handicapped by your inability to do this work yourself? Here is the whole secret of success. This is why mathematics is taught in every school and college. A thorough knowledge of it makes clear so many things which are puzzling you today.

Do not let another day pass without doing something to improve your knowledge of mathematics. But how can you obtain this knowledge? By going back to school or college, or taking an expensive correspondence course? You need do neither!

## At Last! Mathematics Self-Taught This Simple, Easy Way!

Now you can take advantage of this easy method which has been worked out by an expert for those who do not wish to give the time and money required by other methods of mathematical study. A very simple and extremely interesting group of books has been prepared for you by a man who has devoted his life to teaching practical men the fundamentals of this important subject.

# MATHEMATICS FOR SELF STUDY

By J. E. Thompson, B.S. in E.E., A.M.  
Dept. of Mathematics, Pratt Institute, Brooklyn

These books start right from the beginning with a review of arithmetic that gives you all special short-cuts and trick problems that save countless hours of your time and make you more valuable to yourself and your job. Then they go right into higher mathematics and show you how simple it is when an expert explains it for you. Don't let appearances fool you, mathematics is *easy*. You can get these books on approval and see for yourself how much enjoyment you can have while getting this valuable training and solving interesting practical problems that puzzle your friends and fellow-workers. In no time at all you will be tackling with ease the most difficult question on this subject.

### A Complete Reference Work on Mathematics in These Four Inexpensive Books

Starting from the first simple principles, these interesting books take you, by easy stages, into the detailed applications of higher mathematics. Each step is clearly explained and is followed directly by sample problems.

**Arithmetic for the Practical Man**  
**Algebra for the Practical Man**  
**Trigonometry for the Practical Man**  
**Calculus for the Practical Man**  
4 Volumes—1240 Pages—Illustrated

### An Expert Gives You These Simplified Methods

Mr. Thompson, the author of these books, is not an ordinary teacher of mathematics. He has had many years' experience in giving students the kind of mathematical training they need in practical work. He presents each practical method and problem in the clearest and simplest way. He gets right down to the kind of information that you need in your daily work. Look up any mathematical problem that puzzles you in these books and see how quickly you get the solution.

## Send No Money

### Examine These Books for 10 Days FREE!

The coupon below brings you the four books for 10 days' free trial. After 10 days, return the books to us without obligation or send us the small down payment of \$1.65—balance in three monthly payments of \$2.00 each (5% discount for cash).

### MAIL THIS COUPON

D. Van Nostrand Co., Inc.  
250 Fourth Ave., New York

Send me MATHEMATICS FOR SELF STUDY in 4 volumes. Within 10 days I will either return the books or send you \$1.65 as first payment and \$2.00 per month for 3 months—total, \$7.65. (5% discount for cash.) (R. N. 5-31)

Name .....

Address .....

City and State .....

Business Connection ? .....

Reference .....

## The Latest Data!

**Complete and up-to-date information covering the entire field of radio—all arranged for ready reference in this one big guide book.**

**BYRD'S Antarctic Radio Equipment**—Receivers, transmitters, and latest navigation aids used on this epochal flight fully described.

**TELEVISION**—Mr. C. F. Jenkins, father of television and radio movies, gives you in his own words complete directions for building practical television equipment.

**INTERFERENCE ELIMINATION**—New methods systematically outlined by W. F. Fleming, radio engineer.

**RADIO AUTO ALARM**—Description of new device for ships which keeps the SOS watch while operator is off duty.

**SHORT WAVE APPARATUS**—Commercial and amateur, described and illustrated.

**NEW BROADCASTING EQUIPMENT**—Temperature-controlled Piezo crystal oscillator; 100% modulation panel and other new apparatus. —and these are only a few of the new subjects added to the most complete radio handbook ever published.

## THE RADIO MANUAL

**A Handbook for Students, Amateurs, Operators, and Inspectors**



Here's the answer to every question about the principles, operation, and maintenance of apparatus for radio transmitting and receiving. Important new chapters have been added to bring it right up to the minute. Many new photographs and diagrams have been included. It is now more than ever the one complete handbook covering the entire radio field.

**A Complete Course in Radio Operation in ONE VOLUME**

### Prepares for Government License

20 big chapters cover: Elementary Electricity and Magnetism; Motors and Generators; Storage Batteries and Charging Circuits; The Vacuum Tube; Circuits Employed in Vacuum Tube Transmitters; Modulating Systems and 100% Modulation; Wavemeters; Piezo-Electric Oscillators; Wave Traps; Machine Vacuum Tube Transmitters; Radio Broadcasting Equipment; Arc Transmitters; Spark Transmitters; Commercial Radio Receivers; Marconi Auto-Alarm; Radio Beacons and Direction Finders; Aircraft Radio Equipment; Practical Television and Radio Movies; Eliminating Radio Interference; Radio Laws and Regulations; Handling and Abstracting Traffic.

### Prepared by Official Examining Officer

The author, O. E. Sterling, is Radio Inspector and Examining Officer, Radio Division, U. S. Dept. of Commerce. The book has been edited in detail by Robert S. Kruse, for five years Technical Editor of QST, the Magazine of the American Radio Relay League, now Radio Consultant. Many other experts assisted them.

### Examine It FREE!

The revised edition of "The Radio Manual" is now ready. Nearly 800 pages, 369 illustrations. Bound in flexible fabricoid. The coupon brings the volume for free examination. Within 10 days you may return the volume or send the price of \$6.00.

### MAIL THIS COUPON

D. Van Nostrand Co., Inc.  
250 Fourth Ave., New York

Send me the latest edition of THE RADIO MANUAL for examination. Within ten days after receipt I will either return the volume or send you \$6.00, the price in full. (R. N. 5-31)

Name .....

St. and No. ....

City and State .....

Business Connection .....

Reference .....