

RADIO NEWS

**APRIL
25 Cents**

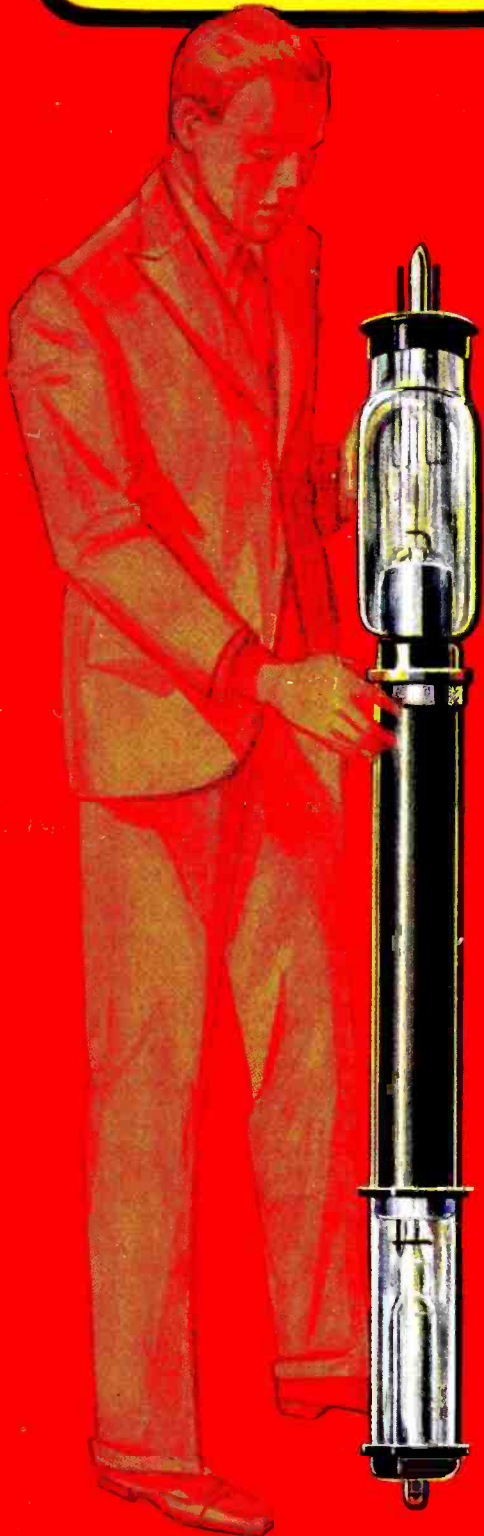

**The Giant Tube
KDKA is Using in Its
400 Kilowatt Station**

**Increasing the Service Area
of Broadcasting Stations**

**Photoelectric Cells—
What They Are and
Where They Are Used**

**The Service Bench—A
Department for Servicemen**

The Stenode and the Amateur — by Humfrey Andrewes

SM

We Honestly Believe A Million Dollars Wouldn't Build a Finer Tuner!

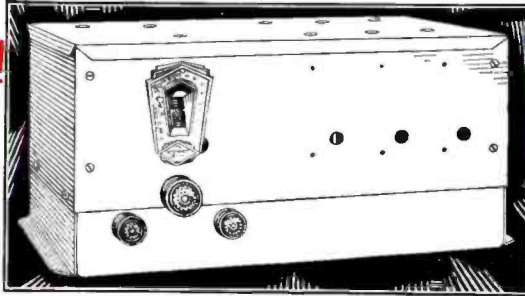

The S-M 714 Superheterodyne Tuner was designed to be the finest radio tuner it is possible to build. Citizens Radio Call Book Magazine says in its spring edition: "It is the most sensitive and selective tuner that has yet been measured by our engineers."

A stock model in the Silver-Marshall main laboratory at Chicago brought in ninety-three stations, one after another, including Cuba, Mexico City, and every station on the west coast that was on the air!

In ideal locations you will get reception on every channel. In any location it will give better reception than any other radio on the market! When operated with a 677B amplifier and an 851 speaker, its tone is beyond compare.

The 714 utilizes eleven tuned circuits (over twice as many as the most expensive t.r.f. sets): two in a dual-selector, precede the first '24 r.f. tube, two are between the r.f. and '24 first detector, and one is in the '27 oscillator circuit. It uses a factory-aligned and tested screen-

grid i.f. amplifier, having in itself six tuned circuits. Size: 16½" long, 8½" high, 9½" deep.

Tubes required: 4-'24s, 2-'27s.

Price (tuner only), completely factory wired, tested and RCA licensed, less tubes\$87.50 list

Component parts total.....\$76.50 list

The 714 Superheterodyne Tuner can be used with any standard audio amplifier but operates at its maximum with the S-M 677B. It is a combination two-stage amplifier and power supply, furnishing the necessary heater and plate supply for the 714. It takes its power from any 105-120 volt, 50-60 cycle source. Tubes required: 1-'27, 2-'45s, 1-'80.

Size: 21" long, 5¾" wide, 5¼" high.

Price of 677B, completely factory-wired, tested and licensed, less tubes\$82.50 list

Component parts total.....\$68.50 list

851 Electro-dynamic Speaker\$33.50 list

A Short-Wave Converter That Gets Them!

The S-M 738 Converter turns any broadcast receiver into a short-wave superheterodyne with a range of from two to ten thousand miles, for to the sensitivity and selectivity of your broadcast set is added the power of three more tubes.

There is nothing that the most expensive commercial short-wave receiver will do, in the way of distance, that the 738 will not duplicate and beat—and at one-third the cost. Under favorable weather and local receiving conditions, it will bring in every American short-wave broadcaster and the principal foreign stations.

It is built in a beautiful black crystalline case with a hammered silver dial—entirely at home in the finest living-room.

The wired model can be hooked up in three minutes—you merely remove the antenna lead from the broad-

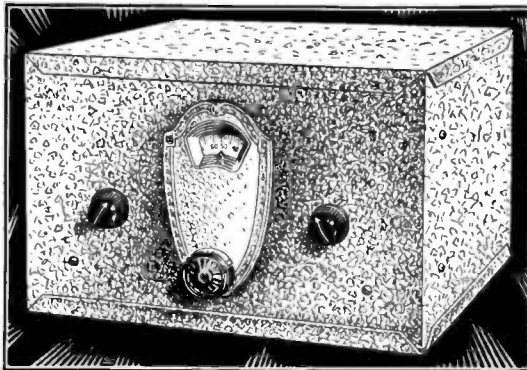

cast receiver and connect it to the antenna post of the converter; then run two leads from the 738 to the antenna and ground posts of the broadcast set—and tune it in. A switch can be easily arranged to throw the set from long to short waves at will.

It tunes by a single dial (which tunes the oscillator circuit) and an auxiliary midget condenser.

It will give, in addition to short-wave broadcasting, phone and i.c.w. where there is any carrier modulation at all.

Included in the list price are eight coils (four pairs) which cover a wave length range of from 18 to 206 meters.

Tubes required: 1-'24, 1-'26, 1-'27.

Price, completely factory-wired, tested and RCA licensed, less only tubes.....\$69.50 list

Component parts total.....\$59.50 list

Silver-Marshall, Inc., 6405 W. 65th St., Chicago, U.S.A.

Send me, free, your 1931 CATALOG with sample copy of the RADIOBUILDER. Also Data Sheets as follows: (Enclose 2c for each Data Sheet desired.)

No. 25. 714 Screen-Grid Superhet Tuner.

No. 20. 677B Amplifier.

No. 23. 738 Short-Wave Superhet Converter.

Name.....

Address.....

Check the coupon for your copy of the Silver-Marshall 1931 General Parts Catalog. Fill in the coupon for a sample copy of the S-M publication—the Radiobuilder

SILVER-MARSHALL, Inc.
6405 West 65th Street • Chicago, U. S. A.



RADIO NEEDS TRAINED MEN
Let Us Train You at Home for a Big-Pay Job

GET into the rich field of Radio via the Radio Training Association. Radio manufacturers, distributors, dealers are all eager to employ our members because we train them right, and qualify them for the positions that require better trained men.

So great is this demand from Radio employers that positions offering good pay and real opportunity are going begging. If you want to cash in on Radio quick, earn \$3.00 an hour and up spare time, \$40 to \$100 a week full time, prepare for a \$10,000, \$15,000, \$25,000 a year Radio position, investigate the R. T. A. now.

Special Attention to Radio Service Work

Thousands of trained Radio Service Men are needed now to service the new all-electric sets. Pay is liberal, promotions rapid. The experience you receive fits you for the biggest jobs in Radio. The R. T. A. has arranged its course to enable you to cash in on this work within 30 days!

Would you like to work "behind the scenes" at Hollywood, or for a talking picture manufacturer? R. T. A. training qualifies you for this work. Television, too, is included in the training. When television begins to sweep over the country, R. T. A. men will be ready to cash in on the big pay jobs that will be created.

**Expert Supervision
 Lifelong Consultation Service**

As a member of the Association you will receive personal instruction from skilled Radio Engineers. Under their friendly guidance every phase of Radio will become an open book to you. And after you graduate the R. T. A. Advisory Board will give you personal advice on any problems which arise in your work. This Board is made up of big men in the industry who are helping constantly to push R. T. A. men to the top.

Because R. T. A. training is complete, up-to-date, practical, it has won the admiration of the Radio industry. That's why our members are in such demand—why you will find enrolling in R. T. A. the quickest, most profitable route to Radio.

Mail Coupon for No-Cost Training Offer

Memberships that need not—should not—cost you a cent are available right now. The minute it takes to fill out coupon at right for details can result in your doubling and trebling your income in a few months from now. If you are ambitious, really want to get somewhere in life, you owe it to yourself to investigate. Learn what the R. T. A. has done for thousands—and can do for you. Stop wishing and start *actually doing something* about earning more money. Fill out the coupon and mail today.

Radio Training Association of America
 Dept. RNA-4, 4513 Ravenswood Ave., Chicago, Ill.

Fill Out and Mail Today!

RADIO TRAINING ASSOCIATION OF AMERICA
 Dept. RNA-4, 4513 Ravenswood Ave., Chicago, Ill.
 Gentlemen: Send me details of your No-Cost Training Offer and information on how to make real money in Radio quick.

Name _____

Address _____

City _____ State _____

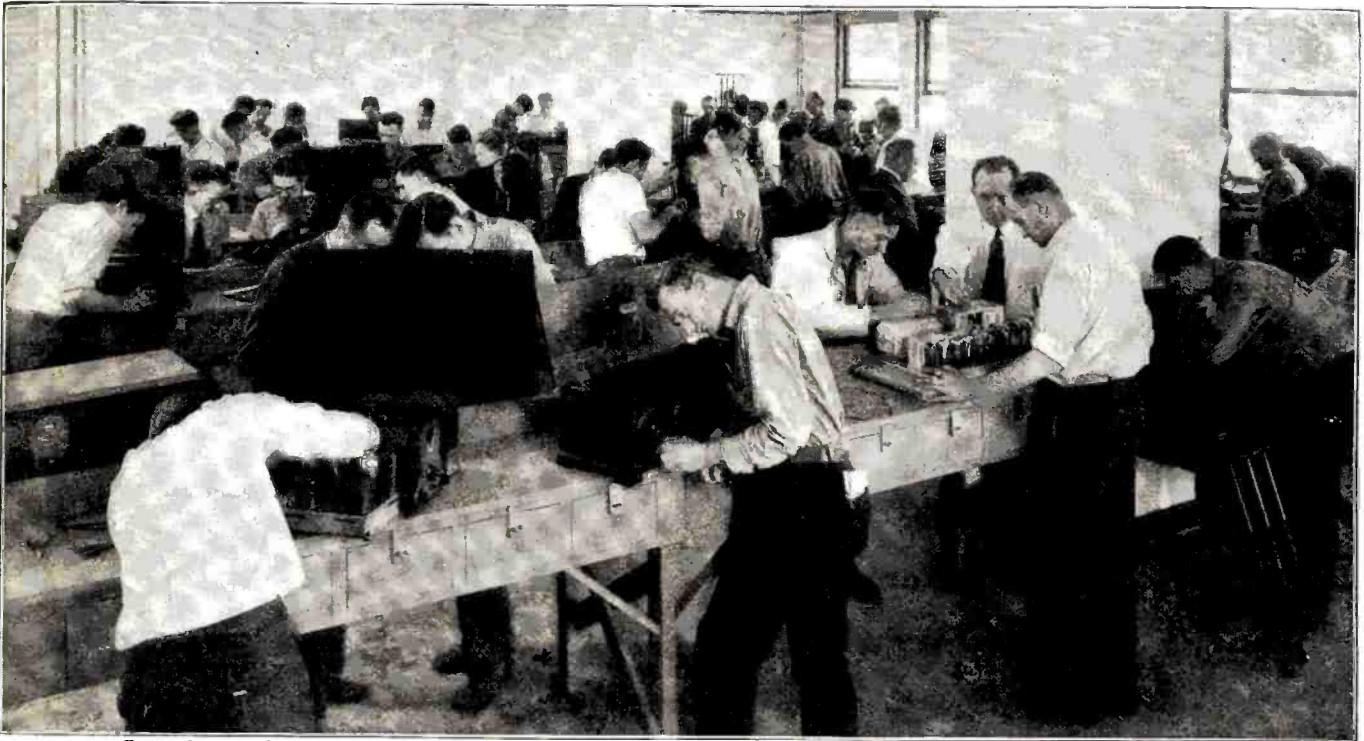

General view of one section of our Service Department, showing students doing actual work on various Radio Receivers

LEARN RADIO~TELEVISION NOT By BOOKS or CORRESPONDENCE-By

Don't spend your life slaving away in some dull, hopeless job! Don't be satisfied to work for a mere \$20 or \$30 a week. Let me show you how to make real money in Radio—the fastest-growing, biggest Money-Making Game on earth!

Golden Opportunities Paying \$60, \$70 and Up a Week

Jobs as Designer, Inspector and Tester paying \$3,000 to \$10,000 a year—as Radio Salesman and in Service and Installation Work, at \$45 to \$100 a week—as Operator or Manager of a Broadcasting Station at \$1,800 to \$5,000 a year—as Wireless Operator on a Ship or Airplane, as a Talking Picture or Sound Expert—THOUSANDS of OPPORTUNITIES LEADING to SALARIES of \$60 A WEEK AND UP!

NO BOOKS .. NO LESSONS All Practical Work

Coyne is NOT a Correspondence School. We don't attempt to teach you from books or lessons. We train you on the finest outlay of Radio, Television and Sound equipment in any school—on scores of modern Radio Receivers, huge Broadcasting equipment, the very latest Television apparatus,

Talking Picture and Sound Reproduction equipment, Code Practice equipment, etc. You don't need advanced education or previous experience. We give you—right here in the Coyne shops—all the actual practice and experience you'll need. And because we cut out all useless theory, you graduate as a Practical Radio Expert in 10 weeks' time.

TELEVISION IS NOW HERE!

And Television is already here! Soon there'll be a demand for Thousands of Television Experts! The man who learns Television now



Instructor explaining principles and operation of a Talking Picture Machine

MAIL COUPON ON OPPOSITE PAGE



Students operating our modern Broadcasting equipment. In the rear you can see our Sound Proof Studio Room

TALKING PICTURES in 10 WEEKS

Actual Work - In the Great Shops of Coyne

can make a FORTUNE in this great new field. Get in on the ground floor in this amazing new Radio development! Come to COYNE and learn Television on the very latest Television equipment.

Talking Pictures .. A Great Field

Talking Pictures and Public Address Systems offer thousands of golden opportunities to the Trained Radio Man. Here is a great new field of Radio work that has just started to grow! Prepare now for these marvelous opportunities! Learn Radio Sound work at Coyne on actual Talking Picture and Sound Reproduction equipment.

EARN AS YOU LEARN

You get Free Employment Service for life. And don't let lack of money stop you. If you need part-time work while at school to help pay living expenses, we will gladly help you get it. Many of our students pay nearly all of their expenses that way. You can find out everything absolutely free by simply mailing the coupon below.

COYNE IS 32 YEARS OLD

Coyne Training is tested, proven beyond all doubt.

You can find out everything absolutely free. How you can prepare for a good job or how you can go into business for yourself and earn from \$3,000 to \$15,000 a year. It costs nothing to investigate! Just mail the coupon for your copy of my big Free book!

H. C. Lewis, Pres. RADIO DIVISION Founded 1899

COYNE ELECTRICAL SCHOOL

500 S. Paulina St., Dept. 41-8C, Chicago, Illinois

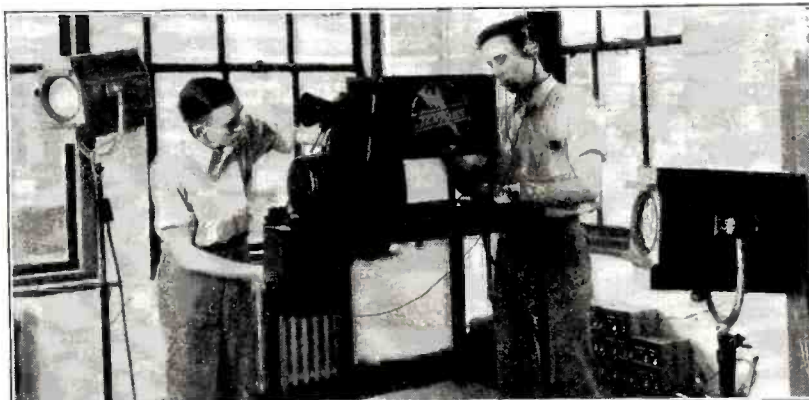

Students operating and adjusting our modern Television Transmitting equipment

FOR BIG FREE BOOK

Name

Address

City State

LAURENCE M. COCKADAY
Editor
 ALBERT PFALTZ
Associate Editor



S. GORDON TAYLOR
Technical Editor
 CARL DORF
Associate Editor

VOLUME XII

April, 1931

NUMBER 10

CONTENTS

(Cover Designed by David Hymes)

Frontispiece	PAGE 870	Mobile Radio Services	
Editorial	PAGE 871	By Carl Butman	PAGE 895
KDKA—Radio's New Voice		Radio News Standard Circuits.....	PAGE 897
By Albert Pfaltz	PAGE 872	Mikro-scopes	
The Companion Receiver		By Harriet Menken	PAGE 898
By A. G. Heller	PAGE 877	Midget Condensers	
Making National Broadcast Coverage Direct		By Donald Lewis	PAGE 899
By Lt. Wm. H. Wenstrom	PAGE 878	Vagaries of Short Waves	
All-Wave A.C. Superheterodyne DeLuxe		By Thomas A. Marshall	PAGE 902
By H. J. Cox	PAGE 882	Talking Movies	
Brass Pounding on the Pan-Am Trail		By Charles Felstead	PAGE 904
By Zeh Bouck	PAGE 885	Amateur Radio	
Pickup Characteristics		By A. D. Middleton	PAGE 906
By S. McClatchie.....	PAGE 888	Junior Transmitter—Part Four	
Testing the New Circuit		By Don Bennett	PAGE 908
By Humphrey Andrews	PAGE 890	The Service Bench	
Army's Amateur Radio System		By Zeh Bouck	PAGE 910
By David Talley	PAGE 892		

DEPARTMENTS

What's New in Radio.....	PAGE 913
In The Radio News Laboratory.....	PAGE 914
Home Laboratory Experiments.....	PAGE 916
Manufacturers' Receiver Circuits.....	PAGE 918
Junior Radio Guild.....	PAGE 920
Radio News Information Sheets.....	PAGE 922

Published Monthly by Radio-Science Publications, Inc., Jamaica, N. Y.

OFFICERS

W. Z. Shafer, *President*
 G. L. Harrington, *Vice President*
 Laurence A. Smith, *Treasurer*
 Byrd D. Wise, *Secretary*

EDITORIAL AND EXECUTIVE OFFICES

381 FOURTH AVENUE, NEW YORK CITY, N. Y.

Entered as second class matter at the Post Office at Jamaica, N. Y., under the act of March 3, 1879. Copyright, 1931, by Radio-Science Publications, Inc. All rights reserved. Title Registered at the U. S. Patent Office. Printed in the United States of America. The contents of this magazine must not be reproduced without permission. We cannot be responsible for lost manuscripts, although every care is taken for their safety.

25c a Copy, \$2.50 a year,
 \$3.00 in Canada, \$3.50 in
 Foreign Countries. Sub-
 scribers are notified that
 change of address must reach
 us five weeks in advance of
 the next day of issue.

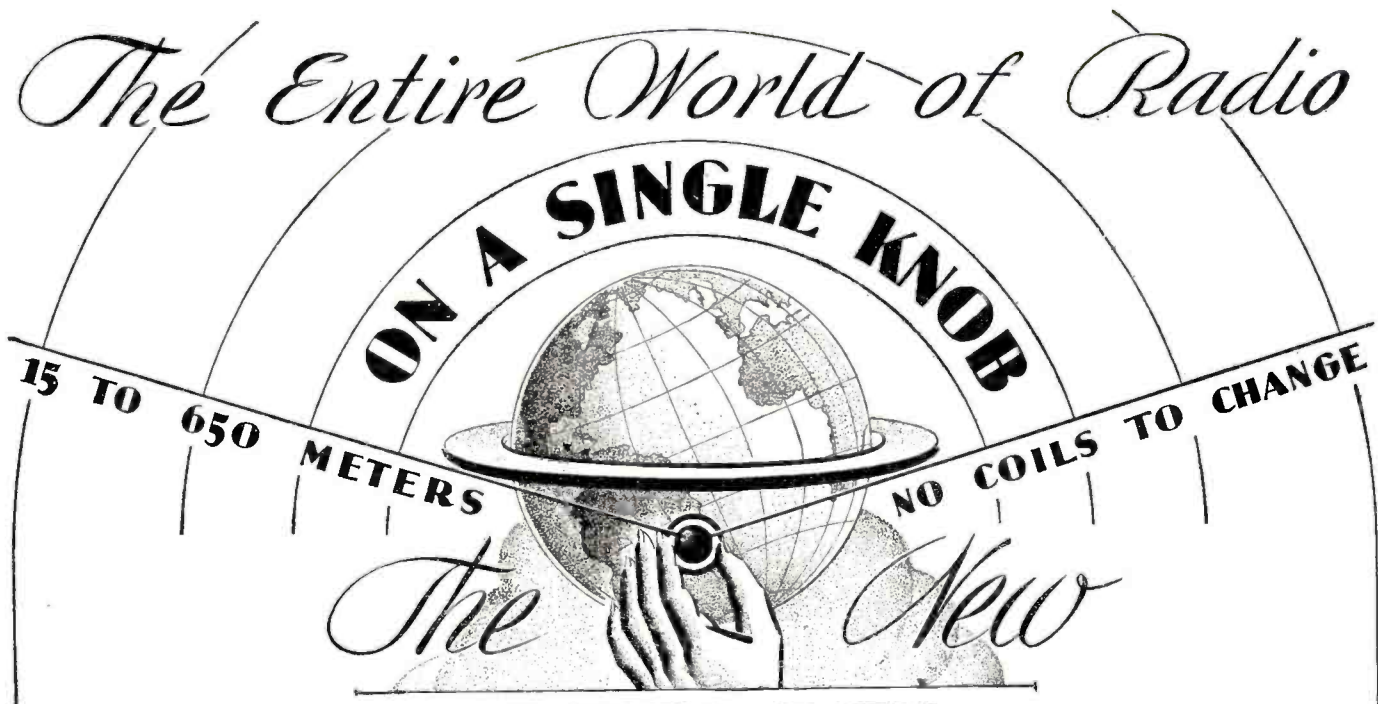

PILOT UNIVERSAL SUPER WASP RECEIVER

Pilot's wonderful wave band changing switch, incorporated in the new Universal Super-Wasp, revolutionizes the short wave art. No longer need numerous coils be changed to cover the various wave bands. No longer need dial settings change each time the same distant stations are tuned in. You can log permanently all the stations you can get throughout the world, you can tune from the short waves to the high ship waves without removing your hand from the single control knob.

Universal Features Revolutionizing the Short Wave Art

Complete coverage all wave bands from 15 to 650 meters *without coil changing*. Complete A.C. operated chassis in cabinet. (Also available in battery model) All Metal Chassis.

Highly sensitive and selective circuit. Screen Grid TRF amplifier plus Screen Grid Detector.

227 First Audio Stage.

Two 245's in push-pull output stage.

Stations can be logged *permanently on dial*.

Regeneration control does not alter tuning.

Provision for *Phonograph Pick-up*.

Earphone Jack on *Front Panel*.

Illuminated Dials.

Handsome Walnut Cabinet.

Most advanced construction yet used for short wave work.

In kit form for easy home assembly; no drilling or cutting, all parts fully prepared.

What You Can Get on the UNIVERSAL Super-Wasp

On the short waves are hundreds of relay broadcasting, experimental and amateur stations transmitting voice and music; actually thousands of amateur and commercial stations sending code; numerous trans-oceanic and ship-to-shore telephone stations; dozens of television transmitters; and police radiophone stations in many cities.

On the broadcast ranges, the Universal Super-Wasp covers the full maximum and minimum limits, bringing in broadcasts never heard on the average broadcast receiver.

Above broadcast ranges, the Universal brings in ship and shore stations on 600 meters.

What other receiver offers you as much radio with as little effort?

Ask your dealer for a demonstration!

NOTICE TO "HAMS": Pilot will continue building the original Super-Wasp in kit form for licensed amateurs and others who want to spread the tuning on their pet wave bands and add their own audio features. A. C. and battery models.

Pilot Universal Super Wasp \$79⁵⁰ A.C. Model (K-136) in Kit Form

PILOT RADIO & TUBE CORP., Lawrence, Mass.



Chicago: 234 S. Wells St.

New York: 525 Broadway

San Francisco: 1278 Mission Street

OFFICES IN PRINCIPAL COUNTRIES OF THE WORLD

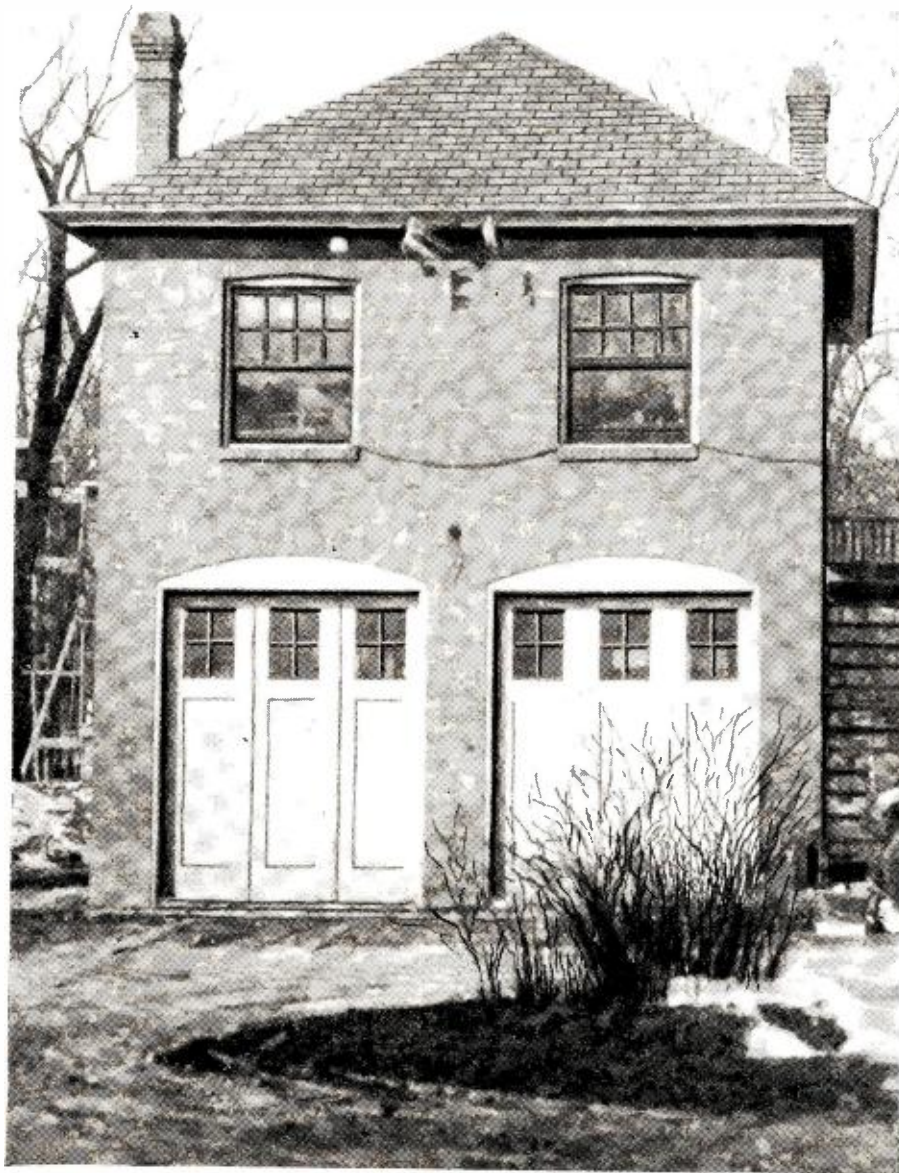

Home of Early Radio Experiments

UPSTAIRS in this garage in the Pittsburgh suburbs was housed a forerunner of our modern broadcasting stations. Here in his amateur station Dr. Frank Conrad carried the experimental development of radio-telephone equipment to a degree which permitted the broadcasting of programs on regular schedule to such amateurs as were equipped with radio receivers. Later these activities were transferred to the roof of the Westinghouse plant, where on November 2, 1920, the first commercial broadcasting was inaugurated from the station which subsequently became KDKA.

The Editor—to You

To You—this issue of the magazine we hope, will be of more than usual interest and helpfulness. We believe that as you thumb these pages you will halt a number of times, no matter what your interest in radio is, no matter in what field of radio you have hewn your own particular niche, to read and to digest the news of latest developments in radio, to find that particular fact you need in the solution of a problem, to consider a new circuit, to learn of a new service kink or one of those thousands of helpful things which go to make up RADIO NEWS.

To the Editor—this issue furnishes opportunity for renewal of many friendships and acquaintances in the radio fraternity, for renewal of service in bringing unbiased and authoritative news and information on radio to your hands. If our readers could only stand and peep over the Editor's shoulders at the mass of timely and vitally interesting articles that are scheduled for publication during the next few months, they would feel almost as impatient over the delay in getting them into print as the Editors are themselves. And among these manuscripts appear articles by the world's foremost scientists, authorities and experts. And we promise the magazine will continue to be edited in a style of simplicity and readability that will make the information it contains just "jump out of the pages" at you.

* * *

WHAT kind of articles do you like best in RADIO NEWS? Which are the most helpful? Which do you find could be dispensed with most readily? Already, in response to Mr. Harrington's announcement in the March issue, in which he voiced our sentiment in asking readers to write to the Editor and to tell him frankly what you think, there have been many letters received which were of great value in realizing your needs. Your comments help greatly in planning the future issues so that RADIO NEWS will be more truly *your* magazine: the mouthpiece, the Forum and the informing friend of amateur, experimenter, serviceman, manufacturer and radio scientist alike. For these many letters, containing such a large measure of encouragement and sincere comment, as well as constructive criticism—our best thanks. Look through the coming issues as they appear and let us know if your wishes are not being more than fulfilled!

* * *

ESPECIALLY are we interested in what you think of the departments. Many of our younger readers, who are seriously trying to learn the rudiments of radio, seem to be getting real information from The Junior Radio Guild. We are making plans to increase its scope and to make it more helpful than ever. A number of requests have been received from engineer readers for a de-

partment which would describe and illustrate the latest inventions and patents in the radio, television, and the acoustical field. We have almost anticipated their wishes by arranging with a well-known radio patent authority to conduct this new department for RADIO NEWS with a compilation of the latest patents each month, containing terse but adequate descriptions and clear illustrations of the new patents on devices and circuits, as soon as they are granted by the Government. Write us just what you think—what departments you find most helpful and what ones you think we could do without.

* * *

SINCE the World War many ingenious schemes have been suggested from time to time, for curing the ills of broadcasting, heterodyning, static and inductive interference. In no other continent in the world are there so many broadcasting stations utilizing such a small band of frequencies as in North America.

* * *

It seems to us significant that the trend of transmitters toward higher and higher power for the cleared-channel stations still goes on while most of the radical schemes which have been suggested soon are forgotten. An article in the present issue tells of the highest power yet to be used, a maximum of more than 500 horsepower for experimental trials in a great Pittsburgh station. Two super-power tubes of 200,000 watts are to throw their gigantic energy skyward, during the early morning hours, to saturate the ether with the most powerful voice ever heard from a broadcast transmitter. Will it cover the whole country so that ordinary sets everywhere may pick it up free from interference? Some experts think that it will.

* * *

At any rate high power has done away with the bugaboo that summer static makes broadcasting only a winter sport. High power has dwarfed the effects of static so that it is no longer a factor in local reception. It will be interesting to find out by actual experience just what the limit of power will be.

* * *

AND right along this line comes a suggested plan from Lieutenant Wm. H. Wenstrom, U. S. A., for direct coverage of the whole nation by means of higher wave bands and enormous amounts of power. This is somewhat in line with the European idea. While this system would have certain definite advantages and is worthy of discussion, there still remains the uneconomical condition it would imply—more complicated receivers for two separate bands of wavelengths, widely separated, or the use of two separate receivers. Some will probably take exception to this scheme, it is thought, on this account.

It is our opinion that higher power on cleared channels, within the present band, with the advantage it would bring of added simplicity in receiver design, will gradually solve the problem. It is true that this will be a slow process because the authorities are wary of going to exceptionally high powers, without trials, on account of the scare of possible blanketing. At any rate there is not much chance of any "cure-all" arising which can, at one fell swoop, do away with all of the interference on the higher and crowded frequencies. We sincerely wish there were.

* * *

THIS issue presents to our readers as Technical Editor, a man already known to our readers as a popular contributor to RADIO NEWS. He is S. Gordon Taylor and he has been associated with the Editor for many years in radio magazine work. He has designed many devices and receivers which have been built and used by radio experimenters and set builders. Mr. Taylor will guard these pages from technical inaccuracies and contribute his share to the many good things you may expect to find in the forthcoming issues. Associated with him in the laboratory is Wm. C. Dorf, who will answer your technical inquiries and help you in your radio problems. Another of Mr. Dorf's activities will be to act as scout to ferret out the new developments in the world's research laboratories and to present them to you to keep you well informed. Of course you already know Albert Pfaltz from whose pen comes the first article of this issue. He it is, who, as Associate Editor, has helped to present the RADIO NEWS articles in such distinctive readable instructive style. And last but far from least is Joseph F. Odenbach, for many years on the staff, working expertly to make the fine diagrams and layouts which illustrate our articles so clearly. All of these able men join me in a promise of service, to you our readers, that is not lightly made.

* * *

THE flood of requests for back numbers of RADIO NEWS emphasizes the wisdom of subscribing by the year instead of relying on the newsstand for your copy. So often is the local newsdealer completely sold out or the publisher out of back numbers—conditions that are, of course, gratifying to the Editor, but so disappointing to the prospective buyer. Or you might ask your newsdealer to reserve your copy for you so that you will not miss the good things in store.

Samuel H. Lockaday

KDKA

Employing two 200-kilowatt, water-cooled tubes, this giant transmitter, erected at Saxonburg, Pa., is an outgrowth of the tiny 100-watt outfit that broadcast the Harding election returns on the night of November 2, 1920

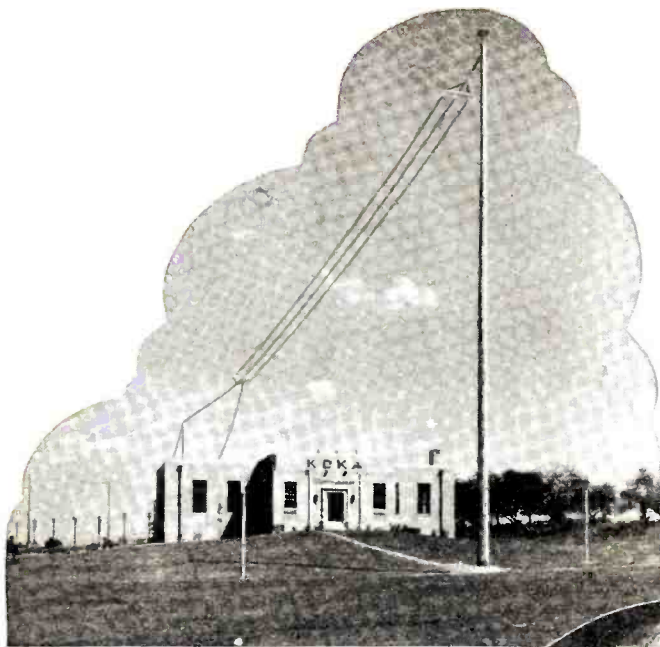

Above is an outside view of the new KDKA transmitters at Saxonburg, Pa. Dr. Frank Conrad—at right—a pioneer broadcaster and assistant chief engineer of the Westinghouse company, who has just been awarded the Edison medal for his contribution to radio broadcasting and short-wave radio transmission



IN the amazing manner of what may some day be known as the "radio decade," our erstwhile pioneer and infant commercial broadcaster, KDKA, has achieved the ripe old age of ten and acquired a 500 horsepower voice. It seems hard to realize that 400,000 watts of power have grown from the feeble, hesitant, 100-watt transmitter that undertook the task of sending news to a few eager listeners on that momentous evening of the Harding presidential election. Since that occasion, November 2, 1920, the station has not missed a single day of broadcasting.

Those gifted with an historic mind or a penchant for first causes may perhaps rejoice that the late war had something to do with the fact that we now listen to Phil Cook, Amos 'n' Andy, or the Philharmonic Symphony. It had—and for the simple reason that the Westinghouse Electric and Manufacturing Company did considerable work in radio during the World War, first for Great Britain and later for the United States. At the end of the conflict, H. P. Davis, vice president, who had been directing war activities of the company, found a large staff of men and considerable equipment on hand. Mr. Davis decided to make use of this personnel and equipment.

Experimental stations 2WE and 2WM were set up, one at the East Pittsburgh plant and the other at the Wilkinsburg home of Dr. Frank Conrad, Asst. Chief Engineer of the Company. Step followed step until it became possible for Dr. Conrad to broadcast entertainment programs from his home each Saturday night. These became so popular with the radio amateurs that one of the Pittsburgh department stores advertised receiving sets that would bring in the Conrad programs.

Seeing this advertisement convinced Mr. Davis that the proper field of radio was unlimited, that it could be a medium of mass communication as well as a means of secret and confidential messages. So plans were made to broadcast regular programs from the Westinghouse plant, instead of from the Conrad home, and to begin this service with the returns of the national election, November 2, 1920.

The company's first broadcasting was from a rough "box" affair on the roof of one of the taller buildings of the plant.

At the right is shown the short-wave antenna system at the Saxonburg site. Through station W8XK programs are regularly sent to listeners in foreign countries

Much of the interesting history of the development of broadcast and entertainment technique by station KDKA is now well known. Thousands of radio listeners, of course, remember that the early program material was drawn largely from phonograph records. They also remember that the KDKA Little Symphony Orchestra was an outstanding feature in those early years of broadcasting. Some may not know that in order to accomplish good sound reproduction it was realized that rooms for that purpose would have to be specially designed and that in the case of the first of the summer broadcasts, it was decided to erect a tent which was used for some months as a broadcast studio. Everything went along satisfactorily during the summer and early fall until one night a high wind blew the tent away. And so the first studio of KDKA passed out and into history. The studio was then moved indoors and the tent "pitched" on the top floor of one of the buildings.

Shortly after that the subject of a specially-constructed studio was again revived and designs were prepared. The elements of the present-day studio in which the ceilings, floors and walls are built of materials, sound absorbing in character, are to be found in the early efforts of KDKA.

Church services, sport events, public addresses, concerts, opera, conventions and scores of other broadcasts followed as new pick-up stations were established, and the wave of popularity that greeted radio during 1921 was greater than anything known in the industrial and commercial world.

In brief, within the last decade radio has progressed from

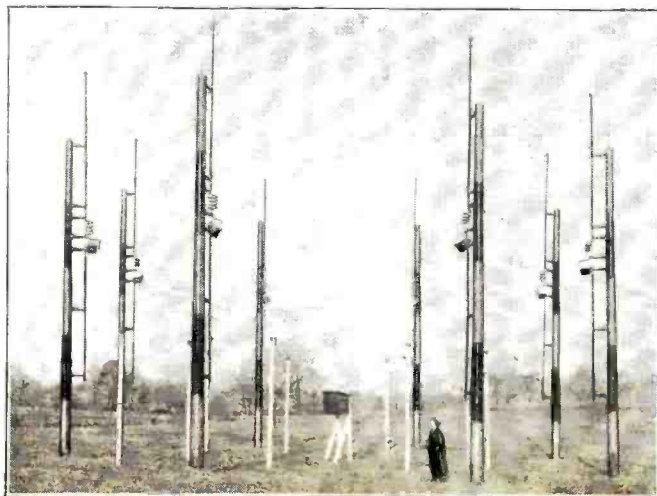

Radio's New 500 Horsepower Voice

By Albert Pfaltz

programs of records to recorded programs, from studio niches, wherein a potted palm tree rubbed elbows with a grand piano, to the "cathedral" studio at N. B. C., from entertainment of sorts to some sort of advertising with good entertainment, from strictly local broadcasting to Little America and return. More than this. Television is no longer lurking around the corner. One might almost say it is larking around the corner. The Radio City in New York is soon to become an actuality. The first step will involve the razing of three whole midtown city blocks. Such is progress.

KDKA Builds for Tomorrow

Anticipating the continuing and increasing rapid growth of broadcasting service, KDKA has recently built a new 400,000-watt transmitter at Saxonburg, Pa. The new station has been operating experimentally between 1 a.m. and 6 a.m. For normal operations, however, the power will be held at 50,000-watts as required by the Federal Radio Commission. (Continued on page 926)

The new AW-220 tube is 72 inches in height, has a diameter of 8 inches and weighs 60 pounds. It has a capacity of 200 kilowatts and is water-cooled

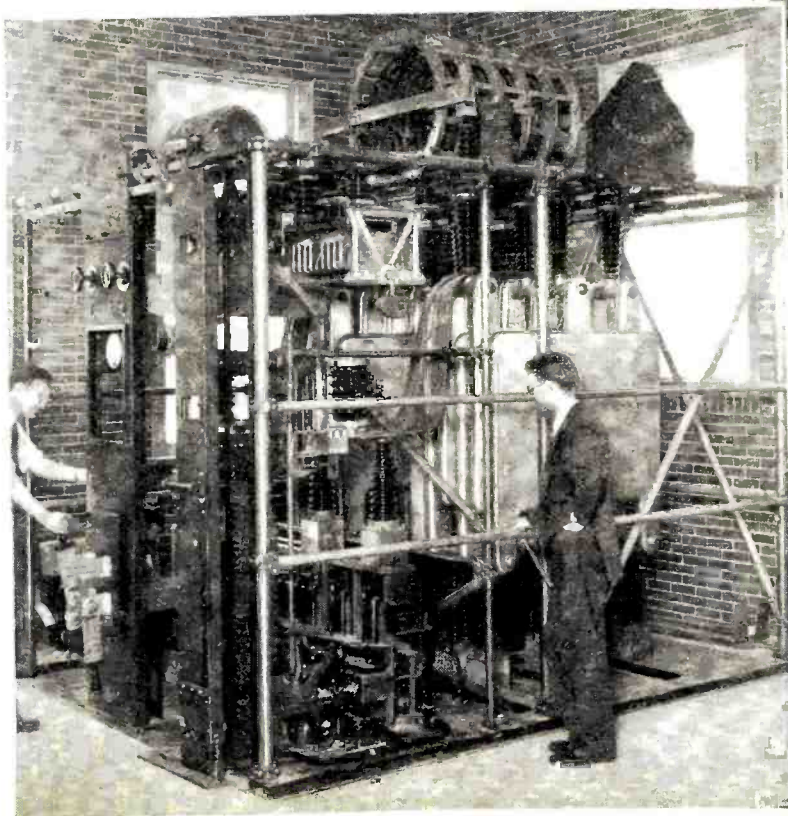

At the left is the power stage equipment of the Saxonburg transmitter and from this panel energy goes directly to the huge spray type antenna designed by Dr. Frank Conrad. Two of the new tubes are shown set up in their tube trucks. The large plates at the right and the coil at the top handle the enormous radio frequency energy generated at this point. They compose the tank condenser of this transmitter and are made of aluminum

Figure 1. Laboratory models of various types of selenium cells. These cells have long been known for their light sensitive qualities, but have not been widely adopted commercially because of their sluggish response to exposure to light

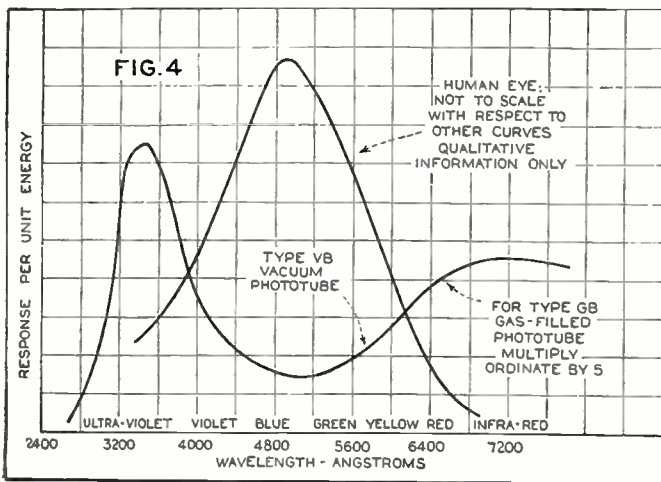
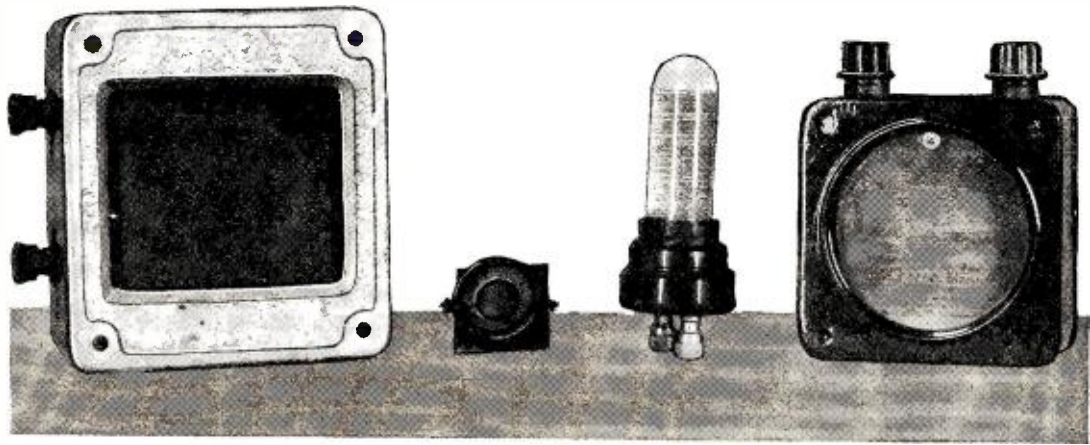

Figure 4. Curves showing the response of the phototube to color. The variation in response to different colors opens up a tremendous field of commercial usefulness for this device

PART ONE

DURING the last few years, electronic tube devices have assumed considerable importance both to the industrial engineer and the experimenter for many uses that are outside the field of radio, although the principles used are so closely related as to be of interest to the radio engineer. Electronic tubes enable the engineer to perform many tasks that have heretofore been impossible, as well as to perform many tasks in a better way. Electronic tubes are equally valuable in the laboratory in that many interesting pieces of equipment may be built that were formerly considered impossible of construction. Some of the more interesting uses of the phototube include the sorting of materials and the detection of smoke, control of lights with daylight and darkness, and the measurement of ultra-violet light. Special types of electronic devices, such as the grid glow tube, are being used in the control of oil burner flames and the control of theatre lights.

Interesting laboratory devices making use of electronic tubes include models of the mechanical men, Herbert Televox and Rastus Robot, which have been of considerable popular interest, and devices by which electric circuits may be controlled by the human voice.

It is the purpose of this series of articles to make the experimenter familiar with recent electronic tube developments in order that he may build many interesting devices that have heretofore been restricted to the

*Engineers, Westinghouse Electric & Mfg. Co.

Modern

The photoelectric cell, in its ability to changes in electrical current, is many branches of industry, to say sion. This article, which is the first has been prepared exclusively for RADIO have made a careful

By H. B. Stevens

large industrial laboratories. In order to make intelligent use of these devices, it is necessary to understand something of their characteristics. This first article of the series deals with the construction, characteristics, and circuits of light-sensitive devices.

Laboratory models of light-sensitive devices have been known for quite a number of years. Intensive electron tube development of the last few years has resulted in a commercially practical light-sensitive device of the photo-emissive type, the phototube. The modern phototube coupled with a single thermionic amplifier tube results in a combination that will initiate an electrical operation requiring an appreciable current when either a condition of light or darkness prevails. The phototube and its amplifier thus form the basis of a number of interesting experiments, whereby light or even a variation in the intensity of light may be utilized to control any device that can be operated by an electric current.

The terms light-sensitive device, selenium cell, and photo-electric cell are often confused. There are three rather distinct phenomena which are the basis of operation of light-sensitive devices and it may be well to distinguish between these different principles before proceeding further.

Photo-Conductive Light-Sensitive Devices

First, certain materials exhibit a change in their electrical resistance to current flow when subjected to light. This might be termed the photo-conductive effect. Selenium is typical of materials of this class. Figure 1 illustrates a number of experimental selenium cells. This type of cell is quite sluggish in its response to light. The time required for the current flow through a selenium cell to reach its maximum value when the device is illuminated is of the order of a number of seconds. The current decrease when the source of illumination is cut off is similarly



Figure 2. A light sensitive device of the photo-voltaic type, somewhat sluggish in its response to rapid changes in light intensity, but nevertheless finding some commercial uses

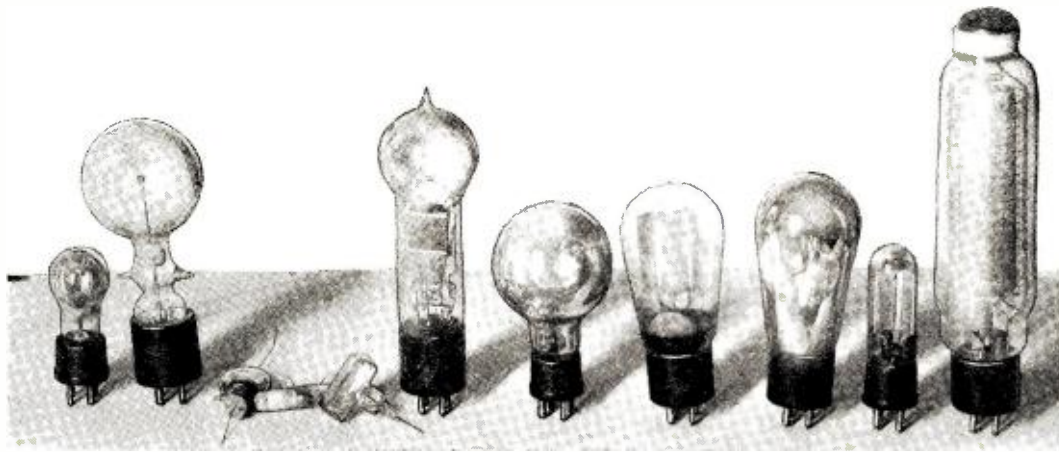

Figure 3. These styles and sizes mark the evolution of the phototube. The one resembling the -99 tube is the modern type, while the large one at the extreme right is a special purpose tube

Phototubes *and their Characteristics*

to convert changes in light intensity becoming more and more useful in nothing of its manifold uses in televi- of a series on this intriguing subject, NEWS readers by two engineers who study of the subject

and M. J. Brown*

slow. This type of device has not as yet assumed very great commercial importance in this country.

Photo-Voltaic Light-Sensitive Devices

A second type of light-sensitive phenomena is that property which certain materials have of generating a voltage from the action of light. This may be termed the photo-voltaic effect. This property is exhibited by certain materials, notably copper oxide. This type of cell is generally considered to be somewhat sluggish in its response to rapid changes of light intensity; however, certain devices of this type are now on the market that have apparently partly overcome this difficulty. One such type of cell is illustrated in Figure 2.

Photo-Emissive Light-Sensitive Devices

A third type of photoelectric phenomena, and the type with which this discussion is principally concerned, has been termed the photo-emissive effect. When certain metals are placed in a vacuum (or chemically inactive gas at a pressure of the order of a millimeter of mercury), and a voltage is applied between the active element (the cathode) and the inactive electrode (the anode), an electron flow results which is proportional to the light impinging upon the cathode. Since the speed of response of this type of light-sensitive device is limited only by the inertia of the electrons in the tube, the response is so rapid that no one as yet has been able to measure a time lag between the application of light and the flow of an electric current through a vacuum phototube.

Construction of the Modern Phototube

A number of alkali metals have been used as cathodes for phototubes, such as lithium, sodium, potassium, and cesium. Sodium and potassium have, in the past,

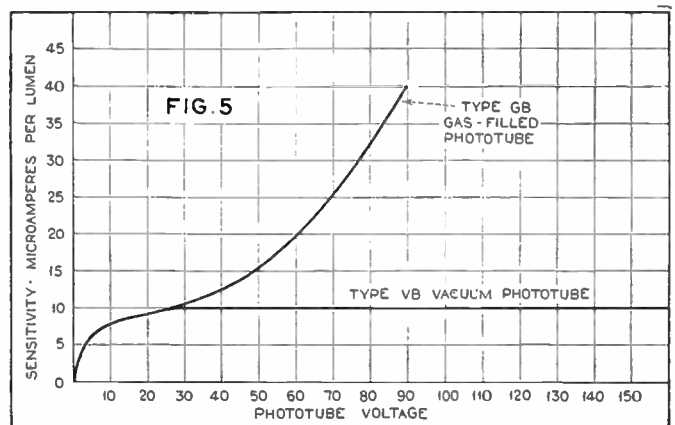

Figure 5. The voltage-illumination characteristics of two types of photo-tubes, details of which are explained in the text

been rather widely used in experimental and commercial cells. A number of experimental tubes leading up to the development of the latest types are shown in Figure 3. The cell which is by far the most sensitive to visible light as yet developed (as far as indicated by published literature) has for its active element a very thin coating of cesium oxide. Referring to Figure 3, the second tube from the right (of the general size and shape of a type -99 tube) is of the cesium oxide type. The one at the extreme right has an especially large cathode resulting in a correspondingly higher current and is used for applications where operation is necessary on relatively low light intensities. This latter type of cell is also designed to be equally sensitive to light from all directions. The smaller tube has its sensitive coating on a cathode of semi-circular cross section. The anode, a straight vertical wire, is supported near the axis of the cathode.

Characteristics of the Modern Phototube

The relative response of a phototube to the different colors of the spectrum depends upon both the active material used and the method of its preparation. The modern cesium oxide tube is quite sensitive to light near the red and infra-red portion of the spectrum (see Figure 4). Since the standard Mazda lamp converts most of the energy it receives

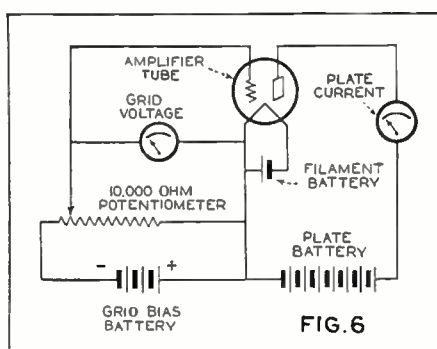

Figure 6. A simple amplifier circuit, with variable grid bias. This is the basic circuit employed in the phototube amplifiers (Figures 8 and 10)

into infra-red light, the cesium oxide phototube is particularly fitted for use with an incandescent lamp.

The sensitivity (see Figure 4) of a phototube may be materially increased by the introduction of a slight amount of one of the chemically inactive gases—helium, neon, argon, krypton or xenon. The current increase of a vacuum phototube is exactly proportional to the increase in illumination over the entire limits of operation, while a gas-filled tube has a slightly higher response per unit of light when highly illuminated.

Referring to Figure 5 it may be seen that the response of the vacuum phototube increases rapidly until the applied voltage reaches a certain comparatively low value. At this point it becomes practically independent of voltage over a wide range. This characteristic particularly fits this type of tube for applications requiring consistent results or for applications where it is convenient to use a fluctuating or high voltage. On the other hand, the sensitivity of the gas-filled type of tube varies considerably for an increase of voltage until a value of approximately 90 volts is reached. Voltages very much in excess of 90 volts will start a glow discharge which will seriously injure the phototube.

The operating current of either the vacuum or gas-filled tube is quite low as compared to many vacuum tube devices; i.e., of the order of a few microamperes. Although it is possible to make a relay that will operate on such minute currents, it is not as a rule practical when amplification to currents of the order of milliamperes may easily be obtained by the use of a single thermionic amplifier tube.

Thermionic Amplifier Tube Characteristics

Before describing a phototube amplifier, it may be well to review the action of a simple thermionic tube circuit such as Figure 6. The current flowing in the plate circuit of the amplifier tube is dependent upon filament voltage, grid voltage, and plate voltage. The change in plate current caused by a change in filament voltage (i.e., for small changes near the rated filament voltage) is quite small for the modern tube fitted with an oxide coated filament. The manner in which the plate current varies with a change in grid potential is shown by Figure 7 which is called the characteristic curve of the tube under discussion. The amplification of the tube is due to the fact that a relatively small change in grid voltage will cause a comparatively large change in plate current. It may also be noted that the plate current of this



Figure 9. The Westinghouse type S-593428 amplifier tube for photo-tube amplification

Figure 10. In contrast to Figure 8, this circuit arrangement results in a decrease in current with an increase in light

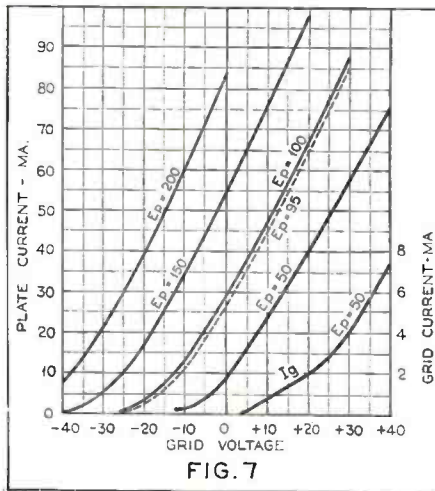

FIG. 7

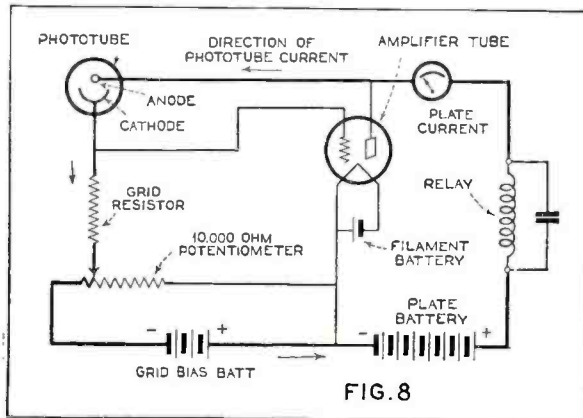

FIG. 8

Figure 7. Here are shown some characteristic curves taken on the amplifier tube shown in Figure 9

Figure 8. The amplifier circuit employed when photo-tube is connected to provide an increase in current with a decrease in light

type of tube is abnormally high unless the grid is maintained at a negative potential with respect to the filament.

If the plate voltage is increased, the characteristic curve will have the same shape, but the plate current value for a given grid voltage will be higher. A decrease in plate voltages will cause a corresponding decrease in plate current values.

This simple amplifier tube circuit may be changed to a phototube amplifier by simply connecting the anode of the phototube to the plate of the amplifier tube, the cathode to the grid, and by adding a grid resistor. As long as the phototube is dark, the circuit conditions will remain unchanged and the plate current will be determined by the grid bias potential (and the other factors discussed above). As soon as light strikes the phototube, a minute current flows through the circuit indicated by the heavy lines of Figure 10. The important factor is that the current flows through the high resistance grid resistor. This current flow produces a voltage drop across the grid resistance which is equal to the product of the current and the resistance value. This voltage drop affects the circuit in exactly the same manner as though a battery were substituted in the circuit for the grid resistor, with its positive pole connected to the grid. Since this voltage drop results in making the grid more positive, the plate current is increased (refer to Figure 7).

It is important to note that the phototube current is quite small, and in order to produce a voltage drop large enough to secure the desired change in grid voltage, the

grid resistor must have a very high value—from 10 to 200 megohms. The higher values of resistance results in a very sensitive amplifier but which is also quite critical and unstable. Leakage across tube sockets and other insulation becomes a considerable factor for very high grid resistors. A compromise must be made between sensitivity and stability. A value of 50 to 60 megohms (which may be obtained by connecting 5 or 6 ten-megohm grid leaks in series) will be found to be a good value to use.

In order to make intelligent use of a phototube amplifier circuit, it is essential that a milliammeter be used in the plate circuit of the amplifier tube. Although the current range will depend somewhat on the type of tube used and its plate voltage, a meter with a 0-25 milliamper scale will probably be found to be about the correct size.

It will also be found very convenient to connect a 10,000- or 15,000-ohm potentiometer across (Continued on page 945)

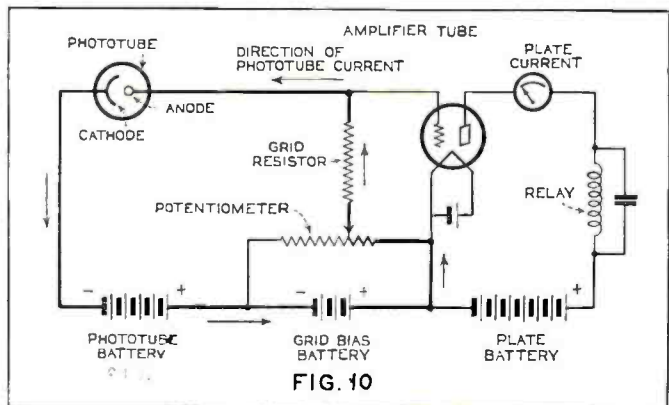

FIG. 10

The Companion Receiver

A two-tube a.c.-operated outfit, which because of its compactness is ideally suited for carrying about on one's travels. The two tubes are -27's, one of which is used as a rectifier

By A. G. Heller*



IN dealing with the progress of the broadcasting art, we invariably mention the transition from the headphone or "selfish" stage of reception to the loud speaker or "unselfish" stage. Therefore, we are to assume that headphone or individual enjoyment of radio programs is decidedly a thing of the past, never to return again. Even our latest short-wave receivers, reducing what has heretofore been an experiment to a positive form of entertainment, replace the headphones with a powerful loud speaker, so that the entire household and even a good part of the neighborhood may hear, willingly or otherwise, the programs from England, Germany, Holland, and other points east, west, north and south.

Perhaps we have been a trifle hasty in branding headphones, or individual, selfish reception as a thing of the past. Perhaps we are foregoing many of the pleasures and advantages of which modern radio is capable, in standing by the usual loud speaker

radio set at all times and in most places. For instance: in the hospital, with its many admonitions to be silent, the standard loud speaker set is decidedly out of place. Again, the traveler, stopping overnight in a hotel room, can hardly carry his home set about with him. Perhaps he may be fortunate enough to stop at a place provided with radio, but most likely not, especially in small cities and towns. Still again, there may be as many radio tastes about the average household as there are individuals. Unfortunately, the usual radio set can supply only one program at a time, and with the present simultaneous superabundance of good programs, there may be plenty of room for different choices.

Finally, the business or professional man may find it essential to listen in on an important broadcast feature during office hours. A standard radio set in an office is just about as welcome as that proverbial bull in the china shop.

And so we come to the need for *individual radio reception*—a return, but in modernized form, to the headphone idea,

whereby the radio listener may shut himself off from his surroundings, enjoying his own selected program without imposing it upon others. In working out this idea, we have been confronted with several major considerations. Firstly, the individual radio set must be simple, compact, practical and inexpensive. It must be a.c.-operated, for batteries are quite unsuitable where the ubiquitous socket is within ready reach. It must be readily portable, not only in the sense of compact dimensions and light weight, but also in the installation sense, requiring a minimum antenna or ground arrangement for satisfactory reception. It must possess the best tone quality for ears long ago grown accustomed to realistic radio entertainment, even though little

(Continued on page 934)



The "Companion" radio open for use. The single tuning control is in the center with the sensitivity control knob at the right

The schematic circuit of the "A.C. Companion" receiver and its built-in power supply, which employs a type -27 tube as rectifier

*Chief Engineer, Insuline Corp. of America.

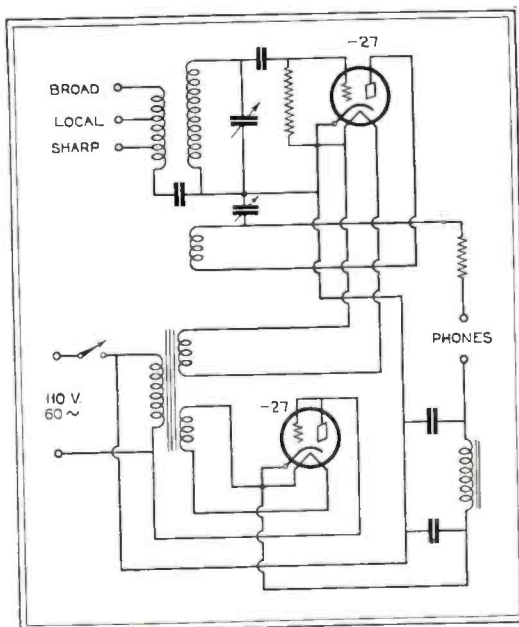

A Plan for Making National

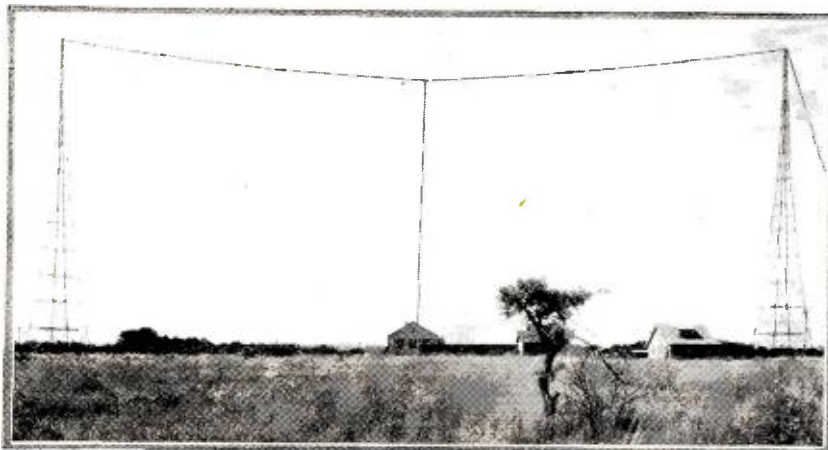

Shown above is a modern antenna installation for present-day high-powered broadcast transmitter—in this case the antenna at WEAJ, Bellmore, Long Island, N. Y.

By Lieut. Wm. H.
Wenstrom

Broadcast

In spite of the ever-increasing power employed by broadcast stations, a large portion of the country is still outside the dependable range of the better class of stations. In fact, much of the country is not dependably reached by any broadcasters. Lt. Wenstrom in this article presents some rather startling facts in this connection. What is more important, he suggests a remedy which, though somewhat radical, nevertheless holds much logic and is worth careful consideration

THEORETICALLY the northeastern section of the United States enjoys excellent radio broadcasting service. Eight 10-kw. to 50-kw. transmitters are spaced with fair regularity from Massachusetts to Maryland. No section of the country is better served except the environs of Chicago, where four high power stations are located practically on top of one another. As a criterion of what we can expect of future broadcasting development under the present system, then, we might look for a moment at actual present receiving conditions in this favored northeastern area.

Let us first visit in imagination a suburb of New York City. A listener here can turn to any one of four powerful near-by stations. Any program selected will issue from a good receiver practically as well as if it were coming in by a private wire line. The same listener can also find, one or two blocks away, a large talkie theatre. He can attend dances, concerts and other entertainments by walking or driving a few more blocks. Half an hour away is the great city, with all the theatres of Broadway and its by-streets.

Now let us change the scene to Cape Cod, whence in days gone by tall whaling ships sailed for the seven seas. A howling northeaster spatters cold rain across a sodden countryside; it is a good night to stay home and listen to the radio. In one of the modest houses surrounding

Dark Harbor a fisherman tunes for his favorite dance orchestra. The program is on several stations, but the best signal comes from a 50-kw. transmitter on Long Island, 150 miles away across salt marsh and salt water. These terrain factors are favorable to transmission, but nevertheless the program fades badly. Now it is too loud, now it sinks to a whisper, and occasionally it goes mushy. There are no movies or theatres among the sand dunes of Cape Cod, and the fisherman goes disgustedly to bed.

Not far from the fisherman's home is a country house whose owner, wishing to have the best in reception, has paid the radio industry something like the price of a Ford. He wants to hear the same dance program, and tunes his expensive set to the same station. His automatic volume control smooths out some of the fading, but it leaves all the mush in. By no stretch of the imagination can he feel that he is listening to the original orchestra, or forget the technical means of hearing and its frailties in the enjoyment of what is heard.

The imaginary pictures above are based on actual observation in the favored northeastern area. In Idaho the nearest station using more than 10 kw. is 600 miles away. National broadcasting seems at present to be more of a name than a reality.

Before examining some possible means of improving the situation, it is necessary to agree on a few fundamental definitions

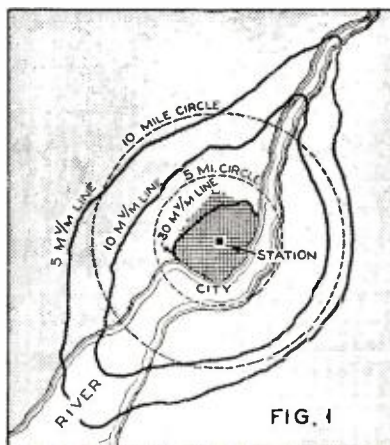

Figure 1. This is a typical map showing the service area of a 500-watt broadcast station. It is made by taking field strength measurements at numerous points, then joining together with lines the points showing similar field intensity

Shown immediately below is a portion of the Radio Central at Rocky Point, Long Island, N. Y. In the foreground is the spray pond used in the water-cooling system of the transmitter. Below, at the right, appears one of the multiple tuned antennas at the Radio Central. This is a high-power long-wave antenna such as may be required for the super broadcast system proposed in this article by the author. Twelve 400 ft. (122 meters) towers support two independent antennas, the towers being spaced 1250 ft. (380 meters) apart. Each tower has a cross arm of 150 ft. (46 meters)



Coverage *Direct*

and principles. First of all, what is true broadcasting service and what is the true service area of a broadcasting station? This question is potent for argument among engineers, experimenters and listeners alike.

Changing Standards of True Service

Broadcasting, along with all the other arts of our modern age, is in a state of change. What is excellent today will not do tomorrow. In 1922 a fifty-watt station used to transmit nightly from Denver, Colorado. A handful of listeners tuned for it in Arizona, 600 miles south, and were delighted beyond measure to hear once in a while the Denver announcer's voice emerge understandably from their loud speakers, amid snatches of music which sometimes steadied into a half-hour concert. Of course they never heard anything in daylight. They might have said that they were getting true broadcasting service on nights when the Denver station was on the air, and were missing it on nights when the transmitter was shut down.

What would be the response of a listener who was offered such service today? Our ideas of true broadcasting service have advanced greatly in the last few years. In 1927 S. W. Edwards, the Radio Supervisor at Detroit, Michigan, completed a series of measurements on broadcasting stations. His results, described by S. R. Winters in RADIO NEWS for July of that year, probably seemed revolutionary to listeners accustomed to nothing better than doubtful night-time service.

The definition of true service accompanying this investigation came from no less an authority than President Hoover, then Secretary of Commerce: "By 'complete service area' I mean the territory within which the average set can depend upon getting clear, understandable and enjoyable service from the station day or night, summer or winter. I do not include

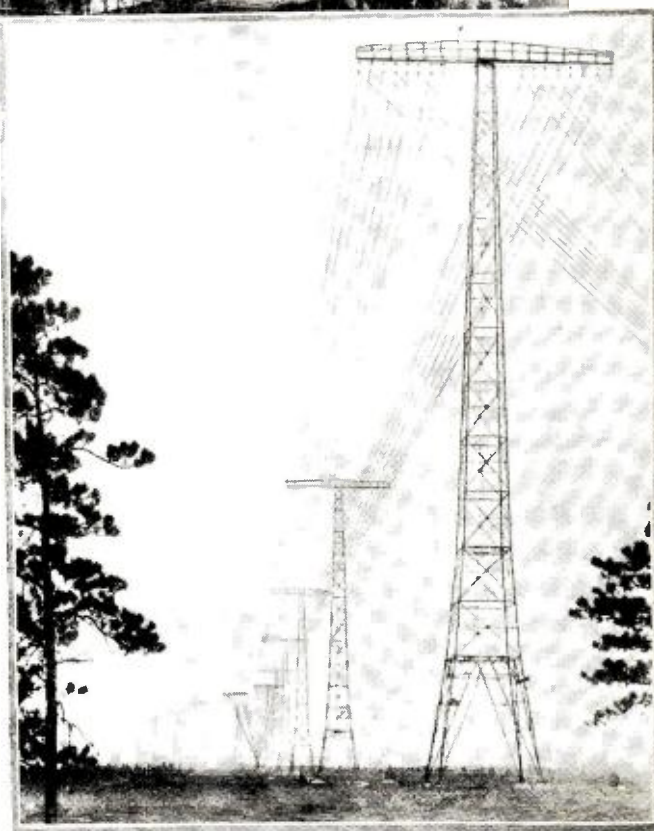

radio golf around the edge of these areas in our conception of public service—that game is an exercise of skill. . . . Actual operation of high-powered stations has proven advantageous in broadening the 'complete service area,' but this area is much more limited than many expected. Subjected to the test of positive and reliable service at all times and in all weather it will be found that the real effectiveness of a station falls within a comparatively small zone."

Edwards found for one thing that the service areas of stations were usually far from circular, though in a location free from tall steel buildings the lines of equal field strength may approach circular form. Figure 1 is a typical map showing the service area of a 500-watt station. Such a map is made by taking at various points a large number of measurements of the signal strength rated in millivolts per meter. The lines of equal field strength, corresponding to contours on a topographic map, are then drawn in between the points. In this investigation, which was mostly in or near cities, the 5 millivolts per meter line was taken as the outer boundary of the complete service area.

In the case of every station investigated this area turned out to be pitifully small. WTAM at Cleveland, radiating 5000



This is a close-up view of the control panels of the Marconi beam system at Rocky Point

watts, pushed the 5 mv/m line out less than 20 miles on the average. WSB of Atlanta, a 1000-watt station, showed a service range of four to nine miles. The fact that some listener in Saskatchewan picked up either or both of these stations every other night has little bearing on the subject. We are considering a service which is good enough to make the listener feel, provided the receiver does its share, that the artist is almost present in the home.

If broadcasting had been content with those five- and ten-mile ranges of 1927, what a sickly infant it would be now! However, it was the admirable desire of engineers to bring true service not only to the suburban areas immediately surrounding the cities, but to some millions of farmers, small town residents and other rural dwellers out in the comparatively open country that is most of the United States. Higher power was the logical answer. When WJZ, first of the great metropolitan broadcasters, went on the air with 50 kilowatts near-by listeners probably felt as if all the white horses of Niagara were being unleashed over their heads. But they lived to tell the tale, their receivers declined to go up in smoke, and they soon found that they could still tune in distant stations by using a simple wavetrap.

In the greatly increased coverage area of WJZ around New York City and New Jersey, the high-power idea immediately proved its worth. At the present time there are about 30 stations in various parts of the country radiating 7 kw. to 10 kw. or more. Those minute true service areas of 1927 have been considerably extended in many cases. The generally accepted idea of true service range compared with power is now about as follows:

5 watts	1 mile
500 watts	10 miles
50 kilowatts	100 miles

This table is seen at once to follow the inverse square law, which is only approximate in actual cases. Other factors, such as wavelength and type of ground, enter the picture. But for distances under 100 miles, the foregoing table will do for the present.

Suppose that we wish to extend further this splendid idea of rural coverage. Let us extend city reception to those who need it most—the tired lumber crew in the northwoods, the levee gang camping beside the Mississippi, the original American on a desert reservation. Suppose that we wish a true service range of 1000 miles. This is ten times the range of a 50-kilowatt station, and if the inverse square law works, we should get the desired results

Figure 4. A map of the United States showing the coverage area of thirty present-day high-powered broadcast transmitters. Compare this with Figure 6. (Reproduction licensed, copyrighted by Rand McNally and Co.)

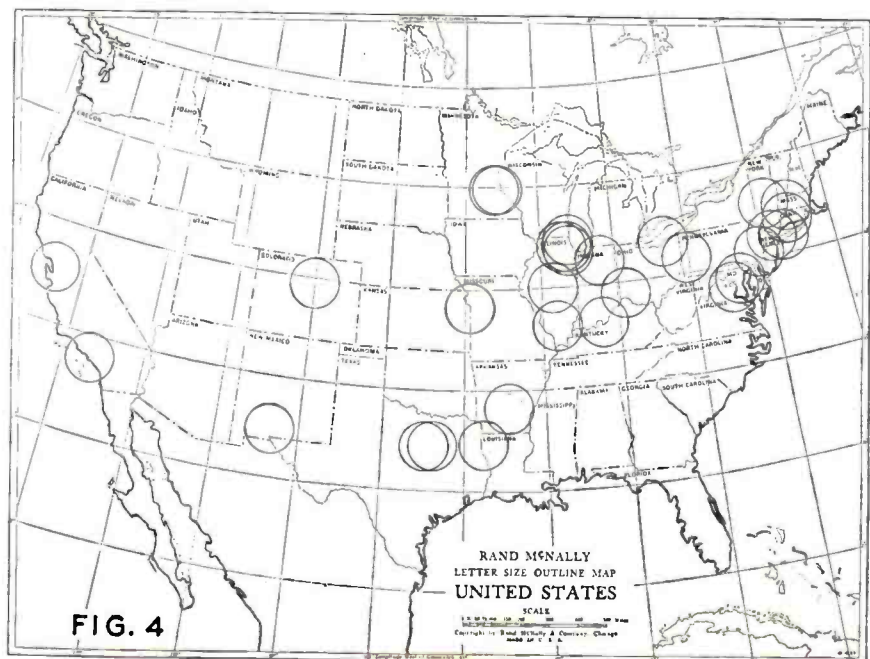

FIG. 4

with 100 times the power, or 5000 kilowatts. Would operating such a station in Kansas, on 400 meters for example, bring true broadcasting service to most of the United States?

It would not. It would be instead a monumental waste of power, for in all probability the true service area would not be much different from that of a 50-kilowatt station.

Fading Restrictions

Another element has entered the picture, and that is fading. Most listeners have noticed that stations less than 60 to 80 miles distant rarely fade, while for those 80 to 100 miles away fading is often quite severe—more so, in fact, than for more distant stations. The reason is that whereas the ground wave dies away roughly in accordance with a curve of familiar exponential shape, as shown in Figure 2, the sky wave, reflected from the ionized layer sixty miles or so above the earth, is very weak at the transmitter and begins to come down strongly some miles out. Due to changes in the ionized layer, the path traveled by the sky wave is continually changing in length while the length of the ground wave path remains constant. The result is that the sky wave is now in step with the ground wave, now opposing it; the phase relations between the two are constantly changing.

Close to the transmitter where the ground wave predominates it does not matter much what happens to the sky wave. But in a region approximately 80 miles out the ground wave and sky wave are of about equal strength. When they are in phase the signal is twice as strong as it ought to be; when they are just out of phase the signal vanishes, as shown in Figure 3. Several hundred miles out where the sky wave alone counts, the fading is less severe, but the constancy of the signal rarely reaches true service standards. It is also apparent from Figure 2 that power increase has little effect on fading because the intensity of the sky wave is increased along with that of the ground wave.

These forms of fading can be smoothed out to some extent by the automatic volume control, but another vagary of the sky wave leaves this device powerless. Between a given transmitter and receiver at any instant different wavelengths will fade differently. The two side bands of a telephone signal are in effect two signals of slightly different frequency, and when these fade unequally the result is destructive distortion, variously known as "hashing" or "mush," but ruinous to the program on which it appears. This distortion sets in at about the same distance as ordinary fading—60 to 80 miles—and the indications are that it is seldom entirely absent beyond this first fading ring. Even in the programs originating from powerful stations several hundred miles distant, which seem fairly constant, this differential sideband fading is usually present in great enough degree noticeably to mar quality.

The upshot of all these facts is that the ground wave only is useful for extending the true service area. Listeners put

up with sky wave service now in the absence of anything better, but its vagaries cannot be tolerated in the broadcasting of the future. This means that a station's maximum true service area is limited by the occurrence of its first fading ring.

In the interests of clearness and understanding it might be well at this point to summarize as follows our basic assumptions:

1. In the radio communication field broadcasting now ranks next in importance after government, sea-air safety and primary inter-continental message services. The relative importance of broadcasting is increasing.
2. Our present system of broadcasting coverage is laid out on metropolitan rather than rural or truly national lines.
3. True service broadcasting is defined as a ground-propagated day and night signal free from fading and of sufficient intensity to override any ordinary atmospheric or interference.
4. As an ideal limit the entire United States should be covered by such service. In practice the ideal limit should be approached as closely as technology and economics permit.
5. It is more economical to cover a given area with few large stations than with many small ones.

We have hinted above at our present paucity of rural coverage. Now, with these definitions in mind, let us have present conditions out in the open where we can look at them. No station using less than 7 kw. to 10 kw. need be considered. Figure 4 shows the locations of the 30 stations using 7 kw. or more, and surrounding them circles of eighty mile radius. The true service areas of these stations, on the average, lie within these circles. Some non-fading ranges are greater, some less, but eighty miles is about the United States' average, as detailed below. These thirty circles then, mostly clustered in the northeast and north central states, give a true generalized picture of our present national coverage. The picture would not be greatly altered if all these stations increased power to 50 kw. We can see at a glance how far from national our coverage actually is.

Synchronization and Antenna Design

The scarcity of channels in our present broadcasting spectrum has spurred engineers to develop practical means of synchronization—running two or more transmitters on exactly the same wavelength. For moderate distances at least, the frequency synchronization problem has been solved. WBZ at Springfield and WBZA at Boston have been synchronized for several years. The occurrence of peculiar fading patterns in the mid-distance between synchronized stations, however, has limited the method's possibilities.

These difficulties have recently been disposed of by the combined frequency and phase synchronization described by C. W. Horn in *Electronics* for December, 1930. Not only do

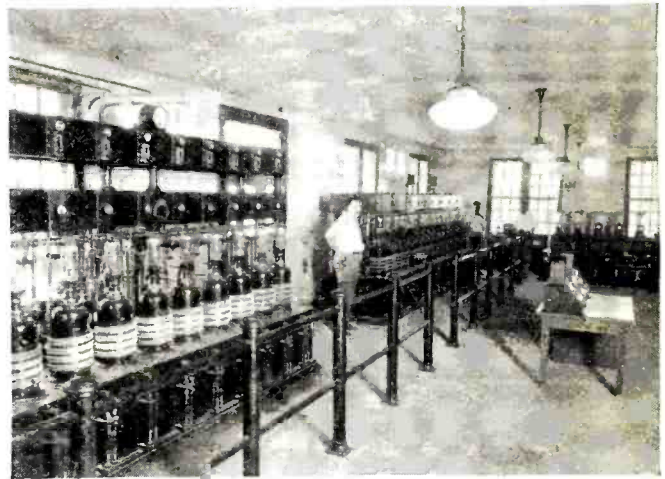

A general view of the thirty-two high-powered tubes with which station WEAJ of the National Broadcasting Company is equipped

the inter-station interference patterns disappear, but the ordinary single-station type of fading appears to be somewhat mollified. This advanced synchronization technique has great possibilities, but as applied to the problem of national coverage it meets two objections. Present-day stations are not logically located for national coverage, and excessive multiplication of small stations violates the primary economic law.

We should mention also that there is a way of pushing out somewhat these troublesome first fading rings by improved antenna design. As first fading is caused by approximate ground wave and sky wave equality, any system which tends to put more radiation into the ground wave at the expense of the sky wave will be helpful. It has been found that a one-half wave antenna, for example, radiates more strongly in a horizontal direction than the conventional quarter wave or Marconi antenna now used by most broadcasters. This effect is shown in Figure 5. In 1928 the Budapest station in Hungary went on the air with an antenna approaching half a wave in length. The fading ring was definitely pushed out, though not to any great distance. The new non-fading service range of the station was about 90 miles, as against 60 miles with a conventional antenna. In New Jersey, WABC is said to be building a half-wave antenna—another interesting experiment along this line.

The methods mentioned above, or other technical advances, may ultimately solve the national coverage problem. The remainder of this article sets forth a different solution which the writer believes is simpler and more logical. It is not claimed that our method positively will work or that other methods will not work. It is claimed that our basic idea is technically sound, and that it presents enough possibilities of great public service to be well worth investigating.

A Powerful Idea

In an epochal paper in the July, 1930, Proceedings of the Institute of Radio Engineers entitled "Service Area of Broadcast Stations," P. P. Eckersley of England, former Chief Engineer of the British Broadcasting Corporation, has shown the fading limitations mentioned above. He has also shown that the fading ring radius, which limits the true service range, is a function of wavelength and type of ground, and is substantially independent of transmitter power. In addition Eckersley has suggested that the obvious remedy for these fading (Continued on page 927)

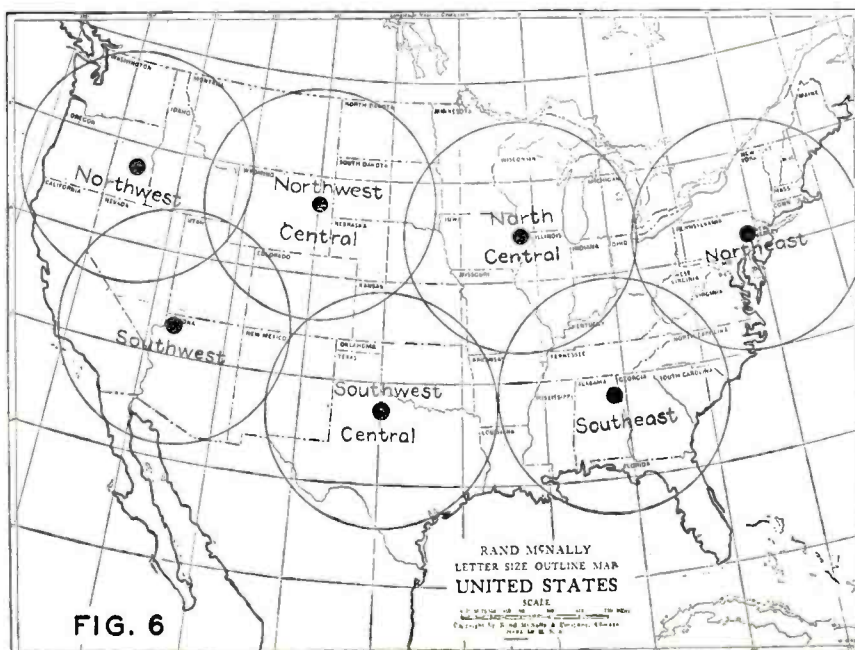

FIG. 6

Figure 6. Seven national super-power stations, located as shown in the map at the left, could supply substantially complete national coverage. (Reproduction licensed, copyrighted by Rand McNally and Co.)

The Design and An All-Wave A.C. Super

A NEW type of superheterodyne, known as the L-32 Ultradyne, is described in this article. It employs the principles of the now famous ultradyne circuit first developed by Robert E. Lecaunt and described a number of years ago in RADIO NEWS. It contains, as well, the principle of the plio-dynatron oscillator for beating the frequency of the incoming signal to the lower frequency of the intermediate amplifier. In designing the model, care has also been given to the details of tone fidelity, selectivity, sensitivity and ease of operation. The set is made for a.c. operation and will tune from 15 to 550 meters. The construction is simple and the final model gives results that any amateur set builder would consider excellent.

The idea of a.c. operation was considered of paramount importance in the design, but, of course, the circuit had to be decided upon before any work could be done along this line.

"All wave" operation determined the type of circuit to be used. No tuned r.f. receiver covers all bands and at the same time maintains maximum selectivity and sensitivity. There remains the superheterodyne, which, with certain refinements, is the ideal circuit. There were many kinks in the "Super" which had to be ironed out, for example: "Image frequency" (double beat), interlocking of controls on the high frequencies and critical tuning. At this point, one departure from usual practice cleared up the situation at one stroke. The plio-dynatron oscillator (hereafter referred to as the dynatron) was used instead of the conventional oscillator.

The dynatron operates on a negative-resistance characteristic of the plate-current curve of the screen-grid tube, which obtains under certain screen and plate voltages. Charles E. Worthen of the Engineering Department, General Radio Company, writing in *The General Radio Experimenter* has this to say: "The frequency range over which the dynatron oscillator may be made to operate is extremely wide, frequencies from a few cycles per second to some 20,000,000 being obtained by merely changing the tuned circuit." . . . "Better frequency stability over an unusually wide range of frequency can be obtained with the dynatron oscillator than is possible with one of the conventional type using a 3-electrode tube. Its stability compares well with that of a piezo-electric crystal oscillator without temperature control."

Reference to the schematic diagram, Figure 2, shows the circuit employed. The upper beat-frequency is used on the broad-

The L-32, latest in a long line of Ultradynes, standing is the dynatron oscillator arrangement—great effectiveness of this receiver throughout

cast band. On the other bands, since the trimmer becomes the antenna tuning condenser and therefore a separate control, either beat may be utilized. There is no interlocking even at 20 meters.

Plug-in coils are used in the antenna and oscillator. These coils automatically connect into the circuit the large tuning condenser for the low frequencies and the small tuning condenser for the high frequencies. This arrangement allows the proper spreading of the bands.

The intermediate frequency is 245 kilocycles. The "image frequency" interference is so small as to be negligible. The antenna circuit is selective enough to practically eliminate repeat points. Even were a station to come in on the upper beat it would fall between channels. In New York City no difficulty from this source was experienced.

Fidelity of tone is assured by the use of resistance coupling between the detector and first audio and parallel plate feed to the first audio.

The L-32 receiver has eight tuned circuits—the antenna and oscillator, and six in the intermediate amplifier. This amplifier is transformer coupled, with both primary and secondary circuits tuned. The degree of coupling

has been accurately determined to give ten-kilocycle separation.

The shielding around the intermediate transformers is oversized to allow sufficient space around the coils, thereby keeping the losses low while the L/C ratio has been kept as high as possible. The result is an amplifier of high gain for which reason each stage has been very carefully isolated. The sensi-

THERE has been perhaps no element in the development of radio more striking than the changes that have taken place in the physical layout and construction of superheterodyne receivers designed for home construction. The custom-built set of today rivals the modern commercial receiver in its appearance. Likewise in its electrical and operating characteristics the modern superheterodyne is a far cry from those of a few years back. Single control, perfect stability, a.c. operation, razor-like selectivity without appreciable sideband cutting, extreme sensitivity, and a considerable reduction in background noise because of the use of a relatively high intermediate frequency. These are some of the features which have taken the "super" out of the laboratory and put it in the living room.

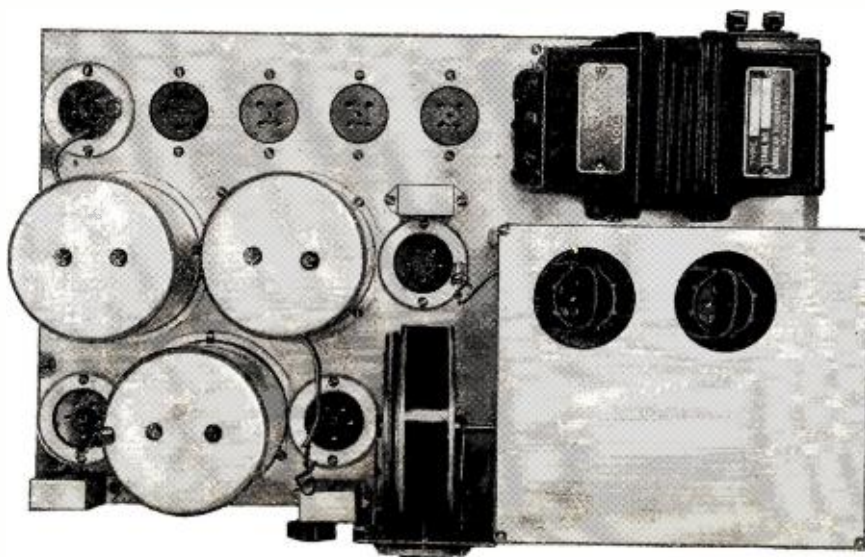

A top view of the receiver with tube shields removed. The holes in the top of the box shield at the right provide the only coupling between the first detector and dynatron oscillator

*Traul Radio Co.

Construction Data on heterodyne *De-Luxe*

includes numerous refinements in design. Outstanding, the stability of which accounts for the the wavebands from 15 to 550 meters

By H. J. Cox*

The author in the act of inserting the plug-in oscillator coil in its socket. The complete degree of shielding employed in this receiver is evident in this photo

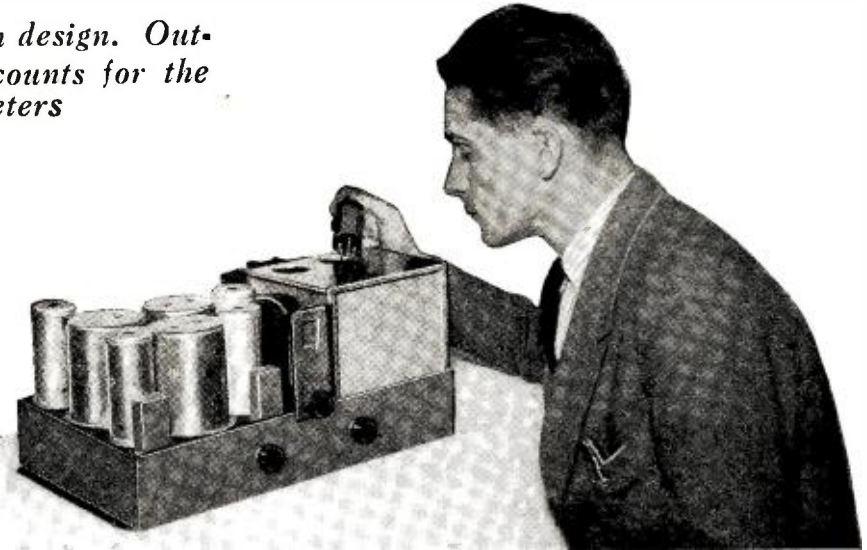

tivity is so great that in any but an extremely quiet location, the noise level is reached long before maximum sensitivity.

Tuning is accomplished with one dial, a trimmer, and a volume control. Whether on high or low frequencies the L-32 receiver is not critical, in fact, it is seemingly broad.

Compact and simple construction has been a watchword of the design. The overall size is 18½ inches by 11 inches by 8 inches, yet nothing is crowded.

If the chassis is obtained in its finished form the only tools necessary are a screw driver, a pair of cutters, and a soldering iron. No special knowledge is required, and anyone reasonably handy should have no difficulty with assembling and wiring.

Circuit Analysis

The antenna is coupled inductively through a small antenna coil (L1) to the grid coil (L2). The grid coil is tuned on the broadcast band by a 250-mmfd. condenser (C2) in parallel with a 50-mmfd. condenser (C1) which acts as antenna trimmer. On the higher frequencies the 50-mmfd. condenser is the only capacity in the circuit. The construction of the coils and condenser connections are shown in Figures 3A and 3B. The first detector is a screen-grid tube self-biased by a 15,000-ohm

Figure 1. The complete schematic diagram of the Ultradyne, Model L-32, including the built-in power supply. Both plate and grid circuits in the intermediate amplifier are tuned to provide maximum amplification and energy transfer. A total of eight tuned circuits provide ample selectivity

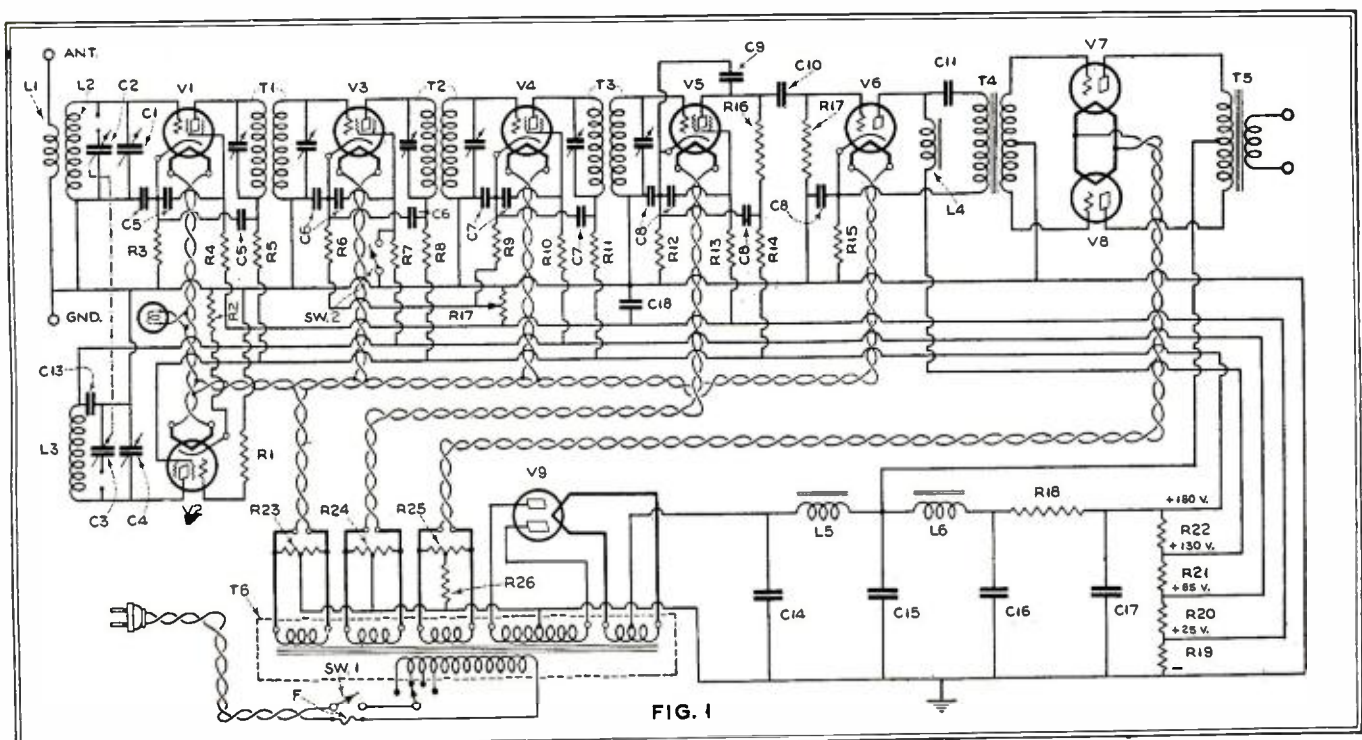

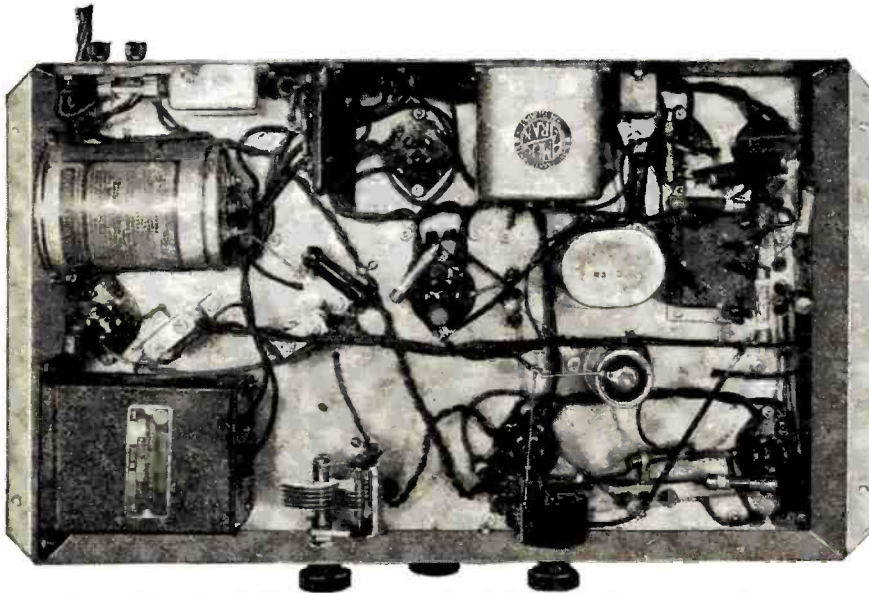

Practically all of the wiring is confined beneath the chassis. In this model the "local-distance" switch (SW-2) was added later and therefore does not appear in these photos. Its place is on the front of the chassis directly beneath the main tuning control

resistors (R3) with 180 volts plate and 25 volts screen. The resistor in the screen-grid lead is 50,000 ohms (R4), and (R5) is 1000 ohms in the plate circuit. These resistors (R3), (R4) and (R5) are by-passed by three .1 mfd. condensers, C5 in one unit. The same isolating arrangement is used in each stage.

The oscillator coil construction and condenser connections are shown in Figures 4A and 4B. As stated before, a screen-grid tube is used as a dynatron, 90 volts being applied to the plate and 180 volts to the screen. To prevent excessive screen and plate current, a 750-ohm resistor, R2, is connected in the cathode lead. The .5-megohm resistor R1 in the grid lead may not be necessary in every case, but some -24 tubes do not oscillate on the high frequencies without it.

The first and second intermediate amplifying tubes are screen-grid tubes, each biased by 1000-ohm resistors, R6 and R9. The plate voltage is 180 and the screen, 85. The isolating resistors and by-pass condensers are the same as in the first detector. The volume control is a 3000-ohm tapered potentiometer, R17, connected from the 25-volt line to ground, the cathodes being brought to the center point. The shaft of this potentiometer carries the 110-volt switch. The local-distance switch grounds the screen of the first intermediate amplifier through the 50,000-ohm resistor, R7.

The second detector is again a screen-grid tube with a 15,000-ohm biasing resistor, R12, and using the same voltages as the first detector. This tube is isolated by a 50,000-ohm resistor, R14, in its plate circuit, and 1000-ohms, R13, in the screen-grid line. By-passing in this case is with 1 mfd. condensers, C8, back to cathode. These condensers are built into a single can which also contains a 1-mfd. for by-passing the grid-biasing resistor in the first audio stage.

The detector is resistance coupled to the first audio by a .25-megohm resistor, R-16, in the plate circuit and a .05-mfd. coupling condenser, C10.

A type -27 tube is used in the first a.f. The grid leak is a .5-megohm resistor, R17. Its plate is parallel fed through a 300-henry choke, L4. The coupling through the input push-pull transformer is with a .25-mfd. condenser, C11.

Two type -45 tubes are used in the power stage connected in push-pull. The output transformer, T5, is not included in the chassis, as it seems to be standard practice to build it into the loud speaker, which should be any good dynamic with a field resistance of about 2000 ohms.

The output from the power tube is brought to a UX socket, the two plates being connected to the grid and plate terminals, and the field to the two filament terminals. The loud speaker should be fitted with a UX tube base or a UX loud speaker plug, care being taken to connect the center tap of the output transformer to the high side of the field.

The rectifier is full wave using a type -80 tube. The filter uses a 15-henry choke, L5, and the dynamic field, L6. The condensers, in one unit, are four 4-mfd., C14, C15, C16 and C17 dry electrolytic which unlike the liquid condensers can be mounted in any position without harmful results.

The resistor, R18, is 1500 for an 1800-ohm speaker, and is mounted separate from the balance of the voltage divider so that if a loud speaker with a different field resistance is used, it can be compensated for by increasing or decreasing its size. The voltage divider, R19, R20, R21 and R22, can be separate resistors or one large resistor tapped at the proper points.

Three filament windings are used, one for the type -45 tubes, one for the second detector, and one for the balance of the tubes. Three 20-ohm center tapped resistors, R15, are connected across these windings. The center tap of the power tube filaments connects to ground through a 790-ohm re- (Continued on page 937)

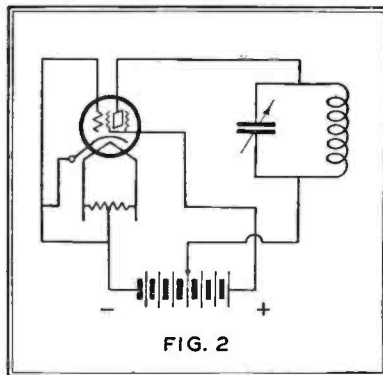

FIG. 2

Figure 2. The dynatron oscillator circuit is extremely simple, including as it does only a single coil and condenser. Yet such is its stability and flexibility that it functions smoothly throughout the entire range required in this all-wave receiver

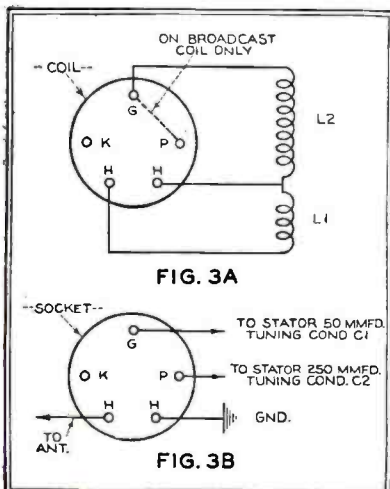

FIG. 3A

FIG. 3B

Figures 3A and 3B. The antenna plug-in coil and socket. The connection indicated by the broken line is included only in the broadcast coil and cuts in the large tuning condenser, C2

Figures 4A and 4B. The oscillator plug-in coil employs an arrangement similar to that in the antenna coil to cut in the higher tuning capacity when the broadcast coil is plugged into its socket

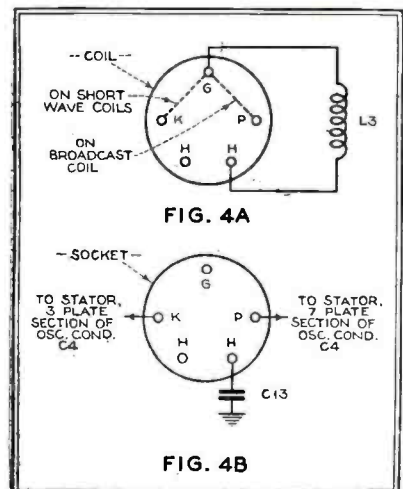

FIG. 4A

FIG. 4B



Brass Pounding on the Pan-Am Trail

Argosies awing offer new thrills to the radio operator. The romance of El Dorado, the ancient trails of Ponce De Leon, Walter Raleigh and Columbus add allure to the call of youth's most fascinating profession

RADIO communication facilities have contributed more than any other single factor to the public's generous acceptance of commercial air lines as established and safe systems of transportation, and to the actual safety and consistency with which schedules are maintained. Pan-American Airways flies 98 planes over 5,000,000 miles a year, carrying mail, express and 100,000 passengers. The last report showed the completion of 99.67 per cent. of all trips on scheduled time—a record considerably better than that of any railroad!

In its dependence upon radio communication, the airplane may be compared with a boat at sea. In both cases radio is the only practical method yet devised whereby communication can be maintained with land or another plane or boat. But here the comparison ceases. A boat carries its own meteorological equipment, and can make a reliable forecast of the weather conditions ahead. The airplane carries no apparatus for predetermining weather. The master at sea depends principally upon his barometer as an indicator of meteorological variations. The barometer, functioning upon the principle of changing air pressure, would be useless in a plane where the fluctuations due to the variation in altitude would far exceed the delicate pressure differences occasioned by changing weather. It is possible, even probable, that some day a differential barometer, functioning in conjunction with a radio or

By Zeh Bouck

other type of absolute altimeter, will be developed. But such a device would be reliable only when flying over water or land approximating sea level, and even then its utility would be limited.

Weather conditions change much more rapidly when flying than when traveling by boat. A plane leaving San Juan, Puerto Rico, at the same time and for the same destination as a ship, may fly through several squalls before the lookout on the bridge will even discern a cloud on the horizon.

A ship at sea can proceed almost independently of weather that will often ground a plane. And the Pan-American Airways flies over sections of the world where all extremes of weather are encountered, often with a rapidity that is, to say the least, disconcerting. Mexico City nestles in a plateau seven thousand feet above the sea, surrounded by mountains smothered more often than not in clouds and storms, and scratching the blue sky above with peaks over twenty thousand feet high. Down the hot, arid prairies of Yucatan the haze at times builds up into an obliterating blanket. For six months of the year Central America reverberates with the thunders of the rainy season, and clouds as black as pitch roll up from nowhere in the twinkling of an eye.

Guatemala City is perched in a valley five thousand feet above the sea, and the eight-thousand-foot mountains that encircle it are shrouded in grey cumulus masses that seep i



H. C. Leuteritz, Communications Engineer, with one of the P. A. receivers

the pass through which the planes are routed. Line squalls dot the course from Panama to Buena Ventura in Colombia. Mountainous billows roll down from the cool Andean altitudes and settle like a London fog on the hills and valleys between Guayaquil and Talara. Low, menacing clouds and the tufted fog cotton mark the meeting of the winds from the hot Peruvian deserts and the cool Japanese Humboldt stream lapping the barren and limitless palisades of the west coastline. Winds whine with the violence of a gale around the rocky promontories, clearing the sky one instant and darkening it the next. The whirling snows of the Cordilleras give way on the Argentine pampas only to ground fog that thickens as the plane approaches Buenos Aires and the coast.

The weather from B. A. to Santos, Rio and Bahia changes with every toss of the wind, and it is only the trades, blowing from Natal to Para, that offer a brief and grateful interlude of consistent weather. Flying north from Para to Trinidad routes the plane across the mouths of the Amazon and Orinoco rivers, into the hurricane belt that curves with the Antilles

THIS is another in the series of articles in which RADIO NEWS has described the radio communication systems of America's major airways. It is particularly fitting that this article should come from the pen of Mr. Bouck, who has probably spent more time aloft in the development of aircraft radio apparatus than any other engineer. His flying hours total many hundreds, and his first experimental aircraft transmitter was designed and made in 1921. He made the first flight from the United States to Bermuda just one year ago. As an operator he has flown over three continents and twenty countries, and has been QSO with practically everyone of the Pan-American ground stations.

THE EDITORS.

across Puerto Rico, Santo Domingo and up to Miami.

We have said that there are times when an airplane cannot fly due to weather conditions that would not necessarily stop slower modes of transportation. Fog is the principal meteorological impediment in the consistent maintenance of flying schedules. In bad fog the boat and the railroad train will slow to a safe speed—a speed that will enable them to stop before hitting such objects as may loom up in the soupy haze ahead. But an airplane cannot fly slowly—its slowest safe speed is that of an express train traveling with a wide-open throttle—and it cannot stop safely unless adequate landing facilities are at hand. But the application of radio to the airways has materially reduced the limitations placed by fog and other unfavorable weather conditions upon air travel.

We call to mind our own flight from Vera Cruz to Guatemala City, in which the utility of two-way radio communication, weather reports and the general efficiency of the Pan-American system were deeply impressed upon us.

We took off from the Vera Cruz airport at Tejeria early on a June morning, climbing into a clear tropical sky. The morning air was crystalline, and for an hour after our take-off we could still see the white cone of Orizaba glistening in the northwest. We stopped at San Geronimo for gas, and proceeded down the west coast of Central America. A weather report from CH, Tapachula, told us that the usual afternoon storms were building up. We could see them in the mountains to our left as we flew over Tapachula, but an encouraging report from TGF, Guatemala City, that the pass was clear, invited us on. We sent through TRs (position reports) at short intervals, fa-

ilitating a search had we been forced down by the weather closing in behind and in front of us. When we were within twenty miles of our destination, TGF radioed us that the valley was completely closed above—that it would be impossible to fly over the mountains, and our only chance was the pass, still clear but threatening to close momentarily. As luck would have it, we got through, but a backward glance showed the fog dropping behind us, like the Red Sea behind the Israelites. Had the last WX indicated that valley was closed both by pass and from above, we would have returned to Tapachula. Under such circumstances a plane without radio equipment and trusting to luck to push through undoubtedly would have crashed.

Pilots are frank to admit that they would hazard the completion of only a fraction of their flights on schedule were they deprived of radio facilities.

From the preceding, it is fairly obvious that a general weather report covering the route traversed, or a weather forecast prepared only a few hours before the flight, is inadequate. Corrected WX, covering conditions at the time of transmission and available at three or four points along the course, is highly desirable, and such a distribution has been effected in

A Fokker loading up at the Pan-Am Field, Tampico



the Pan-Am system. Stations are strategically placed along the routes bordering the Caribbean Sea. This system has recently been extended to include the east coast of South America, as far south as Buenos Aires. Meteorologists are maintained at the principal terminals, and weather experts are stationed at all intermediate points. Altered weather conditions are immediately noted, and weather reports corrected to describe the changed conditions.

A special weather report blank has been prepared to facilitate the copying of a WX. The answers to the following questions are written on the blank (illustrated in my article, "QRD South America," in RADIO NEWS, January, 1931): Source, Time, Date, Address, General weather conditions, Horizontal visibility, Height of base of lower predominating clouds, Amount of Sky covered by lower predominating clouds, Total amount of sky covered with clouds, Direction of surface wind, Force of surface wind, Weather conditions during preceding hour, Barometer reading, Dry thermometer reading, Wet thermometer reading, Remarks. Only the answer to these questions are transmitted, each reply being spaced from the following one by "dot dash dot dash." By using this blank, a complete weather report can be transmitted and copied in about one minute. Pan-American was the first air transport organization in America to appreciate fully the necessity for two-way communication, and the desirability of effecting this by means of code transmission with skilled operators, rather than by the use of radio telephony with added duties for the pilot and a reduction in the reliability of transmission. The transmitters on board the planes are used primarily for requesting and acknowledging weather reports, for the transmission of TRs and for the handling of official traffic. The land stations, in addition to communicating with the planes, are used for point-to-point work, dispatching and

official business. At the present time a ruling of the Federal Radio Commission (one of their less felicitous decisions) prohibits the handling of paid traffic, which ruling, under all but exceptional conditions, limits the communication facilities of the system to its planes and to official business. But it seems probable that, along with a few other decisions, this ruling will be reconsidered by the Commission, and the company will be permitted to handle traffic for passengers and other planes on a commercial basis similar to that practiced by ship and shore stations.

At the time of the inauguration of the Pan-American Airways system no effective short-wave airplane transmitting and receiving apparatus was available in a commercial form. As a matter of fact, conditions in this respect have not altered materially in the last three years. The engineers found it both desirable and necessary to design and manufacture their own radio equipment, for land and

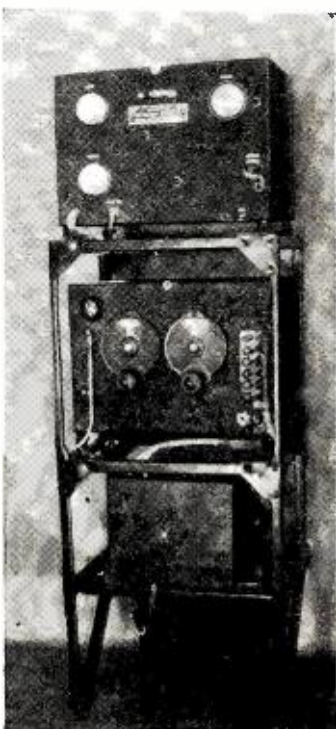

The rack mounting in a Ford installation. The transmitter is on top



A Pan-American outpost. The landing field and radio station on the Island of Curacao, north of Venezuela



A close-up of the P. A. 12-watt transmitter

planes. Appreciating the desirability for intercommunication and the general failure of aircraft transmission on the lower aircraft frequencies, experimentation was confined for the greater part to the development of short-wave apparatus. Too much credit cannot be given to A. A. Priester, chief engineer, and H. C. Leuteritz, communication engineer, and their associates for the development of what undoubtedly is

the finest airplane radio equipment in the world. It has been the pleasure of the writer to operate this apparatus. The research department and laboratory employs the services of three qualified radio engineers, and their concentration upon the problems of aircraft radio has by no means ceased with the production of their present designs.

The general airplane equipment consists of a trailing wire antenna, supplementary to a fixed aerial, and employed in long-distance communication and for 600-meter distress signaling in compliance with the international regulations; the power supply—a 12-volt storage battery, dynamotor and a wind-driven charging generator; the power control panel, with a dynamotor relay controlled by a switch at the operating desk; the high-frequency panel; the receiver and "B" battery supply. The receiver, transmitting key, relay control switch and "B" batteries are generally mounted forward with a comfortable chair and desk for the operator. The antenna reel, power control panel, keying relay (which automatically changes over the antenna, amounting to a break-in system) are usually mounted close together. In the Sikorsky they are placed in the tail. In Ford installations, the receiver, transmitter and associated apparatus are rack mounted.

The P. A. airplane transmitter employs a master oscillator power amplifier circuit with -10 type tubes, outputting from 12 to 35 watts in the antenna. With the dynamotor supplying 450 volts plate potential, the output is 12 watts.

The receiver uses a screen-grid r.f. circuit, followed with a regenerative detector and one stage of a.f. amplification. Plug-in coils cover all aircraft bands.

The complete weight of the transmitter-receiver-power installation (with the exception of the storage battery, which is a part of the airplane lighting equipment) is about one hundred pounds when the effective weight of the wind-driven generator is considered.

The land station transmitter is rated at 200 watts output into a voltage feed horizontal half-wave (Continued on page 954)



A phonograph pick-up developed by the writer. The tone-arm base includes a volume-control. The pick-up head is pivoted on the arm for convenience in changing needles. Various special features are included, such as absence of rubber in the construction and magnetic retention of the needle

THE preceding article described methods of determining the characteristics of pick-ups, and indicated the essential similarity of pick-up curves. It was pointed out that the pick-up is mechanically only a damped vibrating reed, which is usually so dimensioned as to resonate at the upper end of the musical scale. The resonance point is in practice only partially suppressed by the damping. The damping, together with the volume control which usually parallels the pick-up coil, tend to reduce not only resonance, but also the entire upper musical range. These factors which are common to all present-day pick-ups, give them all a certain shape of response curve, which can be varied by manufacturers only within relatively narrow limits.

Our study has heretofore necessarily neglected a number of factors which are of importance. One of these is the characteristic of the record itself.

Record Characteristics

In the accompanying Figure 1, Curve 1 represents a characteristic typical of many of the best of our present-day commercial pick-ups. At the lower end of the scale there is inevitably a flattening out of the curve, due to losses through body vibration. At the upper end there is the resonance peak due to the natural period of vibration of the armature. Between is the downward slope determined largely by damping.

The dotted line 2 of Figure 1 indicates the nature of the response of commercial records at the lower end of the scale. Owing to limitations in the width of the groove in the record it is necessary, as is well known, to limit the recording of the lower frequencies in such manner that the needle velocity falls in direct proportion to the drop in frequency. This gives a rather abrupt falling off of the response below frequencies of about 250. To correct for this, the pick-up response should have the opposite characteristic, and rise abruptly below 250, thus giving the Curve 3.

At the upper end of the scale of recorded frequencies there is a rapid fall beyond 4000 to 5000. This is determined by the fact that the size of the lateral indentations in the record groove becomes nearly infinitesimal at the upper end of the scale, and that the needle point is unable to follow properly such minute fluctuations. It might be thought that it would be desirable to compensate for the drop at this end, but in

Pick-up

By
S. McClatchie

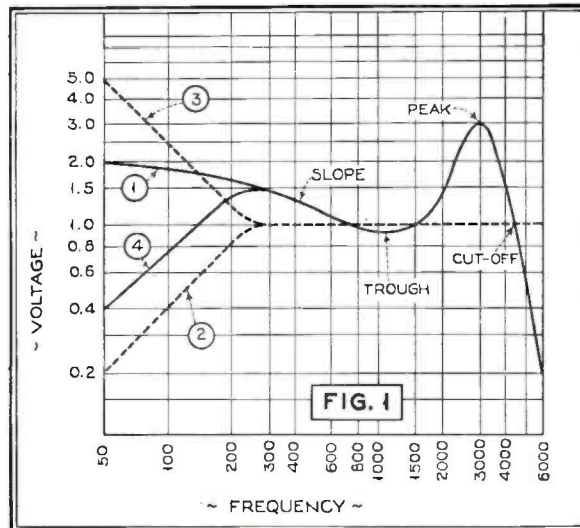

Figure 1. Curve of typical high-grade commercial pick-up, together with correction curves, as explained in text. The resultant Curve 4 indicates the frequency-response of the pick-up as used on normal records

practice this is not the case. For at the upper end we get into the realm of the scratch frequencies. A pick-up with an exaggerated high-frequency response would give us the impression of being too noisy. Straight-line response from the pick-up is here about ideal. Present commercial pick-ups unfortunately have a considerable rise right in the midst of the region of scratch frequencies.

It is obvious from the foregoing that if we are to obtain a true picture of the actual response of the pick-up on the normal commercial record, we must correct the pick-up curve to take into account the curve of the record. As indicated, we may neglect the drop in the record at the upper end of the scale, as it is not desirable to compensate for this anyway. But we must certainly take account of the restriction of the

lower frequencies in the record. If we plot Curve 1 with Curve 2 as a base line, we get the resulting Curve 4. This represents the actual reproduction of the pick-up as applied to normal records. It is what our ear really hears. To be correct, all pick-up curves should be corrected on this basis. The records all have a characteristic, as indicated in Curve 2, and this should be taken as a base line in plotting the pick-up response. As there is no prospect of the records ever being made differently, there is no reason apparent why this should not be adopted as standard practice.

The corrected or resultant Curve 4 is seen to consist of two humps. The first hump serves to a certain extent to camouflage the second one. That is, the emphasis on the frequencies in the middle of the lower range helps to cover up the scratch

THIS and the article by Mr. McClatchie in the last issue are especially recommended for study by those who are interested in electrical reproduction from records. The discussion is most timely in view of the ever-extending popularity of recorded programs or speech, as for instance in the home talkies now being commercially developed, in home recording and in the combination radio-phonographs now found in an ever-increasing number of homes. At best the output of a pick-up unit is extremely weak, for which reason too much attention cannot be given to the possibilities for improving the efficiency of associated apparatus and coupling as discussed here.

THE EDITORS.

CHARACTERISTICS

This month, Mr. McClatchie continues his discussion of phonograph pick-ups to include some extremely practical thoughts on the apparatus and equipment usually associated with the pick-up and the effect of such association in altering the overall operating characteristics of the pick-up

noises which the resonance peak tends to emphasize. Indeed, this artifice is so effective that surface noise in the best recordings is with present-day pick-ups hardly noticeable. The characteristic remains, nevertheless, quite artificial.

The Ideal Pick-up Curve

To match the records and provide ideal reproduction, a pick-up should have the characteristic shown in full line in Figure 2. Corrected on the basis of the record characteristic, this would be simply a straight line. For comparison, Curve 1 of the preceding figure is shown as a dotted line.

It is improbable that we shall ever be able to get the ideal characteristic out of any mechanical system which it would be practicable to actuate by a needle on a normal record. It is true that it is possible by a system of mechanical filters to get almost any conceivable response characteristic, and there are many patents describing such systems. But in the application of such a system to a pick-up we would violate one of the fundamental principles of pick-up design, which is that the system to be

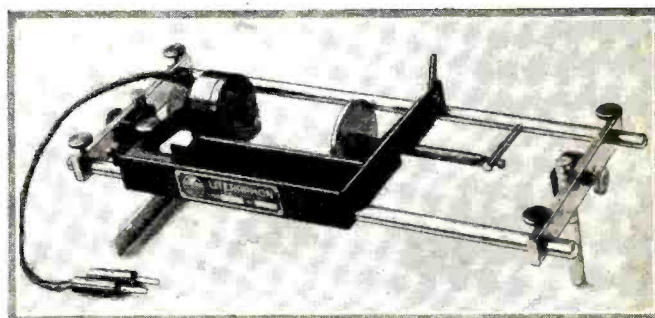

An interesting home-recording device from Germany. A standard pick-up head is mounted on guides and moved across the record blank by a screw-feed device driven by the turntable. A sapphire point cuts the groove in the blank, which is of soft metal

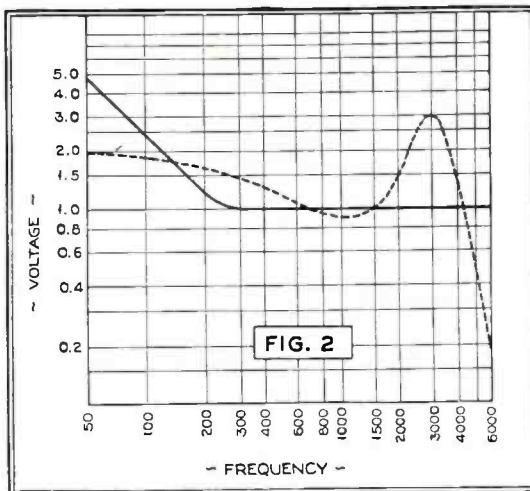

Figure 2. The ideal pick-up curve. This characteristic would give straight-line response on standard records between 50 and 4,000 cycles. For comparison, the actual curve of the present-day standard pick-up is indicated by a dotted line

A popular German phono-radio combination, made by the Telefunken Company. An electrodynamic speaker is at the left and the radio set at the right. In Germany nearly all radio sets are midget or table models. The use of pick-ups there is nearly as common as in the United States



actuated by the needle-point must be as light and simple as possible, to avoid destroying the record.

Two ways to greatly improve the characteristic of the pick-up are open. One is to get armature resonance far above the musical range of the record, so that it no longer plays a rôle in reproduction from the record. The other is to eliminate damping, and with it the main cause of the downward slope in the pick-up characteristic, and the chief source of instability

in the device. The experiments of the writer have shown that it is possible to attain these ends. The result is a straight-line characteristic within the musical range of the record, which provides much more pleasing reproduction than has heretofore been attained. Such a characteristic may very readily be altered by a simple resonant circuit to give the absolutely ideal curve of Figure 2. To properly correct the ordinary pick-up curve, quite intricate filter circuits would be necessary, which would be too expensive for commercial practice.

It is clear from the foregoing that, while present designs have a fair characteristic, there is much room for improvement. On the whole, the problem involved is less complex than that of producing a straight-line loud speaker, and we are justified in demanding substantially better performance from our pick-ups than has heretofore been attained.

Matching Impedances

The curves which have been given are based on the assumption that the pick-up is connected directly to the grid of the input tube of the amplifier. This is the usual practice in radio sets. However, coupling transformers are sometimes used between the pick-up and the grid. In this case the question of matching impedances comes up.

In practice, the impedance of a pick-up approaches that of the grid only at the highest frequencies. The usual radio set pick-ups have an impedance of (Continued on page 932)

Testing the



By
Humphrey
Andrewes*

Previous issues of RADIO NEWS have dwelt at Radiostat, the invention of Dr. James Robinson, wave enthusiasts would begin to consider the application. In this article Mr. Andrewes, an associate make his own

NO doubt since the invention of Dr. Robinson's new receiver system was first described in RADIO NEWS, many of the large band of amateurs in America will have wondered whether this new device can be used on the short-wave channels. Shortly after the first experimental models of the Stenode were constructed in England, the writer had an opportunity of testing out its possibilities on the amateur channels. The apparatus used was primarily designed for the broadcast bands, but as the oscillator and aerial circuits were designed with plug-in coils, it was possible to adapt the apparatus fairly easily to other wavelengths.

The first experiments were made on the 2000 kc. phone band. The results were astonishing. The apparatus was set up in the northern part of London and on this frequency the QRM from all the different phone stations in this area is extremely bad. It was found, however, that it was possible to pick out any one of the good phone stations which were crystal controlled and separate it readily from the others. This receiver, however, showed up the badly operated stations, as it was impossible to receive a station which was not absolutely steady in frequency. A number of broadcast stations were also picked up on this band.

In turn, experiments were made on each of the other amateur bands up to the 14000 kc. band, although the receiver which was used was not really designed for working on these high frequencies. The writer was impressed with the possibilities of the use of this apparatus on the amateur bands, so that a schedule was arranged with one of the amateur stations on the other side of London. It may not perhaps be well known in America, but it is often very difficult to maintain a satisfactory schedule with stations on opposite sides of London.

During the actual tests which were carried out, it was found that there were two stations, one a thousand cycles on one side and one 2000 cycles on the other side of the station which was being received. Both of these stations were local and stronger than the scheduled station, but it was possible to reduce the interference considerably, so that contact with good speech could be maintained.

Ever since amateur radio has started, there has been a little trouble which has worried all those who have tried to communicate with each other. That little trouble

has been QRM. Any amateur who has listened on the short-wave channels or who has owned and operated an amateur transmitter, knows those exasperating interfering signals which come at just the time you are trying to understand what the other fellow is saying. How often have you thought how nice it would be if you could make a receiver which would cut out the interference? This is exactly what the Stenode has proved capable of doing.

The mathematical theory and the analysis of how the system works has been described in great detail by Dr. Robinson in his paper which he gave before the Radio Club of America and which was published in this magazine in February. It is unnecessary, therefore, in this article, to go into the why and wherefore of the theory.

From a perusal of the technical details which have been published up to now it might appear as though the invention necessarily involved elaborate apparatus and a multiplicity of circuits. In the case of a broadcast receiver, to give the finest possible quality and have modern sensitivity, the circuits certainly do become involved, although they are fundamentally quite simple. Whenever we come to a consideration of a simple arrangement which can be used on the short-wave channels, it is possible to devise simple circuits and design a receiver which any amateur can easily build. Let us, therefore, without more ado, turn to the practical ways and means

by which we can adapt this invention to the use of the amateur. Perhaps the simplest arrangement that we can consider is the use of a quartz crystal for single-frequency working. By single-frequency we mean that if two stations have a definite schedule together it is usual for some definite frequency to be fixed (as in the case of the Army or Navy amateur networks), and

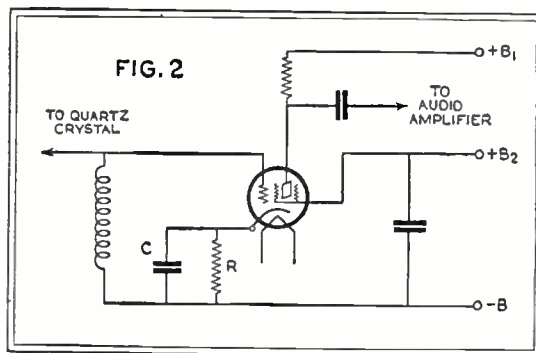

Figure 2. Automatic grid bias is employed in the crystal controlled detector stage. When using a type -24 tube R may be 10,000-50,000 ohms and C = 1 mfd.

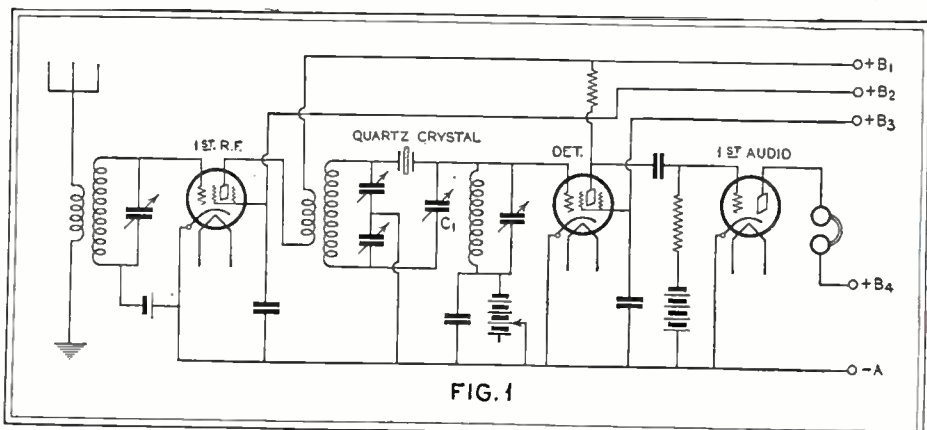

Figure 1. Short-wave Stenode receiver, of experimental design. No constants have been indicated, as the experimenter may design the receiver for the frequency band which he wishes to work. C1 is the quartz crystal balancing condenser

*British Radiostat Corp.

New Circuit

length on the technical features of the Stenode and it is only natural that experimenters and short-coupling of the Stenode to their particular fields of of Dr. Robinson, tells the "ham" just how he can short-wave Stenode

in this case the two stations only wish to receive one particular frequency. If, therefore, four crystals are chosen so that we have two pairs of crystals that have as near as possible the same frequency, then if one is used for the transmitter and one for the receiver in each station it will be fairly obvious that, provided we can arrange the receiving circuits to utilize the quartz crystal, a fixed form of receiver can be devised which makes contact between these two stations. With such an arrangement no searching for stations is necessary, the receiver and the transmitter cannot wander perceptibly out of tune and with careful design interference should be reduced to a very minimum. Figure 1 shows a skeleton circuit diagram of such a receiver. In this circuit the same quartz bridge circuit is utilized, as has been previously described, but as the quartz crystal is ground to the same frequency as the signal to be received, obviously it is unnecessary to utilize the superheterodyne principle. The input transformer from the aerial circuit and any high-frequency stages which may be utilized

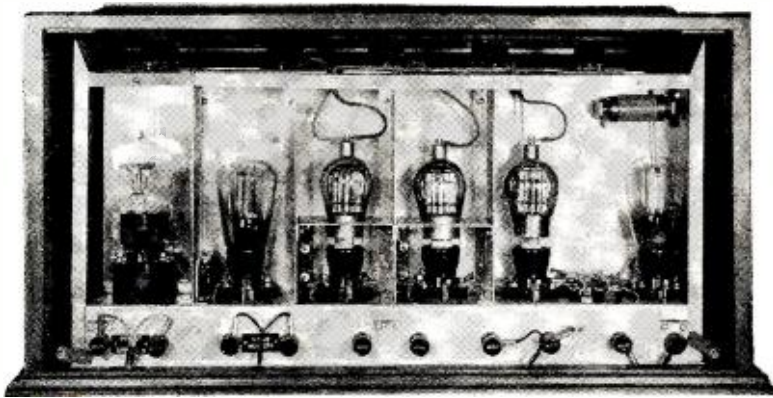

Note the extent to which shielding is carried in this model of the Stenode. This is one of the standard models designed for British tubes

in front of the quartz crystal, are tuned approximately to the frequency of the crystal and then can be left alone. The condenser C1 is adjusted so as to balance the capacity of the quartz crystal mount and this adjustment may readily be found when listening on the receiver. It will be noticed that as the capacity of this condenser is varied, there is one position on the scale where practically all the interference disappears, particularly static, etc. This adjustment is quite critical, but once it is found it will not vary. The low-frequency portion of this receiver can be quite simple and if phones are used for reception one stage of audio-frequency with a suitable correction coupling, which will be discussed in a moment, will be sufficient.

If this receiver is to be used for the reception of pure unmodulated cw, it will be necessary to add a local oscillator for heterodyne purposes, and if the designer desires to make the apparatus as stable as possible, a crystal control oscillator might be utilized having a small audible difference in frequency from the crystal used for reception when a steady heterodyne note would be received. This last, however, is an

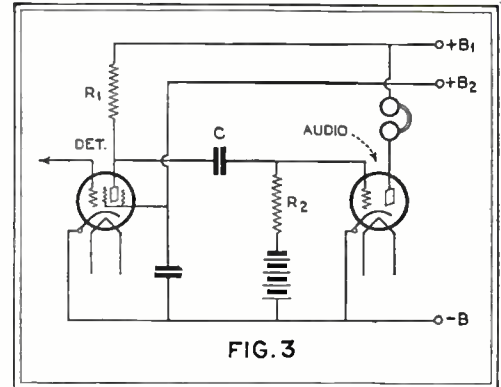

Figure 3. Circuit for first audio stage. The coupling condenser C may have a value of from 200 to 500 mmfd., $R_1 = 300,000$ to 500,000 ohms, and $R_2 = 250,000$ ohms to 1 megohm

elaboration which is by no means essential. It is obviously impossible in one article to give complete constructional details of such a receiver and therefore only the general design can be indicated. The design of such a receiver will obviously appeal to the keen experimenter, who will have an opportunity to carry out experiments in this interesting branch of the radio art.

Let us consider now the case of the design of a receiver which is suitable for use on all the amateur bands and which is not limited to one particular frequency. In this case utilizing again the quartz crystal we must turn to the superheterodyne. In the circuits which have been published in previous issues describing in detail the apparatus, the quartz crystal was inserted in a bridge circuit in the intermediate-frequency amplifier of a superheterodyne. Although the receiver described was designed for use on the broadcast wavelengths, the same arrangement may obviously be adapted to the short-wave amateur bands. The RADIO NEWS Short-wave Superheterodyne described in the September issue can be adapted to this principle. The receiver consists essentially of three parts, the high-frequency portion up to the bridge circuit, which follows the standard superheterodyne practice; secondly, the quartz crystal circuit and second detector and, thirdly, the audio-frequency correction amplifier. The important difference between this superheterodyne and those which have been previously described lies in the use of a high value of grid bias on the second detector and the use of an audio-frequency amplifier in which the amplification increases proportional to the frequency.

The grid bias of the second detector may be obtained automatically by inserting a resistor in the cathode return lead by-passed by a suitable fixed condenser. Such an arrangement is shown in Figure 2. This grid bias is necessary because of the large amplitude of carrier wave which builds up when it passes through the quartz crystal. This is equally important in the case of the reception of code signals. The correction amplifier is necessary, because otherwise the low frequencies in the modulation would be many times stronger than the higher frequencies and give extremely distorted speech or music. An interesting point in connection with this amplifier which should be of great use to the amateur designing a receiver is the fact that an ordinary pair of headphones has a frequency characteristic which slopes up very sharply to about a thousand or fifteen hundred cycles. If a pair of phones is therefore inserted in the anode circuit of the second detector of this special superheterodyne, quite fair music, as far as the bass and middle frequencies are concerned, will be received. If therefore the signals are strong (Continued on page 955)

The Army's Amateur

The amateur, or "ham," is held by the U. S. Army to be a decidedly important link in the emergency communication system of the country. So much so that the U. S. Army Signal Corps has organized the amateurs of the country into a radio reserve system of great importance, as disclosed in this article

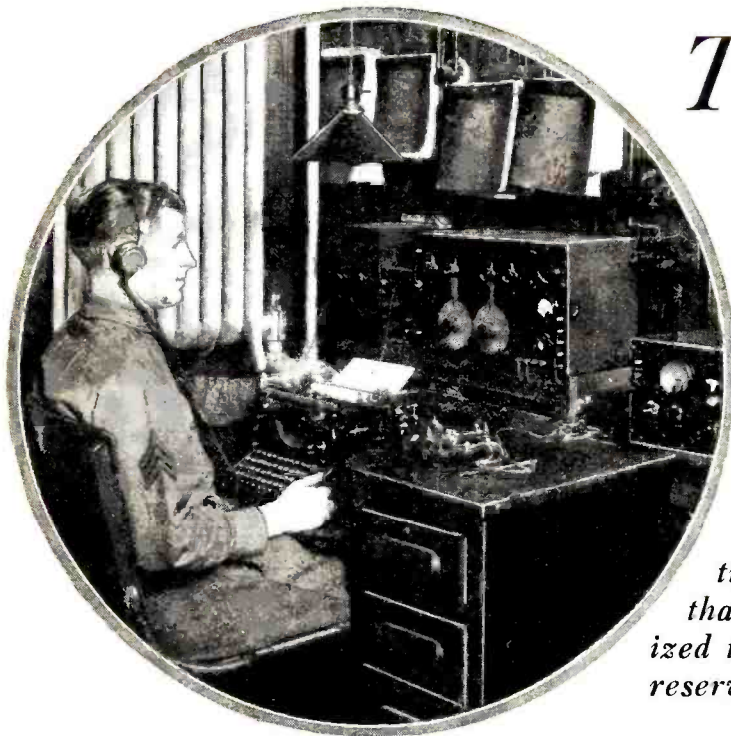

Receivers at the Army station WTW, Fort Monmouth, N. J., one of the 2nd Army Corps Area Network

THAT the radio amateur is a valuable asset to the country is a well-known fact, which has been substantiated innumerable times, as for example, during the floods in Vermont a few years ago, the Mississippi Valley disaster, the recent Miami and Porto Rico hurricane emergencies, etc. In all these emergencies, the local radio amateurs, with the co-operation of other amateur stations in various parts of the United States, were able to maintain communication by means of their low-powered transmitters operating on the short-wave bands assigned to amateurs, and thereby handle the necessary traffic for the direction of relief work, press reports, messages concerning the safety of persons in the stricken area and other emergency communications.

This emergency communication work was organized in a more or less temporary and hasty manner, and the fact that communication to the outside was established and maintained, was due to the loyal co-operation of each individual amateur, who volunteered the services of his station and himself to establish radio channels of communication during the period of the emergency, when all telephone and telegraph wires were out of commission.

In view of this potential public service of the radio amateur, the War Department, through the Signal Corps of the Army, began, in 1925, to develop a nation-wide organization of radio amateurs to provide each community with reliable communication in emergencies. This organization is known as the "Army Amateur Radio System" and has grown in the past five years from a handful of stations to over 700 Army amateur radio stations in the United States and its possessions at the present time.

The Army Amateur Radio System

*U. S. Army Signal Corps Reserve.

is a purely voluntary organization of American radio amateurs who desire to affiliate themselves with the Signal Corps of the Army for the following purposes:

(a) To provide additional channels of communication throughout the continental limits of the United States that can, in time of emergency, be used to augment or replace the land lines, both telephone and telegraph, that may be seriously damaged or destroyed by flood, fire, tornado, earthquake, ice, riots or insurrections.

(b) To place at the disposal of military commanders of all components of the Army of the United States (Regular Army, National Guard or Organized Reserves) and of the Red Cross such amateur radio channels of communication as may be developed.

In return, the Signal Corps has the following objectives:

(a) To provide the amateur radio operators with a knowledge of Army methods of radio procedure and of the basic principles of using radio in the field.

(b) To establish contact with a considerable number of interested amateur radio operators, acquainting them with the Signal Corps and its activities, and securing their aid in experimental work, tests, etc.

(c) To render such encouragement and assistance as may be desirable to firmly establish and perpetuate the American amateur.

It may be well, at this time, to point out that no military service of any nature is required or expected at any time of anyone affiliating themselves with this organization. It is only a voluntary co-operative plan by means of which an amateur radio operator who, realizing his duties and responsibilities as a citizen, may train himself to better serve his community in time of an emergency when communi-

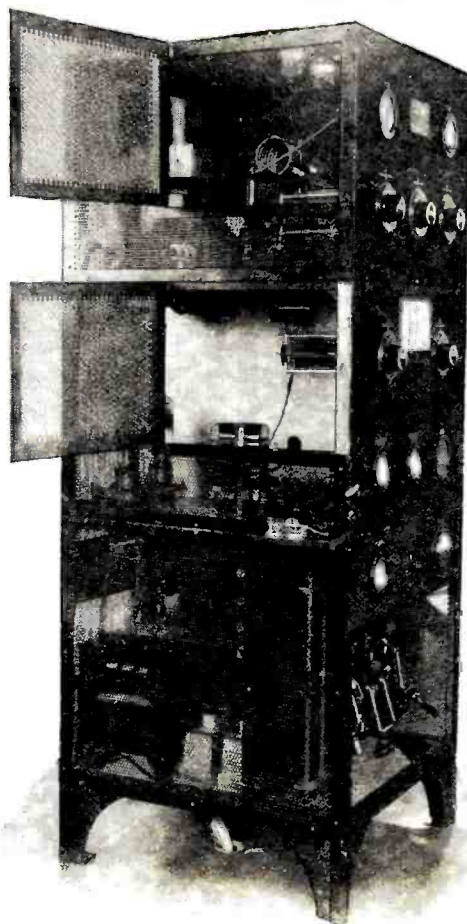

The transmitter at the Army Amateur Net Control Station WLM-W3CXL, Washington, D. C.

Capt. David Talley*
the author of
this article

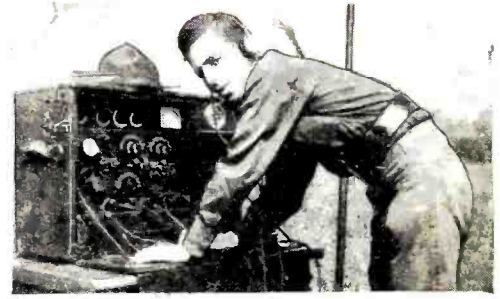

says--

*The Radio Amateur Will
Benefit Because--*

Radio System

ation channels are temporarily destroyed. Any amateur radio operator, having an amateur radio station in active operation that is duly licensed by the Federal Radio Commission, is eligible to join.

Organization

For the purposes of Army organization and military administration, the United States is divided into nine Corps Areas. The First Corps Area, for example, comprises the states of Maine, New Hampshire, Vermont, Massachusetts and Connecticut, with headquarters at Boston. The Second Corps Area consists of the states of New York, New Jersey and Delaware and the Island of Porto Rico. Its headquarters are at Governors Island in New York Harbor. The headquarters of the remaining Corps Areas are, in numerical order, at the following places: Baltimore, Atlanta, Columbus, Chicago, Omaha, San Antonio and San Francisco. It seems logical, therefore, that the Army amateur radio system should follow the same manner of organization, and it does as closely as possible.

Co-ordination

The Army Signal officer in each Corps Area in the United States is charged with the carrying out of this plan of affiliation between the Signal Corps and the transmitting radio amateurs in the Corps Area. In furtherance of this scheme, he appoints an officer at his Corps Area Headquarters to serve as a "Corps Area Liaison Agent" between a representative of the radio amateurs—who is known as the "Radio Aide to the Signal Officer"—and the Corps Area Signal Officer.

In order to coordinate the work in the various Corps Areas, the Chief Signal Officer of the Army, Major-General George S. Gibbs, has designated Captain N. L. Baldwin of Army Amateur Radio Station W3CXM, Washington, D. C., as the Army Liaison Agent and Major Lawrence J. Dunn, Sig.-Res., operator of A.A.R.S. W2CLA, Brooklyn, N. Y., as the Chief Radio Aide.

The antenna at WLM-W3CXL. This station is operated from the Munitions Building, Washington, by remote control

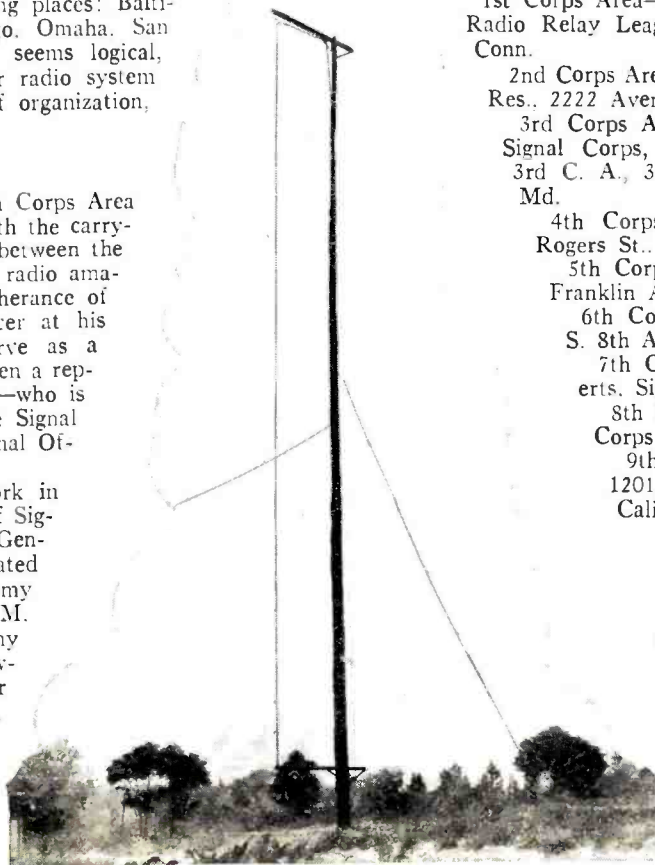

RECOGNITION by the U. S. Army helps to insure the permanency of the amateurs' rights against the encroachment of commercial interests in the assignment of operating frequency bands.

PARTICIPATION in the Army network trains the amateur in efficient and standardized methods of traffic handling and organization.

CONTACTS are provided with other amateurs and opportunities to participate in experimental and development work in co-operation with Signal Corps stations and other amateurs.

to serve as the Army representative of all transmitting amateurs of the United States.

The Radio Aides or Liaison Officers of the Corps Areas are as follows:

1st Corps Area—A. L. Budlong, c/o American Radio Relay League, 1711 Park St., Hartford, Conn.

2nd Corps Area—Captain David Talley, Sig.-Res., 2222 Avenue O, Brooklyn, N. Y.

3rd Corps Area—Captain John M. Heath, Signal Corps, Office of the Signal Officer, 3rd C. A., 311 St. Paul Place, Baltimore, Md.

4th Corps Area—Jas. W. Spratlin, 83 Rogers St., S.E., Atlanta, Ga.

5th Corps Area—L. G. Windom, 1375 Franklin Ave., Columbus, Ohio.

6th Corps Area—V. A. Kamin, 2039 S. 8th Ave., Maywood, Ill.

7th Corps Area—Lieut. H. P. Roberts, Signal Corps, Fort Omaha, Neb.

8th Corps Area—Signal Officer, 8th Corps Area, Ft. Sam Houston, Tex.

9th Corps Area—Harold Lucy, 1201 Fulton St., San Francisco, Calif.

Radio Nets

The basic organization of the radio communicating system in the Army is the net. The net consists of two or more radio stations located at the headquarters of the units which they serve. A Brigade Radio net, for example, would be composed of the radio station at brigade headquarters and those at the

regiments in the brigade. The station at the highest unit or organization in a net is called the Net Control Station and directs the operation of the Net. Following out this principle, the Army Amateur Radio System is built up of a series of nets starting with the Army amateur net control station. W3CXL-WLM, at Washington, D. C.—which is under the direction of the chief signal officer—and branching out through corps area, state, district and local nets; in order to include every affiliated Army amateur radio station in the United States.

The inter-linking of this form of communicating system can best be illustrated by the following detailed net organizations in each corps area:

(1) *The Corps Area Amateur Radio Net* consists of one station in the capital or principal city of each of its states. The net control station is usually located at the corps area headquarters or an amateur station in the same city is selected.

(2) *State Amateur Radio Nets* are based on the division of each state into approximately five (5) geographical areas. The stations are normally located in the principal city or town of each such geographical area. The station in or near the state capital usually serves as the state net control station.

(3) *The District Amateur Radio Nets* are the five (5) geographical areas into which the state was divided as described in (2) above. A station in the principal town or city in each of these districts is selected to serve as the district net control station.

(4) *Local Amateur Radio Nets* comprise all amateurs in the local areas for which the respective sub-stations of the district net may act as net control stations.

It will be evident, from the above net system, that the net control station of each net serves as a subordinate station in the next higher net. In other words, if we take the Second Corps Area net, the net control station is W2SC, located at Fort Wood, Bedloes Island, N. Y. H., and operated by Signal Corps personnel, and the subordinate stations in the net are, respectively, the net control stations of the New York, New Jersey and Delaware state nets and are owned and operated by amateurs. An alternate net control station for every net is also selected to function in place of the net control station in case the latter, for any reason, is unable to keep the assigned net schedules.

Net Operation

In military work, there is a "chain of command" over which all orders pass from the highest commanding officer or office to the lowest subordinate. It is most essential that this "chain" be maintained and all correspondence and messages follow the established routine in order that the Army—or for that matter,

any large business, industrial or public service corporation—should function properly and efficiently. Therefore, subordinate stations in a net only communicate with each other or the net control station, but never with other stations which are in different nets. However, this does not unduly delay the handling of traffic, as one may suppose, due to the handling of the same message by a number of stations in different nets before it reaches the station of destination. While it is true that the message could be handled quicker by sending it direct from the originating station to the station at the place of destination, nevertheless, for the speedy dissemination of information and especially in emergencies, the net organization proves its worth.

To assemble over 700 Army amateur radio stations "over the air" on a particular night of the week, or at any certain time is a colossal task; even assuming that no interference is caused by other amateur radio stations. Nor is it possible to get everyone to agree to a certain night or even time for schedules. However, from the experience gained from several years of operation, it has been found that Monday night is the night most convenient to the majority of A.A.R.S. and it has been chosen for the weekly schedule period. Because of the differences in time between the eastern, central and western parts of the United States, it has been necessary to spread the schedules throughout the entire evening and night. The arrangement of the schedules is best shown on the attached "Master Traffic Schedule," which is self-explanatory.

Every Army amateur radio station is expected to keep these weekly schedules, that are assigned to its net, by working its net control station—or subordinate stations—at the designated times and handling any traffic that is received. In this connection, a "ZLV" (general call to all stations) is broadcasted by the Army amateur net control stations. W3CXM and WLM, at 10:00 P.M. and 11:00 P.M. E. S. T., respectively. W3CXM uses 3950 kc. and WLM transmits on the Army 6990 kc. frequency, so that Army amateurs throughout the country can receive either one of these stations. This "ZLV" is a sort of weekly bulletin from the chief signal officer and all stations stand by to receive it at the above-mentioned times.

All traffic is normally handled in the clear—plain text—but, for the purpose of increasing the proficiency and accuracy of Army amateur radio operators, the chief signal officer is furnishing to all interested operators, a cipher device and instructions in the use of the same. In addition, cipher messages are sent and received during the weekly Monday schedules between the various nets. All information furnished the Army amateur operator in regard to the cipher instruction, including the key words, is, of course, con- (Continued on page 925)

MASTER TRAFFIC SCHEDULE, ARMY AMATEUR RADIO SYSTEM (EFFECTIVE SEPT. 8, 1930)											
CORPS AREA	6:30 7:30	7:30 8:30	8:30 9:30	9:30 10:30	10:30 11:30	11:30 12:30	12:30 1:30	1:30 2:30	2:30 3:30	3:30 4:30	
1	D S	C S*	A*								ARMY OPEN SCHEDULE FOR U.S. ARMY AMATEURS AND PORTO RICO HAWAII, ETC. ARMY OPEN SCHEDULES FOR FOREIGN POSSESSIONS
2	C A	D	D*								
3	D S	C S*	A*								
4	C A	D	D*								
5	D S	C S*	A*								
6	C A	D	D*								
7	D S	C S*	A*								
8	C A	D	D*								
9			D S*	C A	C S	D					
			C*	D S							

- REMARKS -
 A = ARMY NET OPERATES
 C = CORPS AREA NETS OPERATE
 S = STATE NETS OPERATE
 D = DISTRICT NETS OPERATE
 * AT 10 P.M. ZLV FROM W3CXM ON 3950 KC.
 AT 11 P.M. ZLV FROM WLM ON 6990 KC.
 ALL TIME STATED EASTERN STANDARD TIME

This schedule of operations for the Army Amateur Network indicates the precision with which the organization functions

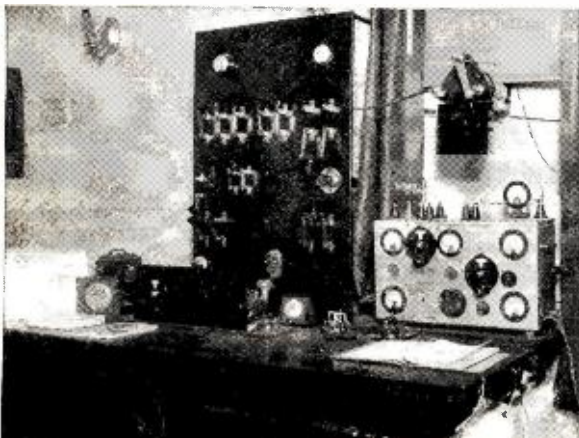

The operating table at W3CXL. The photo at the left shows the power switch-panel and the transmitter. The photo at the right shows the interior of the transmitter with its two 50-watt power amplifier tubes

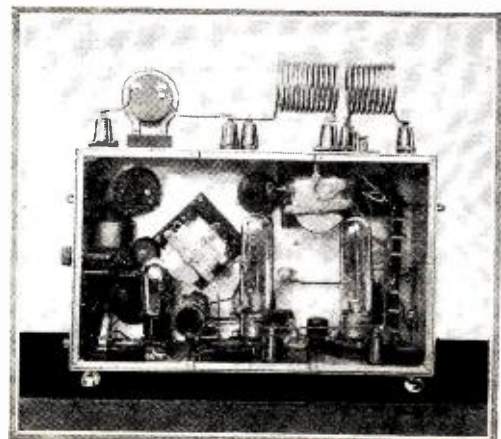

Mobile Radio Services

This is the fourth successive article in a series of five describing the United States Radio Laws and Regulations. The author, in these articles, has drawn from his rich experience as former secretary to the Federal Radio Commission informing prospective applicants of station licenses how best they should go about this important piece of business

ANY discussion of the mobile radio services of this country or any other, of necessity is devoted largely to marine or ship operation; although, of late years, facilities for radio communication from and to aircraft are coming to be more and more desired, if not required.

There are two radio acts on the statute books, although usually only "sea-going" operators are familiar with or function under both. The one most of us recall as The Radio Act of 1927, covering the operation of all radio transmitters in the United States, is of more general importance. The second, literally the first since it was originally approved in June, 1910, and amended in July, 1912, is known as the Radio "Ship Act." Briefly, the "Ship Act" requires that certain passenger-carrying steamers which leave the ports of the United States be equipped with adequate radio facilities, manned by a licensed operator. This act officially designated as Public-No. 238-62nd Congress-S. 3815, was not repealed when the general Radio Act of 1927 was approved, as ship owners and operators well know. A general knowledge of both these laws is indispensable to them.

The United States was perhaps a little slow in adopting a radio regulation aimed to protect life and property at sea. Great Britain enacted its first radio law, known as the Wireless Telegraph Act, in August, 1904, after the successful demonstrations by Marconi and others of wireless communication over considerable distances during the preceding three years. When delving into the history of the transition of "wireless" into the better known "radio" of today, the writer became so interested that he is disposed to recount very briefly some of the initial steps and developments in the late years of the nineteenth century and the first decade of the twentieth.

Early Railroad Experiments with Wireless

Strange as it may seem, the first attempt to transmit a message from or to a moving object without wires seems to have been in connection with railway trains rather than with ships. These experiments began in 1885 by Edison and others. Of course certain earlier exponents of electromagnetic communication had endeavored, with varying degrees of success, to send messages across rivers where no other means of communication existed. I have in mind the work of Lindsay as early as 1845, O'Shaughnessy in 1849; Highton in 1872; and Alexander Graham Bell, across the Potomac, in 1882. No one seemed to think of the great potential value of wireless as a means of communicating with ships, although in 1892 Stevenson suggested its value for sending messages to lighthouses, and Smith three years later established the first such communication. It remained for Marconi, the most advanced thinker and practical adaptor of those days, to effect ship-to-shore communication, over a stretch of water ten miles wide, in 1897. This distance was increased in December of the same year to eighteen miles, at which time Marconi established the first ship station or, as it was then described, the first "floating wireless-station." The next year this new means of communication was used practically: the Kingston regatta

at Dublin was reported via radio to a local newspaper from the Steamer Flying Huntress.

Then things began to move in radio—France led the nations of the world in adapting radio to its naval work when she equipped a gunboat at Boulogne with wireless apparatus, but the United States soon followed, fitting the battleships New York and Porter for radio communication. Great Britain was not far behind—the same year, during manoeuvres, British ships equipped with Marconi apparatus exchanged messages over distances up to eighty-five land miles. During the same year, 1899, the international yacht races were covered or reported by radio for the New York Herald; at the same time the Cruiser New York and the Battleship Massachusetts communicated over distances up to thirty-six miles. A little later the Steamer St. Paul was equipped with Marconi apparatus and estab-

By Carl H. Butman*

lished ship-to-shore communication with the Needles station. The first oceanic newspaper called "The Transatlantic Times" was printed aboard this vessel being made up chiefly of radio reports on the South African war.

In 1901 came the first marine distress call for assistance in the shape of a radio message, not the well-known "SOS," however, as that was not adopted until 1908. It was merely a relay by radio of a message that the Bark Medora was waterlogged off Ratel Bank. It is recorded that assistance was sent immediately. When The Princess Clementine ran ashore a little later, she was reported by wireless to Ostend.

Skipping a bit and passing over the monumental feat of Marconi in December, 1901, when he transmitted the letter "s" via wireless across the Atlantic, a distance of eighteen hundred miles, and many other momentous developments of radio communication, we come eventually to a list of vessels whose radio equipment and operators saved both lives and property. The first actual distress call recorded as sent out from a ship at sea, occurred when the Steamship Republic collided with the Steamship Florida off the United States Coast in 1910. Her calls were answered and through aid brought by wireless her passengers were removed before the unfortunate vessel sank. Many leading American citizens and certain governmental officials began to realize that our shipping would be far better protected and the lives of traveling citizens saved if radio equipment was placed on its passenger steamers.

The First Radio Act

Investigations followed and in June, 1910, the first radio act was enacted by Congress. Its provisions required that within a year it would be unlawful for any ocean-going steamer carrying more than fifty passengers and crew to leave any port of the United States unless equipped with efficient radio apparatus capable of transmitting and receiving messages over a distance of at least one hundred miles, and in charge of a person skilled in such operation. This act did not apply to vessels plying between ports less than two hundred miles apart. To prevent patent monopolies and the refusal of one company or ship to exchange messages with another ship

* Former secretary, Federal Radio Commission.

equipped with a different type of apparatus, it was written that all messages capable of reception were to be accepted from other vessels or shore stations. Masters who failed to comply with the law were subject to a fine of \$5,000. The then Secretary of Commerce and Labor was then designated as the enforcing officer.

As distress calls became more frequent, assistance became more available. The steamer Titanic on its maiden voyage across the Atlantic in 1912 collided with an iceberg and sank, but not before its operator Jack Phillips sent out frantic signals. This early hero of radio unfortunately lost his own life, due largely to his physical exhaustion following strenuous efforts to perfect the operation of the new radio equipment the day and night preceding the accident.

He jumped into the sea as the ship sank but his exhaustion and the exposure caused his death although he was picked up at the time. His name incidentally heads the list on a monument erected in Battery Park, New York, to twenty-four heroic radio operators who have lost their lives in line of duty. Another memorial to radio operator Phillips stands at Godalming, his birthplace in Surrey, England. A study of the accounts of this disaster reveals the fact that another radio-equipped vessel was only a short distance from the Titanic when her radio distress signals were sent. The single operator aboard that ship, however, had signed off for the night after his long day trick. It was realized that, had he or a relief operator been on watch, many more lives than the seven hundred rescued from the Titanic might have been saved. As a result an amendment to the 1910 radio act was introduced and passed in July, 1912.

Constant Shipboard Watch Required

This is the Ship Act previously referred to. It provides that a constant radio watch be kept when under way and that two or more operators be employed on every steamer, thus including cargo carriers. It also required that an auxiliary source of power supply, or a bank of electric batteries, independent of the ship's source of electric power, be available for emergency use. Such auxiliary power supply must be capable of maintaining transmission over the prescribed distance for a period of four hours. A means of maintaining efficient communication between the bridge and the radio room is also specified. Such equipment and operators are placed under the direction of the masters of United States vessels, who are held responsible for them and the radio equipment, being subject to a fine of one hundred dollars for every willful failure to enforce the provisions of the act while at sea. Operators, it should be noted, are under the direction of the masters, who are responsible to the government.

This act did not cover ships operating on the Great Lakes or ocean-cargo steamers until the middle of 1913, providing a member of the crew capable of reporting on distress signals was placed on watch when the regular operator was off duty.

The value of these radio ships acts was soon revealed, for passengers on many ships equipped with radio were saved as a result. As an example, when the *Volturno* was burned in mid-Atlantic in 1913, ten vessels came to her aid in answer to her radio appeal for help and five hundred and twenty-one lives were thus saved. That year witnessed the holding of a Safety at Sea Conference at London, where radio devices for use aboard ships received careful consideration. Progress in ship radio communication from then on was rapid; one application including the installation of radio equipment in motor-life boats on the liner *Aquitania*. Another development of importance was the invention of a practical radio-compass by Fred A. Kolster, then of the Bureau of Standards; a device which has come to be part of the standard equipment of most trans-oceanic and Great Lakes vessels. The first wireless equipped lighthouse in Scotland was opened in 1924, a forerunner of the many radio beacon stations which dot the sea coasts today.

While on the subject of marine radio it is well to consider the immense value of the international distress signal itself, and the priority over all other wireless communications accorded to it by all nations. I refer to the well-known signal "SOS." According to the Director of the Berne Bureau, the first suggestion of a distress call for ships was made by the Italian delegates to the preliminary conference on wireless telegraphy, held at Berlin in 1903. They urged the adoption of a universal signal, "SSDDDD," to be sent by ships in dis-

ress, contending that all stations and ships should be obliged to receive any pertinent messages, suspending their other communications. The other delegates agreed to the need for such a signal but left the final decision to a special conference. Soon after this the Marconi Company recognized the need for a distress call, and on February 1, 1904, the use of the famous call "CQD" was instituted on all its ships. This signal was a combination of the general station call, "CQ," coupled with the letter "D," signifying distress. It was used only at the order of the captain of a ship in distress, or a station retransmitting the signal. All stations were asked to recognize the urgency of this call and make every effort to establish satisfactory communication without delay. The dismissal of operators was to follow the misuse of the call. Several countries, including the United States, adopted the call "CQD" and used it until the Berlin regulations were ratified.

At the Radio Telegraphic Conference in Berlin in 1906, the German Government suggested that ships in distress use the following special danger signal: (SOS).

Previously, German ships desiring to communicate with all vessels in their proximity without knowing their names or calls sent an inquiry signal, "SOE." Germany planned to suggest this signal as the international distress signal, but as the last letter, "E," represented by a single dot, was not believed sufficiently characteristic, being easily susceptible to loss, especially during atmospheric disturbances or in heavy traffic, or when carelessly transmitted, the delegates in 1906 suggested the final letter as "S," thereby having the honor to define what became the universal signal, ".," "SOS."

Such interpretations as "save our souls" or "save our ships" given this call, it is pointed out, should be accepted with reservations. There is no official meaning recorded. In a similar manner, Berne reports the Marconi signal "CQD" has been interpreted to mean, "come quick danger."

The distress signal "SOS" was adopted officially and put into effect by the International Radiotelegraphic Convention of Berlin in July, 1908. It was a matter of keen regret to the Marconi operators that their old signal "CQD" was not adopted, and many continued to send "CQD" as well as "SOS" when accidents occurred. "CQD," however, was gradually forgotten. In 1912 the United States adopted "SOS" when the international agreement was accepted.

The signal today is "SOS," without spaces, the Berne Bureau explains, and should *not* be sent "S O S" (. . . - - - . . .), but (.).

Rules Regulating Distress Signals

Among other things, the 1927 Radio Act in Section 22 provides for the protection of marine communications, including distress signals, familiarly known as "SOS" messages; section 23 requires not only that ships be properly equipped for the transmission and handling of such messages, but that certain shore stations be designated to keep a licensed operator listening on the marine distress channels. Distress signals have absolute priority and ships and shore stations, open to public service, are bound to exchange radio communications with any ship and aid if possible.

Commenting on the use of the signal "SOS," an official of the Radio Division, Department of Commerce, points out that phrases which include the signal "SOS" must not be used in discussing a distress call. Obviously the use of the signal itself may cause confusion, especially when an actual distress signal has been or is being sent out by a ship or is being relayed. Therefore, it is required that in transmitting inquiries or remarks concerning the sending or reception of the "SOS" call, it must be referred to as "distress signal" and not by the signal itself. In other words, do not inquire, "Who sent the SOS," or "SOS with ship now clear."

The necessity of complying with international distress signal regulations, using the specified channel 500 kilocycles or 600 meters, is explained by Captain S. C. Hooper, Chief of Naval Communications. He states that recently station NPN, at Guam, aided the German motorship *Hedwig* after she went ashore on Pirates Reef, by intercepting and relaying the distress call to Cavite and the Cruiser *Pittsburgh*. As a result aid was sent from Hong Kong. The crew was saved although the vessel was a total loss. Particular credit is due the Guam station for intercepting the signal, Captain (*Continued on page 946*)

RADIO NEWS STANDARD CIRCUITS

Crystal and One-Tube Circuits

CIRCUIT A is the schematic diagram of an inductively-coupled tuned crystal receiver. The construction of this circuit is simple. This circuit is especially suitable for the beginner who wants to start out by building a simple set that will give him clear reception of local signals at the smallest cost. There are several minerals used for crystal detectors, two of which are galena and carborundum. The coils L1 and L2 are a standard antenna coupler and the condenser C1 should have the capacity called for by the particular make of coil employed. C2 is a by-pass condenser of .002 microfarad.

Circuit B is the same as circuit A except that the crystal detector has been replaced with a vacuum tube. Its construction is comparatively simple. The receiving range is improved over that of the crystal detector set by the amount of amplification

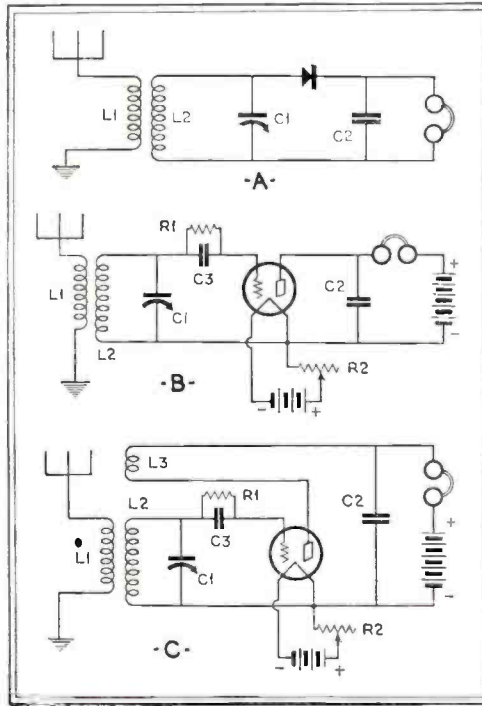

provided by the vacuum tube in addition to its detection or "rectifying" action. This is an easy circuit to tune, and is the logical second step in the progress of the beginner. A circuit of this type will provide good clear signals of excellent quality. R1 is a grid leak resistance of 2 megohms. C3 is a grid condenser of .00025 microfarad. The resistance R2 is to control the filament voltage to the vacuum tube and its value depends upon the type of tube used.

Except for the addition of coil L3, circuit C is the same as in circuit B. By means of this coil L3 regeneration is obtained in the circuit, resulting in increased amplification and selectivity. In the early days of broadcasting this circuit was probably the most popular of all because of its simplicity and effectiveness. An undesirable feature of this circuit is the possibility of re-radiation.

RADIO NEWS STANDARD CIRCUITS

Tuned Radio-Frequency Circuits

THIS is a schematic diagram of a three-tube radio-frequency tuner. It consists of two stages of tuned radio frequency followed by a detector tube. The construction of this circuit is not hard. The selectivity and the distance getting ability as well as the reproduction obtainable from this tuner will reward the beginner for his advancement from the single-tube receivers. This circuit will not re-radiate as regeneration is not used. The resistors R1 and R2 are grid suppressors and are used for controlling oscillation. R1 is 600 ohms and R2 700 ohms. The grid-leak resistor R3 may be anywhere from 2 to 5

megohms. The grid condenser C4 should be .00025 microfarad. The value of the filament rheostat R4 depends upon the type of tube used. This resistance may be utilized as a volume control as well as to control the filament voltage to the tubes. If -01A or -12A type tubes are used in this circuit the value of this rheostat should be approximately around 20 ohms.

A word or two in reference to mounting the radio-frequency coils may be of assistance to the radio beginner. Air-core transformers in a radio-frequency amplifier should be mounted to have the least possible coupling with each

other otherwise the receiver will oscillate, completely spoiling reception. In order to reduce this coupling to a minimum, the coils should be spaced well apart and preferably mounted so their axes are at right angles to each other.

A superior method for reducing undesirable coupling is through the use of shielding to isolate the parts of one amplifier stage from those of the other stages.

This radio-frequency tuner makes an excellent unit to combine with any audio-frequency amplifier to provide loud-speaker reception.

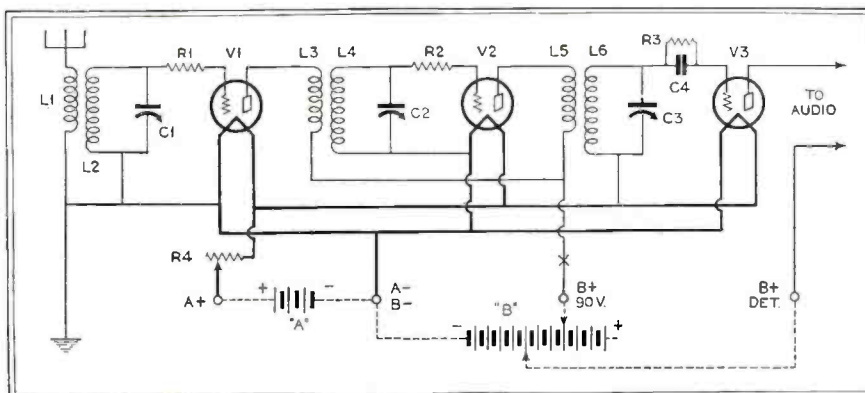

Mike-roscofes



I OFTEN wonder why the title, "Press Representative," is attached to many radio people, they don't seem to do anything about it.

One who deserves the title and has made his department what it is today, I hope he's satisfied, is Jesse Butcher. Mr.

Butcher is really a swell person.

But the incident I really started to tell you about was the other day when Jesse received a present of a beauteous carved humidor while I was at the Columbia studios. He ejaculated, "Now I'll have to learn to smoke!" We all said that the magnificent gift looked much more like the jewel case in "Faust"—but after all, in these hard times a jewel is only a jewel but a good cigar's a smoke!

EVA LE GALLIENNE, actress, whose broadcasts you all enjoyed via Columbia, has turned her ether talents to the National Broadcasting Company of late, playing Nora in Ibsen's "Doll's House."



She is scheduled to be Juliet in Shakespeare's immortal love story, and by the time you read this you will probably have heard her interpretation of the essence of romance.

Most of you know that down in a shabby corner of Fourteenth Street in New York City, the lovely Eva has created the impossible—the Civic Repertory Theatre. Here she gives such plays as "Peter Pan," "The Cradle Song" and "Hedda Gabler." With everyone saying a repertory art theatre could not be accomplished—Miss Le Gallienne went quietly ahead and accomplished it.

When she came out of the studio after giving you her airy Nora at NBC, I asked the actress what was the most important illusion to preserve. She answered, "a sense of magic." And doesn't that cover it all?

Eva Le Gallienne, the daughter of Richard, the poet, was born in London and educated in Paris. I asked her what she would do if she knew she had only one year left to live. "I would go to the country," mused the organizer of the Civic Repertory Theatre, "and get as near the earth as I could, so long as I was going into it so soon. Then I'd read a great deal and be with the flowers and animals."



By
Harriet Menken

"The future of the actress in radio? I don't think any actress would leave the stage for the air unless she had to," said the woman who plays Peter Pan, Marsha and Juliet equally well.

When asked who was the greatest actress of our day, Miss Le Gallienne said, "Claire Eames—or rather she would have been great if she had lived longer. She was on the way. But you cannot be a really great actress under thirty-five. It takes twenty years anyway." We'd like to take four years off of that estimate, for Miss Le Gallienne is only 31!

As we talked, Eva Le Gallienne who was not very striking at first glance, appeared more and more beautiful—her cameo features became illumined by that sense of magic she spoke of—for indeed she creates an illusion and carries with her a certain enchantment.

WHEN you hear radio babies on the air do you think that these children get a lollypop or a toy doll as their reward of merit? And what would you say if I told you that the leading radio youngsters add thousands of dollars



Jimmy McCallion

each year to the family coffer? Winifred Toomey, ten years old, of the blonde curls, the most natural and charming of the group whom you hear in The Lady Next Door, Toddy, Bon Ami, and many other programs at NBC, is said to earn \$5,000 a year. At NBC they put Howard Merrill's and Jimmy McCallion's salaries at approximately \$10,000 apiece for the twelve months. Howard was "Penrod" and Jimmy "Sam." in the famous "Penrod" series, and in fact they each take all the principal roles for fourteen- and eleven-year-old boys on the air over the National Broadcasting System.

Baby Rose Marie, at five years old, tops the list of total yearly youngsters'

earnings, with a figure that NBC put at \$50,000, although rumor doubles that amount. Rose Marie, whose last name is Curley, is the most sophisticated of the youngsters. I've talked with the others, dozens, perhaps hundreds of times, but I've never seen them act as this Baby does. There is a finish, a polish, a hardened something about Baby Rose Marie and her acting, that is very unusual and clever, and yet I wonder if it is worth any amount of money to be on to all the tricks at five years of age?

ONE of the pleasant things that will happen to all of you when television becomes an ordinary actuality, is that you will be able to see the Countess Olga Medolago Albini, an NBC staff concert artist, whom you hear frequently over the General Motors Hour, on the Fleischman Hour, and continually on numerous NBC programs.



Countess Albini is a dark, slender girl, with perfect features. She was appointed sometime ago to represent NBC in the beauty contest at the Radio Show. Countess Albini was born in Barcelona, Spain, though she lived here most of her twenty-five years. She is married to an Italian, a blond from the north of Italy, and has a son, Guardo, three years old. Bored with bridge and dinner parties, she came to NBC where Sophie Braslau introduced her to one of the vice-presidents. The rest you know. She likes fencing, horseback riding, and most of all, singing. I found her very charming—it's an old Spanish custom!

VINCENT LOPEZ had just been holding forth with his peppy St. Regis Orchestra which you hear over NBC, when I interviewed him the other day. We had quite a snappy, typical "Lopez" chat. There is something very alert and alive about this leader, and his orchestra catches it.



Mr. Lopez tells me he receives about one hundred fan letters a day, which curiously enough he catalogues according to states—states in the Union. I gather—not states of emotion! From some of the letters I read, most of them could be filed at 120 degrees Fahrenheit. In case you don't know, this is the top of the thermometer.

(Continued on page 932)

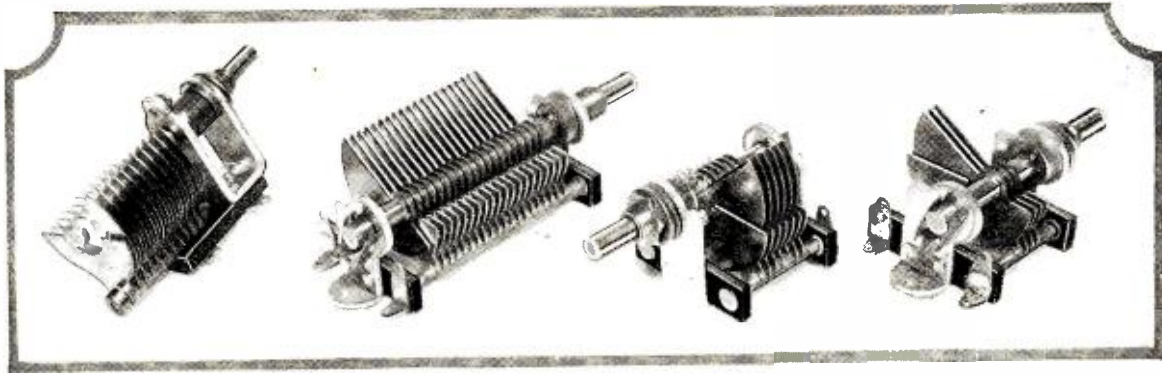

A group of midget variable condensers, giving an idea of the range in capacities in which they are available. The condenser at the extreme left is a 100 mmfd. with semi-circular plates. Next to it is the new large 322 mmfd. condenser followed by one of 100 mmfd. and at the right a 50 mmfd. condenser; the latter three condensers are of the "Midline" type, which makes them especially adaptable for tuning purposes

Midget Condensers

The introduction of midget condensers which provide a straight line tuning characteristic and higher capacities than heretofore should do much to extend their field of usefulness, as indicated in this review of possible applications

EVEN before the days of midget condensers, the days when the only way one could get a small capacity variable condenser was by removing plates from a larger condenser, there existed innumerable uses to which a compact variable condenser could be put. But in those toddling days of radio everything was several times larger than it had to be; who doesn't remember those big awkward variometers using several pounds of insulation?

Today the experimenter has at his disposal a variety of midget variable condensers; some of these condensers are midget in physical size only for they range in capacity up to as high as 322 mmfd. and they can be obtained with the ordinary semi-circular plates or with specially shaped plates to give a "midline" tuning characteristic. The small physical size of these variable condensers, the ease with which they can be mounted, and the wide range in capacities in which they are

By Donald Lewis

made make them almost ideal for the construction of compact or portable receivers, short wave

sets, television receivers; in addition these condensers are indispensable as antenna tuning condensers, regeneration controls, for balancing and aligning, and many other purposes.

The utility of these condensers for short wave receivers and wavemeters has possibly not been fully realized. They make it possible to construct very compact, good-looking short wave sets. The small size of the condenser also causes a reduction in hand capacity effects and in interaction between various parts of the circuits. Since midget condensers are available in all standard capacities (as well as some intermediate capacities) they can be used in all standard types of short wave receivers. No change in the circuit of the receiver is necessary; a small midget condenser is simply substituted for the regular variable condenser. In the past there has possibly been some reason for not using midgets in short wave sets because the condensers

Figures 1, 2 and 3. Perhaps the most common uses for midget condensers are shown in these three circuit diagrams. In Figure 1 the midget is used to provide variable coupling between a short-wave receiver and antenna. In Figure 2 the midget serves as a vernier in sharp tuning. In Figure 3 the addition of a coil and midget condenser between antenna and receiver permit tuning of the antenna circuit with improved sensitivity and selectivity as a result

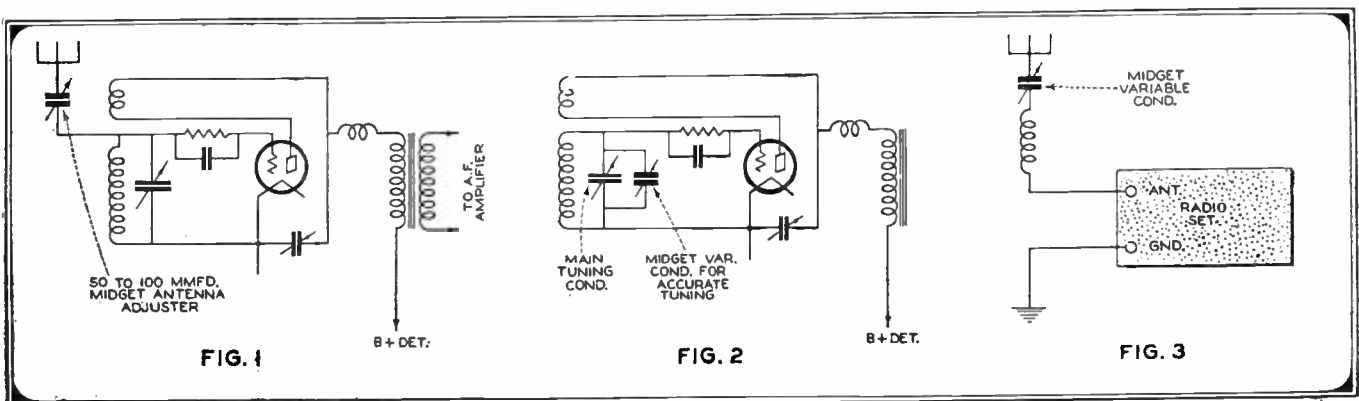

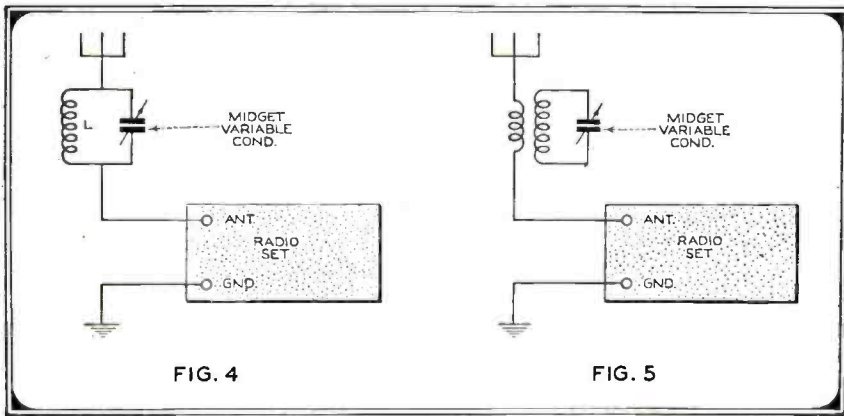

Figure 4. A wavetrapp in the antenna circuit will eliminate the interference produced by powerful local stations. A coil L shunted by a midget condenser is placed in series with the antenna circuit. The condenser is then adjusted until the signal of the interfering station disappears

Figure 5. Use this wavetrapp circuit where the interference to be eliminated is not very severe. For the coil any standard type of r.f. transformer containing a primary and secondary may be used. The midget condenser should, of course, have the proper capacity to work with the coil

could only be obtained with the old type semi-circular plate, which gives a very poor tuning characteristic. This objection no longer exists, however, for midget condensers with special plate shapes are now being made.

In short wave receivers it will frequently be found desirable to connect a small midget of about 50 mmfd. or less in series with the antenna circuit as shown in Figure 1. Although this circuit shows direct connection of the midget to the tuned circuit the same arrangement can be used with an antenna primary coil. By means of the series antenna condenser the natural period of the overall antenna system can be altered and adjusted to a point where it does not seriously affect the tuning of the receiver. In simple oscillating detector type short wave sets (not using any r.f. amplification) the series antenna condenser will prevent the antenna from loading up the receiver circuit and preventing the detector tube from oscillating uniformly over the band. With a series connected antenna condenser an adjustment can usually be found which will make the set oscillate uniformly over the entire band covered by any one coil.

Besides making use of midgets in short wave sets for purposes of tuning, regeneration control, and for antenna adjustment, these condensers are of considerable help in permitting very accurate tuning. For this purpose a small midget is connected across the main tuning condenser; ordinarily the capacity of this midget condenser should be about one-tenth that of the main condenser. For example if the main tuning condenser has a capacity of 100 mmfd. then the midget connected across it should have a capacity of about 10 mmfd. The circuit arrangement is shown in Figure 2. The use of this condenser need not make it impossible to accurately calibrate the main dial of the set. The calibration of the set and the tuning of the main dial should always be done with the dial on the midget set at 50 (assuming a 100 division dial) and then when the station has been tuned-in as accurately as possible with the main condenser, the midget can be used to obtain a finer degree of tuning. If the signal tends to vary in frequency, the midget can be used to keep the set accurately in tune with the signal at all times.

In the broadcast receiver the midget condenser can be used to greatly increase the sensitivity of a set by using it in an antenna tuning circuit. To add an antenna tuning system to any standard type of receiver the circuit arrangement shown in Figure 3 can be used.

Figure 6. A method of increasing sensitivity and selectivity by adding regeneration to the detector circuit. This arrangement can be used with many types of sets, a.c. or d.c., screen grid or otherwise. The midget variable condenser is connected from the plate of the detector tube to the plate of the preceding rf. amplifier tube

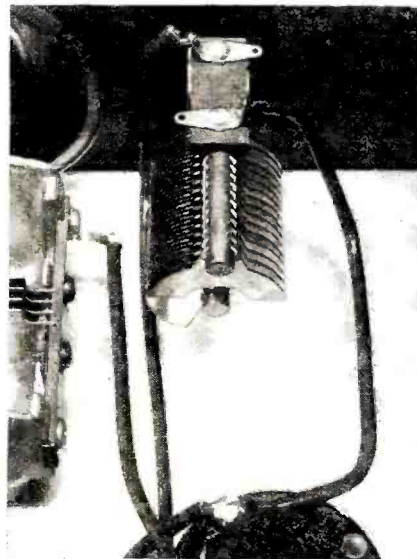

Showing the use of a midget condenser for regeneration control in a short-wave receiver. There is really no better method of controlling regeneration in such circuits than by the use of a midget condenser

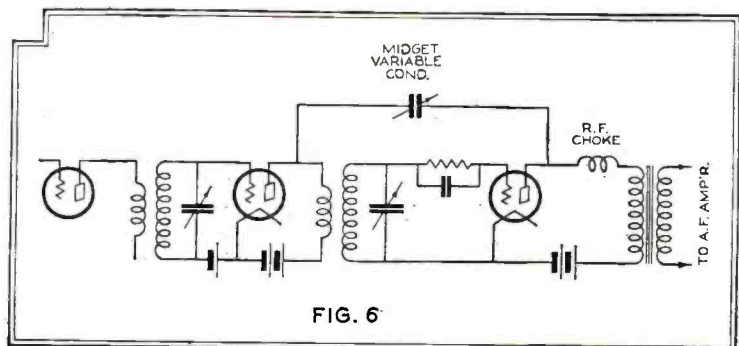

FIG. 6

As the circuit shows, a midget condenser and a coil are connected in series with the antenna system between the antenna post and the antenna itself. The midget condenser should be one of the larger sizes, preferably with a tuning characteristic that will spread out the stations over the dial. In most cases a condenser of about 300 mmfd. gives best results, although somewhat larger or smaller sizes can be used by subtracting from or adding to the number of turns on the coil L. In any case it is not possible to specify the exact number of turns to use on the coil L for this will depend on the size of the antenna and upon the inductance of the antenna coil inside the receiver. The best arrangement is to start with a good large coil, say about 100 turns on a 2½-inch tube. The set should be tuned to some station broadcasting on a frequency around 550 kc., the midget condenser should be set for maximum capacity (plates all in) and the number of turns should then gradually be reduced until maximum volume is obtained, which will indicate that the entire antenna system is in tune with the signal. If the test is carefully made a really tremendous increase in volume should be obtained. After the proper number of turns for L has been found in this manner the set can be tuned to any other station and the antenna system then tuned by adjusting the midget condenser. If the antenna tuning system is only to be used to pick up distant stations a switch can be connected across both coil L and the midget condenser so that both of these units can be shorted out of the circuit when tuning in locals.

Sometimes improved reception, especially at the high frequencies, can be obtained simply by the use of a 300 mmfd. condenser in series with the antenna, leaving the condenser at maximum capacity when listening to stations broadcasting on low frequencies and adjusting the condenser to give maximum volume when the set is tuned to high frequency stations. The improved results obtained by the use of such a series condenser are due to the fact that the antenna circuit frequently has a detuning effect on the first tuned circuit of a receiver, a detuning effect that is most serious at high frequencies. By the proper adjustment of a midget series

antenna condenser this detuning effect can be overcome, bringing the first circuit of the set into exact resonance with the desired signal.

Where satisfactory sensitivity is obtained over the entire band but trouble is experienced because of insufficient selectivity a midget condenser may be used in conjunction with a coil to form a wavetrapp. The circuit is shown in Figure 4. The coil L may be the secondary of any ordinary r.f. transformer; if the r.f. transformer is designed for use with a 0.00025 mfd. condenser (250 mmfd) then a midget condenser of this size should be used. The arrangement shown in Fig. 4 where the wavetrapp is connected directly in series with the antenna circuit should be used where serious interference from some local station is experienced; in cases where the interference is not so severe a 10-turn primary may be wound on the coil and this 10-turn coil connected in the antenna circuit as shown in Figure 5.

Another method of using midget condenser to obtain increased sensitivity and selectivity is shown in Figure 6. Here we have a midget condenser connected from the plate of the detector tube to the plate of the preceding r.f. tube. With this arrangement the detector circuit will be thrown into oscillation as the capacity of the midget is increased; the improved performance which can be obtained from an arrangement such as this is sometimes remarkable. In addition it makes it possible to tune-in distant stations by means of a heterodyne whistle.

With the circuit shown in Figure 6 it may be necessary to reverse the connections to the primary winding of the r.f. transformer in order to make the circuit oscillate. To determine this point it is simply necessary to set the midget for maximum capacity and if the circuit does not oscillate to reverse the primary connections.

Instead of connecting the condenser between the two plates a small regeneration coil may be used as shown in Figure 7. And incidentally this latter arrangement has the advantage that one side of the midget condenser is at ground potential so there will be no hand capacity effect such as might be experienced with the circuit of Figure 6. But whether Figure 6 or Figure 7 is used, in both cases it will almost invariably be necessary that there be an r.f. choke in the plate circuit as indicated. Without the choke it will not be possible to make the circuit oscillate.

In screen grid r.f. amplifiers, especially those using impedance coupling, the midget condenser can be used as a coupling control. Sometimes these circuits tend to oscillate and by gradually reducing the capacity thereby decreasing the coupling the circuit may be set just below the point at which it oscillates.

It seems that a set these days cannot be considered modern unless it has a tone control and it is therefore interesting that a midget condenser can be used for this purpose. To obtain a tone control capable of the most gradual variation the circuit

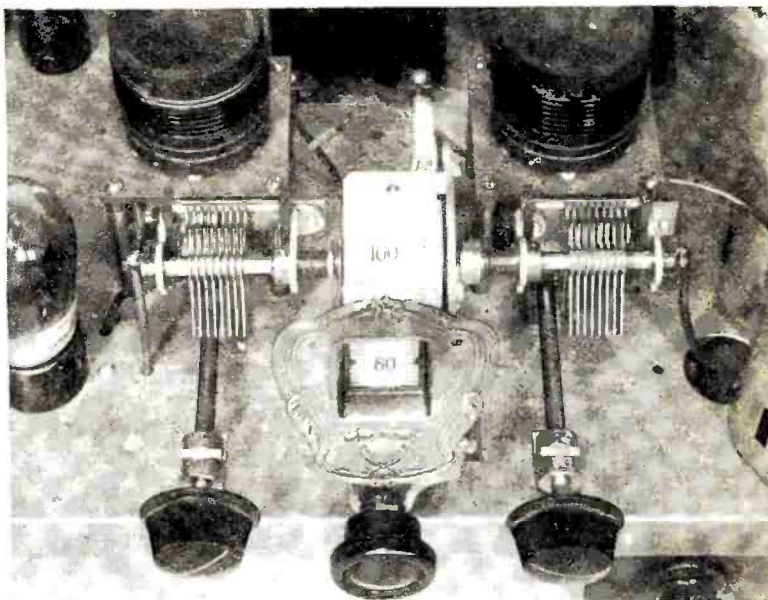

A short-wave superheterodyne receiver now being developed by one manufacturer employs midget condensers for tuning. Here are shown the tuning elements, including the gang controlled midgets

of Figure 8 can be used. Here we show a midget of some 300 mmfd. capacity connected across the secondary of one of the audio transformers in the audio amplifier. With the condenser plates all out the circuit will function normally, but as the plates are gradually tuned in, adding more and more capacity across the secondary the high frequency response will slowly

fall off. In this way the relative emphasis on the low or high audio frequencies can be varied to suit the taste of the listener. If a resistance coupled amplifier is used the midget condenser may be connected directly across the grid leak, or across the grid choke in the case of a double impedance amplifier.

Where a midget condenser is used for tuning radio-frequency circuits it should preferably not be of the ordinary straight line capacity type since the tuning will then be crowded at the lower end of the dial. For such purposes a condenser with a plate shape that will give uniform separation between stations will prove much more satisfactory.

Where only infrequent variation of the condenser setting is necessary there is no need to use a midget variable condenser. Some type of

compact, semi-adjustable condenser will be more practical. For example condensers of this type are used for neutralizing and for balancing the various sections of a gang condenser, since in these cases the condensers when once adjusted do not have to be altered unless tubes are changed.

There are many other uses for both the midget and the equalizing condensers that will immediately suggest themselves to the broadcast and short wave experimenter. Our purpose here has simply been to indicate, in a general way, their utility.

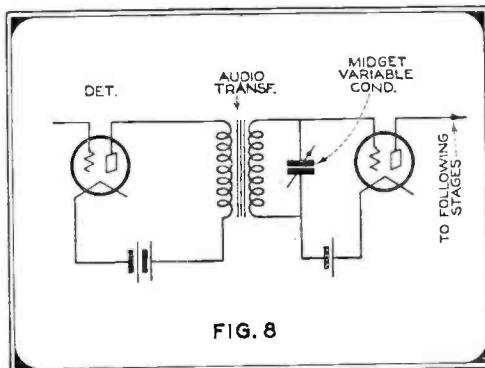

FIG. 8

Figure 8. A midget condenser of about 300 mmfd. can be used as a tone control. The condenser is connected directly across the secondary of the audio transformer, or across the grid leak in a resistance coupled amplifier

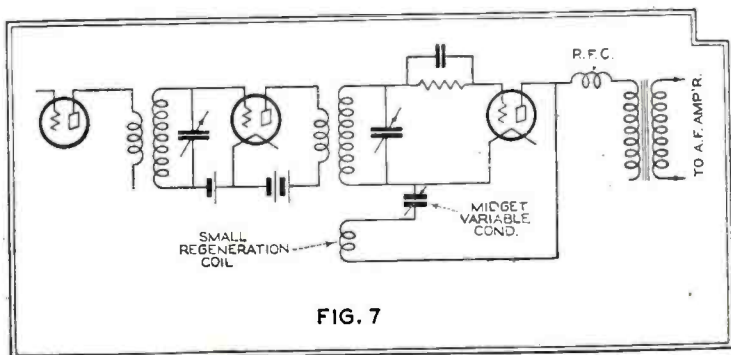

FIG. 7

Figure 7. Another circuit arrangement for adding regeneration to the detector circuit. An additional coil of about 20 turns is wound near the filament end of the r.f. transformer, one side of the coil connecting to the detector plate and the other side to the stator of a 50 mmfd. midget variable condenser

Concerning the

Vagaries of Short Waves

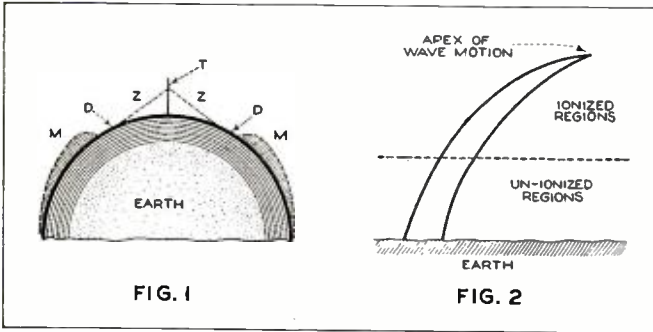
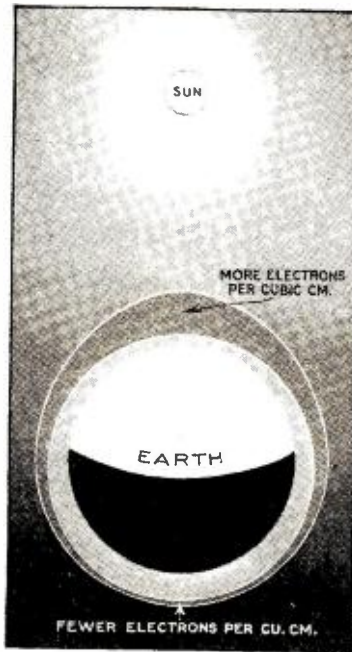

Figure 1. Illustrating one theory of the action of short-wave transmission. Areas Z and M represent the areas reached by the transmitter T. The gaps D indicate the intermediate areas where the signals are not heard. Figure 2 illustrates one theory of short-wave refraction, as explained in the text

Figure 4. Illustrating the proposed theory regarding the massing of electrons caused by the sun and resulting in a lower "electron ceiling" during daylight hours



IN the earlier years of radio it was believed that only long waves were suitable for long distance radio transmission. For instance, between Arlington and Paris the wavelength of 17,000 meters was considered good as it was believed advantageous to the intensity of the electric field if the wave was about one 300th part of the distance for transmission. In 1917, there were many long-wave stations scattered throughout the world using 500,000 watts and giant antenna systems for long distance communications. In the latter part of 1925 radio engineers came to the conclusion that wavelengths between 80 and 15 meters were in many cases as efficient as long waves. These conclusions were based on tests which showed that with less powerful transmitters messages could be received at great distances with volume in excess of that obtained on long waves. It is interesting to note that the same Arlington-Paris circuit today employs a wavelength of approximately 13 meters and relatively low power, while the wavelength is about one-25,000th part of the distance.

The Kennelly-Heaviside layer theory which has for its object the explanation of the reflection of short waves is not an old one. It has, however, found general acceptance, and is looked upon as the most authoritative explanation of the action of the sky-wave component of short waves. The phenomenon of the route taken by short waves is illustrated in Figure 1. In the vicinity of the transmitting antenna there is a zone of direct propagation, illustrated as Z. The behavior of the waves in traversing this zone is characteristically distinct from zone M because they are of a polarized nature, and it is possible to obtain radiogoniometric data. It has been found by observation that the distance of zone Z varies in extent according to the length of the wave and the power of the transmitter. It has also been found that the dead zone D varies in distance according to the length of the wave. For a wave length of 15 meters, it rarely exceeds 425 miles; for waves in the 32 meter band, it is approximately 250 miles; while for waves above 35 meters when sufficient amount of power is used, it does not exist at all. An appreciable amount of energy radiated at T is propagated across the upper region of the atmosphere and returns to the earth, resulting in reception within

zone M. The cause of reflection of the waves back to zone M is said to be due to the ions recombining in the lower levels. However, in higher levels, where the electrons are free to travel without collision, ionization is large. As shown in figure 2, the sky wave component travels at a much higher rate than the lower section, causing the wave to tilt at the apex, where it is finally turned over and brought down to the earth.

Another logical theory has been advanced to the effect that refraction takes place at the layer where the wave is returned to the earth and is reflected back to the layer, thus causing a bouncing of the wave to take place between the earth and the layer. The signals are stronger at a distant receiving station because the region traversed has been through a non-absorbing medium. The medium is brought about as follows: Due to movement about in the great space above the earth, the ions recombine when close enough, causing deionization. However, in regions where gas molecules are sparse, the ions move about a long while before contact is made. Therefore, the ionized region above the surface

Figure 5. The graphic result of listening tests on the short waves to determine the effectiveness of the lowest wavelengths at different seasons of the year

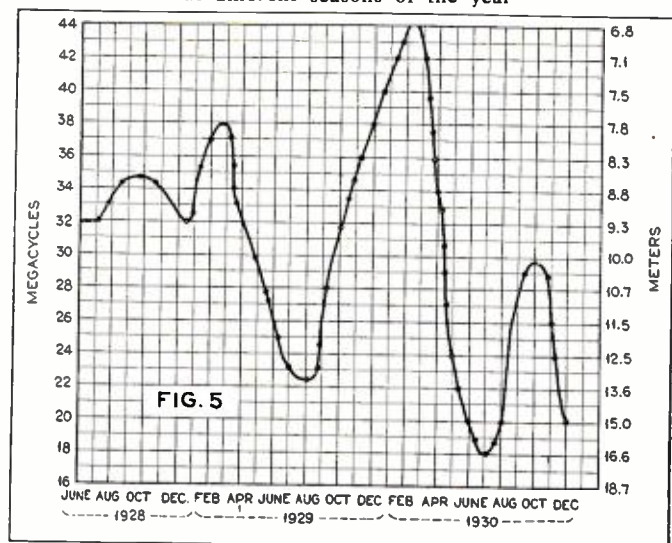

* Chief Radio Electrician, Naval Communication Service.

There has been a vast amount of speculation concerning the reasons behind the many peculiarities encountered in short-wave radio communication. Mr. Marshall here presents his theories which are based on his observations over a period of years devoted to short-wave experimental investigation

By Thomas A. Marshall*

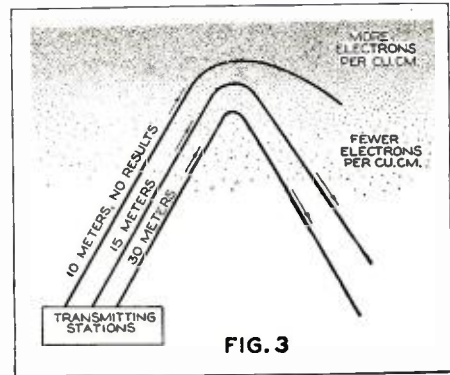

Figure 3. The higher frequencies penetrate the electron masses more readily and therefore travel much higher before refraction takes place

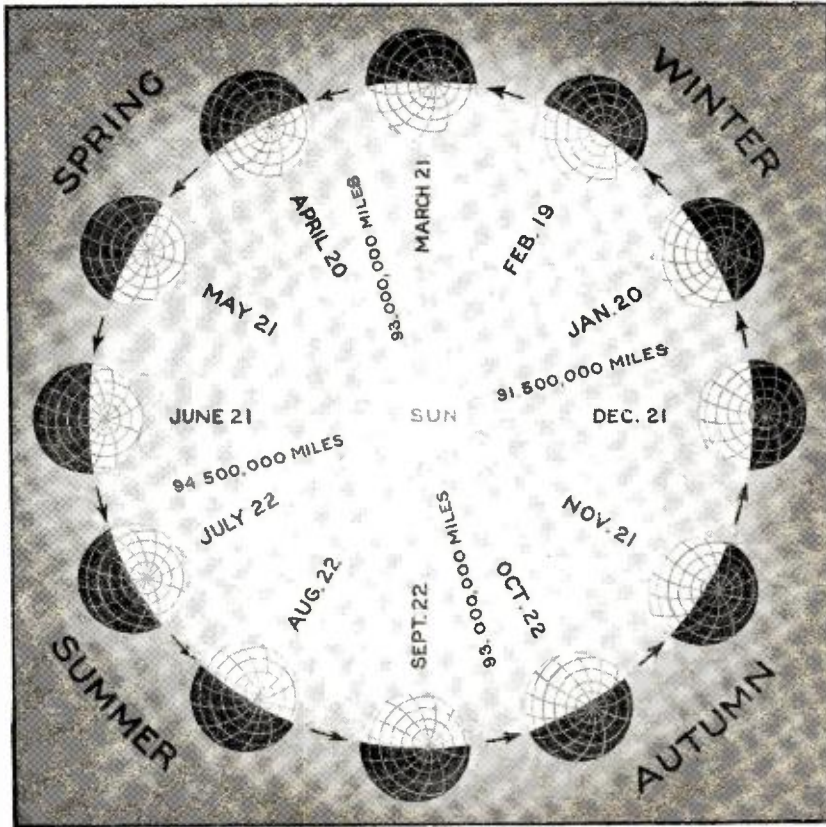

Figure 6. A study of relationship between the northern hemisphere and the sun during the annual cycle. The important bearing of this on the discussion is explained in the text

of the earth gradually increases in higher levels of the earth's atmosphere.

The writer does not agree altogether with the existing theory due, in part, to results accomplished from his own observations which were made over a period of three years. His theories are as follows: The electron density, Figures 3 and 4, of the atmosphere increases gradually with the height. The density of electrons varies according to the number of electrons received from the sun. The variations take place every 24 hours, during the summer and winter, and during sun spot periods. The density is probably changed by bombardment of the outer surface of the earth's atmosphere by electrons from the sun. As shown in Figure 4, the density of electrons is increased above the earth when the sun is directly overhead, and is reduced in either direction around the earth, being less when diametrically opposite, or on the lower side of the earth. The electrons probably reach the lower side of the earth by flexion around the bulge of the earth.

The writer has developed a very sensitive receiver (described in the Sept. and Oct. issues of RADIO NEWS) suitable and adaptable for reception of extremely short waves. For the last three years, continuous observations have been made with this receiver on wavelengths from 4 to 20 meters. Observations of extremely short waves have been made by receiving the second harmonic of certain distant stations. Thus WIY operates on 21.4 meters and can be heard on 10.7 meters. As

shown in Figure 5 reception of short waves over a period of three years has not been in regular cycles as expected.

The diagram in Figure 6 represents that part of the earth in which we live and its changing relations to the sun during the annual route taken. It is known that the earth is not perpendicular to the plane of the elliptic P but is inclined $23\frac{1}{2}$ degrees. Therefore a part of the United States will have longer days and receive more direct rays when the north pole is inclined towards the sun which is during our summer months. However, the earth is actually 3,000,000 miles farther from the sun during this time than during mid-winter season. For this reason, the earth receives less electrons from the sun, resulting in reduced density of electrons at a favorable height for reflection of short wavelengths. During mid-winter, the north pole of the earth is inclined $23\frac{1}{2}$ -degrees away from the sun, causing shorter days and receives less rays from the sun. However, during this time, the earth is actually 3,000,000 miles closer to the sun, resulting in receiving a greater number of electrons. Due to the increased number of electrons at a favorable height for refraction of short waves, we find it possible to receive signals down to extremely short wavelengths.

It is generally recognized that all variations, in magnetic, electric, earth-current, and radio conditions on the earth and in the aurora, are connected in some way with activities of the sun. According to Schwabe (a scientist, 1789 to 1875) sun spots, figures 7 and 8, appeared in a pretty regular period of approximately $11\frac{1}{2}$ years. According to his theory, they were most numerous in the years of 1905, 1917, and 1928-1929, and were fewest in 1900, 1911, and 1923. Figure 9 shows sun-spot cycles. These spots may be viewed through a telescope by projection on a white screen. Some are mere specks, some 500 miles in diameter, while others are as large as 50,000 miles. They are never permanent, although some of them may last for several months. The cause is probably eruptions taking place on the sun. Sun spots are nearly always accompanied by displays of Aurora Borealis in the northern hemisphere and Aurora Australis in the southern hemisphere. In fact, auroras and sun spots are found to wax and wane together, even in their smaller fluctuations. Figure 10 shows the aurora. Severe magnetic disturbances and electric earth currents sometimes powerful enough to interfere with telephone and telegraph lines, are recorded during maximum sun-spot periods. The aurora manifests itself by a soft, vibrating luminosity, extending high into the sky, showing greenish yellow, pale blue and many other colors of the spectrum. These sun spots throw off enormous quantities of electrons, resulting, it is believed, in increasing the density of electrons near the earth.

Just how these sun spots and the distance of the earth from the sun would affect short waves may be stated as follows: When we transmit on higher and (Continued on page 930)

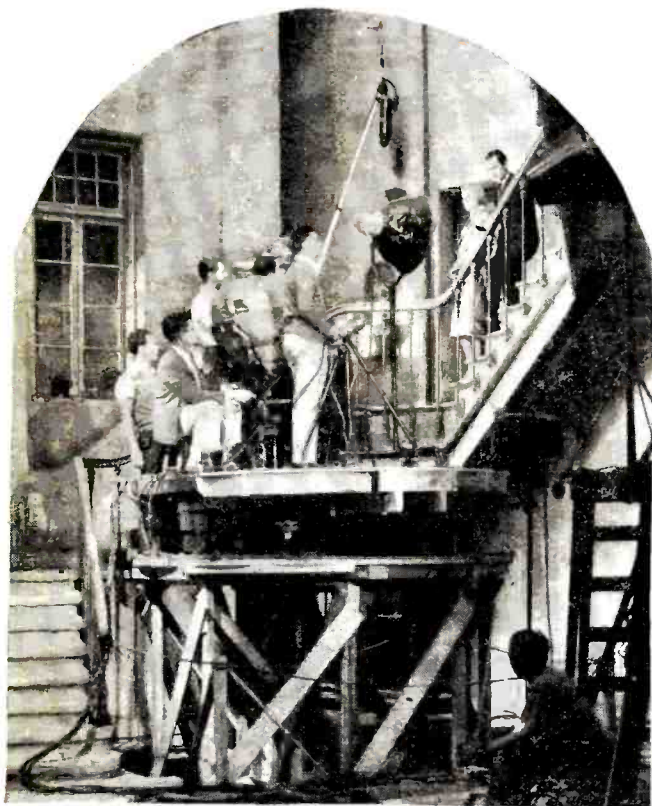

In the photographs shown above and at the right, Clarence Brown is directing Greta Garbo and Robert Montgomery in a scene for Metro-Goldwyn-Mayer's "Inspiration." The turn-table arrangement is rather interesting, showing as it does the facility with which a sequence can be filmed as the actors descend a flight of stairs. Note the microphone placed overhead on a boom arm

THERE can be no question in the minds of intelligent and discerning people that the talking motion picture has come to stay, and that it has become just as much a part of our national life as has radio broadcasting. By making it possible for the average person not only to see but to hear stage plays and operas, and famous actors and singers at a cost that is far from prohibitive, the "talkies" have done a great work in thus bringing to the mass of the public stage productions that formerly were only for the enjoyment of the minority who could afford the relatively high admissions. The writer has often heard the statement made that the sound motion picture will not continue to meet popular favor, that it is merely a passing fancy, and that consequently it will not last for more than a few years longer. When the skeptical persons who make these statements are pinned down to grounds for their opinions, they give absurd and illogical reasons for their belief, and generally their arguments are absolutely without foundation.

It is very true, of course, that the quality of the music and speech accompanying the present sound motion picture still leaves something to be desired. However, when one thinks about it, it is surprising that the voices and music are as excellent as they are. The sound motion picture is yet a baby in its swaddling clothes. Why, it has been a matter of only about three years (about March, 1927) since the first practical public demonstration of the present talking picture was made. In comparison with radio broadcasting, when it was first becoming universally popular in 1922, the sound motion picture is very far advanced. Of course, in the eight years since that time, great improvements have been made in the design of sound recording, amplifying, and reproducing equipment. Another year will see a considerable improvement in the quality and effectiveness of the talkies. New developments and changes are being made every day. The engineers and technicians in charge of the recording and projecting of sound pictures are working constantly on the improvements and addi-

*Sound Engineer, Universal Pictures Corp.

What Radio Has Meant to *Talking Movies*

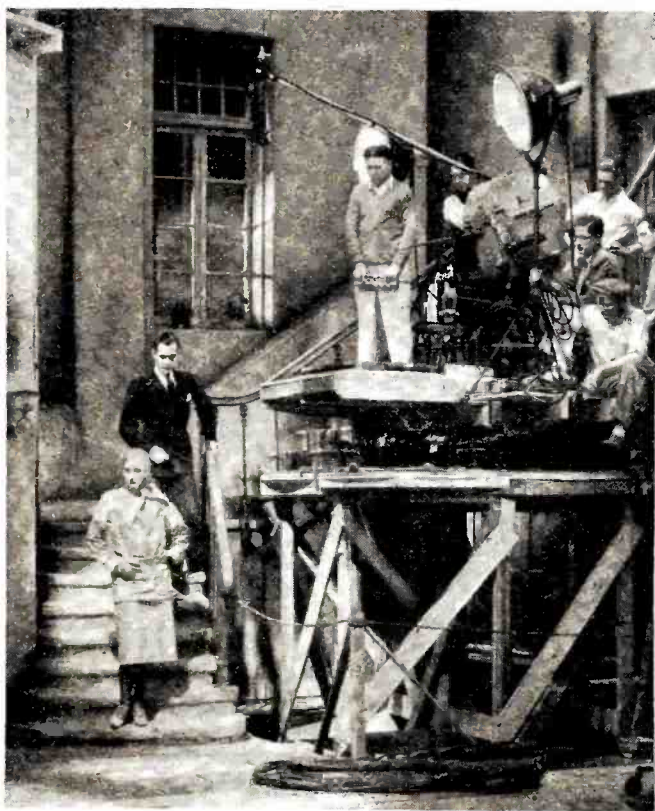

Photographs courtesy Universal Pictures Corp.

tions to the sound devices that are necessary to give perfect reproduction.

Improvements in the amplifying, recording, and projecting apparatus alone are not all that is needed. Thoroughly trained, highly skilled men are also necessary. While most of the technical men are recruited from the ranks of the radio broadcast technicians, and as a general rule are skilled men, this new work is quite different and considerable training and experience are required to fit these men properly to fill their positions. It takes time to break men in for this work; and the industry is so comparatively new that there are but few trained men available. Naturally, as the men become better acquainted with their work, they are going to devise new and improved methods for performing their duties. This is especially true of the men who have to do with the placing of microphones, and with the "mixing" of the volume of sound picked up by the microphones. The technicians who operate the film recording machines are usually camera men, or men from the film

At the right is shown the construction of the enormous "silent" stage that was used for the shooting of Universal's "Broadway" and "King of Jazz." To the left of the partly completed stage may be seen two smaller silent stages with the sound department—the one-story brick building—in between

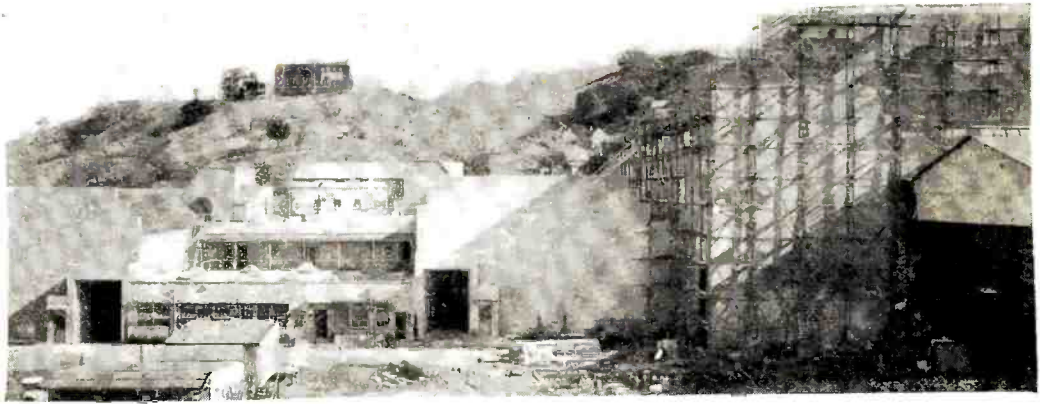

Not until microphones, vacuum tubes, loud speakers and audio amplifiers were developed to their present high degree of perfection were talking movies ever possible as a laboratory experiment. Their general acceptance by a rather critical public is proof enough of the success of engineers to give the movies its own voice

laboratories. The wax, or "disc," recording men generally have had experience with phonograph record manufacturing companies. Their new work is so nearly like the old that these men need very little special training.

Ever since the advent of the motion picture, back around 1900, constantly repeated attempts have been made to give sound to the "silent drama." Most of these sound devices made use of different forms of the phonograph record for the recording and reproducing of sound. There was one system, though, invented by a French woman, that burned a sound track along the edge of the film by means of a white-hot platinum wire. Various expedients were tried unsuccessfully to give the sound great enough volume to fill even a small theatre. All of that was before the invention of the audio amplifier, however, which today makes possible the enormous volume necessary to fill the largest theatres.

These early systems all failed in one respect: sound motion picture systems are necessarily based on perfect synchronism between the sound and the picture, and this they were unable to accomplish. The writer remembers well a demonstration of

By Charles Felstead*

a talking picture that he heard many years ago. A large phonograph was used for the sound projecting unit. It could not be made to stay in synchronism with

the film, the tone quality left very much to be desired, and only the people in the first few rows of the theatre were able to hear it, but nevertheless it worked. That was in those old days when between reels a slide reading "One Minute Intermission While the Operator Changes Reels" was flashed on the screen. The success of the present-day sound motion picture is due almost entirely to the development and perfection of a method of maintaining perfect synchronism between a number of motors, and of holding them indefinitely at a certain speed. The variation in speed of these motors must be, and is, less than one-tenth of one per cent. from a fixed value of twelve hundred revolutions per minute. It is this same method of speed control that, carried much further, may help to make television a thoroughly practicable reality within a few years.

The Vitaphone of Warner Bros., which was the first of the talkie systems actually to be put into commercial use, is merely the evolution of the old-style phonograph method of projecting sound pictures. Developments in the electrical recording of phonograph records, which were still further improved in the Vitaphone system, and the perfecting of the synchronous motor drive system made the Vitaphone possible. The records used in this system are much larger than ordinary phonograph records, they revolve much slower, and the needle travels from the center to the outside, instead of from the outside inward, as in the ordinary phonograph.

The future development of the talkies will undoubtedly be in connection with television. When television has been perfected, it can be combined with the sound motion picture to form an ideal means of entertainment. A play, an opera, or a drama can be recorded, and then simultaneously seen and heard in all parts of the country. The theatre will probably fall into disuse, more or less, for everything but first run productions; and well-to-do people will have equipment in their own homes to receive the broadcast sound pictures. Eventually, too, all motion pictures will be in natural colors; and will have perspective, which is to say, *depth*. By that time the recording and projecting systems for sound motion pictures will doubtless have been greatly (Continued on page 928)

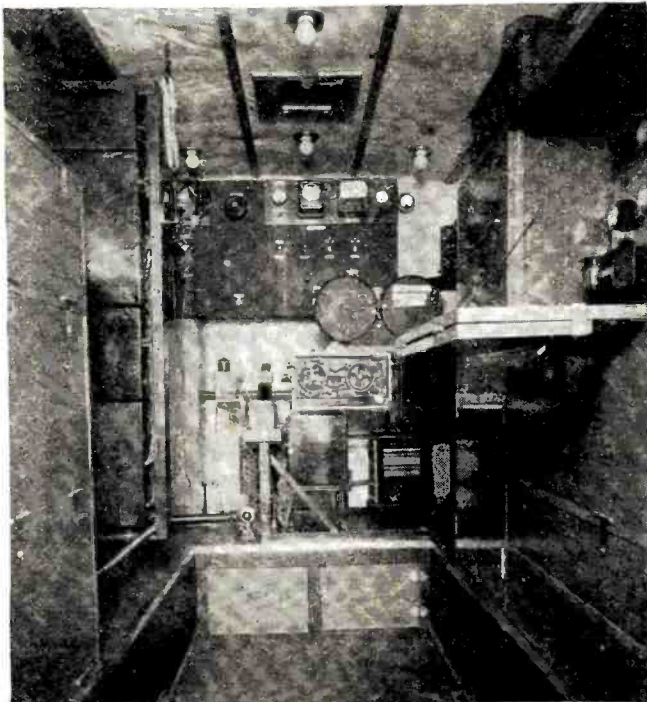

At the left is an interior view of a sound-recording truck. In the exact center of the photograph is the film-recording machine in which the sound is recorded as a narrow band of light and dark lines on the edge of a strip of motion picture film. A regular motion picture camera is used for photographing the action. The amplifying equipment is contained in the metal boxes to the left of the recording machine

Testing

By A. D. Middleton*



Participating operators. Left to right, W8ACZ, W8TP, W8KC, W8CJR, W8UC, W8ADJ, W8FS, W.Nau, W8AZU, W8BS, W8CTP and W8DGP

HOW many times have you wondered what happens after you quit pounding brass when the air is good—when does it go bad, get better or die completely? These questions came up at the Cleveland Amateur Radio Association rag chews but were never definitely settled. Finally, this fall, the boys got together and planned continued operation of the Club Station—W8AKA.

The outfit at W8AKA consists of a self-excited 204A with about 240 watts input. The antenna is a voltage feed Hertz 25 feet high, designed to operate on approximately 7210 kc. The receiver commonly used is a d.c. two-tube, plug in coil and condenser layout that has been used for months at W8AKA. With this outfit in the club rooms, it was thought that operation could go on for a few days without interruption.

A schedule was set up starting at 6 P.M. Wednesday, November 26, 1930, and six-hour shifts were assigned over a period of three days. Many of the boys were out of school for the holidays, thus permitting daytime operating. Every piece of apparatus was overhauled. Batteries were charged, relays adjusted, tubes checked and the transmitter tuned. The rig seemed O.K. But—the day before the test was to start, a local station reported W8AKA—"QSA 5—RAC with bad ripple." This was sad news!—for the reports had been good for months. Usually "DC Sigs" were reported but now something had gone haywire. Nothing could be done to change the note. The circuit was changed from Hartley to a tuned plate-tuned grid arrangement and still the note was terrible. A new plate transformer failed to help. It was finally discovered that by only half-wave rectification a good note would result.

*Engineer, C. A. R. A., Station W8AKA.

A QSO with W5AFF gave W8AKA "QSA4 Xtal." Oh, boy!! However, it was too late to attempt to find the trouble so the rig was left half wave with a resultant reduction in plate current. The outfit drew only 135 mls with half wave.

At 4:45 P.M. Wednesday, W8CTP took the key for the first few hours. QSO's were made with several Ohio and Michigan stations and things looked fine. The snow, which had been falling for hours, turned into a blizzard. W8DGP and W8KC, were almost snowed under coming to the Club. It took Mel Johns and W8UC over two hours to make the fifteen-mile round trip for a National ACSW5 receiver that W8BAII lent for the test. Intermittent success was had during the first twelve hours. Several sixes were worked and K4RJ was raised, but lost due to QRM and QRN from the snow. Signals were erratic and conditions were bad. The snow caused terrific QRM and static sparks a half-inch long would jump from the grounded plate coil of the transmitter, due to the pick-up of the Hertz. When W8TP was relieved by W8UC, the air was practically dead. Over two hours' work resulted in *no* QSO's. Then W6CEL answered a CQ. This was at 8:10 A.M. and the snow was still coming down. Indifferent results were had throughout Thanksgiving Day.

W8CMB reported by radio at 2:30 P.M. that the cold had burst the cooling system in his Chrysler roadster, so he couldn't make his 6 P.M. schedule. That meant a stop in the test unless a man could be found. Since

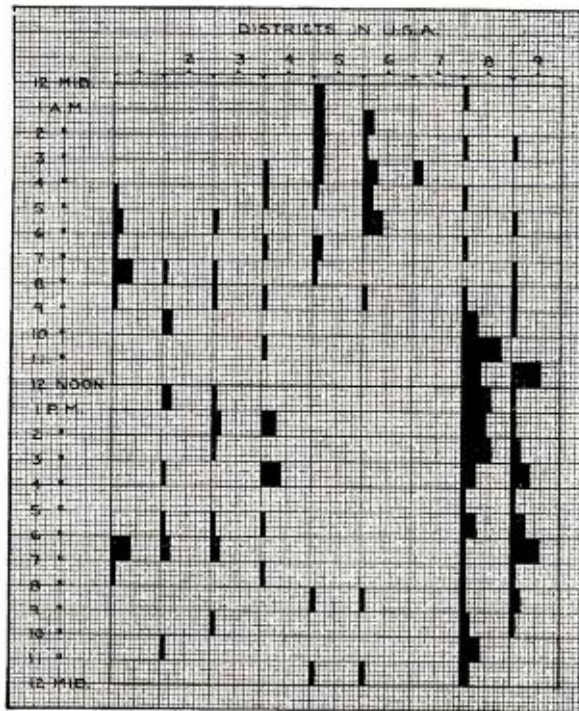

The results of the test are summarized here in terms of stations worked by districts and hours. Each vertical column represents one station worked. Thus a block two columns wide indicates two stations worked, etc.

Close-up of operating table at W8AKA, showing neat layout and easy accessibility of keys, switch, receiver control dial, frequency meter and break-in antenna switch

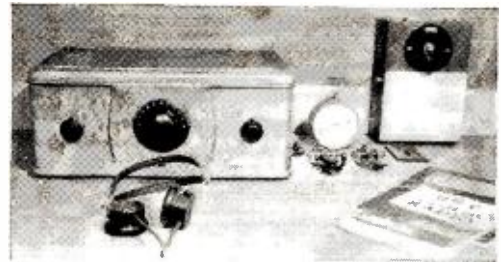

the only means of communication from the shack is by radio, there was a feverish search for a "local" to fill in. W8BS was heard, worked and asked! He would be glad to come over—Hot Dog! The test went on—W8BS was relieved by W8CTP and man after man took his place to do his bit.

W8DBI got up at 4 A.M. and walked four miles through the near blizzard and snow to meet his 6 A.M. schedule. Men had to go out and run the motor of their cars every hour to keep them from getting too cold to start. Coffee, soup, box lunches and cartons of cigarettes were consumed by the operators. W8KC contacted 14 stations in 5½ hours. DX was heard, some of it worked. Sixes pounded in as late as 9:30 A.M. and as early as 5:30 P.M. The snow had put a

Reliability of Amateur Radio

This story suggests one example of the opportunities open to amateurs throughout the country to make their activities serve a definite purpose of technical and scientific value, as well as provide themselves an opportunity to indulge their experimental inclination

blanket down. W8AKA's signals were spotty throughout the continuing hours. The equipment worked splendidly—all seemed to be going fine, when the air got too dead, the National ACSW5 was turned on and never failed to find somebody. The power line interference at W8AKA, always bad, was worse during the test than ever before.

Stations were raised, given a "QSO Party Number" and if "QRU," were clicked off. Traffic, always slim on 40 meters, was almost nil, however, a few messages were gathered in—one of them a hundred words from Detroit. Other members kept track of the number of hours by various means. W8CTP acted as receiving station and reported to W8UC via land phone. W8KC listened every two hours to see how things were coming.

Another local non-member, W8QV, was pressed into service and he did good work. The test was 82 hours old before a seven was worked. W8TP clicked W7VK and W7APR in succession, making all districts. On Saturday evening W8CTP heard a ship—CN2CN—off the coast of Morocco. After a long call and a long wait, in which he twice gave up hope, he heard CN2CN coming back. A half QSO resulted. The ship's frequency varied 30 kc. and at no time was steady enough for solid copy. This was the best DX worked during the test and was made during a bad rain at W8AKA. The weather ran the gamut of human endurance, cold, snow, rain, sleet, wind and sunshine, all did their bit to complete the picture. At times it was necessary

FOR readers who are unfamiliar with the amateur abbreviations employed, the following explanations are given:

- CQ—General attention call for reply from any or all stations.
- QRM—Interference.
- QRN—Static.
- QRU—Have you anything for me? I have something (message) for you.
- QSA (followed by number from 1 to 5) —Indicates degree of readability of signals from minimum (1) to maximum (5).
- QSL—Acknowledgement of message.
- QSO—Communication with.
- RAC—Transmitter sounds like operation from "raw" or unfiltered a.c.
- DC Sigs.—Signals are without a.c. hum or ripple.
- Xtal—Quartz crystal controlled transmitter (d.c. note, unwavering frequency).

to open the window, and clear the snow from the antenna lead-in insulator, as often as every fifteen minutes.

Thirteen operators took their places at their respective times. They were W8ACZ, W8ADJ, W8AZU, W8BS, W8CJR, W8CTP, W8DBI, W8DGP, W8FS, W8KC, W8QV, W8TP and W8UC. Some men put in one shift, some two and many split up the six-hour watches to conform with their various duties. No one passed up his schedule without reporting it in time. The new men did excellent work in operating under trying conditions such as QRM, QRN and weak signals.

Finally after 181 contacts had been made, W8CJR closed the station and turned off the transmitter 109 HOURS and 35 MINUTES or over FOUR AND ONE-HALF DAYS after it had been turned on by W8CTP! Wednesday to Monday.

The test was over!

Since results are the true reward (Continued on page 957)

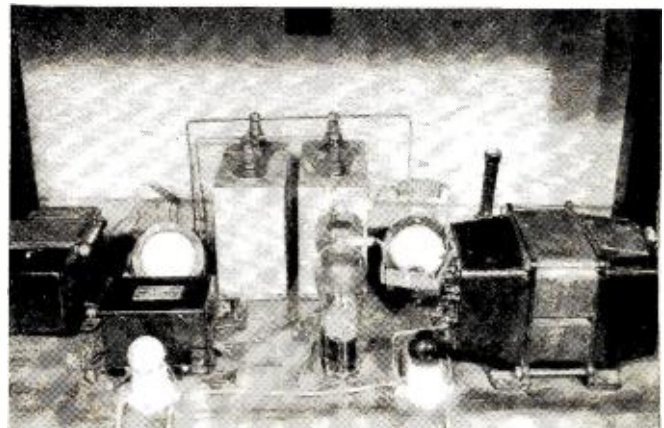
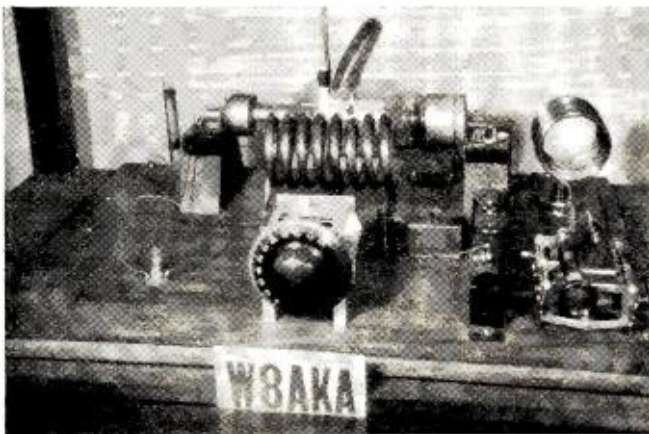

Above is shown the power supply at W8AKA; 30H RCA choke at left. Plate milliammeter behind 866 filament transformer; White main pilot light, two blocks 2MF each filter condenser, 866 tubes, filament meter, red high power pilot light, plate and filament transformer; spark killer resistor sticking up in back

At the left is the tuned plate-tuned grid transmitter at W8AKA using UV20+A tube

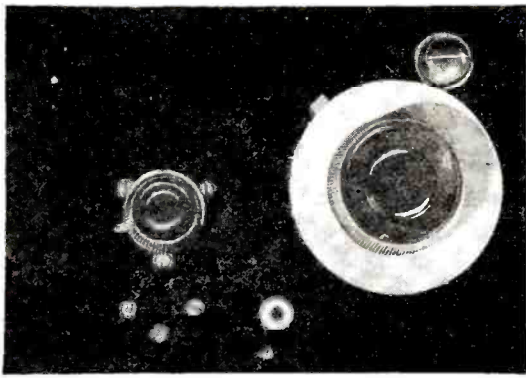

The front view of the handy dynatron frequency meter which is fully described in this article

The "JUNIOR" Dynatron

The calibrated vacuum tube oscillator able by the amateur operator and the serve as a high-precision wavemeter, and as a frequency standard against can be

By Don

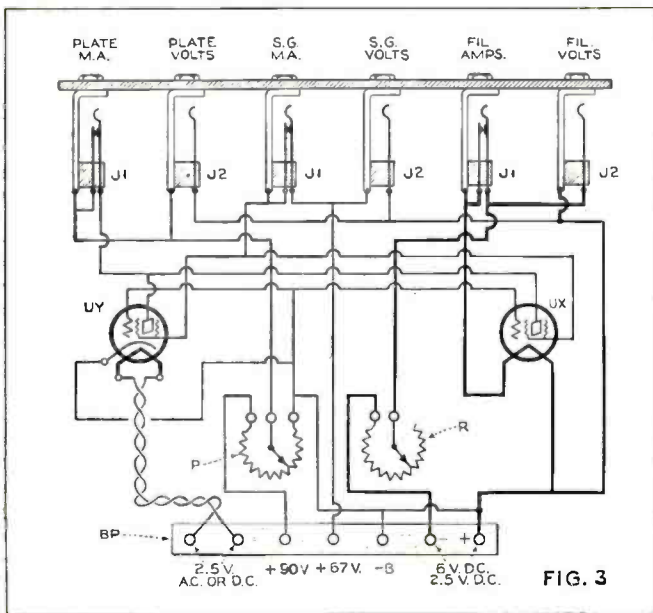

Figure 3. The circuit for a simple set-up used in determining the negative resistance characteristics of screen-grid tubes

PART FOUR

"HELLO, Gus. Sit down. Just working a five. There's an extra pair of cans—"

"How's it going Don? Doing much traffic handling?"

"Sure, handling lots of messages and the transmitter is perking along in fine style. Only thing about it I don't like is that there are several holes in the band I'd like to get into but I hesitate to risk getting out of the band with only a monitor as frequency meter. I've been figuring that with the error of percentage of the monitor, when I adjust it to the center of the band there is almost an even chance that I'm on the edge of the band or even outside of it. What I want is a frequency meter that will tell me where I am"

"Well, Don, is one-tenth of one per cent close enough?"

"Sure, but how can I get a meter that accurate? All the meters I see are from 1 per cent to 2 per cent and some very expensive ones are guaranteed to one-fourth of one per cent. For me, it has to be cheap and accurate."

"The frequency meter I am talking about is cheap and accurate. It can be made to .05 per cent but various errors of

Figure 4. Curves run on a single -22 type tube, showing the effect of a variation in the screen-grid voltage in altering the negative resistance characteristics

handling and adjustment bring the average to about .1 per cent. You've heard of the dynatron oscillator haven't you? Well, the dynatron is very stable and makes an excellent frequency meter. We've known about the dynatron principle for years but it involved the use of special tubes and that made things very expensive. Lately, some one discovered that the average screen grid tube functioned as a dynatron under certain conditions. Everything depends on the negative resistance of the particular tube. That means that when the plate voltage of a dynatron is increased, the plate current falls over a certain portion of the curve. Like this (Figure 1)—When the tube is used in an oscillating circuit and the plate voltage is so adjusted that the tube is working in this section of its curve that I have marked oscillating range, it is functioning as a dynatron oscillator. Incidentally, the amount of capacity and inductance in the tank circuit can be varied so that the dynatron functions as a frequency meter in the radio frequency spectrum below twenty-eight megacycles and when the L and C are large enough it can be used as an audio oscillator.

"Here's the circuit (Figure 2) of a frequency meter designed to function in all five of the present ham bands. For 1750 k.c. it works with the inductance L1 and the condenser C1 on the fundamental. For the 3500 k.c. band it works with the same coil and condenser but on the second harmonic. Throwing the switch (SW) connects the coil L2 and the condenser C2 across C1 and disconnects L1. This combination works on 7000 k.c. on the fundamental and the harmonics take care of the fourteen and twenty-eight megacycle ranges.

"I have built one already and it works fine. No, I won't lend it to you. Build your own. The only thing you need be

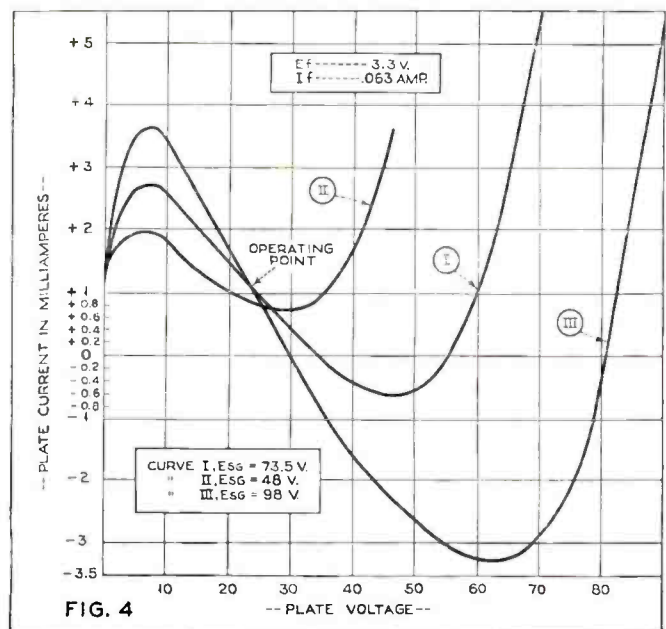

Frequency Meter for TRANSMITTER'

described here will be found invaluable to the experimenter alike. Not only does it but also as a high-frequency driver which all sorts of measurements made

Bennett

careful about outside of neat construction and efficient layout is to get a tube with the proper negative resistance."

"That's fine. But how do you pick those out?"

"Measure them. I'll lend you the bridge I built to test all your tubes and you can pick out the best one to use in your frequency meter. Here's what the bridge looks like--(Figure 3). It has two sockets to take care of both a.c. and d.c. tubes. Except for the filaments the sockets are wired in parallel. The potentiometer (P) is shunted across the 90 volt B battery and serves as a voltage divider. I made my readings in two volt steps and plotted them on cross section paper, one division of the meter scale equivalent to one square on the paper. The plate current was plotted with five squares equaling one milli-ampere. This makes for easy plotting on a ten mil. scale, one division of the scale equals one square on the paper.

"I ran curves on some fifteen tubes in order to pick out a good one. It so happened that it was the first tube I tested but I ran them all to see if there was a better one in the bunch. I tried -22's, 22-A's, -24's and -32's. Tubes of the same manufacture varied considerably in negative resistance. Some were no good at all, some good and one was excellent. Here are the curves I ran on it, (Figure 4) and you'll notice that they vary greatly.

"Curve 1 was run with a screen grid potential of 73.5 volts. The filament was held constant at 3.3 volts and the filament current was .063 amperes, 63 milli-amps. You will notice that with zero voltage on the plate the current was 1.2 m.a. At eight volts this had risen to 2.75 m.a. and then it sloped off on the negative resistance portion of the scale to 46 volts where the plate current was minus .6 m.a. After that it rose quickly until at 70 volts the current was 5.52 m.a.

"I wondered what would happen with a lower screen-grid voltage and shifted down to the next tap which read 48 volts. Curve 2 is the result of that. Notice how the curve has flattened, the I_p varying from 1.96 to .77 m.a. Obviously this was bad so I went the other way and put 98.5 volts on the screen-

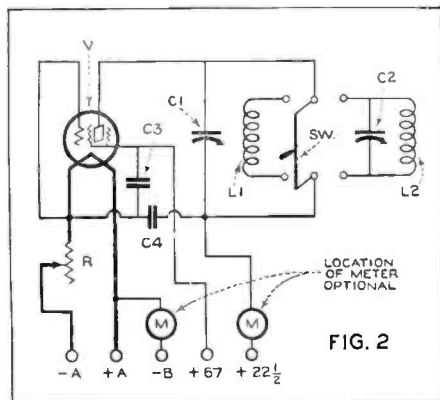
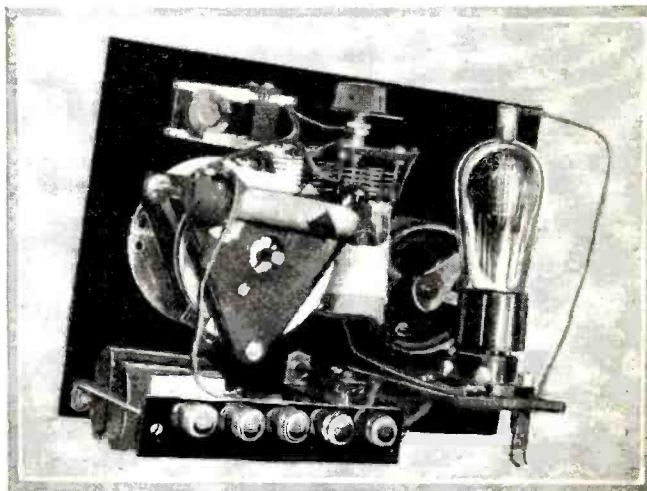

FIG. 2



Rear view of the meter, showing layout of parts to aid the constructor who wishes to duplicate the one described here

grid. Curve three shows the effects of this. At eight volts (E_p) our peak current was 3.63 m.a. and it fell to minus 3.24 m.a. at 64 volts. This was much better. Then I wondered what the effect of change in filament voltage would be. This would result in temperature change inside the tube and consequently could be expected to alter the characteristics. There was a slight difference but it did not affect the negative resistance much (Figure 5) but it did change the frequency slightly when working in the meter.

"When I put this -22 tube to work in the meter I wanted to find the best spot for it to work on the curve. The current flow was so small in the plate circuit that I couldn't rely on the stability of a resistor to hold my plate current at the ideal spot so I had to rely on the taps of the B battery. Incidentally I measured the screen current at the best operating point on all three curves and found that the current on the high voltage curve was slightly higher than I thought advisable. 12 milliamperes. The screen-grid current at the corresponding point on the 74 volt curve was 8.6 mills and that seemed more reasonable. This best operating point was with a plate voltage of 24 (the 22 1/2 volt tap on the battery). This meant a plate current of .89 mills, plate voltage of 24, screen voltage 73.5-74 and screen current 8.6 mills with the filament at 3.3 volts."

"Say Gus, if you ran curves on fifteen tubes, what are you doing with the other fourteen?"

"I'm using one for a dynatron audio oscillator and with the other thirteen I think I'll try and build a thirteen tube short-wave super-bloodydyne and win myself a permanent home in the local nut factory.

"All levity aside. Run yourself a flock of curves on all the screen grid tubes you have around and use the best one for a dynatron. One good thing about the dynatron is that it doesn't involve a lot of extra batteries. You can use the same (Continued on page 936)

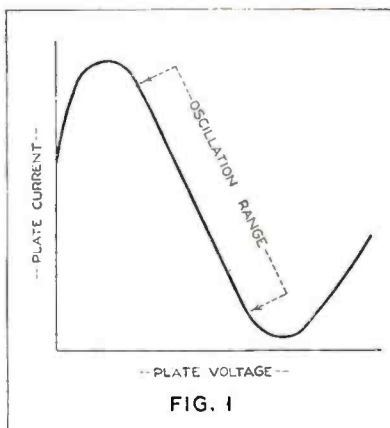

FIG. 1

Figure 1. The negative resistance characteristics of a tube determine its value for use in a dynatron oscillator. This curve is typical of the -22 type

Figure 2. The schematic diagram of the dynatron oscillator. Note particularly that the screen-grid voltage is higher than the plate voltage

The Service Bench

by ZEH BOUCK

Off-Season Trade—Repairing Cones—Tube Protection—Emergency Tools—Demonstration Antennas—Grading the Serviceman—Tracing Man-Made Static—Apparatus and Equipment. Receivers Serviced—Crosley, Philco, Radiola, Graybar and Westinghouse

An Off-Season Racket

THOUGH the Service Editor was instrumental in designing some of the earliest devices for altering battery sets to a.c. operation, in the "harness" era, his experience has been such as to recommend the purchase of a new and modern a.c. receiver rather than attempt the revamping of the direct current design. The change, of course, can be made successfully with practically any receiver, and the task is not a difficult one either from an engineering or mechanical point of view. But when the possible turn-in value of the old set is considered, along with the improved r.f. and audio channels, general appearance and reliability of the present-day a.c. set, the argument is in favor of a one hundred per cent. new investment.

However, many inquiries that have come to the *Service Bench* during the present incumbency adduce the interesting fact that there are still thousands of people who desire their battery sets altered for house current operation, and who turn consistently deaf ears to the proposition of new receivers. It appears that there are enough of these service customers to justify the serviceman's attention for at least another year, and the development of a lucrative off-season business. We are appending herewith abbreviated instructions for the modernization of the average jobs demanding the serviceman's skill.

The principal operation in the electrification of a battery receiver consists of the rewiring of the filament or heater circuit. It is preferable to adapt this circuit for the use of the -27 type of tube. Disconnect the original filament wiring, shorting over the plus and minus leads wherever they have been connected to the sockets. Tape up the short neatly. Short over the following binding-posts with permanent jumpers: "A" plus, "A" minus, "B" minus, "C" plus, "C" minus. Either use new sockets or adaptors having external heater connections. If adaptors are employed, be sure they do not raise the tubes enough to prevent lowering the cover of the cabinet. The

cathode generally plugs through to the negative filament terminal on the socket. The author prefers using new sockets. Wire the grid and plates exactly as before. The heater should be wired with fairly heavy, twisted cable. The cathodes are connected to the shorted plus and minus "A" leads, as shown in the diagram, Figure 1, which indicates the alterations in r.f., detector and first a.f. circuits. No changes are made in the detector gridleak and condenser circuit. The "C" biases are taken care of through IR drops.

The circuit for a single type -45 power tube is shown in Figure 2. This follows the same general changes outlined above, and is self-explanatory. A separate filament lighting transformer is employed for the power tube. It is desirable to use a type -45 even if the available plate voltage is only 180, where the output of this tube still exceeds that of the type -71A.

The circuit diagram for push-pull a.f. is illustrated in Figure 3.

In remodeling a battery receiver it is a good idea to install new audio-frequency amplifying transformers at least in the power stage. This is generally an easy item to sell the customer. Other extras often associated with the work of rejuvenation include one or two filament lighting transformers and a power transformer. It is often possible to utilize the major portion of either a raytheon or filament tube rectifier "B" eliminator. The voltage can generally be stepped-up by the installation of an adequate power transformer. The condensers, chokes and resistors will take care of the additional load in almost every instance. It is desirable, however, to substitute an electrolytic condenser for the existing capacitor next to the rectifier. The condenser removed may be placed in series with the second condenser, thus increasing the breakdown voltage. The additional capacity of the electrolytic condenser will provide sufficient filtering.

Many customers having old a.c. as well as d.c. sets will request a stage of screen grid amplifica- (Continued on page 933)

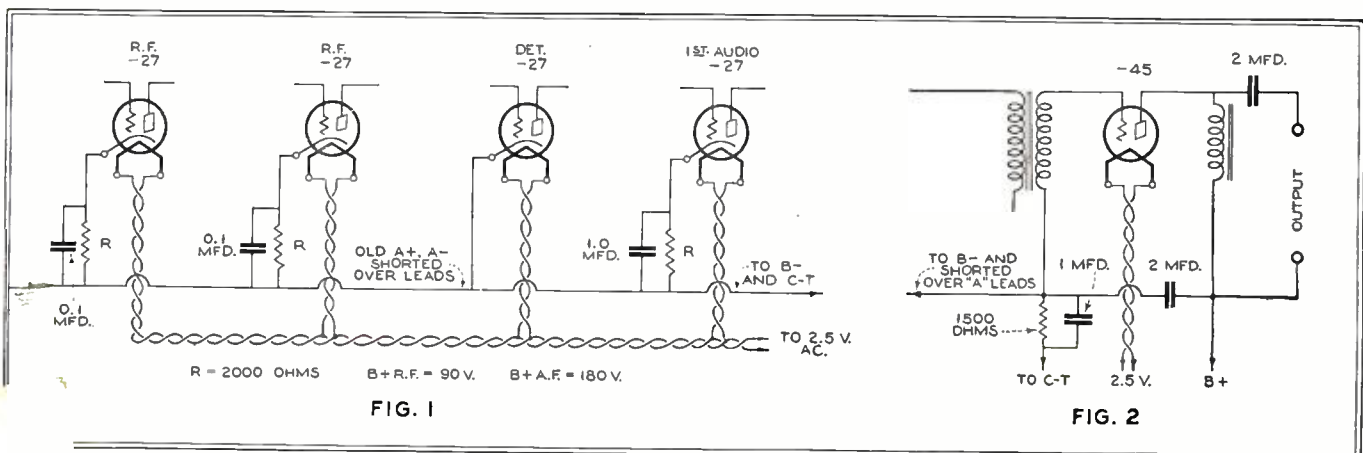

All in a Day's Work

MR. R. L. WOOLLEY of Seattle, Washington, ran into a queer one with a Crosley, model 706. "The complaint was poor volume and distortion. When one of the -71 power tubes was removed, the volume was normal and the quality cleared up. The tubes, circuit, current and voltage readings tested okay. An examination showed that, when loaded with the two power tubes, an arc existed in the dynacone four-wire cable. The obvious replacement permanently cured the trouble."

A Few Pointers on Philcos

J. E. Deines, service manager with the Kansas Light and Power Company, writes:

"In some Philcos you will find three posts for antenna circuit connections. One is marked 'antenna,' one 'ground' and the other 'LOC.' Post 'LOC' is connected to the ground when the antenna is not used. If you employ this last arrangement, better results will often be secured by reversing the electric plug in the socket.

"We receive many complaints from Philco owners, who maintain that their sets are very noisy around the middle of the dial, and, in this locality, only one station is received, and that weakly, in the case of such complaints. We find, in nearly every instance, that the set is either working on ground alone, or with a poor ground, or with antenna and ground reversed.

"It is a habit with some Philcos for the tubes to work up in the sockets. Check this first on the complaint of no reception."

Repairing Cones

"Having had numerous occasions to repair cone type speakers, as well as cones in the dynamics, I am glad to pass on the following information to other servicemen.

"When a section on the periphery becomes separated, the edges should be coated with a good glue, and held securely with paper fasteners or the spring clip type clothes-pins until dry.

"Dents may be removed by holding the cone over live steam spouting from a tea kettle. Do not permit the paper to become wet (nor the steam to penetrate the glued portion at the edge.) The paper should be moist and hot. Shape and form the paper with the hands until it is dry and cool.

"Even barely perceptible dents in the cone will impair quality, as a rule resulting in a rattle on certain notes.

—WARREN J. GRAHAM, Marlboro, Mass."

Radiolas and Majestics

James A. Robinson, radiotrician of Methuen, Mass., recommends a quick glance at the local-distance switch "when
(Continued on page 956)

Service Notes

A NEW name for the serviceman. W. J. Murrow, of Macon, Ga., offers us full rights to the term "radio servician" in exchange for a subscription to RADIO NEWS. Mr. Murrow contributes the following to Webster, Funk and Wagnalls, et al:

"*Servician*; One who services, such as a radio servician, one who services radio apparatus, as distinguished from a radio operator, one who operates radio apparatus."

Real estate agents once decided to emphasize their professional caste by calling themselves "realtors." Friend Murrow gets the subscription, but we relinquish our rights to the term to anyone who prefers to be designated a radio *servician*.

John C. Heberger, Rochester, N. Y., sends us three jottings from his service scrapbook:

Protecting A.C. Tubes

"Some poorly designed a.c. receivers, and some well-designed receivers operated in certain localities, are very hard on tubes. The former sometimes deliver abnormal filament and plate voltages to the tubes, while the latter are affected by high line voltages. In either case the tubes are short lived. When regulators have not been convenient, I have, in several cases, inserted a 100-watt lamp in the cord to the lamp socket. It is only necessary to cut one wire and connect a porcelain socket in the gap. The lamp can be accommodated within the cabinet in most cases. In sets that require more current a bank of two 100- or 150-watt lamps is required. The correct amount can be determined by starting with one 100-watt lamp, and adding a smaller one the value of which will be determined by experiment."

Emergency Tools

"When you haven't the right tool for a certain operation, use the next best.

"To drill a hole in such material as bakelite or hard rubber when you haven't a drill large enough, use a countersink on both sides of the panel, and finish the hole with a sharp jack-

knife. A hole can be easily enlarged by using a three-cornered file in the chuck of a hand-drill, or, better yet, in a brace.

"A piece of beeswax should always be kept in your tool kit. When you wish to start a screw in an inaccessible place, rub a bit of the wax into the slot. The screw will then stay with the screw-driver until safely started.

"Two or three thicknesses of friction tape are more durable than paper, and will stay in place much better when curing grounds between the under parts of socket, and the like, and shielding.

"A copper shield that has been bent in the cutting, can be smoothed with a rolling-pin. A short piece of two-inch steel shafting is very useful in truing (Continued on page 959)



WHILE the technical department of RADIO NEWS is prepared to handle all technical questions, radio servicemen, if they wish, may direct their inquiries to the "Service Editor," where their problems will be considered from the point of view of the serviceman. This somewhat broadens the scope of answerable questions. The conditions under which questions will be answered are the same as maintained by our technical department. The service is free to subscribers, with a consultation charge of one dollar to non-subscribers.

—THE SERVICE EDITOR.

Figures 1, 2, 3 and 4. Circuit diagrams showing the changes necessary in modernizing battery receivers so as to use a.c. tubes, and house current receivers when it is desired to substitute a screen-grid stage in a triode r.f. circuit. A separate filament secondary must be employed for the power tube unless the grid bias is secured by a drop across a resistor in the negative eliminator lead before the minus tap

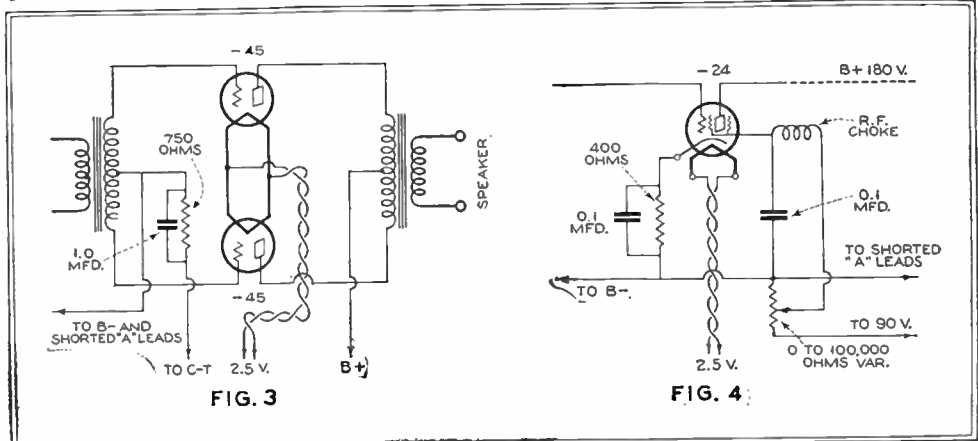

Noise and Man-Made Static

THE intelligent campaign against curable radio noise which has been made a permanent plank in the platform of the *Service Bench* has met with such general acclaim as to encourage us in publishing every available bit of information on the detection and cure of these radio ills which are responsible for more than fifty per cent. of all radio complaints.

Ralph C. Elmgren, Director of the Sound and Radio Laboratories, Cloquet, Minn., sends in the familiar diagram of Figure 5 as an effective noise filter to be included in the feed line to a noise generating device, or in the power circuit to the receiver. (It is more effective in the former circuit.) We are publishing Mr. Elmgren's suggestion because, though an old idea, it is an extremely good one, and the author supplies exact data on its construction.

"Obtain two pieces of bakelite tubing, six inches long and 2½ inches in diameter. Use number 20 wire, preferably enameled, and wind two layers on this form, separating the layers with fiber paper. Mount the two coils, along with four 1. mfd. condensers, in a shielded container such as a tin box.

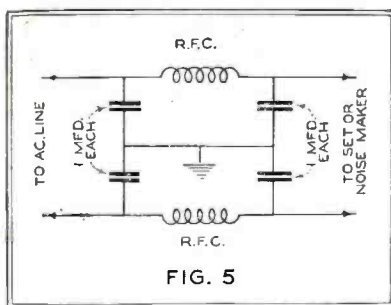

Figure 5. An elementary noise filter circuit worth republishing for those to whom it is unfamiliar

The current passed through the device should not exceed one ampere.

"The arrangement is primarily designed to be placed in series, one leg to a wire, with the power lead to the interfering device. If it is impossible to gain access to the source of trouble, the filter may be connected between the light socket and the receiver. This device will not, of course, eliminate

noise being picked up by the antenna."

Dial 'Phone Interference

The Tobe Deutchmann Corporation of Canton, Mass., has developed a new Filterette designed especially for use in conjunction with dial telephones. The device is very small and is connected across the interrupter contacts in the base of the telephone. The connection is a simple one, and can be made by the serviceman in about five minutes. The interested technician will find it worth while communicating with the manufacturer for information concerning this attachment as well as for general information on the subject of radio noise interference.

The City Checks Up on Man-Made Static

C. Washburn Jr., radio and electrical engineer of Jacksonville, Fla., and associated with the electrical distribution department of that city, sends us the following interesting account of the technique and practice of hunting down stray interference:

"The electrical distribution department of the City of Jacksonville has for several years made a practice of co-operating with set owners in the matter of running down and correcting electrical troubles which cause interference with radio reception.

"At first there were only a few receivers in use, and, as these were not especially sensitive, complaints were few. Also, these early receivers were battery (Continued on page 960)

Apparatus and Equipment

RALPH ELMGREN, who has already contributed to this month's *Service Bench* the design of an elementary noise filter, has boiled down the ohmmeter to its essentials.

"Direct reading ohmmeters," writes Mr. Elmgren, "are often convenient, but the serviceman can save himself a lot of trouble and expense by calibrating one or two of his milliamperemeters against various series resistors in conjunction with a battery of known voltage. Use Ohm's Law.

"Most set testers have several milliammeter ranges. The calibration is easily made on the readily available cross section or co-ordinate paper, as suggested in Figure 6. This chart may be copied without additional measurement for any meter of the same range. Using a 150-milliamperemeter scale with 1.5 volts in series, gives curve A from 10 to 100 ohms. The same scale with 4.5 volts gives curve B ranging from 100 to 1000 ohms. For higher resistances, use a 45-volt battery and read curve B from 1000 to 10,000 ohms. If an 0 to 50 ma. meter is available, use this in the last case for greater accuracy. For resistances from 10,000 ohms to .1 megohm, employ a 0 to 5 ma. scale with 45 volts, reading the milliamperes on curve B as if divided by ten, and the ohms as if multiplied by 100.

"Paste this set of curves in the top of your test set, and you'll find it more than worth the trouble."

Determining Small Fixed Condenser Values

It is a simple matter to identify the values of those poorly marked fixed condensers. H. I. Gulliver of the Radio Repair Shop, Wayne, Nebraska, measures them in the oscillating circuit diagrammed in Figure 7. The meter used is a Weston thermo-galvanometer, type 517. The instrument is calibrated by measuring fixed condensers of known capacities. The variable condenser is used to adjust the meter to any desired position on the scale before testing condensers.

This device also has possible uses as a modulated oscillator and a tube tester.

What the Well-Dressed Serviceman Should Wear

The Victor Company is passing out tips to servicemen—points quite worthy of observance. For instance:

"In addition to technical and sales ability, one of the first requisites of a good serviceman is that he have a neat personal appearance. A clean shaven, neatly dressed man will always make a good first impression upon the customer. The serviceman should be a practical (Continued on page 949)

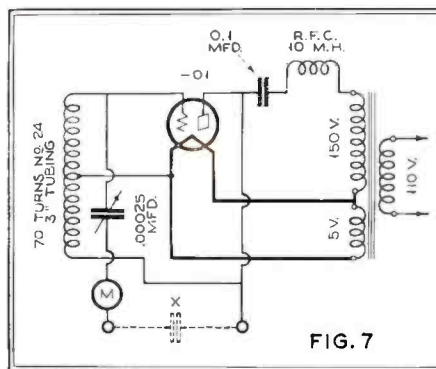
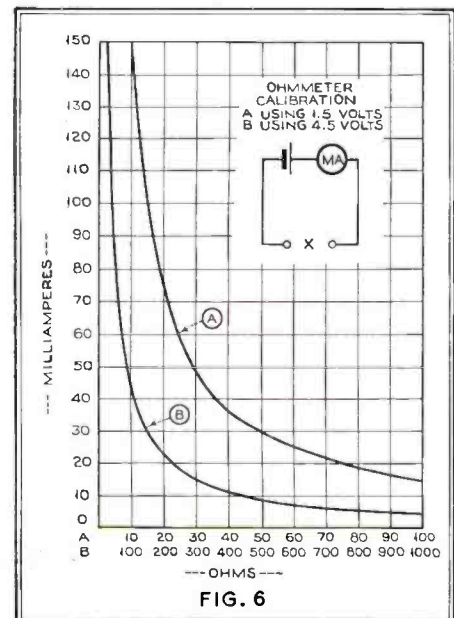

Figure 7. A combination oscillator and tube tester that may be used to measure the values of small fixed condensers

Figure 6. Paste this in the top of your test set, and your milliammeter becomes an ohmmeter



What's New in Radio

Midget Type Tuning Condenser

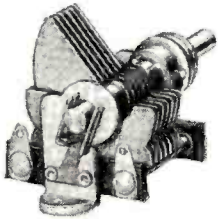

Description: These condensers are made in mid-line and in straight line capacity types and range from 19 mmfd. to 322 mmfd. capacity.

The smallest condenser measures only $2\frac{3}{4}$ inches long and the largest 4 inches long. With the plates fully extended the overall width is $1\frac{1}{2}$ inches. All models use solid brass plates, accurately spaced and soldered. The stator plates are soldered to slotted brass bars and the rotor plates to a slotted brass shaft, thus insuring accurate spacing. Soldered eyelets are employed in the construction of this condenser. This type of construction eliminates the possibility of parts vibration and is a feature of special value in airplane and automobile receivers.

Usage: For use where space is limited, as in midget broadcast receivers.

Maker: Hammarlund Manufacturing Company, 424 West 33rd Street, New York.

Midget Super-Neutrodyne Receiver

Description: A feature of this midget receiver is the new system of condenser mounting which permits full power output from the push-pull audio stage without internal vibrations. Three screen-grid tubes, type -24, are employed, two being used in the radio-frequency stages and one as a power detector. The remaining tubes are: one type -27 tube, two type -45 tubes for the push-pull power stage and one type -80 tube as a rectifier. The receiver is equipped with



a built-in electro-dynamic speaker and a double contact volume control. The single tuning control is calibrated in kilocycles and wave lengths, and also in the conventional 0-100 scale, permitting easy and quick identification of stations. The dial is illuminated and serves as a pilot

light to indicate whether the receiver is "on" or "off". It features pre-selector tuning to prevent cross talk or domination by powerful local stations. The cabinet is 18 inches high by $15\frac{1}{4}$ inches wide and is finished in combination walnut panel with decorative front panel and speaker grille.

Maker: F. A. D. Andrea, Inc., Long Island City, N. Y.

Direct-Coupled Amplifiers Using -50 Type Tubes

Description: Both these power audio amplifiers use the Loftin-White direct-coupled system. Model A250 amplifier has a rated undistorted output of 4.6



A-250

watts with 28 volts input. Power consumption, 85 watts. It utilizes one type -24 tube, one type -50 tube and one type -81 rectifying tube. Model C250

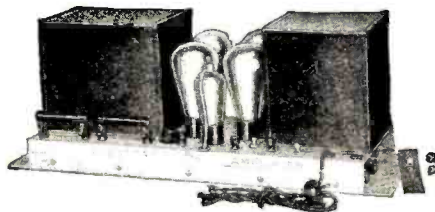

C-250

amplifier provides 10.35 watts of undistorted output with .3 volt input. Power consumption 160 watts. This unit has a tone control and hum compensator. The tubes employed are one type -24, two type -50 and two type -81. These amplifiers are adaptable for use with radio-frequency tuner, phonograph pickups and microphone. Both units are assembled on metal sub-panels.

Usage: A sound-amplifying system to provide high quality of reproduction and capable of large volume.

Maker: Electrad, Inc., 175 Varick Street, New York City, New York.

Variable Transmitting Condenser

Description: This condenser is made entirely of aluminum and was designed for transmitting circuits where weight and space are important factors. The smallest size, with a maximum capacity

of 50 mmfd., weighs $3\frac{1}{2}$ ounces and the largest size, 150 mmfd., weighs 8 ounces. The voltage breakdown rating is 1500 volts. A rigid phosphor bronze spring is included to insure positive contact. The

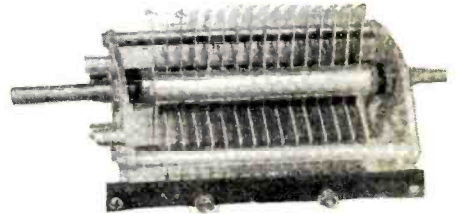

tuning shaft is extended to permit gang-ing. There are three post supports on the end plates for mounting. Single hole mounting as well as brackets for base mounting can be supplied.

Usage: A variable capacity for transmitting circuits.

Maker: Air-Way Condenser Company, 56 Christopher Avenue, Brooklyn, N. Y.

Resistor Assortment



Description: This is a handy resistor assortment packed in a light steel case to fit the serviceman's pocket. There are twenty-four resistors of different values ranging from 100 ohms to 2 megohms including the values most commonly used for replacement in broadcast receivers.

The resistors are marked according to the standard color code adopted by the Radio Manufacturers' Association, a copy of which is inside the hinged cover of the case.

Usage: For the serviceman's bag, to



meet all common resistor replacement requirements.

Maker: Tilton Mfg. Co., New York.



A department devoted to the presentation of technical information, experimental data, kinks and short-cuts of interest to the experimenter, serviceman and short-wave enthusiast

A Homemade "Dynamag" Loud Speaker

By Frederick Keats

ONE of the most fascinating features of radio has been, still is and long will be, loud-speaker experimentation. It is, in its own way, as full of interest as the exploring of an unmapped country. One never knows what new thing will turn up next. However, for those who may not have the time or inclination to blaze their own trail, there is a path marked by guiding signposts known to experimenting fans as the Dynamag Trail.

The word "Dynamag" is derived from "dynamic" and "magnetic," and it means a magnetic speaker with a dynamic tone. By no means is this a stretch of imagination. The tone of the Dynamag has the strength and fulness of an electro dynamic speaker without "drumminess," and as such is a welcome contrast to the somewhat tinny and anaemic tone of the common run of magnetic speakers.

Some people there are who never fail to ask whether a speaker will stand up under high voltage. Will it "stand the gaff" without blasting? Incidentally, the writer wishes to say that this is a wrong attitude. Yes, a speaker may "stand the gaff," but what true satisfaction is there in that? Why give it the "gaff" at all, when you and I and everyone else knows perfectly well that there is a certain degree of volume at which any speaker will perform at its best? It should be realized that some speakers that stand up under excessively high volume and pour forth a very Niagara of sound will not give a real quality performance in a small room at moderate volume. The Dynamag is not one of these. It will stand up well enough at full volume without blasting, but it will give better satisfaction with the volume controlled at normal level, just like any other really good speaker, no matter who made it or how much it cost.

To the many thousands who use a table-model battery or eliminator set (either from choice or from compulsion), the interpretation of the word Dynamag should be full of meaning. As we all know, the

common variety of magnetic speaker is not to be classed as a thing of delight. It is too often harsh toned and of limited volume capacity. On the contrary, the Dynamag is full toned, yet brilliant, and able to stand up well under strong locals without distortion. This is due to the unusual construction and the method of cone suspension. For those who can not, and for those who will not, use a dynamic speaker, the Dynamag will be a welcome discovery. In short, the Dynamag fills a large and definite want, comparing triumphantly with any speaker, home-made or commercial.

The Dynamag cannot be purchased ready made. Every fan must make his own. If he has any familiarity with hammer, saw and screwdriver and is willing to follow directions faithfully, he will achieve success at a cost of no more than six or seven dollars. The frame of the

speaker may be of any size between twelve and twenty inches square, using a single cone from nine to fourteen inches in diameter. The standard size, however (the one which gives the best all-around results with both voice and orchestra), measures fifteen and one-half inches wide and sixteen and three-quarter inches tall, and this is the model to be dealt with in this article.

The wooden frame should be only three and one-half inches deep at top and sides, and the reason for this is the avoidance of box-resonance. The base must be seven and one-half inches deep. Any kind of lumber except oak may be used, but white pine, gum wood or mahogany are preferable. The writer usually uses white pine. For the sides, saw two pieces sixteen and three-quarter inches long by three and one-half inches wide. For the top, one piece fourteen inches long by three and one-half inches wide. For the base, one

(Continued on page 950)

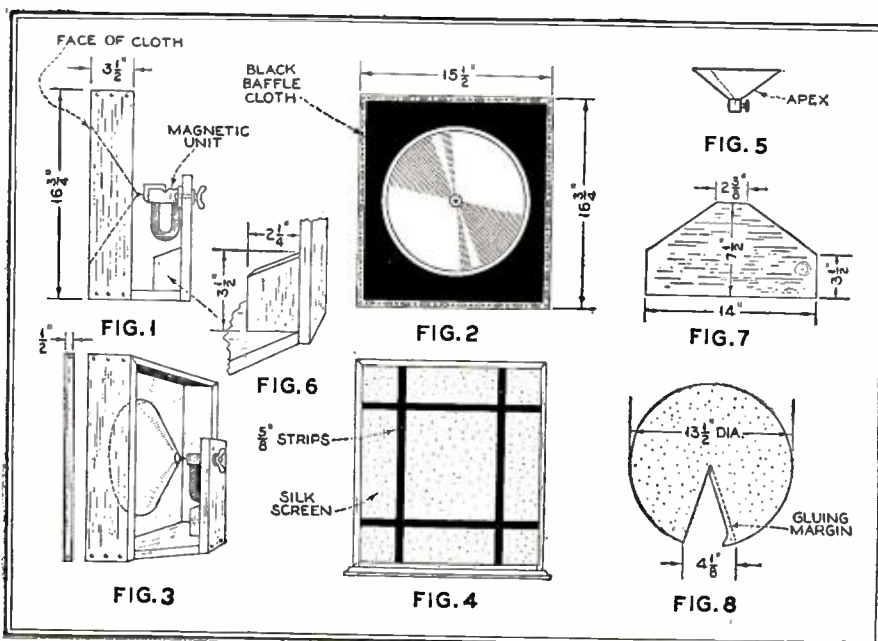

A Volt Ohmmeter

The serviceman who does not have an ohmmeter need not lament the fact if he is able to handle ordinary arithmetic, a crow quill pen dipped in india ink, and can blow his breath on a glass and wipe it clean and free of all oil.

Using the meter which is ordinarily employed as the continuity tester, he must examine it to determine how many ohms per volt are employed by the manufacturers in the construction of the set tester. Usually this is marked on the meter, or if it is a milliammeter, with a resistance in series, the value of the series resistance may be taken. Sometimes a chart of the resistance is included in the testing manual and this may be consulted in the process of calibrating the meter as an ohmmeter.

Calculation of the calibration is not difficult and is the only resort where a calibration curve is not included in the instruction book or where the range in the instruction book is not as great as desired.

Let r be the resistance to be measured. Let R be the total resistance of the meter. This is the ohms per volt multiplied by the volts to the scale on which the battery voltage is read with the continuity test clips shorted. Or it is the series resistance in the case of a milliammeter. Let A be the battery voltage that is being used for testing. This should be for a new battery when calibrating, or one that has been used only a short time to bring it down to its normal voltage which exists throughout the greater part of its useful life. Generally this is $4\frac{1}{2}$ volts, but can be anything desired as long as it is within the range of the meter. Let B be the reading with the resistance r inserted in between the test clips. Then 0 resistance will be at the point indicated by the meter when the test prods are contacted direct. When the test prods are set to say r equal to 1,000 ohms the meter will not indicate $4\frac{1}{2}$ volts, but will indicate a voltage that can be calculated by the formula

$$B = \frac{A}{\left(\frac{r}{R} + 1\right)}$$

Thus let the range of the meter be 5 volts and the ohms per volt 1,000. The total resistance of the meter is $5 \times 1,000$ or 5,000, which we must substitute in place of R . In the place of r we put 1,000, and in the place of A we put $4\frac{1}{2}$, the voltage of the test battery. This gives

$$B = \frac{4.5}{\left(\frac{1,000}{5,000} + 1\right)} = 3.75 \text{ volts}$$

(Continued on page 952)

A Simple But Efficient Ohmmeter

One of the most needed instruments on the shelf of the radio serviceman or the experimenter is an ohmmeter. There are many uses for an efficient resistance measuring instrument such as a continuity tester, a high resistance joint finder, for measuring resistances in amplifiers, etc. The circuit of this ohmmeter is shown in

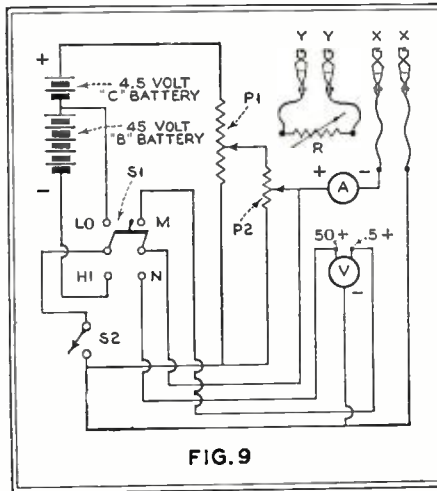

FIG. 9

Fig. 9. This instrument measures resistances up to 50,000 ohms. With larger batteries and a greater range voltmeter you can have an ohmmeter with any range desired, but 50,000 ohms is a great enough range for most of the jobs of the average serviceman. The ohmmeter can be mounted on your service bench or in a box large enough to hold the two batteries.

First cut and drill the panel as shown in Fig. 10. Then mount and wire the parts. Be sure to wire it exactly as shown in Fig. 9, or you might burn out your meters. Solder all connections. You can save some money by making your own voltmeter. Instead of buying the voltmeter, use another 0-1 ma. milliammeter and two Durham precision wire-wound resistances, one of 5,000 ohms and the other of 50,000 ohms. Change the wiring as shown in Fig. 11. Calibrate the meter as shown in Fig. 12.

To measure resistances under 5,000 ohms, set switch $S1$ to "Lo" position and set switch $S2$ to the "On" position. Always be sure that potentiometer $P1$ is turned to the "C" side before turning on switch $S2$ or you are liable to ruin your

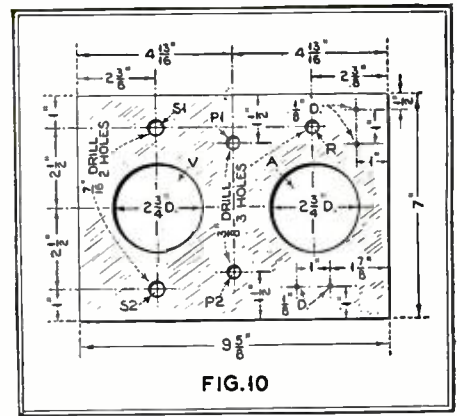

FIG. 10

meters. Place resistance to be measured in the pee-wee clips X . Adjust potentiometers $P1$ and $P2$ until you have a reading of exactly 1 ma. on meter A . The reading on meter V equals resistance across X plus resistance of meter A , which is 30 ohms in the Jewell pattern 88 and is 27 ohms in the Weston type 301. Subtract resistance of meter and you have the value of the resistance across clips X . To measure resistances up to 50,000 ohms turn switch $S1$ to Hi position and proceed as shown above for Lo side.

If the resistance in an amplifier or a radio set is burnt out, place clips Y across the burnt-out resistance and adjust the variable resistance R until the voltage or the current in the circuit is as it should be. Then without changing resistance R , place it in the ohmmeter circuit and measure its resistance. The reading on meter V is the resistance of the burnt-out resistor plus resistance of meter A .

The following is a list of parts used in my ohmmeter. Other makes, of course, can be used, but they should be only of the best, because with cheap parts you cannot make an efficient ohmmeter.

- $P1$ —Carter 5,000-ohm tapered potentiometer.
 - $P2$ —Carter 400-ohm midget potentiometer.
 - $S1$ —Carter jack switch (double-pole, double-throw).
 - $S2$ —Cutler-Hammer toggle switch.
 - R —Clarostat volume control.
 - X and Y —Four pee-wee battery clips.
 - A —Jewell or Weston 0-1 ma. milliammeter.
- (Continued on page 953)

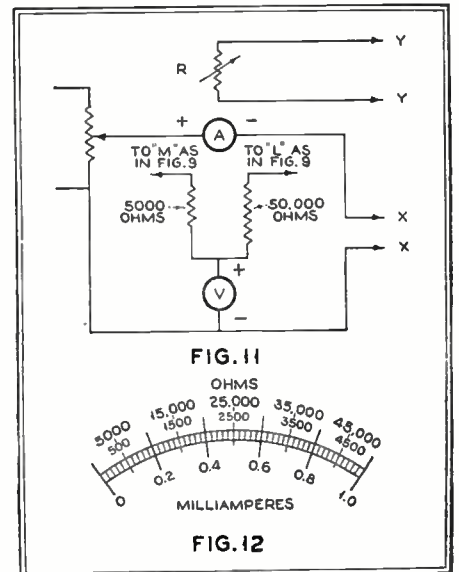

FIG. 11

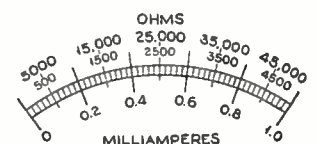

FIG. 12



Figure 13—The volt-ohmmeter included on one corner of Mr. Gonselley's portable test panel

~RADIO NEWS HOME LABORATORY EXPERIMENTS~

Calculating Hum in Amplifiers

A KNOWLEDGE of amplifiers, how to calculate amplification, how to figure power output, etc., proves exceedingly helpful in determining factors affecting the hum output from a receiver. the best circuit arrangement and amount of filtering needed to keep the hum to a satisfactory minimum. Using the general methods of analyzing amplifiers which have been described in past Home Experiment Sheets. let us calculate the hum voltage in a loud speaker circuit with various types of amplifiers.

Offhand, we might consider that the hum audible from the loud speaker need only be sufficiently low as not to interfere with the actual reception of programs; actually, however, the requirements are much more serious and we insist that the hum be so small as not to be bothersome during *silent* periods in the program. This means that the hum power in the loud speaker circuit must be kept at a very low value, down in the order of a few microwatts of power.

The following analysis of some of the factors influencing the amount of hum will bring into practical use the experimenter's knowledge of amplifier characteristics and will serve to show the desirability of being able to analyze the conditions existing in an amplifier system; the desirability, in other words, of knowing something more than just how to read a circuit diagram and hook up a set.

Let us assume for the purpose of our discussion that the actual radiated acoustical power from the loud speaker due to hum must not be more than one microwatt (one-millionth of a watt). Then if the loud speaker is 10 per cent. efficient the actual power fed into the loud

speaker must not be more than $\frac{1}{.10}$ or

10 microwatts; an efficiency of 10 per cent. may seem rather high, but it might be realized because of resonance. In any event, it is merely an assumed figure, and though it averages higher or lower in actual practice, the essential factors discussed below are not altered. All we wish to do here is show how the problem is attacked and really do not want to tie down the discussion to any particular figures or types of circuits.

Now suppose we had a single power tube circuit arranged as shown in Figure 1. Let us roughly calculate the maximum hum output from the "B" power unit which will not give in excess of 10 microwatts of hum in the loud speaker.

Since, as the diagram indicates the tube is a type -45, in which case the a.c. plate resistance will be 2000 ohms, then the load must have an effective resistance of 2000×2 or 4000 ohms. It is in this 4000-ohm load that the hum power must not exceed 10 microwatts. Therefore the current through the load cannot be in excess of that obtained by applying the following formula:

$$I^2 = \frac{P}{R_L}$$

where I is the current, P the power and R the resistance. In this particular case we have

$$I^2 = \frac{10 \times 10^{-6}}{4000}$$

$$I = \frac{1}{20} \times 10^{-3} \text{ amperes}$$

$$= \frac{1}{20} \text{ or } 0.05 \text{ milliamperes of hum current}$$

This hum current, as shown by the equivalent circuit of Figure 2, must flow through the 4000-ohm load and through the tube plate resistance, since they are both in series. The voltage necessary to force this current through the circuit is therefore:

$$\begin{aligned} E &= I \times R \\ &= (0.05 \times 10^{-3}) \times (4000 + 2000) \\ &= 0.3 \text{ volts} \end{aligned}$$

This means that the hum output voltage from the "B" power unit must not be more than 0.3 volts if excessive hum is not to be audible from the loud speaker; expressing the hum output voltage in percentage of the d.c. output voltage of the power unit, we have

$$\begin{aligned} \text{Per cent. hum output} &= \frac{0.3}{300} \times 100 \\ &= .1 \text{ per cent.} \end{aligned}$$

If Figure 1 is again referred to it will be noted that it indicates "large by-pass condenser" across the "C" bias resistance. A large condenser is necessary to preserve quality, although the use of a small condenser is a simple, though not to be recommended, method of eliminating excessive hum; the use of a small condenser cuts down the hum, but it also cuts down the low frequencies in the speech or music.

Assume that a small condenser were used so that at 120 cycles (the predominant hum frequency) the condenser had practically no by-passing effect. Using the same figures as above, we find in this case, as shown by the equivalent circuit of Figure 3, that the 0.05 milliamperes of hum current would have to flow through the load resistance, the plate resistance and *also* through the bias resistance. a resistance we did not have to consider in the first example since the large shunting condenser gave the circuit negligible impedance. If the same power unit were used, the hum voltage in the circuit

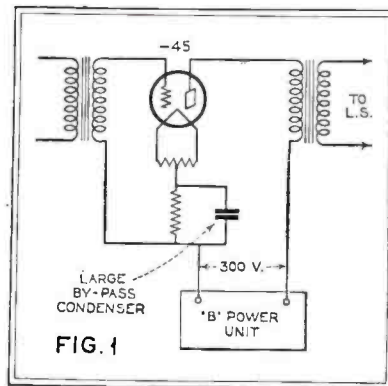

FIG. 1

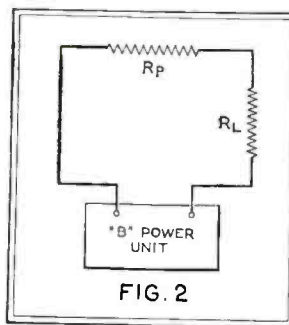

FIG. 2

would be the same, or 0.3 volts. The current through the circuit would be

$$I = \frac{E}{R_L + R_p + R_b}$$

$$= \frac{0.3}{4000 + 2000 + 1500}$$

$$= .00004 \text{ amperes or } 0.04 \text{ milliamperes}$$

But this current flowing through the bias resistance R_b would result in a voltage drop of $0.04 \times 1500 \times 10^{-3}$ or 0.06 volts across the resistor. This voltage would be impressed back on the grid of the tube, after which it would undergo amplification in the tube and reappear in the plate circuit multiplied by the μ of the tube. This amplified voltage would be practically opposite in phase to the original hum voltage from the power unit and would therefore reduce the effective voltage causing the hum. Under these conditions it would therefore be found that a balance between the original voltage and the feedback voltage would be such as to reduce the effective hum voltage from 0.3 to 0.19 volts, bringing the hum power in the loud speaker circuit down from 10 microwatts to only about 2.5 microwatts.

Using insufficient or no by-pass capacity across the "C" bias resistance would therefore be an effective method of reducing hum were it not for the fact that a reduction of the same order would occur at all the desired low audio frequencies; the method has been used, however, in cheap power amplifiers to permit reducing the cost of the filter system.

The difficulty of keeping the hum at a satisfactory low level when the two stages of audio amplification are placed ahead of the loud speaker has been responsible in part for the rather general adoption of single-stage audio amplifiers for modern receivers. The hum in the loud speaker is due largely to amplification of the hum voltages arising in the detector circuit and reducing the overall gain from the detector to loud speaker therefore simplifies materially the problem of building humless receivers.

For example, suppose we have a two-stage push-pull amplifier as shown in Figure 4. If the hum power in the moving coil circuit is not to exceed 10 microwatts, then the voltage across the moving coil must not exceed

$$E^2 = P \times R$$

$$= (10 \times 10^{-6}) \times 10$$

$$= 0.0001$$

$$E = 0.01 \text{ volts across the moving coil}$$

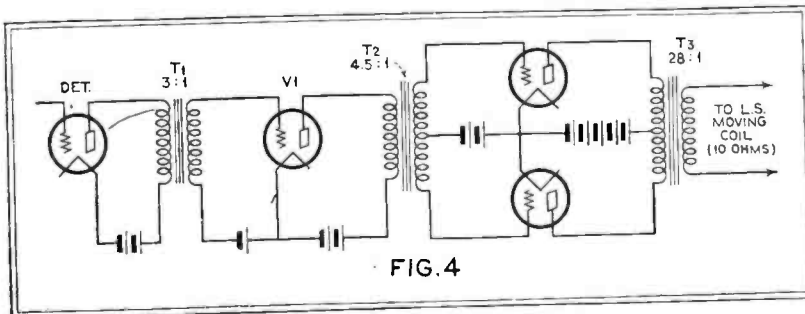

FIG. 4

Multiplying this voltage by the turns ratio of the output transformer T3 gives 28×0.01 or 0.28 volts across the primary. Since the effective primary impedance of the transformer should be approximately twice the plate impedance, the total hum voltage in the plate circuit must

$$\text{be not more than } 0.28 \times \frac{3}{2} = 0.42 \text{ volts.}$$

A type -45 tube has a μ of about 3.5 and the limiting value of hum voltage which can reach the grids of the push-pull power tubes is 0.42 divided by μ (3.5); which gives 0.12 volts. If the push-pull stage is preceded by another stage as shown in Figure 4, then the amplification from detector plate to the grids of the push-pull tubes will be

$$\text{Amplification} = T_1 \times (\text{Eff. } \mu \text{ of } V_1) \times T_2$$

$$= 3 \times 7 \times 4.5$$

$$= 94.5$$

Since the voltage on the grids of the power tubes (which will be the same as the voltage across the entire secondary of T2) is limited to 0.12 volts it follows that the hum arising in the detector circuit must not exceed 0.12 divided by 94.5 or 0.000126 volts, the same as 0.126 millivolts.

If, however, the power tubes were operated without the use of the intermediate audio amplifier tube V1, then the transformer T2 would represent the only gain between detector tube and power tube grids. The hum output voltage from the detector could then be as high as 2.66 millivolts without causing trouble. A comparison of this voltage with that figured for the two-stage amplifier will show that from the standpoint of detector hum the two-stage amplifier is some 20 times more sensitive.

Some Actual Measurements

In connection with this problem some actual measurements, made some time ago on a standard dynamic loud speaker, are of interest. These measurements were made to determine how much voltage at 120 cycles (the predominant hum frequency) could be impressed across the primary of the loud speaker coupling transformer before the sound of the hum became bothersome. The loud speaker was mounted, during the tests, in a large flat baffle and the 120 voltage was obtained from a low-frequency oscillator.

It was found, by making a large number of tests with different listeners and averaging the results, that about 0.15 volts across the transformer primary would produce a just audible hum. Since this was a 4000-ohm loud speaker, the corresponding power is approximately 5 microwatts, not exactly the same as the figure suggested at the beginning of this sheet, but near enough to the suggested figure to indicate that in practice the results are about as we have described.

The fact that even very small amounts of power are audible to the ear indicates how essential it is that the hum be held to a very low value. And apart from the fact that hum is annoying in itself it also has the effect of masking other frequencies; the result is that if we take a receiver which hums badly and listen to it, it would appear to be deficient in low frequencies.

Radio News Manufactured Receiver Circuits

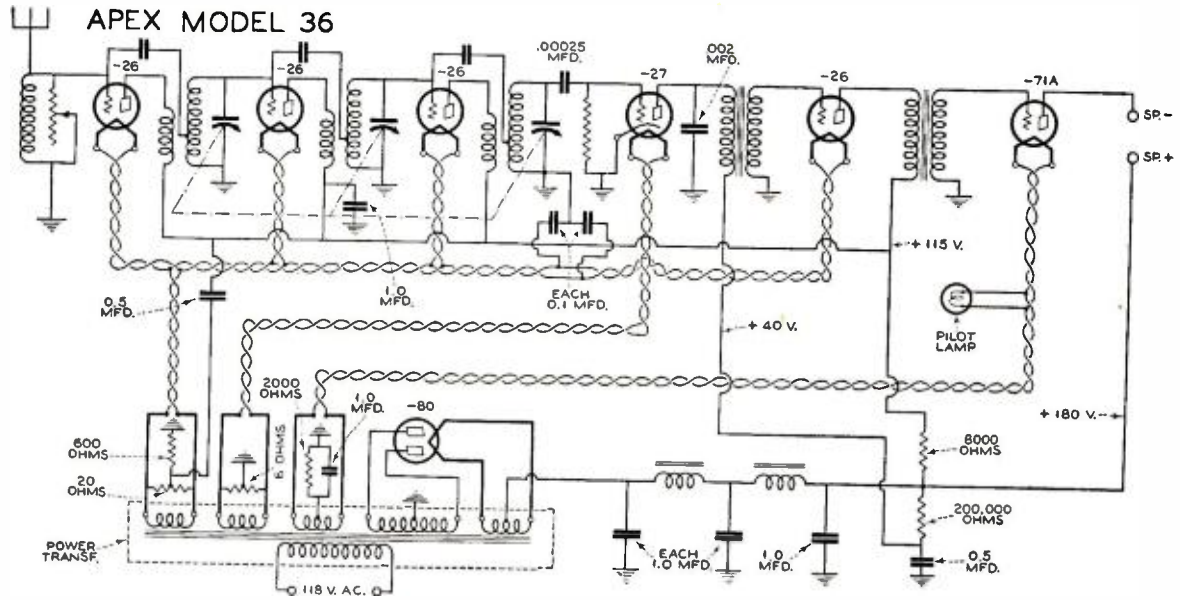

THIS is a six-tube receiver consisting of three stages of tuned, neutralized radio-frequency amplification, a grid-leak and condenser detector, and a transformer-coupled audio amplifier of two stages. Type -26 tubes are used in the three radio-frequency stages and in the first audio stage.

The detector is a -27 type tube. A single -71A tube is used in the output power stage. The radio-frequency stages are gang tuned. The volume control is a variable resistance across the antenna coil. A type -80 rectifying tube is utilized in the power supply.

Radio News Manufactured Receiver Circuits

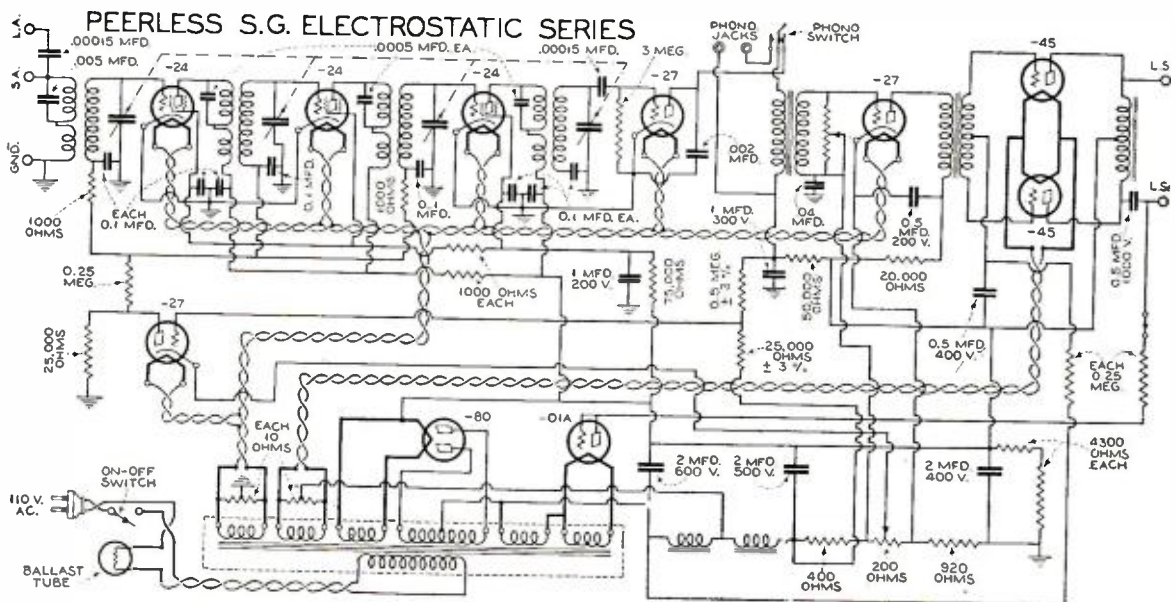

THE Peerless S. G. Electrostatic model embodies several unusual features. An automatic volume control, electrostatic speaker, phonograph jack with switch and an output push-pull stage are some of the features. Type -24 tubes are used in the tuned radio-frequency stages, -27 tubes in the detector stage and first audio stage and -45 tubes in the push-pull output stage. The -27 tube in the center left-hand

corner of the diagram is the automatic volume control tube. A type -80 rectifying tube is utilized for the power supply to the receiver and a -01A used as a rectifier provides the high voltage for the electrostatic speaker. Manual control of volume, supplementing the automatic control, is accomplished with a potentiometer in the grid circuit of the first audio stage.

Radio News Manufactured Receiver Circuits

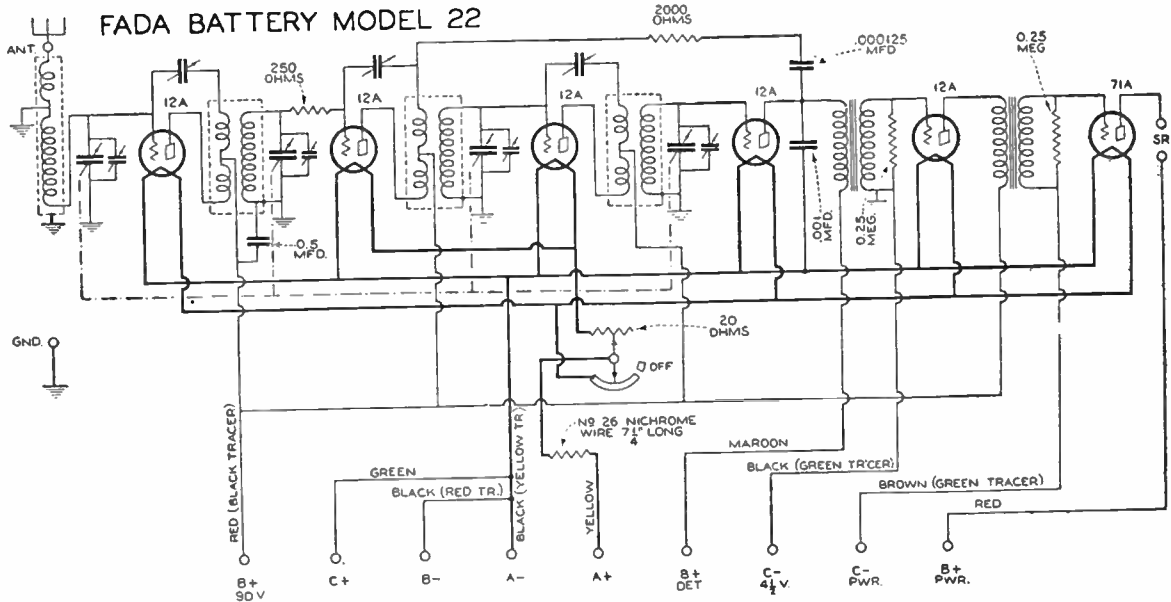

THE Fada Battery Model 22 is a six-tube receiver, employing neutralization in the radio-frequency amplifier. This model utilizes five type -12A tubes in the three radio-frequency stages, detector, and the first audio stage. A single -71A tube is used in the power output stage. The audio amplifier is transformer coupled and consists of two stages. Trimmer condensers are used across all of the main tuning

condensers, accurately matching the tuning of the individual stages. The volume control is a variable resistance in series with the filaments of the second and third radio-frequency stages. There is also a fixed series resistor to prevent excess voltage being applied to the filaments. A receiver off-on switch is incorporated on the same volume control knob, thus eliminating an extra control.

Radio News Manufactured Receiver Circuits

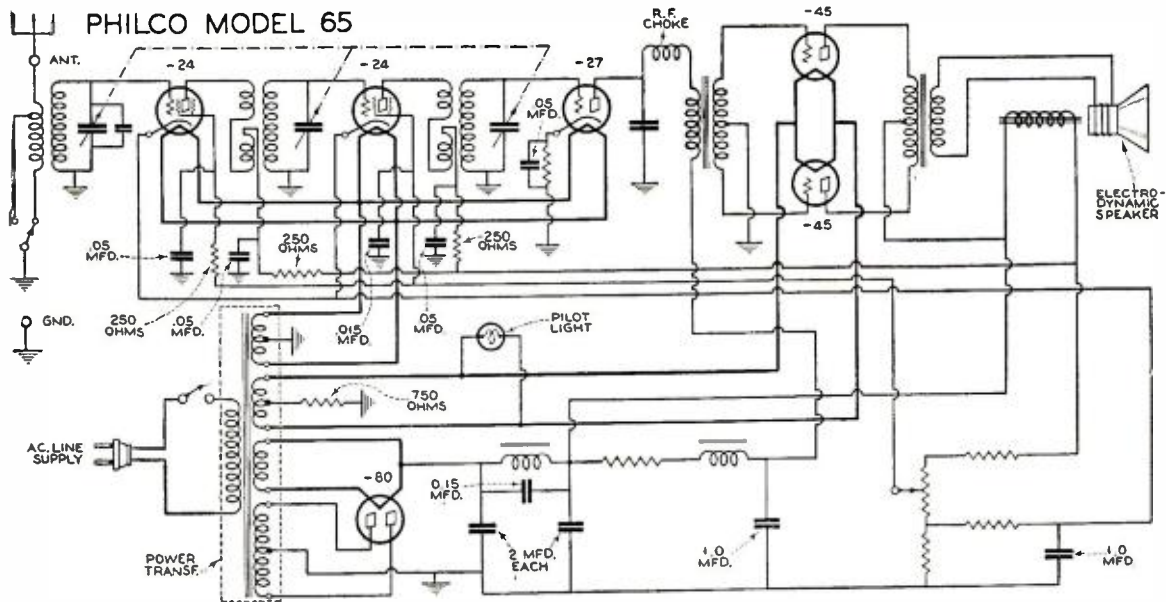

THE Philco Model 65 is a six-tube tuned radio-frequency receiver, using type -24 tubes in the two radio-frequency stages, a -27 tube is used in the power detector stage and -45 tubes in the power stage. The audio amplifier is a single push-pull stage, working directly out of the detector tube. The volume is controlled by varying the potential on

the screen grids of the two radio-frequency tubes. The power supply utilizes an -80 type rectifier tube and is so designed as to supply the necessary current to the speaker field, the latter functioning as one of the chokes of the power supply filter. A separate filter section is provided in the plate supply to the detector.



The Junior Radio Guild



LESSON NUMBER EIGHTEEN

Using Mathematics in Radio

Algebra and Its Application to Radio Engineering

PART FIVE

THROUGHOUT mathematical discussions of various radio designs, we have occasion often to alter the algebraic expressions of certain functions in order to show more clearly the particular application of the problem at hand. The study of the various forms of fractions in algebra will show the liberties and limitations to which an expression can be changed.

As referred to previously, and again emphasized, practically all mathematical discussions abbreviate the number of steps or operations performed in the various calculations of their analyses and it is assumed that the intermediate steps are understood. These intermediate steps are appreciated when the reader has the background of the essentials of algebra, trigonometry, calculus, etc., and it is important that "fractions," as used in algebra, be well understood. The study of fractions teaches the relation of complex mathematical expressions and shows how these can be altered and reduced to simpler forms.

A student who has studied mathematics in most of its branches and has laid it aside without application for several months finds that a mathematical discussion of engineering designs is at first not completely comprehensive. But he soon appreciates that the algebra, trigonometry, etc., are readily applicable, and therein is created an interest for continuing contributions to further designs.

Mathematics is essential to all design work, and algebra is a foundation for the complete building up of an understanding of its application. Fractions in algebra are very important, simply because they show the various relations of expressions as used in multiplication, division, and radical forms.

TO beginners in radio the importance of the fact that the common ordinary garden variety of mathematics (the kind of mathematics which to some seemed so pointless when taught in the elementary and lower classes of high school) is quite necessary to the later assimilation of a knowledge of geometry, trigonometry and calculus cannot be stressed too much. For the truth of this it is only necessary to question those in the radio game who have been unfortunate enough to have slipped up on this part of their education and now wish that they had the opportunity to go back to school again.

RADIO NEWS is glad to present to its readers this fifth of a series of articles prepared by Mr. J. E. Smith (President, National Radio Institute) on the use of mathematics in radio. The first of the series appeared in the December, 1930, issue of RADIO NEWS; the second in the January, 1931, issue; the third in the February, 1931, issue; and the fourth in the March, 1931, issue. Others will follow.

THE EDITORS.

The important rules as applied to fractions will now be reviewed as follows:

A. The value of a fraction is not altered if we multiply, or divide the numerator and denominator by the same quantity.

This is readily appreciated by applying the rule to the numerical fraction $\frac{6}{3}$. Now, multiplying the numerator (6) and the denominator (3)

$$\text{each by 4, we have } \frac{6 \times 4}{3 \times 4} = \frac{24}{12}$$

is seen to have the same result as the first fraction. Likewise, dividing the numerator and denominator respectively by 3, we have:

$$\frac{6}{3} \div \frac{3}{3} = 2 \div 1 = 2$$

which is seen to have the same result.

Several examples will be given of fractions with the purpose of simplifying them or reducing them to lowest terms. In order to do these, it is necessary to recognize certain standard

algebraic expressions which are listed as follows:

(a) When an expression is the difference of two squares. Let us multiply $a + b$ by $a - b$.

$$\begin{array}{r} a + b \\ a - b \\ \hline a^2 + ab \\ - ab - b^2 \\ \hline a^2 - b^2 \end{array}$$

$a^2 - b^2$ Ans.

Thus, any expression being the difference of two squares can be immediately resolved into the expressions $(a + b)(a - b)$. Thus $a^2 - b^2 = (a + b)(a - b)$. We know:

- (b) $a^2 + 2ab + b^2 = (a + b)(a + b)$
- (c) $a^2 - 2ab + b^2 = (a - b)(a - b)$
- (d) When an expression is the sum or difference of two cubes.

Let us multiply $a^2 - ab + b^2$ by $a + b$.

$$\begin{array}{r} a^2 - ab + b^2 \\ a + b \\ \hline a^3 - a^2b + ab^2 \\ + a^2b - ab^2 + b^3 \\ \hline a^3 + b^3 \end{array}$$

Thus, any expression being the sum of two cubes can be resolved—

$$a^3 + b^3 = (a + b)(a^2 - 2ab + b^2)$$

In like manner—

$$a^3 - b^3 = (a - b)(a^2 + ab + b^2)$$

Examples:

Reduce to lowest terms:

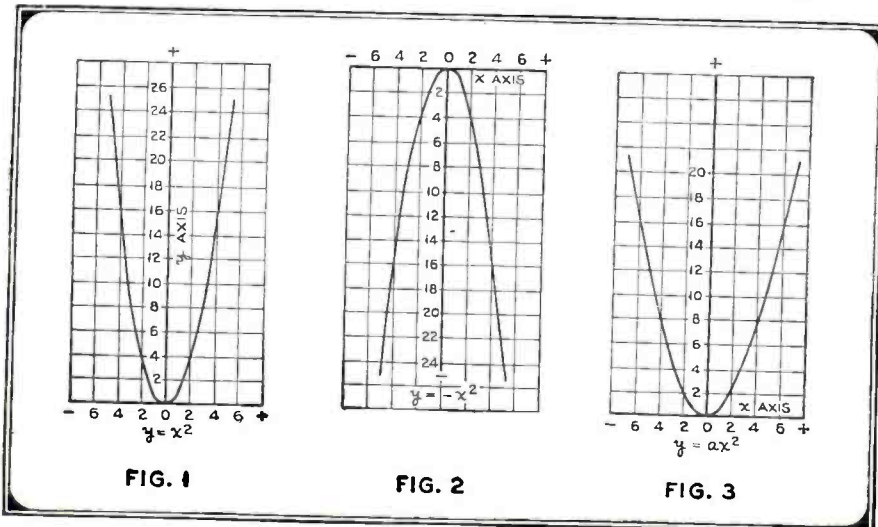

FIG. 1

FIG. 2

FIG. 3

1.
$$\frac{12mn^2p}{15m^2np^2}$$

 To indicate the method:

$$\frac{12mn^2p}{15m^2np^2} = \frac{4mn^2p}{5m^2np^2} = \frac{4n}{5mp}$$
 Ans.

Thus, by applying Rule A, the first operation is to divide the numerical part of the fraction, numerator and denominator, by 3. The next operation is performed in like manner. There is an important note to consider in the reduction of such fractions:

Note: Cancel factors which are common to both numerator and denominator.

2.
$$\frac{40x^3y^4z^5}{69x^2y^3z^4}$$

 3.
$$\frac{ax}{a^2x^2 - ax}$$

 To indicate the method:

$$\frac{ax}{a^2x^2 - ax} = \frac{ax}{ax(ax - 1)} = \frac{1}{ax - 1}$$
 Ans.

4.
$$\frac{2a^2b - 4ab^2}{abx + bx^2}$$

 5.
$$\frac{acx + cx^2}{15a^2b^2c}$$

 6.
$$\frac{100(a^3 - a^2b)}{4x^2 - 9y^2}$$

 7.
$$\frac{4x^2 + 6xy}{4x^2 + 6xy}$$

To indicate the method:
 We find that the numerator is of the form $a^2 - b^2$ where $a^2 = 4x^2$ and $b^2 = 9y^2$

Therefore, the numerator can be resolved as follows:
 $4x^2 - 9y^2 = (2x + 3y)(2x - 3y)$

Thus:

$$\frac{4x^2 - 9y^2}{4x^2 + 6xy} = \frac{(2x + 3y)(2x - 3y)}{2x(2x + 3y)} = \frac{2x - 3y}{2x}$$
 Ans.

8.
$$\frac{a(4a^2x - 9x^2)}{20(x^2 - y^2)}$$

 9.
$$\frac{5x^2 + 5xy + 5y^2}{x^2 - 2xy^2}$$

 10.
$$\frac{x^4 - 4x^2y^2 + 4y^4}{x^2 - 5x}$$

 11.
$$\frac{x^2 - 4x - 5}{x^2 - 4x - 5}$$

B. Multiplication and division of fractions:

(a) To multiply a fraction by an integer.

Note: By integer is meant a whole number.

Let us consider the fraction $\frac{6}{5}$ to be multiplied by 5.

Therefore, $\frac{6}{5} \times 5$ can be treated by dividing the denominator 5 by the integer 5, thus—

$$\frac{6}{5} \times 5 = 6$$

The rule can be applied, then, as follows:

Rule a. To multiply a fraction by an integer:

Multiply the numerator by that integer; or, if the denominator be divisible by the integer, divide the denominator by it.

We have, then, in algebraic form:

$$\frac{a}{b} \times c = \frac{ac}{b}$$

$$\frac{a}{bd} \times d = \frac{a}{b}$$

b. To divide a fraction by an integer:

A similar reasoning to the above will show the algebraic forms:

$$\frac{ac}{b} \div c = \frac{a}{b}$$

$$\frac{a}{b} \div c = \frac{a}{bc}$$

and we have the applied rule as follows:

Rule b. To divide a fraction by an integer:

Divide the numerator, if it be divisible, by the integer, or, if the numerator is not divisible, multiply the denominator by that integer.

c. To multiply together two or more fractions:

We have the algebraic forms:

$$\frac{a}{b} \times \frac{c}{d} = \frac{ac}{bd}$$

$$\frac{a}{b} \times \frac{c}{d} \times \frac{e}{i} = \frac{ace}{bdi}$$

and the applied rule as follows:

Rule c. To multiply together two or more fractions:

Multiply the numerators for a new numerator, and the denominators for a new denominator.

d. To divide one fraction by another, we have the algebraic forms:

$$\frac{a}{b} \div \frac{c}{d} = \frac{ad}{bc}$$

and the applied rule as follows:

Rule d. Invert the divisor, and proceed as in multiplication.

It will be of interest to show a simple proof of this rule.

Let us take the two numerical fractions $\frac{6}{3}$ and $\frac{8}{4}$ such that

$$\frac{6}{3} \text{ is divided by } \frac{8}{4}$$

$$\frac{6}{3} \div \frac{8}{4} = \frac{6}{3} \times \frac{4}{8} = \frac{24}{24} = 1$$

Thus:

Now, applying Rule d by inverting the divisor $\frac{8}{4}$ and multiplying, we have

(Continued on page 942)

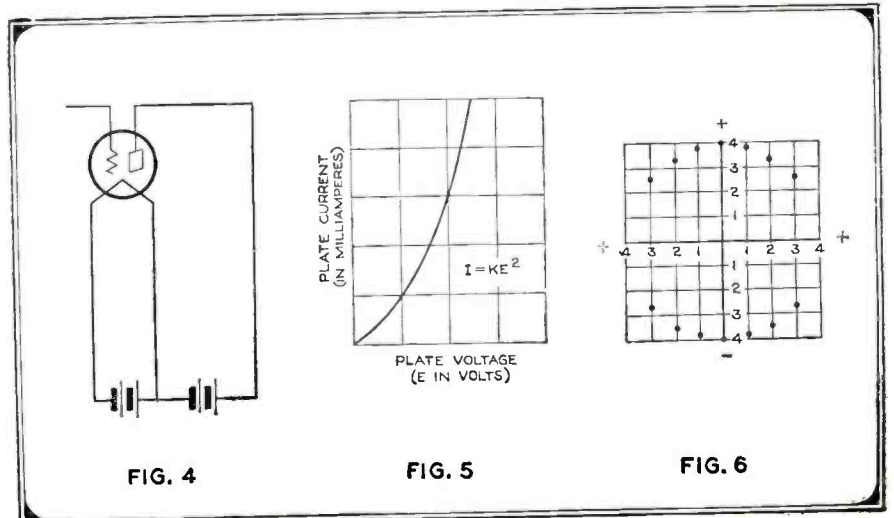

FIG. 4

FIG. 5

FIG. 6

RADIO NEWS INFORMATION SHEETS

Calculation of Effective Resistance in Tuned Circuits

IN the design of radio receivers it is necessary that the designer know the effective resistance of the tuned circuit in order that the impedance load on the plate of the tube may be adjusted to the degree of desired amplification or gain. This is especially true in the case of the screen-grid tube, where the available amplified signal voltage is determined by the load in the plate circuit of the tube.

In the consideration of the tuned impedance and capacity-coupled circuit as shown in the figure, it may be shown mathematically that at resonance the circuit between the points AB and C acts like a high resistance. Neglecting in this instance, for lack of space, the effect of the coupling capacity and the grid leak or choke in the grid circuit of the succeeding tube, the impedance may be determined in the following manner:

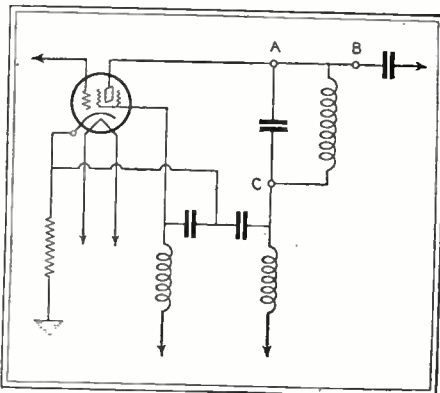

Example: The resonant frequency 1,000 kilocycles (300 meters wavelength), R is 20 ohms, L is 0.24 millihenries (0.00024 henries).

$$2. Z = \frac{(6.28 \times 1,000,000)^2 \times (.00024)^2}{20}$$

$$3. Z = \frac{(6,280,000)^2 \times (.00024)^2}{20}$$

$$4. Z = \frac{39,438,400,000,000 \times .000000576}{20}$$

$$5. Z = \frac{2271651.84}{20}$$

$$6. Z = 113582.159$$

To calculate the gain or amplification in a screen-grid stage in which is used the -24 tube which has a mutual conductance of .001 mhos (G_m), the mutual conductance in mhos is multiplied by the impedance or effective resistance of the tuned circuit as calculated in the example, thus:

$$1. Z = \frac{(6.28 \times f)^2 \times (L)^2}{R}$$

Where Z is the impedance or effective resistance, f is the frequency in cycles, L is the inductance in henries, and R is the d.c. resistance of the circuit between the points AB and C.

$$7. \text{Gain} = G_m \times Z$$

$$8. = .001 \times 113582.159$$

$$9. = 113.58$$

RADIO NEWS INFORMATION SHEETS

Measuring the Power Output of an Amplifier

IN the measurement of the power output of a receiver or amplifier the experimenter or serviceman has often been perplexed as to the proper procedure. In order that the fidelity of reproduction may be obtained with any given amplifier, the output must be of such magnitude that the hall or room will be amply filled. From time to time power output charts and tables have been published, but these at best serve only as a rough or approximate guide as to the actual power delivered by the amplifier system. To better enable the experimenter and serviceman to determine the power output of any given installation the following method is given:

In the figure is shown the set-up of the apparatus for measuring amplifiers of both the filter and transformer output systems. The apparatus required is a resistance to represent the speaker load, which is inserted in place of the speaker winding across A and B, and a vacuum-tube voltmeter calibrated to read effective voltage values instead of peak voltage values. The construction, function and operation of this instrument has been described and explained in past issues of RADIO NEWS.

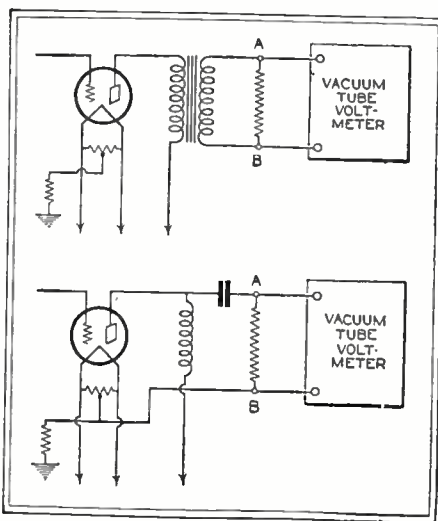

The load resistance connected across A and B should have a value equal to the output impedance of the amplifier. This may be calculated in the case of the output transformer where R_p , the load resistance, is equal to two times the plate resistance of the power tube divided by n^2 , which is the square of the ratio between the primary and secondary turns of the transformer. Usually the value of R_p is known or given more often than the value of n , in which case the above calculation is not necessary. The measuring frequency may be from 300 to 500 cycles. If a modulated radio-frequency signal is used it should be adjusted to 30 per cent. modulation.

Knowing the value of the effective voltage as measured by the v.t. voltmeter connected across A and B, and

the value of the load resistance R_p , the current may be calculated from Ohm's law. The power developed across the load resistance R_p between A and B is equal to the square of the current times the value of R_p in ohms.

The same method of procedure is followed in the case of the filter output system where R_p is given a value equal to twice the plate resistance of the power tube.

RADIO NEWS INFORMATION SHEETS

Measurement of Large Inductances

IN dealing with filter chokes, speaker windings, output chokes, transformers, or other large inductances, the experimenter or serviceman often must know the value of the inductance in order that the speaker may be matched to the output transformer, or that a filter choke may be replaced with one of a like value. As with condensers and resistances the most accurate means of measurement is the bridge method. For those who do not have access to such an instrument a simple means of measuring and determining the inductance is given in this information sheet.

The apparatus required are a d.c. milliammeter, an a.c. milliammeter, a d.c. voltmeter and an a.c. voltmeter. These instruments must be of a suitable scale range consistent with the voltage sources and the current to be measured. The set-up is given in the schematic diagram, and the only additional apparatus required is the single-pole, double-throw switch, which may be of any type.

It is first necessary to determine the d.c. resistance of the inductance, using Ohm's law, thus:

$$R = \frac{E}{I} = \frac{4.5}{.050} = 90 \text{ ohms}$$

When the resistance has been found, the impedance is determined by measuring with the a.c. instruments, thus:

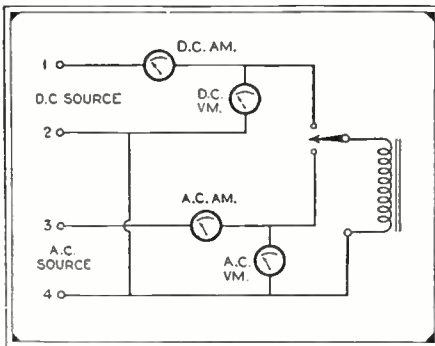

$$Z = \frac{E}{I} = \frac{120}{.060} = 2,000 \text{ ohms}$$

Knowing the d.c. resistance in ohms and the impedance Z in ohms, we may calculate the inductance of the coil in the following manner, as the impedance of a coil equals the square root of the resistance R squared plus 6.28 times the frequency times the inductance in henries, the product of these squared, thus:

1. $Z = \sqrt{R^2 + (6.28 \times f \times L)^2}$
2. $Z = \sqrt{(90)^2 + (6.28 \times 60 \times L)^2}$
3. $Z = \sqrt{8100 + 142129 \times L^2}$
4. $Z^2 = 8100 + 142129 \times L^2$
5. $Z^2 - 8100 = 142129 \times L^2$
6. $(2000)^2 - 8100 = 142129 \times L^2$
7. $4000000 - 8100 = 142129 \times L^2$
8. $142129 \times L^2 = 3991900$
9. $L^2 = \frac{3991900}{142129} = 28.08$
10. $L = \sqrt{28.08} = 5.299 \text{ henries}$

It is extremely important that unless the coil or inductance has more than 50 ohms resistance that it not be placed across the 110-volt line, and then only for a few seconds necessary to obtain the readings, else the coil will be damaged or a fuse blown. For coils having less resistance a step-down transformer should be used in the instance of a.c. and a potentiometer in the case of d.c.

RADIO NEWS INFORMATION SHEETS

Measuring Resistance

THE measurement of resistance is most accurately accomplished by the Wheatstone bridge method. For the experimenter or serviceman not in possession of such an instrument other means of measurement must be resorted to. Two simple methods are presented here that require a minimum of apparatus, and while not as accurate as the bridge method, are sufficiently accurate for the needs of the experimenter or serviceman.

Referring to A in the figure, a milliammeter and voltmeter are seen connected in a circuit with the resistance to be measured. These instruments are of the d.c. type. By measuring the current through the resistance and the voltage across its terminals a calculation by Ohm's law will tell us the resistance in ohms. Example:

$$R = \frac{E}{I}$$

$$R = \frac{18}{.09} = 200 \text{ ohms}$$

where E is voltage of d.c. source, I is current in amperes, and R is resistance in ohms.

The method shown at B, while apparently more simple,

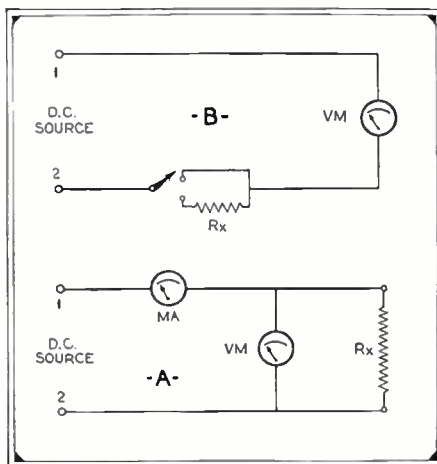

in which the only instrument used is a voltmeter whose internal resistance is known, requires considerable more calculation. This method, while not as accurate as the bridge method, is a great deal more accurate than the method given in A.

The voltage of the d.c. source is first measured by placing the switch on the proper point. Next the switch is placed on the resistance point and the voltage again measured. Knowing the voltage of the source and the voltage dropped through the resistance, we may calculate the resistance from the following formula:

$$R_0 = \frac{E_0 - E_r}{E_r} \times R_m$$

where R_0 is the resistance in ohms, E_r is the voltage measured through the resistance, E_0 is the voltage of the d.c. source, and R_m is the internal resistance of the meter.

To illustrate the method, suppose that the voltage of the source was found to be 6 volts, the voltage through the resistance was 5.75 volts, using a 1000-ohm-per-volt voltmeter on the 10-volt scale which would have an internal resistance of 10,000 ohms, we would have:

$$\frac{6 - 5.75}{5.75} \times 10,000 = 434.7 \text{ ohms}$$

RADIO NEWS INFORMATION SHEETS

Index of Information Sheets

- Bridge circuits, Aug., 1930
 By-passing, Part I, corrected, April, 1931
 By-passing, Part II, Feb., 1931
 Capacities, measuring large, Part I, Mar., 1931
 Capacities, measuring large, Part II, Mar., 1931
 Chokes, notes on r.f., Part I, Feb., 1931
 Chokes, notes on r.f., Part II, Feb., 1931
 Circuits, band-pass, Nov., 1930
 Condensers in series and parallel, Feb., 1931
 Ear, sensitivity of, Apr., 1930
 Filters, electrical, Part I, July, 1930
 Filters, electrical, Part II, Aug., 1930
 Frequency, reference chart, June, 1930
 Impedances, the importance of matching, May, 1930
 Inductance charts, Part I, July, 1930
 Inductance charts, Part II, Aug., 1930
 Inductances, measuring large, Apr., 1931
 LC ratio, the, Jan., 1931
 LC table, Jan., 1931
 Loud speakers, using several, Dec., 1930
 Manual, loose-leaf and re-enforcement, Mar., 1931
 Microphones, carbon, Dec., 1930
 Microphones, condenser, Nov., 1930
 Movies, talking, Dec., 1930
 Multipliers, voltage, for small meters, Mar., 1930
 Oscillator, the neon tube, Nov., 1930
 Photocells, color sensitivity of, Mar., 1930
 Piezo-Electric Crystals, Nov., 1930
 Piezo-Electric Crystals, Part II, Dec., 1930
 Radiation, the spectrum of, June, 1930
 Relays, Oct., 1930
 Resistance, alternating current, Sept., 1930
 Resistance, a.c., Part II, Oct., 1930
 Resistors as frequency blocks or attenuators, Apr., 1931
 Resistance, measuring, Apr., 1931
 Resistors, figuring voltage divider, Jan., 1931
 Shielding, May, 1930
 Sound absorption, June, 1930
 Sound absorption, prepared materials, May, 1930
 Symbols, letter, used in radio, Aug., 1930
 Superheterodynes, mixing circuits in, Sept., 1930
 Tubes, vacuum, two-element, Mar., 1930
 Tubes, vacuum, three-element, Apr., 1930
 Tubes, vacuum, four-element, May, 1930
 Tubes, vacuum, five-element, June, 1930
 Tubes, vacuum, nomenclature, Apr., 1930
 Tubes, vacuum, static characteristics of, Sept., 1930
 Tubes, power amplifier, July, 1930
 Tubes, action of screen-grid in four-element, Sept., 1930
 Tubes, action of s.g. in four-element, Part II, Oct., 1930
 Transformers, output, July, 1930
 Transmission units (decibels), Apr., 1930
 Wattage, Oct., 1930

RADIO NEWS INFORMATION SHEETS

By-passing (Part I)

(Corrected from the January, 1931, issue)

NO item in the design of a receiver is more important than the use of proper values of by-pass condensers. Economy dictates that by-pass condensers be as small as possible, while electrical consideration says otherwise. At some place must a compromise be struck, so it has become practice among engineers to use a condenser whose reactance is one-tenth that of the resistance or reactance that it may be used to by-pass. Repeated experiments have shown that this is a perfectly good compromise, and efficient by-passing will be accomplished when such values are used.

Taking four typical examples, let us consider the requisite size of condenser to be used in each case. Fig. 1 shows resistance to be by-passed, so let us give it a value of 10,000 ohms, for instance. As the reactance of a condenser decreases with frequency, we must take the lowest frequency to be by-passed and predicate our results on this frequency. Suppose we say 120 cycles as the frequency, as this is a common value found in power packs.

The formula for finding the reactance of a condenser is

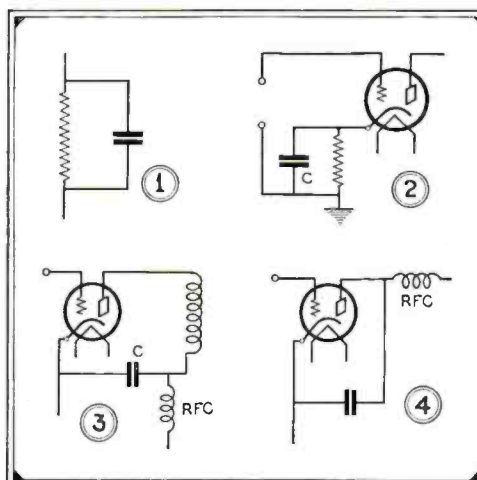

Fig. 1 shows resistance to be by-passed, so let us give it a value of 10,000 ohms, for instance. As the reactance of a condenser decreases with frequency, we must take the lowest frequency to be by-passed and predicate our results on this frequency. Suppose we say 120 cycles as the frequency, as this is a common value found in power packs.

ent. If this tube happens to be in one of the audio stages of a receiver, we will have to estimate the lowest frequency passes by the amplifier. Thirty cycles is a safe choice. However, if this tube happens to be in the radio-frequency end of the receiver, 500,000 cycles will be the figure. A little figuring will show that at radio frequency the by-pass may be very much smaller than at audio frequency. (Part II appeared in the February, 1931, issue.)

1,000,000

where the size of the condenser is expressed in microfarads, F is the frequency and π is 3.14. Now if the resistance to be by-passed is 10,000 ohms, the reactance of the condenser must be 1,000 ohms to satisfy our original premises, so the formula becomes

C equals $\frac{1,000,000}{2\pi F X_c}$ when

X_c is the capacitive reactance. Solving the equation, after substituting the known values, we get C equals 1.32 microfarads.

Fig. 2 is a bias resistance in the cathode circuit of a tube, and the solution is exactly as before, except that the frequency is differ-

Army's Amateur Radio System

(Continued from page 894)

sidered confidential, and messages in the Army amateur cipher are exchanged only between members of the Army amateur radio system. A sample of this cipher, which is always sent in groups of five-letter words, is given below:

FM SARANAC LAKE NY WSDSA NR
47 NOV 29 GR 15
TO RADIO AIDE 2ND CORPS AREA
ARMAC ZPWMX DPCDM VYUFT
NQSO F ACPDL UPJRY EMEOF
TGSM M TFWIP XT TIO BXCMA
QRNOD FJXXX ARMAC—WSDSA.

If you wish to prove the contention that any cipher message can be deciphered in a short time, it is suggested that you try your hand on the above. You will then probably agree that cipher experts must have uncanny minds.

Due to the comparatively short distances within the corps areas, the amateur 3500-4000 kc. frequency band is used in most of the corps area nets, as well as the state, district and local nets. The

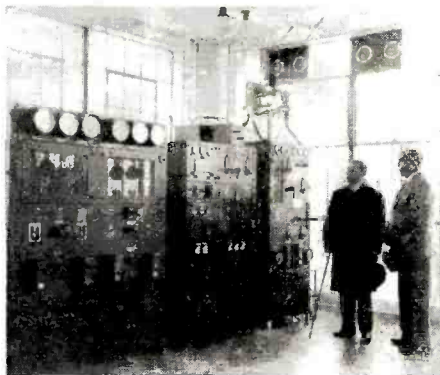

The transmitter at station WAR, Washington, D. C.

7000-7300 kc. frequency band is used in corps areas where difficulty is experienced in maintaining reliable communication on the lower amateur frequency channel. Most of the Army amateur radio stations have their transmitters adjusted to approximately the same frequency so that the net control station can readily tune them in. Many use crystal controlled power amplifier transmitters.

Co-operation with the Red Cross

Since the only emergency normally expected will be something in the nature of a disaster caused by the natural elements, whether local or extensive in scope, it becomes the duty of each individual member of this radio system to acquaint himself with the local Red Cross repre-

sentative in his town or district so that the latter will know of the location of the amateur's station and the service he is prepared to render in an emergency. In case of an emergency, such as was outlined previously, the Army amateur would immediately offer his services to the local Red Cross representative and await his traffic. The first information sent out from a stricken area contains the following facts: nature and location of disaster; number of persons dead; number of persons injured; number of persons temporarily homeless; number of homes destroyed; number of homes damaged and the number of families affected. This information is essential for prompt action in the providing of the necessary relief measures. As an illustration, the following message, referring to the last Florida hurricane, is given:

FM ORLANDO FLA W4—
TO RED CROSS 17TH AND D
STREETS WASHINGTON D C:—
HURRICANE STRUCK TAMPA
DISTRICT FLORIDA STOP TWO
HUNDRED DEAD EIGHT HUNDRED
INJURED TWO THOUSAND HOME-
LESS FIVE HUNDRED HOMES DE-
STROYED SEVEN HUNDRED
HOMES DAMAGED FOUR HUN-
DRED FAMILIES AFFECTED—SIG.
SMITH, RED CROSS.

Of course, in case the local Red Cross representative cannot be found or is not available, it is the duty of the amateur to ascertain this information and transmit it as speedily as possible to Red Cross headquarters in Washington. In order that this may be quickly accomplished, Army amateur radio stations are authorized to use the special Army frequency of 6990 kc. in emergencies, in order to raise the Army net control station W3CXL or WLM in Washington. These stations are on watch day and night and are available at a moment's notice for continuous operation. All possible members of the Army amateur radio system are expected to man their stations in an emergency and help out in the speedy and efficient handling of the important messages. The weekly tactical practice during the Monday schedules tends to perfect the Army amateur in traffic handling and procedure, so that he will be of service to his country in an emergency.

Recent Emergency in New York State

No one knows when a severe storm will tie up, hamper or even totally destroy telephone, telegraph and electric light



Lt. M. S. Mead (center), in civilian life the owner of the net control station W2OP at Schenectady, N. Y.

systems and temporarily cut off a town or city from communication with the outside world. This may happen in your vicinity as well as a thousand miles away. It may be in order, at this point, to tell you of such a calamity that happened not many miles from New York City and which demonstrated the value of the Army amateur radio system.

Communications Blocked

During the 16th, 17th and 18th of December, 1929, a severe sleet storm struck the city of Glens Falls, New York, telephone and telegraph wires as well as the electric power and light wires soon began to break under the weight of the ice and sleet deposited upon them and, on the 18th of December, the city was without electric lighting or communication with the outside. All wires were down and the roads were almost impassable for travel. The railroad lines were even blocked by the snow drifts and ice. In this emergency, Army amateur radio station WSDQP, owned and operated by Mr. H. D. Miller, of Glens Falls, N. Y., was approached by the local power company and asked to send urgent messages to Schenectady ordering necessary wire and other material to restore service and supply the city with light and power. Mr. Miller, in common with many other amateur stations, had an emergency source of power supply for his transmitter available from "B" and storage batteries. He immediately proceeded to call his net control station, W2OP, owned and operated by M. S. Mead in Schenectady, N. Y., and after a number of attempts succeeded in working him and sending the messages. Needless to say, the necessary supplies were sent immediately and the electric light service was restored by the power company on the next day to as many homes as possible. This was possible due to the unselfish efforts of WSDQP, W2OP and other stations who stuck at their keys throughout the night and the next day until all messages had been sent out and replies received. During this time the antenna at WSDQP broke down twice due to the sleet; and it was necessary to collect all the available "B" and storage batteries in the neighborhood in order to maintain communication at his station. That his efforts did not go unnoticed, is evident by the following letter from the Commanding General of the Second Corps Area:

Dear Mr. Miller:

I desire to commend you for the energy and initiative you displayed in operating Army Amateur Station WSDQP during the night of December

(Continued on page 931)

KDKA—Radio's New Voice

One of the most important innovations is the new tube with a capacity of 200 kilowatts. This tube is not merely an enlarged edition of a smaller tube, but is thoroughly engineered as a tube of larger size and of a distinctly novel design. The mere building of a larger tube following the style of the smaller type would not produce the results desired. The quality of output and the life of such a tube would not be up to the desired standard.

The new tube, called the AW-220, is 72 inches in height, has a diameter of eight inches and weighs 60 pounds. Two of the new tubes are incorporated in the transmitter.

In its design engineers found one of their greatest problems to be that of cooling the grid. This difficulty has been solved by I. E. Mourmoutseff, company research engineer, who has produced a water cooled tube of great mechanical strength and sturdiness embodying a double end construction.

A modern water softening system has been installed for use in connection with the cooling system for these gigantic vacuum tubes. There is a practical reason for this installation because these giant tubes are expensive and unless properly protected their useful life period is limited. Therefore, anything that can be done to increase their life constitutes a saving in costly replacements.

According to E. B. Landon, chief operator of the transmitting station, the water must be tested frequently to protect the tubes and the cooling system. Ordinary city water cannot be used because it contains lime and other minerals which form harmful scale in the coils.

At the KDKA station this ultra-soft water is pumped to an outdoor cooling pool before going to the cooling coils and the tubes. Hot water coming from the station circulatory system enters the pool through a fountain-like spray. After cooling in the pool, it is pumped through the same circuit again.

An idea of the capacity of the cooling problem may be obtained from the statement that approximately five tons of cooling water must be passed through the water jacket of the tube each hour it is in operation. This water cools the tube in the same manner as water in an automobile cools the motor. One hour's operation of the tube would heat enough water to supply the domestic requirements of the average home for several weeks.

While of course these AW-200 tubes will only be used to generate high frequency power for radio stations, an appreciation of the power capacity of one of these tubes can perhaps best be gained by a comparison with familiar household devices. For example, a similar amount of power of the kind distributed commercially would operate simultaneously four hundred toasters or flat irons. This would also be the equivalent of power required to light one thousand average homes of five to six rooms or the energy to operate two modern street cars.

(Continued from page 873)

The antenna system of the new KDKA radio transmitting station, conceived by Dr. Conrad, is designed to make the local signal strength less than it would be for the conventional type of antenna, and to make the distant signal strength greater than for the conventional antenna. This is desirable from the standpoint of both listener and broadcaster; it makes the signal less objectionably loud to local listeners, and yet gives better reception to distant listeners; and it allows the broadcaster to use the radiated energy to better advantage in reaching distant points, since less energy is absorbed by objects in the local area.

The Antenna System

Sixty-two rigid tests were made to find a location which would be adaptable to favorable broadcasting before Saxon-

end of a transmission line, except that the lines of force are not guided by wires, and hence follow the ordinary law of equal angle of incidence and reflection. There is really no line of demarcation between the ground wave and the upward radiation, conveniently called the sky wave. The part of the wave which reaches the receiving antenna by moving out horizontally from the antenna or by the descent of the wave front, is what is usually meant by the ground wave, and the part which reaches the receiving antenna by reflection downward from the ionized layer, the sky wave. Since the ground wave is attenuated with comparative rapidity, the distant signals are carried largely by the sky wave, and if the ratio of horizontal radiation to sky-wave radiation can be decreased, the desired ratio of local or distant signal strength should be attained.

This decreased ratio of ground to sky-wave radiation is obtained in the new

KDKA's famous symphony orchestra, which is nationally known for its regular broadcasts



burg was definitely selected. These tests were made to determine the proper altitude with no interference from metal construction, free from trees so as to prevent undue interference and ample area for erection of the necessary structures and antennas.

The site at the new transmitter occupies 130 acres. The long-wave antenna over which KDKA broadcasts consists of a circular arrangement of poles surrounding about eight acres. The poles are 100 feet above the ground and painted, according to law, yellow and black. Aerial hazard beacons also have been erected to serve as a warning to aviators.

A much smaller space is required for the short-wave transmitter of W8XK. It is through the short-wave station that programs are sent great distances for reception in far away lands.

The functioning of this antenna is based on the fact that local reception is due to radiation horizontally outward from the antenna that is, the ground wave; whereas distant reception depends considerably on radiation initially at an angle of elevation, due to the wave front descending as it moves outward from the antenna, and to reflections from the Heaviside layer. The descent of the wave front as it travels outward is due to the fact that the waves travel slower at the surfaces of the earth than in the upper atmosphere; and the reflections from the Heaviside layer are caused by the ionized condition of the layer which makes it conducting, i.e., like a short-circuit on the

KDKA antenna by using an arrangement and spacing of vertical antennas fed with currents in time phase, such that interference between waves from the various antennas reduces the horizontal field strength in comparison to the field strength at an angle of elevation. The interference of the arrangement of vertical antennas will make the horizontal radiation much less than for a single antenna with the same total current; and will make radiation at an upward angle decreasingly less as the angle is increased, so that at high angles the radiation is only slightly less than for a single pole. This great decrease in horizontal radiation will decrease the radiation resistance of the antenna system, and so will cause the current to increase until the total power radiated is the same. This will make the upward radiation greater, and the horizontal radiation less than for a single antenna with the same power radiation.

In its physical arrangement the new KDKA antenna differs considerably from usual transmitting antennas. The usual antenna has 2 or more fabricated steel towers several hundred feet high, with a concentrated flat top suspended between them, and a single vertical down lead usually near the center. To cut down absorption losses, the steel towers are usually detuned and kept as far as possible from the flat top and down lead, and are sometimes insulated from the ground or even broken into insulated sec-

(Continued on page 933)

Making National Broadcast Coverage Direct

limitations is to raise the wavelengths of the more important broadcasting stations of the world, so that really high power can be efficiently used. The writer has developed and investigated this idea as applied to the problem of national broadcasting coverage in the United States.

The first consideration was to determine just how far Eckersley's figures and curves, based on observations in northern Europe, correspond with actual transmission as observed over various types of the highly diversified American terrain—in other words, how well they will serve as a basis for American coverage predictions. At the start we need a simplified table of fading radii corresponding to various wavelengths and common American terrain types (Table 1). From this table we would predict, for example, that in flat country the non-fading range of a 300-meter station should be 80 miles, while that of a 400-meter station should be 120 miles. In hilly or broken country, on the other hand, the range of the 400-meter station would be reduced to 62 miles.

American Data

In order to check this table with transmitting conditions in the eastern United States, observations on high-power eastern transmitters were made at New Haven by the writer and at West Point by Lieut. H. W. Serig, Signal Corps, U. S. A. These observations, covering average conditions over several weeks, are summarized in Table 2. New Haven is surrounded by flat to hilly terrain, and the country immediately surrounding West Point is mountainous. However, both sets of observations point to the same general conclusion. There is little perceptible fading in the case of stations less than 60 miles distant from the receiver, frequent fading in the case of stations 60 to 90 miles distant, and continual fading in the case of stations more than 90 miles away. At longer ranges the fading decreases but, as we have pointed out above, the signal is rarely up to true service standards. These general conclusions check closely with generalized predictions from Table 1.

The next step in the investigation was to see if Table 1 predictions could be verified, not only in the eastern area, but also over the whole United States.

(Continued from page 881)

The writer communicated with the chief engineers of representative broadcasting stations all over the United States, enclosing convenient reply cards for the desired data. In addition to such details as wavelength and power, the particular information wanted for each station was the type of country surrounding the transmitter and the estimated radius of the first night fading ring. The results of this survey are shown in Table 3. The ter-

coverage in the United States. If anything they are too conservative.

Long Wave Super-Broadcasting

What have all these facts to do with the great problem of national broadcasting coverage? Everything. Those inexorable first fading circles, which have been obstinately holding down our true service areas and our economically justifiable transmitter powers, are now going to roll back like morning mists under a

The relatively higher field intensity of higher power transmission does not necessarily eliminate fading, for reasons explained in the text

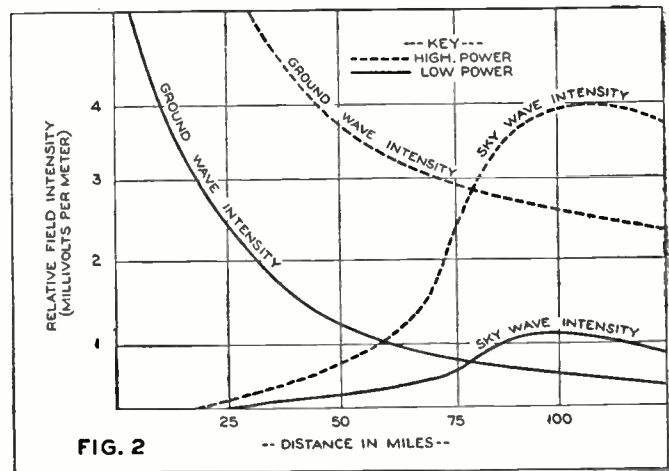

FIG. 2

rain and observed fading radii are listed as reported by station engineers, while from the reported terrain and Table 1 the predicted fading radii were worked out.

The general agreement between prediction and observation is surprisingly close. The widest divergence, in the case of WJZ in New Jersey, can be partly explained by the fact that although the transmitter itself is located in broken country and is so listed, much of its service area is flat ground. Another wide divergence, in Florida, is perhaps explained by the presence of sandy terrain of low conductivity. The average of predicted values (83.8 miles) and the average of observed values (89.2 miles) are in very close agreement considering the precision of the methods employed, probably not over ± 10 per cent. The general conclusion is clear: *Eckersley's curves, drawn from data taken in northern Europe, can be applied reliably to approximate predictions of non-fading*

climbing sun. They are to be pushed out, not a paltry fifty miles or so, but something like three hundred miles. Returning to Table 1, we find that at 200 kc. or 1500 meters, the expected non-fading range is 330 miles in hilly to broken country, which may be called the general American average. In flat country a 1500-meter station should not fade inside of 620 miles. In a letter to the writer Dr. A. Hoyt Taylor, internationally famous investigator of the Naval Research Laboratory, estimates that at 200 kc. fading will not be severe inside of 500 miles from the transmitter. From another authoritative source we have learned that actual 200 kc. broadcasting experiments in the United States at very limited power have shown no fading inside of 300 to 350 miles. Striking a general average of all these estimates, we assume that the average fading radius of a 200 kc. American broadcasting station will be about 400 miles. In mountainous regions it will be less, in flat regions more; these inequalities can be somewhat levelled by using wavelengths longer than 1500 meters in mountainous country and wavelengths shorter than 1500 meters in flat country. 1500 meters is merely the center point of a contemplated broadcasting band.

Now as in Figure 6 we apply these 800-mile circles to a map of the United

(Continued on page 938)

TABLE 1

Approximate Radii of Fading Rings: (After Eckersley)

	200	300	400	500	1200	1500 meters w.l.
Flat country.....	50	80	120	160	480	620 mi.
Hilly or broken.....	24*	37	62	75	260	330 mi.
Mountainous	10*	17*	26	34	110	160 mi.

*Probably too low.

What Radio Has Meant to *Talking Movies*

(Continued from page 905)

reduced in size and complexity. When these developments have all come about, it probably will not be out of the ordinary for a person to sit before a screen in the comfort of his own home and see, for instance, the peaks of the Himalaya mountains from an airplane flying above them. Instead of appearing to be on the screen, as motion pictures at present do, it will seem that the screen is a window through which the person is actually viewing the tops of the mountains. This effect will be due to the *depth* of the picture.

There are two main methods of recording sound motion pictures: on discs, or special wax phonograph records, and on regular motion picture film. Some recording systems use both disc and film. Outside of the actual film and disc machines, the different recording and pro-

jecting systems are very much the same. The main weakness of these two methods of recording is that the sound is converted into electrical energy, amplified, and then changed either into light variations or into mechanical motion. Naturally, these two changes in the sound energy before it is recorded introduce chances for distortion. In projection, the mechanical motion or reproduced light variations have to be re-converted into electrical energy, amplified enormously again, and then re-translated into sound. There are too many steps in this process. The weakest parts of the chain are the devices that are used for converting the electrical energy into light or mechanical motion, and vice-versa. These instruments in particular are far from being perfect in operation. Eventually, a method of directly recording the electrical energy itself will have to be devised.

What seems to be the most practicable method thus far suggested is to record the electrical variations as changes in magnetism. If it could be perfected, some apparatus such as the electromagnetic recorder, known as the Telegraphone, invented years ago by the scientist Poulsen, could be used. In this in-

strument, a soft iron wire is run at a constant, even speed past an electromagnet that is connected to a microphone and battery. Variations in the strength of the electromagnet, which are produced by speaking into the microphone, change the molecular structure of the wire and so are recorded in it. To reproduce the voice, the iron wire is run past another similar electromagnet that is connected to a telephone receiver. The molecular differences in the wire cause a varying current in the pick-up electromagnet which produces sounds in the receiver that correspond to the original voice. If this method were applied to the recording of sound pictures, it would mean that the sound would be converted into electricity, amplified, and then recorded directly as changes in magnetism; and, in projection, that the magnetic variations

would be converted directly into sound after being suitably amplified again.

Complete absence of outside noise is absolutely necessary during the shooting of sound pictures. "Silent stages" have been constructed at all of the motion picture studios as quickly as large crews of men could build them. The silent stages differ from the ordinary motion picture "stages" in that they are built on special heavy foundations, and have extremely thick walls and roof of patented sound-proof materials. It is almost impossible

to make them perfectly impervious to sound, and so the best silent stages are designed to be about eighty-five per cent. sound proof. For all practical purposes, that is near enough. "Silent zones" are formed around the stages to help prevent interference from extraneous noises. The operation of machinery, and all other noises, are forbidden in these zones during the shooting of a picture. The stages are hung with special sound absorbing material on the inside to prevent too much reverberation, as that, too, would interfere with the perfect recording of sound. Portable sound recording outfits mounted on trucks are available for use "on location." These "portables" are small duplicates of the regular studio sound recording equipment. The portable apparatus is much more simple and more compact, of course, as it is necessary for a portable outfit to go to all sorts of locations. One day it will be high up in the mountains, in the desert the next day, and then maybe on a boat at sea a few days later. These portable sound trucks make possible the taking of sound pictures that otherwise would not be available.

In the making of sound motion pictures, smaller "sets" are used as a general rule at present. This is because all of the actors must be close to the microphones. The shooting of a talking picture resembles more the acting of a stage play with the camera taking the place of the audience, than it does the taking of an old time silent motion picture.

Especially noticeable is the utter silence in the stage except for the voices of the actors when a "shot" is being made. The excited director shouting through his megaphone is no more. Fewer sets are used, too, in the making of a talking picture because of the extra time taken up by the dialogue. Music and singing are added to pictures now, and that also helps to stretch out the scenes and make a smaller number of sets necessary.

The studios that are equipped for the making of sound pictures use the apparatus mainly for the recording of their

(Continued on page 946)



Making outdoor shots for the talking movies has its obstacles, not the least of which is the crowd which assembles at the scene of action, even in Hollywood



Even the desert holds no terrors for the sound-recording crew. The camera is enclosed in the sound-proof "bungalow" on wheels. The sound-recording truck is in the background, with extension cables reaching to microphones at scene of action

The Kind of Tubes every good set deserves!

Champion Dated Ribbon Labels present a definite measure of real length of life and service delivered Merchant to Set User.



Getting the best in performance is merely a matter of getting the best in tubes. CHAMPIONS give sparkling reception because every Champion Tube is built up to the highest possible perfection and has passed the most rigid tests before leaving the factory.

The Million Dollar guarantee is the identity of the Champion manufacturer and his organization of a group of Engineers with thirty years of continued vacuum tube making experience.

Champion

RADIO TUBES

CHAMPION RADIO WORKS, INC.
122 Pine Street DANVERS, Mass.

"How to Make It"—FREE!

With *Science and Invention* for 6 Months

All for Only \$1.00



Here's just the book you have been wanting! "HOW TO MAKE IT"—WRINKLES, KINKS, FORMULAS—the complete all-around guide for practically every kind of repairing and construction. The made-to-order handibook for every man who has felt the urge to grip good tools and see useful finished articles take shape as the combined result of skillful hands and brain!

After the fast pace, and mental strain of every-day life, there is no more complete relaxation than the scientific hobby of constructing useful and decorative articles. For the man who really amounts to something works with his hands as well as with his brain!

"HOW TO MAKE IT" brings you many hours of pleasure and recreation—and better still, *valuable, profitable pleasure and recreation!* From these specific plans, you can have the thrill of making and doing things yourself; save yourself up to hundreds of dollars—and be sure that the results are exactly what you want!

Whether it's carpentry, plumbing, masonry, electricity—whether it's repairing or working in metals, concrete, woods, stains, paints, piping, or what have you, "HOW TO MAKE IT" tells you how!

We are offering you this unusual volume free, with an introductory

trial subscription to SCIENCE AND INVENTION—the magazine of fascinating fact. In no other magazine, will you find such an array of absorbing, authentic, thrilling information from all fields of scientific achievement!

A Big Cash Saving

We have arranged to ship you this useful book postpaid, *absolutely free of charge* and enter your subscription to SCIENCE AND INVENTION for six full months—(regular value \$1.50)—all for only \$1.00! BUT SIGN THE COUPON NOW—

SCIENCE & INVENTION, Dept. 2404
381 Fourth Avenue, New York, N. Y.

Gentlemen: Ship me, ENTIRELY FREE, prepaid, the valuable handy book, "HOW TO MAKE IT"—WRINKLES, KINKS, FORMULAS—and enter my subscription for the next six big issues of SCIENCE & INVENTION at only \$1.00 which I enclose.

Name

Address

City and State

Vagaries of Short Waves

(Continued from page 903)

higher frequencies, we find the signals more and more able to penetrate an atmosphere of less density in electrons until the waves become like visible light waves. From this theory, we might advance that no definite and tangible thing has physically moved up or down in re-

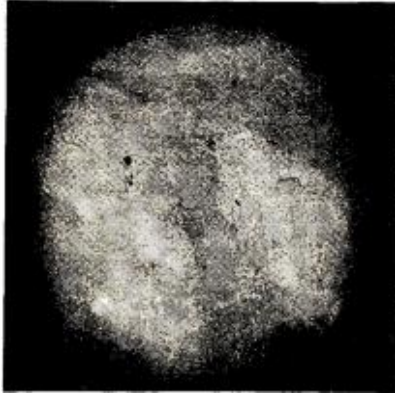

Figure 7. Sun spots as they appear when viewed from the earth. These spots are believed to have an important influence on radio transmission

lation to the earth. Instead, the density of electrons, of the atmosphere above the earth, varies with day and night, summer and winter, and from sun-spot period to the next period. The density is less at a given height during summer, greater in winter, being increased during day time and reduced during night time; intermediate density for Fall and Spring. The effective density for reflection of 10 meters under these various conditions is probably somewhat as follows:

- Winter days 100 miles;
- Winter night 175 to 250 miles;
- Fall or spring 150 to 225 miles;
- Summer day 200 to 350 miles;
- Summer night 250 to 400 miles.

Over the poles of the earth, the density is probably less at a given height than over the Equator, due to the relative distance of these points to the sun. This accounts for the fact that signals from stations near the Equator are received over longer periods and with much better volume than signals coming from stations in the northern part of North America.

From the foregoing data we might say that signals transmitted on the longer wavelengths are apparently unable to penetrate a light medium of electrons. However, on wavelengths below 50 meters, they probably travel in the atmosphere until they reach a stratum where the density is enough to cause refraction where they are turned back to the earth. If the stratum corresponding to a density for refraction of say 10 meters is more than 200 miles from the earth, the signal does not return to the earth. If the wavelength is decreased to the band of 1 millimeter to 0.00075 millimeters we receive infra-red waves from the sun, and detected as heat. Wavelengths of 0.000388 to 0.00075 millimeters are visible to the eye and cause white light. We can readily see that as the wavelength is decreased, we come to a band on which the sun

actually transmits heat and light to us, because these wavelengths are able to penetrate the dense cloud of electrons existing between the earth and the sun.

To give further credence to the proposed theory, Figure 11 shows actual ground-wave limits as observed by the writer. For wavelengths from 4 to 50 meters, actual observations have been made, while from the upper bands the curve has been extended by application of known ranges. From this graph, it is apparent that one part of a radio emission clings to the earth, and is the so-called "earth component." This component extends beyond the longest wavelength used. The absorption of this component is rapid and follows the well-known Austin-Cohen formula. The attenuation is somewhat reduced as the wavelength is increased. On 4 meters, the absorption is so great as to reduce this component to such short range as to make this band useful for only optical work, i.e., between two visible points.

By mathematical treatment, engineers have found that a wavelength corresponding to 214 meters was readily absorbed by ionized conditions of the atmosphere. We therefore see that a wavelength of 0.000388 millimeters is not absorbed by the ionized atmosphere. However, as the wavelength is increased, the absorption, or inability to penetrate the ionized region is increased until we reach 214 meters. At this wavelength, transmission takes place on the ground wave component. During



Figure 8. A close-up of a sun spot. Perhaps "close-up" is not exactly the term to use in describing this spot which may be many times the size of the earth

Figure 10. The aurora seemingly accompanies sun spots, as the aurora is most in evidence at periods of maximum sun spots

night time the region above the earth becomes of less density in electrons which enables the ground wave component to be reinforced by the sky wave component, thus increasing the distance. The distance of longer waves is also increased during

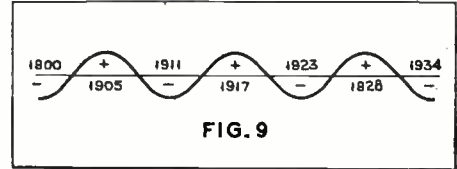

Figure 9. Sun spots are claimed to come and go in cycles as indicated here, the years 1900, 1911 and 1923 being particularly free from this disturbance

night time due to a reduction of the attenuation which is caused by heat and light.

In accordance with the present theory, the layer is too low for summer work for short waves. If this is true, then there should be two brief periods during day time for favorable reception of short waves; one in the morning as the layer height decreases from the highest night-time position, the other should occur during late afternoons when the layer height is ascending to its night-time position. These conditions do not, however, seem to exist as the writer has never heard signals from any station below 14 meters during summer months except during the summers of 1928 and 1929, which was during maximum sun spot period.

We know that solar activities affect the signal much more than atmospheric pressure; further, sun spots surely affected reception of short waves during the maximum sun-spot period of 1928 and 1929. For this reason, it would be of considerable interest to study reception during the sun-spot minimum of 1934 and 1935, and on to the next maximum period of 1940.

It is a well-known fact that reception of short waves is reduced during magnetic storms. On the West Coast, short waves up to 14.5 meters are not to be heard during severe magnetic storms. In investigating the relationship between large sun spots and magnetic storms, scientists

(Continued on page 949)

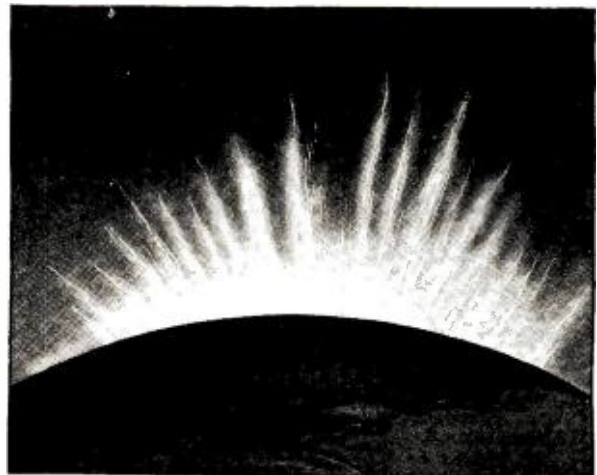

The Army's Amateur Radio System

(Continued from page 925)

18th, and maintaining communication from Glens Falls to the outside when all other means of communication had failed.

H. E. ELY,
Major-General, Commanding.

The Army Amateur

For all his voluntary work, as keeping schedules on Monday nights, enciphering and deciphering messages, learning Army procedure, standing by in emergencies or assisting in emergency work, the Army amateur radio operator does not receive one cent, either directly or indirectly, from the government. He must construct and maintain his radio station at his own expense as no equipment can be furnished him by the War Department under the existing regulations. Nevertheless, he does all this not for any personal glory, but rather to prepare himself to best serve his community or country in time of an emergency.

Incidentally, many amateurs are members of the National Guard of their state, hold commissions in the Officers Reserve Corps or have attended Citizen Military Training Camps or the Reserve Officers Training Corps in college and, therefore, are familiar with the problems of national defense and the military policy of the United States. They, no doubt, would be among the first to serve the country in a national emergency, and the training received from the Army Amateur Radio System would be of great value in that connection.

A Device for Tone Control

Description: Here is a tone control that can be connected to any battery or electrically operated set. A long flexible cord and two adapters or connection discs are furnished with the instrument. No tools are required for its installation. The



adapters are simply slipped over the prongs of the tube or tubes in the power output stage. A bakelite knob controls its operation. It is made in two models, permitting either table or panel operation. This unit permits variation of tone quality to suit different musical tastes. It also compensates for deficiencies in room acoustics.

Usage: A device for varying the tonal quality of radio reproduction.

Maker: Insuline Corporation of America, 78 Cortlandt Street, New York.

Groping Groping

AGAINST A BLANK
WALL OF TROUBLE



THE chances are it's resistor trouble—but he doesn't know. And besides, there's nothing to tell him what types and values this particular set requires.

An I.R.C. Replacement Guide in his service kit would make it clear as day. He would be through with this set and on to the next in probably one-tenth the time he now takes groping in the dark.

Thousands of successful Servicemen have speeded up their work with this wonderful Manual—and permanently cured resistor trouble by using I.R.C. Metallized Resistors. You get the guide FREE with the purchase of ten Metallized Resistors—or it may be bought for 50c. Loose-leaf sheets are mailed periodically to every holder of the Guide—and keep it constantly up to date. Fill out and mail coupon today.

INTERNATIONAL RESISTANCE CO., Philadelphia
Makers of I.R.C. Precision Wire Wound Resistors

I R C

Metallized

Free with
purchase
of ten
Resistors

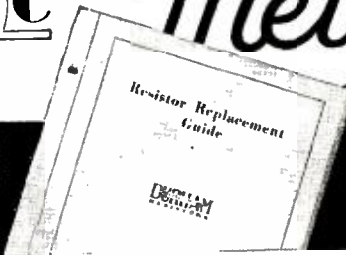

RESISTORS

INTERNATIONAL RESISTANCE COMPANY
2006 Chestnut Street, Philadelphia

Gentlemen:—

(CHECK OFFER YOU ARE INTERESTED IN)

- I enclose 50c. for which send me Replacement Guide.
- Please send price list of Metallized Resistors. I wish to purchase assortment of ten, which will entitle me to Replacement Guide free.

Name

Address

City State

Note.—All orders for Resistors referred to territorial Jobbers.

N-4

Mike-roscopes

(Continued from page 898)

When I commented on the type of musician I saw in his orchestra, Mr. Lopez said, "Yes, the musician has changed, no more greasy, illiterate artists for me."

I was interested to know what this popular leader really most desired his orchestra to represent. "What do you want your name to stand for?" Mr. Lopez answered instantly, "Finesse."

Vincent Lopez tells me that the type of song that is becoming more and more popular of late is the Oriental, Latin type. Some of the numbers which he predicts will be "airy" favorites by the time you read this, are "Don't Forget Me in Your Dreams," "Something Missing in Your Eyes," "Two Hearts in Waltz Time," "Yours and Mine," and "When Your Lover Has Gone."

So if you feel badly when your lover has gone, you may just turn on the radio!

SOME of radio's enemies, or shall I say those people who are still ignorant about radio, often complain of the lack of well-known artists on the air. Then I usually start throwing names at them and names which silence them, believe me! One of them is Rosa Ponselle. Miss Ponselle who comes to you via the National Broadcasting System at times is probably the greatest living soprano. But to me she seems just a very agreeable girl of Italian parents who happens to have a tremendous gift.

She says herself that it's always been a fight between domesticity and a career with her, that she wishes she could go to market every morning personally and pick out the vegetables, that she loves to give dinners, adores children and played with dolls only three years ago! Miss Ponselle thinks if they hadn't discovered the little Italian-American Rosa had a voice when she was a school-girl, "she would be married now and have a big, big family."

As to the particular Prince Charming for a Metropolitan star—well, Miss Ponselle says she hasn't found him yet, though rumor whispers to the contrary. She says either they are rich enough and too old, or young and too poor for her, as she could never respect a man she had to support. How do you men feel about this? Tell me. The soprano frankly thinks that a man and a woman look for "It," as she puts it, in one another, and to h— with intellectuality!

Miss Ponselle sings only the roles she wishes at the Opera House, she likes "Norma" and "Traviata" best. You probably remember she sang an aria from the latter opera on the air for you. She tells me that she thinks of herself as

these heroines when she sings and tries to forget Ponselle entirely. When she broadcasts, the opera star visions a fire-side with a man smoking a pipe and a woman sewing, and as she sings she wonders what these people are thinking of her.

Miss Ponselle further told me that she likes costume jewelry, that she chooses her own ether programs, that she sang in church at about ten years of age, that to sing well you must have a sympathetic nature, that she likes to read fiction, that she goes indoors when the sun goes down, and that she was born in Meriden, Connecticut. Miss Ponselle loves animals. She has a fox-terrier named Whiskers, two cats and a police dog. Or rather she thought it was a police dog when she bought it, but she had to give it away when it turned out to be a fox!

Radio Drama

Two years ago in my column, "Behind the Microphone," in the *New York Sunday World*, I started waving a flag for radio drama. I've continued to do so there, and in all the other radio columns I write. Now the word is going around: Radio Drama! And it is spoken of with bated breath as a new discovery, as the new trend of the time in the "ether" world! Well, no one is a prophet in his own country, and I suppose if I have tears to shed I'd better shed them all alone!

But if there's still any doubt in anyone's mind about the coming popularity of this thing called—no, I mean radio drama—let me hereby predict it all over again.

How many of you listen to the Radio Guild every Friday afternoon on the National Broadcasting System where you may hear such plays as "Cyrano de Bergerac," "The Second Mrs. Tanqueray," "Romeo and Juliet," "Mr. Pim Passes By"? And I hope you didn't miss the RCA program, which as I write, has just given you A. A. Milne's "The Camberly Triangle," with Otis Skinner, Basil Rathbone and Ann Andrews.

Bad Habits of Announcers

I wish something could be done to fine or abolish the many announcers who "fuss with" artists during their broadcasts. Of course, this only goes on in the smaller studios.

I mean announcers who rush in, turn the bodies or heads of artists, move the "mike," hold up fingers, gesticulate and try to communicate with the artists in various ways while the poor souls are attempting to broadcast. Granted that the announcers are only trying to improve the program, I say they are simply defeating their own purpose. Interference is enough to break the spell of any sensitive interpretation. You don't hear a stage manager in a theatre yell out to

(Continued on page 935)

Some Pick-up Characteristics

(Continued from page 889)

something like 20,000 ohms at a frequency of 5000. At a frequency of 50 the impedance is about equal to the d.c. resistance, which is generally upwards of 2000 ohms. As the grid impedance may be considered to be over 500,000 ohms, the pick-up does not come anywhere near matching at any frequency, although the higher frequencies are somewhat favored.

Pick-up reproduction may easily be altered by the use of appropriate coupling transformers. It is common practice to use a transformer whose primary matches the pick-up at a frequency of about 1000. The use of such transformers does not necessarily improve the tonal quality in the least. A glance at the characteristic curve of the commercial pick-up connected directly to the grid, as shown above, will show why this is so. Such a match has the effect of slightly improving the peak-trough ratio, but its main effect is to reduce the entire level of the higher musical frequencies. A similar result can be attained without the use of a transformer by simply connecting a condenser parallel to the pick-up.

With pick-ups having a d.c. resistance of between 1000 and 2000 ohms, a condenser of a few thousand mmfd. will cause moderate resonance in the neighborhood of 1000 cycles. At the same time the response at the upper end of the scale is somewhat reduced. The effect thus produced is about the same as that attained with the usual coupling transformer. It is also easy to reduce the relative value of the higher frequencies by connecting a resistance of from five to twenty thousand ohms parallel to the pick-up. This has the effect of partially short-circuiting the high frequencies, without materially affecting the lower ones. If the pick-up itself is properly damped, none of these measures are necessary or desirable. In fact, with a good pick-up, it is not desirable to match at 1000 at all. A transformer which matches at the top of the musical scale is preferable. Otherwise there is too much loss of high notes.

It is evident from the foregoing that the impression prevalent among engineers not directly engaged in pick-up design, that the use of a coupling transformer is necessary to get the best quality, is unfounded. Maximum quality is attained with properly designed pick-ups by connection directly to the grid. If modifications are desired, they can just as readily be secured by a simple and inexpensive parallel condenser or resistance. However, a transformer in connection with a pick-up may be very useful for other reasons. For one thing, a transformer may be used to increase the overall gain. The input of a 2000-ohm pick-up to the grid may be increased from 3 to 4 times by the use of a suitable transformer. Standard interstage amplifier transformers are about right for this purpose.

(Continued on page 934)



Radio's New Voice

(Continued from page 926)

tions. In contrast to this the new KDKA antenna has eight wood poles about 100 feet high, spaced on a circuit more than 700 feet in diameter and having a vertical down lead at each of the poles, the cage top being suspended between adjacent poles to form a complete circle around the poles. The proper time phase of the currents in the eight vertical leads is obtained by running the transmission line to the center of the system and running individual feeder lines to each pole.

Since the factors governing radio transmission are so many and variable that satisfactory formulas, applicable winter and summer, have not been developed even for the simplest antenna, it cannot be expected that reception will be exactly as calculated. It is possible that in certain localities absorption and minor reflections will entirely over-balance the effect produced by the antenna design. Also while transmission by means of the sky-wave works well at night, it is usually not satisfactory in the daytime. Therefore, for daytime transmission it would be preferable to get the opposite of the effect described above, and to broadcast to a more limited area by means of the ground wave. The opposite effect, suppression of sky-wave and reinforcement of ground wave, can be produced by making currents in opposite poles at 180° out of phase, so that adjacent poles are 45° out of phase. The difference in phase can be obtained by making the feeder lines of different lengths or by artificial lines. Thus, when conditions are not favorable for transmission by reflections of the sky-wave, it is possible to change over by simply changing the feeder line connections, to an antenna arrangement suitable for ground-wave transmission.

The Service Bench

(Continued from page 910)

tion. As a matter of fact, this is a good way of boosting the sensitivity in some of the more sluggish receivers. The general circuit adaptation is shown in Figure 4. Don't forget that the grid lead goes to the cap on the tube, and the screen bias potential to the grid connection on the socket.

These circuits and directions are general rather than specific, and will occasionally be modified to fit special instances. When such changes are necessary, they will be apparent to the serviceman who knows his business.

It is recommended that the charges for these alterations be the list prices of the new parts, with no charge for labor or installation. The fact that the necessary changes will be made free, the customer merely buying the new parts at their advertised market value, may be used as a good sales argument in soliciting this sort of work.

IT'S EASY TO IDENTIFY 1931 TUBES

② Look for these Power Tube Refinements

The loud-speaker voice can be no better than its power tube lungs. That is why De Forest engineers have spared no efforts in refining power tube design. In the De Forest 445 Audion:

1. Special alloy filament insuring intimate contact between coating and base metal. Extreme ruggedness. Uniform resistance throughout life.
2. Mica spacer maintaining proper spacing of elements for positive characteristics.
3. Ceramic spacers keeping mica spacer clear of grid.
4. Ribbed or reinforced plate insuring uniform operation at all temperatures. Buckle-proof.
5. Molybdenum grid wire—20 times the cost of usual nickel—with extreme melting point permitting complete degasification.

These and many other advanced features found in every type of fresh De Forest Audion, insure the 1931 performance of the 1931 radio sets.

This is the second of a series of debunking messages dealing with 1931 radio tube features. The entire story, of vital interest to radio consumer and trade alike, is yours for the asking.

DE FOREST RADIO CO., PASSAIC, N. J.

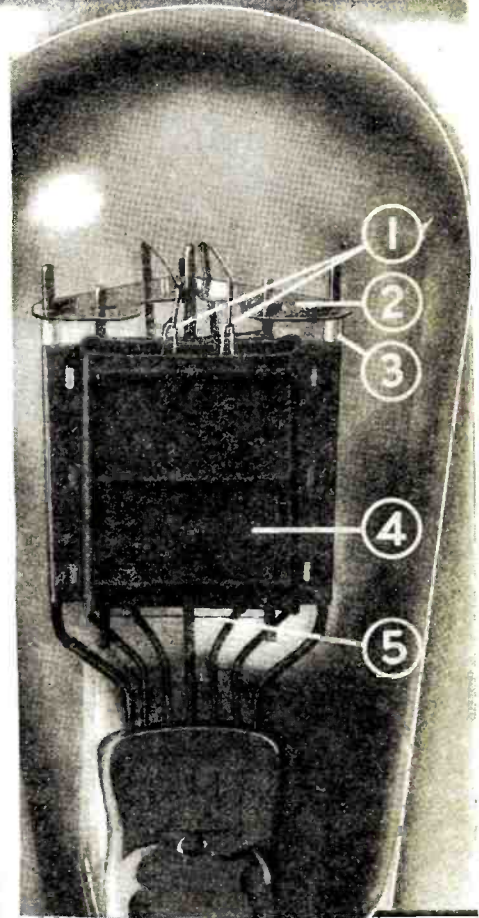

de Forest

AUDIONS

RADIO TUBES

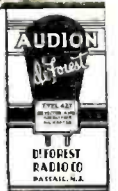

After all, there's no substitute for 25 years' experience



RADIO OPERATORS WANTED



Radio operators are officers aboard ships. Well paid, pleasant work, travel. You can qualify in a short time in our well-equipped school under expert instructors.

Write now for free booklet on "Opportunities in Radio."

West Side YMCA
Radio Institute

113 West 64th St., New York, N. Y.

HOTEL LUDY

SOUTH CAROLINA AVE. AT THE BOARDWALK

ATLANTIC CITY'S

NEWEST
CENTRALLY
LOCATED
FIREPROOF
HOTEL

\$5.00

DAILY
AND UP
AMERICAN
PLAN

WIRE PHONE OR WRITE R. B. LUDY M.D.

The Companion Receiver

(Continued from page 877)

output is required for ample volume from headphones.

Some time ago we conceived the idea of the modern individual radio set. Taking each consideration in due turn, we finally evolved what is now known as the ICA Companion—a self-contained, portable, a.c. receiver for headphone operation, which, like the famed Mary's lamb, is ready to follow its owner everywhere and at any time. This receiver employs two tubes, both of the -27 a.c. heater type, one as a detector and the other as a rectifier. It is necessary only to plug into the 110-volt or 220-volt a.c. line to operate the receiver.

The ICA Companion will furnish headphone reception of a clarity and volume that will be found agreeably pleasant. Its range has proven comparable to that of the usual broadcast receiver employing several tubes. Either a ground or an antenna may be employed. The antenna, of course, will provide better results, but

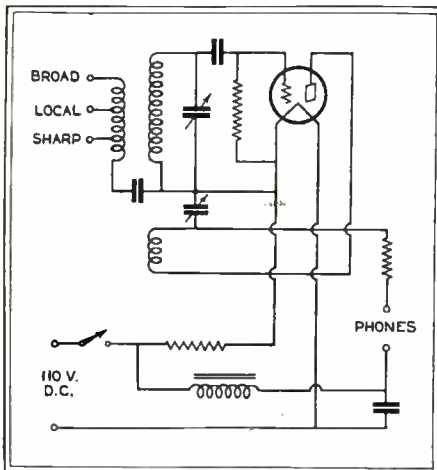

The circuit of the "DC Companion" for use in localities where the light supply is direct current

in most instances the ground will be found satisfactory. Three binding posts are provided for the antenna or ground connections. These are labeled "Broad," "Sharp" and "Local," indicating the types of tuning or reception that an average sized antenna or ground will afford. These binding posts are provided in order to permit the receiver to be adapted to the most efficient use with any of the different types of antennæ or grounds that might be encountered. With an extremely long antenna, the "Sharp" post will usually provide the best results; with an unusually short antenna, the "Broad" post will probably work best. For local work, when selectivity is more important than sensitivity, the "Local" post is employed. However, there are no hard and fast rules in radio. That binding post connection should be employed which provides the best reception. The antenna should be connected to each of the posts in turn until the best reception, denoted by greatest signal strength and

absence of interference, is obtained. Grounds, too, vary, and if one is to be employed, its connection to the binding posts should be chosen in the same manner.

To operate the ICA Companion, two type -27 tubes are placed in the sockets provided for them, while the antenna (or ground, if one is to be employed) is connected, let us say, to the "Local" post. The phones are connected to the tip jacks marked "Phones," and the extension cord plugged into the a.c. outlet. With the snap switch thrown to the "On" position, the tubes will require about twenty seconds to heat, after which the receiver is ready for tuning.

The large dial is the tuning dial or station selector. The small knob is the regeneration or sensitivity control.

To most of us, used to loud speaker or group reception for the past six years, headphones or individual reception is a genuine novelty. There is something decidedly thrilling in virtually going into a figurative radio telephone booth, where we may listen and enjoy a given program without interfering or being interfered with by others. Particularly in the case of a serious talk, a radio lecture or a deep radio drama, is this individual reception important, for it permits of a concentration quite impossible with the usual loud speaker or group reception. Indeed, some real deep-thinking radio broadcasting is now in order, since the anxious listener can isolate himself from any surroundings and concentrate on the desired program.

Self-Biasing Tube Checker

Description: Here is a tube checker that indicates the "end of life" or usefulness of all types of amplifier, power and rectifier tubes. So that tests may be made at the correct filament voltage for



the tube under test, six sockets are provided. Provision is also made so that the two plates of a type -80 rectifier tube can be tested separately. The meter is a D'Arsonval Type with a 0-40 scale. The colored push buttons and the chart shown on the face of the tester, with the complete instructions, simplify the operation.

Usage: For testing all types of tubes.

Maker: The Radio Products Company, Dayton, Ohio.

Some Pick-up Characteristics

(Continued from page 932)

Where long leads are used, it may also be desirable to employ a low impedance pick-up, to avoid feed-back and the picking up of line noises. It is standard practice in theater and public address systems to use 500-ohm lines. Here a pick-up wound to 100 ohms or less is connected to the standard input transformer. Such transformers have a step-up ratio of about 25.

It is unfortunately impracticable to anywhere nearly match the pick-up impedance to that of the grid. In the case of the 2000-ohm pick-up, a step-up ratio of the order of magnitude of 100 would be required. In the case of the 100-ohm pick-up, a step-up of something like 1000 would be necessary. It is out of the question to build audio transformers which will give this gain and at the same time properly cover the musical band. This means in effect that we are able to take advantage of only a small fraction of the energy developed in the device.

Pick-up Mounting

Reproduction of the bass notes is dependent to a considerable extent on the manner of mounting the pick-up head. We have in the foregoing discussion and curves been assuming nearly ideal mounting. This means suitable weight of head and arm, suitable pressure on the record, and proper joints in the arm.

If the armature system is too stiff in relation to the weight of the head, a considerable amount of needle vibration will be imparted to the head. Ideally, the head should be perfectly rigid, and only the armature should be moved by the needle. Otherwise, the lower frequencies are not reproduced as pure notes, but are broken up into tones with a proportion of harmonics and transients. The ideal condition is impossible of attainment, but with low armature stiffness, a fair approximation is possible. For any given stiffness, a certain weight of head is necessary in order to provide the inertia requisite to give reasonably satisfactory low note reproduction. In any case, the head should be heavy enough to make its natural period of resonance well below the lowest frequencies on the record.

Of course, a certain amount of the head weight may be taken off the record by suitable suspension and counterbalancing. This is necessary to prevent undue record wear. But at the same time, a certain amount of pressure on the record is required in order to secure proper tracking. It is customary to apply a pressure of four or five ounces to the needle-point so that it will ride in the bottom of the record groove and not be thrown out by the large amplitudes associated with the bass notes.

The joints in the tone-arm also play a considerable role in the reproduction of the lower frequencies. Any chatter is very undesirable. The ideal arm is one which is rigid throughout its length, the necessary joints being provided in the base. These joints should be such that

(Continued on page 948)

Mike-roscopes

(Continued from page 932)

the artist that he's taking the wrong position. do you?

I could cite dozens of examples of artists whom I have watched writhe under the treatment. Let the control operator amplify as best he may, and if this is sometimes still not enough, be more sure of the artists before they go on the air—but once the curtain is up and the performance begins, for goodness sake—and the sake of the entertainer, the audience and the reputation of radio—let the performance continue without interference. I could write a whole column about bad habits of announcers, but I think this is the worst.

FOR this month's "hall of fame." I want to nominate in radio:

The Most Attractive — Virginia Gardner, actress at NBC.

The Most Poised — Merlin Aylesworth, President of NBC.

The Most Gracious — Bertha Brainard, Program Manager of NBC.

The Most Conscientious—Roger Bower, Production Manager and Announcer of WOR.

The Most Understanding—Marie Elizabeth Flugel, singer at WOR.

The Most Mentally Alert—Alfred J. McKosker, Director of WOR.

The Quietest—Madeline Vose, Assistant Program Director of WOR.

The Best All-Around Girls—Miss Marks and Miss Winston of the Press Department of Columbia.

The Best Looking—Don Clarke, Actor and Head of the Continuity Department of Columbia.

The One with the Newest Baby—(As I write, but you've got to watch these radio folk), Brad Browne, author of the Nit-Wits.



Roger Bower

Ultra-High Experiments

Those "useless frequencies" below 10 meters would be developed for radio-telephony in experiments proposed to the Federal Radio Commission by John J. Long, Jr., of 63 Sonora Parkway, New York City, who applied this week for authority to experiment in the band between 50,000 and 100,000 kilocycles (6 to 3 meters) with the object in view of developing light weight transmitting and receiving equipment, especially for aircraft. Long holds amateur licenses W3ABX and W8AZL and is chief engineer of WHAM, Rochester.

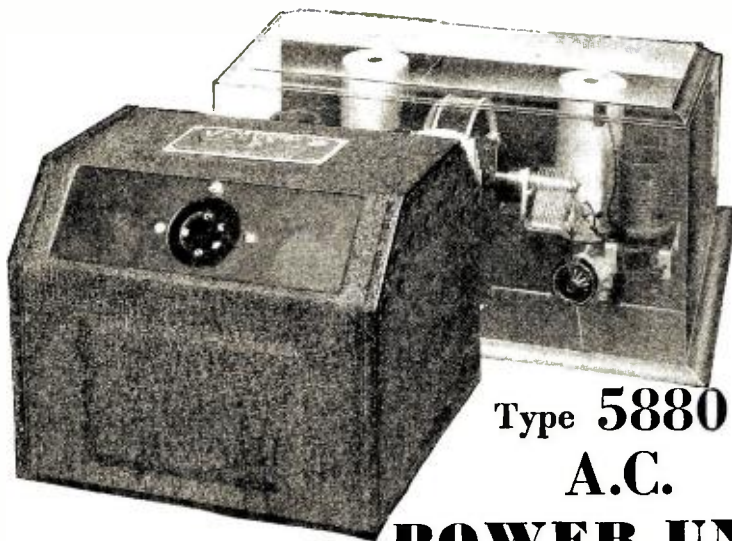

Type 5880
A.C.

POWER UNIT

The HUMLESS Short-Wave Power Supply

Special design makes *Humless* A. C. operation possible on short waves, with this 5880 National power unit. An electrostatic shield in the power transformer isolates the secondary windings from line disturbances and there is an oversize double section, hum filter. In addition, there is an R. F. Filter on the rectifier tube itself, eliminating "tunable hum."

Just another reason for the outstanding superiority of the NATIONAL SW5 THRILL-BOX. (Send 50c in stamps or coin for new 64-page Short Wave Handbook, giving details of all modern S.W. circuits. Bulletin No. 143 is free.)



Byrd's Antarctic Radio Equipment

Receivers, transmitters, and latest navigation aids used on this epochal flight fully described.

Television

Mr. C. F. Jenkins, father of television and radio movies, gives you in his own words complete directions for building practical television equipment.

Interference Elimination

New methods systematically outlined by W. F. Fleming, radio engineer.

Radio Auto Alarm

Description of new device for ships which keeps the SOS watch while operator is off duty.

Short-Wave Apparatus

Commercial and amateur, described and illustrated.

New Broadcasting Equipment

Temperature-controlled Piezo crystal oscillator; 100% modulation panel and other new apparatus. —and these are only a few of the new subjects added to the most complete radio handbook ever published.

The Latest Data!

Complete and up-to-date information covering the entire field of radio—all arranged for ready reference in this one big guide book.

THE RADIO MANUAL

A Handbook for Students, Amateurs, Operators, and Inspectors

Here's the answer to every question about the principles, operation, and maintenance of apparatus for radio transmitting and receiving. Important new chapters have been added to bring it right up to the minute. Many new photographs and diagrams have been included. It is now more than ever the one complete handbook covering the entire radio field.

A Complete Course in Radio Operation in ONE VOLUME

Prepares for Government License

20 big chapters cover: Elementary Electricity and Magnetism; Motors and Generators; Storage Batteries and Charging Circuits; The Vacuum Tube; Circuits Employed in Vacuum Tube Transmitters; Modulating Systems and 100% Modulation; Wavemeters; Piezo-Electric Oscillators; Wave Traps; Marine Vacuum Tube Transmitters; Radio Broadcasting Equipment; Arc Transmitters; Spark Transmitters; Commercial Radio Receivers; Marconi Auto-Alarm; Radio Beacons and Direction Finders; Aircraft Radio Equipment; Practical Television and Radio Movies; Eliminating Radio Interference; Radio Laws and Regulations; Handling and Abstracting Traffic.

Prepared by Official Examining Officer

The author, G. E. Sterling, is Radio Inspector and Examining Officer, Radio Division, U. S. Dept. of Commerce. The book has been edited in detail by Robert S. Kruse, for five years Technical Editor of QST, the Magazine of the American Radio Relay League, now Radio Consultant. Many other experts assisted them.

Examine It FREE!

The revised edition of "The Radio Manual" is now ready. Nearly 800 pages; 369 illustrations. Bound in flexible FabriKoid. The coupon brings the volume for free examination. Within 10 days you may return the volume or send the price of \$6.00.

—MAIL THIS COUPON—

D. VAN NOSTRAND CO., Inc.
250 Fourth Ave., New York

Send me the Revised edition of THE RADIO MANUAL for examination. Within ten days after receipt I will either return the volume or send you \$6.00, the price in full. (R. N. 4-31)

Name

St. and No.

City and State

Business Connection

The Junior Transmitter

(Continued from page 909)



No. 245-A

Set and Tube Tester

Newly designed to meet the servicing needs of all types radio receiving sets. Used by experts. Adaptable for every kind of socket test. Also continuity of circuits, a.c.—d.c., and all tubes including screen-grid and rectifier. Checks line voltage. Charts for resistance and capacity with full instructions furnished. Accurate. Compact. Simple to use. Durable steel case finished in beautiful baked enamel.

\$12 NET to No. 245-A
 Dealer No. 400
 \$20 List Each

If not at your jobber's we will ship direct

Readrite

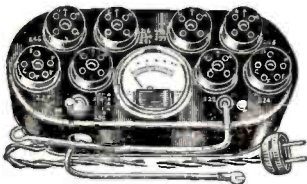

No. 400

Counter Tube Tester

A new tester that gives dealer and customer the required tube value information. Mutual conductance test all tubes, including the new 2-volt tubes. Simple to use. Accurate. Dependable. Connects to A.C. supply. Attractive baked enamel finish. All parts shielded. Complete with up-to-date tube chart.

Send for catalog. Order your testers now.

Readrite Meter Works

Established 1904

19 College Ave. Bluffton, Ohio

ones that work your receiver, same A and B. Even on a.c. you can wire the -24 filament to your power pack.

"Everything can be mounted on a seven by ten inch panel and mounted in a box five inches deep. There are not many parts needed and you can probably find some in your box. One thing that is absolutely essential is a good variable

tube with about 45 turns of wire. It is always safest to wind on a few more turns than called for and then remove them in order to get the band coverage and placing that you want. For example, I wound 48 turns on L2 and 265 turns on L1.

Milliammeter

"The milliammeter may be mounted on the panel above the filament rheostat, or you can do as I have done and make it external, through a jack. It is also well to use a jack or pin jacks across the socket in order that a voltmeter may be plugged in to read the filament voltage. However, once the proper space current has been determined, the filament rheostat may be adjusted, when using the dynatron thereafter, so that the space current is always the same. This is very important as it will affect the calibration. Do not use too small a milliammeter, that is, one with a large scale reading but use one that is just a little more than your total space current. The milliammeter may be hooked in as shown to read only plate current or it may be hooked into the B— lead. In the latter case it will show both the screen and plate



The actual layout of the tube measuring set-up used in checking the negative resistance characteristics of the screen-grid tubes. The circuit is shown in Figure 2

The curves at the right show the relatively small effect of a change in filament voltage

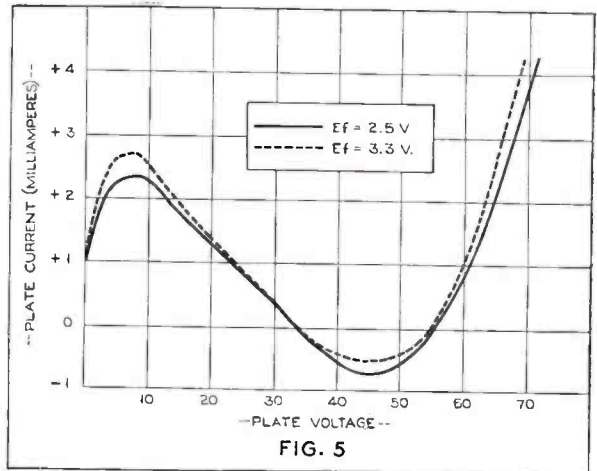

FIG. 5

condenser that will hold calibration for more than ten seconds and it should be one with a fixed tank capacity. I used a General Radio 557. This condenser has two plates that are complete circles and in addition they can be varied to change the tank capacity. Another essential high-grade part is the dial. If your dial can't be read closer than one per cent., why build so accurate a meter? I used the new General Radio dial that is engraved with 200 divisions and can be read to one-tenth of a full division. (The dial is marked 0-100 with half-division markings.)

Condenser

"The condenser C2 is a General Radio Midget type 368-B and is used to spread the 7000 k.c. band over the dial of C1. The coil L1 is wound on a one-half inch tube using No. 30 wire, preferable d.s.c. The coil L2 is wound on a 3/4" or 1"

currents and the setting will not be quite as close as if the plate current alone is read. An O-2 or O-5 milliammeter will do nicely in the B plus 22½ lead or an O-20 will handle the B minus lead."

"What is the best way to calibrate the dynatron, Gus?"

"The same way you calibrated your monitor. Pick up monitor stations and tune the dynatron to zero beat with your receiver. Note the dial markings and the frequency on a piece of cross section paper and when you have all the markers plotted, draw your curve. It is then a simple matter to set your receiver to any desired frequency when you have a schedule to keep. To adjust the transmitter, use the monitor to transfer the measurements. checking back and forth until you feel sure you have the station right where you want it."

"Out of my way, big boy, here goes the order for the parts!"

All-Wave A.C. Super-heterodyne

(Continued from page 884)

sistor, R26, and the other two center points go direct to ground.

After the chassis is ready the sockets should be mounted, using 6/32 machine screws, the heater, or filament prongs toward the rear of the chassis. The row along the rear should read, from right to left, -80, -45, -45, -27, -24, the balance are all -24 type tubes. In mounting the two intermediate amplifier sockets and the two detector sockets, also mount the four tube shield bases, using the same screws for both.

Remove the shaft from the 250-mmfd. tuning condenser. A tension spring will be noticed on one side of the condenser and to this side fasten the end section of the Alcoa shield having the quarter-inch hole. The condenser is then mounted on the chassis, leaving the mounting screws loose. Fasten the center section of the shield to the right-hand side of the condenser. The double section tuning condenser is then mounted, first removing the shaft. Insert the ten-inch steel rod and tighten all mounting screws.

The four coil mounting pillars come next and are placed directly behind the two tuning condensers. The socket marked "Osc. Coil" is screwed to the two pillars behind the double condenser and the antenna coil socket behind the single condenser. The coil sockets are then wired to the condensers. The .01 condenser is connected and is supported by the wiring. The front, back, and remaining sides of the Alcoa shield are assembled and the top screwed on to hold the shielding in place. The dial can now be put on the shaft and then screwed to the base. The three r.f. by-pass condenser blocks and the three intermediate transformers are next mounted. Four 8/32 screws are used to hold the power transformers in place. The filament wiring may next be completed, twisting the leads into pairs.

It is convenient to mount a small terminal board to hold the three center tap resistors and the grid biasing resistor for the power tubes. Following this run the four leads to the rectifier socket. The center tap of the high voltage winding can be grounded to the chassis. The next step is to solder a 3-inch length of wire to the grid terminal of each power tube socket. The input transformer is mounted on the back of the chassis with the secondary terminals nearer the sockets. The two grid leads are now connected to the input transformer. The remaining parts are assembled as follows: The 4-mfd. condenser block next to the detector socket, the parallel feed choke next to that, the voltage divider and electrolytic condenser beneath the power transformer, and the filter choke under the tuning condensers. The midget condenser and the volume control on the front of the chassis. The condenser on the right, the volume control on the left. The balance of the wiring is then completed. Carefully check

(Continued on page 941)

The WORLD'S GREATEST All-Wave SCREEN GRID SUPER ULTRADYNE

ULTRADYNE BOOKLET MODEL L-32

Send 25c for this booklet which tells how to construct and operate the Ultradyne MODEL L-32 Receiver. This booklet also contains life-size picture diagrams and lay-outs of the entire set; also, life-size wiring diagram of the entire circuit showing every wire location and connection.

ULTRADYNE KIT

The kit contains 3 specially tested and matched Ultraformers with double compensating condensers in aluminum sealed cans, 1 special steel chassis drilled and pierced as per specifications, all ready for mounting, three rubber grommets and 4 coil mounting pillars and INSTRUCTION BOOKLET.

List Price **\$32.50**

Operates entirely from A.C. Line
Completely Shielded Throughout
Covers All Wavelengths from 15 to 600 Meters
Tunes as easily and smoothly on the short wave as it does on the broadcast band
10 K. C. Selectivity Over Entire Band
Selectivity and Sensitivity so great, distance range is unlimited
Power Detection
Push Pull Amplification
Full Natural Tone
Not a Trace of Hum or Distortion
Steel Chassis
Simplified Construction

Mr. H. W. Duley of Brooklyn, N. Y., reports he logged 74 stations in one night.

TRAUL RADIO CO., 1074 Atlantic Ave., Brooklyn, N. Y.

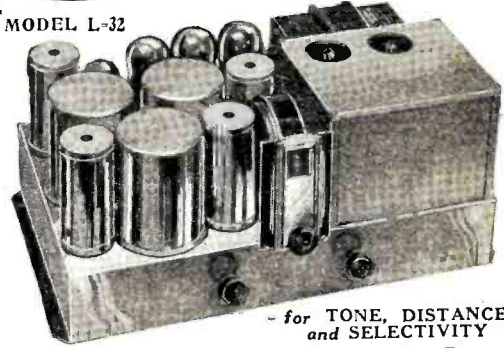

- for TONE, DISTANCE and SELECTIVITY

The model L-32 Ultradyne, with the Dynatron oscillator, works equally as well on short waves as it does on the broadcast band.

An Ultradyne receiver operating in New York City, easily tunes out WOR, Newark, and brings in WLW, Cincinnati, without a trace of interference. Likewise, WMAQ, Chicago, is brought in without interference from WEAF, New York; KGO, Oakland; KSL, Salt Lake City; KFI, Los Angeles; KOA, Denver; XEN, Mexico City, to mention a few, have been logged regularly. Short wave stations from all over the world have been copied on the Ultradyne Receiver.

The Super-sensitive Plio Dynatron system of radio reception responds to weaker signals than the conventional method having far greater selectivity and providing tuning ease that is unmatched. Ultradyne performance is the envy of the radioindustry.

FOR TESTING SUPERHETERODYNES

THE TYPE 360-A TEST OSCILLATOR

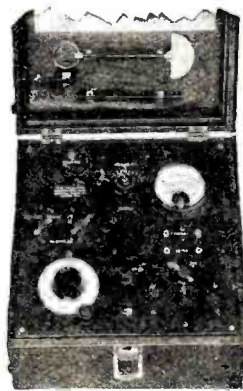

is the result of more than two years of experience with the design and manufacture of test oscillators for servicing Radiola superheterodyne receivers. Several hundred instruments are already in use, and the list of users is growing rapidly as other manufacturers go into production on superheterodynes and recommend "General Radio" to their service men.

Note the following features: (a) modulated signals are available at 175 kc., 180 kc., and at any frequency in the broadcast band; (b) the 175-kc. channel is calibrated at five 1-kc. intervals on either side for aligning band-pass filters; (c) the 500-kc. to 1500-kc. tuning control is calibrated throughout the band; (d) test tools and a copper-oxide-rectifier output meter are included as regular equipment.

Get the facts before you buy a test oscillator

Ask for Bulletin 932-R4

GENERAL RADIO COMPANY

OFFICES, LABORATORIES, FACTORY—CAMBRIDGE A, MASSACHUSETTS

Pacific Coast Warehouse: 274 Brannan Street, San Francisco

A.C. High-Resistance Multi-Range VOLTMETERS

can now be constructed at a low cost, using the new Weston Model 301 Rectifier Type A.C. 0-1 Milliammeter, and the

Super AKRA-OHM Wire Wound RESISTORS

accurately wound and calibrated with precision to insure an accuracy of 1%.

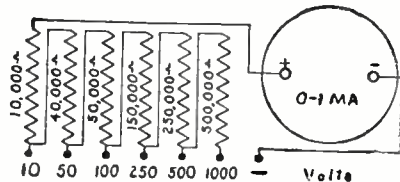

This sketch shows the proper resistors to be used with the new Weston 0-1 A.C. Rectifier Type Milliammeter for a range of 10 to 1000 volts A.C. Higher ranges are possible.

Write for Bulletin 100-D, showing our original Voltmeter Multiplier Chart and other instrument diagrams.

Shallcross Mfg. Company
ELECTRICAL SPECIALTIES
700 PARKER AVENUE
Collingdale, Pa.

Making National Broadcast Coverage Direct

(Continued from page 927)

States, true national coverage begins to look like a splendid possibility. As a first approximation it appears that about seven national super-power stations, located respectively in the northeast, southeast, north central, northwest central, southwest central, northwest and southwest regions, will deliver true service broadcasting, night and day, to practically the entire United States. The actual limits would of course not be circular, and the arbitrary circles are not finite limits anyway. On a good night any listener in the United States might call the roll of national stations in a minute's time. But our calculations are

the case of a mountain transmitter where the radiation is badly distorted at the start. With the power levels we are going to recommend the transmitters must be located in sparsely settled country to avoid excessive interference. At each station great towers would probably rise from a small community complete in itself, and connected to civilization only by an auto road, power lines, and the telephone lines over which come programs from distant city studios.

One principle of location must be emphasized. Some argue: Who is going to pay for a large station located north of the Grand Canyon where inhabitants

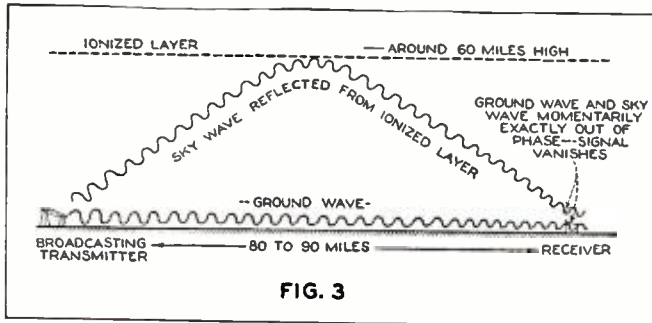

FIG. 3

Illustrating the reason why fading is most severe at a point about 80 miles distant from a broadcast transmitter

based on dependable, non-fading night and day service that will give the loneliest ranch in the Rockies something comparable to what the suburban New York residents enjoy now.

The final number of stations, as well as their final location, can only be determined by detailed topographic surveys and experimental work with portable transmitters and field measurement stations. The northeastern station, for example, might better be located at the tip of Long Island (facetiously suggested by a listener in 1926 as a desirable location for the then super-powered WJZ), than among the hills and other obstructions encountered farther inland. There are indications that where flat country immediately surrounds the transmitter, fading is less severe at all distances than in

are few and far between? But the southwest station is not a state or local station at all; it is a link in the national chain. In addition to the desert area near by, it serves California towns, the Salt Lake City region of Utah, and all the country between. We must go beyond the local and metropolitan viewpoint if national broadcasting is ever to become a reality. Similarly, local and political claims must be ignored in the location of these national stations. They must be placed in accordance with engineering principles so as to bring true service to the widest territory and the greatest present and potential population.

Long-wave broadcasting has other transmission advantages besides the en-

(Continued on page 939)

LEARN RADIO this easy, practical way

WRITTEN by two widely known radio engineers, these three books cover every phase of building, repairing and "trouble-shooting" on modern receiving sets.

Radio Construction Library

This practical Library includes: PRACTICAL RADIO—The fundamental principles of radio, presented in an understandable manner. Illustrated with working diagrams. PRACTICAL RADIO CONSTRUCTION AND REPAIR—Methods of locating trouble and reception faults and making workmanlike repairs. Discusses modern Short Wave Receivers fully. RADIO RECEIVING TUBES—Principles underlying the operation of all vacuum tubes and their use in reception, remote control and precision measurements.

The Library is up-to-the-minute in every respect and is based on the very latest developments in the design and manufacture of equipment.

Three Volumes,
6 x 9—993 pages,
561 illustrations.

See this
Library
FREE!

No
Money
Down



FREE EXAMINATION COUPON

McGraw-Hill Book Company, Inc.
370 Seventh Avenue, New York

Send me the new RADIO CONSTRUCTION LIBRARY, three volumes, for 10 days' free examination. If satisfactory I will send \$1.50 in ten days, and \$2.00 a month until \$7.50 has been paid. If not wanted I will return the books.

Name
Home Address
City and State
Position
Name of Company.....RN-4-31

TABLE 2

Fading in East

	Distance	Station	Fading
New Haven:	Miles		
	35	WITC	Constant—practically no fading.
	55	WEAF	Practically constant—rare fading.
	55	WBZ	Very severe fading and hashing.
	60	WABC	Frequent fading, rapid.
	75	WOR	Fairly frequent fading.
	95	WJZ	Severe fading, hashing.
	115	WGY	Very severe fading, some hashing.
	350	KDKA	Very severe fading, severe hashing.
	600	WLW	Slow fading, quite severe, quality marred somewhat by slight hashing or loss of high and low notes.
West Point:	45	WOR	Constant—absolutely no fading.
	45	WABC	Constant—slight interference at times.
	55	WEAF	Constant—some weak signals—some hashing at times.
	65	WJZ	Frequent fading, slight to extreme, hashing.
	70	WITC	Frequent fading.
	85	WBZ	Severe and frequent fading.
95	WGY	Severe and frequent fading.	

Making National Broadcast Coverage Direct

(Continued from page 938)

largement of fading rings. Dr. E. B. Judson, well-known radio research engineer of the Bureau of Standards, points out the longer wave fading will be slower—more of a day-to-day change. Dr. Taylor estimates that differential side band fading (“hashing” or “mush”) will be less bothersome on the longer wavelengths. In addition, present local signal inequalities should be smoothed out somewhat. At present frequencies the signal may be 100 times as strong on a hilltop as in an adjacent valley bottom. Longer

transmission in the world, estimates that static at the longer wavelength is more than twice and less than four times as intense as the common broadcasting variety. Dr. Taylor independently estimates that atmospherics at 200 kc. are at least twice as bad as those at 600 kc., and will be particularly noticeable in the southern part of the United States and in the mid-west during its hot summers. When two such distinguished authorities agree so closely, their estimates certainly carry weight.

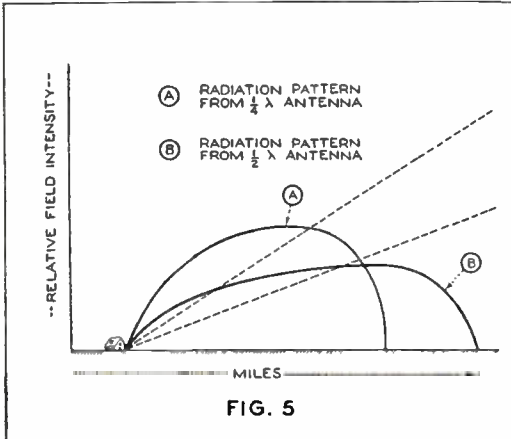

Some experiments show that the non-fading distance can be definitely pushed back through the use of a half-wave antenna, as indicated by the increased ground wave service area indicated here

waves bend around obstructions better and fill in these radio shadows.

Static

Having so far demolished the fading bogie in our approach to national broadcasting, let us investigate the most serious technical objection to the whole scheme—static. It is known that atmospherics at 200 kc. or 1500 meters are worse than similar disturbances at 600 kc. or 500 meters, and that at both frequencies American static is somewhat worse than the north European variety. Dr. L. W. Austin of the Bureau of Standards, one of the greatest authorities on radio

Dr. Judson states that on wavelengths around 17,000 meters, where the static is about twenty times as bad as that at 3000 meters and below, the worst average afternoon atmospherics measured at the Bureau of Standards seldom run above 1 millivolt per meter. He experiences no interference from this level of disturbance while measuring American high-power telegraph signals at the 3m.v./meter level. 200 kc. summer static in the south and southwest is certainly bad, but present broadcasting band interference in these regions is also quite intense. The writer's experience operating field sets around 300 kc. in Arizona and Texas

(Continued on page 940)

TABLE 3
Fading Radii Over the United States

Wavelength	Station	Power	Terrain	Predicted fading radii Miles	Observed fading radii Miles
*	*	5 kw.	Mountainous	17	25
333	WJAX, Fla.	1 kw.	Flat, sandy	95	50
344	WENR, Ill.	50 kw.	Flat	100	125
*	*	50 kw.	Broken	55	60
361	KOA, Colo.	12.5 kw.	Flat (east)	105	150
361	KOA, Colo.	12.5 kw.	Broken (west)	55	75
394	WJZ, N. J.	30 kw.	Broken	60	120
405	WSB, Ga.	5 kw.	Broken	65	70
422	WOR, N. J.	5 kw.	Flat	130	100
428	WLW, Ohio	50 kw.	Flat	130	120
454	WEAF, N. Y.	50 kw.	Flat	140	100
468	KFI, Calif.	5 kw.	Broken—mountainous	55	80
				83.8	Averages: 89.2

*Permission to publish not received.

ENDORSED BY ORDERS



Weston Model 565

The Complete Radio Test Set

Radio dealers and service men from all sections of the country have given this new Weston test set, Model 565, their strongest endorsement. They have bought them.

Many leading service organizations are standardizing on Weston Model 565 because of its complete servicing scope and reliable operation. One exceedingly critical purchaser recently bought 65 Weston Model 565 Test Sets after a most careful comparison with the other test sets on the market for servicing scope, reliability of operation and price.

Just as electrical engineers and laboratories have found that Weston quality and reliability in electrical testing equipment has never been equalled, every day more radio dealers and service men realize that it pays to buy "Weston's" first instead of last.

Weston Model 565 is practically a complete portable radio laboratory. It makes the required tests on every model Radio Set and checks every type tube, A.C., D.C., Pentode and both plates of Rectifiers. As a tube checker, it operates directly from any 50 to 60 cycle, 90 to 135 volt A.C. line. Model 565 contains an R. F. Oscillator, Direct Reading Ohmmeter, A.C. Ammeter, D.C. Milliammeter, A.C. and D.C. Voltmeter—permitting an exceptionally wide range of measurements.

Remember, Weston test sets are endorsed by orders from thousands of radio dealers and service men. Before you buy a test set, inspect Weston Model 565.

In the meantime, for further information

WRITE FOR CIRCULAR HH

WESTON

ELECTRICAL INSTRUMENT CORPORATION

615 Frelinghuysen Avenue
Newark, N. J.

WORLD WIDE
SHORT WAVE
RECEPTION

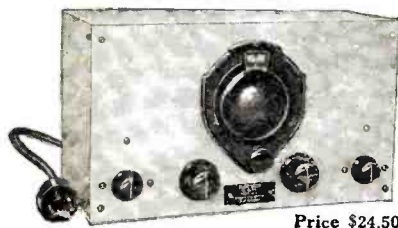

Price \$24.50

THE NEW
"EXPLORER"
PLUGLESS POWER CONVERTER

A sensational advance in short wave reception

NO PLUG-IN COILS
POWER RECEPTION

AUTOMATIC BAND SELECTION! Wave-length range 15 to 160 meters; automatic band selector changes wave-length bands by the turn of a knob in less than a second.

The EXPLORER itself uses two tubes, greatly amplifying distant signals. Used with your broadcast receiver it makes possible reception of stations all over the world with real loud-speaker volume.

With the EXPLORER you can obtain the best possible short-wave reception at lowest cost. Built on entirely new principles of converter design. It is full-sized, thoroughly shielded, and enclosed in a beautiful satin-finish aluminum cabinet. A special vernier tuning condenser permits ease of tuning like a broadcast receiver's. Results obtained are unsurpassed by expensive short-wave receivers, and the elimination of plug-in coils makes the EXPLORER the most convenient of all short-wave receiving apparatus.

Price \$24.50. Models for every receiver, including all superheterodynes. Order now! Sent C. O. D. on receipt of \$2 or prepaid on receipt of price in full. State make and model of broadcast receiver, and tubes used. Foreign, price \$25.50, remit in full with order.

Send for Free Literature
RIM RADIO MFG. CO.

695 GRAND STREET BROOKLYN, N. Y., U. S. A.

Get Greater
Distance
with



One of the greatest innovations since radio itself, this NEW IMPROVED WELLSTON GOLD TEST AERIAL eliminates both outside and inside aeri-als. It follows closely upon the success attained by the original WELLSTON GOLD TEST AERIAL which at present is giving satisfactory service to thousands of radio owners throughout the world. Absolutely non-directional and non-corrosive, the NEW IMPROVED WELLSTON GOLD TEST AERIAL brings in distant stations with crystal clear tone quality and greater volume—gives selectivity without distortion and helps to eliminate overlapping of stations, noise and electrical interference. It does away with all lightning hazards and because it does not connect into a light socket, all AC hum and line noise are eliminated.

IT WILL NEVER WEAR OUT

Made of emerald green genuine solid Condensite with binding posts to match, this NEW AND IMPROVED WELLSTON GOLD TEST AERIAL is of the filtered type endorsed by radio engineers and will last a lifetime. Although small enough to fit the palm of your hand, it has a capacity equivalent to 54 ft. of best grade aerial wire strung 50 ft. high in the air.

IF YOUR DEALER CAN'T SUPPLY, ORDER DIRECT

Price \$2.50

WELLSTON RADIO CORP.

Dept. 115

St. Louis, Mo.

Making National Broadcast Coverage Direct

(Continued from page 939)

during the summer season indicates that higher wave static in the southwest is not prohibitive. Using an oscillating detector and two stages of audio, the headphones could be worn with comfort most of the time.

The static question can be more fully answered only from comprehensive quantitative data not now available. There is need for quantitative measurements of atmospherics, not only at 200 kc. but also at various frequencies within the present broadcasting band, at all seasons of the year in various sections of the United States.

High interference levels call for high signal levels. From a consideration of all the data given above, it appears that in the case of the average national station we must figure on putting down a signal strength of about 3 m.v./meter at the boundary of the true service area—that is, 400 miles from the transmitter. Of course much higher signal levels will obtain in the large areas nearer the transmitter. In the case of one or two stations in the southern states where static is more intense, we must be prepared to put down signal levels approaching 10 m.v./meter at the service area boundaries.

High Power

Returning to Eckersley's curves, we find that such signal levels at such distances call for high power. Perhaps the average listener and broadcast engineers will gasp a little (but let us hear the worst at the start) when we say that the indicated upper limit of antenna power is 1000 kilowatts. However, this power is not considered at all excessive in some other branches of applied physics. The passenger in a large transport airplane sits within a few feet of the continuous delivery of nearly 2000 kw. in mechanical torque. One or two southern stations may have to radiate powers approaching 10,000 kw.

It might seem at first that such broadcasting power levels are scarcely possible. If they are not possible now, there is reason to expect that they will be shortly. At Saxonburg, Pennsylvania, KDKA is now building a 400-kw. transmitter for operation within the present broadcasting band. It is also true that high powers are somewhat easier to obtain at lower frequencies, and that the trend of broadcasting power has been constantly upward. To the great question whether they are economically justified, low frequency non-fading ranges give a favorable answer. Our estimates are purposely near the maximum expected limits. The American transmission experiments mentioned above appear to indicate somewhat lower powers on the order of 100 kw. to 1000 kw. Dr. Taylor estimates that 200 kw. to 500 kw. should be sufficient for the purpose.

At the start moderate powers around 100 kw. would probably be ample, to be increased gradually as the demand for

higher powers developed and the economic basis for them became available. A more detailed treatment of the technical and economic aspects of these high broadcasting powers must wait until a later article.

Receiver Design and Other Matters

Many other questions arise, also to be more fully discussed when more space and time are available. One of the most important is how receiver manufacture and the present heavy receiver investment of the American people will be affected by a proposed opening of a long-wave broadcasting band. The answer is: Favorably, if changes are intelligently made. It must be emphasized that long-wave superbroadcasting will supplement rather than replace our present broadcasting structure, giving an added service and taking nothing away. The long-wave system should be inaugurated gradually, with perhaps a single 100-kw. station in the north central region where rural coverage is now quite inadequate. In addition to giving true broadcasting service to millions now without it, this transmitter should on favorable nights cover the United States with a service good enough to interest thousands of experimenters and to stimulate the sale of adapters. Gradually, as the system filled out and increased power, provision could be made for the addition of long-wave tuners to existing sets both old and new. The final development would of course be combination receivers, employing band-changing switches or separate tuners. The long-wave tuners may be of very simple design due to relaxed sensitivity and selectivity requirements. All these technical receiver problems, in fact, are simple compared to the design difficulties presented by our present overcrowded broadcast spectrum.

It is of course true that the frequencies required for long-wave broadcasting are used by other services at present. With each of the seven stations allocated to a separate channel, a band 70 kc. wide, say between 155 kc. and 225 kc. (1935-1330 meters) is indicated. With partial synchronization, tuning to common frequencies the alternate pairs northeast-northwest central, north central-northwest and southeast-southwest, a 40 kc. band say between 175 and 215 kc. (1715-1395 meters) should suffice. These bands are located so as to coincide with those now used for long-wave broadcasting in Europe. With complete synchronization the national chain might be operated on a single program within a single 10 kc. channel. Canada must also be considered. Although she has no long-wave stations at present, she would naturally want some if the plan works out well on American soil. Mexico would probably not be interested because Central American static favors shorter waves or wired wireless. At the powers we recommend

(Continued on page 941)

All-Wave A. C. Superheterodyne

(Continued from page 937)

all wiring before inserting the tubes.

The aerial should be short, not over forty feet, and a good ground should be provided. Tubes in the receiver take the usual time to warm up, and in addition, there is a certain amount of drift during the first ten to fifteen minutes. On broadcast it is not noticeable, but on short waves it is sometimes great enough to detune a station completely. This only happens when the receiver is first turned on and after the oscillator has become completely heated, there is no further drift. If the local-distance switch reduces the sensitivity too much, connecting 1000 ohms in series will lessen its effect.

Since the operation is simple, no special tuning instructions need be given.

Performance

An L-32 ultradyne operating in New York City brings in WLW in Cincinnati any evening without a trace of interference from WOR, Newark. Likewise, WMAQ, Chicago, without interference from WEA, New York. XEN, Mexico City; KFI, Los Angeles; KOA, Denver; KSL, Salt Lake City, have been received regularly. On short waves, stations all over the world have been logged.

List of Parts

- 1 Pilot Antenna coil, L1, L2.
- 1 Pilot oscillator coil, L3.
- 1 Amerchoke Type 3842, L4.
- 1 Amerchoke Type 709, L5.
- 1 National S.E. 50 condenser, C1.
- 1 National E.C. 250 condenser, C2.
- 1 National special condenser, C3, C4.
- 3 Aerovox special 0-1-1 condenser, C5, C6, C7.
- 1 Aerovox special 0-1, 0-1-1-1 condenser, C8.
- 1 Aerovox Type 1460 .0005 condenser, C9.
- 1 Aerovox Type 480 .05 condenser, C10.
- 1 Aerovox Type 250 .25 condenser, C11.
- 1 Aerovox Type 1450 .01 condenser, C13.
- 1 Aerovox Type E5-4444 0-4-4-4-4 condenser, C14, C15, C16, C17.
- 1 Aerovox Type E5-4 4.0 condenser, C18.
- 3 Ultraformers Type L-32, T1, T2, T3.
- 1 Amertran Type 151 Trans., T4.
- 1 Amertran Type Pf 245A Trans., T6.
- 2 Lynch resistors .5 megohm Type LF4, R1, R17.
- 1 Aerovox resistor 750 ohm Type 991, R2.
- 2 Lynch resistors 15,000 ohm Type LF4, R3, R12.
- 4 Lynch resistors 50,000 ohm Type LF4, R4, R7, R10, R14.
- 6 Lynch resistors 1000 ohm Type LR4, R5, R6, R8, R9, R11, R13.
- 1 Aerovox resistor 2000 ohm Type 992, R15.
- 1 Lynch resistor .25 megohm Type LF4, R16.
- 1 Clarostat resistor 3000 ohm Type M-3-T5P, R17.
- 1 Aerovox resistor 1500 ohm Type 992, R18.

- 1 Aerovox resistor 2000 ohm Type 992, R19.
- 1 Aerovox resistor 3000 ohm Type 992, R20.
- 1 Aerovox resistor 1000 ohm Type 992, R21.
- 1 Aerovox resistor 2500 ohm Type 992, R22.
- 3 Aerovox resistors 20 ohm Type 986, R23, R24, R25.
- 1 Aerovox resistor 790 ohm Type 992, R26.
- 1 Chassis drilled.
- 1 National dial 270 degree.
- 4 National tube shields.
- 1 Alcoa box shield.
- 1 length 1/4-inch rod.
- 8 UY sockets Eby.
- 4 UX sockets Eby.
- 1 UX loud speaker plug.
- 2 National knobs for 1/4-inch shaft.
- 5 National screen grid clips.
- 1 antenna ground binding post.
- 50 feet of hook-up wire.
- 2 feet rosin core solder.
- Screws, nuts, lugs, washers, etc.
- 1 instruction book.
- 5 -24's.
- 1 -27.
- 2 -45's.
- 1 -80.
- 1 d.c. dynamic speaker 2000-ohm field with input PP trans, T5.

Making National Broadcast Coverage Direct

(Continued from page 940)

there might be possibility of inter-continental interference.

The general answer to all these questions is: The greatest good for the greatest number. If long-wave super-broadcasting proves itself experimentally, if it will bring new standards of service to immense rural areas and to millions of farm and small town dwellers which can be reached in no other way, then the system will overcome all objections. In the light of national broadcasting as a realized dream, all difficulties will vanish.

Value of National Coverage

No one can say positively at the present time that long-wave super-broadcasting will solve our rural radio problems, or that other methods will fail. But the national coverage plan does open up immense and interesting possibilities. It is well worth careful consideration. It should lead not only to academic discussion, but to unbiased experiments which can alone prove or disprove its validity. It may be the technical answer to the expressed desire of Congress for "equality of radio broadcast service, both of transmission and reception."

A Valuable Guide

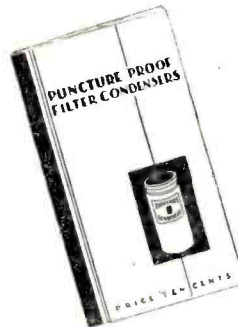

to

Servicemen and Dealers

EVERY SERVICEMAN KNOWS that the filter condenser is a vital part of every radio set. Radio manufacturers and their engineers have worked for years to find the solution of their condenser problems. Here is the answer—two million radio receivers equipped with MERSHON ELECTROLYTIC CONDENSERS are operating successfully today—at their best—free from all condenser trouble.

NOW, the results of all this experience have been written down in a little booklet "PUNCTURE PROOF FILTER CONDENSERS" designed especially for the serviceman. This booklet contains many photographs and diagrams illustrating all the important points discussed. It shows you why the MERSHON CONDENSER has won first place in this important field of radio equipment and suggests how you can use the MERSHON most effectively in the set which you are building or repairing. Ten thousand set builders and servicemen have found in this booklet the answer to their condenser problems. Send the coupon today for your copy of this

Valuable Mershon Booklet

THE AMRAD CORP.,
151 East Ohio Street, Chicago, Ill.

Gentlemen:

Please send me a complimentary copy of your booklet "PUNCTURE PROOF FILTER CONDENSERS."

Please show me how to use the MERSHON CONDENSER in my set. I am enclosing diagram.

Name

Address

City State

Announcing DUBILIER Hi-Mike Condenser



Here's maximum capacity at minimum cost. A perfected electrolytic condenser in standard aluminum can $4\frac{1}{2}$ by $1\frac{3}{8}$ inches. Upright or inverted mounting. 8 mfd. capacity. Highest percentage effective capacity. Working voltage 400; peak 430. Fully self-healing. Lowest leakage. Long life. Positively non-spillable. Sets new standard in electrolytic condenser art.

Write for data regarding Dubilier Hi-Mike Condenser as well as complete line of Dubilier paper and mica condensers for every radio, electrical and industrial purpose.

DUBILIER

Condenser Corporation

4377 Bronx Blvd. New York City

RIGHT NOW!

Send for Our
NEWEST CATALOG

Largest Assortment and
Biggest Bargains in

Hammarlund, National, Amertran, Aerovox, Yaxley, Samson, Sylvania, Arcturus, de Forest, RCA Tubes, Public Address Amplifiers, Weston, Jewell Meters, Jensen, Rola, Best Speakers, Universal Microphones, etc.

ALL MERCHANDISE AT WHOLESALE

S. HAMMER RADIO CO.

142 Liberty St., New York—Tel. Hitchcock 1152—Dept. N

ACME WIRE PRODUCTS

Parvolt Filter and By-Pass Condensers, Magnet Wire—All Insulations, Varnished Insulations, Coils.

THE ACME WIRE CO.
NEW HAVEN, CONN.

ALUMINUM BOX SHIELDS

Genuine "ALCOA" stock, silverclad finish. 5x9x0 \$1.00
—Cabinet size \$4.65. 10x6x2 Monitor size \$2.25. 5x5x3
Coil Shield (like picture on the left) \$1.00.

ANY SIZE TO ORDER

Coil Shields, Coil Hole Covers, Shielded Wire, Intermediate frequency coils 95¢ pair, .0005 Bakelite condenser 12c, 70-MMF Hammarlund equipter condenser 17c, National Drum Dial, list price \$3.50, Special \$1.50, National Enutrine, 500 MMF condenser excellent for double spacing, Regular price \$5.00, Special, \$1.50, Aerovox .01 Bakelite condenser, 34c.

We specialize in parts exclusively. We can furnish everything described in this magazine. Give us a trial. B9 Cortlandt St., BLAN, the Radio Man, Inc., Box 24, New York City

The Junior Radio Guild

(Continued from page 921)

$$\frac{6}{3} \times \frac{4}{8} = \frac{24}{24} = 1$$

which is the same as the quotient obtained above. It is seen how readily these rules can be proven when numerical examples are used.

A Few Examples That Are More Complex

We shall now give a few examples, some of which will be a little more complex than the previous ones, but are of value in applying the rules already obtained. These examples will demand a thorough knowledge of the expressions investigated under the heading "A" dealing with the application of the algebraic expressions (1) of the difference of two squares, (2) the sum and difference of two cubes, and other standard forms.

Examples:

Simplify:

$$1. \frac{7a^2b^3}{9ax^2y} \times \frac{18x^2c}{15ac^4} = \frac{21a^2b^3c}{45ax^2y^2c^4} = \frac{7a^2b^3c}{15ax^2y^2c^4}$$

$$2. \frac{13mn^2}{2x^2y} \div \frac{39m^2n^3}{5z^2x} = \frac{13mn^2}{2x^2y} \times \frac{5z^2x}{39m^2n^3} = \frac{5z^2x}{6mn^3y}$$

$$3. \frac{3yz}{14x^2 - 7x} \div \frac{7xy^2}{2x - 1} = \frac{3yz}{14x^2 - 7x} \times \frac{2x - 1}{7xy^2} = \frac{2yz}{7xy^2(2x - 1)}$$

$$4. \frac{12x^3 + 24x^2}{x^2 + 2x} \div \frac{x^2 + 2x}{2x - 1} = \frac{12x^2(x + 2)}{x(x + 2)} \times \frac{2x - 1}{x + 2} = \frac{12x(2x - 1)}{(x + 2)^2}$$

To indicate the method: Applying Rule d, under the heading "E," we have:

$$\frac{14x^2 - 7x}{12x^3 + 24x^2} \times \frac{2x - 1}{x^2 + 2x}$$

$$\frac{14x^2 - 7x}{14x^2 - 7x} \times \frac{x^2 + 2x}{x^2 + 2x} = 1$$

$$\frac{12x^3 + 24x^2}{12x^3 + 24x^2} \times \frac{2x - 1}{2x - 1} = 1$$

and simplifying:

$$= \frac{7 \times (2x - 1)}{12 \times (x^2 + 2x)} \times \frac{(x^2 + 2x)}{(2x - 1)}$$

and cancelling those factors which are common to both numerator and denominator, we have:

$$= \frac{7}{12} \text{ Ans.}$$

$$\frac{a^2b^2 + 3ab}{4a^2 - 1} \div \frac{ab + 3}{2a + 1}$$

$$5. \frac{4a^2 - 1}{x^2 - 4a^2} \times \frac{2a + 1}{2a} = \frac{(2a + 1)(2a - 1)}{(x + 2a)(x - 2a)} \times \frac{2a + 1}{2a}$$

$$6. \frac{ax + 2a^2}{m^2} \div \frac{x - 2a}{36p^2q^2} = \frac{ax + 2a^2}{m^2} \times \frac{36p^2q^2}{x - 2a}$$

$$7. \frac{8n}{a^2 - 121} \div \frac{27n^2xy}{a + 11} = \frac{8n}{(a + 11)(a - 11)} \times \frac{27n^2xy}{a + 11}$$

$$8. \frac{a^2 - 4}{x^2 + 5x + 6} \div \frac{a + 2}{x^2 - 2x - 3} = \frac{(a + 2)(a - 2)}{(x + 3)(x + 2)} \times \frac{(x + 3)(x - 3)}{(x + 2)(x - 3)}$$

$$9. \frac{a^2 - 4}{x^2 - 1} \times \frac{a + 2}{x^2 - 9} = \frac{(a + 2)(a - 2)}{(x + 1)(x - 1)} \times \frac{a + 2}{(x + 3)(x - 3)}$$

To indicate the method: An algebraic expression which is similar to the numerator $(x^2 + 5x + 6)$, shown above, can often be simplified, since it is the product of two or more expressions. Thus, if $(x + 3)$ is multiplied by $(x + 2)$, we have:

$$\frac{x + 3}{x + 2}$$

$$\frac{x^2 + 3x}{x + 2} = \frac{x(x + 3)}{x + 2}$$

$$x^2 + 5x + 6 = (x + 3)(x + 2)$$

and this shows that the numerator can be resolved into the two factors $(x + 3)$ and $(x + 2)$. We notice, then, that:

1. The product of the first terms of the two factors gives the first term in the answer.

2. The product of the second terms of the two factors gives the last term in the answer.

3. The algebraic sum of the second terms of the two factors gives the coefficient of x in the second term of the answer.

Thus, the numerator of the second fraction can be resolved by these rules: if $(x - 3)$ is multiplied by $(x + 1)$, we obtain the product $x^2 - 2x - 3$.

Therefore, example 9 above is simplified as follows:

$$\frac{x^2 + 5x + 6}{x^2 - 1} \times \frac{x^2 - 2x - 3}{x^2 - 9} = \frac{(x + 3)(x + 2)}{(x + 1)(x - 1)} \times \frac{(x - 3)(x + 1)}{(x + 3)(x - 3)}$$

$$\frac{(x + 2)(x - 1)}{(x + 1)(x - 1)} = \frac{x + 2}{x + 1} \text{ Ans.}$$

$$10. \frac{x^2 + 3x + 2}{x^2 + 9x + 20} \times \frac{x^2 + 7x + 12}{x^2 + 5x + 6} = \frac{(x + 2)(x + 1)}{(x + 4)(x + 5)} \times \frac{(x + 3)(x + 4)}{(x + 3)(x + 2)}$$

$$11. \frac{x^2 - 4}{b^2 - 27b} \times \frac{2x^2 + 9x + 4}{4b^2 - 25} = \frac{(x + 2)(x - 2)}{b(b - 27)} \times \frac{(2x + 4)(x + 1)}{(2b + 5)(2b - 5)}$$

$$12. \frac{2b^2 + 5b}{2b^2 - 11b + 15} = \frac{b(2b + 5)}{(2b - 3)(b - 5)}$$

$$C. \text{ Addition and Subtraction of Fractions.}$$

Occasions arise where fractions must be added and subtracted, and to appreciate the forms which such algebraic expressions take we have:

$$\frac{a}{b} + \frac{c}{d} = \frac{ad + bc}{bd}$$

for the addition of fractions; and

$$\frac{a}{b} - \frac{c}{d} = \frac{ad - bc}{bd}$$

for the subtraction of fractions.

To prove the first expression by a numerical expression let us take the two fractions—

$$\frac{3}{5} + \frac{7}{9}$$

Now, applying the rule that the value of a fraction is not altered if we multiply the numerator and denominator by the same quantity, we have:

$$\frac{3 \times 9}{5 \times 9} + \frac{7 \times 5}{9 \times 5} = \frac{27}{45} + \frac{35}{45} = \frac{62}{45}$$

$$\frac{3}{5} \times \frac{9}{9} + \frac{7}{9} \times \frac{5}{5} = \frac{27}{45} + \frac{35}{45} = \frac{62}{45}$$

(Continued on page 943)

The Junior Radio Guild

(Continued from page 942)

adding these two fractions:

$$\frac{3}{5} + \frac{7}{9} = \frac{3 \times 9}{5 \times 9} + \frac{7 \times 5}{9 \times 5} = \frac{3 \times 9 + 5 \times 7}{5 \times 9}$$

which is the proof.

Applications to Radio Circuits

To illustrate the application of fractions in radio circuits, an example is shown to indicate the more or less complex algebraic form a somewhat simple circuit can obtain.

Let us investigate the following circuit:

(A)

We know that the two resistances R2 and R3 are equivalent to a resistance R0, which is expressed in the algebraic form:

$$\frac{1}{R_0} = \frac{1}{R_2} + \frac{1}{R_3}$$

In the right-hand expression, we recognize the standard form for the addition of fractions:

$$\frac{a}{b} + \frac{c}{d} = \frac{ad + bc}{bd}$$

and we have:

$$\frac{1}{R_0} = \frac{R_2 + R_3}{R_2 R_3}$$

and by the rule under heading "A" we have:

$$R_0 = \frac{R_2 R_3}{R_2 + R_3}$$

Therefore, the above circuit is equivalent to the following:

(B)

$$E = I1R$$

where:

$$R = R_1 + \frac{R_2 R_3}{R_2 + R_3}$$

Again, in the right-hand expression, we recognize the standard form for the addition of fractions. In this case, R1 can

be considered as a fraction $\frac{R_1}{1}$, and

we have:

$$R = \frac{R_1 (R_2 + R_3) + R_2 R_3}{R_2 + R_3}$$

simplifying:

$$R = \frac{R_1 R_2 + R_1 R_3 + R_2 R_3}{R_2 + R_3}$$

Since:

$$E = I1R, \text{ we have, by substitution: } I1 (R_1 R_2 + R_1 R_3 + R_2 R_3)$$

$$E = \frac{R_2 + R_3}{I1 R_1 R_2 + I1 R_1 R_3 + I1 R_2 R_3}$$

$$E = \frac{R_2 + R_3}{I1 R_1 R_2 + I1 R_1 R_3 + I1 R_2 R_3}$$

This expression is rather a formidable one to leave in a final form, and it would be better to simplify it. This can be simplified by actually dividing the denomina-

tor into the numerator, and we have:

$$\frac{R_2 + R_3}{I1 R_1 R_2 + I1 R_1 R_3 + I1 R_2 R_3} = \frac{I1 R_1 R_2 + I1 R_1 R_3 + I1 R_2 R_3}{I1 R_1 R_2 + I1 R_1 R_3 + I1 R_2 R_3} + \frac{I1 R_2 R_3}{I1 R_1 R_2 + I1 R_1 R_3 + I1 R_2 R_3}$$

and we see that R2 + R3 goes into the numerator I1 R1 plus the fraction:

$$\frac{I1 R_2 R_3}{I1 R_1 R_2 + I1 R_1 R_3 + I1 R_2 R_3}$$

$$R_2 + R_3$$

left over; therefore,

$$E = I1 R_1 + \frac{I1 R_2 R_3}{R_2 + R_3}$$

which we know is correct from the investigation of the above circuit.

Algebraic Graphs

We know that the algebraic expression $y = x + 2$ is an equation of a straight line, and it was noticed that the line took various directions dependent upon the assigned values of x and a.

It is of interest to investigate the algebraic expressions of curves, for by the study of such graphs, a full appreciation of the value of algebra is obtained.

The Parabola

Let us investigate the expression $y = x^2$.

For x equal

0. the corresponding value of y is 0	1
1	4
2	9
3	16
4	25
5	
-1	-1
-2	-4
-3	-9
-4	-16
-5	-25

And we see that the curve takes the shape of Figure 1, bending upwards to the right for positive values of x, and upwards to the left for the corresponding negative values of x.

Also, let us investigate the expression $y = -x^2$.

For x equal

0. the corresponding value of y is 0	-1
1	-4
2	-9
3	-16
4	-25
5	
-1	-1
-2	-4
-3	-9
-4	-16
-5	-25

Thus, from Figure 2, for positive values of x, the curve bends downward to the right, and for the corresponding negative values, bends downwards to the left. It is noted that both curves pass through the origin, where the x and y axes meet at zero.

It is instructive to study this curve and determine in what way the contour can be altered. We have seen that a very small change of x will produce a very large change of y and we shall occasion such conditions of analyses in various

(Continued on page 944)



They all come in with the I. C. A. CONQUEROR!

Short Wave and Broadcast Receiver, 14 to 600 Meters. A.C. or Battery Operated

The world's your field with this marvelous short-wave receiver. The AC Conqueror employs a 224 screen-grid RF, one 227 (A.C.) detector and two 227's and a 245 in the transformer-resistance-transformer audio. A superb job, beautifully built. The I C A plug-in coils supplied with this receiver kit are world famous for their precision and performing qualities—what else counts?

Investigate the I C A Conqueror before buying any Short Wave set. Compare the engineering features, the records of performance. Then compare prices. I C A Engineers, and their reputation is well known, know that this set cannot be equalled at a lower price nor can it be surpassed at any price. Send for complete information and see for yourself!



List Price \$65.00

Complete with S. W. Coils
Power Pack—\$34.50

Price to dealers and pro set builders less 40%

INSULINE CORPORATION of AMERICA
78 CORTLANDT STREET NEW YORK CITY

CHIRAD

Complete Parts for the
**NEW NATIONAL
SHORT-WAVE
RECEIVER**

ACSW5—NATIONAL complete set of parts for 5-tube AC Short-Wave Thrill Box. List \$79.50
NET \$46.75

DCSW5—NATIONAL complete set of parts for 5-tube Battery operated Short-Wave Thrill Box. List \$75.00
NET \$44.10

We can have either of the above sets of parts wired up for you at an additional list price of \$10.00.
NET \$5.88

When desired completely wired add the letter (W) to our catalog symbols.

Type 5880 AB Power Supply (less tube) for use with above AC Short-Wave Thrill Box. List \$34.50.
NET \$20.30

(Licensed under R.C.A. patents)

"CHI-RAD"
Power Transformer

No. 104—110-115 volt primary with four secondaries. No. 1—400-0-400 volts, 100 M.A.; No. 2—2½ volts, 14 amps.; No. 3—2½ volts, 3 amps.; No. 4—5 volts, 2 amps.
Powerful, sturdy, E type high grade Silicon Steel, non-coupling case, leads to terminal strip without crossing or coming close to one another.
NET \$4.95

"CHI-RAD"
No. 700 Filter Choke

No. 700—30 Henry 100 M.A. choke with a D.C. resistance of 200 ohms. Completely shielded. E type Silicon steel core. Built to stand the gaff.
NET \$1.95

1931 CATALOG FREE

Write for your copy. Complete line of transmitting and receiving short-wave supplies.

CHICAGO RADIO APPARATUS CO.
415 S. Dearborn St., Dept. RN-3, Chicago, Ill.

RADIO OPERATORS and STUDENTS



Learn Code quickly at home through Junior Course Scientific Code Instruction, or DOUBLE Code and Typing Speed through Advanced Course and Radio-Touch Typewriting. We've trained thousands during our 19 years as only Code Specialists in field. You receive personal instruction from Mr. Candler, world's leading authority whose original methods have developed fastest operators. Including former champion, T. R. McElroy, whose speed was 59 wpm. We help you get your "ticket" quickly, easily and inexpensively. Write TO-DAY for particulars.

THE CANDLER SYSTEM CO., Dept. N-4
6343 So. Kedzie Ave., Chicago, Ill.

**TRY IT
30 DAYS FREE
BEFORE YOU BUY**

Factory to you. Save to 50% on latest Screen Grid Electric or Battery Radio. Get Send No Money Offer.

MIRACO Radio

Amazing bargains direct from big, old reliable factory. Don't buy unless 30 days use proves entire outfit unbeatable at up to twice our price for tone, selectivity, distance, power. 1 yr. guar.

FREE! Send for BIG SPECIAL OFFER—No obligation.

Midwest Radio Corporation
11th Successful Year
804-DA, Miraco Dept., Cincinnati, Ohio

**SUPER
Screen
Grid
\$49.88
Complete
less tubes**

All styles of latest cabinets

Write for our great Catalog check full of Bargains. Specials galore. Our prices guaranteed lower than any other house. Let us prove it.

Uncle Dave's Radio Shack
115 No. Pearl St. Albany, N. Y.

The Junior Radio Guild

(Continued from page 943)

radio designs. Taking the expression $y = ax^2$, and assuming that a is equal to $\frac{1}{2}$, we have:

For x equal

0,	the corresponding value of y is 0
1	.5
2	.2
3	4.5
4	8
5	12.5
6	18
—1	.5
—2	2
—3	4.5
—4	8
—5	12.5
—6	18

The corresponding graph is indicated in Figure 3, and we see that for the same values of x , the values of y do not increase as rapidly. A further consideration of this expression will show that the rate at which y varies is directly proportional to the numerical value of a .

An analysis of tube design, and the relation of the elements, filament and plate, in a two-element vacuum tube shows that the plate current does not vary in direct proportion to the plate voltage, but may be expected to vary according to the relation—

$$i = KE^2$$

The magnitude of the exponent may take the value of 2, and we have for a certain practical condition of operation that

$$i = KE^2$$

where K is a constant dependent upon the geometric spacing of the elements.

Thus, the electron emission of the tube circuit of Figure 4 may be expected to take the shape as shown in Figure 5.

The Circle

Let us investigate the algebraic expression—

$$x^2 + y^2 = a^2$$

Adding $-x^2$ to both sides of the expression will not alter its value, and we have:

$$y^2 = a^2 - x^2$$

Therefore—

$$y = \pm \sqrt{a^2 - x^2}$$

Assuming $a = 4$, we have $a^2 = 16$.

For x equal, the corresponding value of y is

0	$\sqrt{16} = \pm 4$
1	$\sqrt{15} = \pm 3.85$
2	$\sqrt{12} = \pm 3.45$
3	$\sqrt{7} = \pm 2.65$
4	$\sqrt{0} = 0$
—1	$= \pm 3.85$
—2	$= \pm 3.45$
—3	$= \pm 2.65$
—4	$= 0$

And we see that the curve takes the shape of a circle in Figure 6, where the diameter of the circle will be dependent upon the value of the constant "a".

Thus, algebraic expressions are shown to present definite forms, and these few applications indicate with what interest mathematics can be utilized.

Radio Industry Uses Huge Quantities of Materials

The strikingly large quantity and variety of materials which is annually consumed by the American radio industry in the manufacture of receiving sets is revealed in a statistical report compiled by the Electrical Equipment Division, Department of Commerce, from information furnished by manufacturers.

Thousands of tons of steel, copper, brass, bronze, aluminum, tin, nickel, zinc, and other metals, paper, synthetic resin products, glass, cloth and miscellaneous other materials, go into the estimated annual production of 3,900,000 receiving sets. Steel, in strips and bars, leads the metals in quantity totalling 110,000 tons per year. Copper, in sheets and as wire, follows with 12,000 tons. Copper alloys take their place with 4,000 tons. The use of aluminum is placed at 4,000 tons. Tin in foil form and tin-plate aggregates 1,800 tons. Nickel alloys, used in tubes, amounts to 1,500 tons. Zinc totals 1,200 tons.

Paper, in many varieties such as bond, tissue, glassine, manila, and cardboard, is consumed to the extent of 4,365 tons annually. Synthetic resin products, used in tubes as well as in sets and speakers, amount to 2,600 tons. Glass, used in the manufacture of tubes, reaches the total of 3,000 tons. Cloth insulation finds its place with 1,000 tons.

A number of other materials find an

outlet in the demand from the radio industry. Included among these are the various woods, such as poplar, chestnut, walnut, birch, burl maple, spruce, and balsa wood, which go into the construction of cabinets; felt, kid leather, graphite, lava, hemp, mica, rosin, cotton threads, cord, glue, paraffin wax, and other items essential to the manufacture of sets, speakers, or tubes.

More Police Radio Stations

Thirty-seven state and local police radio stations are now in operation in almost as many American cities and 18 others are now building, according to the Federal Radio Commission's newest police radio station log. Most of the stations are used for local low power broadcasting to squad cars via the short waves.

Television Ticker Tape

Ticker tape quotations lend themselves peculiarly well to television transmission in the present state of that art, and Station W9XAP of the Chicago *Daily News* is now broadcasting such quotations regularly.

Modern Phototubes

(Continued from page 876)

the grid bias battery, and to connect the grid resistor to its movable arm. This will provide a convenient means of adjusting plate current. This potentiometer should be of the wire-wound type.

Selection of Proper Amplifier Tube

A vacuum tube selected for use as a phototube amplifier must operate with extremely low grid current when properly biased. If the tube draws an appreciable grid current, a voltage drop is produced across the grid resistor which will affect the circuit much more than any current flow caused by the phototube. A screen-grid tube cannot be successfully coupled directly to a phototube, due to its high grid current, without resorting to a special circuit. Proper values of plate and grid voltage for the tube selected may be obtained by referring to the instruction sheet furnished with the tube. In general, the higher the plate voltage used, the higher the plate current for a given amount of light on the phototube. A grid voltage should be used which will result in a plate current very near zero when the phototube is dark or out of its socket. The amplification will be materially reduced if a greater bias voltage is used than is necessary.

If a circuit is set up so that the plate current may be adjusted over the entire range of the milliammeter by moving the grid bias potentiometer, but at the same time the phototube has little or no effect on the circuit, it is probable that the amplifier tube grid current is excessive, and another tube should be used.

Amplifier Tube

Figure 11 illustrates a type of amplifier tube especially manufactured and tested for phototube circuits. Its use is recommended for circuits where it is essential that the amplifier operate with a high degree of reliability.

The phototube amplifier circuit just described will give a plate current proportional to the light on the phototube; i.e., as the light increases, the current increases. It is often more desirable to set up a circuit that will result in an increase of current when light intensity is cut down, or the light source obstructed entirely. This may be accomplished by modifying the circuit so that the phototube current flows in the opposite direction through the grid resistor. This makes the grid more negative and the plate current less with an increase in light. In the circuit of Figure 8, the phototube potential is obtained from the sum of the plate and grid bias voltages, but in the circuit of Figure 12, another battery is required to supply this potential. In either case, the phototube potential may be almost any value above approximately 30 volts for a vacuum type, but must be limited to 90 volts for the gas-filled type.

For the circuit of Figure 10, it is also

necessary that the grid bias be so adjusted that the plate current is quite low when the light sensitive device is fully illuminated, and correspondingly high when the illumination is removed. This condition calls for a lower grid bias voltage than for the first circuit.

Selection of Relay

In most cases, it is probably desirable to operate a relay in the plate circuit of the amplifier tube. In selecting a relay for such operation, it is important to remember that the maximum amount of energy is available in the plate circuit if a vacuum tube amplifier output is con-



Figure 11. Telephone type relay which is connected into the amplifier plate circuit to provide the necessary link between the phototube equipment and the circuits under control

nected to a device whose impedance is the same as that of the tube itself. The plate impedance of the tube selected may be found from the instruction sheet furnished with the tube. The tube of Figure 9 has a plate impedance of approximately 2,000 ohms. Although the best theoretical efficiency may be obtained by exactly matching the impedance of the relay used with that of the tube, it will be found that very good results may be obtained by using a relay of 800 or 1,000 ohms even though the tube has an impedance of 2,000 ohms. Relays are made for telephone switchboard service in quite a wide range of resistances and contact combinations. One such type that has been very successfully used in phototube amplifier circuits is shown in Figure 11.

Value of Plate Voltage

If a circuit is set up for intermittent operation, a value of plate voltage may be chosen that will result in an amplifier tube plate current very much in excess of its continuous rating. This procedure will make it possible to operate a relay with a considerably lower impedance (and correspondingly higher current requirement) than that of the tube to which it is connected.

The authors wish to acknowledge the aid of Dr. E. D. Wilson, Messrs. R. F. Hughes and E. H. Vedder.

SPECIFIED

in the

Ultradyne Circuit



Type 151 Transformer



Type 3842 AmerChoke



Type 709 AmerChoke



Type PF-245A Power Transformer

Amertran parts, as illustrated above, are specified in the Ultradyne Circuit described elsewhere in this issue.

Where fine quality and superior performance are the first consideration, Amertran parts are always in demand. From single transformers to complete sound systems, Amertran equipment sets the "Standard of Excellence."

For full information on Amertran parts, send the coupon below.

AMERTRAN

American Transformer Company
178 Emmet St., Newark, N. J. RN 4-31

Please send me your general catalog describing Amertran audio parts and power amplifiers.

Name

Street and No.

Town State

Mobile Radio Services

(Continued from page 946)

with what frequencies, power, etc.

The Radio Division of the Department of Commerce, organized in June, 1910, had complete charge of radio activities in this country until the creation of the Federal Radio Commission in 1927, and is still charged with the licensing of all operators, and the inspection of all stations, including those on shipboard, as well as certain other duties conducted under the direction of the Commission. Mr. W. D. Terrell, chief of this division, states that today there are approximately twenty-two hundred American flag vessels licensed for radio operation. During the past year over fifteen thousand and five hundred vessels required by law to carry radio cleared from American ports, the Radio Division report states. Of this number, the radio force was able to inspect and pass upon only eleven thousand, three hundred and thirty-four, indicating the need for more inspectors and additional sub-offices at minor ports. Of over three thousand voluntarily equipped vessels which cleared, only one thousand, two hundred and eighty-seven were inspected. Mr. Terrell explains that in the near future, however, sub-offices will be opened at the cities of Miami, Savannah, Galveston and San Juan, from which ports a considerable number of vessels now clear without inspection. It should be understood that these field men are required to inspect passenger-carrying steamers flying foreign as well as the American flag. Of the American flag ships licensed under the law, only about ten per cent. are required to carry radio equipment, the balance being voluntarily equipped to insure safety. The value and need of this sort of inspection is revealed when it is known that three hundred and eighty-two defects in radio installations were detected last year under inspection and corrected before the vessels were permitted to sail. In addition to these routine inspections, the radio inspectors also passed upon twelve hundred and eighty-seven applications for ship licenses, checking the equipment and reporting to the Commission.

Mobile Station Channels

According to the International Radio Telegraph Convention, a mobile station is one capable of moving and which ordinarily does move. Hence such stations include ships, aircraft, automobiles, etc. Similarly, mobile service means a service for radio communication carried on between mobile and land stations or between mobile stations communicating with one another. The maritime mobile communication channels assigned to this type of service in accordance with international agreement lie chiefly in what is termed the low-frequency or long-wave band, between 10 and 550 kilocycles, just below the broadcast band. These channels are shared by many stations being assigned in this country for ship, coastal, radio-compass and radio-beacon services. Certain additional maritime and aviation

channels lie in the medium-high frequency band between 1500 and 6000 kilocycles, and the high-frequency band between 6000 and 23,000 kilocycles.

Besides some twenty-two hundred non-government ships, several hundred radio-equipped governmental ships and over two hundred commercial aircraft, this government has licensed approximately ninety coastal stations for communicating with ships, one hundred aeronautical stations for communicating with aircraft, and about fifty municipalities for police communication with patrol cars. Certain press organizations are also using a few of the high-frequency mobile channels for transmitting news to vessels at sea. Installations of radio compasses on United States commercial vessels now number 832 and on governmental vessels 436, making a total of 1268, compared with 2285 foreign vessels so equipped. There are now eighty radio beacons on our coasts and approximately that number operate on foreign shores.

Pertinent Laws and Regulations

Operators of ship and coastal, as well as all mobile stations, should be familiar with the International Radio Convention and Regulations (copies are available from the Superintendent of Documents, Government Printing Office, Washington, D. C., Treaty Series 767, price thirty cents), and the Radio Acts (same source, price five cents).

Among the pertinent General Orders of the Commission are Numbers 51, 70, and 82, relating to the limited use of damped wave apparatus or the old spark sets; General Order 74 covering allocations in the band 1500 to 6000 kc.; General Order 75 concerning procedure when cited by inspectors. Orders 79 and 83 are regulations pertaining to stations in Alaska; 85 on police service; 88 covers channel separation in the band above 1500 kilocycles; 89, on filing of renewal applications; 90, requiring the posting of station and operators' licenses; 93, on practice and procedure before the Federal Radio Commission; and 95, relative to assignment or transfer of radio stations. Number 99 covers aeronautical regulations and channels; 100, marine relay or coastal station regulations, and 101 extends the licenses of ship stations above 1500 kilocycles; aeronautical and aircraft stations, coastal and certain other stations until April 1st, and Alaskan stations until June 1, 1931. Ships assigned channels below 1500 kilocycles, however, not covered by this order, must comply with the general procedure of applying for license renewals thirty days prior to the expiration of their yearly licenses. The Commission, although it may license stations other than broadcasting for five years, is not disposed to do so yet, preferring to follow the present system of annual issuance.

Those ships which still used damped waves or spark transmitters, covered by General Orders 51, 70 and 82, are now

(Continued on page 948)

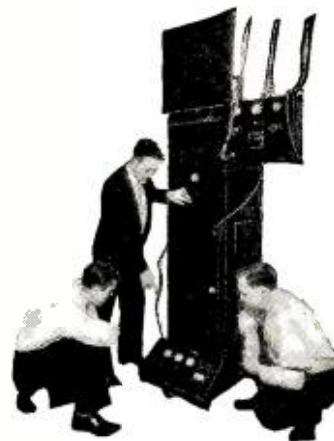

. . . Get the
RADIO
TRAINING
you need at home
in your spare time

IN order to help you learn radio in the shortest possible time, RCA Institutes, Inc., was established. You may study radio at home in your spare time . . . or at any one of the Institute's resident schools throughout the country.

It is not hard to study radio the way it's taught by RCA Institutes. You learn radio by actual experience on the latest type of radio equipment. And you need not give up the position you now hold. You can study an hour a day or any number of hours a day at home in your spare time.

The RCA Institutes Home Laboratory Training Course teaches you in a most thorough manner. You learn about servicing and selling, operating, radio telephony and telegraphy...also instruction in sound motion picture installation, maintenance and repairs. And you receive at no additional cost the complete RCA Institutes' home laboratory equipment, a modern outlay of apparatus furnished to every student, enabling you to easily solve radio problems.

Home Training Course by America's Finest and Foremost Radio Training Organization

This home training course and free laboratory equipment are backed by more than twenty years' experience.

Send for our FREE BOOK Today!

Everything you want to know about radio . . . describes in detail the home training that has placed thousands of men in good paying positions.



RCA Institutes, Inc.

RCA INSTITUTES, Inc.,
Dept. EX-4
75 Varick St., New York, N.Y.

Gentlemen: Please send me your FREE book which tells about the many opportunities in Radio and about your famous laboratory method of radio instruction at home.

Name-----
Address-----

Occupation-----



Span the World with this Set!
 A new radio thrill for you! Listen in DIRECT to London, Paris, Berlin, Buenos Aires and other broadcasting stations throughout the world via short waves. Enjoy unique foreign programs from strange lands. Your ordinary receiver cannot tune in these low wave stations. **WORLD-WIDE RECEIVER** gets 14 to 550 meter stations with surprising clarity. **SEND NO MONEY!** Just write your name and address on a postcard and ask us to send you this wonderful guaranteed short wave set. Pay postman \$6.45 plus a small delivery charge. All orders West of Rockies must be accompanied by \$1.00 deposit. Foreign countries must remit in full. Order today!

NEW RADIO BARGAINS
 Low Power Transmitter adaptable for phone or code. With plug-in coils \$14.75
Auto Radio—Uses 3—224, 2—227 tubes and 1—245 power tube, single dial, tremendous volume. Compact. Fits any car. We guarantee this set to perform better than sets selling up to \$150. . . 20.00
B Eliminator, Bone Dry, with 280 tube, 180 volts, will operate up to ten tube set, fully guaranteed. . . 6.75
AC—A B C power packs 8.75
 Tubes: UX type, 30-day replacement guarantee, No. 210, \$2.25; No. 250, \$2.35; No. 251, \$1.85; No. 245, \$1.25; No. 224, \$1.25; No. 227, 75c; No. 228, 65c; No. 171, 75c.
International Microphone, two-button, for public address systems and transmitters, speech or music \$9.75
 WRITE FOR BARGAIN CATALOG
CHAS. HOODWIN CO.
 4240 Lincoln Ave., Dept. D-3, CHICAGO

JOBBER SERVICE DEALER

We repair all makes power units, dynamic speakers, sets, etc. Try our service.

We manufacture new condenser, choke and transformer replacement units for jobber—dealer. Repairs on all makes.

MOE VERITAS METALLIZED RESISTORS

2 Watt 30c (Any Resistance) 5 Watt 50c

National distributors of the famous ACME Replacement Power and Audio Transformers—for all radios.

New merchandise—not surplus left over

MOE MFG. CO., MELROSE, MASS.

Largest Radio Repair Service in U. S. A.

Write for Free Catalog

ACCOUNTING

New Revised Home-Study Course Now Ready
 The uncrowded, highly paid profession of Accountancy offers marvelous opportunities. Send for "The Accountant—Who he is, What he does, How to become one," and first lesson. Both sent free. State age and position.
INTERNATIONAL ACCOUNTANTS SOCIETY, Inc.
 A Division of the
Alexander Hamilton Institute
 Dept. 166, 3411 South Michigan Ave., Chicago, Ill.

SEND FOR **FREE CATALOG** JUST OUT
COAST TO COAST RADIO CORPORATION
 HEADQUARTERS—ALL RADIO SUPPLIES—PARTS
 142-N LIBERTY ST. NEW YORK CITY

Massachusetts Radio and Telegraph School
 18 Boylston Street, Boston
 Send for Catalogue
 Tel. Hancock 8184 Established 1905

Mobile Radio Services

(Continued from page 947)

only permitted to operate on the following channels: 375, 410, 425, 454 and 500; the last being the international marine calling and distress channel. These channels are respectively 800, 723, 700, 660 and 600 meters. The international regulations also permit, with restrictions, the use of the channels 665, 1000 and 1364 kilocycles, but they are not approved for use by spark transmitters in this country.

Aeronautical and Aircraft Stations

At present, aircraft, even when carrying passengers, are not required, as are passenger ships, to be equipped with radio, although it is highly desirable. The Commission specifies its requirements and the channels available for aeronautical ground and aircraft radio stations in General Order 99. Only companies which cooperate in the use of chain frequencies are authorized to operate ground stations along the particular airways. These stations are required to accept any public business relating to the safety of life and property. Similarly, licensed aircraft, be they transport or itinerant, must comply with regulations and handle pertinent and emergency messages on the channels assigned.

The distress, calling, radio-compass and navigational channels, other than those assigned to chains or airways, are:

278 kilocycles, calling and working frequency for all ground stations to aircraft, the power being limited to 15 watts;

333 kilocycles, the International calling channel to be used outside the United States between craft of the air and for-

eign ground stations;

375 kilocycles, the general radio-compass channel;

500 kilocycles, the International calling and distress frequency for ships and aircraft over the seas;

3,106 kilocycles, National calling and working frequency for all itinerant craft in talking to ground stations;

5525, 11050 and 16580 kilocycles, primarily assigned to coastal stations and ships but also designated for use by aircraft over seas when calling coastal and ship stations; and 414 and 457 kilocycles, working frequencies for aircraft on sea flights requiring international channels. Upon application certain channels assigned for marine calling and working may also be used by planes over seaways.

Specific channels, over 2300 kilocycles, other than those listed above, are assigned the main airways as grouped by the Commission under the heads of mobile and fixed services, as recounted in General Order 99. The order also specifies certain regulations, including a limit in power of 1 kilowatt to an aeronautical ground station on channels above 1500 kilocycles, and 50 watts to planes. Ground aeronautical stations maintain a watch on designated channels for messages and distress calls just as do ships and coastal stations.

Literally, police and geophysical services, since they are chiefly mobile, should be included in this article, but due to the lack of space and because they can perhaps be better covered under the head of special services, such discussion will be reserved until the next article of this series is published in a subsequent issue of RADIO NEWS.

Pick-up Characteristics

(Continued from page 934)

a minimum of vibration from the head is transmitted to the cabinet.

As the weight of most pick-ups is very scant, in order to minimize record wear, it is usually necessary to apply some additional weight in order to arrive at the actual characteristic of the armature system in itself. This characteristic may vary considerably from the normal curve of the device in its commercial form. Our consideration of the pick-up as involving primarily nothing but a damped vibrating reed must therefore be modified to some extent, so far as the low frequencies are concerned, to allow for imperfect mounting of the vibrating system.

Under this head comes also the pivoting of the armature. The latter is usually mounted in rubber bearings. As the upper end of the armature is also held between rubber buffers, there is bound to be a certain amount of lateral motion in the

bearings, the extent of this depending on the relative stiffness of the buffer mounting and the bearing mounting. As the rubber in the bearings ages and breaks down, this lateral motion becomes quite considerable, thus introducing a marked secondary resonance in the pick-up characteristic. The use of rubber is perhaps the most unfortunate feature of the present-day pick-ups. It has many initial disadvantages, and in the course of time tends to break down completely.

Limitations in Design

In designing pick-ups we are limited basically by the record itself. This consists of an almost microscopic groove in a very fragile compound with a shellac base. We can apply only a very limited pressure against this fragile tracing.

On the other hand, we demand from the pick-up a voltage output sufficient to
 (Continued on page 952)

The Service Bench

(Continued from page 912)

technician and not a mechanic; he should dress accordingly."

It appears there is dignity in radio servicing. Victor continues:

"The conduct of the serviceman in the customer's home is a subject which has at one time or another been the cause of concern on the part of practically every dealer.

"Your job as a serviceman is to keep the instrument in perfect operating condition, and to keep the customer in a satisfied and happy state of mind. To do this successfully you must be thoroughly sold on the product yourself as the salesman was who made the sale. You cannot otherwise expect to go out into the trade and radiate confidence in the machine and optimism in regard to its performance.

"One of the first principles of salesmanship is that the customer is always right. Of course you will not agree with him in your own mind at all times, and it is then that he should be shown, not through argument, but through constructive explanation that he has been misinformed.

"After you have adjusted the instrument, be sure to instruct the customer carefully in the operation. Explain the importance of correct tuning, and of controlling volume with the volume control rather than the tuning dial."

Our Own Set of Rules

And to these words of wisdom we add our own personal instructions to servicemen, gleaned both as customer and expert.

1. First find a convenient place to lay down and spread out your tools. The top of a grand piano is very convenient for this purpose. The tools may be nicely displayed to impress the customer, and the area is sufficiently large to catch the screwdrivers and pliers when tossed in the general direction of the piano.

2. When you arrive, always complain of the cold. The customer may offer you a drink.

3. Regardless of what is wrong with the receiver, inform the customer that it is antiquated, and he needs a more modern set, and that you can sell him one at a discount. This will show him that you are interested in his welfare.

4. Drop cigarette ashes, and if possible a butt or two, on the rug. This leaves a lasting impression, and the customer will think of you the next time his radio goes out of order.

5. When using the customer's bathroom, wipe your hands on the towels before washing them, as this lessens the chance of dirtying the wash bowl.

6. Always criticize the pictures on the walls and the general furnishings of the house. This will show the customer that you have taste and are used to working in the best of homes.

7. Kick any piece of tape, insulation, nuts, bolts and hunks of stray wire under the chair or couch. Neatness is appreciated by the customer.

8. If you blow a fuse, discontinue work immediately, but return early the

next day with new fuses.

9. If company is present, use profanity in doing delicate work, as this will show them that you are a man of force.

10. Do not lay a hot soldering iron on a bare table top. Put a book under it.

Radio Set Census by States

Having completed its census of American radio receiving sets on April 1, 1930, the U. S. Census Bureau hopes to have the total compiled by April 1 of this year. In the meantime, it is issuing, as fast as they can be compiled, the "radio set populations" by states. The first state count last week showed that New Hampshire, with 119,660 families, has 53,111 with sets. In other words, 44.4 per cent. of the families of the state have radios. The second count released showed Delaware, with 59,295 families, has 27,183 or 45.8 per cent. owning radios.

Vagaries of Short Waves

(Continued from page 930)

have found that one or more storms usually occur during the life of any particular sun spot. Extensive experiments show that magnetic storms pull the most

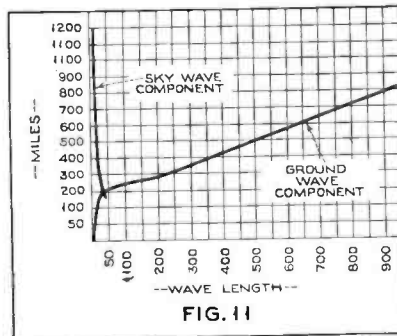

Figure 11. The general relation between the ground wave component and the sky wave component

delicately balanced needles more than 1½ degrees out of the magnetic meridian.

The phenomena known as the Aurora is believed to be caused by sun spots which also set up magnetic fields about the earth. We know that the electrons in the atmosphere are affected by the earth's normal magnetic field which causes them to move about in spiral fields. Could it be possible that the optimum wavelength of this motion may coincide with that of our shorter wave radio emissions, causing such violent rotation of plane of polarization of the emitted radio wave during severe magnetic storms that acute absorption results along the route in which they travel in high altitudes?

The Two Latest Books on RADIO SERVICING—

Official Radio Service Manual
and Complete Directory of All Commercial Wiring Diagrams
Edited by HUGO GERNSBACK

Radio Service Man's Handybook
With Addenda Data Sheets

THE OFFICIAL RADIO SERVICE MANUAL is the greatest achievement ever attempted in the Radio Service Field. It is not only the OFFICIAL RADIO SERVICE MANUAL and Complete Directory of all Commercial Wiring Diagrams, but it contains a complete and comprehensive course of instruction for radio service men. Just off the press and more than 19,000 copies sold. And why not, when it fills such a universal need among Manufacturers, Jobbers, Dealers, Service Men and all interested in radio? The OFFICIAL RADIO SERVICE MANUAL is complete and gives you every circuit of every set manufactured of which there is any information. Its looseleaf and flexible leatherette covers enable additional servicing data to be added periodically. There are hundreds of time-saving kinks which will help to increase your business and profits.

As the NEW YORK SUN says, "It is difficult to see how any service man can conduct his business satisfactorily and efficiently without this 350-page volume".

Hundreds of diagrams, 200 pages, 9 x 12 inches

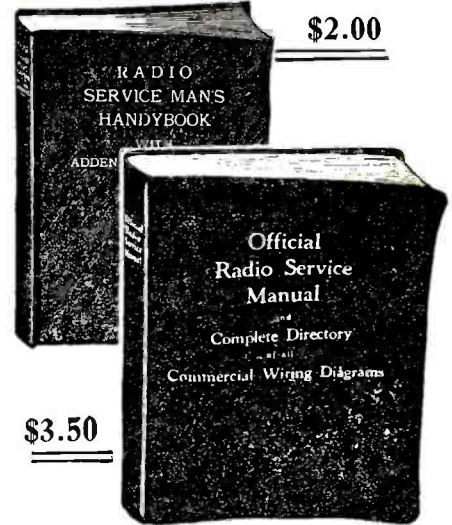

Over 1,000 Diagrams and Illustrations—352 Pages

The RADIO SERVICE MAN'S HANDBOOK contains a tremendous amount of authentic material and practical information on: Modernizing old receivers; Servicing obsolete sets; Repairing power packs; Construction of test laboratory equipment; Vacuum tubes; Set testing with analysers and hundreds of other similar subjects. Among the contributors are Bertram M. Freed, Leon L. Adelman, Paul I. Welker, Sylvan Harris, C. W. Palmer and others.

The HANDBOOK enables service men to record notes, diagrams and charts on the special 48-page section of specially ruled sheets included in the book. Over 200 pages in all—size 9 x 12 inches.

▶ BOTH BOOKS for \$5.00 ◀

Mail Coupon TODAY!

GERNSBACK PUBLICATIONS, Inc. RN-4
95-98 Park Place, New York, N. Y.

I enclose herewith check or money order for \$.....
for which you are to send to me postage prepaid the
() Official Radio Service Manual.....\$3.50
() Radio Service Man's Handybook..... 2.00
OR BOTH BOOKS FOR \$5.00.

Name

Address

City

State

In the RADIO NEWS Laboratory

(Continued from page 914)



**ALL PROGRAMS
Are Good With a
FILTERMATIC
FOR ALL RADIOS**

ONLY \$1.00 POST PAID

Entirely Automatic
No Bothersome Tuning
Improves Tone—Reduces Static
Brings in Distance
Increases Volume
Prolongs Life of Tubes
Separates Stations

Send Cash or P. O. Money Order

Satisfaction Guaranteed or Money Refunded

**AND NOW!
THE SUPER-FILTERMATIC \$2.00
AERIAL OF THE FUTURE** Post-paid

The Filtermatic Mfg. Co. wishes to introduce a remarkable invention, named the SUPER-FILTERMATIC, which takes the place of all present type Aerials, in addition to having all the wonderful features the Filtermatic has, such as improving tone, reducing static, bringing in distance, increasing volume and separating stations. The SUPER-FILTERMATIC will never wear out due to its rugged construction. It is very compact measuring only 1 1/2 x 2 inches, is absolutely non-directional, non-corrosive. It does not connect in the light socket; all A.C. hum and line noise are eliminated, it is easy to install (one minute time required), no tools needed, once installed no further attention required. It is the equivalent of an outside aerial 75 feet long and 50 feet high, more than sufficient for the modern set. The SUPER-FILTERMATIC is being introduced at the special low price of only \$2.00 postpaid. Satisfaction guaranteed or money refunded. Just stop and think, of the trouble and expense the Super-Filtermatic will save, if used to replace the expensive, unsightly dangerous outside aerial. THE SUPER-FILTERMATIC IS THE AERIAL OF THE FUTURE.

**SERVICE MEN & Dealers Write for
Our Attractive Offer**

FILTERMATIC MFG. CO., Dept. B-10
4458 Frankford Ave. Philadelphia, Pa.

The MARS SUPER-MIDGET

\$55.70 LIST

No other midget performs like the MARS. A coast to coast receiver of exceptional quality. For daytime reception. Deep tone & sweet, clear & toned circuits. Super-dynamic speaker. Tone Control. "T. I. K." coil. Power Audio. 4-Gank Condensers. A real radio—just an imitation. Dealers, Service Men—WRITE! Dealers asking real money. MARS Super-Midget. Customers buy on first demonstration. Exclusive territories. Write for profit-making proposition.

COMMONWEALTH RADIO MFG. CO., 555 W. Harrison St., Cable: RADCOM. Chicago, Ill.

HOME-STUDY BUSINESS TRAINING

Your opportunity can never be bigger than your preparation. Prepare now and reap the rewards in earlier and larger success. Free 64-Page Books Tell How. Write now for book you want, or mail coupon with your name and address in margin today.

- Higher Accountancy
- Mod. Salesmanship
- Traffic Management
- Law: Degree of LL.B.
- Commercial Law
- Industrial Mgmt
- Banking and Finance
- Telegraphy
- Rail. Station Mgmt
- Railway Accounting
- Paper Salesmanship
- Business Mgmt
- Business Cases.
- Credit and Collection
- Correspondence
- Modern Foremanship
- Personnel Mgmt
- Expert Bookkeeping
- C. P. A. Coaching
- Business English
- Commercial Spanish
- Effective Speaking

LASALLE EXTENSION UNIVERSITY
Dept. 494-R Chicago

Dealers and Service Men Send for the Latest Issue of

NUBOR FLASHES

It contains hundreds of Radio and Electrical bargains
Have You Received Your Copy?
NUBOR RADIO CO., 14R Warren Street, New York City

New Ellis 2-Button HAND-MIKE

ELLIS Model 12N Hand Microphone employs the same patented buttons used in our most expensive broadcast models. Diphthongs in a special convex gold plated metal. Especially recommended for home recording, portable public address outfits, home and industrial talking picture machines. Write for specifications. List price without cord, \$25.00. Export "Simmons." 25 Warren St., New York. Cable: "Simmons"

ELLIS ELECTRICAL LABORATORY
337 WEST MADISON ST. Sales Corporation Chicago, Ill. 606

piece fourteen inches wide by seven and one-half inches deep, with the corners cut away as per dimensions shown in Fig. 7. The thickness of the lumber used must be three-quarters of an inch. The unit block at rear of base should measure two and one-quarter inches square and three and one-half inches high. The unit stick (to which the magnetic unit is to be attached) must measure two and three-eighths inches wide, ten inches high and half an inch thick.

The magnetic unit should be the one known as a "B.B.L.," coming in a red box with an orange label. The unit known as a manufacturer's type B.B.L., while by no means worthless, should not be used for this particular job if the writer's guaranteed results are to be secured. The genuine B.B.L. provides double the volume of any ordinary unit and cannot be excelled for our purpose. Of course, some other may be used if insisted on, but that will be an experiment on your part, and as the design of the various magnetic units is different, the method of attaching some of them may not be convenient or easy. It will be noted that the B.B.L. unit is mounted on an upright stick, with one end free, in which way some undesirable frame vibration is avoided. The small strut, or retaining bar, at back of stick, which is connected to unit by two bolts and nuts, may be of metal, but in the event that you are unable to obtain, or make, this item, use a bar made of hard wood. If perchance you have no brace and bit to bore the two bolt holes, burn them with a heavy nail, or an ice pick, heated red hot.

Having put the frame together, using both glue and nails to insure rigidity, the next thing will be to saw a segment off the front of frame just half an inch deep. Lay this half-inch shallow frame aside and on the front of the three-inch deep portion of the frame proceed to stretch and tack the baffle cloth. This cloth, when tightly stretched and tacked on the frame with No. 2 tacks, is painted ("doped" we call it) with airplane dope such as was used in the making of airplane loud speakers two years ago. Do not use lacquer dope, as it usually sets too stiff and contracts rather severely.

The making of the cone will, at first glance, look like a simple job indeed. As a matter of fact, it is not what you might call a difficult task, but one must take pains if an evenly balanced cone is to result, with a perfectly fitting apex. The fit of the apex is everything. Don't forget that. Its angle must agree with the angle of the cone. On this demand being properly met will depend largely the character of the tone you will get. An ill-fitting apex will mean distorted music. The angle of the apex should be as near 125 degrees as possible for best results, and the underpart of the nut which goes on the apex bolt should be beveled, so that it will fit snugly into the apex. If there be no bevel, the edge of nut will tend to spread the apex angle when you

screw the nut down tightly, resulting in an unnatural strain. Be sure that the apex is accurately centered in the cone before tightening it permanently. The bolt must not lean to one side even in the slightest degree. Only by being precise in such details will best results be secured. If you fail to get tip-top results, you will have only yourself to blame.

Now as to the cone itself. The choice of material is limited. If one is to get a clean, firm tone, the standard cone paper popular about three years ago will not be A-No. 1. There is, however, a very good material known as artist's Bristol board, two-ply. The natural finish is the best, not the glossy finish, although either may be used. Ask for Bainbridge's or Reynolds'. It is usually obtainable at any artists' materials counter and will cost you only around thirty cents for a sheet measuring twenty by thirty inches. If you have never rolled a cone before, it would be well for you to experiment on a piece of heavy brown wrapping paper or a side cut from a cardboard suit box. It is likely that some of you may get an apex slightly different in degree of angle, which possibility precludes the writer giving universally applicable data on cone measurements. He will, however, give the measurement of the cone used by himself, and each experimenter can make his own slight variations in fitting the apex, if necessary. Draw a circle on your material measuring thirteen and one-half inches across (diameter). As few of you will have a pair of compasses large enough to inscribe this size circle, take a strip of cardboard eight inches long and half an inch wide. Punch a hole at extreme end with an ice pick; then, seven inches away at other end of strip, punch another hole. Through the first hole put the point of the ice pick and hold it at center of cone paper on a table, put point of a lead pencil through hole at other end of cardboard strip and inscribe the desired circle. Having cut around edge of circle with a pair of scissors, find which way the paper rolls the easiest, which will be the way the grain runs. From the center hole of the circle, right through to the edge, make a clean cut the way of the grain. By thus cutting along the grain the cone will roll more readily into a well formed shape.

Now examine Fig. 8 very carefully and draw pencil lines on the paper to guide you in cutting out the V-shaped piece correctly. To decide just how much overlap to allow for gluing, roll the cone into shape on a table top and while keeping the seam in place with left hand, put one of the apex shields into cone and see if it fits snugly. If it does not, contract or expand the angle of cone until it seems all right, then with a pencil draw a line on the cone to show just how much the overlap is, cut out the V piece and allow no more than a quarter of an inch for the gluing margin. When you glue the seam of the finished Bristol board cone, use a light application of hot glue no thicker than ordinary cream, pressing the joint

(Continued on page 951)

In the RADIO NEWS Laboratory

(Continued from page 950)

thoroughly and repeatedly from end to end until it adheres. If you rush this part of the job you may find that the joint will force itself open at spots. Hold it down until it sticks thoroughly and makes a perfect joint, particularly up near the apex.

Now to make the necessary hole for the apex bolt. Around the pointed apex of the cone, draw a pencil circle that will be approximately three-eighths of an inch across, then, with the corner of a Gem razor blade, or any other, start cutting around the circle a bit at a time. Don't try to slice the whole top off, like taking the top off a boiled egg. It can't be done neatly. Having cut the hole nice and level (not lopsided, remember), put on the apex shields (one inside and one outside) and the bolt and nut. The bolt goes in from the outside of cone and the nut, of course, inside. Before tightening up the nut very firmly be sure that the apex is accurately centered, so that the bolt stands up straight. If it leans to one side at all, you will have trouble when you come to insert the vibrating wire of the magnetic unit. If this wire does not enter the bolt easily and freely when unit is placed in its correct position, there will be constriction and impaired tone quality.

Cloth Baffle

To return to the matter of the cloth baffle. Tack the cloth on the frame with No. 2 flat-head tacks placed approximately half an inch apart. Keep the cloth taut, without any pucker or wrinkle. Get a half pint can of airplane dope and a flat, medium soft paint brush two inches wide. Apply the dope freely and rapidly over areas of six inches or so at a time until you have worked over the entire surface. Brush the first coat (inside and out) well into the cloth and let it dry for twenty minutes or so. Then repeat the process. Let this dry half an hour or more and test by tapping the cloth with the fingers. If it is tight and resonant, like a drum, do not add more dope. This can be done (should it seem desirable) after you have attached cone and unit and tried out the speaker on your set. If you think results are good, leave well enough alone—unless you want to experiment. Remember, the cone can be removed without damage, the cloth taken off and another substituted, if desired.

We can now go about attaching the cone to the cloth baffle. Lay speaker frame face down on a table and place cone inside, the circle of it resting on the cloth, apex up. With magnetic unit attached to its holding stick (as shown in Fig. 6) place the end of unit wire in the cone apex bolt, see that cone is centered correctly on the cloth, then screw the unit stick, with its attached unit, to the wood block on baseboard. With cone centered on baffle and unit stick in proper place on block, move unit up or down stick until everything is centered, then tighten the two bolts and nuts in the retaining strut and anchor the unit in this

setting. Now take hold of the cone apex and press down gently so that rim of cone touches the cloth all the way round. Retain it in this position by tightening the little setscrew in the apex bolt so that it grips the unit wire. Using a tube of either Dupont's or Collin's transparent cement, squeeze a ribbon of cement along edge of cone where it touches the cloth. This will set hard enough to use after two hours, but it will not become thoroughly hard for twelve hours, and the cone will not sound at its very best until then.

All that now remains to be done is to draw a circle with a pair of compasses on front of cloth. Let this circle be an inch smaller than the circle of the cone. Then take a safety razor blade and cut out the cloth along the line of this circle, thus revealing the interior of cone. The speaker may now be tried out.

And now for the reason we sawed off the half-inch section from the front of wood frame. We now put this section back in its original place on the main frame, attaching it with six one-inch flat-head screws, with the heads countersunk. In this way we conceal the tacks around edge of cloth baffle. But that is not the real reason. The detachable section was primarily designed for the purpose of keeping the ornamental front covering, or grille, from resting on the sensitive doped baffle cloth, thus avoiding any dampening of the vibrations—an important consideration.

Painting the Frame

The wood frame may be painted with black brushing lacquer, which the writer has found to be more satisfactory than any other type of finish for all ordinary use, and much less trouble and expense than staining and polishing.

To make a really first-class job, the half-inch deep section ought to be sawed off with a circular machine saw. For those, however, who have no such facility in their neighborhood, the frame may be left in one piece, and instead of using an ornamental silk covering, or grille, over face of speaker, they may paint the front of cloth baffle with Woolworth's ten-cent brushing lacquer (black) and cover up the cloth tacks with some kind of wood moulding, either just plain strips or something on the order of picture moulding. The Woolworth kind of brushing lacquer is not the type advised against at the beginning of this article and may be used with impunity if not used too copiously.

One final word of advice: For the first two or three weeks, release the small setscrew in the apex every other day or so for just a moment and then tighten up again. This will relieve any undesirable pull on the unit vibrating wire due to any contraction of cement or dope likely to occur during the first week or two. Also be sure that your set, your batteries and your tubes are all in good condition before testing out this speaker. Then you will surely get the excellent results guaranteed.

MEN WANTED 20 to 35 years old

RADIO First Lesson Free!

Broadcasting
Television
"Talkies"
Manufacturing
Service
Sales
Auto-Radio
Aviation

See how easy to learn

See how quickly you can get ready for well-paid positions in fastest growing, most prosperous industry.

Big demand *right now* from employers for broadcast operators, testers, inspectors, service-men, designers, installers, and "trouble-shooters".

\$40 to \$75 a week—and more!

With free radio lesson we'll send you our amazing combined training and employment agreement—good for help in securing a beginner's job *when you're only half way through*. Guarantees you help in finding a position, satisfactory in salary, after you finish, or money refunded.

A World of Opportunities to Choose From

Rockefeller is building a \$500,000,000.00 "radio center" in New York. 20,000 movie theaters have gone "talkie". Auto-radio is selling like wild-fire. Midget sets are selling at rate of 10,000 a day! Aviation, television, servicing, sales—all these mean highly paid jobs and plenty of them. All you need to get one is the kind of training we give you, backed by a real placement service.

Lesson FREE! Mail Coupon

for free radio lesson and book of thrilling facts about this wonder-industry and how to "break in."

American School
Dept. R-480, Drexel Ave. &
58th St., Chicago



**RADIO TESTER
GIVEN**

\$20.00 set analyzer and trouble-shooting job-tickets a part of this training without extra charge.

THE AMERICAN SCHOOL
Dept. R-480, Drexel Ave. & 58th St., Chicago

Please send without cost or obligation, free radio lesson and job ticket and radio bulletin.

Name.....Age.....
St. No.....
City.....State.....

1931 Radio CATALOG

RADIO BARGAINS
WHOLESALE DISCOUNTS
LOWEST PRICES

REGULAR WHOLESALE TRADE DISCOUNTS!

Nationally-advertised, guaranteed radio merchandise, including the sensational **BONDED LAFAYETTE ALL ELECTRIC RADIO RECEIVER** with tone control. Write at once for **FREE 1931 Radio Bargain Catalog**, showing complete selection. *Don't buy until you see this wonder catalog!*

WHOLESALE RADIO SERVICE CO.
Dept. D-12, 38 Vesey St., New York

FREE!

RACON PRODUCTS

FOR SOUND REPRODUCTION!
..... ARE UNSURPASSABLE!

Newest Storm-proof Horn



TRUMPET HORN
(Illustrated)

Bell 22 inches round, length 40 inches. Equipped with cast aluminum ferrule and suspension ring. For Public Address and all Outdoor use. This horn has been perfected after years of exhaustive research in Racon Laboratories. Will withstand all weather conditions. Requires no replacements or servicing after heavy rainstorms. Guaranteed for one year. Prices slightly higher than regular horns.

Racon horns and units are covered by U. S. Patents Nos. 1,507,711, 1,501,032, 1,577,270, 73,217, 73,218, 1,722,448, 1,711,514, 1,781,489

Write for Catalog Containing Complete Line
RACON ELECTRIC CO., INC.
The largest horn speaker manufacturers in the world
18 WASHINGTON PLACE, NEW YORK
England and Canada

\$375

RCA SPEAKER CHASSIS

Identical chassis as used in R. C. A. Model 100B and 103 magnetic speakers. Note built-in output transformer—huge magnet—self bathing metal housing. Delivers great volume without rattling or distortion! 9" diameter—4 1/2" deep.

FREE

SEND FOR THIS BOOK JUST ISSUED

RADIO ENGINEERS' HANDBOOK

SET ANALYZER—TUBE TESTER

Resembles in appearance and construction most expensive and most elaborate testers. Tests (push-button principle) 0-7, 0-150v. A.C.; 0-20, 0-100 D.C. mills.; 0-10, 0-50, 0-500, D.C. Volts. Tests all type tubes. Complete with continuity test cables, other test leads, clips, leatherette case 7 1/2" x 9" x 3".

RADIO SURPLUS CORP.
56 N. Vesey St. New York

SERVICEMEN

Books
By John F. Rider

PRACTICAL TESTING SYSTEMS
A compilation of 84 different subjects relating to tests and testing systems of interest to Servicemen, Engineers and Experimenters. 147 pages, 99 illustrations. Printed. Bound in stiff canvas cover. Gold letters.
The New 1931 Trouble Shooters Manual, approximately 800 pages, will be ready about March 15th. **\$5**

Practical Radio Repairing Hints
A thorough and comprehensive discussion of practical radio repairing. Material up-to-date. 270 pages, 6 x 9. Printed. Bound in stiff canvas cover. 206 illustrations. **\$2**

These books are sold with a money-back guarantee.

RADIO TREATISE CO., INC.
1440 Broadway, New York City

- BETTER AMPLIFYING EQUIPMENT
 - SPECIAL MATCHING TRANSFORMERS
- FERRANTI, INC. 130 West 42d St. New York, N. Y.

MASON, FENWICK & LAWRENCE
PATENT LAWYERS
New York City Washington, D. C.
Established 70 years. Send sketches.
Electrical, Aeronautical, Refrigeration and Chemical Inventions carefully handled. Practice before the U. S. Courts and the Patent Office. Prompt and careful service. Write us. Protect your inventions.
TRADE MARKS REGISTERED

A Volt Ohmmeter

(Continued from page 915)

Clean off the meter glass thoroughly with the breath and a tuft of cotton and with a crow quill pen make a mark with india ink directly over the 3.75-volt division and mark this as 1, signifying "1,000." (See scale A in the accompanying photograph.)

Now assume various values of r such as 500, 1,000, 1,500, 2,000, 2,500, 3,000, 3,500, 4,000, 5,000, 10,000, 20,000, 30,000, 40,000, 60,000, 80,000, 100,000, and calculate the corresponding voltage readings that would be obtained were the test prods placed on the terminals of such resistances. Make the corresponding marks on the top of the glass directly over the point on the scale. In the photograph, Fig. 13, the lettering falls directly over the scale lettering and in photographing cannot be easily seen. However, only the numbers 1, 2, 3, 4, 5, 10, 20, 40, are placed on the glass, the rest of the intermediate calculations being remembered from a knowledge of the above values of r assumed. The other markings in between may be estimated by the eye closely enough and inserted if desired.

The limits of scale A are from 0 to 100,000 ohms, but the upper limits have to be very carefully estimated and read. To magnify the readings somewhat, when the resistance is well known to be above 15,000 to 20,000 ohms, a 22-volt battery is used, but only 18 volts are tapped into use. This is because 18 is exactly 4 times 4 1/2 volts. The reading with this battery will be just four times the volts read with the 4 1/2-volt battery. It is possible to go through and calibrate the scale again as in scale B, which it is seen goes from 13,000 ohms to 500,000 ohms. In this case the value to be used for A in the formula is 18 instead of 4 1/2 and it is apparent that no new calculations need be made, since all that is necessary is to multiply the 4 1/2-volt readings by 4 to get the 18-volt battery readings.

In using the B scale much caution must be used to see that not less than 13,000 ohms is ever allowed to come between the test prods, for the meter will go off the scale and possibly burn out. This latter scale is not to be recommended unless the serviceman is well experienced and not apt to be absent-minded. The 4 1/2-volt scale does very well in practically all service work.

Some pointers that are to be noted as additional conveniences are the use of pins that are cut off and hooked over in a short hook to keep them from pulling out and then inserted in the hole of the binding post and the binding head turned tightly and permanently down. All the binding posts are equipped in this manner as shown at D. The spade lugs of the accessories are then equipped with the bulldog clips shown at E and F which have been insulated with rubber tape.

There are many advantages in this design. The clips spin on the pin heads if the leads become twisted, thereby avoiding kinks in the leads. The heavy spring working on such a small point of contact on the pin insures high contact pressure at all times. The speed of hooking up the apparatus from post to post to make

different tests is incomparable. It is a great time saver and saves the binding posts. To make external hook-ups to the set, or in making any temporary hook-ups to anything, a dozen extra lengths of hook-up wire are equipped as the coil shown at G. These save much time in making test hook-ups since clipping is all that is necessary, and if more than one length is necessary, two may be clipped together to get any desired length. Some about a foot in length and others about 3 feet in length are a good assortment.

The test prods themselves were greatly improved by cutting off the nibs, drilling the remaining portion to the size of a "soft" phonograph needle, inserting such a needle and soldering in place, the finished job appearing as at C. The needles should be cleaned with emery or fine sandpaper after soldering. These are very useful in prodding insulation that would otherwise need to be cut to permit a test.

As a final note, keep the fingers off the ohmmeter glass, and clean with a brush. Dusting will be all that is necessary, and the calibration will last with very little repair being necessary.

V. V. GUNSOLLEY, St. Paul, Minn.

Some Pick-up Characteristics

(Continued from page 948)

actuate at full capacity the standard amplifier. The amount of audio amplification available in many modern radio sets is comparatively small. This requires the use of a sizable armature and of a powerful magnetic field. The sizable armature means heavy resonance within the musical band, and this in turn entails considerable damping, which in turn means stiffness. The stiffness in its turn entails a certain weight of pick-up head, to give the inertia necessary to resist vibration. And the stiffness and weight are the factors which tend to wear out the fragile record.

So the pick-up designer is hard put to it to gain the required output and at the same time spare the records. As a matter of fact the modern pick-up is much easier on the records than the old sound box used to be. And still we are getting voltage enough for most amplifiers. The most obvious way to improvement lies in more efficient coupling of the pick-up to the amplifier. This means either very high impedance pick-ups and careful shielding, or the use of the best possible coupling transformers. With a reduction in the output demands upon the pick-up, we can lighten up the armature, shove the resonance point up out of the musical band, eliminate damping, improve the tone quality, and further reduce the wear upon the records. These are the improvements which the future should bring us.

Grand Island Monitor Would Be DX Paradise

By Martin Codel

AMERICA'S magnificent new "policeman of the air," the constant-frequency radio monitoring station recently erected by the Radio Division of the Department of Commerce near Grand Island, Neb., is standing idle while traffic congestion grows more acute every day along the invisible roadways of the ether.

Although the federal government has expended about \$250,000 to build the station, which represents probably the most sensitive "radio ears" in the world, it has thus far failed to appropriate the \$100,000 or so necessary to man the station with adequate radio engineering personnel. Members of Congress, like Senators Dill and Norris, who have visited the station and expressed themselves as greatly impressed by its purpose, are bending their efforts to secure the much-needed moneys.

Engineers Needed

Thirty-six trained engineers are needed to enable radio's super-traffic cop to furnish "stop-go" instructions to radio stations in America and the rest of the world by standing continuous 24-hour watches to measure their signals. Only six are available, and they are finding little time away from their routine duties at the plant to attend the complicated apparatus of this receiving system.

The vast network of antennas, covering the better part of 50 acres in the midst of a sparsely inhabited prairie and located near the exact geographical center of the United States, is capable of receiving radio signals over the whole range of useful frequencies between 10 and 60,000 kilocycles (30,000 to 5 meters). There is hardly a radio station in the world with substantial power, whether it is broadcasting by voice or telegraph code, that cannot be tuned in at Grand Island.

Results of Tests

Tests already conducted have brought in stations on all the continents, including speech and music being broadcast on long, intermediate and short waves from England, France, Germany, Russia, Japan and Java. By certain manipulations of the antennas, it is possible even to discern at least the call letters of low and medium power stations all over North America which are being badly heterodyned because their wavelengths are so crowded. Grand Island would be a veritable paradise for the DX or distance-hunting radio fan, if that were its purpose. But its real purpose is much more serious than mere play.

Designed by S. W. Edwards, former federal radio supervisor at Detroit, and built under his direction, the Grand Island monitoring station was installed to enable the federal authorities to measure frequencies against precision standards established by the U. S. Bureau of Standards in collaboration with other countries; that is, its highly sensitive apparatus is designed to determine whether

radio stations are operating on their assigned wavelengths.

Broadcasting, ship, aviation, military, police and in fact any stations on the air that are within tuning range can have their "bearings" taken at Grand Island to learn whether they are operating up to standard. The apparatus at Grand Island is so sensitive that its measurements are precise to within one part in one million. This knowledge is particularly important in view of the international uses of radio waves, the interference that prevails between many national services and the utter necessity of maintaining order on both domestic and international radio channels—subjects that have led to previous international treaties and that will lead to the revision of those treaties at Madrid in 1932.

First Accurate Checking Method

"This is the first efficient method that has ever been devised to let us know whether stations are on their wavelengths," said Senator Dill, following his visit at Grand Island. "There isn't anything anywhere in the world like it. The station is important to other countries as well as to the United States. I regard it as one of the greatest technical steps ever taken toward improving the conditions prevailing in the ether, which everyone knows are bad."

Senator Dill has introduced a bill appropriating \$55,000 for two more buildings and the acquisition of more land for the vast antenna system. He wants the money for the personnel of the station made available, at once, also. Otherwise it will continue to stand idle, or at least partly idle, until Congress meets again. As matters stand now, it is as though the government had ordered the finest automobile ever made, and then denied its employees the funds needed to purchase gasoline with which to run that car.

A Simple But Efficient Ohmmeter

(Continued from page 915)

meter.

V—Jewell or Weston 0-5-50 voltmeter (see text).

B—One 4½-volt "C" and one small 45-volt "B" battery.

Bakelite panel 7" x 10" x 3/16" (with walnut face).

JAMES H. MILLS, South Haven, Mich.

Recording Rehearsals

To enable artists to hear themselves as other would hear them on the radio, Station WGY, Schenectady, has installed a film sound recorder on which auditions and rehearsals are recorded. When the film is reproduced through a loud speaker, the performance is heard precisely as though it were broadcast.

USE a REESONATOR for

Sharp Tuning
Distance and Power



Now Only \$3.95

NO—the Reesonator is not new—it is an instrument which has been on the market for over three years and we have over 40,000 satisfied customers throughout the United States, Canada; in fact, the Reesonator is in use throughout the entire world. Its principle is used in most high powered, modern sets of today. The Reesonator will increase the selectivity and power of your machine to the equivalent of two extra tubes. The Reesonator will enable you to play distant stations with dance volume, that were barely audible without it. It is connected across aerial and ground wires, and can be done by anyone without tools in a minute. The Reesonator is only recommended for sets having an untuned antenna or floating tube, such as: Atwater Kent models 30, 32, 35, 37, 38, 48 and 49; Radiola models 16, 17, 18, 33, 51 and 333; Crosley Bandbox and Jewelbox and most models in Victor, Temple, Silver-Marshall, General Electric, Westinghouse, Apex radios and many others.

F. & H. CAPACITY AERIAL

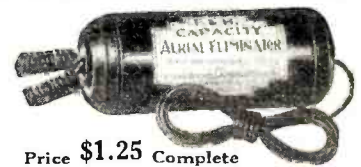

Price \$1.25 Complete

Every Instrument Tested on Actual 1000 Mile Reception

The F. & H. Capacity Aerial Eliminator has the capacity of the average 75 foot aerial 50 feet high. It increases selectivity and full reception on both local and long distance stations and is absolutely guaranteed. It eliminates unsightly poles, guy wires, mutilation of woodwork, etc. It does not connect to the light socket and requires no current for operation. Enables set to be moved into different rooms with practically no inconvenience. We predict this type of aerial will be used practically entirely by in the future. Installed in a minute's time by anyone. Return in three days if not satisfied. **Some dealers handle our line. Dealers! Over 80 leading jobbers carry this line; or order sample direct.**

ITEMS SHIPPED POSTPAID

Name

Address

City

State

Included find check M. O. for \$.....

or send C. O. D. items checked, under three-day trial money-back guarantee.

REESONATOR

F. & H. Capacity Aerial Eliminator

Literature Dealers' proposition

F. & H. RADIO LABORATORIES
FARGO, N. DAK., Dept. N

DEALERS AND SERVICEMEN!

Standardize on

LYNCH METALLIZED RESISTORS

For Permanent Replacement—Accurate—Guaranteed

Write for descriptive catalogue "N"

LYNCH MFG. CO., INC., 1775 B'way, N. Y.

DEALERS AND SERVICEMEN

SEND FOR IT

Federated Purchaser

20 Hudson Street New York City

Write for Your FREE Copy of this BIG Catalog 40 PAGES OVER 1000 ITEMS OF REPLACEMENT PARTS FOR ALL STANDARD SETS

SHORT WAVE WITH YOUR PRESENT RADIO



“THE SUBMARINER”

Short wave reception from all parts of the world is enjoyed by many users of “Submariners.”

No need to buy a special short wave receiver, as the “Submariner,” attached to your receiver in a few seconds, will bring in reception for only a fraction of the cost.

“Submariners” are available designed for operation with each type of receiver. They are priced from \$17.50 to \$27.50, with fixed wave band of 19-50 meters, or interchangeable coils of 12-145 meters. The “J” feature, an exclusive “Submariner” achievement, enables you to get superior results with all of the newest receivers. The model JAY, 19-50 meters, at \$22.50, or the JIAY, 12-145 meters, at \$27.50, have a tremendous wallow when attached to the

NEW SCREEN GRID SUPER-HETERODYNE receivers.

ORDER TO-DAY

Sent postpaid upon receipt of price, or C. O. D. if \$1.00 accompanies order. Foreign—Cash with order.

J-M-P MANUFACTURING CO., INC.
3417 Fond du Lac Ave., Milwaukee, Wis., U.S.A.

SOLDER LIKE A PROFESSIONAL with the “Esico Junior”

Reg. U. S. Pat. Off.

Every radio worker—amateur or professional—needs this iron. A high grade 85-watt tool at a moderate price. Plugs in any current; heats quickly; stays hot! Same features as the famous “Esico” Heavy Duty types used by U. S. Navy and leading radio mfrs. Replaceable forged copper tip; grade A nickel chrome heating element; heat-insulated handle, dark mahogany. Length 13 1/2 in.; wt. 1 lb.; 6 ft. cord, complete, \$2.75. Send to us direct if your dealer can't supply you.

Electric Soldering Iron Co., 135 W. 17th St., New York, N. Y.

LEARN BY LISTENING

Telegraphy
Morse or Continental

Step into this interesting—uncrowded—HIGHLY PAID Profession. Become a trained operator in Morse or Radio Code, easily, quickly, at home, with TELEPLEX, the Master Teacher. Used by the U. S. Government and leading schools.

Write for Folder B-4

TELEPLEX CO.
76 Cortlandt St., New York, N. Y.

Learn AT HOME
With



Teleplex

The CROSLLEY ROAMIO

AUTOMOBILE RADIO RECEIVING SET

MILLION PARTS

Replacements for Freshman, Freed - Eismann, Earl, etc., sets. Freshman Volume Control Model N (250 Job), if you send in your defective Volume Control \$.75

If you don't send it in 1.35

Replacement R.f. coils each .35

Grid suppressors, 250, 400, 600, 600 ohm. doz. 1.00

EXPERIMENTERS RADIO SHOP
129 West Street, N. Y. C. Price List Just Out

Brass Pounding on the Pan-Am Trail

(Continued from page 887)

doublet. The plate potential is full wave rectified. The receiver is similar to that used in the flying equipment.

Both aircraft and ground stations operate on the aircraft frequencies assigned by the Federal Radio Commission. Traffic is generally cleared on the 5650 k-c band. When interference is experienced a shift may be made to 6400 k-c, and for long daylight distances the 9400 k-c band is employed. These frequencies provide consistent daylight communication up to 3500 miles. On the 54-meter band, the planes can be depended upon for a reliable daylight range of 800 miles.

Direction-finding Apparatus

Direction-finding apparatus has been developed employing directional antennas both on land and on the planes. The larger planes carry loops, while the pilots on all planes may avail themselves of the

ica, when the motor conked north of Cuba and forty miles from the nearest land. The story of our SOS and the assistance rendered by the Pan American

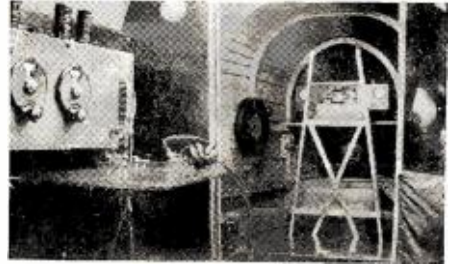

The receiver and operator's table in the Sikorsky “Creole”

station CMM, at Bayamo, was told in the last issue of RADIO NEWS.

This company is taking full advantage of the possibilities of aircraft radio, and in so doing it is making genuine contributions not merely to the development of aircraft radio apparatus but to the general promotion of air transportation.

Hospital Headphones Replaced by “Talking Pillow”

Description: It is not often that a radically new device presents itself even in such a rapidly advancing field as radio. The talking pillow shown here seems to be one of the exceptions to the rule. In hospitals radio has been found invaluable in helping patients to pass the time, but, particularly in wards, the use of headphones has been imperative because of the disturbance to others that might be caused by a loud speaker in operation. But to one who has worn headphones for

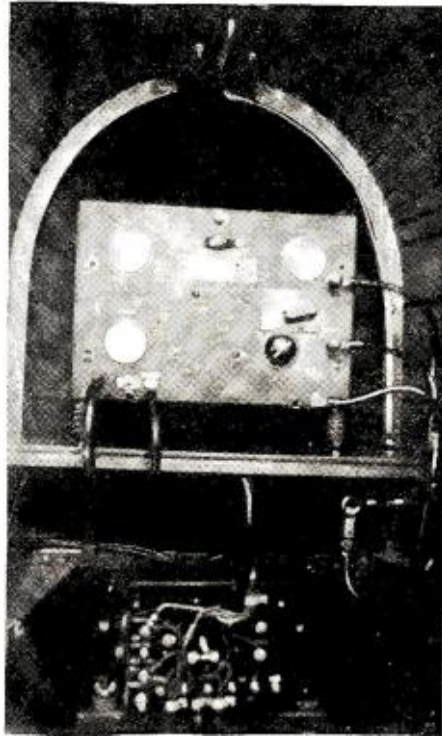

The transmitter in a Sikorsky plane



bearings transmitted from the ground. The lower aircraft frequencies are used for d-f work.

Radio operators have excellent positions. Their salaries are good, their employers reasonable and the work, particularly on the planes, is most fascinating. The operators are competent to a high degree. They hold first grade commercial licenses, or better, and are good for thirty words a minute clean copy.

It is some time since we worked a Pan Am station, but it is doubtful if we shall ever forget the occasion of our last QSO. This was on the return flight of the ill-fated “Pilot Radio” from South Amer-

any length of time no explanation of their discomforts will be needed. This pillow is of soft sponge rubber with a reproducing unit concealed in its depths in such a way that the programs are clearly audible to the person using the pillow and to that person only. It is equipped with an extension cord for connection to the radio set or other source of programs.

Usages: As a substitute for headphones to eliminate the discomfort which accompanies the wearing of this type of reproducer for any length of time.

Maker: RCA-Victor Company, Inc., Camden, N. J.



Tallest Hotel in the World
—
46 Stories High

Chicago's
MORRISON HOTEL
Corner Madison and Clark Sts.

The Morrison Hotel is closest in the city to stores, offices, theatres and railroad stations. All rooms are outside with bath, running ice water, bed-head lamp and Servidor.

1,950 Rooms—\$2.50 Up
Write or Wire for Reservations



GEARS
In stock—immediate delivery
Gears, speed reducers, sprockets, thrust bearings, flexible couplings, pulleys, etc. A complete line is carried in our Chicago stock. Can also quote on special gears of any kind. Send us your blue-prints and inquiries.
Write for Catalog No. 40
CHICAGO GEAR WORKS
769-773 W. Jackson Blvd., Chicago, Ill.

In SCIENCE AND INVENTION
For April

Who Said—"No More Gold Rushes"?—Orville H. Kneen tells us all about that ever fascinating quest of man—the search for Gold, and explains its economic importance.

My Wireless Memories and Inventions—for the past fifty years Sir Ambrose Fleming has been doing electrical engineering and radio experimenting. . . here are his impressions of the people he worked with and the products he invented.

Canned Sunshine for Live Stock—Gene A. Day presents a fascinating tale of scientific achievement in irradiating goats, cows and poultry.

When the Earth Quakes—Just what happens when the earth trembles and quakes? The Rev. Joseph Lynch, of the Seismic Station, Fordham University, tells you.

Strong Man Tricks Which You Can Do—It's how you do the trick, says Seymour A. Davidson, who lets you in on several of the vaudeville strong man's stunts.

When Scientists Blow Soap Bubbles—Soap bubbles may mean the difference between life and death to an aviator. . . read just how.

How You Can Photograph the Stars—the amateur astronomer; Overhauling Your Outboard Motor, for the motorboat enthusiast; Taking Care of Your Car, for the motorist; Try These in Your Own Workshop, and For the Home Machinist.

Radio Equipped Toy Balloons to Aid Aviators—How the army uses toy balloons for determining wind variations at high altitudes.

Behind the Scenes of a Nationwide Broadcast, and What's New in Radio, for our radio fans.

Several How to Make Its, including: New Tools You Can Easily Make; An Indian Tent Light; A Jig Saw for Your Workshop; A Mechanical Trainer in which you can learn to fly on the ground; Experiments with Sunlight.

Testing the New Circuit

(Continued from page 891)

enough to be received without any audio-frequency amplification such an arrangement simplifies the apparatus. If, however, an audio-frequency amplifier is used a simple correction circuit *must* be inserted between the second detector and the first audio tube. This is shown in Figure 3. The second detector is resistance-capacity coupled to the first

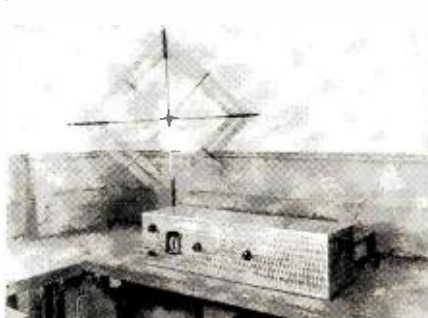

A laboratory model of the Stenode for broadcast reception

audio tube, the coupling condenser being made much smaller than the conventional value so that the amplification of the lower frequencies is enormously reduced. This simple arrangement will enable the receiver to be used for 'phone work, although it may be found necessary to increase the audio-frequency amplification slightly. This correction circuit, it should be noted, may not be found necessary if only code signals are to be received and the frequency of the heterodyne note is kept fairly high, say two thousand cycles.

The above, however, is only a brief outline of some of the circuits which may be employed to design a Stenode receiver for use on the amateur bands. To experiment on such receivers is fascinating because of the virgin field of experimental work for the amateur when new facts about the circuit may be brought to light.

Urges New SOS Waves

An international regulation reserving a block of high frequencies (short waves) for SOS calls is urged by Capt. S. C. Hooper, director of U. S. Naval Communications, who points out that the present distress frequency of 500 kilocycles (600 meters) is often inadequate over vast expanses of water like the Pacific, Indian and South Atlantic oceans. The 500-kilocycle frequency's daylight range is about 500 miles and at night it carries perhaps 2,000 miles. Ships in distress are sometimes farther than that from other ships or from land stations and hence in danger of having their SOS signals go unheard, according to Capt. Hooper. Periodical watches should be maintained on a set of high frequencies as well as the present intermediate distress frequency, he maintains.

SERVICEMEN-DEALERS
You need this Book!

TELLS how to service any and all sets with a mere handful of **CENTRALAB** Volume Controls. 22 volume control circuit diagrams—index covers hundreds of sets.

The only book of its kind ever published. Send at once.

Centralab
922 Keefe Ave.



MAIL COUPON NOW

CENTRAL RADIO LAB.
922 Keefe Ave., Milwaukee, Wis.

Here is 25c. Send me new VOLUME CONTROL GUIDE.

Name

Address

City State

R. News



Hi 31

CUSTOM BUILT RADIO

Send 10c for This Helpful Book

FORTY-EIGHT pages of valuable radio information, including a complete description of the remarkable "HiQ-31" Custom-Built Radio. Contains 57 illustrations, graphs and charts, with a handsome gravure insert on cabinets, and chapters on meters, testing, antenna design, house-wiring, tube characteristics, amplifiers, sound installations, microphones, etc.

Every radio worker, amateur or professional, should have a copy of this helpful book at the special price, 10c. Use coupon in ordering.

HAMMARLUND-ROBERTS, Inc.
424-438 W. 33rd St.
New York

HAMMARLUND-ROBERTS, INC.
424-438 W. 33rd St., New York
Enclosed 10 cents (stamps or coin) for 48-page "HiQ-31" Manual.

Name

Address

RN-4

Read Classified Advertising—It Pays

Advertisements in this section twenty-six cents a word for each insertion. Name and address must be included at the above rate. Cash should accompany all classified advertisements unless placed by an accredited advertising agency. No advertisements for less than 10 words accepted. Objectionable or misleading advertisements not accepted. Advertisements for these columns should reach us not later than 1st of 2nd month preceding issue.

Agents

Guaranteed Genuine Gold Leaf Letters anyone can put on store windows. Large profits, enormous demand. Free samples. Metallic Letter Co., 422 N. Clark, Chicago.

New, Vest Pocket Adding Machine—adds, subtracts like \$100 machines—costs only \$2.50. Lightening fast. Guaranteed accurate. Sells on sight to offices, stores, homes—all who use figures. More than half profit. Write today for FREE SAMPLE offer and full details. Cleary, 303 West Monroe, Chicago, Dept. 17.

Business Opportunities

FREE BOOK, Start little Mail Order Business. Hadwll, 38-A, 74 Cortlandt Street, New York.

Correspondence Courses

Used correspondence school courses sold on repurchase basis. Also rented and exchanged. Money-back guarantee. Catalog free. (Courses bought.) Lee Mountain, Pisgah, Alabama.

CORRESPONDENCE COURSES—Sold, Bought, Exchanged, Rented, Bargain Catalogue Free. Handling, C-799 Broadway, New York.

Detectives

DETECTIVES. Work home or travel. Experience unnecessary. Particulars free. Write George Wagoner, 2190-X Broadway, N. Y.

For Inventors

INVENTIONS COMMERCIALIZED. Patented or unpatented. Write Adam Fisher Mfg. Co., 278 Enright, St. Louis, Mo.

Patent Attorneys

PATENTS—Write for Free Information. HOW TO OBTAIN A PATENT and RECORD OF INVENTION—or send Drawing or Model for Examination. Miller & Miller, Patent Attorneys (former Patent Office Examiners), 1006-D Woolworth Building, New York; 262 McGill Building, Washington, D. C.

PATENTS, TRADE MARKS—All cases submitted given personal attention by a member of the firm. Information and booklet free. Lancaster, Allwine & Rommel, 269 Ouray Building, Washington, D. C.

PATENTS—Advice and booklet free. Highest references. Best results. Promptness assured. Watson E. Coleman, Patent Lawyer, 724 9th Street, Washington, D. C.

Inventors—Should write for our Guide Book, "How to Obtain a Patent," and Record of Invention Blank, sent Free. Send model or sketch of inventions for our inspection and instructions free. Radio, Electrical, Chemical, Mechanical and Trademark Experts. Terms Reasonable. Victor J. Evans & Co., 922 Ninth, Washington, D. C.

Radio

Earn \$7 to \$10 spare time evenings servicing receivers. (No selling scheme.) Radio Doctors, Inc., 132 Essex St., Salem, Mass.

Song Poem Writers

SONGWRITERS! Advance royalty payments, new talking picture songs requirements, etc., fully explained in our free instructive booklet. Write today. Song poems examined free. Newcomer Associates, 1674-VV Broadway, New York.

COMPOSERS—VERSE OR MUSIC. Brilliant opportunity. Write at once. Van Buren, 2321 McClurg Bldg., Chicago.

SUBMIT THEME SONG POEMS. Hollywood Composers. Box 378 EX, Hollywood, Calif.

SONGWRITERS — Poems — Melodies — opportunity. Tommie Malle, ERG3706 Grand Ave., Chicago.

Wireless

LEARN WIRELESS (Radio) and Morse Telegraphy. School, oldest and largest; endorsed by Telegraph, Radio, Railway and Government officials. Expenses low—earn part. Catalog free. Dodge's Institute, Cour St., Valparaiso, Ind.



LEARN CODE AT HOME RADIO AND TELEGRAPHY
 Has Helped Thousands NOW! On Land, Ships, and Air—Your Career To Better Positions. Future is Secure. Know Code. The Auto-Omnigraph U. S. Govt. Depts., Colleges, Scientists, and Schools use it. Listening. Models \$15-\$40. Catalog Free.
 THE OMNIGRAPH MFG. CO., 810 E. 39th St., N-11, Brooklyn, N. Y.

Button Rupture Newest Way

Without Cruel Pressure

Science now advises discarding cruel steel springs, filthy leg straps and other ox-harness that severely press against the rupture and prevent nature from healing it. After thousands of test cases a new method has been perfected. It employs newest Magic Dot. Entirely new and different. It anchors in a way that allows circulation to heal where possible and of course permits the wearer to have consistent freedom of movement in safety. He can run, cough, bend, etc.

Magic Dot weighs less than an ounce. It comes to you on a generous Free Trial, by Actual Wear, and if you are not pleased, you have your money back. With it comes all needed accessories to allow you to abandon your present truss if you so decide. Users often forget they are wearing Magic Dot.

FREE SAMPLE

Try to write this very hour so as not to forget it. You will get an educational book and an interesting sample of material free of all cost or future obligation.

NEW SCIENCE INSTITUTE
 1483 Clay St. Steubenville, Ohio

In April "AMAZING STORIES"

ACROSS THE VOID, by Leslie F. Stone. (A serial in 3 parts) Part I. Once more this author comes forward with a tale of rare value in the field of scientific fiction. Many months ago, in her story, "Out of the Void," we got startling news from a distant planet, of which we of the earth had known nothing. Now, in this new, novel-length serial, we get the thrilling sequel, telling of the extraordinary adventures of the earth people, who had gone back with the strange visitor.

THE AMBIDEXTER, by David H. Keller, M.D. Obviously, even eminent surgeons of international fame are not immune to the tendency toward revenge. How another famous surgeon, in his supreme hour of need, trusts himself implicitly to this world-known colleague, and with what subtly drastic results, is exquisitely told in this extraordinary short story.

THE LAUGHING DEATH, by Stephen G. Hale. If an atom contains an almost limitless amount of energy, which, under the proper control, would yield enormous constructive power, what devastating destruction could such atomic energy, uncontrolled, exercise! Mr. Hale is, in our humble opinion, a real find for AMAZING STORIES.

THE MENACE FROM ANDROMEDA, by Nat Schachner and Arthur L. Zagat. The title and the names following speak for themselves.

TOO MANY BOARDS, by Earl Vincent shows how systematically things are arranged for our further misery—all done for our apparent good.

And other scientific fiction.

The Service Bench (Continued from page 911)

the complaint is low volume and few stations on many of the Radiola, Westinghouse and Graybar models. This switch is often inadvertently snapped, particularly when there are children in the family, and generally results in a hurry call for the serviceman.

"Complaints of noise, due to faulty tubes of the heater type, are common in the experience of the busy serviceman. The filament type of tubes rarely give trouble in this respect. But I have recently run into several cases where new -45s left satisfied clients. One case was a Majestic Number 20. The noise was particularly bad, and was accompanied with a faint flicker in the dial light. Everything tested perfect with my Jewell kit, and for apparently no reason at all new -45s did the trick. Probably something microphonic in the base.

"A somewhat similar difficulty was experienced with a Westinghouse W.R.5. Reception would be perfect for about ten minutes; and then the volume would drop to almost nothing. Heater tubes were naturally suspected, but once again it turned out to be the -45s.

"Watch out for heavy rubber covered lead-ins when the complaint is noise and a fluctuating signal. I ran into trouble with one of these that I had installed two years before. I knew the antenna was okay, and as far as I could see the lead-in was equally good. However, shaking it brought on the trouble, and it was finally located as a broken wire that had not injured the insulation. A fairly good way of definitely locating antenna or lead-in troubles is to drop a coil of wire out of the window as a temporary antenna.

(See the item under *Service Notes* for several aerials suitable for emergency and test purposes.—Ed.)

Hoover's Secretary to Dabble in Radio

With George Akerson due to sit in the councils of the Columbia Broadcasting System, which is half owned by the Paramount motion picture interests, there are those who think that President Hoover, who as Secretary of Commerce was the patron saint of American radio in its infant days, may be constrained to pay more attention to radio's manifold governmental problems.

Akerson, secretary and confidante of the President, left the White House on February 1 to take a public relations position with Paramount. Part of his duties will be to act for Paramount on radio matters, probably sitting with the network's board of directors. From "the chief" Akerson probably has learned considerable about radio, although since becoming President, Mr. Hoover, aside from appointing several radio commissioners, has conspicuously refrained from assuming any direct or indirect leadership in the development and control of that industry.

Testing Reliability of Amateur Radio

(Continued from page 907)

of any adventure, the following facts are recorded:

1. No mechanical or electrical breakdown was encountered in any piece or part of the apparatus. The receiver and transmitter worked as well at the close as at the start. (Careful workmanship and use of oversize parts pays in the building of any equipment.)

2. An average month's operation was crowded into five days with the resultant increase of wear and tear on apparatus.

3. New operators were tried "under fire." They had to keep going and could not afford to let contacts go. All the men have expressed their liking of such a test since their own efforts helped bring the excellent results obtained.

4. Due to the terrible weather, exact data on normal operation from Cleveland, could not be obtained. The resultant list of contacts shows that the signals from the East were considerably below par. For example, the almost total absence of Second District signals—and the same for the North Middle-West.

5. The tests were disappointing in one respect. The weather conditions made it impossible to tell when changes took place, since at no time were conditions normal for this season and locality. The snow produced abnormal results in reception, but apparently lessened the working range of the transmitter.

6. A large number of Ohio stations were contacted. This is unusual and likely due to an increased ground wave effect.

7. Many stations were contacted again and again. Some Sixth District stations were contacted several times. This points out that the outfit was consistently efficient, regardless of the effect of poor conditions.

The reliability test shows conclusively that a well-built amateur station can operate continually for days, without trouble of any kind, thereby coming near the peak of efficiency obtained by commercial and government stations—this without special apparatus. The test also showed that the new men can be counted on to do their best when occasion presents itself. The test roused considerable interest among the stations worked and many men expressed their desire to "be there and help."

Every contact will be "QSL-ed" by card. Many cards have been received and it is hoped that all stations will respond.

In conclusion: For all the men, scattered all over the country, who helped make the contest a success by either contacting or testing with W8AKA—we of the Cleveland Amateur Radio Association sincerely thank you and hope that you will call again!

The chart appearing with this article gives the coverage of station W8AKA during the test. The chart is laid out horizontally in ten spaces for each district in the U. S. A. (foreign contacts were not counted in this graph). Vertically, the time is shown for the entire twenty-four hours, in blocks of one hour each.

In the vertical lineup each space, blacked in, denotes a contact with the particular district, in the hour shown. For example; the total contacts made during the test, between the hours of twelve and one in the morning were—two with the fifth and one with the eighth districts.

For the purpose of analysis, we assume that the test ran an even four days, from midnight to midnight four days later.

A few of the interesting facts that can be obtained from this chart are listed here:

1. The greatest number of contacts, per hour, were made between the hours of six and seven P.M. These fifteen contacts were distributed over five districts.

2. The greatest number of districts were contacted between the hours of eight and nine A.M. when six districts were worked. The six were the first, third, fourth, sixth, eighth and ninth.

3. Contact was had with the west coast (sixth district) during eight hours of the twenty-four.

4. East coast contacts were quite below par—the log and the chart shows this. The first and second districts, usually very easy to work were poor during the test.

5. The third and fourth districts were much better than their neighbors, the first and second. The fifth was also much below its usual standards.

Stations Contacted During C. A. R. A. Test at W8AKA

W1atp, w1aki, w1awn, w1axr (2), w1bly (2), w1cde, w1crw, w1ctg (2), w1di, w1mg, w1zm.

W2asz, w2avs, w2bby, w2bpy, w2bwf, w2hxl, w2cl, w2db, w2lb, w2lt.

W3aao (2), w3aia, w3ajd, w3apj, w3aqk, w3bbb, w3bfh, w3cbv (2), w3sce.

W4aev, w4afm, w4ahl, w4aig (2), w4ei (3), w4if, w4hb, w4sg, w4ty, w4zzz (2), w5afz, w5agu, w5axu, w5azo, w5bad, w5bcx, w5hbh, w5brm, w5ew (2), w5gr, w5ke (2), w5zx.

W6bck, w6bcn, w6bdn, w6bfa, w6bht, w6bvr, w6byz, w6cel, w6cvf, w6cri, w6csp (2), w6der (2), w6dhp, w6eth, w6eqj, w6exq.

W7apr, w7vk.

W8aav, w8acz, w8adj, w8aog, w8apo, w8apy, w8aqz, w8ata, w8avj, w8axf, w8axm, w8axv, w8azu (2), w8bbv, w8bcf, w8beh, w8bi, w8bie, w8bkm, w8bhh, w8bs, w8bth, w8btm, w8bvs, w8bz, w8cbe, w8cfo, w8cgl, w8cha, w8ckx, w8clo, w8cmb, w8cqa, w8cqv, w8ctb, w8cvt, w8czn, w8det, w8dfe, w8dgp, w8dh, w8dlt, w8dnt, w8drs, w8dsq, w8kc, w8go, w8nt, w8oq, w8qq, w8tk, w8tm, w8tp, w8vk.

W9aad, w9aeb, w9afb, w9ase, w9azw, w9bbj, w9bjo, w9buv, w9cgc, w9cgh, w9civ, w9ciz, w9cne, w9cub, w9cuo, w9cws, w9dhh, w9dwa, w9dwl, w9eqg, w9eth, w9fbc, w9feu (2), w9fum, w9gbg, w9ges, w9ghk, w9giy (2), w9lf, w9rh, w9vl.

K4rj (2), k4ug, ve3dt, cn2cn.

"The Set Builders Use Kester"



so I do too!"

The men "in the know" solder radio connections with Kester Radio Solder every time.

The flux in Kester is a plastic rosin—highly non-conducting, non-corrosive characteristics that gives minimum resistance, thereby aiding receptivity.

And another thing! Kester Radio Solder carries its flux inside itself . . . and is so easy to use that anyone can get expert results with it. If you want more advice on this matter—just ask any service man, radio expert or manufacturer about Kester!

Try this safe permanent solder at our expense, or buy it from your radio store or other dealers. Kester Solder Company, 4201-13 Wrightwood Avenue, Chicago, Illinois. Incorporated 1899.

Write for a Free Sample

KESTER

RADIO SOLDER

TYPEWRITER 1/2 Price

Save over 1/2-Rock Bottom Price on all standard office models—Underwood, Remington, Royal, etc.—Easiest terms ever offered. Also Portables at reduced prices. **SEND NO MONEY** All late models completely refinished like brand new. **Full Guarantee.** Sent on 10 days' trial. **Send No Money.** Big Free Catalog shows actual machines in full colors. Greatest bargains ever offered. Send at once!

10-day Trial
231 W. Monroe St.
International Typewriter Exch., Dept. 493, Chicago

For Exact Radio Tube Voltage IN A. C. RADIO!

Only AMPERITE automatically insures stable line voltage for electric radio. AMPERITE saves trouble, saves tubes, saves service. No radio is modern without AMPERITE. The new AMPERITE can be installed in your electric set in five minutes.

Write Dept. R.N.-4 giving name and model number of your set.



AMPERITE Corporation
561 BROADWAY, NEW YORK

AMPERITE

Self-Adjusting
LINE VOLTAGE CONTROL

RADIO CIRCULAR CO.
225 VARICK ST. NEW YORK, N. Y.

Send for Our
BARGAIN BULLETIN

These money-saving bargains are typical of the many sensational radio values that we offer in our monthly bargain bulletins. Radio sets, speakers and accessories at amazing prices. Send for your free copy now. Use coupon below.

MISCELLANEOUS SPECIALS

Sprague Electrolytic Condenser.....	\$.95
Thorndarson R171 Power Compact.....	4.95
Telerad.....	1.80
Peerless ABC Power Transformer.....	4.75
Melofonic Speakers.....	2.50
Zenith Power Transformer.....	2.95
Shield, Cap and Base (set of 3).....	.10
Centralab Twin Potentiometer.....	.50
Soldering Iron.....	.60
Automatic Voltage Control.....	.50
United Electric Motor & Turntable.....	7.95
Philco Power Transformer.....	2.95
RCA Condenser Block (Part No. S333).....	1.50
Victor Replacement Condenser Block.....	2.25
General All-Purpose Condenser.....	.25
Utah Dynamic A.C. Power 33A Sp.....	6.50
Victor ABC Power Transformers.....	2.75
A. F. Kelford Shielded Transf., ratio 2-1.....	.75
Antenna Kit, complete.....	.55
7 Strand Copper Aerial Wire.....	.16
General Filament Switch.....	.20
Yaxley 2000 ohm Volume Control.....	.45
Indoor Ribbon Antenna.....	.36
Thorndarson Power Transformer (for sets using 226, 227, 245, 280).....	2.75
4 Gang Condenser.....	1.50
Frost Twin Volume Control.....	.39
Naald Bakelite Sockets.....	.10
Eby Twin Field and Sp. Posts, each.....	.20
Freud-Eisemann 8 point Switch.....	.20
Centralab Volume Control. 6000 and 9000 ohm. ea.....	.30
Freshman Basket Weave T.R.F. Coils (set of 3).....	.30
Freshman Output Transformer, ratio 1-1.....	.30
Extension Cord for Dynamic Speaker (20 ft.).....	.50
Aluminum Shields.....per dz.....	.75
Polymet 4 1/2 mfd. 400 volts, D.C. Condenser Block.....	.90
Polymet 3 mfd. Filter Condenser.....	.65
Paradon 6 mfd. Condenser Block.....	1.20
Dubilier Condenser, 5 1/2 mfd.....	1.50
Fada 1 mfd. 400 volts D.C. Cond.....	.50
Buffer 1 mfd. Condenser.....	.65
Kurz Kasch Port Dials.....	.40
Franklin Power Trans., Type 171A.....	2.65
Radiart Power Transformer, 171A and 245.....	3.95
Victor Input and Output Push-Pull Transformer.....	1.50
Crosley Dynacone Speaker Chassis.....	2.75
Bosch Speaker.....	3.50
General Replacement Transformer.....	2.75
Dumont AB Bone Dry Eliminator.....	15.50
Dumont 180 volt B Eliminator.....	8.95
Dumont Silent A Eliminator.....	9.50
Stewart-Warner Rotary Snap Switch.....	.15
Brandes Phones.....	1.25
RCA Loudspeaker 103.....	4.25
Kolster Magnetic K6 Sp. Chassis.....	2.45
Atwater Kent Replacement Transformer.....	1.50
Sprague Midcet Condenser, .001.....	.08
A.K. 37 Condenser Block Repl.....	3.95
Majestic "B" Eliminator Condenser Block.....	2.95
Potter High Voltage Filter Condenser.....	1.25
Voice Call for Dynamic Speaker.....	.95
Jefferson Step-Down Transformer.....	.95
Victor Resistor.....	.95
Baldwin Rival Unit.....	.75
F. & H. Caparty Aerial Eliminator.....	.75
Earl Speaker Output Choke.....	.95
I.C.A. Resistovolt No. 99.....	1.05
Potter 1/2 Mfd. By-Pass Condenser.....	.25
Crosley 1/2 Mfd. By-Pass Condenser.....	.25

All prices are F.O.B. New York City, transportation charges extra. Specify whether you desire shipment by Freight, Express or Parcel Post. 20% Cash must accompany all orders, balance C.O.D. Where full cash remittance is sent with order 2% discount may be deducted. All merchandise guaranteed to be exactly as represented.

BARGAIN BULLETIN COUPON

RADIO CIRCULAR CO.
225 Varick St., New York, N. Y.
Send me your bargain bulletins free of charge.

Name

Address

City State

RADIO CIRCULAR CO.
225 VARICK ST. NEW YORK, N. Y.

INDEX TO ADVERTISERS

A	
Acme Wire Company.....	942
Aerovox Wireless Corp.....	959
Alexander Hamilton Institute.....	948
American Sales Co.....	946
American School.....	951
American Transformer.....	945
Amperite Corp.....	957
Amrad Corp., The.....	941
B	
Baltimore Radio Company.....	960
Blan, the Radio Man.....	942
C	
Candler System, The.....	944
Cardwell Mfg. Co., The Allen D.....	946
Central Radio Laboratories.....	955
Champion Radio Works, Inc.....	929
Chicago Gear Works.....	955
Chicago Radio Apparatus Co.....	944
Clark Instrument Co., Inc.....	946
Clarostat Mfg. Co.....	946
Classified Advertising.....	956
Coast to Coast Radio Corp.....	948
Commonwealth Radio Mfg. Co.....	950
Coyne Electrical School.....	866-867
Crosley Radio Corp.....	954
D	
DeForest Radio Co.....	933
Drake Hotel.....	958
Dubilier Condenser Corp.....	942
E	
Electrad, Inc.....	960
Electric Soldering Iron Co.....	954
Ellis Electrical Laboratory.....	950
Excello Products Corp.....	960
Experimenters Radio Shop.....	954
F	
Federated Purchaser.....	953
Ferranti, Inc.....	952
F. & H. Radio Laboratories.....	953
Filtermatic Mfg. Co.....	950
G	
General Radio Co.....	937
Gernsback Publications.....	949
H	
Hammarlund-Roberts, Inc.....	955
Hammer Radio Co., S.....	942
High Frequency Laboratories.....	960
Hoodwin Co., Chas.....	948
I	
Insuline Corp. of America.....	943
International Resistance Company.....	931
International Typewriter Exchange.....	957
J	
J. M. P. Mfg. Co., Inc.....	954
K	
Kester Radio Solder Co.....	957
L	
La Salle Extension University.....	950
Ludy Hotel.....	933
Lynch Mfg. Co., Inc.....	953
M	
Mason, Fenwick & Lawrence.....	952
Massachusetts Radio & Telegraph School.....	948
McGraw-Hill Book Co., Inc.....	938
Metal Cast Products.....	960
Midwest Radio Corp.....	944
Moe Mfg. Co.....	948
Morrison Hotel.....	955
N	
National Co., Inc.....	935
National Radio Institute.....	Back Cover
New Science Institute.....	956
Nubor Radio Co.....	950
O	
Omnigraph Mfg. Co.....	956
P	
Pilot Radio & Tube Corp.....	869
R	
R.C.A. Institutes, Inc.....	947
Racon Electric Co., Inc.....	952
Radio Circular Co.....	958
Radio Surplus Corp.....	952
Radio Trading Co.....	958
Radio Training Association of America.....	865
Radio Treatise Co., Inc.....	952
Readrite Meter Works.....	936
Rim Radio Mfg. Co.....	940
S	
Shallcross Mfg. Co.....	938
Silver-Marshall, Inc.....	Inside Front Cover
T	
Teleplex Company.....	954
Traul Radio Co.....	937
U	
Uncle Dave's Radio Shack.....	944
V	
Van Nostrand Co., Inc., D.....	935
W	
Wellston Radio Corp.....	940
Weston Electrical Instrument Corp.....	939
West Side Y. M. C. A. Radio Inst.....	933
Wholesale Radio Service.....	951

"An Address of Distinction"



One of the World's Great Hotels

OUTSTANDING not only among the hotels of Chicago . . . but among all the hotels of the World. Costs compare favorably with other establishments where distinguished standards of service prevail. Rates begin at \$5 per day. Permanent Suites at Special Discounts.

THE DRAKE HOTEL, CHICAGO
Under Blackstone Management

F R E E



We have just issued our new "RADIO SERVICE TREATISE." It's red hot all the way through. 52 new hookups and circuit diagrams. 110 illustrations. Partial contents: Modernizing old radio sets. How to convert battery to power sets. Selection of tubes. The detector tube. The power tube. Changes in grid or "C" bias circuits. Push pull amplifiers. Replacing audio transformers. Phone attachments. How to choose power transformers. Voltage dividers. Wattage of power transformers. Selecting and installing replacement parts in radio sets. Filter condensers. Repairing "B" eliminators. ALL BRAND NEW DOPE-NOT A REPRINT. Send 2c postage. Catalog yours by return mail.

RADIO TRADING CO.
27 West Broadway, N. Y. C.

Build Your Receiver With the Aid of Blueprints!

A limited supply of blueprints still available on the following receivers:

The Junk Box Short Wave Receiver.

Milk Shaker Special Receiver.

How to Construct the Pre-Selector.

A Bloopless One-Dial Two-Tube Set.

Now only 25c each

Write to Radio News, BLUEPRINT DEPARTMENT, 381 Fourth Avenue, New York City.

The Service Bench

(Continued from page 911)

the edges and corners of a shield. It is used after the technique of a rolling-pin, but its weight and small size make it more effective for small work."

Save the Direction Sheets

"The information sheets that come with tubes, replacement transformers, etc., contain valuable information, and are well worth saving.

"Procure several large envelopes and a filing box to keep them in. Keep the tube data sheets in one envelope; in another put all sheets concerning resistors, etc. Mark the envelopes and add to them on every occasion. For practical purposes, this file is often handier than the finest radio book or manual."

Test and Demonstration Antennas

The serviceman and radio salesman will often have use for an emergency antenna—the serviceman in an effort to ascertain definitely whether or not the aerial circuit is at fault, and the salesman in making a home demonstration of a receiver.

A simple and effective antenna for the modern receiver, consists of fifty feet of wire stretched along the floor through two or more rooms, or dropped out of the window.

A "lead-in" caught under the hook of a telephone is remarkably effective. Also, a tin plate, connected to the antenna post, and placed under a desk-stand telephone, provides a satisfactory pick-up.

The serviceman should never be without a lamp socket antenna plug. An emergency plug of this type can be made by connecting two condensers in series across a standard light plug. The common connection of the two condensers leads to the antenna post on the set. The condenser may have any value from .1 mfd. up.

A heavy battery clip on the end of fifteen feet of wire makes it possible to ground the receiver on a convenient radiator.

Grading the Serviceman

By Walter J. Holmes

"WORKING conditions vary in different parts of the country, but the Mid West Radio Trades Association of Chicago have a plan that is of interest to every young man interested in entering the radio service business.

"The association maintains an employment bureau for radio servicemen and employers. In order to insure employers of getting men capable of doing the work for which they are hired, references are investigated and an examination is given all men who apply to this bureau for work. They are then issued rating cards according to their knowledge and experience.

"When the dealer or manufacturer wants a man he calls the association and explains that he wants a service manager,

serviceman or apprentice. Two or three men with the proper rating cards are then sent to interview the prospective employer, who may make his choice without unnecessary delay in looking up references or trying out the applicant.

"The examination is based upon education, practical experience, a written practical examination and a written theoretical examination.

"The subjects covered in the examination are the same for class A, B and C cards, though they are considerably wider in scope for class A.

"Men who receive class A cards must have a grade of 90 per cent. or over. They must have a total of five years experience, and have worked at the trade for at least eighteen months out of the past two years. Men holding cards of this class are entitled to act as service managers for any radio dealer, jobber or manufacturer.

"The holders of class B cards must have had at least twelve months experience during the two years prior to taking the examination, and their passing grade is 75 per cent. Men holding this card are recommended as regular servicemen.

"Applicants for both A and B cards are required to draw a diagram of any licensed radio receiver of not less than six tubes, including the rectifier. Class C applicants are excused from this.

"Previous employment is not required of an applicant for a class C card, which recommends him as an apprentice. But he must pass with a grade of at least 50 per cent. an examination on the general principles of electricity, the theory, adjustment, operation and care of modern broadcast receivers and associated apparatus.

"He must also have an understanding of the operation and care of storage batteries, motors and generators. Underwriters' regulations governing the installation of radio sets in homes, apartments, hotels, etc., are brought out in the examinations.

"Credit is given for experience, if any, in a radio dealer's store, or service as a commercial radio operator in the United States Army, Navy or Signal Corps.

"If a man fails to qualify, he may be re-examined after a period of three months. If he qualifies, but wishes to try for a higher rating, he will be permitted to take the second examination after six months."

Walker Made Examiner

With the appointment of Ralph L. Walker, for the last two years a member of the legal staff of the Federal Radio Commission, the staff of examiners of the Commission was increased thus to its full complement of four. The examiners conduct all the Commission's hearings, making recommendations as to the disposition of cases.



**Manufacturers of
The Most Complete
CONDENSER and
RESISTOR Line
in Radio**



Sent Free on Request

This interesting and helpful Manual and Catalogue containing a wealth of information on condensers and resistors and complete electrical and mechanical data on the complete line of Aerovox condensers and resistors will be mailed free of charge on receipt of the coupon below.



The Aerovox Research Worker is a free monthly publication issued to keep radio engineers, experimenters and servicemen abreast of the latest developments in receiver and power supply design, and especially with the proper use of condensers and resistors. A request on the coupon below will place your name on the mailing list.

Check and Mail This Coupon

AEROVOX WIRELESS CORP.
78 Washington St. April, 1931
Brooklyn, N. Y.

Gentlemen:

Please send me without charge or obligation:

- () Your 40-page Condenser and Resistor Manual and Catalogue.
- () The Research Worker.

Name

Street

City State



EXCELLO RADIO



MIDGET

Quadruple Screen Grid
with Tone Control

An ideal set that will meet the most exacting conditions and has every modern feature to insure fine performance.

Complete catalog free on request

EXCELLO

Products Corporation

4832 West 16th Street, Cicero, Illinois

ELECTRAD PERFECTED

Loftin-White AMPLIFIERS

Three of the finest expressions of the Loftin-White Direct-Coupled Amplifier System—designed and built by Electrad.

245, 250 and 250 Push-Pull Output—
\$40; \$87.50 and \$135 respectively.
(Complete, less tubes.)

Send 10c (stamps or coin) to Dept. RN-4 for new complete Electrad Catalog, 36 pages of useful radio information.

175 Varick St., New York, N.Y.

ELECTRAD
INC.

WANTED MEN
To Manufacture Metal Toys and Novelties

Big demand for 5 and 10c store Novelties, Ashtrays, Toy Soldiers, Animals, Auto Radiator Ornaments, etc. We cooperate in selling goods you make; also buy these from you. Small investment needed to start and we help you build up. WE FURNISH COMPLETE OUTFIT and start you in well-paying business. Absolutely NO EXPERIENCE and no special place needed. A chance of a life-time for man with small capital. Write AT ONCE if you mean strictly business and want to handle wholesale orders now being placed.

METAL CAST PRODUCTS COMPANY, Dept. 12
1696 Boston Road, New York City

FREE! FREE!

Send today for a copy of our latest Radio Bargain Bulletin full of real Bargains.

BALTIMORE RADIO CORP.
725 Broadway, Dept. "N", New York City

NEW KIND OF RADIO

New H-F-L Mastertone—new in magnificence of tone—new in power with world-wide reach—new in quick tuning—new in sensitivity and selectivity with a station at every point on dial. A new price—America's finest radio at amazingly low cost. FREE Book explains all. Send for it and Special Offer now.

HIGH FREQUENCY LABORATORIES
A-134, 3900 N. Claremont, Chicago

The Service Bench

(Continued from page 912)

operated, and were relatively free from noises occasioned by line leaks that cause so much trouble in a.c. operated sets.

“However, it was found early in the game that interference seemed to originate in the street lighting circuits, and these circuits were traced and retraced for leaks, crosses and other defects, without result. Finally the interference was traced right into the power house, and was found to be caused by the mercury arc rectifier tubes which were employed to rectify a.c. into d.c. for the street arc circuits. Two types of circuits are used in this city, d.c. circuits carrying magnetite arc lamps and using the rectifiers mentioned above, and a.c. circuits for incandescent lamps. It was found that these a.c. circuits did not radiate interference. The General Electric Company was consulted, and they submitted the design of a coil to be applied to the d.c. circuits which effectively eliminated the interference.

“In this work, a Radiola superheterodyne receiver built into a portable case with the batteries, was carried on the back seat of an auto, and the familiar loop aerial was used.

“We have also had considerable trouble from tree grounds, both on the street lighting circuits carrying up to 6000 volts, and on the 2300 volt primaries, which are, of course, the feeders running out of the substations and supplying the individual transformers along the streets.

“Since the use of electric receivers in large numbers, tree grounds on 110-volt lines which supply the house, have assumed a great prominence, due to the fact that the electric sets are connected directly to these secondaries.

Limits of Noise Area

“In tracing down these grounds, and in some cases grounds from metal objects such as pieces of wire thrown over the line wires, or crosses with other wires, we have found that the best procedure is to set the volume control so that the noise is very faint, and then to ride in all directions until the noise is no longer heard, in this way determining the limits of the noise area. We then find the actual trouble on the line by watching the lines and insulators as we ride along. When a certain pole seems to give the loudest response, a line man is sent up and the fuses and jumpers and switches are inspected and tapped with a switch stick while listening in on the set for any additional noise. In this manner any loose or poor contacts in the switches or fuses or jumpers will be shown up. In this connection we found it helpful at times to use a small auxiliary set, less sensitive than the super. to aid in narrowing down the interference area. In one case we found interference on a street light circuit and narrowed down the trouble to four lights, but we could not get a noticeable peak in volume from any one of the four. We then took a two-tube set and mounted it on a long

pole with a wire run up to the top of the pole. The set was held up to each of these lights in turn, and one showed a definite increase in volume. This was taken down, and proved to have a loose connection in the socket. In another instance a split insulator was found by a similar procedure.

“I should also like to point out the fact that the loop aerial does not seem to have the usual directive qualities when used in this work. We have found that it invariably points parallel to the power line. It is useful, however, when coming to the intersection of two lines, as it will indicate on which line the interference lies.

“We have had several baffling cases of trouble which serve to show how parallel wires pick-up interference and spread it far from the source. One case was that of a relay on a battery charger. The relay was stuck so that it fluttered constantly, and by its make and break action cause the interference to go out on the secondary line. However, it was not confined to this particular secondary, but was induced into the primary line, and carried to other secondary lines, causing trouble for several blocks around.

“Another case was that of a primary down tap which was swayed by the wind so that it touched a steel guy wire. This guy had an insulator on both ends. Nevertheless the interference was audible three blocks in every direction. Another instance was caused by a piece of hay wire that someone had thrown up over the wires, and which was touching one wire (2300 volts) and the cross arm. This leak could be heard six blocks away from the source.

“Just the other day our interference man found the cause of a heavy interference on a street light circuit. The wires passed through a tree, and the street lighting wires, being nearest the tree, were held away by means of a large porcelain screw knob. It was discovered that the current was passing through a place where the porcelain had broken through to the head of the screw, and thence into the tree and to the ground.

“The most baffling cases of trouble are those associated with the low voltage secondaries. These causes of interference do not affect battery receivers, but are severe with a.c. sets which are connected directly to these lines. These troubles consist of secondary tree grounds, bad wiring in houses, such as slight leaks and grounds and loose connections. Such troubles, in some instances, have to be individually investigated in each house. In a few cases, we have found that some secondary interference is caused by transformers with loose cores, those in need of refilling with oil or those requiring new primary leads and insulators.

“We have found that this work necessitates great patience and a certain persistence that will not leave anything untested, as often a little thing, seemingly quite innocent, is at the bottom of the trouble.”

The Most Fascinating Radio Book of the Year!



The Latest Most Authoritative Information Available on
SHORT WAVES

5 Big Months of RADIO NEWS for \$1.00 and this valuable book Free

THE thrill of the Short Waves! It's like the invention of radio all over again. If you've ever decoded messages straight from South Africa or Australia—if you've ever known the kick of getting Europe or Little America direct—if you've ever had SW chats with friends hundreds of miles away, then you know what we mean.

The Short Waves are opening up a tremendous new field of amazing possibilities. An entirely new world of experimenting, of thrills, of new experiences with these miraculous SWs lies ahead.

Because you and thousands of other radio men want to keep posted on all the latest wrinkles on Short Waves, the Technical Staff of RADIO NEWS has especially prepared a complete new, up-to-the-minute SHORT WAVE MANUAL.

Its twenty-three chapters, replete with illustrations, diagrams, charts and plans, bring you the results of years of research work by the foremost authorities in the field—the last word in authentic SHORT-WAVE data. Many of the chapters were especially written by that famous

SW expert, Lieut. W. H. Wenstrom. You will be fascinated with such features as:

- Breaking Into Amateur Transmitting SW Transmitter for the Average Home and Purse
- A Portable SW Transmitter and Multi-wave Receiver
- For Real Thrills Get Down in the Amateur Wave Bands
- Ready for a Short-Wave Chat
- Getting the Most from Your SW Transmitter
- Some Experiments on Ultra-High Frequencies
- Short-Wave Stations of the World

It is one thing to pound the key of a short-wave transmitter and hope to high heaven that your signals are "getting out." It is another thing to understand intelligently the conditions under which perfect results are secured and how to get the most out of Short Waves.

Here is the book that explains everything—that describes and illustrates all the new inventions and improvements —that gives you the complete and latest SW data. In short, here's just the book you want!

Many radio men have paid a substantial price for this book, but you may have it **FREE!** And besides save on your special 5 months' subscription to RADIO NEWS!

FREE
 You may secure the SHORT WAVE MANUAL without cost with a subscription to RADIO NEWS. See coupon below.

Mail Coupon TODAY!

RADIO NEWS, Dept. 2404
 381 Fourth Avenue, New York, N. Y.

Ship me ENTIRELY FREE the new SHORT WAVE MANUAL and enter my subscription for the next five big issues of RADIO NEWS at the special price of only \$1.00 which I enclose (regular newsstand price \$1.25).

Name

Address

City and State

Are you a Serviceman ? Engineer ? Dealer ? Experimenter ?

Present subscriptions will be extended from expiration.

Here are a few examples of the kind of money I train "my boys" to make

Started with \$5. Now has Own Business



"Can't tell you the feeling of independence N.R.I. has given me. I started in Radio with \$5, purchased a few necessary tools, circulated the business cards you gave me and business picked up to the point where my spare time earnings were my largest income. Now I am in business for myself. I have made a very profitable living in work that is play."

HOWARD HOUSTON,
512 So. Sixth St., Laramie, Wyo.

\$700 in 5 Months Spare Time

"Although I have had little time to devote to Radio my spare time earnings for five months after graduation were approximately \$700 on Radio sales, service and repairs. I owe this extra money to your help and interest. Thanks for the interest shown me during the time I studied and since graduation."

CHARLES W. LINSEY,
537 Elati St., Denver, Colo.



\$7396 Business in two and one-half months

"I have opened an exclusive Radio sales and repair shop. My receipts for September were \$2332.16—for October, \$2887.77 and for the first half of November, \$2176.32. My gross receipts for the two and one-half months I have been in business have been \$7396.25. If I can net about 20% this will mean a profit of about \$1500 to me."

JOHN F. KUK,
1514 No. Main St., Spencer, Iowa.

My Free book gives you many more letters of N. R. I. men who are making good in spare time or full time businesses of their own



Here you get the Tube Service Grid Tuned Band Converter set — only one of the many circuits you can build with my parts.



You'll get practical Radio Experience with my new 8 Outfits of Parts that I'll give you for a Home Experimental Laboratory!

My course is not all theory. You use the 8 Outfits I'll give you, in working out the principles, diagrams and circuits used in modern sets and taught in my lesson books. This 50-50 method of home training makes learning easy, fascinating, interesting. You get as much practical experience in a few months as the average fellow who hasn't had this training gets in two to four years in the field. You can build over 100 circuits with these parts. You experiment with and build the fundamental circuits used in such sets as Crosley, Atwater-Kent, Eveready, Majestic, Zenith, and many others sold today. You learn how these circuits work, why they work, how they should work, how to make them work when they are out of order.

I will show You too

how to start a spare time or full time

Radio Business of Your Own without Capital



J. E. Smith, Pres.,
National Radio Institute

The world-wide use of receiving sets for home entertainment, and the lack of well trained men to sell, install and service them have opened many splendid chances for spare time and full time businesses. You have already seen how the men and young men who got into the automobile, motion picture and other industries when they were young had the first chance at the key jobs—and are now the \$5,000 \$10,000 and \$15,000 a year men. Radio offers you the same chance that made men rich in those businesses. Its growth is opening hundreds of fine jobs every year, also opportunities almost everywhere for a profitable spare time or full time Radio business. "Rich Rewards in Radio" gives detailed information on these openings. It's FREE.

So many opportunities many make \$5 to \$30 a week extra while learning

Many of the ten million sets now in use are only 25% to 40% efficient. The day you enroll I will show you how to do ten jobs common in most every neighborhood, that you can do in your spare time for extra money. I will show you the plans and ideas that are making as high as \$200 to \$1,000 for others while taking my course. G. W. Page, 107 Raleigh Apts., Nashville, Tenn., writes: "I made \$935 in my spare time while taking your course."

Many \$50, \$60 and \$75 a week jobs opening in Radio every year

Broadcasting stations use engineers, operators, station managers, and pay \$1,800 to \$5,000 a year. Radio manufacturers continually need testers, inspectors, foremen, engineers, service men, and buyers for jobs paying up to \$15,000 a year. Shipping companies use hundreds of operators, give them world-wide travel at practically no expense and pay \$85 to \$200 a

month. Radio dealers and jobbers are continually on the lookout for good service men, salesmen, buyers, managers, and pay \$30 to \$100 a week. Talking Movies pay as much as \$75 to \$200 a week to the right men with Radio training. My book tells you of other opportunities in Radio.

I will train you at home in your spare time

Hold your job until you are ready for another. Give me only part of your spare time. You don't have to be a high school or college graduate. Hundreds have won bigger success. J. A. Vaughn jumped from \$35 to \$100 a week. E. E. Winborne seldom makes under \$100 a week now. The National Radio Institute is the Pioneer and World's Largest organization devoted exclusively to training men and young men, by correspondence for good jobs in the Radio industry.

You Must Be Satisfied

I will give you an agreement to refund every penny of your money if you are not satisfied with my Lessons and Instruction Service when you complete my course. And I'll not only give you thorough training in Radio principles, practical experience in building and servicing sets, but also train you in Talking Movies, give you home experiments in Television, cover thoroughly the latest features in sets such as A. C. and Screen Grid.

My 64-Page Book Gives the Facts

Clip and mail the coupon now for "Rich Rewards in Radio." It points out the money-making opportunities the growth of Radio has made for you. It tells of the opportunities for a spare time or full time Radio business of your own, the special training I give you that has made hundreds of other men successful; and also explains the many fine jobs for which my course trains you. Send the coupon to me today. You won't be obligated in the least.

Get my new book It points out what Radio Offers You



J. E. SMITH, President
Dept. 1-DR,
National Radio Institute
Washington, D. C.

THIS COUPON IS GOOD FOR ONE FREE COPY OF MY NEW BOOK **mail it TODAY**

J. E. SMITH, President,
National Radio Institute, Dept. 1-DR,
Washington, D. C.

DEAR MR. SMITH:—Send me your book. I want to see what Radio offers. I understand this request does not obligate me and that no agent will call.

Name

Address

City State

Get the facts on my Lifetime Employment Service to all Graduates