

COMPLETE BROADCAST CALL LIST

RADIO NEWS

**MARCH
25
CENTS**

**How to Build
THE MIGHTY MITE
A Midget
Superheterodyne**

**Feature
Articles by:**

**JAMES MARTIN
JOSEPH HELLER
DON BENNETT
B. B. BRYANT
ZEH BOUCK**

**and
Other Famous
Authors**



Removal Sale

Due to the tremendous growth of our business, we are forced to move to larger quarters, where we can give our customers prompt and efficient service and handle a larger variety and greater quantity of select radio merchandise.

SEND FOR OUR FREE BIG BARGAIN CATALOG!

BAL-RAD
Replacement
Block for
Majestic "B"
Eliminator



The condensers in this block are composed of high voltage condensers. Guaranteed for 1 year. Each **\$2.95**

PEERLESS
A.B.C. Power
Transformer



For use with 245, 280, 224, 227. Also has a 3-volt winding for 199 tubes or amperita voltage control. Our Price **\$4.75**

EARL & FREED
Power
Transformers



Our Price **\$4.50**

YAXLEY
2,000-Ohm
Volume
Control



For Radiola 17, 18, 32, 42, 44, and practically all sets. Insulating strip (easily removed) for metal panels. List Price 1.95. EA. **45c**

POLYMET



Hi-Volt 1 mfd. Filter Condenser. 300 Volts D.C. Each **35c**

Complete stock of replacement parts—all models
Brunswick-Radiola receivers

RPA-1 AP 947	RPA-3 AP 950	RPA-4 AP 832	RPA-5 AP 952	RPA-7 AP 991
Volume Control Potentiometers		Rectifier and Power Amplifier Assemblies Fixed Capacitors		Receiver Assemblies Catacombs

Write Us for Prices

BAL-RAD HY VOLTAGE

Surge-Proof Condensers for General Repair and Power-Pack Work

We guarantee these condensers for 100 percent. free replacement. Repairmen should carry a few dozen in stock.



	MFD.	Working Volts	Each
One	600	"	30c
Two	600	"	40c
Four	600	"	60c
One	800	"	50c
One-half	300	"	25c

Brach Bell Ringing Transformer. \$.85	Kolster Condenser Block..... \$.95
Naald Replacement Transformer— Ratio 3-1..... .50	Quam Magnetic Speaker..... 3.75
Philco Power Transformer— Model 87..... 3.95	Muter Dynamic Speaker..... 8.95
R.C.A. No. 64 Power Trans- former..... 10.90	R.C.A. 106 Speaker..... 14.50
United Electric Motor and Turn- table..... 6.50	Kolster K-6 Speaker..... 4.95
Pacent Phonovox..... 4.95	Brandes Type "H" Speaker..... 1.45
R.C.A. Power Transformer, Part No. 8335..... 3.95	R.C.A. No. 103 Speaker Chassis.. 3.25
R.C.A. Part No. 8333..... 1.50	Kolster K-6 Speaker Chassis..... 2.45
R.C.A. Part No. 5996..... .35	Baldwin Rival Unit..... .75
Zenith Power Transformer..... 3.50	Westinghouse PT Meters..... 1.00
Zenith Audio Transformer..... .95	4 Gang Condenser..... 1.50
Zenith Output Transformer..... .90	H & H Toggle Switch..... .20
Zenith Inter-Stage Audio Trans- former..... 1.25	H & H Rotary Snap Switch..... .25
Freshman Replacement Trans- former..... .45	Freed-Earl Wood Knobs...per doz. 1.00
Crosley double 30 henry Chokes.. 1.50	Insulated Staples.....per 1,000 .95
Polymet 2 mfd..... .55	Lead-in Wire.....100-ft. rolls .31
Potter 1/2 mfd. Condenser..... .25	Shielded Lead-in Wire— 50-ft. rolls, \$.60 ; 100-ft. rolls 1.00
Crosley 1/2 mfd. Condenser..... .25	Hook-up Wire.....25-ft. coils .12
	Push Back Wire.....100-ft. roll .50
	Crosley Crystal Detector..... .15
	Sonora 15-Volt Tubes.....ea. .75
	Sonora SO-1 Tubes..... 1.60
	Western Electric VT-1..... .35
	B.H. Type Tubes..... 1.85

PIGTAIL CARBON RESISTANCES

	Ohm	Ohm	Ohm
	500	15000	10000
	1000	25000	20000
		Megohm	
	4700	2	75000

\$1.00 Per doz.

**RCA VICTOR Uncased
Condenser**

1000 Volts D.C. Working Voltage

This genuine R.C.A. Victor uncased condenser is composed of the highest grade materials. They are compact and moisture proof. Impregnated in special heat resisting compound.

100% Replacement Guaranteed

1 Mfd.....	.35c	\$3.60 dozen
2 Mfd.....	.50c	5.50 dozen
4 Mfd.....	.85c	9.00 dozen

TERMS: 20% with order, balance C.O.D.
2% discount allowed for full remittance with order only.
NO ORDERS ACCEPTED FOR LESS THAN \$2.50

BAL-RAD
Replacement Block
For Atwater Kent
No. 37



This unit contains the proper chokes and high voltage condensers. All flexible wire colored leads identical to the original. Fully guaranteed. **\$4.95** anted Ea.

Thordarson
Power
Transformers
For Replacement in
Zenith Sets



Models ZE, 10-33-33X-34. This transformer can also be used for circuits employing the following type tubes: 5-227-1-171A-1-280. Our price... **\$3.50**

RCA CHOKE
COILS
15 Henries



Impregnated in Rosin. Ideal choke for use in "B" Elim. and A.C. Sets. D.C. Resistance 500 ohms. Each **25c**

POLYMET
By-Pass Tubular
Condenser



1mfd., 200 volts
Can be used across
Choke Terminals in
Victor Sets to reduce
hum. Per dozen **\$1.00**

TOGGLE
SWITCH



For Electric or
Battery Sets.
20c each

BALTIMORE RADIO CORP.

47-N MURRAY STREET,
NEW YORK CITY



RADIO NEEDS TRAINED MEN
Let Us Train You at Home for a Big-Pay Job

GET into the rich field of Radio via the Radio Training Association. Radio manufacturers, distributors, dealers are all eager to employ our members because we train them right, and qualify them for the positions that require better trained men.

So great is this demand from Radio employers that positions offering good pay and real opportunity are going begging. If you want to cash in on Radio quick, earn \$3.00 an hour and up spare time, \$40 to \$100 a week full time, prepare for a \$10,000, \$15,000, \$25,000 a year Radio position, investigate the R. T. A. now.

Special Attention to Radio Service Work

Thousands of trained Radio Service Men are needed now to service the new all-electric sets. Pay is liberal, promotions rapid. The experience you receive fits you for the biggest jobs in Radio. The R. T. A. has arranged its course to enable you to cash in on this work within 30 days!

Would you like to work "behind the scenes" at Hollywood, or for a talking picture manufacturer? R. T. A. training qualifies you for this work. Television, too, is included in the training. When television begins to sweep over the country, R. T. A. men will be ready to cash in on the big pay jobs that will be created.

**Expert Supervision
 Lifelong Consultation Service**

As a member of the Association you will receive personal instruction from skilled Radio Engineers. Under their friendly guidance every phase of Radio will become an open book to you. And after you graduate the R. T. A. Advisory Board will give you personal advice on any problems which arise in your work. This Board is made up of big men in the industry who are helping constantly to push R. T. A. men to the top.

Because R. T. A. training is complete, up-to-date, practical, it has won the admiration of the Radio industry. That's why our members are in such demand—why you will find enrolling in R. T. A. the quickest, most profitable route to Radio.

Mail Coupon for No-Cost Training Offer

Memberships that need not—should not—cost you a cent are available right now. The minute it takes to fill out coupon at right for details can result in your doubling and trebling your income in a few months from now. If you are ambitious, really want to get somewhere in life, you owe it to yourself to investigate. Learn what the R. T. A. has done for thousands—and can do for you. Stop wishing and start *actually doing something* about earning more money. Fill out the coupon and mail today.

Radio Training Association of America
 Dept. RNA-3, 4513 Ravenswood Ave., Chicago, Ill.

Fill Out and Mail Today!

RADIO TRAINING ASSOCIATION OF AMERICA
 Dept. RNA-3, 4513 Ravenswood Ave., Chicago, Ill.

Gentlemen: Send me details of your No-Cost Training Offer and information on how to make real money in Radio quick.

Name _____

Address _____

City _____ State _____



General view of one section of our Service Department, showing students doing actual work on various Radio Receivers

LEARN RADIO~TELEVISION NOT By BOOKS Or CORRESPONDENCE- By

Don't spend your life slaving away in some dull, hopeless job! Don't be satisfied to work for a mere \$20 or \$30 a week. Let me show you how to make real money in Radio—the fastest-growing, biggest Money-Making Game on earth!

**Thousands of Jobs Open
Paying \$60, \$70 to \$200 a Week**

Jobs as Designer, Inspector and Tester paying \$3,000 to \$10,000 a year—as Radio Salesman and in Service and Installation Work, at \$45 to \$100 a week—as Operator or Manager of a Broadcasting Station at \$1,800 to \$5,000 a year—as Wireless Operator on a Ship or Airplane, as a Talking Picture or Sound Expert—THOUSANDS of JOBS PAYING \$60, \$70 and on up to \$200 A WEEK!

**NO BOOKS -- NO LESSONS
All Practical Work**

Coyne is NOT a Correspondence School. We don't attempt to teach you from books or lessons. We train you on the finest outlay of Radio, Television and Sound equipment in any school—on scores of modern Radio Receivers, huge Broadcasting equipment, the very latest Television apparatus,

Talking Picture and Sound Reproduction equipment, Code Practice equipment, etc. You don't need advanced education or previous experience. We give you—right here in the Coyne shops—all the actual practice and experience you'll need. And because we cut out all useless theory, you graduate as a Practical Radio Expert in 8 weeks' time.

**TELEVISION
IS ON THE WAY!**

And now Television is on the way! Soon there'll be a demand for Thousands of Television Experts! The man who learns Television now

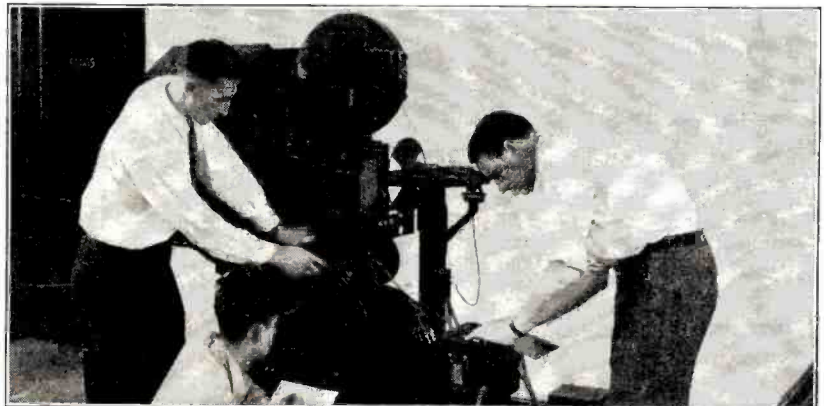

Instructor explaining principles and operation of a Talking Picture Machine

MAIL COUPON ON OPPOSITE PAGE

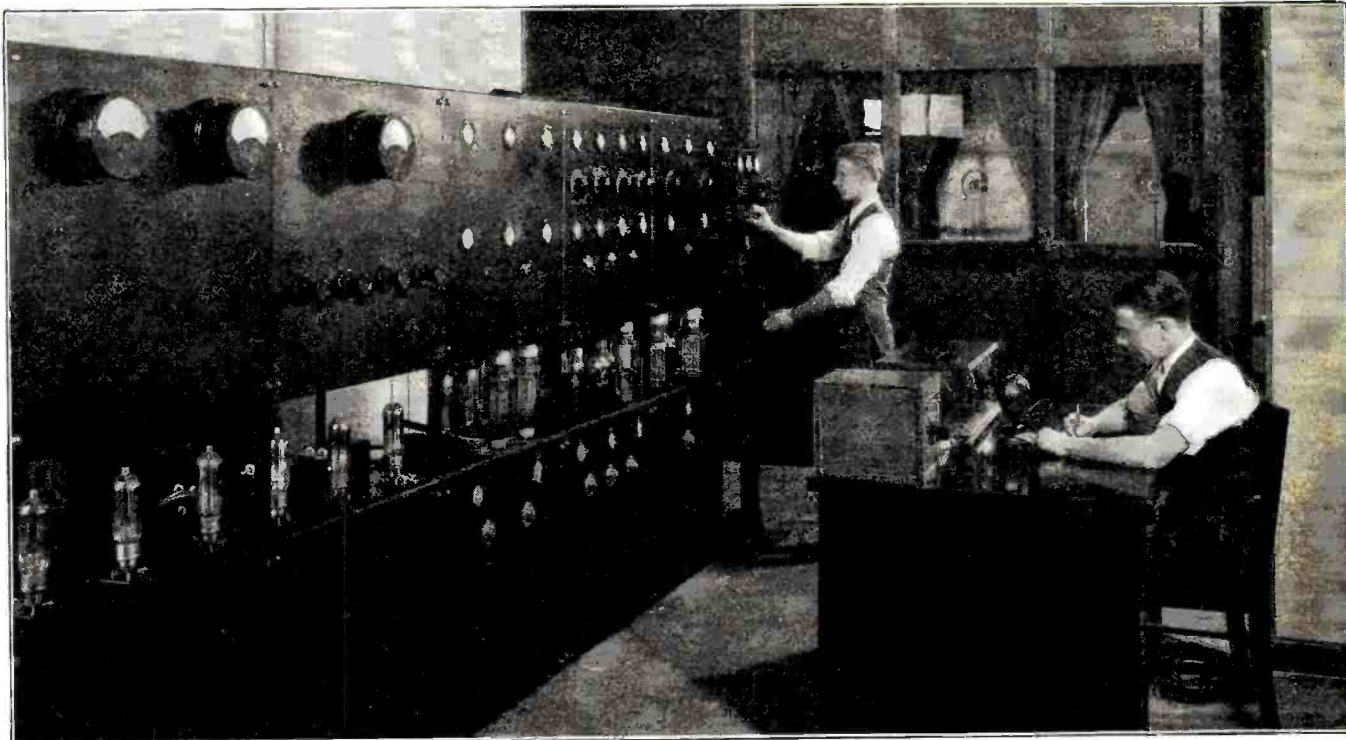

Students operating our modern Broadcasting equipment. In the rear you can see our Sound Proof Studio Room

TALKING PICTURES in 8 WEEKS

Actual Work - In the Great Shops of Coyne

can make a FORTUNE in this great new field. Get in on the ground floor in this amazing new Radio development! Come to COYNE and learn Television on the very latest Television equipment.

Talking Pictures - A Great Field

Talking Pictures and Public Address Systems offer thousands of golden opportunities to the Trained Radio Man. Here is a great new field of Radio work that has just started to grow! Prepare now for these marvelous opportunities! Learn Radio Sound work at Coyne on actual Talking Picture and Sound Reproduction equipment.

EARN AS YOU LEARN

Don't worry about a job! Coyne Training settles the job question for life. We often have more calls for Coyne Graduates than we can supply. You Get Free Employment Service For Life. And don't let lack of money stop you. If you need part-time work while at school to help pay living expenses, we will gladly help you get it. Many of our students pay nearly all of their expenses that way.

COYNE IS 32 YEARS OLD

Coyne Training is tested, proven beyond all doubt.

You can find out everything absolutely free. How you can get a good Radio job or how you can go into business for yourself and earn from \$3,000 to \$15,000 a year. It costs nothing to investigate! Just mail the coupon for your copy of my big Free book!

H. C. Lewis, Pres. RADIO DIVISION Founded 1899

COYNE ELECTRICAL SCHOOL

500 S. Paulina St., Dept. 31-80, Chicago, Illinois

H. C. LEWIS, President
Radio Div. Coyne Electrical School
500 S. Paulina St., Dept. 31-80, Chicago, Ill.

Send me your Big Free Radio Book and all details of your Special Introductory Offer. This does not obligate me in any way.

Name

Address

City State

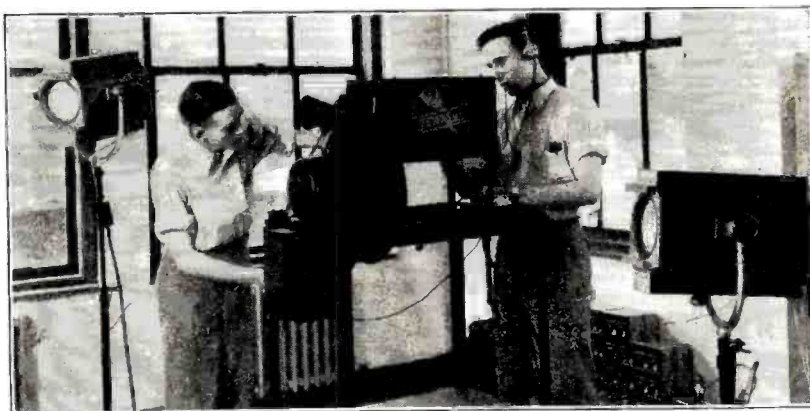

Students operating and adjusting our modern Television Transmitting equipment

FOR BIG FREE BOOK

ARTHUR H. LYNCH
Editor

JOHN B. BRENNAN, JR.
Managing Editor



BERYL B. BRYANT
Technical Editor

ALBERT PFALTZ
Associate Editor

VOL. XII

NO. 9

BY far the most important article in this issue of RADIO NEWS, from the viewpoint of the engineer and experimenter, is that describing the comments of leading radio engineers on the paper presented by Dr. James Robinson, inventor of the Stenode Radiostat, before the Radio Club of America. This paper was reprinted in full in last month's RADIO NEWS. In addition to these comments is Dr. Robinson's reply to the remarks of these gentlemen and, for the first time, we are able to lay before the readers of RADIO NEWS response curves of the radio-frequency and audio frequency portion of the Stenode, which in every way uphold and bear out the claims for the astounding performance of the Stenode.

Strangely enough, the fidelity curve shows an audio response which not a few American receivers would like to lay claim to. Yea, verily, those who were the scoffers are now the praisers.

* * *

SYSTEMS for the recording of sound on records, in the home workshop are beginning to command a serious portion of attention from experimenters and servicemen. The article in this issue by our old friend Joseph Heller illustrates the simplicity of the arrangement which will satisfactorily produce results.

* * *

OF course, we have our usual departments which continue month by month to bring pertinent information to servicemen, short-wave fans and experimenters alike.

And so, I take my leave.

JOHN B. BRENNAN, JR.

CONTENTS FOR MARCH

Cover—From a Painting by David Hymes

An Announcement	774
How to Build a Home Recorder for Home Talking Movies <i>By Joseph I. Heller</i>	776
Is American Broadcasting Economically Sound?..... <i>By Arthur H. Lynch</i>	778
All About Frequency Measurements and Meters..... <i>By John Martin</i>	780
Antennas, Frequency Adjustments and Monitors for "The Junior Transmitter"..... <i>By Don Bennett</i>	783
Sydney, Rio and Sharks..... <i>By Zeh Bouck</i>	786
Radio Aboard the DO-X.....	789
RADIO NEWS Manufactured Receiver Circuits.....	790
"The Explorer," a Plugless Coil S.W. Converter.... <i>By Irving L. Fishman</i>	792
The Service Bench..... <i>By Zeh Bouck</i>	794
The Navy's Volunteer Communication Reserve <i>By Lieut. Comm. Wm. Justice Lee</i>	796
Some Theory of Push-Pull Audio Amplification, Part II <i>By Louis Martin and John F. Lorber</i>	799
How to Build "The Mighty Mite"..... <i>By Beryl B. Bryant</i>	802
All Radio Is Not Broadcasting..... <i>By Carl Butman</i>	806
Quality with Selectivity?.....	808
Electromagnetic Pickups..... <i>By S. McClatchie</i>	810
Complete U. S. Broadcast Call List.....	812
RADIO NEWS Home Laboratory Experiments.....	820
News from the Manufacturers.....	822
RADIO NEWS Information Sheets.....	824
The Junior Radio Guild.....	826
Mike-roscopes..... <i>By Harriet Menken</i>	832

25c a copy
\$2.50 a year

Published Monthly by
RADIO-SCIENCE PUBLICATIONS, INC.
184-10 Jamaica Avenue, Jamaica, N. Y.

\$3.00 in Canada
\$3.50 in Foreign

W. Z. SHAFER, Pres.

BYRD D. WISE, Sec'y

LAURENCE A. SMITH, Treas.

Guy L. Harrington, Vice-Pres.

Entered as second class matter at the Post Office at Jamaica, N. Y., under the act of March 3, 1879.
Copyright, 1931, by Radio-Science Publications, Inc. Editorial and Executive Offices, 381 Fourth Avenue, New York, N. Y.
All Rights Reserved.

I will train you at home



Here's Proof

to fill a

BIG PAY

Radio Job!

If you are earning a penny less than \$50 a week, send for my book of information on the opportunities in Radio. It is free. Clip the coupon NOW. Why be satisfied with \$25, \$30 or \$40 a week for longer than the short time it takes to get ready for Radio.

Radio's growth opening hundreds of \$50, \$75, \$100 a week jobs every year

In about ten years Radio has grown from a \$2,000,000 to a \$1,000,000,000 industry. Over 300,000 jobs have been created. Hundreds more are being opened every year by its continued growth. Men and young men with the right training—the kind of training I give you—are needed continually.

You have many jobs to choose from

Broadcasting stations use engineers, operators, station managers and pay \$1,800 to \$5,000 a year. Manufacturers continually need testers, inspectors, foremen, engineers, service men, buyers, for jobs paying up to \$15,000 a year. Shipping companies use hundreds of Radio operators, give them world wide travel at practically no expense and a salary of \$85 to \$200 a month. Dealers and jobbers employ service men, salesmen, buyers, managers, and pay \$30 to \$100 a week. There are many other opportunities too. My book tells you about them.

So many opportunities many N. R. I. men make \$5 to \$25 a week while learning

The day you enroll with me I'll show you how to do 10 jobs, common in most every neighborhood, for spare time money. Throughout your course I send you information on servicing popular makes of sets; I give you the plans and ideas that are making \$200 to \$1,000 for hundreds of N. R. I. students in their spare time while studying.

Talking Movies, Television, Wired Radio included

Radio principles as used in Talking Movies, Television and home Television experiments. Wired Radio, Radio's use in Aviation, are all given. I am so sure that I can train you satisfactorily that I will agree in writing to refund every penny of your tuition if you are not satisfied with my Lessons and Instruction Service upon completing.

64-page book of information FREE

Get your copy today. It tells you where Radio's good jobs are, what they pay, tells you about my course, what others who have taken it are doing and making. Find out what Radio offers you, without the slightest obligation. ACT NOW.

**J. E. SMITH, President
National Radio Institute Dept. ICR
Washington, D. C.**

Our Own Home

Pioneer and World's Largest Home-Study Radio training organization devoted entirely to training men and young men for good jobs in the Radio industry. Our growth has paralleled Radio's growth. We occupy three hundred times as much floor space now as we did when organized in 1914.



I will give you my new 8 OUTFITS of RADIO PARTS for a home Experimental Laboratory

You can build over 100 circuits with these outfits. You build and experiment with the circuits used in Crosley, Atwater - Kent, Eveready, Majestic, Zenith, and other popular sets. You learn how these sets work, why they work, how to make them work. This makes learning at home easy, fascinating, practical.

Back view of 5 tube Screen Grid A. C. tuned Radio frequency set—only one of many circuits you can build with my outfits.

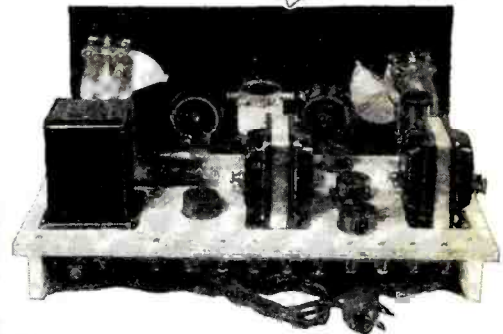
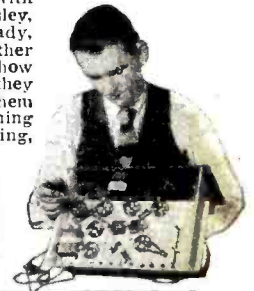

I am doubling and tripling the salaries of many in one year and less Find out about this quick way to

BIGGER PAY



FILL OUT AND MAIL THIS COUPON TODAY

J. E. SMITH, President,
National Radio Institute, Dept. ICR
Washington, D. C.

Dear Mr. Smith: Send me your book. This request does not obligate me.

Name

Address

City State

\$500 extra in 6 months

"In looking over my records I find I made \$500 from January to May in my spare time. My best week brought me \$107. I have only one regret regarding your course—I should have taken it long ago."

**HOYT MOORE
R. R. 3, Box 919,
Indianapolis, Ind.,**

Lifetime Employment Service to all Graduates

An Announcement

WITH this issue, Mr. Arthur H. Lynch, who has guided the editorial policy of RADIO NEWS for the past two years, takes leave of this publication and its readers but not, we are glad to be able to announce, of the science and art of radio. For Mr. Lynch, in his future endeavors, we of the organization and you our friends and readers join, I am sure, in the best of wishes and the highest of hopes.

With the next issue of RADIO NEWS, Mr. Laurence M. Cockaday, whose name is sufficient introduction to every old-timer in radio, will assume Mr. Lynch's responsibilities as Editor of this magazine. As inventor of the famous four-circuit tuner, the Cockaday tone filter and many other devices; as former Technical Editor of Popular Radio and other publications; as one of the first broadcasters in the world, Mr. Cockaday has been for twenty years an outstanding figure in radio. Alike among old-time "hams," among designers and makers of radio equipment and among the newest crop of listeners to modern broadcasting and experimenters with modern television, Mr. Cockaday's achievements are well known. He will continue as Lecturer on Science in the School of Commerce, Accounts and Finance of New York University.

The policies of RADIO NEWS remain unchanged. This magazine will endeavor to present, authoritatively and impartially, news of every important development in the radio field. To present clearly and accurately the scientific background of these developments will be one of our especial cares. Endeavors to foresee, imaginatively but sanely, what will happen in the future is a duty which the well-known dangers of prophecy will not induce us to shirk.

This magazine will be, as always, *your* magazine; the mouthpiece, the Forum and the informing friend of manufacturer, amateur, serviceman and radio scientist. If *you* know anything that we can do to make RADIO NEWS more useful to you or to everybody. Mr. Cockaday asks me to beg you to take your pen in hand and write him what you think.

GUY L. HARRINGTON
Vice-President.

THIS is the last issue of RADIO NEWS which will come under our Editorial guidance. The issues between June 1929 and March 1931 have been wrought with a view to following an editorial policy fixed in advance, which seemed to us to be sound. Apparently, if we may judge by the result, this policy has been very satisfactory to our readers and advertisers alike. We take a great deal of personal pride in what has happened to RADIO NEWS since the June 1929 number, and we feel sure that the continuation of this policy will result in even greater improvement in the future.

The American Radiostat Corporation, which is a subsidiary of the British Radiostat Corporation, has been organized with the view to taking care of the interests of the British Radiostat Corporation in America. I have accepted the invitation of the Board of Directors to become Vice President and a Director of the American corporation.

John B. Brennan, Jr., who has been associated with me for a number of years in the editorial and technical departments of radio magazines, has accepted an invitation to come along with me.

We are leaving the reins of RADIO NEWS in the hands of an old friend whose reputation and ability are in the first rank. Mr. Cockaday has our sincerest wishes for success in this enterprise at which he is an old hand. We feel certain that his expressed continuance of our present editorial policy will result in a similarly satisfactory magazine for our readers.

In bidding you adieu, we wish to express our sincere gratitude for the patience with which you have accepted our effort and the very great encouragement which you have given us through your correspondence.

ARTHUR H. LYNCH

an OPPORTUNITY

TOO GOOD TO MISS!

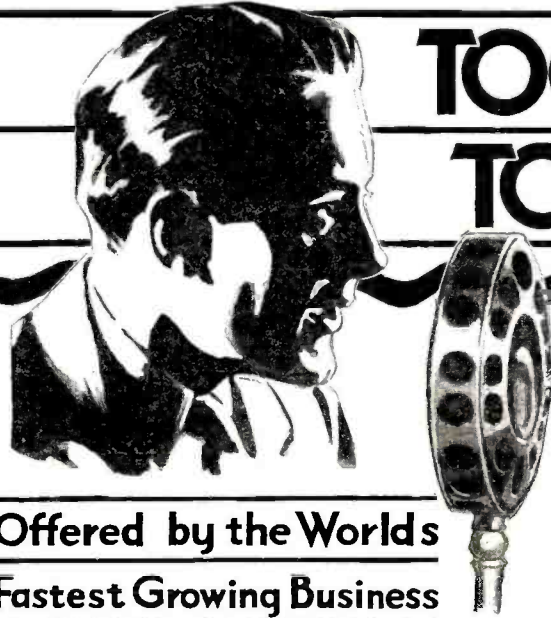

The great Radio Industry, because of its amazingly rapid growth, is today badly in need of hundreds of "trained" men to fill its more responsible jobs in Radio, Talking Pictures, and Television work.

Offered by the World's Fastest Growing Business

spare time, and at a very nominal cost, for these better paying jobs in Radio, Talking Pictures and Television.

The Institute's Course of home-training was planned, written, and is actually supervised by an Advisory Board made up of prominent and highly paid engineers and executives, each of whom is actively connected with some big Radio concern.

To qualify for these jobs men must know Radio as they know their A B Cs. They must know the theory as well as the practice, and be able to teach other men some of the things they know.

This means that your training will be right, because these men, working with big Radio concerns, know exactly what the industry needs in the way of "trained" men, and exactly how you should be trained to meet that need. And this Advisory Board will have complete supervision over your training from the day that you become a student of this Institution.

To such men the great Radio industry offers a wonderful opportunity for steady work at exceptionally good pay, now, and early advancement to still better jobs as a future. It is, in fact, the chance of a life-time for ambitious men.

For this reason, prominent Radio men, everywhere—and our country's largest and most important Radio Trades Associations—are unqualifiedly endorsing this home training, and recommending it to men whom they want to see make good in Radio work.

But first these men must be trained, for no ordinary knowledge of Radio will do.

So, if you are ambitious—if you are making a cent less than \$75 a week—investigate.

The Radio Industry, itself, has no time to train these men. It is growing so fast, and changing so fast, that its manufacturers and jobbers have all they can do to keep up with the trend of the times, by improving their methods of manufacture and distribution.

Find out for yourself all about this amazingly easy Course of home-training, and also all about the wonderful opportunities for "trained" men in this, the world's fastest growing industry. Everything is fully explained in the Radio and Television Institute's "Opportunity" book. Send today for your copy. It's free.

So the training of men for these jobs has become the task of the Radio and Television Institute, of Chicago.

As few men can afford to quit their work and get this Training at some University or Technical School, the Radio and Television Institute has been organized to train such men at home—no matter where they live,—in their

RADIO AND TELEVISION INSTITUTE, Dept. 843

2130 Lawrence Ave., Chicago

Without obligation of any kind please send me a copy of the Radio Opportunity Book. I am interested in your home-training and the opportunities, you say exist in the great field of Radio, for "trained" men.

NAME _____

ADDRESS _____

Figs. 1, 2 and 3, to the right, show the use of a double-pole double throw switch for recording or reproducing with the "Home Recorder" and the connection of the microphone to the microphone transformer and tube base

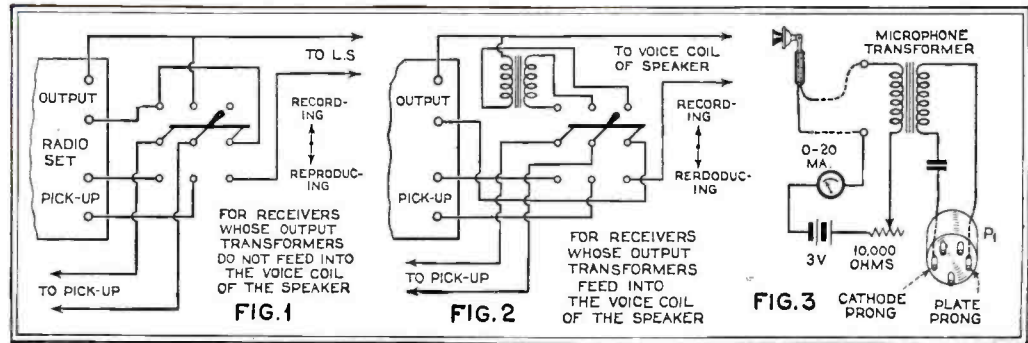

Mr. Joseph I. Heller, author of this article, is shown with some of the apparatus used in making home recordings

WITHIN the last few months several radio receiver manufacturers have incorporated a device in their receivers which will undoubtedly enhance and extend the enjoyment to be derived from the radio set. Unfortunately, however, this latest improvement came at a time when many people have receivers which, while satisfactory in every respect, do not incorporate the device. It is the purpose of this article to inform those of our readers who are accustomed to building things for themselves as to the exact way in which they can construct this unit. It can be built very inexpensively and with very little trouble. In most cases it is entirely possible that there will be enough apparatus and parts in the experimenter's junk box to make it unnecessary to buy a single thing. Fundamentally, this device, for home recording, consists of a microphone or phonograph pick-up, or both; an input transformer for either microphone or pick-up, or both; a suitable amplifier and a suitable power amplifier.

On the microphone depends, to a great extent, the type of recording which can be obtained. It should therefore be of the best type that its use warrants. A very good microphone can be bought for \$6.00. A better one will cost \$25.00 or thereabouts. The input transformer fed by the microphone should be of some standard make. If, however, you have available a good

How to Build a Simple Recorder

audio transformer it can be changed very easily into a microphone transformer by winding about 300 turns of No. 26 wire over the secondary coil of the transformer. The output amplifier should be equivalent to two -45 type tubes in push-pull. Fortunately, the receivers in most homes are equipped with an amplifier of this type.

In recording the voice or music with the microphone, the output of the -45 push-pull tubes should be sent through the ordinary output transformer which has a secondary impedance of from 2,000 to 5,000 ohms. The output can be fed into practically any phonograph pick-up which then becomes a cutting head. In our experiments with the device we tried practically every type of pick-up available in New York City, and found that they all work almost equally well. Even the poorest

type tested gave perfectly satisfactory results.

For those who have radio sets having a phonograph turntable and pick-up device included, we would suggest the following procedure. Procure several of the new home recording records. They are double-faced and look like the miniature standard hard-rubber records. They are inexpensive and can be bought in almost any music or radio store. Remove the

phonograph pick-up leads from their binding posts and turn the radio set on. Tune in some program which you would care to record and plug the phonograph pick-up leads into the output posts of the amplifier. This procedure assumes that the output transformer is arranged to feed into an ordinary speaker. If the output transformer is not of this type, but is made to feed directly into the voice coil of the speaker, it will not be possible to record as outlined above. (In a subsequent paragraph we shall tell how recording can be accomplished in this case.) Press the phonograph record down upon the turntable in the proper position and move the pick-up arm on to the record. The volume should be turned on rather high, although no distortion should be permitted. A weight of approximately $\frac{1}{2}$ pound should be tied to the top of the pick-up while recording. The ordinary phonograph needles will not be suitable but you can procure recording needles at the same time that you get the records. These

TALKING movies for the home is a coming thing, bound to grow to greater proportion as we learn more about the really simple technique involved in recording sound on records.

To experimenters and custom-set builders this activity opens up a brand new field for the exercise of the inquisitive natures. Servicemen will not be slow to recognize the opportunity for increased sales of parts and completed units by which home recording can be accomplished.

The apparatus described by Mr. Heller is simple to build and not at all difficult to operate and as the builder becomes more adept in the technique of its operation he can really provide himself with talking movies of his relatives, his friends and himself with a degree of perfection which is quite satisfactory.

THE EDITORS.

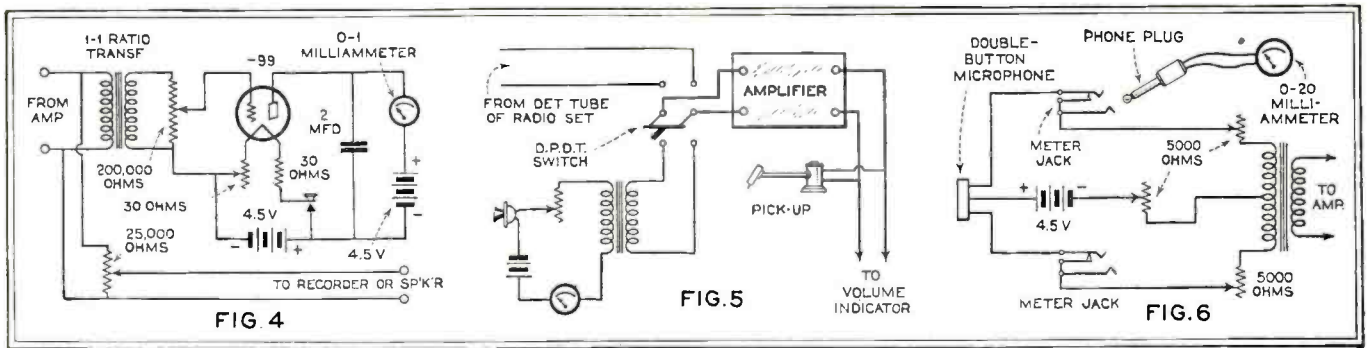

Figs. 4, 5 and 6 show respectively the circuit for a visual volume indicator, microphone-amplifier-pick-up circuit and the connections to be used for double-button microphone

for Home Talking Movies

With a few simple pieces of apparatus, in addition to the audio amplifier in your radio receiver, you can make your own voice or music-recording device. This outfit, when completed, can be used to extremely good advantage in synchronizing sound with home movies. Last month's RADIO NEWS described several commercial forms of home talking movie outfits

By Joseph I. Heller*

needles have their shanks colored red and may be used for both recording and playing.

The "Play Back"

At the first trial allow just a small portion of the recording surface to be covered, then connect all units just as they were before and proceed to play the recording just as you would an ordinary record, remembering, however, to remove the weight. In the "play back" you can learn many things. If there is a loud, scratching noise, the weight has been too heavy. If the sound is not as loud as that on an ordinary record, it may be due to one of several reasons; either the signal was not loud enough or the weight was not heavy enough. Try the other side of the record and listen carefully to the needle as the recording takes place. If there is a scratching or buzzing sound, place your finger lightly on the pick-up while it is on the record and determine whether pressure of the fingers can remove the buzzing

*Chief Engineer, Wireless Egert Engineering Co., Inc.

sound. If it does, add some more weight. Three or four trials will enable you to judge just how much weight and how much volume are necessary to give you the best results. With a good radio, the experimenter will be very much surprised at the results obtained. The recording, in most cases, will be almost as good as electrically cut records. In fact, we have been able to make recordings using a good radio set and pick-up during which we played the record and the radio alternately and no difference was noticed in the tone.

For those of our readers who might care to make this unit a permanent feature of their set, we would suggest studying Fig. 1, which explains the switching system. For those whose amplifiers have output transformers feeding directly into the voice coil of the dynamic speakers, Fig. 2 shows the method of connecting an external transformer to the device in order to (Continued on page 841)

Below, from left to right, is shown the external view of the microphone amplifier, the visual volume indicator and a rear, inside view of the microphone amplifier



Is American

By Arthur H. Lynch

Canada's Radio Revolt



Gen. Charles Saltzman

BACK in 1920 when radio broadcasting was first introduced, the "problem" of who would ultimately pay for it was immediately recognized. Doctors, lawyers, communication magnates, editors, magazine and newspaper publishers, and many others, puzzled by the thought that, though this new medium was entirely worth while, it might be difficult to locate a sugar daddy who would keep it in a suitably luxurious fashion, drew up many proposals.

Some very bizarre prophecies were made and some very interesting conjectures were entertained by many of the political big-wigs because they recognized in radio a particularly strong weapon in carrying their story to their constituents.

In some circles there is a very rapidly growing tendency which indicates that there are some who consider our method of handling the broadcasting situation most unsatisfactory.

England has established a broadcasting policy which is completely different from ours and, although it may serve England quite well—and we have our doubts about that—it would not get to first base in America.

Canada has, up to the present time, been operating on a policy which in most respects is very similar to our own. But lately a group of influential Canadians has become interested in the project of establishing a Government-owned and operated system for broadcasting in Canada, similar to the English system and directly counter in principle to the system we employ. The entire analysis of the Canadian situation, prepared for us by Martin Codell, the representative of RADIO NEWS at Washington, D. C., gives us a picture of the proposed Canadian set-up.

Says—

"In England, broadcasting is controlled by one corporation. I have listened to British broadcasting. I think that the corporation gives the public what the corporation thinks the public ought to hear."

"Spontaneous, vigorous and bearing the endorsement of some of the best men and minds in Canada, is this movement for the reorganization and nationalization of the Canadian radio broadcasting structure launched by the newly formed Canadian Radio League. To American radio listeners, broadcasters and government officials it bears tremendous significance, for in some respects it represents a revolt against American broadcasting practices under what United States Senator Dill has aptly called 'Radio by the American Plan.'

"Ultimate success of the Canadian Radio League's campaign will mean the establishment on the North American continent of a somewhat modified counterpart of one of Europe's great broadcasting systems, the British Broadcasting Corporation. The plan contemplates government ownership and operation of the radio, pure and simple, though the Canadian government monopoly would be given the powers of a private enterprise and kept as free from political sway as is the British Broadcasting Corporation under its charter.

"Success of what the Ottawa Citizen calls 'Young Canada's Cause' will mean, moreover, that there will be established to the north of this country—but within tuning range of American receiving sets, since the basic Canadian stations must necessarily be of extremely high powers to serve the Dominion's widely scattered population—a system of broadcasting free of all advertising except the more refined forms that are undertaken, as are most of the programs on the American networks, by the leading national advertisers primarily for good-will purposes.

"The Canadian Radio League's plans do not contemplate eliminating advertising sponsorship, but minimizing it. Presumably, although the League's report does not say so, the new government broadcasting organization would be supported by such indirect advertising but also very largely by license fees on receiving sets, as in England.

The British Broadcasting Corporation, however, carries no advertising whatever. Canadians must now pay an annual receiver license fee of only \$1.

"Practices that have grown up under the American system are cited over and over again in the Canadian Radio League's pronouncement as 'horrible examples' to be avoided in re-ordering radio in the Dominion. And these Canadians resent the fact that 'American stations cover the whole of Canada' and that 'only three out of five Canadian families can hear Canadian programs.' Even the Canadian programs are unsatisfactory, for 'the programs of the best quality are few and the majority of them are mixtures of advertising announcements and phonograph records.'" Referring as well to Canada's present 70 broadcasters as to the American influence, the report remarks:

"Canadian public opinion, so far as it may be influenced by the radio, is in the hands of irresponsible authorities, however public spirited, and is at the mercy of American chains.' This indictment is aimed primarily against Canada's own broadcasters and incidentally to those in the United States, but the Ottawa Citizen goes even further in expressing its fears of

Broadcasting Economically Sound?

Should we be taxed for radio, as they are in England and as they seem to wish to be in Canada, or should we continue to let revenue from advertising foot the bill?

the American radio invasion: 'Commercial interests in the United States are debasing this new gift of engineering science to the Hollywood level. . . . The Canadian radio field will be absorbed into the American orbit, just as surely as the motion picture field has been absorbed, unless there is national action through Parliament to hold the fort, during the experimental years ahead, under public ownership.'

"If any American believes that there is little of substance behind this radio revolt in Canada, let him glance at some of the names making up the council of the Canadian Radio League: Louis St. Laurent, president, Canadian Bar Association; Col. J. H. Woods and W. M. Birks, past presidents, Canadian Chamber of Commerce; Dr. W. Harvey Smith, president, British Medical Association; Tom Moore, president, Trades and Labor Congress of Canada; F. W. Wood, president, United Farmers of Canada and director of the Canadian Wheat Pool; Fred N. Southam, president, Southam Publishing Co.; Gen. Sir Arthur Currie, principal, McGill University; Dr. R. C. Wallace, president, University of Alberta and the Association of Canadian Clubs; the Rt. Rev. Archbishop Matheson, former Primate of all Canada, and nearly twice as many more persons equally prominent. As if their endorsements were not sufficient, the Canadian Radio League publishes a list showing that the leading national clubs and associations and several score leading Canadian newspapers are on record in support of a national system of broadcasting for the Dominion."

Is Canada Wrong?

We wonder just how familiar the gentlemen suggesting this radical departure are with actual conditions in the ether as they affect the average listener-in and how well they are qualified to act in a broad and impartial manner in this work. We fear that a large percentage of them may well be placed in that group of individuals who are amply supplied with this world's goods and who are imbued with a viewpoint which we believe to be extremely conservative. We wonder how many hours a day these gentlemen listen to broadcast programs, if they listen at all. Isn't it very likely that from their very stations in life we can assume that they are one with correspondingly wealthy

conservatives here who believe that there is no enjoyment to be had from a radio receiver because whatever good might come from it is overbalanced by the unwelcome and more or less blatant ballyhoo for someone's soap, lipstick, cigarette, flesh reducer, or what not?

There is much to be said for their position and we agree that a great many of the broadcast programs forced into the American homes would create a very much more friendly attitude toward their sponsors if the proportion of advertising-to-entertainment were not only materially reduced but the character of the advertising itself very completely altered.

Examples of good and poor types of advertising programs may be heard almost any night. Our contact with the listening public, particularly those who take their radio listening seriously, indicates that a perfectly delightful entertainment feature can be made to produce extremely bad will by the injection of advertising material which the audience itself believes to be in poor taste. This contact with the listener-in also indicates very definitely that the old-fashioned bugaboo built around direct advertising need no longer be feared. Doubtless the average listener-in would very much rather hear a very brief but at the same time very well-placed piece of direct advertising than have forced on him the very thinly veiled, and generally most futile attempts at stage setting and transparent disguise designed to introduce air advertising by what radio script writers believe to be subtlety.

What They Do in England

In order that we may have a much more comprehensive idea of what broadcasting conditions are like abroad, so that we may not judge too harshly the efforts in this country, it is interesting to observe what is happening in England, where a system somewhat similar to that proposed for Canada has been in use for several years. The British Broadcasting Corporation is a broadcasting monopoly operated under a special Government charter. Every user of a radio receiver in England must pay an annual tax of two and a half dollars. The income derived from this is split between the Government, for relief of taxation, the (Continued on page 828)

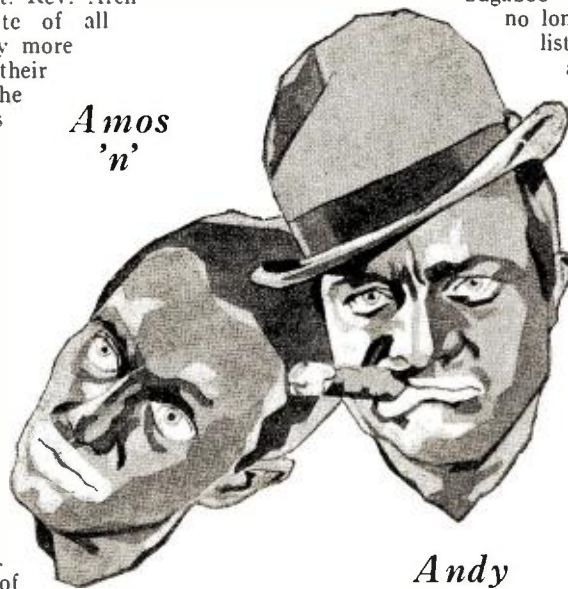

What are the rights of broadcasters against theatres, dance halls, hotels, railroads who use their programs to attract the public for commercial reasons? Louis G. Caldwell, former general counsel for the Federal Radio Commission, cites the case of Amos 'n' Andy, whose popularity threatened the box offices of theatres and vaudeville houses until those resorts installed loud speakers and offered the noted black-face team as added attractions, advertising the fact. The advertiser who paid heavily for the program did not even have the satisfaction of receiving credit. Mr. Caldwell notes, for the theatres tuned out the advertising part of the program

All About Frequency

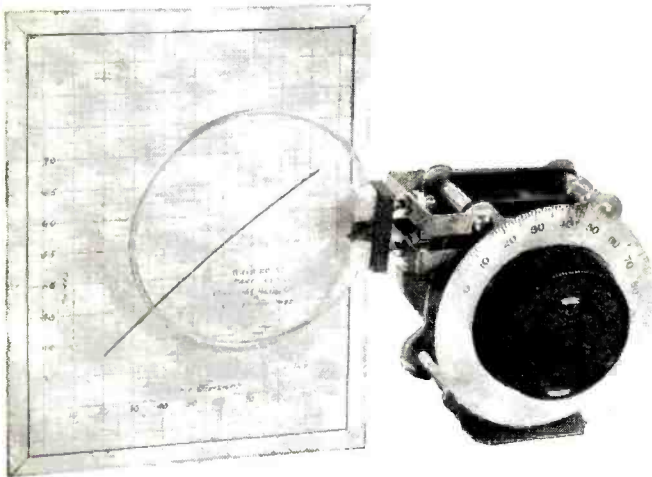

Photographs courtesy General Radio Company
A seven-meter wavemeter

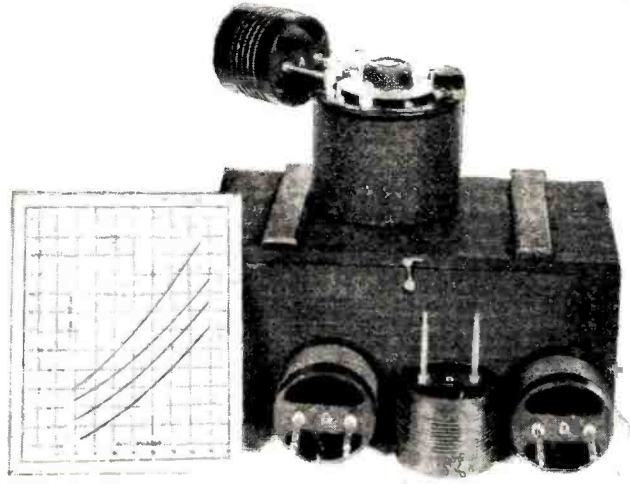

The amateur's wavemeter ranging from 14 to 240 meters

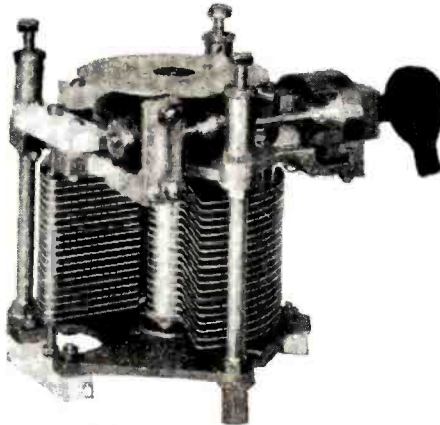

A precision condenser used in wavemeters requiring a high degree of accuracy in dial adjustment

THE problem of measuring the frequency of a radio-frequency current became of importance with the very inception of radio as a means of communication, but in those first years of radio's development the need for accurate measurements was not very great. The passing years have seen, however, a rapidly increasing need for measuring frequency with a considerable degree of accuracy. The various radio communication bands are now so generally used it is essential that transmitters be tuned accurately to the assigned frequency or band of frequencies.

A number of devices have been devised to enable one to determine the frequency of a radio-frequency oscillator or to determine the frequency of an incoming signal. Some of these devices are capable of quite accurate calibration, whereas others are of such a nature that they are only useful where a rough idea of the actual frequency is required. In the following notes a number of the various methods for measuring frequency are discussed with respect to their accuracy and practical use in the hope that the discussion may prove helpful to short-wave and broadcast experimenters. We do not intend to give constructional data on the various instruments for excellent constructional articles have been published in RADIO NEWS and other publications.

Frequency meters naturally divide themselves into two classes:

1. Those used for measuring the frequency of a transmitter.

2. Those used for generating a current of known frequency.

Practically we will find that many of the units in the second class can, by means of a somewhat different technique of operation, be used for either purpose.

It is but natural that a discussion of the subject should start with a consideration of the simple wavemeter, Fig. 1, consisting of a coil L and a condenser C_1 . By using the correct constants for the coil inductance and the condenser capacity the simple wavemeter may be used at any desired frequency; in all cases it is best to use a straight-line frequency condenser (or one having approximately such characteristics) so that a reasonably straight-line calibration curve of frequency against dial setting will be obtained.

When such a wavemeter is used without any indicating device we must depend for indications of resonance upon the effect of coupling between the wavemeter and the receiver or oscillator in whose circuits are flowing the currents the frequencies of which are to be determined. In the case of a receiver the decrease in signal strength can be used to indicate when the wavemeter is in tune with the signal and then by means of a calibration curve the frequency of the signal can be determined. In all cases the coupling between the set and the wavemeter should be as loose as possible; practically, this means that the wavemeter should be placed as far as possible from the receiver. If this is done the point on the wavemeter corresponding to resonance will be indicated more sharply and

The circuits and curve below illustrate typical simple wavemeter circuits fully explained in the text

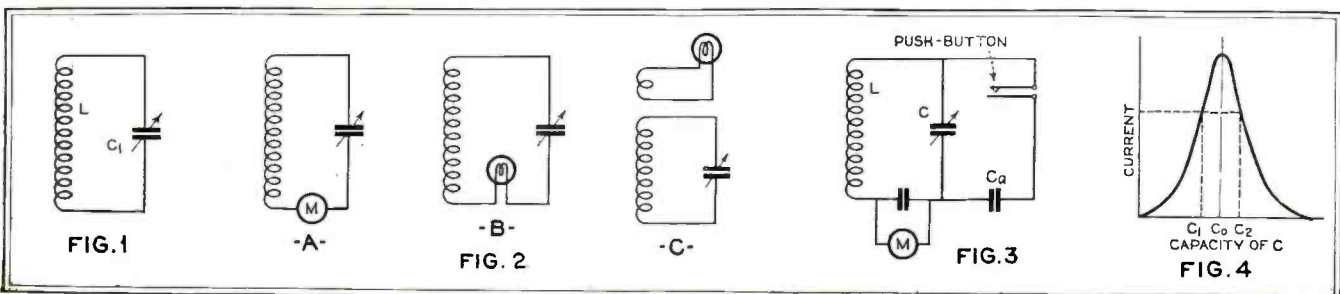

Measurements

By
James Martin

and Meters

To the amateur, the experimenter, the laboratory technician or the serviceman nothing is quite so important as the accurate determination of frequency by reliable, well designed instruments. In this article the author explains the importance attached to accurate frequency measurement and describes some of the accepted forms of efficient frequency meters, including wavemeters, r.f. oscillators, monitors and crystal controlled frequency meters

greater accuracy can be obtained. When the simple wavemeter is used to determine the frequency of an oscillator the change in antenna current or plate current meter readings can be used to indicate resonance. If the wavemeter is placed very close to the transmitter, a change in antenna current or plate current will be indicated all the time the wavemeter circuit is in tune or partially in tune with the oscillator frequency, and fairly exact determinations of the frequency will be difficult—we might say impossible. Again the solution is to increase the distance between transmitter and wavemeter until a very sharp indication is obtained; when the coupling is made very loose one small sharply defined change in antenna current or plate current will be found and the accuracy with which the wavemeter may be set to resonance is greatly increased.

A number of different types of indicators can be used with the simple wavemeter to show resonance. Several of the more common methods are illustrated in Fig. 2. At A we have a hot wire or thermocouple meter M directly in the tuned circuit, at B a small flashlight lamp is used to show resonance, at C resonance is indicated by a small lamp placed in series with a single-turn loop placed adjacent to the wavemeter coil. All these arrangements, circuits A and B especially, have the disadvantage that they introduce additional resistance into the wavemeter circuit so that the exact point of resonance is more difficult to determine. If a simple wavemeter circuit is to be used, it is generally best that dependence for resonance indications be placed on noting a change in receiver output, or

plate or antenna current readings in the case of an oscillator. Greater accuracy can almost invariably be obtained in this manner than would be the case were some indicating device used in the wavemeter circuit.

If a simple wavemeter is well designed with good, low resistance, sturdy coils, its inherent accuracy may be very high, but even in such cases the peak of the resonance characteristic is so flat (comparatively speaking) that the accuracy with which the dial may be set to resonance is far less than the inherent accuracy of the wavemeter. Anyone who has worked with the ordinary wavemeter is aware of the difficulty in accurately setting it at resonance. This is true no matter what type of indicating circuit is used, although, of course, those which introduce a minimum amount of resistance into the wavemeter circuit are the best. To get away from the difficulty of properly adjusting a wavemeter to resonance, engineers of the General Radio Company developed what was termed the incremental capacity method of indicating resonance. The circuit

of such a wavemeter is shown in Fig. 3. It consists of a coil L and a condenser C with an indicating meter M (the condenser shunted across the meter is used simply to make the meter indications more constant over the entire band covered by the wavemeter) and in parallel with the tuning condenser C is a push-button and a small capacity Ca.

When testing for resonance by means of this circuit the main tuning condenser C is slowly adjusted and the push-button switch is opened and

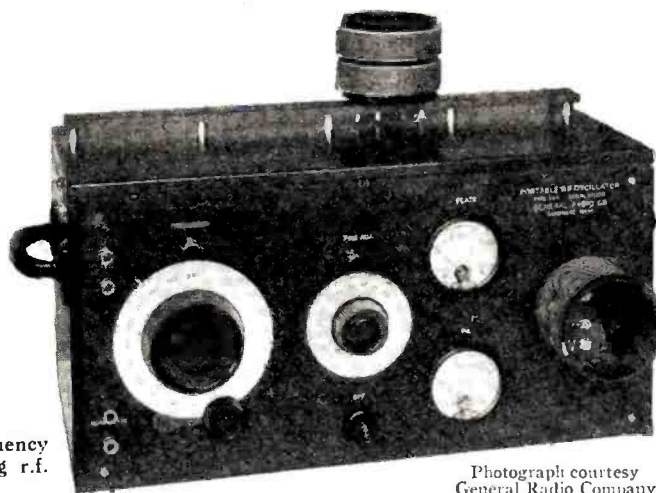

A portable radio-frequency oscillator for generating r.f. oscillations

Photograph courtesy General Radio Company

More complicated circuits for frequency-determining instruments

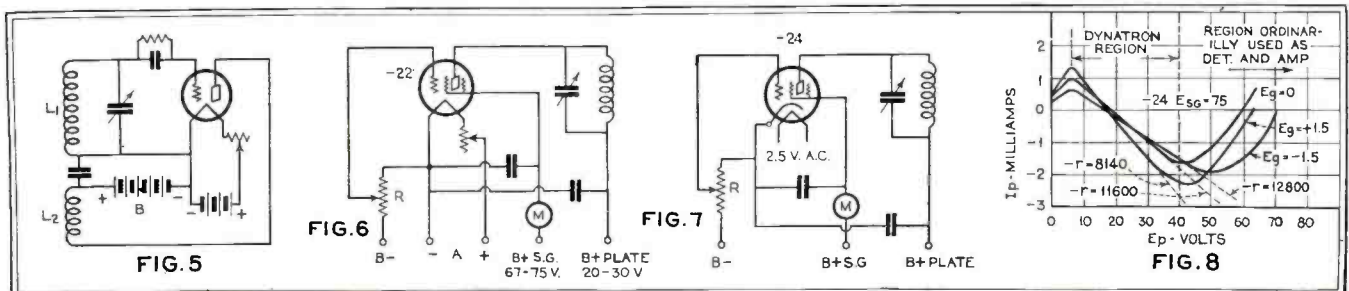

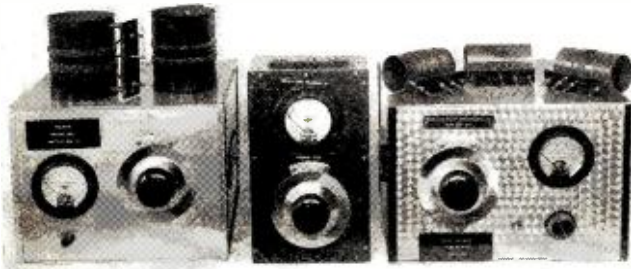

Photograph courtesy Wireless Egert Engineering, Inc.

Three types of frequency-measuring equipment, an oscillator, wavemeter and monitor

(Right) A station frequency meter employed at transmitters to determine accuracy of adjustment of the emitted frequency



Photograph courtesy General Radio Company

closed. There will be found an adjustment of C where the meter reading does not change whether the push-button is closed or open. Under this condition the reading of the dial can be used to determine the frequency from the proper calibration chart.

The principle of the method can be understood by reference to Fig. 4, which shows the resonance curve of an ordinary tuned circuit. There are two values of capacity, C1 and C2, both of which cause the same current to flow in the circuit. C1 represents the capacity slightly less than C0, the capacity necessary to tune to resonance, and C2 represents a capacity somewhat greater than that necessary to tune to resonance. In tuning the wavemeter the correct adjustment indicated by no change in the meter reading with push-button opened or closed is obtained when the main tuning capacity has a value equal to C1 so that when the push-button is pressed, placing Ca (Fig. 3) across the circuit and thereby increasing the total capacity to C1, we reach a point on the opposite side of the resonance curve where the current is equal to that obtained with C1 alone.

The ability of this method to give accurate indications is due to the fact that the adjustments are actually made along the sides of a resonance curve where a very slight change in capacity produces a large change in current. For this reason the condenser dial can be adjusted much more closely than would be possible were an attempt made to actually tune to resonance. The precision with which frequency measurements may be made with a wavemeter of this type is very high, apparently in the order of one part in twenty thousand. This means that an oscillator may be set within one thousand cycles of a desired frequency around twenty thousand kilocycles or 15 meters. A transmitter may be adjusted within a few hundred cycles in the region around 5,000 kc. or 60 meters.

In using a wavemeter of this type care is required, since it depends for its operation on *not* tuning the wavemeter circuit to resonance with the source of operations. Under such conditions the reactive impedance of the wavemeter circuit may be reflected into the oscillator circuit and thereby alter the effective impedance of the oscillator circuit and hence change its frequency. For this reason this type of wavemeter must be used with care and with as small a coupling between the oscillator and the wavemeter as is possible.

The wavemeter in one of the forms described in the preceding paragraphs is about the only device that can be used by itself to indicate frequency. Other methods of determining frequency involve the use of oscillating wavemeter circuits. Such circuits will now be described.

Oscillating wavemeter circuits depend for their operation on the phenomena of beat notes. As most readers know, when-

ever two radio-frequency currents are impressed on a detector circuit a beat note is produced whose frequency is equal to the difference in frequency between the two r.f. currents. If the two r.f. currents are 1,000 cycles apart, then the beat note frequency is 1,000 cycles. If one frequency is held constant and the other is varied the beat note is first heard as a high audio frequency which gradually drops to zero when both currents have exactly the same frequency. As we continue to vary one frequency the beat note again rises and finally passes out of audibility. Consequently, if we set up an oscillating tube circuit and calibrate the condenser dial in frequency as we would a wavemeter we can determine when the oscillating wavemeter is exactly in tune with the signal whose frequency is to be determined, by listening to the beat note in a detector circuit and adjusting the wavemeter dial to give zero beat.

Various circuits can be used in the design of an oscillating wavemeter. The circuit of Fig. 5 shows one which is really a single-tube receiver, with the difference that the tickler or feedback coil L2 is fixed rather than variable; the number of turns on the tickler should be adjusted to make the circuit oscillate with fair uniformity over the band it is desired to cover. Determination of the proper number of turns can best be done by "trial and error." As a general rule it will be found that the higher the frequency band the greater the number of tickler turns L2 requires with respect to the number of grid turns of L1.

The circuit of Fig. 5 does not, however, yield to very accurate or permanent calibration and a much better and simpler unit can be built using a dynatron circuit. The circuits of two dynatron oscillators, one for d.c. and one for a.c., are shown in Figs. 6 and 7. They make use of screen-grid tubes operating at such voltages that they have negative resistance characteristics. Under such conditions the tube will oscillate if a tuned circuit is placed in the plate circuit. The dynatron circuit, in addition to being simple because it requires no tickler coil, has the advantage of a very high order of frequency stability. In fact, much better frequency stability can be obtained from the dynatron circuit than from any ordinary oscillator circuits using three-element tubes. Its stability is stated to be comparable to that of a crystal with temperature control. This allows it to be used for precise measurements, since it can be calibrated and will hold its calibration over long periods of time. (Continued on page 857)

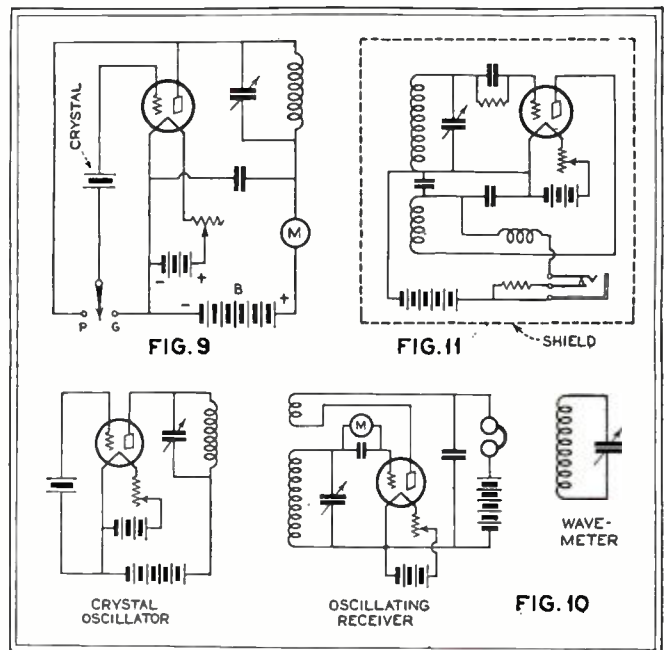

(Right) Circuits for crystal controlled oscillators, monitors and calibrating receiver circuits

Antennas, Frequency Adjustments and Monitors for The "Junior Transmitter"



A front view of the completely shielded s-w monitor

Before the amateur is legally permitted to transmit a signal he must first know that his transmitter is tuned to some frequency within the waveband allotted by the Government to the use of the "hams." In this third successive installment on the construction and operation of the "Junior Transmitter" our friend Gus instructs his charge on the business of erecting the proper type of antenna and accurately tuning the transmitter to a frequency within the assigned amateur band and describes the construction of a simple monitor by which to frequently check the transmitter's frequency

PART THREE

"HELLO, Gus. How's the boy today? Ready to help me with the aerial?"

"Not only that, but with the monitor. Don't get that expression on your face—you need a monitor and you're going to have one before that transmitter perks. The way you act anyone would think you were lazy. Come on, snap out of it, let's string wires."

"I have the wire and a flock of insulators. There are a couple of sticks up on the roof we can use for masts and we're all set."

"Before we go up on the roof let's figure out what kind of an antenna you're going to have."

"Do antennas have 'kinds.' What's this, another lecture on the theory of radio telegraphy?"

"Nope. Just a conference to decide what kind of decorations we're going to put on your roof. And as far as 'kinds' go, there are three that concern you, the Zepp, or Zeppelin feed; the Hertz single wire feed and the doublet. The doublet isn't so practical for our purposes because of the convenient coil forms we used in building your transmitter. If you had heavy copper tubing coils, then the doublet would be practical but we didn't use those because we wanted quick changeover. However, dig out your little note book and file these formulae away in case you ever want to use the doublet. The doublet looks like this (Fig. 1). You'll notice that we have four factors involved, the length of the antenna L, the coupling C, the clearance of the feeder from the antenna X and the spacing of the feeder S. Here are the formulas for these factors:

$$\text{Length in feet} = \frac{492,000}{\text{Freq. in k.c.}} \times 0.95$$

The final factor 0.95 is for the band from 3000 k.c. to 28,000 k.c.

$$\text{Coupling feet} = \frac{492,000}{\text{Freq. in k.c.}} \times 0.24$$

$$\text{Clearance feet} = \frac{492,000}{\text{Freq. in k.c.}} \times 0.30$$

Explanation

Spacing S, is $S = 98$ times the diameter of the wire used.

No. 12 wire is 0.080 inches.

No. 14 wire is 0.064 inches.

Therefore the spacing for No. 12 wire would be 98×0.080 or 7.84 inches or $7\frac{3}{4}$ inches.

And the spacing for No. 14 wire would be 98×0.064 or 6.272 inches or $6\frac{1}{4}$ inches.

"The doublet antenna is hooked on to the transmitter by clips on the plate coil that are adjusted at the time of tuning. An alternative is to use an antenna tank with the clips on the tank coil (Figs. 2a, 2b). A .002 condenser is inserted in series with each side of the feeder to keep the high voltage out of the system. 600 volts can be painful if one comes in contact with it or a grounded feeder or antenna would cause a lot of damage in the transmitter." It is well to keep this in mind at all times.

The Zepp Antenna

"The Zepp feed was explained by Schnell in the December issue of RADIO NEWS. He also explained the Hertz, both of them excellently. On page 557 he gives the layout of a Zepp (Fig. 3), showing a half wave radiator (the antenna proper) with quarter wave feeders. If this were straightened out we'd have a full wave antenna but as the two quarter wave feeders parallel each other at a relatively close distance, they cancel out and the half wave radiator represents our working frequency.

"Authorities differ somewhat on the formulae for computing the antenna length (radiator). Windom and Lamb give it as $\frac{468,000}{\text{Freq. in k.c.}}$

while Schnell gives the figure 471,000 in place of the 468,000 of Windom and Lamb. Likewise in the formula for computing radiator length from wavelength, there are differences of opinion. Windom using the formula: Length in feet equals wavelength in meters times 2.07, while Lamb uses the factor 1.56 and Schnell gives 1.57. In the case of the first formula, I cannot see that any great losses can occur as at

By Don Bennett

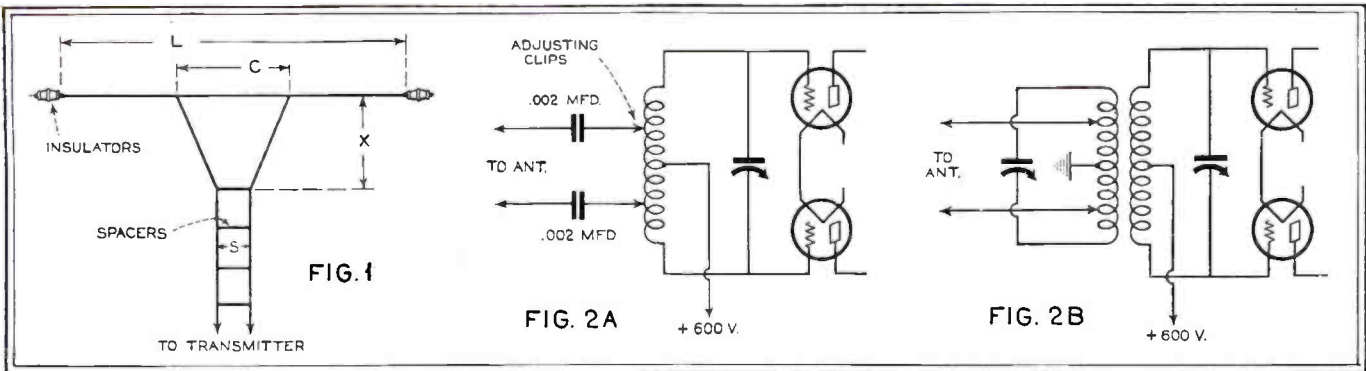

Fig. 1. The "doublet" antenna—refer to text for explanation. Note that the coupling distance "C" is distributed equally on each side of the center of the radiator itself. Fig. 2. (A) How the doublet is connected to the transmitter. Clips must be used and this makes it impractical for use with our transmitter as laid out at present. (B) An alternative method of coupling the doublet to the transmitter. Clips are used here too and the same objection arises

the frequency of 7250 k.c. used by Schnell as an example the difference is only four-tenths of a foot, about five inches. In the latter case, however, the discrepancy between the factor of 2.07 and 1.56 or 1.57 is another story. The difference is 30 feet at 41.4 meters. I am inclined to think that Windom is in error as his own calculations and graphs do not check with this figure. Schnell's seem to be closer to the truth and we'll use them.

Checking the Transmission Frequency

"Until you get some accurate means of checking your frequency, I'd suggest that you aim for the middle of the band and as you are going to work on 40 meters (7000-7300 k.c.) that means that we should lay out the antenna for 7150 k.c. Applying Schnell's formula; Length in feet = $\frac{471,000}{7,150}$ = 65.8 feet. Half that

amount will be the length of each feeder or 32.9 feet. The spreaders should be made of half-inch dowel, each spreader ten inches long. The feeder wires can be passed through holes bored close to the ends of the dowels or the ends can be slotted with a saw to a depth of about one-quarter inch and the feeder wires lashed in with wire or paraffined twine.

"To use a single wire feed, which, incidentally, is not as good for push-pull as the Zepp, we must use a tank at the transmitter to tune the antenna circuit and then tap off the hot end to the feeder (Fig. 4). This involves a slight change in our transmitter, one easily made and it might be worth while to try it as an experiment. We eliminate one of the antenna ammeters and one of the antenna tuning condensers. Hook the other condenser in series with the remaining antenna ammeter and both of them across the antenna coil (See Fig. 4). The feeder is then attached to one end of the coil. This single wire feeder must be fastened to the antenna at a very definite place, 14% of the length of the radiator from its center. And inches count. Let's see—our antenna is 65.8 feet in length. 14% of that is 9.212 feet or 9 feet 2½ inches from the center of the radiator.

"For the time being let's put up a Zepp. We'll cut everything to length before we put it up and the job will be much easier that way."

"O.K., Gus, up she goes."

(Here we fade out to denote a passing of some time while Gus and Don are putting up the antenna and we fade in to

Fig. 3. The Zepp feed antenna with constants for a frequency of 6150 kilocycles. See the text for additional information

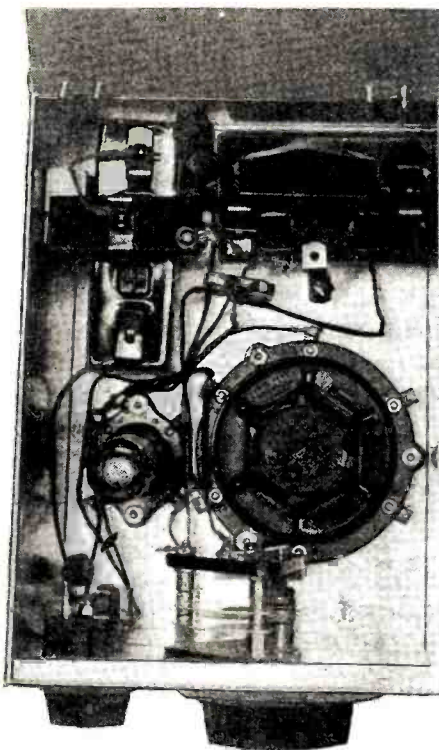

At the left is a top view of the s-w monitor which shows the layout of the various parts employed in its construction

discover them in Don's shack [amateur parlance for anything from a dry goods box to a mansion that contains a radio transmitter] discussing the monitor.)

Building a Monitor

"Aw, Gus, let's stick her on the air just to see that she perks."

"No, absolutely no! No monitor, no transmit."

"All right, what do you want for it?"

"Here's the circuit (Fig. 5), you see it calls for an inductance, a variable condenser, a tube, batteries, phone jack, radio frequency choke, a resistor, a fixed condenser and a shield can. We want to be able to change bands so we must use plug-in coils. Most hams use tube bases but I'm against them because of the losses they introduce. I'd say, use the same R.E.L. receiving coil forms we used for the transmitter. Not the same ones, but ones just like them. We have to wind two sets of coils on them, one for the grid circuit and one for the tickler. We'll put seven turns on the grid and twelve on the tickler for a starter. We can trim later if necessary

to get where we want in the frequency spectrum.

(AUTHOR'S NOTE: It is impossible to give the exact number of turns for the grid coil as the way each monitor is wired changes the characteristics. Start at seven turns and try it. Taking off a half or a full turn or increasing the spacing will enable you to get the dial spread you want and place the range of the monitor where you want it in the band.) We won't bother with the coils for the 80 and 20 meter bands right now. Let's get the transmitter working on 40. (7150 k.c.) The condenser (C1) is that wreck over there in the junk box. We'll pull all the plates out except two stator plates and one rotor plate and we'll double space those. Now we also need a .001 mfd. Sangamo by-pass condenser, a General Radio type 349 socket, a double circuit jack and a radio-frequency choke. This

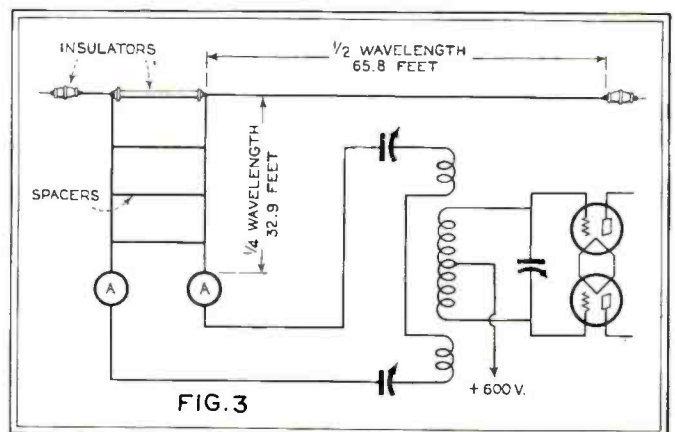

can be any manufactured receiving choke, a General Radio 379, an REL or you can make it of 150 turns of No. 30 wire on half-inch dowel. A 5"x6"x9" shield can will hold everything including the batteries which are an Eveready No. 768 or No. 763 small 'B' block and an Eveready No. 771-T 'C' battery. We also need a UX-99 tube. We might try a type -30 tube in here with some Uni-cells for 'A' supply. That might work and the -30 tube is more stable than the -99. If we use the -99 and the 771-T battery we can include a 30-ohm rheostat to drop the battery voltage of 4.5 to 3 volts for the filament or we can tap right off the battery at 3 volts. We also need some hardware for battery clamps and the like. Four rubber feet, one near each corner, will do nicely to absorb shocks. Oh, yes. We need a 2000-ohm resistance across the jack and a battery switch.

"Let's lay out the can so that it won't be crowded (Fig. 7). I think if we use one of the 6"x9" sides for the bottom we'll have plenty of room and the can will be rigid without any bracing."

(Another fadeout to denote the passage of time necessary to assemble and wire the monitor and adjust it, using the s-w receiver and a few marker stations as a guide.)

Marker stations that can be used in calibration. 40 meter band—7000-7300 k.c.

NDA 7320 k.c. WIZ 6965 k.c. GBS 6905 k.c.
RXC 6985 k.c. W1MK 7150 k.c.

Also standard frequency signals transmitted by S.F. stations of the A.R.R.L.

Going on the Air

"All right, Don, now we're set to go on the air. First, we'll set the monitor right in the middle of the band, according to our calibration. Now with the phones inserted, start up the transmitter. Keep your hands off! I'll do this first adjustment and you'll watch me. First we adjust the grid tuning condenser, oh, about halfway out. Now we slowly turn the plate tuning condenser and watch the needle of the plate milliammeter. There she goes up. Watch for the dip—up—up—now she's dipping—there she goes up again—now back with the dial to the bottom of that dip—there she is. Now let's find out where we are. Here—take one of the phones and listen while I twist the monitor dial—we're not between 7150 and 7000—try the other way—there we are—let go the key—yep, that's us—let's see—that should be about 7280—too high—our antenna is built for 7150—and it's too close to the edge of the band for our accuracy—this monitor isn't any too accurate—bring the grid condenser out a little more—now the plate condenser, till we hit resonance again—watch that dip—hold it—now the monitor—closer, but we're still too high—out some more on the grid condenser—now the plate con-

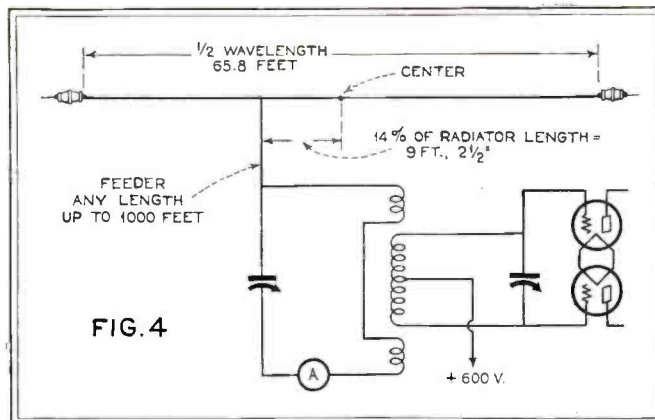

FIG. 4

Fig. 4. The tank-fed Hertz. This eliminates one antenna ammeter and one antenna tuning condenser. While it is simpler than the Zepp shown in Fig. 3, the Zepp is preferred because of the better results obtained

denser again—there we are right smack on 7150—according to the monitor—maybe we're within 20 kilocycles—can't get any closer though without a good frequency meter.

"Now for the antenna—You hold the key down—or better yet—send dit dit dahs for awhile and break every tenth one with your call—and make those dashes longer—how do you expect me to make any adjustments—that's it—now watch these antenna meters—see them go up—got to get them both the same—there we are—is the plate current normal—yep—okay boy—we're on the air—now for a CQ—and don't send forty times and sign once—three and three—"

"Say, Gus—she tuned up nice—but what if we hadn't been able to get in the band?"

"Well put, Calamity—if we hadn't been in the band, we would have fooled with the coils until we were—increased spacing—lopped off turns—put on turns—all the usual stunts to get in the band and well in."

(AUTHOR'S NOTE: The adjustment of coils applies to the transmitter as well as the monitor. The characteristics of each transmitter, governed by layout, wiring, etc.; affects the frequency and the coil data we give is relative only, a guide and not a fixed rule.)

"How does that note sound to you, Gus?"

"Ummm—fair. A little 60-cycle ripple in it. Shut off the power and I'll try adjusting the center tap of the 481's to see if it's there. Doesn't seem to be quite centered. O.K. Kick the switch again—that's a little better—now I'll try the filament center tap on the 510's—there it goes—no ripple. Boy, you've got a transmitter here!"

"Here comes Calamity again, Gus. What could we do if that didn't take it out?"

"Sensible question. We could increase the inductance and capacity in the filter. We have a good filter here though and it isn't necessary. A two mike condenser across the output of the filter would be the first thing to try.

"We have a good stable transmitter here and with the power supply giving us good d.c. we won't have to worry about 'wobulation.' And it is a worry—because it is illegal. Government regulations specify a clear steady note and a wobbly signal is neither clear nor steady."

"Well, Gus—here goes another (Continued on page 838)

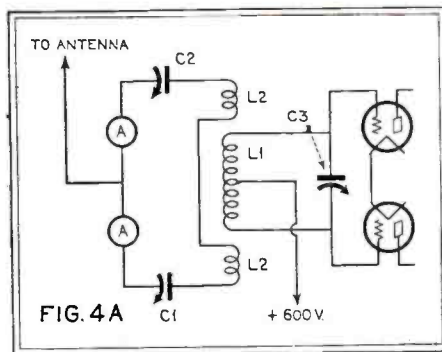

FIG. 4A

Fig. 4A. Variation of the tank-fed Hertz. This arrangement permits closer adjustment of the transmitter to the antenna. L1, plate tank inductance; C3, plate tank tuning condenser; L2, split antenna inductance; C1, C2, antenna tuning condensers; A, A, radiation meters

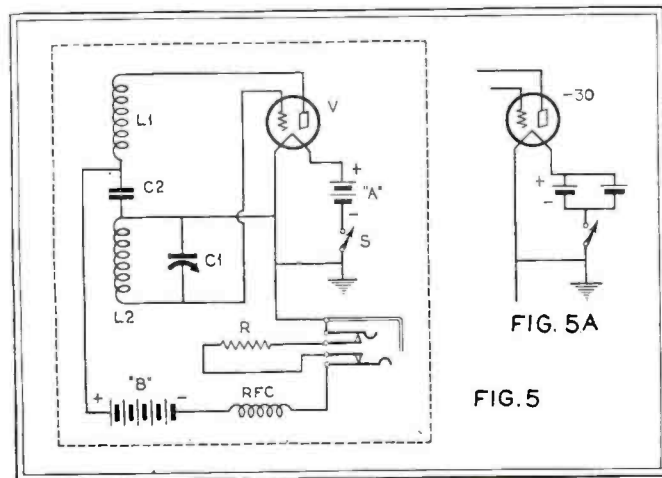

FIG. 5A

FIG. 5

Fig. 5. The monitor circuit. See the text for constructional details of inductance, L1, L2. C1 is the variable tuning condenser. C2, .002 mfg. Sangamo fixed condenser. V-type -99 tube or type -30 tube. A, 3-volt or 1.5-volt A battery. B, Eveready 763 or 768 B block. S, filament switch. R, 2,000-ohm resistance. Fig. 5A. Battery arrangement when using type -30 tube. Note two uni-cells arranged in parallel to give 1.5 volts

A N S. O. S. at sea! A staccato of dots and dashes pounding a rhythmic bastinado on taut nerves. A solitary signal across the silent ether tells of a land plane over a shark-infested sea with the motor "conking."

So ends Bouck's tale of his flight around South America, a fitting climax to a story of true adventure that shows that the romance of radio operating survives the era of tape transmitters and siphon recorders!

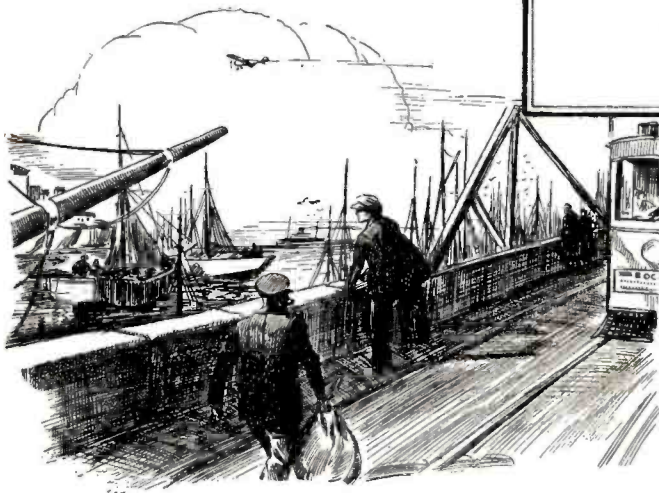
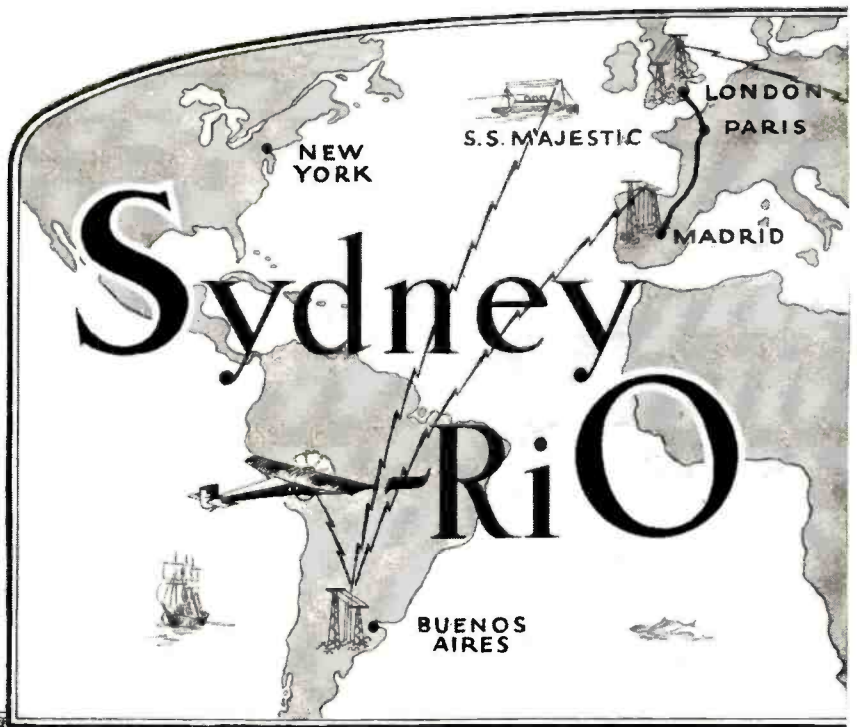

BUENOS AIRES! The magic city of South America, the Paris of the western hemisphere, the home of the tango, white-slave traffic, the Rivadavia, La Boca, two hundred thousand ladies of the evening and la Plaza de Mayo!

"B. A." is most comfortably inspected from a chair in the Grand Hotel Jousten. Buenos Aires is more glamorous in fiction than in reality. A city of almost three million somehow or another survives the bustle of modern civilization without the recreations in which we are accustomed to seek relaxation. That one may not forget that there is such a thing as night life in Buenos Aires, the city co-operates in the publication of a monthly magazine, *La Luma*—"A Guide to Night Life in Buenos Aires," in which are listed the four caba-

rets, the handful of theatres and the several hundred licensed houses of prostitution which the metropolis offers those seeking entertainment.

Of course, there is La Boca. La Boca means "the mouth"—the jaws that gobble up the last dregs of humanity before they finally pass from the light of day into an oblivion that is equally pleasing to the victims and to the world. Take the Tenderloin district of old New York, what was once the Barbary Coast of California, the Apache-infested cellars of Paris, mix well with a dash of South American technique, and you have—La Boca. La Boca is the section just south of Buenos Aires, where the wharves are—where the boats come in from the far corners of the globe. Here, indeed, is a night life where a guide is most desirable—several guides, as a matter of fact, all friendly and well armed. If you tire of the more usual forms of entertainment, so readily available in every cabaret and bar, two pesos will admit you to any one of several motion picture houses specializing in obscene photoplays. Or, if you are a bear for realism, you may watch them being taken for another peso.

When wholesale murders assume revolutionary proportions, the authorities occasionally take a hand, and La Boca is in for a moral uplifting. Once the city decided that all girls in cabarets must be professional entertainers. Happy to comply with the law, the girls immediately dubbed themselves "artistes." Then the law, deciding that the loophole was entirely too obvious, declared that no women would be permitted in the cabarets unless they were hired musicians. This stumped them—but not for long. I know a

Rio de Janeiro

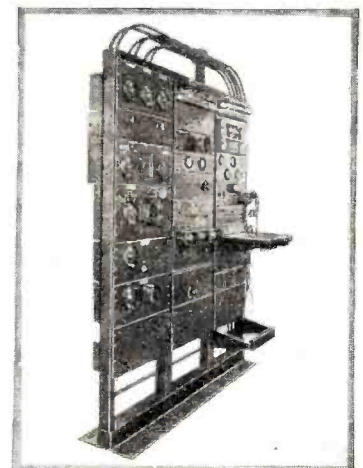

The short-wave receiver at the New York end of the New York-Buenos Aires beam transmission system

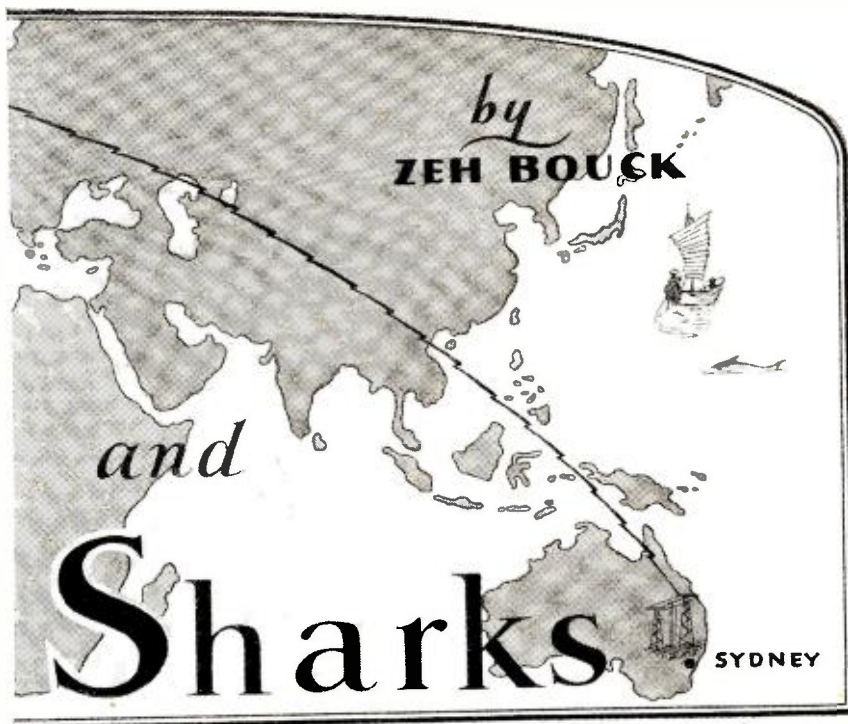

“Hello Australia!”

Spoken in an Airplane Flying Over South America, Were the Words That Made the World's Record for Long-Distance Voice Transmission. A Highlight in the History-Making Flight of the “Pilot Radio”

cabaret in La Boca where twenty beautiful girls play industriously upon twenty violins. They play apparently by ear, for their eyes and smiles wander constantly among the clientele. The music is somewhat thin—but this may be because only three of the violins have strings.

But we were in Buenos Aires for experimental investigations of a different order; and on the third of July, with an emergency antenna, we worked New York City while grounded at Moron Field.

The following evening we took the plane up for a flying schedule with WHD, and made an even more satisfactory contact. This was to be expected, due to the improved radiation and receiving characteristics of the apparatus in flight. The field was covered with a slight mist, but twenty miles to the south, the lights of Buenos Aires cast a ruddy glow against the sky, and a needle of light ran out along the Rivadavia to Moron. In the midst of a press dispatch to New York, the motor cut dead, caught for a moment, then conked again. I hastily broke my message, sent through word that we were forced down by motor trouble, and reeled in the trailing wire antenna. Burgin slipped the plane over the fence and straightened out into the almost invisible field, between two cans of burning gasoline that had been lighted as flares. As soon as we had rolled to a stop, we strung out the emergency antenna and were back in communication with New York in less than ten minutes after the first pop-back of the motor.

The distance was in the neighborhood of eight thousand miles, and the signals on both ends were excellent. New York was sweltering in a summer heat wave—we were

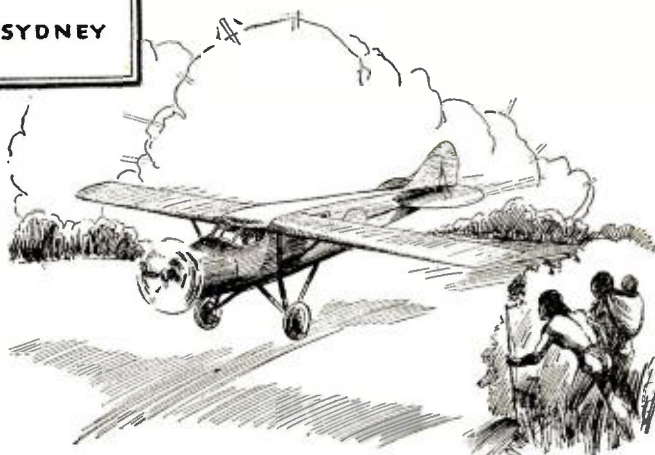

freezing in the South American winter, hugging a kerosene lamp in the cabin of the plane.

Telephone Relay Experiments

The International Telephone and Telegraph Company operates two beam telephone transmitters from Buenos Aires, one on the New York channel and the other with Madrid. These transmitters work on wavelengths from 14 to 31 meters, and are employed in handling commercial telephone traffic between B. A. and the United States and Europe. The transmitters are located at Hurlingham, about twenty miles northeast of Buenos Aires, and the receivers at Platinos, about twenty-five miles south, on the Rio de la Plata.

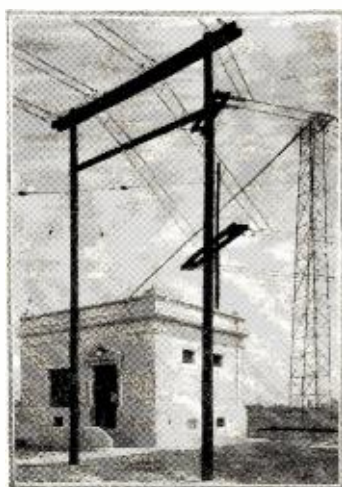

The 500-kw. substation at Hurlingham, the English end of one of the Buenos Aires beam transmission systems

Buenos Aires



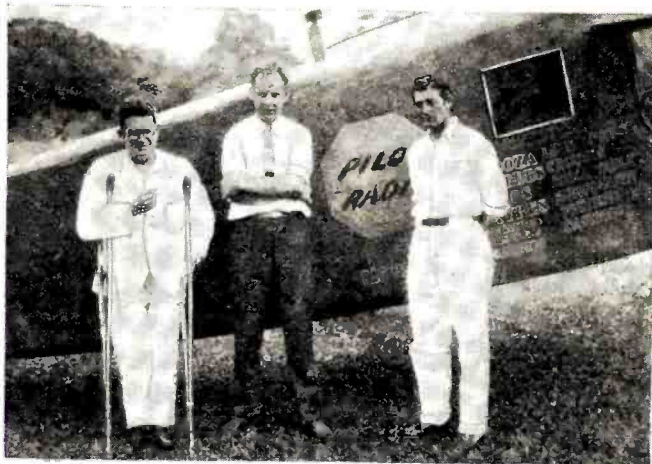

The last photograph taken of the "Pilot Radio" and its crew of three. From left to right, Zeh Bouck, radio communication engineer; Captain Yancey and Eddie Burgin, pilot. To the right, the course of the last leg of the flight which terminated so unfortunately on the sands of Great Exuma Island

The transmitters and receivers are connected through a telephone central at Cuyo with any telephones on the general subscription list in Argentina, Chile and Uruguay. It is possible to pick up a telephone in one of the serviced areas, and call a number in Europe or the United States with the ease of making any other long-distance call. Highly efficient directional transmitters and receivers are employed, with the resultant elimination of cross talk on adjacent channels, and the reduction of static to a negligible degree. A bolt of lightning striking one mile behind the receiving antenna will not produce even a faint click in the receiver output. Automatic volume control results in a steady signal, and the overall audio characteristics are superior to those of a long land line.

A dinner with the engineers and publicity department of the I. T. and T. brought up the possibility of some interesting experiments between the plane and their international network, providing we could modulate the output of the plane transmitter with voice. We designed a simple Heising modulator, employing one stage of speech amplification and two UX211 tubes as modulators, with a common filter-modulating choke to both the oscillator-power amplifier and modulating panels. The entire unit was suspended in the cabin of the plane with rubber bands cut from a Ford tire! A standard studio broadcast two-button microphone was used, mounted on springs in an Edgeworth tobacco tin, which, in turn, was packed in a cardboard carton. A round corrugated tube led into the diaphragm for speech admittance. This arrangement provided excellent shielding against the pick-up of engine noise. To insure the stable operation of the entire combination, separate twelve-volt storage batteries were carried, one unit for lighting the filaments of the modulating tubes, one for the operation of the Esco dynamotor and the lighting of the filaments of the oscillator-power amplifier tubes, a third unit for the receiver, and a fourth twelve-volt battery as a spare. This meant that we would fly with over five hundred pounds of storage-battery setting loosely on the floor—a pleasant thought in the anticipation of a crash or forced landing on a soft field!

A separate fixed antenna was strung from the wing tips to the stabilizer, and up to a bakelite tube through the top of the fuselage into the radio shack. This antenna was used for transmitting, and the regular trailing wire for receiving. Operating on the fundamental, the transmitter was tuned to about 32 meters, making it possible to receive through our own car-

rier on 14 and 15 meters (the waves employed by the New York and Madrid transmitters) without harmonic interference. Thus, instantaneous two-way conversations could be carried on.

Our first tests were made on a Sunday afternoon—an off-traffic period for the Madrid transmitter, LSF. We first worked LSO, a third transmitter of the I. T. and T., on code, then shifted to phone, and finally worked two-way phone with LSF. Our signals were being picked up on the field strength measuring receiver at Platinos. We were then plugged through to the Jousten Hotel, where we spoke at length with Yancey, and made the necessary arrangements for our first international contact, the following morning, with New York.

The next day, traffic was suspended on both the New York and Madrid channels from 9:00 a.m. to 10:00. We took off with Yancey, Leigh Wade, the famous around-the-world flier, and the full load of batteries at 8:45. We immediately established communication with LSF. The line-up was as follows: Our speech was to be picked up at Platinos, fifty miles south of the plane, sent through Cuyo to Hurlingham, and out on the New York beam, LSN. The incoming signal from New York would in turn be picked up at Platinos, put on the land line through Cuyo to Hurlingham, and retransmitted to the plane over the Madrid transmitter.

At nine o'clock, we spoke to Mr. Ritchie, the New York technical operator, and shortly after put through a call to Mr. I. Goldberg, the president of the Pilot Radio and Tube Corporation, backer of our flight, at Lawrence, Mass. The conversation was carried on as easily as over a local circuit, and we later talked with the *New York Times*, Mrs. Yancey; and Leigh Wade put through a call to his office.

Learning of our experiments, the editor of the *San Francisco Examiner*, taking the chance one morning that we might be in the air, put in a call for us. Just by luck, we did happen to be flying, and the first telephone call ever made to an airplane without pre-arrangement was plugged through over a distance of

ten thousand miles! Shortly after, we were again in contact with California, this time with a call from the plane by a representative of Metro-Goldwyn-Mayer for Ramon Novarro.

Our tests were temporarily discontinued a few days later when the diaphragm of the microphone was split three ways during a cold night. Our next call was to the captain of the *Majestic* while that vessel was still one day's sailing from Southampton. The signals traveled from the plane to Platinos, then to Hurlingham and Madrid. At Madrid, land wire carried the voice to Paris and London, and then by wireless again to the *Majestic*. The captain spoke (*Continued on page 830*)

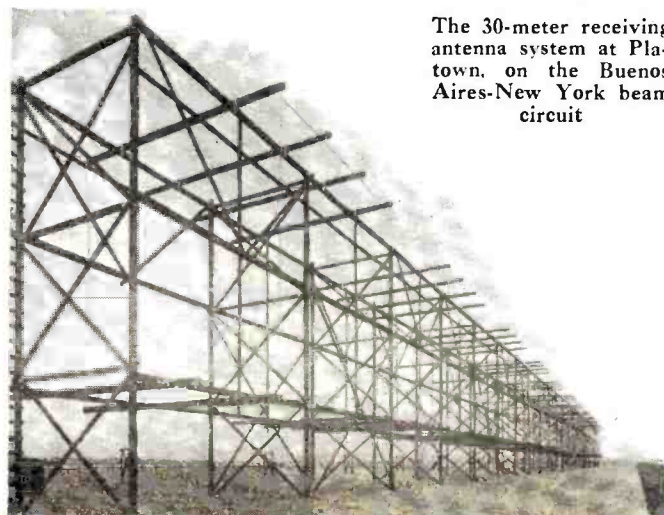

The 30-meter receiving antenna system at Platinos, on the Buenos Aires-New York beam circuit

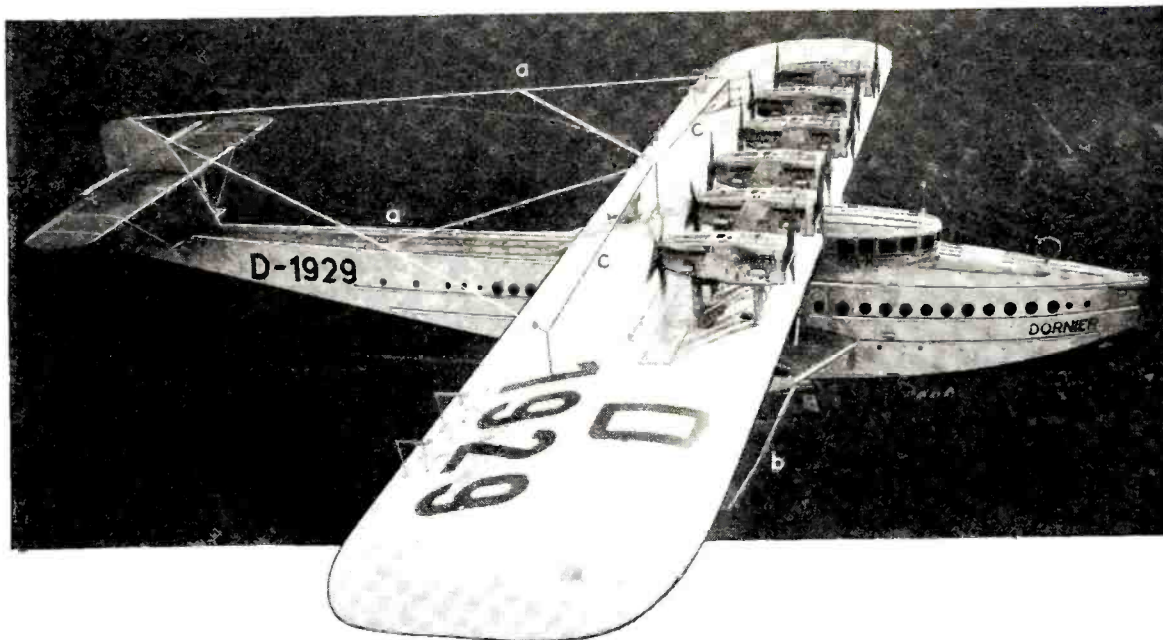

Radio *Aboard the* DO-X

The Largest Flying Boat in the World Employs Three Antenna Systems, Two Transmitters and a Multi-Wave Receiver to Maintain Radio Contact with Ship and Shore Stations

WHEN the mammoth German transatlantic airliner, Dornier DO-X, leaves European shores on its contemplated flight to South America, it will maintain constant communication with both its taking-off place and destination, to say nothing of the contacts with numerous ships overtaken on its course, by means of two transmitters and an elaborate receiving system. This radio installation is probably the most pretentious ever included in any airplane.

In one of the cabins on the upper deck (the DO-X has three decks) is located all of the transmitting and receiving apparatus. Along the upper surface of the main wing and extending back to the tail are two antennas, while from the hull a trailing wire antenna may be lowered. In addition, in the bow of the hull, a loop antenna is installed for direction-finding purposes.

The two transmitters are used for different purposes. One is a long-wave transmitter rated at 120 watts, covering a wavelength of 550 to 2,300 meters. Communication with it may be carried on on either telephony, straight cw. or icw., so that vessels along the course of the flight may be contacted. This transmitter is the more generally used of the two, being employed mainly for routine commercial message handling. The other transmitter is for long-distance work and is of the short-wave, crystal controlled type, working on a waveband of from 25 to 80 meters. Its power is rated at 10 watts.

Besides housing the transmitting apparatus, this cabin also contains the receiving equipment, which consists of a flexible circuit arrangement employing seven tubes in all. This receiver covers a waveband of from (Continued on page 845)

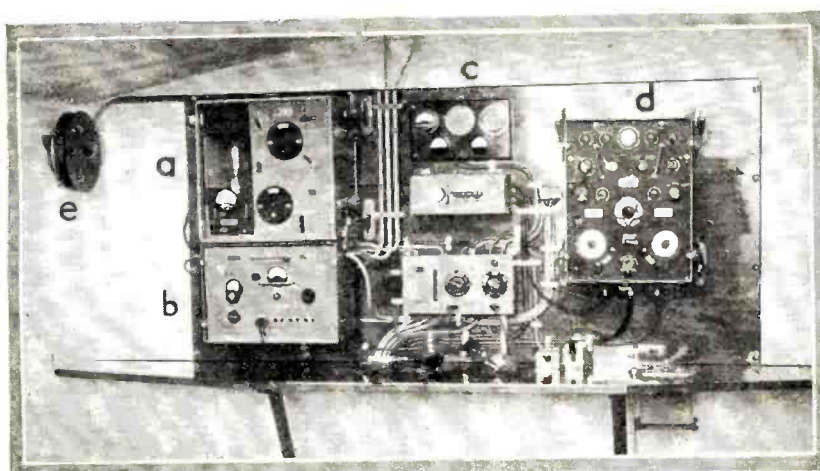

The radio cabin aboard the giant airliner DO-X. "A" shows the long-wave transmitter; "B" the short-wave transmitter; "C" the switchboard and indicator instruments; "D" the all-wave receiver, and "E" the reel for the trailing antenna

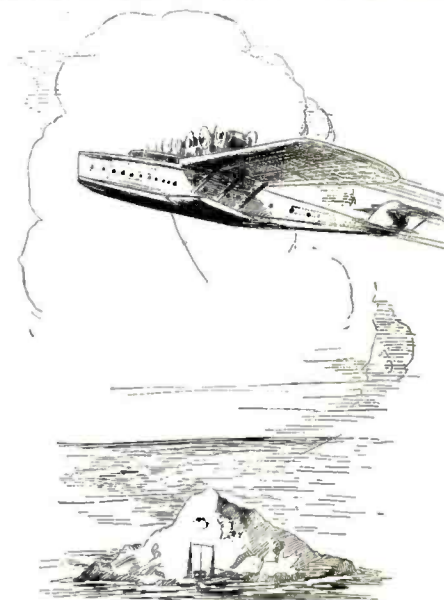

Radio News Manufactured Receiver Circuits

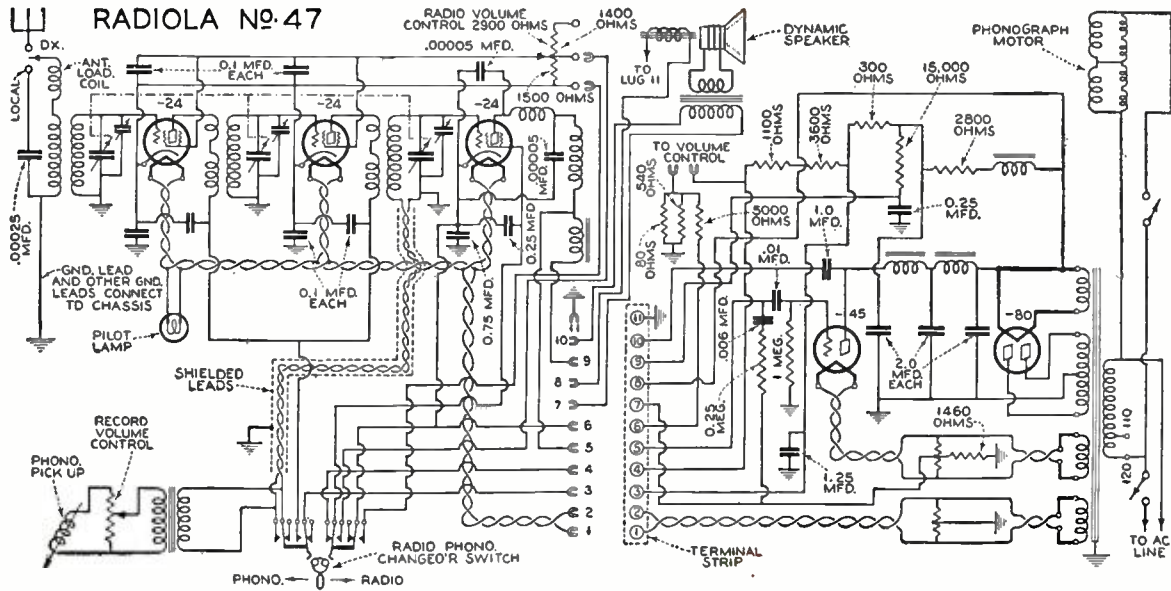

THE Radiola No. 47 is a tuned radio frequency receiver of four tubes. The two r.f. stages and the power detector are of the -24 type, the single audio stage of the power type employs the -45 power tube. The power unit uses the -80 full wave rectifier tube followed by a two section choke-capacity filter.

Provision is made for phonograph connection by a radio phonograph change over switch. The antenna circuit is arranged for local or distance reception. The receiver, speaker, phono pickup and phono motor are contained in the same housing.

Radio News Manufactured Receiver Circuits

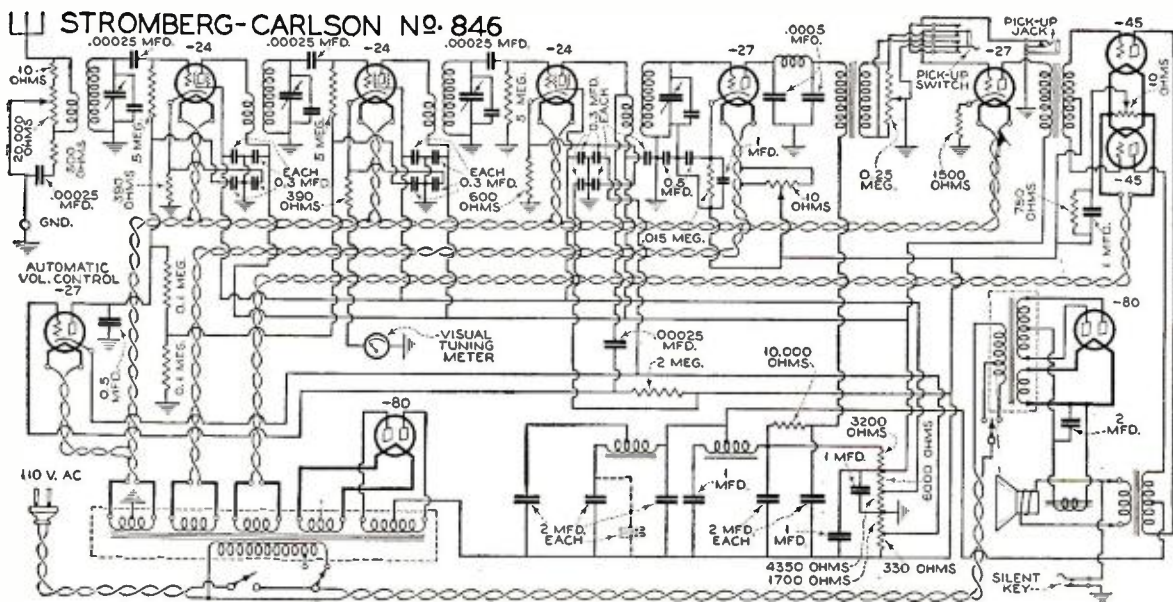

THE Stromberg-Carlson No. 846 is a seven tube receiver with an automatic volume control. The three r.f. stages are of the -24 type, the power detector is of the -27 type, followed by a single audio stage with the -27, and a power push-pull stage in which the -45's are used. The power unit is of the -80 full wave type followed by a

tuned filter trap circuit. The speaker field is supplied by a separate -80 full wave rectifier, arranged with a switch for low or high voltage input to the field. The power transformer of the receiver is also arranged with a high or low voltage switch.

Values of the parts are as indicated above.

Radio News Manufactured Receiver Circuits

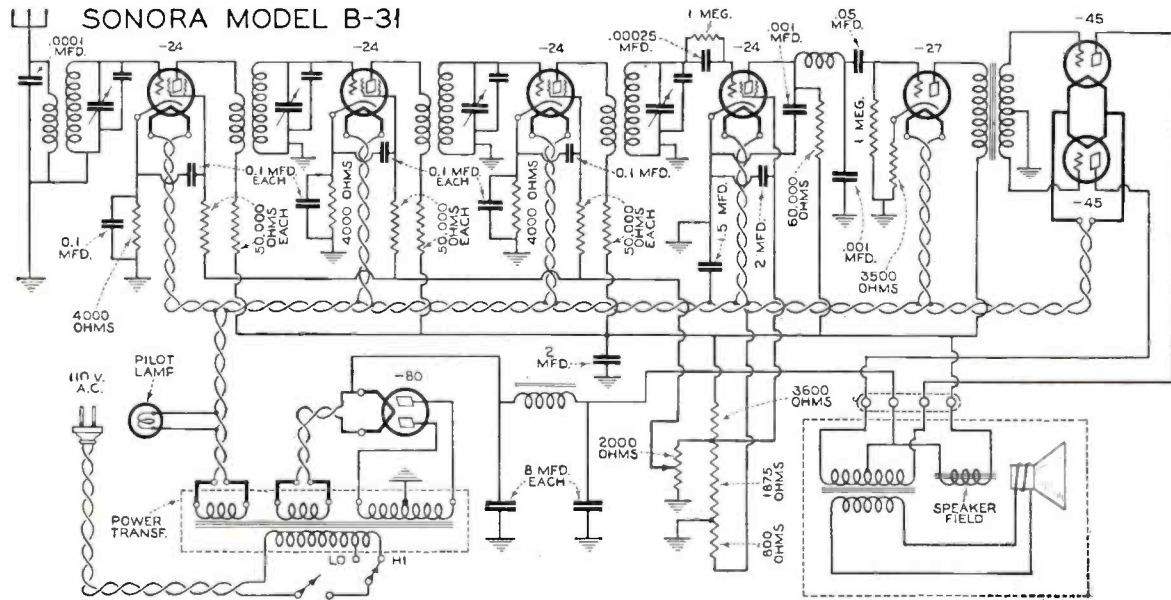

THE Sonora Model B-31 receiver is a seven tube receiver. Type -24 tubes are used in the three radio frequency stages, and as the high gain detector of the grid-leak condenser type. A -27 is used in the first audio stage, its input coupled to the detector through resistors and capacity. Its output coupled to the push-pull -45 tubes by a transformer of low turns ratio. Trimmers are used across the tuning con-

densers. To further facilitate compensation a .0001 condenser has been placed across the antenna primary winding. The r.f. return circuits are well by-passed to the cathodes. The power unit is of the usual -80 full wave type, filtering is accomplished with a single choke and the speaker field, with high capacity condensers. A switch is provided for high or low line voltages.

Radio News Manufactured Receiver Circuits

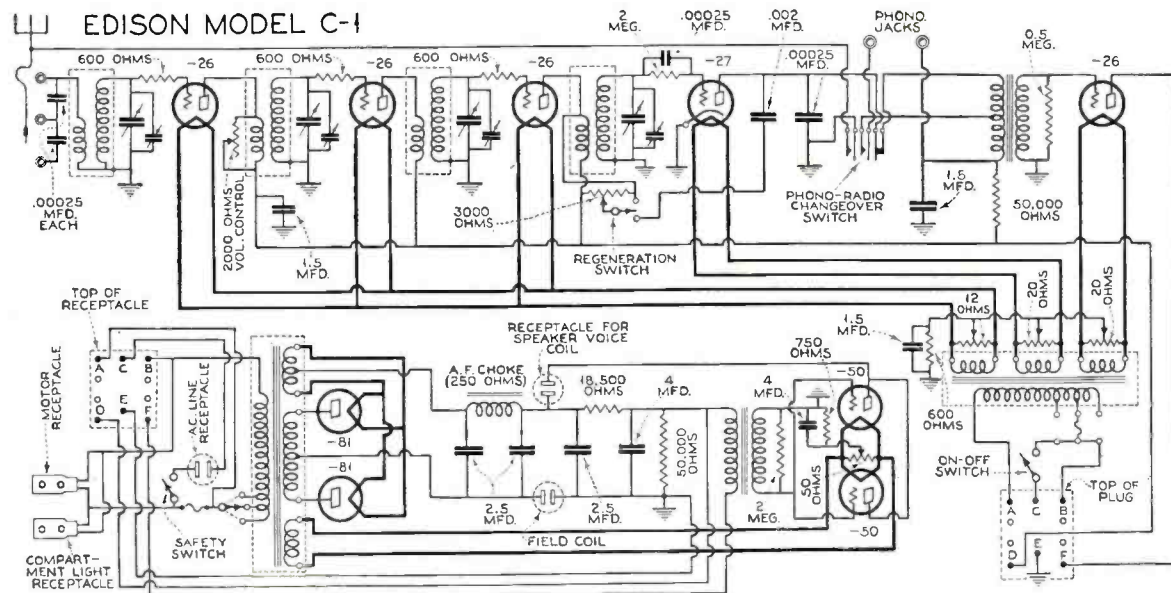

THE Edison Model C-1 is a seven tube receiver in which the three r.f. stages use -26 type tubes, stabilized with grid suppressors. The detector is a -27 of the grid leak and condenser types, followed by a -26 transformer coupled first audio stage. The output tubes are -50's in push-pull.

The phono-radio change over switch automatically shorts the antenna primary to ground. The antenna circuit is arranged for adjustment to any antenna. The power unit uses -81's in full wave rectification followed by a semi-tuned choke-resistance filter.

"The Explorer"

A Plugless Coil S-W Converter

With this extremely simple device attached to the regular broadcast receiver, short-wave reception is at your fingertips. Simplicity of operation and loud speaker results are only two of the dominant features of this efficient short-wave unit. A new type of construction employing a simple switch arrangement eliminates the necessity for changing coils for the various short-wave bands

SHORT-WAVE radio reception, with its numerous inherent advantages and tremendous possibilities, has for some time been in the stage of its development where the advance guard of radio, the amateurs and experimenters, can be well satisfied with the work they have done. But these pioneers have been interested in results primarily, and the difficulty imposed because of the means used in attaining those results did not trouble them at all. They have simply disregarded the weaknesses of their receiving apparatus, the difficulty of tuning, critical and unreliable operation requiring frequent readjustment, lack of good loud speaker or even headphone volume, and the annoyance, inconvenience, and waste of time incidental to the necessity of using a set of interchangeable plug-in coils to change wavelength bands. To hear the whisper of a station in England, Argentina, or Java has repaid them a thousandfold for their strenuous efforts and unlimited patience.

The fascination of reception on short waves has drawn the lively interest of the vast army of broadcast listeners, a great many of whom are wearied of the sameness and banalities of some broadcast programs, and who are seeking new radio thrills. The broadcast listener, however, is far more exacting in his demands than is the experimenter. He wants the simplicity of operation, ease of tuning, and real loud speaker volume to which he is accustomed in the broadcast band. Failure to meet these demands in the past has deterred him to a large extent from exploring this remarkable field of short-wave reception.

To the broadcast listener who has decided to join the constantly increasing number of short-wave listeners, there is available a choice of either an independent short-wave receiver, or a short-wave converter or adapter which may be attached to his broadcast receiver. The short-wave receiver must contain its own audio amplifying system, and it necessitates the use of some form of independent power supply, either batteries or an electric power unit, as well as an extra number of tubes. The converter uses the highly efficient audio system and power supply of the broadcast receiver. The complete short-wave receiver must therefore be considerably more expensive. In either case, until now, the use of cumbersome plug-in coils has been taken for granted as being absolutely necessary.

In the past, as many have found to their sorrow, the majority

*Rim Radio Manufacturing Co.

Enclosed in a metal shield box, the Explorer converter need only be connected to the regular broadcast receiver for reception of short waves

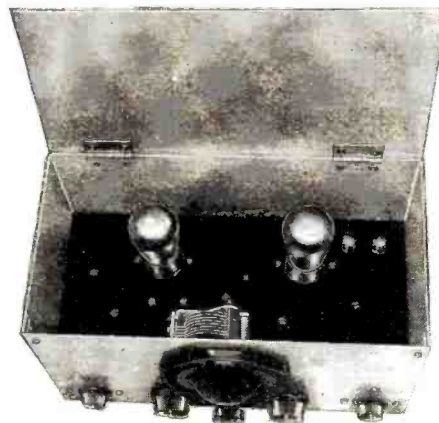

A top view of the two-tube s-w converter

of single-tube converters have given results which could in no way be compared to the results obtained by short-wave receivers. Their defects have been numerous; lack of volume, difficulty of tuning, difficulty of handling due to excessive compactness, audio howling, "fringe" howling, motorboating, lack of oscillation or too violent oscillation, and failure to operate at all with some broadcast receivers. When work was begun on the new "Explorer" eight months ago the problem was faced of eliminating every one of these defects, of obtaining real loud speaker volume on distant short-wave stations, and last, but not least by far, of eliminating entirely the bothersome plug-in coils.

The final result more than justified original expectations. A series of comparative tests have been made, checking

the converter against a standard four tube screen-grid receiver. The converter proved superior in practically every respect, with far greater simplicity of operation, easier tuning, and much more volume. For example, LSX in Buenos Aires, Argentina, which could be heard only with headphones on the receiver, was received with sufficient loud speaker volume by the converter to fill a good-sized room. Shifting wave bands on the receiver by means of a double set of plug-in coils required at least two minutes; the same operation on the converter by means of the automatic band-selector takes half a second!

Two major problems were considered in developing the converter. The first was to eliminate plug-in coils for changing wavelength bands. The necessity for using plug-in coils has been one of the chief obstacles in the way of the spreading popularity of short-wave reception. The problem was solved by using a special automatic band-selector system, whereby wavelength bands are changed by simply turning a knob located

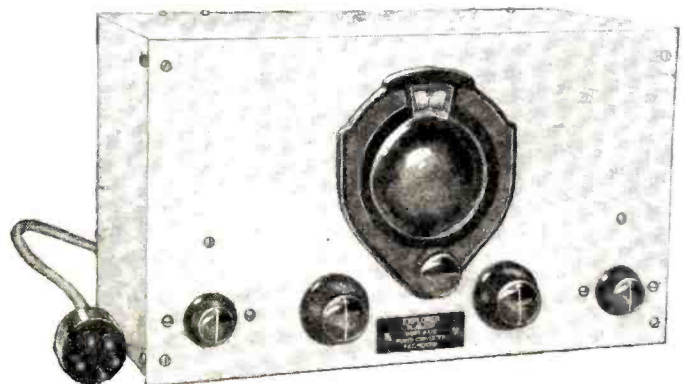

By Irving L. Fishman*

on the panel of the converter, resulting in the greatest possible simplicity and convenience of operation. More than a year's work was required to perfect the band-selector system so that it would be smooth, reliable, and efficient. It is protected by a patent pending. The knob which controls the band-selector is the small one at the extreme left of the panel.

The second major problem was to obtain real loud speaker volume even on the weakest stations. A short-wave converter is intended for loud speaker reception, due to the fact that headphones cannot readily be attached to modern broadcast receivers, and their use is undesirable anyway; whereas short-wave receivers can depend on headphones for the reception of weak stations. The problem of obtaining sufficient loud speaker volume is therefore of even greater importance in a converter than in a short-wave receiver. It was solved by incorporating a stage of audio-frequency amplification in the converter itself.

There is nothing complicated about the method of operation of the band-selector system. It is diagrammed in the circuit of the converter shown in Fig. 1. A wavelength range of 15 to 160 meters, which covers practically all short-wave activity, is covered in three steps by means of the three coils indicated in Fig. 1 as A (L1L1'), B (L2L2'), and C (L3L3'). The coils are mounted compactly beneath the bakelite subpanel near the coil-selector so that connections may be as short as possible. The vertical axes of the coils lie in the three different planes, in order to minimize interaction of the electrical fields and prevent the occurrence of oscillation absorption spots.

All the coils are wound on forms 1/4 inches in diameter. The coil data are given below.

Coil A—15 to 28 meters grid winding L1—3 turns No. 24 d.c.c. wire spaced 1/8 inch apart. Tickler winding L1'—6 turns No. 24 d.c.c. close wound. Coil B—27 to 65 meters grid winding L2—8 turns No. 24 d.c.c. wire close wound; tickler winding L2'—7 turns No. 24 d.c.c. wire close wound. Coil C—63 to 160 meters; grid winding L3—24 turns No. 28 d.c.c. wire close wound; tickler winding L3'—12 turns No. 28 d.c.c. wire close wound.

Ample overlap is provided on the edges of each band. The connections of the coil windings are shown in Fig. 1. One end

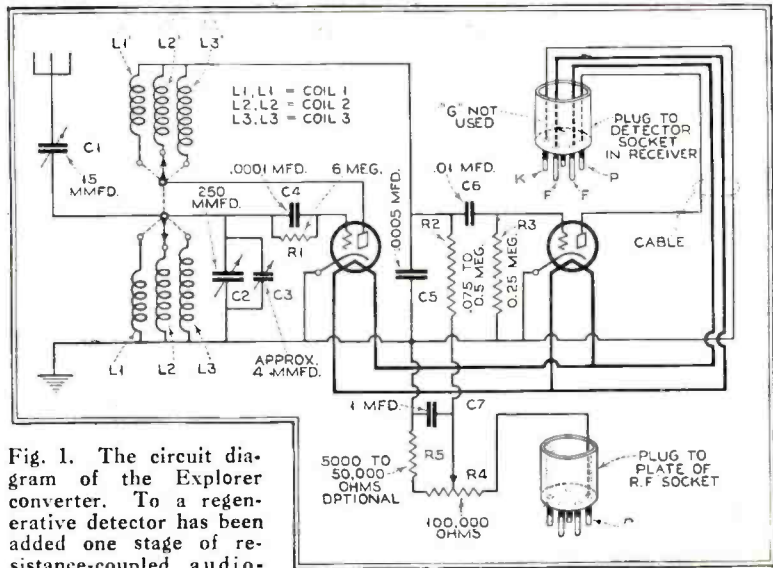

Fig. 1. The circuit diagram of the Explorer converter. To a regenerative detector has been added one stage of resistance-coupled audio-frequency amplification. Note the arrangement of the wave-band switch

of each grid winding is grounded, and the other end is attached to a terminal with which the movable arm, S1, of the coil-selector makes contact. This arm leads to the grid side of the tuning circuit. The tickler windings of each coil are similarly connected. One end of each winding goes to the B plus side of the detector plate circuit, and the other end is connected to a terminal with which the arm, S2, of the coil-selector contacts. This arm in turn leads to the plate of the detector tube. The arms, S1 and S2, are moved simultaneously by turning the band-selector knob on the panel of the converter.

The positions of the band selector knob corresponding to the three wavelength bands are shown in Fig. 2. With the knob in position 1, the wavelength range is 15 to 28 meters; in position 2, 27 to 65 meters; and in position 3, 63 to 160 meters. The circuit diagram, Fig. 1, shows the contact of the arms of the coil-selector with windings L2 and L2' of coil B, which corresponds to position 2 of the band-selector knob. Coil B is now in the circuit, and coils A and C are effectively cut out.

The stage of audio-frequency amplification used is of the resistance-coupled type. The output of the audio stage is delivered through the cable and connector plug into the detector socket of the broadcast receiver. Since the great majority of receivers employ two stages of audio amplification, a total of three stages are used altogether. This great amplification results in satisfactory loud speaker volume on even the most distant stations; on the more powerful short-wave stations the volume is comparable to that of stations in the broadcast band.

The plate voltage of the converter detector tube is drawn from one of the radio-frequency sockets of the receiver, instead of from the detector socket, as has generally been the practice in the past. The reason for this is the comparative uniformity of the r.f. plate voltages in different broadcast receivers, varying in the majority of cases between 110 and 180 volts; while the detector plate voltages in the same receivers may vary anywhere from 15 to 260 volts. With 15 volts on the detector plate oscillation is insufficient, with 260 volts it is terrifically violent and uncontrollable. In either (Continued on page 834)

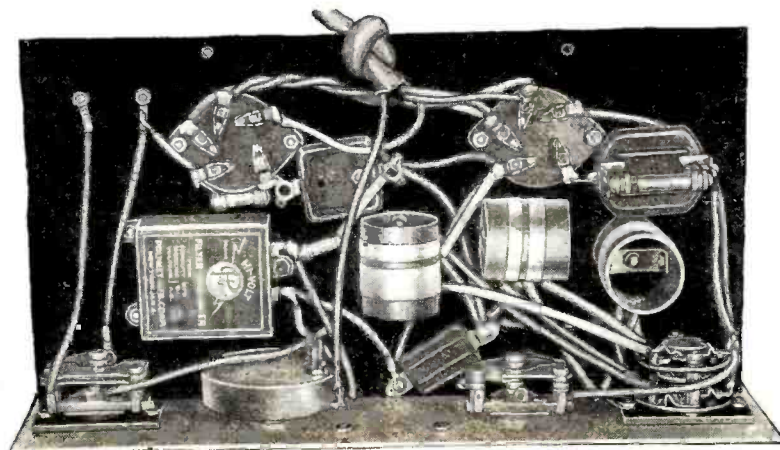

Underneath the sub-panel of the converter is located the tuning coil sockets and, with the exception of the tubes and tuning condenser, practically all of the parts comprising this unit

MR. FISHMAN has built and described here a short-wave converter which should excite the interest of not only every dyed-in-the-wool experimenter, but that vast army of broadcast listeners who, with a limited pocket-book, have, up to the present, confined their short-wave activities to the purely educational side of reading about the developments in this rapidly developing field. Now, without much expenditure, they can build the simple unit described here to augment their present radio equipment and enjoy all the thrills which abound in short-wave reception.

THE EDITORS.

The Service Bench



Discussing hum, noise, intermittent reception, time payments and service, magnetic speakers, phonograph pickups, fading signals. Receivers serviced: Majestic, Amrad, Crosley, Radiola, Temple, Zenith

IN the last appearance of the "Service Bench," we published a description of a vacuum tube voltmeter calibrated especially for the quantitative determination of hum. This device will be particularly useful in practising the procedure outlined in the following article.

Hum Hunting

By Boris S. Naimark

IT is generally conceded that no receiver is entirely free from hum. However, this hum may be of such a low value that it is not objectionable. Unfortunately, one often encounters cases where the hum attains an abnormal value, and the source of hum must then be quickly localized and remedied.

Objectionable hum may be due to any one of the following causes:

1. Mechanical; 2. Faulty adjustment of the hum balancers;
3. Poor tubes; 4. Induction; 5. Current supply; 6. Insufficient filtration; 7. Defective parts and circuits.

We have placed the mechanical causes of hum at the head of the procession, not because they are the most common instance of hum, but because they are probably the easiest to locate. If the hum is accompanied by a simultaneous mechanical vibration within the power supply section of the receiver, it may be assumed that the hum is due to a mechanical defect, generally loose laminations in the power transformer. Remove the transformer from the receiver assembly, and in a pan heat it slowly in an oven until the sealing compound adheres to the laminations. Allow the transformer to cool for at least twelve hours before returning it to the receiver.

The incorrect adjustments of hum balancers, when such adjustments are provided, cause a great deal of trouble. Hum

balancers generally consist of potentiometer type resistors connected across the filament supply windings, the center taps being returned to ground. If a receiver hums badly, and hum adjustment is possible, the balancers should be adjusted before looking elsewhere for trouble. With only one balancer, the adjustment is extremely simple. A screw-driver is engaged in the movable arm slot, and is turned carefully until a point of minimum hum is achieved. In sets having more than one hum adjustment a certain sequence in the order of adjustment must be observed. The majority of receivers have three hum adjustments, one across the detector tube filament, one across the filaments of the radio-frequency amplifying tubes and the third across the power stage filament.

First remove the detector and first audio tubes from their sockets, and adjust the power stage potentiometer. Replace the first audio tube, and adjust the radio-frequency hum balancer. Lastly replace the detector tube and vary the third potentiometer for a similar minimum. Where there are only two adjustments to be made, the detector potentiometer should always be the last one adjusted. The detector tube should be removed from the socket when the other balancer is being adjusted.

Poorly matched tubes will cause an objectionable hum when used in a push-pull stage. Low emission rectifier tubes also account for their share of hum.

Tubes in the detector and first audio sockets are, perhaps, the greatest offenders, and in the order mentioned. While quick heater tubes have been developed that are relatively hum free, there is a margin of safety, in our opinion and experience, in employing slow heater tubes.

A simple procedure enables us to determine whether hum finds its origin in the detector or first audio tubes. Detune the receiver and listen carefully for hum. Remove the detector tube and note the difference, if any. If the hum is minimized more than a negligible degree, the detector tube is at fault and

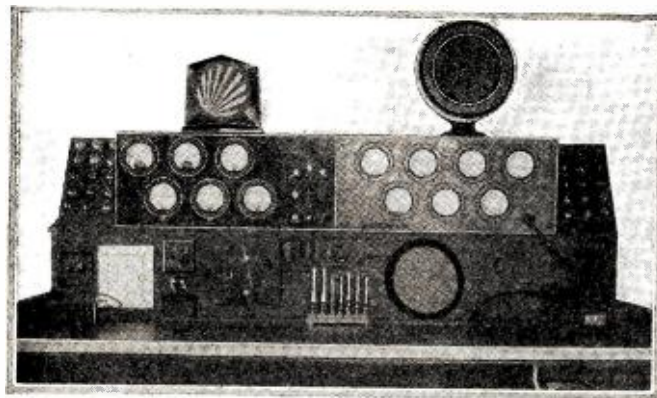

Hum tracing apparatus is incorporated in these modern and efficient service benches. Left—Radio Studios, Inc., Tuckahoe, N. Y. Right—The Radio Specialty Service, Mobile, Ala.

should be replaced. Make the same test with the first audio tube. When maneuvering these tubes, it is often desirable to disconnect the aerial, and listen for hum with the volume control at various settings.

Hum originating in the radio-frequency tubes is rarely apparent when not tuned to a carrier. However, a tunable hum is frequently due to the generator in the broadcasting station. Tune in as many strong carriers as possible. If hum is bad on all of them, it is a safe assumption that the fault lies in the r.f. section of the receiver.

Induction hums, in the modern compact receiver, offer serious problems which tend to be emphasized by the advent of the mantelpiece receiver. Offenders in this respect are the power transformer, rectifier tubes, associated leads, the first choke coil in the filter system and a.c. dynamic speakers in proximity to the detector and first audio stages. Quite often hum results from poorly filtered current being used to energize the speaker field.

It is suggested that a magnetic speaker be used temporarily with a receiver having an objectionable hum. The substitution will enable you to estimate the proportion of hum due to induction from the dynamic speaker. (Ed. Note: Make due allowance for the reduction in low note and hum response of the magnetic speaker.) Excessive hum is occasionally due to worn-out dry rectifiers.

By shorting the grid input to the second or power stage, additional hum in the loud speaker would indicate induction from the output transformer, the last audio tubes or the filter.

Induction hums may be reduced and eliminated by effectively shielding the first audio and detector circuits from the influence of the power transformer and filter circuits.

It is well known that the detector input circuit, particularly where grid leak and condenser detection is employed, is susceptible to electrostatically induced hum. To determine the amount of hum due to static induction in the detector circuit, the grid leak should be temporarily shorted. A reduction in hum should be noted. To minimize static induction at this point, the best practice is to rewire the grid connection so that both grid condenser and leak are mounted close to the grounded chassis as possible without upsetting the balance of the tuning condenser.

In fishing for hum reduction, always try reversing the a.c. plug.

Hum due to imperfect apparatus or circuits may be detected by visual inspection or careful circuit continuity tests. Shorted choke coils, open condensers, poor ground connections, shorted or open filament potentiometers all result in abnormal hum.

The more advanced students of radio technology, and I hope all good servicemen belong in this category, will be interested in the article by B. F. Miessner, appearing in the January, 1930, issue of the *Proceedings of the Institute of Radio Engineers*, entitled "Hum in All-Electric Receivers."

Freak Reception on a Temple

W. L. Morley, chief service engineer with the Temple Corporation, tells one on his own receiver that applies equally well to many other makes.

"Cases are occasionally reported where, when a loud signal is tuned in, the set will suddenly go dead, but immediately start operating again if it is returned. I have discovered that this con-

dition is due to the collection of a fine metallic dust between the condenser plates, causing an electrostatic short at irregular intervals. This trouble should not be encountered on Temple receivers having a serial number over 8000, and in any case is easily remedied by cleaning between the plates with a pipe cleaner."

-27 Filaments and Poor Connections

J. Paul Miller, custom set-builder and general radio retailer of Philadelphia, sends in the following notes on intermittent reception and noise:

"Watch for cracked filaments in the -27 type of tube in cases of intermittent reception. You can generally see the tube light up and then go out, like a thermostatic blinker.

"Noisy volume controls can be cleaned by the judicious application of graphite. Rub a drawing pencil over the winding, and tighten up the tension of the spring arm.

"I was temporarily stumped by a service call on a Zenith. The complaint was noisy reception and sudden fading. When I called, everything seemed okay, including all voltages, tubes and reception in general. But when the owner tried his radio that same evening, the usual fading was in evidence, resulting in a hurry service call. When I arrived the set was nearly dead, and none of the usual tricks seemed to do any good. Upon inspecting the lightning arrester, I discovered that the antenna and lead-in were spliced, originally being held together with a nut and bolt which, in the course of years, had disappeared. The connection now was badly corroded and decidedly microphonic. This explained the fading, the resistance of the joint varying as the antenna swung in the wind.

"In similar cases now, the antenna is inspected before the set itself."

Another Soldered "Joint"

"A Murad Super Six receiver was brought into my laboratory with a chronic case of fading, loss of volume and noisy reception. The usual mechanical and electrical tests failed to reveal the trouble. The volume control was inspected for a perfect wiping contact, and was found in good condition. However, while handling the volume control, the signals suddenly faded out. A second motion of the volume control brought the signals in again, localizing the trouble in this, so often guilty, piece of apparatus. The small soldering tap which connects with the shell of the volume control had broken loose, and the connection was highly microphonic and badly oxidized. This was resoldered and the receiver functioned perfectly evermore.

HERBERT F. BROOKS,

Authorized Silver-Marshall Service, Hackensack, N. J."

More Thermostatic Effects

One of our old reliable contributors, H. W. Huddleson, of H. W. Huddleson and Son, Auto and Radio Service and Merchandise, of Vandalia, Mo., keeps the ball a-rolling:

"Nearly all of the troubles with which we have had to contend in radio equipment of recent manufacture has been tube trouble. The complaint has been noise, or else our clients have said that reception was loud but not clear. We have also had a few (Continued on page 829)



THE utility of the test-set cannot be questioned. It is as useful to the serviceman as the stethoscope is to the physician. But many servicemen are too eager to apply the test-set without a simple preliminary examination that might be quite as illuminating as the more involved testing of each tube and voltage. For instance, in a dead receiver, a tap on the detector tube will inform the expert where to start with his test-set—in the r.f. or a.f. section. And there are other tests which, performed before individual socket analysis, will save time and needless labor in many service calls.

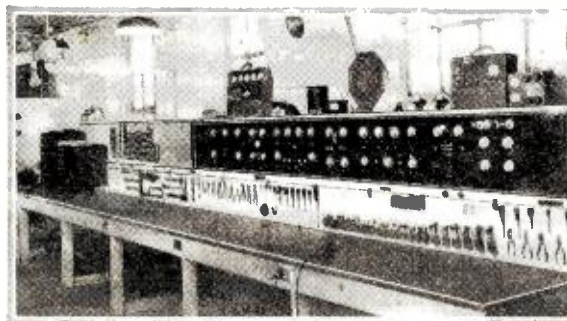

Where neatness and efficient arrangement contribute to the facility and dispatch of servicing. The service laboratory of the B. K. Sweeney Electrical Company, Denver, Colo.

The Fort Myers unit of the Naval Communication Reserve, Seventh Naval District

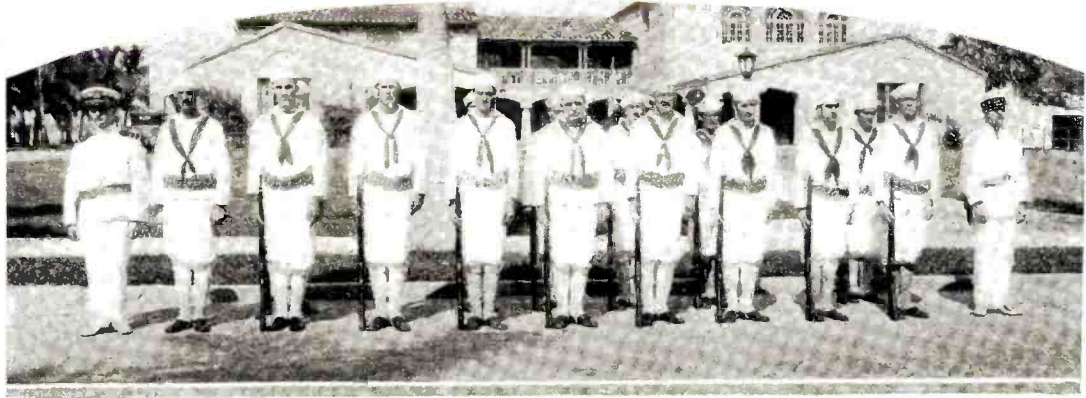

The Navy's Volunteer

BACK in 1917 the United States needed radio operators and needed them badly. Every possible means of obtaining them for the Navy was utilized. Commercial and amateur operators were virtually at a premium and they could not enlist too fast to meet the requirements of the Service. The supply of trained operators soon was exhausted and in consequence large training schools were established, where, during the course of the war, several thousand men were graduated and sent to duty as radio operators. Practically all of these operators were enlisted in the Navy and Naval Reserve.

Many are the tales told since then of the splendid service performed, the excitement of intercepting enemy radio traffic, of service with the fleet and the long watches stood during the hours of the night as a convoy approached the zone of submarine action. We have heard the story of the radio operator serving on one of our ships who had waited a month for orders from the captain to open up with his transmitter, and when the order finally did come down, found his fingers so nervous he could not operate the key for a full five minutes—but when he did begin transmitting, he made history.

The boys of 1917 and 1918 are mature men now, busy with their businesses and professions. It is not surprising to know that many of them hold positions of great responsibility in the commercial communication companies, not only in this coun-

The Navy offers to all commercial shipping the position-finding service. By taking radio compass bearings at several Navy receiving stations and plotting the findings on a map an intersection of bearing lines indicates the ship's position

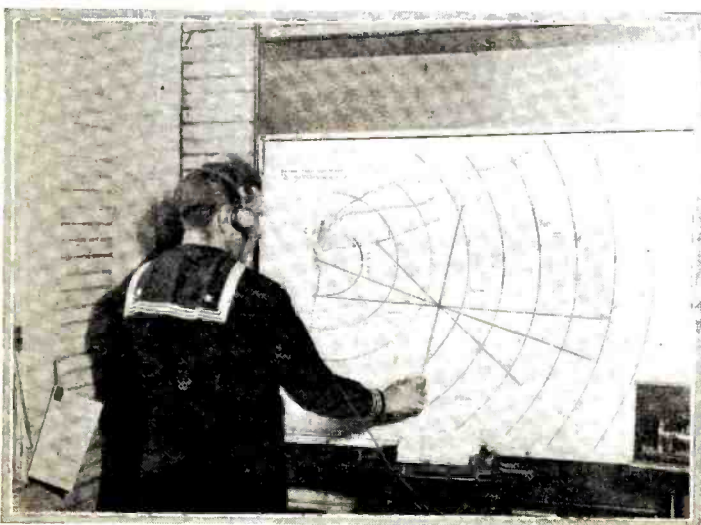

Since 1925, when the United States Naval prominent in the Naval Communications selves and honor to their organization by national emergency. The Porto Rican and England floods are typical instances when, tion broken down, the Naval amateur has ency lines of

try but all over the world. Many of them can look back on their original naval service as the first step up the ladder of success.

I mentioned the need for radiomen during the last war particularly because it proved difficult to obtain and train enough men in a limited time. Because of this, when the Naval Reserve was reorganized in 1925, provision was made for a group of officers and men to be known as the Volunteer Communication Reserve which is a branch of the United States Naval Reserve.

Until 1927 the Communication Reserve consisted of a handful of officers and men. Steps were then taken to formulate a policy to promote expansion and recruiting. One of the first steps consisted in laying out a plan of organization so that it could function on a voluntary basis. The Commandant of each Naval District designated a few class C-V(S) officers to act as recruiting officers and to take charge of drills and other training activities. Districts were later divided into geographical sections, these sections in turn being composed of units. Officers were placed in command of these.

Among the officers intimately connected with the early days of organization were Lieutenant Commanders Fred Schnell, A. H. Babcock, C. C. Kolster, Hiram Percy Maxim, J. C. Cooper, R. H. G. Mathews, Thomas S. Stevens, and Lieutenants John Clayton, M. W. Wells, F. W. Taylor, C. F. Clark, Fred Best, and many others. Some of these men are in command now as District Communication Reserve Commanders and Section Commanders.

The first District to be organized was the Seventh which comprises the State of Florida east of the Apalachicola River. The first Naval Reserve Radio Station was built in Orlando, Florida, and after considerable persuading by the writer, was assigned the Navy Call Letters "NRRG." The photograph shows the "Breadboard" set built of odd parts and powered with two fifty-wattors. The circuit was the usual Hartley oscillator with "self-rectification." A small doublet antenna was erected entirely too close to a low flat tin roof. Contrary to the laws of probability, the set worked excellently and we never had any trouble to work from Florida to Maine, even in the Summer months. The tin roof was later credited with wonderful powers of reflection instead of

absorption, and is still "doing its stuff" to the present day. The transmitter, of course, has been rebuilt and is now a modern crystal controlled power amplifier built in a proper stand and each stage shielded. I remember well the troubles we had in getting that transmitter. Each member of the local section donated something: Danforth a transformer. Clark the wire. Rossetter the stand, Maurer the panels and the writer the tubes—and so it went. It was a great day when the transmitter put about a hundred watts in the antenna.

We enlisted all the local radio celebrities that had two good ears, two good eyes, two hands and two feet; requisitioned uniforms and rifles and started out to build a real live unit of radio men. In another year NRRG3 was so improved that it

**By Lieut. Comm.
Wm. Justice Lee**

U. S. Naval Reserve

enlisted an ex-regular Army man for the event.

But to get back to radio and the Communication Reserve—from a handful of officers and men in the beginning, we have now grown to a more reasonable size and have a total personnel of 2500 officers and men spread over the country from Maine to Florida and California and up and down the two coasts. I think it is safe to say that in another two years we will have increased 1500 more based upon the present rate of net gain in the various districts.

Several hundred of our members own their own amateur radio stations. Our officers and men are employed in practically every major communication activity in this country including telephone and telegraph, radio broadcasting, television,

Communication Reserve

Reserve was reorganized, radio amateurs Reserve have brought distinction to them—rendering unstinted service in times of Florida hurricanes, the Mississippi and New with other ordinary forms of communication stuck to his post and maintained emergency communication

laboratories, transatlantic radio, marine service, commercial point-to-point, air beacon service, Department of Commerce, mining, exploring, aviation, surveying and their various ramifications.

The Communication Reserve Radio Net has become a thing of importance. Today we have twenty-three Naval Reserve Stations with call-signs and locations as follows:

Naval Reserve Stations

Naval District	Master Control	Alternate Control
1st.	NDA (Medford, Mass.)	NDR (Augusta, Me.)
3rd.	NDF (S. Manchester, Conn.)	NDB (New York)
4th.	NDM (Philadelphia, Pa.)	NDC (Wilmington, Del.)
5th.	NDE (Baltimore, Md.)	NDK (Norfolk, Va.)
6th.	NDJ (Atlanta, Ga.)	None
7th.	NDL (Orlando, Fla.)	NDU (Jacksonville, Fla.)
8th.	NDD (Pensacola, Fla.)	NDZ (Oklahoma City, Okla.)
9th.	NDS (Chicago, Ill.)	NDP (Kansas City, Mo.)
11th.	NDT (San Diego, Cal.)	NDV (Los Angeles, Cal.)
12th.	NDO (Oakland, Cal.)	NDH (San Francisco, Cal.)
13th.	NDQ (Seattle, Wash.)	NDI (Portland, Ore.)
15th.	NDG (Balboa, C. Z.)	None
D.C.	NKF (Washington, D. C.) (Navy owned)	NDN (Washington, D. C.)

could not have been recognized. The station was regularly manned twice a week by neat and correctly uniformed officers and men who observed the proper military courtesies and customs. Promptly at eight o'clock each Thursday night NRRG opened up with a broadcast message (C. W. of course) to its member stations in other parts of Florida; and simultaneously the entire station personnel was mustered and the roll called.

Now the thing that seems remarkable about this, is not that it could be done, but that it could be done on a voluntary basis without pay. The explanation is not difficult—it lies in the enthusiastic interest of radio operators in radio and their desire to learn phases of it which are not available to those outside the Naval and Reserve Communication Service.

We used to have a "bean feed" occasionally which was financed by a "kick in" from the various members—and by the way, they usually had a 2 kw. appetite.

On one occasion we summoned to drill, the Mayor, the President of the Chamber of Commerce, the local representative of the Associated Press and City Editor of the local morning paper. We told them we would like to show them how our radio net would work in case of emergency, and offered to send a message from the Mayor of our city to the Mayors of Jacksonville, Tampa, Ft. Myers, St. Petersburg and one or two other points. So the messages were filed and transmitted in record time. The first answer came back and was delivered in eleven minutes; the second, a couple of minutes later and so on. The city officials were astonished—and so was I! Someone must have passed the word around, and I still believe some of the answers were ready before the original messages were sent. Certainly the spirit of enthusiasm was there. From then on we had fine cooperation from the city, which cooperation still exists.

Another time we staged a competition in the Manual of Arms with the local company of the National Guard. The Naval Reserve and the National Guard each picked a squad of its best men. The competition was to be run on the basis of elimination—the last man left, to win. The boys came down every night for a week beforehand and worked hard. They were really good and could snap a rifle around in fine style. The competition came off as planned and the National Guard won. The runner-up was a Naval Reservist we had enlisted for the occasion. Later we heard the National Guard had

A radio drill at Naval Reserve station NDK, which is typical of those conducted in this branch of the Naval service



Each District with one or two exceptions, has one master and one alternate control station. These stations all use 4045 kilocycles, the Navy frequency assigned for this purpose. The transmitters must be crystal controlled to insure necessary frequency stability. Their frequency is regularly measured by the Navy Department. At the present time the average frequency variation is approximately .003 of one percent—not bad for such a number of stations, most of which have been built by the local personnel. Occasionally a station swings off too far but it is usually promptly corrected.

There is a national emergency drill conducted once each three months. Only six hours notice is given to the Commandants who then have to notify the reservists in charge of the stations. Sometimes this means relaying the notice by phone or landwire several hundred miles—yet at the last emergency drill held in November, every District in the United States was represented except one. That one District failed to receive its notice of the drill due to failure of a message to reach its destination until the following day. Ten of the eleven Districts answered smartly when called.

The net is centered in and controlled by a Reserve officer on duty in radio central in the Navy Department. From there is keyed one of the NKF transmitters at Bellevue, D. C. which is especially assigned for this work. It also uses 4045 kilocycles on Thursday nights. The power is about 1 kw.

Naval procedure entirely is used for all communication between control stations and also between the control stations and amateur stations belonging to the members of the Naval Reserve. The increase in proficiency in the use of Naval procedure

LIEUTENANT COMMANDER WM. JUSTICE LEE, U. S. N. R.,

was born in Philadelphia, Penna., in 1891, attended school at Asheville, N. C., college at University of Pennsylvania (M.E. 1913) and first entered the Naval Service as Lieutenant, junior grade, class 5, Naval Reserve Flying Corps, in August, 1917. He was subsequently promoted to Lieutenant for aviation general service, and Lieutenant Commander for communication duty in 1925.

He has been connected with amateur, experimental and commercial radio since 1921, and has held practically all grades of commercial and amateur operator's licenses. He was responsible for the construction and operation of various transmitters at WDBO, 4XE, NRRG, NDL, NDN and amateur stations W4IU, W1BCY, W3ALN. At present he is on duty in the Navy Department, Washington, in connection with the organization, training and drilling of the U. S. Naval Communication Reserve, and personally does much of the operating of NKF during Reserve drills.



members of the Naval Reserve throughout the country. The Red Cross expects to invite a considerable number of Reservists to be members of the local Chapters' Committees on transportation and communication. In case of disaster or emergency the Naval Reservist will have already at hand complete instructions with regard to establishing emergency radio communication from the affected area. The accumulation of the necessary data has only just been completed and as yet the system has not been called upon to function under the stress of disaster or real emergency.

However, during the Florida hurricane of 1927 when the city of Miami was cut off from the outside world for many hours, the first word of the disaster was received from an amateur station in Miami by an amateur station in Jackson-

ville, Florida, owned and operated by Gifford Grange, Radioman, First Class, U. S. Naval Reserve. The first messages included appeals for help to the Governor of the State, to the Red Cross and to the Florida National Guard. For many hours, Grange stood by his transmitter and handled the only channel of communication with the stricken city.

This was before the present Red Cross emergency relief communication system had been worked out.

For several years past, the Secretary of the Navy has each year had transmitted a Navy Day message on 27 October, the birthday of the late President Theodore Roosevelt, addressed to the amateurs of the United States. This message this year was sent through Naval Radio Stations NAA at Arlington and NPG at San Francisco. The amateurs enter the competition on the basis of submitting the most (Continued on page 855)

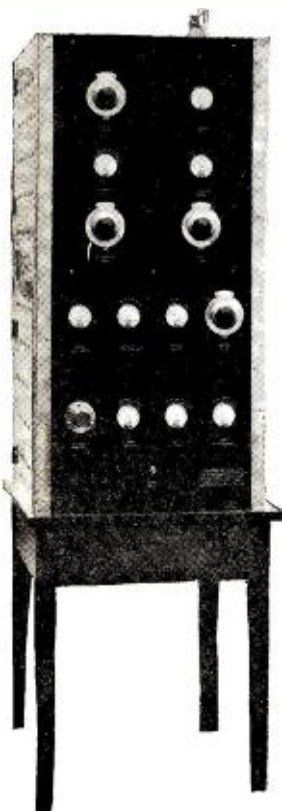

has been remarkable during the past year and now many of our Reserve stations can boast of operation that would be a credit to radio stations of the regular Navy.

During the past year a system of emergency communication has been developed in connection with Red Cross Relief. Briefly, the Red Cross has been furnished with the name, address and call letters of the Naval Reserve and amateur radio stations belonging to

To the left, the front view of the 250-watt transmitter at the Master Control Station, NDS, Chicago, Illinois. Below, old NRRG, the first Naval Reserve station erected in the United States, built in early 1926. To the right, a rear view of the NDS transmitter

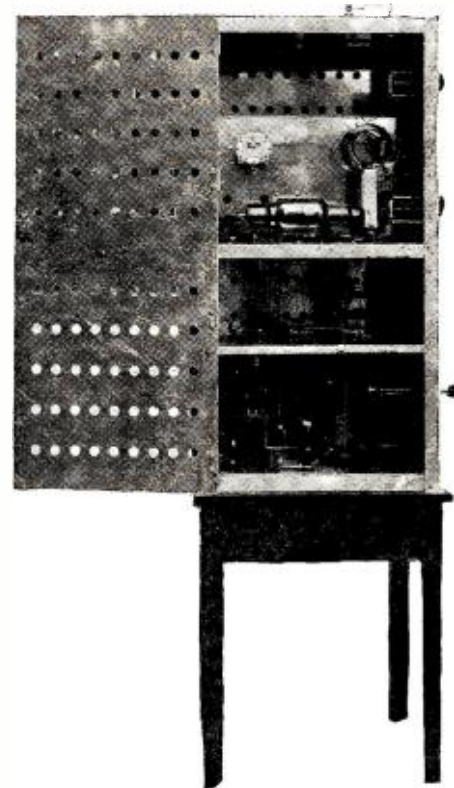

Some Theory of PUSH-PULL Audio Amplification

Continuing the discussion begun in last month's RADIO NEWS on the generation of harmonics and their effect on push-pull audio-frequency amplifier operation. Since what we hear coming from the loud speaker depends largely on the fidelity of tone reproduction in the audio channel, a better understanding of its function is essential to the design of the well-nigh perfect audio amplifier

IN the preceding issue of RADIO NEWS the subject of harmonics and harmonic analysis were discussed. Different wave shapes were analyzed to determine whether they contained even or odd harmonics, or both. In the following, the manner in which the various harmonics are generated and their effect in push-pull amplifiers will be given.

PART TWO

By Louis Martin
and John F. Lorber

LET us consider first the various types of harmonics and the manner in which they may be generated by a vacuum tube. Of this there are two types, grid distortion and plate distortion.

Grid Distortion. If a sine wave of alternating voltage be applied to the grid of a tube, and during a portion of the cycle the grid goes positive, the shape of this voltage will be distorted due to the grid going positive, causing grid current to flow, which in turn causes a leakage by impedance drop. The shape of the sine wave will be changed to the form shown in Fig. 9.

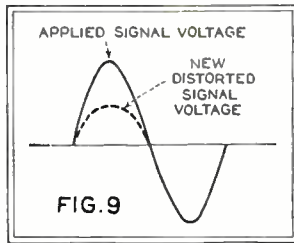

It is to be noted that the grid only goes positive during the positive half of the cycle. If the grid is positive during both halves of the cycle, then both halves of the wave will be reduced in amplitude. In general, however, the upper loop will be smaller than the lower loop. From a previous analysis of this type of wave, Fig. 5, this distortion signifies an introduction of a second harmonic.

Plate Circuit Distortion. Assume a grid voltage, plate current characteristic as shown in Fig. 10. If for some reason the tube is worked at point A or point B and the form of the grid voltage is sinusoidal, then one-half of the plate current loop will be greater than the other half, as shown in Fig. 10. Such a plate current form also contains a second harmonic; this, as previously pointed out, is what happens in a linear detector.

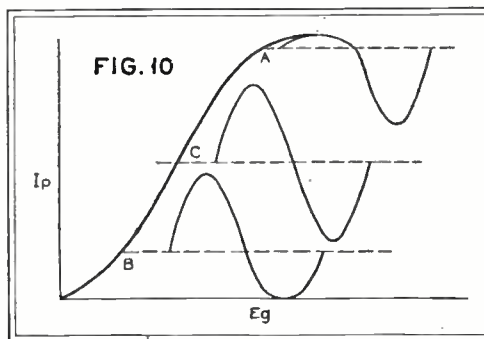

If the tube now be worked at the center of the curve, Point C, which is the proper operating point for an amplifier tube, and a large signal is impressed on the grid so that both the upper and lower bends of the curve being used then the form of the plate current will be as shown in Fig. 11. This type of wave contains

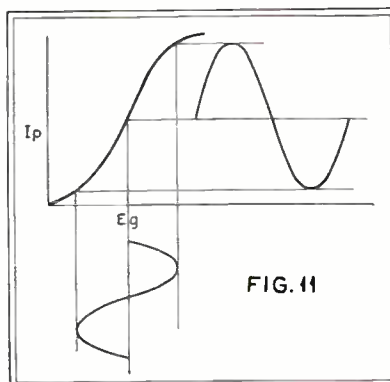

a predominance of odd harmonics.

If a pure sine wave of voltage is applied to the primary of a loaded transformer, then the secondary voltage will also be a sine wave. If a distorted wave of the type shown in Fig. 5 is impressed, then the form of the wave of the secondary will be as shown in Fig. 12B.

The secondary voltage therefore contains not only a second but a third harmonic, this latter harmonic having been introduced by the transformer. This type of wave is discussed under Fig. 8.

If a distorted wave which has both top and bottom loops flat is applied to the primary of the transformer the form of the secondary voltage will be as shown in Fig. 13. This type of wave contains only odd harmonics. This type of wave is discussed under Fig. 7B.

In any case where the primary voltage is flat-topped the secondary voltage contains a dip. This is evident from the fact that the secondary voltage depends upon the change in primary voltage. During the flat portion of the wave the change in voltage is practically zero, which means that during this flat portion the secondary voltage will drop.

Inductance wire carrying a current generates a magnetic field around it in a direction given by the right-hand rule. If this current be alternating, then the intensity of this magnetic field is in time phase with the current. Since the intensity of the field is measured by the number of magnetic lines per square inch, then the number of magnetic lines per square inch is in time phase with the current. A wire, if it is being cut by a varying magnetic field, has induced in it a varying voltage; and the magnitude of this voltage is dependent upon the length of the wire in the field being cut, the flux density and the frequency of variation of the flux. The generated voltage is given by the formula

$$E = B f l$$

where B = flux density
f = frequency
l = length of wire.

If this wire is wound in a coil and if the practical system of potential difference the volt is desired, then the formula for generated voltage becomes

$$E = \frac{4.44 f N B}{10}$$

N—Number of turns.

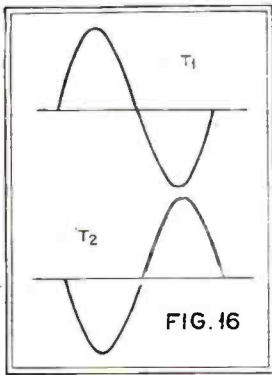

4.44—Constant based on the assumption of sine wave. B—Flux density.

Since the current through an inductance lags the impressed voltage by 90° , the voltage generated in the coil is maximum when the current is passing through its zero value. This also follows from the statement previously made that the generated voltage is always a maximum when the change in current is greatest. No voltage is generated in a coil when the current is not changing in value.

It is important to remember that the direction of the induced voltage is dependent upon the direction of current flow through the coil. If the coil has more than one applied voltage, each one of these voltages being applied to a different section of the coil, then the direction of the induced voltage in each section of the coil not only depends upon the direction of current flow through each section, but also upon the direction in which each section is wound and whether this current be increasing or decreasing.

Consider the coil depicted in Fig. 14. This coil is wound continuously in one direction and is tapped at the exact center of the winding, the end terminals of the potentiometer P is connected across the extreme terminals of the coil. A variable voltage is interposed between the slider on P and the center tap of the winding. The variable voltage is obtained by means of an additional potentiometer K placed across the battery. The voltmeter V is placed across the ends of the coil to indicate the total generated voltage across the coil.

CASE I. Suppose both potentiometer sliders be kept in their center positions and switch S suddenly closed, current will flow through the circuit and through the coil in the directions shown in Fig. 14. Since the coil is wound continuously in one direction and the current in section A is flowing in the opposite direction to the current in section B, the voltage generated in section A will be opposed to the voltage generated in section B (these being 180° out of phase) and the voltmeter V which indicates the total voltage generated across the entire coil will not show any indication.

CASE II. Suppose switch S be open and the potentiometer slider be moved

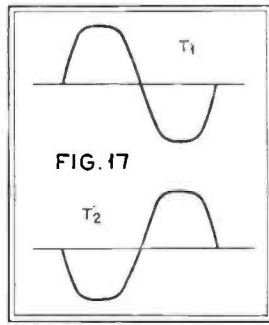

FIG. 17

to point L, then if switch S be suddenly closed the current through section A of the coil will be greater than the current through section B. The voltage generated across section A will be greater than the voltage generated across section B. The voltmeter V will indicate and its indication will be equal to the difference between the voltages generated in sections A and B.

It should be noted that thus far the circuit is merely a simple bridge affair and the considerations outlined in cases I and II apply when the bridge is balanced and when it is unbalanced.

CASE III. Suppose switch S is now closed and the sliders of both potentiometers be kept at their center positions. A steady current will flow through the windings of the coil. If the slider of potentiometer P now be moved to position L the current through section A increases above its normal value, generating a certain voltage across section A. At the same time the current through section B decreases below its normal value, generating a voltage in section B which adds to the voltage generated in section A, producing a voltage across the entire coil which is the sum of the voltages in each section. The reason for the voltage generated in section B now being additive is that, whereas, in case II the currents in each section were increasing in opposite directions, the voltages generated were 180° out of phase, while in this consideration the current through section B suffered a different type of change. That is, it was decreasing instead of increasing, which resulted in a reversal of the polarity of the voltage generated in section B.

Push-Pull Amplifier

Fig. 15 is a typical circuit diagram of a push-pull amplifier. With no signal impressed on the primary of the input transformer normal plate currents flow through the primary winding of the output transformer as shown. The plate current of each tube flowing in opposite directions through the continuous winding produce flux in opposite directions which neutralize each other, eliminating d.c. saturation of the core.

Assume a sine wave of voltage applied to the primary of the input transformer the voltage across the secondary of this transformer will be applied to the grids of both tubes. The peak of this signal being smaller than the grid bias.

The voltage of each grid with respect to its filament will be one-half of the total secondary voltage. The form of the plate current of each tube is as shown in Fig. 16. It will be noted that the currents are 180° out of phase. Due to the fact that they are flowing in opposite directions, the voltage generated by each coil add, the total voltage across the primary being the sum of both voltages. Another way of looking at the problem is as follows:

When the grid of tube No. 1 is increasing in potential in the $+$ direction the grid of tube No. 2 is decreasing in potential, which means that while the plate current of tube No. 1 is increasing, the plate current of tube No. 2 is decreasing.

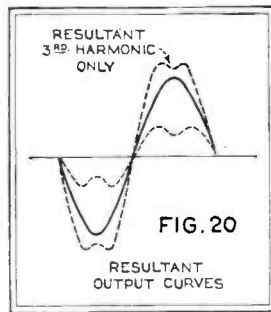

FIG. 20

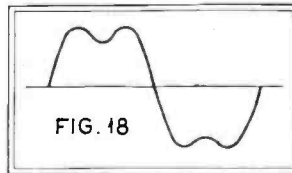

FIG. 18

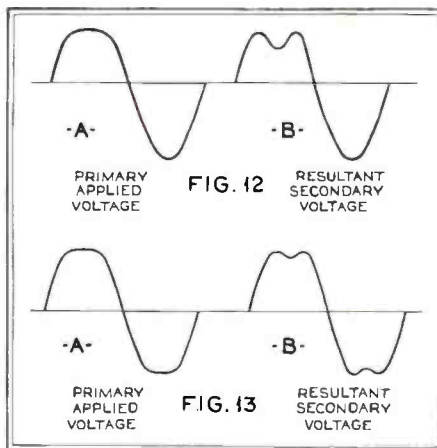

FIG. 12

FIG. 13

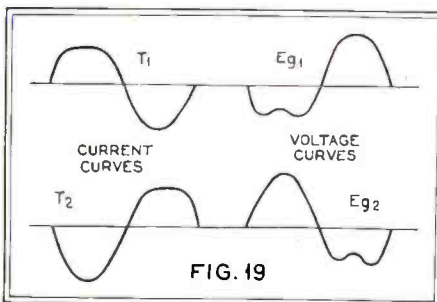

FIG. 19

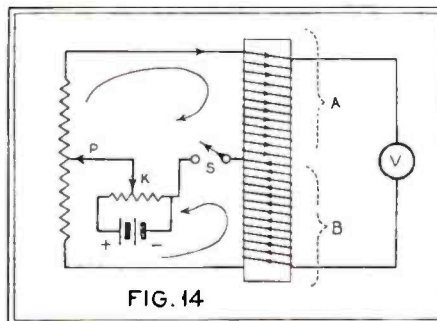

FIG. 14

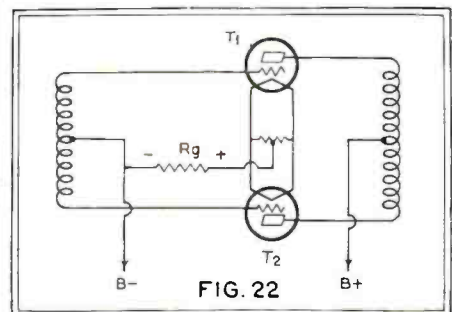

FIG. 22

ing, and since these currents are flowing in opposite directions the generated voltages are additive. This is exactly the same condition as cited under the heading of inductance case III.

If a large signal voltage be applied to the grids of both tubes such that the plate current of each tube rises above the saturation point and down below the lower end of the curve, the form of the plate currents in each tube is as shown in Fig. 17.

The voltages generated by each half are additive and have the form shown in Fig. 18.

The dips in this curve are due, as previously explained, to the flat-top form of current. This voltage curve contains a large third harmonic which is passed on to the speaker.

If, however, the tubes are worked off the center of the straight portion of the curve such as point A or B in Fig. 10 through the form of the plate current in each tube is shown in Fig. 19. The form of the total generated voltage across the primary of the output transformer is as shown in Fig. 20.

The form of the voltage curves depicted in Fig. 19 shows the presence of a second and third harmonic as was previously analyzed. The resultant of the two voltages shown in Fig. 20 indicates the presence of only the third harmonic, the second harmonic having been eliminated. The magnitude of the third harmonic that is usually present is small enough to be neglected.

It was previously mentioned that the current is about 90° out of phase with the voltage. This is true only in a simple inductance; but in a transformer under load the phase relation between primary current and the applied voltage depends upon the power factor of the load on the transformer, neglecting the magnetizing current. It is assumed in this discussion that the load on the secondary of an interstage transformer is resistive, hence, the primary current is practically in phase with the voltage. With this in mind it can be seen how the dip voltage wave is obtained from a flat-top current wave.

Suppose the form of the plate current of a stage of amplification previous to the push-pull stage is as indicated in Fig. 21A. The voltage generated across the primary is as indicated in Fig. 21B. The voltage across the secondary is shown in Fig. 21C, which is the voltage on each grid with respect to the mid point of the winding. The plate current of each tube is shown in Fig. 21D. The voltages generated in each half of the secondary is as shown in Fig. 21E and the resultant voltage across the primary of the output transformer is as depicted in Fig. 21F. An inspection of this final wave shape will reveal the presence of a second harmonic which existed in the wave impressed on the primary of the input push-pull transformer. The push-pull amplifier therefore does not eliminate harmonics originating in previous stages.

By a similar reasoning it is found that harmonics existing in a sound wave are not eliminated.

The sweeping conclusion is that the

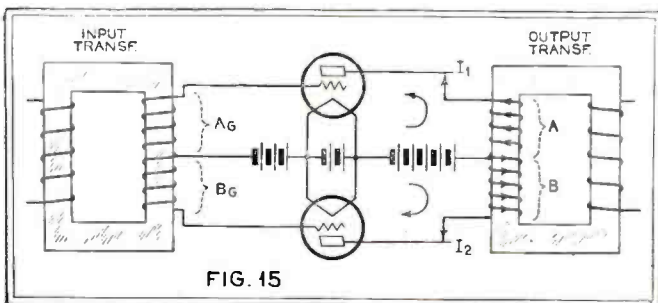
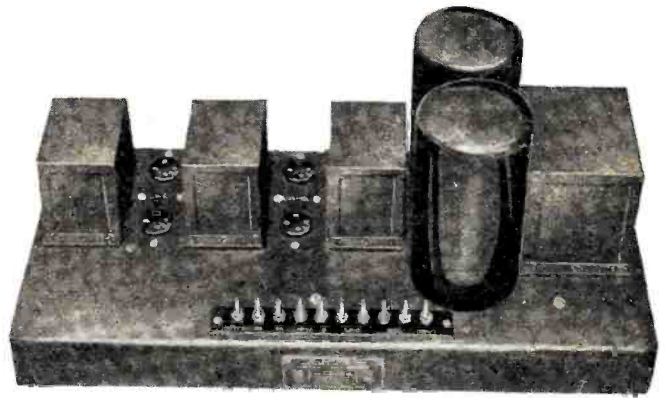
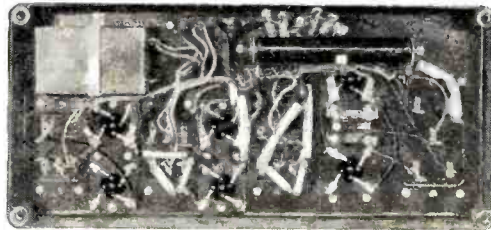

FIG. 15



Courtesy R.C.A. Photophone Co., Inc.

Figs. 23 and 24

Above and at the left are front and underneath views of a type of audio-frequency amplifier employing push-pull amplification in the final stages

only even harmonics that are eliminated are those that would be present if push-pull amplification were not used.

Maximum power output is obtained from a tube when the load impedance equals the impedance of the tube. If the load impedance is made equal to the tube impedance in a straight amplifier, maximum output will be obtained, but the percentage of the second harmonic present due to the curvature of the characteristic prohibits the use of this one-to-one ratio. The ratio of load impedance to tube impedance is usually two to one, in order to minimize distortion. In a push-pull amplifier in which the second harmonics due to overloading are eliminated the load impedance may be equal to the tube impedance and so a greater output may be realized. Usually about 25 per cent. more undistorted output is obtained with two tubes in push-pull than with two tubes in parallel.

The formula for power output of two tubes in push-pull is

$$P = \frac{\mu^2 E_g^2}{2R_p}$$

where R_p is the tube impedance and is equal to the load impedance.

If the automatic bias method is used and both tubes have the same mutual conductance and output resistance no condenser is necessary across this automatic "C" bias resistance, for the reason that the plate currents will always be equal and 180° out of phase. The sum of both currents will then always be a constant. Since there is no a.c. component in the plate current, no by-pass condenser is necessary. This is true regardless of the form of the plate current as long as both tubes are matched.

If both tubes of a push-pull amplifier are not matched so that the mutual conductances are not the same, then the plate current flowing through this grid bias resistance will be unequal and 180° out of phase. The result will be an a.c. component which can be by-passed with a condenser. If this by-pass condenser is omitted the voltage across the grid bias resistance will vary. This variation will be 180° out of phase with the grid voltage of the tube having the greater variation of plate current and in phase with the grid voltage of the other tube. In other words, the tube having the greater mutual conductance will receive degenerative action while the other tube will receive regenerative action, the tubes tending to divide the load equally.

Perhaps a little more detailed explanation of the above phenomenon should be given. Consider Fig. 22: R_g is the automatic grid bias resistance. Suppose (Continued on page 837)

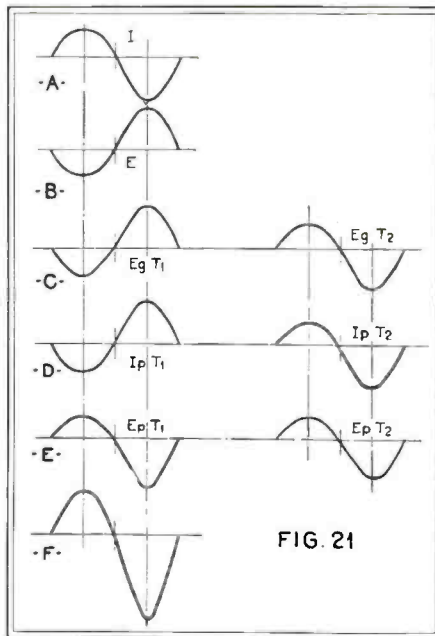
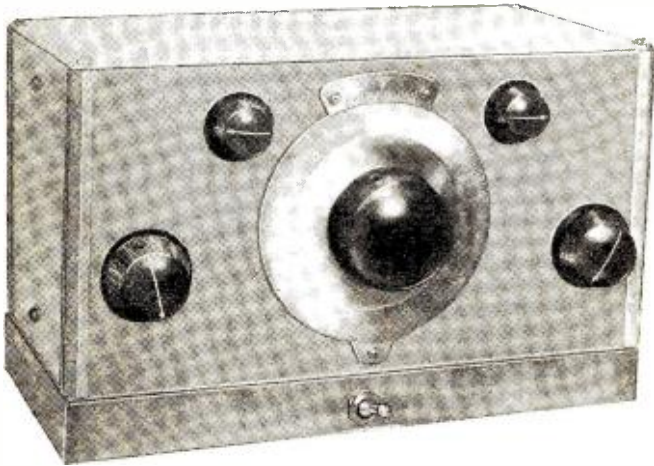

FIG. 21

Inside this metal box is contained an extremely efficient short-wave and broadcast superheterodyne. It employs six tubes, three of which are screen-grids

How to Build "THE



A six-tube midget superheterodyne stage, a dynatron oscillator, two quency amplification, a regenerative transformer-coupled audio-frequency three or five-volt tubes may be it covers a waveband range of from use as a midget, portable, automobile standard, readily available parts

THE miniature has ever had an appeal that, when combined with the performance of the giant, has met with instant popularity. The midget radio receiver is a typical example for it delivers a highly satisfactory order of reception and quality of reproduction in spite of its small size. The size of the midget receiver has been limited only by the necessary circuit arrangements, for after all, there must be tuned circuits, with variable condensers and coils. These parts may be made small only at the sacrifice of circuit function. The closer spacing of the plates in a condenser to increase capacity and to reduce size makes it almost impossible to arrange for gang control, yet these tuned circuits are necessary in order that interference between stations shall be eliminated. The regenerative receiver with a preceding stage of radio frequency followed by a two-stage transformer-coupled amplifier has met with some popularity as a small or portable receiver but has never been able to really deliver the goods, so to speak. Thus we may run the gauntlet of receiver circuits in our selection of a suitable circuit for a small receiver until we reach the super-heterodyne.

The Rolls-Royce of radio has always been associated with that of a large size receiver but after some thought the idea of a small super-heterodyne was conceived. In addition a receiver was desired that could cover a tuning range of 15 to 550

meters in wavelength. This has been accomplished with a single variable condenser, a fixed condenser, two coils and two switches. The current consumption by necessity had to be small and the receiver was required to deliver loud speaker volume on all local stations. To satisfy these requirements it was decided to experiment with the new 2-volt tubes in this receiver. Thus we have the Mighty Mite, which to the writer's knowledge is one of the smallest and most powerful radio receivers of modern design ever built.

Design

The design of this receiver has not been without its problems as to the circuit, the layout and to the parts to be employed. The latter are all of standard manufacture and may be obtained from most any radio parts dealer, or else may be obtained directly from the manufacturers.

The first conception of the receiver circuit was that consisting of a modified Hartley oscillator, arranged with one tuning condenser of .00025 mfd. capacity, having a fixed condenser of equal size placed in series with it. This fixed condenser is shunted with a switch in order that the maximum capacity of the variable condenser could be halved when used on short waves. A Magister modulator or first detector as described by the writer in the October, 1929, issue of RADIO NEWS, with untuned antenna circuit, employing the new -32 screen-grid tube was used. Then followed a single stage of intermediate frequency coupled to the modulator through a tuned filter of 150 kilocycles (2000 meters wavelength); tuned impedance coupling between the intermediate frequency stage and the regenerative detector. The regenerative detector was selected for three reasons, first, to introduce as great load in the plate circuit of the intermediate stage as possible by lowering the resistance of the tuned impedance; second, to take

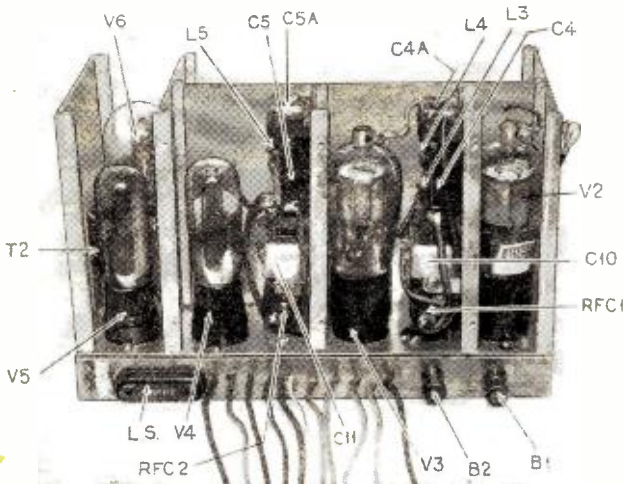

Looking at the back of the chassis with the rear compartment wall removed to show the location of the various parts. In this top view (at right) the placement of the coils, condensers, sockets and variable resistors may be observed. The tube in the foreground gives some idea of the size of the receiver

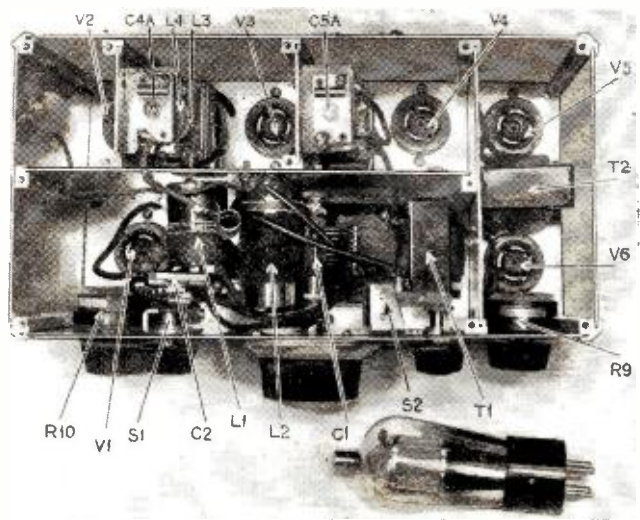

MIGHTY MITE''

employing an untuned first detector stages of screen-grid intermediate-frequency second detector and two stages of amplification. So arranged that two, used. By means of a selector switch 15 to 550 meters. Ideally suited for or motorboat radio receiver. Only are used in its construction

By
Beryl B.
Bryant



advantage of the regenerative gain in the detector, and third, to provide a means of autodyne reception of continuous wave code signals. The -32 tube was tried as detector as well as in the first audio stage using resistance capacity coupling. After considerable work the -32 as a second detector and as the first audio stage was discarded, the old standby transformer-coupled system being substituted using the -30 and the -31 tubes respectively.

After considerable testing, the selectivity of the receiver seemed to be of a very low order and the project considered not nearly so successful as anticipated. Various types of oscillators were tried until the dynatron oscillator, recently given considerable publicity as a constant frequency generator was adapted to the receiver. From that moment the success of the receiver was assured, as the steadiness of the generator was such that the selectivity of the converted signal was comparable to that of the single r.f. stage followed by a regenerative detector, in which is used two tuned circuits.

Yet, the reader is cautioned not to expect too much from the receiver for even though it is of the super-heterodyne type, it has only six tubes and only a single tuned circuit. It is not believed that it will bring in stations situated at great distances, nor will it receive a weak signal through a powerful next-door broadcast station. Tests in the RADIO NEWS Laboratories and at the writer's home in the Flatbush section of Brooklyn gave reception without interference from all locals. In noisy locali-

ties, in the proximity of electrical interference, such noises, having a natural period corresponding to the intermediate frequency, will be passed without the heterodyne action of the oscillator, as an analysis of the circuit will show. It is a queer sensation to be listening to a high noise level, and have stations pop in and out on the rotation of the tuning condenser.

Building the Receiver

The construction of the receiver has been simplified as much as possible, and is so designed that the home builder will have

Fig. 4. The circuit employed in the Mighty Mite six-tube superheterodyne. It is arranged for use with a six-volt source, but as described in the test slight changes in the values of resistance for the filament resistors make it possible to supply the receiver with either a two or three-volt source

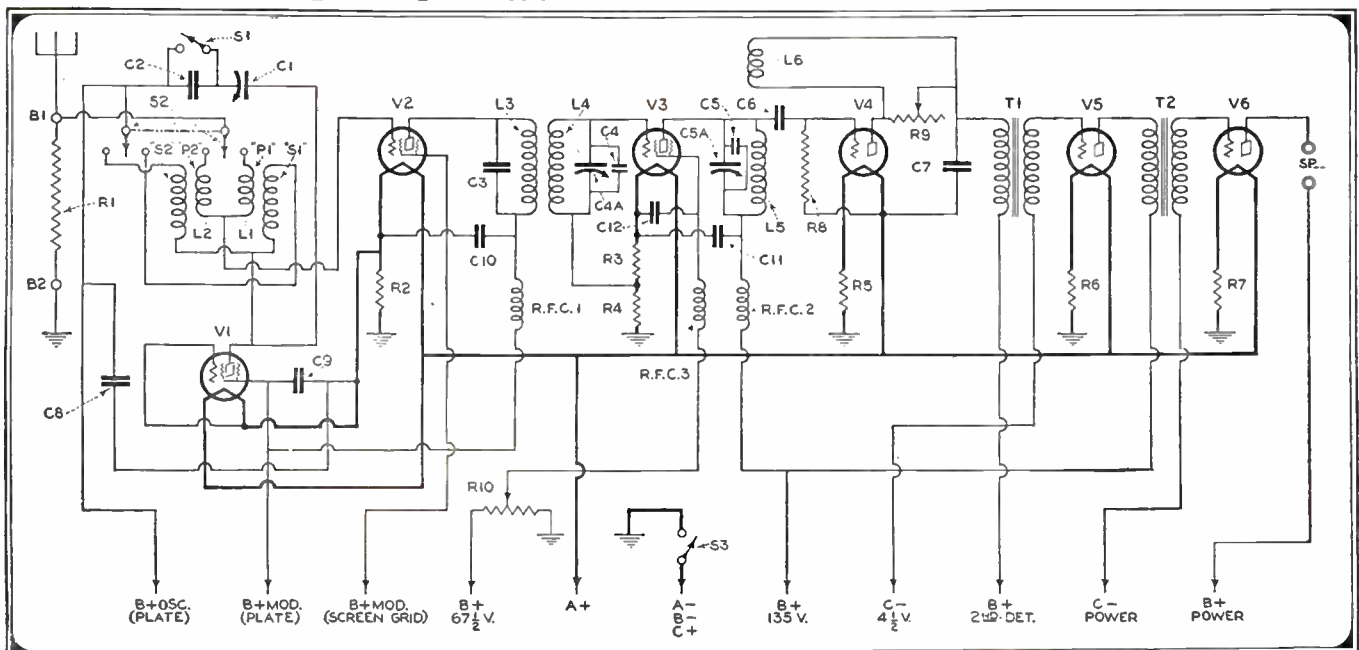

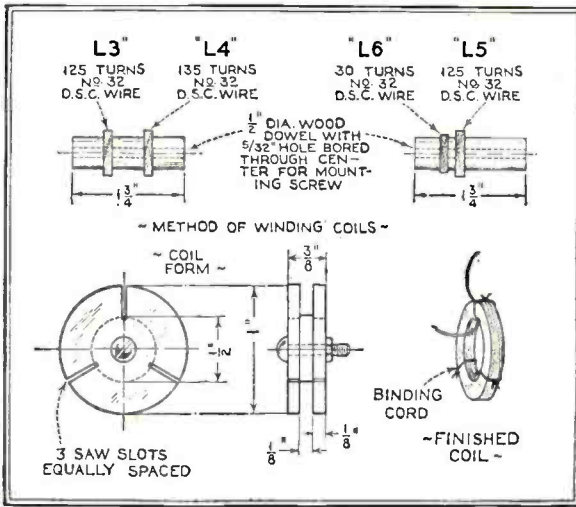

Fig. 5. (At left) Here are given the constructional, winding and assembly details for the coils and forms of the intermediate frequency amplifier transformer

Fig. 6. (Below) The intermediate stage transformers, tuning condenser and by-pass condensers are mounted on their respective compartment walls, as shown in the drawing above

a minimum of assembly difficulties. The size is such that it will prove difficult to substitute parts, with the exception of the sockets, resistors and mica fixed condensers. The parts as listed are first collected and tested after which the construction of the chassis is in order.

Making the Chassis

The one-inch by one-half inch angle brass $32\frac{3}{4}$ inches long is now prepared by measuring off points at $\frac{3}{4}$ inch, $6\frac{1}{2}$ inches, 17 inches, $22\frac{3}{4}$ inches, $32\frac{1}{2}$ inches and $32\frac{3}{4}$ inches, along the one-half inch edge. The angle is bent into a rectangular frame after cutting out wedge-shaped pieces at the corners which are at the points marked with the exception of the $31\frac{1}{2}$ and the $32\frac{3}{4}$ inch points. The one section between the $31\frac{1}{2}$ and $32\frac{3}{4}$ inch points along the $\frac{1}{2}$ inch side is removed in order to form a tongue that will lap and fit under the $\frac{3}{4}$ inch section. The frame is joined at this point by screws and nuts, solder, rivets or by welding. At this time the holes for binding posts B1 and B2, the hole for the loud speaker pin jack block SP and the holes for the battery leads are drilled in the rear of the rectangular frame as shown in the drawing, Fig. 11. The hole for the battery switch is then drilled in the front of the frame. The bottom plate of aluminum is cut to the size of $10\frac{1}{2}$ by $5\frac{3}{4}$ inches, and the positions for the socket holes marked. The positions of the partitions are scribed on the top of the plate in order that the holes for the fastening of the aluminum slotted corner and partition posts may be placed accurately. The plate is next drilled, placed on the rectangular frame, and is fastened by mounting of the corner and partition posts. The ends, back, front and partition walls are cut to size and drilled as shown in the drawings (Fig. 10) and laid aside until needed.

Making the Coils

The only difficult coils to make are the intermediate coils L3, L4, L5 and L6. For their construction a small form is necessary which is made of three pieces as shown in Fig. 5. The core and side pieces are assembled with a screw and fastened with a nut. Fine strong thread is placed through the slots provided, after which the wire is wound into the slot, jumble fashion. The coil L3 is wound with 135 turns, coil L4 and L5 with 125 turns, and the coil L6 wound with 35 turns. After the coils are wound in the slot to the required number of turns, the tie threads are tied around the coil, after which the winding form is taken apart and the core removed from

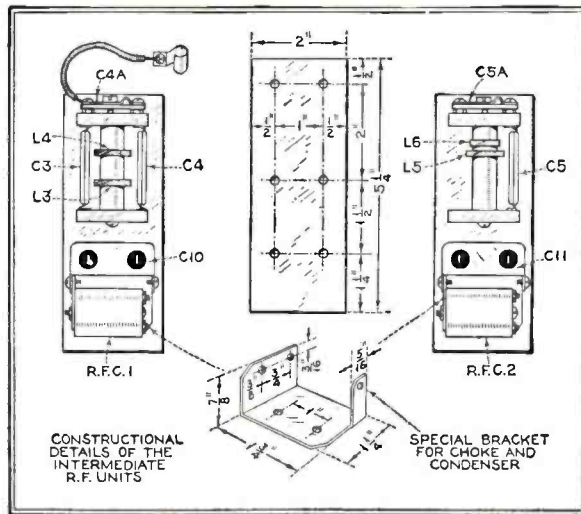

the flattened portion to pass another 6-32 screw for fastening to the tubing. The coils are mounted as shown in the drawing by fastening in a horizontal position to the central partition within the oscillator compartment.

Assembly

The sockets are placed through the holes in the chassis and fastened with screws and nuts. The central partition is put in position, after which the condenser C1, which has previously been fastened to its support panel, is fastened down to the bottom plate. It is necessary that C1 be insulated, as both the rotor and stator are at high potential; this is accomplished by mounting the condenser on a bakelite panel support and the use of a bakelite or fibre shaft for the dial. Next are mounted the audio transformers, T1 and T2, in the positions shown. After this are mounted the switches S1 and S2, vari-

the coil. The coil is then dipped into airplane or celluloid dope or cement. This cement can be obtained in tube form from most hardware stores and is known as Du Pont's household cement. The cement should be diluted with amyl acetate or acetone in order that it will penetrate into the winding. The coils are placed aside to dry, during which they may be placed under a weight to make them flat and smooth. This is best accomplished by placing them between two pieces of glass with a weight on top. After the coils are dry they are assembled on wood or bakelite dowels as shown in Fig. 5.

To cover the tuning range of 15 to 550 meters wavelength, only two tuning inductances are required, details of which are shown in Fig. 9. The coils have two windings each, the oscillator plate coil and the modulator grid-pickup coil. The larger coil L2 is wound with 82 turns of No. 26 double silk-covered wire for the plate coil and 25 turns of No. 36 double silk-covered wire for the pickup coil. The smaller coil L1 has 20 turns of No. 22 double silk-covered wire for the plate coil and 4 turns for the pickup coil. The windings are made on bakelite tubing one inch in diameter, which for the larger coil is two inches long, and for the smaller coil is one and one-quarter inches long. The coils are provided with a single mounting lug which is made by flattening the end of a 6-32 stud and drilled through

Underneath the chassis are located much of the wiring and the small by-pass condensers, fixed resistors, etc., as indicated in the photograph below by the various symbols

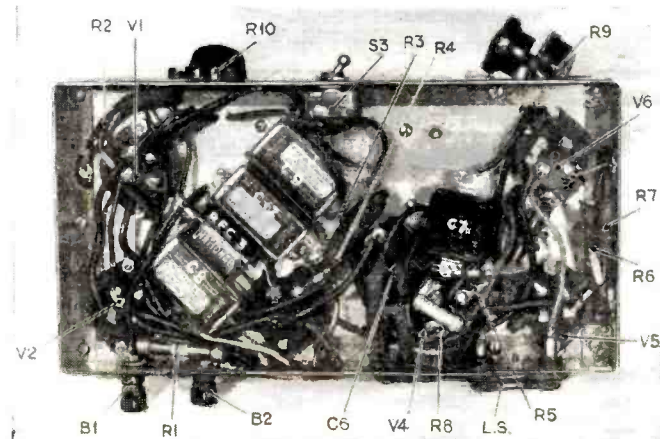

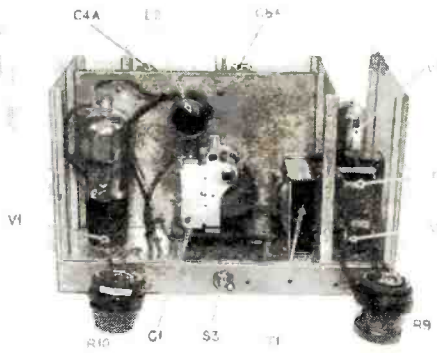

This photograph shows the tuning condenser of the oscillator circuit mounted in place before the coils have been included in the assembly

The tuning coils are wound on one-inch diameter tubular forms to the specifications as shown in the sketch to the right

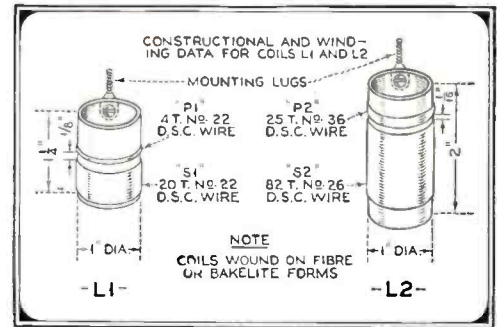

able resistors R9 and R10, and the precision vernier metal dial, on the front panel plate. Before placing the front panel in place the coils L1 and L2 are mounted on the central partition in the positions shown, and all wiring completed in this compartment. The clip for the control grid of the oscillator tube V1 is provided with a lead of sufficient length which passes through the bottom panel and is soldered to the negative filament post of the socket V1. The transformer T2 is now wired into the circuit after which the end panel of the audio compartment is placed in position.

Before proceeding further, the intermediate units are assembled on the inner partition panels. The radio-frequency chokes RFC1 and RFC2 and their corresponding by-pass condensers C10 and C11 are fastened to a support bracket, the details of which are shown in Fig. 6. This unit is now fastened to the bottom of the inner partition as shown. The dowels, of either wood or bakelite, which serve as a means of support for the intermediate-frequency coils are fastened to two bakelite endplates, the upper plate of which carries the midget mica adjusting condensers C4A and C5A. This entire assembly is fastened to the upper portion of the inner partition panels as shown in the drawing, allowing ample clearance between the bottom bakelite plate and the by-pass condenser. Note that the fixed condenser C3 is mounted similar to the fixed condenser C4 but on the opposite side of the intermediate-frequency coils. C2 is mounted directly on the switch S1.

The intermediate-frequency units are placed in position and wired, after which the back plate or panel is fastened into position. This completes the assembly and wiring on top of the chassis plate. The top of the receiver may now be put in place temporarily and the receiver turned upside down for completion of the assembly and wiring on the bottom of the chassis. The filament resistors are of the pigtail type ordinarily used as grid suppressor resistors. These are soldered directly to the negative posts of the respective sockets. In order to obtain the proper bias for the screen-grid i.f. stage, two resistors, R3 and R4, are connected in series, to the center connection of which is connected the grid return of the coil L4. The by-pass condensers C8, C9 and C12 are mounted in position by screws and nuts which were previously placed through the bottom panel. The condensers are raised from the bottom panel the height equal to that of the nuts used to hold the fastening screws in position. One end of the radio-frequency choke RFC3 is soldered directly to the grid post of the socket as shown. The binding posts B1, B2, the loud speaker jack SP and the filament switch S3 are now mounted. One pigtail terminal of the antenna resistor R1 is soldered directly to the B1 binding post, the other pigtail connection being soldered directly to the chassis. This, in conjunction with the filament resistor R2, places the proper bias on the control grid of the modulator tube V2. After all the wiring is completed, the battery leads are soldered to the (Continued on page 819)

The several pieces of sheet aluminum which go to make up the compartment walls are cut to the sizes indicated below and drilled as shown

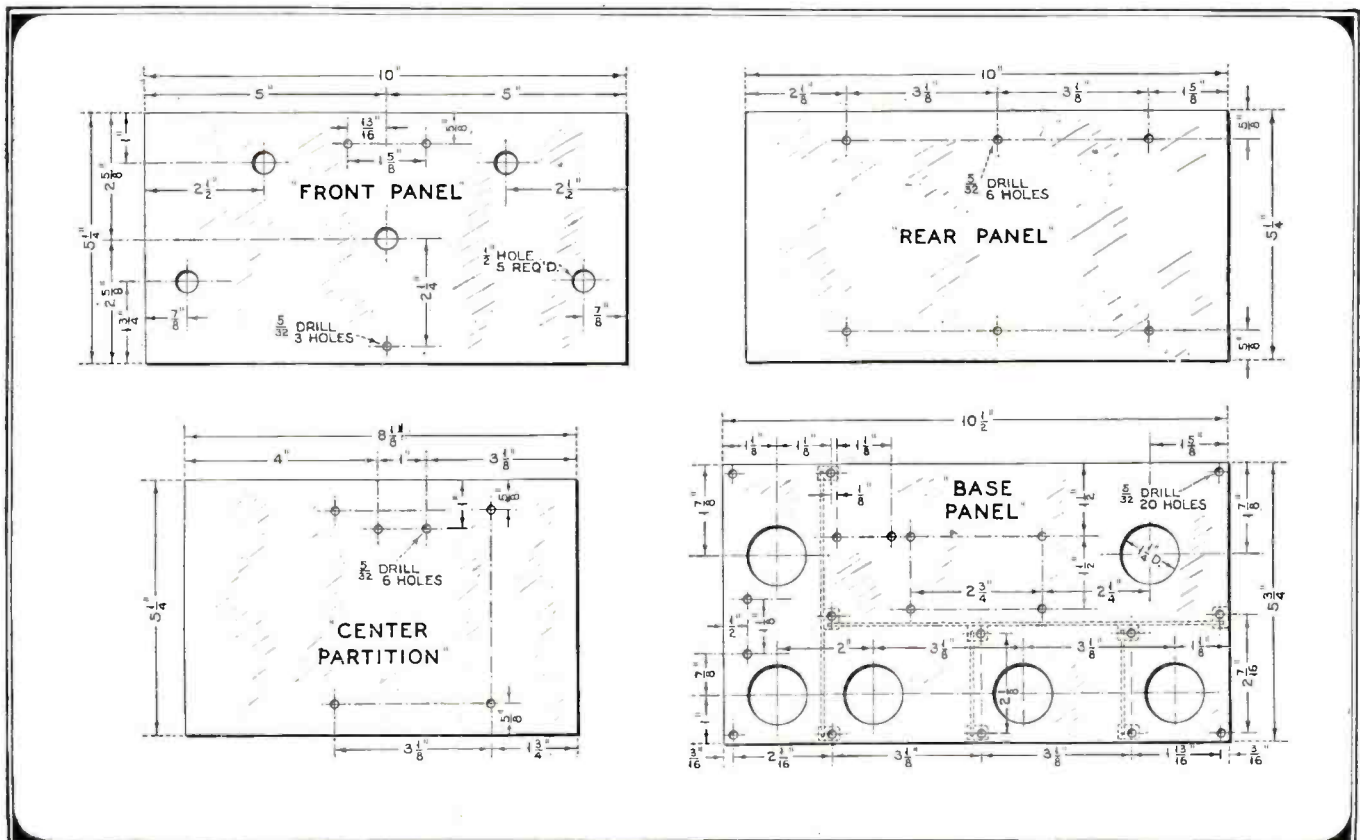

All Radio is Not

MOST radio fans, "tinkers," and plain listeners think of radio as "broadcasting," but perhaps some do realize that a great body of amateurs known as "hams" are also on the air. Few broadcast listeners realize that one of the most important of the radio services today is that maintained for the public in foreign and domestic communication; a service antedating broadcasting by about twenty years, but lacking the popular appeal of the latter.

Students of radio history, however, will recall that Senator Marconi transmitted the first wireless signals across the Atlantic, over a distance of 1,800 miles on December 12th, 1901. To be sure this signal was a very brief message consisting of merely a series of groups of three dots, the Morse code symbol for the letter "s." Hardly a commercial message, but indicative of what was possible and it was, as we know now, the first step in the direction of what is today trans-oceanic radio communication, connecting the United States with practically all countries of the world.

Hawaii inaugurated a public wireless service when it opened circuits between the five principal islands of the territory on March 1, 1901. The actual opening of a communicating station or circuit in Continental United States, however, was established off the coast of Massachusetts on August 16th, of the same year. On that occasion the Nantucket Shoals Light Ship, No. 66, accepted a radio message from a ship seventy-two miles off the coast and relayed it to a shore station at Siasconset, forty-two miles distant. This project was not under Governmental supervision; there was no radio control and few ships flying the American flag were equipped with wireless. The endeavor was sponsored by the *New York Herald*. That paper deserves great credit for the establishment of the first commercial radio station in this country and for handling incoming messages of a public nature. Thereafter, radio messages from many ships were accepted for delivery or relay via wires to points inland.

One of the first long distance trans-oceanic messages was picked up by the S.S. Philadelphia in February, 1902, over a distance of 1,550 miles from the Poldhu station in England. President Roosevelt in January, 1903, opened the trans-Atlantic radio service between Cape Cod and the Poldhu station, dispatching a radiogram to King Edward VII. Some messages between Cape Breton and England had been exchanged during the preceding December. These early activities presaging the great traffic exchanges of today, were immediately followed by increased activity. The first radio-telegraph conference was held in Berlin in August; then came press messages for publication in the daily press of the two countries.

Gradually American ships began to install wireless apparatus although it was not required by law until 1910. This law was amended in 1912 just prior to the first general Radio Act, itself now obsolete, having been superseded by the 1927 Radio Act.

Review of Regulations

The Radio Act of 1927 was enacted to regulate all interstate and foreign radio transmissions and communications, all transmitters operating within the limits of the United States and its possessions, and messages to foreign stations outside these limits, in compliance with the International Radio Convention. This act placed the Federal Radio Commission in charge of all radio communication and directed it to maintain control

Television, aircraft radio, beacon radio, other services have increased so rapidly accommodate the demand for new channels. legal problem in the lap of the U. S. Fed- of a series dealing with this important sub- by all the public radio

By Carl

over all channels, providing for the use thereof by individuals, firms or corporations for certain periods of time under licenses issued by the Commission. It is provided that no one may use or operate any apparatus for the transmission of energy, communications or signals by radio, without express authority of the Federal Radio Commission; receiving sets are not mentioned. Familiarity with this Radio Act, as it has been amended, is essential to the proper and successful operation of a radio transmitting station. This applies especially to a station handling international public communications, since such services may interfere with the long-range circuits of other nations.

Among other things, the Act provides for the protection of Marine communications, including distress signals, familiarly known as "S O S" messages; requiring not only that ships be properly equipped for the handling of such messages, but that Coastal and certain other stations may be designated to keep a licensed operator listening on the marine distress channel, so as to cease operating if interference is likely to be caused. Distress signals have absolute priority and Coastal stations must exchange radio communications with all ships. The Act goes into many details which will not be recounted here, but it seems pertinent to call attention to the fact that those receiving or assisting in receiving radio communications are expressly

forbidden from divulging or publishing such messages without permission, and that it is required that they be delivered only to the person addressed or his agent. Do not allow your operators to violate this requirement.

Development of Service

To indicate the extent of the fixed radio services of the United States; there were in operation June 30, 1930, four hundred and sixty-eight commercial land stations, including point-to-point domestic and trans-oceanic stations; ship-to-shore or coastal stations and aeronautical or ground stations serving aircraft. Besides these there were three hundred and thirty-seven Governmental land stations operating on Governmental frequencies and conducting services to certain cities in the United States and its possessions, or to ships and aircraft. Under the classification of public point-to-point there are now approximately one hundred and sixty licensed transmitters functioning in the trans-oceanic services but over one hundred outstanding construction permits indicate that more transmitters will soon be on the air. There are approximately sixty-five public point-to-point stations engaged in a domestic service between the cities of Continental United States. In Alaska alone, there are over one hundred and twenty trans-

IN connection with the observation made by the chairman of the now permanent Federal Radio Commission, C. McK. Saltzman, to the effect that we must look to further engineering developments for the ultimate solution to the problem satisfying the ever-increasing demands for more and more frequency assignments, it is important to know of the practical possibilities of Dr. James Robinson's invention, the Stenode Radiostat. THE EDITORS.

Broadcasting

marine radio, amateur radio, and many that apparently we no longer have space to These demands have thrown a very difficult eral Radio Commission. In this, the third ject, we are apprised of the difficulties faced communications services

Butman*

mitters engaged in public service, communicating either with Alaskan stations or ships off the coast and actually forming part of the Alaskan Signal Corps radio net-work. These stations are licensed by the Commission but operate under the direction of the Supervisor of Radio at Seattle and the supervision of the Chief Signal Officer of the Army, in accordance with General Order No. 79.

There are approximately seventy limited commercial stations in operation handling traffic with other specified stations in operation and indications are that approximately twenty more will be ready for service within a short time.

All the commercial and Government radio stations of the United States are listed, as of June 30th, 1930, in a publication of the Department of Commerce entitled "Commercial and Government Radio Stations of the United States."

Securing a License Difficult

In its fourth annual report the Federal Radio Commission states frankly that the demand for frequencies or channels for "point-to-point" communication and many other services, being already greater than the supply available, the future responsibilities, of the now permanent Commission, include a demand for creative work through the development of plans and policies whereby a better and more extensive use may be made of the limited number of frequencies. "It is no job for a nervous woman," the Chairman states. There is only one answer to this situation—closer spacing of the channels used, a requirement which of course calls for better engineering practice, efficient modern equipment and greatly improved frequency control.

Literally, the field of international radio communication is full to the brim; there is little chance for a new company to get into this well-organized business of trans-oceanic communication, and little opportunity for existing companies to greatly extend their contacts to other foreign points, as the present circuits now literally girdle the world. The narrowing of the channels now in use merely will give opportunity for improvement of circuits and increased movement of traffic by making available a few more channels.

However, those who do seek additional or new facilities for point-to-point communications should not, as some have tried, persuade a group of Congressmen, state officials or politicians to intercede in their behalf. Procedure requires that the applicant file with the Commission duly executed forms requesting such facilities as are believed available. In this connection an application for a construction permit, (Form 6B-1, used for other than broadcasting stations) covers the essential first step.

Aliens of course are barred from operating. Don't answer the question of citizenship, by saying "native" or "yes," as some have endeavored to do. If a corporation seeks the privilege, a copy of its charter and a financial statement must accompany the application. Naturally, the stations to be communicated with must be listed, but new foreign contacts are difficult to secure today, as most countries have granted these privileges already. Newcomers who try to enter this field must ascertain whether or not they can secure good equipment and a license from the patentees to operate a commercial radio system; some applicants have secured the authority of the Commission to erect stations, only to learn that they could not secure suitable

equipment or found themselves involved in extensive and expensive patent and legal suits. Another and separate license than that of the Federal Radio Commission may be necessary to cover the communication equipment patents.

Furthermore the attitude of the Commission now prevents the issuance of a construction permit or license for private service alone, but necessitates the qualification of the applicant as a bonafide public service organization. He must present evidence of his ability to handle traffic with domestic or foreign stations. A permanent and reliable service must be guaranteed similar to that of other public utilities. For example, railroads are only authorized to operate by and under the direction of the Interstate Commerce Commission. Radio channels may be assigned only in public interest just as are railroad rights of way. While there have been private stations, they are disappearing except in remote sections not otherwise supplied with communication facilities.

Prospective licensees should also make a careful study of the frequencies available conferring with radio engineers if possible, and testing the channels suitable, for not every channel is useful between two given points even if available. Engineers agree that from two to four widely separated, high frequencies are required to maintain good service over a long-range circuit in operation

twenty-four hours a day; these frequencies must be selected with regard to geographical, seasonal and day and night conditions. The site chosen must be carefully selected and exactly designated by latitude and longitude. Don't make errors in this. I recall the embarrassment of an applicant at a hearing who learned that an error of his in longitude placed the site of his transmitter in the Pacific Ocean. Without trying to discourage all those inspired to open public communication circuits for international traffic, permit me to state that the necessary equipment costs between one hundred and five hundred thousand dollars. Properly designed equipment is becoming more and more necessary. Additional engineers on the Commission staff now make possible the checking of applications far more carefully than in the past, and haywire, cheap or inefficient sets will be the cause of rejecting applications.

Prior to the issuance of a license, if changes are desired in the apparatus, site, frequency or if the time required for equipment installation is not adequate, an application for modification of the construction permit should (*Continued on page 831*)

TO those who are commercially, financially or otherwise interested in the erection, maintenance and operation of any form of radio transmitting station or service within the United States or its possessions it is recommended that copies of the General Orders of the Federal Radio Commission, and also a copy of its fourth annual report, be obtained from the Superintendent of Documents, Government Printing Office, Washington, D. C., and also "Radio Laws of the United States and International Convention of 1927, Treaty Series No. 767."

THE EDITORS.

*Formerly Secretary, Federal Radio Commission.

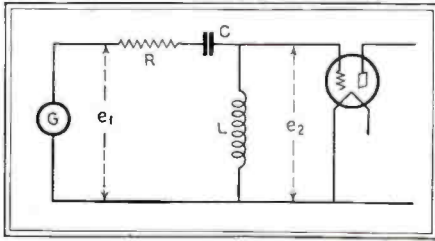

Fig. 1

By J. G. Aceves

Amy, Aceves and King

THERE are several features pertaining to the "Stenode" which are worth discussing.

In the first place, it is my belief that in this type of receiver, the piezo-electric effect has been utilized for the first time in order to secure an extreme degree of selectivity in a broadcast radio set.

It is well known that no electrical vibratory system has a decrement as low as a mechanical system. If the latter could be employed as means of obtaining a high degree of selectivity, which is a consequence of low damping factor, the selectivity of a receiver could be considerably improved. A mechanic-electric converter has to be secured, and this is precisely the function of the quartz crystal used in the Stenode.

A receiver equipped with such a sharp "filter"—after all, this is the way the crystal acts—must obviously pass the side frequencies, or for that matter any frequency in general departing from the resonance frequency, with a rapidly increasing attenuation.

It follows that for tolerably good overall fidelity response in the case of a broadcast receiver, some means must be resorted to in order to secure an adequate compensation. In the case of the Stenode, the audio-frequency amplifier is compensated. How far this compensation is feasible may be surmised from the following calculations.

Let us consider the effect of the crystal by analogy to an equivalent electrical circuit.

Let a constant voltage, variable frequency sine wave generator *G*, Fig. 1, impress an electromotive force *E* into a circuit formed by an inductance *L*, a capacity *C* and a resistance *R*. If we take the voltage drop across the coil, which may be connected to a valve *V* and call this drop *e*, the ratio between the impressed electromotive force *E* and the received electromotive force *e* will be the gain, which we shall call *H*, and it is given by the expression:

$$H = \frac{e}{E} = \frac{pL}{\sqrt{(pL - \frac{1}{pc})^2 + R^2}} \quad (1)$$

in which *p* stands for the frequency in radians (6.283 times the frequency in cycles).

Let us use frequency ratios *n* and introduce the "efficiency" of the circuit, each one defined respectively as follows:

$$p = np_0 \text{ where } p_0 = \frac{1}{\sqrt{LC}} \text{ or (resonance frequency). Let}$$

(Continued on page 836)

Quality with

A most spirited discussion followed the Radiostat by Dr. James Robinson before a ica at Columbia University. This paper, the Stenode Radiostat, was printed in full pleased to present the views of several noted lication of the discussion in its entirety. The Stenode's performance, which are published shadow of a doubt that, in spite of the modulation frequencies

By Ellsworth D. Cook

United Research Corporation

THE radio profession has heard so many conflicting reports on the Stenode that we are indebted to Dr. Robinson for his explanation of what it is and how it is supposed to operate.

A review of his remarks shows that it does not question the existence of side bands. Any suggestion that a difference would exist between the modulated wave and the three separate frequencies into which it can be resolved mathematically would be too naive to warrant discussion. Dr. Robinson, however, calls in question the need for such broad circuits in receiving. It will be essential, therefore, to discuss both the steady state and transient conditions. In the steady state case, a receiver designed so that a band lying 1000 cycles on either side of the carrier would be passed without attenuation while all frequencies outside of this band and extending up to 5000 cycles on either side of the carrier frequency, though still accepted by the receiver, are greatly attenuated, may be made to produce a uniform audio-frequency output by compensating the audio amplifier to properly (Continued on page 843)

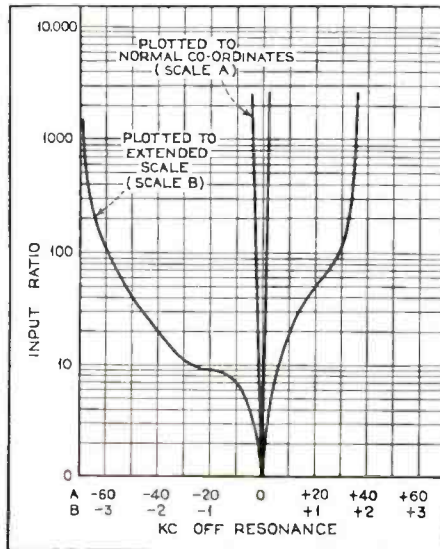
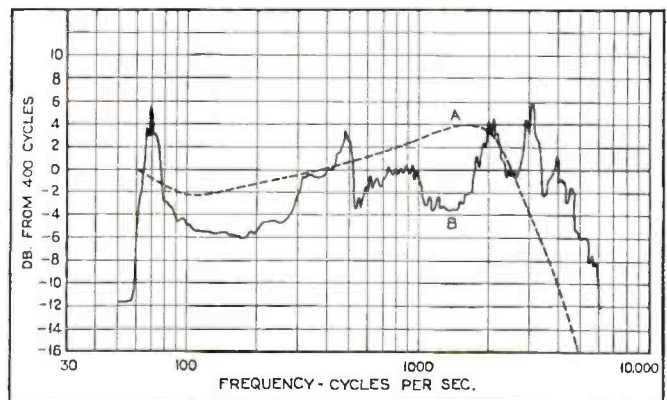

Fig. 3. (Above) Selectivity curves of the Stenode receiver. Curve A is plotted to co-ordinates accepted as standards. Curve B is plotted to an extended scale to show the shape of the tip of Curve A. These curves were taken at an arbitrary frequency of 1,000 k.c., but the figures applied to any frequencies within the range of any receiver

Fig. 4. Fidelity curves of the Stenode receiver. Curve A is measured at the loud speaker terminals. Curve B is that of the loud speaker measured alone. From these two curves, a general idea of the overall fidelity of the complete receiver may be obtained



Selectivity?

presentation of the paper of the Stenode recent meeting of the Radio Club of America the first completely technical explanation of in last month's RADIO NEWS. Here we are engineers, lack of space preventing the publication of fidelity and selectivity curves showing the here for the first time, prove beyond the Stenode's super-selectivity, all the required are present in the output

By L. C. F. Horle
Consulting Radio Engineer

I AM pleased that the committee on publications has given me this opportunity to add to the general discussion of Dr. Robinson's paper since my rather completely occupied position as mediator at the discussion following Dr. Robinson's paper did, quite obviously, preclude the possibility of my contributing any technical discussion at that time and I feel that some effort of summarizing the extended and, at times, highly controversial discussion is well worth while.

I am afraid that I must admit that neither the lengthy analysis of the action of the "Stenode" nor the demonstration of the device by any means convinced me of the validity of the broad claims of its deviser as given in his paper. In so far as the analysis is concerned I must admit that my difficulty in following his explanation, disclosing as it did the action of the device only under transient conditions with the consequent need for my constant interpretation in terms of the more familiar and commonly employed "side band" basis caused me to miss such points in support of the alleged characteristics of the device as were made.

Similarly, I can, by (Continued on page 838)

Fig. 7. (Below) The fidelity curve of one of the most prominent of American made superheterodynes, the R. C. A. Radiola, which was fully described in the November, 1930, issue of RADIO NEWS

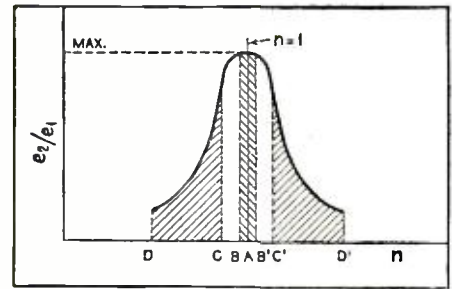
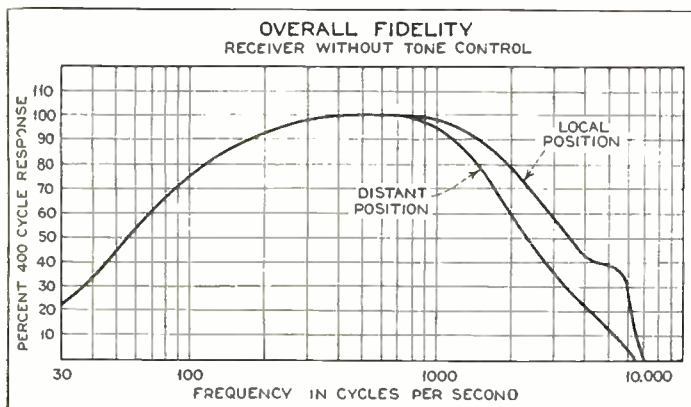

Fig. 2

By Dr. Jas. Robinson, M.B.E., Ph.D.
Inventor Stenode Radiostat

THERE seems to be an impression from the discussion that the demonstration of the Stenode receiver was given in circumstances which were not accurately specified, and in consequence it is suggested that the demonstration was not entirely convincing to some members of the audience. It is difficult to understand how such a public demonstration can be completely satisfactory to everyone, and all that I hoped to do was to give a general idea of the performance of the Stenode. Had anything further been my intention, no demonstration whatever could have been given, it being impossible to test the apparatus adequately prior to the lecture as the room was occupied almost continuously.

My object was to demonstrate the sharpness of tuning of the receiver and that all modulation frequencies were received without sacrifice. In order to determine precisely the type of response with the Stenode, careful measurements, which certainly could not be made at the demonstration, are necessary. The accompanying curves taken by the Crosley Radio Corporation during their investigation of the Stenode, and reproduced by their kind permission, illustrate graphically the achievements of the invention and answer a number of questions that

have been put to me. Fig. 3 shows the selectivity of the Stenode and Fig. 4 shows the overall fidelity. These curves show that with the very great selectivity of the Stenode the high modulation frequencies are reproduced.

Another object was to show the greatly increased freedom from interference when the selectivity of a receiver is increased and that when the apparatus demonstrated is employed it is possible to receive broadcast stations five kilocycles apart without appreciable mutual interference. For this purpose two local modulated oscillators were employed with their carrier frequencies set five kilocycles on either side of WJZ's carrier frequency. It was shown that the Stenode received these transmissions individually without interference, whereas a present-day receiver, considered to be of extremely good selectivity did not do so. Had conditions allowed, it would certainly

have been arranged to demonstrate that the field strengths were as nearly as possible identical for the two receivers.

During this experiment the variable balancing condenser in the quartz bridge circuit of the Stenode was first adjusted so that the resonance curve was exceedingly sharp. When the balance position has been correctly set the three simultaneous transmissions can each be received independently but by increasing or decreasing the value of the balancing capacity the mutual interference increases and the larger the deviation from the correct value the greater becomes the mutual interference. (Continued on page 8

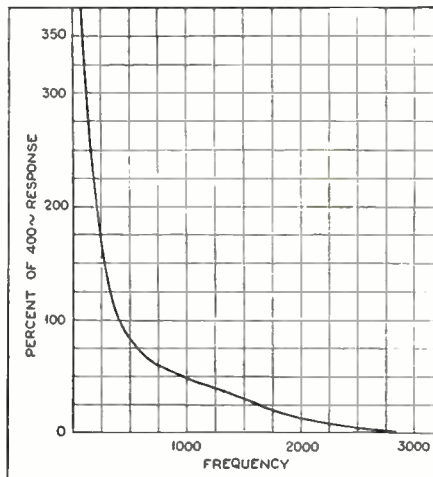

Fig. 5. A curve showing a mean of the two halves of the resonance curve of the receiver plotted to a linear extended scale

ELECTROMAGNETIC

In this simple analysis of the electromagnetic pickup and its characteristics the author reviews the historical development of the pickup and outlines a few easy methods for determining pickup characteristics. A second article by Mr. McClatchie will be published next month

AWAY back in 1890 a man by the name of Capps got a patent on a telephone receiver. There is something startlingly modern about this invention. For it embodies the essentials of nearly all our present-day magnetic loud speakers and pickups. The man was a generation ahead of his time. Pickup history starts with Capps Patent No. 441,396 of Nov. 25, 1890. See Fig. 1.

Thirty-five years later engineers took the four-pole system of Capps, pivoted the armature in rubber bearings, provided the free end of the armature with rubber buffers, and inserted a needle setscrew. This was the first widely used commercial phonograph pickup, and about all that has been done since has been to somewhat refine the design. The type of structure which was introduced on the G.E.-designed Panatrope has been copied from California to Moscow. It is true that other types of pickup have been designed and put to commercial use, but probably nine-tenths of the pickups in use today are based on the one original idea. It will be the main purpose of this article to discuss the merits, limitations and characteristics of this design.

As will be evident from a glance at the illustration, Fig. 2, this type of phonograph pickup is a remarkably simple device. Its moving system is in effect nothing but a simple reed arranged to be vibrated by a needle-point. A loud speaker involves, by comparison, a labyrinth of complications, due to the special characteristics of cones and diaphragms, and the problems of coupling the armature to these parts, and these in turn to the air, which is the transmitting medium.

Frequency Characteristics

The frequency characteristics of the

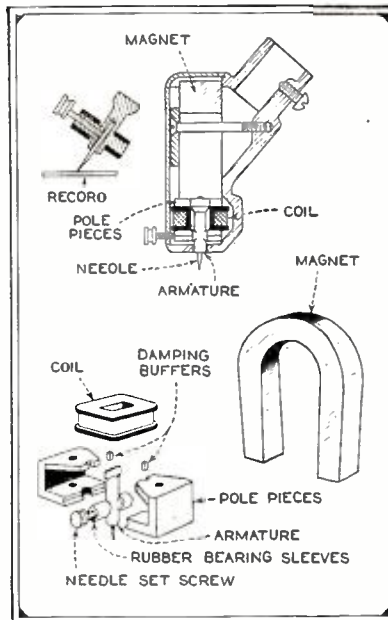
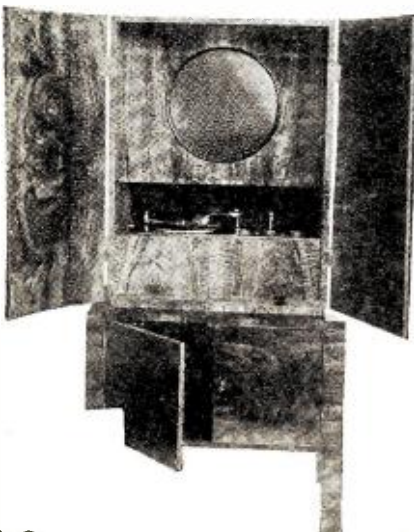

Fig. 2. (Above) The pickup designed by the G. E. Co. in 1925, which was first used on the "Panatrope." This construction has been closely followed by many succeeding pickup manufacturers. The armature is pivoted in rubber sleeves held between the lower pole-pieces. Rubber buffers, held by the upper pole-pieces, serve to center the armature and damp its tendency to resonance. Upper views show device in cross section; below, the parts "exploded"

pickup are almost wholly dependent on the character of the reed or armature, which makes up, with the needle, its simple vibrating system. Now a reed set in motion manifests a certain resonance frequency. In the best modern pickups, this resonance point usually lies between frequencies of 3000 and 4000. In order to prevent an excessive response at these frequencies, it is necessary to damp the system. This is usually accomplished by means of rubber buffers applied to the free end of the armature. These buffers serve also to center the armature in the magnetic air-gap.

Now the damping does not affect merely the resonance frequencies. It tends to cut down the entire level of the upper musical range. Its effect is progressive. It is most effective for the highest frequencies reproduced and least effective for the lowest. This tends to give the response curve a downward slope. The volume control which is almost always connected across the pickup emphasizes this tendency. With a properly designed pickup, the output values are at a maximum at the lower end of the frequency scale. From here they fall off gradually until a frequency of about 2000 is reached. From this point on there is a sharp rise, due to armature resonance, the extent of which is determined by the amount of damping applied. After the resonance peak, the curve falls off steeply. The upper limit of frequency response is determined strictly by the location of the resonance point. Just beyond resonance there is always a cut-off. This cut-off falls almost always between 4000 and 6000, as commercial pickups generally resonate at about 3500. The effective range of the best modern pickups is from 100 to 5000,

Fig. 3. (Left) An elaborate German radio-phonograph combination, embodying a Vogt electro-static loud-speaker. The pickup and turntable are just under the speaker. German taste in cabinetry runs to simple lines and highly finished woods



46)

PICKUPS

By S. McClatchie

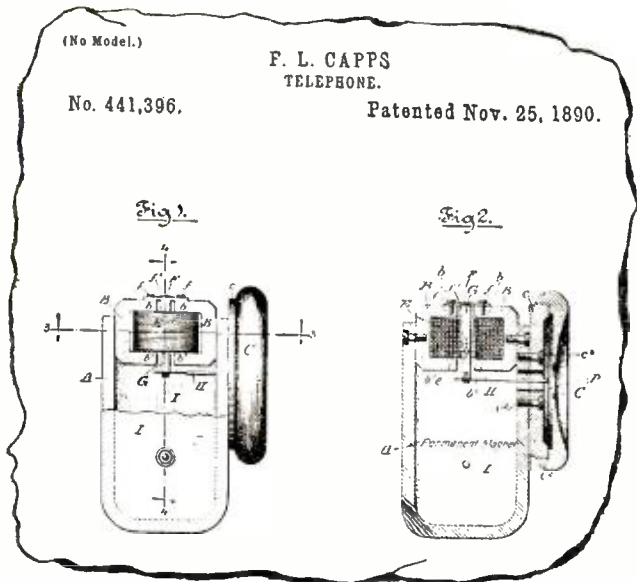
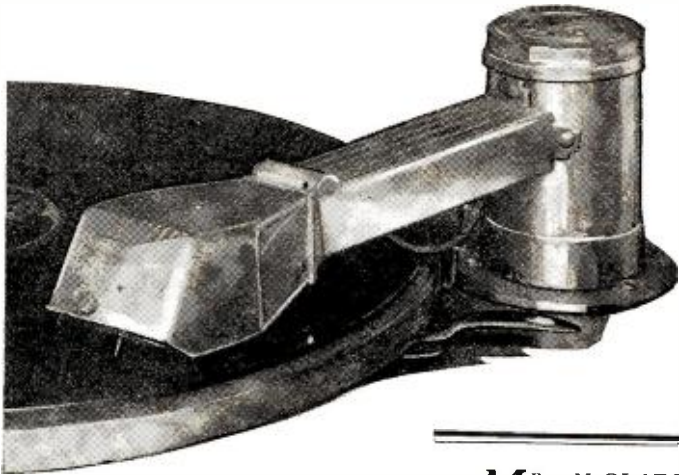

Fig. 1. The granddaddy of them all. The Capps patent of 40 years ago, which shows the four-pole electro-magnetic system which is the basis of nearly all present-day pickups (and magnetic loudspeakers as well). All you have to do to this design to have a very passable pickup is to add a needle set-screw

which corresponds to the usual range of the phonograph record.

It is evident from the foregoing that the frequency characteristic of the commercial pickup is fixed basically by the simple natural laws governing damped vibrating reeds. There are dozens of brands of pickups on the market which resemble one another in tone characteristic so closely that only a very lively imagination can tell the difference between them. This means simply that the dimensions of the armature and the amount of damping applied have been standardized in commercial practice. It is indeed very simple by poor dimensioning to make a worse pickup, but it is with present designs and requirements next to impossible to make a materially better one. That is, so far as tone quality is concerned.

Measuring Pickup Characteristics

Frequency records are available to the public, and it would at first sight

MR. McCLATCHIE started with "wireless" away back in the days of spark gaps and cat-whisker detectors. Out in California at the age of 14 he built a transmitting and receiving station with a 175-foot aerial stretched between two 90-foot poles. By 1911 he was already manufacturing and selling wireless apparatus.

In 1914 Mr. McClatchie abandoned the then not so very promising "wireless" field for other pursuits, among them university work and extensive travel in Europe. He did engineering work on electrical equipment in Germany for many years. In 1923 he again entered the radio field. He carried out the first rebroadcasting of American radio programs to be accomplished on the Continent. The same year he built a magnetic recording machine, which was used to record a program of Christmas greetings from the German to the American people. Stvesemann, the President of the Reichstag, and Dr. Eckener, of Zepelin fame, contributed speeches.

For a year and a half Mr. McClatchie has been devoting himself to the improvement of electrical phonograph pickups. He has written two articles especially for RADIO NEWS which embody some of the fruits of his study of the pickup art, of which the accompanying article is the first.

seem a simple matter to take pickup curves. One need but measure the response of the pickup at various frequencies with a tube voltmeter and plot the results. In practice this is not such a simple matter. The phonograph companies are not in the habit of releasing the frequency records which they use in their own laboratories, and those that they do release require a lot of correction on the part of the user, if even approximately correct results are to be attained. Here a warning: Even if the records are allegedly calibrated, don't accept the makers' calibrations for any purpose, no matter how reputable the name of the maker may be. Do your own calibrating! The most imposing calibrations in TU or Db are of little value unless they happen to be right. The most commonly available frequency records have calibration errors up to 20 per cent.

It is fortunately a comparatively simple matter to calibrate the records oneself. Hold any frequency record at such an angle to a source of light that a band of reflected light beams is seen running radially across the grooves. The width of the band at any point indicates the relative velocity of the cut. For instance, if at one frequency the width of the band is one inch and at another one and one-half inches, then the velocity of the cut at the second frequency is 50 per cent greater than at the first. This may sound to some readers like a "believe it or not," but it is nevertheless a fact capable of exact demonstration. The explanation of the fact would take up too much (Continued on page 848)

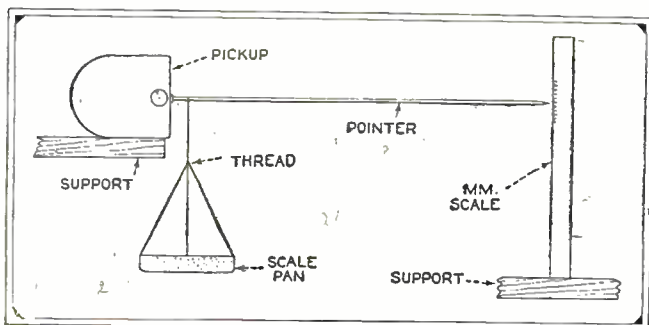

Fig. 4. The author's setup for measuring the "stiffness" of pickups. A light pointer is fixed in the needle holder of the pickup. At a point corresponding to the position of the needle-point is attached a thread which supports a light pan for holding weights. The stiffness is measured in terms of the weight required to cause a deflection of 0.002" at the needle-point

Complete U. S. Broadcast Call List

By Frequency, Call Letter and Location

(Corrected to November, 1930) *Can. Excl. in this list for frequency only in this C. 4-1332 231.2*

Also a Supplementary List of Additional North American Stations

sup. 11. S. and P. 635 Jan 31.

Call Letters	Main Studio Location	Power (watts)	Call Letters	Main Studio Location	Power (watts)	Call Letters	Main Studio Location	Power (watts)
550 KILOCYCLES			660 KILOCYCLES			850 KILOCYCLES		
WGR	Buffalo, N. Y.	1 kw.	WEAF	New York City	50 kw.	KWKH	Shreveport, La.	10 kw.
WKRC	Cincinnati, Ohio	1 kw.	WAAW	Omaha, Neb.	500	WWL	New Orleans, La.	5 kw.
KFUO	Clayton, Mo.	500	670 KILOCYCLES			860 KILOCYCLES		
KSD	St. Louis, Mo.	500	WMAQ	Chicago, Ill.	5 kw.	WARC	New York City	5 kw.
KFDY	Brookings, S. D.	500	680 KILOCYCLES			WHB	Kansas City, Mo.	500
KFYR	Bismarek, N. D.	500	WPTF	Raleigh, N. C.	1 kw.	KMO	Tacoma, Wash.	500
KOAC	Corvallis, Oregon	1 kw.	KFFO	St. Joseph, Mo.	2 1/2 kw.	870 KILOCYCLES		
560 KILOCYCLES			KPO	San Francisco, Cal.	5 kw.	WLS	Chicago, Ill.	5 kw.
WLIT	Philadelphia, Pa.	500	690 KILOCYCLES			WENR	Chicago, Ill.	50 kw.
WFI	Philadelphia, Pa.	500	<i>(Canadian Exclusive)</i>			880 KILOCYCLES		
WQAM	Miami, Fla.	1 kw.	700 KILOCYCLES			<i>(Canadian Shared)</i>		
KPDM	Beaumont, Texas	500	WLW	Cincinnati, Ohio	50 kw.	WGBI	Scranton, Pa.	250
WNOX	Knoxville, Tenn.	1 kw.	710 KILOCYCLES			WQAN	Scranton, Pa.	250
WBO	Chicago, Ill.	1 kw.	WOR	Newark, N. J.	5 kw.	WCOJ	Meridian, Miss.	500
WPCC	Chicago, Ill.	500	KMPC	Beverly Hills, Calif.	500	WSUI	Iowa City, Iowa	500
KLZ	Denver, Colo.	1 kw.	720 KILOCYCLES			KLX	Oakland, Calif.	500
KTAB	San Francisco Calif.	1 kw.	WGN	Chicago, Ill.	25 kw.	KPOF	Denver, Colo.	500
570 KILOCYCLES			730 KILOCYCLES			KFKA	Greeley, Colo.	500
WNYC	New York, N. Y.	500	<i>(Canadian Exclusive)</i>			890 KILOCYCLES		
WMCA	New York City	500	740 KILOCYCLES			<i>(Canadian Shared)</i>		
WSYR	Syracuse, N. Y.	250	WSB	Atlanta, Ga.	5 kw.	WJAR	Providence, R. I.	250
WKBN	Youngstown, Ohio	500	KMMJ	Clay Center, Neb.	1 kw.	WKAQ	San Juan, P. R.	500
WEAO	Columbus, Ohio	750	750 KILOCYCLES			WMMN	Fairmont, W. Va.	250
WWNC	Asheville, N. C.	1 kw.	WJR	Detroit, Mich.	5 kw.	WMAZ	Macon, Ga.	250
KGKO	Wichita Falls, Texas	250	760 KILOCYCLES			WGST	Atlanta, Ga.	250
WNAK	Yankton, S. D.	1 kw.	WJZ	New York, N. Y.	30 kw.	KGJF	Little Rock, Ark.	250
KXA	Seattle, Wash.	500	WEW	St. Louis, Mo.	1 kw.	WILL	Urbana, Ill.	250
KMTR	Los Angeles, Calif.	500	KVI	Tacoma, Wash.	1 kw.	KUSD	Vermillion, S. D.	500
580 KILOCYCLES			770 KILOCYCLES			KFNF	Shenandoah, Iowa	500
<i>(Canadian Shared)</i>			KFAB	Lincoln, Neb.	5 kw.	900 KILOCYCLES		
WTAG	Worcester, Mass.	250	WBBM	Chicago, Ill.	25 kw.	<i>(Canadian Exclusive)</i>		
WOBU	Charleston, W. Va.	250	780 KILOCYCLES			WBEN	Buffalo, N. Y.	1 kw.
WSAZ	Huntington, W. Va.	250	<i>(Canadian Shared)</i>			WKY	Oklahoma City, Okla.	1 kw.
KGFX	Pierre, S. Dakota	200	WEAN	Providence, R. I.	250	WJAX	Jacksonville, Fla.	1 kw.
WIBW	Topeka, Kansas	500	WTAR	Norfolk, Va.	500	WLBL	Stevens Point, Wis.	2 kw.
KSAC	Manhattan, Kansas	500	WGOR	Memphis, Tenn.	500	KHJ	Los Angeles, Calif.	1 kw.
590 KILOCYCLES			WMC	So. Madison, Wis.	250	KSEI	Pocatello, Idaho	250
WEEL	Boston, Mass.	1 kw.	KELW	Burbank, Calif.	500	KGBU	Ketchikan, Alaska	500
WKZO	Berrien Springs, Mich.	1 kw.	KTM	Los Angeles, Calif.	500	910 KILOCYCLES		
WCAJ	Lincoln, Neb.	500	790 KILOCYCLES			<i>(Canadian Exclusive)</i>		
WOW	Omaha, Neb.	1 kw.	WGY	Schenectady, N. Y.	50 kw.	920 KILOCYCLES		
KHQ	Spokane, Wash.	1 kw.	KGO	San Francisco, Calif.	7 1/2 kw.	WBSO	Needham, Mass.	500
600 KILOCYCLES			800 KILOCYCLES			WWJ	Detroit, Mich.	1 kw.
<i>(Canadian Shared)</i>			WBAP	Ft. Worth, Tex.	50 kw.	KPRG	Houston, Texas	1 kw.
WCAC	Storrs, Conn.	250	WFAA	Dallas, Texas	50 kw.	WAAF	Chicago, Ill.	500
WCAO	Baltimore, Md.	250	810 KILOCYCLES			KOMO	Seattle, Wash.	1 kw.
WBS*	New York City	250	WPCB	New York, N. Y.	500	KFEL	Denver, Colo.	500
WREC	Memphis, Tenn.	500	WCCO	Minneapolis, Minn.	7 1/2 kw.	KFXF	Denver, Colo.	500
WMT	Waterloo, Iowa	500	820 KILOCYCLES			930 KILOCYCLES		
KFSD	San Diego, Calif.	500	WHAS	Louisville, Ky.	10 kw.	<i>(Canadian Shared)</i>		
610 KILOCYCLES			830 KILOCYCLES			WIBG	Elkins Park, Pa.	50
WJAY	Cleveland, Ohio	500	WHDD	Boston, Mass.	1 kw.	WDBI	Roanoke, Va.	250
WFAN	Philadelphia, Pa.	500	WRUF	Gainesville, Fla.	5 kw.	WBRG	Birmingham, Ala.	500
WIP	Philadelphia, Pa.	500	KOA	Denver, Colo.	12 1/2 kw.	KGBZ	York, Neb.	500
WDAF	Kansas City, Mo.	1 kw.	840 KILOCYCLES			KMA	Shenandoah, Iowa	500
KFRC	San Francisco, Calif.	1 kw.	<i>(Canadian Exclusive)</i>			KFWI	San Francisco, Calif.	500
620 KILOCYCLES			850 KILOCYCLES			KROW	Oakland, Calif.	500
WLBZ	Bangor, Maine	500	940 KILOCYCLES			940 KILOCYCLES		
WSUN	Clearwater, Fla.	1 kw.	WAAT	Jersey City, N. J.	300	WCSH	Portland, Maine	1 kw.
WTMJ	Milwaukee, Wis.	1 kw.	WFWH	Hopkinsville, Ky.	1 kw.	WFAW	Madison, Wis.	750
KGW	Portland, Oregon	1 kw.	WDAY	Fargo, N. D.	1 kw.	KOIN	Portland, Oregon	1 kw.
KTAR	Phoenix, Arizona	500	KGU	Honolulu, T. H.	1 kw.	950 KILOCYCLES		
630 KILOCYCLES			860 KILOCYCLES			WRC	Washington, D. C.	500
<i>(Canadian Shared)</i>			<i>(Canadian Exclusive)</i>			KMBC	Kansas City, Mo.	1 kw.
WMAL	Washington, D. C.	250	870 KILOCYCLES			KFWB	Hollywood, Calif.	1 kw.
WOS	Jefferson City, Mo.	500	960 KILOCYCLES			KGHL	Billings, Mont.	1 kw.
KFRU	Columbia, Mo.	500	<i>(Canadian Exclusive)</i>			960 KILOCYCLES		
WGBF	Evansville, Ind.	500	880 KILOCYCLES			<i>(Canadian Exclusive)</i>		
640 KILOCYCLES			890 KILOCYCLES			<i>(Canadian Exclusive)</i>		
WIAU	Columbus, Ohio	500	970 KILOCYCLES			<i>(Canadian Exclusive)</i>		
OI	Ames, Iowa	5 kw.	980 KILOCYCLES			<i>(Canadian Exclusive)</i>		
I	Los Angeles, Calif.	5 kw.	990 KILOCYCLES			<i>(Canadian Exclusive)</i>		
650 KILOCYCLES			1000 KILOCYCLES			<i>(Canadian Exclusive)</i>		
	Nashville, Tenn.	5 kw.	1010 KILOCYCLES			<i>(Canadian Exclusive)</i>		
	Seattle, Wash.	100	1020 KILOCYCLES			<i>(Canadian Exclusive)</i>		

Call Letters	Main Studio Location	Power (watts)
970 KILOCYCLES		
WCFL	Chicago, Ill.	1 kw.
KJR	Seattle, Wash.	5 kw.
980 KILOCYCLES		
KDKA	Pittsburgh, Pa.	50 kw.
990 KILOCYCLES		
WBZ	Springfield, Mass.	15 kw.
WBZA	Boston, Mass.	500
1000 KILOCYCLES		
WHO	Des Moines, Iowa	5 kw.
WOC	Davenport, Iowa	5 kw.
KFVD	Culver City, Calif.	250
1010 KILOCYCLES (Canadian Shared)		
WAOA	New York, N. Y.	250
WHN	New York, N. Y.	250
WRNY	New York, N. Y.	250
KGGF	Pleher, Okla.	500
WNAD	Norman, Okla.	500
WIS	Columbia, S. C.	500
KQW	San Jose, Calif.	500
1020 KILOCYCLES		
WRAX	Philadelph. Pa.	250
KYW	Chicago, Ill.	10 kw.
1030 KILOCYCLES (Canadian Exclusive)		
1040 KILOCYCLES		
WMAK	Buffalo, N. Y.	1 kw.
WKAR	East Lansing, Mich.	1 kw.
KTHS	Hot Springs	10 kw.
KRLD	Dallas, Texas	10 kw.
1050 KILOCYCLES		
KFKB	Millford, Kansas	5 kw.
KNX	Hollywood, Calif.	5 kw.
1060 KILOCYCLES		
WBAL	Baltimore, Md.	10 kw.
WTTC	Hartford, Conn.	50 kw.
WJAG	Norfolk, Neb.	1 kw.
KWJJ	Portland, Oregon	500
1070 KILOCYCLES		
WTAM	Cleveland, Ohio	50 kw.
WCAZ	Carthage, Ill.	50
WZC	Tuscola, Ill.	100
KJBS	San Francisco, Calif.	100
1080 KILOCYCLES		
WBT	Charlotte, N. C.	5 kw.
WCBT	Zion, Ill.	5 kw.
WMBI	Chicago, Ill.	5 kw.
1090 KILOCYCLES		
KMOX	St. Louis, Mo.	50 kw.
1100 KILOCYCLES		
WPG	Atlantic City, N. J.	5 kw.
WLWL	New York City	5 kw.
KGDM	Stockton, Calif.	250
1110 KILOCYCLES		
WRVA	Richmond, Va.	5 kw.
KSOO	Sioux Falls, S. D.	2 kw.
1120 KILOCYCLES (Canadian Shared)		
WDEL	Wilmington, Del.	250
WDBO	Orlando, Fla.	500
WTAW	College Station, Texas	500
KTRH	Houston, Texas	500
WISN	Milwaukee, Wis.	250
WHAD	Milwaukee, Wis.	250
KFCS	Los Angeles, Calif.	500
KMCS	Inglewood, Calif.	500
KRSC	Seattle, Wash.	50
KFIO	Spokane, Wash.	100
1130 KILOCYCLES		
WOV	New York City	1 kw.
WJJD	Mooseheart, Ill.	20 kw.
KSL	Salt Lake City, Utah	5 kw.
1140 KILOCYCLES		
WAPI	Birmingham, Ala.	5 kw.
KVOO	Tulsa, Okla.	5 kw.
1150 KILOCYCLES		
WHAM	Rochester, N. Y.	5 kw.
1160 KILOCYCLES		
WWVA	Wheeling, W. Va.	5 kw.
WOWO	Ft. Wayne, Ind.	10 kw.
1170 KILOCYCLES		
WCAU	Philadelphia, Pa.	10 kw.
KTNT	Muscatine, Iowa	5 kw.
1180 KILOCYCLES		
WDGY	Minneapolis, Minn.	1 kw.
WHDI	Minneapolis, Minn.	500
KEX	Portland, Oregon	5 kw.
KOB	State College, N. M.	20 kw.

Call Letters	Main Studio Location	Power (watts)
1190 KILOCYCLES		
WOAI	San Antonio, Texas	50 kw.
1200 KILOCYCLES (Canadian Shared)		
WABI	Bangor, Maine	100
WNBX	Springfield, Vt.	10
WCAX	Burlington, Vt.	100
WORC	Worcester, Mass.	100
WBO	Utica, N. Y.	100
WBX	Cincinnati, Ohio	100
WBHC	Canton, Ohio	10
WLAP	Louisville, Ky.	100
WEHC	Emory, Va.	100
WLBG	Petersburg, Va.	100
WNEO	Silver Haven, Pa.	100
WCOO	Harrisburg, Pa.	100
WKJC	Lancaster, Pa.	100
WNBW	Carbondale, Pa.	10
KMLB	Monroe, La.	50
WABZ	New Orleans, La.	100
WJBW	New Orleans, La.	30
WBBZ	Ponca City, Okla.	100
WFBC	Knoxville, Tenn.	50
WRBL	Columbus, Ga.	50
KGHI	Little Rock, Ark.	100
KBTM	Paragould, Ark.	100
WJBC	LaSalle, Ill.	100
WJBL	Hammond, Ind.	100
WVAE	Laporte, Ind.	100
WRAF	Marshalltown, Iowa	100
KFJB	Mandan, N. D.	100
KCCU	Rapid City, S. D.	100
WGAT	Huron, S. D.	100
KGDJ	St. Louis, Mo.	100
KFWF	Fergus Falls, Minn.	100
KGDE	Janesville, Wis.	100
WCLO	Green Bay, Wis.	100
WHBY	St. Louis, Mo.	100
WIL	Los Angeles, Calif.	100
KSMR	Santa Maria, Calif.	100
KWG	Stockton, Calif.	100
KGEK	Yuma, Colo.	50
KGEW	Ft. Morgan, Colo.	100
KVOS	Bellingham, Wash.	100
KGY	Lacey, Wash.	10
1210 KILOCYCLES (Canadian Shared)		
WMRJ	Jamaica, N. Y.	100
WJBI	Redbank, N. J.	100
WGBB	Freeport, N. Y.	100
WCOH	Yonkers, N. Y.	100
WOCL	Jamestown, N. Y.	25
WLCI	Ithaca, N. Y.	50
WPAW	Pawtucket, R. I.	100
WDWF	Providence, R. I.	100
WSEN	Columbus, Ohio	100
WJW	Mansfield, Ohio	100
WALR	Zanesville, Ohio	100
WBAX	Wilkes-Barre, Pa.	100
WDBS	Lehighburg, Pa.	100
WBBL	Richmond, Va.	100
WMBG	Richmond, Va.	100
WSIX	Springfield, Tenn.	100
WRBU	Gastonia, N. C.	100
WJBY	Gadsden, Ala.	50
WODAS	Thomasville, Ga.	50
KGMP	Elk City, Okla.	100
WRBO	Greenville, Miss.	100
WGCM	Gulfport, Miss.	100
KWEA	Shreveport, La.	100
KDLR	DeVils Lake, N. D.	100
KCCR	Watertown, S. D.	100
KFOR	Lincoln, Neb.	100
WHBU	Anderson, Ind.	100
KFVS	Cape Girardeau, Mo.	100
WEBO	Harrisburg, Ill.	100
KGNO	Dodge City, Kansas	100
WBSB	Chicago, Ill.	100
WCRW	Chicago, Ill.	100
WEDC	Chicago, Ill.	100
WCBS	Springfield, Ill.	100
WTAX	Springfield, Ill.	100
WHBF	Rock Island, Ill.	100
WOMT	Manitowoc, Wis.	100
WBU	Poynette, Wis.	100
KMJ	Fresno, Calif.	100
KFXM	San Bernardino, Cal.	100
KPPC	Pasadena, Calif.	50
KDFN	Casper, Wyo.	100
1220 KILOCYCLES		
WCAD	Canton, N. Y.	500
WCAE	Pittsburgh, Pa.	1 kw.
WDAE	Tampa, Fla.	1 kw.
WREN	Lawrence, Kans.	1 kw.
KFKU	Lawrence, Kans.	500
KWSC	Pullman, Wash.	1 kw.
1230 KILOCYCLES		
WNAC	Boston, Mass.	1 kw.
WPSC	State College, Pa.	500
WSBT	South Bend, Ind.	500
WBNB	Indianapolis, Ind.	1 kw.
KGGM	Albuquerque, N. M.	250
KYA	San Francisco, Calif.	1 kw.
KFOD	Anchorage, Alaska	100
1240 KILOCYCLES		
WXYZ	Detroit, Mich.	1 kw.
KTAT	Ft. Worth, Texas	1 kw.
WACO	Waco, Texas	1 kw.
1250 KILOCYCLES		
WCGP	Newark, N. J.	250
WODA	Puterson, N. J.	1 kw.
WAAM	Newark, N. J.	1 kw.
WDSU	New Orleans, La.	1 kw.
WLB	Minneapolis, Minn.	1 kw.
WRHM	Minneapolis, Minn.	1 kw.
KFHM	Northfield, Minn.	1 kw.
WCAL	Northfield, Minn.	1 kw.
KFOX	Long Beach, Calif.	1 kw.
KIDO	Boise, Idaho	1 kw.

Call Letters	Main Studio Location	Power (watts)
1260 KILOCYCLES		
WLBW	Oil City, Pa.	500
KWWG	Brownsville, Texas	500
WTOC	Savannah, Ga.	500
KRGV	Harlingen, Texas	500
KOIL	Council Bluffs, Iowa	1 kw.
KVOA	Tucson, Arizona	500
1270 KILOCYCLES		
WEAI	Ithaca, N. Y.	1 kw.
WBBR	Baltimore, Md.	250
WASH	Grand Rapids, Mich.	500
WOOD	Grand Rapids, Mich.	500
WJDJ	Jackson, Miss.	500
KWLC	Decorah, Iowa	100
KGCA	Decorah, Iowa	50
KTW	Seattle, Wash.	1 kw.
KOI	Seattle, Wash.	1 kw.
KFUM	Colorado Springs, Colo.	1 kw.
1280 KILOCYCLES		
WCAM	Camden, N. J.	500
WCAP	Asbury Park, N. J.	500
WAOX	Trenton, N. J.	500
WDOO	Chattanooga, Tenn.	1 kw.
WRR	Dallas, Texas	500
WBA	Madison, Wis.	500
KFBB	Great Falls, Mont.	1 kw.
1290 KILOCYCLES		
WNBZ	Saranac Lake, N. Y.	50
WJAS	Pittsburgh, Pa.	1 kw.
KTSA	San Antonio, Texas	1 kw.
KFUL	Galveston, Texas	500
KLCN	Blytheville, Ark.	50
WBCB	Superior, Wis.	1 kw.
KDYL	Salt Lake City, Utah	1 kw.
1300 KILOCYCLES		
WBBR	Brooklyn, N. Y.	1 kw.
WHAP	New York, N. Y.	1 kw.
WEVD	New York, N. Y.	500
WHAZ	Troy, N. Y.	500
WIOD	Miami Beach, Fla.	1 kw.
KFH	Wichita, Kansas	1 kw.
WOO	Kansas City, Mo.	1 kw.
KGFB	Los Angeles, Calif.	1 kw.
KTBI	Los Angeles, Calif.	1 kw.
KFJR	Portland, Oregon	500
KTBR	Portland, Oregon	500
1310 KILOCYCLES		
WKAU	Laconia, N. H.	100
WEBR	Buffalo, N. Y.	100
WMO	Auburn, N. Y.	100
WNBH	New Bedford, Mass.	100
WOL	Washington, D. C.	100
WGH	Newport News, Va.	100
WEXL	Royal Oak, Mich.	100
WEDF	Ft. Mich.	100
WHAT	Philadelphia, Pa.	100
WFKD	Philadelphia, Pa.	50
WJAC	Johnstown, Pa.	100
WFBG	Allentown, Pa.	100
WRAW	Reading, Pa.	50
WCAU	Lancaster, Pa.	100
WVAJ	Grove City, Pa.	100
WBRE	Wilkes-Barre, Pa.	100
WBCB	Birmingham, Ala.	100
WRBI	Tifton, Ga.	20
WOBT	Union City, Tenn.	100
WYOB	Knoxville, Tenn.	50
KRMD	Shreveport, La.	50
KTSL	Shreveport, La.	100
WSJS	Winston-Salem, N. C.	100
KTLC	Houston, Texas	100
KFPB	Greenville, Texas	15
KTSM	El Paso, Texas	100
WDAH	El Paso, Texas	100
KFPL	Dublin, Texas	100
KFXR	Oklahoma City, Okla.	100
WBS	Galesburg, Ill.	100
WCLS	Joliet, Ill.	100
WKBK	Joliet, Ill.	100
KWCR	Cedar Rapids, Iowa	100
KFYJ	Ft. Dodge, Iowa	100
KFGO	Boone, Iowa	100
KGFU	Ravenna, Neb.	100
WBOW	Terre Haute, Ind.	100
WJAK	Marion, Ind.	50
WJBC	Muncie, Ind.	50
KGBX	St. Joseph, Mo.	100
KFIU	Juneau, Alaska	10
KFBK	Sacramento, Calif.	100
KORJ	Jerome, Arizona	100
KGCX	Wolf Point, Mont.	100
KGEZ	Kalispell, Mont.	100
KFUP	Denver, Colo.	100
KFXJ	Edgewater, Colo.	50
KMED	Medford, Oregon	50
KXRO	Aberdeen, Wash.	75
KIT	Yakima, Wash.	50
1320 KILOCYCLES		
WADC	Tahmadre, Ohio	1 kw.
WBSB	New Orleans, La.	500
KGIO	Twin Falls, Idaho	250
KID	Idaho Falls, Idaho	250
KGHE	Pueblo, Colo.	250
KGMB	Honolulu, Hawaii	500
1330 KILOCYCLES		
WDRC	New Haven, Conn.	500
WDAI	Cincinnati, Ohio	500
WTAO	Eau Claire, Wis.	1 kw.
KSCJ	Sioux City, Iowa	1 kw.
KGB	San Diego, Calif.	250
1340 KILOCYCLES		
WSPD	Toledo, Ohio	500
KFPW	Fort Smith, Ark.	50
WCOA	Pensacola, Fla.	500
KFPY	Spokane, Wash.	1 kw.

Call Letters	Main Studio Location	Power (watts)
1350 KILOCYCLES		
WBNY	New York, N. Y.	250
WMSG	New York, N. Y.	250
WCDA	New York, N. Y.	250
WKBO	New York, N. Y.	250
KWK	St. Louis, Mo.	1 kw.
1360 KILOCYCLES		
WFBL	Syracuse, N. Y.	1 kw.
WQBC	Vicksburg, Miss.	300
WCSC	Charleston, S. C.	300
WJKS	Gary, Ind.	1 kw.
WCES	Chicago, Ill.	500
KGIR	Butte, Mont.	500
KGER	Long Beach, Calif.	1 kw.
KPSN	Pasadena, Calif.	1 kw.
1370 KILOCYCLES		
WRDO	Augusta, Maine	100
WQDM	St. Albans, Vt.	5
WLEY	Lexington, Mass.	100
WSVS	Buffalo, N. Y.	50
WBGF	Glens Falls, N. Y.	50
WPOE	Patchogue, N. Y.	100
WBTM	Danville, Va.	100
WLVA	Lynchburg, Va.	100
WHBD	Mt. Oriskany, Ohio	100
WHDF	Calumet, Mich.	100
WJBK	Highland Park, Mich.	50
WIBM	Jackson, Mich.	100
WRAC	Williamsport, Pa.	50
WELK	Philadelphia, Pa.	100
WFDV	Rome, Ga.	100
WRBJ	Hattiesburg, Miss.	10
WHBO	Memphis, Tenn.	100
WRBT	Wilmington, N. C.	100
KGFC	Oklahoma City, Okla.	100
KCRG	Enid, Okla.	100
WMBR	Tampa, Fla.	100
KGGC	San Antonio, Texas	100
KFJZ	Ft. Worth, Texas	100
KONO	San Antonio, Texas	100
KGKL	San Angelo, Texas	100
KFLX	Galveston, Texas	100
WGL	Ft. Wayne, Ind.	100
KGDA	Mitchell, S. D.	100
KFJM	Grand Forks, N. D.	100
KWKC	Kansas City, Mo.	100
WRJN	Racine, Wis.	100
KGAR	Tucson, Arizona	100
KOH	Reno, Nevada	100
KRE	Berkeley, Calif.	100
KZM	Hayward, Calif.	100
KOOS	Marshfield, Oregon	100
KFBL	Everett, Wash.	50
KVL	Seattle, Wash.	100
KFJI	Astoria, Oregon	100
KGFL	Raton, N. M.	50
1380 KILOCYCLES		
WSMK	Dayton, Ohio	200
KOV	Pittsburgh, Pa.	500
KSO	Clarinda, Iowa	500
WKBH	LaCrosse, Wis.	1 kw.
1390 KILOCYCLES		
WHK	Cleveland, Ohio	1 kw.
KLRA	Little Rock, Ark.	1 kw.
KUOA	Fayetteville, Ark.	1 kw.
KOY	Phoenix, Arizona	500

Call Letters	Main Studio Location	Power (watts)
1400 KILOCYCLES		
WCGU	Brooklyn, N. Y.	500
WBSH	Brooklyn, N. Y.	500
WLTH	Brooklyn, N. Y.	500
WBBC	Brooklyn, N. Y.	500
KOCW	Chickasha, Okla.	250
WCMA	Culver, Ind.	500
WKBFA	Indianapolis, Ind.	500
WBAA	W. Lafayette, Ind.	500
KLO	Ogden, Utah	500
1410 KILOCYCLES		
WLEX	Lexington, Mass.	500
WMAF	S. Dartmouth, Mass.	500
WSSH	Boston, Mass.	500
WRBK	Roanoke, Va.	250
WBCM	Bay City, Mich.	500
KGRS	Amarillo, Texas	1 kw.
WDAG	Amarillo, Texas	250
WODX	Mobile, Ala.	500
WSFA	Montgomery, Ala.	500
KFLV	Rockford, Ill.	500
WHLV	Sheboygan, Wis.	500
1420 KILOCYCLES		
WHDL	Tupper Lake, N. Y.	10
WTBO	Cumberland, Md.	100
WILM	Wilmington, Del.	100
WPAD	Paducah, Ky.	100
WEDH	Eric, Pa.	30
WMBC	Detroit, Mich.	100
WELL	Battle Creek, Mich.	50
WEHS	Wichfield, W. Va.	100
WBR	Steubenville, Ohio	50
WFDW	Talladega, Ala.	100
WJBO	New Orleans, La.	100
KGFF	Alva, Okla.	100
KTAP	San Antonio, Tex.	100
KXYZ	Houston, Texas	100
KPYO	Abilene, Texas	100
WSPA	Spartanburg, S. C.	100
KICK	Red Oak, Iowa	100
WIAS	Ottumwa, Iowa	100
WLBFF	Kansas City, Kansas	100
WMBH	Joplin, Mo.	100
KLPM	Mt. N. D.	100
WEHS	Evansville, Ill.	100
WHFC	Cleora, Ill.	100
WKBI	Chicago, Ill.	100
KFIZ	Fond du Lac, Wis.	100
KFXV	Flagstaff, Ariz.	50
KGIX	Las Vegas, Nev.	100
KFOU	Holy City, Calif.	100
KFXD	Nampa, Idaho	50
KGIW	Trinidad, Colo.	100
KGGX	Sandpoint, Idaho	100
KGGC	San Francisco, Calif.	100
KXLF	Portland, Oregon	100
KBPB	Portland, Oregon	100
KORE	Eugene, Oregon	100
KFOW	Seattle, Wash.	100
1430 KILOCYCLES		
WHP	Harrisburg, Pa.	500
WEAK	Harrisburg, Pa.	500
WGAH	Columbus, Ohio	500
WGBG	Memphis, Tenn.	500
WNRB	Memphis, Tenn.	500
KGNF	North Platte, Neb.	500
KECA	Los Angeles, Calif.	1 kw.

Call Letters	Main Studio Location	Power (watts)
1440 KILOCYCLES		
WHEC	Rochester, N. Y.	500
WABO	Rochester, N. Y.	500
WCBA	Allentown, Pa.	250
WSAN	Allentown, Pa.	250
WBIG	Greensboro, N. C.	500
WTAD	Quincy, Ill.	500
WMBD	Peoria Hgts. Ill.	500
KLS	Oakland, Calif.	250
1450 KILOCYCLES		
WBMS	Hackensack, N. J.	250
WNJ	Newark, N. J.	250
WHOM	Jersey City, N. J.	250
WKBO	Jersey City, N. J.	250
WJAR	Providence, R. I.	250
WFJC	Akron, Ohio	500
WTFI	Toccoa, Ga.	500
KTBS	Shreveport, La.	1 kw.
1460 KILOCYCLES		
WJSV	Alexandria, Va.	10 kw.
KSTP	St. Paul, Minn.	10 kw.
1470 KILOCYCLES		
WLAC	Nashville, Tenn.	5 kw.
WTNT	Nashville, Tenn.	5 kw.
KGA	Spokane, Wash.	5 kw.
1480 KILOCYCLES		
WKBW	Buffalo, N. Y.	5 kw.
KFJF	Oklahoma City, Okla.	5 kw.
1490 KILOCYCLES		
WCKY	Covington, Ky.	5 kw.
WJAZ	Mt. Prospect, Ill.	5 kw.
WCHI	Chicago, Ill.	5 kw.
1500 KILOCYCLES		
WMBA	Newport, R. I.	100
WLOE	Boston, Mass.	100
WNEF	Binghamton, N. Y.	100
WMBQ	Brooklyn, N. Y.	100
WCLB	Long Beach, N. Y.	100
WLBX	Long Island City, N. Y.	100
WWRL	Woodside, N. Y.	100
WSYB	Rutland, Vt.	100
WLBZ	Ludington, Mich.	100
WMPD	Lapeer, Mich.	100
WFEN	Philadelphia, Pa.	100
WMBJ	Wilkesburg, Pa.	100
WOPI	Bristol, Tenn.	100
WDIX	Tupelo, Miss.	100
WRDW	Augusta, Ga.	100
KGFI	Corpus Christi, Texas	100
KUT	Austin, Texas	100
KGKB	Brownwood, Texas	100
KGIZ	Grant City, Mo.	50
KGKY	Scottsbluff, Neb.	100
WKBV	Counersville, Ind.	100
KGFK	Moorhead, Minn.	50
KPJM	Prescott, Arizona	100
KXO	El Centro, Calif.	100
KDB	Santa Barbara, Calif.	100
KREG	Santa Ana, Calif.	100
KUJ	Long View, Wash.	100
KFQ	Wenatchee, Wash.	100

Call Letters	Main Studio Location	(Watts) Power	Kc.
WAAF	Chicago, Ill.	500	920
WAAM	Newark, N. J.	1 kw.	1250
WAAT	Jersey City, N. J.	300	940
WAAW	New York City	500	660
WABC	New York City	5 kw.	840
WABI	Bangor, Maine	100	1200
WABO	(See WHEC-WABO)		
WHEC	New Orleans, La.	100	1200
WABZ	Waco, Texas	1 kw.	1240
WACO	Tallmadge, Ohio	1 kw.	1320
WADC	Columbus, Ohio	500	640
WALR	Zanesville, O.	100	1210
WAPI	Birmingham, Ala.	5 kw.	1140
WASH	Grand Rapids, Mich.	500	1270
WBAA	W. Lafayette, Ind.	500	1400
WBAK	Harrisburg, Pa.	500	1430
WBAL	Baltimore, Md.	10 kw.	1060
WBAP	Fort Worth, Tex.	10 kw.	800
WBAX	Wilkes-Barre, Pa.	100	1210
WBBC	Brooklyn, N. Y.	500	1400
WBBL	Richmond, Va.	100	1270
WBDM	Chicago, Ill.	25 kw.	710
WBBD	Brooklyn, N. Y.	1 kw.	1300
WBZB	Ponca City, Okla.	100	1200
WBCM	Bay City, Mich.	500	1410
WBEN	Buffalo, N. Y.	1 kw.	900
WBGF	Glens Falls, N. Y.	50	1370
WBIG	(formerly WNRC) Greensboro, N. C.	500	1440
WBIS	(See WNAC-WBIS)		
WNAC	Hackensack, N. J.	250	1450
WBMS	New York, N. Y.	250	1350
WBNO	(See WABC-WBNO)		
WBOW	Terre Haute, Ind.	100	1310
WBRC	Birmingham, Ala.	500	930
WBRE	Wilkes-Barre, Pa.	100	1310
WBSO	Needham, Mass.	500	920
WBT	Charlotte, N. C.	5 kw.	1080
WBTM	Danville, Va.	100	1370
WBZ	Springfield, Mass.	15 kw.	900
WBZA	Boston, Mass.	500	900
WCAC	Storrs, Conn.	250	600

Call Letters	Main Studio Location	(Watts) Power	Kc.
WCAD	Ganton, N. Y.	500	1220
WCAE	Pittsburgh, Pa.	1 kw.	1220
WCAH	Columbus, Ohio	500	1130
WCAJ	Lincoln, Neb.	500	500
WCAL	Northfield, Minn.	1 kw.	1250
WCAM	Camden, N. J.	500	1280
WCAO	Baltimore, Md.	250	600
WCAP	Asbury Park, N. J.	500	1280
WCAT	Rapid City, S. D.	100	1200
WCAU	Philadelphia, Pa.	10 kw.	1170
WCAX	Burlington, Vt.	100	1200
WCAZ	Carthage, Ill.	50	1070
WCBA	Allentown, Pa.	250	1440
WCBH	Zion, Ill.	5 kw.	1080
WCBZ	Springfield, Ill.	100	1210
WCCO	Minneapolis, Minn.	7 1/2 kw.	870
WCDA	New York City	250	1350
WCDB	Chicago, Ill.	1 1/2 kw.	970
WCGU	Brooklyn, N. Y.	500	1400
WCFL	Chicago, Ill.	5 kw.	1490
WCKY	Covington, Ky.	5 kw.	1490
WCLB	Long Beach, N. Y.	100	1500
WCLO	Janesville, Wis.	100	1290
WCLS	Joliet, Ill.	100	1310
WCMA	Culver, Ind.	500	1400
WCOA	Pensacola, Fla.	500	1340
WCOC	Meridian, Miss.	500	880

Call Letters	Main Studio Location	(Watts) Power	Kc.
WCOD	Harrisburg, Pa.	100	1200
WCOH	Yonkers, N. Y.	100	1210
WCRW	Chicago, Ill.	100	1210
WCSC	Charleston, S. C.	500	1360
WCSD	Portland, Maine	1 kw.	940
WDAE	Tampa, Fla.	1 kw.	1220
WDAP	Kansas City, Mo.	1 kw.	610
WDAG	Amarillo, Texas	250	1410
WDAH	El Paso, Texas	100	1310
WDAY	Fargo, N. D.	1 kw.	940
WDBJ	Roanoke, Va.	250	930
WDBO	Orlando, Fla.	500	1120
WDEL	Wilmington, Del.	250	1120
WDGY	Minneapolis, Minn.	1 kw.	1180
WDIX	Tupelo, Miss.	100	1500
WDOB	Chattanooga, Tenn.	1 kw.	1280
WDRC	New Haven, Conn.	500	1330
WDSU	New Orleans, La.	1 kw.	1250
WDFW	Providence, R. I.	100	1210
WDFL	Tuscola, Ill.	100	1070
WEAF	New York, N. Y.	50 kw.	660
WEAI	Ithaca, N. Y.	1 kw.	1270
WEAN	Providence, R. I.	250	780
WEAO	Columbus, Ohio	750	570
WEBC	Superior, Wis.	1 kw.	1290
WEBO	Harrisburg, Ill.	100	1210
WBRB	Buffalo, N. Y.	100	1310
WEDC	Chicago, Ill.	100	1210
WEDH	Erie, Penna.	30	1420
WEEI	Boston, Mass.	1 kw.	590
WEHQ	Emory, Va.	100	1200
WEHS	Evansville, Ill.	100	1420
WELK	Philadelphia, Pa.	100	1370
WELL	Battle Creek, Mich.	50	1420
WENR	Chicago, Ill.	50 kw.	870
WEPS	(See WORC-WEPS)		
WORC	New York City	500	1300
WEVD	St. Louis, Mo.	1 kw.	760
WEXL	(formerly WAGM)	50	1310
WFAX	Dallas, Texas	50 kw.	800
WFAN	Philadelphia, Pa.	500	610
WFBC	Shreveport, Tenn.	50	1200

Stations
by Call Letters

Table listing radio stations with columns for Call Letters, Main Studio Location, (Watts) Power, and Kc. The table is organized into three main sections: stations starting with W (left), stations starting with W (middle), and stations starting with W (right).

Table with 3 columns: Call Letters, Main Studio Location, (Watts) Power Kc. for three different stations. Includes call letters like KGRS, KGU, KGW and locations like Amarillo, Texas, Honolulu, Hawaii, Portland, Oregon.

Table with 3 columns: Call Letters, Main Studio Location, Owner. Organized by state: Alabama, Alaska, Arizona, Arkansas, California, Connecticut, Delaware, District of Columbia, Florida, Georgia, Illinois, Indiana. Lists call letters, locations, and owners for various radio stations.

Table with 3 columns: Call Letters, Main Studio Location, Owner. Includes stations like WKBF Indianapolis, WRAF La Porte, WJAK Marion, etc.

Table with 3 columns: Call Letters, Main Studio Location, Owner. Includes stations like WOI Ames, KFGO Boone, KWCR Cedar Rapids, etc.

Table with 3 columns: Call Letters, Main Studio Location, Owner. Includes stations like KGNO Dodge City, WLFB Kansas City, WREN Lawrence, etc.

Table with 3 columns: Call Letters, Main Studio Location, Owner. Includes stations like WKY Covington, WFIW Hopkinsville, WHAS Louisville, etc.

Table with 3 columns: Call Letters, Main Studio Location, Owner. Includes stations like WPAD Paducah, KMLB Monroe, WABZ New Orleans, etc.

Table with 3 columns: Call Letters, Main Studio Location, Owner. Includes stations like WDSU New Orleans, WJBO New Orleans, WJWB New Orleans, etc.

Table with 3 columns: Call Letters, Main Studio Location, Owner. Includes stations like WWL New Orleans, KRMD Shreveport, KTBS Shreveport, etc.

Table with 3 columns: Call Letters, Main Studio Location, Owner. Includes stations like WRDO Augusta, WABI Bangor, WLBZ Bangor, etc.

Table with 3 columns: Call Letters, Main Studio Location, Owner. Includes stations like WBAL Baltimore, WCAO Baltimore, WFRB Baltimore, etc.

Table with 3 columns: Call Letters, Main Studio Location, Owner. Includes stations like WBZA Boston, WEI Boston, WHDH Boston, etc.

Table with 3 columns: Call Letters, Main Studio Location, Owner. Includes stations like WSSH Boston, WSAR Fall River, WLEX Lexington, etc.

Table with 3 columns: Call Letters, Main Studio Location, Owner. Includes stations like WNBH New Bedford, WMAF Springfield, WBZ Springfield, etc.

Table with 3 columns: Call Letters, Main Studio Location, Owner. Includes stations like WROC Worcester, WTAC Worcester, WELL Battle Creek, etc.

Table with 3 columns: Call Letters, Main Studio Location, Owner. Includes stations like WBCM Bay City, WKZO Berrien Springs, WHDF Calumet, etc.

Table with 3 columns: Call Letters, Main Studio Location, Owner. Includes stations like WXYZ Detroit, WJR Detroit, WMBC Detroit, etc.

Table with 3 columns: Call Letters, Main Studio Location, Owner. Includes stations like WKAR East Lansing, WFDE Flint, WASH Grand Rapids, etc.

Table with 3 columns: Call Letters, Main Studio Location, Owner. Includes stations like WJBM Jackson, WMPC Lapeer, WKBZ Ludington, etc.

Table with 3 columns: Call Letters, Main Studio Location, Owner. Includes stations like KGDE Fergus Falls, WCCO Minneapolis, WJDX Jackson, etc.

Table with 3 columns: Call Letters, Main Studio Location, Owner. Includes stations like WRBO Greenville, WJDX Jackson, WQBC Vicksburg, etc.

Table with 3 columns: Call Letters, Main Studio Location, Owner. Includes stations like KFVS Cape Girardeau, KFRU Columbia, KGIZ Grant City, etc.

Table with 3 columns: Call Letters, Main Studio Location, Owner. Includes stations like WMBH Joplin, KWKC Kansas City, WDAF Kansas City, etc.

Table with 3 columns: Call Letters, Main Studio Location, Owner. Includes stations like WJWB St. Joseph, KMOX St. Louis, KSD St. Louis, etc.

Table with 3 columns: Call Letters, Main Studio Location, Owner. Includes stations like WJWB St. Louis, WIL St. Louis, KGHL Billings, etc.

Table with 3 columns: Call Letters, Main Studio Location, Owner. Includes stations like KGIR Butte, KFBB Great Falls, KGEZ Kallispell, etc.

Table with 3 columns: Call Letters, Main Studio Location, Owner. Includes stations like KGKX Wolf Point, KMMJ Clay Center, KFQR Lincoln, etc.

Table with 3 columns: Call Letters, Main Studio Location, Owner. Includes stations like WJAG Norfolk, KGNF North Platte, WAAW Omaha, etc.

Table with 3 columns: Call Letters, Main Studio Location, Owner. Includes stations like KGFV Ravenna, KGGY Scottsbluff, KGBZ York, etc.

Table with 3 columns: Call Letters, Main Studio Location, Owner. Includes stations like KGIX Las Vegas, KOH Reno, WKAV Laconia, etc.

Table with 3 columns: Call Letters, Main Studio Location, Owner. Includes stations like WCAP Asbury Park, WPG Atlantic City, WCAM Camden, etc.

Table with 3 columns: Call Letters, Main Studio Location, Owner. Includes stations like WJWB Jersey City, WHOM Jersey City, WKBO Newark, etc.

Table with 3 columns: Call Letters, Main Studio Location, Owner. Includes stations like WODA Paterson, WJBI Red Bank, WOAX Trenton, etc.

Table with 3 columns: Call Letters, Main Studio Location, Owner. Includes stations like KGGM Albuquerque, KGLF Baton Rouge, KOB State College, etc.

Table with 3 columns: Call Letters, Main Studio Location, Owner. Includes stations like WMBO Auburn, WNBFB Binghamton, WBBB Brooklyn, etc.

Table with 3 columns: Call Letters, Main Studio Location, Owner. Includes stations like WSGH Brooklyn, WEBR Buffalo, WGR Buffalo, etc.

Table with 3 columns: Call Letters, Main Studio Location, Owner. Includes stations like WEAI Ithaca, WLCI Ithaca, WMRJ Jamaica, etc.

Table with 3 columns: Call Letters, Main Studio Location, Owner. Includes stations like WOCL Jamestown, WCLB Long Beach, WLBB Long Island City, etc.

Table with 3 columns: Call Letters, Main Studio Location, Owner. Includes stations like WBNY New York, WCDA New York, WEAF New York, etc.

Table with 3 columns: Call Letters, Main Studio Location, Owner. Includes stations like WVEV New York, WHAP New York, WJZ New York, etc.

Table with 3 columns: Call Letters, Main Studio Location, Owner. Includes stations like WKBO New York, WLWL New York, WMCA New York, etc.

Table with 3 columns: Call Letters, Main Studio Location, Owner. Includes stations like WNYC New York, WOV New York, WPCW New York, etc.

Table with 3 columns: Call Letters, Main Studio Location, Owner. Includes stations like WQAO New York, WRNY New York, WFOE Poughkeepsie, etc.

Table with 3 columns: Call Letters, Main Studio Location, Owner. Includes stations like WHAM Rochester, WHEC Rochester, WNBZ Saratoga Lake, etc.

Table with 3 columns: Call Letters, Main Studio Location, Owner. Includes stations like WGY Schenectady, WFBL Syracuse, WSYR Syracuse, etc.

Table with 3 columns: Call Letters, Main Studio Location, Owner. Includes stations like WHAZ Troy, WHDL Tupper Lake, WIBX Utica, etc.

Table with 3 columns: Call Letters, Main Studio Location, Owner. Includes stations like WWRH Woodside, WYONK Yonkers, WUNC Asheville, etc.

Table with 3 columns: Call Letters, Main Studio Location, Owner. Includes stations like WBT Charlotte, WRBQ Gastonia, WBIG Greensboro, etc.

Table with 3 columns: Call Letters, Main Studio Location, Owner. Includes stations like WPTF Raleigh, WRBT Winston-Salem, WSJS Winston-Salem, etc.

Stations by Location

North Carolina

North Dakota

Ohio

Oklahoma

Oregon

Pennsylvania

Fre- quency in Kilo- cycles	Wave- length in Meters	Call	City	County, State or Province	Power (Watts)
900	333	NEB	Mexico	Mexico	1,000
		CMCF	Habana	Cuba	250
		CMX	Habana	Cuba	250
910	330	CJGC-CNRI	London	Ontario	500
		CKGC-CNRS	Saskatoon	Saskatchewan	500
920	326	IHK	Port au Prince	Haiti	1,000
923	325	CMHD	Caiabarien	Cuba	200
		XFF	Chihuahua	Mexico	200
930	323	CJCA-CNRE	Edmonton	Alberta	550
		CHNS-CNRH	Halifax	Nova Scotia	550
		CFRC	Kineston	Ontario	500
		CKPR	Midland	Ontario	50
		CKIC	Wolville	Nova Scotia	50
955	314	CMRD	Habana	Cuba	150
		CMCQ	Habana	Cuba	1,000
960	313	CFCK	Charlottetown	Prince Edward Island	250
		CHCK	Charlottetown	Prince Edward Island	30
		CFRB-CNRX	King, York Co.	Ontario	4,000
		CHWC	Pilot Butte	Saskatchewan	500
		CKFC-CJBR	Regina	Saskatchewan	500
961	312	NED	Reynosa	Mexico	10,000
1,000	300	NEE	Linars	Mexico	10
		NEK	Mexico	Mexico	100
		NEI	Mordia	Mexico	100
1,010	297	CFCR	Prescott	Ontario	50
		CKCR	Waterloo	Ontario	50
		CMCZ	Habana	Cuba	150
		CMBW	Marianao	Cuba	150
1,030	291	CFCF	Montreal	Quebec	500
		CNRV	Vancouver	British Columbia	500
		NEG	Mexico	Mexico	2,000
1,035	290	NEV	Puebla	Mexico	100
1,050	286	CMGF	Matanzas	Cuba	10
1,063	282	CMGC	Matanzas	Cuba	30
1,070	280	WTAM	Cleveland	Ohio	25,000
		CMBT	Habana	Cuba	150
		CMCC	Habana	Cuba	150
		CMBG	Santiago de las Vegas	Cuba	150
1,090	275	CMAA	Guanajay	Cuba	30
		NEL	Saltillo	Mexico	10
1,100	273	CMKD	Santiago de Cuba	Cuba	10
		NETA	Nogales	Mexico	1,000
1,110	270	CMHI	Santa Clara	Cuba	15
1,120	268	CJFC	Karloops	British Columbia	15
		CJGC	Lethbridge	Alberta	50
		CHGS	Summerside	Prince Edward Island	100
1,130	265	CMBC	Habana	Cuba	150
		CMQ	Habana	Cuba	250
1,131	265	NEH	Monterrey	Mexico	100
1,132	265	NEP	Oaxaca	Mexico	100
1,140	263	CMGD	Matanzas	Cuba	5
1,154	260	CMHA	Cienfuegos	Cuba	200
1,185	253	CMGB	Matanzas	Cuba	712
1,199	250	IOAE	Bowmanville	Ontario	—
		IOBQ	Brantford	Ontario	—
		IOBU	Canora	Saskatchewan	—
		IOAY	Kelowna	British Columbia	—

Fre- quency in Kilo- cycles	Wave- length in Meters	Call	City	County, State or Province	Power (Watts)
		IOCB	Liverpool	Saskatchewan	—
		IOAB	Moose Jaw	Saskatchewan	—
		IOBI	Prince Albert	Saskatchewan	—
		IOAK	Stratford	Ontario	—
		IOBP	Wingham	Ontario	—
		CAKCB	Santiago de Cuba	Cuba	15
		NEA	Guadalajara	Mexico	100
1,210	246	CFCO	Chatham	Ontario	100
		CHWK	Chilliwack	British Columbia	5
		CKMJC	Colbit	Ontario	15
		CFNB	Fredericton	New Brunswick	50
		CKPC	Preston	Ontario	25
		CJOR	Sea Island	British Columbia	50
1,225	245	CMBK	Marianao	Cuba	15
		CMCG	Guanabacoa	Cuba	30
		CMCX	Habana	Cuba	15
		CMCA	Habana	Cuba	100
		CMCN	Habana	Cuba	100
1,250	240	CMAB	Pinar del Rio	Cuba	20
		CMBAZ	Santiago de Cuba	Cuba	50
1,285	233	CMBJ	Habana	Cuba	15
		CMCK	Habana	Cuba	100
		CMCM	Habana	Cuba	20
		CMBM	Marianao	Cuba	15
		CMBQ	Marianao	Cuba	50
1,304	231	CMKC	Santiago de Cuba	Cuba	150
		NEK	Mexico	Mexico	500
1,321	227	CMJC	Camaguey	Cuba	15
1,332	225	CMJA	Camaguey	Cuba	10
1,333	224	CMJB	Ciego de Avila	Cuba	10
		NEG	Toluca	Mexico	50
1,335	224	CMGDW	Cienfuegos	Cuba	10
1,345	223	CMBA	Habana	Cuba	50
		CMBF	Habana	Cuba	7 1/2
		CMCD	Habana	Cuba	15
		CMCU	Habana	Cuba	50
		CMCV	Habana	Cuba	50
1,375	218	CMGE	Cardenas	Cuba	30
1,405	213	CMBE	Habana	Cuba	15
		CMBL	Habana	Cuba	30
		CMBN	Habana	Cuba	30
		CMBR	Habana	Cuba	15
		CMBY	Habana	Cuba	100
		CMCA	Marianao	Cuba	15
1,429	210	CMHE	Santa Clara	Cuba	20
1,450	205	CMKA	Santiago de Cuba	Cuba	20
1,487	202	CMCT	Guanabacoa	Cuba	5
		CMHH	Habana	Cuba	30
		CMHJ	Habana	Cuba	15
		CMHP	Habana	Cuba	15
		CMHM	Habana	Cuba	15
		CMHN	Camaguey	Cuba	20
		CMHF	Sagua la Grande	Cuba	10
1,561	192	CMJD	Ciego de Avila	Cuba	15
6,005	49.95	CFB	Tegucigalpa	Honduras	2,300
6,667	45	NFD	Mexico	Mexico	50
6,977	43	NEA	Mexico	Mexico	50
9,091	33	NFD	Mexico	Mexico	50
9,734	30.8	NRE	Heredia	Costa Rica	7 1/2
11,111	27	NFD	Mexico	Mexico	50
11,720	25.6	CJRX	Middlechurch	Manitoba	2,000
21,429	14.0	XFA	Mexico	Mexico	50

How to Build "The Mighty Mite"

respective returns and passed through the rear end of the chassis as shown.

Putting the Receiver in Operation

Before placing the receiver in operation the wiring should be thoroughly checked in accordance with the schematic diagram, as well as by continuity tests. After the wiring is known to be correct, it is next necessary to test the oscillator. This is best accomplished by the insertion of the -32 type tube in the socket V1, applying about 22½ volts to the "B" plus oscillator plate and between 45 and 90 volts on the "B" plus modulator plate. The "A" battery is also connected to the battery leads. Taking a long piece of insulated wire, three or four turns are wound around the coil L2, then carried over to another broadcast receiver and wound around the antenna coil a similar number of turns. The condenser C2 is shorted by the switch S1 and the switch S2 adjusted to place the coil L2 in the circuit. By tuning in a broadcast station or r.f. signal or carrier wave on the broadcast receiver, the variable condenser C1 is slowly rotated until the beat is heard through the loud speaker of the broadcast receiver. The oscillation of the oscillator V1 should be checked against the broadcast receiver over the entire broadcast range.

(Continued from page 805)

The link test circuit between the oscillator and the broadcast receiver is next removed. All the tubes are placed in their respective sockets, and proper potentials applied to the battery leads. The antenna and ground are connected to their respective binding posts, and earphone receivers inserted in the SP jack. Slowly

rotating the condenser C1, a broadcast signal or carrier wave should be heard in the earphone receivers. The condenser C1 is adjusted until the signal in the phones is as loud as possible. The midget mica condenser C4A is now adjusted until the signal is peaked, with slight leeway in the adjustment. The same process is repeated with the condenser C5A. Should

(Continued on page 844)

To the right are shown the constructional and drilling details for the chassis, and mounting plates for the tuning condenser

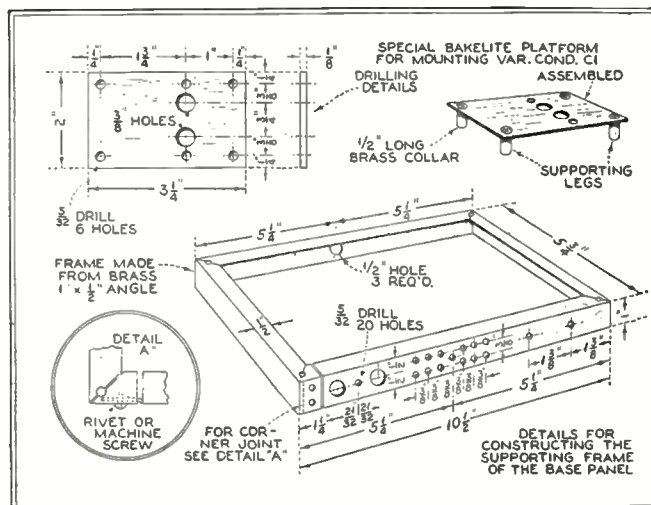

~RADIO NEWS HOME LABORATORY EXPERIMENTS~

*Simple Methods of Measuring Resistance
Capacity and Inductance*

NO matter what field we study, we will find that knowledge is based on measurements of some sort. In no field is this truer than in engineering where definite quantitative tests form the basis on which we judge the merit of a device. The tube, for example, is almost useless until we measure its characteristics; knowing these characteristics, we are then readily able to determine the sort of circuit in which the tube will perform most efficiently.

Last month's Home Experiment Sheet described some simple methods for the measurement of tube characteristics by the home experimenter. This month we describe elementary bridge circuits which can be used to measure resistance, capacity or inductance. With the aid of a simple bridge circuit it is possible to measure any one of these quantities with a comparatively high degree of accuracy and will in addition give the experimenter an excellent working knowledge of the design, construction and use of bridge instruments.

All bridge circuits are based on the fundamental Wheatstone bridge circuit. In its most elementary form the Wheatstone bridge consists of four resistors arranged as indicated in Fig. 1. The values of three of these resistors are known and R_x represents the unknown resistance whose value is to be determined. The operation of this circuit depends upon the fact that the voltage drop from a to b must be the same over the path through R_1 and R_x as it over the path through R_2 and R_3 and that therefore there must be some point along the upper path which is at exactly the same potential as some point along the lower path. In practice this point is found by adjusting the values of the various known resistors until there is no current indicated by the meter M. Since there is no current through the meter it follows that the points c and d must be at the same potential since current would flow through the meter were these two points *not* at the same potential. When this condition of no current through the meter M is found the bridge is said to be balanced and under such conditions there is a very simple and definite relation between the values of the resistances in the circuit. If I_t is the current through the top branch and I_b is the current through the bottom branch, then the voltage drop between a and c is $I_t \times R_1$ and this voltage drop is equal to $I_b \times R_2$, the voltage drop across R_2 . In equation form, we can say

$$(Equation 1) \\ I_t R_1 = I_b R_2$$

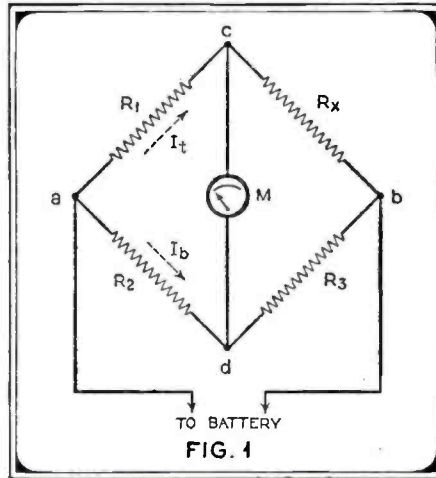

which, transposed, gives us by simple algebra

$$(Equation 2) \\ \frac{R_1}{R_2} = \frac{I_b}{I_t}$$

By similar reasoning the voltage drop through R_x is $I_t \times R_x$ and the voltage drop across R_3 is $I_b \times R_3$. Equating these two quantities and transposing as was done above, we have

$$(Equation 3) \\ \frac{R_x}{R_3} = \frac{I_b}{I_t}$$

Since we have two quantities both equal to $\frac{I_b}{I_t}$ they can be equated

$$\frac{R_1}{R_2} = \frac{R_x}{R_3} \quad (Equation 4)$$

and therefore

$$R_x = \frac{R_1 R_3}{R_2} \quad (Equation 5)$$

The preceding equations represent the fundamental characteristics of a bridge circuit. Obviously, if the three known resistances are adjusted so as to give zero current through the meter M, the value of the unknown resistance R_x can be readily calculated from this simple equation. For example, if we set up a simple bridge circuit and found that we obtained a balance (zero current through the meter M) with R_1 ten ohms, R_2 one hundred ohms and R_3 sixty-five ohms, then, the value of the unknown resistance R_x will be

$$R_x = \frac{10 \times 65}{100} \\ R_x = 6.5 \text{ ohms}$$

From the standpoint of simplicity it is not necessary that three variable resistances be used. In practice R_1 can be fixed and the ratio of R_3 to R_2 adjusted to satisfy the equation. Also it is not necessary that the absolute values of R_3 and R_2 be known. It is simply necessary that we know the ratio. that is, whether R_3 is ten times R_2 , one-half of R_2 or any other value. With these ideas in mind, it is possible to work out a very simple bridge arrangement, as illustrated in the picture diagram of Fig. 2.

In this diagram we use a single length of resistance wire such as manganin or nichrome. The total length of this wire should be about 24 inches. Across the terminals 1 and

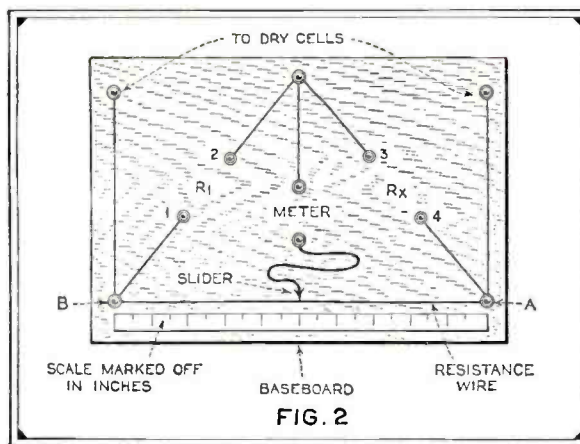

2 is connected a fixed resistance R1 whose value is known. Across the terminals 3 and 4 is connected a resistance whose value is to be determined. A low-range milliammeter is connected to the meter terminals, a few dry cells are used as the battery and the slider on the resistance wire is then moved back and forth until the meter reads zero current. The value of the unknown resistance will then be equal to

$$\text{unknown resistance} = \frac{\text{distance in inches from A to slider}}{\text{distance in inches from B to slider}} \times R1$$

The distances are readily measured by providing the bridge with a scale marked off in inches as indicated in the picture diagram Fig. 2. The circuit will most accurately measure the value of an unknown resistance when the balance point is near the center, but reasonably accurate measurements can be expected when one distance is up to about ten times as large as the other distance. For this reason with a fixed value of R1 the circuit can be used to measure resistances from one-tenth the value of R1 up to about ten times the value of R1. To cover a wide range of values a set of fixed resistors are therefore required and the following values are recommended:

For measuring resistances of	Value of R1 should be
1-100 ohms	10 ohms
100-10,000 ohms	1,000 ohms
10,000-1,000,000 ohms	100,000 ohms

Of course somewhat more accurate results will be obtained if a few additional fixed resistances are available with values between those indicated. It would, for example, be useful to have on hand resistors that could be used for R1 with values of 100 ohms, 10,000 ohms and 50,000 ohms.

This simple bridge circuit is designed for use with d.c. voltages obtained from a few dry cells with a d.c. milliammeter used as the indicating device. Particularly when measuring high resistances this arrangement is not altogether satisfactory, since comparatively large voltages must be used to obtain good indications on the meter, or conversely, if low battery voltages are used a very sensitive meter is required. For a number of reasons, including the fact that satisfactory meters may not be found in the laboratories of many experimenters, it is suggested that the bridge be designed for a.c. Even greater accuracy of adjusting can be obtained using a.c. there is no danger of burning out any meters and also, as will be made clear later, a.c. must be used in measuring capacity and inductance.

To operate the simple bridge circuit from a.c. only minor changes are necessary. The revised circuit is given in Fig. 3. The oscillator consists of a single tube which may be a -99 operated from dry cells. Details on the construction of such an audio oscillator may be found in last month's Home Experiment Sheet. In place of the d.c. indicating milliammeter, an audio transformer is used in conjunction with a single- or two-stage audio amplifier. In many cases it will be found possible to dispense with the audio amplifier and simply connect earphones directly

across the bridge circuit. Since a good pair of earphones are sensitive to microamperes of current, it is obvious that much closer balances can be obtained than by the use of a d.c. milliammeter.

The same method of obtaining a balance is used with the a.c. bridge circuit, the slider being moved one way or the other to a point where no sound is heard in the earphones and the unknown resistance is then calculated from the preceding equation (6). If, for example, R1 has a value of 10,000 ohms and the distance from A to the slider is ten inches and the distance from B to the slider is fourteen inches, then the value of the unknown resistance Rx is

$$R_x = 10,000 \times \frac{10}{14} = 7,140 \text{ ohms}$$

The same a.c. bridge circuit shown in Fig. 3 can be used with a small change for the measurement of capacity. To measure the capacity of the condenser, the condenser whose value is to be determined is connected across terminals 3 and 4 and a standard condenser is connected across terminals 1 and 2. A balance is obtained in the same manner as

when measuring resistors. The formula to determine the value of the unknown capacity is somewhat different, however, and becomes

$$\text{Value of unknown capacity} = \frac{\text{capacity of standard} \times \text{distance in inches from B to slider}}{\text{distance in inches from A to slider}}$$

It will be noted that the two distances in the above equation (7) are reversed from the arrangement in equation 6 for determining resistance. This is due to the fact that the larger the capacity of the condenser the lower its impedance. In using this simple capacity bridge a number of fixed known capacities should be available for connection between points 1 and 2. The following values are suggested:

For measuring capacities between	Use a standard capacity of
10-.1 mfd.	1 mfd.
2.5-.025 mfd.	.25 mfd.
1-.001 mfd.	.01 mfd.
.005-.00005 mfd.	.0005 mfd.

Although the figures in the above table would indicate that the bridge could be used to measure very small capacities, its accuracy under such conditions is quite poor due to stray capacity effects. The small capacities have a very high impedance to the audio-frequency currents obtained from the oscillator and for this reason any slight inequalities in the circuit are magnified and it will be

found difficult to obtain an accurate balance.

The measurement of inductance is similar in many respects to the measurement of resistance. The general circuit of Fig. 3 is again applicable with the addition of one variable resistor and with the difference that for R1 must be used a standard inductance, i.e., a coil whose inductance is known. This standard inductance is connected across terminals 1 and 2 and the coil whose inductance is to be determined across terminals 3 and 4. At balance the inductance of the coil under (Continued on page 842)

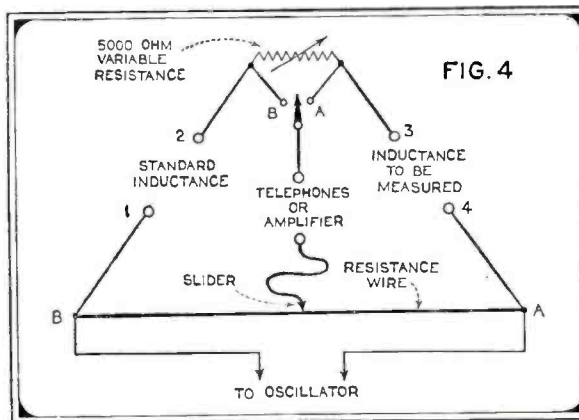
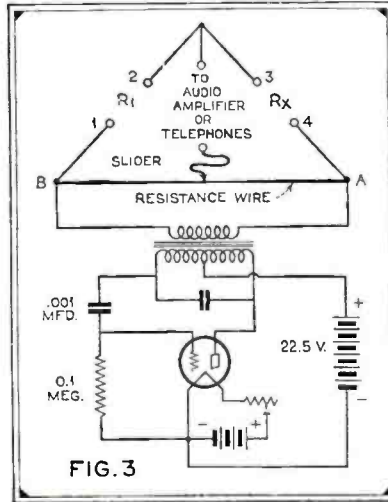

NEWS from the MANUFACTURERS

Transformers

The Kenyon Transformer Corporation, 122 Cypress Avenue, New York, announces a line of step-down auto transformers, 220 to 110 volts, for use with radio receivers, amplifiers, and similar equipment. These transformers are particularly suited to adapt standard 110-volt equipment to the existing 220-volt lines frequently found here and in the export field. The transformers are furnished in 50-, 100- and 150-watt capaci-



ties for use on 50- to 60-cycle lines. Kenyon transformers of this type are designed to carry more than 50 per cent. overload before reaching the A. I. E. E. standard for transformer temperature rise. A six-foot cord and plug for connection to line and a 110-volt outlet to take set plug make a very convenient arrangement for installation. A 100 per cent. over potential test and an insulation test at ten times the normal working voltage assure reliable performance.



"Little General" Receiver



A new small six-tube a.c. screen-grid set in three styles of finish, to be known as the "Little General," has been announced by General Motors Radio Company at Dayton, Ohio.

Only 19 inches high, 16 inches wide and 10½ inches deep, the "Little General" is finished in three optional colors, genuine butt walnut, or lacquered in green or buff. The receiver is equipped with tone selector using the continuously variable type which permits smooth shifting from bass or treble without interruption. The speaker is of the electro-dynamic type. Four type -24 screen-grid tubes are employed, three being used in the radio-frequency stages and one as a power detector. One type -45 tube is used in the power output stage, while the rectifier is of the -80 type. The new set uses four tuned circuits; dual volume control,



Photoelectric Relay

The G-M Laboratories, Inc., Grace and Ravenswood Avenues, Chicago, Ill., have recently completed the development of a compact photoelectric relay and light

source for application to many industrial and commercial operations. This device is essentially an electric switch controlled by means of a beam of light. Any interruption of the beam of light operates the switch.

In operation, the light from the upper lens is reflected from the remotely placed mirror to the lower lens, where it is received by the photoelectric cell. Any



interruption of this beam of light by a piece part, metal stamping, finished product or other object causes the relay contacts to close, thereby operating a counter, power switch, signal or other device. The advantage of this arrangement is the frictionless interruption of the light beam by the object to be counted or controlled.

The Visitron photoelectric cell, single-stage amplifier, light source and other essential parts are enclosed in a steel case, simplifying installation of the unit.



Amplifiers

Sound Systems, Inc., of New York, announces a complete line of "direct-coupled" amplifiers, manufactured under the Loftin-White patents, for phonograph, radio, recording and public address systems.

The unit shown is model 21, two stages using -24 and -45 with -80 rectifier, designed especially for phonograph work. It is compact and has a gain of about 450,



with practically a flat amplification curve from 40 to 9,000 cycles, and down only 2 db. at 10,000 cycles, and is suitable for the home, record demonstrators, etc.

Model 201M, designed especially for public address work, contains microphone transformer and current supply. Model 201D has a screen-grid detector and two stages of amplification and will work on any r.f. tuner.

Two-Volt Audions

Three standard two-volt audions, including an all-purpose type, a screen-grid type and a power tube, are announced by the De Forest Radio Company of Passaic, N. J.

The De Forest 430 audion is an all-purpose tube with the following characteristics: filament voltage, 2 volts; filament current, 60 milliamperes; maximum plate voltage, 90 volts; grid voltage, -4.5; plate current, 2 milliamperes; amplification factor, 8.8; plate resistance, 12,500 ohms; mutual conductance, 700 micromhos.

The De Forest 432 audion is a screen-grid amplifier, with the following characteristics: Filament voltage, 2 volts;



filament current, 60 milliamperes; maximum plate voltage, 135 volts; plate current, 1.5 milliamperes; control grid, 3 volts; screen grid, 67½ volts; amplification factor, 440; plate resistance, 800,000 ohms; mutual conductance, 550 micromhos.

The De Forest 431 audion is a power tube, with the following characteristics: Filament voltage, 2 volts; filament current, 130 milliamperes; maximum plate voltage, 135 volts; grid voltage, 22.5 volts; plate current, 8 milliamperes; amplification factor, 3.5; plate resistance, 4,000 ohms; mutual conductance, 875 micromhos; undistorted power output, 170 milliwatts.

Philco Expands Factory

Confident that 1931 is going to show an improvement over 1930 for the sale of home radios and that in addition a great and virtually new market will be opened through the perfection of the automobile radio, the Philadelphia Storage Battery Company, makers of Philco radios and Philco-Transitone automobile radios, is expanding its factory and laboratory fa-

cilities through the erection of a new five-story building adjacent to its present plant in Philadelphia. The company has also acquired the Holmes Mills a few blocks distant from Philco headquarters at C and Ontario Streets.

So far as Philco itself is concerned, the year 1930 was a banner one, with sales going 100 per cent. ahead of the preceding year.

Voltage Compensator

Sola Corporation, 2525 Clybourn Avenue, Chicago, Ill., is bringing out a new volume compensator designed to reduce high incoming voltages and increase low incoming voltages automatically and instantaneously. The voltage compensator, placed between the line and radio receiver,



filters out much of this outside interference and compensates for annoying line voltage drop caused by motorized equipment. The compensator is also applicable, of course, to other equipment requiring regulated voltage such as photoelectric cell equipment, film printing lamps, synchronous sound equipment, relay applications and signalling devices, etc.

New Structure in Tube Design

A new construction principle known as the "Unitary Structure" has been applied to the design of Arcturus Tubes by the Research Department of the Arcturus Radio Tube Company, Newark, N. J.

It is certain that the major characteristics of a vacuum tube are entirely controlled by the dimensions and relative positions of the tubes' electrodes, even though uniformly efficient emitters are employed and tubes are properly processed. A slight change in the elements even as small as one-thousandth (0.001) of an inch will alter the characteristics and appreciably affect the sensitivity, fidelity and power output of radio receiving sets. Obviously, therefore, the structural design in vacuum tubes is extremely important.

"The 'unitary structure' principle employed in Arcturus tubes," says W. L. Krahl, chief engineer, "as its name implies, constitutes assembling the electrodes of a vacuum tube as a rigid unit in which the electrodes are interdependent and cannot move with relation to one another. All electrodes in such a tube are supported at both ends by yokes in planes perpendicular to the axis of the electrodes.

"In an assembly of this kind, each part fits into this unit in exactly its proper location and cannot be inserted in any position other than the correct one. No adjustment is required and the 'human element' is thereby eliminated. The unit, thus assembled, slips over the stem wires and is spot-welded to them."

Philco Announces New Line of Receivers

A complete line of superheterodyne receivers, available in three furniture styles, has been announced by Philco for 1931.

Former models in the line will be retained, so that the company now offers a complete array of receivers ranging from the seven-tube screen-grid Baby Grand to the new eleven-tube Superheterodyne Plus Radio-Phonograph with automatic record changer.

The Superheterodyne-Plus receiver, illustrated here, utilizes eleven tubes—four type -24 screen-grid tubes, four type -27, two type -45 power amplifier tubes, and one type -80 rectifier tube. A double-tuned input circuit prevents crosstalk and permits the use of any length antenna without affecting selectivity.

The set is non-oscillating and will not regenerate electrical disturbances impairing near-by radio reception, thereby eliminating one of the major problems attached to the use of receivers of this type heretofore. It is thoroughly shielded, and obtains the maximum results from the superheterodyne circuits.

A range switch at the back of the



cabinet permits changing from normal sensitivity to supersensitivity for use in zones of extra low broadcast signal strength. Philco engineers declare that the set is so powerful that it will operate successfully in "dead spots" in which reception has heretofore been unsatisfactory.

Selectivity is keen throughout the entire broadcast frequency spectrum, and there is uniform gain throughout. The set is equipped with tone control which permits adjustment of the tone of the broadcast to whatever degree most pleases the listener; the Philco station recording dial, which is translucent and indirectly illuminated, and on which the call letters of stations may be inscribed, and once logged may always be tuned with perfect accuracy, and automatic volume control, which holds both near and distant programs at a constant level without fading, and also prevents blasting from strong near-by locals.

The Superheterodyne-Plus will be available in three furniture styles—a lowboy, a highboy with doors, and a combination radio-phonograph with record changer.

Modulating Transformer and Hand Microphone

The Kellogg Switchboard and Supply Company, 1066 West Adams Street, Chicago, Ill., announces a new hand microphone and a modulating transformer.

The No. 29 microphone is only 6½ inches in length, small enough to be hidden in the hand, and weighs about 10 ounces. It can easily be carried in the



pocket. The handle is cast aluminum with a case of formed brass. The back and stretching rings are accurately machined of alloy steel. The diaphragm is made of phosphor bronze. The microphone is supplied with a 60-inch durable moisture-proof tinsel cord, strengthened and protected by a dark brown mercerized cotton braid.

The company is also developing a modulating transformer to be used with the No. 29 microphone. The microphone is connected to the primary side, which then feeds into the grid circuit of the amplifier through the secondary winding. It is arranged so that it can be used with a single or double-button microphone.

The heavily enameled copper wire is wound over a core of silicon steel. There is a shield between the primary and secondary test, or can be grounded if necessary.

Short Tester and Preheater

Supreme Instruments Corp., of Greenwood, Miss., has developed a device known as the Supreme short tester and preheater for use in the testing of radio tubes. As the name indicates, the device not only serves the purpose of preheating

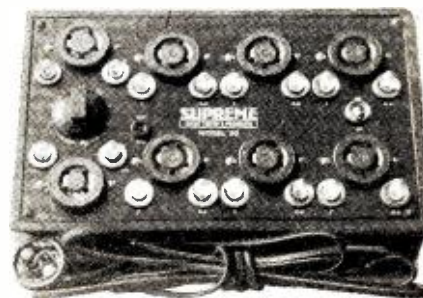

heater type tubes in advance of more thorough testing but also detects open filaments and shorts between the various elements of the tube. There are eight tube sockets located on the panel of the device, seven of these sockets being for five-prong tubes of the heater type and the remaining for various types of four-prong tubes.

RADIO NEWS INFORMATION SHEETS

Measuring Large Capacities (Part 1)

THE experimenter or serviceman lacking a capacity bridge has a need for a simple means of measuring large capacities such as filter condensers.

The method given here, while not without error, is sufficiently accurate for most purposes. The accuracy of the measured values is dependent on the accuracy of the instruments, and the accuracy by which the readings are taken.

The test apparatus required are an a.c. milliammeter, an a.c. voltmeter (the scale of which is determined by the voltage source) and an a.c. supply of known frequency.

Connecting the condenser to be measured in the position shown in the diagram, C, the reading of the a.c. milliammeter is taken, and then the reading of the voltmeter. Knowing the frequency of the source, a simple calculation will give the capacity within 5 per cent., if one is careful.

The formula:

$$C = \frac{1,000 \times I}{6.28 \times f \times E}$$

where C is capacity in microfarads, f is frequency of a.c. source, I is current in milliamperes, and E is voltage.

Having a large condenser of unknown capacity on hand and wishing to know its capacity, we connect the condenser in a circuit with the meters as shown in the dia-

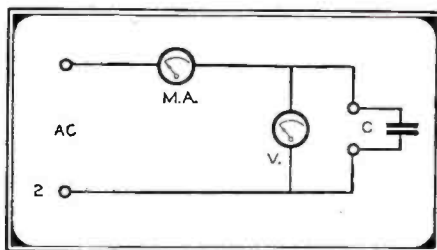

gram. Apply 60 cycles a.c. across 1 and 2, a reading is taken from the meters. The milliamperes are found to be 150 and the voltage 110.

$$\text{Thus: } C = \frac{1,000 \times 150}{6.28 \times 60 \times 110} = \frac{150,000}{41,888} = 3.57 \text{ microfarads.}$$

In measuring condensers of large capacity of the low-voltage electrolytic type, such as the condensers used in "A" eliminators, the voltage of the a.c. source must not exceed a value of three volts. Should the voltage exceed this value it is apt to damage the condenser. For the purpose it is best to use a low-voltage transformer with a rheostat inserted in the primary winding circuit. This rheostat should have a value of from 0 to 1,500 or 2,000 ohms. The measuring instruments are an a.c. voltmeter of low-scale reading, and the a.c. ammeter should have a maximum scale range of 10 amperes.

The formula to be used is:

$$C = \frac{I \text{ (amperes)} \times 1,000,000}{6.28 \times f \times E}$$

where the terms remain the same as the formula above with the exception of I, which is in amperes.

RADIO NEWS INFORMATION SHEETS

Measuring Large Capacities (Part 2)

THE method of measuring large capacities as given in Part 1 may prove difficult for most experimenters or servicemen, as usually an a.c. milliammeter of suitable range is not found among their testing instruments. Most will possess a suitable a.c. voltmeter with which the measurements may be made, with the same degree of accuracy though with more involved calculation.

The only apparatus required in addition to the current source and the a.c. voltmeter (which should be of the 1,000-ohm-per-volt variety where possible) is a single-pole, double-throw switch.

To make the measurements, suppose that the full voltage across the current source is 100, and in series with the condensers, is 70 volts.

Using the formula:

$$E_s^2 = rE^2 + xE^2$$

where: E_s is voltage of current source, rE^2 is voltage through condenser, xE^2 is the unknown capacitive reactive voltage

then: $100^2 = 70^2 + xE^2$ or

$$xE^2 = 100^2 - 70^2 = 10,000 - 4,900 = 5,100$$

therefore: $xE = 5,100 = 71.25$.

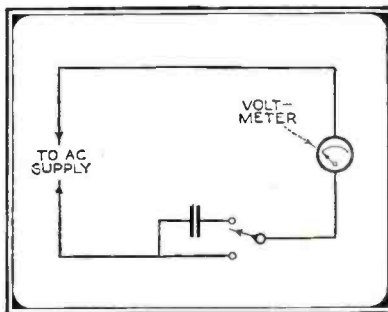

The unknown capacity formula is:

$$C = \frac{I}{6.28 \times f \times xE}$$

where: I is current flowing in condenser, found by dividing voltmeter reading by its internal resistance. With a 1,000-ohm-per-volt, 250-volt scale meter, 70 volts divided by 250,000 ohms would give .00028 milliamperes. f is frequency, xE capacity resistance, and C is capacity in farads.

Solving:

$$C = \frac{.00028}{6.28 \times 60 \times 71.25} = \frac{.00028}{27132} = .0000001031 \text{ farads}$$

To convert farads to microfarads, multiply the value of farads by 1,000,000, thus: $1,000,000 \times .0000001031 = .1031$ microfarads.

The power consumed by a condenser in an a.c. circuit is:

$$W = \frac{6.28 \times f \times C \times E^2 \times P}{1,000,000}$$

where W is expressed in watts, f is frequency in cycles per second, C is capacity in microfarads, E is the voltage squared, and P is the power factor which ordinarily does not exceed a value of .01 for paper condensers.

RADIO NEWS INFORMATION SHEETS

Resistors as Frequency Blocks or Attenuators

UPON consideration of the faults of radio-frequency chokes when used in radio receivers for circuit isolation or as frequency blocks, engineers have endeavored to design more efficient chokes with greater or lesser success. In many receiver designs the r.f. choke has been eliminated entirely, with circuit isolation obtained by the use of resistors with perhaps larger bypass condensers, than would be used with r.f. chokes.

The use of resistors has the disadvantage of requiring high voltages in order to overcome the voltage drop of the resistor. In order to apply 180 volts to the plate of a -24 and to obtain satisfactory circuit isolation it is necessary to use at least a 30,000-ohm resistor, the voltage drop at 4 m.a. would be 120 volts, requiring a total applied voltage of 300. Considering modern-day power units, this voltage is not in excess, and as a matter of fact, is the maximum output of the present-day power supply employing the -80 full-wave rectifier for the -45 plate and bias voltages. With receivers designed for operation with the -50 tubes, requiring a total voltage of 530 volts, the value of the blocking resistors can be considerably increased.

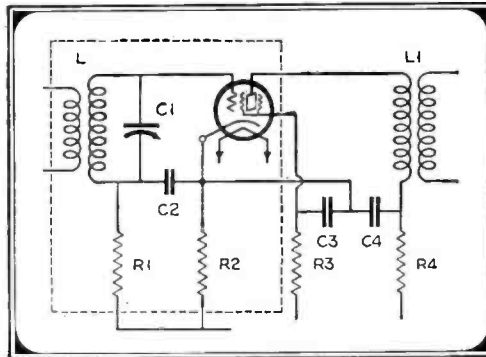

In selecting the resistor to be used, the total voltage of the source must be known and the amount of current that is to flow through the resistor. For -24 tubes operated at 180 volts on the plate the current would be 4 m.a., the screen-grid current would be 1/2 m.a. For the -27 tube the plate current is 6 m.a. when operated at 180 volts. These values can be had by consulting any tube characteristic sheet or chart.

It is recommended that adjustable wire-wound resistors be employed, or else obtain the resistors from the manufacturer, specifying a tolerance of variation not to exceed 2 per cent. It is also necessary that the resistor be measured while hot, as otherwise the resistance would change. A very satisfactory resistor is the Electrad truvolt type B and C, which is small in size and can be mounted in a very small place. These resistors have a metallic core which in some instances would be of a disadvantage. However, they may be obtained with a gut core directly from the manufacturer.

The fused graphite porcelain resistors (this is the super-tonatrol type) made by the same concern are admirable for this purpose although requiring more space.

RADIO NEWS INFORMATION SHEETS

Loose-Leaf Manual and Re-enforcement

THE editors of the RADIO NEWS Information Sheets have had a great many requests for the sheets in book form. Others have asked for a printed index, while others have asked for information concerning the mounting and filing of the sheets in a loose-leaf binder.

Pending the publication of a sufficient number of the Information Sheets, at which time they will be compiled in book form, it is recommended that the reader cut these sheets from the magazine and suitably mount them for insertion in a loose-leaf binder.

A suggested means of doing this is to re-enforce the printed sheet with heavy tough paper, thin cardboard or cloth. The latter is preferred. The procedure, after removing and trimming of the sheet, is to re-enforce the sheet by cementing to the re-enforcing medium with any non-buckling adhesive such as rubber or celluloid cement.

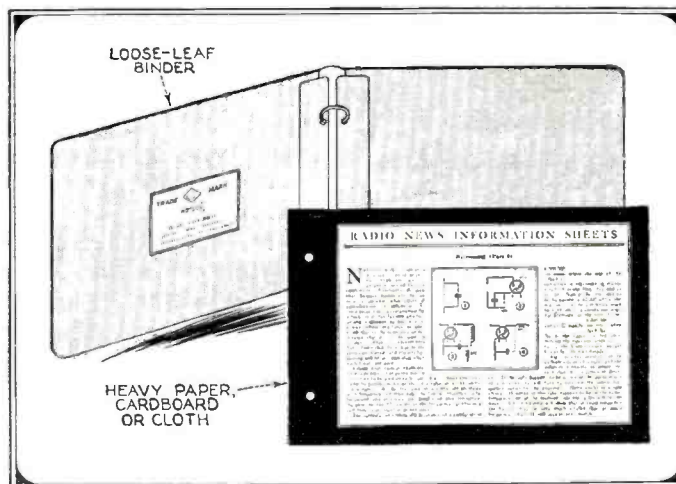

The latter, such as DuPont's Household cement, may be had from any hardware or stationery store.

The Information Sheet is placed face downward, covered with a thin film of cement, after which the re-enforcing back is placed over the sheet. The wrinkles and buckling are ironed out with the heel of the hand or by other suitable means. The sheet with its re-enforced backing is then placed between two flat boards under a weight until thoroughly

dry. If desired, the Information Sheets may be placed on both sides of the re-enforcing back. If desired, two sheets may be placed on each page, or four if placed on front and back.

The next issue will carry an index of the Information Sheets published, arranged in such manner that the reader may fill in the page as may better suit his particular requirements.



The Junior Radio Guild



LESSON NUMBER SEVENTEEN

Using Mathematics in Radio

Algebra and Its Application to Radio Engineering

PART FOUR

THE multiplication of algebraic expressions is encountered in practically every mathematical analyses of radio circuits and apparatus design and it is important that a fundamental knowledge of this phase of algebra be well understood.

If the letter *a* is multiplied as follows:

- (1) $a \times a$
- (2) $a \times a \times a$
- (3) $a \times a \times a \times a$

We know that (1), (2) and (3) can be expressed respectively as a^2 , a^3 , a^4 . The numbers above the letters are called the index of the letters.

If a^2 is multiplied by a^3 , we have: $a \times a \times a \times a \times a \times a \times a = a^7 = a^{2+3}$.

(a) We see that in the product of two letters the index is the sum of the respective indexes of the letters. This is a very important rule and much use is made of it throughout various mathematical discussions.

Examples:

Find the value of

1. $5x^2 \times 7 \times 5$.

To indicate the method:

$$= 5 \times 7 \times x^2 \times x^2 = 35 \times x^{2+2} = 35 \times x^4 = 35x^4 \text{ Ans.}$$

2. $4a^3 \times 5a^8$.

$$= 20a^{11} \text{ Ans.}$$

3. $7ab \times 8a^3b^2$.

To indicate the method:

$$= 7 \times 8 \times a \times a^3 \times b \times b^2 = 56 \times a^{1+3} \times b^{1+2} = 56a^4b^3 \text{ Ans.}$$

4. $6 \times y^2 \times 5 x^3$.

5. $8a^3b \times b^5$.

6. $2abc \times 3ac^3$.

7. $2a^3b^3 \times 2a^2b^3$.

8. $5a^4b^3 \times x^2y^2$.

9. $x^3y^3 \times 6a^2x^4$.

10. $3a^2b^2x^2 \times 5a^3bx$.

11. $3a^2x^2y^2 \times a^2x^2y^2$.

12. $(5x + 3y) \times 2x^2$.

To indicate the method:

$$= 2x^2(5x + 3y) = 10x^3 + 6x^2y \text{ Ans.}$$

13. $(5a^2 + 3b^2 - 2c^2) \times 4a^2bc^3$.

14. $(5x^2y + xy^2 - 7x^2y^2) \times 3x^3$.

If the number $3a$ is multiplied by the number $-4a^2$, we have

$$3a \times (-4a^2) = -12a^3$$

We have here the rule of signs, which can be expressed as:

(b) The product of two terms with like signs is positive, but the product of two terms with unlike signs is negative.

Examples:

Multiply together—

1. ax and $-3ax$.

To indicate the method:

$$= 1x(-3) \times a \times ax = -3 \times a^2 \times x^2 = -3a^2x^2 \text{ Ans.}$$

*T*O beginners in radio the importance of the fact that the common ordinary garden variety of mathematics (the kind of mathematics which to some seemed so pointless when taught in the elementary and lower classes of high school) is quite necessary to the later assimilation of a knowledge of geometry, trigonometry and calculus cannot be stressed too much. For the truth of this it is only necessary to question those in the radio game who have been unfortunate enough to have slipped up on this part of their education and now wish that they had the opportunity to go back to school again.

RADIO NEWS is glad to present to its readers this third of a series of articles prepared by Mr. J. E. Smith (President, National Radio Institute) on the use of mathematics in radio. The first of the series appeared in the December, 1930, issue of RADIO NEWS; the second in the January, 1931, issue; the third in the February, 1931, issue. Others will follow.

THE EDITORS.

- 2. $-2abx$ and $-7abx$.
 $= 14a^2b^2x^2$. Ans.
- 3. a^2b^2 and $-ab^2$.
- 4. $6x^2y$ and $-10xy$.
- 5. xyz and $-5x^2y^3z$.
- 6. $ab - bc$ and a^2bc^3 .
- 7. $-2a^2b - 4ab^2$ and $-7a^2b^2$.
- 8. $-7x^2y - 5xy^3$ and $-8x^2y^3$.
- 9. $4x^2y^2z^2 - 8xyz$ and $-12x^3yz^3$.
- 10. $-a^2bc + b^2ca - c^2ab$ and $-ab$.

If the two compound numerical expressions $(2 + 3)$ and $(5 + 8)$ were multiplied together, one way of performing this operation would be as follows:

$$(2 + 6) \times 5 = 10 + 30 = 40$$

$$(2 + 6) \times 8 = 16 + 48 = 64$$

and adding the result = 104. Ans.

A check on this is seen as follows:

$$(2 + 6) \times (5 + 8) = 8 \times 13 = 104 \text{ (Checked).}$$

(c) In like manner, in order to multiply two compound algebraic expressions, multiply each term of the first expression by each term of the second. The algebraic sum of the products thus obtained gives the complete product.

Examples:

Find the product of—

1. $x + 5$ and $x + 10$.

To indicate the method—applying rule (c):

$$\begin{array}{r} x + 5 \\ x + 10 \\ \hline \end{array}$$

$$\begin{array}{r} x^2 + 5x \\ + 10x + 15 \\ \hline \end{array}$$

$$x^2 + 15x + 15 \text{ Ans.}$$

2. $x + 5$ and $x - 5$.

3. $x - 7$ and $x - 10$.

To indicate the method:

$$\begin{array}{r} x - 7 \\ x - 10 \\ \hline \end{array}$$

$$\begin{array}{r} x^2 - 7x \\ - 10x + 70 \\ \hline \end{array}$$

$$x^2 - 17x + 70 \text{ Ans.}$$

4. $x + 7$ and $x + 10$.

5. $x + 8$ and $x - 4$.

6. $x + 12$ and $x - 1$.

7. $x - 15$ and $-x + 3$.

8. $-x + 7$ and $x - 7$.

9. $x - 13$ and $x + 14$.

10. $x + 19$ and $x - 20$.

11. $2x - 3$ and $x + 8$.

12. $x - 5$ and $2x - 1$.

13. $3x + 5$ and $2x - 7$.

14. $3x - 5y$ and $3x - 5y$.

15. $a - 9b$ and $a + 5b$.

Multiply together—

16. $x^2 + 3y^2$ and $x + 4y$.

17. $x^2 - x^2y^2 + y^2$ and $x^2 + y^2$.

18. $a^2 - 2ax + 4x^2$ and $a^2 + 2ax + 4x^2$.

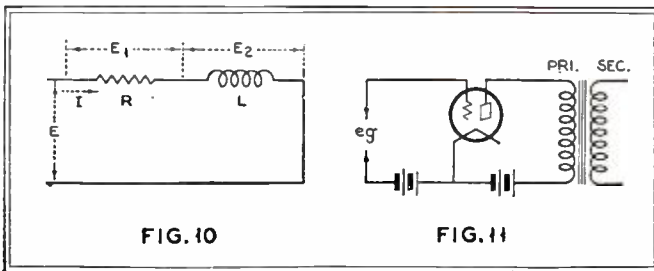

FIG. 10

FIG. 11

To indicate the method:

$$\begin{array}{r} a^2 - 2ax + 4x^2 \\ a^2 + 2ax + 4x^2 \\ \hline a^1 - 2a^1x + 4a^1x^2 \\ + 2a^1x - 4a^1x^2 + 8ax^2 \\ + 4a^1x^2 - 8ax^2 + 16x^1 \\ \hline a^1 + 4a^1x^2 + 16x^1 \end{array}$$

Ans.

19. $x^2 - 2xy + y^2$ and $x^2 + 2xy + y^2$.

20. $27x^3 - 36ax^2 + 48a^2x - 64a^3$ and $3x + 4a$.

An application:

Multiply $10a + 5$ by $10a + 5$

$$\begin{array}{r} 10a + 5 \\ 10a + 5 \\ \hline 100a^2 + 50a \\ + 50a + 25 \\ \hline 100a^2 + 100a + 25 \end{array}$$

(I) $100a^2 + 100a + 25$

Now, from (I) above, we have a method of applying the algebra to simplify certain arithmetical operations.

To Square Numbers Ending in 5

(A) Let us square the number 45; this number is equal to $10a + 5$ where $a = 4$.

(I) Above is $100a^2 + 100a + 25$, which can be put in the form:

(II) $100a(a + 1) + 25$.

Substituting for $a = 4$ we have $100 \times 4 \times 5 + 25 = 2025$, which is the square of 45.

(B) Square the number 35.

Applying II, where $a = 3$ we have $100 \times 3 \times 4 = 1200$
adding $25 = 1225$ Ans.

(C) Square the number 75:

we have $100 \times 7 \times 8 = 5600$
adding $25 = 5625$ Ans.

(D) Square the number 95:

$100 \times 9 \times 10 = 9000$
adding $25 = 9025$ Ans.

The Division of Algebraic Expressions

Division is the inverse operation of multiplication, and the division of algebraic expressions is as important as the multiplication and is used extensively in all mathematical discussions.

If $2 \times 2 \times 2 = a \times a \times a$ and we divide this by $2 \times 2 = a \times a$, we have

$$\frac{2 \times 2 \times 2}{2 \times 2} = \frac{a \times a \times a}{a \times a}$$

The numerical part of this expression is $\frac{8}{4}$, which we know is 2, and can be obtained by cancellation, as follows:

$$\frac{2 \times 2 \times 2}{2 \times 2} = 2 \text{ Likewise, } \frac{a \times a \times a}{a \times a} = a = \frac{a^3}{a^2}$$

We see that in the quotient:

(a) The index of any letter in the quotient is the difference of the respective indexes of the letters. This a very important rule, and much use is made of it when dividing numerous complicated expressions.

If the expression $35a^2$ is divided by the expression $-7a$, we have

$$\frac{35a^2}{-7a} = -5a$$

We have, here the rule of signs for dividing, which can be stated:

(b) Like signs give plus (+) for the quotient and unlike signs give minus (-).

Examples:

Divide—

1. $3x^2$ by x^2 . To indicate the method:

$$\frac{3x^2}{x^2} = 3x^{2-2} = 3x \text{ Ans.}$$

2. 27×4 by $-9x^3$.

To indicate the method:

$$\frac{27x^4}{-9x^3} = -3x^{4-3} = -3x \text{ Ans.}$$

3. x^2y by x^2y .

4. $12a^3b^2c^4$ by $-3a^2b^2c$.

5. $15x^2y^3z^4$ by $5x^2y^2z^2$.

6. $-48a^9$ by $-8a^3$.

7. $28a^3b^3$ by $-4a^2b$.

8. $x^5 - 7x^3 + 4x^2$ by x^2 .

To indicate the method:

$$\frac{x^5 - 7x^3 + 4x^2}{x^2} = x^3 - 7x + 4x^2$$

Now, dividing the denominator into each factor of the numerator, we have:

$$\frac{x^5}{x^2} - \frac{7x^3}{x^2} + \frac{4x^2}{x^2} = x^3 - 7x + 4x^2 \text{ Ans.}$$

This method can be checked as follows:

If we have the numerical expression—

$$\frac{9 + 6 + 12}{3} = \frac{9}{3} + \frac{6}{3} + \frac{12}{3} = 3 + 2 + 4 = 9$$

and $\frac{27}{9 + 6 + 12} = \frac{27}{27} = 9$ Ans. and check

9. $15x^3 - 25x^4$ by $-5x^2$.

10. $34x^2y^2 - 51x^2y^3$ by $17xy$.

11. $3x^2 - 9x^2y - 12xy^2$ by $-3x$.

The Division of Compound Expressions

Dividing two compound algebraic expressions is a little more complicated than the previous algebra but the operations can be appreciated by applying a set rule.

Let us divide $x^2 + 3x + 2$ by $x + 1$.

Let us assume that $x + 1$ will go into

$x^2 + 3x + 2$ just $x + 2$ times. This can be compared to dividing $\frac{28}{7}$ where 7 will go into 28 just 4 times. If the above

assumption is correct and remembering that division is only the inverse operation of multiplication, if we multiply $x + 1$ by $x + 2$, we should obtain the numerator $x^2 + 3x + 2$. Thus:

$$\begin{array}{r} x + 1 \\ x + 2 \\ \hline x^2 + x \\ 2x + 2 \\ \hline x^2 + 3x + 2 \end{array}$$

$x^2 + 3x + 2$ Check

Examples:

Divide—

1. $x^2 + 3x + 2$ by $x + 1$.

To indicate the method:

$$\frac{x^2 + 3x + 2}{x + 1}$$

(a) Divide x^2 , the first term of the dividend, by x , the first term of the divisor.

$$x + 1 \quad x^2 + 3x + 2(x$$

(b) Multiply the whole divisor ($x + 1$) by x , and put the product ($x^2 + x$) under the dividend:

$$\begin{array}{r} x + 1 \quad x^2 + 3x + 2 \\ x^2 + x \\ \hline \end{array}$$

(c) Subtract and bring down from the dividend the next number: (Continued on page 847)

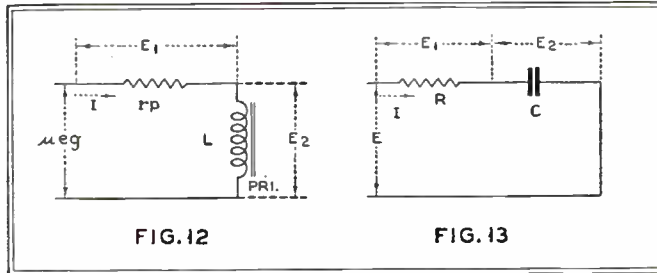

FIG. 12

FIG. 13

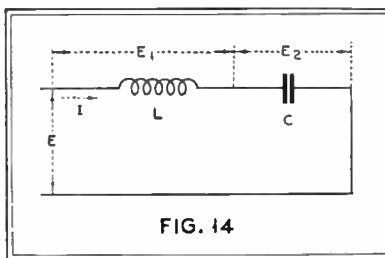

FIG. 14

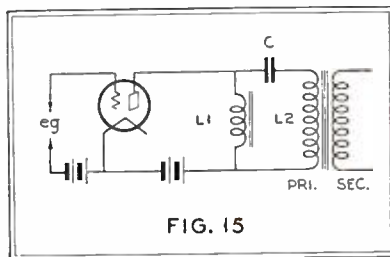

FIG. 15

Is American Broadcasting Economically Sound?

By Arthur H. Lynch

(Continued from page 779)

Post Office and the British Broadcasting Corporation; the largest proportion going to the last. The sum received by the British Broadcasting Corporation is used for the financing of the broadcasting stations, the executive organization necessary for their maintenance and the payment of regular broadcasting talent. The entire broadcasting situation in that country is controlled by a "board of governors"—a carefully chosen and comfortable collection of "public-spirited" people (incidentally quite well paid) who virtually leave nearly everything in the way of policy to the administrative chief, Sir John Reith, a man of dominating personality and intense views on certain subjects which some consider almost fanatical.

No advertising is permitted on a British Broadcasting Corporation program and as the particular gentleman in control is generally considered to be keenly interested in church movements of one kind or another, he is opposed to certain types of broadcasting on Sundays. As a matter of fact a typical Sunday broadcasting schedule is very illuminating to us in America, who, at almost any hour of that particular day would have our selection of practically any kind of broadcast entertainment, even up to a very late hour on Sunday night or, if we must be technical, Monday morning. Here we have a summary of what the English listener-in may expect from the English stations on this holy day.

No programs until 3 p.m. except on very special occasions.

3 to 4 p.m.—Bach Church Cantata (no alternative).

4 to 4.15—Service or "talk for the children."

4.15 to 5.30—Classical Music or Chamber Music Concert.

5.30 to 6—Bible Reading (no alternative).

6 to 8—Dead silence.

8 to 8.45—Church Service (no alternative).

8.45—Good Cause Appeal (no alternative).

8.50—News Bulletins (no alternative).

9 to 10.30—Light Classical Music (alternative).

10.30—Epilogue (short religious service).

10.50—Close-down.

Dance Music is Absolutely Prohibited on Sundays.

Just outside London there is a twin 50 kw. transmitter designed to give London two alternative programs of equal strength and contrasted in program matter. On Sundays, except for concerts in the afternoon and evening, the two programs will be identical or only alternative as regards the religious services.

As a consequence, during the silent period of 6 to 8 p.m. several European stations put on programs paid for by English firms, the programs being announced in English in addition to the local language.

The statement that no advertising is permitted "must be taken with a grain of salt, in very much the same way that it is generally supposed that the political party in power will not use local broadcasting stations to further its own political ends. To imagine for a minute that there is no advertising on English air programs is pure hallucination. Two examples will suffice to illustrate this point.

H. M. V. which is the English abbreviation for "His Master's Voice," an organization somewhat similar to the old Victor Phonograph Company in the United States, and the other leading record companies, supply the British Broadcasting Corporation with phonograph records which are incorporated as part of the broadcast programs; full announcements of the names, makers of the record and the actual catalogue number and label, often follow the reproduction itself. Of course this is not considered advertising because the various companies do not pay for it. But we know just how long that sort of thing went on in this country before the broadcasting stations began to demand a consideration from the record manufacturers.

A certain newspaper in England has several feature writers on its staff who appear before the microphone periodically and discuss in a very familiar fashion the same things that are discussed in their sections of the newspaper. Their identity is not concealed and the fact that they are associated in such and such capacities with such and such a newspaper is made equally clear. In the English sense this is not advertising but to do the same thing in this country it costs some of our national magazines and some of our newspapers a very tidy fortune. Single acts from plays are also broadcast with full acknowledgment.

So much for the broadcasting itself and in this connection it seems to us that a system of this kind controlled by a comparatively small group of individuals who may or may not have a particularly accurate viewpoint of the manner on which this important subject of public relations should be based, could be brought to a point, if it has not already been, where extremely unfair business practices might

result because of the friendliness of the control board with certain broadcasters and its possible unfriendliness to others. In other words, we see in this system the possibility for flagrant partisan abuses which we feel are materially minimized by the American system even though there may be some objection to some details in the latter.

The situation is ably summed up by General Charles Saltzman, chairman of the American Federal Radio Commission, as follows: "In England broadcasting is controlled by one corporation. I have listened to British broadcasting. I think that the corporation gives the public what the corporation thinks the public ought to hear."

An interesting sidelight on the English situation may be drawn from the fact that certain progressive business houses in England have realized that some of the programs coming from France and other parts of the world are securing an increasing English audience. In certain instances some of these programs are considered to be better than the programs sent out from the English stations. This is particularly true during hours when people would normally like to have some radio entertainment provided by their local stations but find it is not forthcoming. Realizing the importance of this situation some English merchants have contracted for advertising time on the air with foreign stations whose programs reach England in a satisfactory fashion. As a matter of fact, a great many English listeners satisfy themselves with programs from the United States which they are able to receive on short waves. We do not believe it impossible or improbable that some adroit English advertiser, like Sir Thomas Lipton, would find it impractical to purchase time on the air with one of the American short-wave stations for the advertising value such a program would have in England. In direct contrast to this situation, it is doubtful that our own system for financing our broadcasting is so completely bad as some misinformed extremists are wont to have us believe.

Needless to say, an experiment of this nature in the United States would not enjoy the lingering death for which our noble experiment in temperance is now making us appear ridiculous in the eyes of most of the world.

In certain circles, particularly circles outside of the advertising profession itself, various attempts have been made to bring about advertising censorship in very much the same fashion that censorship of almost every other type has been suggested at one time or another. As a general thing, the individuals or groups be-

(Continued on page 840)

The Service Bench

(Continued from page 795)

complaints on fading of near-by stations.

"Several complaints have come from Majestic owners that their sets would stop operating for a short time every once in a while. In almost every case we found that the grid support wire was located very close to the cathode of the -27 tube, and the close point is nearly always at the lower end of the cathode—that is, near the glass stem. We have also found -45 tubes that are responsible for a similar complaint, and in one instance, a -26 tube caused the same trouble. It seems that the elements are shifted slightly at a point practically invisible, and undetectable in the average tube tester. However, when operated in a radio receiver at high plate voltages for some time the defect will show up. When the set is turned off, and the tubes permitted to cool before being turned on again, the cooling will cause a contraction of the elements which removes the trouble until a similar period of operation—sometimes several days—brings it on again.

"As an illustration of heat causing the elements to shift, I will mention a set of new tubes I had occasion to test a few days ago. The -80 had one filament shifted to one side. There was also quite a sag in the same, and as it heated the expansion caused it to sag more. until the filament shorted against the plate. Three out of five of the -27 tubes developed a grid-to-cathode short when allowed to remain in the tube tester for about three minutes, and upon examination I discovered that the heater element had warped and was causing the cathode to touch the grid at a point about half way down the heater element. However, when these tubes were cold the warp was imperceptible and the tubes tested okay. Needless to say they would cause trouble in almost any receiver.

"I wish to advise servicemen not to depend too much on tube testers to locate all tube troubles. There are many tube difficulties that do not show up for several minutes, or even hours after the tube has been in operation; and again they may never show up if the tubes are tested with different voltages from those applied in the radio receiver. I have several good tube testers, and have tested many tubes that were perfect as far as any conclusions justified by the tests were concerned, and yet, when placed in actual operation, they developed troubles and definite defects within a few hours.

"A principal source of trouble with new tubes is shifted elements in the -45 power tube, and would advise the most careful handling of the same. The elements of these tubes are so long and heavy that it requires a comparatively slight jar to cause a fatal shift. Also, we have found a good many tubes in which the element leads had not been soldered to the base prongs. Look for these loose connections when a loud signal causes the radio to develop suddenly a crackling noise, or intermittent reception. Also, if there should be considerable hum in sets employing the -80 rectifier tube, or a drop in

volume, you may find an 'open' in one of the plates. Another source of grief, which we experienced for the first time this year, was soldering flux on the tube prongs. This grease was apparently a good insulator and gave trouble in receivers in which the socket contacts made contact on the side of the prong, well up toward the base of the tube. Those that contacted on the solder gave no trouble. We now wash all tube prongs with alcohol before testing and placing in stock. It saves trouble later on."

Tricks of the Radiola Trade

By H. Fred Pitzer

EVERY line of manufactured receivers has its own characteristics that recommend some particular methods of short-cutting to repairs. While Radiolas are not alone in this respect, they present some of the most intriguing cases ever encountered by the radio Philo Vance. And their very widespread usage justifies the compilation by the serviceman of the results of his experiences. I hope the following notes will help the serviceman to render better service on his next Radiola call. All current models, and the better known of the older types, are treated serially.

Oscillation Control on Models 16, 17, 41

Usually the grid resistors will suppress any undesirable oscillations in these models if they are of the correct size; i.e., first stage, 800 ohms, second stage, 600 ohms. Substitution of higher values in an unstable receiver will result in weak reception over a good bit of the tuning range. The following methods are preferred, in the order they are presented. A 600-ohm resistor in series with the red, 135-volt, power pack lead will reduce the voltage applied to the r.f. stages. This resistor will be found in many of the 17's. A 600-ohm resistor shunted across the primary of the second or third r.f. stage will reduce oscillations, as will a short-circuited turn of wire placed near the offending coil. With the 41, I have found the shorted turn most effective. To apply this correctly, first try a turn of insulated wire with the ends unconnected. Place this single turn around each r.f. coil until the oscillating circuit is determined. Tighten in place where it prevents spilling over on the short wavelengths. If this does not take out the whistle, ground one end of the wire loop to the chassis. If oscillations still persist, connect the ends of the wire loop together, and insert under the offending coil just far enough away to produce the desired result. These adjustments should be made with the volume on full, and at a low wavelength.

A Few Common Bugs

No "B" voltage at pack. Burned-out voltage divider.

Model 17

No "B" voltage at sockets; pack okay. Shorted a.f. by-pass condenser.

No "B" voltage at detector. Shorted plate-cathode by-pass condenser.

Loud hum other than unbalanced c.t. Shorted -26 filament by-pass condenser.

Lack of volume; no detector voltage. Open grid resistor.

Enough voltage to operate a -45 may be obtained by connecting a 2 or 4 mfd. condenser from the -80 filament to the center tap of the secondary of the power transformer. If a -45 is used, don't forget to change over the "C" bias from the -71 center tap to the -27 leads which will be used for filament supply.

Model 18

Same as the first three on Model 17.

Noisy. Partially shorted a.f. by-pass condenser.

Oscillation. Compensating screw (located between the first and second tuning condensers) screwed in too far.

Adjust to short wave.

Everything tests okay, but no signal. Shorted output condenser. Test by inserting phones in -71 plate lead, which should provide a signal.

Models 33 and 41

As above, excepting that there are a few bugs in the power pack of the 41. If the fuses blow when the 41 is turned on, the rectifier stacks in the speaker are shorted and must be replaced. This can be ascertained by measuring the resistance of each section, remembering that each stack is composed of two rectifiers connected in series, the two stacks being connected in parallel. Reverse connection and take the highest reading, which should be over 1,000 ohms per section. Below this reading they will hum and should be replaced. When testing the speaker, only one side of the moving coil should show ground. Due to the great labor of replacing the condenser block in the 41, it is advisable to blow open any section founded shorted, if it will blow. Usually it is the "C" by-pass condenser that shorts. When the short is located, isolate it from the circuit, and clip two 110-volt a.c. leads across the terminals. This will usually open the condenser. If it will hold a charge for three minutes, it may be used again in the receiver. An intermittent hum in the 41 can be cured by temporarily shorting from plus "B" power or plus 45 to minus "B" with a screwdriver while the set is operating. This short should be only momentary, and should be repeated several times.

Refinishing Model 33 Metal Cabinets

To match the coloring of the RCA 33 cabinet, use burnt amber or burn sienna, singly or mixed, to give the desired shade with shellac or japan. If preferred, these colors can be purchased ground in japan. Cover the section to be finished with the correct shade, and when dry give it a coat of plain lacquer, and finish with a hand rub just before it is dry. A little experience will produce results similar to new.

(Continued on page 859)

Sidney, Rio, and Sharks

By Zeh Bouck

(Continued from page 788)

to us from the bridge of his ship.

Our most spectacular achievement during the course of these experiments was the conversation with the Postmaster General at Sydney, Australia. This retransmission followed practically the same route as the *Majestic* feat, only continued by wireless from Rugby, England, to Australia, a total distance of over 18,000 miles! This, I believe, is the longest distance over which anyone has ever talked.

An interesting discovery made during these tests was the manner of signal cut-off behind the directional transmitting antennas. We would generally fly at an altitude of about four thousand feet, and within gliding distance of the Moron Field. One day, when poor visibility and a low ceiling limited us to an altitude under two thousand feet, we found it impossible to pick up a good signal from either LSN or LSF. The explanation is interesting and fairly obvious. Moron is located about twenty miles away from Hurlingham, pretty much to the west, quite in back of the directional screen of the Madrid transmitter, and partially shielded by the screen of the New York transmitter. The screening effect would, of course, be most pronounced on the ground, lessening with altitude, when an upward component or vertically propagated wave would begin to make an appearance. The analogy is that of a boy with an air rifle, about five or ten feet behind a solid twelve-foot fence. About fifty feet on the other side of the fence is a tall tree. On his side of the fence, the boy could shoot a bird on the ground or at any altitude within the range of his gun. On the other side of the fence, he could shoot a bird on the top of the tree, but not one on the lower branches.

On the ground, signals from LSF were very faint—giving an idea of the effectiveness of the directional screen. They became fairly understandable above the motor noise at two thousand feet, were excellent at three thousand, while at four thousand feet they were so loud as to require attenuation by volume control, regardless of the direction of flight. (A considerable directional effect, due to the characteristics of the trailing wire antenna, was observed as the plane turned in its slow circles.)

Buenos Aires, Hasta La Vista!

The evening before we left B. A., the International Telephone and Telegraph Company gave a banquet to the three of us. I seem to recall that it ran into many courses, and far into the night, champagne being served twice—or was it three times—with each course. We rose from the festive table at 4:00 a.m., hopped into a taxi and took our last long ride down the Rivadavia to Moron.

We took off shortly after daybreak and headed west and north for Porto Allegro, in Brazil. We wiggled our wings as we

flew low over the transmitting towers at Hurlingham. It was about noon when we felt the disastrous effects of the banquet, and discovered that there was neither fruit nor water on board the plane! The motor droned—conversation lagged. Occasionally one of us would mutter something to the effect that “. . . if I ever look at a bottle of champagne again . . .” The sun was hot at three thousand feet—and the pampas still hotter at one thousand. As usual, we bucked a head wind, and Porto Allegro seemed an interminable number of miles away.

We arrived at the Aeropostale field just at sundown, and found plenty of liquid awaiting us—gas and oil, but no water!



Pilot Radio and its crew, Burgin, Yancey and Bouck, and a few well-wishers

We consumed a few bottles of warm soda, gazed longingly at every river running under the bridges we passed over enroute to the city, and, when finally at the Grand Hotel Schmidt, we ordered ice water before registering.

The next morning they presented us with a bill for one hundred and sixty American dollars—which was rather high, unless they charged us for water. Arriving at no compromise, we referred the matter to the American Consul, and took-off for Florianapolis. Here we gassed up again, and proceeded to Rio, flying low over the picturesque city of Santos, the port of Sao Paulo. We landed at the Campo Alphonse at five that evening.

Settled comfortably at the Hotel Gloria, a council of war was called to pass judgment on what should be done to the motor. Our faithful Wright J-6 had pulled us through some 170 hours of tough flying since the overhaul at Roosevelt field, and a general check-over seemed to be in order before embarking on the possibly hazardous hops between Rio and home. It appeared that better attention could be given the motor at Sao Paulo, so Eddie flew the “Pilot Radio” to that city in the mountains two hundred miles southwest of Rio. There it was decided, among other things, to pull the valve

guides, and therein lay the rub—as it turned out to be, a very serious rub. Yancey cabled to the States for spare parts by air mail, including a complete set of guides. But for some reason or another, the guides were not sent, and a new set had to be machined at Sao Paulo. Unfortunately these were made to insufficient clearances, with ultimate grief of almost tragic proportions.

Just before the take-off from Sao Paulo, a valve stuck, and the plane was held up another day for running-in. I was at the Campo Alphonse to meet the plane on its return to Rio. It was with somewhat of a thrill that I heard it drone in from the hills, and then disappear in the direction of the city, apparently on a joy hop over the beautiful harbor. Five minutes later she returned, loosing altitude and obviously in trouble. As the plane taxied across the field, with a spitting motor, I could see that the number eight cylinder was missing. A sticking valve again, and the motor was in the hands of the mechanics the entire day following. Running her in on the ground, she seemed okay, and in the air, the next day, Sunday, she hummed consistently along for six hours. We were assured by the mechanics that the valves had been adequately run-in, and we took-off Monday morning for Bahia.

This was really our start for home. New York in eight days and eight hops—Bahia, Natal, Para, Cayenne, Port of Spain, Puerto Rico, Miami and New York. The cheering throng at Roosevelt field were just beyond the horizon as we sailed forth over the scenic harbor of Rio, stretching south in a double horseshoe on each side of the Pao de Assucar. The sun had burned away the morning mist before we turned our tail on Copacabana and roared confidently west toward Bahia.

Two hours later the motor coughed—and lost revs. A sticking valve again! Just east of Campos, Eddie picked a field and set her down. We were almost instantly surrounded by a crowd of ferocious looking natives that made up in machetes what they lacked in teeth. Armed with nothing but wrenches, Yancey and Burgin clambered out of the plane, tapped the valve back into place, and packed the rocker-arm box with grease. We took-off again through the mass of Brazilian humanity that parted respectfully on each side of our whirling prop, like the waters of the Red Sea about the Israelites. An hour later we passed over the Aeropostale field at Victoria. We spotted the field mentally, and recalled its position when, a half hour later, we returned with another sticking valve!

When we took-off a half hour later, it was evident that we could never make Bahia that evening. We raced the shadows and dropped down on the Aeropostale field at Caravellas, just as the sun made a three-point landing behind the western hills.

(Continued on page 850)

All Radio Is *Not* Broadcasting

By Carl Butman

(Continued from page 807)

be filed on Form No. 54, obtainable from the supervisors. When construction is completed, the stations may be tested but the district supervisor and Commission must be advised in advance. At that time, an application for a radio station license should be filed. For all commercial stations, or stations other than broadcasting, mobile or amateur, license application Form No. 1-A should be filed with the supervisor. Except for testing, no station should go on the air until the application for license is granted. Incidentally, all station licenses must be posted conspicuously in the transmitting room.

If at any time after a commercial station is licensed, a modification of the license is required, Form No. 13 should be filed stating exactly what changes are desired, but no changes are permitted without the authority of the Commission. Rebuilding or moving the transmitter requires a new construction permit followed by a modification of license application.

Commercial licenses are issued for only one year. Although the Commission may now issue licenses to commercial stations for a period of five years, it is not its policy.

Licenses issued to fixed point-to-point radio stations specify exactly the periods of time covered, the frequency or frequencies to be used, and what type of emission is authorized, whether CW or ICW or radiotelephony. They also specify the frequency stability to be maintained, far less deviation being allowed than to broadcasting licenses. The output power is shown in watts and the normal radiated power in meter amperes. Detailed requirements cover the height of the antenna, as well as the antenna current. Stations with which the licensed station is authorized to communicate are enumerated, the station is classified, the hours of service recorded, the nature of the service specified and the apparatus described in detail.

Concerning Operators' Licenses

The Government is quite particular who runs or operates radio stations. The licensing authority, through the Radio Division of the Department of Commerce, specifies the regulations governing the issuance of radio operators' licenses, following international requirements. Copies of the United States regulations may be secured from the Radio Division or the Department of Commerce at Washington or from any supervisor.

The Radio Division classifies commercial operators as commercial first class and commercial second class, and they are the only ones authorized to operate commercial radio stations, except first-class operators. Applicants for license as first- or second-class commercial operators must pass examinations given by supervisors including code tests in transmission and reception at certain

speeds in Continental Morse Code (radio). Practical and theoretical examination consists of comprehensive questions on the general principles of radio and electricity, wiring, transmitting and receiving apparatus, storage batteries, motors and generators, and the international and Federal radio laws and regulations. The applicant is also required to have had satisfactory experience at a station open for public communication. Commercial extra first-class operators are required to pass special examinations after having had experience in the other classes and after demonstrating their ability to handle both American Morse (telegraphy) and the Continental Morse (radio) Codes. Considerable experience is required before anyone is able to qualify as a commercial extra first-class operator and there are only a few listed in this class.

One would suppose that an operator would guard his license carefully, but strange as it seems, fifty-seven licenses were misplaced or lost during the past year, according to the radio supervisors. To date there are thirty thousand and eighty-four operators on the active lists. Operators who do not comply with the regulations are suspended for periods of sixty days. Many have been so penalized, but they are functioning as part of a public service and must live up to their responsibilities.

Scope of International Radio Services

The scope of international radio communication is expanding rapidly. Today United States operating radio companies handle about fifty per cent of the trans-Pacific service and around twenty per cent of the trans-Atlantic communications, showing the successful competition of radio with the older cable services. This competition of radio is considered as largely responsible for a reduction in the former communication rates to foreign countries. After lower rate radio service was inaugurated, cable rates came down considerably and today radio and cable rates are on a par, but this result was also influenced by increased demands for efficient service. Further, radio now offers direct services to many more countries than the cables serve. The public which needs fast and reliable communication facilities has accepted and uses the word "radiogram" quite as well as the older term "cablegram."

The Radio Corporation of America, or RCA Communications, Inc., have five main public trans-oceanic stations on this continent, and others in Porto Rico, Hawaii and the Philippines, but at each

site there are operated many transmitters each with a special call signal. Collectively these RCA stations communicate directly with stations in thirty-eight other countries.

The Mackay Radio and Telegraph Company operates four such stations in the United States proper and one each in Hawaii and the Philippines. Each station operates with several call letters and on a number of frequencies. This general communication company is licensed to communicate by radio with fifteen countries, but relays via its cables to a number of others.

Globe Wireless, Ltd., formerly the Robert Dollar Co., is licensed to operate several public stations communicating with foreign countries. The Tropical Radio Telegraph Company; Southern Radio Corporation, formerly the Standard Oil Company; and the U. S. Liberia Radio Corporation, previously the Firestone Company, also operate trans-oceanic public service stations for radio telegraphic communication.

The American Telephone and Telegraph Co. now operates a trans-Atlantic radio telephone system on four telephone circuits to Europe, and one circuit to South America. A new radiophone circuit to Hawaii is under active construction and is said to approximate between one and two millions of dollars in cost.

Press Wireless, Inc., is doing business over five stations, and the American Radio News Corp. is building five stations for the transmission of news by both printer and facsimile systems.

The United States Army and Navy and a few other governmental bureaus handle official business over long-range trans-oceanic circuits to American territories or foreign countries utilizing governmental channels.

The maximum number of trans-oceanic channels in the band lying between 6,000 and 23,000 kilocycles on which U. S. Stations may operate is 224. Channelling is described on a two-tenths of one per cent (0.2%) basis in General Order 88, as amended by the Commission on November 14th, 1930, but this order is expected to be further modified to provide a one-tenth of one per cent (0.1%) channelling system, in the near future.

Proposed World-Wide Regulations

Many improvements and changes in the international regulations are expected in view of the recommendations the International Consulting Committee, familiarly known as the "C. C. I. R.," made following the Hague Conference. Recommendations as to classification of channels to services, power, type of antenna, frequency standards, suppressing harmonics, precision of frequency meters, stability of frequency, elimination of damped-wave transmitters, listing of frequency assign-

(Continued on page 854)

Mike-roscofes



THE Jewish dialect comedian of the ether, the Milt Gross of the air, is Henry Burbig. Henry is Columbia's highest paid artist—at \$1100 a week he gives you four minutes on the NECCO hour and another program, his Syncopated History hour. You

may remember that he rose to fame as chief artist on the Aco-radio Tube program. Henry used to be a gymnasium teacher in the days when men were men, but now they're broadcasters! Anyway, as he would say, "that's his story and he's stuck with it". Henry is only on the air a few minutes a week, but look in on the reception room at the Columbia Broadcasting Studios at 485 Madison Avenue, and you'll see him there sunlight or moonrise!



By
Harriet Menken

morist said, "Optimism." "You mean oculism," said Fields. "That's a piece of the ear, ain't it?" retorted Weber—and so on, far far into the interview.

When I asked the inimitable pair who were the best comedians on earth, they said modesty forbade their reply!

WEBER AND FIELDS came to you recently over the Columbia Broadcasting System. They told me that they were both thrown out of school at eight years of age for clowning. The rest is history.

They like radio and were quite excited at getting so many fan letters. Neither Weber nor Fields enjoy radio rehearsals, but the minute they know they're on the air, everything is hotsy-totsy.



ED THORGESEN, NBC announcer on the Lucky Strike and other hours, confided in me that if he ever lost his job, he'd try for a pilot's license and fly to Brazil. But this isn't likely, as Ed even turned down the post of supervisor of announcers at NBC, he told me, to concentrate on announcing special programs there. The Powers That Be decided he couldn't continue in both capacities, so "just for a handful of silver," he chose the announcer duties. Ed tells me he's only made two slips on the air in two years and one was his own name. Page Mr. Freud!

While we're on the subject, let us register the complaints we hear on all sides concerning the Lucky Strike announcements. It's too bad that a broadcast as "swell" as B. A. Rolfe's should be spoiled by making Thorlesen give these dull sponsor speeches; and he can't help it! He is forced to say these lifeless words in that monotonous tone. How many votes against putting Ed and the radio audience in this position?

As to his age, Weber said, "Well, I'm able to vote and I voted for Sol Bloom." They both first awoke to this world in the mad little town we call New York, as though there were anything new about it!

"Married? I've been married 34 years." Weber said. "But after 25 years you forget about it!"

"No, you get used to it," Fields corrected. "I know. I've been married four years longer."

Asked what was the funniest sound they'd ever heard, Weber thought it was "Come around on pay day," and Fields suggested, "It's my broker calling me every morning for more money."

Joe Weber, in answer to what qualification he considered necessary for a hu-

naive of me? He says—"the only real requisite for a woman is to be charming." Try this on your violin!

Mr. Seidel was born in Odessa, Russia, and is 30 years old. He has black hair, blue eyes, and may be seen around the studios any day, pipe in hand. This violinist's ambition is to become a scientist, and his hobby is bacteriology. However, the thing he's done that he loves best so far in his life, was to play the Brahms Concerto. In fact, Mr. Seidel owns a complete collection of Brahms songs, unusual for a violinist. And you may be interested to hear something else the violinist told me—that Caruso's voice was the most beautiful sound he had ever heard.



Mr. Seidel himself speaks German, English, Russian and Norwegian. Are all rights to you reserved, Mr. Seidel, even the Scandinavian? Oh, I see! For Mr. Seidel has just told me that swimming is his favorite recreation—in deep water!!

He wouldn't commit himself on his favorite radio artist, but he's the kind about whom you know that he doesn't secretly mean "Toscha Seidel."



JANE COWL has treated you to the liquid melody of her voice over both chains, NBC and CBS, of late. "This is the voice that has launched a thousand" . . . matinee girls, and the microphone does not detract an iota from its beauty—showing what I've always

felt, that if you're really good in one acting medium you can excel in them all.

When I asked Miss Cowl, as we sat in her dressing room, what quality is essential in an actress, she said, "Magnetism. There is one thing an actress cannot do without, and that is magnetism. I cannot define it for you—I cannot tell you what it is—Dusé, an insignificant little woman, had it—but it is essential." Asked what

(Continued on page 860)



Now You Can Have Seventy Stations in Twenty Minutes!

S-M 714 Superheterodyne Tuner

The 714 Superheterodyne Tuner is the finest piece of radio equipment it is possible to produce today—just as the famous Sargent-Rayment 710 was the “boss of the air” in its day. A stock model in the Silver-Marshall Main Laboratory at Chicago brought in clearly and distinctly, and at room volume, ninety-three stations, one after the other, including Cuba, Mexico City, and every station on the west coast that was on the air! Over a period of a month you should be able to log every station in the call book that is within reason.

The 714's excellence isn't an accident—it is the result of two years of painstaking development in the great S-M Laboratories under McMurdo Silver's personal supervision. It contains eleven tuned circuits (over twice as many as the most expensive t. r. f. sets): two, in a dual-selector, precede the first '24 r. f. tube, two are between the r. f. and '24 first detector, and one is in the '27 oscillator circuit. It uses a factory-aligned and tested 443 screen-grid i. f. amplifier, having in itself six tuned circuits. Imagine, if you can, adding six more tuned circuits to the 710 or 712—and all six tuned to a single frequency!

Tubes required: 4—'24's, 2—'27's.

Price (tuner only), completely factory-wired, tested and RCA licensed, less tubes.....\$87.50 List
Component parts total.....\$76.50 List

The 714 Superheterodyne Tuner can be used with any standard audio amplifier but operates at its maximum with the S-M 677B. It is a combination two-stage amplifier and power supply. It furnishes the necessary heater and plate supply for the 714 and takes its power from any 105-120 volt, 50-60 cycle source. Tubes required: 1—'27, 2—'45's, 1—'80.

Price, completely factory-wired, tested and licensed, less tubes.....\$82.50 List
Component parts total.....\$68.50 List

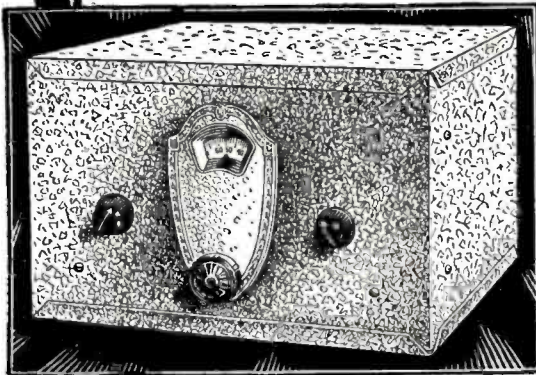
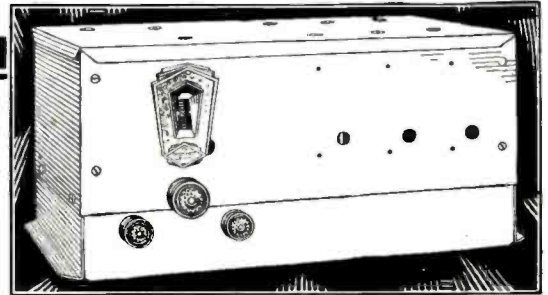

Foreign Programs in Your Home

The S-M 738 Converter turns any broadcast receiver into a short-wave superheterodyne with a range of from two to ten thousand miles, for to every bit of the sensitivity and selectivity of your broadcast set, is added the power of three more tubes!

There is nothing that the most expensive commercial short-wave receiver will do, in the way of distance, that the 738 will not duplicate and beat—and at one-third the cost. Under favorable weather and local receiving conditions, it will bring in every American short-wave broadcaster and the principal foreign stations.

It is built in a beautiful black crystalline case with a hammered silver dial—entirely at home in the finest living-room.

The wired model can be hooked up in three minutes—you merely remove the antenna lead from the broadcast receiver and connect it to the antenna post of the converter; then run two leads from the 738 to the antenna and ground posts of the broadcast set—and tune it in. A switch can be easily arranged to throw the set from long to short waves at will.

It tunes by a single dial (which tunes the oscillator circuit) and an auxiliary midjet condenser.

It will give, in addition to short-wave broadcasting, phone and i.c.w. where there is any carrier modulation at all. Included in the list price are eight coils (four pairs) which cover the wave length range of from 18 to 206 meters.

Tubes required: 1—'24, 1—'26, 1—'27.

Price, completely factory-wired, tested and RCA licensed, less only tubes.....\$69.50 List
Component parts total.....\$59.50 List

Get Your Free Copy of the S-M General Parts Catalog

Check the coupon for your copy of the SILVER-MARSHALL 1931 GENERAL PARTS CATALOG. The Radiobuilder, Silver-Marshall's official publication, tells the latest news of the great S-M laboratories. Fill in the coupon for a sample copy.

SILVER-MARSHALL, Inc.
6405 West 65th Street • Chicago, U. S. A.

Silver-Marshall, Inc., 6405 W. 65th St., Chicago, U. S. A.

.....Send me, free, your NEW 1931 CATALOG with sample copy of the RADIOBUILDER. Also Data Sheets as follows: (Enclose 2c for each Data Sheet desired.)

.....No. 25. 714 Screen-Grid Superhet Tuner.

.....No. 23. 738 Short-Wave Superhet Converter.

Name.....

Address.....

USE REESONATOR for
Sharp Tuning
Distance and Power



Now Only \$3.95

NO—the Reesonator is not new—it is an instrument which has been on the market for over three years and we have over 40,000 satisfied customers thruout the United States, Canada; in fact, the Reesonator is in use thruout the entire world. Its principle is used in most high powered, modern sets of today. The Reesonator will increase the selectivity and power of your machine to the equivalent of two extra tubes. The Reesonator will enable you to play distant stations with dance volume, that were barely audible without it. It is connected across aerial and ground wires, and can be done by anyone without tools in a minute. The Reesonator is only recommended for sets having an untuned antenna or floating tube, such as: Atwater Kent models 30, 32, 35, 37, 38, 48 and 49; Radiola models 16, 17, 18, 33, 51 and 333; Crosley Handbox and Jewelbox and most models in Victor, Temple, Silver-Marshall, General Electric, Westinghouse, Apex radios and many others.

F. & H. CAPACITY AERIAL



Price \$1.25 Complete

Every Instrument Tested on Actual 1000 Mile Reception

The F. & H. Capacity Aerial Eliminator has the capacity of the average 75 foot aerial 30 feet high. It increases selectivity and full reception on both local and long distance stations and is absolutely guaranteed. It eliminates unsightly poles, guy wires, mutilation of woodwork, etc. It does not connect to the light socket and requires no current for operation. Enables set to be moved into different rooms with practically no inconvenience. We predict this type of aerial will be used practically entirely in the future. Installed in a minute's time by anyone. Return in three days if not satisfied.

8,000 dealers handle our line. Dealers! Over 80 leading jobbers carry this line; or order sample direct.

ITEMS SHIPPED POSTPAID

Name

Address

City State

Inclosed find check M. O. for \$.....

or send C. O. D. items checked, under three-day trial money-back guarantee.

REESONATOR

F. & H. Capacity Aerial Eliminator

Literature Dealers' proposition

F. & H. RADIO LABORATORIES
 FARGO, N. DAK., Dept. N

Dealers and Service Men Send for the Latest Issue of



It contains hundreds of Radio and Electrical bargains
 Have You Received Your Copy?
 NUBOR RADIO CO., 14R Warren Street, New York City

PORTABLE ADDRESS Systems
 (LOFTIN-WHITE LICENSED)



BRINGS BIG PROFITS

RENT for special occasions, get your investment back quickly—future rentals are all profit. SELL for permanent installations, at big profits. Build big business with AMPLEX, matched unit portable sound systems, including famous AMPLEX, Loftin White amplifiers. Compact, complete, ready to operate, quick to set up. Models to cover audiences of 500 or 2000. Priced as low as \$185 complete. Write in detail to our General Manager.

AMPLEX INST. LABS.
 132-P West 21st St. New York City

“The Explorer”

(Continued from page 793)

case good results are impossible. Failure to take this factor into consideration in the past accounts for the frequently unsatisfactory operation of most single-tube short-wave converters.

The use of resistance-coupled audio amplification was found to provide the key to the solution of several serious problems.

howling at this point makes a short-wave converter or receiver useless for long-distance reception. Short-wave receivers not using resistance coupling depend on a fixed resistance of about .1 megohm across the secondary of the first audio transformer to prevent “fringe” howl. It is obviously extremely inconvenient and impractical to install such a resistance in a receiver with which a converter is to be used, and the difficulty must therefore be forestalled in the converter itself, as has been done in this case.

The method used for controlling oscillation is of great importance, and was given a good deal of attention. The requirements here are smooth, gentle, gradual control of oscillation, a control which does not detune the signal being received when the control is varied, and one which is noiseless.

Because a variable series resistance in the detector plate circuit meets all these requirements, its use was decided upon. A variable stepless 100,000 ohm potentiometer of high quality, R4 in the circuit diagram, is employed for this purpose. The movable arm of R4 is bypassed to the ground through a 1 mfd. condenser, C7, which smooths out any noises which would otherwise be present, and makes the control absolutely noiseless. This method also has the advantage of supplying the detector tube with the minimum plate voltage at which it will oscillate, regardless of the conditions of antenna coupling or wavelength to which the converter is tuned, thus assuring the smoothest possible oscillation under all circumstances.

In most cases, one end of the potentiometer, R4, is grounded through a resistance, R5, the value of which depends on the voltage of the plate current supplied by the receiver. The resistances R4 and R5 together form a bleeder resistance, with R4 the variable portion. The value of R5 in each case is determined so as to obtain the most gradual control of oscillation.

The detector plate current, being drawn from an r.f. socket of the receiver, passes through the primary coil of the r.f. transformer in the receiver. The inductance of this coil, together with the variable resistance, R4, and the condenser, C7, combine to form an effective auxiliary filter circuit which confines radio-frequency currents to the converter, and which also acts to prevent motorboating.

Again bearing in mind that a converter makes its appeal primarily to the (Continued on page 835)

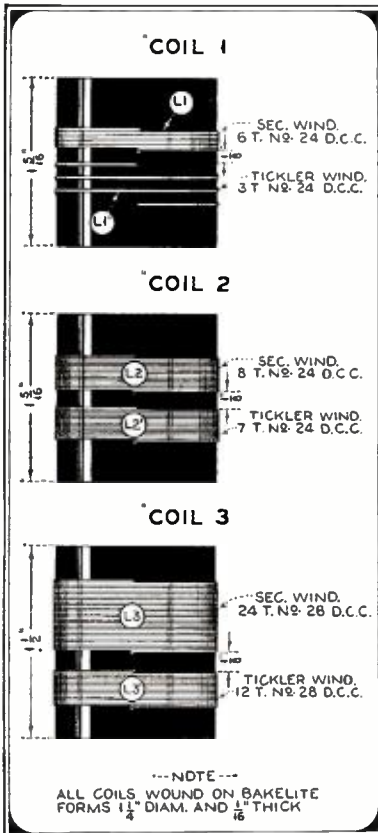

It assures the supplying of the proper plate voltage to the detector tube, which is absolutely necessary for smooth control of oscillation, and consequently for good results. The plate resistor, R2, is interchangeable at the factory, so that the proper value can be determined according to the voltage of the plate current to be drawn from the r.f. socket of a receiver, thereby reducing the supplied voltage to the ideal value for satisfactory oscillation.

Using resistance coupling also eliminates the possibility of audio and “fringe” howling. “Fringe” howling occurs at the oscillation point, where oscillation just begins. It is at the oscillation point that the receiving apparatus is most sensitive, and

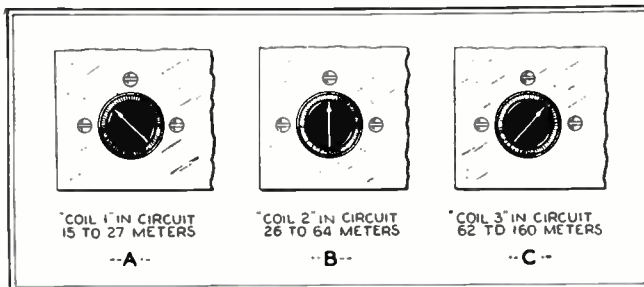

Here is shown the position of the switch knob for connecting the tuning coils into the circuit, covering three s.w. ranges

"The Explorer"

(Continued from page 834)

broadcast listener, the question of obtaining ease of tuning received ample consideration. This point is also of great significance, since too critical tuning makes the reception of weak stations very difficult, if not impossible. Extreme ease of tuning was assured in the converter through the use of a special two-plate midget condenser, C3, which is connected across the main tuning condenser. Turning the knob of the vernier condenser gives an effective ratio of 200 to 1 as compared to the movement of the large tuning dial. Stations can therefore be easily tuned in and held even on the low wavelengths. The use of the vernier knob results in comfortable broadness of tuning equal to that of a broadcast receiver.

A 15 mmfd. variable midget condenser, C1, is inserted in the antenna lead to compensate for antenna absorption and to eliminate dead spots in the tuning range. The control knob is mounted on the panel so that it can be readily varied at any wavelength in order to obtain the most effective antenna coupling.

The mechanical construction of the converter represents a new angle in converter design. Most of the parts, including the coils and band-selector, the midget condensers, and oscillation control are mounted underneath the bakelite subpanel. A very neat and simple appearance is presented when the cover of the cabinet is lifted. The panel is of aluminum, and the chassis is enclosed in a satin-finished aluminum cabinet, resulting in thorough shielding and a handsome, business-like appearance. The chassis is easily removable from the cabinet. When desired, it can therefore be installed in the same console with a broadcast receiver, making a permanent installation. The automatic band-selector feature and the construction of the converter make this entirely feasible.

Attaching the converter to a receiver is a simple operation. One of the two connector plugs is inserted into the detector socket of the receiver, and the other plugs into one of the r.f. sockets, usually the last. The aerial and ground wires are removed from the receiver and connected to the appropriate binding posts located on the top of the subpanel. Two -27 tubes are used in the regular model, and at least one of these can usually be "borrowed" from the receiver.

Tuning the converter involves the use of only two controls at any one time. The antenna coupling condenser controls selectivity and the degree of oscillation obtained. It can be left adjusted in one position while a wide frequency range is being covered. Before beginning to tune, the vernier is set in its middle position. The tuning dial is slowly turned with one hand while the other holds the oscillation control near the oscillation point. Once the heterodyne whistle indicating a station is heard, the tuning dial knob is deserted for the vernier knob by the tuning hand. The vernier is moved back and forth as oscillation is reduced to the point where the signal is clearest

(Continued on page 837)

"I WOULDN'T ATTEMPT TO STAY IN BUSINESS WITHOUT IT"

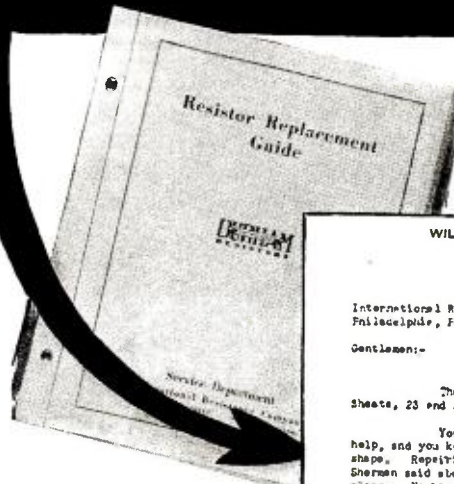

WILLIAM L. GORDON
 Rev. 8th, 1930.
 International Resistance Co.,
 Philadelphia, Pa.
 Gentlemen:-
 Thanks for the new Service Sheets, 23 and 24.
 Your Guide is a wonderful help, and you keep it up to date in great shape. Repairing sets is a horse that what Sherman said about war, until the Guide came along. No trouble at all now to tell resistor values - and which one goes where. I take care of dozens of sets now and I wouldn't attempt to stay in business without your Manual.
 Sincerely,
 Wm L. Gordon

THIS is the way one successful Service Man expresses his enthusiasm for the I. R. C. Resistor Replacement Guide.

His letter, here shown, is but one of many hundreds which tell us how completely the Guide has simplified radio repair work. This remarkable book (8" x 10") is already used by service men in every State in the Union, and each day brings more requests for it. It is a *magic short-cut to trouble-finding*.

The manual shows how to locate cause of trouble in radio sets. It shows the proper type and values of resistors to use in every popular make of radio receiver produced since 1926.

* FREE WITH TEN METALLIZED RESISTORS

With the purchase of 10 I. R. C. Metallized Resistors, you will receive our complete authoritative Guide free—or it may be bought for 50c.

Loose-leaf sheets, made up by our engineers, are mailed periodically and *without charge* to every holder of the Guide—and keep it constantly up to date. The I. R. C. Guide is the dominant book of its kind in the world. Fill out and mail coupon today.

INTERNATIONAL RESISTANCE CO., PHILADELPHIA

*All orders for Resistors referred to territorial jobbers.

INTERNATIONAL RESISTANCE COMPANY
 2006 Chestnut Street, Philadelphia

Gentlemen:
 (CHECK OFFER YOU ARE INTERESTED IN)

I enclose 50c, for which send me Replacement Guide.

Please send price list of Metallized Resistors. I wish to purchase assortment of ten, which will entitle me to Replacement Guide free.

Name.....

Address.....

City..... State..... N

Makers of
I. R. C.
Metallized
RESISTORS

RACON PRODUCTS

For Sound Reproduction Are Unsurpassable

PORTABLE HORN

Racon's Latest Development!



Racon horns and units are covered by U. S. Patents Nos. 1,507,711, 1,501,032, 1,577,270, 73,217, 73,218, 1,722,448, 1,711,514, 1,781,489

Air column length—slightly less than 7 feet. Oval bell 27" x 35", depth 28". Can be separated in two halves for portability. Excellent for music as well as speech.

Newest Storm-proof Horn



TRUMPET HORN (Illustrated)

Bell 22 inches round, length 40 inches. Equipped with cast aluminum ferrule and suspension ring. For Public Address and all Outdoor use. This horn has been perfected after years of exhaustive research in Racon Laboratories. Will withstand all weather conditions. Requires no replacements or servicing after heavy rainstorms. Guaranteed for one year. Prices slightly higher than regular horns.

The new unit for radio use is the baby electro-dynamic type horn unit which is slightly higher priced than the ordinary speaker, but marvelously better.

The largest horn speaker manufacturers in the world Write for Catalog Containing Complete Racon Line

RACON ELECTRIC CO., INC.

FACTORIES:
18 WASHINGTON PLACE, NEW YORK
Slough, Bucks, England, and 3 Mutual Street Toronto, Canada



The MINUETTE RADIO \$34.65

Screen Grid Super powerful set with nation-wide range and magnificent tone quality. New Utah Full Flux Dynamic Speaker and finest component parts. More sensitive and selective than most "big" sets! Beautiful

walnut cabinet. 9 1/2 x 12 1/2 x 20 1/2 in.—entirely self contained. For 50-60 cycle 110-120 volt A.C. current. Regular \$59.50 value. Order direct now at this special introductory price \$34.65 complete with tubes—nothing else to buy. Send \$3 with order—pay balance C.O.D. Satisfaction Guaranteed. Local Agents Wanted. SUPERADIO MANUFACTURING CO. Dept. 603, 2356 Byron Street CHICAGO



NEW WAY to WASH CARS!

SAVES TIME - LABOR - MONEY
Gy-ro washes cars in less than half the usual time. No soap or chemicals needed. Simply attach to ordinary garden hose. Water pressure does the work. Inexpensive. Saves its cost many times over. Active agents make good money. Write now for FREE OFFER. GY-RO BRUSH COMPANY Dept. C-31, Bloomfield, N. J.

Quality With Selectivity?

By J. G. Aceves

(Continued from page 808)

$$Q = \frac{poL}{R} = \frac{1}{poC R}$$

or ratio of reactance to resistance at resonance and by multiplying and dividing the fraction in the second member of expression (1) by R and substituting, we obtain:

$$H = \frac{1}{\sqrt{(n-1/n)^2 + 1/Q^2}} \quad (2)$$

For values of n so close to unity that $(n-1/n)^2$ may be ignored in comparison with $1/Q^2$.

$H = n Q$ and as n is very close to 1, H will be constant and equal to the efficiency of the tuner. In the curve shown in Fig. 2, this portion lies between A and B.

As the frequency ratio n departs from unity, the quantity $(n-1/n)^2$ increases very rapidly and soon will be much larger than $1/Q^2$ and if we ignore the latter in comparison with the former, expression (2) will become

$$H \pm \frac{n}{n-1/n} = \frac{\pm n^2}{n^2 + 1} \quad (3)$$

Care should be taken to use the proper sign so that H will come out always positive.

This proportionality holds beyond point C in Fig. 2 where the resonance curve approaches a hyperbola. Hence, for proper compensation, it is necessary to have an audio amplifier with a gain directly proportional to the audio frequency, as Dr. Robinson properly pointed out. But how far from unity must n be so that equation (5) will hold true, even approximately?

If we make $(n-1/n)^2$ at least four times $1/Q^2$, the error committed by ignoring the second quantity in comparison with the first will be about 3% in the calculation of H from expression (2) which thusly simplified becomes expression (3) or (5).

Giving numerical values to our data, let us make $Q = 1000$ which is a higher value than can be obtained electrically without regeneration. Let also, by hypothesis, as previously mentioned:

$$\frac{1}{(n-1/n)^2} = 4$$

hence; $\pm(n-1/n) Q = 2$ and with $Q = 1000$, $n-1/n = .002$, or $n^2 - .002n - 1 = 0$ from which $n = 1.001$ and therefore, from a frequency 1/10% away from the carrier, and thereafter, equation (5) will hold true for values of n in-

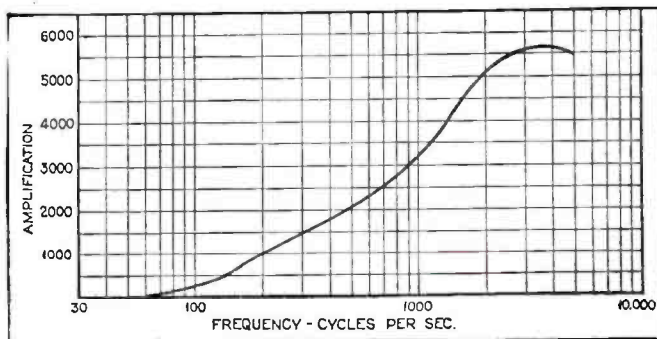

Fig. 6. Frequency response of the corrected audio amplifier

For a frequency change within the range that we are interested in, which will correspond to values of n between say .98 and 1.02, (2% away from resonance) we can write:

$$n = 1 \pm \Delta n \quad (4)$$

hence $H = \frac{1 \pm 2 \Delta n}{\pm 2 \Delta n}$
(Whenever $(n-1/n)^2$ is large compared to $1/Q^2$.)

and ignoring $2 \Delta n$ in comparison with unity,

$$H = \frac{1}{2 \Delta n} \quad (5)$$

This expression means that the gain is inversely proportional to the percentage of frequency deviation from resonance and this deviation is proportional to the resultant audio frequency after demodu-

cluded between .9 and 1.1 at least. If we choose a value of resonance frequency of 50 kilocycles, then the expression will hold good for frequencies 50 cycles away from 50,000 and beyond. These will generate audio frequencies of 50 cycles and beyond after demodulation. It is clear that the inverse proportionality law in the audio response will hold for the entire audio frequency range. The same results that are obtainable with the sharply selective system involved in the Stenode with its highly compensated audio system could be secured without the crystal to more or less the same extent by substituting the "band-pass" type of intermediate-frequency amplifier in a superheterodyne by a very sharply tuned regenerative stage, as has been done by Mr. E. V. Amy. The old fashioned audio-frequency transformers had a response curve which was approximately proportional to the audio frequency up to a value a little
(Continued on page 839)

Some Theory of Push-Pull Audio Amplification

(Continued from page 801)

the mutual conductance of tube No. 1 is greater than that of tube No. 2. Let us further assume that the signal voltage of T1 is increasing in a positive direction while that of T2 is increasing in a negative direction. The increase of plate current of T1 is greater than the decrease in plate current of T2 resulting in an average increase of voltage drop across R_g. The grid bias becomes more negative. The increasing bias is in phase with the increasing negative signal voltage of T2, producing regenerative action and at the same time being 180 degrees out of phase with the signal voltage of T1, producing degenerative action.

Too much cannot be expected from the push-pull amplifier. All that can be hoped for is the elimination of harmonics in the output that would be present if this type of connection were not used. No by-pass condenser is required across the automatic grid bias resistance and furthermore the tubes do not have to be absolutely matched in order that equal voltages be built up across each half of the primary of the output transformer.

Output Transformers

Output transformers for push-pull amplifiers are usually designed on the assumption that d.c. component of the flux in the core is zero. If the plate current of each tube is different a d.c. component will be present which will tend to saturate the core. In a well-designed transformer a slight amount of d.c. component of flux will not seriously impair the operation of the amplifier.

Fig. 23 shows a commercial three-stage push-pull amplifier which is used in a standard sound motion picture installation. The sockets which house the two tubes for each stage of amplification can be clearly seen. The tubes of the last stage are shielded to prevent interstage coupling. Fig. 24 portrays a bottom view of this same amplifier. The bottom of the audio transformers with their center-tapped connections are clearly visible. Note that cable type wiring is used throughout. This is done to minimize capacity coupling between adjacent wires.

"The Explorer"

(Continued from page 835)

and loudest. Tuning in this way becomes very easy, as the vernier makes it difficult, if anything, to lose a station.

The features of the converter make it ideal for the novice in short waves, as well as for the experienced fan. With its simplicity and convenience of operation, ease of tuning, and real loud speaker volume, it offers a new and easier way of delving into the sensations of short-wave reception.

Now FREE to All Servicemen and Dealers—this New Condenser Guide

IN this day, with power-converters being universally used, it is vitally important that men in the radio business know how they are made—how they can be improved—how they can be repaired. Not the least important part of a power-converter or power-pack is the filter condenser, and the New Mershon booklet on Filter Condensers is the most complete, helpful booklet on this phase of radio ever written.

In successive chapters this booklet deals with the various condenser problems and their solutions. Voltage surge effects, condenser life limits, moisture, safety-valve action, cost and size, are all carefully and completely analyzed so that the average man can easily understand which filter condensers are the best to use and why.

The booklet is replete with diagrams and photographs illustrating all the important points. It also contains a complete description of the Mershon Puncture-Proof Filter Condenser and shows why it ranks first in this all-important field of radio equipment. Although the regular price of the booklet is 10 cents, we offer it FREE to RADIO NEWS readers. Send for your copy today.

30 Prominent Manufacturers Use Mershon Condensers in their Receivers

Zenith, Sparton, Crosley, Colonial, Kennedy, Howard, Amrad and DeForest-Crosley of Canada are among the numerous manufacturers using Mershons. Rigid tests in their own laboratories have proved that Mershons provide better filtering, greater reliability, almost unlimited life—all at lower cost.

How You Can Use Mershons

If the receiver you handle, or the ones you repair, give you filter condenser trouble, Mershons will eliminate it for you. Use them for replacements.

If you build power-amplifiers or transmitters, Mershons in the power-packs will assure you of freedom from condenser replacements.

This new booklet shows you how to use them. A FREE COPY will be sent you for the asking.

Costs No More Than Other Condensers

Mershon Puncture-Proof Condensers cost no more than other condensers, yet their first cost is their last.

Once you have them installed you can forget about condenser troubles. That is why thousands of service men are using Mershons to replace burned-out condensers in their daily work.

Because of their larger capacity, Mershons improve the filtering of the power-pack with the result of considerably reduced hum.

Available Through Your Jobber

Mershon Condensers are carried in stock by fifty leading radio parts distributors in the United States and Canada. Any radio parts distributor can obtain Mershons for prompt delivery.

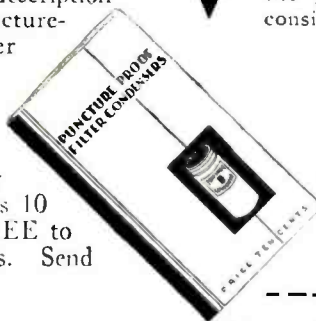

Now FREE Mail Coupon Today!

The Amrad Corporation
156 E. Ohio St.
Chicago, Ill.

Gentlemen:

Please send me a copy of your new booklet, entitled "Puncture Proof Filter Condensers," regularly priced at 10 cents a copy, but FREE to me.

Name

Address

**"Hold on! . . .
That's a great set,
but the wrong solder
will spoil it!"**



"Take my advice and use Kester Radio Solder when wiring and re-wiring that set of yours. It's safe and permanent and so easy to use that even a dub like I am can do an expert job with it!"

When you use Kester, all you have to do is apply heat. The flux is inside the solder, and the right amount of it flows to the job at the right time. The flux is plastic rosin—a non-conductor, and absolute assurance against corrosion. Leading manufacturers, service men, set builders and radio experts all over the country use and recommend Kester Radio Solder. Try it now—at our expense. Kester Solder Company, 4201-13 Wrightwood Ave., Chicago, Illinois. Incorporated 1899.

Write for a Free Sample

KESTER
RADIO SOLDER

NEW . . .

$\frac{1}{3}$ THE BULK!
 $\frac{1}{3}$ THE WEIGHT!
LOWER IN PRICE!

But A Real Condenser

For receiving, up to 365 MMF.
For transmitting, up to 150 MMF.

THE **MIDWAY** CARDWELL
FEATHERWEIGHT

Send for Literature

THE ALLEN D. CARDWELL
MFG. CORP.

89 Prospect Street, Brooklyn, N. Y.

DEALERS AND SERVICEMEN!

Standardize on



For Permanent Replacement—Accurate—Guaranteed

Write for descriptive catalogue "N"

LYNCH MFG. CO., INC., 1775 B'way, N. Y.

Quality With Selectivity?

By L. C. F. Horle

(Continued from page 809)

no means accept the demonstration of the device as being indicative of the unusual, and to me, as yet unexplained characteristics claimed for the device. There was, of course, evidence of a high degree of selectivity and it may be assumed, similar evidence of compensation of the speech amplifying equipment to accommodate the frequency distortion of the high frequency amplifier. But, certainly, by no stretch of imagination could the quality of reproduction of the device be termed even "fair." There was of course, no suggestion of numerical values of any of the characteristics of the device either given in the paper or suggested by the demonstration. In the case of the latter much doubt was cast on its complete validity by the facts brought out in the discussion, namely, the fact that in addition to there being no actual demonstration of the frequency difference between the remote transmitter and the local interfering transmitters no effort was directed at indicating to the membership the relative magnitudes of the signal voltages induced in the antennas of the "Stenode" and the comparison receiver by either the remote or the local transmitters.

It is, however, to be noted especially that two significant points were brought out by the discussion and concurred in by Dr. Robinson. These were: First, the fact that the performance of the "Stenode," consisting as it does of a high frequency amplifying system of an unusually high degree of selectivity in connection with a low frequency amplifier properly compensated to accommodate the "sharpness" of the high-frequency amplifier would be duplicated by a combination of a high frequency amplifier of the conventional type having a selectivity of the order of that of the "Stenode" along with a similarly compensated low-frequency amplifier.

Second: The only basis on which the "Stenode" might be expected to differentiate between side bands of the carrier to which it was tuned and such potentially interfering side bands of another and possibly closely adjacent carrier lay in the simple and constant phase relationship between the carrier and the desired side bands and the lack of this constancy and symmetry in the side bands of the undesired signals with respect to themselves or to the desired carrier.

The significance of this second point escapes me in my efforts to understand its application to the circuits of the "Stenode" but the significance of the first point seems to me to be all important in that it brings within the range of my capacity for consideration the circuits and operating characteristics of the "Stenode". And since, in view of Dr. Robinson's repeated acquiescence to the former proposition, I feel that I need not concern myself with such claims as have been made by others for the "Stenode".

I believe that all that was shown in the demonstration needs no other explanation

than the unquestionably high selectivity of the piezo electro crystal included in the "Stenode" and I certainly feel that the ingenious inclusion of the extremely "sharply" tuned piezo electric crystal within a high frequency amplifier so as to bring into play the extreme selectivity inherent in such a crystal with the resultant high degree of selectivity of the system as a whole is of utmost importance and must attract to itself further and successful effort in the adaptation of this scheme to practical radio apparatus.

The use of the crystal in a bridge structure balanced for the non-resonant condition appeals to me because of its simplicity and economy but it is to be borne in mind that there are other arrangements that may be devised for the employment of the crystal as a selective coupling means and it is in the investigation of all of these means for the employment of the crystal and the adaptation of these means to their proper fields of usefulness that further work must be done.

It is my conviction, in contradistinction to the suggestions made by the deviser of the "Stenode," that neither the crystal coupling nor any even more markedly selective device—if such exist—will serve to greatly modify at any early date the broadcast frequency allocation under which the nation now operates—and suffers. Even though the impossible might be accomplished in apparatus design so that closer frequency assignment might be made without loss of fidelity of reproduction, or even though the audience to radio broadcasting might be further reconciled to the elimination of the higher tones in the reproduction of music and speech, the large number of radio receivers that are now in use and which are, so obviously, considered satisfactory by their users, makes quite impossible within less than ten to fifteen years any such revolutionary alteration of the broadcast pattern as would allow of materially increasing the number of channel assignments within the broadcasting band without more than proportionally increasing the resultant interference.

The Junior Transmitter

(Continued from page 785)

C.Q.—let's see what we pull in—"

Gus Continues Next Month

Next month's article will describe the construction of a very accurate frequency meter—the dynatron oscillator—accurate to within one-tenth of one per cent—if you can be that accurate. The monitor described in this issue will enable you to get in the band and stay there but the dynatron frequency meter will tell you just *where* in the band you are!

Quality with Selectivity?

By J. G. Aceves

(Continued from page 836)

higher than 1000 cycles, after which the decline was very rapid due to the distributed capacity within the windings and also that due to internal capacity between anode and grid of the valves.

I wonder how feasible it is to make an audio amplifier the gain of which is proportional to the frequency for a total range of from 50 to 5000 cycles.

Granted that we lower the gain at 50 cycles to as little as 40 D.B. or 100 to one, the amplification at 5000 cycles would have to be 10,000.

An alternate method would be to use a power detector with a gain of about 10 at 50 cycles from there to the loud speaker. In that case the upper frequency of 5000 cycles would have to be amplified 1000 times and unless the detector was strictly linear at the low sound intensities the bass notes will be wiped out and a frightful distortion may result in case of loud signals of very different frequency components, due to non-linear relations in the characteristics of the valves. A compromise would have to be secured, and this is precisely the impressions that I gathered from the demonstration at the Radio Club meeting.

Being fortunate enough to play the pipe organ and the pianoforte, and being a lover of symphonic music, I may be able, perhaps, to detect the presence of all the frequencies present in a reproduction of music and my ears tell me—right or wrong (?)—that the bass notes below 200 cycles and the treble tones above 2000 were inaudible during the demonstrations.

There is another novel feature in the Stenode receiver; the use of an electronic "reversing switch" for the purpose of bringing the low decrement circuits (or crystal) to a standstill and cutting short the "tails" due to free vibrations. There is nothing in this that involves the same principle used in super-regeneration since the effective resistance in the latter case alternates from a positive to a negative value at every half-cycle of the intermediate supersonic frequency. In the super-regenerative circuits the r.f. tuned circuit having a negative decrement builds up with or without external impulse until the effective circuit resistance changes sign. The extent to which it will build up is governed by the amplitude of the signal at the time that the resistance is negative. Nothing of this sort happens in the Stenode since the resistance is always positive. It is true, however, that the maximum amplitude that the free vibrations will reach before the input signal is reversed will depend upon the amplitude of such signal at the beginning.

ERRATA

An error occurred in the RADIO NEWS Information Sheet on By-passing (Part 2) in the February issue of RADIO NEWS. The first sentence of the third paragraph should read: Solving, the inductive reactance will be 31,400.00 ohms.

AMERTRAN POWER AMPLIFIERS

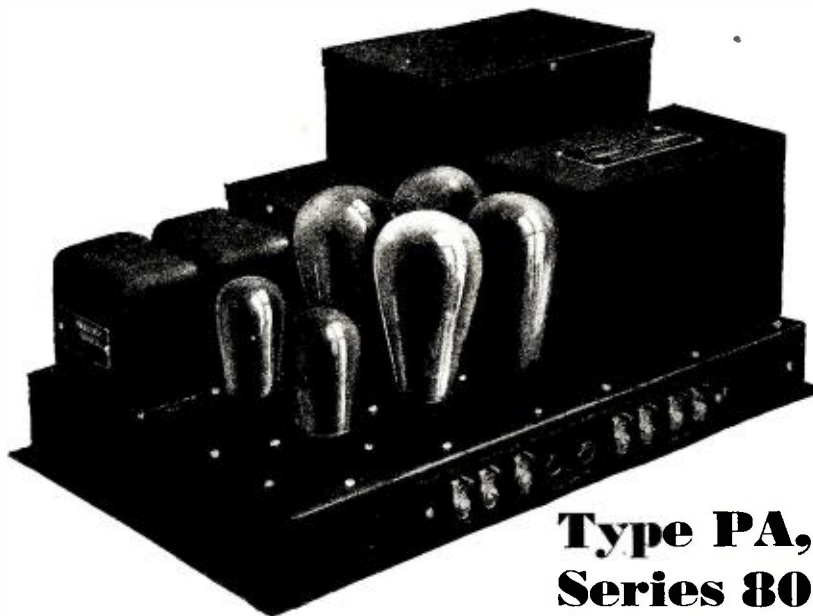

Type PA, Series 80

An economical means of obtaining flawless reproduction of sound in large volume is available in a new series of Amertran Power Amplifiers, the result of months of laboratory experimentation and exhaustive field tests.

There are four sizes in the new Series 80, one to fill every requirement. The big Type PA-86, shown in the illustration, will flood an auditorium with a full volume of music or speech without distortion. Smaller models are made for installations in restaurants, clubs, dance halls, schools and homes—wherever exceptional fidelity of reproduction at high volume is desired.

The mounting and construction is such that they are installed easily, with no bothersome wiring and connections, and are proof against tampering or damage. Simple controls and ease of portability are added features that contribute to the popularity of Amertran Power Amplifiers whose record of performance has won the distinction of being considered The Standard of Excellence for Audio Reproduction.

Licensed under patents of R.C.A. and Associated Companies

AMERICAN

TRANSFORMER
178 Emmet Street



COMPANY
Newark, N. J.

For complete description and information contained in Bulletin 1079 send us the coupon below:

AMERICAN TRANSFORMER COMPANY
178 Emmet Street, Newark, N. J.

RN 3-31

Gentlemen: Send me Bulletin 1079 with complete description of Type PA, Series 80 Amertran Power Amplifiers.

Name.....

Street.....

City and State.....

Build Your Own Wheatstone Bridge

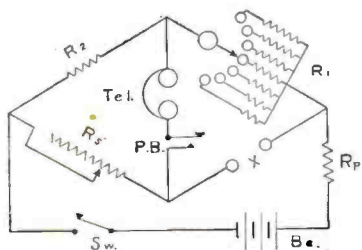

As a result of many requests, we have developed a kit of specially-designed Super Akra-Ohm Resistors, which makes it possible to construct an inexpensive Wheatstone Bridge for measuring resistances from 1 ohm to 10 megohms.

We manufacture wire-wound resistors of any value from 0.01 to 10,000,000 ohms, having negligible inductance and distributed capacity and calibrated to an accuracy of 1%. Their use is highly recommended for Laboratory Standards, High Voltage Regulators, Telephone Equipment, Television Amplifiers, Grid and Plate Resistors, Electrical Apparatus, and Test Equipment.

Send today for our Bulletin No. 74-D, which describes this special kit and the construction of an inexpensive Wheatstone Bridge.



SHORT WAVE WITH YOUR PRESENT RADIO



"THE SUBMARINER"

Short wave reception from all parts of the world is enjoyed by many users of "Submariners."

No need to buy a special short wave receiver, as the "Submariner," attached to your receiver in a few seconds, will bring in reception for only a fraction of the cost.

"Submariners" are available designed for operation with each type of receiver. They are priced from \$17.50 to \$27.50, with fixed wave band of 10-30 meters, or interchangeable coils of 13-143 meters. The "J" feature, an exclusive "Submariner" achievement, enables you to get superior results with all of the newest receivers. The models J.A.7, 14-30 meters, at \$22.50, or the J.I.A.7, 13-143 meters, at \$27.50, have a tremendous wallop when attached to the

NEW SCREEN GRID SUPER-HETERODYNE

receivers.

ORDER TO-DAY

Sent postpaid upon receipt of price, or C. O. D. if \$1.00 accompaniment order. Foreign—Cash with order.

J-M-P MANUFACTURING CO., INC.
3417 Fond du Lac Ave. Milwaukee, Wis., U.S.A.

ALUMINUM BOX SHIELDS



Genius ALCOA stock—superb finish. 5x8x6 \$1.89—Cabinet size \$4.05. 10x6x7 Monitor size \$3.25. 5x5x5 Coil Shield (like picture on the left) \$2.00.

ANY SIZE TO ORDER

Coil Shields, Coil Hole Covers, Shielded Wire, Intermediate frequency coils 350 pair, 5000 Bakelite condenser 10, 70-MMFED Hammarlund equalizer condenser 15c.

We specialize in parts exclusively. We can furnish everything described in this magazine. Give us a trial. **BLAN, the Radio Man, Inc.** 89 Cortlandt Street, Box 3, New York City

Send for your

FREE

Copy of "RADIO TROUBLE FINDER"

See Inside Back Cover

Is American Broadcasting Economically Sound?

(Continued from page 828)

hind movements of this character have been of the same honest but misguided zealots blessed with a superficial knowledge of a particular subject combined with a complex for imposing their likes and dislikes upon the rest of us.

Most of them seem to forget the fact that we have radio censorship at present. In fact, radio programs are more completely censored than any other type of entertainment. In the final analysis, the success of any particular program feature sponsored by advertising depends upon the manner in which it is accepted by the listener. If it is pleasing, the audience will increase; if it is displeasing, the audience dwindles rapidly. As a general rule the success of advertising programs in this country is judged by the "box-office receipts." There are a great many instances where the phenomenal growth of certain business organizations can be traced directly to radio broadcasting. On the other hand, the selection of mediocre broadcast material by an advertising agency lacking in experience and in a realization of the critical viewpoint of the listener-in, have resulted in the expenditure of huge sums for the production of most unsatisfactory returns. We need no other form of censorship than the very formidable weapon found in the simple single tuning dial on the average radio receiver. The listener is absolute master.

The success of advertising by air depends in no small degree upon the announcer who introduces and acts as master of ceremonies for the program. There are some perfectly marvelous announcers, but there are many who irritate most of us almost beyond words. We find a very apt summation of these gentlemen in a recent copy of *The New Yorker*, which we quote for your edification and to which we subscribe most heartily:

"Somewhere in the past we have met radio announcers before—somewhere radio announcers came into our life, long before the radio. The sound of their voices touches a familiar chord in memory. We know what chord it is, too; radio announcers are the little boys of twenty years ago who used to delight their grammar-school teacher by reading 'with expression.' That's it. How well we remember them, the little sissies. Half the time they didn't know the words, but they read them with expression anyway. They are still doing it, still raising their voices on the last word of the sentence in the ecstasy of putting their personalities over with teacher. We could have knocked their little blocks off in those days. We still can, damn it. Give us that rock!"

A typical example of the manner in which a program costing thousands of dollars for a single hour can fall completely shy of its mark—and one instance should suffice, although infinitely more are available—is found in the reaction to the recent broadcast of a particularly popular dance orchestra used in connection with advertising. During the time that the band was playing, the music was so fine that an entire ballroom swayed to

its seductive rhythm. At the conclusion of one particularly good dance selection, the announcer broke it with an advertising harangue. The effect was instantaneous and unanimous. The entire ballroom, filled with people who move in reasonably fashionable social circles, became babel. Ladies and gentlemen in evening attire who never could be counted upon for such action were in the midst of a complete uproar until the advertising blurb was finished. With the first few strains of the next number the dancing was resumed. It is doubtful that more than a half dozen of the sixty or seventy people in the ballroom were able to hear anything the announcer said. Possibly advertising of this nature is effective, but we believe that such a claim would be a subject for considerable debate.

Moderation In Our Advertising

We agree that there is room for vast improvement in the manner of presenting advertising programs coupled with entertainment features. It seems to us the height of bad taste to break in on a series of operatic arias by some golden-voiced star of world-wide reputation with a ballyhoo for beds by an announcer whose voice is semi-effeminate and whose general demeanor before the microphone is completely devoid of personality and obviously effected. Instances of this character go a long way toward bringing about the criticism which is brought down so strongly upon the broadcasting stations themselves, the announcers and the advertisers who use them. It would seem that even a superficial study of mass psychology would penetrate the apparent mental void of the more self-satisfied and self-opinionated advertising folk who may be successful in other fields of advertising, but who are actually placed at a handicap in dealing with an ether advertising program.

In some instances there appears to be a fairly good reason for the continuance of advertising policies of this impolite nature in the return which can be shown when such programs first come on the air. But for a long period of time, when normally sound advertising effort should be pyramiding its result, we find that the following of such a policy results in dwindling audiences, especially when more acute advertising brains direct a competing program of much the same character but with the advertising in better taste on another chain during the same hour.

Many of the larger advertising agencies are now specializing on radio broadcasting and have established regular departments for the handling of air programs. As a rule, these departments are operated in much the same fashion followed in connection with stage presentations. There is no loss of advertising value and there is often a building of *entente cordiale* between the advertiser and the listener-in. In spite of the fact that many people believe that all advertising is obnoxious,

(Continued on page 844)

Home Recorder

(Continued from page 777)

get the same results as before. And now for the recording of the voice. We would not suggest any hay-wire hook-up for this unit, as the results obtained will depend in a great measure on the care and thought expended in the construction of the device. Fig. 3 gives the diagram and the necessary explanatory notes. The plug marked P1 is plugged into the detector socket. The same tests should be made for the microphone unit as for the radio recording. If desired, a visual volume indicator can be constructed as shown in Fig. 4. Fig. 5 shows the complete diagram of a first-class home recording unit. Although the meter in the microphone circuit is not absolutely necessary it will be a great aid in prolonging the useful life of the microphone and will prevent overloading of this circuit through excessive current. The range of the milliammeter will depend on the type of microphone used. In case a double-button microphone is used the circuit shown in Fig. 6 should be used. In this case jacks should be so arranged on the control panel as to allow switching the meter into both sides of the microphone. If the microphone is near the radio set while the tests are made, it will be found impossible in most cases to try the results on the loud speaker, since the familiar microphone howl will be generated as soon as the loud speaker is connected. For this reason the visual volume control, indicated in the figure, is suggested as the best means for monitoring the recording. When using the microphone the face should not point towards the microphone, unless the amplifier gain is sufficient to allow a distance of twelve inches or more from the microphone. In most cases the gain will not be sufficient. Therefore the lips should be quite close to the microphone, but the voice should be directed past it. In those sets which have a tone control the experimenter should try recording with the tone control at the treble end. When reproducing excellent results will be obtained with the control near the bass. For those who find that there is not sufficient gain in the radio set to give good volume when using the microphone, we would suggest the construction of the unit, the diagram of which is indicated in Fig. 7. It is suggested that the microphone be placed in a separate room for recording during a party or gathering, since the reproduction depends to a great extent on the entire absence of background noise. The photographs shown in this article have been taken in our laboratory and are not meant to indicate the appearance of the completed units when installed in the home of the user.

These photographs show two microphone amplifiers and the visual indicator mentioned above. The volume indicator is in reality a vacuum tube voltmeter and has all the batteries contained inside its case. There are three control knobs. The lowest one controls the bias by means of the filament voltage and merely varies the range of the meter. The upper left-hand control varies the input to the meter. The upper right-hand control va-

(Continued on page 842)

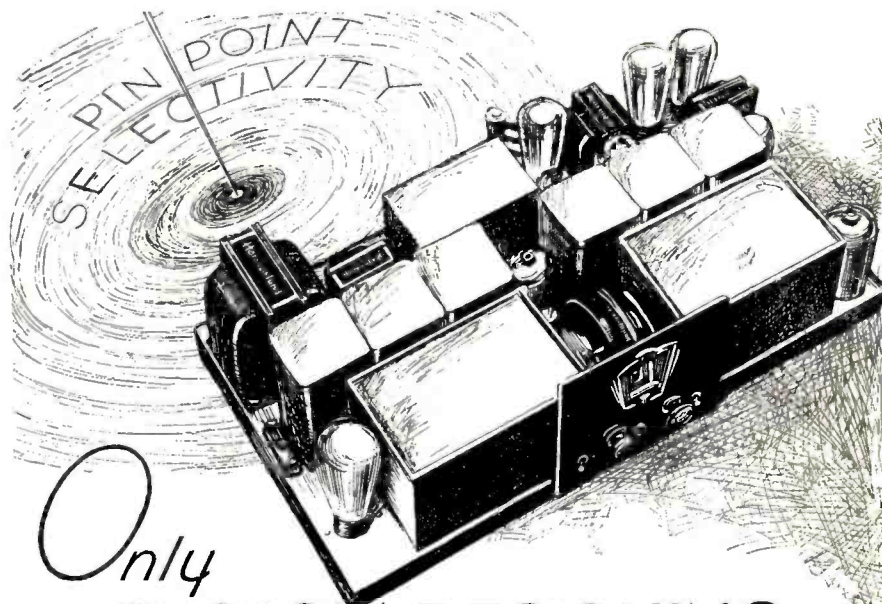

Only
CUSTOM DESIGNING
Can Insure Such
QUALITY!

LOCATION has much to do with successful radio reception. Only a masterpiece can "deliver," when conditions are unfavorable.

In our studio in a radio-congested section—alongside the power lines of the Pennsylvania R.R.—the new "HiQ-31" Custom-Built Radio amazes even the experts.

The HAMPTON
One of ten distinctive
"HiQ-31" Consoles and
phonograph combinations.



HiQ-31

In broad daylight it cuts through powerful local stations, only ten kilocycles away, and brings in distant stations with thunderous volume and sweet, clear sonorous tones that charm.

Owners of earlier "HiQ" models call the "HiQ-31" the greatest receiver of all time. We believe you will agree with them.

A.C. and D.C. models, complete (less tubes), \$146.00 upward—or factory-wired units, easily assembled by you or your custom-radio builder. Mail coupon for the 48-page "HiQ-31" Manual, giving all details.

HAMMARLUND-ROBERTS, INC.

424-438 W. 33rd St.,
New York

Custom-Built Radio
by **HAMMARLUND**

HAMMARLUND-ROBERTS, INC.
424-438 W. 33rd St., New York
Enclosed 25c (stamps or coin) for which please
send me the "HiQ-31" Manual.
Name: _____ Address: _____ N.Y.C.

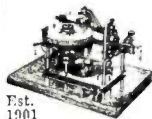

LE CODE AT HOME RADIO AND TELEGRAPHY

ROMNIGRAPH *Has Helped Thousands To Better Positions*
N *U.S. Govt. Depts., Colleges, Scientists, and Schools use it*
NOW! On Land, Ships, and Air—Your Career Future is Secure. Know Code. The Auto-Omnigraph teaches you easily and quickly. Learn by Listening. Models \$15-\$40. Catalog Free.
THE OMNIGRAPH MFG. CO., 810 E. 39th St., N-10, Brooklyn, N. Y.

ELLIS MICROPHONES
A complete line of two-button microphones for indoor and outdoor Public Address systems, Radio Broadcasting and Home Recording, available in several models at \$25.00, \$45.00, and \$75.00 list. Also a complete line of stands, cables, and other accessories. New two-button Hand-Mike now ready. Have you seen our new DEMOUNTABLE Microphone? Write for catalog sheets.
ELLIS ELECTRICAL LABORATORY
337 WEST MADISON ST. Sole Corporation Chicago, Illinois

The New
WOOD - SUPERSONIC
SHORT-WAVE CONVERTER
and complete short-wave battery and A.C. electric sets are now available.
A revelation in short-wave performance. Write or wire now for attractive prices!
AUTOMATIC RADIO MFG. CO., INC.
Dept. E. 112-118 Canal St. Boston, Mass.



MODERNIZE YOUR RADIO

With the new I. C. A. **SELECTONE** TONE CONTROL



ANYONE can attach it in a jiffy and what a difference it makes! Simply place the disks under your power tube or tubes. Allows you to select the tone you most prefer. Eliminates distortion and outside noises. Puts your set on a par with the finest 1931 receivers. Insist on I C A, their trademark is your guarantee for satisfaction. If your dealer does not stock order direct from us.

\$ **2.50**

INSULINE CORPORATION of AMERICA
78 CORTLANDT STREET NEW YORK CITY

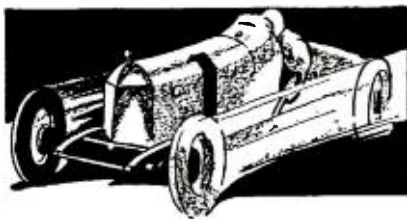

CONTROL rides with the winner!

He rounds "death curve" on two wheels, his steed under perfect control. If your radio is CENTRALAB Equipped, it, too, is under perfect control . . . for smooth, sputterless reception.



DEALERS AND SERVICEMEN:

Send 25c for VOLUME CONTROL GUIDE, showing how you can service practically all sets with a handful of CENTRALAB CONTROLS.

MAIL COUPON

Centralab

CENTRAL RADIO LABORATORIES
Dept. 225G, 22 Keefe Ave., Milwaukee, Wis.
Enclosed find 25c for VOLUME CONTROL GUIDE.

Name
Address
City State

Home Laboratory Experiments

(Continued from page 821)

test is determined from the formula:
Unknown inductance = standard inductance in inches from A to slider

$$\text{tance} \times \frac{\text{distance in inches from B to slider}}{\text{distance in inches from A to slider}}$$

For inductance measurements a series of inductors are necessary, as indicated below:

For measurement of inductances between	Use a standard inductance of
10-100 mh.	85 mh.
100 mh.-1 h.	125 mh.
1-15 h.	3 h.
15-60 h.	30 h.

Note: In the above table mh. means millihenries and h. indicates henries.

The above suggested standards seem to have rather odd values, but coils of these values of inductance are readily available in the form r.f. and a.f. filter chokes.

Variable Resistance

By reference to Fig. 4, which is the circuit diagram of the bridge for inductance measurement, it will be noted that there is an additional 5,000-ohm variable resistance connected in the circuit, the two ends of which are brought down to the terminals of a single-pole, double-

throw switch. This additional resistance in the circuit is necessary due to the fact that the bridge must be balanced for both inductance and resistance and there may be comparatively large differences in the resistance of the standard coil and the resistance of the coil under test. With the switch Sw thrown in one position (position A) the resistance is placed in series with the standard inductance; when thrown to the opposite position (position B) it is effectively in series with the unknown inductance. It will be found possible only to balance the bridge when the switch is thrown so as to place the resistance in series with the inductance which has the lowest resistance. This can of course be determined by actual trial and error.

Bridge Circuit

By means of this simple bridge circuit described in the preceding paragraphs the experimenter can determine with good accuracy the characteristics of filter choke coils, filter condensers, by-pass condensers, bias resistors and many other components of radio receivers and power supplies. These bridges will, we feel, be found a useful addition to the laboratory equipment of most servicemen and serious experimenters.

Home Recorder

(Continued from page 841)

ries the input to the speaker or pick-up. Tip jacks are inserted in the panel for either speaker or pick-up. The procedure in using the indicator is as follows: The speaker terminals are inserted in the tip jacks and the volume control brought up

volume is what it was originally. The circuit for this instrument is shown in Fig. 4. The necessary values are indicated in the diagram. It may be found upon attempting to use the microphone that there is not sufficient gain in the

Fig. 7. Circuit of the resistance-coupled amplifier for home-recording

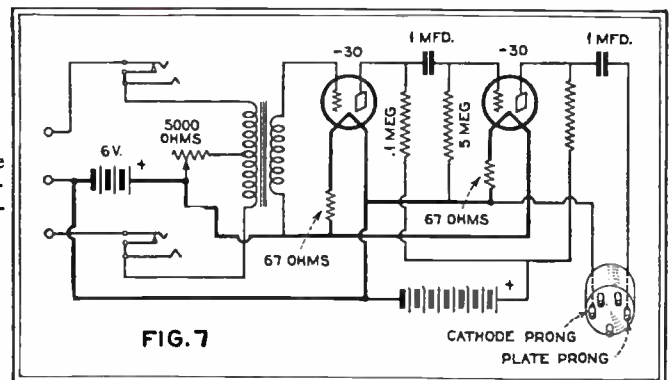

full. With the signal quite loud the left-hand rheostat is varied until the normal signal gives approximately one-half scale deflection of the meter. Thereafter whether the speaker is connected or not, if the meter swings to the one-half scale position it will be an indication that the

amplifier. If this is the case, an amplifier should be built for use with the microphone only. Those depicted in the photographs were built up in such a fashion as to allow of use anywhere in the laboratory. Fig. 7 shows the circuit and constants of the amplifier.

Quality with Selectivity?

By Ellsworth D. Cook

(Continued from page 808)

accentuate the higher frequencies between 1000 and 5000 cycles. Outside of this range, it is assumed that no signal can pass through the radio system. It is obvious that neglecting detector distortion, no audio frequencies in excess of 5000 cycles can now exist in the output of the set.

Detection is well understood to require at least one frequency separated from the carrier by the audio frequency in order

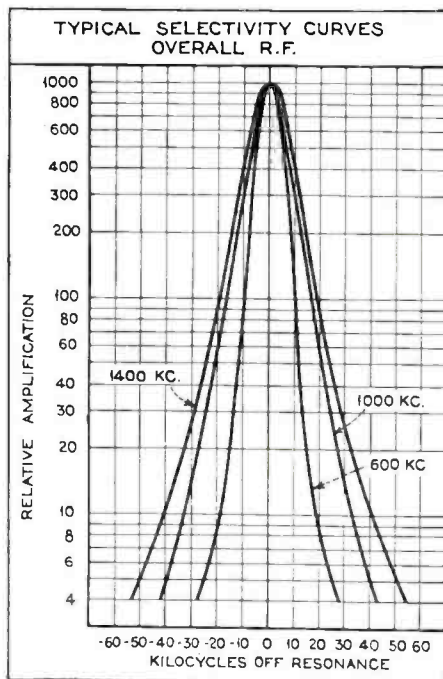

Fig. 8. Selectivity curves for the RCA Radiola Superheterodyne

to provide a beating note with the carrier which, after detection, yields the audio signal. Assuming single side-band transmission in the steady state, if this side-tone frequency is supplied from a separate oscillating system, the same audio output will be obtained. The manner of generation of this side-tone frequency is unknown to the detector. Thus in the steady state at least, there is no difference between the Stenode which is designed with a compensating audio-frequency amplifier and a receiver designed with a flat band-pass radio-frequency characteristic for 5000 cycles width on either side of the carrier frequency having a perfect detector and audio-frequency amplifier. This has been freely granted by Dr. Robinson this evening in the various discussions.

The flat band-pass radio-frequency characteristic would seem to be the more desirable since it does not require as careful tuning to give good audio quality as the Stenode does. Furthermore, the increase in high-frequency audio gain is

(Continued on page 845)

IT'S EASY TO IDENTIFY 1931 TUBES

① Look for Positive Characteristics

TUBES must do more than light, or ride on testimonials. From factory to ultimate socket, they must provide definite electrical characteristics precisely matched to radio set requirements at all times.

And that is the function of ultra-sturdy De Forest construction:

1. Nickel support wires of twice the normal diameter.
2. Heavy, accurately punched mica spacer positively positioning elements at top.
3. Perforated metal plate in place of wire mesh.
4. Heavier side supports providing ample rigidity four ways.
5. Special tempered glass press produced on unique De Forest automatic units, accurately mounting support wires.

These and other advanced features, found in fresh De Forest Audions—tubes produced a month or two ahead of sale—insure the 1931 performance of the 1931 radio set.

This is the first of a series of debunking messages dealing with 1931 radio tube features. Perhaps you would like the entire story at once. If so, we shall gladly send you our literature.

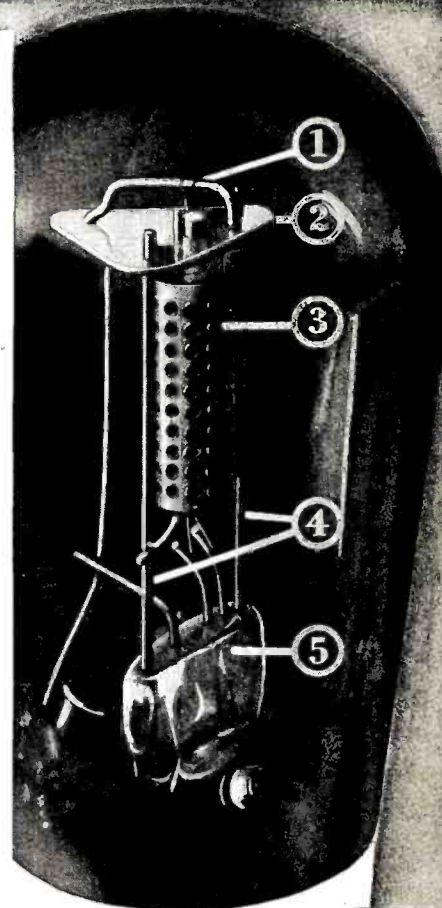

de Forest
AUDIONS
RADIO TUBES

DE FOREST RADIO CO., PASSAIC, N. J.



After all, there's no substitute for 25 years' experience



RIGHT NOW!

Send for Our

NEWEST CATALOG

Largest Assortment and Biggest Bargains in

Hammarlund, National, Amertran, Aerovox, Yaxley, Samson, Sylvania, Arcturus, de Forest, RCA Tubes, Public Address Amplifiers, Weston, Jewell Meters, Jensen, Rola, Best Speakers, Universal Microphones, etc.

ALL MERCHANDISE AT WHOLESALE

S. HAMMER RADIO CO.

142 Liberty Street, New York
Tel. Hitchcock 1152—Dept. N

THE NEW
"EXPLORER"
SHORT WAVE



Price \$24.50

PLUGLESS POWER CONVERTER
A sensational advance in short wave reception

AUTOMATIC BAND SELECTION
POWER RECEPTION

Plug-in coils entirely eliminated! Wave-length range 15 to 160 meters; automatic band selector changes wave-length bands by the turn of a knob in less than a second.

The EXPLORER itself uses two tubes, greatly amplifying distant signals. Used with your broadcast receiver it makes possible reception of stations all over the world with real loud-speaker volume.

With the EXPLORER you can obtain the best possible short-wave reception at lowest cost. Built on new principles of converter design, it is full sized, thoroughly shielded, and enclosed in a beautiful satin-finish aluminum cabinet. A special vernier tuning condenser with an effective ratio of 200 to 1 gives ease of tuning like a broadcast receiver's even with the most distant stations. Results obtained are unsurpassed by regular short-wave receivers, and the elimination of plug-in coils makes the EXPLORER the most convenient of all short-wave receiving apparatus.

Price \$24.50. Fully guaranteed. Models for every receiver, including all superheterodynes. Order now! Sent C. O. D. on receipt of \$2, or prepaid on receipt of price in full. State make and model of broadcast receiver, and whether A. C. or D. C. Foreign, price \$25.50, remit in full with order.

Send for Free Literature
RIM RADIO MFG. CO.
695 GRAND STREET BROOKLYN, N.Y., U.S.A.

Is American Broadcasting Economically Sound?

(Continued from page 840)

clever printed advertising is making many friends for itself, even among the intelligentsia.

Big Business

The National Broadcasting Company sells advertising time on approximately seventy-six of the country's six hundred odd stations. The time purchased by this corporation from the outside stations, which go to make up its chain for programs sponsored by advertisers, averages three hours per day. The remaining hours are sold by the stations themselves; sometimes at a higher rate than the NBC charges for the same station when it is used as part of its network.

The revenue derived by the NBC from advertisers for 1930 is approximately \$18,000,000. This figure includes the revenue from the NBC artists bureau.

The total receipts for the Columbia Broadcasting System from advertising, covering the same period, is approximately \$6,700,000. Approximately \$720,000 were spent for talent. This figure applies to the CBS network of 76 stations.

These programs have given employment to many thousands of script writers, employed by the advertising agencies which handle the programs for the advertisers, many artists (among whom there are some whose ability to perform in most satisfactory fashion before the microphone would not be reflected in anything like similar remuneration because of certain characteristics which would make their performance on the stage or the screen improbable and in some cases impossible), groups of studio managers, broadcasting station operators and electricians, to say nothing of the many thousands employed in the sale of time on the air to advertisers and advertising agencies.

The importance of this enterprise to the advertising fraternity becomes apparent, when we consider that 1-5 per cent. of all of the money spent for advertising programs goes into the coffers of the advertising agencies which arrange for placing the programs on the air. In passing, we must observe that the advertising agency which has a clear understanding of radio as an advertising medium and can intelligently apply all of the technique which present-day broadcasting facilities provide, is in a position to offer an advertising service which we know can be inestimably valuable to the advertiser.

Recorded Programs

Another particularly important, new, but rapidly growing phase of broadcast advertising, is found in the very marked development of electrical transcription which the last year has brought in the recording of entire programs on specially prepared records or on film. These programs can be put on at will and make the entire advertising service much more flexible. As a typical example of how important this type of broadcasting is be-

coming, a single large automobile company placed with one of the record-producing studios a single contract for its broadcasting requirements for ten weeks which totaled \$800,000. Other important advertising programs, involving even larger expenditures, are now being negotiated.

After consider the tremendous strides that have been made in the radio industry in this country during the short time it has been in existence, it seems to us that we are a little impatient in demanding perfection so soon. We feel, on the other hand, that in spite of some of its more flagrant incongruities, radio broadcasting, as it exists here today, is on a sound economic basis. Its ills are minor ones and the attempt to convince us that a major operation is necessary is ill-advised. It seems to us, also, that if the Canadian point of view in connection with present agitation for centralized control in Canada is likely to have any reflex on American thought, advertising agencies, advertisers and broadcasters would do well to utilize their own facilities in providing the American listener-in with a more complete picture of the advantages to be gained by a system such as ours and the disadvantages which might follow the introduction of any type of broadcasting monopoly, government guided or otherwise, which would interfere with its normal functioning and improvement. Our present system, shorn of its shortcomings, is much better.

"The Mighty Mite"

(Continued from page 819)

either of these adjustments not result in a definite peaking of the signal, it will be necessary to remove or add turns to the coils L4 or L5 until the peaking is obtained within the range of the small mica variable condensers. It might be mentioned at this time that the adjustments should be made with the tickler coil L6 out of the circuit, as otherwise change in tuning will be noted on the adjustment of R9. This is directly due to the change brought about in the tuned impedance circuit of V3. After the intermediates have been adjusted the tickler is again placed in the circuit. To produce regeneration it may be necessary to reverse the leads to the tickler coil. The number of turns given for L6, while of the proper value for the receiver made by the writer, may be found to vary with different receivers. In any event, the tickler coil should be of such size as to cause the detector V4 to nearly break into sustained oscillation when the resistance of R9 is all in the circuit.

Suggestions

Inasmuch as it is believed that this re-
(Continued on page 846)

A CURE
for SICK
RADIO
that PAYS You
a PROFIT



AMPERITE automatically corrects line voltage variations up and down between 100 and 140 volts, to exact requirements. Saves tubes, prevents overloading, improves tone, reduces free service.

A type for every radio, including midset models. Can be installed in five minutes without chassis changes.

Ask your dealer or write to Dept. RN-3, naming your set and model.

AMPERITE Corporation
501 BROADWAY, NEW YORK

AMPERITE
Self-Adjusting
LINE VOLTAGE CONTROL

ACME WIRE PRODUCTS

Parvolt Filter and By-Pass Condensers, Magnet Wire—All Insulations, Varnished Insulations, Coils.

THE ACME WIRE CO.
NEW HAVEN, CONN.

Quality with Selectivity?

(Continued from page 843)

contrary to the usual American design. It is becoming general commercial practice to decrease the amplification at high audio frequencies in order to reduce the noise.

The paper, however, suggests a difference between a modulated and an unmodulated wave where the unmodulated wave existed at the identical frequency of one side-tone. This difference is ascribed to the transient condition, that is, the energy build-up mentioned by Dr. Robinson. There is, however, no discernible difference in the radiation of a modulated wave where the modulation is by a single frequency tone, and the individual waves called for by the mathematical resolution of the modulated wave into its components. Phase difference between these three frequencies is meaningless unless the instant under consideration is given since all possible phases are successively taken on. The solution of the ordinary differential equation of a resonant circuit will show no difference in the results for the two cases even in the transient case. The additional phenomena of detection do not alter the situation since a difference in grid signal applied to the detector must be discernible before detection in order for the detector to differentiate between the two signals. The only possible conclusion left is that the fundamental theory of transients in resonant circuits is faulty and such a conclusion is untenable.

It then remains to find the advantage possessed by the Stenode. If the crystal used to provide the high degree of selectivity claimed, can be made as selective as claimed, it would seem that the advance made is in providing a receiver with this much selectivity without an array of resonant circuits which, to say the least, would be very imposing and certainly a trial to one assigned the problem of maintenance.

Radio Aboard the DO-X

(Continued from page 789)

25 to 3,000 meters, the one receiver being used for either short- or long-wave communication. Precautions have been taken in the installation of the receiver to make it quite insensitive to shock and vibration set up by the twelve motors with which the plane is powered.

Antenna Systems Unique

The antenna system is unique. For transmission on long waves either the trailing wire antenna (B) or one of the fixed antennas (A) or (C) may be used. A measured wire forms the antenna for short-wave transmission. Any one or all three antennas may be used for reception.

Power for the transmitters and the receiver is obtained primarily from a wind-driven generator which, when the plane is not in flight, may be actuated by a small 14-horsepower Benz motor.



New Electrad Catalog

The new Electrad catalog covers the complete line of Electrad Resistors, Voltage Controls and Loftin-White Amplifiers, including several important new products.

In addition, it contains a great deal of helpful information on resistance problems.

In order that we may be certain it reaches only those who are interested, please request your copy on the coupon below and mail it to us with ten cents (stamps or coin) to cover mailing cost.

36 Pages of
Helpful Radio
Information

175 Varick St., New York, N.Y.
ELECTRAD

Electrad, Inc., 175 Varick St., New York, N. Y.
Enclosed 10 cents for my copy of the new Electrad Catalog.
Name
Street
City State RN3

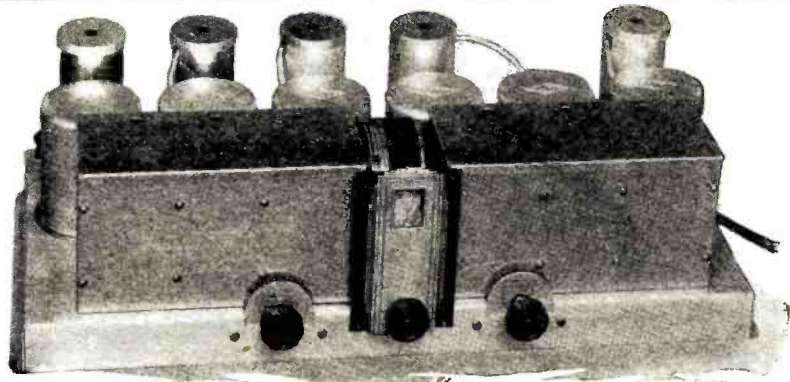

MB-30 TUNER

Here is a TUNER

Setting new standards in performance and tone quality—based on the new Vreeland Band-Selector principles.

A new and finer instrument is this MB-30 Tuner. Performance second to none. Uniform sensitivity over the entire band—very high selectivity without loss of tone quality, no cross-talk, no oscillation at any frequency.

CIRCUIT DETAILS. Double pre-selector stage, six (6) Tuned Circuits, 4 Screen-Grid R. F. Stages, low impedance output 227 Power-Detector. Chassis thoroughly shielded and mechanically rugged.

WIRED or KIT. Furnished wired, laboratory tested and adjusted (Licensed under Vreeland Patents), or as assembled unwired parts. New Velvetone Amplifier Speaker. Type VSA has been especially designed for use with the MB-30 Tuner, forming with it a complete de luxe Radio Set.

Write us today!



Licensed under
Vreeland, Federal, Telegraph
Company, National Co. and
R.C.A. Patents

NATIONAL
MB-30 TUNER AND
AMPLIFIER-SPEAKER

NATIONAL CO., INC., 61 SHERMAN ST., MALDEN, MASS.

LEARN RADIO

this easy, practical way

WRITTEN by two widely known radio engineers, these three books cover every phase of building, repairing and "trouble-shooting" on modern receiving sets.

Radio Construction Library

This practical Library includes: PRACTICAL RADIO—The fundamental principles of radio, presented in an understandable manner. Illustrated with working diagrams. PRACTICAL RADIO CONSTRUCTION AND REPAIR—Methods of locating trouble and reception faults and making workmanlike repairs. Discusses modern Short Wave Receivers fully. RADIO RECEIVING TUBES—Principles underlying the operation of all vacuum tubes and their use in reception, remote control and precision measurements.

The Library is up-to-the-minute in every respect and is based on the very latest developments in the design and manufacture of equipment.

Three Volumes,
6 x 9—993 pages,
561 illustrations.

See this
Library
FREE!

No
Money
Down



FREE EXAMINATION COUPON

McGraw-Hill Book Company, Inc.
370 Seventh Avenue, New York

Send me the new RADIO CONSTRUCTION LIBRARY, three volumes, for 10 days' free examination. If satisfactory I will send \$1.50 in ten days, and \$2.00 a month until \$7.50 has been paid. If not wanted I will return the books.

Name

Home Address

City and State

Position

Name of Company.....RN-3-31

RADIO OPERATORS WANTED



Radio operators are officers aboard ships. Well paid, pleasant work, travel. You can qualify in a short time in our well-equipped school under expert instructors.

Write now for free booklet on "Opportunities in Radio."

West Side YMCA
Radio Institute

113 West 64th St., New York, N. Y.

We carry full line replacements for
Earl Freed's Freshman Receivers
Special . . . AK37 replacement **\$3.75**
blocks. 90-day guarantee.

Write for service parts bulletin
FREED SALES SERVICE CO.
16 Hudson St. New York City

The CROSLLEY
ROAMIO
AUTOMOBILE RADIO
RECEIVING SET

Quality With Selectivity?

By Dr. James Robinson

(Continued from page 809)

This experiment demonstrates that the sharper the resonance curve the greater is the ability to overcome interference and with the Stenode in its present form it is possible to receive broadcasting stations five instead of ten kilocycles apart without sacrifice for fidelity.

In my paper I have indicated certain reasons which lead to an explanation of the great advance brought about by the Stenode—an advance which cannot be too strongly emphasized. Mr. Cooke examines these reasons of mine and apparently comes to the conclusion that they do not yield a satisfactory explanation. He states that the transient nature of the effects cannot lead to any positive difference, and further proceeds to show that we cannot really discuss the phase difference of various components of any modulation when we are considering complicated modulations where many modulation frequencies may be present. If this is true the same remark surely applies to the actual components or sidebands themselves so that we could not really discuss sidebands in such conditions. I am sure Mr. Cooke does not wish to draw this deduction. He further dismisses the question of rectification with a few words as

having no possible influence at all, and apparently he has overlooked the fact that a strong carrier actually demodulates a weaker carrier. This phenomenon has been discussed in England by Butterworth. When he has taken these effects into account he will not so definitely draw the conclusion that the Stenode does not give better results against interference than a band-pass receiver.

Certain other remarks in the discussion of more detail and less importance could be taken up, such as the fact that Mr. Horle states that I advanced the phases difference explanation as the only means of explaining the distinguishing between the sidebands of the two stations. Answers to remarks of this type will be obvious from a perusal of my paper.

Mr. Horle states that it would be impossible to place broadcasting stations closer together today because there are so many million receivers which would be unable to separate them. This difficulty can be overcome by arranging that receivers supplied to the public in future provide such a desired separation and in due course the stations could then be placed closer together.

"The Mighty Mite"

(Continued from page 844)

ceiver will meet with diversified uses, comment on the filament supply and tubes is not amiss. As a dry-cell portable receiver where volume required is not in excess of the 170 milliwatt output of the type -31 power tube, it is recommended that the filament supply be two volts. In this case it will be necessary to insert the proper "C" bias for the screen-grid i.f. stage in series with its grid return between the coil and the tap between the resistors R3 and R4 made to the chassis instead of between the resistors. For two-volt filament supply the filament resistors should be eliminated entirely, connecting the negative filament post of the sockets directly to the chassis. For operation with the new air-cell, which delivers slightly over two volts, R2 should be 5 ohms, R3 and R4 combined 10 ohms, with the grid return of the i.f. stage brought to an external 3-volt "C" battery. R5 and R6 10 ohms, and R7 5 ohms. For operation on a filament supply of 3 volts the resistor R2 should be 10 ohms, R3 and R4 combined 15 ohms, with the grid return of the i.f. stage made directly to chassis. R5 and R6 each 15 ohms, and R7 10 ohms. For operation on a filament supply of 4 volts the resistor R2 should be 15 ohms, R3 15 ohms, R4 15 ohms, R5 and R6 30 ohms, R7 15 ohms. For 4½-volt filament supply R2 should be 20

R6 40 ohms and R7 20 ohms. For 5- or 6-volt operation it is recommended that the type -71 power tube be used for V6. This will deliver an undistorted output in the order of 700 milliwatts. However, 500 milliwatts may be obtained with -31 tubes in push-pull and 340 milliwatts when in parallel. The use of these tubes in this manner will require an increase in the size of the chassis with corresponding increase of the audio-frequency compartment dimensions. For 5-volt operation R2 should be 25 ohms, R3 15 ohms, R4 30 ohms, R5 and R6 50 ohms, R7 25 ohms. For 6-volt operation R2 should be 25 ohms, R3 15 ohms, R4 50 ohms, R5 and R6 are 65 ohms, and R7 is 30 ohms.

For use with any type of battery tubes the filament resistor may be found by dividing the excess voltage to be dropped by the filament current of the tube. The point for the bias return is figured in the same manner. Thus on a 6-volt battery leaving 4 volts to be dropped, and 4 divided by the filament current required by the tube would give the required value of resistance.

For those who may desire to adapt this receiver to line operation, either d.c. or a.c., with the heater type tubes, or to an automobile receiver with the same type tubes, the adaptations will be explained in the next issue.

(Continued on page 855)

Junior Radio Guild

(Continued from page 827)

$$\frac{x + 1}{2x + 2} \times \frac{x^2 + 3x + 2}{x^2 + x}$$

Repeating the operations:

(d) Divide 2x, the first term of the result obtained, by x, the first term of the divisor, and multiplying the whole divisor

$$\begin{array}{r} x + 1 \quad x^2 \times 3x + 2 \quad (x + 2) \quad \text{Ans.} \\ \underline{x^2 + x} \\ 2x + 2 \\ \underline{2x + 2} \\ 0 \end{array}$$

If this method is correct and if the quo-

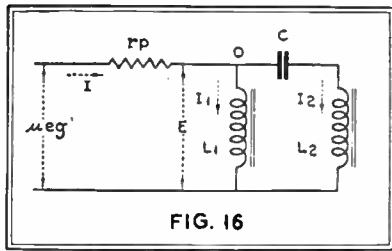

FIG. 16

tient (x + 2) is multiplied by the divisor (x + 1), the dividend should be obtained.

Check

$$\begin{array}{r} x + 1 \\ \underline{x + 2} \\ x^2 + x \\ \underline{2x + 2} \\ x^2 + 3x + 2 \end{array}$$

Check. $x^2 + 3x + 2$

Divide—

2. $x^2 - 7x + 12$ by $x - 3$.

To indicate the method:

$$\begin{array}{r} x - 3 \quad x^2 - 7x + 12 \quad (x - 4) \quad \text{Ans.} \\ \underline{x^2 - 3x} \\ -4x + 12 \end{array}$$

$$\begin{array}{r} -4x + 12 \\ \underline{-4x + 12} \\ 0 \end{array}$$

Check

$$\begin{array}{r} x - 4 \\ \underline{x - 3} \\ x^2 - 4x \\ \underline{-3x + 12} \\ x^2 - 7x + 12 \end{array}$$

Check. $x^2 - 7x + 12$

3. $a^2 - 11a + 30$ by $a - 5$.

4. $a^2 - 49a + 600$ by $a - 25$.

5. $3x^2 + 10x + 3$ by $x + 3$.

6. $2x^2 + 11x + 5$ by $2x + 1$.

7. $2y^3 - 3y^2 - 6y - 1$ by $2y^2 - 5y - 1$.

To indicate the method:

$$\begin{array}{r} 2y^2 - 5y - 1 \quad 2y^3 - 3y^2 - 6y - 1 \quad (y + 1) \quad \text{Ans.} \\ \underline{2y^3 - 5y^2 - y} \\ +2y^2 - 5y - 1 \end{array}$$

$$\begin{array}{r} +2y^2 - 5y - 1 \\ \underline{2y^2 - 5y - 1} \\ 0 \end{array}$$

$$\begin{array}{r} 2y^2 - y - 1 \\ \underline{y + 1} \\ 2y^2 - 5y^2 - y \end{array}$$

$$\begin{array}{r} 2y^2 - 5y^2 - y \\ \underline{2y^2 - 5y - 1} \\ -4y^2 - 4y + 1 \end{array}$$

Check. $2y^3 - 3y^2 - 6y - 1$

8. $6m^3 - m^2 - 14m + 3$ by $3m^2 + 4m - 1$.

(Continued on page 861)

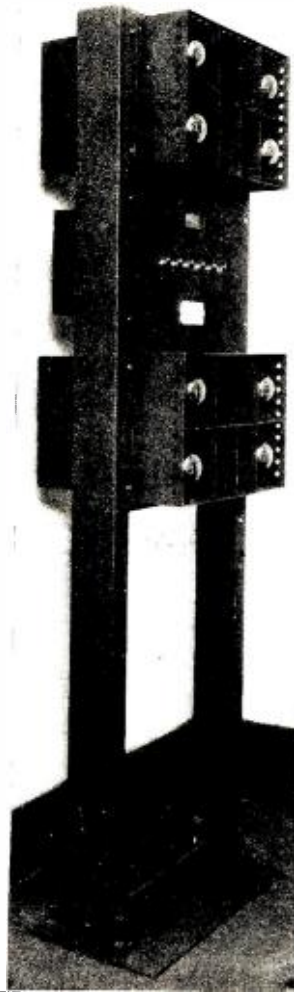

RACK AND PANEL AMPLIFYING EQUIPMENT

Ferranti D3 rack type amplifiers are ideal for experimental and educational purposes and for the distribution of sound and music.

SPECIAL MATCHING TRANSFORMERS

Now Made in the U. S. A. in 48 Hours

Ferranti special matching transformers have flat curves suitable for precision requirements.

Write for prices, recommendations and other details.

FERRANTI, INC.
130 West 42nd Street
NEW YORK, N. Y.

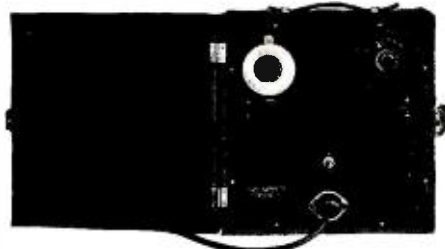

TYPE 404 Test-Signal Generator. Price \$95.00

SENSITIVITY MEASUREMENTS FOR THE SERVICE MAN

THIS new General Radio instrument makes it possible for the independent service man to make sensitivity measurements on radio receivers in addition to the usual neutralizing and aligning adjustment tests. When used in conjunction with an output power-measuring device the TYPE 404 Test-Signal Generator will show the approximate sensitivity of a receiver at any point in the broadcast band.

Further details will be supplied on request to all who ask for them on their business letterhead. Ask for Bulletin 932-R3.

GENERAL RADIO COMPANY

OFFICES, LABORATORIES, FACTORY — CAMBRIDGE A, MASSACHUSETTS
Pacific Coast Warehouse: 274 BRANNAN STREET, SAN FRANCISCO

WELLSTON GOLD TEST AERIAL

Gets Greater Distance!



Reduces Static & Hum

The World's Smallest Aerial
2 1/2 by 3 inches in Size

IMPROVES RADIO RECEPTION

IT WILL NEVER WEAR OUT

Made of emerald green genuine solid Condensite, with binding posts to match, this NEW AND IMPROVED WELLSTON GOLD TEST AERIAL is of the filtered type endorsed by radio engineers. Although small enough to fit the palm of your hand, it has a capacity equivalent to 54 ft. of best grade aerial wire strung 50 ft. high in the air.

EASY TO INSTALL

It is a simple matter to install the WELLSTON GOLD TEST AERIAL—even a child can do it in a few minutes time. No extra tools are needed. Place it anywhere—inside on the back of the radio cabinet. Once installed, no further attention is required.

IF YOUR DEALER CAN'T SUPPLY, ORDER DIRECT

Price \$2.50

WELLSTON RADIO CORP.
Dept. 112 St. Louis, Mo.

MAYO...

Guaranteed Replacements for Service Men—

CONDENSER BLOCKS for

	List	Net
Majestic B	\$6.00	\$3.00
Majestic Special	6.50	3.25
Willard B	6.00	3.00
Zenith	7.00	3.50
Atwater Kent No. 37	10.00	5.00
Majestic Set (70, 80, 90 series)	10.00	5.00

Write for Complete New Catalog
MAYO LABORATORIES, Inc.
283 East 137th St. New York City

SEND FOR FREE CATALOG

COAST TO COAST RADIO CORPORATION

HEADQUARTERS... ALL RADIO REPLACEMENT PARTS

142-N LIBERTY ST. NEW YORK CITY

GEARS

In stock—immediate delivery
Gears, speed reducers, sprockets, thrust bearings, flexible couplings, pulleys, etc. A complete line is carried in our Chicago stock. Can also quote on special gears of any kind. Send us your blue-prints and inquiries.

Write for Catalog No. 40
CHICAGO GEAR WORKS
769-773 W. Jackson Blvd., Chicago, Ill.

Send for your **FREE** copy of "RADIO TROUBLE FINDER"
See inside back cover.

Electromagnetic Pickups

(Continued from page 811)

space here. All we have to do then, is to measure as accurately as possible the relative width of the reflected light beams at all of the frequencies to be used, and multiply the voltmeter readings by corresponding factors.

Our readings will be very greatly facilitated if "sliding frequency" records are used; that is, records which vary constantly in frequency from the top to the bottom of the scale, or vice versa. Such records include the entire frequency band in a single recording, and a set of read-

values and real values. To arrive at the true relative response at the lowest frequencies, it is necessary to apply a filter to the measuring circuit which will cut off all frequencies above the one to be measured. The losses of the filtering device for the desired frequency must also be known, and accounted for in the resulting curve. The difference between the filtered and the unfiltered response at the lower end of the scale is a measure of the production of unwanted overtones by the pickup.

While we may thus correct for the weaknesses of the pick-up at the low frequencies, it is much more difficult to allow for the imperfections of the available frequency records. The above mentioned German records are not satisfactory below 200. The Victor records available to the public have abnormal amplitudes below 250. The maximum swing allowable in commercial records is only about 0.002" in each direction. The lower frequencies on the Victor records have amplitudes several times as great as this. It is quite unreasonable to expect a pick-up to perform properly at such amplitudes. So far as the writer is aware, no frequency records have as yet been issued which are satisfactory at the lower end of the scale. The best way to get around this difficulty is to take a record cut at say around 250 and run it at a slower rate to get the lower frequencies.

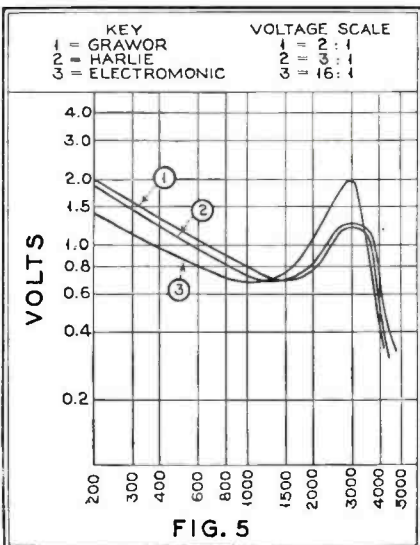

Fig. 5. A group of frequency response curves of foreign and domestic electromagnetic pickups

Stiffness Measurements

ings may be taken in about three minutes. The frequency may be kept track of by counting off the revolutions of the record. A certain number of revolutions from the start will always bring one to a certain frequency. Such records may be obtained from the Carl Lindström A.G. of Berlin, Germany, which is a branch of the Columbia concern. A set of three records costs about \$7.50. I have not heard of such records being sold in this country. They are, however, available in England under the name "Parlophone."

The earlier pickups were designed with a view to showing a nice frequency curve. Lots of damping was applied to iron out the resonance point as completely as possible. The result was a very stiff armature system. The rigidly held needle acted on the record about like the cutting tool of a lathe. To save the records, the amount of damping has of late been greatly reduced in almost all commercial pickups. The stiffness of the armature system is a very important factor in pick-up design.

The voltmeter readings should either be reduced to Db or plotted on a logarithmic scale. For comparison of characteristics it is convenient to reduce the various curves to a common base line. For instance reduce the value at 600 in all cases to 1, and plot the remaining values up or down from this level. The actual voltage output at 600 may be noted separately. The frequency value 600 is suggested because this falls about in the middle of the possible frequency scale of commercial records or pickups.

While the stiff pickup had a fairly nice characteristic on paper, there was a grave defect in the method of taking the curves which formerly led engineers to believe that lots of stiffness, with the attendant high damping, was just the thing. These curves did not take into account the amount of overtones present in the output at the lower frequencies. The stiff armature system caused the whole body of the pickup to be vibrated unduly on the low notes. The present tendency is to save the low notes and the records, and let the resonance peak climb.

As the output of the pickup at the lower frequencies is usually very much diluted with overtones due to the failure of the armature to properly follow the groove at these frequencies, it is necessary to distinguish between indicated

There are a number of very complicated devices for measuring the stiffness of pickups, but the writer has devised a very simple set-up which does all that is required in practice. As above mentioned, the maximum swing or needle displacement with commercial records amounts to about 0.002 of an inch. All that is required is to find the pressure required at the needle-point to cause this

(Continued on page 849)

Electromagnetic Pickups

(Continued from page 848)

much displacement. The writer's arrangement (See Fig. 4) consists of nothing more than a pointer 8 or 10 inches long, which is provided with a pan for small weights suspended about $\frac{3}{8}$ " from the pivot end. The pivot end of the pointer is inserted in the needle holder of the pickup. The latter is held on its side, as indicated in the accompanying sketch. A scale is held next to the pointer end, as shown. The specified $\frac{3}{8}$ " represents approximately the length of the average phonograph needle.

The pointer should preferably be made of $\frac{1}{16}$ " aluminum rod or hard wire. It should have a length which is a large enough multiple of the needle length to give a legible movement at its outer end, say 1 mm. for a movement of 0.002" at the position of the needle-point (0.002" corresponds to 0.05 mm.). Weights are added to the pan until the required deflection is obtained. The total weight suspended from the needle-point position to obtain this deflection is taken as a measure of the stiffness of the armature system.

Measured by this system, the older pickups showed a stiffness of 6 ounces or more. Small wonder that the records and the reproduction of bass notes suffered! The best modern pickups have a stiffness of about 2 ounces. In any case, the stiffness must be set off against the frequency characteristic in judging the merits of any pickup device.

Voltage Output

Pickups are most commonly connected directly to the grid of the first amplifier tube. The device must deliver sufficient e.m.f. to adequately actuate the amplifier, even when soft records are played. An average maximum of about 1 volt is demanded of pickups for present-day radio sets. This fact is mentioned in connection with the discussion of pickup measurements, because the voltage output plays an important role in forming an overall judgment of the device.

This output depends, of course, for one thing, on the impedance of the pickup winding. It is practicable to surround the armature with as much as 10,000 or 20,000 ohms of wire, which would yield an impedance quite nearly matching the grid impedance for the highest frequencies reproduced. But such windings tend to pick up hum from the lighting circuit and to cause regeneration in the amplifier. With careful shielding such difficulties may be overcome, but most manufacturers prefer to avoid them in advance by putting not more than 2000 ohms of wire on the coil.

We may say, then, that general practice demands a pickup with an average maximum output of 1 volt from a coil of 2000 ohms d.c. resistance, or less. To obtain this, a considerable magnetic field strength is required, and the armature must be thick enough to handle this without approaching saturation. The armature also must be long enough to provide

(Continued on page 853)

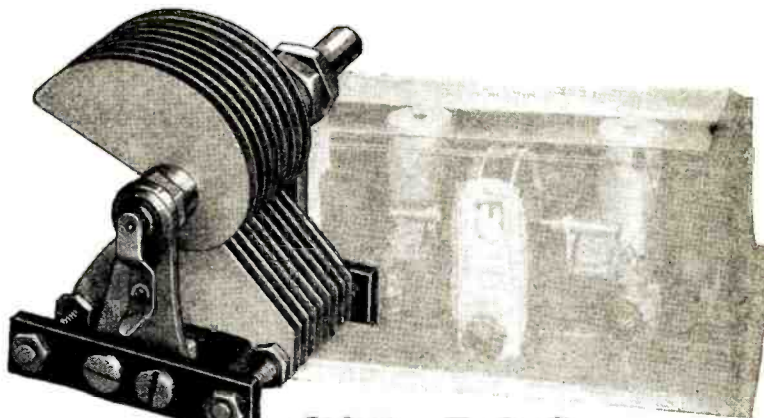

SE-100

The First Real S. W. Condenser

NATIONAL COMPANY made this condenser for short wave work only. No detuning from pigtail, because pigtail is special type with constant impedance. No noise from shorted turn in condenser, because special construction and single insulated bearing eliminate trouble. Standard model has 270° straight frequency line plates. Model ST-100 has 180° Equitune plates.

Just another reason for the outstanding superiority of the NATIONAL SW5 THRILL-BOX. (Send 50c in stamps or coin for new 64-page Short Wave Handbook, giving details of all modern S.W. circuits. Bulletin No. 143 is free.)



NATIONAL A. C.—SW5 THRILL-BOX

NATIONAL CO., INC., 61 SHERMAN STREET, MALDEN, MASS.

Byrd's Antarctic Radio Equipment
Receivers, transmitters, and latest navigation aids used on this epochal flight fully described.

Television
Mr. C. F. Jenkins, father of television and radio movies, gives you in his own words complete directions for building practical television equipment.

Interference Elimination
New methods systematically outlined by W. F. Fleming, radio engineer.

Radio Auto Alarm
Description of new device for ships which keeps the SOS watch while operator is off duty.

Short-Wave Apparatus
Commercial and amateur, described and illustrated.

New Broadcasting Equipment
Temperature-controlled Piezo crystal oscillator; 100% modulation panel and other new apparatus. — and these are only a few of the new subjects added to the most complete radio handbook ever published.

The Latest Data!

Complete and up-to-date information covering the entire field of radio—all arranged for ready reference in this one big guide book.

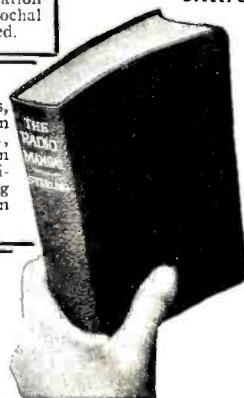

THE RADIO MANUAL

A Handbook for Students, Amateurs, Operators, and Inspectors

Here's the answer to every question about the principles, operation, and maintenance of apparatus for radio transmitting and receiving. Important new chapters have been added to bring it right up to the minute. Many new photographs and diagrams have been included. It is now more than ever the one complete handbook covering the entire radio field.

A Complete Course in Radio Operation in ONE VOLUME

Prepares for Government License

20 big chapters cover: Elementary Electricity and Magnetism; Motors and Generators; Storage Batteries and Charging Circuits; The Vacuum Tube; Circuits Employed in Vacuum Tube Transmitters; Modulating Systems and 100% Modulation; Wavemeters; Piezo-Electric Oscillators; Wave Traps; Marine Vacuum Tube Transmitters; Radio Broadcasting Equipment; Arc Transmitters; Spark Transmitters; Commercial Radio Receivers; Marconi Auto-Alarm; Radio Beacons and Direction Finders; Aircraft Radio Equipment; Practical Television and Radio Movies; Eliminating Radio Interference; Radio Laws and Regulations; Handling and Abstracting Traffic.

Prepared by Official Examining Officer

The author, G. E. Sterling, is Radio Inspector and Examining Officer, Radio Division, U. S. Dept. of Commerce. The book has been edited in detail by Robert S. Kruse, for five years Technical Editor of QST, the Magazine of the American Radio Relay League, now Radio Consultant. Many other experts assisted them.

Examine It FREE!

The revised edition of "The Radio Manual" is now ready. Nearly 800 pages; 368 illustrations. Bound in flexible Fabrikoid. The coupon brings the volume for free examination. Within 10 days you may return the volume or send the price of \$6.00.

—MAIL THIS COUPON—

D. VAN NOSTRAND CO., Inc.
250 Fourth Ave., New York

Send me the Revised edition of THE RADIO MANUAL for examination. Within ten days after receipt I will either return the volume or send you \$6.00, the price in full. (R. N. 3-31)

Name

St. and No.

City and State

Business Connection

Practical Testing Systems

by
John F. Rider

A compilation of 84 different subjects relating to tests and testing systems of interest to Service Men, Engineers and Experimenters. Capacity, inductance, resistance, tube characteristics, signal input, signal output, oscillators, shunts for current meters, multipliers for voltmeter, etc. 147 pages, 99 illustrations. Printed. Bound in stiff canvas cover. Gold letters.

Price \$1.00

Practical Radio Repairing Hints

by
John F. Rider

A thorough and comprehensive discussion of practical radio repairing. No theory. No formulae. The finest book for the practical radio worker. Replacement, repair, hints, kinks, simple tests and every day tables of value to the practical radio man. Modern—up-to-date.

270 pages, 6 x 9. Printed. Bound in stiff canvas cover. 206 illustrations.

Price \$2.00

These books are sold with a money back guarantee

RADIO TREATISE CO., Inc.

1440 Broadway NEW YORK CITY

NATIONAL SW-5

This Famous Short-Wave A. C. Receiver: outstandingly the best of its type.

\$81.60 COMPLETE

with tubes and power-pack, wired, tested, ready to use. Doubly guaranteed: by National and H & Y.

Act now: price lasts only for present stock!

Get an H & Y catalog—25c.

HATRY & YOUNG, INC.
119 Ann St. Hartford, Conn.

Fascinating-Profitable
LEARN TELEGRAPHY
This Easy Way —

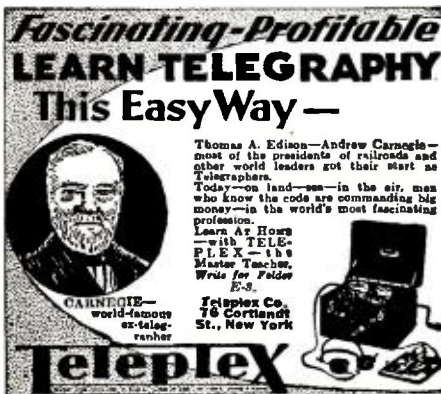

Thomas A. Edison—Andrew Carnegie—most of the presidents of railroads and other world leaders got their start as Telegraphers.
Today—on land—on—in the air, men who know the code are commanding big money—in the world's most fascinating profession.
Learn At Home —with TELEPLEX—the Master Teacher, Write for Folder E-3.
Carnegie—world-famous ex-telegrapher
Teleplex Co. 76 Cortlandt St., New York

Massachusetts Radio and Telegraph School
18 Boylston Street, Boston
Send for Catalogue
Tel. Hancock 8184 *Established 1905*

Sidney, Rio and Sharks

(Continued from page 830)

We were four thousand feet in the air before the next morning's sun sent up its first rays from the rim of the Atlantic, regilding the faded gold on the under-surface of our wings. We had wasted an hour in returning to Victoria the preceding afternoon, and the gas situation was becoming unpleasantly problematical. To save miles, we cut across the fifty kilometers of water between Cayru and Bahia, measuring with our eyes the last faint flicker of the gas guage. The motor cut just as we taxied up to the hangars!

Gassing-up was subjected to the usual mañana technique, and our delayed take-off from Bahia put Natal on the dark end of the flight. So we landed at Recife, or Pernambuco. The next morning as we revved her up, the exhaust stacks stabbing the twilight with orange blue darts, we found the motor cutting badly on the left mag. A faulty plug was located, but, badly stuck, another hour was lost digging it out with a cold chisel.

Welcoming a day of comparative rest, we made a short hop to Natal, and were prepared to bask in the friendly if dirty hospitality of that city, when I happened to look at our tail wheel. An eloquent gesture to Yancey and Burgin called forth a groan that was made unanimous when we inspected a completely wrecked wheel assembly. Recalling our past experience with a South American welder, it looked like a week's stay in Natal. But to our gratified amazement, my high school French elicited the fact that the Aeropostale mechanics could and would do the necessary welding "aujourd'hui"—gratified amazement that my French worked and that the job could be so expedited.

We had considered our hop from Natal to Para one of the most hazardous in our flight, having given a credulous ear to the myths of danger about the delta of the Amazon. But instead of finding it a desolate and dangerous region, it was our relief and genuine luck to discover here the most consistent stretch of populated and excellent flying country we had looked down upon since leaving the Argentine pampas.

I say "luck," because just seven hours after taking-off from Natal, while over the legendary bad lands, our motor conked—again with a sticking valve. Forced down, Eddie picked a field that any airport might envy as a runway, and glided in to his usually perfect landing. Once more we were surrounded by natives, but of a wilder variety—more distinctly Indian. They watched Burgin and Yancey curiously as they tapped back the valve and hopefully stuffed the rocker-arm box, but scattered when the motor started. They watched our take-off from behind bushes and small trees. An hour later we were over the Para River, and located our landing field, a farm belonging to a Frenchman, who had marked the preferred approach with flags. In landing on the rather rough field, the fork of the tail wheel assembly was badly bent. This was straightened out after a fashion, and replaced at four o'clock the next morning.

But still additional troubles added to

the already intriguing possibilities of a consistently sticking valve. The spark-plug we had put in at Recife had gone haywire. We had been and still were unable to locate our own spare plugs. After two hours of repeated cleanings, we gave up the job, and screwed the dead plug back into the cylinder. In the meanwhile it had been discovered that our inboard right gas tank was leaking through the gauge. So practically all the gas was put in the port tanks, which made the plane fly wing heavy, with the possibility of a bad bump throwing her into a left-hand spin.

Our next destination was Cayenne, 930 kilometers away, the capital of French Guiana, the French penal colony. The landing field was a strip of grass fifty feet wide, and swept consistently by a cross wind. The approach was to side-slip down the slope of a high hill, clipping the top branches of the trees, and slip her clean to the ground to counteract the effect of the cross wind. Eddie made one of the most difficult landings of the flight, and it is to his skill and credit that the side-swiping motion did no more damage than to wreck the already weakened tail fork.

Tight Corners

With the tail wheel repaired by an ex-naval officer (serving a life term for murdering his wife and her boy-friend), but still with a leaking gas tank and a Champion motorcycle plug in our number seven cylinder, we took-off at daybreak. We careened down the narrow runway before rising and turning the nose north for Port of Spain, Trinidad. Our course cut across the delta of the Orinoco, north of Georgetown, for three hundred miles of the worst flying country I have ever seen. The tropical forest is unbroken, except for muddy rivers, the estuaries of the Orinoco. There is neither habitation nor beach, nor any sort of place where an airplane could be put down, or its occupants seek succor should they survive the crash—an interesting observation, made silently by all of us, with attentive ears tuned to the motor. Ordinarily the valve stuck only once every eight hours. But rules are made to be proved by exceptions.

Rain and fog drove us out to sea as soon as we began to feel fairly comfortable about being over the worst of the hop. Here, with land a faint hazy line ten miles to our left, we had to dodge repeated squalls that were building up into a hurricane. Flying low, skimming ten to fifty feet over the water, we'd fly between the dark storm centers, blinded by rain even in these relatively calm areas, and tossed about by violent bumps.

As the southern coast of Trinidad loomed up through the mist, we could see that it was clearing in the north, while an apparently endless line squall was building up in the southern and western sections. However, Yancey determined to

(Continued on page 851)

Sidney, Rio and Sharks

(Continued from page 850)

brave the latter, as we had been informed that an excellent landing field existed in the neighborhood of the oil wells. And so we crashed headon into the worst bit of weather we had yet encountered.

Skimming over the palm trees, visibility was less than five hundred feet, the torrent sweeping back over the glass windows of the cabin like a tidal wave. We cut across the southwestern point of the island, and headed out to sea—over the Gulf of Paria, into fog and worse rain. With our wheels almost in the water, I personally figured it was a case of a friendly obit to “three goodwill fliers.” I grabbed a bundle of clothing and packed it between myself and the cabin gas tank to prevent the tank from going through my ribs in the event of a crash. Just then Yancey got his bearings, and ordered Burgin to cut into the right. As we picked up the shore line we found it still clearing to the north, and the sun was shining when we flew over Port of Spain. I tossed the bundle of clothes to the floor.

However, neither Burgin nor Yancey wanted to land at Queen's Park, and they decided to fly south again in search of the field near the oil wells—which, we found out later, never existed! So back we went, into the storm, with the motor spitting from rain in the carburetor, a quarter hour supply of gas in a fast leaking tank, and a valve just about due to stick after eight hours of flying!

Back we went, headlong into the torrential rain, and sure enough, thirty-five miles south of Port of Spain, the valve stuck! We picked out an old race track, soggy and overgrown with tropical foliage, and Eddie prepared to slip her in. I tossed all our baggage aft into the radio compartment, and Yancey climbed in after it—to get as much weight rear as possible and reduce the probability of the plane going over on her back as the wheels sank in soft stuff. Once more I placed the bundle of clothing where it would do the most good. Eddie slipped over a fence, stalled the plane, and pancaked. As the wheels touched, the tail raised, but dropped again as we slushed to a quick stop a hundred feet from the fence. Congratulations were much in order all around. The only damage was to the tail wheel fork. A new fork was forged in a local shop while we enjoyed the hospitality of the British operators of the oil wells.

We lay over in Port of Spain for two days, checking the motor and reaming one of the valve guides that had given us so much heartache. We painted on the fuselage the names of all our stops north of Rio. We took-off for Puerto Rico just before sunrise, Wednesday morning, the eighth of September, flying north through the somber pass known as the Dragon's Mouth. We flew up the Parabola of the Windward and Leeward Islands, watching each spot of land climb over the horizon as the last island sank beneath the sea behind us. Coming in south of the Virgin Islands, the ceiling dropped, and we dodged rain squalls north of Puerto Rico, heading into the Pan

American field at San Juan virtually out of the mist. Here our wheels touched American soil for the first time since the “Pilot Radio” rolled down the soggy turf of France Field, Canal Zone, some three months before.

As Burgin unstrapped himself, I gesticulated wildly to the right wing. The gas gauge has disappeared—along with the gas! How long we had been running on our imaginations, I don't know.

With the hole patched, it was exactly seven o'clock, Eastern Daylight Saving time, the next morning, when Burgin turned the plane around at the far end of the San Juan field, revved up the motor wide open, and let up on the brakes. The plane lurched forward, and picked up speed rapidly on a fast runway. As the pitot tube jabbed the wind, the airspeed needle swung over—40—50—60—70—80 miles an hour. Not sure what she would do with the load—the biggest we had ever taken-off—Eddie held her down, taking the whole field, and then zoomed her over the bay. Perhaps the old ship knew it was her last take-off, and bit the air like a pursuit plane, with a glorious toss of her droning motor.

From San Juan we skirted the north coast of Puerto Rico, hopping across the ninety miles of water to Haiti. Our next water hop was the sixty miles across the Windward Passage. We cut to the north at Guantanamo, heading for Sama on the north coast of Cuba. At 11:00 I crawled aft to the radio shack, let out the antenna, and after listening for a few minutes, called the Pan American station CMG, at Camaguay, Cuba, then about 250 miles west of us. We informed them that we were going straight through to Miami, without stop, and asked for a general weather report. He gave us the wx at Camaguay, and a report of probably fine weather over the Bahamas, clean in to Miami.

We heard several planes working WKDL, at Miami, but were unable to pick up WKDL for some reason. We called CMG again, requesting the exact wave of WKDL, but still no luck in picking him up, though CMG reported through to us that we were QSA at WKDL. Other Pan American stations, as far south as Trinidad, were coming in with good signal strength.

Shortly after noon, CMG shut down for work on his transmitter, and I transferred my attentions to CMM, at Bayamo, Cuba, then about one hundred miles to the southwest. At 1:25 we sent through the following position report to Miami, five hundred miles to the northwest.

“AT 1:00 15 MILES NORTH POINT SAMA HEADING FOR GREAT RAGGED ISLAND.”

At 1:51 we sent the following messages, also to WKDL.

“STANDARD OIL MIAMI ARRIVE ABOUT FIVE REQUIRE TWO HUNDRED GAS AND TEN STANAVO 140—YANCEY.”

(Continued on page 852)



New

Output Meter

(Constant Impedance
4,000 Ohms)

Weston Model 571

THIS OUTPUT meter is a portable instrument for measuring directly the output voltage of radio receivers.

It may also be used to compute power output of radio sets; to determine the maximum gain when lining up R.F. and I.F. stages or when a calibrated input voltage is applied to a radio set or to an audio amplifier; to determine the relative gain of tubes; to measure the comparative selectivity of R.F. tuners; to observe the period and percent of fading; and to approximately measure the relative fidelity of amplifiers such as used in theatres and public address systems.

Model 571 OUTPUT meter consists of a standard Weston Model 301 A.C. Voltmeter of the Rectifier type with a constant impedance of 4,000 ohms. Its five ranges, 1.5/6/15/60/150 volts, selected by means of a dial switch, are brought out to two binding posts. The instrument is enclosed in a sturdy black Bakelite case. Size: 5½ x 3½ x 2½ inches. Weight: 1 pound, 10 ounces.

Write for Circular RR

WESTON ELECTRICAL
INSTRUMENT CORPORATION

615 Frelinghuysen Avenue
Newark, N. J.



Sydney, Rio and Sharks

(Continued from page 851)

Read it! **AEROVOX** **Faradon** **Webster's** **Leak** **Leak** **Leak**

EXTRA **EXTRA**

AMERICAN SALES COMPANY

19-21 Warren Street NEW YORK CITY

Radio and Electric Wholesale Bargain Bulletin

Experimenters! Servicemen!
!! NOW READY !!

New Wholesale Catalog No. 66 full of real low prices on: Condensers, Transformers, Speakers, and other numerous items including replacement parts.

GET COPY NOW

Graybar Kolster Sylvania Edison Westinghouse Western Electric
Eaton Radio Shack Radio Shack Radio Shack
Powerizer Flechtrem Jewell

American Sales Company
44 West 18th St., N. Y. C.

DOES THE WORK OF A HIGH PRICED IRON

Just the iron you have been looking for!—a sturdy, practical electric soldering iron that does the work of larger types costing two and three times as much. Essentially the same as the Esico Industrial Irons used by U. S. Navy and leading radio and electrical factories. Makes soldering easy. Steady heat. Replaceable copper tip; nickel chrome heating element highest grade; 85 watt Mahogany handle, heat insulated. Wt. only 1 lb., length 12 in. Plug in any current. 6 ft. cord. Complete—\$2.75.

Send direct if your dealer can't supply you. Write for catalog.

ELECTRIC SOLDERING IRON CO., INC.
135 W. 17th St., New York, N. Y.

ESICO "Junior"

RADIO PARTS

We carry one of the largest stocks of standard and replacement parts in the country. Our prices are lowest and all orders shipped the same day as received.

SEND FOR CATALOG

SILMAN CO.
614-620 Grant Street
PITTSBURGH PA.

NEW KIND OF RADIO

New H-F-L Mastertone
—new in magnificence of tone—
—new in power with world-wide reach—
—new in quick tuning—
—new in sensitivity and selectivity with a station at every point on dial. A new price—America's finest radio at amazingly low cost. FREE Book explains all. Send for it and Special Offer now.

HIGH FREQUENCY LABORATORIES
A133, 3900 N. Claremont, Chicago

"ROY MARTINE MIAMI BEACH WILL ARRIVE ABOUT FIVE PAN AMERICAN AIRPORT—YANCEY."

These messages were sent direct to Miami, but, as I still could not hear WKDL, I received my acknowledgement through CMM. At 2:30 we sent through a TR to CMM that we were passing over Racoon Cay.

At 3:00, exactly eight hours after our take-off, one cylinder of the motor quit cold—undoubtedly a sticking valve. Hitting on only eight cylinders, the motor roughened. Burgin cut her down to about fifteen hundred r.p.m. to lessen the strain. I reeled in the antenna and went forward to ease the flying and for instructions. The situation was interesting. Out over the open ocean in a land plane, and with motor trouble! With a glance at his chart, Yancey told me to raise someone quickly, and I went aft again. CMM was my best bet, but to make sure of a reply, I interspersed the call with SOS. Before the roar of the dynamotor died down in my ear phones, CMM was back at me with a quick "K"—the first time, to the best of my knowledge, that an airplane distress signal was ever answered. I told him that we were having motor trouble, and the following messages went back and forth in quick succession:

"POSITION SIXTY MILES WEST SOUTHERN POINT LONG ISLAND."

"LAT 22 R 25 LONG 75 R 45 HEAD-ING GREAT EXUMA ISLAND."

"ALTITUDE 4000 FEET BUT LOS-ING IT AS MOTOR IS REVVED BACK."

"HOW FAR ARE YOU FROM THE ISLAND?"

"ABOUT FORTY MILES."

"HOPE YOU MAKE IT."

"SO DO WE."

"NAME OF ISLAND AGN PLEASE."

"GREAT EXUMA ISLAND—SOUNDS LIKE A SKIN DISEASE."

"WILL YOU REQUIRE AID?"

"SURE WILL IF WE GO DOWN ON WATER. AM GOING TO CHARGE BATTERY FOR A FEW MINUTES. PSE QRX THIS WAVE. WILL BE BACK SOON OR BEFORE ANY-THING HAPPENS."

"SHALL WE SEND OUT A PLANE FOR YOU?"

"DON'T KNOW WE MAY MAKE IT."

At twenty minutes after three Great Exuma Island crawled up over the horizon.

"ISLAND SIGHTED TEN MIN-UTES MORE TO GO ALTITUDE 1000 PRAYERS ARE IN ORDER."

"OK OM WE'RE PRAYING FOR YOU."

"DON'T TAKE ME SERIOUSLY YOU MIGHT SINK US ARE THERE ANY SHARKS AROUND HERE."

"HELL YES PLENTY."

"STILL LOSING ALTITUDE BUT THINK WE'LL MAKE IT."

"OVER LAND NOW EVERYTHING OK SEARCHING FOR LANDING PLACE WE WILL WORK YOU FROM THE GROUND IF WE DON'T CRACK

UP ISLAND INHABITED TOWN AT NORTH END."

But landing places were scarce—and so was time. Choosing among several beaches and a stretch of what looked like hard sand between a beach and a low hill, Eddie picked the latter, and signaled to me that he was landing. I sent through my last message to CMM.

"LANDING NOW SEE YOU TEN MINUTES IF OK."

I reeled in the antenna, opened all switches, and went forward. Again I threw the baggage in the radio shack, and again I hugged the bundle of clothes on my lap. Yancey went aft and braced himself. I, too, grasped the cross member above my head. I noticed that my hands were perspiring—I had been working like hell for the last half minute—and I figured I had better wipe them on my knees or they'd slip like a greased pig. At the moment, Eddie was slipping the ship, about twenty feet off the ground. I glanced down and the place looked better than ever. So I didn't bother wiping my hands, and I turned around to re-mark to Yancey:

"Hell, this is going to be a cinch."

Eddie straightened out the plane—she began to settle—the wheels touched—and the Atlantic Ocean poured over the motor and wind-shield. Things happened! There was a queer grinding noise, discordant cymbals and drums, two dull thuds, and I was lying on my back, on the top of the plane, with the spare parts, pistons, rings, valves, guides, valve springs raining down on me from under the seat I had been sitting on a split second before! Right in front of me, in the radio shack, Yancey was standing on his head. He had braced himself so well that he had gone over with the plane! I bent my head backward, and saw Burgin hanging upside-down from his safety belt, like a monkey on a trapeze. To my left, a half inch from my head were the storage battery and the dynamotor which had torn loose from the floor—now the roof. I understood the two thuds! Something salty—blood or acid from the battery I figured—was trickling down my face. I considered my probable disfigurement, until I realized that it was sea water, scooped up by the heater in the floor, now dropping down from above.

The door was jammed. Yancey, who had by now righted himself, crawled through the window and opened it from the outside, and we all slipped out upon the wing, none of us hurt beyond a few cuts, bruises and a general shaking up. We had landed in a swamp. Those smooth hard sands were two feet under crystal clear water! The wheels had not turned over once!

A few minutes later we had tossed some of our luggage from the plane, now filled with a foot of water, to a dry spot beyond the wing tip. As I sat on a bag, gazing mournfully at the "Pilot Radio," ignominiously on her back, I saw a puff of smoke rise forward, where the gravity

(Continued on page 853)

Electromagnetic Pickups

(Continued from page 849)

an adequate degree of movement between the poles. And on the dimensions of the working system of the pickup depend to a large extent the frequency characteristic and necessary stiffness of the device. Voltage requirements are a very important limiting factor in pickup design.

Characteristic Curves

An English magazine not so very long ago published curves of 30 different makes of pickups. These included a great variety of types. There were four-pole, three-pole and two-pole systems, there were rocker armatures, tongue armatures and needle armatures, there was nearly all the variety which the combined English, German and American markets afford in the way of pickup designs. But in spite of all this variety in construction, there was a surprising uniformity in the curves. Of course, many of the pickups were of distinctly poor design, so that they would be in any case ruled out of consideration, but as for the remainder, there was not one which stood out enough from the others to be worth bragging about.

Types of Pickups

In Fig. 5 is shown a sample of three of these curves. Each represents a distinct type of pickup. One is of the two-pole type, with a tongue armature, another is of the usual American type, and the third has a three-pole system. These three devices differ radically in construction, yet the frequency characteristics are nearly identical. One of the three shows a marked resonance peak, but this is due simply to light damping. As the damping buffers are usually adjustable in some way, it is possible for the user to regulate the amount of resonance to suit himself, so that one could, in fact, adjust most of the better pickups in such a way that there would actually be no material difference whatever in the frequency response. That is, assuming that the resonance points in all the devices used is located in the same region.

This fact emphasizes the point made above, that a pickup is essentially nothing but a damped vibrating reed operating in an electromagnetic system. There is no opportunity for the innumerable hills and dales which characterize loudspeaker curves. The pickup response may be analyzed into slope, trough, peak and cut-off. As it is difficult, for reasons above suggested, to obtain uniformly accurate pickup readings below a frequency of about 200, we may take this as a starting point. The ratio of the value at 200 to the value at the bottom of the trough is for pickups resonating between 3000 and 4000 usually about 2.5 to 1. The ratio of peak to trough is a matter of damping adjustment. This ratio should preferably be less than 2 to 1. This is the only factor which is subject to material variation. The cut-off point can be influenced only by changing the point of resonance.

Owing to the high output and low stiff-

ness generally required in this country, it has become the usual practice here to allow a very high resonance peak. American pickups generally have a characteristic about like curve 3 on the curve sheet we have just been considering. One effect of allowing considerable resonance is to broaden out the trough and to lower the 200 to trough ratio. The curve does not look very pretty, but it is considered the best compromise between stiffness and damping for the given voltage requirements. The trouble is that "stiffness" and damping are with present designs correlated. This is due to the use of rubber for damping purposes, which must be applied in quite heavy doses in order to obtain full damping. That is, when applied with sufficient pressure to eliminate the resonance peak, it renders the armature system stiff for the low frequencies. What is needed is a more selective damping substance, which would absorb the vibrations at the upper end of the scale, where resonance occurs, without greatly affecting the freedom of armature movement at the lower end.

Design Possibilities

It is of course obvious that the possibilities in pickup design have not been exhausted by the instances here cited. It is possible to design pickups with a single mountainous peak in the middle of the scale. Or one can make electrostatic pickups which have a drop in their characteristic almost directly proportional to the rise in frequency. But such possibilities are not desirable.

Sydney, Rio and Sharks

(Continued from page 852)

tank was located under the instrument board. One of our six tanks blew up before Yancey was altogether clear, blowing off the skin of his right arm. An hour later only a pall of black smoke, and what was left of the plane, marked the scene of our crash.

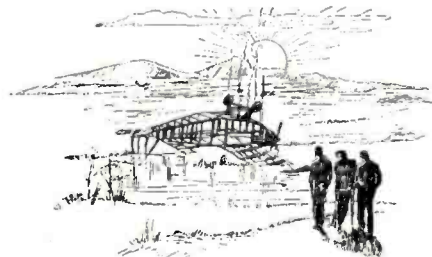

The skeleton of the plane still lies there on its back—black and rusty against Exuma's sands. May the tropic rains fall warm and sweet upon her.

Atterrizaje suave!



RCA INSTITUTES trains men in RADIO

MEN who need radio training . . . who wish to know all about radio servicing, operating, radio telephony and telegraphy and broadcasting can quickly obtain this valuable knowledge through RCA Institutes and its famous Home Laboratory Training Course.

*Radio Instruction by
America's Oldest and Foremost
Radio Training School*

You can study at home in your spare time or at any of the RCA Institutes resident schools throughout the country. Thorough and reliable training given you. As a student you also receive the complete RCA Institutes Laboratory Equipment . . . enabling you to easily solve radio problems at home in your spare time. This is the recognized way to speedily acquire the commercial knowledge and ability demanded in Radio today.

Free Book for Ambitious Men

Send for this free book . . . many pages of pictures and text giving full details about the Home Laboratory Training Course . . . the RCA Institutes Laboratory Equipment . . . RCA Institutes and the noted staff of instructors . . . that have helped thousands of men to make good in Radio.



RCA INSTITUTES, Inc.

RCA INSTITUTES, Inc.,
Dept. E.X.-3
75 Varick St., New York, N.Y.

Gentlemen: Please send me your big FREE book which tells about the many opportunities in Radio and about your famous laboratory method of radio instruction at home.

Name.....

Address.....

Occupation.....

EXCELLO RADIO



MIDGET Quadruple Screen Grid With Tone Control

This beautiful Excello Radio assures excellent reproduction—perfect in tone quality.
Complete catalog free on request

EXCELLO
PRODUCTS CORPORATION
4832 West 16th St. Cicero, Illinois

F R E E



We have just issued our new "RADIO SERVICE TREATISE." It's red hot all the way through. 52 new hookups and circuit diagrams. 110 illustrations. Partial contents: Modernizing old radio sets. How to convert battery to power sets. Selection of tubes. The detector tube. The power tube. Changes in grid or "C" bias circuits. Push pull amplifiers. Replacing audio transformers. Phone attachments. How to

choose power transformers. Voltage dividers. Wattage of power transformers. Selecting and installing replacement parts in radio sets. Filter condensers. Repairing "R" eliminators. ALL BRAND NEW DOPE—NOT A REPRINT. Send 2c postage. Catalog yours by return mail.

RADIO TRADING CO.
27 West Broadway, N. Y. C.

MASON, FENWICK & LAWRENCE
PATENT LAWYERS
Court Practice Washington, D. C.
Established 70 years. Send sketches.
Electrical, Aeronautical, Refrigeration and Chemical Inventions carefully handled. Practice before the U. S. Courts and the Patent Office. Prompt and careful service. Write us. Protect your inventions.
TRADE MARKS REGISTERED

MILLION PARTS

Farrand Inductor Dynamic Unit.....\$1.59
Coil for above as replacement, also a very good (300 ohm) R. F. choke......25
Paper for inductor speaker......20
Experimenters, repairmen ask for new Price List
EXPERIMENTERS RADIO SHOP
129 West Street New York City

All Radio Is Not Broadcasting

(Continued from page 831)

ments at Berne, channelling, etc., will no doubt be dealt with further by the next International Conference scheduled to be held at Madrid in 1932. It is somewhat of an undertaking to revise or change the world-wide regulations, ordinarily requiring five years, but the representative radio engineers and Governmental officials of this country are taking a leading part and great progress is being made.

Following the Washington Radio Conference of 1927, presided over by President Hoover, then Secretary of Commerce, and attended by General Saltzman, now Chairman of the Radio Commission; and the late Admiral Bullard, a former Chairman, came the first technical committee meeting at the Hague in 1929. The next or second session of that committee will be held in 1931 at Copenhagen, prior to the International Radio Conference at Madrid the following year. The third C. C. I. R. committee meeting will be held at Rome in 1933.

As all international regulations are based upon treaties, changes in which may only be initiated by the conference itself, it is seen that the Treaty of 1927 may not be changed or amended until the Madrid Conference in 1932—five years later.

The art of radio communication is fast developing, the need for more channels is being manifest already and some jealousy exists among nations. Generally the world's quota list is already more than four hundred per cent over subscribed, and yet each country is finding need for additional commercial channels, consequently the International Bureau at Berne, charged with listing assignments by countries is kept awful busy. The bands of carefully specified and separated channels cannot well be extended. All services are becoming crowded. The practical spectrum cannot now be further expanded. Therefore, the channels must be placed closer together, improved and efficient operation maintained, and definite regulations promulgated to the end that enough stations may operate in general public interest to make for better international contacts and understanding through quick and reliable communication.

There is another public radio service besides that of public trans-oceanic or international communication; namely, public point-to-point domestic service, under which stations located within the confines of the United States communicate with other similarly located stations, paralleling to a large extent the well-known wire systems of the telegraph and telephone companies. These services have come into being only recently, but today there are several companies offering such domestic radio service and a few others are contemplated. Among the companies operating these circuits are: Mackay, RCA Communications, Globe Wireless and Tropical Radio. The Inter-city Radio Telegraph Company has cases pending in court.

(Continued on page 856)

DEALERS AND SERVICEMEN SEND FOR IT

Write for Your FREE Copy of this BIG Catalog 40 PAGES OVER 1000 ITEMS OF REPLACEMENT PARTS FOR ALL STANDARD SETS

Federated Purchaser
20 Hudson Street New York City

WANTED MEN
To Manufacture Metal Toys and Novelties

Big demand for 5 and 10c store Novelties, Ashtrays, Toy Soldiers, Animals, Auto Radiator Ornaments, etc. We cooperate in selling goods you make; also buy these from you. Small investment needed to start and we help you build up. WE FURNISH COMPLETE OUTFIT and start you in well-paying business. Absolutely NO EXPERIENCE and no special place needed. A chance of a life-time for man with small capital. Write AT ONCE if you mean strictly business and want to handle wholesale orders now being placed.

METAL CAST PRODUCTS COMPANY, Dept. 12
1696 Boston Road, New York City

TYPewriter 1/2 Price

Save over 14-Rock Bottom Price on all standard office models—Underwood, Remington, Royal, etc.—Easiest terms ever offered. Also Portable at reduced prices.

SEND NO MONEY
All late models completely refinished like brand new. Fully Guaranteed. Sent on 10 days' trial. Send No Money. Big Free Catalog shows actual machines in full colors. Greatest bargains ever offered. Send at once!

10-day Trial
231 W. Monroe St. Dept. 393, Chicago

International Typewriter Exch., Dept. 393, Chicago

In March AMAZING STORIES

THE THING THAT WALKED IN THE RAIN, by Otis Adelbert Kline. Although discussion on glands has passed the "parlor fad" period, the subject continues to be of enormous speculative interest to scientists who are interested particularly in endocrine and thyroid glands. Much has recently been established as fact in the field of possibilities, but the science of glands is still in its infancy and much can be expected in the near future. Our well-known author hardly needs any introduction to our readers. Apparently he has made a study of his subject, and he gives it to us in a most delectable manner.

ON THE MARTIAN LINER, by Miles J. Breuer, M.D. Mysterious offenses will undoubtedly not stay confined to the earth, when space-travel, or even air-travel, has gained its logical advancement. Detectives, too, will find a new sphere for their activities.

THE VALLEY OF TITANS, by L. A. Eschbach. The many hundreds of our readers who have been clamoring for more of Merritt will welcome this scientific fiction gem, so reminiscent of Merritt, which goes once more, though in an ingeniously new way, into the possibilities of ruling intelligences that are not housed in what we know as the human body.

THE EARTH'S CANCER, by Capt. S. P. Meek, U.S.A. Our well-known author is obviously not immune to the all-prevalent interest abroad in the subject of this malignant disease. Far from being a medical treatise, Capt. Meek's offering is an absorbing tale based on the definite findings of our medico friends who devote their lives to the study of this subject.

TELEVISION HILL, by George McClord. (A Serial in 2 parts) Part II. Here's a subject for competition! Will we travel to the moon and the other planets of our universe or will we get our first-hand information first through television? There is no doubt about it! "Television Hill" is extremely thought-provoking.

AND OTHER SCIENTIFIC FICTION.

Navy's Communication Reserve

(Continued from page 798)

perfect copy that they can make. These copies are sent to the American Radio Relay League at Hartford, Connecticut, where they are tabulated and classified and in due course, the names of the twenty-five winning amateurs are announced and each of these receives a personal letter of appreciation from the Secretary of the Navy.

The mission of the Naval Reserve is to procure, organize and train the officers and men necessary in the event of war or national emergency for the expansion and operation of the United States Fleet and Naval Transportation Service. The mission of the Volunteer Communication Reserve is to procure, organize and train the officers and men necessary for the expansion and operation of Naval Communications in the event of war or national emergency. Those men who have become members of the Communication Reserve and are giving their time and effort, no matter how limited, are preparing themselves in time of peace for desirable assignments at some future time when they may be needed. In the meantime, I know of no greater pleasure than participating in the radio drills and contacts of the Communication Reserve. I believe it is safe to say that we have on our rolls at the present time at least a thousand or more of the most prominent amateurs and best qualified operators in this country.

No one can help but get a thrill from listening to the various control stations answer the roll call during the national emergency drill. They are called one at a time beginning with stations in the State of Maine and progressing down the

The Navy Department upon its part appreciates very highly the splendid interest and service that is being given and is cooperating with the Communication



One of the portable "radio station" trucks of the U. S. Naval Reserve

Reserve in every possible way. To quote Captain S. C. Hooper, U. S. Navy, Director of Naval Communications. "The Navy is proud of the fine work being done on a voluntary basis by our Communication Reservists."

"The Mighty Mite"

(Continued from page 846)

List of Parts

- 2 Hammarlund mica midget balancing condensers, 90 mmfd. capacity (C4A, C5A).
- 1 .00025 mfd. variable condenser, United Scientific Laboratory or equivalent (C1).
- 2 audio-frequency transformers, type 260A Silver-Marshall or equivalent size (T1, T2).
- 6 four-prong type 216 Pilot sockets (V1, V2, V3, V4, V5, V6).
- 2 tuning coils to specifications (L1 and L2).
- 4 intermediate-frequency coils, to specifications or Blan Radio (if manufactured coils are used remove 10 turns from two coils for L4 and L5 and 80 turns from another for L6) L3, L4, L5 and L6.
- 2 r.f. chokes. 80 millihenry, Pilot neutro-cap or equivalent (RFC1 and RFC2).
- 1 r.f. choke. 90 millihenry. National Company or equivalent (RFC3).
- 5 by-pass condensers, .5 mfd., Aerovox type 260 or equivalent (C8, C9, C10, C11, C12).
- 2 moulded mica condensers, .00025 mfd., Aerovox or equivalent (C2 and C6).
- 1 moulded mica condenser, .0005 mfd., Aerovox or equivalent (C7).
- 3 midget moulded mica condensers, .0005 mfd., Aerovox or equivalent (C3, C4, C5).

(Continued on page 860)

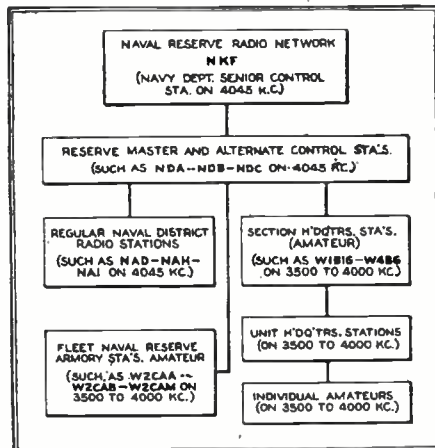

This chart is illustrative of the organization of the Naval Communication Reserve

Atlantic Coast, across the Gulf, up the Mississippi Valley from the Great Lakes through Missouri and Oklahoma to the West Coast and thence through California to the State of Washington. Stop and think what this means. These officers and men are in this organization because of their love of radio and the thrill that they get from the service.



No. 245-A

Set and Tube Tester

Newly designed to meet the servicing needs of all types radio receiving sets. Used by experts. Adaptable for every kind of socket test. Also continuity of circuits, a.c.—d.c., and all tubes including screen-grid and rectifier. Checks line voltage. Charts for resistance and capacity with full instructions furnished. Accurate. Compact. Simple to use. Durable steel case finished in beautiful baked enamel.

\$12 NET to No. 245-A
 Dealer No. 400
 \$20 List Each
If not at your jobber's we will ship direct

Readrite



No. 400

Counter Tube Tester

A new tester that gives dealer and customer the required tube value information. Mutual conductance test all tubes, including the new 2-volt tubes. Simple to use. Accurate. Dependable. Connects to A.C. supply. Attractive baked enamel finish. All parts shielded. Complete with up-to-date tube chart.

Send for catalog. Order your testers now.

Readrite Meter Works

Established 1904

19 College Ave. Bluffton, Ohio

"How to Make It"



FREE!

With 6 Months of

Science and Invention

All for Only \$1.00

Here's just the book you've been waiting for. "HOW TO MAKE IT—WRINKLES, KINKS, FORMULAS"—the complete all-around guide for practically every kind of repairing and construction. A common-sense aid to the man or boy who feels the urge to see useful finished articles take shape as the combined result of skillful hands and brain!

HERE are new thrills awaiting you—the thrills that come from making and doing things you can take pride in! Here, also, is real recreation and profit!

Breakfast nooks—Fireplaces—Cedar Chests—Modernistic Sideboards—Blow Torches—Auto Accessories—Decorative Lighting Fixtures—Garden Fountains—Wood Lathes . . . whether it's carpentry, plumbing, masonry, electricity, "HOW TO MAKE IT" will tell you what to make and do—and how!

Hundreds of things for your car, for making your home more beautiful and comfortable, for broadening the facilities and usefulness of your own work shop!

Whether it's repairing or working in metals, concrete, woods, stains, paints, piping, or what have you—this handy book, the work of our expert mechanics and engineers, tells you exactly how, in simple English and with scores of clear pictures, diagrams and plans.

A Gift to You from Science and Invention

We are offering you this unusual volume free—with an introductory trial subscription to Science and Invention—the magazine of fascinating fact! In no other magazine will you find such an array of absorbing, authentic, thrilling information from all fields of popular scientific achievement.

New developments in radio—in aviation—in all the crafts from the four corners of the earth! A complete survey of the needs in industry and science, with the latest news and description of what has already been accomplished. A "made-to-order" guide and starting point for the experimenter and

the seasoned inventor. *Science and Invention is the only magazine of its kind!*

And a Big Cash Saving!

Amateurs and experts in all lines—hundreds of thousands of them, have bought this "How to Make It" book at a substantial price—and thousands of others have subscribed for Science and Invention without thought of a gift.

BUT—We have arranged to ship you this useful book, postpaid, *absolutely free of charge*, and at the same time we will enter your subscription to Science and Invention six full months (regular value \$1.50) for only \$1.00. *But don't delay!* To get the book FREE and six big issues of Science and Invention at a 33 1/3% saving over the single copy cost, mail the coupon while we still have enough books on hand!

Send for Your FREE

"How to Make It" Book—TODAY!

SCIENCE AND INVENTION, Dept. 2403
381 Fourth Avenue, New York, N. Y.

Gentlemen: Ship me, ENTIRELY FREE, prepaid, the valuable handy book, "HOW TO MAKE IT—WRINKLES, KINKS, FORMULAS"—and enter my subscription for the next six big issues of SCIENCE AND INVENTION at only \$1.00 which I enclose.

Name

Address

City and State

All Radio Is Not Broadcasting

(Continued from page 854)

Stations of this type are assigned channels lying in the so-called "Continental Band," or frequencies between 1500 and 6000 kilocycles and to a lesser extent in the low frequency band of 165-195 kilocycles. There are one hundred and forty-five fixed service channels in the "Continental Band" and most of them are used here, in Alaska or the Hawaiian Islands. The channels allotted to these fixed services may be observed in General Order 74, and in the Commission's Annual Reports for 1929 and 1930.

Four cases now before the Court of Appeals of the District of Columbia are of especial interest to those concerned in, or contemplating entry into, what we may term domestic, public radio services. These appeals arose from decisions of the Commission refusing to license certain stations for point-to-point service in Continental United States; arguments are expected to be heard in the near future and decisions of this court are expected to clarify the situation. In the meantime, however, the Commission is restrained from opening up this type of service as extensively as was expected. The appeals include those of the Intercity Radio Telegraph Company, Wireless Telegraph and Communications Co., RCA Communications, Inc., and Mackay Radio and Telegraph Co.

Certain other appeals before the same tribunal include those of alleged private as against public interest, and indicate that the Commission does not intend to grant licenses to private individuals or companies for their own use.

In view of these pending cases, the Commission has made only minor changes in assignments in the band reaching from 1,500 to 23,000 kilocycles.

The use of certain of the trans-oceanic channels above 6000 kilocycles has been authorized for domestic communication in instances where such use will not cause interference with the systems of other countries. This has enabled some of the trans-oceanic companies to communicate over long distances, such as coast to coast in this country. During the past year the band above 23,000 kilocycles was opened for commercial service to United States stations for the first time, when the Mutual Telephone Company of Hawaii was authorized to use channels between 34,000 and 54,000 kilocycles for radio telephone service in the islands.

Other services of the fixed class are emergency service, granted to power and light companies wherein one frequency is used jointly, with a limit of 500 watts power. These circuits are used only when other means of rapid communication fail. There are now some forty stations of this type licensed. A few channels have also been allocated to the agricultural interests, but to date only the California State Marketing Association has opened such service.

(Continued on page 857)

Frequency Measurements and Meters

(Continued from page 782)

Referring again to the circuits of Figs. 6 and 7 it will be noted that the plate voltage is *less* than the screen-grid voltage. It is only under such conditions that the negative resistance effect is obtained. Some curves, on the type -24 tubes, taken from a recent *General Radio Experimenter*, illustrated this point. These curves, given in Fig. 8, show that with a screen-grid voltage of 75 that the plate current *increases* as the plate voltage is *decreased* over a range in plate voltage from about 10 to 40 volts. With screen voltages of 75 the plate voltage should therefore be about 20 or 30 volts; screen voltages of 67 require plate voltages of not more than about 20 or 25 volts. Slight changes in voltage can be taken care of in the circuits of Figs. 6 and 7 by always adjusting the 2,000 to 3,000-ohm potentiometer R to give the same reading on the 10 ma. meter M connected in series with the screen grid.

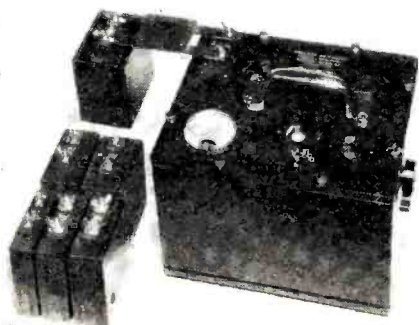

A General Radio Company precision wavemeter

In using the oscillating wavemeter circuits we must depend upon beat notes for indications. To determine the frequency of a signal the oscillating wavemeter can be brought near the receiver and the wavemeter dial varied until zero beat note is obtained between the signal and the current from the wavemeter. Under such conditions the wavemeter's frequency is the same as that of the signal. To check a transmitter the signal from the transmitter can be picked up on a monitor (described later) and the oscillator wavemeter adjusted to zero beat with the transmitter signal.

Undoubtedly, the best standard of frequency which the experimenter, the short-wave experimenter particularly, can use is a quartz crystal whose fundamental frequency is known. A quartz crystal when placed in a circuit such as that indicated in Fig. 9 will generate not only its fundamental frequency but additional harmonic frequencies as high or even higher than the twentieth. All of these harmonics of course bear a fixed relation to the fundamental frequency of the crystal. The second harmonic has a frequency exactly twice as great as the fundamental. The third harmonic has a frequency three times the fundamental, etc. If an oscillating receiver, the old stand-by

three-circuit tuner for example, is placed near the crystal oscillator a number of beat notes or heterodyne whistles will be heard in the phones connected in the plate circuit of the oscillating receiver. These whistles or beat notes are due to the fact that the currents being generated in the receiver are beating with the currents being generated by the crystal. As the frequency of the oscillating receiver is brought near that of the crystal (or any of the harmonics of the crystal) a high-pitched note is heard and, as we continue to tune the receiver this note gradually decreases in pitch until it reaches zero and then again begins to increase.

Because of the many harmonics generated by a quartz crystal oscillator it can be used very effectively in calibrating wavemeters. For example, suppose we set up apparatus as shown in Fig. 10 where we indicate the crystal oscillator, a single-tube oscillating receiver with a milliammeter M in the grid circuit and the wavemeter to be calibrated. The receiver circuit constants should be such that the set can be made to oscillate at the fundamental frequency of the crystal and, by listening in the headphones as the set is tuned, this frequency can be found by a beat note which will be very loud. If the coupling between the crystal oscillator and the receiver is too close this beat note will not gradually go to zero but will "pull in" and it will be difficult to find the exact setting for the tuning condenser on the receiver. The remedy of course is to increase the separation between the crystal oscillator and the receiver until a very smooth beat note is obtained, which will permit the tuning condenser on the receiver to be accurately adjusted to zero beat note. Now bring the wavemeter to be calibrated within a short distance of the oscillating receiver. At the same time we should listen on the headphones

(Continued on page 858)

All Radio Is Not Broadcasting

(Continued from page 856)

An up-to-date list of all effective General Orders was printed in an article in the January issue of *RADIO NEWS*, but since then the following have been issued:

- 98—Broadcast studio requirements, amending G. O. 28.
- 99—Aeronautical regulations, repealing G. O. 94.
- 100—Marine Relay Regulations.
- 101—Extension of Point-to-point and other licenses until Spring of 1931.

Another valuable source of pertinent information is the monthly *Radio Service Bulletin*, which publishes all Federal Radio Commission orders, corrections to call letter lists, new assignments and records all radio stations licensed. It also contains many items of information of value to the radio-minded public.

MEN WANTED 20 to 35 years old

RADIO

First Lesson Free!

Broadcasting
Television
"Talkies"
Manufacturing
Service
Sales
Auto-Radio
Aviation

See how easy
to learn

See how quickly you can get ready for well-paid positions in fastest growing, most prosperous industry.

Big demand *right now* from employers for broadcast operators, testers, inspectors, service-men, designers, installers, and "trouble-shooters".

\$40 to \$75 a week — and more!

With free radio lesson we'll send you our amazing combined training and employment agreement—good for help in securing a beginner's job *when you're only half way through*. Guarantees you help in finding a position, satisfactory in salary, after you finish, or money refunded.

**A World of Opportunities
to Choose From**

Rockefeller is building a \$500,000,000.00 "radio center" in New York. 20,000 movie theaters have gone "talkie". Auto-radio is selling like wild-fire. Midget sets are selling at rate of 10,000 a day! Aviation, television, servicing, sales—all these mean highly paid jobs and plenty of them. All you need to get one is the kind of training we give you, backed by a real placement service.

**Lesson FREE!
Mail Coupon**



**RADIO TESTER
GIVEN**

\$20.00 set analyzer and trouble-shooting job-tickets a part of this training without extra charge.

for free radio lesson and book of thrilling facts about this wonder-industry and how to "break in."

**American School
Dept. R-380, Drexel Ave. &
58th St., Chicago**

**THE AMERICAN SCHOOL
Dept. R-380, Drexel Ave. & 58th St., Chicago**

Please send without cost or obligation, free radio lesson and job ticket and radio bulletin.

Name.....Age.....

St. No.....

City.....State.....

Radio's Biggest Values

Up-to-the-minute offerings at lowest wholesale prices. Includes new—4 Tone Control, Screen Grid Superheterodyne, Radio-Phonograph combinations, short wave receivers, automobile radios. Public address, attractive walnut consoles and latest accessories, parts and kits. Don't buy until you see our big catalog.

**Send for
FREE
Complete
Catalog**

**Western Radio Mfg. Co.
128 W. Lake St. CHICAGO**

WORLD-WIDE SHORT WAVE RECEIVER

ONLY \$6.45
Span the World with this Set!
 A new radio thrill for you! Listen in DIRECT to London, Paris, Berlin, Buenos Aires and other broadcasting stations throughout the world via short waves. Enjoy unique foreign programs from strange lands. Your ordinary receiver cannot tune in these low wave stations. **WORLD-WIDE RECEIVER** gets 14 to 550 meter stations with surprising clarity. **SEND NO MONEY!** Just write your name and address on a postcard and ask us to send you this wonderful guaranteed short wave set. Pay postman \$6.45 plus a small delivery charge. All orders West of Rockies must be accompanied by \$1.00 deposit. Foreign countries must remit in full. Order today!

NEW RADIO BARGAINS
 Low Power Transmitter adaptable for phone or code. With plug-in coils \$14.75
Auto Radio—Uses 3—224, 2—227 tubes and 1—245 power tube, single dial, tremendous volume. Compact. Fits any car. We guarantee this set to perform better than sets selling up to \$150.. 20.00
B Eliminator, Bone Dry, with 28u tube, 180 volts, will operate up to ten tube set, fully guaranteed. 6.75
AC—A B C power packs 8.75
 Tubes: UX type, 30-day replacement guarantee, No. 210, \$2.25; No. 250, \$2.35; No. 281, \$1.85; No. 245, \$1.25; No. 224, \$1.25; No. 227, 75c; No. 226, 65c; No. 171, 75c.
 International Microphone, two-button, for public address systems and transmitters, speech or music \$9.75
WRITE FOR BARGAIN CATALOG
CHAS. HOODWIN CO.
 4240 Lincoln Ave., Dept. C-3, CHICAGO

RADIO OPERATORS and STUDENTS



Learn Code quickly at home through Junior Course Scientific Code instruction, or DOUBLE Code and Typing Speed through Advanced Course and Radio-Touch Typewriting. We've trained thousands during our 19 years as only Code Specialists in field. You receive personal instruction from Mr. Candler, world's leading authority whose original methods have developed fastest operators, including former champion, T. R. McElroy whose speed was 59 wpm. We help "ticket" quickly, easily and inexpensively. Write TO-DAY for particulars.
THE CANDLER SYSTEM CO., Dept. N-3
 6343 So. Kedzie Ave., Chicago, Ill.

\$375 **RCA SPEAKER CHASSIS** **FREE**

Identical chassis as used in R. C. A. Model 100B and 103 magnetic speakers. Note built-in output transformer—huge magnet—self baffling metal housing. Delivers great volume without rattling or distortion! 9" diameter—4 1/2" deep.

SEND FOR THIS BOOK **JUST ISSUED**

REAR SET ANALYZER—TUBE TESTER
 Resembles in appearance and construction most expensive and most elaborate testers. Tests (push-button principle) 0-7, 0-150v. A.C.; 0-20, 0-100 D.C. mills.; 0-10, 0-50, 0-500, D.C. Volts. Tests all type tubes. Complete with continuity test cables, other test leads, clips, leatherette case 7 1/2" x 9" x 3".
RADIO SURPLUS CORP.
 56 N. Vesey St. New York

TRY IT 30 DAYS FREE BEFORE YOU BUY
 Factory to you. Save to 50% on latest Screen Grid Electric or Battery Radio. Get 'Send No Money Offer.'

MIRACCO Radio
 Amazing bargains direct from big, old reliable factory. Don't buy unless 30 days' use proves entire outfit unbeatable at up to twice our price for tone, selectivity, distance, power. 1 yr. guarantee. **FREE!** Send for BIG SPECIAL catalog.

SUPER Screen Grid \$49.99
 Complete See tubes

Midwest Radio Corporation
 11th Successful Year
 804-DM, Miracco Dept., Cincinnati, Ohio

Frequency Measurements and Meters

(Continued from page 857)

to determine if the tuning of the wavemeter is affecting the frequency being produced by the receiver. If such an effect is taking place a beat note will be heard as the wavemeter is brought near the resonance. For most accurate results it is essential that the wavemeter be placed far enough away from the oscillating receiver that the receiver keeps to zero beat with the crystal as the wavemeter is tuned through resonance.

If the tests are carefully made it will be possible to very accurately adjust the dial on the wavemeter to the point corresponding to that at which the meter in the grid circuit of the receiver shows a dip. Since the receiver had been previously tuned to the fundamental frequency of the crystal oscillator it follows that this point on the wavemeter corresponds to the frequency of the crystal.

Now, as we listen carefully in the headphones the r.f. being produced now by the oscillating receiver should gradually be increased—which means that the dial will have to be turned in a direction such as to decrease the capacity of the tuning condenser. Another beat note will be heard which will be due to the beat between the oscillating receiver and the second harmonic of the crystal and at the point of zero beat the receiver will therefore be oscillating at a frequency exactly twice the fundamental frequency of the crystal.

The procedure then is to again bring the wavemeter near the oscillating receiver and adjust the wavemeter dial until a dip is obtained on the meter in the receiver circuit. This gives a second point on the wavemeter calibration. We then proceed to tune the oscillating receiver to the third harmonic of the crystal, then the fourth, fifth, etc., each time finding the corresponding point on the wavemeter.

harmonics of the crystal. But such calibration points will not fall in line with the other points previously obtained and in this way the errors can be detected. After the main points have been plotted, intermediate points can be obtained by making use of these beats between harmonics of the receiver and crystal.

It may soon be found that the receiver can no longer be tuned so as to make its fundamental correspond with the desired harmonic of the crystal, thereby making it necessary to change coils in the receiver. The change in coils is accomplished without difficulty by noting the point where the preceding harmonic was tuned in on the wavemeter and then adjusting the receiver with the new coil so that its frequency corresponds to this last point on the wavemeter. This, of course, necessitates some overlap in the ranges of the various coils used in the receiver.

In calibrating wavemeters the procedure is somewhat simpler in that we need merely to pick up the desired crystal harmonic on the receiver and then adjust the dial of the oscillating wavemeter to give zero beat note with the crystal signal. Such tests are best carried out with the receiver in a non-oscillating condition.

The crystal circuit by itself is of course an excellent wavemeter and it finds general use in modern broadcast stations not using crystal controlled transmitters. In such stations a crystal oscillator perhaps with headphones or an audio amplifier coupled to the plate circuit is used so that the beat note between the transmitter and the crystal can be heard. The transmitter can then be held to a frequency that will give zero beat.

The amateur not only has to assure himself by means of some frequency

(Continued on page 859)



A piezo-electric oscillator, a device which maintains constancy of frequency

High-Voltage Paper Condensers

A line of high-voltage paper dielectric filter condensers for more severe operating conditions than those encountered in the usual broadcast receiving circuits, is announced at this time by the Dubilier Condenser Corporation of New York City. These condensers are being adopted largely by various laboratories, universities, radio tube manufacturers, makers of public address system equipment, and others who require the highest quality condensers in obtaining dependable results. The present Dubilier high-voltage capacitors are provided with special insulated terminals to insure perfect insulation on high-voltage operation. They are available in 2 and 4 mfd. capacities at 600 volts D.C.; 1, 2 and 4 mfd. at 1000 volts D.C.; and 1 and 2 mfd. at 2000 volts D.C.

It is best to plot calibration curves of the wavemeter as each point is obtained and if the measurements are correctly performed a smooth curve will be obtained. Incorrect points on the wavemeter may be obtained due to adjusting the receiver such that one of the harmonics it generates beats with one of the

Frequency Measurements and Meters

(Continued from page 858)

meter that his transmitter is operating within the desired amateur band but also that its note is clean. This necessitates that the amateur be able to listen to the signal being sent out by his own transmitter and has brought about the design of a number of small units generally termed monitors. A monitor consists essentially of a simple single-tube receiver mounted inside a shield and placed so that it picks up only a moderately strong signal from the transmitter. By means of a pair of headphones connected to the output of this small monitor receiver the operator is thereby enabled to listen to his own transmitter. Shielding of the monitor receiver is essential in practically all cases since otherwise the signal impressed on the monitor receiver would be so great as to block it and nothing but a series of thumps would be heard in the phones. The circuit of a simple monitor receiver is shown in Fig. 11 and it will be noted that all the apparatus, including the batteries, is placed inside the shield. In some cases it may be found that the phone cords pick up quite a bit of r.f. and then it will be necessary to shield the phone cords also.

It is not essential that the monitor have the frequency stability and permanence of calibration required of a wavemeter. The monitor is merely used as a check on one's own transmission and it is not a matter of serious importance if it requires some slight adjustment each day.

In many cases it is a good idea to arrange for a double-pole, double-throw switch so that the phones may be connected either to the short-wave receiver or to the monitor. In this way a quick change over can be made from one to the other and all transmissions can readily be monitored; should anything go wrong with the transmitter or antenna to cause a frequency to change, the trouble is immediately apparent.

The Service Bench

(Continued from page 829)

Improving the Bass on the 33 and 41

The lower frequencies may be emphasized on these models by inserting a condenser of suitable size between the plate of the first audio tube and the chassis ground. A .004 mfd. condenser is about right. If desirable, a switch can be installed in one of the leads, so that either tone may be selected. The higher value the condenser, the more the bias.

Bug Chasing in the 44 and 46

Oscillation is generally caused by dirty shield joints. This refers to both tube and r.f. coil shields. These shields must be on tight, and the clamps must fit

(Continued on page 863)

Designers of the Sextet Special described in the February RADIO NEWS

introducing

the new Duraum Superheterodyne—the Magister circuit improved! Available in kit or laboratory-wired form.

The Duraum is an A.C., 6-tube, single-dial tuner, with a 245 push-pull audio with a cast-aluminum chassis and perfectly shielded.

Made by Duraum Radio Corporation—specialists in radio receivers.

DURAUM RADIO CORPORATION
135 Liberty Street New York City



ALL PROGRAMS Are Good With a FILTERMATIC FOR ALL RADIOS

ONLY \$1.00 POST PAID

Entirely Automatic
No Botherome Tuning
Improves Tone—Reduces Static
Brings in Distance
Increases Volume
Prolongs Life of Tubes
Separates Stations

Send Cash or P. O. Money Order

Satisfaction Guaranteed or Money Refunded

AND NOW!

THE SUPER-FILTERMATIC \$2.00 POST PAID
AERIAL OF THE FUTURE

The Filtermatic Mfg. Co. wishes to introduce a remarkable invention named the SUPER-FILTERMATIC, which takes the place of all present type Aerials, in addition to having all the wonderful features the Filtermatic has, such as improving tone, reducing static, bringing in distance, increasing volume and separating stations. The SUPER-FILTERMATIC will never wear out due to its rugged construction. It is very compact measuring only 1 1/2 x 2 inches, is absolutely non-directional, non-corrosive. It does not connect in the light socket; all A.C. hum and line noises are eliminated. It is easy to install (one minute time required), no tools needed, once installed no further attention required. It is the equivalent of an outside aerial 75 feet long and 50 feet high, more than sufficient for the modern set. The SUPER-FILTERMATIC is being introduced at the special low price of only \$2.00 postpaid. Satisfaction guaranteed or money refunded. Just stop and think, of the trouble and expense the Super-Filtermatic will save, if used to replace the expensive, unsightly, dangerous outside aerial. THE SUPER-FILTERMATIC IS THE AERIAL OF THE FUTURE.

SERVICE Men & Dealers Write for Our Attractive Offer

FILTERMATIC MFG. CO., Dept. B-10
4458 Frankford Ave. Philadelphia, Pa.



Tallest Hotel in the World

46 Stories High

Chicago's
MORRISON HOTEL

Corner Madison and Clark Sts.

The Morrison Hotel is closest in the city to stores, offices, theatres and railroad stations. All rooms are outside with bath, running ice water, bed-head lamp and Servidor.

1,950 Rooms—\$2.50 Up

Write or Wire for Reservations

A BIGGER JOB—and YOU'RE THE MAN

Are you hunting a bigger job, or does the bigger job hunt you? Why waste years learning through routine work, when you can acquire in your spare time in a comparatively few months the experience and specialized knowledge which bring promotion and salary increase? Thousands of men have increased their incomes by home-study business training under the LaSalle Problem Method. Let us show you how you can do just as well or better. The coupon will bring you complete information about our "experience training" in the business field you check, together with details of our convenient payment plan. Make your start toward that bigger job today.

ing under the LaSalle Problem Method. Let us show you how you can do just as well or better. The coupon will bring you complete information about our "experience training" in the business field you check, together with details of our convenient payment plan. Make your start toward that bigger job today.

Find Yourself Through LaSalle!

LA SALLE EXTENSION UNIVERSITY, Dept. 394-R, CHICAGO

Please tell me about your salary-increasing plan for my advancement in the business field checked. Send also copy of "Ten Years' Promotion in One," all without obligation.

- Business Management
- Modern Salesmanship
- Higher Accountancy
- Traffic Management
- Railway Station Management
- Law: Degree of LL. B.
- Commercial Law
- Industrial Management
- Modern Foremanship
- Personnel Management
- Modern Business Correspondence
- Expert Bookkeeping
- C. P. A. Coaching
- Railway Accounting

- Business English
- Commercial Spanish
- Effective Speaking
- Banking and Finance
- Telegraphy
- Credit and Collection Correspondence

Name _____
Street & Number _____ Town _____ State _____

Read Classified Advertising—It Pays

Advertisements in this section twenty-six cents a word for each insertion. Name and address must be included at the above rate. Cash should accompany all classified advertisements unless placed by an accredited advertising agency. No advertisements for less than 10 words accepted. Objectionable or misleading advertisements not accepted. Advertisements for these columns should reach us not later than 1st of 2nd month preceding issue.

Agents

Guaranteed Genuine Gold Leaf Letters anyone can put on store windows. Large profits, enormous demand. Free samples. Metallic Letter Co., 422 N. Clark, Chicago.

Business Opportunities

FREE BOOK. Start little Mail Order Business. Hadwil, 38-A, 74 Cortlandt Street, New York.

Correspondence Courses

Used correspondence school courses sold on repurchase basis. Also rented and exchanged. Money-back Guarantee. Catalog free. (Courses bought.) Lee Mountain, Pisgah, Alabama.

CORRESPONDENCE COURSES—Sold, Bought, Exchanged, Rented. Bargain Catalogue Free. Handling, C-799 Broadway, New York.

Detectives

DETECTIVES. Work home or travel. Experience unnecessary. Particulars free. Write George Wagoner, 2190-X Broadway, N. Y.

For Inventors

INVENTIONS COMMERCIALIZED. Patented or unpatented. Write Adam Fisher Mfg. Co., 278 Enright, St. Louis, Mo.

Patent Attorneys

PATENTS—Write for Free Information. **HOW TO OBTAIN A PATENT and RECORD OF INVENTION**—or send Drawing or Model for Examination. Miller & Miller, Patent Attorneys (former Patent Office Examiners), 1006-D Woolworth Building, New York; 262 McGill Building, Washington, D. C.

PATENTS, TRADE MARKS—All cases submitted given personal attention by a member of the firm. Information and booklet free. Lancaster, Allwine & Rommel, 269 Ouray Building, Washington, D. C.

PATENTS—Advice and booklet free. Highest references. Best results. Promptness assured. Watson E. Coleman, Patent Lawyer, 724 9th Street, Washington, D. C.

Patent Attorneys (Cont.)

PATENTS. TIME COUNTS in applying for patents. Send sketch or model for instructions or write for free book, "How to Obtain a Patent" and "Record of Invention" forms. No charge for information on how to proceed. Clarence A. O'Brien, Registered Patent Attorney, 309-C Security Savings and Commercial Bank Bldg., Washington, D. C.

Inventors—Should write for our Guide Book, "How to Obtain a Patent" and Record of Invention Blank, sent Free. Send model or sketch of inventions for our inspection and instructions free. Radio, Electrical, Chemical, Mechanical and Trademark Experts. Terms Reasonable. Victor J. Evans & Co., 922 Ninth, Washington, D. C.

Radio

ECONOMETTE. An economic attachment for your radio. Doubles life of tubes. Protects expensive parts from premature burn-outs. Reduces light bill. Automatic action regulates fluctuating line voltage. Sensitive fuse compartment disconnects damaging short circuits. Easily plugs in light socket. \$3.50 Postpaid. Guaranteed. Raymond Mfg. Co., Box 1758, Los Angeles, Cal.

Wanted—Men to work with National Radio Service organization. No selling scheme. Radio Doctors, Inc., Dept. N, Essex St., Salem, Mass.

Song Poem Writers

SONGWRITERS! Advance royalty payments, new talking picture song requirements, etc., fully explained in our free instructive booklet. Write today. Song poems examined free. Newcomer Associates, 1674-VV Broadway, New York.

COMPOSERS—VERSE OR MUSIC. Brilliant opportunity. Write at once. Van Buren, 2291 McClurg Bldg., Chicago.

Wireless

LEARN WIRELESS (Radio) and Morse Telegraphy. School, oldest and largest; endorsed by Telegraph, Radio, Railway and Government officials. Expenses low—can earn part. Catalog free. Dodge's Institute, Cour St., Valparaiso, Ind.

"The Mighty Mite"

(Continued from page 855)

- 1 500 to 50,000-ohm variable resistance, Electrad Royalty type C (R10).
 - 1 0 to 2,000-ohm variable resistance, Electrad Royalty type F (R9).
 - 2 Eby binding posts for antenna and ground (B1 and B2).
 - 1 loud speaker terminal jack, Eby moulded bakelite (SP).
 - 1 double-pole, double-throw Yaxley Imp switch (S2).
 - 1 single-pole, single-throw Yaxley Imp switch (S1).
 - 1 Hart-Hegeman power filament switch (S3).
 - 1 National metal precision vernier dial, type VND.
 - 1 Lynch pigtail 100,000-ohm 1-watt grid leak resistor (R1).
 - 1 Lynch pigtail 1-megohm ½-watt grid leak resistor (R8).
 - 6 Electrad pigtail resistors, as explained in article for filament resistors (R2, R3, R4, R5, R6 and R7).
 - 4 Hammarlund aluminum slotted-corner shield posts.
 - 8 Hammarlund aluminum inner partition slotted shield posts.
 - 1 sheet aluminum 20 by 38 inches by 3/64 inch thick.
 - 1 piece bakelite 3½ by 2 by ⅛ inch thick for condenser mounting plate.
 - 3 feet 1 by ½ by 1/16 inch thick angle aluminum or brass.
- Hardware, bushings and wire for battery leads.

Mike-roscopes

(Continued from page 832)

she would like to be if she could not be a great actress, Miss Cowl offered, "A second-rate actress then, but an actress always!"

Jane Cowl thinks brains are more important to a woman than beauty. If she had to choose, she'd select the former. "Ugly, brainy women have gotten further than beautiful, dumb ones, you'll notice," she said. As to what a man looks for in a woman, "My dear, I don't know," said Miss Cowl, in a melting voice. "I never had time to find out. But I can tell you what a woman wants in a man. It is tenderness."

Jane Cowl is married. She asked me not to reveal her husband's name. "It's so private, don't you think?" trilled the star. "Why, I've been married ever since I can recall. I don't seem to remember the time I wasn't married," said the beautiful brunette, waving a Shakespearian arm at me as she sat in the costume she had just worn as Viola in "Twelfth Night."

Yes, she still has illusions. She wouldn't want to live if she couldn't have them, Miss Cowl affirmed. "There's love here, friendship there, you stretch your hand out in the dark and find it," she concluded. But are finders keepers?

Build Your Receiver With the Aid of Blueprints!

A limited supply of blueprints still available on the following receivers:

Now only 25c each

The Junk Box Short Wave Receiver.

Milk Shaker Special Receiver.

How to Construct the Pre-Selector.

A Bloopless One-Dial Two-Tube Set.

Write to Radio News, BLUEPRINT DEPARTMENT, 381 Fourth Avenue, New York City.

ACCOUNTING LESSON FREE

New Revised Course Now Ready!

Find out about it by trying it free

Send for our new book, "The Accountant—Who he is, What he does, How to become one," and the first lesson free of charge.

In reply please state age and position

INTERNATIONAL ACCOUNTANTS SOCIETY, INC.
A Division of the
ALEXANDER HAMILTON INSTITUTE
Dept. 166, 3411 So. Michigan Ave., Chicago

AN EASY WAY TO SHAPE your NOSE

Anita Nose Adjuster shapes flesh and cartilage—quickly, safely, painlessly, while you sleep or work. Lasting results. Gold Medal Winner. Doctors praise it. 87,000 users. Write for FREE BOOKLET.

30 DAYS HOME TRIAL

ANITA INSTITUTE, C21 Anita Bldg., Newark, N. J.

Write for our great Catalog chock full of Bargains. Specials galore. Our prices guaranteed lower than any other house. Let us prove it.

Uncle Dave's Radio Shack
115 No. Pearl St. Albany, N. Y.

Junior Radio Guild

(Continued from page 847)

9. $6a^5 - 13a^4 + 4a^3 + 3a^2$ by $3a^2 - 2a^2 - a$.

Applications

The following relations of alternating current circuits are important in radio designs:

(a) Resistance and inductance in series:

Fig. 10

In such a circuit as shown in Fig. 10 the current (I) in all parts of the circuit is the same. The supply voltage (E) is consumed throughout the circuit as follows:

(A) $E_1 = IR$, the voltage drop across the resistance.

(B) $E_2 = IXL$, the reactive voltage drop across the inductance. The relation of the voltages throughout such a circuit is as follows:

(C) $E = \sqrt{E_1^2 + E_2^2}$.

Substituting the corresponding values (A) and (B):

$E = \sqrt{(IR)^2 + (IXL)^2}$

Simplifying:

(D) $E = \sqrt{I^2 (R^2 + XL^2)} = I \sqrt{R^2 + XL^2}$.

The impedance Z is expressed as the relation of $\sqrt{R^2 + XL^2}$. Thus:

(E) $Z = \sqrt{R^2 + XL^2}$.

Substituting in (D):

(F) $E = IZ$, thus $I = \frac{E}{Z}$

Let us analyze the tube circuit of Fig. 11. Such a tube is known to have internal plate resistance between the filament and plate of r.p. Therefore, any impressed alternating e.m.f. "eg" can be said to work into an equivalent circuit as follows: Fig. 12, where μ is the amplification factor of the tube.

From (F) $I = \frac{\mu eg}{Z}$

Substituting from (E):

$I = \frac{\mu eg}{\sqrt{rp^2 + XL^2}}$

Remembering that:

$XL = 2\pi f L$

If $rp = 10,000$ ohms (an average plate resistance of tubes) and $L = 100$ henries, and $f = 100$ cycles

$XL = 62,800$ ohms

From (A) and (B):

$E_1 = I(10,000)$

$E_2 = I(62,800)$

And we see the advantage of designing the inductance of the primary of the radio transformer to have a large inductance so that most of the voltage μeg will appear across it.

(b) Resistance and capacity in series:

As in the case of a resistance and inductance in series, the supply voltage E is consumed throughout the circuit, and $E_1 = IR$, the voltage drop across the resistance.

$E_2 = IX_c$, the reactive voltage drop across the condenser.

Following the same procedure of analysis, as shown above, we have

$E = I \sqrt{R^2 + X_c^2}$

(c) Inductance and capacity in series:

Again, in the case of an inductance and condenser in series, the supply voltage E is consumed throughout the circuit, and $E_1 = IXL$, the reactive voltage drop across the inductance.

$E_2 = IX_c$, the reactive voltage drop across the condenser.

We have that the impedance of such a circuit is expressed as:

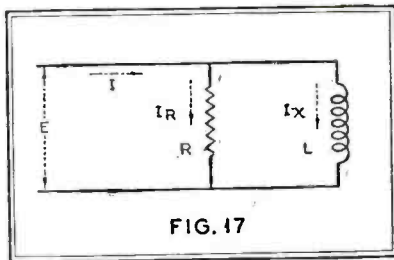

FIG. 17

$Z = \sqrt{R^2 + X^2}$ where the total reactance (X) of the circuit is $Z = XL - X_c$.

Since the resistance of this circuit is taken as negligible

$Z = \sqrt{X^2 - X_c^2}$

we know that:

$XL = 2\pi f L$

$X_c = \frac{1}{2\pi f C}$

Therefore, $Z = 2\pi f L - \frac{1}{2\pi f C}$

Let us suppose $2\pi f L = \frac{1}{2\pi f C}$

Therefore, the impedance Z would equal zero and the current in the circuit would be infinite. In practice there is always resistance in the circuit, so the current has some definite value directly proportional to this resistance.

Let us analyze the tube circuit of Fig. 15 and show how the application of such a series circuit of Fig. 14 is actually used in radio.

The equivalent circuit of such a system is shown as follows:

Current I will flow in the circuit and divide at O, I, flowing through L, and I2 through C and L2 in series. These currents are determined by the formulas:

(1) $I_1 = \frac{E}{XL_1}$

(2) $I_2 = \frac{E}{XL_2 - X_c}$

Let $L_1 = 100$ henries.

$C = .25$ mfd. = .00000025 farads

$f = 100$ cycles

$L_2 = 10.15$ henries.

From (1):

$I_1 = \frac{E}{XL_1}$ where $XL_1 = 2\pi f L_1 = 6.28 \times 100 \times 100$

$XL_1 = 62,800$ ohms.

From (2):

$I_2 = \frac{E}{XL_2 - X_c}$

(Continued on page 863)

Learn Electricity IN LOS ANGELES

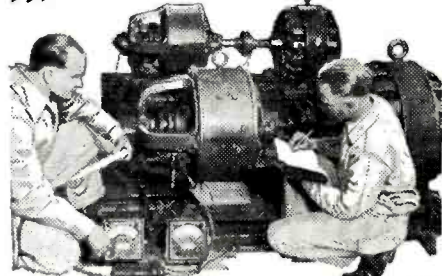

and LEARN IT RIGHT!
You need **GOOD TRAINING** to earn **BIG PAY!**

National Electrical School—a Million Dollar Institution—established in 1905—is recognized throughout the electrical industry as the foremost school of the West. *National* gives you practical intensive training in all electrical branches. No age limit. No previous experience necessary. Life Scholarship privileges. Start any time of the year.

Qualify Quickly for Big Pay Jobs!

We train you right in the shortest possible time. Our condensed practical training in the best equipped school in the country qualifies you as a Practical Skilled Electrician. Don't take a chance without this training.

Don't Worry About Enough Money! We'll Help You!

If you are low on cash, we'll make it easy for you to get National Training. Part-time jobs to earn living expenses while learning **GUARANTEED**. Unlimited Lifetime Employment Service assures you proper co-operation in getting started in the electrical game. The Electrical Industry needs you as soon as you can get this training—that's why it's easy for us to help you.

Your RAILROAD FARE ALLOWED to Los Angeles!

We'll allow your full railroad fare from any point in the United States. Come West, get trained, enjoy life, and make more money because you are qualified.

NEW Descriptive Books Tell Everything!

Fill out coupon now—and mail it today for full details of the greatest offer ever made ambitious men. You'll never equal this great offer—so send today for the complete story. Mail this coupon at once!

WRITE for FREE BOOK NOW

NATIONAL Electrical School

Dept. 311C1006 Figueroa St., Los Angeles, California.

Send me your big free illustrated catalog of Electrical Opportunities showing how I can learn quickly and get a Big-Pay Electrical Job.

Name.....
Address.....
Age.....City.....State.....

SERVICEMEN!

THE CLAROSTAT AUTOMATIC LINE VOLTAGE REGULATOR regulates the line voltage on all makes of electric sets. Reduces noises. Saves tubes from excessive voltages. Made in 2 types—"A" for sets consuming less than 100 watts—"B" for sets consuming 100-150 watts.

Price.....\$1.75

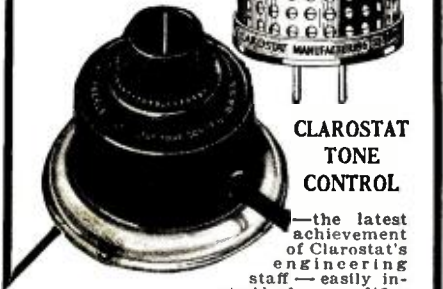

CLAROSTAT TONE CONTROL

—the latest achievement of Clarostat's engineering staff—easily installed—modifies the tone gradually to suit individual musical taste. Price\$2.35 Also made in panel type. Price.....\$1.80 Send for literature or better still order samples now from your Jobber or direct from us.

CLAROSTAT MFG. CO., INC.
285 N. 6th Street Brooklyn, N. Y.
If your Jobber cannot supply you, order direct from us using this coupon.

CLAROSTAT MFG. CO., INC.
285 N. 6th St.
Brooklyn, N. Y.

Please send us

Tone Control, portable type

Tone Control, panel type

Automatic Voltage Regulator

Name

Street

City State

CHIRAD
APPROVES
NEW NATIONAL SHORT-WAVE

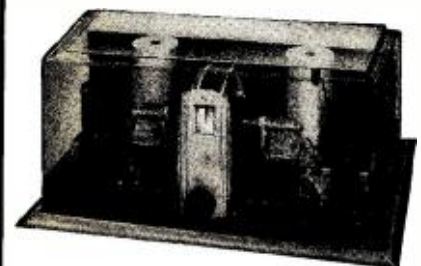

A. C. THRILL BOX

A new humless A. C. operated short-wave receiver. Wave length range of 15 to 550 meters. Loud speaker reception frequently occurs on foreign broadcasts. No back lash or hand capacity. Completely shielded. Uses standard heater tubes. Complete receiver or in kit form. Also available for D.C. or Battery operation.

Parts for the New
SUPERSONIC SHORT WAVE ADAPTER
as described in January Radio News

1931 CATALOG FREE
Write for your copy. Complete line of transmitting and receiving short-wave supplies.
CHICAGO RADIO APPARATUS CO.
415 S. Dearborn St., Dept RN-3, Chicago, Ill.

INDEX TO ADVERTISERS

A	
Acme Wire Company	844
Aerovox Wireless Corp.	863
Alexander Hamilton Institute	860
American Sales Co.	852
American School	857
American Transformer	839
Amperite Corp.	844
Amplex Instrument Laboratories	634
Amrad Corp., The	837
Anita Institute	860
Automatic Radio Mfg. Co., Inc.	841
B	
Baltimore Radio Company	Inside Front Cover
Blan, the Radio Man	840
C	
Candler System, The	838
Cardwell, The Allen D., Co	838
Central Radio Laboratories	842
Chicago Gear Works	848
Chicago Radio Apparatus Co.	862
Clarostat Mfg. Co.	862
Classified Advertising	860
Coast to Coast Radio Corp.	848
Coyne Electrical School	770-771
Crosley Radio Corp.	846
D	
DeForest Radio Co.	843
Duraum Radio Corp.	859
E	
Electrad, Inc.	845
Electric Soldering Iron Co.	852
Ellis Electrical Laboratory	841
Exello Products Corp.	854
Experimenters Radio Shop	854
F	
Federated Purchaser	854
Ferranti, Inc.	847
F. & H. Radio Laboratories	834
Filtermatic Mfg. Co.	859
Freed Sales Service Co.	846
G	
General Radio Co.	847
GyRo Brush Co.	836
H	
Hammarlund-Roberts, Inc.	841
Hammer Radio Co., S.	843
Hatry & Young, Inc.	850
High Frequency Laboratories	852
Hoodwin Co., Chas.	858
I	
Insuline Corp. of America	842
International Correspondence Schools	864
International Resistance Company	835
International Typewriter Exchange	854
J	
J. M. P. Mfg. Co., Inc.	840
K	
Kester Solder Co.	838
L	
La Salle Extension University	859
Ludy Hotel	862
Lynch Mfg. Co., Inc.	838
M	
Mason, Fenwick & Lawrence	854
Massachusetts Radio & Telegraph School	850
Mayo Laboratories, Inc.	848
McGraw-Hill Book Co., Inc.	846
Metal Cast Products	854
Midwest Radio Corp.	858
Morrison Hotel	859
N	
National Co., Inc.	845-849
National Electrical School	861
National Radio Institute	773
Nubor Radio Co.	834
O	
Omnigraph Mfg. Co.	841
P	
Pilot Radio & Tube Corp.	Back Cover
R	
R. C. A. Institutes, Inc.	853
Racon Electric Co., Inc.	836
Radio Surplus Corp.	858
Radio & Television Institute	775
Radio Trading Co.	854
Radio Training Association of America	769
Radio Treatise Co., Inc.	850
Readrite Meter Works	855
Rim Radio Mfg. Co.	844
S	
Shallcross Mfg. Co.	840
Silman Co.	852
Silver-Marshall, Inc.	833
Superadio Mfg. Co.	836
T	
Teleplex Company	850
U	
Uncle Dave's Radio Shack	860
V	
Van Nostrand Co., Inc., D.	849
W	
Wellston Radio Corp.	848
Western Radio Mfg. Co.	857
Weston Electrical Instrument Corp.	851
West Side Y. M. C. A. Radio Inst.	846
Wholesale Radio Service	864

HOTEL LUDY
SOUTH CAROLINA AVE. AT THE BOARDWALK
ATLANTIC CITY'S
NEWEST CENTRALLY LOCATED FIREPROOF HOTEL
\$5.00
DAILY AND UP
AMERICAN PLAN
WIRE PHONE OR WRITE R. B. LUDY M.D.

In SCIENCE AND INVENTION for March

My Adventures on the Ocean Floor—J. E. Williamson, the first photographer of undersea films, vividly describes his dangerous adventures.

Andrée's Photos Reveal His Fate—Thrilling extracts from Andrée's diary, written during the ill-fated Polar expedition. Featuring the thirty-three-year-old films found among the ruins, and just developed. Exclusive to **SCIENCE AND INVENTION**.

"Duck" Plane Appears to Fly Backwards—Dr. Alfred Gradenwitz details the principles which govern the operation of the latest claimant for the title of a foolproof, safety plane.

It Is Safer to Kiss a Dog—Than it is to kiss a human being, says Dr. Frederic Damrau, in a timely discussion of the diseases each of your family pets may carry.

Short Waves Menace Battleships—Proving radio waves are not an unmitigated blessing.

Ants Fight Like Humans—They have their armies, divided into scouts, warriors, generals . . . and they are absolutely fearless in battle!

Is The Earth Getting Warmer?—A popularly written explanation of why the glaciologists predict warmer climate all over the world.

Physical Experiments; Machine and Workshop Hints; Suggestions for the Motorist; Prize Puzzles; Magic and Strange Scientific Facts.

A Multitude of How-to-Make-Its—including: photographs of invisible insects and animals; an electric phone recorder; new tools; a permanent rust-proof for metals; sound lumber from packing cases; modernistic whatnots; jig saw from pipe fittings; a stroboscope for your photograph.

Science Pops Corn and Freezes Light Rays—Just two of the feats accomplished recently, when scientists plunged some light into liquid air, carried it from Schenectady to New York, and thawed it out, one color at a time.

Why Electric Clocks Keep Time—George E. Fleming gives a detailed explanation of the workings of an electric clock.

Some Outboard Stunts You Can Do—Leaping in an outboard through a wall of fire, jousting with aquaplanes, flying through the air in an outboard, flying with an aquaglider are made easy for you.

Cooking a Banquet in a Fourteen-Foot Box—That's exactly what is done on the B. & O. Railway cars, says Walter Raleigh; and he proves it.

The Pygmy Planets—How astronomers can make improved measurements of the size of the solar system, because of the near approach of Eros. **In the Spotlight of Science—**Eight pages packed with interesting happenings in all fields of science.

The Service Bench

(Continued from page 859)

tightly over the condenser shaft. A poor ground is a similar offender in this respect. If volume is lacking on the local position of the aerial switch, take the ground wire off the radiator, switch plate or bed spring, and put it where it belongs—on the water pipe in the cellar.

Noise when turning the station selector, but no noise after the station is tuned in, comes from a loose or dirty spring washer at the drum end of the variable condenser assembly. This assembly may be taken apart without removing the chassis, merely by driving out the tapered pin on the shaft, and drawing the dial mechanism sufficiently far off the shaft to allow the contacts to be cleaned. This is the most common 44 and 46 trouble, and the most difficult to cure by any other means.

"C" bias readings on the -45 tube in the 44, 46, 47, 66 and 67 will not read more than 12 volts due to the 1 megohm resistor in the circuit.

Inoperation of these receivers is generally due to a short between resistors in the power pack, an open in the vitreous resistors, or a broken wire in the chassis. This chassis is unusually free from typical chassis troubles.

Sometimes the hum in the 46 rises to an annoying degree when a station is tuned in, but is absent between stations. When this occurs, make the following change: On the -80 socket remove that green wire that checks through to the yellow filter reactor lead. This lead will be found on the extreme end of one of the vitreous resistors. Take this green wire and resolder it to the red wire found on one corner tab of the condenser block. (This red wire also leads to the filter reactor.) Solder a wire on the resistor lug to which the yellow lead is connected, and short this over to the adjacent lug to which a red wire will be found connected. This operation results in adding a choke to the detector "B" supply, while the last directed operation takes out the resistance value added by the choke, the voltages to receiver remaining the same. This is very effective.

The Service Scratch Pad

FROM the service grab bag, we have drawn up a few miscellaneous kinks, items of interest technically and otherwise. A. J. Barron, radiotrician and electrician of Shawnee, Oklahoma, shows how to wire a magnetic speaker to a receiver also using a moving coil reproducer. This arrangement, illustrated in Fig. 1, will in many cases solve the problem of that second loud speaker to be located somewhere else in the home—away from the set itself.

"All that is needed," writes Mr. Barron, "are two 1 mfd. condensers with a 300-volt rating, and two little thin brass strips about 1/4 inch wide and 2 inches long. Drill a hole in one end of the strips with a drill slightly smaller than the diameter of the small prong on the base of the power tubes, which we shall assume are connected in a push-pull arrangement. Slip one strip on each of the plate prongs; bend the string along the base of the tube

and tape in place. Solder a piece of insulated wire to each strip and connect to the condensers. The remaining terminals of the condensers are led to the magnetic speaker."

Increasing Phonograph Response

Alfred J. Cooper, of Chicago Heights, Ill., observes that many of the phonograph pick-up circuits plug in the pick-up to the first audio stage. This occasionally results in unsatisfactory volume. Mr. Cooper points out that the response can be greatly increased by inputting before the detector tube. Where grid leak detection is employed, the pick-up may be connected across the grid leak, and in other forms of detection, by breaking the grid
(Continued on page 864)

Junior Radio Guild

(Continued from page 861)

$$XL_2 = 2\pi fL_2 = 6.28 \times 100 \times 10.15 = 6350 \text{ ohms.}$$

$$X_c = \frac{1}{2\pi fC} = \frac{1}{6.28 \times 100 \times .00000025} = \frac{1}{.000157} = 6350 \text{ ohms.}$$

Therefore, $I_2 = \frac{E}{O}$ which is infinite, but,

due to resistance which must be part of the inductance L_2 , possibly as high as 100 ohms, is of some finite value.

It is seen that practically all the current will flow through L_2 and as a result a high voltage will be developed across it.

(d) Resistance and inductance in parallel:

In such a circuit as shown in Fig. 17 the current I divides at the junction o and flows through R and L . These currents, I_R and I_x , are determined by the formulas:

$$(A) I_R = \frac{E}{R}$$

$$(B) I_x = \frac{E}{XL}$$

The relation of the currents throughout such a circuit is as follows:

$$(C) I = \sqrt{I_R^2 + I_x^2}$$

Now, very often the value of the currents through R and L are not known, although ammeters inserted in the respective circuits will indicate their proper effective values. But the values of R and the inductance L are usually determined.

Substituting (A) and (B) in (C) we have:

$$I = \sqrt{\frac{E^2}{R^2} + \frac{E^2}{XL^2}} = \frac{E\sqrt{1 + \frac{R^2}{XL^2}}}{R}$$

and

$$I = E\sqrt{\frac{1}{R^2} + \frac{1}{XL^2}}$$

AEROVOX
BUILT BETTER
CONDENSERS AND RESISTORS

-1931-

Time to Change to

**AEROVOX
HI-FARAD**

DRY

**ELECTROLYTIC
CONDENSERS**



Aerovox Hi-Farad DRY Electrolytic Condensers embody the latest developments in the electrolytic condenser art. They are DRY, compact, light in weight and are available in ratings up to 500 volts D.C. peak. Their self-healing, surge-proof characteristics and their ability to withstand both high and low temperatures, without damage, provide high safety factor and freedom from servicing troubles. The cost per microfarad is very low.

If you have not yet received a copy of the above 32-page booklet on electrolytic condensers in general and the Aerovox Hi-Farad DRY Electrolytic Condenser in particular, you have missed some mighty important information on electrolytic condensers, the modern condensers for filter and audio bypass use. The booklet is

FREE

for the asking. Send for your copy today by filling out and mailing the coupon below.

Fill and Mail This Coupon

AEROVOX WIRELESS CORP.,
78 Washington St.,
Brooklyn, N. Y. March 1931
Gentlemen:

Please send me, without charge or obligation, a copy of your 32-page booklet "The Aerovox Hi-Farad DRY Electrolytic Condenser."

Name.....

Street.....

City..... State.....

AEROVOX WIRELESS CORP.
78 Washington St., Bklyn, N. Y.
PRODUCTS THAT ENDURE

ARE YOU TIRED OF THE SAME OLD JOB?



Have you gotten to the place that you dread to go to the office or shop? Are you tired of doing the same old things, week after week, in the same old way? And have you given up hope of ever finding more money in your pay envelope? If you're tired of your job, look out! The most likely reason you are at a standstill is because you lack the training to go ahead. Modern business is looking for men to promote!

All over the world, thousands of men have earned the right to better jobs — and more pay — by securing the training they needed from the International Correspondence Schools at Scranton. They changed the whole course of their lives by marking and mailing a coupon! Col. Edward V. Rickenbacker, S. E. Coneybear, R. J. Wensley, E. E. Whitney — national leaders — were inspired and helped by I. C. S. The same opportunity is yours. Will you accept it? Or will you stay chained to that tiresome old job? What the future holds for you depends on what you do now!

Decide today — mark and mail the coupon.

INTERNATIONAL CORRESPONDENCE SCHOOLS

"The Universal University"

Box 8281-K, Scranton, Penna.

Without cost or obligation, please send me a copy of your booklet, "Who Wins and Why," and full particulars about the subject before which I have marked X:

TECHNICAL AND INDUSTRIAL COURSES

- | | |
|--|--|
| <input type="checkbox"/> Architect | <input type="checkbox"/> Bridge Engineer |
| <input type="checkbox"/> Architectural Draftsman | <input type="checkbox"/> Automobile Work |
| <input type="checkbox"/> Building Estimating | <input type="checkbox"/> Plumbing <input type="checkbox"/> Steam Fitting |
| <input type="checkbox"/> Wood Millworking | <input type="checkbox"/> Heating <input type="checkbox"/> Ventilation |
| <input type="checkbox"/> Concrete Builder | <input type="checkbox"/> Sanitary Engineer |
| <input type="checkbox"/> Contractor and Builder | <input type="checkbox"/> Sheet Metal Worker |
| <input type="checkbox"/> Structural Draftsman | <input type="checkbox"/> Steam Engineer |
| <input type="checkbox"/> Structural Engineer | <input type="checkbox"/> Marine Engineer |
| <input type="checkbox"/> Electrical Engineer | <input type="checkbox"/> Refrigeration |
| <input type="checkbox"/> Electric Wiring | <input type="checkbox"/> R. R. Locomotives |
| <input type="checkbox"/> Electric Lighting | <input type="checkbox"/> Air Brakes |
| <input type="checkbox"/> Welding, Electric and Gas | <input type="checkbox"/> Train Operation |
| <input type="checkbox"/> Telegraph Engineer | <input type="checkbox"/> R. R. Section Foreman |
| <input type="checkbox"/> Telephone Work | <input type="checkbox"/> R. R. Bridge and Building Foreman |
| <input type="checkbox"/> Mechanical Engineer | <input type="checkbox"/> Chemistry <input type="checkbox"/> Pharmacy |
| <input type="checkbox"/> Mechanical Draftsman | <input type="checkbox"/> Coal Mining Engineer |
| <input type="checkbox"/> Patternmaker <input type="checkbox"/> Machinist | <input type="checkbox"/> Navigation |
| <input type="checkbox"/> Reading Shop Blueprints | <input type="checkbox"/> Agriculture |
| <input type="checkbox"/> Civil Engineer | <input type="checkbox"/> Textile Overseer or Supt. |
| <input type="checkbox"/> Highway Engineering | <input type="checkbox"/> Cotton Manufacturing |
| <input type="checkbox"/> Surveying and Mapping | <input type="checkbox"/> Woolen Manufacturing |
| <input type="checkbox"/> Gas Engines <input type="checkbox"/> Toolmaker | <input type="checkbox"/> Fruit Growing <input type="checkbox"/> Radio |
| <input type="checkbox"/> Diesel Engines | <input type="checkbox"/> Poultry Farming |
| <input type="checkbox"/> Aviation Engines | |

BUSINESS TRAINING COURSES

- | | |
|--|---|
| <input type="checkbox"/> Business Management | <input type="checkbox"/> Business Correspondence |
| <input type="checkbox"/> Industrial Management | <input type="checkbox"/> Lettering Show Cards |
| <input type="checkbox"/> Personnel Management | <input type="checkbox"/> Stenography and Typing |
| <input type="checkbox"/> Traffic Management | <input type="checkbox"/> Complete Commercial |
| <input type="checkbox"/> Accountancy | <input type="checkbox"/> English <input type="checkbox"/> Signs |
| <input type="checkbox"/> Cost Accountant | <input type="checkbox"/> Civil Service |
| <input type="checkbox"/> C. P. Accountant | <input type="checkbox"/> Railway Mail Clerk |
| <input type="checkbox"/> Bookkeeping | <input type="checkbox"/> Mail Carrier |
| <input type="checkbox"/> Secretarial Work | <input type="checkbox"/> Grade School Subjects |
| <input type="checkbox"/> Spanish <input type="checkbox"/> French | <input type="checkbox"/> High School Subjects |
| <input type="checkbox"/> Salesmanship | <input type="checkbox"/> Illustrating <input type="checkbox"/> Cartooning |
| <input type="checkbox"/> Advertising | <input type="checkbox"/> Lumber Dealer |

Name..... Age.....
 Street Address.....
 City..... State.....
 Occupation.....

If you reside in Canada, send this coupon to the International Correspondence Schools Canadian, Limited, Montreal, Canada

1931 Radio CATALOG **RADIO BARGAINS** **WHOLESALE DISCOUNTS** **LOWEST PRICES**

REGULAR WHOLESALE TRADE DISCOUNTS!

Nationally-advertised, guaranteed radio merchandise, including the sensational **banded LAFAYETTE ALL-ELECTRIC RADIO RECEIVER**, with tone control. Write at once for **FREE** Bureau Catalog, showing complete selection. Don't buy until you see this wonder catalog!

WHOLESALE RADIO SERVICE CO.
 Dept. C-12; 38 Vesey St., New York

FREE!

The Service Bench

(Continued from page 863)

circuit at the most convenient point. A simple switch or jack arrangement can be devised to shift from radio to phonograph reproduction.

plays a more important part in the success of the radio dealer than it ever has in the past. It will offer the customer no excuse for complaint and give him no reason for stalling off his payments."

Servicing the Crosley Showbox

"When a Showbox is dead, and a voltmeter test shows no plate voltage on the first audio tube, the trouble may be an open audio transformer (C, in Fig. 2), or a shorted condenser A. To determine which is the case, test for voltage at E. If the voltage here is normal (125 to 140 volts), transformer C is open and should be replaced. However, if no reading, or a very low reading is obtained at E, condenser A is shorted and the rubber-covered resistor B will become very hot. In all voltmeter tests, the negative side of the meter should be connected to the frame of the set.

"H. M. LICHT, Radio Division, Williams Hardware Co., Streator, Ill."

Mr. Licht also makes the trenchant observation that, "In this day and age, when nearly every radio set is sold on the time payment plan, quick and efficient service

Equalizing the Atwater Kent 55 and 60

Nelson E. Grubbs, of Eutaw, Ala., has helped some of his A K customers to better reception by the following changes:

"The model F4 speaker, which is made of metal, gives a better response to high notes such as needle scratch and some static frequencies than the type F4C using the wooden baffle.

"This response characteristic may be improved by inserting a small fixed condenser across the grid terminals of the tubes in the push-pull stage. The condenser should have a capacity from .001 mfd. to .006 mfd. About .002 mfd. is a good average."

(Ed. Note: The same effect will be secured by connecting the condenser across the secondary of the first audio transformer.)

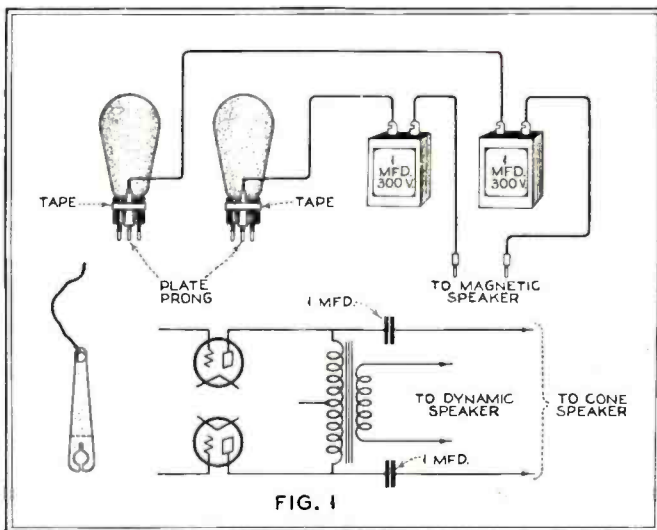

FIG. 1

A. J. Barron, of Shawnee, Oklahoma, shows how to wire a magnetic speaker to a receiver also using a moving coil reproducer

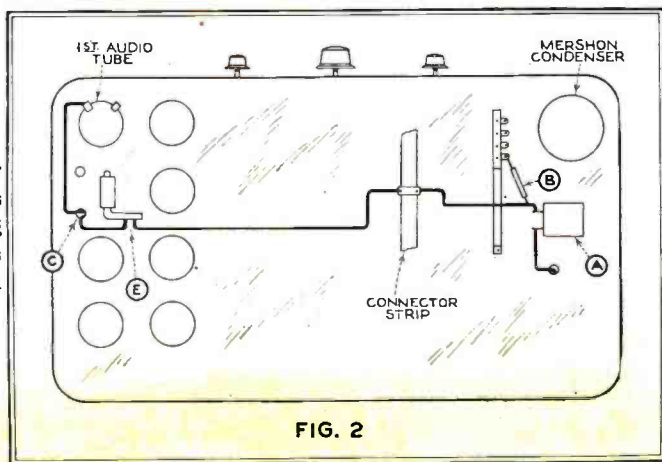

FIG. 2

Servicing the Crosley Showbox. (The letters shown in the drawing are referred to on this page in the item from Mr. Licht)

Find Radio Troubles in 30 Seconds



FREE

Send for Your Gift Copy **NOW**

The Easiest Way to Learn Radio!

HAVE you ever invited friends to listen to a good radio program and then been keenly embarrassed because your radio wouldn't work? Has your radio reception ever been distorted or imperfect just when you wanted to hear every word distinctly? Most of us *have had* such experiences, and most of us *will have them* for years to come.

That's why our staff of expert radio engineers has especially prepared this RADIO TROUBLE FINDER volume for you. In times of need, it's worth its weight in gold. In simple words and easy-to-understand pictures and diagrams, it shows you just how to find and correct any radio trouble *quickly*.

Simple Charts Show You How

In the fastest form of reading—*by charts*—you learn at once what to do when tubes do not light; when tubes light and you get no reception; when your reception is weak. What to do when



A PROFITABLE RADIO REPAIR BUSINESS

This book will help you lay the foundation for a radio repair business in which hundreds of men earn as high as \$3.00 an hour. In many cases such a profitable side line has grown into a worthwhile full-time business. If you'd like to be your own boss, if you're searching for financial independence, send for this book today. It's FREE!

you get a hum or whistle; when your reception fluctuates; when your reception is distorted; when your power device overheats; etc.

After you have read this RADIO TROUBLE FINDER volume, you will know how to locate any kind of radio difficulty, and how to repair it in a jiffy!

Over a hundred thousand set owners already have the RADIO TROUBLE FINDER constantly at their elbows. They know that with it at hand they can depend on getting whatever radio programs they want, *when they want them!* Thousands have used the knowledge gained from this handy volume to make marked improvements in the reception of their sets, and in repairing the sets of friends. In many cases it has been the basis for starting a very profitable radio repair business.

These people have gladly paid real money for the RADIO TROUBLE FINDER. **BUT**, we have set aside a copy to be shipped to you, prepaid, **ABSOLUTELY FREE!**

A Gift from RADIO NEWS

We are offering you this remarkable volume FREE as an unprecedented reward for your merely accepting a six months' cut-rate introductory subscription to RADIO NEWS, the world's greatest radio magazine that no set owner should be without.

Do you want to know all about new sets and latest improvements? Would you like to know what goes on behind the scenes of the big broadcast stations and the inside stories of broadcast programs and artists? Do you know how to tell a good loud-speaker from a bad one? How to construct the latest power-supply unit? How to save money in servicing your set? *It's all in RADIO NEWS!*

If you are a DX fan, you'd probably like to have a list of every broadcasting station in the world. Or perhaps you'd like to experience the thrill of hearing foreign continents direct with a modern short wave receiver. Or perhaps it's television, auto radios, aviation radio telephony, or the projection and filming of talkies that interests you? *Frankly, whatever it is, if it's radio news you will find it in RADIO NEWS!*

That's why RADIO NEWS has practically twice as many readers as any other radio magazine. That's why you should read it too!

Send for Your FREE TROUBLE FINDER Volume TODAY!

Simply mail the coupon below and we will ship you your copy of the complete TROUBLE FINDER volume by return mail ENTIRELY FREE—at the same time entering your subscription to RADIO NEWS for the next six months at only \$1, saving you 50c on its regular newsstand value!

RADIO NEWS,
Dept. 2403, 381 Fourth Avenue, New York, N. Y.

Gentlemen: Ship me ENTIRELY FREE, postpaid, a copy of your RADIO TROUBLE FINDER volume—at the same time entering my subscription for the next 6 big issues of RADIO NEWS at only \$1 which I enclose. (Regular newsstand value \$1.50.)

Name

Address

City and State

Are you a serviceman ? Dealer ? Engineer ? Experimenter ?
Radio Enthusiast ?

FOR WORLD RECEPTION Short and Long Waves (14 to 500 Meters)

In two years this wonderfully efficient and economical "kit" receiver has not only established itself as the favorite of all real DX fans but is rapidly becoming the favorite of Licensed Amateur Operators. They receive relay messages with it from every place in the world where short wave communication originates.

**BATTERY SET KIT
\$29.50**

KIT K-110: The battery operated Super Wasp. Batteries and tubes extra.

**A-C KIT SET
\$34.50**

KIT K-115: AC Super Wasp. Use own ABC Pack or Pilot K-111, specially designed for the Super Wasp.

PILOT SUPER WASP

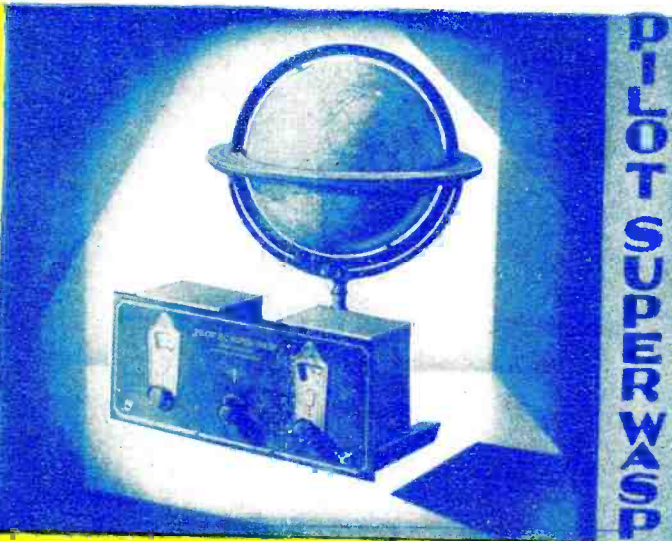

PILOT SUPER WASP



PILOT MIDGET

The "QUALITY" MIDGET

People can't believe they are *hearing* a Pilot Midget unless they see it! Its clarity, volume and range of tone makes the owners of most *big* consoles, wonder what they paid *big* money for. In its beautiful, NEW, two-tone walnut cabinet, it delights all who see it as much as it delights all who hear it. Illuminated Dial Knob Control, Tone Control and Phonograph Connection.

AC MODEL: 2-224 Screen Grid TRF, 1-224 Screen Grid Power Detector, 1-227 1st Audio, 1-245 Output Audio, 1-280 Rectifier.
DC MODEL: 4-201-A's and 2-271-A's.

Less Tubes \$59.50

PILOT MIDGET

PILOT'S NEWEST

A gem in cabinet design, this charming little two-tone walnut Queen Anne Model is coveted by every home loving woman the moment she sees it.

It has double sliding doors. Baffling area of cabinet is ample to bring out lowest tones of the special electro-dynamic speaker. Illuminated Dial, Knob Control, Tone Control and Phonograph Connection.

2-224 Screen Grid TRF, 1-224 Screen Grid Power Detector, 1-227 First Audio, 1-245 Audio Output, 1-280 Rectifier. (The DC Model uses 4-201-A's and 2-271-A's.)

Dimensions: Height, 33 inches; width, 19½ inches; depth, 13 inches.

Less Tubes \$79.50

PILOT De Luxe CONSOLETTA



PILOT DE LUXE CONSOLETTA

PILOT'S SERVICE TO ALL LOVERS OF RADIO GROWS! Broadcast Listeners, Short Wave Enthusiasts, Licensed Amateurs, Service Engineers, Professional Custom Set Builders, Amateur Set Builders and Sound Distribution Experts, now find all their needs met by Pilot Products. The New Pilot Plant at Lawrence, Mass., is the largest in the world owned and operated by a radio manufacturer. See the Pilot Receivers at your dealer or write for description folder to

PILOT RADIO



LICENSED UNDER

RCA PATENTS

PILOT RADIO & TUBE CORPORATION

LAWRENCE, MASS.

New York Office: 525 Broadway

OFFICES IN PRINCIPAL COUNTRIES OF THE WORLD

Chicago Office:
234 S. Wells Street

San Francisco Office:
1278 Mission Street