

SPECIAL BATTERY NUMBER

RADIO NEWS

**OCTOBER
25 CENTS**



**A BROADCAST
RECEIVER
for the NEW
BATTERY TUBES**

**HOW TO BUILD
A MODULATED
OSCILLATOR**



**BATTERIES
Where and How
to Use Them**

ALL the Latest Features in Radio Receivers!

Screen Grid, Tone Control
Dynamic Speakers
All-Electric Sets, Battery Sets



EVERYTHING
AT
WHOLESALE
PRICES

Tune In On This Catalog

This remarkable book of Radio Bargains — 168 pages and over 500 illustrations — contains all the latest and best in Radio equipment—sets, accessories, parts and kits—priced so low it will startle you!

All the standard devices and last-minute improvements—New 1931 Screen Grid, Tone Control, A. C. Humless All - Electric Sets, Public Address, Phono-Combinations, Dynamic Speakers, Beautiful Consoles. Also battery operated sets.

A brand new Slot Machine Radio, coin-operated—offers extra profits for restaurants, stores, hotels and other public places.

Radio's Greatest Money-Savers!

All this wonderful line of radio merchandise is available to you at Wholesale Prices—bed-rock figures and the most

unusual values ever catalogued. Our tremendous buying power makes this possible. From first to last page this

Catalog is brimful of astounding bargains—money-saving items and information. Send for it today. It's FREE.

ALLIED RADIO CORPORATION

711 W. Lake Street Dept. B-1 Chicago

The House
Of
Outstanding
Values

Resources
Over Three
Million
Dollars



TRAIN

with the R.T.A. ~ where Radio Employers

HIRE!

We Could Have Placed 5000 More Qualified Men Last Year in Good Pay RADIO Positions

GET into the rich field of Radio via the training school that supplies big Radio employers with their new men! The Radio Training Association of America has a standing order from radio trade organizations, large manufacturers and dealers, for members qualified for full time work at splendid pay.

So great is this demand from Radio employers that positions offering good pay and real opportunity are going begging. If you want to cash in on Radio quick, earn \$3.00 an hour and up spare time, \$40 to \$100 a week full time, prepare for a \$10,000, \$15,000, \$25,000 a year Radio position, investigate the R. T. A. now.

Special Attention to Radio Service Work

Thousands of trained Radio Service Men are needed now to service the new all-electric sets. Pay is liberal, promotions rapid. The experience you receive fits you for the biggest jobs in Radio. The R. T. A. has arranged its course to enable you to cash in on this work within 30 days!

Would you like to work "behind the scenes" at Hollywood, or for a talking picture manufacturer? R. T. A. training qualifies you for this work. Television, too, is included in the training. When television begins to sweep over the country, R. T. A. men will be ready to cash in on the big pay jobs that will be created.

Expert Supervision Lifelong Consultation Service

As a member of the Association you will receive personal instruction from skilled Radio Engineers. Under their friendly guidance every phase of Radio will become an open book to you. And after you graduate the R. T. A. Advisory Board will give you personal advice on any problems which arise in your work. This Board is made up of big men in the industry who are helping constantly to push R. T. A. men to the top.

Because R. T. A. training is complete, up-to-date, practical, it has won the admiration of the Radio industry. That's why our members are in such demand—why you will find enrolling in R. T. A. the quickest, most profitable route to Radio.

Mail Coupon for No-Cost Training Offer

Memberships that need not—should not—cost you a cent are available for a limited time. The minute it takes to fill out coupon at right for details can result in your doubling and trebling your income in a few months from now. If you are ambitious, really want to get somewhere in life, you owe it to yourself to investigate. Learn what the R.T.A. has done for thousands—and can do for you. Stop wishing and start *actually doing something* about earning more money. Fill out the coupon and mail today.

**Radio Training Association of America
Dept. RNA-10, 4513 Ravenswood Ave., Chicago, Ill.**

Fill Out and Mail Today!

RADIO TRAINING ASSOCIATION OF AMERICA
Dept. RNA-10, 4513 Ravenswood Ave., Chicago, Ill.

Gentlemen: Send me details of your No-Cost Training Offer and information on how to make real money in Radio quick.

Name _____

Address _____

City _____ State _____

Radio News

Vol. XII

CONTENTS FOR OCTOBER, 1930

No. 4

ALBERT PFALTZ
Associate Editor

ARTHUR H. LYNCH, Editorial Director
JOHN B. BRENNAN, JR.
Managing Editor

GEORGE E. FLEMING
Technical Editor

And Now—

Batteries !!

THE pendulum, having reached the end of its swing moves back again. In radio we have become accustomed to the cycle of events which after a short span of time brings with it a repetition of the popularity of ideas, systems and fads which formerly had been relegated to the limbo of the discard after having served their purpose faithfully. Right now the battery star seems to be in its ascendancy. The last few years has seen practically all activity devoted entirely to the development and perfection of line-operated receivers. First the "B" batteries were "eliminated". Then the "A" batteries. Next, special a.c. operated tubes were developed. Today, we have some of the finest radio receivers ever designed.

Yet, there are a great number of homes in the country which cannot make use of a.c. operated receivers. Realizing this vast potential market, manufacturers of radio equipment have only recently developed new rugged low-current tubes designed for use with batteries. They have produced new batteries, too, which last many months. And so, in a way, we have come back to the use of batteries.

This issue of RADIO NEWS contains the most authoritative information on batteries, battery-tubes, battery-operated receivers which it has been possible to collect.

Next Month

An issue of RADIO NEWS devoted especially to superheterodynes.

Also articles from prominent men in radio such as Wenstrom, Silver, Hatry, Dreher, and Marshall.

	PAGE
Cover—From a Painting by David Hymes	
Frontispiece: Radio Joins the Ends of the World.....	292
Editorial	294
The Stenode Radiostat.....	296
A new idea in receiver circuit design, by W. T. COCKING	
A Two-Tube Short-Wave Receiver.....	299
Complete constructional details for a receiver suitable for Amateur or S-W broadcast use, by JOHN B. BRENNAN, JR.	
Some Facts About "B" Batteries.....	302
The source of plate supply now widely used for radio receivers in airplanes, motor-boats and automobiles, by JAMES MARTIN	
Backstage in Broadcasting.....	304
It's a far cry from program idea to microphone, by P. W. H. DIXON	
How to Build a Modulated Oscillator.....	306
An easily constructed battery-operated laboratory instrument, by GEORGE E. FLEMING	
Don Mix—The Radio Pioneer Extraordinary.....	308
A pen sketch of a man who has done much to popularize battery-operated transmitters and receivers, by NAT POMERANZ	
The Marshall S.-W. Push-Pull Receiver, Part Two.....	310
By THOMAS A. MARSHALL	
A High Quality 80-Meter Phone Transmitter.....	314
A T. P. T. G. job especially designed for the amateur, by JOHN B. BRENNAN, JR.	
How to Join the RADIO NEWS Radio Association.....	317
Laboratory Report on a Battery-Operated Broadcast Receiver.....	318
Suitable for rural use, by W. H. HOFFMAN and DON MIX	
Riding the Roads with Radio.....	321
A novel auto-radio receiver design, by ROBT. HERTZBERG	
A Broadcast Superheterodyne, Part Two.....	322
By GEORGE E. FLEMING	
The RADIO NEWS S.-W. Superheterodyne Receiver.....	324
The third and final installment on the construction of this receiver, by FRED H. SCHNELL	
The All-Purpose Short-Wave Receiver.....	327
A battery-operated receiver especially designed for use for S-W broadcast or amateur code or phone reception, by ROBT. S. KRUSE	
Superheterodynes to the Fore!.....	330
A theoretical treatment of the principles underlying superheterodyne operation, with a description of a commercial receiver of this type soon available for general use, by McMURDO SILVER	
News from Manufacturers.....	333
RADIO NEWS Manufactured Receiver Circuits.....	334
Junior Radio Guild.....	336
RADIO NEWS Information Sheets.....	338
Radio Forum.....	344
RADIO NEWS Home Laboratory Experiments.....	350
Radio Joins the Three "R's".....	354
How the schools are using radio to teach music, by B. H. DARROW	

Published Monthly by the Radio-Science Publications, Inc., at 184-10 Jamaica Ave., Jamaica, N. Y.

Member: Audit Bureau of Circulations

B. A. MACKINNON, President

H. K. FLY, Vice-President and Treasurer

Entered as Second-Class Matter at Jamaica, N. Y., under Act of March 3, 1879.

Executive and Editorial Offices, 381 Fourth Ave., New York, N. Y.

RADIO NEWS is published monthly, on the tenth day of each month preceding that of date. Entered as second-class matter at the postoffice, Jamaica, N. Y., under the act of March 3, 1879. Copyrighted 1930 by Radio-Science Publications, Inc.; title

registered U. S. Patent Office. Subscription price \$3.00 a year; \$3.50 in Canada and \$4.00 in foreign countries. Single copies, 25 cents each. The contents of RADIO NEWS are indexed in the Industrial Arts Index.



No Store "Around the Corner" At the South Pole

So the Byrd Expedition Couldn't take a Chance



Exploring dangerous and unknown regions, with serious injury and death stalking every footstep, scientists take no needless risks. Dependable radio battery power might mean the difference between life and death. That is why four successive Byrd Expeditions have used Burgess Radio Batteries . . . why the Wilkins South Pole Expedition, and countless others—both in the past and right now—are relying upon them.

Scientists take nothing for granted. Boastful, or misleading statements are ignored. Entirely! Numberless tests . . . electrical, chemical, physical, mechanical . . . prove absolutely and conclusively that Burgess Radio Batteries have no equal in power, capacity, length of service, dependability and uniformity.

They are the best to be had . . . and it will pay you in many different ways to use, in your own set, Burgess Radio Batteries.

ASK FOR THEM BY NUMBER:

"Super B" No. 21308

Made especially for heavy-current consuming sets

\$4.25

"Super B" No. 22308

Designed for general, all-around use on sets requiring only average power

\$2.95



BURGESS BATTERY COMPANY
111 West Monroe St., Chicago, Ill.

Please send me free copy of your booklet: Dry Cell "B" Batteries for Mobile Radio Receivers.

Name

Street Number

Town State

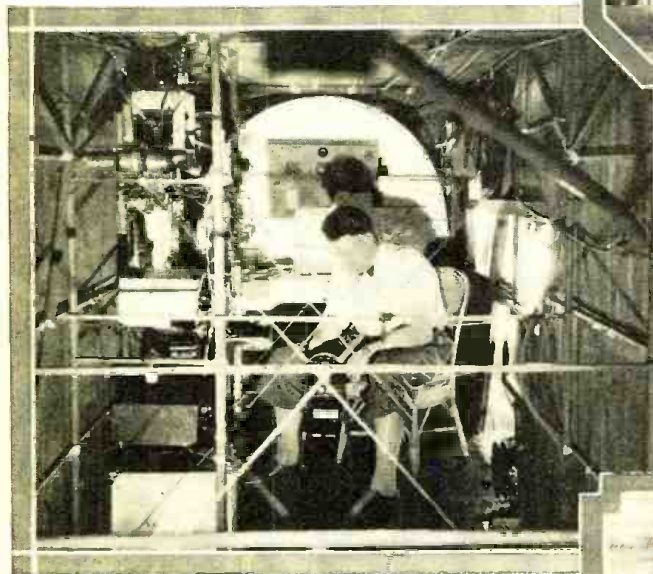
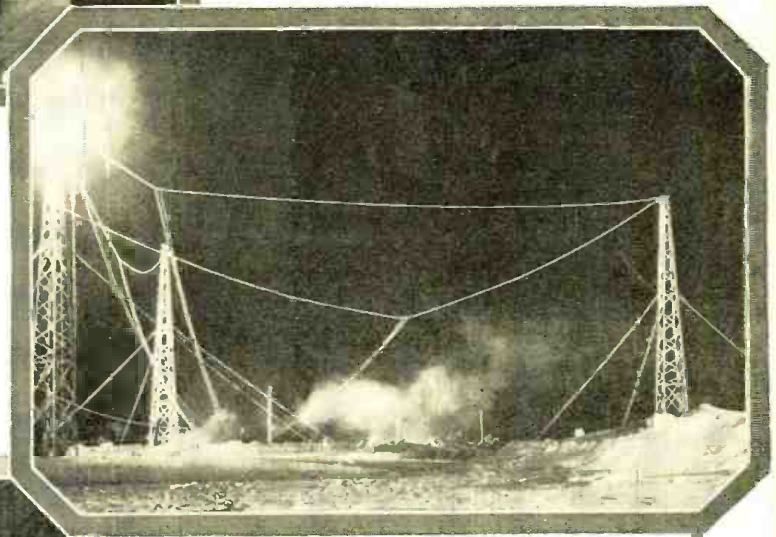
BURGESS

Radio Joins the Ends of the World



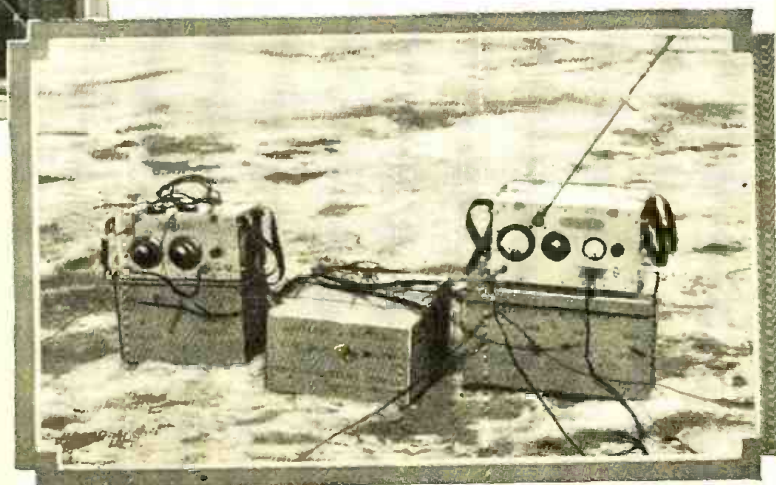
At the left, the members of the Dickey Expedition which departed last Spring to seek the source of the Orinoco River in South America, are examining the radio receiver which they took with them. At the extreme right is Robert W. Durrett, radio operator, who has been in frequent communication with the *New York Times* from the South American wilds, using a portable battery-operated short-wave receiver weighing less than 100 pounds. Dr. Herbert Spencer Dickey and Mrs. Dickey appear at the left

This interesting night scene at the right has an appearance of realism and naturalness which is in strange contrast to its actual location—the southern end of the earth. The towering ice and snow-coated aerial mast and antenna were part of the remarkable radio equipment of Little America, by means of which the Eyrd Expedition was able to keep in communication with the entire civilized world



At the left is a view of the interior of the "Southern Cross" which recently completed a successful transatlantic flight. The 600 and 30-meter transmitter-receiver installation is mounted at the left, while the shadow of the earth inductor compass may clearly be seen over the table at the rear. This portion of the cabin was occupied by the radio operator and navigator during the flight

Radio has also been a frequent visitor within the Arctic Circle—the receiver and transmitter appearing at the right accompanied the Sir Hubert Wilkins Expedition. Both the receiver on the left and the transmitter at the right are resting on boxes of special airplane batteries. Incidentally, this radio equipment was used by Sir Wilkins in his Arctic flights. His plane later became part of the Southern Cross





BROADCASTING

TELEVISION

TALKING PICTURES

WIRELESS OPERATING

WIN FAME and FORTUNE in RADIO!

Don't spend your life slaving away in some dull, hopeless job! Don't be satisfied to work for a mere \$20 or \$30 a week. Let me show you how to make real money in Radio—the fastest-growing, biggest money-making game on earth!

THOUSANDS OF JOBS ARE OPEN
Paying \$60, \$70 and on up to \$200 a Week

Jobs as Designer, Inspector and Tester, paying \$3,000 to \$10,000 a year—as Radio Salesman and in Service and Installation Work, at \$45 to \$100 a week—as Operator or Manager of a Broadcasting Station, at \$1,800 to \$5,000 a year—as Wireless Operator on a Ship or Airplane, as a Talking Picture or Sound Expert—THOUSANDS of JOBS Paying \$60, \$70 and on up to \$200 a WEEK!

Learn Without Lessons *in* 60 Days

You learn ALL branches of Radio at Coyne—in 8 short, pleasant weeks—NOT BY CORRESPONDENCE, but by actual work on actual Radio, Television and Sound equipment. We don't waste time on useless theory. We give you just the practical training you will need—in 8 weeks' time.

No Books - No Lessons
All Practical Work at Coyne

Coyne is NOT a Correspondence School. We don't teach you from books or lessons. We train you on the greatest outlay of Radio, Television and Sound equipment in any school—on scores of modern Radio Receivers, huge Broadcasting equip-

ment, the very latest JENKINS Television apparatus, Talking Picture and Sound Reproduction equipment, Code Practice equipment, etc. You don't need advanced education or previous experience. We give you—right here in the Coyne Shops—all the actual practice and experience you'll need.

TELEVISION *Is on the Way!*

And now Television is on the way! Soon there'll be a demand for THOUSANDS of TELEVISION EXPERTS! The man who learns Television NOW can make a FORTUNE in this great new field. Get in on the ground-floor of this amazing new Radio development! Learn Television at COYNE on the very latest JENKINS Television equipment.

Talking Pictures *A Great Field*

Talking Pictures and Public Address Systems offer thousands of golden

opportunities to the Trained Radio man. Here is a great new field of Radio that has just started to grow! Prepare NOW for these marvelous opportunities! Learn Radio Sound Work at Coyne, on actual Talking Picture and Sound Reproduction equipment.

Coyne is 31 Years Old

Don't worry about a job! Coyne Training settles the job question for life. You get Free Employment Help as long as you live. And if you need part-time work while at school to help pay expenses we'll gladly help you get it. Coyne is 31 years old! Coyne Training is tested—proven beyond all doubt. You can find out everything ABSOLUTELY FREE. JUST MAIL COUPON FOR MY BIG FREE BOOK.

H. C. Lewis, Pres. **Radio Division** Founded 1899
Coyne Electrical School
500 S. Paulina Street Dept. 70-6A, Chicago, Illinois

H. C. LEWIS, President
Radio Division, Coyne Electrical School
500 S. Paulina St., Dept. 70-6A, Chicago, Ill.

Send me your Big Free Radio Book and all details of your Special Introductory Offer. This does not obligate me in any way.

Name

Address

City..... State.....

Batteries

POSSIBLY some among our readers will think we are taking a step backward in featuring batteries as strongly as we are in this special battery number. Such a viewpoint is logical in view of the very rapid growth of light socket operated receivers. As a matter of fact, the proportion of receivers operated from the light socket, as compared to those operated from batteries, has increased tremendously. There are a number of very sound reasons for this increase.

However, it is the purpose of RADIO NEWS to provide as many folks with enjoyable radio entertainment as the knowledge of the art permits. A series of new battery-operated tubes has been announced and by the use of these tubes we are now offered almost the same character of performance from battery-operated receivers as we are in the habit of getting from the best of those operated from the light socket.

These tubes have been designed with a view to efficiency, and with a suitable set of batteries we can look for satisfactory performances for a period of approximately one year before battery renewal becomes necessary. Then, too, there are many uses for radio equipment where the electric light socket is entirely out of the question.

The recently developed automobile radio market has resulted in an entirely new type of design which up to six months ago was considered almost an impossibility by some of the leading engineers. By the application of suitable and comparatively cheap devices, the so-called ignition noise has been completely eliminated. This is also true of motorboat receiver installations, and to a large extent it is true in aircraft. In all three cases batteries, both filament and plate, are an actual necessity.

Many of our farmers are still unaware of the very great value that radio may be to them in the disposition of their crops and that the United States Department of Commerce is spending huge sums in an effort to make the farmer's radio receiver just as serviceable to him as his plow and harrow.

There are approximately six million farm homes in this country, of which two million are already supplied with radio equipment. It is doubtful that we will ever sell radio to more than two-thirds of the farm population, but inasmuch as some of the farm radio equipment now in use is of a somewhat obsolete nature we may consider the number of farm homes to which additional enjoyment may be brought by the new battery-operated receiver as being somewhere in the neighborhood of three million.

There are approximately twenty-five million licensed automobiles in this country. If only 2 per cent. are equipped with radio receivers by the end of this year it will mean that we have utilized almost a million sets of "B" batteries, and the use of receivers in automobiles is growing very rapidly. Nearly all of the objections which were raised to this form of entertainment have been overcome and almost every one who rides in a radio-equipped car for any length of time becomes convinced of the value and pleasure to be derived from its use.

Then, too, batteries are almost a foregone conclusion for comparative short-distance aircraft communication, for the portable transmitters and receivers used by various exploration expeditions, as well as by the outposts of our Army, Naval and industrial organizations.

Nearly all radio laboratory and experimental work is done with batteries and their use is very likely to be necessary in connection with the research work which is bound to follow the introduction of the Stenode Radiostat, making its bow to American radio enthusiasts with this number.

Arthur H. Lynch

R. T. I.

R. T. I. QUALIFIES YOU TO MAKE MONEY AND ITS SERVICE KEEPS YOU UP-TO-THE-MINUTE ON THE NEWEST DEVELOPMENTS IN RADIO, TELEVISION, AND TALKING PICTURES

R. T. I.

OPPORTUNITY

IS KNOCKING AT YOUR DOOR

RIGHT NOW

from this GREAT FIELD of

RADIO TELEVISION TALKING PICTURES

BIG MONEY STEADY JOBS OFFERED and the Definite Way to Get Them

Good Jobs at Good Pay! Steady, Interesting Work! Fine Profits for your Spare Hours! Big Money as Your Own Boss! That's the Opportunity for you in Radio right Now! Why? Because the great, fast-growing Radio industry has reached the stage where it must have many more trained men. Most of those now employed are untrained—they just "picked up" what they know about radio, and even many of them get good pay. But the *Big Pay Steady* jobs go to the *Trained Man*, and R. T. I. offers you the definite way to prepare for them. R. T. I. training is endorsed by Leading Radio Men and Radio Trade Associations.

R. T. I. TRAINS YOU AT HOME FOR THE BETTER PAID RADIO JOBS

Do you want to get into some branch of Radio where trained men can easily make \$40 to \$50 weekly—where some earn \$75 to \$100 per week—where trained experienced men are selected for executive positions paying up to \$5,000 and \$10,000 yearly and more? Then send for the R. T. I. Radio Opportunity Book. Find out how R. T. I. trains you at home for this well-paid work—you don't have to give up your present job—you learn quickly and thoroughly—just a little time needed at home—earn an extra \$10 to \$20 per week in spare hours while learning—Then step into radio and go steadily on up to the Big Money. No experience needed to start—R. T. I. starts you right.

LEARN TELEVISION— and Talking Pictures, TOO

Be prepared for Television! Learn Talking Picture Apparatus installation, adjustment, etc.! Both of these great branches of Radio are included in the R. T. I. practical training.

LEARN FROM LEADERS

Why does the radio industry want men trained the R. T. I. way? Because you learn under experts—leading men in different branches of Radio—well known specialists of high standing.

FREE OPPORTUNITY BOOK

Remember, you need no experience to start in Radio—R. T. I. starts you right—and helps you on to success. The big R. T. I. Radio Opportunity book explains everything. If you are interested, send for it now. Don't wait.

Use the coupon, or write, or telegraph to
RADIO AND TELEVISION INSTITUTE
Dept. 847, 4806 St. Anthony Court, Chicago, Ill.



BROADCASTING

Stations demand better trained men

SERVICE

Where R. T. I. training brings quick money.

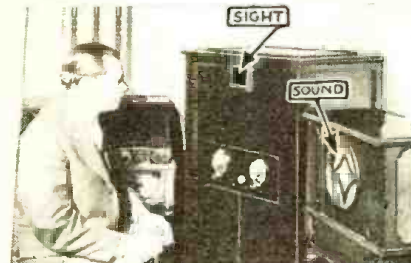


TALKIES

Studio and theatre apparatus requires trained men.

AUTO-RADIO

Great field for men with R. T. I. training.



AVIATION

Trained radio men needed more and more.

TELEVISION

Great new branch of radio soon to call for many trained men.

R. T. I. Home Training includes all these and the other branches of Radio. You learn under F. H. Schnell, "The Ace of Radio," and the R. T. I. Advisory Board of prominent radio men.

R. T. I. R. T. I. TRAINS YOU AT HOME FOR A GOOD JOB OR A PROFITABLE PART TIME OR FULL TIME BUSINESS OF YOUR OWN



RADIO & TELEVISION INSTITUTE
4806 St. Anthony Court, Chicago, Dept. 847

Send me Free and prepaid your **BIG RADIO OPPORTUNITY BOOK**, "Tune In On Big Pay," and full details of your three-in-one Home Training (without obligating me in any way).

Name _____

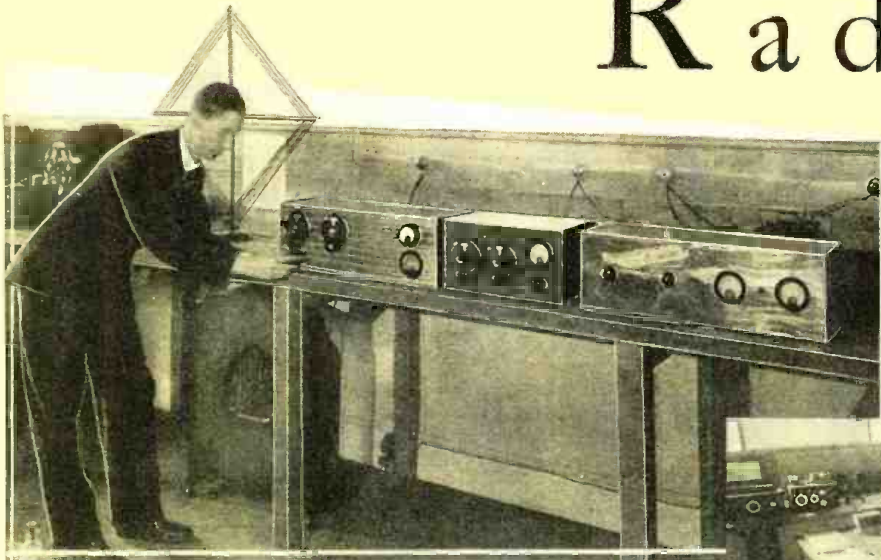
Address _____

City _____ State _____

The Stenode Radiostat

By

W. T. Cocking*



Is there anything new under the radio sun? Some say "yes," some "no." Be that as it may, the three big things that have come down the pike are the regenerative circuit, the tuned radio-frequency circuit and the superheterodyne circuit. Now, it seems, we may be compelled to revise our generally accepted ideas about sideband transmission and reception. A gentleman named Robinson, over in England, has devised what purports to be a new circuit and a new interpretation of transmission and reception without sidebands. The article presented here is from a man who has had a first-hand opportunity to observe the practical aspects of the Robinson Stenode Radiostat system. In a forthcoming issue of RADIO NEWS we will present a series of articles by Mr. Robinson dealing with this interesting new system

SOME months ago considerable interest was aroused in England by reports of a new invention which enabled interference with broadcasting to be eliminated. It appeared that this new apparatus would allow the complete separation of all stations, and that the present 9 kc. spacing of broadcast stations was unnecessarily great. Certain of the claims made for the apparatus were to the effect that with it a spacing of 1 kc., or even less, would become practicable, and that first-class reproduction with a complete absence of heterodyne whistles would be possible.

Through the courtesy of the inventor, Dr. J. Robinson, M.I.E.E., F.Inst.P., the writer was able to examine the appa-

*Radio Engineer, The Receptite Co., London, England

The two photographs above illustrate the interior of the laboratory of the British Radiostat Company, where the developmental work on the Robinson Stenode Radiostat is being carried out. The upper photograph shows the rather pretentious receiver layout, while the lower one gives a general view of the laboratory itself

ratus and circuit in detail, and to be present at a practical demonstration on broadcasting. The apparatus, of course, is not yet out of the experimental stage; but it certainly produces results which appear to justify the claims made for it, and which are unobtainable with any ordinary receiver.

The circuit diagram is shown in Fig. 1, and it will be seen that it consists of an ordinary superheterodyne receiver up to the point of the last intermediate-frequency amplifier. This intermediate frequency is about 100 kc., but there is no particular reason for this choice of frequency, other than that of convenience; any frequency will work satisfactorily, and the choice is governed by the same consideration as in an ordinary supersonic receiver.

The last stage of i.f. amplification is obtained by means of a neutralized triode in preference to a screen-grid tube, owing to the superior power-handling capacity of the former. This stage of amplification immediately precedes a quartz crystal and its associated circuit, which may be termed the heart of the apparatus; this portion of the circuit is shown in greater detail in Fig. 2. The quartz crystal is used instead of a number of sharply tuned cascade resonant circuits in order to obtain high selectivity; and that used in the Radiostat has a decrement of the order of 0.00004. It is obvious that the selectivity given by such an arrangement is much higher than could be easily obtained by the more normal method of cascade tuned circuits. The band width passed by this crystal circuit

A New Idea in Receiver Circuit Design

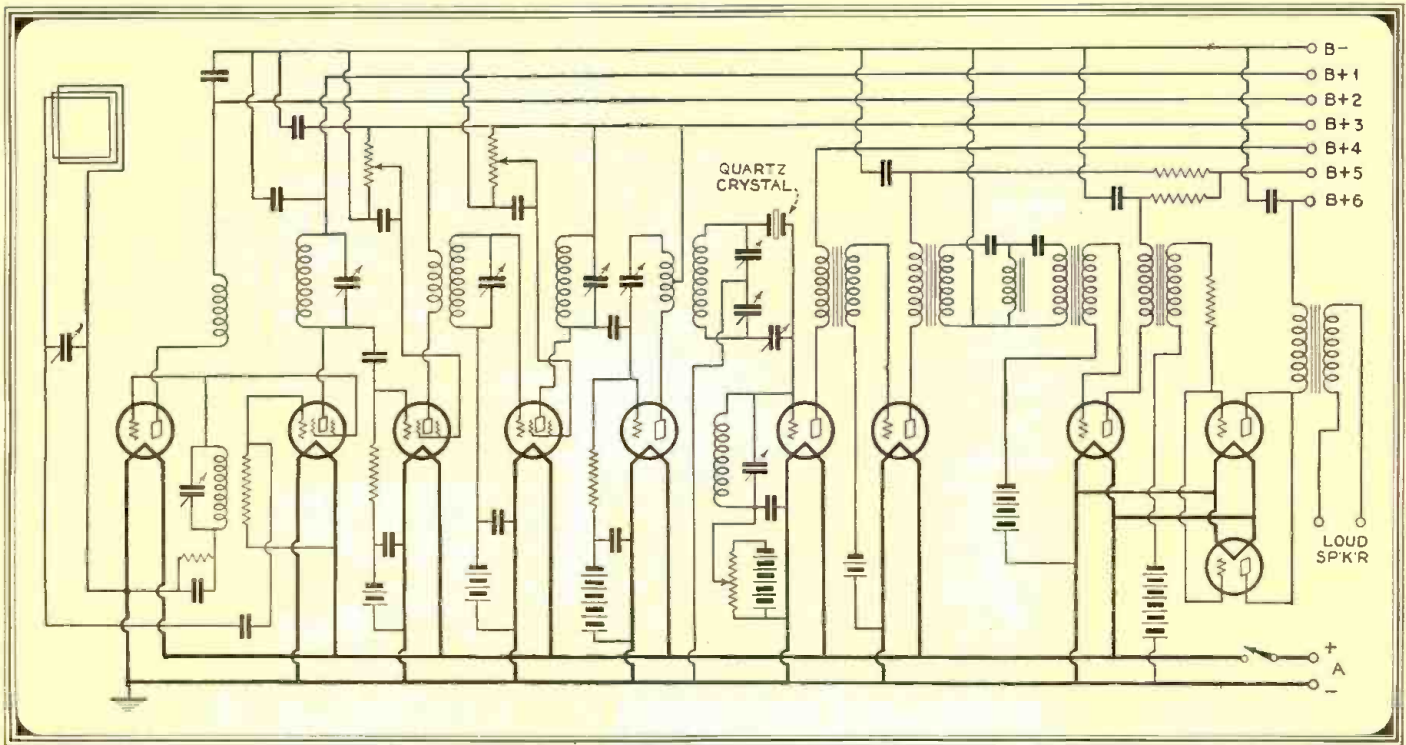


Fig. 1. The circuit diagram of the Robinson Stenode Radiostat is much like any other superheterodyne circuit, up to the point of the last intermediate-frequency amplifier. Here, instead of employing a number of sharply tuned cascade circuits, a quartz crystal circuit is employed. The complete description of the function of the circuit is given in the text

is only about 50 cycles; consequently any interference on a frequency different from the frequency of the desired station by more than 50 cycles should be completely eliminated.

It will be seen from the circuit of Fig. 2 that the crystal is connected to the preceding tuned circuit, A, by a bridge arrangement, of which the completing arm is the condenser, C. This method of connection is necessary in order to insure that no voltages reach the last tuned circuit, B, other than by the legitimate path through the crystal. If the circuit be unbalanced, a certain proportion of the currents flow through the self-capacity of the crystal holder, and upon these currents the crystal has no selective action.

When the circuit is properly balanced, however, the only currents affecting the tuned circuit B are those passing through the crystal proper; those currents passing through the capacity of the holder are balanced out by an equal current of opposite phase passing through the balancing condenser, C.

The second detector of the normal superheterodyne receiver is connected directly to the tuned circuit, B. It operates upon the plate bend principle, and its negative grid biasing voltage is controlled by a potentiometer. Following the detector is a special three-stage a.f. amplifier, in which the power output stage consists of two tubes in parallel.

It will immediately be obvious how the enormous selectivity of this receiver is obtained, and the theory of this will, therefore,

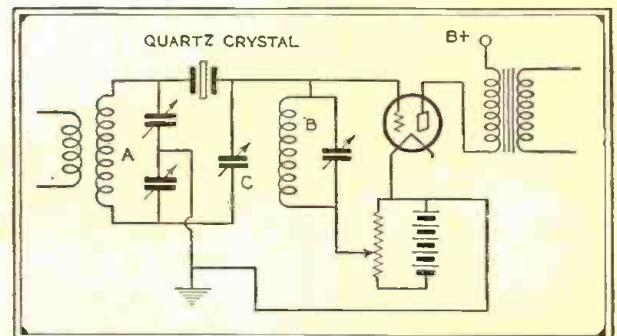


Fig. 2. The quartz crystal circuit. The band width passed by this crystal circuit is only about 50 cycles; consequently any interfering signal differing by more than 50 cycles of the frequency to which the circuit is tuned should be completely eliminated

"... this new apparatus would allow the complete separation of all stations, and that the present 9 kc. spacing of broadcast stations was unnecessarily great."

"The quartz crystal is used instead of a number of sharply tuned cascade resonant circuits in order to obtain high selectivity; ... the band passed by this crystal circuit is only about 50 cycles; consequently any interference on a frequency different from the frequency of the desired station by more than 50 cycles should be completely eliminated."

"... a modulated carrier may be considered as a carrier of constant frequency, the amplitude of which is varying at the modulation frequency."

"... with the Stenode Radiostat, the quartz crystal circuit has so sharp a resonance curve that practically none of the sideband frequencies are passed to the succeeding circuits. At a demonstration in the heart of London at about 15 miles from the twin-wave broadcast transmitter at Brookman's Park (842 kc. and 1148 kc., power 30 kw.) the writer heard numerous stations whose frequencies were so close that a heterodyne whistle was audible on an ordinary receiver, but the Radiostat was quite free from this form of interference."

need little explanation. The crystal circuit is so selective that for most practical purposes it may be said to offer a low impedance to currents of its natural frequency, and an infinite impedance to currents of frequencies 50 cycles or more different from its natural frequency. All interference, then, which is of a different frequency from that of the desired station can be eliminated, and with it, the heterodyne whistles audible on all ordinary receivers.

What is not at all obvious is how such a circuit can pass the modulation of a broadcast transmitter; and in order to explain this it is necessary to delve a

little into the theory of modulation. A modulated carrier wave is commonly spoken of as consisting of a carrier of constant amplitude and frequency with a number of sideband frequencies. Thus a carrier of 1,000 kc., modulated with a note of 1,000 cycles of constant strength, is said to consist of a carrier of 1,000 kc. of constant amplitude with two sideband frequencies each of constant amplitude and having frequencies greater and smaller than the carrier frequency by 1,000 cycles; that is, 1,001 kc. and 999 kc.

The normal design of tuning circuits for broadcast reception is carried out on the assumption that the presence of all these sideband frequencies is necessary for proper reproduction. There is, however, another way in which a modulated carrier may be considered; and that is one which is always used when examining the characteristics of a detector tube. A modulated carrier may be considered as a carrier of constant frequency the amplitude of which is varying at the modulation frequency. It is obvious that the higher the modulation frequency the more rapidly is the carrier amplitude changing; therefore, in order to prevent the high modulation frequencies being reduced in strength, it is necessary so to design the receiver circuits that they allow the amplitude of the current through them to change at least as rapidly as the carrier amplitude is changing. If the circuits will not allow this rapidity of change the strength of the higher modulation frequencies will be reduced.

In general, with ordinary tuning circuits the results are much the same whichever theory of modulation is used in the calculations; and it has come to be the common practice to use whichever theory is the easier for the analysis of a particular circuit. In consequence of this, the sideband theory is now always used in considering the design of tuning circuits, and the amplitude variation theory when examining the operating conditions of r.f. and detector tubes. That this is usually quite accurate can be shown mathematically, for it can quite easily be proved that the two theories are identical; or perhaps it is better to say that they are two different ways of looking at the same thing, and that each way is quite accurate. If a modulated carrier of varying amplitude is analyzed, it is found to consist of the carrier and a number of sidebands; while if a carrier and a number of sidebands are regarded as a whole they are found to be identical with a single frequency wave the amplitude of which is varying.

Now with the Stenode Radiostat, the quartz crystal circuit has so sharp a resonance curve that practically none of the sideband frequencies are passed to the succeeding circuits. Since no sidebands are passed, the sideband theory is useless in explaining how the receiver can reproduce speech and music; and it is necessary to use the alternative, and equally correct, theory of amplitude variation. There is no attempt to deny the existence of sidebands, and any such attempt would be futile in view of the many proofs that they have an actual physical existence. It is said, however, that they are unnecessary for the proper reproduction of the modulation frequencies.

It was mentioned earlier in this article that if the decrement of a circuit is sufficiently high to allow the current through that circuit to follow exactly the amplitude variations of the carrier at the highest modulation frequencies, the reproduction will be satisfactory. It becomes necessary to inquire what happens when the circuit decrement is low, and the circuit will not allow the current to change sufficiently rapidly. Briefly, the mean amplitude of the

The Stenode Radiostat, fundamentally a superheterodyne, but radically different in accepted principle, makes its first bow to the American radio public.

Infinite selectivity is accomplished without loss of high or low notes by using "sidebandless" reception, or the reception of a carrier wave modulated in intensity only. Theoretically this would require a band of zero width, but assuming that a band 1 kc. wide were necessary, the number of transmitters in a given existing legal band could be increased by ten with no interference.

Here's something that the serious-minded experimenter will find pregnant with possibilities.

carrier is unaffected, but the amount by which the carrier amplitude can change within a given time is reduced. The result of this is that the depth of modulation is apparently reduced for those modulation frequencies for which the circuit decrement is too low. With the Stenode Radiostat the crystal decrement is so low that there is a considerable reduction in the amplitude variation, even for the low modulation frequencies, while the higher modulation frequencies are enormously reduced.

The current through the circuit B (Fig. 2) which has passed through the quartz crystal is different from the current in circuit A in that it has apparently been partly demodulated; that is, the amplitude variations have to a certain extent been smoothed out, and the extent of this action depends upon the modulation frequency;

the greater the modulation frequency, the greater the smoothing action. The output current, therefore, differs from the input only in the following manner: the depth of modulation has been decreased at all modulation frequencies, and this decrease is greater for high modulation frequencies than for low.

Now the output of the quartz crystal circuit is very large, and if the normal voltages were applied to the detector, a large power tube would be necessary to provide efficient rectification. But although the mean carrier amplitude is large, the variation in amplitude due to modulation is comparatively small; consequently, satisfactory results can be obtained from the normal detector tube and circuit if a large negative bias is applied to its grid. The actual bias voltage required depends upon the amplitude of the input, and is adjusted during reception to suit the particular signal being received. The tube is over-biased, but since the input is only weakly modulated, the variations in amplitude can be applied to the straight portion of the grid-volts—plate-current characteristic, and distortionless rectification can take place.

From the foregoing it will be seen that the output of the detector contains, in addition to the normal d.c. and r.f. currents, a.f. currents of frequencies corresponding to the modulation frequencies of the original signal. The amplitudes of the a.f. currents, however, will vary with frequency for constant modulation depth, due to the smoothing-out process in the quartz crystal being less effective at low frequencies.

There is, therefore, a very considerable high note loss associated with the r.f. portion of the Stenode Radiostat; or, to be strictly accurate, there is a low note accentuation, for the high notes are not actually reduced in strength; the low notes are increased. Now if the detector output were connected to a normal a.f. amplifier, the reproduction would sound almost completely deficient in high notes. A special audio amplifier is used, therefore, which is so designed that the amplification at high frequencies is much greater than that at low. This is accomplished by the inclusion of what is really a form of high-pass filter, shown at F in Fig. 1, which has a

filtering ratio between 5,000 cycles and the very low frequencies of about 50-1. The actual amount of compensation is readily adjustable by means of a 10,000-ohm variable resistance, not shown in the diagram, which is connected in series with the choke Ch. By this means a more or less flat overall fidelity curve up to 5,000 cycles is obtained.

So far the action of the Stenode Radiostat has been explainable on normal theory, and it can be seen that it consists of a superselective circuit of an unusual type. The use of the supersonic principle is necessitated (Continued on page 360)

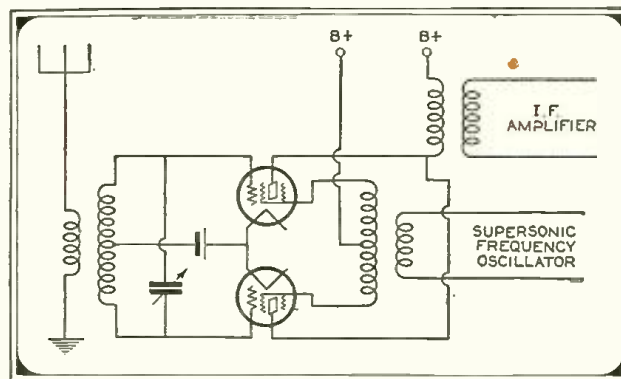


Fig. 3. By means of this circuit the crystal current amplitude was artificially limited, thus automatically limiting modulation

"B" Batteries

ourselves as to what's inside a B battery be given batteries during their useful life. down in plain, every-day language the will aid in conserving and lengthen-composition of batteries, their "useful depreciation and some hints on "how to of the subjects dealt with here

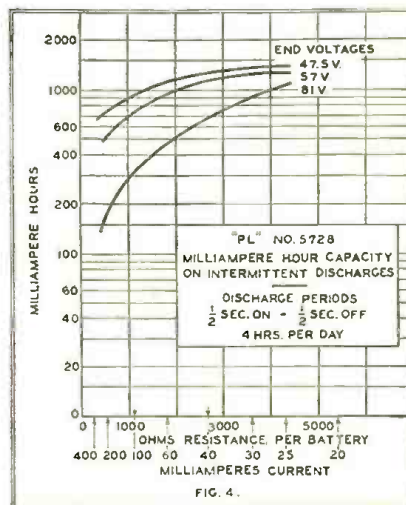
Martin

"What Is a Good Loud Speaker?,
Amplifier" and "Shall We Use Grid or
Detectors?"

line (2), etc., but the active surface is practically the same for line (3), for example. as when the battery was new. In the case of the layerbuilt, therefore, the active surface decreases but slightly with life and this is one of the major, but not generally realized, reasons why the layerbuilt has a longer life. Another reason for the longer life of this type of battery is that when round cells are placed in a case there is an unavoidable space left between each cell, whereas in the layerbuilt close packing is possible, which means that more space is available for active material.

Now let us examine the factors that affect the life of batteries in operation. The rating of "B" batteries is given terms of milliampere-hours. This means, for example, that if a battery is rated at 5000 milliampere-hours, it would supply a load of 10 milliamperes for 500 divided by 10 or 500 hours. Now the milliampere-hour capacity of a battery depends largely upon the load drawn from it. If we plot for any battery a curve showing the relation between the milliampere-hour capacity actually obtained and the current drawn from the battery we obtain a curve like that shown in Fig. 3. Here we note that at either very low currents or at very high currents the actual milliampere-hour capacity obtained from the battery is lower than at an intermediate value of current. Over a certain range the curve is quite flat and maximum capacity is obtained—this portion of the curve has been marked "useful range." Since "B" batteries are not usually subjected to constant use, that is, they are used but a few hours a day, the ratings are based on a certain number of hours' daily use. For example, the figures given in Table 1 show the milliampere-hour capacity of certain Eveready "B" batteries and the range of useful current which corresponds to the "useful range" portion of the curve of Fig. 3. The figures of Table 1 are based on a daily use of from 2 to 4 hours and the useful life is assumed to have ended when the voltage of a 45-volt "B" battery reaches 34 volts. Actually the limit of 34 volts is quite flexible, since in many circuits the battery may be used down to 30 volts per 45-volt bank. Of course, if a 30-volt limit is

Fig. 4 shows the milliampere hour capacities of the "PL" No. 5728 at various resistances with a service of one-half second on, one-half second off for a period of four hours per day



assumed, the life of the battery is increased. In this connection the figures in Table 2 show the milliampere-hour capacity of these batteries for limiting voltages of 34, 30 and 24 volts. It will be noted that the capacity is increased by 25 per cent. for a 30-volt limit and 50 per cent. for a 24-volt limit.

The figures of Table 1 marked "useful range" are especially important in deciding what battery to use in operating a particular receiver. If, for example, the total plate current is quite low, say 6 ma., then the proper battery is the medium size round cell; if the drain is 20 milliamperes, then a large layerbuilt battery should be used. For intermediate current drains one of the other sizes would be satisfactory.

Many users of batteries prefer to think of battery life in terms of the number of months' service one can expect. We have therefore prepared the figures of Table 3 which show the number of hours, days or months service one can expect from the various types of batteries at various current drains. The figures given in Table 3 are all based on 2 hours' use per day. This data and that given in the preceding parts of this article apply especially to Eveready batteries. It will, of course, not

apply to batteries made by other manufacturers. The Burgess Battery Company has developed a number of batteries for special service where it was felt that the standard types of batteries could not conveniently be used. Photo-cells, for example, require high voltage but very low current, and a "B" battery giving high voltage but light in weight can be used to advantage where weight is a factor, as, for example, airplane receivers, or portable transmitters and receivers. The

PL 5728 is a 108-volt battery, tall, narrow, measuring 15³/₄ inches high by 3³/₈ inches by 2⁵/₈ inches. The PL 4963 is not quite as high but is somewhat thicker—rated at 144 v.

The curves of Fig. 4 and Fig. 5 show the hours of service obtained from these two batteries at various current drains. The data given on (Continued on page 379)

¶ The B battery is now being widely used for airplane receiver operation where absolutely trustworthy operation is essential.

¶ Another field, by no means negligible, where the B battery still plays an important part is in the laboratories of all the radio companies, in tube laboratories and in the lab of the experimenter and serviceman.

TYPE TYPE No.	MILLIAMPERE-HOUR LIFE FOR END VOLTAGE PER 45 VOLT BANK OF		
	34 VOLTS	30 VOLTS	24 VOLTS
772	4,100	5,125	6,150
485	5,200	6,500	7,800
770	8,000	10,000	12,000
486	10,000	12,500	15,000

NOTE:—FIGURES BASED ON 2 TO 4 HRS. USE PER DAY.



Doubling in brass is as nothing compared with an announcer's effort to cajole honeyed words from a precocious child. Little Betty Blatherskite may be a great boop-boop-a-doop artiste in her home town, but in the studio she holds her breath and looks askance at life in general

IF your eyes are watching the scene in the radio studio you will see a tall, substantially built woman and a short chunky man standing at the microphone.

From the speaker in the radio reception room from which you are watching you hear impassioned dialog.

She loves him dearly. He loves her sincerely. If you close your eyes you can picture the ideal lovers plighting the well-known troth under the apple tree. It is better to keep your eyes closed if you wish to enjoy the play being broadcast. The dialog is planned for the setting your imagination will create. No thought is given to the physical appearances of the principals in the radio play and the fact that an old melodrama is being enacted in an ultra modern room doesn't make any difference. The persons to whom it is designed to appeal comprise that large and scattered group referred to as "the invisible audience." They hear the romantic words and phrases and their imaginations complete the picture.

Before the love scene which climaxes the radio play goes on the air, other actors in the production have painted the scenery, costumed the players and set the time of the play. Not with brushes and grease paint but with appropriate combinations of vowels and consonants, occasionally aided by musical notes. If the radio play is well done these sounds, though actually appealing to but one sense, will create in the mind of the listener an image of the actors and have him smell the apple blossoms in the orchard on the Old Homestead.

The dramatic type of radio production, whether it be a cleverly written sketch which delicately suggests the use of a certain brand of toothpaste, or whether it be a condensed version of one of the world's greatest plays, has become one of the most popular forms of broadcasting entertainment. The National Broadcasting Company presents twenty-five or more dramatic programs each week.

Dramatic sketches on the air are not new. A number of Shakespearian dramas were broadcast seven years ago—a long time in radio history. Plays have been a regular part of the program fare since that time but it is only in the past twelve months that dramatic programs have begun to rival jazz bands and concert ensembles in listener interest on the big networks.

New material for broadcast drama is very much in demand and very hard to get. Though would-be radio writers almost stand in line to submit their manuscripts, only a small percentage of the material submitted meets the first requirements of the air. Even skilled writers of plays and vaudeville sketches fail miserably when they attempt to write for the air. The fact that not even a "how" book has been written on radio writing is ample evidence that no one is quite sure how it is done except the successful radio writers and they are too busy to conduct classes.

Radio listeners are largely responsible for this trend toward

Backstage

A radio script, ending within a or half-hour, is an achievement writing and acting to production. original program idea and the described in



The half-way mark—and the actors are knee-deep in verbiage. Such is the fluttering fate of the author's brain children—typewriter to waste-basket—and another characteristic angle of show business on the air

the dramatic on the air. Their demands for something different in the method of program presentation grew so insistent that the program makers turned to dialog and the principles of dramatic craftsmanship to meet the demand. Dialog and plot first were used on what are known as "sustaining" programs—the programs planned and paid for by the broadcasters themselves. Then the program sponsor—the big-hearted business man who is willing to finance a period of entertainment in return for the privilege of telling the family circle that his product is worth their attention—noticed the success of this new trick in attracting favorable comment and demanded that his programs be made dramatic. The result was that at the present time dramatic radio productions are being used to exploit department stores, yeast, tire gauges, medical supplies, tooth paste, gasoline, a railroad, shoes, fish, cigars and several dozen other well-advertised products.

This sudden interest in dramatic methods on the part of the program sponsors has given the program makers some real problems. While a presentation advertising a railroad suggests a dramatic sketch involving travel, it is another thing to construct thrillers about tooth paste. And when a manufacturer of bathroom paper naively requested ideas for a series of radio programs and evinced a willingness to advertise his product over a national network, the program makers frankly admitted they were licked.

Having established a reason for this theater of the air, we will return to the studio where we left the little rosebud and the strong and handsome one concentrating one of life's greatest moments into mere words.

This concentration of great moments into few words is the whole trick of producing a radio play. Shakespeare had it, according to the radio people and they point to him as one of the world's greatest writers of radio dramas.

They remind you that the Bard worked under many of the

in Broadcasting

second or two of its scheduled hour combining a score of techniques from The painstaking steps between the broadcast product are interestingly this article

By P. H. W. Dixon

Illustrations by G. Ricca

handicaps that radio producers must overcome. The theater of his time had little scenery, unconvincing costumes and no special lighting effects. Women's roles often were played by boys. Thus Shakespeare developed the ability to make his characters speak lines that left no doubt in the mind of the audience as to where the action was taking place, in what period the play was set and what costumes would have been worn if there were costumes.

Our hero and heroine—if they have had any experience at all in broadcasting, which they must have had or they wouldn't be playing leading parts—are fully conscious of these handicaps. Therefore their technique is to extract every possible bit of meaning out of the lines given them to read. Actresses in

the air premiere. Actors may be changed and the writer may be called in to make changes in certain scenes. Then, when all corrections apparently necessary have been made, the play is offered to the radio audience. A close watch is kept on letters from listeners and on comments of newspaper critics to determine how the show is being received by the radio audience. After a few weeks, if the new program is satisfactory, it becomes a part of the vast and intricate pattern of broadcast entertainment and is continued until its interest-creating possibilities are exhausted.

Here is what happens when a play known to be well written and with a successful record in the theater, is selected for broadcasting:

A radio director, responsible for the production of at least one radio drama a week, looks over a list of famous plays available for broadcasting. Selecting one, he sends it to a young writer skilled in adapting the work of others to the limitations of radio.

This adapter first reads the play and then rewrites it, substituting new speeches for stage business and eliminating such speeches as would not be readily understood unless accompanied by appropriate gestures. Other lines and scenes are pruned out until the play fits into the hour or half hour of time allotted it on the broadcasting schedule. Despite this surgery, the play goes back to the director in clearly understandable form. The adapter—usually called a continuity writer—has condensed the play to the required reading time, has written in sound effects and has presented the really important scenes without mangling the previous work of the original author.

The play that cannot be condensed to an hour of dialog doesn't exist—"Strange Interlude"—included—according to these adapters. Many plays can be (Continued on page 362)



Some consider that the striking of musical chimes to introduce station call letters is a "Belasco touch" in broadcasting

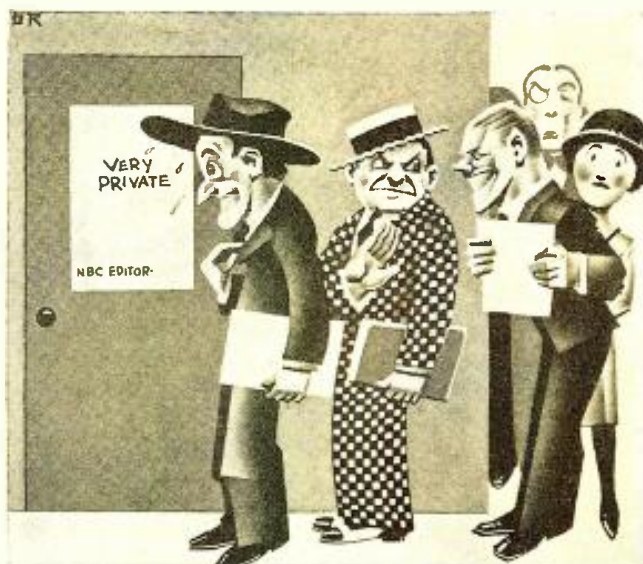
radio dramas sometimes reach emotional heights seldom if ever achieved behind the footlights and tears stream as readily at rehearsals as during the actual production.

Broadcast drama comes from two sources. Either an adaptation of a stage play or a novel is made, or original material is used. In event the sketch produced is an original idea developed from radio it must go through many hands before it reaches the radio listeners—if it ever does.

A writer submits a script to the National Broadcasting Company. The script goes first to a reading committee composed of experts on radio drama. One member of the committee is Burke Boyce, manager of the continuity department.

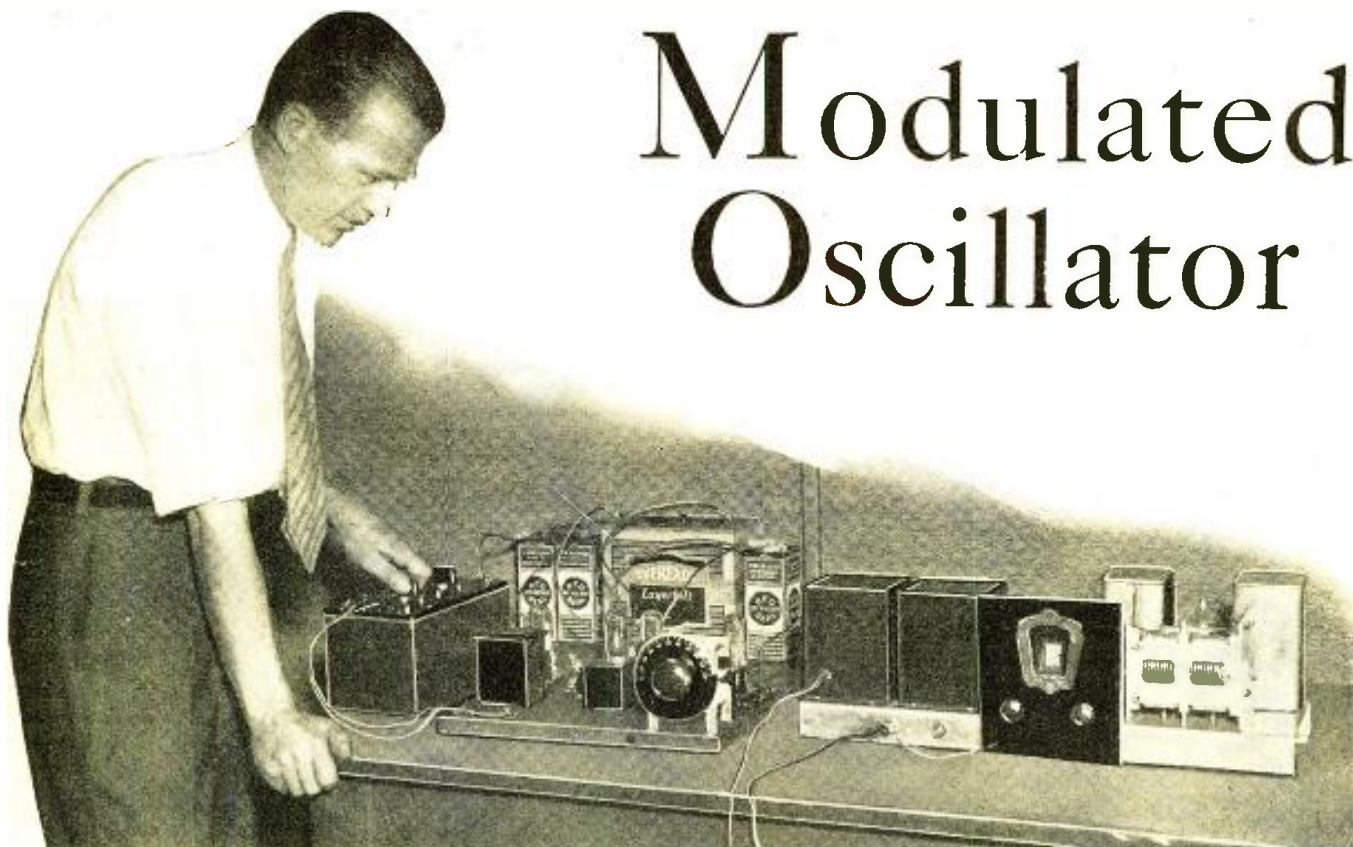
If the script has possibilities it is next read and discussed by the Program Board, a group composed of executive heads of the program department. If a majority of the board members approve of the script an audition is set. The script is turned over to a production man who casts it, rehearses it and then presents an episode for the Program Board to pass upon. If the radio play, in its finished form, still is pleasing, a date is set and it is put on the air.

Often changes are made between the time of the audition and



"Hope springs eternal . . ." Whether the line of would-be radio writers will be lengthened or shortened when the first "how to write for radio" treatise is published is entirely problematical, but it is quite evident today that only a few authors are technically qualified

How to Build a Modulated Oscillator



The modulated oscillator set up to test a manufactured receiver. The operator is adjusting the "tone-control condenser"

WHEN the need arose in the laboratory of RADIO NEWS for a ready method of testing receivers both as to their radio-frequency sensitivity and selectivity, as well as their audio frequency response, it was decided after considerable confabulation to design a modulated oscillator suited to our purpose. As we sought, not precise measurement, but rather a hasty method of determination prior to the actual running of curves on apparatus, the following design evolved. However, as it was to be a permanent adjunct to our laboratory, the best quality of apparatus was used.

Looking at the wiring diagram it will be noticed that we have a radio frequency oscillator of conventional design, modulated by the Heissing system, the audio tone being furnished by an oscillator of rather unusual feature. Any audio tone from sixteen cycles to eight thousand cycles may be produced at will, with a clear, pure tone that sounds very much like a pipe organ. The system is in reality a small transmitter, with speech amplifier equipment and a source of audible tone.

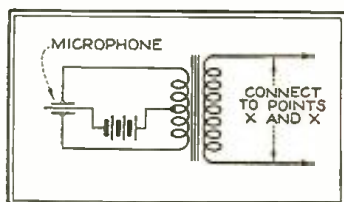
For the actual construction, a soft wood base board should be procured, and thoroughly dried. A coat of stain and two coats of clear varnish will both improve the appearance and protect the wood from moisture. A small drawing board is ideal for the purpose, if one cares to go to that expense. The size is 9 x 14 inches.

The actual parts of the electrical circuit were chosen, first, for their utility, and, secondly, because they are all easy to obtain. The coil for the audio oscillator is the secondary circuit of a Silver-Marshall push-pull input transformer number 257. This gave the necessary split inductance for the oscillator stage. The coupling device into the amplifier stage is S.-M. 256, hooked

up as an auto-transformer. The "constant current choke" is also an S.-M., but substitution may be made here of another kind of choke, provided the inductance is at least 30 henries. The coil of the radio-frequency oscillator is an S.-M. No. 131-Y. The National Type DX tuning condenser was chosen because it is supplied with feet for base board mounting, and also has a vernier dial that fastens to the condenser shaft directly, thus obviating the necessity for any type of panel. The rest of the parts may be any that the experimenter has handy, provided their electrical characteristics are suitable.

The actual layout of the parts as used is clearly shown in the photograph in the upper right hand corner of the page. The clips for the battery connections, eight in number, are equispaced along the rear edge of the base board. They are held by $\frac{3}{4}$ No. 6 wood screws sunk into the board, with a solder lug under the head of each screw. The sockets for VT1 and VT4 are lined up two inches from the back edge, and one inch from each end. The other two sockets are grouped together in the center of the board in line with the end ones. A grid leak mounting is placed on the extreme right hand end of the base board, and an amperite mounting between the first two sockets. Room will be found between the last two sockets to mount the constant current choke with a grid leak mounting directly in front of it. The condenser C4 should be placed beside the grid leak mounting.

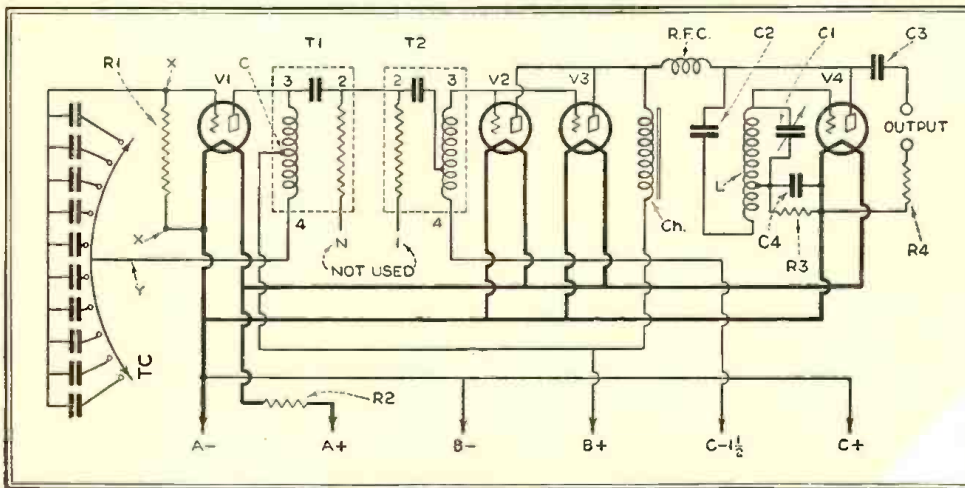
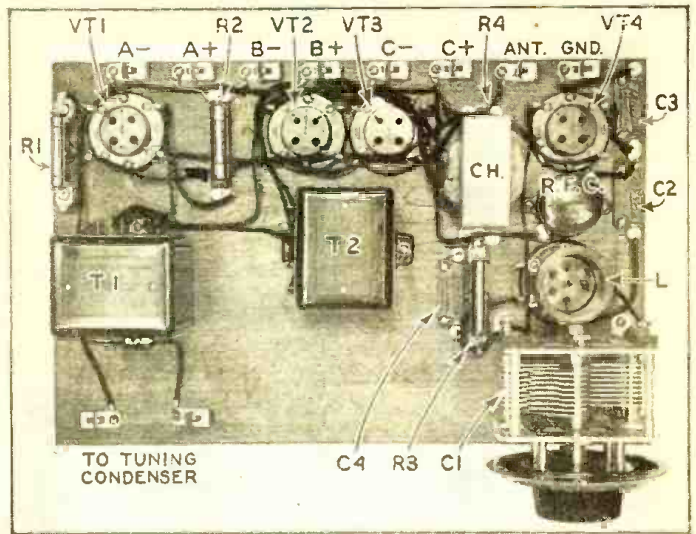
The tuning condenser for the radio frequency oscillator is in the extreme "south-east" corner, with the coil directly behind it. Between the coil and the socket space will be found for the r.f. choke. The two condensers C2 and C3 are screwed in place along the extreme right hand end of the board. With the two transformers placed as shown, and the clips for the tone control on the front, all parts will have been mounted



It's easy to get Hongkong if you just know how. Try this one on your radio

Where precision measurements are unnecessary, this modulated oscillator will make all required tests on a receiver, both for sensitivity of the radio-frequency end and for fidelity of tone of the audio channel. The system also lends itself to numerous interesting experiments

By George E. Fleming



Top view of the oscillator. The designations shown conform to the parts listed in the text

Close-up of the radio-frequency end. Similar layout to the one shown should be used for ease of wiring, and maintaining short leads throughout

The unusual connections of the audio units and the tone-control condenser are to be noted in the schematic wiring diagram. The two oscillators are self-biased by the 10,000-ohm grid leaks

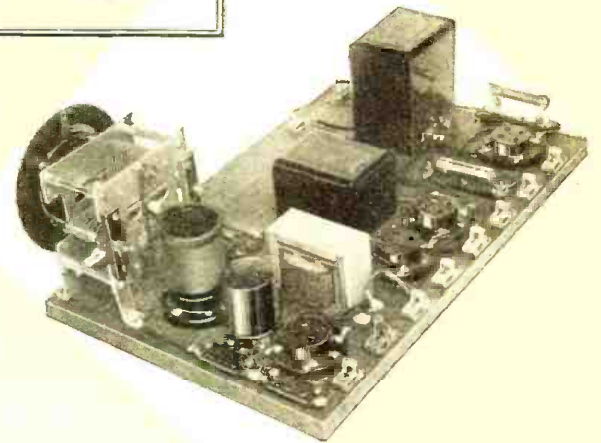
so that they are in very good position for ease of wiring. The tone control condenser is not mounted on the base board. Details of this part of the equipment will be given in full later.

The wiring is straightaway work that, with one or two exceptions, requires no particular comment. The connections to the audio units, however, are tricky, and must be carefully done. The point marked 3 on the first unit connects to the plate of the oscillator tube, and "C" goes to B plus. Point 4 goes to the tone control condenser. Wire together the two points numbered "2" on the two units. Numbers 3 and 4 go to the grids of the amplifier tubes, and to the "C" battery respectively. Note here that VT1 and VT2 are in parallel.

The Silver-Marshall 131Y coil is designed to fit a regular five-prong socket and all the wiring necessary is done to the socket. The "G" of the socket goes directly to the grid connection on the socket for the radio frequency oscillator. Connecting the two filament connections on the coil socket together establishes the center tap point, and should be connected to the negative filament through the leak-condenser combination R3 and C4.

With all connections made, the oscillator is ready for testing. Place the tubes in the sockets, and wire up the batteries. Only 45 volts of battery are necessary in the "B" circuit. The "A" battery voltage will be determined by the tubes used. The tubes may be -12A's or -01A's, or, if available, you may use the new dry battery tubes designated as 230's. These latter were used very successfully in the laboratory model.

With the tubes in place, and the batteries connected, the oscillator should be ready to work. The condenser C3 and the resistance R4 form a dummy antenna circuit. Connect the antenna and ground connections of the receiver under test to



this dummy antenna circuit. A word of caution here. Remove the actual antenna from the receiver before making this connection, for the oscillator is in reality a small transmitter, and if connected to an outside antenna, it will broadcast to all and sundry for a radius of about ten miles.

Now we are all ready to work with the exception of the tone control condenser. For a test, simply place a .05 mfd. condenser across the two leads of the oscillator brought out for that purpose. This will give one note of about 3000 cycles.

Place the tuning condenser of the oscillator on 50 and tune in the signal on the receiver. The audio note should come through clear and pure in the loud speaker connected to the receiver.

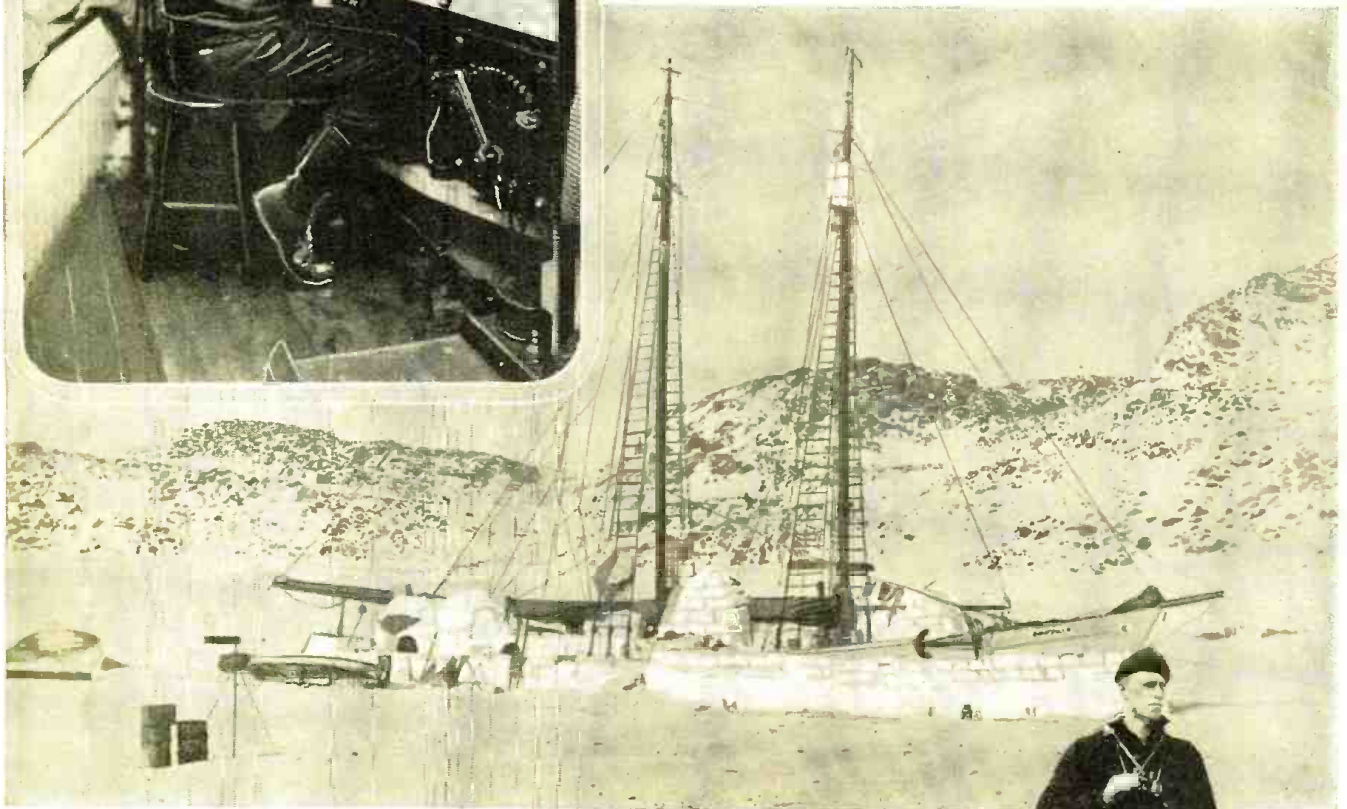
Now for the tone control condenser. In the laboratory we have a General Radio Decade condenser box that we use. The range of this box is from .01 to 1 mfd. in twenty steps. This, of course, is rather an expensive method, and just as good results will be obtained by getting several .01 condensers and connecting them to a fan switch (Continued on page 363)

Don Mix-

By N. Pomeranz

W2WK—W2APD

At the left, Don Mix shown in his quarters aboard the Bowdoin, operating station WNP



EIGHTEEN years after he first saw the light of this world, Donald H. Mix sat in the living-room of C. D. Tuska in Hartford, Conn., and waited all afternoon for Mr. Tuska, who was to sell him a small 22½-volt "B" battery.

When Mr. Tuska finally did arrive, Don found that he had an insufficient amount of money to pay for this small battery. He told Mr. Tuska of his plans—just some new ideas he had in mind on radio reception and transmission. He pointed out to him the benefits that would come from his experiments. Don got the battery.

Although he first became interested in radio in 1915 through reading some electrical magazines, loaned to him by a friend, and had been operating his own spark transmitter under the call of ITS for nearly a year, in 1919, this small battery started his actual radio work.

Most radio experimenters adopt one pet field into which they pour most of their work. Some delight in working out different antenna systems for transmission. Others have a propensity for building receivers. Everyone has his little pet topic on which he can discourse to his heart's content. Don Mix took to batteries and their usefulness in radio transmission and reception. Mr. Tuska's battery so delighted him that he spent hours in just looking at it and building imaginary transmitters and receivers and operating them. His dreams came true.

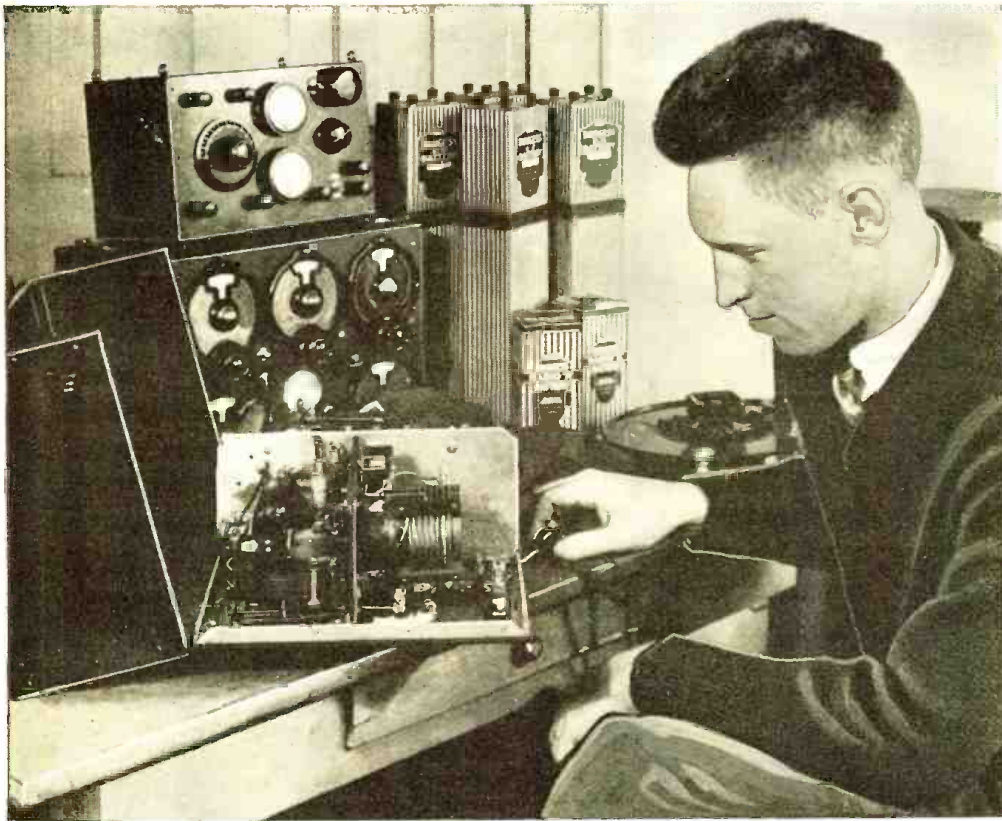
He had a spectacular rise to a position where he is now considered one of the leading authorities on battery-operated radio equipment.

Mix was born in Bristol, Connecticut, in 1901, and passed through the normal stages of boyhood with a penchant for mechanical things. He spent the first four years of his radio "life" in building simple crystal receivers. His first spark



A RADIO PIONEER

Extraordinary

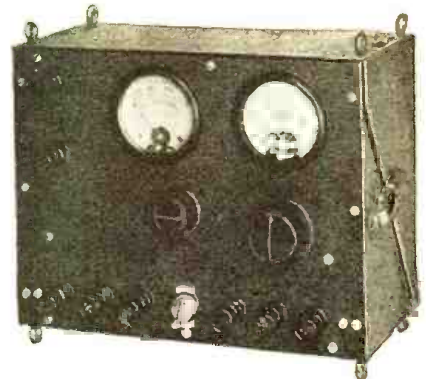


On the opposite page is a view of the Bowdoin frozen in for the winter in the Arctic wastes, 1923-1924. Immediately below is an interesting picture of the Bowdoin's famous radio operator

Immediately at the left Don Mix is shown examining an experimental receiver in a corner of the Burgess radio laboratory

The small picture below shows a portable dry battery operated transmitter for short-wave work. It is interesting to note that the recent Byrd Antarctic Expedition carried with it six similar to the one shown here

In looking around for a personality which exemplifies the true pioneer spirit and one which is tied up undeniably with uses of batteries in radio, Donald Mix, W9AT, stands head and shoulders above everyone else. He it was who was chosen for a radio berth on one of MacMillan's exploration trips to the North Pole, where reliance on battery-operated transmitters and receivers was one of great moment. Mix's career is unusual, not because of any one or several outstanding achievements, but because to him was given the opportunity to do those things which any live radio amateur dreams of some day accomplishing



transmitter was no "world-beater." It grew up in stages until it became one of the best in Connecticut. Amateurs who can think way back to the "old" spark days can remember the smooth and powerful tone of 1TS. Mix still retains this call, although it has been enlarged to W1TS by our own Federal Radio Commission.

In 1920 he started to devote his business hours in radio work for the C. D. Tuska Company in Hartford. His first "B" battery had made a friend for him and aided him in obtaining

his first radio position. Mr. Tuska was never sorry that he practically presented Don with a battery.

Donald continued to grow up. His ideas grew with him, old ones were forgotten and new ones entered his mind. He had to keep up with the ever-changing trend of radio receiver and transmitter design. But the battery stuck with him. Everything else changed, spark transmitters gave way to tube outfits, transformers gave way to generators.

Don had foresight. He reasoned (*Continued on page 375*)

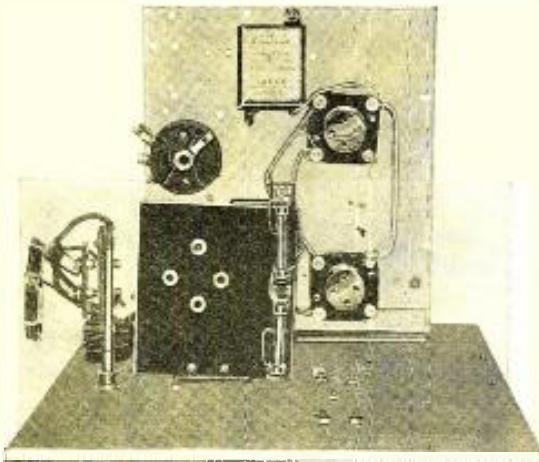
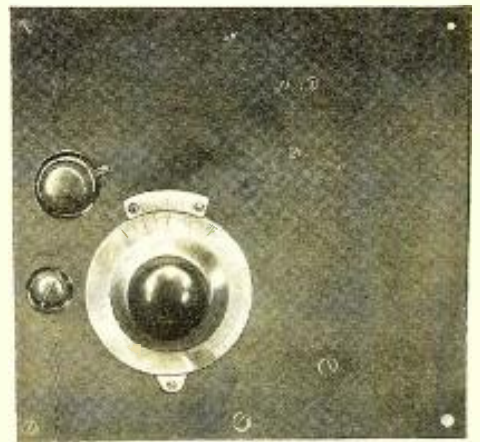


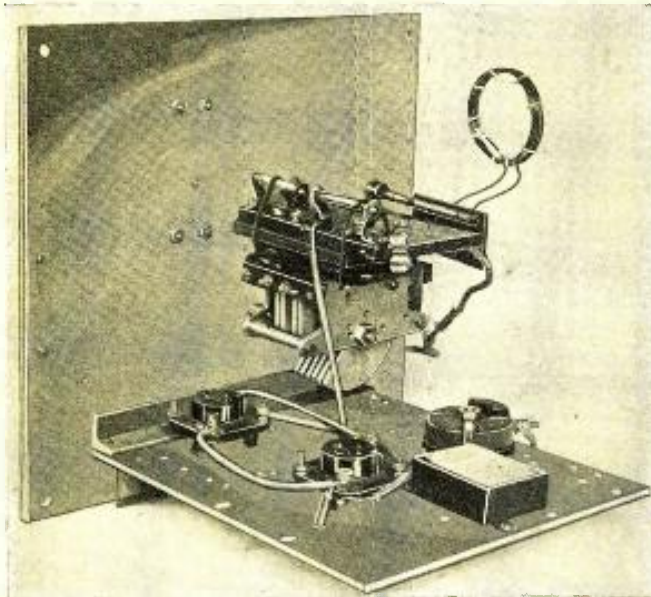
Fig. 2. At the left and right, respectively, are shown the top and front views of the short-wave radio-frequency amplifier section of the complete receiver. The large dial is the main tuning control for the unit, while the large knob is for antenna coupling and the smaller knob for trimming



Practical Design and Constructional **Marshall S-W P**ush-Pull

In this second and final installment on the constructional details of the receiver built by Mr. Marshall, and selected officially by the United States Navy for their ultra-short-wave reception work, is given the necessary data for the winding and preparation of the various coils used, together with the layout and placement of the parts employed in the receiver's construction. Providing the illustrations are studied carefully and the directions for building strictly adhered to, the duplication of this receiver is not a difficult job

By Thomas A. Marshall



IN the July issue of RADIO NEWS a general description of the Marshall push-pull receiver was published. For those interested in one of the newest and most efficient types of short wave receivers, an article is published herewith which gives a complete outline of dimensions and practical information.

The receiver itself is built in an aluminum cabinet having dimensions as follows:

Bottom and top panels.....	33 $\frac{3}{8}$ x 9 $\frac{1}{2}$
Back panel	33 $\frac{3}{8}$ x 10 $\frac{1}{2}$
Front panel	33 x 10 $\frac{1}{2}$
Ends and partitions.....	9 5-16 x 10 $\frac{1}{2}$

Accompanying photographs show arrangements of the top panel and the sub-panel shielding. These panels are cut from 3-16-inch aluminum or duralum. The latter material is easier to handle, and gives better shielding. However, aluminum is satisfactory. The reason for using heavy aluminum is to give perfect mechanical construction, making all parts as rigid as possible, thus reducing microphonic noise and vibration to an absolute minimum. The builder should keep in mind that in order to obtain satisfactory results it is necessary to shield short-wave receivers. Practically all types are shielded with thin aluminum. Very few of these receivers are free from microphonic noise, and variation of reception of a pure CW signal due to poor mechanical construction. For this reason, the builder might just as well do a real job in shielding, resulting in perfect reception on all frequencies.

There are a number of refinements incorporated in the design of the receiver which should be retained by the builder. Some of these features are: control of the detector grid bias

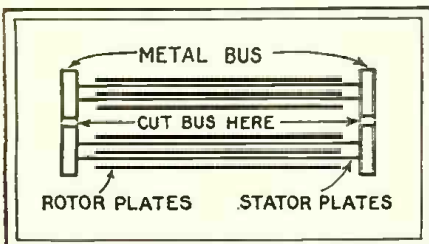


Fig. 1. The Cardwell condensers used in the tuning circuits of the receiver are split, as shown at the left, so as to obtain two tuning sections

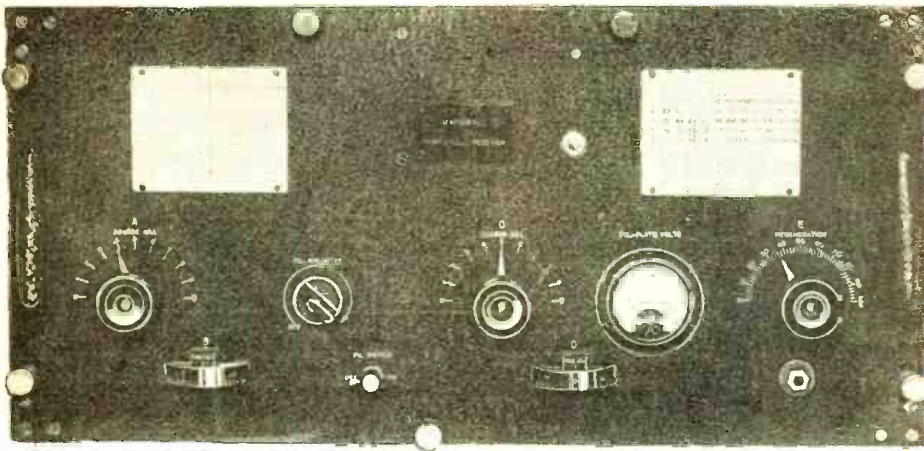


Fig. 3. At the left, a front view of the panel appearance of the Marshall short-wave receiver. Charts are mounted directly on the face of the panel to indicate coils required for various wavelength ranges

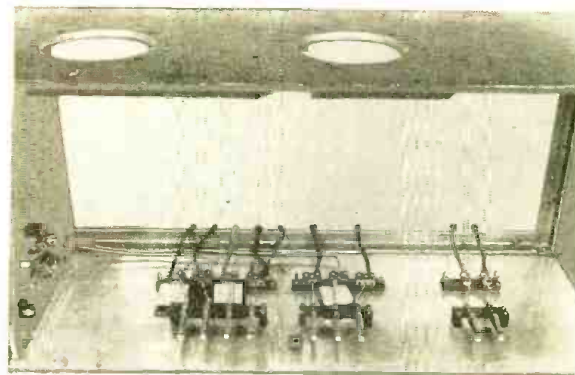
Data on the Receiver

Part Two

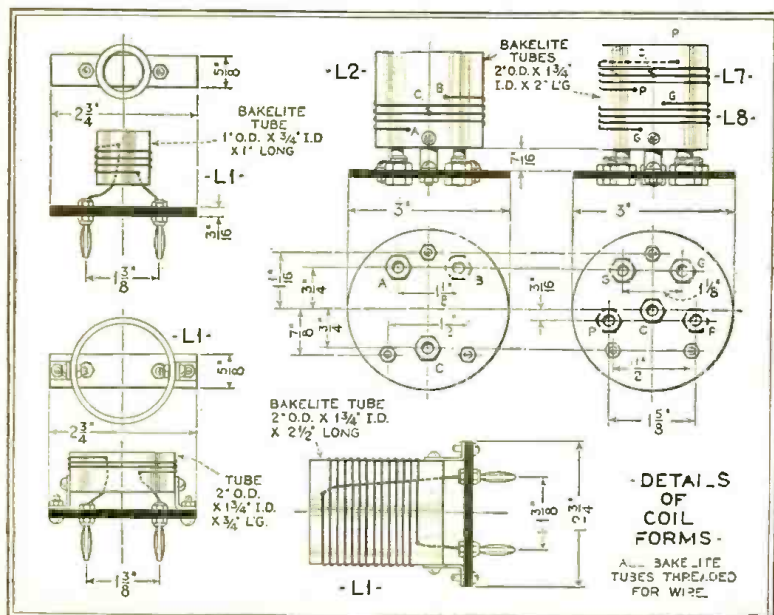


Fig. 4. So that the entire receiver may be readily removed from its metal cabinet, a system of plugs and jacks, as shown at the left, are provided. Above, Mr. Marshall at the controls of his receiver

by use of a 200-ohm potentiometer shunted across the filament leads, with the return of the grid leaks going to the center arm of the potentiometer; perfect symmetry of the radio-frequency stages and the detector stage; variable antenna coupling coil to the secondary circuit of the first radio-frequency amplifier stage; regeneration control by a variable resistor in series with the detector plate voltage supply system. The resistance method for regeneration control permits the receiver to be calibrated, enabling dial



settings for any given frequency to be used. The variable antenna coupling system permits coupling at any frequency. Also, it permits a favorable signal-to-noise-level ratio to be selected by the operator, and improves selectivity.



By means of plug-in coils a wide wavelength range is obtained, extending from 5 to 80 meters, or higher if desired. The entire broadcast band may be covered with three plug-in coils.

The condensers C1 and C2 (shown in the diagram printed last month) are mounted directly underneath the coil mounts, resulting in decreasing the grid leads to a minimum in length. Tuning of each coil by means of Cardwell 165-E condensers and vernier dials, permits easy control of the receiver. The Cardwell type of condenser is rigid, smooth in operation, and permits a double type of condenser for push-pull operation to be constructed. This is accomplished by cutting the two metal bus bars at the center as shown in Fig. 1. The center stator plate is removed as shown. It is to be noted that both halves are equal in capacity and permits tuning of both sides of the circuit simultaneously.

Note that the writer uses a special vernier dial, built by the National Electric Supply Com-

Fig. 5. The coil constructional details for the entire series of inductances required in the receiver are given at the left

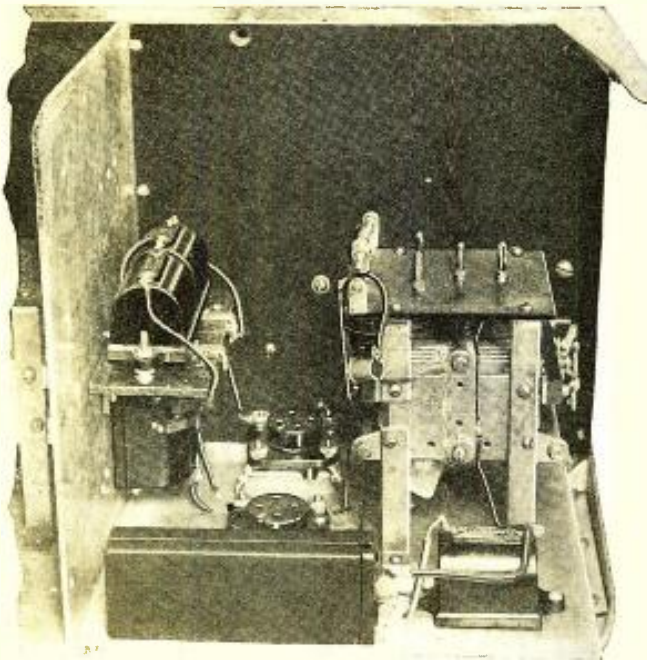


Fig. 6. In the second r.f. stage of the receiver, which is shown above, it is important that the three r.f. chokes be mounted as illustrated

pany. This type of dial is especially recommended; it is quite expensive as it has a 100-to-1 ratio, no backlash, and is easy to handle. However, very good results may be obtained by employing National VV dials.

In viewing the photographs, Figs. 6, 9, 10 and 12, it will be seen that the coil bases are mounted directly on top of the condensers.

In the photographs is illustrated the bakelite base for mounting the detector and audio tubes. Note that L9 is secured to this base and is mounted directly between the detector tubes.

Below the sub-panel shielding are mounted the various filament rheostats, the connector cables, and by-pass condensers. Below the sub-panel supporting the detector and audio tubes are the audio transformer, output transformer, telephone jack and the regeneration control resistor R9, which is an Electrad Super Tonotrol, 200,000 ohms. Practically all the wiring is accomplished underneath the sub-panels. Solid bus-bar wire covered with cambric sleeving is used so as to make all wiring as rigid as possible. Note that all the wires extend up through holes in the sub-panel shielding. In order to avoid short-circuits due to rough edges of the holes in the panel, it is well to use eyelets or use a reamer on each side of the panel, thus avoiding cutting through the insulation of the wiring. Holes for mounting the apparatus and for wiring are not shown by diagram. To identify the various holes study the photographs carefully.

Master Rheostat

It is to be noted that provision has been made for controlling all the filament voltages by means of a master rheostat, R, which is manually controlled from the front panel. This rheostat is a 6-ohm, 2-ampere type. The voltmeter is connected directly across the 5-volt filament side. Rheostats R1 and R11 are mounted underneath the sub-panel shielding and are adjusted so as to give 3.3 volts on the detector and audio tubes.

Mounting of the component parts in the second radio fre-

quency amplifier stage is critical. To identify the location of the various pieces of apparatus in this circuit, it will be well to study the layout as shown in Figs. 6 and 8. The high inductance, low capacity chokes L4, L5 and L6 are Sampson No. 125 type, and must be mounted as shown. These chokes are mounted near the tubes and permit a certain amount of feed-back to take place within the circuit. The amount of feed-back is not great enough to cause reaction on the detector. In fact, the coils are so located as to give an increase in amplification due to regeneration and to increase the selectivity of the circuit. By carefully observing the arrangements of the choke coils and mounting of the tubes and plug-in coil system, the correct amount of feed-back will be made possible. Note that the height of L5 and L6 corresponds to about the same height as the caps on V2 and V3. The second radio-frequency amplifier is coupled to the detector circuit through the two condensers C9 and C10. These condensers are mounted directly under the shelf supporting L5 and L6. About 50 micromicrofarads in each condenser is required to feed the detector circuit. The correct value of capacity may be determined by tuning in a given station around 15,000 kilocycles (20 meters) and adjust the capacity of each (keep both condensers near the same value) until the desired results are obtained with a minimum of reaction taking place on the detector circuit. Do not change the capacity of these condensers after the receiver has been calibrated.

Parts required for building the push-pull receiver as described in this article:

- 3—type 169-E Cardwell variable condensers.
- 1—2 mfd. by-pass condenser.
- 1— $\frac{1}{2}$ mfd. by-pass condenser.
- 1—1 mfd. condenser.
- 1—.01 by-pass condenser.
- 5—Sampson No. 125 chokes.
- 4—1 megohm metallized grid leaks.
- 2— $\frac{1}{2}$ megohm metallized grid leaks.
- 2—15-ohm rheostats.
- 1—6-ohm, 2 ampere rheostat.
- 1—Electrad super tonatrol, 200,000 ohms.
- 1—Electrad potentiometer, 200 ohms.
- 8—tube sockets.
- 6—grid leak holders.
- 1—voltmeter, 0-6 scale.
- 3—dials, VV National type.
- 2—dials, small type for regeneration control and antenna coupling.
- 1—filament "ON-OFF" switch.

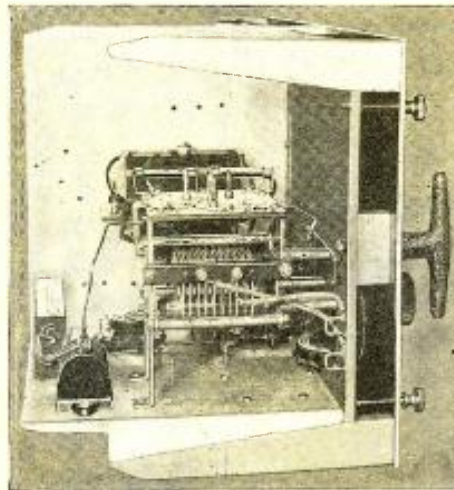
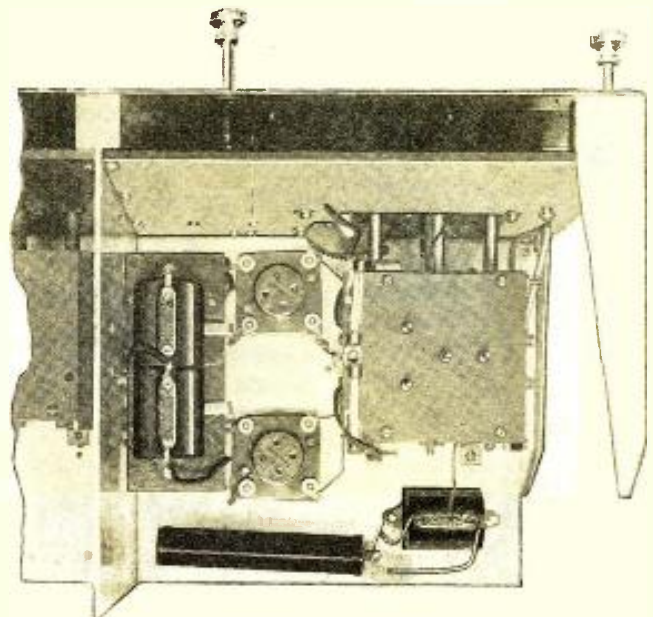


Fig. 7. An end view of the second r.f. stage

Fig. 8. Below, the top view of the second r.f. stage further illustrates the method employed in laying out the parts



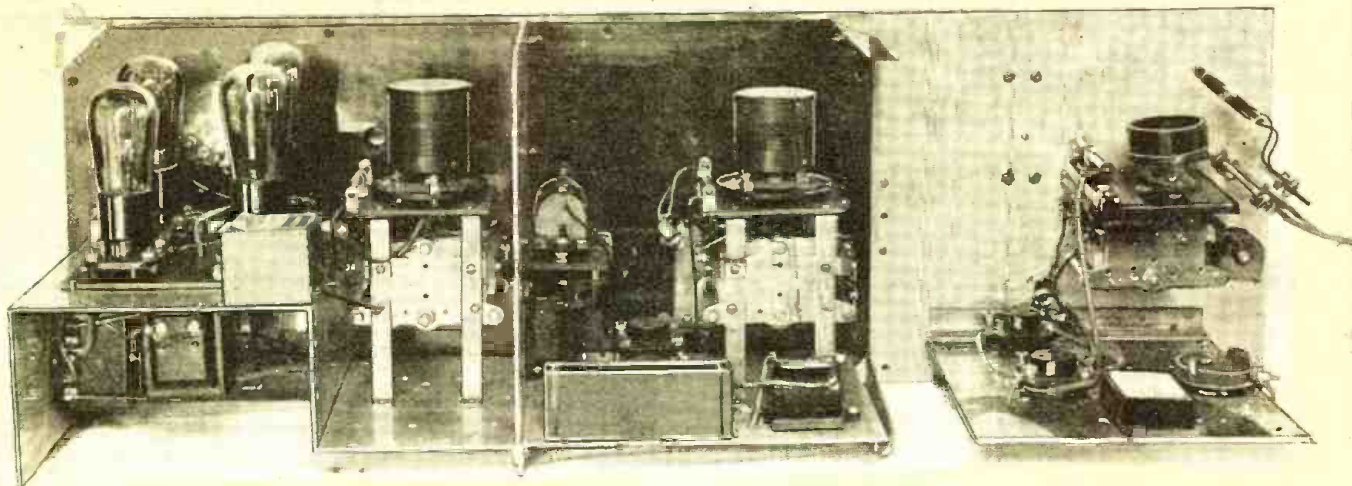


Fig. 9. Above is shown the rear view of the complete receiver, including the first r.f. stage. Note how the audio channel is located below the specially formed shield base

- 4—grip cap connectors for -22 tubes.
- 6—.0001 mfd. Sangamo stopping condensers.
- 1—2-1 ratio audio transformer.
- 1—5-1 ratio audio transformer.
- 1—telephone jack.
- 1—1-1 ratio output transformer—not essential.
- 2—variable Midget condensers, 0-100 micromicrofarads.
- 3—dozen General Radio jacks.
- 1—dozen General Radio plugs.
- 3—pieces 1/8-inch bakelite, 3 3/8 x 3 3/8.
- 1—piece 1/8-inch bakelite, 2 x 5.
- 1—piece 1/8-inch bakelite, 5 1/2 x 6.

No attempt has been made to set down by means of actual parts layout drawings to indicate a definite procedure of construction. It is felt that the individual experimenter will want to alter the layout shown so that it will fit in with his own particular ideas. In this connection enough of an idea as to the mode of construction followed by the author will be obtained from the numerous photographs which accompany this article. Various dodges of assembly and construction have been employed, which, it is well to point out, really make for efficiency in operation. For instance, note that the bakelite platforms which sup-

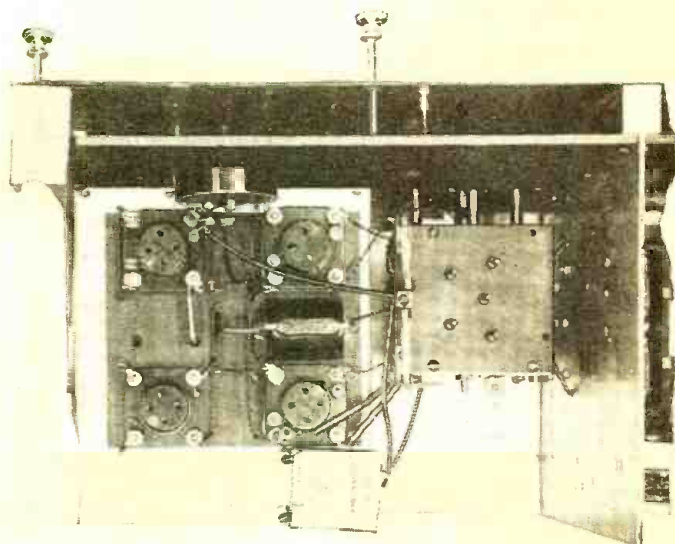
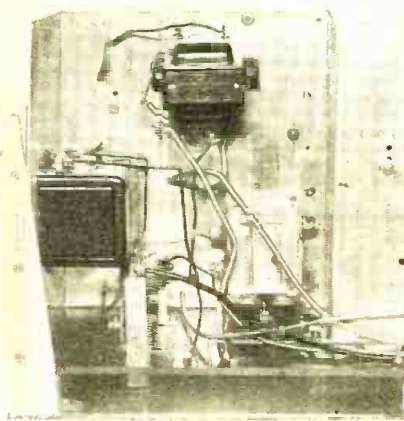
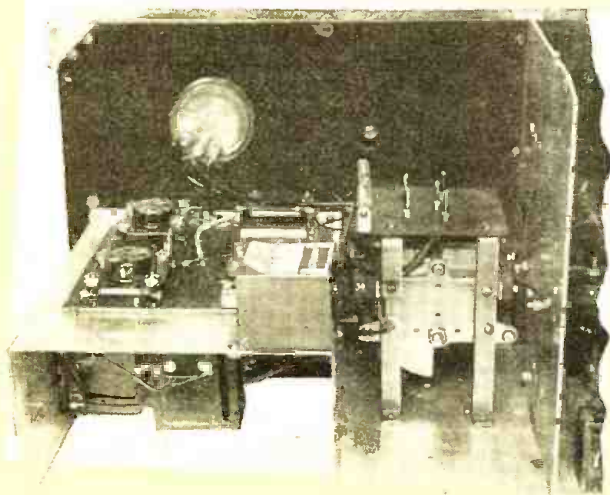


Fig. 10. A top view of the layout of the apparatus in the detector-audio compartment

Fig. 11. To the right, a photograph looking at the bottom of the audio section of the receiver

Fig. 12. Below, a close-up of the detector-audio channel compartment, showing how the coil base is mounted directly on top of the tuning condenser



port the coil forms are made an integral part of the tuning condenser assembly. Similarly the two chokes in the detector unit are mounted so that a slight amount of regeneration is maintained. Here is an instance where if the experimenter was to employ a different layout the mounting of these chokes in any other position than that shown would tend to adversely affect the final operation of the receiver.

While appearance has, to a certain degree, governed the layout of the apparatus, nevertheless the qualification of efficiency in operation has been uppermost in mind and has been the dominating factor in the construction of this receiver. Doubtless many other types of layout will suggest themselves to the interested experimenter, but a study of this text and a consideration of the mode of construction employed in the receiver described here and as indicated in the accompanying photographs should be kept in mind if real results are to be expected.

As far as possible the general trend of construction as exemplified here should be followed. Substitution of other parts, providing electrical characteristics are maintained, is quite permissible and to this extent some slight variation in construction may be necessary. However, in the main, it is well if the general scheme of construction as outlined is adhered to.

A High Quality 80-Meter Phone Transmitter For Amateur Use



PROBABLY ever since the inception of amateur radio there has been a continuous controversy between "hams" as to whether this or that is the better transmitting circuit. Some hold that one circuit is the "par excellence," while others swear by another. The question is much the same as that which exists in the broadcast receiver circuit field. It is no wonder then that a comparative newcomer in the transmitting fraternity is somewhat confused and rather uncertain as to which system of short-wave transmission to use in the station he intends building.

This is the problem which confronted me some weeks ago when I had decided that it was high time that I stop talking

about amateur radio and really get into the game. For many years I had thought about putting up a station but never really got around to the actual work of constructing a transmitter for myself, much less taking the trouble to bone up on the code so that I could with a degree of certainty go before the Radio Inspector for my amateur ticket.

Of course, I had built and helped build any number of transmitters ranging from simple -99 transmitters to a pretentious 250-watt outfit. But my interest was purely a professional one. Always there had been some definite type of circuit to employ or some particular design to follow. Now, confronted with the job of selecting a suitable circuit and design for my own transmitter, the job became one fraught with much solicitousness as to whether I were taking the right step. Deciding to be guided solely by my peers in the matter, I indulged in a rather serious reading campaign of all the past issues of *QST* which I could lay my hands on. I dusted off Handy's Official Handbook and read up on that priceless dope. Then I talked with Nat Pomeranz, W2WK, of our Technical Information Department, and finally went into a huddle with George Fleming, our Technical Editor. Very patiently George and I went over any number of plans for suitable transmitter designs and the result is that I selected the one which is described here, while George, who in the course of events was also smitten with the urge, has worked out plans for his own transmitter, one quite a bit different than the one described here. In a forthcoming issue George will describe the constructional details of his job.

The circuit of the transmitter described here is shown in Fig. 1. It will be seen that it is the conventional series-fed, tuned-grid, tuned-plate circuit, plus a speech amplifier of three stages employing the usual Heising modulation system. The oscillator is a De Forest 50-watt

oscillator used in a tuned-grid tuned-plate circuit. V5 is another 50-watt tube functioning as a modulator in a three-stage speech amplifier. Three -27 tubes comprise the balance of the audio unit, two of them being used in push-pull in the second stage. The two tubes, V6, V7, are mercury rectifiers converting the stepped-up 110 volts a.c. into 1,000 volts d.c.

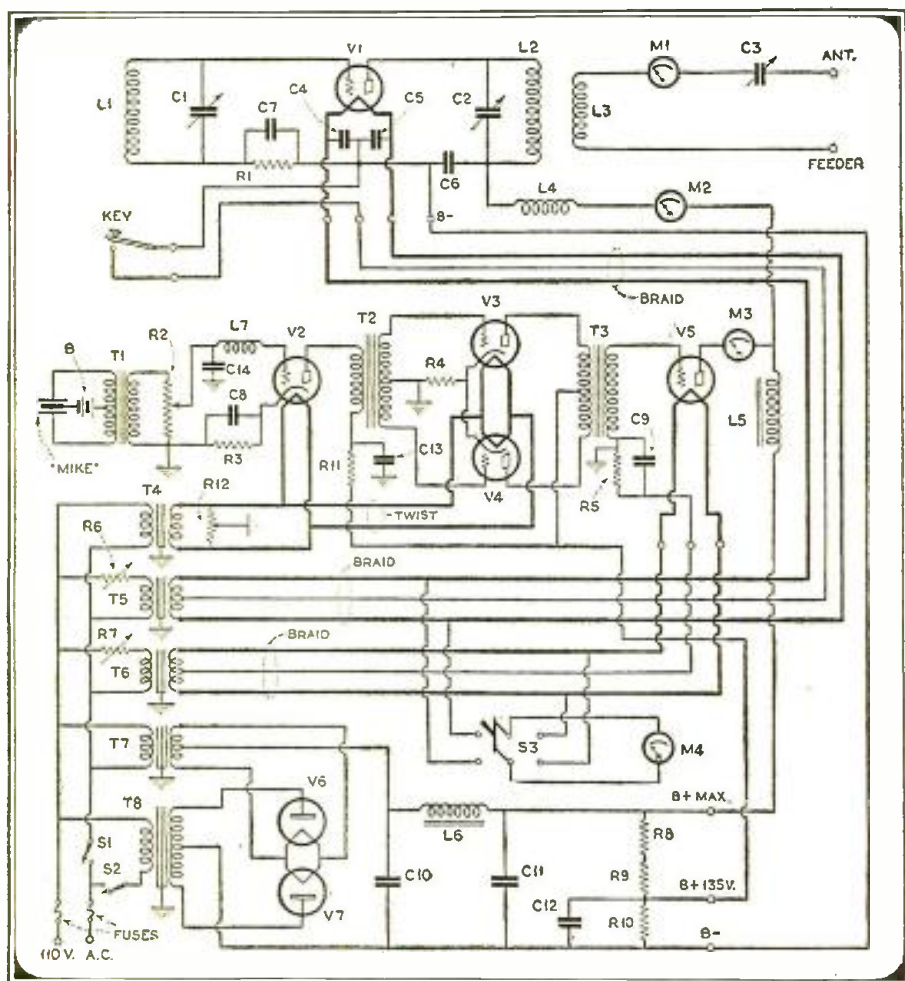


Fig. 1. The tube, V1, is a 50-watt oscillator used in a tuned-grid tuned-plate circuit. V5 is another 50-watt tube functioning as a modulator in a three-stage speech amplifier. Three -27 tubes comprise the balance of the audio unit, two of them being used in push-pull in the second stage. The two tubes, V6, V7, are mercury rectifiers converting the stepped-up 110 volts a.c. into 1,000 volts d.c.

Here's a completely a.c.-operated short-wave transmitter which any amateur will be proud to build. It employs a 50-watt tube as an oscillator and a 50-watt tube as a modulator in the last stage of a three-stage speech amplifier. The transmitter uses the tried and true tuned-grid tuned-plate oscillator circuit with Heising modulation. Two -66 mercury tubes provide full-wave rectification in the power supply unit. A simple but efficient outfit

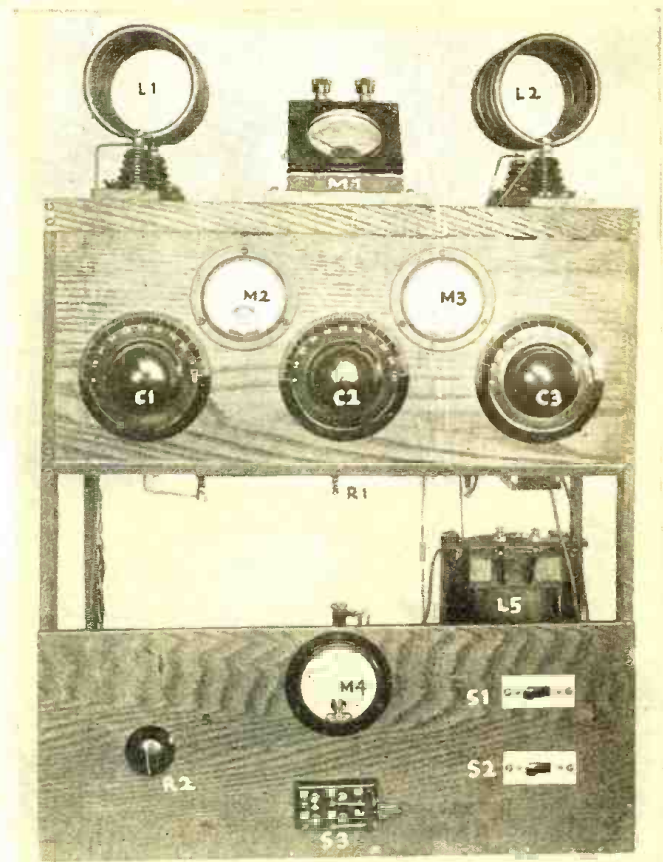
By John B. Brennan, Jr.

(503A) tube, while the speech amplifier employs a single -27 in the first stage of transformer-coupled audio amplification, a pair of -27's arranged in push-pull for the second stage and the final stage consisting of a De Forest 50-watt (545) modulator tube.

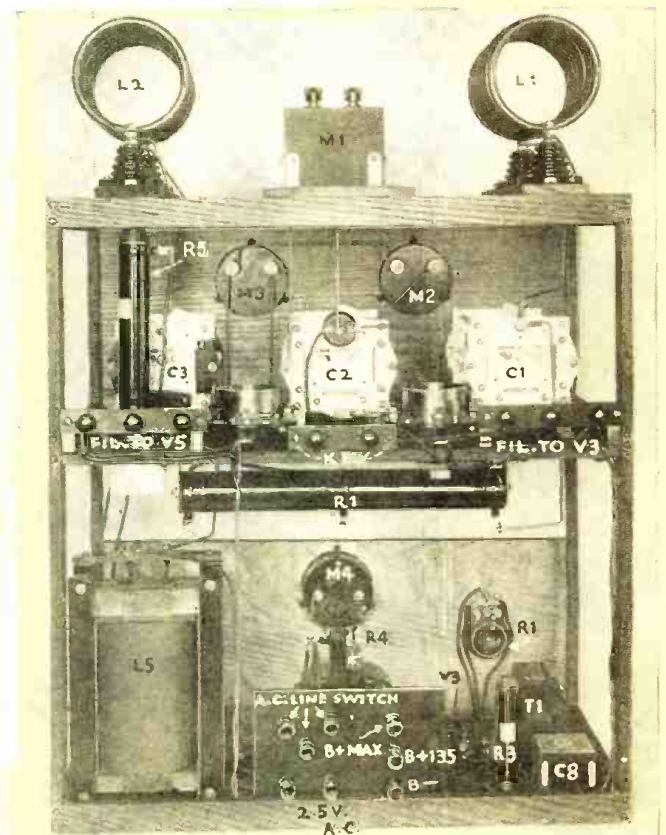
In the power supply circuit a pair of De Forest 566 mercury rectifier tubes arranged for full-wave rectification are supplied potential from a 1000-volt transformer secondary and output to a brute-force filter system terminating in a voltage divider so as to supply the maximum voltage to the two 50 watters and 135 volts plate supply for the tubes in the speech amplifier. A brace of transformers supplies individual filament voltage to each of the 50 watters, the two rectifiers and the tubes in the audio amplifier.

Beginning at the beginning, a double-button microphone, energized by a local battery, is connected to a microphone transformer which in turn couples to the first audio stage. Control of modulation is obtained by means of a 500,000-ohm Electrad potentiometer shunted across the secondary of this transformer, the center-arm being connected to the grid of the first-stage tube. A push-pull input transformer couples the plate of this tube to the grid circuits of the next two tubes which are arranged in push-pull. This stage, in turn, is coupled to the grid circuit of the 50-volt modulator tube by means of an interstage coupling transformer. All of these transformers are Thordarsons. The modulation, or constant current choke, in the plate circuit of the modulator tube is a 30-henry affair capable of handling 300 mils plate current.

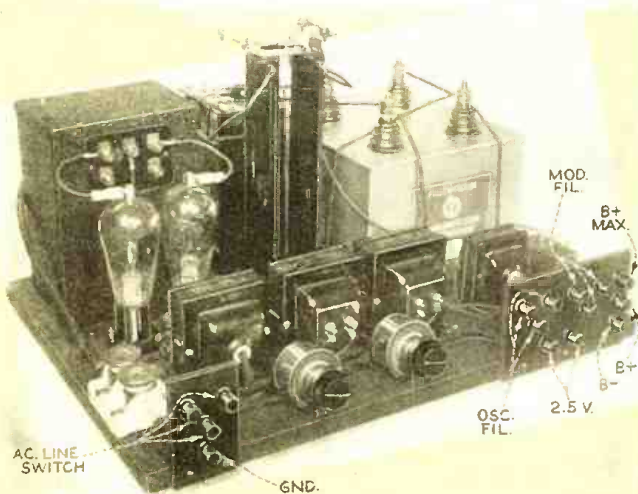
Designed for complete a.c. operation, with the exception of the voltage supply to the microphone, the tubes in the amplifier



Hey, you amateurs, doesn't this look good? Here's the front view of the 50-watt 80-meter phone transmitter using the t.p.t.g. circuit. Tuning controls are located on the upper panel, while the audio control is below



This rear view of the transmitter gives a pretty clear idea of how the various parts are mounted on their respective shelves. Although they cannot be seen, the audio transformers for the second and third stages are directly behind the terminal board and constant current choke, L5



The power supply for this transmitter is mounted quite simply on a sturdy drawing board, as shown above

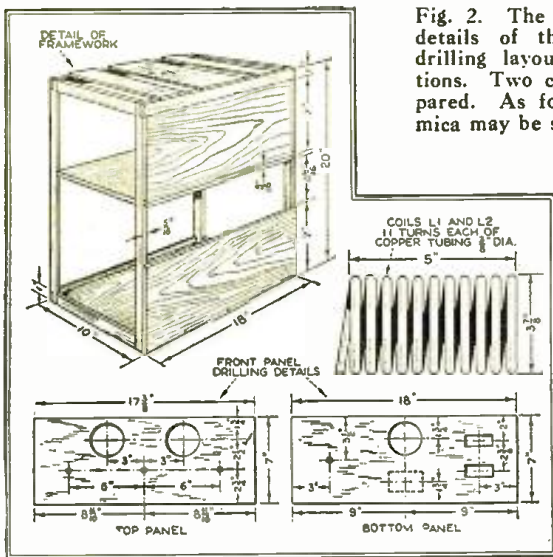
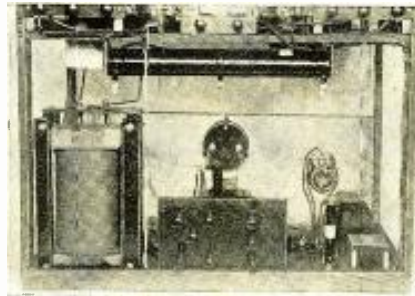
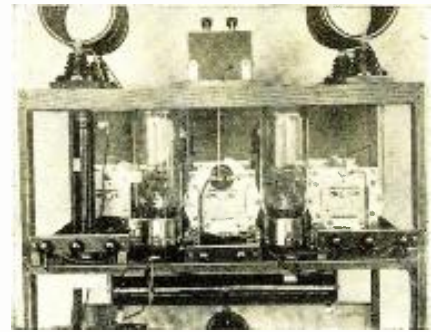


Fig. 2. The sketch to the left shows the details of the frame construction panel, drilling layout and coil winding specifications. Two coils, as shown, should be prepared. As for the panels, bakelite or formica may be substituted for wood, if desired

Above, to the right is a close-up of the oscillator shelf, showing in detail the location of the condensers and tube sockets, etc. Below is a close-up view of the rear of the speech amplifier shelf



are -27's and grid bias for these tubes is obtained by means of grid biasing resistors connected between the lower side of the transformer secondaries which are grounded to "B" negative and the cathodes of the tubes.

Through a plate meter and an r.f. choke, series feed of the plate potential is provided for the oscillator tube, and for this reason a husky condenser with double-spaced plates is employed in the tuned plate circuit. For reasons of symmetry the same type of condenser is used in both the tuned grid and antenna circuits. Keying is accomplished by breaking the center leg of the filament supply to the oscillator tube.

Tuning Inductances

The only items in the construction of the transmitter which are home-made are the coils employed in the oscillator part of the circuit. For the grid and plate circuits of the oscillator two coils of similar design are used. These coils are wound from 3/8-inch copper tubing on a form so that ultimately when the form is removed the finished coil assumes a diameter of 3 1/8 inches, inside diameter. Enough turns can be wound so that two coils each having eleven turns can be cut from the one prepared piece.

The antenna coil is wound from about thirty-five turns of No. 10 or 12 cotton-covered copper wire wound on a form which can fit inside the plate coil with ample clearance. In some instances the builder will want to conductively couple his Zepp antenna to the plate coil and in this case an antenna coil is unnecessary. As a matter of fact, the subject of antenna coils is so tied up with the type of antenna used that it will be up to the builder, more or less, to provide his own design of antenna coil.

By means of a double-pole, double-throw knife switch connected to a 15-volt a.c. voltmeter and to the two 50-watt filament windings it is possible to read the voltage applied to these two tubes. Since they take 10 volts and the supply from their transformer secondaries is 12 volts, a line clarostat is inserted in each of the primary circuits of these two transformers. Thus an accurate filament voltage adjustment is provided.

Three other rather necessary meters are included in the cir-

cuit. One is a milliammeter having a full-scale deflection of 200 mils. connected in the plate circuit of the modulator tube to denote modulation conditions; another is a similar meter connected between the modulation choke and the r.f. choke which connects to the plate circuit of the oscillator tube so as to indicate oscillatory conditions. While the third meter is a radiation ammeter having a full-scale deflection of 2.5 amperes, connected in the Zepp antenna circuit.

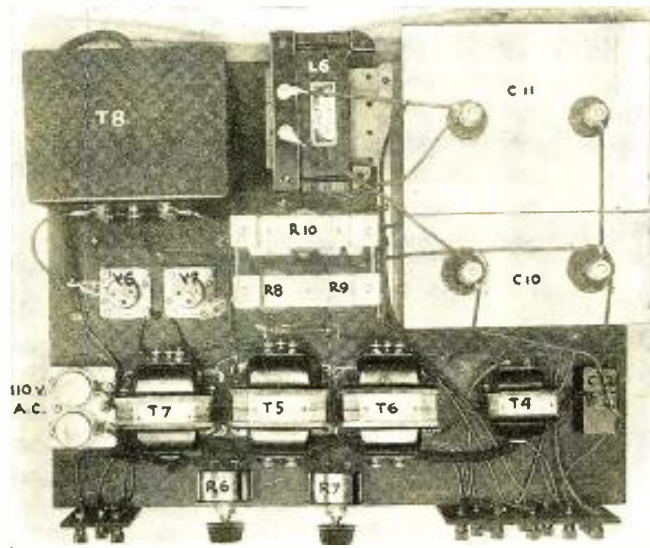
In the power supply the 1000-volt taps from the Thordarson transformer are employed and connect direct to the plates of the two mercury rectifier tubes. These tubes have their filaments supplied from a common transformer delivering 2.5 volts. In the filter circuit a 2 mfd., 2000-volt Flechtheim condenser precedes the 30-henry, 300 mil choke and a 4-mfd., 2000-volt condenser of similar make follows it. The voltage divider consists of three 100-watt Electrad wire-wound resistors, one of 675 ohms providing a tap for the 135 volts

required for the plates of the audio amplifier tubes and two 1325-ohm resistors, connected in series between the 675-ohm resistor and the B-plus maximum lead from the filter section. A 2-mfd., 1000-volt filter condenser—Flechtheim type H.S.—is shunted across the B— and 135-volt output posts to complete the filtering.

A separate line toggle switch in the parallel primaries of all the filament transformers and another in the primary of the line power transformer makes it possible to turn on the a.c. to the filaments of all the tubes before the plate potential is applied. For safety's sake both sides of the 110-volt supply are fused.

As illustrated in the photographs which accompany, the transmitter proper is built on three decks. The top deck supports the tuning inductances and the radiation ammeter, the second deck supports the two 50-watt tubes and tuning condensers and the third or base deck houses the complete audio channel. On the face of the panel for the second deck is mounted the three tuning controls and the two plate milliammeters, while on the panel for the audio channel is mounted the filament voltmeter and throw-over switch, microphone control and both line switches. All connections to the transmitter, including microphone and key leads, are made to binding post strips conveniently located on the wooden frame of the transmitter.

As a guide for those who wish to (Continued on page 356)



A top view of the power supply unit. The various parts are numbered in accordance with the symbols used in the circuit diagram of Fig. 1

How to Join the Radio News Radio Association

This club has been organized to gather together in a working organization not only amateurs, but the vast army of short-wave broadcast listeners. By means of lectures and code classes, instruction, by way of short waves over the club's transmitter, will be brought to all members. Become a member and get into this thrilling game

RADIO NEWS magazine believes that there is need of an organization which will enroll the interest of thousands of short-wave fans and be of direct benefit to them. In forming the Radio News Radio Association, with that purpose in view, we are attempting to provide an informal club for the thousands of serious-minded young men who are experimenting with the receiving end of short-wave radio, and, of course, for the transmitting amateurs as well, so that they may get together, personally or on the air, for the exchange of ideas, for a source of technical information and for an organization which will aid in the safeguarding of their interests.

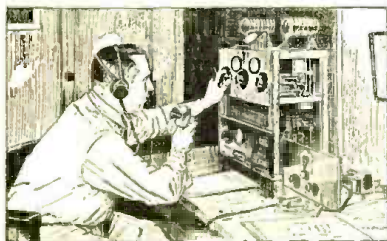
Amateur Activities

Amateur radio activities have been on a steady upward climb ever since this most fascinating work was started some years ago. One organization in particular, the American Radio Relay League, has been instrumental in assisting the rapid development of short-wave radio. It is safe to say that short-wave amateur radio would not be where it is today if it had not been for the guidance and zealous care over short-wave radio of the A. R. R. L. This association has a membership of more than 17,000, and includes practically every transmitting amateur in the country. This number, however, does not begin to include those other thousands of amateurs who are not primarily licensed short-wave operators but who are vitally interested in building better short-wave sets and obtaining better reception over greater distances.

It is for both the transmitting amateurs and this latter group of experimenters that RADIO NEWS has formed the Radio News Radio Association.

Membership Free

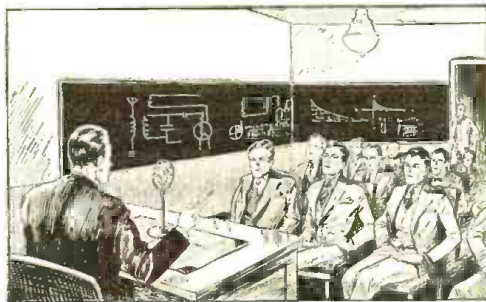
Membership in the R. N. R. A. is free and open to anyone who is



At present only a 50-watt outfit, W2RM is on the air. Later a 250-watt station is to be built

interested in short-wave radio. The only requirement which you must observe is to outline in your application for membership just what you have done in short-wave radio. Tell us if you are an amateur or if merely a s-w broadcast listener, whether you built your set or bought it. If you are neither, what you want to learn about this fascinating game then tell us what you intend to do in the way of obtaining a short-wave receiver.

What we have done so far is to prepare the ground work for the organization. Naturally the whole thing can't be completed overnight and as the work of organization goes along we will keep you advised through the pages of the magazine. Our immediate plans include the erection of a 250 watt transmitter and suitable receiving apparatus in our pent-house laboratory. At stated intervals, perhaps, twice a month, a local meeting will be held in the club rooms, at which time leaders in the amateur radio field will give technical talks. By means of the transmitter we hope to bring these club activities to the members who because of residence in places far removed from headquarters are unable to attend in person.



Authorities and leaders in the short-wave field will address gatherings and those listening in on pertinent technical short-wave subjects

Ultimately, of course, our aim is by means of a closely co-operating organization to make further advances in the art of short-wave radio, to assist members in becoming capable operators or more experienced technicians and to build up a possible source of trained radio men in the event of a national emergency.

Anyone interested in joining the club merely has to fill out the small information slip printed at the bottom of this page and mail it to the Radio News Radio Association at 381 Fourth Avenue, New York City.

To join the RADIO NEWS Radio Association fill out this information slip and return it to the address indicated. Print the information required in ink.

Name

Address..... City.....

Do you own a short-wave receiver?.....

What make?.....

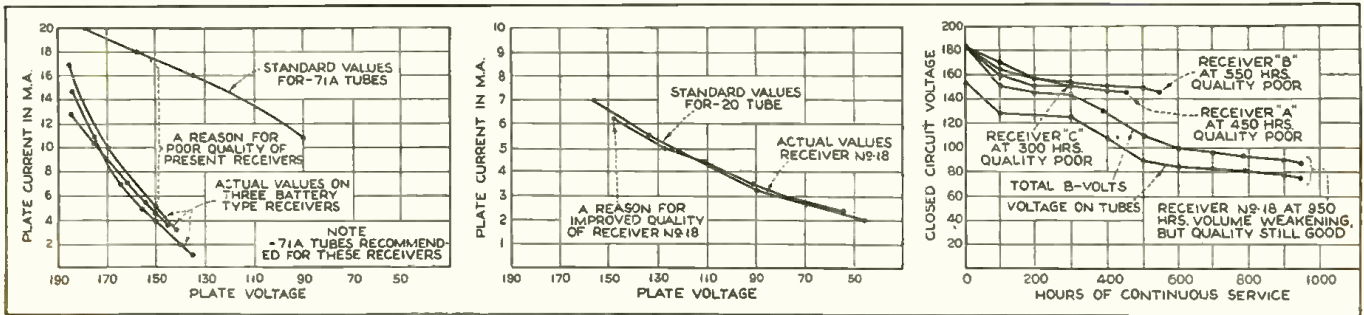
Are you a transmitting amateur?.....

What's your call?.....

What kind of a transmitter is used?.....



The station and club rooms are located in a four-room pent-house apartment atop a 16-story building in the heart of New York City



Curve No. 1. Plate voltage and current values of output tubes on present dry-battery receivers

Curve No. 2. Receiver No. 18, the one described in the text below, produced these plate voltage and current values

Curve No. 3. Here is indicated the total B voltages measured on the three commercial receivers compared to No. 18

FROM:
 ENGINEERING DEPARTMENT
W.H. HOFFMAN
 AND
DON H. MIX
 BURGESS BATTERY COMPANY.

LABORATORY

A COMPREHENSIVE REPORT DEALING WITH THE OPERATED RECEIVERS, CAUSES FOR POOR RECEIVERS, ECONOMICAL LONG-LIFE BATTERY DISTORTION AND TYPES OF DRY-CELL TUBES

IN this receiver many of the common faults of battery-operated radio receivers have been removed or improvements made. This receiver will give satisfactory operation for a year on a single set of "B" batteries; will operate for one to two months on a single charge of the 100 ampere-hour storage "A" battery; uses no "C" batteries, biasing potentials being kept at correct values automatically during the entire life of the "B" batteries; and only four battery leads are necessary—a pair for the "A" battery and a pair for the "B" battery. Although only a magnetic type loud speaker is used, quality of reproduction is high during the entire life of the "B" batteries. Due to the long battery service obtained, the maintenance cost of this receiver is only one-third or less than that of the average battery-operated receiver in present use.

Market for Battery Receivers

During recent years most of the engineering attention has been devoted to the design of radio receivers to be operated from alternating house-lighting circuits while little attention has been given to the problem of development of a receiver for use where lighting circuits are not available. Statistics show that there are 9,250,000 such homes—a surprisingly large field for a properly designed battery-operated receiver.

Burgess Receiver No. 18 has been especially designed with economy and convenience of maintenance and simplicity of operation in mind. Probably the most outstanding detriment to economical battery operation has been the fact that most receiver circuits were so arranged that use of the "B" batteries to an end voltage lower than 35 or 36 volts per 45-volt unit was unsatisfactory. Investigation has shown that this is due to two very apparent causes.

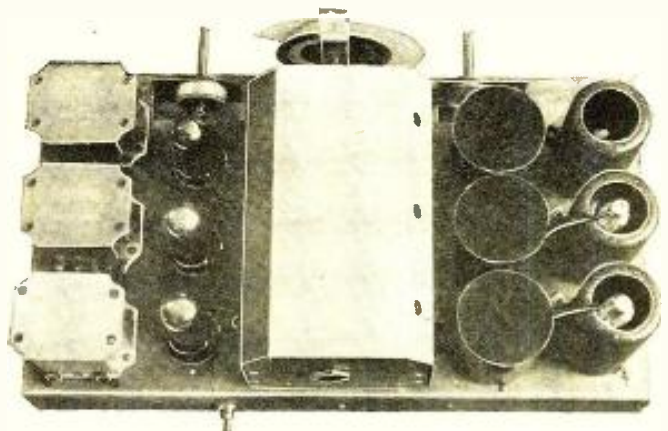
Causes of Poor Quality in Present Receivers

By far the most important of these causes is the manner in which the biasing potentials for the grids of the various tubes in the receiver are obtained. These potentials are universally obtained by means of a separate dry battery generally designated as the "C" battery. It is well known that the correct value of these potentials is fairly critical if distortion is to be avoided. With a given type of tube, this correct value of biasing potential depends upon the value of plate potential used. In a battery-operated receiver this plate voltage gradually falls as the voltage of the "B" battery decreases with use. However, since there is no drain upon the "C" battery, its potential remains practically constant. As the "B" battery voltage drops, the plate potential soon assumes a value to which the unchanging grid potential is wholly unsuited, resulting in an abrupt drop in plate current and accompanying dis-

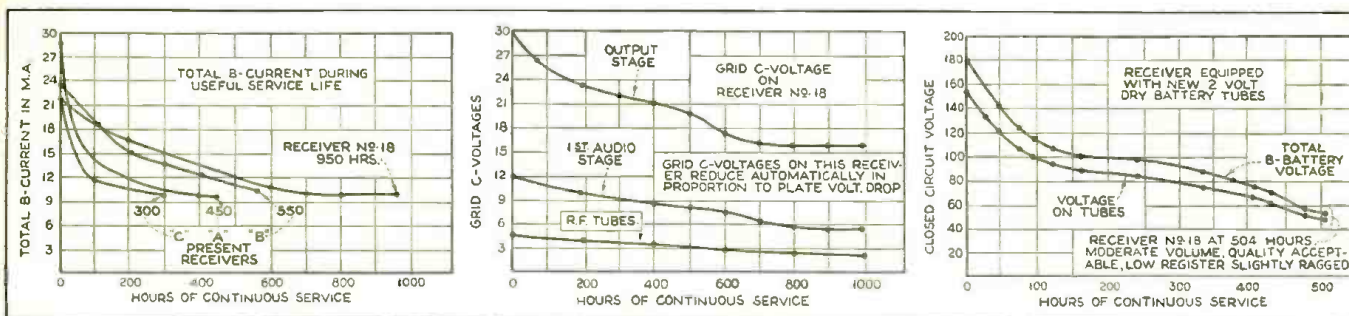
ortion and loss of sensitivity. This effect is shown graphically in Curve I. The upper curve shows the values of plate current corresponding to various values of plate voltage as recommended by the manufacturers of the type -71A power output tube. The other curves show the actual values measured during the test of three leading makes of battery-operated receivers. A comparison of these curves with the recommended values makes it very apparent that the tubes cannot operate properly.

Automatic "C" Bias—A Remedy

In designing the Burgess Receiver No. 18, this fault has been taken into consideration and a different method of securing grid potentials has been used. This system, while not new in the a.c. receiver field, is an innovation in the receivers of the battery-operated class and in this class has a distinct advantage not apparent when used in the a.c. type receiver. In this receiver, the grid potential for each type of tube is secured from the voltage drop across a resistance of proper value placed in the "B" battery lead. Since the grid potential now depends upon the drop across the resistance which varies with the value of plate current through the resistance which, in turn, depends largely upon the value of plate voltage, it is clearly seen that as the plate "B" battery voltage falls off with use, the value of grid potential also falls off. How closely this may be made to fall off according to the recommended values may be seen from Curve II, which compares the rated values of plate voltage and current of the type -20 power tube with the actual



A top view of the totally shielded battery-operated receiver No. 18. Note that shielding is employed around the tubes, coils and the tuning condensers



Curve No. 4. This curve illustrates the manner in which the plate current was maintained in receiver No 18

Curve No. 5. The grid potentials on receiver No. 18 varied automatically as the B-battery voltage falls off

Curve No. 6, showing the B-battery and plate voltage at different periods during the useful life of the battery

REPORT

SUBJECT:

A BATTERY-OPERATED RECEIVER SUITABLE FOR RURAL USE

POTENTIAL MARKET FOR BATTERY-QUALITY IN PRESENT-DAY OPERATION, REMEDIES FOR WHICH CAN BE EMPLOYED.

values measured in Receiver No. 18 which uses this tube. This method of biasing also has the advantage of eliminating all necessity for "C" batteries.

It may be noticed that since there is an appreciable drop in voltage through the biasing resistances, the total voltage available for the plates of the tubes is reduced. To compensate for this loss, an additional 45-volt block of "B" battery is used, making a total of 180 volts for the 135-volt tubes. While this apparently adds to the battery cost, it will be remembered that no "C" batteries are required, so that the initial battery cost remains practically unchanged.

Lower "B" Battery Cut-Off

The second cause of trouble in using the "B" batteries to a low end voltage is much less serious. This is the trouble caused from oscillations in either audio or radio-frequency amplifiers due to coupling introduced between stages caused sometimes by increased resistance of the "B" batteries as their age increases. This cause, we believe, is much less frequent than is normally suspected, as it has been found that any well-designed amplifier is free from troubles from this source. Carefully designed filters will eliminate any possibility of coupling through the batteries, and since such filters are prerequisites in modern amplifiers of high gain, no trouble from this source should be experienced.

To determine the limit of "B" battery end voltage, a test

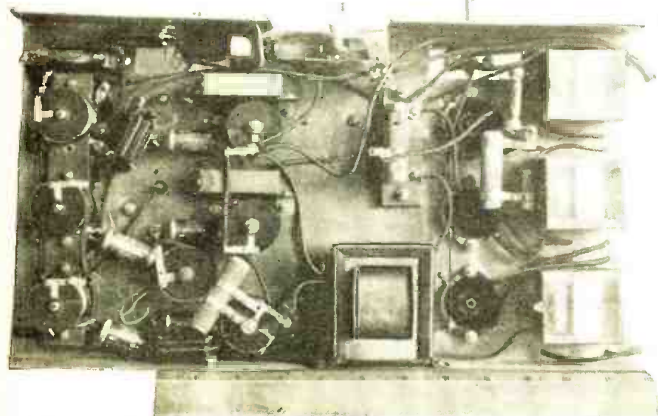
was made on Receiver No. 18 as well as on the three commercial sets mentioned previously. These tests were run continuously 24 hours per day without interruption and readings were made approximately every 24 hours. In each case a set of 4 Burgess No. 21308 "Super" "B" batteries was used. Curve III shows the total "B" voltages measured on the three commercial sets, as well as on Receiver No. 18. It will be noticed that only 300 to 550 hours of service was obtained on the commercial sets without encountering serious loss of quality or volume. The "B" battery end voltages averaged about 37 volts per 45-volt unit. On the other hand, it will be noticed that Receiver No. 18 maintained its quality and a satisfactory proportion of its original volume for a period of 950 hours of continuous service, at which time the "B" battery end voltage was 22 volts per 45-volt block. At 950 hours the maximum volume had fallen to a point which might be considered too low for satisfactory reception. To determine if the discharge of the "B" batteries might be carried further without trouble, two new 45-volt blocks were added in series to those already in use and the discharge continued for an additional 240 hours. This gave a total of nearly 1200 hours of continuous service. At this point the batteries each showed a closed-circuit voltage of 10 volts per 45-volt unit. A total of 16,000 milliampere-hours had been taken from the original set on continuous service. An increase of at least 50% in this service may be expected with ordinary intermittent use. During the entire test no trouble was experienced at any time from noises or instability of amplifiers. At the conclusion of this test the "B" batteries were broken apart. Inspection showed that while the zinc cans were well perforated, no leakage had occurred between cells due to the excellent individual insulation between cells which accounted for the lack of open circuits or leakage currents between cells.

Curve IV shows the manner in which the plate current was maintained in Receiver No. 18 during the life of the "B" batteries in contrast to the rapid drop experienced with other receivers.

Curve V shows the manner in which the grid potentials on the three types of tubes used in Receiver No. 18 varied automatically as the "B" battery voltage gradually fell off.

Selection of Tubes

A second important item which should be considered from the viewpoint of economy and convenience is the matter of "A" battery drain. This is limited mainly to the selection of available standard tubes. Until recently this has been quite a problem to the engineer due to the lack of satisfactory tubes of low filament current consumption. The general difficulties encountered with available low-current tubes has been the lack of amplification as compared to the heavier current tubes,



A bottom view of the receiver, looking at the under side of the chassis. Here is mounted the chokes, bypass condensers and bias resistors. Also, all the connecting leads from the units mounted above the chassis are located below the chassis

comparatively low value of undistorted output of tubes of the power class, severe tube noises caused by weakly supported elements and the ease with which the tubes were "paralyzed." The lack of satisfactory tubes has, no doubt, been due largely to the focusing of engineering attention on the a.c. operated tubes.

New Dry-Battery Tubes

During the early part of this year, however, several manufacturers have once more turned to the improvement of low-current tubes for battery operation. The first important step was the development by De Forest of a screen-grid radio-frequency amplifier of increased amplification -22 type. During the first tests of Receiver No. 18, two of these tubes were used followed by a standard -99 type tube in each of the detector and first-stage audio circuits and two standard type -20 power output tubes arranged in push-pull fashion. This gave a six-tube combination which, operating at the rated filament voltage of 3.3, drew less than one-half ampere. The economy in filament power can easily be appreciated when it is considered that each of the three standard sets drew a total of from 1 1/4 to 2 1/2 amperes from the "A" battery. On continuous test it was found that while other receivers obtained 36 to 70 hours service per charge

THE receiver which is described here is only one of the many battery-operated receivers employing the new two-volt tubes which RADIO NEWS contemplates presenting to its readers. Obviously in the limited space available it is not possible to give all of the constructional details for these receivers. This should not hinder the custom set-builder in the construction of the receiver described here, for fortunately the Engineering Department of the Burgess Battery Company, Madison, Wis., has offered to place at the disposal of those attempting the construction of receiver No. 18 all of the information necessary for building this excellent receiver.

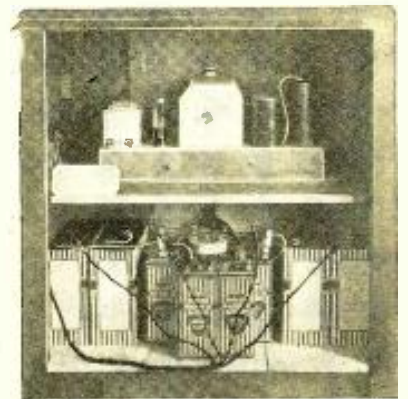
from a 100-ampere-hour storage battery, it was possible to secure 150 hours of service from the same "A" battery with the Burgess receiver. This not only means an appreciable economy over the other sets, but much more important is the fact that it reduces the necessary but inconvenient recharging of the storage batteries. This is an important factor where the rural user is to be considered.

Two-Volt Dry-Battery Tubes

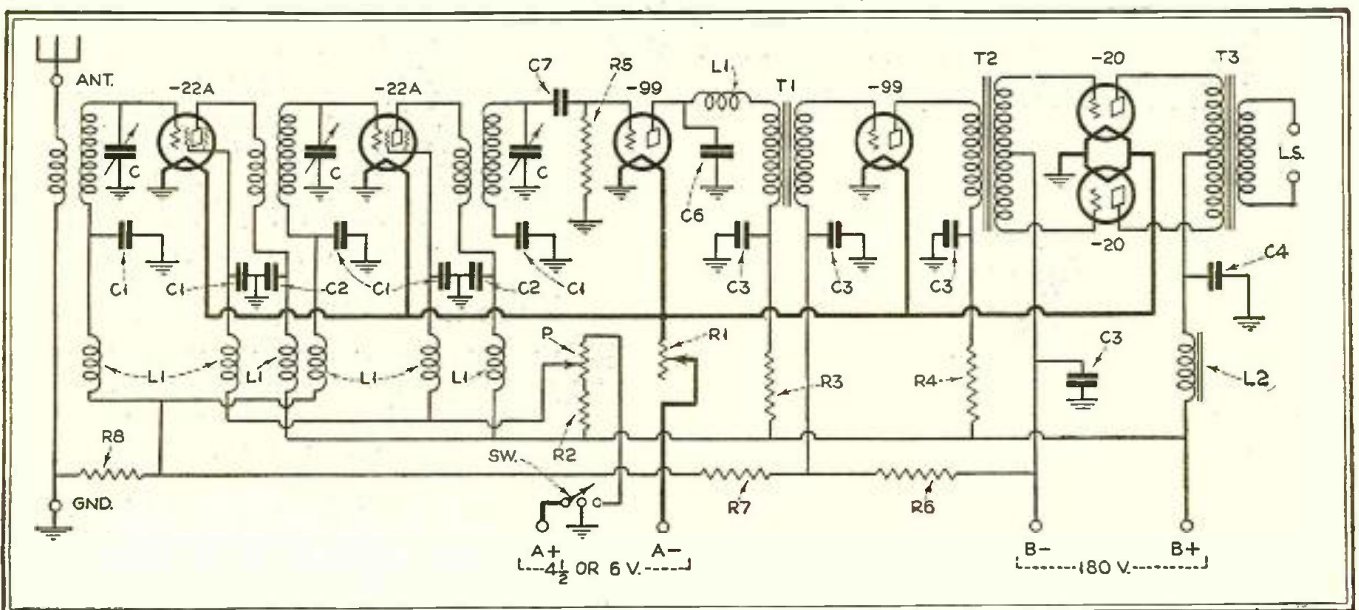
Still more recently has been the development of a new line of battery tubes by the Cunningham, De Forest and RCA organizations. A complete new line of the three important types—general purpose, screen-grid r.f. amplifier, and power output—are being made available, all to operate at 2 volts filament potential. Each type draws but 0.06 amperes except the power output tube, which draws 0.15 amperes. This makes possible a six-tube arrangement similar to that previously described drawing a total "A" current of less than 1/2 ampere, with the added advantage of the necessity of only a single 2-volt storage cell, reducing materially the size, weight, and cost of the "A" battery itself. Other marked improvements incorporated in this line of tubes are an increase in the amplification factor of the general purpose tube which puts it in the -01A class; an increase in the amplification factor of the screen-grid tube which makes it practically the equal of the present a.c. tube of this type; and an appreciable increase in the undistorted output of the power tube. Another important improvement is that all of the tubes are rigidly made, eliminating practically (Cont'd on page 373)



The No. 18 receiver all dressed up in its console cabinet, presenting a rather pleasing commercial-looking appearance



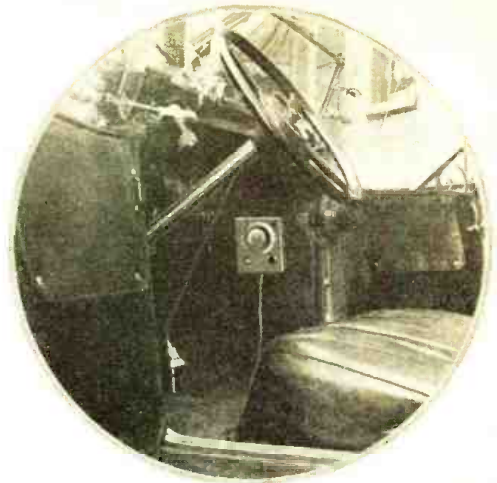
In this rear view of the receiver cabinet the location of the receiver chassis, the speaker and the batteries required is clearly shown



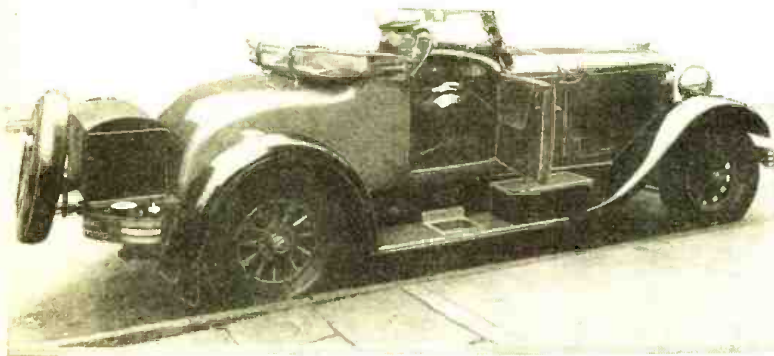
This is the circuit employed in receiver No. 18. It consists of two stages of tuned r.f. amplification, a non-regenerative detector and two stages of transformer-coupled audio amplification the last stage of which is arranged in push-pull fashion. The values for the various lettered parts is contained in the parts list

Riding *the* Roads with RADIO

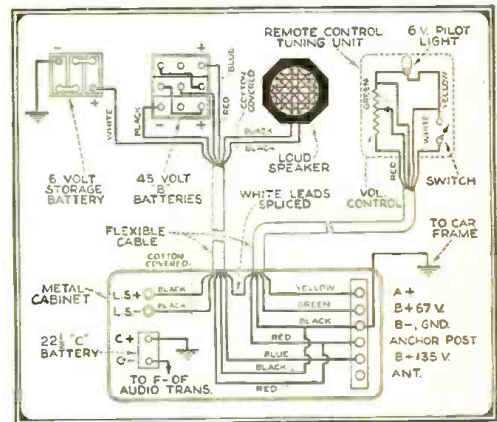
By Robert Hertzberg*



Shown above is the small remote-control unit for this auto installation



In the above picture, the receiver is mounted on the running board of the car and is enclosed in a metal housing. At the right is a diagram indicating the connections which must be made between the various units of the complete installation



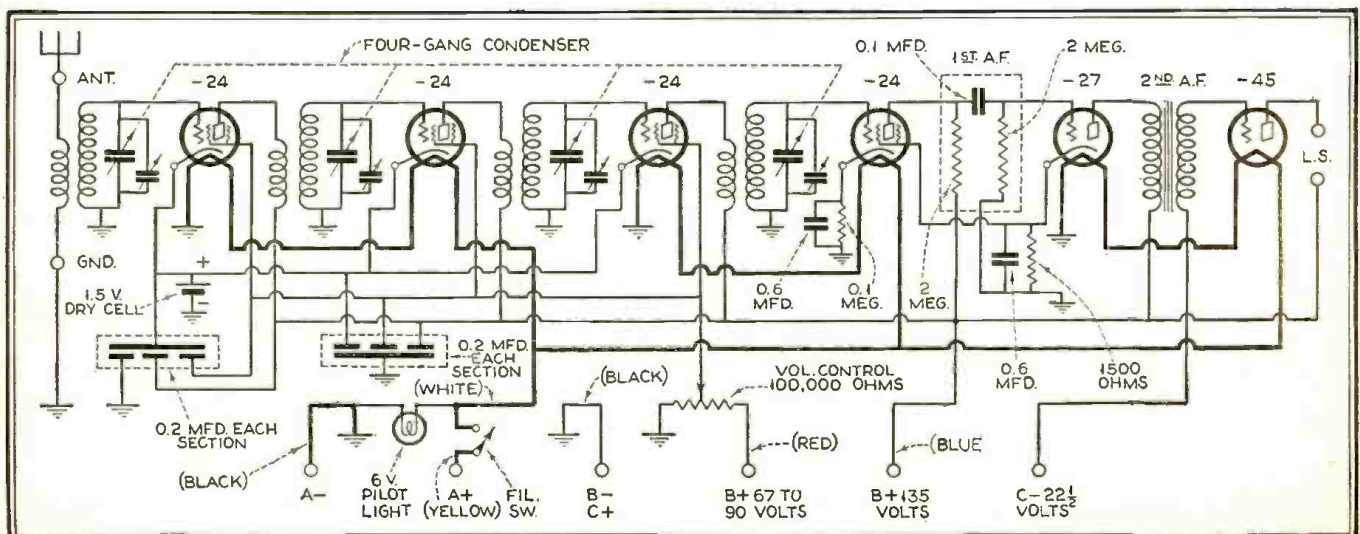
PRACTICALLY all of the automobile radio receivers that have appeared so far are intended for concealment behind the instrument board or under the engine covers. A new set in kit form, recently placed on the market by the Pilot Radio & Tube Corporation, is rather unusual in that it is designed only for mounting on the running board, or possibly in the rumble seat of roadsters or coupés. The new outfit, bearing the name "Auto Pilot," must be assembled, wired and installed by the individual purchaser, who will find the work easy, interesting and enjoyable.

The receiving unit itself is contained in a black japanned steel case. This is 22 inches long, 8 inches wide and 6 7/8 inches high, and is flat enough to let the floors of all makes of cars clear it by a comfortable margin. The set is controlled

*Pilot Radio & Tube Corp.

from the inside of the car by means of a flexible cable which terminates at a neat little control box 5 1/2 inches square and 2 inches deep. The cable is six feet long and is enclosed in a protective sheath of waterproof fabric.

The movement of the dial on the control panel is transmitted to the shaft of the variable condenser by means of two brass chains fastened to pulleys at both ends. These chains slide in separate flexible tubes, and run quite smoothly in spite of their length. The other devices on the control panel are the usual pilot light, volume control and filament switch. The volume control is a potentiometer that regulates the voltages to screens of the r.f. tubes. (Continued on page 366)



Above is the complete wiring diagram for the six-tube auto-radio receiver

S. A BROADCAST Superheterodyne

Using a Loftin-White Audio Channel

—Part 2—

Full constructional data is given this month on how to build the broadcast superheterodyne, and how to adapt the Loftin-White audio amplifier to the system

IN spite of its apparent complexity, the superheterodyne is probably one of the easiest of receivers to build, provided that moderate care is exercised in the work involved. This is true for a number of reasons. To begin with, in a multi-stage radio-frequency tuner one always has the problem of making the various tuned stages keep in step with one another. This of course means that all of the coils must be matched with very narrow margins, and this applies as well to the condensers. Not only that, but the various components must be so placed that the wiring in each stage is identical, for even an inch or so difference in the length of a lead is enough to throw that stage off. On the other hand, in a super all of the radio-frequency amplification is accomplished in the intermediate amplifier, where each stage may be individually tuned one time to maximum, and then it remains so tuned unless the circuits are in some manner disturbed. Since all the amplification is at one frequency, and that is set, we have practically equal efficiency over the entire spectrum of frequencies that we wish to receive.

Oscillation in the radio-frequency amplifier presents much less of a problem in a super than in the conventional tuner. We have all of us experienced trouble at one time or another with a broadcast receiver that was perfectly stable on the higher wavelengths, but given to uncontrollable oscillation on the lower wavelengths. This is due to a number of factors,

among them being the fact that capacity coupling effects between wires, etc., is much more bothersome at the higher frequencies. As the radio-frequency amplifier of a super operates at a high wavelength, or low frequency, this cause of trouble is eliminated.

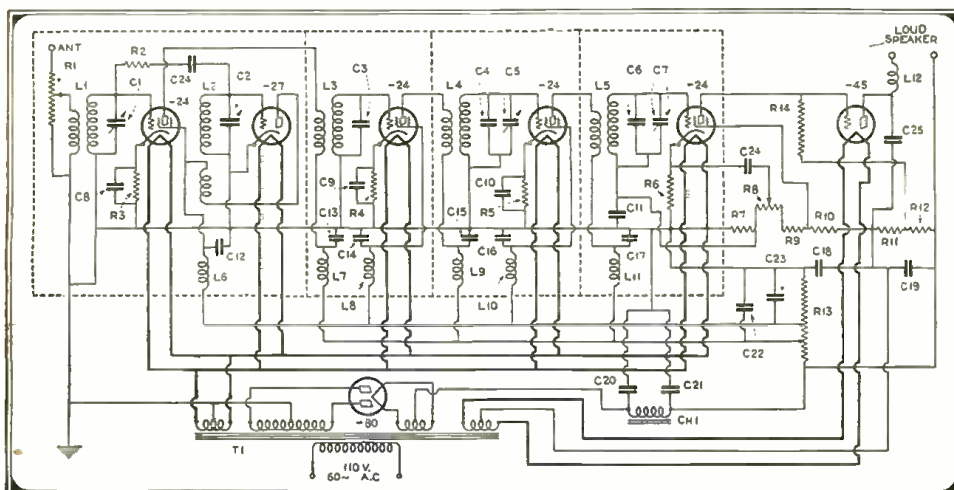
The question of efficiency also arises. At broadcast frequencies it is rare indeed to find a circuit that realizes a gain of more than 20 per stage. In a super, however, working at the low frequency that it does, it is comparatively easy to design circuits that realize 40 to 50 gain per stage. Hence the overall gain of a good super will far exceed that of any other type of receiver with a given number of tubes in the radio-frequency channel.

Now that the sales talk is over and done with, let's get along with our knitting. Last month we gave a general description of the various units that comprise our entire assembly. This month we will go into each unit individually and explicitly.

The coils required in the detector-oscillator are two: the antenna coil and the oscillator coil. Both are of simple construction, being wound on 1½-inch bakelite tubing with No. 28 double silk-covered wire. For the antenna coil, start at one end, allowing ¼-inch space from the edge of the tube, and wind on 105 turns of wire. The ends of the wire should be brought through small holes drilled for the purpose at each end of the winding. The primary is wound on the same tube, a

¼-inch separation being allowed, and consists of 15 turns of the same size wire, the ends of the wire being brought out as in the secondary winding. For electrical connections to this coil, the ends of the wire may be brought to the primary end and fastened to solder lugs bolted to the tube, or they may be left long so that in assembly spaghetti may be slipped over them, and used as leads to the points to which they will be connected. Either method is satisfactory.

The oscillator coil is similar in every respect to the antenna coil, with the exception of the number of turns on each coil. Allowing ¼ inch from the end, the grid coil is wound with 55 turns, and the plate coil with 40 turns, with a ¼-inch separation. It is important that all of the windings be



Schematic diagram of the Broadcast Super. The builder should wire from this diagram in preference to the one printed last month, as one error occurred in the previous diagram

THE superheterodyne undoubtedly is one of the most sensitive and selective receivers that can be built. This accounts for the popularity it has enjoyed in the past. With the advent of screen-grid tubes, far more gain can be used now than ever before, with perfect stability. This results in an even more sensitive system than former supers. Combining these advantages with the Loftin-White audio system results in a receiver of amazing sensitivity and perfect fidelity of tone. In every sense this is a 1931 receiver.

By George E. Fleming

in the same direction. The leads may be disposed of in the same manner as those of the antenna coil.

The mountings for the coils may be made in any manner that is convenient for the builder. On the model receiver, the antenna coil is mounted on the base with a brass angle of sufficient height to permit the solder lugs on the bottom of the coil to clear. The oscillator coil is mounted on two round brass pillars $2\frac{1}{2}$ inches high. It is necessary, however, to mount the coils at right angles to one another in respect to their planes, so that incidental coupling between them will be as little as possible.

The disposition of the double drum dial, condensers, volume control, and sockets will be left to the builder, as they are relatively easy to dispose of. One should bear in mind, however, that short direct leads in the wiring are always desirable.

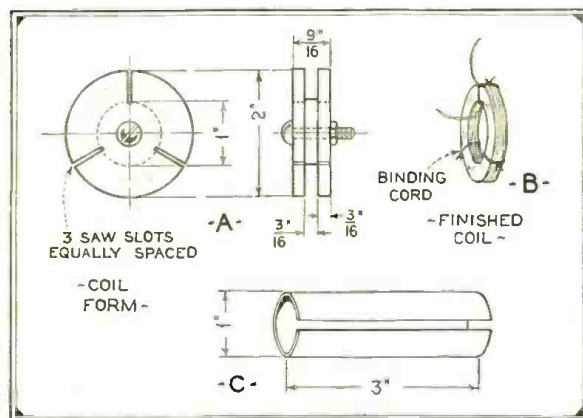
In the most fundamental sense this unit consists of a one-tube receiver coupled to an oscillator. Its function is to select the desired signal and mingle the wave generated by the oscillator with the original wave, to establish the intermediate frequency. Only one lead from the first unit to the second unit is required, as the B— is common to the ground throughout the entire assembly.

The intermediate-frequency amplifier is perhaps the most difficult part of the entire assembly to build, but it is simple enough if we realize that it is only a two-stage radio-frequency amplifier and detector circuit, whose tuning is fixed at one frequency. As before mentioned, a tuner working at this low frequency is inherently stable, so no especial precautions need be observed. A study of the diagram will show just what components go into each section of the can. In each instance, the radio-frequency choke in the plate circuits of the tubes belongs electrically to the tube in the preceding can, but placing them in the succeeding can prevents any possibility of feed-back from that source.

The coils are not difficult to make. First one should make up the winding form for them. Cut three circles from a $\frac{3}{8}$ -inch piece of bakelite. One of these circles should measure exactly one inch in diameter. The other two circles may be of any



The completed receiver in the author's home. This receiver in New York City cuts through the locals to get distant stations at will



Details of the winding of the intermediate amplifier transformers. A—The winding form. B—The finished coil. C—The coil mounting

diameter, as long as they allow at least $\frac{1}{2}$ inch of depth in which to wind the coil. The three discs should then be assembled by passing a 2-inch No. 8 machine screw through holes in their centres and clamping them with a machine nut. With a hacksaw cut three slots equispaced around the circumference so that the slot extends a bit into the centre disc. Chuck the machine screw into a lathe or into a breast drill held in a vise, and we are ready to wind the coils. Wind 200 turns of No. 32 d.s.c. wire into the winding space and secure the end of the wire by bending it back through one of the slots. There should be no attempt to wind smoothly, but scramble wind as much as possible.

A binding thread should then be passed under and over the coil in each of the slots, and tied securely. The form may then be disassembled, and the coil clipped off of the centre disc. It would perhaps have been a good idea to slightly taper the centre disc by sandpapering one edge of it, but no difficulty was experienced by the writer in removing the coils. When removed, the coils should be coated with collodion and allowed to dry. Six coils in all are needed, the primaries and secondaries being alike.

The mountings for these coils are made by removing a $\frac{1}{8}$ -inch section of a 1-inch bakelite tube 3 inches long, by cutting lengthwise with a hack saw. The form may be squeezed together and the coils slipped on. Three such mounts are needed, and two coils placed on each mount. The coils should be so placed that their windings run in the same direction and if this is done the inside of the primary should go to the plate of the preceding tube, and the (Continued on page 383)

Details on the Superheterodyne Receiver

broadcast fan, this receiver pro- means for listening in on real DX gives complete details for tuner circuits, and suitable volume- and construction hints

By Fred H. Schnell*
W9UZ



Lieut. Comm. Fred H. Schnell, designer of the RADIO NEWS S-W Superheterodyne receiver

These new battery tubes are to be used in this receiver as soon as the tubes are available. They are to be recommended for consideration in place of the 5.0-volt tubes. To find out how well they operate is to test them under actual operating conditions. Such information will be valuable to the tube manufacturer as well as to the radio experimenter.

No radical changes will be necessary in construction. The filament resistors in the screen-grid tubes, T1, T3 and T4, would be omitted. The circuit remains the same otherwise. Battery voltages would be different. The filament would be 2.0 volts throughout and the total current would be slightly more than 0.6 of an ampere. Think of that! The total plate current would be less than 20 milliamperes under normal operating conditions (the plate current of a type -71A tube alone) and with possibly equal or better output for normal room volume. Things well worth consideration.

Since no two experimenters use the same construction methods, it would be a waste of space to attempt to set down the hard fast rules of assembly. Everybody likes to incorporate ideas of originality to meet some particular need. This receiver is built for operating convenience and ease of control, more particularly from the angle of the radio amateur. The two control dials are mounted on the right side of the cabinet and the audio amplifiers are mounted on the left. This makes for ease in operating an amateur station where the key is placed for greatest convenience at the right of the cabinet. When copying an amateur signal, the left hand operates the oscillator dial (the one to the left) when the transmitting station frequency has a tendency to creep —most generally noticed in amateur transmitters. Since the detector circuit inherently is broad, no control is necessary except when tuning for stations, in which case the right hand is free. If the dials are mounted on the left side of the cabinet, it makes it rather awkward to shift the position of the body from one side to the other.

Fig. 1 gives an idea of the front panel layout with dimensions for spacing the components on the 7" x 22" x 1/16" aluminum panel. The control just below the voltmeter and to the left is the filament rheostat. The control (same type knob) to the right is the volume

*Chief of Staff, Radio and Television Institute, Chicago, Ill.

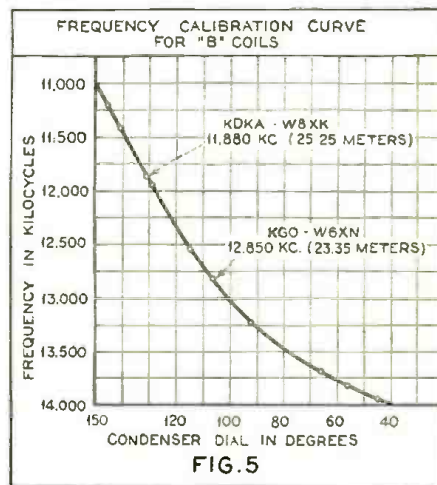


Fig. 5. A frequency curve plotted from the figures given in Table Two for the B coils. Such a curve is helpful in locating the dial position of stations whose frequency is known

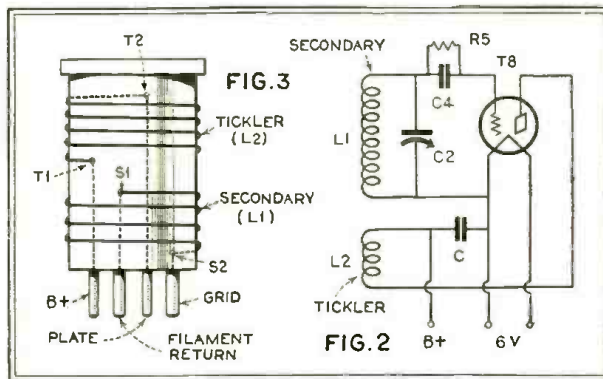
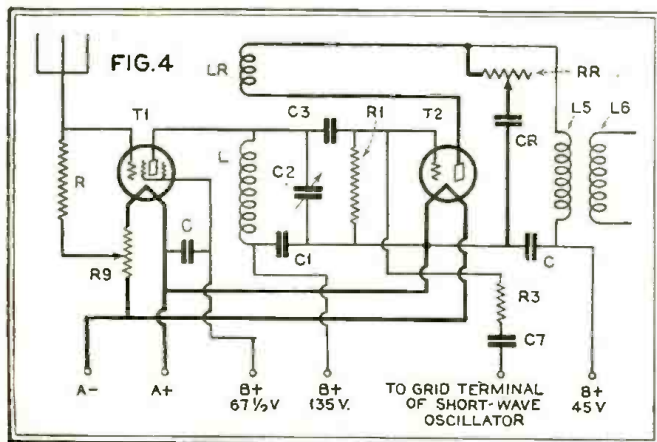


Fig. 2. above. The first detector and oscillator coils are wound on S-M No. 131 coil forms in the manner shown above. The terminal leads of the coils are connected to the tube circuit in accordance with the diagram also shown. Fig. 4, to the left, shows how an additional coil, LR, may be wound to provide regeneration in the first detector circuit

control. Directly under the filament rheostat control are the two terminals for the speaker, both insulated from the panel. The switch to the right of the speaker terminals is for the filament "on-off" and the switch to the right of the filament switch is for c.w. or i.c.w. reception. This switch throws the filament circuit of the long-wave oscillator tube in or out as desired. For c.w. reception, the switch is thrown to the "on" position, the long-wave oscillator beating on the frequency of the intermediate amplifiers.

By careful examination of the complete circuit diagram, it can be seen that there are no "tricky" gadgets or "dodads" concealed beneath the fundamental circuit. If there were things of this sort, then one might expect difficulties. The most important things to bear in mind are those which go toward making any receiver, if the greatest returns are to be expected. The wiring should, in all cases, be uniform, keeping all leads as short as possible. All connections should be soldered carefully, using a non-corrosive flux and a hot soldering iron. This has been gone into by RADIO NEWS and anybody who doesn't know how to solder connections in a radio receiver had better look through the past issues. Flexible wire of the stranded type is suggested; preferably the insulation should be rubber and cotton covered—the flexible lamp-cord type.

The first detector coil and the short-wave oscillator coil inductances are wound on Silver-Marshall forms, No. 130. No. 26 d.s.c. wire is used for each inductance. The circuit arrangement of the short-wave oscillator is shown diagrammatically in Fig. 2, the purpose being to keep the high-potential terminals away from each other and the ground or low-potential terminals. C4 is a grid condenser of 0.00025 mfd. capacity; C2, National equeicycle, 50 mmfd.; C, .025 mfd. by-pass condenser (Sprague); R5, Lynch 0.03 megohm grid leak.

L1 is the secondary tuning inductance and L2 is the tickler inductance. The number of turns varies with the frequency or wavelength band to be covered. Construction or assembly of these inductances is shown in Fig. 3. The inductances are wound in the same direction. The secondary inside terminal, S1, connects to the filament return; S2, the secondary outside terminal, connects to the grid through the grid condenser and the grid leak. The tickler inside terminal, T1, connects to the plus of the "B" battery; the tickler outside terminal, T2, connects to the plate of the oscillator tube. The spacing between the windings L1 and L2 is about one-quarter of an inch.

The first detector coil inductance is wound on the same style

B COILS			
CALL	OSCILLATOR DIAL DEGREES	FREQUENCY IN KILOCYCLES	WAVE-LENGTH IN METERS
WQ5	45-16½	13.915	21.559
WQT	47-20	13.885	21.606
WPE	55-26	13.480	21.676
WQU	56½-30	13.855	21.653
KKP	63-38	13.705	21.890
KKZ	66½-37	13.690	21.914
WKD	83½-60	13.435	22.330
KGO	107-96½	12.850	23.35
KPH	115-106½	12.550	23.90
KKQ	129-122	11.950	25.105
KDKA-W8XK	131-124	11.880	25.25
WPN	146½-140	11.350	26.43
KTK	148-141	11.050	27.15
KGQ	148½-141½	10.930	27.45

TABLE 2

form, but since there is only one winding, direction of the winding makes no difference. This is the inductance L shown in the circuit diagram. Both of these coil forms plug into tube sockets, since more than one set of coils is necessary to cover a wide range of frequency or wavelength bands. Coil windings are given in Table 1 (No. 26 d.s. covered wire—Silver-Marshall No. 130 coil forms). That additional ½ turn may sound fussy, but it just happens that the coil terminals happen to come out that way on the coil form. Additional coils can easily be made for other frequency or wavelength bands. L is wound on one form. L1 and L2 both are wound on the same form.

To add regeneration to the first detector, an additional tickler winding will have to be made on the same form with the secondary inductance, L. Regeneration is not included in the circuit diagram, but it is shown in Fig. 4. LR is the detector tickler winding; RR regeneration control, 10,000 ohms and CR is a 0.0005 mfd. condenser. L and LR are wound the same as L1 and L2, with about the same number of turns.

In calibrating the receiver it is necessary only to calibrate the oscillator condenser dial, since the detector tuning is rather broad. Most accurate calibration can be made from the regular commercial stations which have stabilized frequency control. While it takes longer to do it this way, the calibration is very accurate, since the commercial stations usually stay on frequency. The complete list of U. S. stations appears in the "Commercial and Government Radio Stations of the United States," published by the Department of Commerce, price 15 cents, from the Superintendent of Documents, Washington, D. C. From the frequency or wavelength calibrations, a curve can be plotted, a mighty handy thing to have, especially when tuning for a station. Three examples of calibration charts are given in Tables 2, 3 and 4.

*WQU in Table 2 doesn't check exactly—the above dial reading is exactly as logged. On this set of coils, HJO is received at 73 degrees; G2IV, 119; XDA, 131; CJRX, 137; PPW, 144; GBU, 121, and G5SW, 136 degrees. Both points on the oscillator dial are given, high and low sides. The frequency or wavelength curve which was plotted from these calibrations is shown in Fig. 5.

The C coils calibrate as in Table 3. On this set of coils, VK2ME dial reading is 85 degrees; WSBN, 138; PPW, 45; XDA, 123½; CKA, 39½; PCJ, 114, and VMZAB, the Southern Cross, was copied during the flight from Ireland to New York on (Continued on page 368)

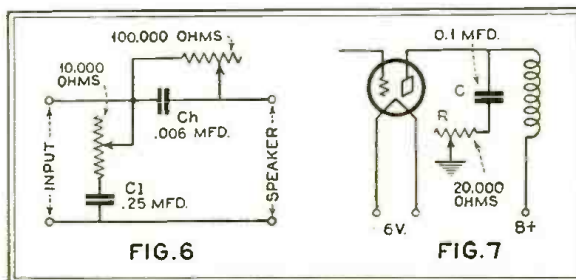


FIG. 6

FIG. 7

Figs. 6 and 7. Above are shown two methods of tone control which may be used in the superheterodyne receiver described here. That shown in Fig. 6 is recommended because it has the property of suppressing either the high or low notes, as desired. The circuit shown in Fig. 7, while useable, suppresses only the high frequencies

To the left, the Table indicating dial settings, wavelength settings and stations tuned in on the C coils

To the right, a dial-setting table for the D coils. Above, at the top of the page, is listed the coil table for the B coils

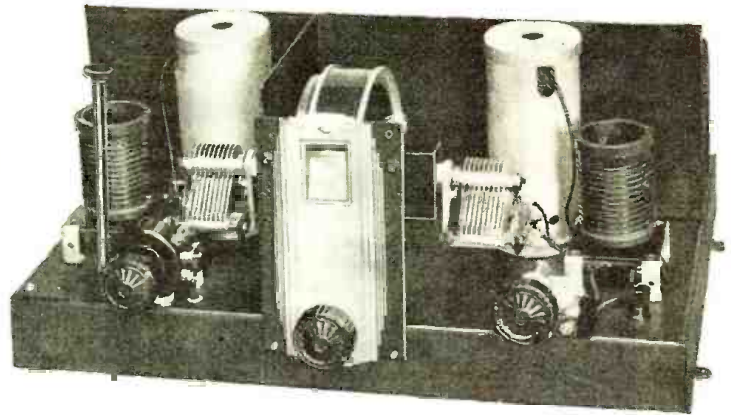
C COILS			
CALL	OSCILLATOR DIAL DEGREES	FREQUENCY IN KILOCYCLES	WAVE-LENGTH IN METERS
WPN	26	11.350	26.42
WEA	71½-41½	10.610	28.275
KEZ	86½-65	10.400	28.846
WMI	109½-97½	9.870	30.40
WGY-W2XAF	119½-110	9.530	31.48
WET	121-112	9.470	31.679
WKJ	121¼-112¼	9.460	31.712
WML	126-117½	9.270	32.29
WND	129½-121	9.170	32.71
KEJ	134-125½	9.010	33.30
WEC	135-127	8.930	33.594
WOO	143-135	8.630	34.76
WAR	-140	8.510	35.75
WHD	-145	8.250	36.36

TABLE 3

D COILS			
CALL	OSCILLATOR DIAL DEGREES	FREQUENCY IN KILOCYCLES	WAVE-LENGTH IN METERS
WEG	65-22	7.415	40.459
WEM	66-24	7.400	40.451
WIZ	98½-74½	6.965	43.073
WEO	104-83	6.957.5	43.119
WEZ	104½-83½	6.927.5	43.306
WND	113-98	6.755	44.41
WEJ	113¼-98¼	6.740	44.51
WQO	115-99½	6.725	44.61
WER	115½-100	6.710	44.709
KDKA	137½-126	6.140	48.86
W3XAL	139-128	6.100	49.18
W8XAL-WLW	141-129	6.060	49.50
WENR	142-130½	6.020	49.83
WKDA	146-134	5.885	50.975

TABLE 4

The All-Purpose Short Wave Receiver



A front view of the National battery-operated Thrill Box, with metal cabinet removed to display the internal assembly and layout details

The nationally known receiver described here is suitable for code, radiophone or short-wave broadcast use. While intended primarily as a short-wave receiver, its range extends from 9 to 550 meters with the aid of plug-in coils. It has single-dial tuning and can be built for either a.c. or battery operation. The use of the new two-volt battery tubes in this receiver makes it one of extremely economical operation

By Robert S. Kruse*

MOST short-wave receivers have been altogether too limited in their possibilities. The international short-wave broadcast "fan" needed one sort of receiver, the radio-telegraphing "c.w." amateur wanted another and still a third kind seemed necessary to the radiophone amateur. Furthermore, all three kinds of sets seemed to share between them some outstanding shortcomings, which may be listed as follows:

- 1—Lack of a continuous tuning range, or else very cramped tuning at some wavelengths.
- 2—Inability to work with different sorts of antennas without readjustments or even recalibration ("logging").
- 3—Lack of true single control.
- 4—Poor selectivity.
- 5—Complexity, either by reason of many sorts of coils or else by reason of switch-gear or range-shifting condensers.
- 6—Inflexibility as to "A" and "B" supply.
- 7—Mechanical instability.

A year ago measurements and tests were made with the purpose of arriving at a receiver design which should also be suited to all three sorts of short-wave reception—international broadcasting, amateur phone and amateur radio-telegraphy. The design went through the well-known preliminaries and emerged as a model which, in the hands of the National Company, became a commercial chassis known as the SW-5. In addition to meeting the requirements previously mentioned this chassis can readily be constructed for either a.c. or d.c. operation, likewise it provides a degree of sensitivity not usual in short-wave receivers. Other incidental advantages appear in the present form, as manufactured.

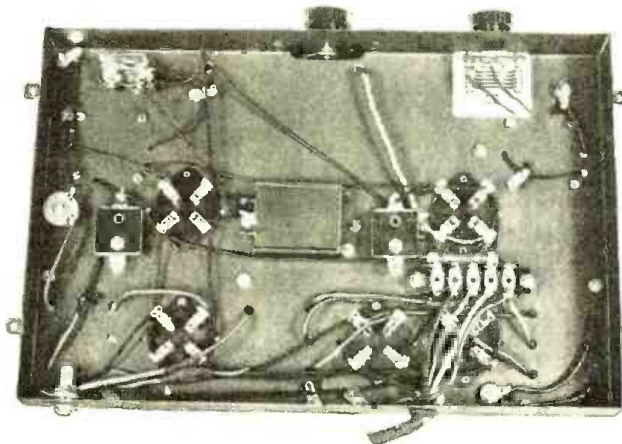
It is practically self-evident that good sensitivity and good

selectivity cannot be combined unless one uses tuning ahead of the first tube in the set—that is to say, "selectivity before gain." Should anyone be in doubt it is only necessary to recall that a few years since we had broadcast receivers with such "untuned inputs," "coupler tubes" and the like, but that now we have gone to the opposite extreme and invariably put one, two, and even three tuned circuits ahead of the first tube. The only reason broadcast receivers ever tolerated the coupling tube was that it was considered "impossible to produce alignment of the first circuit with the rest because of the association of the first circuit with the antenna." As soon as this was discovered to be a mere superstition all manufacturers dropped the coupling tube in a moment. Why not? Has it any advantages whatever?

Similarly the short-wave receiver has stuck to the "coupling tube" idea because it is "impossible to—" and so on. Some consideration of this belief suggested that it was not altogether sound; indeed, the suspicion arose that it was probably not more than 2 or 2½ times as difficult as in the usual broadcast receiver. The ganging problem was accordingly attacked as the heart of the matter. Experiments soon confirmed the sus-

picion that satisfactory ganging could not be expected from cut-down broadcast condensers. A smaller, more rigid tuning condenser was devised, with due attention to avoidance of all wiping contacts. Some details of the construction were discussed in the June paper referred to above.

Having found the new tuning gang to maintain alignment it was necessary next to assure the permanence of the coils. This is a thing not quite as simple as it sounds. From the standpoint of mechanical solidity it was desirable to wind the wire in threads, cut in a molded bakelite form. A very few tests confirmed the previous experience that such a coil is very bad at short waves.



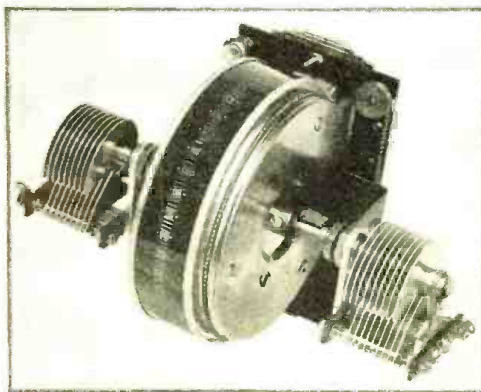
Practically all of the wiring of the receiver is accomplished underneath the chassis of the receiver. Also here are located such items as sockets, by-pass condensers, chokes, etc.

*Consulting Engineer.

correct, and the problem is to make L1 "run with" or align with it. Now L2 has across its secondary the capacity of the tuning condenser C2, also the input capacity of the detector tube. In addition to this there is *coupled to* the secondary a portion of the plate-circuit capacity of the detector itself (via the tickler T2) and in addition to this there is coupled in some of the plate-circuit capacity of the preceding r.f. tube via the primary P2. Since these capacities differ somewhat with tubes it is important to start by making them as small as possible, as well as attempting to keep them from shifting as a result of any ordinary tuning operation. We have already seen that the 2-to-3 primary winding tends to keep the preceding r.f. plate out of the picture to some degree. It is now evident, also, that the detector's own plate circuit must be back-coupled as loosely as possible. This in itself would be ample reason for choosing the grid-leak screen-grid type of detector. The screen-grid construction, as is well known, lowers the plate-grid capacity through the tube and thus tends to minimize the unavoidable "tuning effect" of the regeneration control. In addition to this the very high gain of such a tube gives us a high output as compared to the input. Thus only a very little of the energy *need* be coupled back, and we are able to use a small tickler winding, not too close to the secondary. Both matters tend to minimize the objectionable back-coupling of capacity into the tuned circuit L2C2. It only remains to explain why any regeneration control has been retained, which will be done somewhat later.



A front view of the very ship-shape looking National Thrill Box short-wave receiver



The two tuning condensers for the two tuned circuits are supported rigidly on brackets attached to the drum dial, as shown above

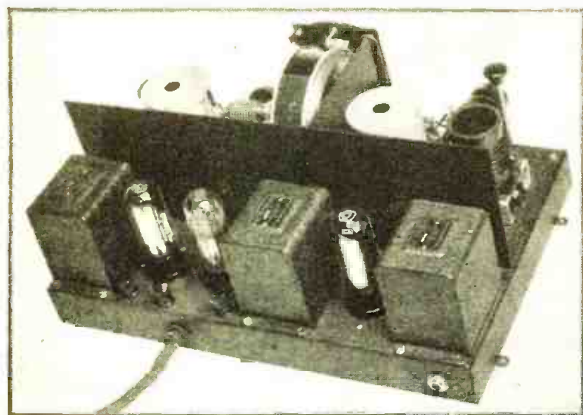
tennas, or tubes, and to make up for the effect by a twist of the makeup condenser. The adjustment is found easily in the usual manner—by the rise in background murmurs as resonance is reached. After that true single control exists, as in a standard broadcast receiver. In the process we have had to use but ONE type of coil for each tuning range. It is not only easier for the manufacturer to make the coils alike but it is also easier for the user of the set to jump to another range; he has but to reach for two coils of the same color and to put one in each socket.

The regeneration control is by detector screen-voltage variation, as this has both a positive action and a wide range which will produce the desired action with any ordinary tube, and with "B" and "A" voltages within about 20% either way from the proper values.

Since short-wave reception sometimes demands the use of the headset a jack has been provided in all models, directly after the first a.f. tube. This does not monitor across the audio transformer but is a cutoff jack, removing the transformer completely from the circuit when the headset is jacked in. One is thereby freed from the confusion due to hearing from two sources (headset and speaker), also for weak signals one has slightly (about 3/1) better sensitivity. The final stage is a push-pull one with an output transformer, so that the output terminals are entirely dead except for signal voltages. In the a.c. set there is used a pair of -27 tubes which are operated so as to produce somewhat more output than could be had from a -71 or -71-A while at the same time producing negligible hum. In the d.c. set there is used a pair of the new -31 output tubes. The biases are provided by cathode drop for the a.c. case and by a "C" battery in the d.c. case.

A special point with regard to the audio channel will be mentioned in the paragraph on amateur c.w. reception.

In the d.c. set particular attention has been paid to the matter of power-supply convenience. The 2-volt filament circuit load consists of two -32 filaments, a -30 filament and a pair of -31 filaments. This is a load which can be handled during about a year of ordinary use by the new Eveready 2½-volt semi-dry battery. This battery may be transported dry and light. It has about the dimensions and appearance of an ordinary 100 ampere-hour storage battery and is filled with water after arrival. It then has about the same weight as a storage battery but requires no attention and is free of sulfuric acid. The filament supply (Continued on page 370)



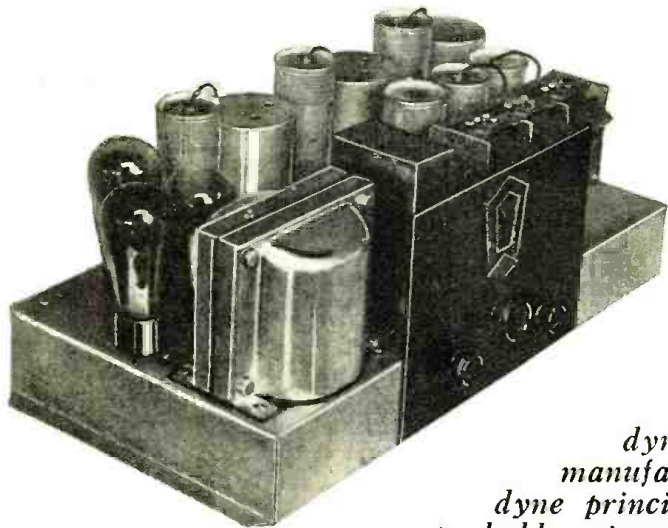
Looking down on the top of the receiver. Metal shield walls separate the tuning elements from the audio channel which is located along the rear edge of the chassis

Turning to the r.f. input (antenna coupling) circuit we will now undertake to produce the same conditions, after which we may expect the two circuits to "track" or "run together." It is evident that the primary and tickler windings must have connected across them something which will couple-into L1 a capacity equal to those provided by the plate circuits associated with L2. The plate-circuit-capacity across P2 is perhaps 15 micro-microfarads and very obviously cannot be replaced by the antenna in the case of P1. Even a small antenna has more capacity than that, yet would be ruined if we tried to operate it in series with a fixed condenser of 15 mfd. The detector-plate-circuit capacity across T2 is somewhat larger and this winding accordingly looks more promising as a possible antenna winding. This is actually the arrangement used. The "tickler," T1 becomes the antenna winding and the "primary" P1 is shunted by a "makeup" condenser which imitates the effect of a preceding plate circuit. Ideally the makeup condenser should exactly imitate the preceding plate circuit and the antenna-capacity should exactly replace the detector-plate-circuit-capacity. Practically, however, it is found quite possible to use one for compensating differences in the other. This compensation is a "set-and-forget" adjustment. Except for differences from one set of coils to another *it need not be changed after the set is in operation.* The coils, as supplied with the set, are of sufficiently exact construction so that such changes are usually needless. This is due to the use of a moulded form with cut threads.

By the "dodge" just mentioned it is possible to change an-

Superheterodynes

to the Fore



Front view showing the power transformer and audio tubes at the left, while the three-gang condenser tuning the r.f. and first detector stages is at the right

The Radio Corporation of America has only recently opened up the superheterodyne situation by allowing their licensees to manufacture receivers embodying the superheterodyne principle of reception. The coming season will probably witness great activity in this field. The receiver described here is one of the first to be given to the public in accordance with this arrangement. It embodies excellent features of mechanical and circuit design and will commend itself to its builders by its outstanding performance.

By McMurdo Silver

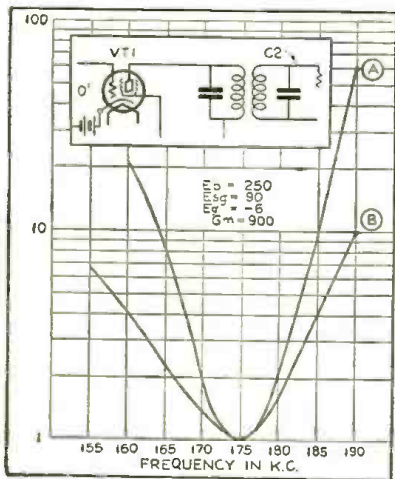
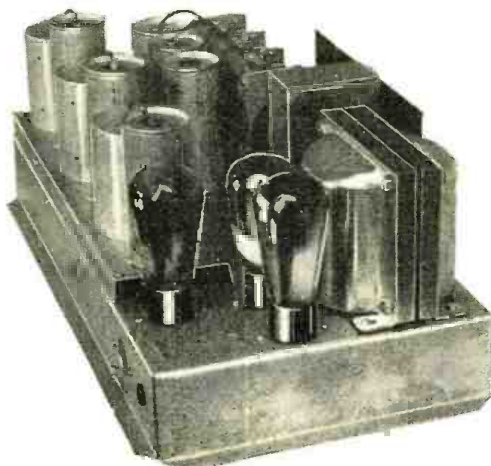


Fig. 3. The band-pass effect of the first i.f. stage is graphically pictured—curve A was made with the switch in "distance" position, while curve B was made with the switch in "local" position



The back view of the Silver super. The shielding of tubes and coils is clearly shown

IT has often been said that the superheterodyne system of radio reception is the Rolls-Royce of radio, and not without excellent justification, yet in the past several years we have seen practically all engineering development concentrated upon tuned radio-frequency receivers, due to certain defects extant in past practical superheterodynes which have been aggravated by increasingly congested broadcasting conditions, and because of certain developments, principally screen-grid tubes, which have contributed greatly to t.r.f. performance possibilities.

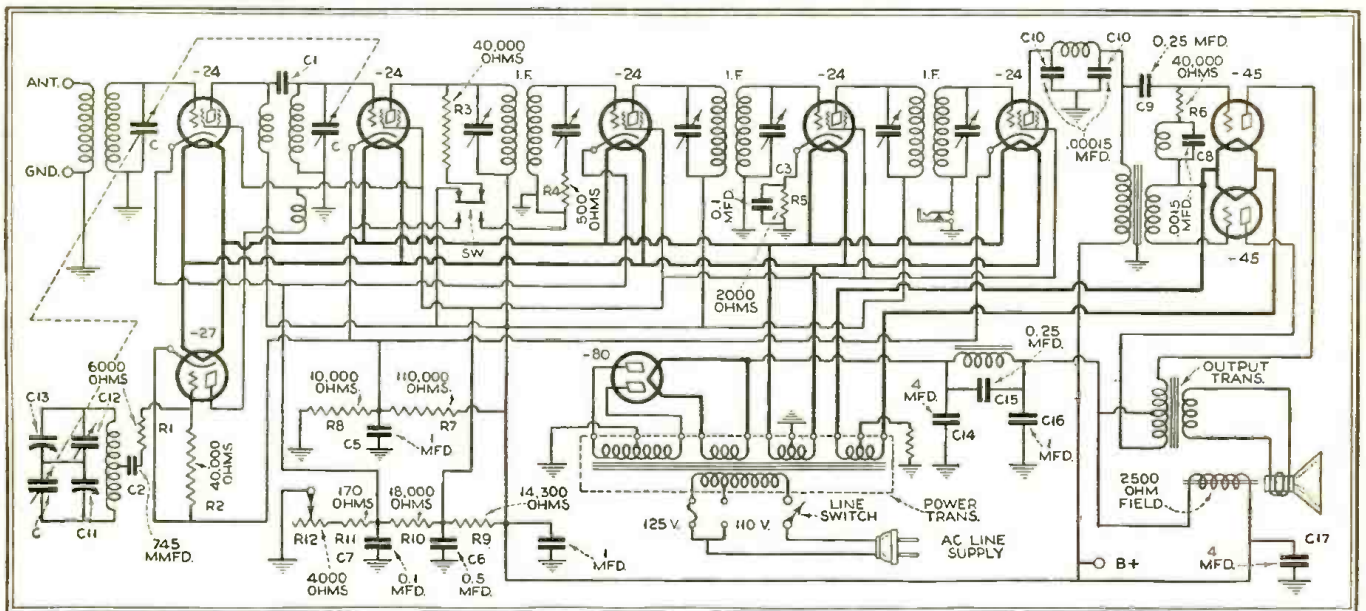
Looking back, for a moment, through the past eight years, we find that superheterodynes first enjoyed popularity in the fall of 1923, at which time it was possible to build a super of far higher sensitivity than was available in the simple t.r.f. or regenerative sets then being built. The actual selectivity of these old supers, normally employing five to six tuned circuits, was appreciably superior to that of one or two-tuned circuit regenerative or four-tuned circuit t.r.f. sets, though they suffered from what was then relatively low-powered, uncrowded broadcast conditions, the not very serious drawback of image frequency interference, sometimes called harmonics, plus a variety of other forms of interference manifesting themselves in a multiplicity of dial points at which a

single powerful station could be tuned in. Their sensitivity made up for this drawback under old conditions, and it may be said that the real factor of original superheterodyne popularity was sensitivity. With the advantage that screen-grid tubes provide, it became possible to build t.r.f. receivers of as high an order of sensitivity as is practically desirable, and a very good order of selectivity, which, when compared with a conventional super of 1927, showed possibly better apparent selectivity due to freedom from image and other types of interference peculiar to the super alone. New additions, the increasingly important factors of single control tuning and all electric operation, seemed to favor t.r.f. development, at least in the minds of most engineers, to whom the problem of adapting these features to the super seemed an almost insurmountable problem. And, of course, the patent situation was a very definite factor and one which has just now been ironed out by the offering of superheterodyne licenses to a number of radio manufacturers.

Long before the appearance of the first commercial superheterodyne the writer was intrigued by the super and was, in fact, co-designer of the first commercial superheterodyne kit ever to gain popularity—and, although the tangible results of his recent work have been t.r.f. sets, much thought and development work has gone into supers, against the time when they could legally be made, and during this period he has devised methods for completely electrifying the superheterodyne, and providing it with a degree of absolute selectivity and sensitivity that will put the best t.r.f. sets to shame, as the accompanying curves of a new design will illustrate. This receiver will be described in this and following articles, but before consider-

IT is with genuine pleasure that we are able to present here an article dealing not only with a brief résumé of superheterodyne operation, but also with the design of a particularly interesting job by one who has done much to bring superheterodynes to their present high stage of perfection.

the oscillator is set to heterodyne the 1000 kc. signal to 175 kc. In the first case of 1000 kc. and 1010 kc., the percentage difference is 1%—in the second case of 175 kc. and 165 kc., the percentage difference is about 5.7%, so that the selectivity problem for the super is about six times simpler than for a t.r.f. set, neglecting entirely the fact that 1% discrimination at 1000 kc. is practically impossible to any t.r.f. set ever made or now being made. Compare this tremendous advantage with the fact that a good super can employ quite practically nine tuned circuits, whereas a practical t.r.f. set cannot exceed five tuned circuits, and the selectivity advantage of the super becomes overwhelmingly apparent. The advantage from the selectivity



This is the circuit employed by Mr. Silver in his latest superheterodyne. Nine tubes in all are used; one as a first detector, one as an oscillator, three as i.f. amplifiers, one as a second detector, two in push-pull as a final audio stage and one in the rectifier circuit of the power supply unit. A.C. tubes allow complete a.c. operation of the receiver

ing it in detail it will be interesting to consider a few of the problems inherent in the superheterodyne system of reception.

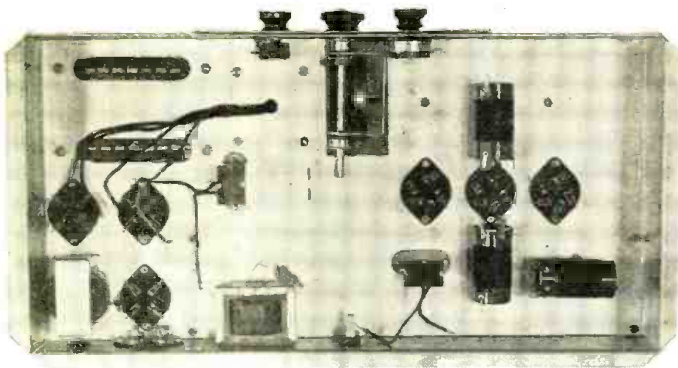
Essentially, a t.r.f. receiver consists of an r.f. amplifier which can be adjusted, today by one dial, to different frequencies in the broadcast band. Essentially, a "super" consists of a pre-tuned low radio-frequency (generally called intermediate-frequency) amplifier to which different signals are adjusted by heterodyning them to the r.f. amplifier frequency. The difference between a t.r.f. set and a super can probably be most simply expressed by saying that a t.r.f. set is tuned to the signal, while the signal is tuned to the super. The tuning of the signal to the super r.f. amplifier is accomplished by means of an oscillator operating at a frequency differing from the signal frequency by the frequency of the r.f. (usually called the intermediate-frequency) amplifier, thus producing a beat essentially equivalent in modulation to the signal frequency, but at the i.f. amplifier frequency.

Two very great advantages result, the first the possibilities of very great amplification made possible by the selection of a low intermediate or amplification frequency, and the second what may be called the "arithmetical" selectivity gain. This is easily understood by considering the selectivity problem presented by the attempt to discriminate between a 1000 kc. and a 1010 kc. signal, an almost impossible problem for any t.r.f. set. Considering a super using the, for this purpose, disadvantageously high intermediate amplification frequency of 175 kc., we find that the interfering signal is still 10 kc. away when

and fidelity viewpoint of using two tuned circuits in a tuned-plate, tuned-grid arrangement (variously known as dual-selector, siamese, etc., circuits) has long been recognized. In t.r.f. circuits, the capacity variations which arise from the misalignment in the variable condensers required by commercial tolerances prevent their being anything but an approximation of a real "siamese" circuit. In the superheterodyne these circuits can be used in the i.f. amplifier where they operate at a fixed frequency and where full realization of their advantage can be had.

Two serious disadvantages of the super cannot be ignored, however. Consider the reception of a 1000 kc. signal with the oscillator set 175 kc. away to produce a 175 kc. beat for the i.f. amplifier, or at 1175 kc. It will also heterodyne a signal at 175 kc. further away, or at 1350 kc. at the same time, and unless the tuned circuits preceding the first detector are sufficiently selective to shut out definitely a 1350 kc. signal when they are tuned to 1000 kc., interference which is called image frequency interference results.

Obviously, the higher the intermediate frequency, the simpler will be the problem of pre-selection, but 175 kc. is the highest practical i.f. for reasons which will be brought out later. The second problem is where the stations themselves may be separated by the i.f. when, if both reach the first detector, a beat will result carrying the modulation of one or both stations, which will be amplified. Here, again, the problem is selectivity ahead of the first detector, which can be obtained by the use of,



A view from underneath. The simplicity of the layout lends itself to easy wiring and efficient operation. The socket shown in the vertical plane is for loud speaker connection

Fig. 1. The over-all selectivity of the entire receiver. Great sensitivity with sufficient selectivity without appreciable side-band cutting are the features of this system

say, two tuned circuits, one as an r.f. amplifier ahead of the first detector.

The choice of an intermediate frequency has, in the past, often seemed a matter of designer's whim, but is actually definitely settled upon an examination of the actual problems involved. For amplification and direct selectivity, the lower the i.f. the better, whereas for freedom from image-frequency interference, the higher the better, even to the extreme of the infradyne, in which the i.f. was actually above the broadcast band. As the image-frequency problem is the most serious today, a high i.f. is indicated, but another factor enters, limiting the point to which i.f. may go. Any detector generates harmonics of the r.f. signal carrier applied to it, and in the case of a power detector handling high signal voltages, harmonics, up to the third, represent quite a fair percentage of the fundamental. It has been found that if the third harmonic of the i.f. falls in the broadcast band, leakage in the set from second detector output back to first detector can cause serious interference problems, so that the i.f. should be low enough to keep its third harmonic below the broadcast band. The third harmonic of 175 kc., for example, is 525 kc., just safely below the broadcast band, and therefore 175 kc. is indicated as the ideal i.f. Why not 170 kc., may be asked. The choice of an i.f. that is a multiple of 5 kc. rather than 10 is desirable, since broadcasting stations in the American system are spaced 10 kc., and two stations themselves separated by 170 kc. or 180 kc. will cause less trouble to a sharp 175 kc. i.f. amplifier than they would to a 170 kc. amplifier (see above for details of this type of interference).

The ideal superheterodyne is one combining the points of good t.r.f. amplification, and the pre-tuned i.f. amplification of the super. and such is the receiver design illustrated herewith. To fully utilize these characteristics, the first detector should be preceded by at least one stage of t.r.f. amplification and the i.f. amplifier should employ the best tuning features found in modern t.r.f. sets, or double tuned circuits between each i.f. tube.

The receiver illustrated and described herewith incorporates these features, and a consideration of its design and construction should prove interesting, inasmuch as it incorporates the features necessary to make a modern superheterodyne the real Rolls-Royce of radio—features not found in any previous superheterodyne designs.

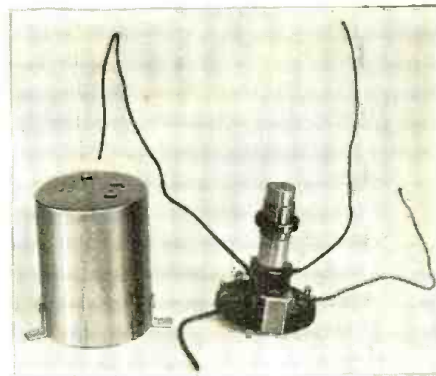
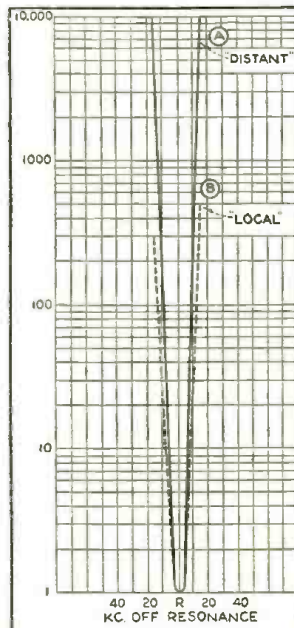
Examining the super structure picture, it will be seen that the assembly is a symmetrical one in that the tuning dial is located at the exact center of the chassis with the on-off switch

and volume control symmetrically disposed above the tuning knob. The chassis is 19½ inches long and 10½ inches deep and carries the complete receiver and power supply assembly. The three-gang condenser tuning the r.f. amplifier stage, the first detector and oscillator will be seen at the right front end of the chassis, while on the opposite side of the dial are located the filter condenser bank and the power supply transformer. Directly behind the gang condenser are located first the r.f. amplifier tube, then the second detector, and, closest to the center, the oscillator tube, all three being shielded. The r.f. amplifier and first detector are -24 type a.c. screen-grid tubes, while the oscillator is a -27 type tube. Directly behind the gang condenser and its three tubes is located the intermediate amplifier and second detector assembly, which is built as a complete assembly on a sub-chassis which, in turn, is fastened to the main chassis. The reason for this is that the "peaking"

adjustments on the intermediate amplifier are relatively critical, since the amplifier must be adjusted to exactly 175 kc. This i.f. amplifier pre-tuning is done at the factory, so that the serviceman or experimenter receives an accurately pre-tuned amplifier, requiring in itself no adjustment to insure proper alignment of the i.f. amplifier circuit. To the left of the second detector are the two -45 push-pull power output tubes and to their left the -80 rectifier tube. An examination of the bottom view photograph of the chassis indicates that the r.f. and first detector coils are placed at mutual right angles to eliminate coupling, while the oscillator and first detector coils are mounted coaxially to provide the necessary coupling.

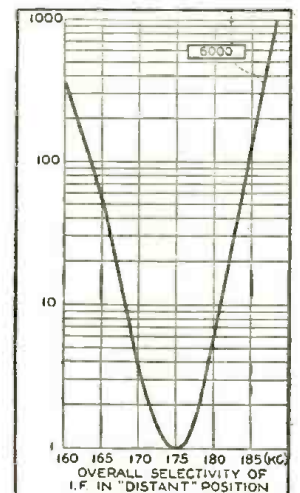
At the rear center of the chassis is located the phonograph jack and to its right the audio transformer coupling the second detector to the -45 push-pull stage. To the right of this will be seen a socket for loud speaker connections and on the rear of the chassis, just above, a socket for one -45 push-pull tube, to the right of which is located the power supply filter choke. Behind this choke is a -80 rectifier tube socket; to the left of it the second -45 tube socket, and just to the front the lugs of the power transformer which project through the bottom of the chassis. Additional small by-pass condensers and chokes will be seen located on the under side of the chassis in various positions.

For the sake of simplicity and clarity, and in order to give a better idea of the location of individual parts, the wiring has been left off this chassis. (Continued on page 371)



The "innards" of the intermediate frequency transformer. The single plate condensers on the bakelite base are to tune the primary and secondary to obtain a band-pass effect

Fig. 2. The over-all selectivity of the i.f. amplifier



NEWS from the MANUFACTURERS

New Flechtheim Condensers

A. M. Flechtheim & Co., Inc., 136 Liberty Street, New York, announces among several new types of condensers, its type HS which has a small physical size and high working voltage with a rating of 1000 volts d.c. or 660 RMS rectified a.c. This condenser is especially valuable for use in aircraft receivers and transmitters and in portable radio outfits.



The Flechtheim Company also announces a new 5000 volt d.c. (3300 RMS-RAC) transmitting condenser for use in broadcast stations.

The new 1930-31 Flechtheim fall catalogue is now available and will be sent on request.

Aircraft Radio Receiver

Stromberg-Carlson Telephone Company, Rochester, N. Y., is manufacturing a new and improved type of aircraft radio receiver known as Model D, fol-



lowing specifications developed by the Aircraft Radio Corporation, Boonton, N. J. An outstanding feature is that it is universal as to frequency band and class of service. A frequency range of 250 to 15,000 kilocycles is covered by the new model, through the use of a re-

movable coil assembly. The receiver proper measures 15 by 7½ by 6½ inches. The weight with tubes and shock mounting is 18 pounds. The receiver may be operated from dynamotor or dry battery plate supply; filaments of the tubes are heated from the 12-volt airplane battery. Four screen-grid -24 type heater tubes and one -27 heater tube are employed.

Four tuned circuits insure adequate selectivity for the increasing congestion of aircraft radio channels in the United States. Extreme sensitivity enables this receiver to operate satisfactorily with an antenna exposure as small as two feet above the fuselage.

The remote tuning control is also furnished since most installations require that the receiver be located in the rear part of the fuselage away from the pilot or operator.

High-Voltage Filter Condensers

Dubilier Condenser Corporation, 342 Madison Avenue, New York, announces a line of high-voltage filter condensers designed for an extremely high safety factor, thus eliminating possibility of breakdown at rated voltages. They are



available in a medium-voltage range with 600, 1000 and 2000 volt units of wax-filled and oil-impregnated construction, and in a high-voltage range, with 3500, 5000, 6000 and 10,000 volt units oil impregnated and oil filled.

Each of these new condensers represents a single section, and not a number of sections connected in series. Therefore, there are no drawbacks such as series balancing resistors and unequal voltage stresses. The high voltage condensers employ paper dielectric.

Grimes Joins RCA

David Grimes, radio engineer and writer, has recently joined the License Division of Radio Corporation of America. Mr. Grimes has been appointed engineer in charge of the Circuit and Apparatus Section of a recently organized Patent License Division Laboratory which co-operates with various manufacturing companies licensed under RCA patents.

Mr. Grimes, who is well known in the industry as a writer and consultant, organized and operated the David Grimes Company in the early days of broadcasting.

Auto-Radio Loud Speaker

Tilton Mfg. Company, New York, has brought out a new Ex-Stat speaker for automobile installation which combines beautiful appearance, remarkable tonal range and a method for central mounting



in almost any part of the car. This speaker has a totally shielded driving unit which eliminates troubles usually arising from the accumulation of dust and grease in installations of this kind. There is a small window in the driving unit case to enable the adjustment of the armature when necessary. The special case is moisture proof and has been designed with a view to furnishing the best possible reproduction under the difficulties which motor car acoustics produce.

Radiola Combination



Coincident with the announcement of the Radio Corporation of America that all of their licensees will be permitted to manufacture superheterodyne receivers, comes the announcement of the new RCA superheterodyne, Model 86, illustrated here. This receiver is equipped with the latest improved type of electric phonograph and is housed in an attractive console type cabinet.

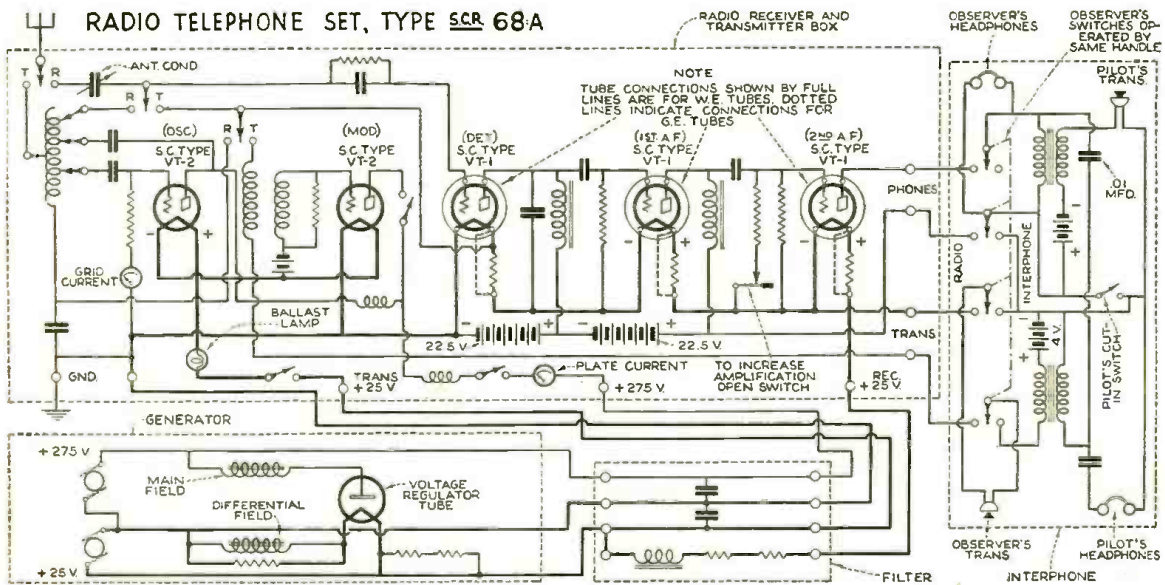
Electrodynamic Speaker Units



Jensen Radio Mfg. Company, Chicago, Illinois, is manufacturing two new electrodynamic speaker units designed as the Jensen Midget and Jensen Concert Junior.

These new models have been designed for use with automobile and so-called mantel or midget type radio receivers and for similar purposes requiring a speaker which permits installation in limited space. The cone diameter
(Continued on page 369)

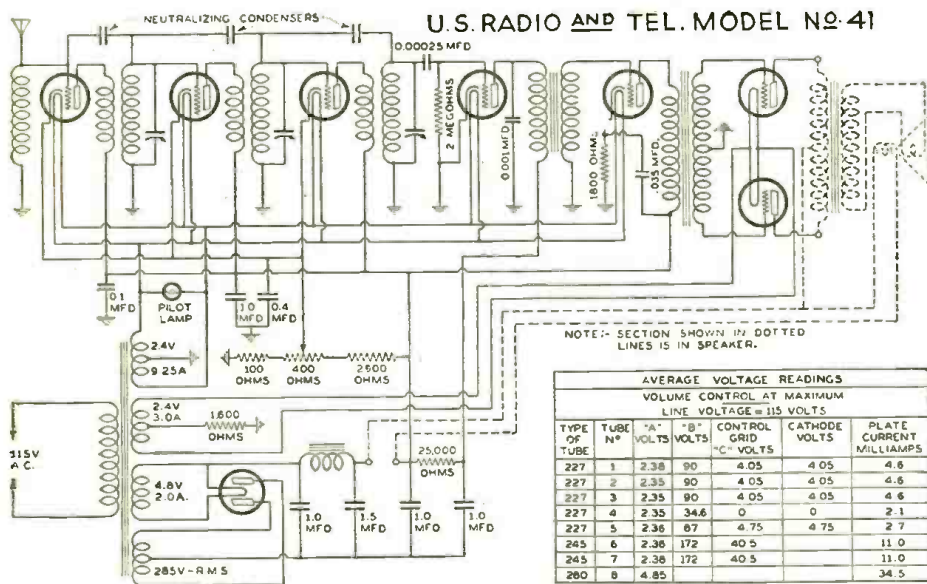
Radio News Manufactured Receiver Circuits



THE United States Signal Corps radio telephone transmitter and receiver, the wiring diagram of which is given above, is printed by permission. The entire assembly includes a complete transmitter, and receiver circuit. These circuits are so arranged that either the pilot or the observer may operate them, and the interconnecting lines necessary to do this are utilized as a telephone system between the seats of the two operators. The outfit is powered

by a wind driven generator, although two 22 volt batteries are utilized on the first two audio stages. 2 type VT2 tubes, 3 type VT1 tubes, and one voltage regulator are used. The voltage regulator tube keeps the voltage practically constant regardless of the speed of the generator. This system was designed particularly for airplane use, and is of the rugged construction necessary for such use. Provision is made to use either Western Electric or General Electric tubes.

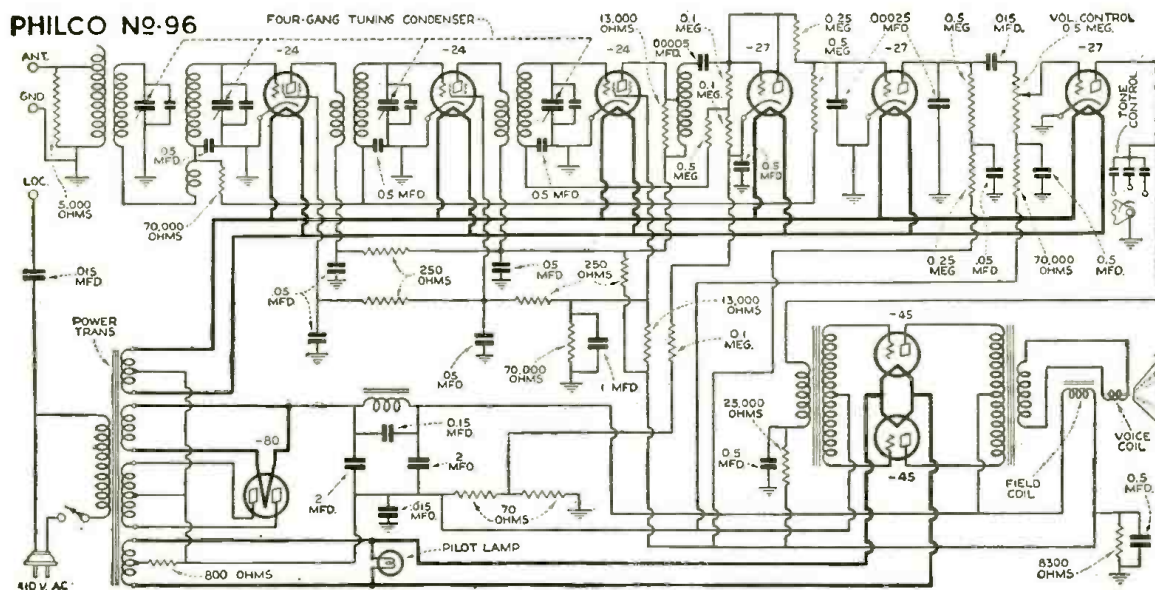
Radio News Manufactured Receiver Circuits



THE U. S. Radio and Telephone Co.'s model 41 is a 7 tube receiver. Three stages of tuned radio frequency, neutralized, feed into a leak-condenser detector which in turn transformer coupled to the first audio stage. The power output stage is push-pull. The radio frequency stages, detector, and first audio stage all use type -27 tubes, and the power output stage type -45 tubes. All potentials

are supplied from one power transformer. A type -80 tube is utilized in the power supply, supplying B potential to the tubes. The necessary voltage to furnish field excitation to the electro-dynamic speaker field. Control of volume is accomplished by varying the cathode bias on the radio frequency tubes. The proper voltages applied to the tubes are shown in the insert.

Radio News Manufactured Receiver Circuits

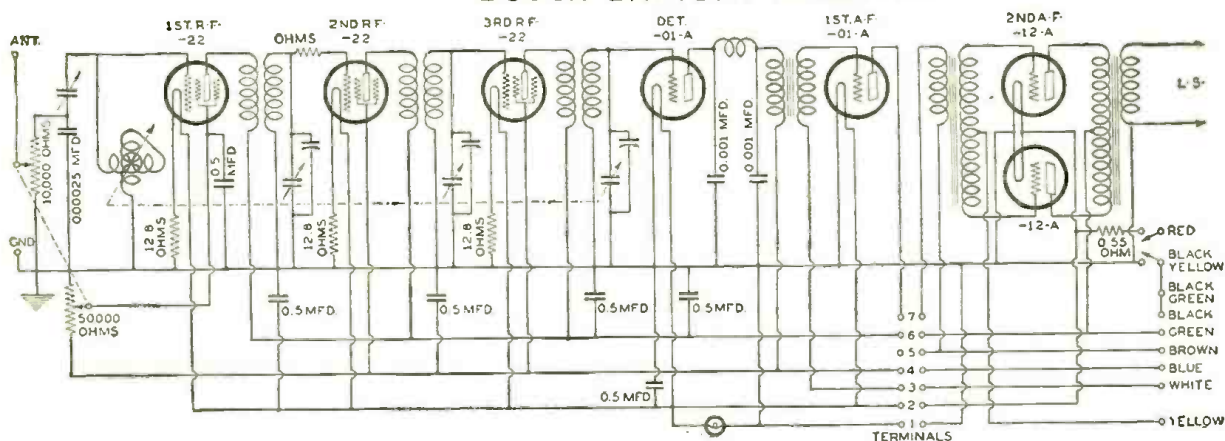


THE Philadelphia Battery Co.'s model 96 receiver embodies numerous interesting features. Among them are: band pass tuning ahead of the first radio frequency stage, automatic volume control, resistance coupled first two stages audio, push pull power output stage, and tone control are some of these features. The receiver uses eight tubes, three type -24 tubes in the tuned radio frequency stages, one type -27 tube in the volume control tube, two stages of

audio utilizing type -27, and a power output stage using type -45 tubes. Manual control of volume, supplementing the automatic control, is accomplished with a potentiometer in the grid circuit of the audio stage immediately preceding the power output stage. The power supply utilizes a -80 type tube, and is so designed to supply the necessary current to the speaker field, the speaker field acting as the second choke of the filter system.

Radio News Manufactured Receiver Circuits

BOSCH BATTERY RECEIVER



IN the field of battery receivers we find the American Bosch Co.'s battery model one that utilizes a good many of the engineering features found in the A.C. models. Type -22 tubes are used in the tuned radio frequency stages, -01A's in the detector and first audio, and -12A's, push pull in the output stage. Seven tubes in all are so used. Typical of this company's receivers, the antenna is tuned to resonance with a variometer, tuned with the condenser

shaft, and trimmed with a vernier condenser. This in no way complicates the tuning of the circuit, but adds tremendously to the sensitivity and selectivity of the circuit. The radio frequency stages are gang tuned, with trimmer condensers on each stage. The volume is controlled by varying the potential on the screen grid of the first tube. The audio channel is transformer coupled, the first stage being on the receiver chassis; second on power supply.



The Junior RADIO Guild



LESSON NUMBER THIRTEEN

Batteries

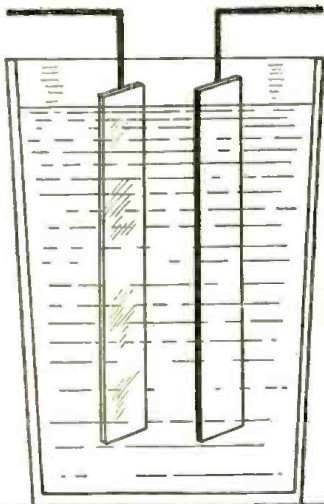
IF one should study the history of batteries from the time that Volta first discovered that two metal plates immersed in an acid solution would act as a source of potential, he would have a very complete picture of the development of electrical apparatus up to the present date. However much we would like to romanticise on this subject, space demands that we stick to the semi-technical side of batteries and their uses.

Chemical to Electrical Energy

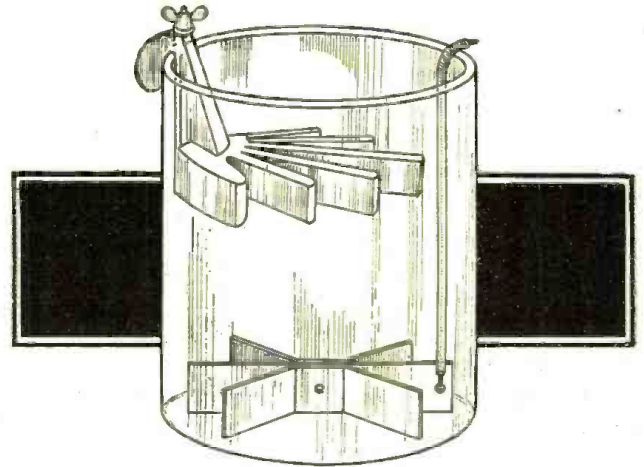
Fundamentally, a battery is just what is described above, two metal plates immersed in any solution that will act chemically upon one plate more than on the other. This has been variously described as a voltaic, primary, or galvanic cell, and the action is simply to convert chemical energy into electrical energy. The two plates, or poles, as they are technically termed, are at opposite potentials, and if connected together or to an electrical circuit, current will flow from one pole to the other. When the cell is in such a state that current will flow, it is said to be charged, and when the cell will no longer furnish current it is said to be discharged. Sometimes it is possible to recharge such a cell to an extent by putting current through it in opposite direction from the discharging current, but as a rule this is unsatisfactory.

The Two Plates

The two plates, or poles, are, as said, at opposite potentials, that is positive and negative respectively. In the earlier days of experimentation it was assumed that the current flowed from the positive pole toward the negative pole; in fact, this assumption accounts for their being called positive and negative. The fallacy of this assumption has now been demonstrated by the electron theory as applied to vacuum tubes, which clearly demonstrates that current really flows from the negative pole toward the positive pole. However, for convenience, we still apply the original terms. In a cell the negative pole is the



The primary or voltaic cell consists of two metal plates in an acid. Electrical energy results from the chemical action on the plates.



The copper sulphate, or "crow-foot" battery

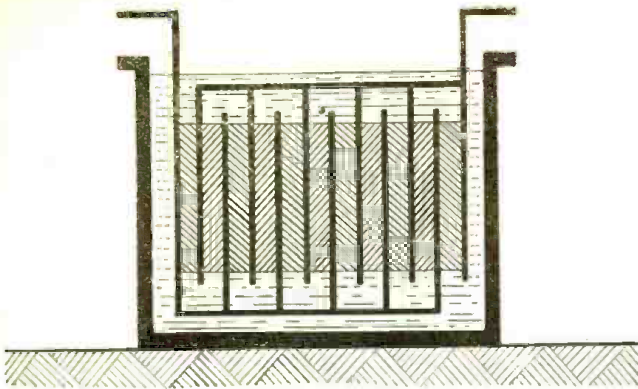
one that is acted upon chemically to the greatest extent. As the energy is used up in a cell, free hydrogen is liberated from the electrolyte, which collects on the negative pole of the cell. Unless some means are taken to remove or neutralize this free hydrogen, the resistance of the cell will finally become so great that the entire electromotive force of the cell will be required to overcome this resistance, and there will be no more potential available from the cell for other work. In this condition the cell is said to be polarized. Various methods have been used at one time or another to overcome this condition, or to depolarize the cell. One method is to remove the negative pole from the cell so that the hydrogen may combine with the oxygen in the air. The valence of hydrogen is 1 and the valence of oxygen is 2, so that they combine to form water, or H₂O. Various chemicals have at one time or another been added to the electrolyte to accomplish this end in a purely chemical method, notably copper oxide, and in the instance of the so-called dry cell, manganese dioxide. Regardless of what depolarizing agent is used, its one function is to combine oxygen with air to make water.

"Crow Foot" Battery

A good illustration of this fundamental type of cell is the "crow foot" battery. A cell of this type usually consists of a fan-shaped copper plate in the bottom of a glass jar or other container, with a zinc electrode suspended near the top of the container. The jar is filled with a saturated solution of copper oxide, or "blue stone." More crystals of copper oxide are added until the copper plate is nearly covered. In this cell the zinc electrode is the negative pole, and the copper plate is the positive pole. In practice, the zinc is made very heavy so that it will last for quite a long time; in fact, until the zinc is used up or cell becomes polarized. The physical shape of the zinc electrode gives rise to the name "crow foot." This type of cell is also known as a "closed circuit cell"; that is to say, it is often used in a circuit that draws current at all times. In such use it has the ability to furnish a practically constant potential for long periods of time.

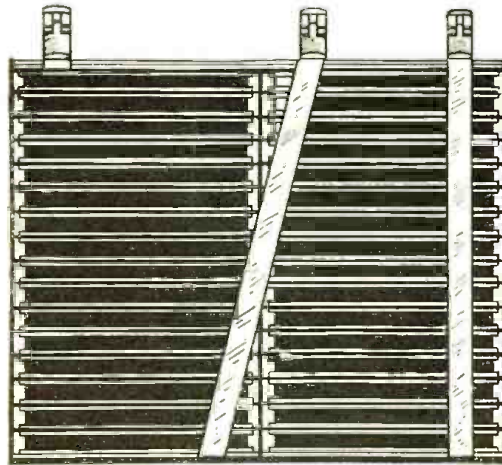
Storage Cell

A storage cell is one that may be recharged when exhausted. This type of cell is sometimes called a secondary cell, and by



The storage cell is sometimes called a secondary cell. Instead of creating electrical energy, it acts as a reservoir for electricity through its ability to accept a charge

The conservation of space in a "layerbuilt" battery allows more active material in a given space than in the older type of construction. This reflects itself in longer useful life



our English cousins, an accumulator. In its most common form it consists of two lead plates suspended in a solution of sulphuric acid and water. In practice, the plates are pierced to form an open framework, or grid, so that the surface presented to the electrolyte is increased. The positive plate is coated with red lead and the negative plate with litharge. The electrolyte is composed of 1 part of sulphuric acid to 4.5 parts of water. When the plates are suspended in the solution, and a current passed through the cell, the red lead changes to peroxide of lead and the litharge to pure lead, deposited in a sponge-like mass, by chemical action. Usually the plates are held in place by wooden separators, although this has no effect on the electrical action involved. This type of cell may be charged and discharged at will. When fully charged the voltage from a cell of this type will be about 2.3 volts, and the specific gravity of the electrolyte is 1.275 to 1.3. The cell should be recharged when the voltage drops to 1.7 under load, and specific gravity falls to 1.25.

The Edison cell is a variation of the cell described above, using nickel and iron plates in a solution of potash.

The positive plate of this type of cell is made up of a collection of steel tubes which are hollow and perforated to permit the "active material" to be placed inside of the tubes, but still to be in contact with the electrolyte. These tubes are arranged in a framework so that the tubes are vertical, and the framework together with the tubes make up the complete assembly of the plate. The entire assembly is nickel plated. The tubes are then packed with nickel peroxide and flake nickel in alternate layers. The nickel peroxide is the active material, while the flake nickel is used to make the internal resistance of the cell lower than if the flake nickel were not used.

The negative plate is similar to the positive plate with the exception that instead of tubes being used in the assembly, the plate is punched so that numerous pockets are formed. The plate is steel, nickel plated. These pockets are then filled under pressure with iron oxide. The chemical action which takes place at the time of the first charge changes this iron oxide to metallic iron.

The electrolyte is a potassium hydrate solution, mixed 1 part in 5, or, to be more exact, about 21 per cent., the specific gravity of which is 1.200. The addition of a small amount of lithium hydroxide completes the solution.

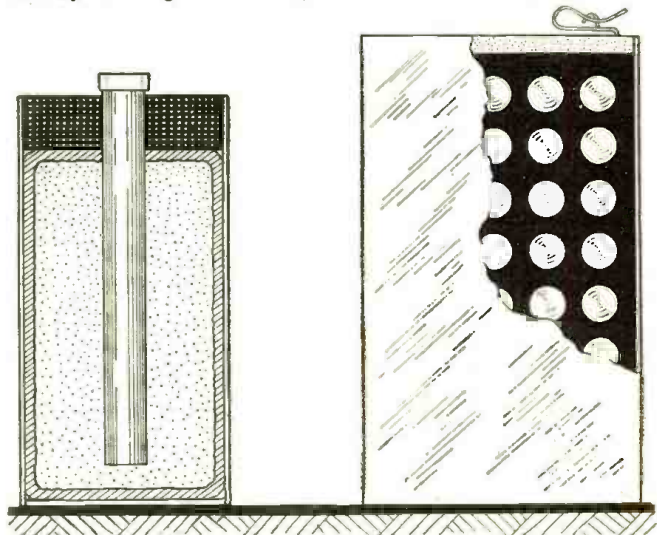
The plates and electrolyte are usually contained in a

metal container, so that the entire assembly is very rugged. The voltage from such a cell is about 1.5 when fully charged, and drops to 1.2 on discharge. The efficiency of the cell is a little lower than a lead plate cell, but the rigid mechanical construction recommends it for many uses when the usual type of cell is unsuited. The Edison cell is capable of suffering almost any kind of abuse without injury. Upon occasion, individual cells have been known to last through 2,000 chargings and subsequent dischargings.

Another, and perhaps the most familiar, type of cell is the dry cell. In this cell the container is made of zinc, which also serves as the negative pole of the cell. This container is lined with absorbent paper like blotting paper, which serves to insulate the zinc from the "mass," as well as to serve as a suspending medium for the electrolyte. The "mass" is usually powdered manganese dioxide, although carbon is sometimes used. In the centre of the mass a carbon rod is inserted, this rod being the positive pole of the cell. The mass and the paper lining are then wet with sal ammoniac, which is the electrolyte used. The manganese dioxide is the depolarizing agent. In this type of cell the chemical action is a slow eating away of the zinc, and the life of the battery is theoretically until this zinc is entirely gone. This is not quite literally true, because the internal resistance of the cell rises, due to the failure of the depolarizing agent to fully neutralize the hydrogen, until the electromotive force is insufficient to overcome the resistance. So we see that the larger the cell, the greater its useful life is, although its voltage remains the same regardless of size. The voltage is about 1.5 volts per cell when new.

Such batteries are rated at a maximum current withdrawal, so that the depolarizing effect will have a chance to keep step with the hydrogen liberation. This rating should never be exceeded for any appreciable length of time, lest the cell be ruined.

The present-day "B" batteries are groups of these cells in one paper container connected together to give the requisite voltages. These units are made up in various sizes to meet various needs, but generally speaking, the larger the cells contained therein, the greater will be the economy in their use, as long as the physical dimensions are held within reason. Some manufacturers are making such units with flat cells, thereby utilizing the waste space between round cells.



The vitals of a dry cell. The center electrode is a carbon rod, surrounded by the "mix." A layer of absorbent paper insulates this from the zinc container which is the negative electrode. The container is sealed at the top with sealing wax. (Right) A group of cells is called a "battery." The older type "B" batteries used round cells that were very wasteful of space. The life of a battery is directly proportional to the amount of active material per cell!

RADIO NEWS INFORMATION SHEETS

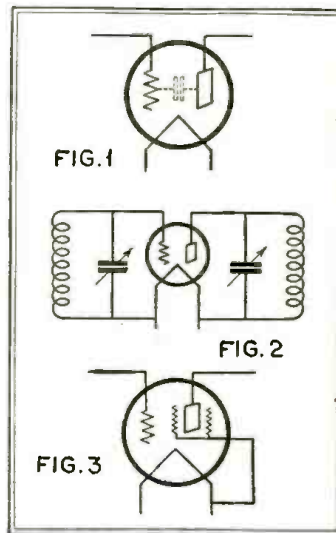
Action of the Screen Grid in Four-Element Tubes (Part 2)

WE discussed the accelerating action of the screen grid last month, and now we will consider another function of even greater importance. That is, the reduction of the internal capacity of a vacuum tube by the interposition of the fourth element.

We know that if two metallic bodies are brought into close proximity with each other we have a condenser. In the three-element tube the grid and plate are sufficiently close to each other to form a condenser of quite appreciable capacity. This is shown diagrammatically in Fig. 1. We also know that at radio frequencies the reactance of even a very small condenser is very little, so that we have almost a perfect path for the plate to feed back to the grid, causing the tube to oscillate. This is true to the extent that the principle is used as in Fig. 2 to make up a very stable and satisfactory oscillating circuit.

The difficulty experienced by early designers of radio receivers is attested by the numerous means used to overcome the effect. The neutrodyne circuit is a good example of this.

However, with the advent of the screen-grid tubes the



difficulty was corrected at its source rather than corrective measures being taken in the circuit. If two condensers are connected in series the capacity is reduced proportionately. The screen grid is between the control grid and the plate in the four-element tube. Hence, due to its position, the capacities are reduced to the point that little feedback is possible from this source.

So we see that, due to the two actions discussed, we have a more efficient tube in the first place and also one that can be used in more efficient circuits. The plate impedance of tubes of this type is very high, so that it is impossible to realize their theoretical μ , but even so, an appreciable portion of this μ will give so much greater gain than is possible from three-element tubes that very high gain amplifiers are made practical. The writer does not understand just why the "big boys" gave us a tube

with a μ of six hundred, out of which only about one-tenth can ordinarily be realized, when a tube with a μ of one hundred and fifty could have as easily been designed out of which practically its entire μ could have been realized. However, they did not, but the present tube is a step in the right direction.

RADIO NEWS INFORMATION SHEETS

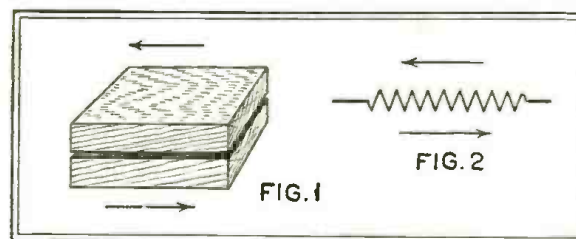
Wattage

WE are all familiar with mechanical friction as we see its evidence in any surfaces that rub together. Such friction manifests itself as heat. If the two blocks of wood shown in Fig. 1 are rubbed briskly one on the other, they will appreciably warm. This principle is used by some savage tribes to obtain fire.

We also have electrical friction. Some theorists hold that electrical conduction is accomplished in a medium by molecular motion. Be that as it may, any medium that is carrying a current of electricity will dissipate a portion of that current as heat. Some mediums offer greater resistance to the flow of current than do others; in other words, the friction is greater. With all other values the same, the heat dissipation of a high resistance conductor will be greater than that of a low resistance conductor. The unit of measure of the heat is the watt, so called after the scientist of that name.

The formula for ascertaining the heat so dissipated is $W \text{ equals } I^2 R$

where W is the heat in watts, I the current flowing in the circuit, and R is the resistance of the circuit. So we have a new addition to the Ohm's law family.



So we see that the wattage dissipation varies as the square of the current, and directly as the resistance. Since voltage, current, and resistance are all functions dependent one on another, the formula can be expressed even more simply as

$W \text{ equals } E I$

where W again is wattage, E is the potential or voltage across the conductor and I is the current. A simple problem will serve to make this clear. Suppose we have a conductor of 10 ohms resistance and a voltage drop of 50 across it. Ohm's law tells us that current " I " is the voltage divided by the resistance. Fifty divided by 10 gives us 5 amperes as the current flowing. Now to solve for watts. Using the first formula, 5^2 is 25, and 25 times the resistance, 10 ohms, is 250 watts. The second formula gives us the voltage, 50, times the current, 5 amperes, and the result is 250 watts. The two formulas are interchangeable.

Since heat is energy, the term watts is frequently used to express energy. For instance, one horsepower is equal to the heat energy of 746 watts. Sound is also energy, and is frequently expressed in watts, or fractions thereof. When so expressed, it is usually termed "power" and we rate radio receivers and transmitters in terms of watts out.

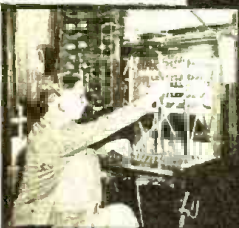


Radio Mechanic and Inspector \$1800 to \$4000 a Year

The only course in Radio sponsored by RCA

LET THIS SHORT-CUT HELP YOU INTO

SUCCESS *in* RADIO



Broadcast Operator \$1800 to \$4000 a Year

THOUSANDS of men are making good money at Radio—and so can you!

Commercial training is all you need to give you the professional confidence and ability. You can secure this training in your spare time... through a marvelous home-laboratory course sponsored by the Radio Corporation of America. Our big FREE Radio book tells all about it.

Round out your knowledge with this home-laboratory training

Put the finishing touch to your Radio experience. Get the "How" as well as the "Why" of Radio with this commercial training. Only an hour or so a day—in spare time—is all you need. As part of your course, you receive absolutely free of extra charge—a magnificent outlay of fine apparatus. With this outfit you learn to build fine sets and solve the radio problems that bring good pay. You acquire not only the ability but the confidence to succeed in a real commercial way.

Training backed by Radio Corporation of America

Our graduates are in demand everywhere. They enjoy greater success because they're

posted right up-to-the-minute in *everything* in Radio. Radio's progress each year is measured by the accomplishment of the great engineers at work in the research laboratories of Radio Corporation of America. This Radio organization sets the standards for the industry.

Money back if not satisfied

The lessons prepare you for success in all phases of Radio—manufacturing, servicing, selling, ship and shore broadcasting and all types of Radio equipment. A signed agreement backed by RCA assures you of complete satisfaction upon completion of the training—or your money will be promptly refunded.

Read this thrilling free book

It may mean the turning point in your life. It gives you the real "dope" about Radio and it describes in detail the famous training that has enabled us to place thousands of our students in fine positions, usually from 3 to 10 days after graduation! It tells in 40 fascinating pages and photos all about Radio's brilliant opportunities for adventure and success. Mail the coupon now—the book is absolutely free! RCA Institutes, Inc., 75 Varick Street, New York, N. Y.



Land Station Operator \$1800 to \$4000 a Year



Broadcast Station Mechanic \$1800 to \$3600 a Year



RCA INSTITUTES
INC.

(A Division of Radio Corporation of America)

RCA INSTITUTES, Inc., Dept. EXP-10
75 Varick Street, New York, N. Y.
Gentlemen: Please send me your big free 40-page book which tells about the great opportunities in radio and about your famous laboratory method of radio instruction at home.

Name.....
Address.....
Occupation.....

SM Now, At Last— SUPERHET

The superheterodyne has always been called the Rolls Royce of radio receivers, but after you see, hear and tune one of these new S-M custom-built and RCA licensed supers, you'll say that S-M has out-Rolls'ed Mr. Royce when it comes to absolutely perfect radio reception. Take everything that the famous Sargent Raymond 710, and last year's 712 (both extra-hot and selective receivers) had, then boost their epoch-making performance up to the sky, and you'll have some idea of what these new S-M supers will do—absolute 10 kc. selectivity, sensitivity that

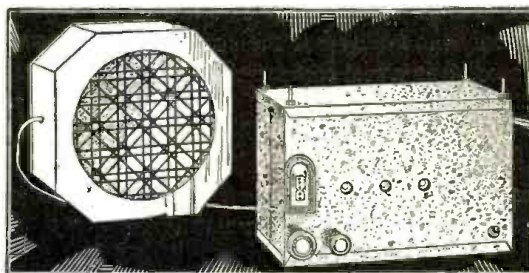
will get any signal that can be detected thru the lowest noise level, and not a trace of harmonics, "repeat spots", cross modulation or a.c. hum! In other words, you've got radio sets that will do everything but sit up and beg.

But you might have expected it from S-M, for McMurdo Silver was designing knock-out supers long before there was a commercial superheterodyne on the market, and in these new S-M supers you're getting all the experience of the oldest and most versatile commercial super designer in America.

And a Whale of a t.r.f. Auto-Set—the S-M 770

It has everything an automobile receiver needs—plus! Get this: Three screen-grid tubes (with s.g. power detection)—a sensitivity of eight microvolts per meter—selectivity that slices 'em right off—real console tone—"vest-pocket" size (12" x 7½" x 6¼")—and direct tuning.

And you don't need a jig-saw to get it in the car either—it doesn't even touch the instrument panel. It mounts under the cowl to the right of the driver's seat, with the dial clearly in view. And if you want to take it out to trade in the car, there's not a mark or scar to cut the trade-in value.



The cost of the Auto-Set is way down. The list price is only \$112 wired, less tubes—and that includes the receiver, a hot little S-M 870 magnetic speaker, battery box, brackets, spark suppressors, and everything you need to install it, except tubes and batteries.

Tubes required: 3—'24, 1—'12A, 1—'71A.

The Receiver—S-M 770 Auto-Set (only), factory wired and tested, \$79.50 List.

The list price for component parts totals only \$61.40. The Speaker—S-M 870 Automotive Magnetic, \$15.00 List. Accessories—S-M 771 complete assortment, \$17.50 List.

The new line of S-M superheterodynes described on these pages will almost double the value of a Silver-Marshall Authorized Service Station franchise. 4000 stations are now in operation all over the world. Write for complete information.

SILVER-MARSHALL, Inc.
6405 West 65th Street • Chicago, U. S. A.

SM HETERODYNES

Silver-Marshall (Licensed) Custom-Built

S-M 724AC and 724DC Screen-Grid Superhets

There's no doubt about it—the 724 is a super-heterodyne custom-built receiver that will make a DX bug of you again. It has six tuned circuits (three dual selector circuits) in the i.f. amplifier, preceded by two tuned r.f. circuits, plus the oscillator circuit—making a total of nine tuned circuits in an unusually moderate priced receiver.

Uniform selectivity and sensitivity over the entire broadcast band are to be expected, of course, and you get them. And there is

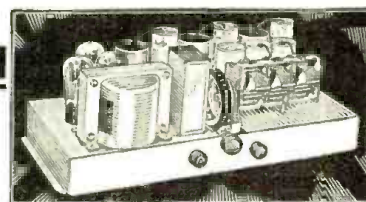
absolutely no trace of second "spot" or repeat points—decidedly a super innovation.

Tubes required (in the 724 AC model): 5-'24, 1-'27, 2-'45, 1-'80.

Tubes required (in the 724 DC model): 5-'32, 1-'30, 2-'31.

S-M 724AC Superhet, completely factory-wired and RCA licensed, \$99.50 List. Parts total \$87.50 List.

S-M 724DC factory-wired, tested, and licensed, \$82.50 List. Parts total \$68.50 List.



S-M 724 Superhet Receiver

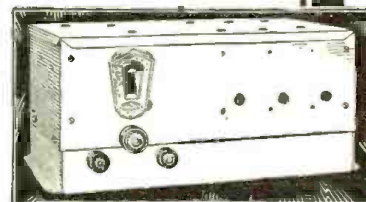
S-M 714—Dual Pre-Selector Screen-Grid Superhet Tuner

The 714 Tuner—successor to the famous Sargent-Rayment 710 and the 712—accomplishes a perfection of design never before attempted; the building of a double pre-selector tuned-radio-frequency circuit into a single-control screen-grid superheterodyne for all a.c. operation. Amazing sharpness of tuning is achieved through the use of eleven tuned circuits. The two dual-selector r.f. circuits absolutely prevent the cross-modulation

usually encountered in ultra-sensitive supers, and insure complete suppression of the second resonance "spot". The 714 Tuner is ideal for use with the best amplifiers in any installation, or where interference is at its worst.

Tubes required: 4-'24, 2-'27.

S-M 714 Superhet Tuner (only), completely factory wired, tested and RCA licensed, \$87.50 List. Component parts total \$76.50 List.



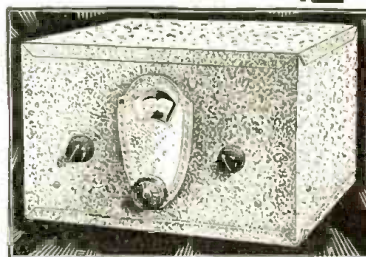
S-M 714 Superhet Tuner

S-M 738—Short-Wave Superhet Converter

Here is the newest and most interesting of all sensations—a self-contained all-a.c.-operated converter which makes a powerful short-wave superheterodyne out of any broadcast receiver. The antenna lead is merely removed from the broadcast receiver and connected to the antenna post of the 738; two leads are then run from the converter to the antenna and ground posts of the broadcast set. Tuning control is by a single dial which tunes the oscillator circuit, and an auxiliary midget

condenser. All the sensitivity and selectivity possessed by the broadcast receiver contribute to the short-wave performance, giving results never before achieved. Operation is much simplified by the absence of any critical regenerative control. Included in the list price are eight coils (four pairs) covering the wave length range of from 18 to 206 meters.

S-M 738 Superhet Converter, completely factory-wired and RCA licensed, \$69.50 List. Component parts total \$59.50 List.



S-M 738 Superhet Converter

The new S-M 1931 Catalog is off the presses. Write for your copy. The Radiobuilder, Silver-Marshall's official publication, telling the latest developments of the laboratories, gives full inside information of great value to the radio world. See the coupon.

SILVER-MARSHALL, Inc.
6405 West 65th Street • Chicago, U. S. A.

Silver-Marshall, Inc.
6405 West 65th Street, Chicago, U. S. A.

Please send me, free, the new 1931 S-M Catalog; also sample copy of The Radiobuilder.

For enclosed _____ in stamps, send me the following:

..... 50c Next 12 issues of The Radiobuilder

..... \$1.00 Next 25 issues of The Radiobuilder

S-M DATA SHEETS as follows, at 2c each:

..... No. 19. 692 Power Amplifier (50 Push-Pull)

..... No. 20. 677B Power Amplifier (45 Push-Pull)

..... No. 21. Short Wave Bearcat

..... No. 22. 770 Auto-Set

..... No. 23. 738 Short-Wave Superhet Converter

..... No. 24. 724 Screen-Grid Superhet Receiver

..... No. 25. 714 Superhet Tuner

Name _____

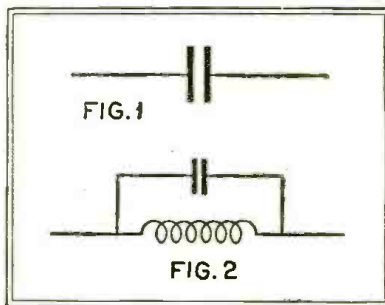
Address _____

RADIO NEWS INFORMATION SHEETS

A.C. "Resistance" (Part 2)

THE condenser is one of the simplest electrical devices, and yet one of the most complex in its electrical action. In its most fundamental form it consists of two plates insulated one from the other by air or some other insulating medium. This insulating medium is called the "dielectric."

Let us disregard the complex whys and confine our discussion to the action. A condenser, if connected to a source of potential such as a battery, will absorb current from the battery until the potential of the condenser equals that of the source and then cease to draw current. Removed from its charging source, the charge will remain in the condenser until it is discharged by short circuiting or connecting it to a source of potential in reverse polarity to the original source. In the latter case the condenser will first discharge itself and then charge again in conformity with the polarity of the new source. This ability to charge, the amount of current drawn from the source and the rapidity with which the charge is accepted is all summed up in the word "capacity." The unit of capacity is the farad, but for convenience we used the microfarad, or one one-millionth of a farad. The capacity of a condenser is determined by the size of the plates, their spacing, and the "dielectric constant" of the insulating material between



the plates.

We have seen that when the polarity is reversed the condenser must discharge before it can charge again, or, in other words, at the moment of reversal a counter electromotive force is set up, momentarily retarding the charging process. If the reversal is periodic we, of course, have alternating current, with the condenser charging and discharging on every cycle, but always opposing the direction of current flow due to this counter E.M.F. In short, the condenser has reactance.

Since a good condenser has infinite direct-current resistance, its reactance is equal to its impedance. The following formula will give the reactance of a condenser:

$$\frac{1,000,000}{2\pi f c}$$

$$2\pi f c$$

where f is the frequency in cycles per second of the alternating current, and C is the capacity in microfarads.

Various combinations of inductance and capacity are used in radio work to obtain desired results. In Fig. 2 we have what is called a resonant circuit, or a circuit that is tuned to have very high impedance at a given frequency. In this case, maximum impedance is reached when the inductance reactance is equal to the capacitive reactance at the frequency at which resonance is desired.

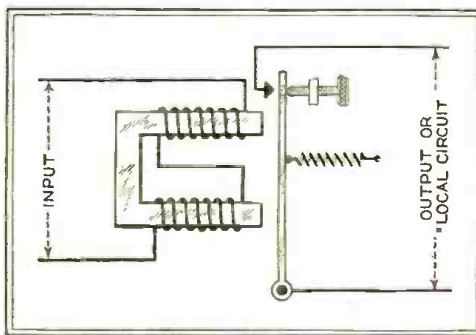
RADIO NEWS INFORMATION SHEETS

Relays

IT is a frequent necessity in all electrical work to control a large amount of current with a comparatively small current. For instance, in telegraphy by wire a signal coming into a receiving station is weakened to a point that it would not operate a recording instrument directly, so this small current is used to operate a relay, and a recording instrument, such as a sounder, is operated in the local circuit.

In the drawing we see the fundamentals of a relay circuit. A large number of turns of wire are wound on a soft iron core to form an electromagnet. Near the ends of the core where the magnetic field is strongest an armature is suspended on a pivot and held away from the pole pieces by a light spring, the distance or clearance being determined by an adjusting screw. Contact points are placed one on the armature and another stationary, so that they touch when the armature is drawn toward the magnet, and do not touch when the armature is at rest and held back by the spring.

Now let us see what we can do with such a device. As the armature is light, very little energy is required to move it, and as it is placed at the point where the magnetic field is concentrated very little current is required



in the input side to bring the contact points into contact with one another. The contact points may, of course, be as large as is convenient, so we have control over practically limitless current in the local circuit.

This is true, because a small potential applied to the grid of the tube controls a larger potential in the plate, or output side of the tube.

The uses of relays are manifold. One use was mentioned above, and others are: the control of high-tension circuits in power houses where it would be dangerous to handle the switches directly, remote control of any number of devices, such as turning on the lights of signs located at distant points, keying transmitters, controlling railroad signalling systems, and other uses ad infinitum.

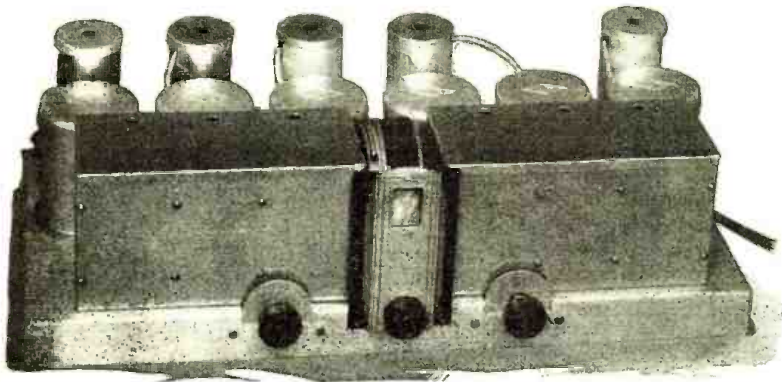
Vacuum tubes as used today in all radio receivers and transmitters are, in the most fundamental sense, simple relays.

Where a very sensitive relay is required, an instrument called a "polarized relay" is used. The armature is not held with a spring, but is suspended between the poles of a permanent magnet, so that the attraction is equal on both sides.

The New MB-30 Tuner

Improved 1930-31 Model. New and higher Sensitivity and Selectivity, Absence from Cross-Talk, Absolute Freedom from Oscillation.

MADE WITH GENUINE **NATIONAL** RADIO PARTS



An entirely new and further improved design of the well-known MB-29 Tuner.

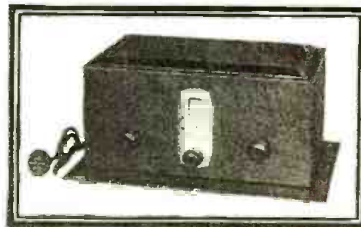
High selectivity—no tendency to cross-talk. Distance to limit of noise level. Absolute freedom from oscillation. Elimination of tube-hiss and other background noises. Exceptionally rigid construction, thoroughly shielded. Especially suitable as radio pick-up for existing amplifiers—may be built on rack panel, if desired. Assembling and connections very simple, easily understood by anyone. *Designed for use with improved new R. C. A. Licensed Velvetone Amplifier.*

NATIONAL
Precision Built
Radio Products
are used by

Byrd Expedition
General Electric Co.
Westinghouse Electric and Mfg. Co.
R. C. A.
Tropical Radio (United Fruit Co.)
Federal Tel. & Tel. Co.
Canadian Marconi
U. S. Naval Research Laboratories
U. S. Navy
Signal Corps U. S. Army
Jenkins Television Corp.
Press Wireless, Inc.
DeForest Radio Co.
Universal Wireless Communications, Inc.
U. S. Dept. of Commerce (Lighthouse Service)
Pan-American Airways
Curtiss-Wright
Boeing Airplane Co.
Western Air Express
Roosevelt Field, Inc.
Southern Air Transport

and

by thousands of leading Amateurs, Experimenters, Colleges, Universities, Schools and Research Laboratories the world over.

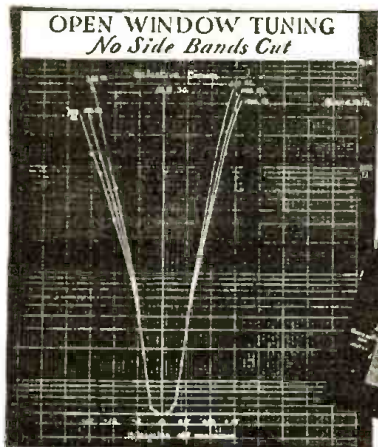
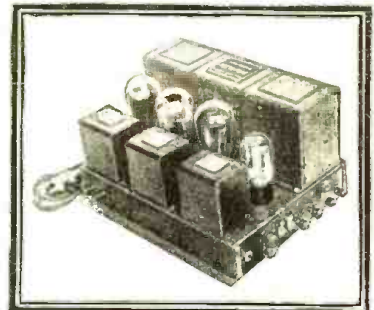


NEW A.C. THRILL BOX

Double screen grid. Full A.C. operation. No hum even with head phones. Made also in new battery model.

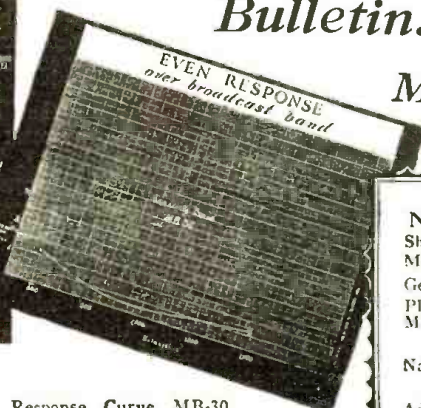
IMPROVED 1930 MODEL VELVE-TONE AMPLIFIER
Special amplifier power supply, designed for best use with National MB-30 Tuner.

R. C. A. Licensed



Curve Showing Tuning Characteristics of MB-30 Tuner. Note "Open Window" effect giving high selectivity without cutting of side bands.

Send Today for New Free Bulletin.



Response Curve MB-30. Note that reception is just as good on long as on short waves.

Mail Coupon

NATIONAL CO., INC.
Sherman, Abbott & Jackson Streets
Malden, Mass.

Gentlemen:
Please send me your new free bulletin describing the 1930-31 MB-30 Tuner.

Name

Address

RN-9

The Radio Forum

*A Meeting-Place for Experimenter, Serviceman
and Short-Wave Enthusiast*

The Experimenter

A Novel 32-Volt "A" Eliminator and AC Voltage Regulator

By Roy B. Moulin
Gilman City, Mo.

ANYONE who is handy with tools can make a very beautiful and efficient 32-volt "A" battery eliminator or an a.c. voltage regulator, as his requirements dictate. In designing these the writer has tried to do away with that "mechanical appearance" which greets the eye when you peer into a machine shed and to substitute in its place that delicate touch which will harmonize with the furnishings of almost any home. From his viewpoint he succeeded when he designed them in that attractive pyramid effect such as is shown in one of the accompanying drawings.

The constructional details of the 32-volt "A" battery eliminator will first be given. Procure the following material:

One lamp stem.
Two keyless sockets.
One 0-8 volt d.c. voltmeter (V).
One 40-ohm Carter hi-watt type rheostat (R).
One Carter 44 switch (S).
One heavy-duty choke coil (Ch).
One 5-wire battery cable.
Five feet of lamp cord.
One attachment plug.
Correct incandescent lamps (L1, L2).
 $\frac{3}{4}$ "", preferably 5-ply, board 14" x 18" or larger.

A few screws, brads or glue, hook-up wire, etc.

One 0.1 mid. condenser (C).

Having obtained the material proceed to construct the base or container of the eliminator which likewise, with a few alterations, may be used as the base of the a.c. voltage regulator. Saw the board mentioned under list of material into strips seven inches in width. Place these in the miter box (one at a time, of course) and saw out four pieces like the one shown in A. These are the four sides of the base or container of the eliminator. Holes should be drilled in one of these side as shown in B so that the voltmeter, rheostat and switch may be mounted on it. Next fasten a small strip $\frac{1}{2}$ " x $\frac{1}{2}$ " x 5" one-half inch from bottom to each of

the two sides adjoining the front side of the eliminator, so as to serve as a support for the choke coil. The other side, or rather the side which is to be the back of the eliminator, should have two holes about $\frac{3}{8}$ inch in diameter drilled in it about one inch from the bottom, to serve as openings or outlets for the wires leading to and from the eliminator. For the next and only remaining item to be made before assembling the base "fashion" the small top of the base. An end view, with complete dimensions, is shown in C.

The base may either be fastened together with small ($\frac{1}{2}$ "") wire brads or with glue. In case the former is used a nail set should be used to drive the brad heads down into the wood so that they may be concealed with putty. Also if the corners do not fit close enough after

The only practical way of reducing a 32-volt direct current down to a voltage that is suitable to furnish the filament current for a battery set is by means of a resistance or resistances. With the ordinary resistance considerable current is wasted as heat in reducing 32 volts down to 6 volts. For example, if a receiver required 1.5 amperes at 6 volts, in operating it from a 32-volt line only 9 watts would be used out of 48 watts expended. However, by using incandescent lamps for resistance a considerable portion of this wasted energy would be converted into light which, as you know, can easily be utilized around a radio.

Rheostat R is used to secure the correct filament voltage at all times as indicated by voltmeter V. It also may be used as a volume control with good results.

The 32-volt (positive) lead may be used in place of the first "B" battery on some receivers, or in case the voltage of the "B" batteries has dropped somewhat it may be used to boost their voltage. However, this latter case is not to be recommended very highly except in emergencies, as a "B" battery whose voltage has dropped to such an extent that additional voltage is needed to operate the receiver is very apt to become noisy.

Choke coil I is used to smooth out any disturbances or fluctuations that may occur on the line. If considerable disturbances

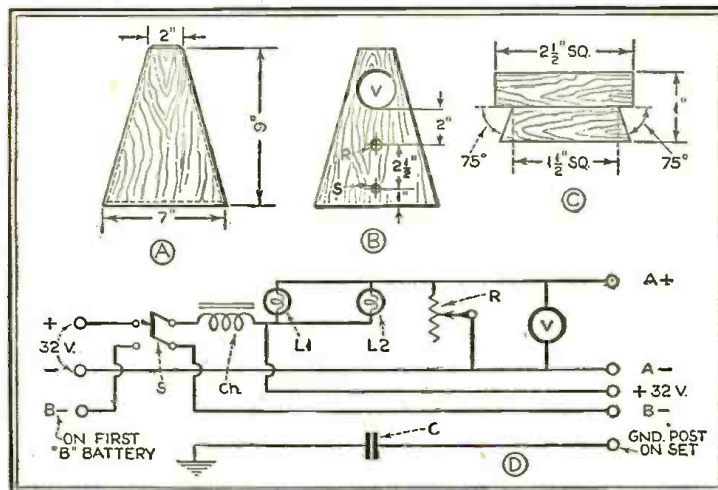
are present use a filter condenser in conjunction with the choke. No doubt it will be necessary to apply automobile interference tactics to the light plant engine to quiet it.

A few operating and installing hints that should be remembered are as follows:

1. The wattage of the two incandescent lamps depends, of course, upon the requirements of the receiver to which the eliminator is to be connected. For the most economical operation use the smallest wattage possible that is consistent with satisfactory operation of the receiver at all times.

2. A receiver to be ideally adapted for use with this eliminator should have a method of volume control that does not

(Continued on page 361)



being fastened together, fill all cracks with a good grade of crack filler, allow to harden, and then sandpaper the entire base. Finish in a color that will harmonize with the furnishings of the home in which it is to be installed, if possible. The accompanying photograph of the eliminator will help answer any details that may have been omitted in the above description.

The wiring diagram of the eliminator is shown in D. A brief explanation of a few of its parts follows:

Incandescent lamps are used as the chief resistors. One of the reasons being that they are more economical, for this purpose, than any ordinary non-illuminous resistance. As this later statement is apt to be misleading, an explanation will be given at this point.

FACTORY TO YOU—SAVE to 50%—COMPARE WITH COSTLIEST OUTFITS BEFORE YOU BUY

Enjoy a powerful new **Miraco** 30 DAYS FREE

Latest 1931 SUPER Screen Grid Outfit (No obligation to buy)



NEWEST IN RADIO! 1931 Miraco "Easy-Chair" model with magazine racks, each end. Place it anywhere in any room. Easily moved about. Contains a complete full-size radio and Super-Dynamic speaker! No outside aerial or ground required. Many other new, clever models, obtainable nowhere else, shown in free literature.

Get Our **"SEND NO MONEY"** 11th Anniversary Offer!

Latest 1931 **Super Screen Grid** FULL YEAR'S GUAR.
lighted 1 dial steel chassis
Vari-Tone and Automatic Sensitivity Control
Also latest PUSH-PULL Amplification

Built like—looks like—performs like newest radios in many outfits much more costly. Latest, finest, heavy duty construction. Skillfully engineered to super-utilize a battery of "224" SCREEN GRID tubes—in addition to "245" PUSH-PULL POWER, "224" HUM-FREE long-lived POWER DETECTOR and AMPLIFIER and "280" A-C TUBES. Vari-Tone feature gives any tone-pitch your ears prefer. Automatic Sensitivity Control reduces "fading," protects tubes. Phonograph pick-up connection. Built-in hose wiring aerial and ground. Built-in plug for electric clock, lighter, lamp, etc. Super-sturdy power section. Razor-edge selectivity; Super-Dynamic Cathedral tone quality; marvelous distance-getter. Solid one-year guarantee if you buy! Wide choice of cabinets.

Easy Chair Model Only \$49.⁸⁸
(as illustrated less tubes) COMPLETELY ASSEMBLED

Values possible because you deal direct with big factory

MIRACO

TRADE MARK REGISTERED

CATHEDRAL TONED, SUPER SELECTIVE, POWERFUL DISTANCE GETTERS

You need not send us a cent! For its 11th successful year, America's big, old, reliable Radio Factory again sets the pace in high-grade, latest guaranteed radios *direct to you*. And now—at history's greatest savings.

Don't Confuse with Cheap Radios

With Miraco's rich, clear Cathedral Tone, quiet operation, razor-sharp separation of nearby stations, tremendous "kick" on distant stations, Vari-Tone and automatic sensitivity control, and other latest features—be the envy of many who pay 2 or 3 times as much!

EASY TERMS to reliable persons only

USER-AGENTS WANTED

Exclusive Territory—Try it at Our Risk!
Spare or full time. No contract, no experience required. Big money! Send coupon now!

Send for proof that delighted thousands of Miraco users cut through locals, get coast to coast, with tone and power of costly sets.

Miraco's are built of finest parts—approved by Radio's highest authorities. Our 11th successful year!

Deal Direct with Big Factory

Miraco outfits arrive splendidly packed, rigidly tested, to plug in like a lamp and enjoy at once. No experience needed. Entertain yourself 30 days—then decide. Liberal year's guarantee if you buy. Play safe, save lots of money, insure satisfaction—deal direct with Radio's big, reliable, pioneer builders of fine sets—successful since 1920. SEND POSTAL OR COUPON NOW for Amazing Offer!

With this newest perfected SUPER SCREEN GRID, push-pull, super-powered and humless electric AC set in clever, beautiful new Miraco-Master-crest consoles obtainable nowhere else—you are guaranteed satisfaction, values and savings unsurpassed. *Get Amazing Special Offer!*
At our risk, compare a Miraco outfit with highest priced radios 30 days and nights. Surprise, entertain your friends—get their opinions. Unless 100% delighted, *don't buy!* Your decision is final—no argument!

Only marvelously fine radios, of latest perfected type, at rock-bottom prices, can back up such a guarantee. Send postal or coupon for *Amazing Special Factory Offer!*

MIDWEST RADIO CORP., 804-AO Miraco Dept., Cincinnati, Ohio

BEAUTIFULLY ILLUSTRATED LITERATURE, TESTIMONY OF NEARBY USERS, PROOF OF OUR RELIABILITY—

All the proof you want—of our honesty, fairness, size, financial integrity, radio experience and the performance of our sets—including *Amazing Factory Offer*—sent without obligation!

MIDWEST RADIO CORPORATION
Pioneer Builders of Sets—11th Successful Year
804-AO Miraco Dept., Cincinnati, Ohio

THIS COUPON IS NOT AN ORDER

- WITHOUT OBLIGATION, send latest literature, *Amazing Special Free Trial Send-No-Money Offer*, testimony of nearby users and all Proof. User. Agent. Dealer
- Check here if interested in an EXCLUSIVE TERRITORY PROPOSITION
- NAME..... ADDRESS.....

NEW LOW FACTORY PRICES
SAVE to 50%
Similar Low Prices on Beautiful Variety of Latest Fine Consoles
Send Coupon!
30 DAYS' FREE TRIAL



Full-size wall console with latest 1931 features. Beautiful design and woods. Priced very low, factory to you.

Popular "Lo-Boy". Takes very little space. Stores haven't anything as classy at \$50.00 more.



Medium-size "Hi-Boy". Sliding doors. Rich design, fine woods, fine finish. Astonishingly low factory price to you.

These Consoles are Equipped with **SUPER DYNAMIC CATHEDRAL TONE REPRODUCERS**

Also built-in aerial and ground and built-in extra light socket!

Magnificent new creation. Super Screen Grid Radio. Phonograph under same lid. Greatly under priced. Send coupon for low factory to you prices.



Free!

The Serviceman

Repairing "A" Power Filter Condensers

When the serviceman goes out on a call where the complaint is too much hum in the loud speaker the trouble can usually be traced back to the "A" power. In this part of the equipment is a bank of electrolytic condensers, usually three of about fifty thousand microfarads each. After these condensers have been in use for four or five months they have to be replaced due to drying out and not properly filtering the rectifier current. When this replacement has to be done twice or three times a year the set owner would be far better equipped with a storage battery and trickle charger.

For the serviceman or those electrically inclined the rebuilding of these condensers is a simple task. Mix a solution of ammonium phosphate, one pound to a gallon of water, and let it stand in a jar overnight. Remove the condensers from the mounting in the eliminator and remove the covers. The inside is aluminum sheets spaced with tissue paper and care should be taken in handling to not tear or puncture it. As the solution has stood overnight, all that will have to be done is to stir it and then carefully lay the condensers in the solution and let sink to the bottom. After they have been in this condition for six hours, take out and allow to drip off excess solution. This usually takes an hour and then the condensers are ready to be put back in their containers and assembled in the "A" power.

This rebuilding will last for three months, or the length of time the original condensers lasted, besides being cheaper in cost.

D. A. BROWN,
Marion, Ohio.

Dust and Dirt Responsible For Reception Noises

One of the weak points of the average radio set is the volume control. When it is realized that a resistance of thousands of ohms is required for distortionless volume control, and that an amplification of thousands of times takes place between the circuit and the powerful loud speaker, it stands to reason that the slightest uncertainty of contact causes tremendous noises. Many sets sound like the rumble

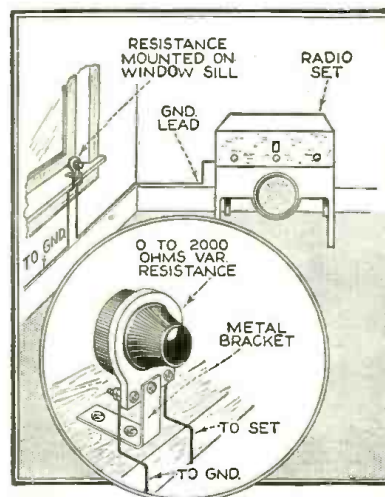
of thunder when the volume control is adjusted. The serviceman, called upon to repair the set, simply cleans the contact and the wire turns. Dust and dirt may be the cause of noise in wire-wound devices, although poor design may also cause uncertain contact and therefore noise. In the case of non-wire devices, noises may arise from uncertain or poor contact or conduction in the resistance material employed.

By enclosing the wire winding and the contact member, given the proper design in the first place, dust and dirt may be eliminated as the most common source of noise in the usual radio set. The better types of volume control are now enclosed, so that no dust and dirt can reach the working parts.

CHARLES GOLENPAUL,
Brooklyn, N. Y.

Remote Volume Control For the Radio

A rheostat (0-2000 ohm variable resistor) inserted in the ground lead of the radio makes an excellent volume control that may be placed at any convenient point.



In the case shown in the accompanying diagram, the ground lead ran around the room underneath the window. The lead was cut and the resistance inserted and mounted on the window-sill by means of a small brass bracket, much the same as it would be mounted on the panel of a receiver. The method of mounting is shown in the insert on the diagram.

This arrangement has been successfully

used on a Philco Model 86 a.c. receiver and the particular corner mentioned contains an easy chair and a reading lamp, and the control of volume without moving from that favorite spot adds greatly to the comfort of both the chair and the radio.

G. G. WHEELER.

Fixed vs. Automatic Line Voltage Controls

Although many devices for protecting the radio set against excessive voltages have made their appearance, there is still some confusion regarding their exact meaning.

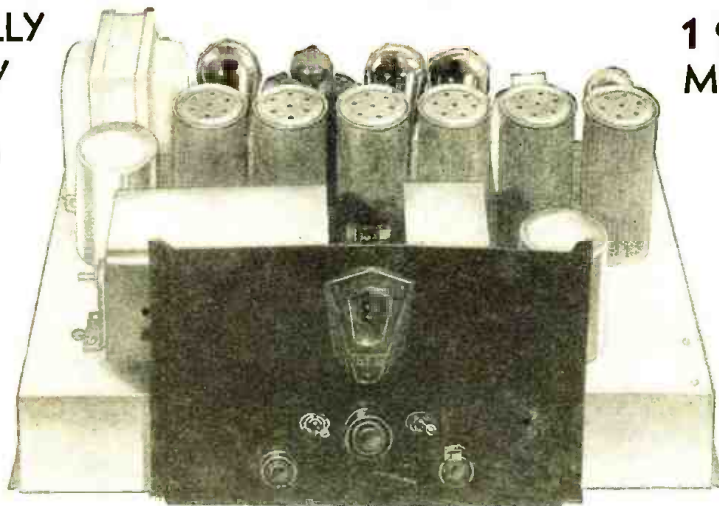
The most common type is the fixed resistance, usually of 15 to 25 ohms, inserted in the primary circuit of the socket-power radio set. The fixed resistance serves to reduce the applied voltage to safe values, and therefore protects the receiver. In some instances there are taps for handling a variety of line voltages. However, the resistance is fixed, and when the line voltage drops down to normal or below normal the resistance should be eliminated from the circuit if the radio set is to operate properly. Low voltage, it will be noted, affects the sensitivity, volume and tone of the radio set, while high voltage strains the tubes, power transformer and filter condensers.

The ballast or automatic type provides a variable resistance in the circuit, in keeping with line voltage fluctuations. Thus when line voltage is high, more resistance is automatically introduced in the circuit. When line voltage drops to normal or below normal, less and less resistance is introduced automatically. Therefore the true ballast type provides approximately uniform voltage down to normal line voltages, for satisfactory operation, when employed in conjunction with the usual set, in the form of an accessory or plug-in device in the attachment cord. If regulation is desired for sub-normal voltages, then it becomes necessary to use a lower voltage primary for the power transformer, say an 85-volt winding, with the ballast supplying the required drop from any line voltage to the 85-volt value required. In such a case the ballast is a built-in feature, as in the more advanced sets.

CHARLES GOLENPAUL,
Brooklyn, N. Y.



WHOLLY
NEW



1931
MODEL



10 TUBES
« « « «
EMPLOYS
HOPKINS
BAND-REJECTOR SYSTEM

10 KILOCYCLE
STATION
SEPARATION
« « « «
WORLD-WIDE
RECEPTION!

WHEN RADIO'S HISTORY IS FINALLY WRITTEN
THIS AMAZING SUPER WILL BE SET DOWN AS

THE FIRST « « « REALLY GREAT RECEIVER

In the development of all arts and devices, there stand out epochal, basic achievements toward perfection. Motor car men know exactly the feat that marked the turning point to today's unfailing reliability of the automobile. The aviation expert knows what 'plane established the pattern of design and construction to insure safe travel through the air.

And, we know enough of radio now to make this bold claim that this wonder 1931 H. F. L. Mastertone 10 marks entry to an entirely new era in this new art.

The Super's the Thing!

Long known to be the ideal circuit for receiver use, it remained for H. F. L. to adapt the super-heterodyne to practical home reception. True to its name, the super has been the superior set in power, in selectivity, in pure tonal quality. Yet to combine these qualities with the demanded simplicity of control and ease of operation was a task that baffled radio's best engineers for years.

Now we have all these features in a history-making receiver and at a price that bespeaks the genius and

cleverness of today's engineering skill and manufacturing ingenuity.

Awe-Inspiring in Action!

This receiver is actually, definitely revolutionary. It sets up entirely new standards of design, building and performance. Operation of silky smoothness that thrills you to new heights of radio enjoyment. Sharpness of selectivity that is truly breath-taking in its surprising precision. A sweet, full tone quality that is inspiring in its sheer naturalness! Power and reach that awes even the hardened, experienced DX explorer!

Why It is Different

H. F. L. exclusively uses the newly perfected Hopkins Band Rejector System, a circuit of which you will hear much from now on in radio. By this method, the width of the band may be adjusted to **absolute precision, without impairment of the audio.** Tune the entire scale in steps of 10 kilocycles, just as surely as you set the clock! Distant stations reproduced with

the same clarity and definiteness as locals!

Try It at Home

Surging power that lays the world of broadcast at your finger tips! Tone that lifts you to the realm of illusion with the artists before you—reproduction that elevates you to hitherto unscaled heights of musical enjoyment.

Give H. F. L. the chance to prove all these unusual claims. Test the giant power of the Mastertone in your own home. Experience its uncanny separation of stations. Thrill at its amazing reach into the far corners of the world. Do this all at our risk.

Book Tells All

Details of this history-making receiver and our new policy of distribution, placing this wonder set within the reach of all, are set out in a new Brochure. Send for and get this book without cost or obligation. No salesman will call on you—you will not be importuned to buy. Write now. You owe it to yourself to know all about the H. F. L. Mastertone 10 before purchase of any new set.

HIGH FREQUENCY LABORATORIES

DEPT. D-930, 3900 CLAREMONT AVENUE
CHICAGO, ILLINOIS

AMERICA'S LOWEST PRICED FINE RADIO!

H « F » L

MASTERTONE
SUPER 10

HIGH FREQUENCY LABORATORIES, Dept. D-930
3900 Claremont Ave., Chicago.

Without cost or obligation, please send me a copy of your new Brochure describing the new 1931 H. F. L. Mastertone 10 and your liberal selling policy.

Name _____

Address _____

City _____ State _____



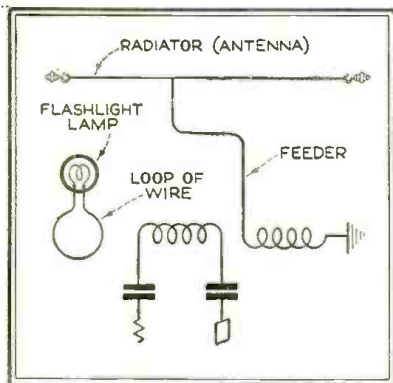
With the Short Wave Fans

E. A. Clem, Station W9FBE, Pueblo, Colorado, gives us this month two suggestions that are of interest to short-wave fans.

Debunking the Single Wire Feeder

During the past year or so there has been much discussion in various radio magazines about the single wire fed Hertz antenna and in private it has been much cussed. Most of the cussing has been caused by the general practice of coupling the feeder direct to the transmitter inductance. When connected in this way it is very difficult to keep the feeder from radiating and it also makes the transmitter tune broadly.

The way to make this type of antenna work properly is to couple the feeder with a coupling coil, one side of which connects to the feeder and the other to the ground. When connected in this way there is no trouble from the feeder radiating and the transmitter tunes much sharper. The only precaution is to get the feeder and ground wires of such a length that they are not resonant to the working wave. The way to test for this



is to place a flashlight globe in series with the feeder and at the same time hold a loop of wire, with another flashlight globe in the center, near the transmitter inductance. If the transmitter is oscillating properly, the globe will light up when the loop is held near the inductance. The coupling coil is placed close to the inductance, this is because when working properly, it is not tuned to the working wave, therefore it is necessary to use tighter coupling than if a two wire tuned feeder is used.

The wave-length of the transmitter is then varied until resonant spots, denoted by the flashlight globe in the center of the loop growing dimmer, are found. When the transmitter is tuned to resonance with the feeder, the globe in series with the feeder will light up, but if this wave is far enough from the fundamental wave of the radiator, the globe

will not light or if so, very dimly, when the transmitter is tuned to resonance with the radiator. When tuned to either wave, the globe in the loop will dim because the antenna is taking current away from it. If a plate milliammeter is used it will not be necessary to use the loop because resonance will then be indicated by an increase in plate current.

Another point that has been much discussed is the position of the feeder on the antenna. According to some, this point has to be exactly at a distance of 13.9 per cent from the center, but my experience is that there is nothing magical about this point. If the tap is placed nearer to the center, the coupling coil inside the station will have to be placed closer to the transmitter inductance, and if it is placed farther from the center, vice versa. The operator can put the tap on at 13.9 per cent from the center and then vary the number of turns in the coupling coil until the proper amount of coupling is had, or he may decide on the size of coupling coil he wants to use and then vary the tap on the antenna. In either case, it should be arranged so that the coupling coil is close to the transmitter inductance. If the operator will take pains to change the length of the feeder until it is not in resonance with the working wave, the results with this antenna will surpass any other type. Pains should be taken to get a good ground also.

Eliminating Fringe Howl

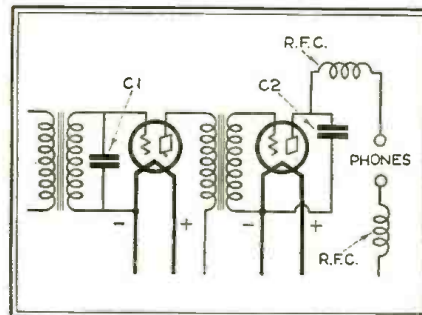
A great many short wave receivers are cursed with a condition known as fringe howl; that is, when the regeneration is reduced to the edge, the receiver breaks out into an audio howl. This condition is caused by radio frequency currents present in the audio amplifier. It is not troublesome with one stage of amplification, but when two stages are used, the receiver becomes unmanageable.

This condition is easily cured by using the by-pass condensers and radio frequency chokes as shown in the diagram. C1, which is shunted across the secondary of the first audio transformer, has a capacity of .00025 mfd. In some cases it might have to be increased, but it should be kept as small as possible because a large condenser cuts down the volume. C2, which is shunted from the plate of the last tube to the filament, has a capacity of .006 mfd. This capacity is not critical.

The radio frequency chokes prevent body capacity troubles from the phone cord. If they are omitted, touching the phone cord will detune the receiver or knock it out of oscillation. When by-passed in this way, it is possible to run the receiver full blast without any trouble from fringe howl and the regeneration works as smoothly as on a two-tube receiver.

A Simple Antenna Switch

In a set having a midget condenser in series with the antenna it may be found that there are times when it may be used

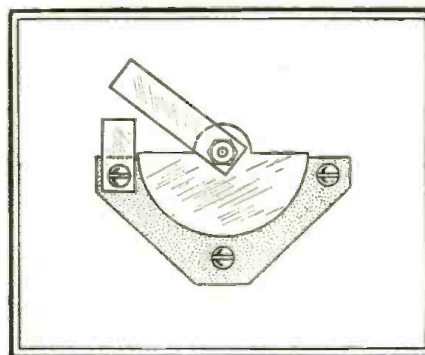


to better advantage when there is a direct antenna connection.

I have such a set. Finding a switch not quite as handy as I would wish I began casting about for a solution to the difficulty. I finally hit upon the idea of fixing the midget condenser so that it would short-circuit itself when so desired.

The idea may not work on every midget, but with a little ingenuity anyone may readily devise a method that suits his own condenser.

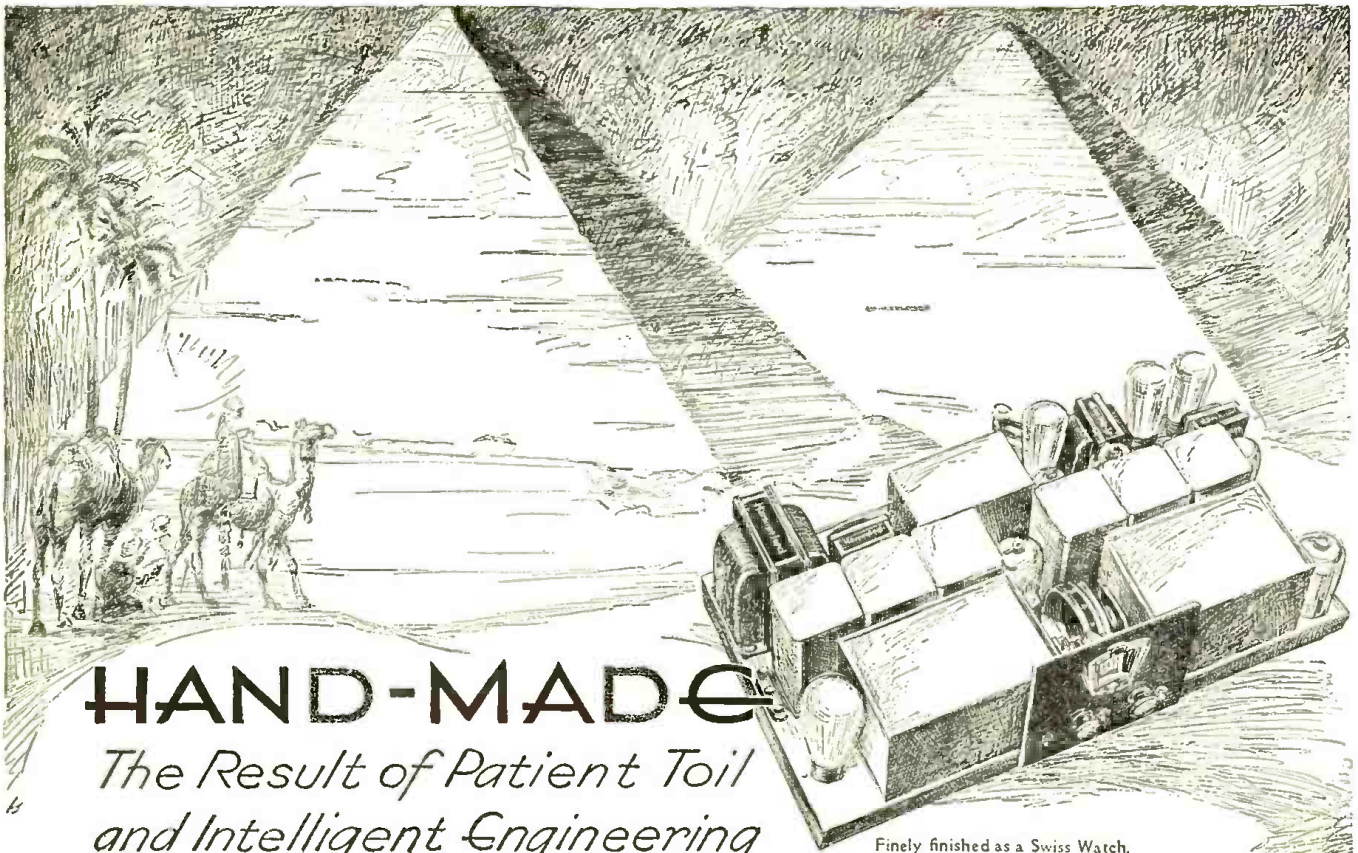
I made a self-contained switch by affixing a small piece of old brass condenser plate to the stator screw and another to the rotor so that they would mesh when the condenser had just passed the maximum capacity state.



Herewith is a simple sketch showing how the trick was done. The switch may be set to make and break at any desired point. The contact members should be shaped so that they do not interfere with the normal action of the condenser.

Roy J. Austin,
Columbus, Ohio

Contributions which are accepted and published in this department will be paid for at the customary space rates. We will be glad to hear from any of our readers who may wish to relate their short-wave experiences.



HAND-MADE

*The Result of Patient Toil
and Intelligent Engineering*

History records no greater engineering feat than the building of the Pyramids—tombs of ancient kings—towering through the ages, majestic monuments to human ingenuity, persistence and thoroughness.

Radio, too, has its noble achievements—its testimonials to the skill and purposefulness of its pioneers.

For six years, Hammarlund Receivers have stood in the forefront of radio. They have embodied the very essence of all that is good in design and performance.

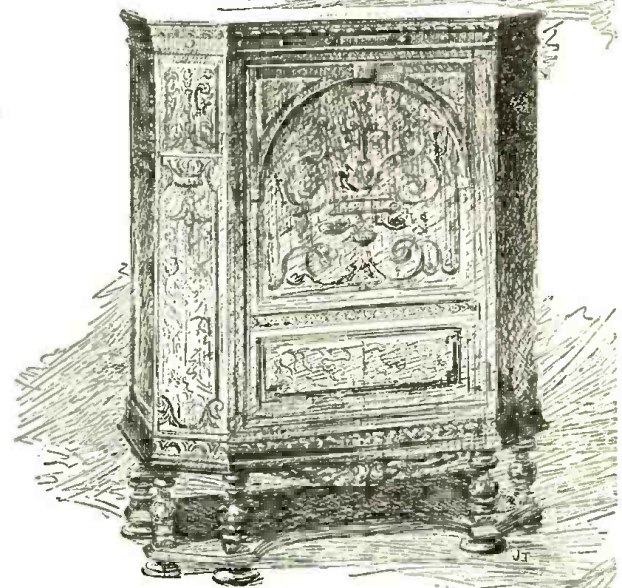
Adjectives may describe, but only by seeing, hearing and operating the new Hammarlund HiQ-31 Receiver can you accurately gauge its superiority over anything the radio world has as yet presented.

Custom-built, of course, as all really fine things must be, it appeals to those who appreciate quality.

Whatever your interest in radio—as designer, builder or buyer—you will welcome a copy of the 48-page HiQ-31 Manual, profusely illustrated and containing a 12-page gravure insert of cabinet designs, it tells the complete HiQ-31 story. Mailed postpaid, upon receipt of 25 cents (stamps or coin).

HAMMARLUND-ROBERTS, INC.
Dept. RN-10, 424-438 West 33rd St., New York, N. Y.

Finely finished as a Swiss Watch,
New Band Filter - New R. F. Amplifier - New Detector System -
New Power Supply - New Audio Amplifier - New Tone Control, with Noise Filter - New Volume Control - New Phonograph Hook-up -
Amazingly Selective - Thrilling in Performance.



Cabinets of rare Distinction and Acoustical Accuracy. Radio and Radio-Phonograph Combinations - styled and priced for the needs of cottage or castle.

HiQ-31

Custom-Built Radio
by **HAMMARLUND**

~RADIO NEWS HOME LABORATORY EXPERIMENTS~

How to Use Power Tubes

Among other things, this *Experimenter Sheet* tells you about power tube efficiency, undistorted output and coupling devices. The subject is concluded next month.

THE power tubes in a radio receiver must supply power to a loud speaker—and it is the task of the engineer to see that this transfer of power is performed efficiently and with but a small amount of distortion. Only a small amount of power is available from a tube and the circuits must therefore be designed to usefully employ as much of this power as is possible, without producing excessive distortion.

The important factor determining the amount of power obtained from a tube is the load into which the tube works. This sounds complicated, but it really is not. Let us illustrate by means of an example. Suppose we have a battery supplying 40 volts and the resistance of the battery is 10 ohms. We want to connect a resistance across this battery (see Fig. 1) of such value as to obtain maximum power in the resistance. What value should the resistance have?

Most of us know Ohm's law, which states that Current = $\frac{\text{Volts}}{\text{Resistance}}$ and we must also recall that Power = Volts \times Amperes. Now, using these two simple equations, let us see if we cannot determine the proper value of the resistance to obtain maximum power. Suppose we connect 5 ohms across the battery. The current will be Current = $\frac{40}{5} = 2.67$ amperes. The voltage drop across the 5-ohm resistor will be Voltage = Current \times Resistance = $2.67 \times 5 = 13.35$ volts and therefore the power in the resistor will be Power = $13.35 \times 5 = 66.75$ watts.

Now you can work out other examples in a similar manner, using other values of resistance. We did this and obtained the data shown in Table 1. This table shows some very fundamental facts. Let us first look at the second column showing the current in amperes. Here we note that as the external resistance is increased, the current goes down. If we wanted to obtain maximum current from the battery we would therefore use the lowest possible resistance—actually we would short the battery, and what experimenter doesn't know that shorting a battery is the quickest way to run it down? Now examine the third column showing the voltage across the resistance. This column shows just the opposite characteristic. Maximum voltage is obtained with a large resistance across the battery. So if we want to obtain maximum voltage we should use a very large external resistance. Now look at the last column showing the power. Here we note a very peculiar thing. The power is small with either a very low

or a very high resistance. The power is a maximum when the external resistance is 10 ohms. The important point is that the external resistance that gives maximum power has a value exactly equal to the internal resistance of the battery. This relation will always be true—maximum power output will be obtained when the resistance connected across the device is equal to the internal resistance.

TABLE 1
BATTERY VOLTAGE = 40 VOLTS
BATTERY RESISTANCE = 10 OHMS

EXTERNAL RESISTANCE R1 IN OHMS	CURRENT IN AMPERES	VOLTAGE ACROSS R1	POWER IN WATTS
2	3.33	6.66	22.2
4	2.86	11.45	32.7
5	2.67	13.35	35.6
8	2.22	17.6	39.1
10	2.0	20.0	40.0
15	1.6	24.0	38.4
20	1.33	26.6	35.4
30	1.0	30.0	30.0
50	0.67	33.5	22.4
100	0.364	36.4	13.3

TABLE 2

TYPE OF TUBE	PLATE RESISTANCE IN OHMS
-71A	2000
-45	1900
-50	1800

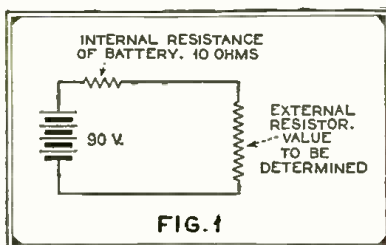
All of these relationships apply with equal force to the power tube. In tube circuits (see Fig. 2) we deal with the a.c. plate resistance of the tube instead of the internal resistance of the battery, and in place of the external resistor connected across the battery we have the loud speaker or other device which the tube is used to operate. Values of plate resistance of various tubes will be found in any standard tube chart. A few representative values are given in Table 2.

Working on the basis that the facts determined from Table 1 are equally applicable to the tube, we can decide that the -71A will supply maximum output when the load resistance is 2000 ohms, the -50 will require a load resistance of 1800 ohms and so forth.

But in radio circuits we cannot only consider power, for of equal importance is the problem of distortion. Radio engineers have set a limit of 5 per cent. as the maximum permissible distortion in a power tube circuit and with this figure as the criterion, experiments show that the tube should be worked into a load resistance twice as great as the plate resistance. Therefore the load resistance for the -71A should be 4000 ohms. Since the load resistance is then not equal to the plate resistance, maximum power output will not be obtained. The problem is then to determine by how much we reduce the maximum possible power when we work with a load resistance twice the tube resistance. To determine this point we can again refer to the data in Table 1. In this example we had an internal resistance of 10 ohms, and when the load resistance had the same value the power in the load was 40 watts. Now when we connect across this battery a resistance equal to 2×10 or 20 ohms, we find from column 4 that the power is reduced to 35.4 watts. The percentage reduction in power is $\frac{35.4}{40} \times 100 = 89$ per cent. Therefore by working a tube into a load resistance twice that of its plate resistance the power output is decreased by about 11 per cent. Actually a decrease in power output of 25 per cent. would be just noticeable to the ear and therefore a decrease of 11 per cent. will not cause trouble.

Circuits using power tubes are therefore designed on the basis that the load resistance will be equal to twice the a.c. plate resistance of the tube. This condition is always assumed in plotting tube characteristics and in all tables of tube characteristics will be found a column headed, "Maximum Undistorted Power Out-

(Continued on page 352)

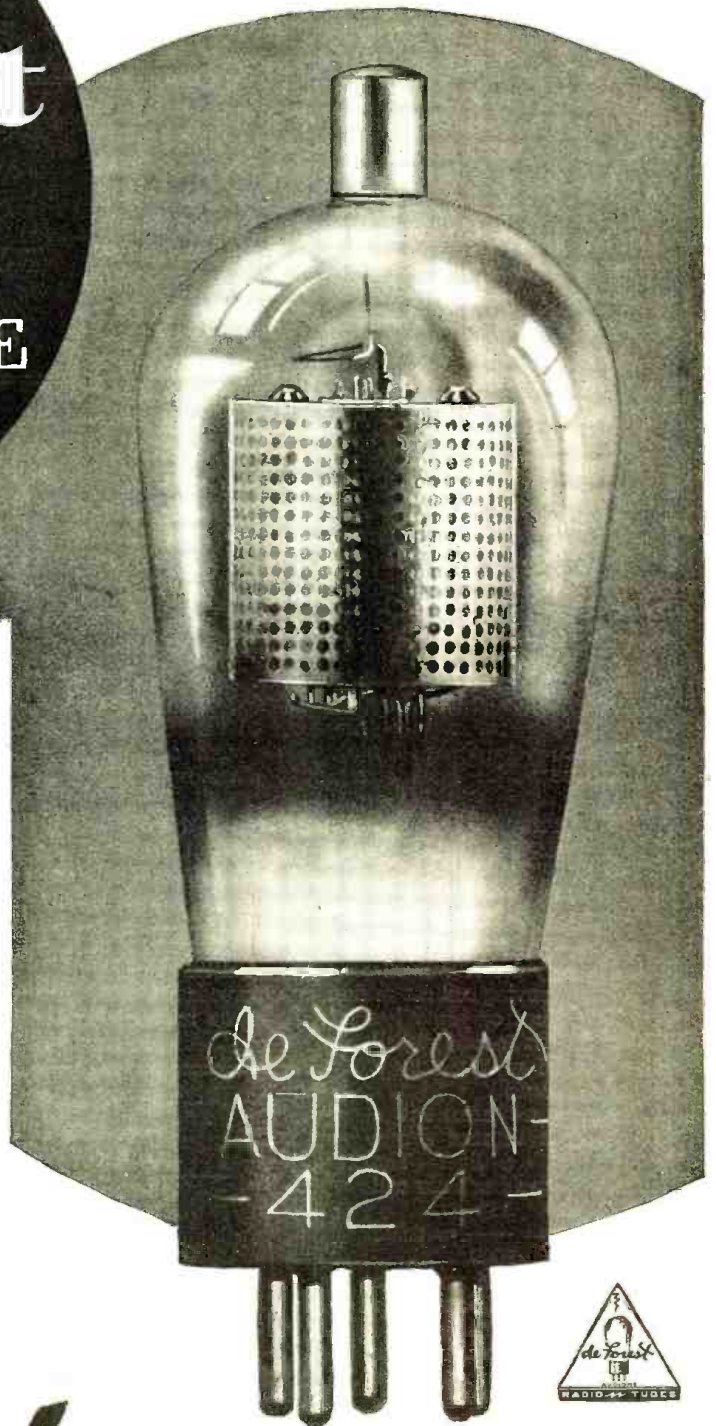


de Forest
meets the
CHALLENGE
!

RADIO dealers have been demanding of the tube industry: "Give us a screen grid tube that will deliver consistent performance and cut down service calls!"

We have responded with the de Forest Type 424 Screen Grid tube and the perfected 427 Audion. That we have successfully met the challenge of the trade is conclusively proved by the many glowing reports from radio manufacturers, dealers and service men. The greater degree of vacuum of these tubes, their rugged oxide-coated filaments, extreme sensitivity, uniformity and *demonstrated long life* reveal them as the radio tubes you have been waiting for.

PUSH de Forest tubes. In so doing you are showing your customers that not only are you interested in the sale of a tube, but also what it does after it goes into his set.



de Forest
(AUDIONS)

RADIO TUBES

DE FOREST RADIO COMPANY, PASSAIC, NEW JERSEY

BOSTON • NEW YORK • PHILADELPHIA • ATLANTA • PITTSBURGH • ST. LOUIS • KANSAS CITY • DENVER
 LOS ANGELES • SEATTLE • CHICAGO • MINNEAPOLIS • DETROIT • DALLAS • CLEVELAND

Export Department, 304 East 45th Street New York City, N. Y., U. S. A.

put" which indicates the power output of the various tubes when they are worked into a load resistance equal to 2Rp (two times the plate resistance).

Experimenters will wonder why we talk about working the tube into a resistance when in actual practice we never do this but always connect the tube to a loud speaker. The reason for this is that to determine the power output of a tube when it is working into a loud speaker would necessitate taking into consideration the effective resistance and effective reactance of the loud speaker. These two quantities vary considerably, depending upon the frequency at which they are measured, and are not the same in any two loud speakers. In order to make it possible to measure tubes under certain simple conditions, reproducible at any time, a resistance is always used. Measurements made by different engineers in various laboratories are therefore directly comparable and this is of course of immense advantage in discussing tube characteristics and in standardizing their constants.

The fact that a loud speaker does not look like a pure resistance but acts instead like an electrical circuit containing resistance, inductance and capacity complicates the problem of efficiently connecting a loud speaker to a tube. Since the impedance of a loud speaker varies with the frequency, what we do in practice is to pick some impedance which gives a good characteristic and work out the necessary design of the remainder of the circuit using this value of impedance. In working with the old W. E. 540AW cone, for example, we assumed that its effective impedance was about 400 ohms, although actually the impedance varies from about 2000 ohms up to 30,000 ohms.

The moving coil system of the modern dynamic loud speaker has a very low impedance, usually around 10 or 20 ohms. This raises the problem of how we can work such a loud speaker with ordinary power tubes which usually have an a.c. plate resistance of about 2000 ohms. This difficulty is solved by the use of a transformer which has the very useful characteristic of permitting us to make a 10-ohm moving coil act as though its impedance was 1000 or 5000 ohms or any other impedance we might choose. How this is accomplished can best be explained by a simple example.

Suppose we connect a 5000-ohm resistance across a 110-volt a.c. line. The current from Ohm's law will be $I = \frac{E}{R} = \frac{110}{5000} = 0.022$

amperes, and the power in this resistance will be $\text{Power} = E \times I = 110 \times 0.022 = 2.46$ watts. Now suppose we had a 10-ohm resistance and wanted to get the same power in it. To do this the voltage across the 10-ohm resistor would have to be 4.96 volts. This can be proven as follows. If the voltage is 4.96, the current in the 10-ohm resistor will be $I = \frac{4.96}{10} = 0.496$ amperes and the power will be $\text{Power} = E \times I = 4.96 \times 0.496 = 2.46$ watts, which is the same as in the previous case.

We all know how we use power transformers to step up or step down the line voltage. With a line voltage of 110 volts we frequently use transformers that give us 400 volts on the plates of rectifiers and 2.5 volts for the heaters of

type -27 tubes. Quite evidently a transformer can be used to obtain either more or less voltage. Now a transformer consists of two windings, a primary and a secondary, and the voltage across the secondary depends upon the ratio of the number of turns on the primary to the number of turns on the secondary. If the secondary has twice as many turns as the primary, the secondary voltage will be twice as great as the primary voltage; if the secondary has half as many turns of wire as the primary, the secondary voltage will be half as great as the primary voltage. Stated as a simple formula, the secondary

$$\text{voltage} = \frac{\text{Primary voltage}}{\text{Ratio of turns}}$$

Now in the previous example we found that we required 4.96 volts across the 10-ohm resistor in order to have the same power in it as the 5000-ohm resistor connected across the 110-volt line. We can get this 4.96 volts by using a transformer to step down the line voltage and the required ratio of turns can be determined from the above simple formula. $4.96 \text{ (secondary voltage)} = \frac{110 \text{ (primary voltage)}}{\text{Turns ratio}}$

$$\text{Turns ratio} = \frac{110 \text{ (primary voltage)}}{4.96 \text{ (secondary voltage)}} = 22.4. \text{ There-}$$

fore the primary must have 22.4 times as many turns as the secondary. Now from all these figures we can obtain a very interesting and important relation that is always true. If we divide the original resistance, 5000 ohms, by the second resistance, 10 ohms, the ratio is 500. Also, if we square the turns ratio, 22.4 times 22.4, we also obtain 500. In other words, the ratio of the two resistances = (turns ratio)². This is a fundamental relation in all transformer circuits and it greatly simplifies the problem of determining the turns ratio required if the primary and secondary load resistances are known.

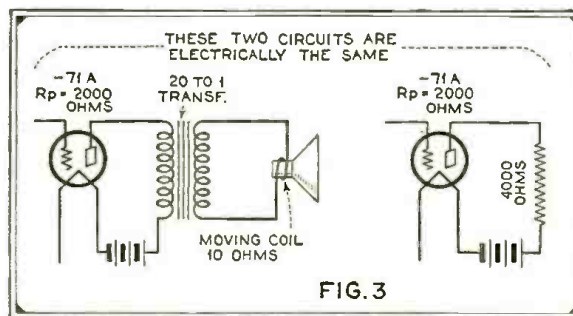
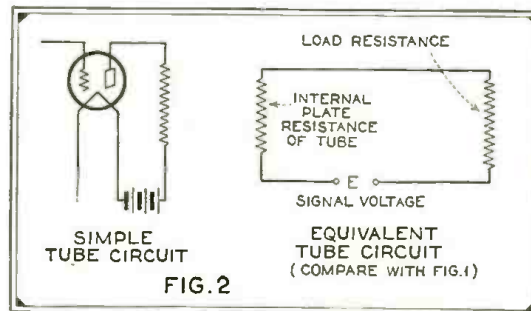
Let us apply this to a tube problem. Suppose a -71A tube was to be used with a moving-coil loud speaker, the effective resistance of the moving coil being 10 ohms. We know from our previous discussion that the -71A tube has a plate resistance of 2000 ohms and therefore the load resistance should be twice as great or 4000 ohms. We want

to work with a loud speaker that is only 10 ohms and therefore the ratio of the desired resistance to the actual resistance is 4000 divided by 10 or 400. Therefore from the preceding equation $400 = (\text{turns ratio})^2$, therefore turns ratio = 20. This all means that if we take a 10-ohm loud speaker and connect it to the secondary of a 20:1 transformer that the primary may be connected to a 2000-ohm tube and the

entire circuit will operate just as though the loud speaker had an impedance of 4000 ohms, the correct load impedance for a 2000-ohm tube. The circuit is shown in Fig. 3.

The power tube is one of the most important parts of the radio receiver and space is not available in this month's Home Experiment Sheet to describe some simple experiments. The discussion of the power tube will therefore be continued next month, when some simple experiments will be described.

For supplementary reading on this subject we refer you to the article entitled "What Power Tube Shall I Use?" by James Martin, appearing in the August, 1929, issue.



HOW-TO-MAKE-IT FREE



*With 6 Months of
Science and
Invention
All for Only \$1*

Here's just the book you've been waiting for. "HOW TO MAKE IT—WRINKLES, KINKS, FORMULAS"—the complete all-around guide for almost all kinds of repairing and construction. A boon to every red-blooded man who has ever felt the urge to grip good tools and see useful finished articles take shape as the combined result of skillful hands and brain!

*FREE with Big Cash Saving on
Science and Invention*

HERE are new thrills awaiting you—the thrills that come from making and doing things you can take pride in! Here, also, is real recreation and profit!

Breakfast Nooks — Fireplaces — Cedar Chests — Modernistic Sideboards— Blow Torches — Auto Accessories — Decorative Lighting Fixtures — Garden Fountains — Wood Lathes . . . whether it's carpentry, plumbing, masonry, electricity, "HOW TO MAKE IT" will tell you what to make and do—and how!

Hundreds of things for your car, for making your home more beautiful and comfortable, for broadening the facilities and usefulness of your own work shop!

Whether it's repairing or working in metals, concrete, woods, stains, paints, piping, or what have you—this handy book, the work of our expert mechanics and engineers, tells you exactly how by means of simple English, and scores of clear pictures, diagrams and plans.

Amateurs and experts in all lines—hundreds of thousands of them, have bought this "HOW TO MAKE IT" book at a substantial price, and have had countless occasions to congratulate themselves on their wise investment.

BUT—we have arranged to ship you this useful book, postpaid, **ABSOLUTELY FREE OF CHARGE!** And at the same time we will enter your subscription to **SCIENCE & INVENTION** for six full months (regular value \$1.50), for only \$1.00. *But don't delay!* To get the book **FREE** and two big issues of **SCIENCE & INVENTION** virtually **WITHOUT COST**, mail the coupon while we still have books on hand!

Mail Gift Coupon NOW!

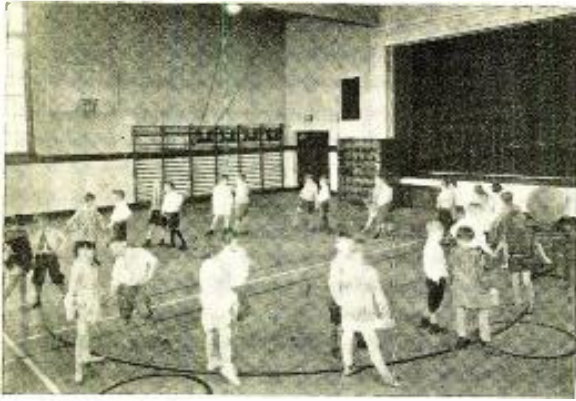
SCIENCE & INVENTION, Dept. 2410
381 Fourth Avenue, New York, N. Y.

Gentlemen: Ship me, **ENTIRELY FREE**, prepaid, the valuable handy book, "HOW TO MAKE IT—WRINKLES, KINKS, FORMULAS"—and enter my subscription for the next Six Big Issues of **SCIENCE & INVENTION** at only \$1, which I enclose. I understand you will promptly refund my \$1 and I may keep the book if I am not more than satisfied.

Name

Address

City and State



Radio Joins the Three 'R's

Musical supervisors throughout the country have been quick to realize the almost unlimited possibilities of radio as an active participant in the classroom. With several coast-to-coast and other smaller chains of broadcast stations planning series of specially prepared hours, the school-children of the nation will have every opportunity to know and understand the world's finest music

By
B. H. Darrow*

THERE is every indication that increasing use of the radio will be made by the musical supervisors of the nation. Of course, in this, they are merely following the lead of radio stations and others who have already used radio transmitters to carry well-nigh every kind of musical production into the homes and consciousness of almost every type of people.

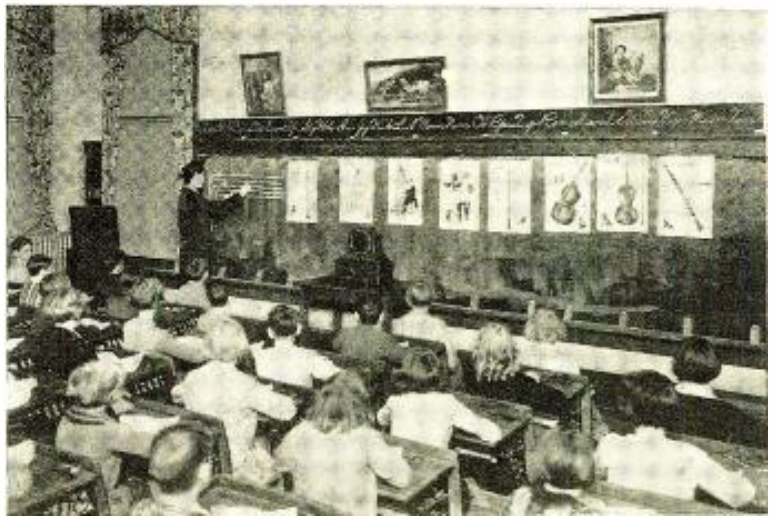
But it does not always follow that because a new medium appears to the taste of the general public that it is immediately accepted by the schools. In fact, the contrary is more nearly true. Professionalized education is sometimes the least interested in a new device.

Fortunately, the educators in the field of music give evidence of not only an awakening but also of immediate activity.

They recognize that music has so much to offer to life that they want its blessings to reach every man, woman and child. They recognize that radio is a wonderful successor to a number of other devices which, from time to time, have materially increased human happiness. The invention of musical nomenclature made possible the preservation of melodies which otherwise might have been lost. Music publishers, the makers of musical instruments and then the phonograph spread the circle more widely until the less fortunate—the poorer and isolated—were reached.

But the task is not done. It presents a challenge to radio to do three things—to increase music both quantitatively and qualitatively—to not only encourage appreciation but also increase participation. To do this, it must recognize that there are at least three fields which must be given individual attention. To conceive of one program satisfying the needs of these three is as fatuous as to send kindergarten children to high school or high school pupils to the kindergarten. There is still considerable confusion in the matter. Wherever people discuss the problem of teaching music or music appreciation by radio, people with at least three different viewpoints are in evidence.

Manifestly, there are many larger and metropolitan schools whose ability to serve themselves the good things in music is limited only by their own lack of administrative ability. They can use their own orchestras, bands, glee clubs, etc., for many purposes—for instruction and for appreciation—for either musical appreciation or active participation. Such



When schools open again this Fall, scenes like the above will be enacted throughout the entire country, with radio taking a leading rôle in the modern method of musical education

schools are interested only in broadcasts which present the supremely good in music. They are glad of an opportunity to listen to the great living masters sing and play, for even with their greater numbers and money they cannot bring all the masters to their auditoriums. The new medium is not an enemy of the phonograph record any more than spoken speech is the enemy of the book, which preserves it for all time.

Further, this class is attentive to symphony music. They have a musical background which makes it possible for them to obtain both joy and instruction from the symphony broadcasts. However, such schools, ready for a diet of symphony and the masters, do not perhaps number more than a few hundred.

There is a far larger group, perhaps typifying several thousand communities, which are not ready for so much music which is involved or intricate. They may feel a bit lost and call it "highbrow." They will, of course, want to hear the masters and some symphony music, but they will want much of the broadcasting to be of a much simpler nature. Simple music will be desired. Instruction in the fundamentals will be in order. A type of instruction that (Continued on page 358)

*Director of Ohio School of the Air.

CHAMPION RIBBON LABELS FOR DATING

END BOTHERSOME ADJUSTMENT DISPUTES



now—



that you have checked your inventory for price adjustment—

you know

what tubes you are low on— place your orders *now*—for

Champion

RADIO TUBES

CHAMPION RADIO WORKS, Inc.
122 Pine St. Dan Vers, Mass.

**RADIO
WORLDS FAIR
MADISON SQ. GARDEN
NEW YORK
SEPT. 22-27- Inc.**

Over half a million people, including the trade and public will visit these two great Radio Expositions

**CHICAGO
RADIO SHOW
COLISEUM
CHICAGO
OCT. 20-26- Inc.**



OFFICIAL

SHOWS

NEW FEATURES INCLUDE LATEST DEVELOPMENTS IN SHORT WAVE AND TELEVISION

This year marks the entrance into the radio industry of some of the country's largest and strongest manufacturing organizations. A number of these will make their first public displays of radio at these two shows.

Newest developments in models of receivers, speakers, tubes and other accessories designed since the June Trade Show will also be shown for the first time at the New York and Chicago Expositions. The popularity of short wave transmission and reception has spurred

the development of short wave apparatus, which will be featured in the short wave section. There will also be interesting displays of air-craft, marine and automobile radio. Material progress has been made in Television during the past year, the latest developments of which will be a feature of these shows.

This year of all years, in order to know what to sell to increase your profits, you should attend either of these two great Radio Expositions

RADIO MANUFACTURERS' SHOW ASSOCIATION

G. CLAYTON IRWIN, Jr., General Manager

U. J. HERRMANN, Managing Director

80-Meter Phone Transmitter

(Continued from page 316)

NEW AMERTRAN AUDIO TRANSFORMERS



.. Maintaining the Standard of Excellence

In announcing the new and improved Amertran DeLuxe Audio Transformers, it is again shown that Amertran sets the "Standard of Excellence".

Redesigned for even greater protection from moisture—constructed to live a still longer, more useful and trouble-free life, with perfect fidelity of tone—Amertran DeLuxe Audio Transformers are always demanded when the best is required.

For perfect satisfaction—for long-lived economy—Amertran equipment is everywhere recognized as the wisest choice.

Send the coupon below for Bulletin 1050 giving complete descriptions and technical information on all Amertran Audio-Frequency Transformers.

American
Transformer Company
178 Emmet Street Newark, N. J.



American Transformer Company R N 10-50
178 Emmet Street, Newark, N. J.

Gentlemen: Send me Bulletin 1050 with complete description of Amertran Audio Transformers.

Name.....
Street.....
City and State.....

duplicate the construction described here the details for the panel and framework are given. However, it is not absolutely necessary that the exact layout be followed and individual experimenters may exercise their own ingenuity in the matter of assembly and construction. A bread-board layout may without question provide a simpler layout, but then the nicer, more shipshape-looking appearance is sacrificed. All in all, the layout shown here may be accepted as that which gives a satisfactory degree of efficiency together with an appearance which, so to speak, makes the job look like "a million dollars" and one which any ham will be proud to lay claim to. No attempt is made to lay down hard and fast rules of construction, for usually to those fellows who, by acquiring an amateur's ticket, have demonstrated their ability to understand and operate a short-wave transmitter, the matter of layout and construction is one which they want to alter to fit in with their own ideas.

While it is undoubtedly true that a transmitter can be constructed from hay-wire or junk-box parts, nevertheless, it stands to reason that the chances for efficient satisfactory operation are much better when new equipment from reputable manufacturers is employed. In the design described here an attempt has been made to use only quality apparatus. For instance, Weston meters are used throughout; then there are National transmitting condensers and dials, Thordarson audio, power and filament transformers and chokes, Flechtheim filter condensers, Electrad resistors, Clarostat line voltage rheostats and a Universal double-button microphone. Quality apparatus all the way through. The complete list of parts employed is as follows:

- C1, C2—National transmitting condensers, .00045 mfd., 3000 volts.
- C3—National transmitting condenser, .00025 mfd., 3000 volts.
- C4, C5, C6, C7—Aerovox fixed condensers, .00025 mfd.
- C8, C9—Flechtheim by-pass condensers, 2 mfd.
- C10—Flechtheim high-voltage transmitting condenser, 2 mfd., 1000 volts d.c.
- C11—Flechtheim high-voltage transmitting condenser, 4 mfd., 1000 volts d.c.
- C12, C13—Flechtheim filter condensers, 2 mfd., 1000 volts d.c.
- C14—Sangamo fixed condenser, .00025 mfd.
- L1, L2, L3—Homemade transmitting inductances, as described in text.
- L4—S.-M. r.f. choke, 20-200 meters.
- L5, L6—Thordarson filter chokes, 30 henrys, 300 mls., type T2027.
- L7—Hammarlund shielded r.f. choke, 85 mh.
- R1—Electrad wire-wound resistor, 5000 ohms, 150 watts.
- R2—Electrad royalty potentiometer, 500,000 ohms.
- R3—Electrad wire-wound resistor, 2000 ohms.
- R4—Electrad wire-wound resistor, 1000 ohms.

- R5—Electrad wire-wound resistor, 815 ohms.
- R6, R7—Clarostat line rheostat.
- R8, R9—Electrad wire-wound resistors, 200 watts, 1325 ohms.
- R10—Electrad wire-wound resistor, 100 watts, 675 ohms.
- R11—Electrad wire-wound resistor, 50 watts, 100,000 ohms.
- R11—Electrad wire-wound resistor, 100 watts, 675 ohms.
- R12—Electrad center-tapped wire-wound resistor, 20 ohms.
- M1—Weston radiation ammeter, 0-2.5 amps, type 425.
- M2, M3—Weston milliammeter, 0-200 mls, type 301.
- M4—Weston a.c. voltmeter, 0-15 volts, type 476.
- T1—Thordarson microphone transmitter, T-3020.
- T2—Thordarson input push-pull transformer, T-2922.
- T3—Thordarson interstage push-pull transformer, T-2973.
- T4—Thordarson filament transformer for 2.5 volt filaments, T-3081.
- T5, T6—Thordarson filament transformers for 50 watt tubes, T-2382.
- T7—Thordarson transformer for rectifier tubes, 2.5 volts, 10 amps, T-3680.
- T8—Thordarson high-voltage line transformer, 1000-1500 volt secondaries, T-2387.
- V1—De Forest oscillator tube, 50 watts, type 503A.
- V2, V3, V4—DeForest -27 tubes.
- V5—De Forest modulator tube, 50 watts, type 545.
- V6, V7—De Forest mercury rectifiers, type 566.
- Two 50-watt sockets.
- Three five-prong a.c. tube sockets (Benjamin 9036).
- Three National velvet vernier dials, 4-inch diameter.
- Two four-prong sockets (Benjamin 940) for 566 rectified tubes.
- One Muter double-pole double-throw knife switch, S3.
- Two G-E line toggle switches, S1, S2.
- 31 Eby binding posts with terminal strips, as illustrated.
- One Weston student base for antenna ammeter.
- One double fuse block.
- For General radio stand-off insulators (for L1, L2).
- One Universal double-button microphone, model K.
- One Eveready 4½-volt "C" battery for microphone.
- One transmitter key.
- One framework for transmitter, as illustrated.
- One baseboard for power supply (standard drawing board 16x22").
- Lugs, wire, solder, screws, etc.

Preliminary Adjustments

Let us assume that in accordance with the type of construction illustrated here the transmitter has been built and is now ready for adjustment, all the accessory

(Continued on page 357)

80-Meter Transmitter

(Continued from page 356)

equipment, power supply and antenna having been connected.

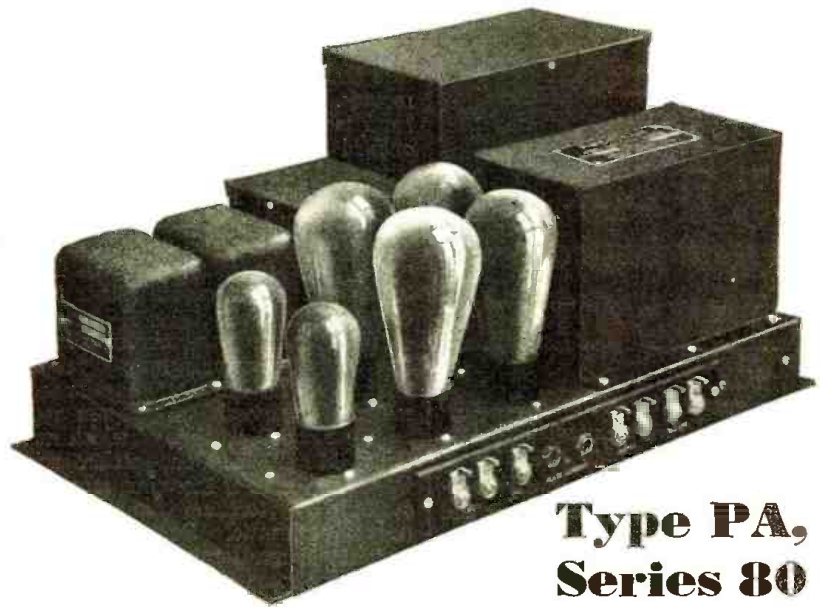
Having given the filaments a chance to warm up, the high potential is applied and the two condensers, C1 and C2, set at about 75 on the dials. Now, immediately rotate either one or the other of these condensers, the while watching the plate milliammeter, M2, so as to identify the dip in deflection which will indicate an oscillatory condition. Once the dip has been noted then the antenna condenser may be rotated so as to obtain an indication of current flowing in the antenna. As a preliminary step some fellows may wish to work without the antenna and feeder, merely shorting the two antenna posts so as to obtain an absorption circuit with L3, M1 and C3. As a safety measure it might be well to shunt a fine piece of wire across the antenna ammeter to prevent burn-out. Of course, in this operation the key should be closed. To determine whether a stable oscillatory condition has been obtained the key can be worked, noting the while whether the plate milliammeter, M2, still indicates the same deflection.

Up to this point we have merely determined whether the oscillator works satisfactorily. The next and a most important move is to adjust the oscillator to some frequency in the 80-meter phone band. This is done best by employing some type of wavemeter or frequency indicator which has been previously accurately calibrated. The grid-dip meter described by Edward W. Wilby in the June, 1930, issue of RADIO NEWS is ideal for the purpose. Set the grid-dip meter at the frequency to which it is desired to adjust the transmitter and then coupling it very loosely to the grid or plate coil of the transmitter, rotate slowly that tuning condenser on the transmitter which tunes the circuit to which the wavemeter is coupled. When resonance is obtained the needle on the meter in the grid-dip meter will take a decided dip. With a simple wavemeter a little different procedure must be followed. First, revolve the wavemeter dial slowly. If the coupling between the wavemeter and one of the tuned circuits of the transmitter is too loose, no indication of resonance will be manifest; therefore slightly tighten the coupling until, during the rotation of the dial, the wavemeter indicator lamp glows. Having determined the wavelength adjustment of the transmitter at that particular setting of its dials it is a simple matter to determine whether the dials should be turned to a higher or lower setting so as to ultimately get the transmitter adjusted to a frequency somewhere within the 80-meter phone band.

From this point on it remains only to get the audio amplifier working properly. Since it has been determined in the design of the transmitter as to the correct plate and grid voltages which are required for satisfactory operation the only adjustment which can be made to this part of the circuit is in regulating the amount of modulation obtained to provide an un-

(Continued on page 358)

AMERTRAN POWER AMPLIFIERS



**Type PA,
Series 80**

An economical means of obtaining flawless reproduction of sound in large volume is available in a new series of Amertran Power Amplifiers, the result of months of laboratory experimentation and exhaustive field tests.

There are four sizes in the new Series 80, one to fill every requirement. The big Type PA-86, shown in the illustration, will flood an auditorium with a full volume of music or speech without distortion. Smaller models are made for installations in restaurants, clubs, dance halls, schools and homes—wherever exceptional fidelity of reproduction at high volume is desired.

The mounting and construction is such that they are installed easily, with no bothersome wiring and connections, and are proof against tampering or damage. Simple controls and ease of portability are added features that contribute to the popularity of Amertran Power Amplifiers whose record of performance has won the distinction of being considered The Standard of Excellence for Audio Reproduction.

Licensed under patents of R.C.A. and Associated Companies

AMERICAN

TRANSFORMER

178 Emmet Street



COMPANY

Newark, N. J.

For complete description and information contained in Bulletin 1079 send us the coupon below:

AMERICAN TRANSFORMER COMPANY
178 Emmet Street, Newark, N. J.

RN 10-30

Gentlemen: Send me Bulletin 1079 with complete description of Type PA, Series 80 Amertran Power Amplifiers.

Name.....

Street.....

City and State.....



POPULAR!! the new improved TRIAD LINE

Every development known to radio tube science—you will find them *all* built into the new, improved TRIAD line. Types T-24 and T-45 have been entirely redesigned to assure greater power output and less distortion at higher signal voltages. The new construction and thoriated tungsten filament makes T-210 an easy oscillator and guarantees a longer life. The construction of T-50 has been strengthened to withstand the most severe usage.

All through the entire TRIAD line you will find the same sensational improvements carried out. No wonder TRIAD tubes have won the confidence of trade and public alike!



NEW 210 TUBE

We have designed this tube for strenuous service under transmitting conditions. The filament is thoriated tungsten and the plates are molybdenum. At exhaust, each 210 is individually treated and evacuated for the highest possible vacuum.

For further information send for our bulletin T-10. Special prices extended to Licensed Amateurs and Members of A. R. R. L.

TRIADS are now manufactured under R. C. A., G. E. and Westinghouse patents.

TRIAD MFG. CO., INC.
Pawtucket, R. I.

TRIAD RADIO TUBES

Radio Joins the Three R's

(Continued from page 354)

would seem foolish to the first-mentioned group would please this one. Illustrative material for this class should be largely of a simpler nature.

They may or may not have phonographs. If they do have, it is most often true that they lack a sufficient library of records. They have little or no assistance from mechanical instruments. They are obliged to depend mainly upon vocal instruction. The radio can give them just the mechanical illustrations which they need for both appreciation and instructional purposes. Such use of the radio is more likely to cause them to increase their libraries of records rather than be content with them.

If the first group numbered a few hundred and the second group a few thousand, then this third group must number scores of thousands. There are approximately 250,000 schools, of which number about 150,000 are one-teacher schools. Of course, some of these one-room schools are taught by teachers who are splendidly trained in music. But this number is certainly a small minority. A majority of the one-room schools and many of the two-room schools have no teachers of music. They have no orchestras, no glee clubs, no bands. Music which radio can bring to them is a far bigger blessing than to either of the other groups. They need it for variety's sake—the need it for relaxation—they need it for inspiration—they need it for instruction.

The music which they desire can contain a touch of the symphonic. They can, with the teacher's help and her enthusiasm at being able to hear the grand old masters, obtain values from such programs, but generally speaking they are not ready for a full diet of such involved and difficult music. They have no orchestras or glee clubs which they can use for instruction and appreciation purposes. They are not even ready for some of the instruction mentioned in connection with the schools having inadequate leadership. However, everyone of them enjoys music. Everyone of them can profit by the radio bringing to them the simpler things.

What a godsend such a teaching could be to young men and women in their early years of teaching when they lack not only training in music but courage to do what little they can. Many teachers are appalled at the idea of attempting to sing many songs outside of the small list which has already become their own through much repetition. With a twist of the wrist an assistant teacher can walk into every one of these classrooms.

Reports indicate that former efforts at musical education by radio are to be continued and several new ones added. The Damrosch lessons in music are to be continued by the National Broadcasting Company. The Columbia chain, through its American School of the Air, is contemplating the adding of a course in music. The Ohio School of the Air is working on plans for music for the third group—that having little or no musical leadership. The Pacific-Western Broadcasting chain, WMAQ and twelve others which have sprung up and are calling

themselves schools of the air, are considering the inclusion of music in one or more forms.

The subject is receiving considerable attention during the summer school at Ohio State University, where a course in radio education is being offered for the first time as a subject for study by teachers. It was also recently discussed during the twelve-day institute which the State Department of Education, the Payne Fund and Ohio State University conducted June 23 to July 3. It was even under consideration during the National Education Association Convention, June 28 to July 5. Instruction and appreciation of music by radio have come to stay.

80-Meter Transmitter

(Continued from page 357)

distorted output from the modulator tube. Modulation can be adjusted and checked by varying the setting of the microphone control, R2, the while watching the plate milliammeter, M, for overloading effects.

Inasmuch as we are dealing with a three-stage audio amplifier it is not altogether improbable that audio oscillation may be experienced. In such an event flipping the connections to either the primaries or secondaries of the audio transformers will obtain the required dephased condition so that oscillation at audio frequencies will not occur. Grounding the cores of all the audio transformers is recommended and in some instances it may be found necessary to slightly alter the plane of the cores of the transformers so as to prevent intercoupling between stages. Inasmuch as the grid of the first audio tube looks into a normally high impedance circuit (the 500,000-ohm potentiometer of the mike modulation control), some difficulty may be experienced in the production of an audio sing due to the condition which is set up here of having the grid virtually floating. One remedy is to shunt from grid to ground a 100,000-ohm resistor. Another more expensive remedy is to employ in place of T1 a microphone transformer having an impedance ratio of only 750 to 1 in comparison to that originally specified, the T3020 having an impedance ratio of 2000 to 1.

In actual test it was found that the long microphone leads picked up quite a bit of r.f. and rather than go to the trouble of completely encasing these leads in a protective braided metallic shield, a shielded Hammarlund r.f. choke of 85 mh. was inserted in the grid circuit of the first audio stage, being placed as close to the grid as possible. A by-pass condenser of .00025 mfd. was shunted from the transformer side of the grid to the grounded side of the circuit, thus effectively preventing the r.f. currents from passing on through the audio amplifier.

Book Reviews

The Radio Amateur's Handbook, by A. Frederick Collins, edited by George C. Baxter Rowe. 394 pages. Thomas Y. Crowell Company, New York. \$2.00.

This is the sixth and latest edition of an eight-year-old book that has outlived its usefulness. It is a rather confused mixture of ancient and modern material, and suffers very badly by comparison with the A.R.R.L. book of exactly the same title. Baxter Rowe, who was formerly an editor of RADIO NEWS, obviously had a thankless job in front of him in revising the volume, and he has rewritten whole sections of it to make it presentable. His own stuff is good, but the original copy is pitiful.

Several complete chapters, for instance, are devoted to single-slide tuners and spark-coil transmitters, and full directions for the installation and operation of the latter are given in spite of the fact that amateur spark transmitters have been illegal for years. I feel sorry for the reader who follows all this information and learns to his expense and chagrin that rolling-pin tuners and Ford coil transmitters are as old-fashioned and passé as bobbed hair and short skirts. The later chapters, dealing with up-to-date short-wave apparatus, power amplifiers and television, are more interesting and instructive, but even much of their contents is already obsolescent.

Reviewed by Robert Hertzberg

How to Become a Radio Amateur, American Radio Relay League. 10c.

Ten cents doesn't begin to pay for the booklet just published by the American Radio Relay League entitled "How to Become a Radio Amateur." In its twenty-nine well illustrated pages is contained the direction which even the most seasoned of amateurs would do well to brush up on every so often. For those who are about to enter the short-wave amateur game this booklet provides a guide which is bound to leave a profound influence on the newcomer in guiding him into the right channels. Besides outlining the requirements which must be observed by the newcomer in short-wave radio, this booklet also describes the construction and operation of a simple but nevertheless efficient short-wave transmitter and receiver. Do yourself a good turn and get this booklet.

Photocells and Their Application. John Wiley and Sons. \$2.50.

"Photocells and Their Application" is undoubtedly one of the most interesting textbooks that it has been the pleasure of the reviewer to study in many moons. The authors, Zworykin and Wilson, have managed to get into one hundred and seventy-five pages just about everything that is known about photocells, their history from their inception, and many applications of the cell in everyday life.

While the book is intended for the more advanced student, and a thorough knowledge of mathematics is necessary for its complete assimilation, the matter is so comprehensively handled that the layman will find much to interest him.

Reviewed by George E. Fleming



FREE RADIO BOOK~

describes many opportunities to make big money in the Radio field.

Here's a famous book that has shown many a man the way to "cash in" on the big-pay opportunities in Radio. I'm not asking \$5 or \$6 for this book—it's FREE. If you're earning a penny less than \$50 a week, mail the coupon below and get a copy of this free Radio book for yourself. It will be a revelation to you!

Salaries of \$50 All the Way Up to \$250 Weekly Not Unusual

Radio—the NEW, uncrowded, growing, live-wire profession—needs trained men for its good jobs. Television, trans-Atlantic Radio telephony, many other wonderful inventions and developments are being made constantly in this field! Each one means more big-money opportunities for a trained Radio man. My book gives the facts about these Radio opportunities. And more—it tells how you can get all the training in Radio you need, quickly and easily in your spare hours at home, by my new and practical methods. In a short time, through my training, you will be prepared to take advantage of these big-money Radio opportunities—salaries of \$50 all the way up to \$250 a week not unusual. My Free Book will give you all the facts and proof of what I have done for hundreds of other men.

Extra Dollars for You Almost at Once

Think of making \$15, \$20, \$30 extra each week "on the side," without interfering with your regular job! I'll show you how to do that, too, by using spare time that you're wasting now. I'll show you how to turn what I'm teaching you into cash almost at once, when you and I get started together. My Free Book tells you all about it. If you send for the book today, and if you have the average man's ability, it's possible for you to be making extra money thirty days from now. And you'll be ready for a good full-time Radio position after eight to twelve months of spare-time training.

I'll Send You This Big NEW 64-Page Book FREE

My book is filled with photos and facts—the pay-raising facts you want to read. If you're interested in Radio, or if you're interested in making more money, you owe it to yourself to read this book. The book absolutely won't cost you a cent, and you place yourself under no obligation by sending for it. No previous Radio experience needed to take advantage of this offer. No special schooling required. Fill in and mail the coupon NOW!



J. E. Smith

Address J. E. SMITH, President National Radio Inst., Dept. OLSSS, Washington, D. C.

Hundreds of Men Have Won Success This Way

The National Radio Institute is the oldest and largest Radio home-study school in the world. It has prepared hundreds of men for the Radio profession—some of them now holding leading positions in this industry. You'll find N. R. I.-trained men in practically every Radio organization of any importance throughout the world. The same practical tested training that enabled these men to get ahead is now open to you. And this training has been improved, enlarged and greatly kept up with the constant expansion of Radio opportunities.

Has Made \$10,000 More in Radio

"I can safely say that I have made \$10,000 more in Radio than I would have made if I had continued at the old job. When I enrolled with you I didn't know I could make a cent more. I advise all ambitious young men to get into Radio. There is no greater opportunity."

Victor L. Osmond,
1101 Bay View,
Brooklyn, N. Y.

Over \$400 Monthly

"I had 15 years as a traveling salesman and was making good money, but could see the opportunities in Radio. Believe me I have made more money than I ever did before. I have made more than \$100 each month. I can't say too much for your school."

J. G. Daddeland,
1484 So. 13th St.,
Salt Lake City, Utah

Mail coupon Today!

J. E. SMITH, President,
National Radio Institute,
Dept. OLSSS, Washington, D. C.

Dear Mr. Smith: Kindly send me a free copy of your famous 64-page Radio book, which tells all about the big-pay opportunities in Radio and how you can train me at home to take advantage of them. I understand this places me under no obligation.

Name

Address

Town

The Stenode Radiostat

(Continued from page 298)

Getting the Business!

AUTOMATIC MOTOR CAR RADIO

Performs the best by actual test. Clearest reception—greatest distance.

JUNIOR MODEL List \$49.50
SENIOR MODEL List \$95

Less Equipment With Equipment
 Less Tubes and Batteries

Wire Today!



AUTOMATIC RADIO
 Manufacturing Company
 112-118 Canal St. Boston, Mass.

by the fact that the natural frequency of a quartz crystal cannot be varied at will, as can that of a tuned resonant circuit possessing inductance and capacity. The belief that such a selective circuit, which passes no sidebands, would be useless for the reception of modulated continuous waves is based upon two misconceptions. First, it has been assumed that in order to obtain high quality reproduction it is essential to receive all the sideband frequencies, and secondly, that the same results would be obtained in considering a circuit from the different points of view of the two theories of modulation. This second assumption appears to be quite true when dealing with ordinary low selective circuits, but there seems to be no reason why it should necessarily be true when dealing with circuits of very low decrement. It seems very probable, therefore, that with a low circuit decrement the results calculated from the two theories of modulation would not agree. In any case, it is necessary to consider such a circuit from the point of view of the amplitude theory of modulation; for according to the sideband theory such a circuit is useless, while it has been amply demonstrated that it is capable of very good results indeed.

present in the output of the receiver. It is not present in the output of the Stenode, although it is in the output of any ordinary set. The reason is that such a case is not the same as a modulated current. In an ordinary receiver, the whistle is produced by the rectification of heterodyning radio-frequency currents, and an audio-frequency beat note, which might modulate a r.f. current, is not produced until rectification has taken place. In the Stenode, all such unwanted currents are eliminated before rectification, and so are not present in the output. It must, of course, be realized that if any of the i.f. amplifier tubes are working on a non-linear portion of their characteristics, the applied i.f. voltages will be rectified and the carrier of the desired signal may become modulated by the beat note formed by the rectifying process. Such modulation would, of course, be passed by the crystal, and appear in the output as interference. It is, therefore, necessary to insure that all the i.f. tubes are worked upon the straight portions of their characteristics, and that the amplifier is never overloaded.

In some of the early experimental models of the Stenode Radiostat a different means was adopted to prevent the loss of high notes. The a.f. compensating circuit was not used, but means were taken in the r.f. circuits to prevent the high note loss. The input to the intermediate-frequency amplifier was applied in the form of a series of pulses (about 20,000 pulses per second), by means of the circuit shown in Fig. 3. As a result of this the i.f. voltages were only applied to the crystal for a very short time, and the crystal current could only build up to a fraction of its normal maximum amplitude in that time. Since the maximum variation in amplitude was thus artificially limited, the maximum variation in amplitude, due to the modulation, was also limited. This would have greater effect upon low modulation frequencies than upon high, and consequently, the low note accentuation in the crystal circuit would be eliminated. The method is not used now for broadcast reception because the a.f. compensating circuit has been found as satisfactory and it is more economical, since the overall efficiency of the receiver is greater and two tubes less are required.

At a demonstration in the heart of London, and at about 15 miles from the twin-wave broadcast transmitter at Brookman's Park (842 kc. and 1148 kc., power 30 kw.) the writer heard numerous foreign European broadcast stations received free from interference other than static, artificial static, and interference caused by more than one station working on the same frequency. Stations whose frequencies were so close together that a heterodyne whistle was audible on an ordinary receiver were received on the Radiostat quite free from this form of interference. The selectivity was enormously high, and the quality of speech and music was very good. While it did not appear to be quite as good as that from an ordinary receiver with only a small high-note loss in the tuned circuits, it was much better than that given by the majority of selective sets of the usual type. In fact, taking into consideration the enormous selectivity, the quality was extraordinarily good.

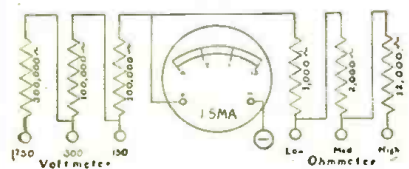
It must be understood that for satisfactory reception with this receiver the frequency of the carrier wave of the broadcast station must not vary during modulation. The selectivity is so great that if the frequency varies the station may disappear completely. Nearly all broadcast stations have a certain amount of frequency modulation, but this is not serious as long as it is very slight. The British stations are fairly satisfactory in this respect; during deep modulation there is a small amount of frequency modulation, which results in a few notes of the music being missed. This is so slight that it is not serious, and would hardly interfere with the enjoyment of broadcasting; it reduces the apparent selectivity of the apparatus, however, for if a station working on a frequency close to that of the desired station is suffering from frequency modulation, occasional interference may result.

In the foregoing theory of the operation of the Radiostat one difficulty will have been evident. It is stated, and has been amply demonstrated, that the apparatus will eliminate interference due to a local oscillator working on a frequency about 1 kc. different from that of a broadcast station to which the receiver is tuned. The receiver will also eliminate two local oscillators, each spaced 1 kc. on either side of the desired station.

Now this appears exactly to represent the case of a carrier modulated with a 1,000-cycle note, and one would, therefore, expect a 1,000-cycle note to be

(Continued on page 361)

Measure Easily Resistance — Voltage — Current



Super Akra-Ohm wire wound Resistors and Shunts afford an inexpensive means to build test equipment for the measurement of resistance, voltage and current with accuracy.

A combination for the measurement of voltages and resistances is shown in the above diagram.

Super Akra-Ohm wire wound Resistors are manufactured in any value from 100 ohms to 10 megohms. They are carefully designed to insure an accuracy of one per cent and a constant permanency of calibration. Their use is highly recommended for Laboratory Standards, High Voltage Regulators, Telephone Equipment, Television Amplifiers, Grid and Plate Resistors, Electrical Apparatus and Test Equipment, etc.



Prices range from \$1.25 for 100 ohms to \$4.00 for 500,000 ohms

Send us your dealer's or jobber's name and we will send you a copy of

Bulletin 73-D

Containing complete information regarding the conversion of millimeters into multi-range ohmmeters, multi-range voltmeters, and multi-range milliammeters.

Shalleross Mfg. Company

ELECTRICAL SPECIALTIES
 700 PARKER AVENUE
 COLLINGDALE, Pa.

The Stenode Radiostat

(Continued from page 360)

Many of the foreign European broadcast stations are badly affected by frequency modulation, some being so bad that a station would disappear completely for several seconds, and suddenly reappear as the modulation depth was altered. In this respect it is interesting to note that the Rome station, which is one of the latest American 50 kw. transmitters, is almost completely free from this defect.

It seems probable that some considerable time must elapse before the Stenode Radiostat is sufficiently developed for it to be suitable for general broadcast reception in the hands of unskilled listeners. For commercial reception, and for the reception of code where many messages are sent simultaneously over a single cable, its high selectivity should prove very valuable.

At present the apparatus is fairly expensive, and is rather difficult to tune owing to the number of controls. There are the loop antenna tuning condenser, the oscillator condenser, the second detector biasing potentiometer, the volume control, and the tone control; to say nothing of the crystal balancing condenser, which, however, requires only occasional adjustment. With the exception of the oscillator condenser, none of the controls is really critical, but a considerable amount of practice is required before their adjustment can be carried out with facility. The setting of the oscillator condenser is very critical, and although the condenser is fitted with a reduction-gear dial, it has been found necessary to connect in parallel with it a very small variable condenser. This small condenser has only one moving plate, and is stated to have a maximum capacity of about 10 mmfd. with a minimum capacity of 5 mmfd., giving a capacity change of only 5 mmfd. In spite of this, a reduction-gear dial with a 5-1 ratio is fitted, and a movement of this dial of about 90°, that is a capacity change of about 0.25 mmfd., is sufficient to tune in and tune out again a 30-kw. station only 15 miles away. These difficulties of control will doubtless be overcome in time, and then it should be possible to build the apparatus in a form more suitable for presentation to the non-technical broadcast listener.

The Experimenter

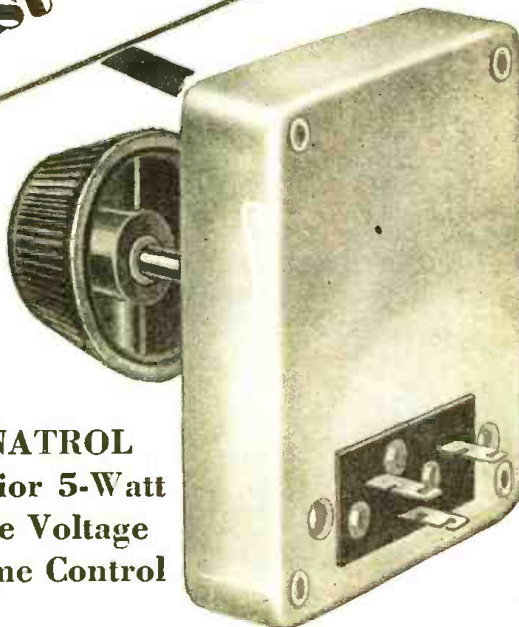
(Continued from page 344)

depend upon varying the filament current to any of the tubes. For example, if the volume is controlled by varying the filament current to the radio-frequency tubes, for best results, replace this rheostat with the correct amperite and connect a suitable variable resistance across the aerial and ground for a volume control.

3. If the 32-volt lead is used the "B—" lead is not. For an explanation refer to D.

It SATISFIES The Most Critical

Licensed under U. S. Pat. Pend., and issued Canadian Patents 281172—280778



Super-TONATROL The Superior 5-Watt All-Purpose Voltage And Volume Control

"YOU can't beat the Super-TONATROL for performance," say radio engineers, experimenters, service men all over the world. And rightly, too, for the Super-TONATROL has distinctive qualities no other volume control can offer. Smoother variation—absolutely stepless—quiet—the Super-TONATROL is aptly termed "The world's most perfect volume control."



Cover Removed, Showing Mechanism

Built on the new DURATROL Principle

A new type resistance element is permanently fused to a vitreous enameled metal plate, over which floats, by direct contact, a pure silver multiple brush contact with delightful smoothness.

So firm is the resistance element, and so smooth the floating contact, that Super-TONATROL units under load have withstood over 100,000 oscillations of the contact without showing appreciable signs of wear or variation in resistance value. Metal cover aids rapid heat dissipation.

7 types for all usual requirements—\$2.40 and \$3.50
Also 2-3 gang manufacturers' models for all purposes.

Better Resistors and Voltage Controls for Every Radio and Power Supply Purpose

Electrad manufactures a complete line of resistors and voltage controls for every radio and power supply purpose, including TELEVISION.

Superior engineering facilities and efficiently organized mass production to meet world-wide demand effect substantial savings in original manufacturing costs—savings which are expressed in ELECTRAD'S fine quality at moderate prices.

175 Varick St., New York, N.Y.
ELECTRAD
INC.

Mail Coupon for Super-TONATROL Circular
Electrad, Inc., Dept. RV-10
175 Varick St., New York, N.Y.
Please send free Super-TONATROL Circular showing recommended uses.
 Check here for information on Complate Electrad Line.
Name _____
Address _____

Backstage in Broadcasting

(Continued from page 305)

RACON'S

Newest Development The ALL WEATHER PROOF HORN



TRUMPET HORN (ILLUSTRATED)

Bell 22 inches round, length 40 inches. Equipped with cast aluminum ferrule and suspension ring.

For Public Address and all Outdoor use. This horn has been perfected after years of exhaustive research in Racon Laboratories. Will withstand all weather conditions. No time limit to guarantee. Made to last forever. Requires no replacements or servicing after heavy rainstorms. . . . Prices slightly higher than regular horns.



Baby Electro-Dynamic Type Horn Unit
List Price, \$35.00

The New Unit

This revolutionary change in the type speaker for radio use is but slightly higher priced than the ordinary speaker, but marvelously better. Tests prove it. Write for descriptive catalog.

The largest horn speaker manufacturers in the world

RACON ELECTRIC CO., INC.

FACTORIES:

18 WASHINGTON PLACE, NEW YORK
Slough, Bucks, England, and 3 Mutual Street
Toronto, Canada

SERVICE MEN!

HERE IS THE

Automatic Line Voltage Regulator
CLAROSTAT



That regulates the line voltage on all makes of electric sets insuring an even steady flow of current. Reduces Noises—A Real Saver of tubes from excessive voltages. Make your share of the profits from this big market.

Carry a supply in your Kit Bag and sell them to your service patrons.

List Price \$1.75

Type A—for sets consuming less than 100 watts.
Type B—for sets consuming 100-150 watts.

Send for circular and discounts
CLAROSTAT MANUFACTURING CO.
281 North Sixth St. Brooklyn, N. Y.

STUYVESANT ELECTRIC CO.

53 Walker St. New York

Write for
FREE CATALOGUE
ON LATEST RADIO BUYS

cut to thirty minutes if necessary.

One young writer, to settle an argument, condensed "Camille" to twenty minutes and did not eliminate a line of the famous death scene nor take anything out of the plot. It was subsequently used on the air.

As soon as the revised script is available, the production man starts casting. Physical characteristics, aside from the voice, are never considered. A homely woman can play the part of a young and beautiful girl and it isn't necessary for the leading man to have his shoes built up if the leading woman tops him by an inch or so.

Glancing through his card index of available talent—and that index in a big studio is a "who's who on Broadway"—the director picks up his players by their voice characteristics. He finds his "female emotional lead voice," "romantic male voice," "character ingenue voice," "Irish dialect voice," and so on.

The leading characters are seldom called upon to double in rôles, but often one person will play four or five minor parts. In one radio drama recently a clever young actress took the parts of an old negro mammy, a twelve-year-old boy and the middle-aged wife of a Yankee preacher. Not content with these parts she marched up and down the studio in company with the director and two other actors, treading heavily and helping in a sound effect that indicated a marching regiment. In mob scenes her shrill voice rose above the bass rumbles of the men. Her pay check, incidentally equalled that of the leading woman.

Rehearsals usually begin three days before the date set for the broadcast, though on a few occasions rehearsals have started two weeks before the actual production. The players get their scripts at the first rehearsal, usually held in a small studio or an audition room. The play is read several times and is carefully timed until the speeches, musical interpolations and announcements run exactly sixty minutes . . . no more and no less.

If the adapter has been careless, the script is either too long or too short. Then lines must be eliminated to shorten the play or additional lines and scenes must be written in. As a rule, though, the short cut to lengthening a play is to have the orchestra play an additional selection or an extra chorus. As there is always an orchestra this is possible.

By the time of the second rehearsal the actors are supposed to be thoroughly familiar with their lines and cues and to be able to read them at a glance. That in itself takes study for a good sight reader is not common.

Memory work is not necessary. The players read their lines even when the production is on the air. This great difference from the usual theatrical practice has caused actors in Broadway shows to comment enviously on the easy life of a radio actor. The radio thespian, however, has to work as hard to read lines so that they will not sound as if they were

being read as has his brother behind the footlights in memorizing his speeches.

While the players sit around in comfortable chairs at the first rehearsal, lounging is abandoned at the second rehearsal and the actors go through the gestures and facial expressions appropriate to their rôles.

This matter of appropriate gestures is a curious example of radio technique. Virtually all the actors heard on the air are from the legitimate theater. They seldom speak on the stage without some movement of the face, hand or body. It has become second nature for them to do so and like many excitable people, they would be speechless if tied hand and foot. So the leading lady stamps her foot in anger, the leading man draws an imaginary sword and the dialect comedian uses all the silly notions and grimaces he would use in front of an audience.

The script from which the lines are read presented a handicap but the players soon overcame this by putting their scripts on elevated music stands which left them free to gesticulate to their heart's content.

During the first two rehearsals the director works in the studio with the actors, checking interpretations of lines and otherwise functioning as he would in a theater. When the third rehearsal is called he leaves his players in the studio and goes into the monitoring booth. This is a small room just off the studio. It has a soundproof glass window through which every part of the studio can be seen and it is equipped with a radio speaker connected with the studio microphone. In the booth the director can watch his actors, see how far they are from the microphone and hear their voices as they will sound on the air.

Once it was necessary for the director to keep dashing into the studio to give instructions from time to time. Now he merely speaks into a microphone at his elbow and his words come from another radio speaker in the studio.

"Mike" rehearsal is very important. The speaking voice is affected by the distance from the lips to the microphone and the player must know just how close to work. On some lines the speaker must be several feet away from the microphone. On others he whispers into the sensitive mechanical ear.

Sound effects, too, are worked out at this rehearsal as well as mob scenes. Eight men who know the trick can give the effect of a mob of several hundred angry persons.

Different dialects are tested for often the microphone plays strange tricks with a dialect. Sometimes a character voice that is easily understood in a theater is blurred and indistinct through the air.

By the end of the third rehearsal the radio play has been timed to a split second. The director has made notes on his script so that he can check up on the tempo of the play while it is on the air. If a certain actor must say "Aha, the

(Continued on page 364)

Book Reviews

Electricity for Beginners, by Edward Harper Thomas. Published by Norman W. Henley Publishing Company, 2 West 45th Street, New York City. \$1.50.

The readers of this book will find it valuable as a fundamental text and introductory to a more advanced study of the subject. The author originally conceived the idea of 40 elementary lessons in electricity to be used in leaflet form in schools requesting them, supplying one lesson a week for the entire school year. These proving popular, they were subsequently brought out in a small book, the present volume including these lessons in revised and enlarged form.

Modulated Oscillator

(Continued from page 307)

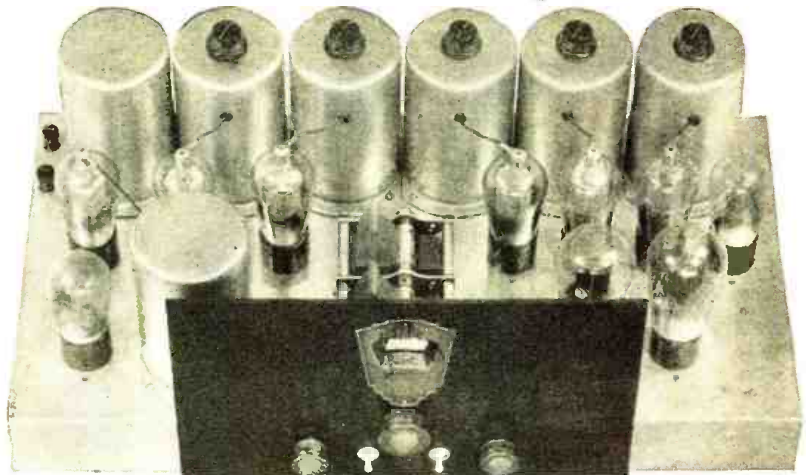
as shown in the wiring diagram, or several condensers of different capacities may be used with a sample selector switch. This is something that the individual user will wish to determine by experimentation anyway, so we leave it to his discretion. It is interesting to note, however, that by careful selection the chromatic scale may be easily played with pipe organ effect, but only one note at a time.

Another experiment that is interesting is to connect a microphone and transformer to the input at points X and X after opening point Y. If connected to the receiver, any sound picked up by the mike will be reproduced in the loud speaker of the set. In this way it is easy to "get" Hongkong at any time for the elucidation of your unsuspecting friends, and effectually silence the pest who gets "California on the loud speaker."

Parts List

- 1 Silver-Marshall 257 audio transformer, T1.
 - 1 Silver-Marshall 257 audio transformer, T2.
 - 2 Electrad grid leak mounts or equivalent.
 - 2 Electrad 10,000-ohm grid leak type resistors or equivalent.
 - 1 amperite and mounting. (Size determined by tubes used.)
 - 1 National .0005 tuning condenser or equivalent. C1.
 - 1 Silver-Marshall 30 henry choke or equivalent.
 - 10 battery clips.
 - 2 .00025 fixed condensers, C2 and C3. Aerovox or Sangamo.
 - 1 .0001 fixed condenser, C3. Aerovox or Sangamo.
 - 1 Electrad 20-ohm strip type resistance, R4.
 - 4 4-prong sockets.
 - 1 5-prong socket.
 - 1 Hammarlund 85 mh. choke or equivalent.
 - 1 Silver-Marshall 131Y coil.
- Condensers for tone control as explained in text.

Actual Verified Performance



New Standards Again Set by the Lincoln De Luxe 31

SELECTED by men of international fame who want the best.

APPROVED by prominent Engineering Colleges.

VERIFIED by unbiased published laboratory reports.

Lincoln Engineering has never produced any sensational discoveries, but has conservatively offered to the discriminating buyer radio performance which has been made possible by years of research work.

AND NOW comes the new De Luxe "31" with all of the proved superior qualities of the De Luxe "10" with added features: High grade cadmium plated steel chassis; Six screen grid tubes with high gain perfectly controlled; Completely shielded antenna and oscillator coils; Phonograph attachment utilizing the finest audio system known; Local and long distance switch; Absolutely no A.C. hum. Price: Chassis and power unit (no tubes) \$190.00.

Think of 312 verified stations logged on the De Luxe in Brooklyn, N. Y. This exceptional performance has been published repeatedly in New York papers by enthusiastic owners.



Lincoln De Luxe B-31

DISTRIBUTION: Made only thru qualified distributors. Many of our distributors are making from \$200.00 to \$400.00 a week. When you sell the De Luxe "31" you not only are selling verified performance, but you are getting the co-operation of everyone in our nine-year-old Corporation, who, together with hundreds of our good friends and authorized distributors, have put Lincoln equipment into many of America's most prominent and wealthy homes. If you are qualified to handle and service this equipment, write for full information and special demonstrator discounts.

LINCOLN RADIO CORPORATION
Dept. N 329 S. Wood Street Chicago

FREE "101 Radio Hookups" See Page 372

JOHN F. RIDER

announces
A personally written and personally conducted
ADVANCED HOME STUDY COURSE
for serious minded

RADIO SERVICEMEN EXPERIMENTERS
PROFESSIONAL SET BUILDERS

who wish to increase their earning power, prepare themselves for future radio developments and better their financial condition.

JOHN F. RIDER, 1440 Broadway, New York City
Dear Mr. Rider: Please send me all details about your SPECIAL HOME STUDY COURSE without any obligation upon my part.

Name
Address
City State

Backstage in Broadcasting

(Continued from page 362)

Makes Your Radio BEHAVE!

ENJOY steady radioperformance with uniform volume undisturbed by the everchanging house electric supply.



The new AMPERITE for electric radio smooths out current fluctuations automatically. Requires no attention.

Insist on AMPERITE in the electric radio you buy or build. Install AMPERITE in the set you now own.

FREE — Useful AMPERITE Bulletin. Write Dept. RN 10, naming set you now have.

AMPERITE Corporation
561 BROADWAY, NEW YORK

AMPERITE Self-Adjusting LINE VOLTAGE CONTROL

The CROSLEY ROAMIO AUTOMOBILE RADIO RECEIVING SET

RESONATOR TRADE MARK Over 40,000 Satisfied Users



Now, Only \$3.95 Complete

Are you bothered with a lack of selectivity and power in your set? If so, this is the instrument you need. The Resonator is recommended for all sets having an untuned antenna or ballast tube. Attaches across aerial and ground leads, without tools in less than a minute.

It will enable you to tune sharper and plays with dance volume, stations which are barely audible without it. Attractively constructed from hard rubber and bakelite in a highly polished rich mahogany color. Leading dealers carry this item in stock or order direct. If you are not thoroughly satisfied after a three days' trial, your money will be cheerfully refunded. Ref. Fargo Nat'l Bank. Dun's or Bradstreet's.

F. & H. RADIO LABORATORIES Fargo, N. Dakota

Dept. 90 I enclose check or money order for \$3.95 for which send me a Resonator postpaid.

Send Resonator C. O. D.
Send Dealer's proposition.

Name.....
Address.....
City..... State.....

papers!" at 17 minutes past eight, then he must say that line at that time when the show is on the air. If there is variance either way, the production man knows that his presentation is not running according to schedule and he must either slow down or speed up his players to make the production end on time.

The tempo of the play is set during microphone rehearsals, too. There must be no pauses without reason and the show can never lag or it will lose its audience. Radio tempo, because there is nothing to hold the attention of the audience except the appeal to the ear, is somewhat faster than stage tempo.

There is a story told about a clever actor who had made a name for himself on Broadway and who decided to "go radio." He was used in several productions and then was never called again. His tempo was not constant. His speed of reading lines during rehearsals varied from the speed he used while the production was on the air and as a result the director was never sure when his play would end. The actor couldn't correct what was a serious fault in radio and returned to the theater where three minutes more or less aren't so important.

The last rehearsal usually is held within four hours of the time the show goes on the air. Sometimes the players rehearse right up to the time for broadcasting, though directors as a rule prefer to let them rest before going on the air. In this last rehearsal different scenes are given a final polishing and if the actors have the feel of their parts it is an easy-going affair.

There is no "Belasco touch" to broadcasting, unless one considers the musical chimes that introduce the call letters of stations associated with the NBC. The lights in the studio are not dimmed nor does a gong sound to attract the attention of the audience to the stage. An announcer strolls to the microphone, glances at a clock and calls for silence. He throws a few switches in a black box and then reads the opening announcement. The name of the play, something about its setting and a few other important facts are included in this opening announcement. The names of the players usually are announced at the close of the production.

There is no last minute rush to take places on the stage. The actors who are to speak first are grouped casually at microphones scattered around the studio. There is no frantic scurrying around to see if all the properties are in place. In fact the quietest time in the studio is the moment before a play actually goes on the air.

The wings in a radio studio are chairs placed along the walls. The actors relax when they aren't at the microphone. They follow the play with their scripts, going to the microphone when their cues near.

Smoking is not permitted. Radio actors, to use an old expression of the theater, don't "chew the scenery."

Even though they may have very emotional parts there is no bellowing for the microphone won't stand for bellows. The experienced radio actor knows he can raise his voice by merely moving near the microphone.

Many of the spoken lines cannot be heard across the studio for the skilled radio actor knows that words spoken scarcely above a whisper but very close to the "Mike" can be heard clearly by the radio listener. Use of a low soft voice is said to bring out pleasant lower tones not detected in ordinary conversation.

While the play is on the air, the director keeps one eye on his stop watch, checking the progress of the play against the notes on his script. He also watches his actors to see that they remember to keep their proper distances from the microphone.

The play moves on and the players discard page after page of their scripts on the floor where they will be out of the way. The big scene is acted and there is no storm of applause to tell them that it has "gone over."

The closing announcement is made and then the announcer waves his hand to signify that the curtain has fallen—that the studio is off the air. There may be a few minutes of post mortems and then the actors drift away—some to rehearse for another play, others out of the studio and home.

Perhaps a few telephone calls of congratulations are waiting. Sometimes there are telegrams of applause. The real applause will come several days later through the mails when the fan letters come in. There may be a paragraph of comment in a column of radio criticism the next morning but these columns are few and far between. Since radio plays are heard but once, many newspapers see no reason in reviewing them.

The financial rewards of a career in the theater of the air are not comparable with the income that goes with stardom on Broadway. However, a good actor can make a steady income twelve months out of the year which is more than many find in the theater. The National Broadcasting Company permits an actor to work in two shows in one night, providing they are on different stations or networks. As a result some actors appear in five or six dramatic programs each week.

Much has been written and said about microphone technique but there is no real mystery about it. A trained actor, provided he has sincerity, intelligence and good fiction has every chance of succeeding in radio. However, the supply of radio actors at the present time is far in excess of the demand. Amateurs are not encouraged by the big broadcasters.

Microphone technique was once summed up in a very few words. Walter Hampden, noted actor, was to speak over a National network. He arrived in the studios five minutes before he was to go on the air and admitted he hadn't the

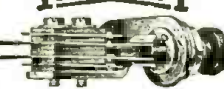
(Continued on page 365)

**HAVE YOU SEEN OUR
RADIO BARGAIN
BULLETIN No. 31?
HERE ARE A FEW OF THE
ITEMS IT CONTAINS:**

- THORDARSON DOUBLE FILTER CHOKE, Model T-2425, contains two 18 Henry 250 Mill Chokes.....\$6.25
- FILTER CHOKE—30 Henries—120 Mills.....\$2.00
- POWERIZER 180-VOLT B-ELEMENTATOR.....\$8.00
- DUHLIER 1 1/2 MID-HIGH VOLTAGE FILTER CONDENSER BLOCK, D. C. Working Voltages 1000, 600 and 400.....\$3.75
- SAMSON "PAM" No. 16, TWO-STAGE POWER AMPLIFIER (less tubes).....\$38.50
- THORDARSON HIGH-VOLTAGE POWER TRANSFORMER—250 Watts—for 2-UX-250 or 210's, and 2-CX-250 Tubes.....\$5.75
- THORDARSON HIGH-VOLTAGE POWER TRANSFORMER—175 Watts—for 1-CX-250 or 210 and 2-CX-251 Tubes.....\$4.25
- RCA POWER TRANSFORMER for CY-234 Screen Grid and UX-245 Power Tubes, Type 350.....\$3.75
- KOLSTER—K-5—ELECTRO-DYNAMIC SPEAKER, complete with 210 or 250 Power Amplifier and "A" Supply Unit in Cabinet, List \$175.00 (less tubes).....\$26.50
- The New GOLD KATHANODE UNIPOWER 6-VOLT Automatic Radio, "A" Power, from light socket.....\$9.75
- DUHLIER 1 MID-HIGH VOLTAGE FILTER CONDENSER, D. C. Working Voltage 600.....\$1.80
- R. C. A. POWER TRANSFORMER No. 8335 For Radiolas 33, 18 and 17, Single Plate Filament Voltages for four tubes, one 257, and one 171-A and 250 tubes.....\$3.75
- R. C. A. TWO STAGE AUDIO TRANSFORMER PACK Part No. 5907, For Radiolas 33, 18 and 17, Ratio of each Transformer 3-1.....\$1.95
- ARROYO 7 MID-HIGH VOLTAGE FILTER CONDENSER BLOCK, D. C. Working Voltages 1000, 800 and 400.....\$3.25
- JEFFERSON STEP-DOWN TRANSFORMER, 110 V. to 113 V. at 1-1/2 Amps.....\$1.00
- THORDARSON SONORA POWER TRANSFORMER, Single plate and filament voltages for four 257's, one 257, two 245's and one 250 tubes.....\$3.75

AMERICAN SALES CO.
19-21 Warren St., New York, N. Y.

YAXLEY Push Button Switches



In a wide range of multi-spring combinations, Yaxley construction throughout. Now, in the following numbers:

- No. 2001—Make Contact.....\$1.00
- No. 2002—Break Contact.....1.00
- No. 2003—Single Pole, Double Throw.....1.15
- No. 2004—Two Make Contacts.....1.30
- No. 2005—Two Break Contacts.....1.30
- No. 2006—Double Pole, Double Throw.....1.60


YAXLEY MFG. CO.
Dept. N 1528 W. Adams St. Chicago

ACME WIRE PRODUCTS

Parvolt Filter and By-Pass Condensers, Magnet Wire-All Insulations, Varnished Insulations, Coils.

THE ACME WIRE CO.
NEW HAVEN, CONN.

ELLIS MICROPHONES



Model 29N and 30N, \$75.00 list. Approved by every high grade Amplifier Manufacturer in the country. Used by Broadcast Stations and Public Address Systems everywhere. Complete line of stands, coils, etc. Write for descriptive literature and name of nearest jobber.

ELLIS ELECTRICAL LABORATORY
337 W. Madison St. Chicago, Illinois

MASON, FENWICK & LAWRENCE
PATENT LAWYERS
600 F St., N. W., Washington, D. C.
Estb. over sixty years. Send sketches. Electrical, Aeronautical and Chemical Inventions carefully handled. Practice before the U. S. Courts and the Patent Office. Prompt and careful service. Write us. Protect your inventions.
TRADE MARKS REGISTERED

Backstage in Broadcasting

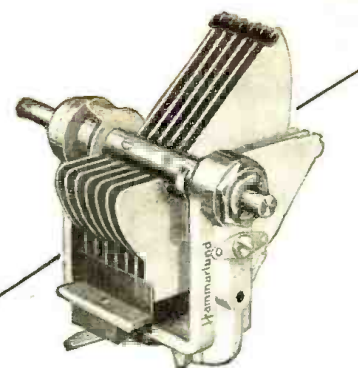
(Continued from page 364)

slightest idea of how to talk to a microphone.

Vernon Radcliffe, a production man assigned to coach Hampden, had to think fast.

"It is like this," Radcliffe explained, taking the actor to the microphone. "Consider the microphone the ear of a friend. If you are going to speak in a low voice, get close to that ear. When you raise your voice step back as if you were talking directly to him. Just treat the 'mike' courteously and it will do the rest."

It did and Hampden could find a job waiting for him at any time in the radio studio.



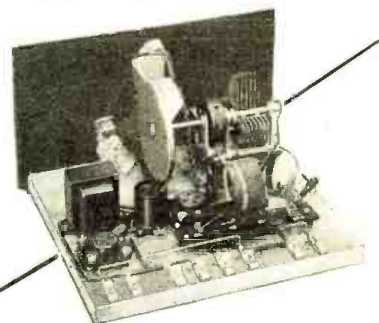
A New and Better Condenser For SHORT-WAVE Work

Heavy, widely-spaced plates for strength. Less chance for accumulation of dust affecting capacity changes in close tuning.

"Parmica" insulation, the remarkable new material which so closely matches the ideal dielectric efficiency of dry air. Current loss greatly reduced; sensitivity and selectivity improved.

Double cone, smooth-operating bearings—easily adjusted for wear. Non-corrosive brass plates, with tie-bars. Strong aluminum alloy frame.

A real short-wave condenser in the three most desirable sizes: 150—125—and 100 mmf.



Here's Fun for the SHORT-WAVE Fan

A remarkably efficient two-tube distance getter, with regenerative detector and one audio-stage. Designed for use with the new 230-type, 2-volt battery tubes. Easily constructed from the Hammarlund kit, containing all parts, as illustrated.

It includes the famous Hammarlund Drum Dial, the new Hammarlund wide-spaced short-wave "Midline" condenser and the improved Hammarlund space-wound plug-in coils. Extra coils are available covering wave bands from 10 to 225 meters. Makes a wonderful tuning unit for the short-wave experimenter.

Write Dept. RN10 for Details of Hammarlund Short-Wave Equipment.
HAMMARLUND MFG. CO.
421-438 W. 33rd Street, New York

For Better Radio
Hammarlund
PRECISION PRODUCTS

Book Reviews

Television Today and Tomorrow, by Sidney A. Moseley and J. H. Barton Chapple. Isaac Pitman & Sons. \$2.50.

Television is a very promising art: in fact, little to date has been accomplished but promises. Laboratory experiments galore, and very interesting ones, too, but when one waits for the commercial television that has been for years "just around the corner," one feels that verily he is on the lane with no turning.

"Television Today and Tomorrow," by Sidney A. Moseley and H. J. Barton Chapple, gives every impression of being a publicity release from one of the companies interested in the commercialization of television. It contains much material on how television should work, but very little of practical value. Its most comprehensive parts are its defenses of past failures.

However, the authors may be forgiven a little, when we realize that they are looking to the future with hopeful expectation, as we all are.

Reviewed by George E. Fleming

Radio and Its Future. Harper Brothers. \$4.00.

Capably edited by Martin Codel. "Radio and Its Future" gives one a good insight into just how the machinery of this industry, which in a few years has grown to gigantic proportions, is run. The book is a collection of papers written in turn by various experts in every phase of the art.

Divided into five parts, Broadcasting, Communications, Industry, Regulation, and Some Scientific and Other Considerations, and further subdivided, every subject is thoroughly covered by such men as Merlyn Hall Aylesworth, Maj.-Gen. James G. Harbord, E. H. Colpitts, Hiram Percy Maxim, Capt. Stanford C. Chooper, David Sarnoff, O. H. Caldwell, William C. Grunow, James Couzens, Lee De Forest, and many others equally as well versed in their particular lines.

Reviewed by George E. Fleming

CONTROL Counts Most!

BABE RUTH recently wrote that "Control makes a pitcher and lack of it breaks him." Simple . . . easily understood.

In radio it's also a case of CONTROL. That's where CENTRALAB comes to bat with a Volume Control that is as smooth as Dizzy Vance's pitching—yet as powerful as Babe Ruth's slugging.

CENTRALAB volume controls in millions of radio receivers are making this a nation of red hot radio fans.



Write Dept. 225-G for Free Booklet, "Volume Control, Voltage Control and Their Uses."

Centralab

CENTRAL RADIO LABORATORIES
Dept. 225-G 22 Keele Ave. Milwaukee, Wis.

Riding the Roads with Radio

(Continued from page 321)

Electrically, the receiver is of simple but reliable design. It makes use of three stages of tuned R. F., a screen-grid detector, one resistance-capacity coupled audio stage and one transformer coupled stage. All the parts are mounted on a formed and drilled aluminum chassis or foundation unit. Six tubes are employed: four 224's, one 227 and one 245. Plate voltage must be supplied by three 45-volt "B" batteries. The 245 tube, used as the output valve, works quite satisfactorily with only 135 volts on the plate and 22½ on the grid, being much more convenient than a 171A in this position, because its 2½-volt filament can be ganged very nicely with that of the preceding 227.

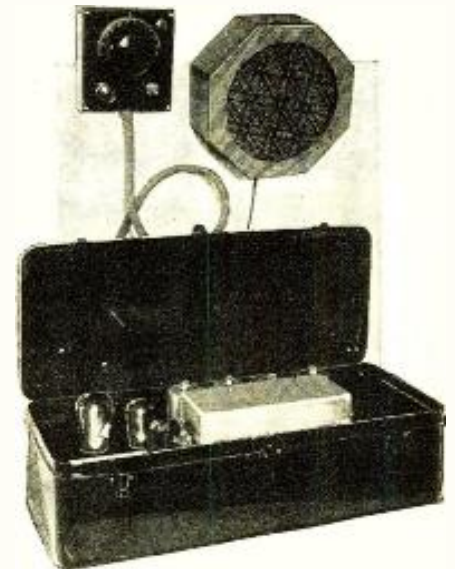
R.F. Gain High

The radio-frequency gain in this receiver is pushed quite high and little attention is given to selectivity because this matter is taken care of automatically by the necessarily small antenna that is used. For an aerial, a pair of wires strung between the front and rear axles, under the car, has been found very effective. Where the shielding effect of the chassis is too great, a piece of copper screening may be tacked to the inside top of the car, or a wire run around the edges of the running boards.

The "Auto Pilot" kit does not include a loud speaker, a "B" battery container or spark-plug interference eliminators. However, a special flat speaker of the

rear floorboard. The size and construction of this box will depend on the particular batteries on hand and the number of obstructions under the board. The choice of the ignition attachments is also left to the purchaser of the kit.

The left running board has been found to be the best place for the "Auto Pilot,"



In this photograph are shown three of the four main elements of an auto-radio installation, the control mechanism, speaker and receiver. The fourth item is the battery container. Because of its all-steel construction, this receiver may quite readily be mounted on the running board of a car

CORWICO VULCAN LIGHTNING ARRESTER

Also Ejects Static Charges
Improving Reception



The Corwico Vulcan Lightning Arrester is manufactured in accordance with a new engineering principle that protects your radio against damage from lightning and also dissipates accumulated static charges. Buy one today for lightning protection and better reception.

At Your Dealer's or Direct
Upon Receipt of Price.

See the Corwico Display
RADIO WORLD'S FAIR, NEW YORK, SEPT. 22-27
Section K.K. Booth 5

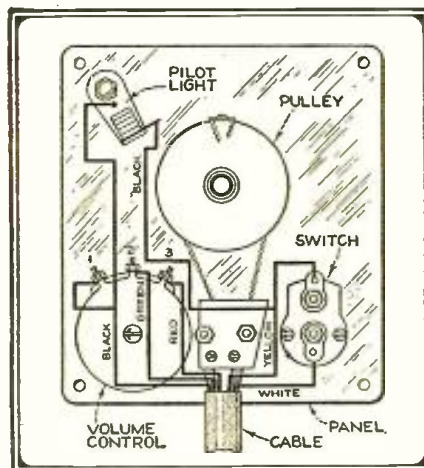
CORNISH WIRE CO.

24 Church St. New York City

MAKERS OF THE FAMOUS



BRAIDITE HOOKUP WIRE



Here are the layout and wiring details of the control board. A pulley and chain afford rotation of the tuning condenser shaft

cone type is available as a separate accessory. The Pilot people feel that every car presents an individual problem as far as the placement of the "B" batteries is concerned, and leave its solution to the owner of the vehicle. The batteries may be placed under the rear seat, in the rumble seat of luggage carrier, or in a box suspended from the

as the left doors are used very much less frequently than the right ones. Holes are merely cut in the step-plate and the floorboard to pass the cable, and the case is bolted down. When the cover is closed the case looks like a perfectly innocent toolbox, and will not invite tampering by the inevitable small boys.

The right runningboard may be used just as well as the left, as the accompanying illustrations show.

The control box may be placed in any convenient position, the instrument board being the preferred place. The box should be mounted as close as possible to either side of the car, to prevent the cable from interfering with the movement of the driver's or passenger's legs.

The "Auto Pilot" has been tested thoroughly and has proved to be sensitive, selective and sturdy. Sample sets have been driven thousands of miles in four representative cars: a Ford sedan, an Oakland coupé, a Hudson roadster, and a La Salle coach.

The price of the "Auto Pilot" kits is \$47.50. This includes the case, the control panel, the cable and all the hardware and special parts, but no tubes, loud speakers, or batteries. Detailed instructions for assembly, installation and operation are furnished.

RADIO NEWS S-W Superheterodyne

(Continued from page 368)

It will be to the advantage of both to spend a little time helping to educate these people into the ways of short waves and the fruits of such labors will come in due time. We shall have plenty of short-wave programs from different parts of the world and in justice to everybody interested, let it not be a big hollow bubble like that which attempted to cram television down the throats of the public even before television had come out of its diapers in the experimental laboratory. Television of today is so far ahead of that flop of three years ago, that one would hardly recognize it—yet there isn't that awful ballyhoo.

Without presuming to forecast, it is to be expected that by the time this last article reaches its readers, we all will see the biggest program of superheterodyne activity that has ever appeared in radio and no one should be surprised to find a short-wave superheterodyne in the lot.

News from the Manufacturers

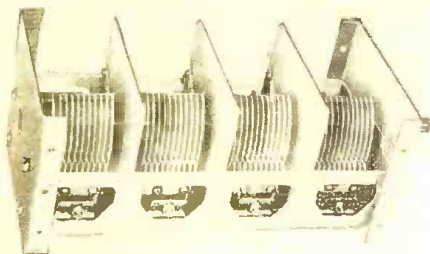
(Continued from page 333)

of the Midget is 7¼ inches and it can be mounted in a space 8½ inches wide by 4¾ inches deep. This new unit is suitable for operation with amplifiers using type -71 or -45 tubes connected either singly or in parallel or in push-pull.

In the Concert Junior model an entirely new design of moving coil assembly is used. While this unit can be installed in the same size space as required for the Midget its construction is more sturdy. It can be mounted either through the cone housing or by means of a supporting bracket which is an integral part of the unit. Both units are available for operation with a.c. or d.c. current.

Shielded Condensers

The Precise Products, Inc., 254 Mill Street, Rochester, N. Y., is manufacturing a new line of completely shielded condensers with capacity specifications as follows: No. 100, single; No. 200, dual; No. 300, three-gang; No. 400, four-gang



(illustrated here); No. 500, five-gang, of .00035 and .0005 capacity.

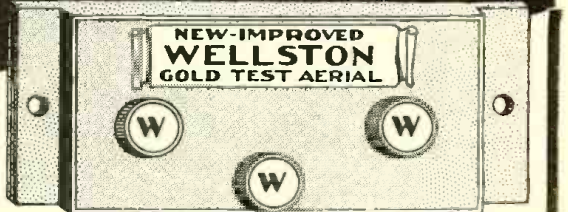
The compensator capacities for these condensers have a variation of 1 mmfd. to 30 mmfd. The foregoing capacities on the condensers do not include the com-

(Continued on page 370)

ANNOUNCING THE NEW. IMPROVED WELLSTON GOLD TEST AERIAL

The
World's
Smallest
Aerial
2½ by 5 inches
in Size

Patent
Pending



This Amazing New Invention Takes the Place of All Present Type Aerials and Improves Radio Reception!

The New Improved Wellston Gold Test Aerial has been heralded far and wide as one of the great test innovations introduced to the radio industry during the past decade. And such praise is well deserved. This startling invention not only eliminates the necessity for all present type indoor and outdoor aerials, but IMPROVES radio reception as well. This new improved aerial follows closely upon the success attained by its predecessor—the original Genuine Wellston Gold Test Aerial which, at present, is giving excellent service in the homes of thousands of Radio owners throughout the country.

It Will Never Wear Out

The new improved Wellston Gold Test Aerial is made of genuine solid, emerald green Condensite with binding posts to match. It is a filtered type aerial and has a capacity equivalent to 64 feet of aerial wire, 50 feet high in the air. This small, compact aerial—it measures 2½ by 5 inches in size—is absolutely NON-DIRECTIONAL, NON-CORROSIVE and WILL NEVER WEAR OUT. The Wellston Gold Test Aerial does away with all lightning hazards and because it does not connect into a light socket all AC hum and line noise are eliminated. Not fully efficient on battery sets.

Easy to Install

It is a simple matter to install the Wellston Gold Test Aerial—even a child can do it in less than a minute's time. No extra tools are needed. Place it anywhere—inside or on the back of your radio cabinet if you wish. Once installed no further attention is required. It is fully efficient at all times.

For Sale by Leading Radio Dealers Everywhere

Price \$2.50

THE WELLSTON RADIO CORP., Dept. 100, St. Louis, Mo.

SOUND SYSTEMS for SCHOOLS By AMPLEX + LOFTIN-WHITE

SPECIALLY designed rack and panel equipment—by AMPLEX plus Loftin-White—meeting those exacting requirements of Educational Institutions: Quality, Simplicity and Low Cost. Here, in one complete foundation unit, flexibly and efficiently arranged—a sound system capable of furnishing programs from radio, phonograph or microphones from one or more locations, to a selective system of one to twenty, or one to forty speakers, including monitor speaker. Quality—well, it's all Loftin-White by AMPLEX plus complete matching of all units, resulting in a practically flat fidelity curve. Volume—all and more than ever required. Distortionless and humless. Efficiently arranged for ease of installation. Simplicity of design and operation eliminates need of a technician. Flexibility and interchangeability of panels, so that equipment may be enlarged as requirements demand, without obsolescing any parts. Built with the usual AMPLEX high safety factor, insuring a minimum of servicing, plus longevity. Lower in cost—and markedly superior.

ENGINEERING COUNSEL—as recognized amplification authorities, further enhanced by exhaustive laboratory and field study of the sound systems requirements of educational institutions, hotels, air-ports, parks and small auditoriums, AMPLEX offers a complete engineering counsel service, WITHOUT CHARGE. Send sketch and details of your proposed installation—we will give you expert counsel and quotations—FREE.

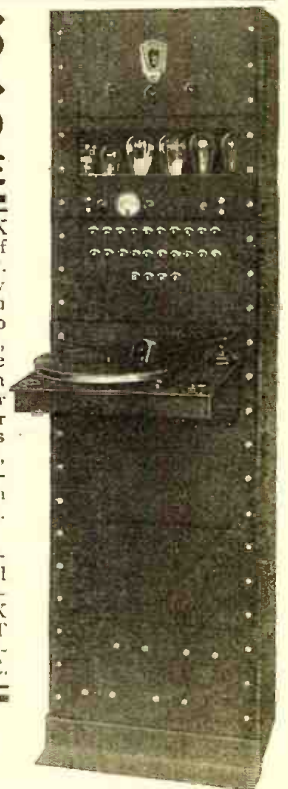
A booklet describing AMPLEX I-W Amplifiers and Sound Systems, from single '45 to 50-Watt output and rack and panel models, now available.

Amplex

INSTRUMENT LABORATORIES

132G West 21st Street

New York, N. Y.



Model RPM 20—List. \$895
Licensed under Loftin-White patents pending.

An Interesting and Profitable proposition for responsible Installation Engineers, Custom Builders, Service Men, Dealers, Contractors. More sound systems sales, bigger profits and better results. Protected territories. Write in detail to our General Manager.

All-Purpose Short-Wave Receiver

(Continued from page 329)

may also be taken from one cell of any convenient motor-car or boat battery—or even a motor-cycle battery. For more permanent locations the new Philco single-cell storage battery supply, developed for the 230 series of tubes, is excellent.

Plate supply may be from suitable "B" substitutes but batteries are recommended. Three heavy-duty "B" blocks will serve for a year's ordinary use.

For International Broadcast Reception

The ease of handling and good sensitivity make the set especially useful to the international broadcast fan. Unlike other sets a coil is provided to go down to 9 meters, thus including the very low-wave French stations. At the same time—if short waves do not produce results one may always shift to the ordinary broadcast band. While a set with but two tuned circuits cannot pretend to deal with extreme interference conditions as well as a standard set with 4 or 5 tuned circuits, none the less the set has selectivity unusual with so simple a structure and satisfactory reception from station can usually be counted on.

The power levels at the headset jack and the speaker posts are so proportioned that a strong headset signal becomes a strong speaker signal when the phone plug is pulled out; there is no violent jump or need for readjustment.

The tuning effect of the regeneration control has been made so small as to be negligible in broadcast reception, thus avoiding most of the difficulty of "clearing up" a station.

The SW-5 is useful for either c.w. or phone amateur reception. There is a coil for each band and the small size of the tuning condensers, together with their 270 degree travel and the smooth non-metallic vernier dial drive produces an ease of operation not customary in the more specialized "band covering" receivers. At the same time one has the advantage of some actual selectivity ahead of the detector, not being compelled to depend on "beat-note selectivity" which is helpless before noises, thumps and strong signals. The r.f. stage gives a gain which rises gradually from the vicinity of 12 meters until it flattens off around 80 meters, then having a value comparable to that obtained in good standard broadcast stages. The screen-grid leak detector shows much higher sensitivity through the whole range than do other detectors.

The use of two coils of the same sort for each range greatly facilitates the process of jumping from band to band and the single-control speeds up the process of searching over any one band after a call.

Other familiar amateur tuner difficulties have been avoided or greatly decreased. The regeneration control has been adjusted to give a small tuning effect, useful as a vernier—but no more. The choke coil deadspot is not present. The antenna deadspot is not encountered except with an excessively large antenna, poor tube and wrong battery voltage—usually all three must appear together to obtain

the effect. The possibility of using a small receiving antenna makes breaking operation simple. Changing tubes does not shift the tuning range—the logbook is still correct, or very nearly so. Even with a long ground lead hand capacity is absent. Finally—the 5 coils covering the amateur bands are represented by OVER FOUR FEET of tuning scale!

Coil Arrangements

The coil ranges are so located that exchanges are not necessary in any band, except the standard broadcast one where rapid traverse is never necessary.

The coils marked ** are standard equipment with the set, either a.c. or d.c.

Catalogue Number	Wave-length Range	Purpose
10	9—15	International broadcasts; commercial signals; amateur 28 megacycle band.
11**	14—25	International broadcasts; commercial signals; amateur 14 megacycle band.
12**	23—41	International broadcasts; commercial signals.
13**	38—70	International broadcasts; commercial signals; amateur 7 megacycle or 7000 k.c.
14**	65—115	International broadcasts; amateur 3.5 megacycle or 3500 k.c. band.
15	115—200	Amateur 1.75 megacycle or 1750 k.c. band.
16	200—360	Regular broadcasts.
17	350—550	Regular broadcasts.

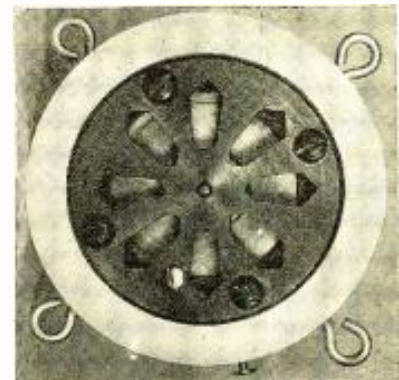
News from the Manufacturers

(Continued from page 369)

pensating capacity but include the minimum capacity of the condenser unit. The adjustment of the variable element of the compensator is at ground potential. The compensator is so designed that it may be mounted on the right- or left-hand side of the condenser case.

Double-Button Carbon Microphone

Miles Reproducer Company, 45 W. 17th Street, New York, is manufacturing



a heavy-duty double-button carbon microphone which operates on any voltage from 1½ volt upward. It has a frequency characteristic of from 60 to 7,000 cycles.



THE WESTON Model (555) Counter Tube Checker

Here is a valuable scientifically constructed instrument for radio dealers who desire to keep down their service costs and insure customer satisfaction by selling only thoroughly tested radio tubes.

With this checker, tubes may be tested accurately and quickly, thus preventing "come-backs" and "profit-less" service calls.

Model 555 has sockets for UX, UY and A. C. screen grid tubes; a six-point filament voltage dial; four push-button switches; and two 3/4 inch diameter Weston meters—an A. C. voltage and a "tube test" meter.

Weston Model 555 checks all types A. C. and D. C. tubes and '80 and '81 type rectifiers. It tests A. C. screen grid tubes and both plates of '80 type rectifiers (at one time) without the use of adapters. Indicates shorts between the filament and cathode.

Write for descriptive literature

WESTON ELECTRICAL INSTRUMENT CORPORATION
615 Frelinghuysen Ave. Newark, N. J.



YOUR 1st Consideration SHOULD BE

FLECHTHEIM SUPERIOR CONDENSERS FOR THE NEW FILTER

The Very Finest Made

250 V. D.C. to 5,000 V. D.C.



"Over 50 per cent. of the broadcast stations in the U. S. A. use Flechtheim Superior Condensers."

Write for Catalog No. 22

A. M. FLECHTHEIM & CO., INC.
138 Liberty Street, New York City, N. Y.

Enjoy **SHORT WAVE** reception on your radio.



“THE SUBMARINER”
Short wave reception from all parts of the world is now possible with the SUBMARINER.
No need to buy a special short wave receiver when the SUBMARINER will bring to reception at a fraction of the cost.
Plug in on your present broadcast receiver. Versatile tuning device with a ratio of 10 to 1 makes tuning exceptionally easy, thus enabling you to pick up stations otherwise impossible to get. The SUBMARINER made since 1926 is completely shielded—a quality product throughout.
Price: Regular model AC or DC, fixed wave band 19-50 meters, \$17.50. Interchangeable coil, 13-14.5 meters \$22.50. The feature, an exclusive “Submariner” achievement, gives five times the volume of any other adapter. AC or DC, prices as follows: Fixed wave band, 19-50 meters, \$22.50. Interchangeable coil, 13-14.5 meters, \$27.50. In ordering give model of set and numbers on tubes in it. Five-prong tube for AC receivers recommended for short waves, \$2.50.
Will be sent prepaid on receipt of price, or C.O.D. if \$1.00 accompanies order. Foreign orders, add 60c postage; no C.O.D.
J-M-P MANUFACTURING CO., INC.
3416 Fond du Lac Ave. Milwaukee, Wis., U.S.A.

✓ FREE BOOKS of BUSINESS HELPS

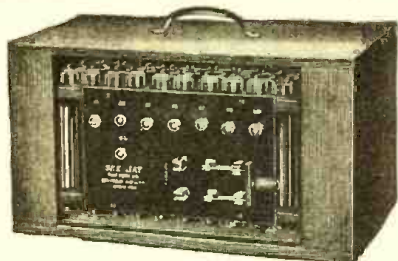
We publish over 200 Home Study Books, each a complete treatise of its subject. We have one or more for you. Books on

- | | |
|--|---|
| <input type="checkbox"/> Commercial Art | <input type="checkbox"/> Decoration |
| <input type="checkbox"/> Lettering | <input type="checkbox"/> Automobiles |
| <input type="checkbox"/> Advertising | <input type="checkbox"/> Battery Work |
| <input type="checkbox"/> Sign Making | <input type="checkbox"/> Electricity |
| <input type="checkbox"/> Radio | <input type="checkbox"/> Carpentry |
| <input type="checkbox"/> Aviation | <input type="checkbox"/> Building |
| <input type="checkbox"/> Painting | <input type="checkbox"/> Contracting |
| <input type="checkbox"/> Silk Screen Process | <input type="checkbox"/> Sheet Metal Work |
- and many other subjects. All fully described in our FREE CATALOG. Check the subjects in which you are interested and write today.

FREDERICK J. DRAKE & CO., Publishers
Room 510—179 No. Michigan Blvd., Chicago
Drake books are for sale in all book stores

“Dependable ‘B’ Battery Power”

For long and short wave receivers. Prices reasonable. Also “B” batteries operating from 32 to 110 volt D. C. farm lighting systems.



Write for our free interesting booklet. See Jay Battery Co., 911 Brook Ave., N. Y. C.

AUTO RADIO
Built-Up—Kits—Accessories
PILOT RECEIVERS
In Kit Form Or Completely Constructed
New Low Prices on Standard Tubes
Write for New 1930 Catalog of Standard Parts and Supplies
NELSON ELECTRIC COMPANY
Wholesale Radio Apparatus
508 South Dearborn Street, Chicago, Illinois

\$375 **RCA SPEAKER CHASSIS**
A wonderful value. Used in Models 100A and 100B Radios. Speakers which sold as high as \$30.00. Made by General Electric Co. Limited quantity. Order by check, money order or stamps. Send for **FREE RADIO CATALOG**
RADIO SURPLUS CORP.
56 N. Vesey St., New York

Superheterodynes to the Fore

(Continued from page 332)

In Fig. 3 is depicted the schematic circuit of the receiver, which may be examined, progressing from left to right. At the upper left end of the circuit is located the first r.f. transformer or antenna coil, which is seen to have a primary with only one tap, as well as a secondary. It is customary in a transformer of this type to employ two taps on the antenna coil primary, one for long and one for short antenna, but with a superheterodyne under present broadcast conditions it is relatively important that the antenna coil primary should not resonate near the broadcast band, as is customary in t.r.f. receivers, but that it should resonate at approximately 150-200 kc.

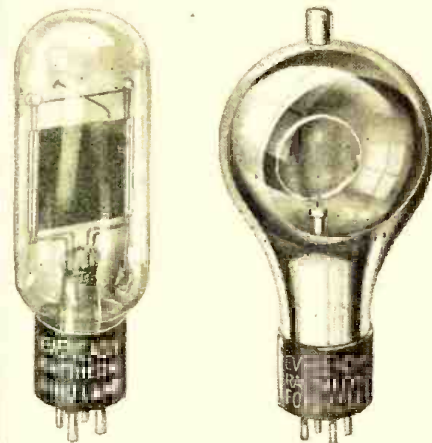
The secondary of the antenna coil is tuned by one 400 mmfd. section of the three-gang condenser and is arranged to cover a range of from 550 to 1500 kc. This secondary circuit feeds into a -24 r.f. amplifier which is operated at a plate voltage of approximately 250 volts—the values recently recommended by R.C.A.—and with a negative bias available to control volume. The -24 r.f. tube is coupled to the first detector coil by means of a choke and an extremely low capacity—approximately 4 to 5 mmfd.—to insure the least possible loading of the detector circuit by the preceding tube capacity. Directly below the detector circuit, which employs a tuning condenser and secondary coil similar to that in the r.f. amplifier stage, is the oscillator circuit, using a -27 tube, tapped secondary and tickler. This coil is appreciably smaller than the coils employed in the r.f. and detector circuits, though the tuning condenser is still 400 mmfd., as the oscillator must operate at all times at a frequency 175 kc. above that of the first detector and r.f. circuits. In practice it is not practical to so proportion the oscillator coil and condenser with respect to the first condenser and r.f. coils so that the oscillator will track with the other circuits—that is, be 175 kc. above these other circuits at all adjustments of the gang condenser. The oscillator coil and condenser are, therefore, so proportioned that the oscillator circuit tracks only over the middle of the frequency range and diverges slightly at both high and low ends. This, in turn, is compensated for by one fixed and two trimming condensers in the oscillator circuit.

Oscillator Circuit

Looking at the oscillator circuit, it will be seen that at the lower left is represented the oscillator section of the gang tuning condenser (c) and, shunted across it to the right, is the alignment condenser (C11) employed to bring the oscillator circuit into line at the high-frequency end of the range. Directly above these two condensers will be seen one fixed condenser at the right (C12), shunted by a trimmer (C13) at the left. This is a relatively large value of fixed condenser, being approximately the size of the tuning condenser and trimmer which shunt it. It is used to align the oscillator at the low-frequency end of the range. The de-

(Continued on page 374)

» FOR PRACTICAL JOBS



EVEREADY RAYTHEON TUBES FOR TALKING PICTURES, TELEVISION AND ALL INDUSTRIAL PURPOSES

THE Eveready Raytheon Foto-Cell is a long-life transmitting tube for talking pictures and television. It is being used more and more for such industrial purposes as color matching, paper testing, automatic counting, control of illumination and many others. It comes in several types or can be made to specification.

Eveready Raytheon Kino-Lamp is the first television receiving tube developed commercially that will work with all systems. Each tube is thoroughly tested in our laboratories.

Write, if you are interested in talking pictures, television or any application of the Foto-Cell. Free—Eveready Raytheon Technical Bulletin No. 1, for the Kino-Lamp, and No. 2, for the Foto-Cell.

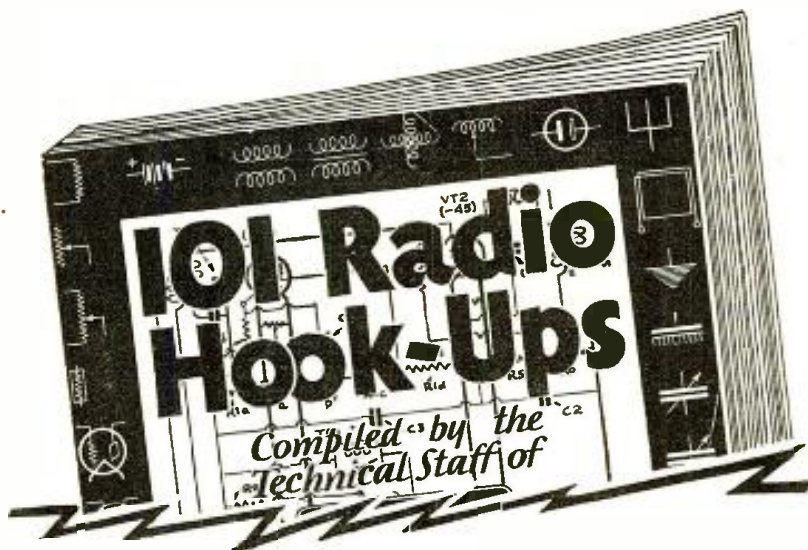


The Eveready Hour, radio's oldest commercial feature, is broadcast every Tuesday evening at nine (New York time) from WEAJ over a nation-wide N. B. C. network of 30 stations.

NATIONAL CARBON CO., INC.
General Offices: New York, N. Y.
Branches: Chicago Kansas City
New York San Francisco
Unit of **UCC** and Carbon Corporation
Union Carbide Corporation



Trade-marks



FREE This Big New Radio Book with 6 Months of RADIO NEWS only!

NOTE—This Gift Offer, announced in last month's RADIO NEWS, was intended for one month only. But so many hundreds of readers have asked that the time limit be extended, that we have decided to fill all orders as long as our supply of books holds out!

HERE'S a big brand new book that every radio fan, set owner, set builder, service man and experimenter has been eagerly looking for! In it we present a cross-section of the latest progress made in every phase of radio reception, to serve both as an ideal source of reference and as a stimulant for even greater achievement.

As the book's title indicates, it contains complete schematic diagrams and thorough descriptions of Short-Wave Transmitters and Receivers, all the most popular types of Manufacturers' and Home-Built Receivers, Serviceman's Test Apparatus and a Group of the New Loftin-White Direct-Coupled Amplifiers. Below are a few of the more than 101 sets included in this invaluable book, which will be shipped to you **ENTIRELY FREE!**

- Radiola No. 33
- HFL Mastertone Colonial Model SG32
- The Stromberg-Carlson Screen-Grid Receiver
- Zenith 34P and 342P.
- Hammarlund Roberts HiQ 30
- Grebe D.C. No. SK-1
- Atwater Kent No. 35
- Silver Marshall Automobile-Radio Receiver
- Lincoln 8-80 Superheterodyne 10-Tube
- Silver Marshall Auditorium Power Amplifier
- National Screen-Grid Short-Wave
- 4 Loftin-White Direct-Coupled Amplifying Systems
- Cornet Short-Wave Receiver

- A Short-Wave Adapter for Use on an A.C.-Operated Receiver
- Bosch No. 48
- Fada No. 35B
- Freshman Q15 Jackson NJ-30
- Pilot A.C. Short-Wave Super-Wasp
- Kolster K-21
- Majestic No. 180
- Stewart-Warner Series 950
- Victor Radio Models R32 and RE45.
- Test Panel for Radio Serviceman or Radio Laboratory
- Tube Tester Eliminating Need of Batteries
- An Audio-Frequency Oscillator
- A High-Power Crystal-Control Short-Wave Transmitter

Other diagrams and descriptions cover complete receivers or units thereof used in virtually every field of radio activity.

The New Loftin-White System

No single radio development in recent years has received the attention now being given the Loftin-White System. It has provided us with a new, cheaper and better method of reproduction and one which, from the standpoint of true radio and mechanical engineering, offers some really astounding possibilities. Their ingenious system has been incorporated with remarkable results in many of the circuits contained in this publication. As RADIO NEWS has the exclusive right to the publication of articles by Messrs. Loftin and White, this authoritative, first-hand information is not obtainable from any other source.

Get Your FREE Copy NOW!

As you can readily see from the copy you are now reading, RADIO NEWS is deservedly the outstanding leader of all radio magazines. Of course, you want it every month. Here's your opportunity to get 6 big issues (\$1.50 single copy value) for only \$1.00—and to have this big new manual, "101 Radio Hook-Ups," shipped to your home, postpaid, entirely free. You save 50 cents on RADIO NEWS and get the book **WITHOUT COST!** Risk nothing—

-----Mail Coupon TODAY!-----

RADIO NEWS, Dept. 2410,
381 Fourth Avenue, New York, N. Y.

Gentlemen: Send me, **ENTIRELY FREE**, postpaid, the new completely revised 1930 edition of your book "101 RADIO HOOK-UPS" and enter my subscription for the next Six Big Issues of RADIO NEWS at only \$1, which I enclose (regular price \$1.50). I understand you will cheerfully refund my \$1 and I may keep the "101 RADIO HOOK-UPS" if I am not perfectly satisfied after reading the first issue.

Name

Address

City and State

Are you a Serviceman ? Engineer ? Dealer ? Experimenter ?

Present subscriptions will be extended from expiration.

Laboratory Report

(Continued from page 320)

all objections to "microphonic" noises so prevalent in the earlier types—and all types are made with the oxide-coated type of filament, considerably reducing the hazard of paralysis.

As soon as these tubes were available an installation was made in Receiver No. 18 for test. To furnish additional data, this second test was run, using four Burgess No. 2308 45-volt blocks of "B" battery. This type of battery is of much lower rated capacity than those used in the previous test and represents a battery of the lower price class. In using these tubes all rheostats and other filament circuit resistances were removed and the tubes operated on direct connection to a single two-volt storage cell without adjustment. Most satisfactory operation has been secured in this manner and actual tests show that at the rated voltage of 2 volts, the total current drain of a set of the six proper tubes is well under one-half ampere. These tubes will operate without noticeable fluctuation in sensitivity or volume over the usual voltage range of a storage cell, 2.1 to 1.8 volts.

"B" Battery Service

Curve VI shows the "B" battery voltage and the voltage at the tube plate terminals at the different periods during the useful life of the battery. Other performance curves remained substantially the same in character as those shown for the receiver when 3.3-volt tubes were used and, for sake of brevity are omitted. It will be noticed from Curve VI that it was possible to use the batteries to a still lower end voltage without excessive loss in quality or volume in the case of 2-volt tubes. This is due principally to the increase in sensitivity of the 2-volt screen-grid tube over its predecessors. While the usual capacity rating of the No. 2308 battery is only about one-third that of the No. 21308 super battery used in the first test, satisfactory performance was secured over a period of 504 hours of continuous service with Receiver No. 18. Allowing 50% increase in service for intermittent operation, six months may be considered as the average period of usefulness provided by this smaller type of battery. It might also be mentioned that the initial "B" battery drain was 28 milliamperes with the 2-volt tubes in this test compared with 21 milliamperes in the first test when 3.3-volt tubes were used.

Fewer Battery Leads

Another point which has become a considerable source of trouble and irritation to not only the purchaser of a battery set but also to the dealer and serviceman is the ever-increasing and changing number of battery leads without a semblance of standardization, a misplacement of one or more of which is easily made and which renders the set inoperative temporarily if not causing actual damage to the receiver itself. In the

design of Receiver No. 18 this fault has also been kept in mind. It has been previously described how the necessity for all "C" batteries is eliminated. In addition to this, fixed resistances of proper value have been used to secure the proper plate voltage for the detector and first audio tubes and also for the shield-grids, rather than the use of taps on the "B" battery. By these means the battery leads have been reduced to a total of four, *i.e.*, a pair for the "A" battery and a pair for the "B" battery. The resistances also form a part of the filter system. It also has the advantage of placing an equal load on the entire "B" battery and, in the case of the well made batteries, the lives of all units are practically the same and all are ready for discard at the same time, removing the necessity of frequent testing. This idea also includes the possibility of the efficient use of a single 180-volt "B" battery without taps.

Circuit Diagram

The accompanying circuit diagram shows all the important circuit constants. These constants are those used with the 3.3-volt tubes. Slight changes in the biasing resistors and the elimination of the filament rheostat are the only necessary changes to adapt this set to the use of the new 2-volt tubes. A change in method of volume control to the antenna circuit may be found more desirable since, in the position shown, biasing potentials on the tube grids are slightly affected by the setting of the volume control.

A brief general description of Receiver No. 18 may be of interest. The circuit is composed of two conventional stages of the screen-grid radio-frequency amplification followed by a tuned detector stage of the condenser-leak type which is followed by two stages of transformer-coupled audio amplification. The first stage is a standard single-tube circuit, while the second stage is of the push-pull type. The plate circuit resistances are of such a value as to reduce the plate voltage of the detector to about 67.5, that of the first-stage audio tube to about 90 volts, and that of the shield-grid to a maximum of about 45 volts (67.5 for the new 2-volt series). All circuits are well filtered with by-pass condensers and chokes. The choke in the last audio stage has thus far been found necessary, but there is a possibility of reduction in the amount of filtering in the r.f. stages, particularly if the r.f. amplifier is confined to two tuned stages. All resistors for biasing are calculated from the plate current ratings of the tube manufacturers at an operating voltage of 135. The automatic biasing action takes care of any excess voltage during the first few hours of operation. In the first test all tubes were of the 3.3-volt filament class. Two each of types -22A, -99 and -20 were used. In the second test two each of the types -32, -31 and -30 were substituted.

(Continued on page 380)



*Answering the Latest Demand
of the Industry—*

a Jensen Electro-Dynamic Speaker for Automobile and Mantle Type Radio Sets—or other Installations where the Finest Tone Quality, Size of the Unit and Low Price are Major Considerations.

Jensen
MIDGET SPEAKER

The new Jensen Midget Speaker, Model D-11, has all the exclusive Jensen features, but with a cone diameter of only 7 $\frac{1}{2}$ inches. The entire speaker can be mounted in a space 8 $\frac{1}{2}$ inches wide by 4 $\frac{1}{4}$ inches deep. Due to the efficiency of the magnetic structure, the field coil dissipates a minimum of current, yet has an unusually high degree of sensitivity.

This new Jensen Speaker is suitable for operation with amplifiers using type 171 or 245 tubes connected either single, in parallel or in push-pull.

In spite of the small size and low price of the D-11, its performance meets fully the Jensen standards of brilliance, sensitivity and uniform response at all frequencies.

The New
JENSEN CONCERT JR.
Electro-Dynamic Speaker

The new Jensen Concert Jr. can be called the De Luxe model Speaker for Automobile and Mantle type Radio Sets and similar installations. Its dimensions are the same as the Model D-11 except that it has a larger size magnetic structure. It is equipped with the new TYM-FLEX Conc. an exclusive Jensen patented feature.

LIST PRICES

Model D-11 Jensen Midget Speaker, 90 to 110 Volt, D.C., \$15.00. Model D-10 Jensen Concert Jr. Speaker, 90 to 110 Volt, D.C., \$18.50

Both of these Speakers are also available for other voltages, either DC or AC.

Licensed under Lektophone Patents

Write or wire today for Jensen Folder No. 33 describing these two new Electro-Dynamic Speakers. Address,

JENSEN RADIO MFG. CO.
6601 South Laramie Ave.
Chicago, Ill.

CHIRAD

OFFERS SILVER-MARSHALL

S.-M. 724 SUPERHETERODYNE

is a 5 screen grid battery-operated receiver with 9 tuned circuits; AC or DC operation.

S.-M. 714 TUNER

Successor to the Sargent-Rayment 710 and 712. Single dial operation with 11 tuned circuits.

S.-M. 738 SHORT-WAVE CONVERTER

makes a superheterodyne out of any broadcast receiver. Single dial operation.

S.-M. 770 AUTO RADIO

is a small sensitive 3 screen grid receiver easily installed without cutting the instrument panel.

NEW NATIONAL SHORT-WAVE

A new powerful AC or DC operated receiver. Tunes in foreign stations with remarkable regularity on wavelength range of 15 to 550 meters. Complete Receiver, or in Kit form.

AUTO-RADIO

Kits, Sets and Accessories

1930 CATALOG FREE

Set Builders! Write for your copy. Complete line of short-wave supplies, standard parts and accessories.

CHICAGO RADIO APPARATUS CO.

415 S. Dearborn St., Dept. RN, Chicago, Ill.

Superheterodynes

(Continued from page 371)

velopment of this type of circuit was primarily empirical, but the net results are extremely satisfactory, inasmuch as by the two individual trimmer adjustments, substantially non-reactive, it is possible to align the oscillator both at the high and low ends of its frequency range. These adjustments made, it will track properly throughout the center of its range. The leak resistance R2 keeps the oscillator grid at the desired d.c. potential, while the resistance R3, which may be likened to the grid suppressor often found in t.r.f. receivers, tends to equalize the oscillator output so that it feeds approximately 6 volts to the first detector. The oscillator is coupled to the first detector inductively through the proper placement of the first detector and oscillator tuning coils. The -24 first detector tube is automatically biased, but in order to insure a more constant value of bias than would be obtainable through the use of the common grid-plate return resistor in the -24 circuit alone, the oscillator plate current is also bled through this resistor, though the drop across this resistor biases the first detector only, the grid potential of the oscillator being determined entirely by the resistor R2 connected between oscillator grid and cathode. The first detector feeds into the first i.f. transformer, which differs from the two following transformers in that it provides very much sharper tuning. Its actual selectivity is determined by the position of switch SW which, in one position, shorts out resistor R4 which is seen to be in the tuned secondary circuit of the i.f. transformer; it also disconnects R3, in shunt with the primary of the first i.f. transformer. In this position, the tuning of the first i.f. transformer is extremely sharp and the gain is approximately 28 to 30 through the first detector. With the switch in the opposite, or local position, R3 is shunted across the i.f. transformer primary and R4, then connected in series with the tuned secondary circuit, which results in an appreciable broadening of this transformer and a reduction in gain in about a twenty-to-one ratio. The purpose of the local-distance switch is to allow reception of local programs with an extremely high order of fidelity when switch is in local position and to provide the maximum possible gain or selectivity when switch is in distant position.

The first i.f. transformer feeds into the first i.f. tube which, in turn, feeds into the second i.f. tube feeding the third i.f. transformer and then into the second detector. All of these -24 tubes are operated at 250 volts plate and approximately 90 volts screen—the new recommended values. Resistor R5, by-passed by C3, biases the second i.f. tube, while the first i.f. tube cathode is joined to the cathode of the r.f. tube and brought to ground through resistance R11. The 170-ohm resistor determines the minimum fixed bias on these two tubes, while R12, the variable resistance of 12,000 ohms, provides necessary bias adjustment. This provides extremely satisfactory control of

(Continued on page 377)

NEW BISMARCK HOTEL

A MODERN hotel where the hospitality of yesterday is enhanced by the cheering luxuries of today.

Light, airy rooms—beautifully furnished and providing home-like comfort.

Famous for good food.

Rooms \$2.50 up
With Bath \$3.50 up.

Write for booklet
with downtown map.

RANDOLPH AT LA SALLE

CHICAGO

RADIO OPERATORS WANTED



Radio operators are officers aboard ships. Well paid, pleasant work, travel. You can qualify in a short time in our well-equipped school under expert instructors.

Write now for free booklet on "Opportunities in Radio."

West Side YMCA

Radio Institute

113 West 64th St., New York, N. Y.

AN INCOME BUILDER



Two distinct lines in one. For either salesmen or those mechanically inclined.

\$50.00 value for \$6.00

with profits accordingly large

We can provide you with unlimited quantities of all leading makes of Electric vacuum cleaners at sensationally low prices; each guaranteed perfect in action and appearance. Such extreme value and profit offers any man of average intelligence a splendid income even for spare time.

Free Vac Course

To our associates we give, in bound book form, free expert advice and seldom disclosed instructions in building and servicing all vacs. Through this free training you may readily develop a permanent, well-paying business all your own. From our immense resources we supply all needs. At trifling cost and no risk you can prosper with us, the originators. Oldest and largest in the line. Literature tells all.

URON ASSOCIATED INDUSTRIES
1311 Engineers Building Cleveland, Ohio

WANTED MEN

To Manufacture Metal Toys and Novelties



Big demand for Toy Soldiers, Animals, 5 and 10c Store Novelties, Ashtrays, etc. We cooperate in selling goods you make also buy them from you. Small investment needed to start and we help you build up. WE FURNISH COMPLETE OUTFITS and start you in well paying business. Absolutely NO EXPERIENCE and no special place needed. A chance of a life time for man with small capital.

CHRISTMAS RUSH is now starting, so if you mean strictly business and want to handle wholesale orders now being placed, write AT ONCE for full information. METAL CAST PRODUCTS COMPANY
Dept. 12 16% Boston Road, New York City

OCTOBER ISSUE NOW READY!

Radio Bargain News
BUY FOR CASH AND SAVE HALF

DEALERS AND SERVICEMEN
Write for Your FREE Copy of this BIG Catalog
40 PAGES
OVER 1,000 ITEMS

Free Write

FEDERATED PURCHASER
20 HUDSON STREET, N. Y. C.

Radio's Biggest Values

Up-to-the-minute offerings at lowest wholesale prices. Includes newest Tone Control, Screen Grid Superheterodyne, Radio-Phonograph combinations, short wave receivers, automobile radios, Public address, attractive walnut consoles and latest accessories, parts and kits. Don't buy until you see our big catalog.

Send for FREE Complete Catalog

Western Radio Mfg. Co.
128 W. Lake St. CHICAGO

Don Mix—Radio Pioneer Extraordinary

(Continued from page 309)

that by using batteries for plate power in transmitters, one did not need transformers and generators and electric lines. He had in mind transmitters and receivers for mobile use. How near he came to hitting the proverbial nail on the proverbial head can best be seen by his later accomplishments.

His big chance came in 1923. From a group of radio amateurs and commercial operators suggested as probable candidates for the position, Don was chosen as the first radio operator to accompany an expedition into the Arctic regions. His fine radio work and persistent character had won him a job with the MacMillan Arctic Expedition sailing from Wiscasset, Maine, on the schooner *Bowdoin*.

With the aid of Mr. West, engineer and designer of radio equipment, he assembled his transmitters and receivers. They were built by the Zenith Radio Corporation. His main transmitter used 100 watts and was designed to operate in the 200 to 450-meter band. Small battery-operated portable stations were included in the equipment. These were used to communicate with WNP (the call of the *Bowdoin*). They were placed on sleds in boxes and were invaluable in keeping different sections of the expedition in touch with each other. These battery-operated sets were creations of Mix's.

With the radio gear installed in the forecabin of the ship and the entire radio personnel of the expedition (one Donald H. Mix) in good spirits, they set sail on a balmy day in June. It was Don's first sea trip and he, with the self-restraint so well known to radio operators, was not seasick. He later attributed this to the fact that he received excellent food during the entire voyage.

The hardships were great. During intense spells of cold, Don grimly stuck to his key and kept MacMillan in touch with civilization. During these periods he wore heavily padded gloves to keep his hands from freezing. They had to be flexible for the work he did.

Note how he laconically described his brief swim in the icy waters surrounding the ship, in his written report on his activities: "During the last week in September (1923), as the ice had frozen around the ship sufficiently to hold it in a permanent position, we took the original antenna down and put up a cage inverted-L of 6 wires, 6 inches in diameter, running it in a southerly direction. While putting this antenna up I absent-mindedly walked on a soft spot in the ice alongside the ship and fell through, taking a rather cool bath." He then goes on to describe the new antenna. In one sentence he described an experience that would have killed another person. He does not tell us of the fact that he spent the next few days "thawing out." - His was just a swim, an accidental "cool bath."

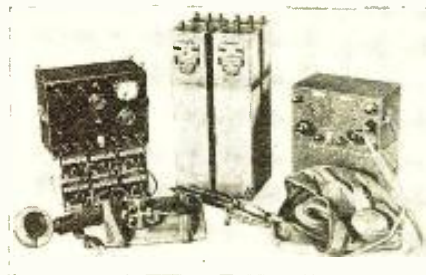
Until September, 1924, he proved his ability to be the connecting link between the MacMillan Expedition and the civilized world. He supplied his "boss" with the latest press dispatches from the

United States and supplied the United States with the latest press dispatches from his "boss" with the help of a score of amateurs.

Among other things, Don established a few records. He communicated with 6CEI in Hawaii, using a wavelength of 200 meters, and his signals were reported heard in New Zealand with a surprising consistency. He experimented with low-powered battery-operated transmitters and successfully communicated with stations in the United States while using these. He further demonstrated that the short waves could successfully be used in the Arctic regions. And Don learned one other thing. Dry batteries were not affected by the intense cold. That furthered his faith in the use of batteries.

When he returned, Donald Mix was accorded a hero's welcome. He deserved it.

In 1925 his true dreams were realized. He took a position which enabled him to



Portable short-wave radio transmitter and receiver developed for airplane use by the Burgess Radio Laboratory

continue with his experiments with batteries—joining W. H. Hoffman, Fred H. Schnell and Phil Zurian in the radio research department of the Burgess Battery Company.

Here he came into his own. He aided in the development of short-wave transmitters and receivers—all battery operated. His beliefs that batteries could successfully be used to communicate over remarkably long distances were found true. He found that pure, steady, d.c. signals could penetrate to greater distances than other types of radio "tones."

Don sponsored a low-power "B" battery transmitting contest which was won by Windom of W8GZ. W8ZG of Columbus, Ohio, who successfully carried on two-way communication with New Zealand while using but 45 volts on the plate of a small receiving tube. This was verified and witnessed and still stands as the modern low-power distance record in radio annals.

Through his own station, W9AT, in Madison, Wisconsin, Don is known "on the air" for his pure and steady signals. He built and installed his own station, W4DM, on Burgess Isle, Florida. His aid in building the Burgess station W9EK-W9XH at Madison was beneficial in making that station known as the

(Continued on page 376)

New Developments!

Complete Instructions and Data on All Recent Radio Inventions Now Yours for Ready Reference in This One Big Guide Book of Radio.

BYRD'S Antarctic Radio Equipment—Receivers, transmitters, and latest navigation aids used on this epochal flight fully described.

TELEVISION—Mr. C. F. Jenkins, father of television and radio movies, gives you in his own words complete directions for building practical television equipment.

INTERFERENCE ELIMINATION—New methods systematically outlined by W. F. Fleming, radio engineer.

RADIO AUTO ALARM—Description of new device for ships which keeps the SOS watch while operator is off duty.

SHORT WAVE APPARATUS—Commercial and amateur, described and illustrated.

NEW BROADCASTING EQUIPMENT—Temperature-controlled Piezo crystal oscillator; 100% modulation panel and other new apparatus.

—and these are only a few of the new subjects added to the most complete radio handbook ever published.

THE RADIO MANUAL

A Handbook for Students, Amateurs, Operators, and Inspectors



Here's the answer to every question about the principles, operation, and maintenance of apparatus for radio transmitting and receiving. Important new chapters have been added to bring it right up to the minute. Many new photographs and diagrams have been included. It is now more than ever the one complete handbook covering the entire radio field.

A Complete Course in Radio Operation in ONE VOLUME

Prepares for Government License

20 big chapters cover: Elementary Electricity and Magnetism; Motors and Generators; Storage Batteries and Charging Circuits; The Vacuum Tube; Circuits Employed in Vacuum Tube Transmitters; Modulating Systems and 100% Modulation; Wavemeters; Piezo-Electric Oscillators; Wave Traps; Marine Vacuum Tube Transmitters; Radio Broadcasting Equipment; Arc Transmitters; Spark Transmitters; Commercial Radio Receivers; Marconi Auto-Alarm; Radio Beacons and Direction Finders; Aircraft Radio Equipment; Practical Television and Radio Movies; Eliminating Radio Interference; Radio Laws and Regulations; Handling and Abstracting Traffic.

Prepared by Official Examining Officer

The author, G. E. Sterling, is Radio Inspector and Examining Officer, Radio Division, U. S. Dept. of Commerce. The book has been edited in detail by Robert S. Kruse, for five years Technical Editor of QST, the Magazine of the American Radio Relay League, now Radio Consultant. Many other experts assisted them.

Examine It FREE!

The 1930 edition of "The Radio Manual" is now ready. Nearly 800 pages; 369 illustrations. Bound in flexible Fabrikoid. The coupon brings the volume for free examination. Within 10 days you may return the volume or send the price of \$6.00.

MAIL THIS COUPON

D. Van Nostrand Co., Inc.
250 Fourth Ave., New York

Send me the Revised edition of THE RADIO MANUAL for examination. Within ten days after receipt I will either return the volume or send you \$6.00, the price in full.

(R. N. 10-30)

Name.....

St. and No.....

City and State.....

RUPTURE IS NOT A TEAR NO BREAK TO HEAL

Rupture is not a tear, but is due to a muscular weakness in the abdominal wall. Trusses merely brace these muscles but do not strengthen them—on the contrary, the gouging of the ordinary truss pad often increases this weakness as it tends to shut off circulation of the blood.

STUART'S ADHESIF PLAPAO-PADS are **patently different**—being mechanico-chemico applicators—made self-adhesive purposely to keep the muscle-tonic called "Plapao" continuously applied to the affected parts, and to minimize danger of slipping and painful friction. The adhesive fabric is **soft as velvet** and clings to the body **without straps, buckles or springs. Easy to apply—comfortable—inexpensive.** Awarded Gold Medal, Rome, Grand Prix, Paris, Honorable Mention, Panama Pacific Exposition, San Francisco, etc. For almost a quarter century stacks of **sworn testimonials** from many different countries report success—**without delay from work.** The epidermatic absorption of Plapao utilizing "mechanico-chemico therapy" tends toward a natural process of recovery, **after which no further use for a truss.**

Stop wasting your time and money on old-fashioned devices. Learn how to close the hernial opening as nature intended, so the **rupture can't come down.** Send no money; just mail the Free Test coupon below. For your own good—write today—tomorrow may be too late.

FREE TEST COUPON

Plapao Laboratories, Inc.
686 Stuart Bldg., St. Louis, Mo.

Send me a Free 10 day test supply of the remedial factor Plapao and 48-page illustrated book on Rupture; no charge for this now or later.

Name.....
Address.....

HOTEL WASHINGTON

PENNA. AVE. 15th & F STREETS N.W.
WASHINGTON, D. C.

400 ROOMS — 400 BATHS

Opposite the United States Treasury and the new \$17,000,000.00 Department of Commerce Building

Easy of access yet located at the very center of life in the Capital City

Rates no higher than any other first class hotel

BOOKLET SENT UPON REQUEST
S. E. BONNEVILLE, Managing Director

"HAMS" AND SERVICEMEN

Donnan 250 watt transformers with Arcoturus line ballast tubes. Primary 110-120 volts a. c. Secondary 1500 volts center-tapped at 750 volts. Filament, 7 1/2 center-tapped 2 1/2 center-tapped at 15 volts. Completely shielded and mounted with terminal lugs on top for connection. \$6.50

High-quality first-class UX type tubes. X806, \$6.00; X250, \$2.15; X281, \$1.60; X210, \$2.05. 30-day free replacement guarantee.

Auto-tastic sets. The smallest and easiest mounting set on the market. Direct drive tuning control. Set uses three 224 screen-grid tubes for r. f. amplification, two 227 tubes as detector, and first audio, and a 245 as a power tube. Price includes set, speaker, aerial, battery box, filter condensers and ignition resistor suppressors. Everything but tubes and batteries. Priced at only \$52.00. All merchandise guaranteed. Cash or C. O. D. Write for free list. 20% with C. O. D. orders.

COLUMBIA SPECIALTY COMPANY

1036 Longwood Avenue New York City

Don Mix—Radio Pioneer

(Continued from page 375)

battery-operated pioneer in the amateur ranks.

Then came airplanes and the use of radio as a means of two-way communication. Here, again, Mix came to the fore. He perfected portable short-wave equipment for aircraft use, showed their practicability. This equipment was not bulky and foolproof. The battery was the keynote of their design. His work along these lines was recognized. He was asked to build six sets for use in the Byrd Antarctic Expedition for communication on dog sleds, airplanes and boats of the expedition. How well he succeeded can be learned by reading the reports of the Byrd operators. The Byrd planes were in constant touch with their bases, and on a few occasions they established communication with New York while in flight over the desolate regions of the uninhabited South Pole area. Small touring parties, out for scientific observations, owe their safety to these battery-operated sets. They aided in saving the expedition from loss of life.

He is still perfecting receiver and transmitter design and, with the aid of Hoffman, has brought about further interesting and useful revisions in dry-receiver construction. It seems as if they never will be perfected with Don Mix "on the job." No matter how perfect he builds his equipment, he always comes up with something new and beneficial in his next experiments.

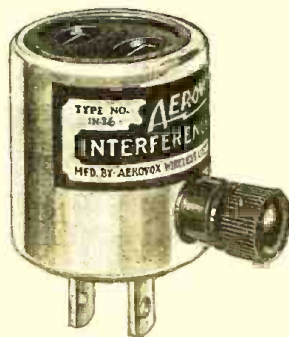
While bringing the battery to the fore, Don earned himself the title of the "Sleepless Wonder." No matter what time of night one were to "listen in," they would hear the familiar "fist" of Don Mix. It seemed as if he operated continuously, regardless of time or sleep.

Possibly an answer to Don Mix's accomplishments can be found in the fact that he is red-headed.



Interference Filter

Aerovox Wireless Corp., 70 Washington Street, Brooklyn, N. Y., announces a new type of interference filter in which a



plug receptacle is provided on one face of the unit and plug prongs on the opposite face. The prongs plug into any
(Continued on page 381)



EARN BIG MONEY

AS A FOOT SPECIALIST

Learn **PEDOPRACTIC**—the new system of correcting foot disorders and deformities without medicine or surgery that's making tremendous strides these days. It's a new uncrowded profession and offers amazing opportunities in an unlimited field. Dignified, interesting and profitable. No thinking man or woman will willingly neglect foot troubles when they produce so much discomfort and disability and can be so easily corrected.

LEARN QUICKLY AT HOME IN SPARE TIME!

With but ordinary education and leisure home study you can quickly qualify for this profession with its social, professional and financial advantages.

EARN WHILE YOU LEARN

The demand for your services will be so great that you can start in your own home and earn the cost of your training while you are studying the course. We teach you how to quickly "cash in" on your knowledge.

You can quickly build up a practice and have an office of your own. It's a wonderful opportunity so act quickly. Clip coupon below, sign your name and address, mail today for full information about this wonderful new science. Do it now. No obligation.

CUT HERE

AMERICAN COLLEGE

Chartered 1915 by the State of Illinois
Dept. P-10 54 W. Illinois St., Chicago

NAME

STREET

TOWN STATE

Make big money AS A SALESMAN

Learn selling—fix your own hours—choose your own field—control your own income—be independent! As a salesman your income depends only on results. Many LaSalle-trained salesmen, in every section of the country, earn from \$5,000 to \$10,000 a year; many much more. A great number started without experience—doubled their incomes the first year. Train in your spare time by the LaSalle Problem Method, under the supervision of expert salesmen. Low cost; easy terms. 64-page booklet, "The Modern Salesman, Ambassador of Progress," free. Send for it today.



FREE

LaSalle Extension University, Dept. 1094-S, Chicago

ROBUN TUBES

Guaranteed for 90 Days

201A—50c. UX 199—75c. UV 199—75c. WD 11—\$1.25. WD 12—\$1.25. 226—65c. 227—65c. 245—80c. 171A—75c. 280—75c. 281—\$1.75. 250—\$2.20. 210—\$2.00. 112A—90c. 224—\$1.25. 125 Mil BH type—\$1.75. 2 Amp. Tungar type—old or new type—\$2.15. 20% with C.O.D. orders.

Write for latest bargain catalog

Nubor Radio, 12K Warren St., N. Y. C.

In October AMAZING STORIES

"The Man from the Moon," by Otis Adelbert Kline. Here is a unique story by this well-known author, in which he gives us some highly ingenious new ideas for interstellar warfare and some original explanations for several phenomena which are still a matter of conjecture—albeit absorbing conjecture—among eminent scientists.

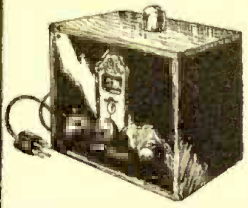
"The Man Who Saw the Future," by Edmond Hamilton. It is more difficult than it would seem at first blush to conjure up even a fantastic picture of the future—if only 50 years hence. It would seem to have been a simple matter for past generations. Read what Edmond Hamilton finds in this excellent short story.

"Skylark Three" (A Serial in three parts). Part III, by Edward E. Smith, Ph.D. If Dr. Smith advocates lightning-like velocity for his heroes' travels through space, he does not fall so far behind in his story writing. Read the final installment of "Skylark Three."

"The Prince of Liars," by L. Taylor Hansen. The author gives us here a story that is totally different from any other "Newtonian" or Relativist yarn we have ever published. And it is beautifully told.

And Other Features

EXPLORE THE SHORT WAVES



WITH THE
**EXPLORER PLUGLESS
CONVERTER**
\$14.50

NO PLUG-IN COILS!
Wave length range 15 to 200 meters; CHANGES WAVE LENGTH RANGE BY TURNING OF A KNOB. The EXPLORER enables you to explore the wonders of modern short wave reception with your broadcast receiver. Stations all over the world are at your disposal on the short waves.

The EXPLORER is a 1930 model, efficient and scientifically improved converter. Beautiful appearance; illuminated vernier dial; shielded tube inertia inside of cabinet; and absence of plug-in coils make it the most convenient of all converters.

Best performance at the lowest price. **GUARANTEED. Sold Direct From Factory.** ORDAN, ROWE, A. C. or D. C. model only \$14.50. Sent postpaid upon receipt of price or C. O. D. plus postage upon receipt of \$1. State whether A. C. or D. C. model is desired. **SEND FOR FREE LITERATURE.**

RIM RADIO MFG. CO.
695 Grand Street Brooklyn, N. Y.

HOTEL LUDY
SOUTH CAROLINA AV. AT THE BOARDWALK
ATLANTIC CITY'S
NEWEST
CENTRALLY
LOCATED
FIREPROOF
HOTEL
\$6.00
DAILY
AND UP
AMERICAN
PLAN
WIRE PHONE OR WRITE R. B. LUDY M.D.

See the Craters in the MOON!
Astronomical and Terrestrial
TELESCOPE
Magnifies 30 Times
Own a genuine Astronomer's Telescope. See thousands of miles away. Make Sun, Moon, Planets. Start your next door neighbors. Moon, Craters, Sun Spots, Eclipses, enlarged 30 times. Strange thrills!
Hours of fun looking at every game, bathing beauties. Great for trips and voyages. Made like telescopes used in observatories. Getting wrote, "Moon seemed 10 yards away."
Price Only \$3.95
Five Days' Free Trial
Rush only \$1.00 now. Pay balance (\$2.95 plus postpaid) when postpaid delivery. Keep 5 days. If not delighted, return telescope and money will be refunded.

EARN \$10 A DAY
Charge 25c to look at the moon
ROLL-O SPECIALTY CO.,
Dept. L-335
220 E. 3rd St., Cincinnati, O.

QUIT TOBACCO
Don't try to banish unaided the hold tobacco has upon you. Thousands of inveterate tobacco users have, with the aid of the Keeley Treatment, found it easy to quit.
KEELEY TREATMENT FOR TOBACCO HABIT
Quickly banishes craving for tobacco. Successful for over 40 years. Write today for FREE BOOK and particulars of our MONEY-BACK GUARANTEE.
THE KEELEY INSTITUTE, Dept. L-608, Dwight, Ill.
Home of the famous Keeley Treatment for Liquor and Drugs. Booklet Sent on Request. Correspondence Strictly Confidential.

RADIO BARGAINS
Low Power Transmitter adaptable for phone or cord. With plug-in coils \$14.75
Auto Radio—Uses 3-334 and 3-227 tubes, single filament, tremendous volume. Compact. Fits any car 20.00
B Eliminator. Bone Dry with 280 tube, 180 volts, will operate up to ten tube set, fully guaranteed. 6.75
AC-A B C power packs 8.75
Power and Filament Transformers for 220, 227 and 171 tubes, with double choke 4.00
Tubes: 1X type, 30-day replacement guarantee. No. 219, \$2.25; No. 22, \$2.35; No. 28, \$1.85; No. 245, \$1.25; No. 224, \$1.25; No. 227, 75c; No. 226, 65c; No. 171, 75c.
CHAS. HOODWIN CO. 4240 Lincoln Ave. Dept. K-3 Chicago

Superheterodynes

(Continued from page 374)

volume and sensitivity, in that not only does it cut down r.f. and i.f. amplification but through cutting down the r.f. gain before signal reaches i.f. amplifier, it reduces the circuit noise due to high gain preceding the i.f. amplifier—and in a receiver of the sensitivity of the one described herewith, where the limiting factor for amplification is really tube noise, this is an important point.

The i.f. transformers consist of small Universal wound coils mounted upon a wooden dowel with primaries and secondaries individually tuned by small compression type mica condensers having a range of approximately 100 to 220 mmfd.

In the first i.f. transformer the spacing or coupling between the primary and secondary coils is quite low, resulting in a very high factor of selectivity, whereas in the second and third stages the coupling is just below critical, so that a response curve with a broad top but extremely sharp steep sides is obtained. This is an extremely important point, for with the selectivity obtained in a receiver of this type coming almost entirely from the intermediate amplifier, the matter of tone fidelity must be guarded very zealously, and were a single humped i.f. stage used, the high audio notes would suffer badly. With the combination employed, however, fidelity of tone control is extremely good up to 4000 cycles, though what sideband cutting there is must be compensated for by a rising hump in the audio amplifier at the higher audio frequencies.

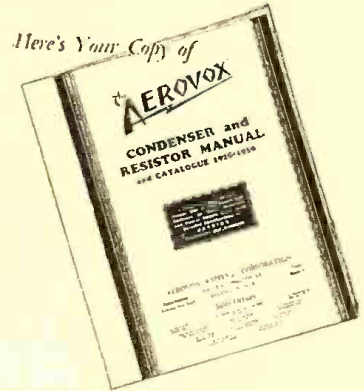
The second detector is operated with a screen potential of 90 volts, plate potential of 250 volts and semi-automatic "C" bias determined by resistor R8, which also determines the bias of the first detector, both biases being held more constant than would be possible with individual automatic bias by bleeding oscillator plate current through the common bias resistor R8, as mentioned above. The second detector plate circuit is filtered by means of two .00015 mfd. condensers, C10, and r.f. choke. The left condenser, or the one running directly from the detector plate to ground, is mounted directly from detector plate to chassis, having one end soldered to the detector plate socket lug and the other lug to the chassis. This is extremely important in order to prevent any loop in the detector plate circuit, from which harmonics of the intermediate frequency might leak back to the first detector or r.f. circuit. The second detector is coupled to the pushpull audio stage by an arrangement consisting of a two-winding choke, the isolating condenser C9, the resistance R6 and the condenser C8, which is shunted by the small audio choke. The purpose of R6 is to function as a grid leak for the power -45 push-pull tube but, being placed in series with C8, which, in turn, is shunted by a small choke, the combination of the three is resonated in such a manner as to provide a rise in audio amplifier curve on the

(Continued on page 378)

AEROVOX

BUILT BETTER
CONDENSERS AND RESISTORS

**Without a Doubt
The Most Complete
CONDENSER and
RESISTOR Line
in Radio**



Sent Free on Request

This interesting and helpful Manual and Catalogue containing a wealth of information on condensers and resistors and complete electrical and mechanical data on the complete line of Aerovox condensers and resistors will be mailed free of charge on receipt of the coupon below.



The Aerovox Research Worker is a free monthly publication issued to keep radio engineers, experimenters and servicemen abreast of the latest developments in receiver and power supply design, and especially with the proper use of condensers and resistors. A request on the coupon below will place your name on the mailing list.

Check and Mail This Coupon

AEROVOX WIRELESS CORP.
78 Washington St.
Brooklyn, N. Y.
Gentlemen:
Please send me without charge or obligation:
() Your 32-page Condenser and Resistor Manual and Catalogue.
() The Research Worker.
Name
Street
City State





"The reporter took the death drop! Trelawney's gun spat lead but a split second before the noose could do its deadly work." Illustration from the \$2.00 book-length story in the October issue of COMPLETE DETECTIVE NOVEL.

A \$2.00 Detective Story for Only 25c

THINK of it! Every month your newsdealer has a brand new COMPLETE DETECTIVE NOVEL waiting for you—just the kind of tense, rip-snortin' thriller that thousands buy at \$2.00 per when it later appears in book form. It costs you—not \$2.00—but only 25c!

If you haven't as yet given yourself one of these enthralling, inexpensive treats, buy the October COMPLETE DETECTIVE NOVEL today! It contains the intriguing "Mystery of

the Murdered Bridegroom," by the world-famous author, Henry Thew Stephenson.

The High Society Gang Leader picks the wrong dupe when she tops off a series of sensational crimes and murders with the killing of the wealthy bridegroom. And crack sleuth Trelawney, on vacation, never came closer to death than when he volunteered as witness at the strangest wedding ceremony ever performed.

Try to solve this exciting book-length thriller—this full \$2.00 novel for 25c—in the October

COMPLETE
DETECTIVE
NOVEL
MAGAZINE
NOW on Sale - Buy it TODAY!

Superheterodynes

(Continued from page 377)

higher audio frequencies, thus effectively compensating for the opposite characteristic due to extreme sensitivity of the i.f. amplifier, even with its broad-topped second and third i.f. transformers. The low value of R6 contributes to this and also tends to equalize the impedance presented by the audio coupling choke over the entire lower and middle audio range, so that the bass reproduction of the combination is extremely pleasing, despite what has heretofore been considered the extreme difficulty of coupling the -24 power detector directly into the push-pull stage (the method here utilized will also be found to be employed in a number of commercial t.r.f. receivers now appearing upon the market). The -45 tubes are coupled to the loud speaker through an output transformer of conventional type.

The power supply consists of the usual multiple secondary power transformer having one filament winding for -24 and -27 tubes and a second for -45 push-pull stage in the center tap of which is placed biasing resistor for the push-pull tubes. It has also a high-voltage secondary winding and a filament winding for the -80 rectifier tube.

The primary of the power transformer has two taps which are brought out to individual sets of clips, so that by shifting the fuses from one set of clips to another, voltage variations of 105 to 115 volts may be handled in one position and from 115 to 130 volts in the second position.

The filter circuit consists of a condenser, C14, of 1 mfd., the choke 339 with its tuning condensers, C15 and 16, and the 2500-ohm field of dynamic speaker and output condenser C17, C16 and C17 having a capacity of 4 mfd. each. The small tuning condenser C15 effectively resonates the 339 choke to approximately 120 cycles, thus effectively reducing the a.c. hum in the first section of the filter to a greater extent than can be obtained with an untuned filter. The overall filtration is so good that in normal operation it is necessary to place the ear practically inside the dynamic speaker cone in order to hear the operating hum. Only one audio stage is employed in the receiver to simplify filtration and obtain the lowest possible final hum level and, in addition, because in a receiver of this type it is far easier to obtain the required gain in the intermediate amplifier than in the audio system.

The overall performance of the receiver is well illustrated by the curves herewith which show a degree of selectivity absolutely unobtainable with any commercially practical type of t.r.f. receiver, with an accompanying selectivity so high as to actually exceed the normal home requirements.

In Fig. 1 the selectivity curve for the first i.f. stage is shown at A, while B indicates the selectivity for the second and third stages. The voltage amplification through the first detector and first dual selector circuits is 28. The second and third stages have been deliberately broadened, as shown in curve B, to improve the

(Continued on page 381)

Some Facts About "B" Batteries

(Continued from page 303)

the curves make them self-explanatory. An example will make clear their usefulness. If three PL 4968 batteries were to be used to operate a small 210 transmitter tube, the plate current drain of which was 40 ma., then from Fig. 2 the batteries would last 190 hours if the transmitter was used about 4 hours a day and if we

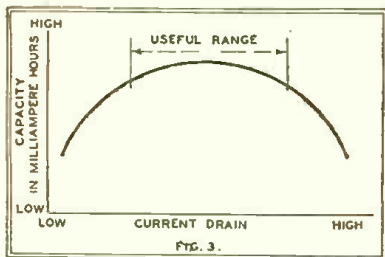
- TABLE 3 -

TYPE 772			
MA DRAIN	6	8	10
HOURS	683	512	410
DAYS	342	256	205
MONTHS	11.5	8.5	7
TYPE 485			
MA DRAIN	8	10	12
HOURS	650	520	433
DAYS	325	260	216
MONTHS	11	8.5	7
TYPE 770			
MA DRAIN	10	14	18
HOURS	800	572	444
DAYS	400	286	222
MONTHS	13	9.5	7.5
TYPE 486			
MA DRAIN	16	20	24
HOURS	625	500	417
DAYS	313	250	209
MONTHS	10.5	8.5	7

figure that an end voltage of 109 volts per battery is the lower limit. Other examples can be worked out in similar fashion.

Most "B" batteries are not used immediately after they are made, but stay on the shelf of the dealer's store for a few months. For this reason it is essential that batteries have good shelf life—in other words, it is important that the battery lose but a small amount of its capacity during the time it is not in use. Shelf depreciation of batteries is due largely to evaporation of the moisture in the battery and corrosion of the zinc. Reducing evaporation is a matter of getting a good seal. Corrosion of the zinc is largely prevented by using very pure metal and by having the inside surface very smooth. Actually the modern battery loses but a small part of its capacity even after many months of idleness on the shelf.

In connection with this matter of shelf depreciation it is interesting to know that



The number of milliampere-hours you obtain from a B battery depends largely upon the amount of current drawn from it. At currents either higher or lower than normal, the capacity falls off, as shown by this curve. Over a certain "useful range" the curve is quite flat and best results are obtained when the battery is operated at some current within this useful range. See Tables 1 and 2

temperature has a very important effect. Increasing the temperature increases shelf depreciation by accelerating evaporation and zinc corrosion. Low temperatures, on the other hand, reduce the shelf depreciation to an exceedingly small quantity, with the result that batteries can be kept for very long times in cold-storage rooms.

The serviceman will appreciate that the rapidly growing field of automobile radio will bring him frequently up against the problem of installing batteries and in other cases of deciding what type of battery will be most economical for use with a set of his own construction. In any case, the data in the preceding pages will be helpful in reaching a solution to the problem. To determine the plate current drain of the receiver the total plate current can of course be measured with a meter; or, more simply, the plate current

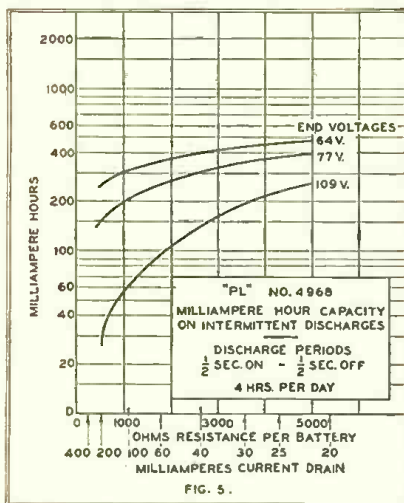
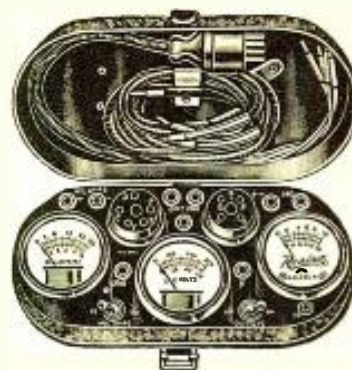


Fig. 5 shows a similar curve for "PL" No. 4968. It will be seen that as the resistance increases the curves flatten out. This indicates that the curve is approaching the zone of maximum efficiency

drain can be calculated, since the voltages at which the tubes are to be operated are known and any standard table of tube characteristics will indicate the plate current of the various types of tubes under the specified voltage conditions. Offhand, it might appear more accurate to actually measure the plate current, but it is really better to figure the plate current from a chart. If the current is measured, an incorrect value might be obtained due to a poor tube in the set or to some improper connection.

Many articles in radio magazines, especially those describing how to build something, end with some paragraphs on "how to look for trouble," although many experimenters probably feel that usually it is altogether too easy to find something wrong. But the precedent is too strong to break and we must therefore conclude with a few notes of warning.

The figures on battery life are based on proper radio equipment and normal operation.
(Continued on page 380)



No. 245-A

Set and Tube Tester

More service men use the No. 245-A tester because it does all necessary field work, is dependable, rugged and most compact. Simple to use. A complete tester for checking all voltages at the socket, also line voltage. Tests all usual tubes. Complete illustrated instructions.

\$12 NET to Dealer No. 245-A
No. 400
\$20 List Each
At Your Jobber's

Readrite



No. 400

Counter Tube Tester

For testing tubes direct from A.C. supply. Simple to use. Gives the required test for accurately determining the condition of all tubes. Attractive baked enamel finish. Full instructions.

Ohmmeters and other radio instruments in our new catalog.

Readrite Meter Works

Established 1904

19 College Ave. Bluffton, Ohio

Stop Ignition and Generator NOISES

EX-STAT
IGNITION FILTER SYSTEM

in Auto Radio

Insure perfect, quiet radio enjoyment while traveling by automobile, motor boat or aeroplane. Quickly installed. No bothersome adjustments, nothing to get out of order.

There are more than 25,000,000 licensed auto owners—all are prospects

Every motorist, motor boat and aircraft enthusiast is a prospect for a radio... but an ignition filter system is absolutely necessary. An Ex-Stat positively eliminates all noises, and radio sets cannot be used without a system of this kind, here is a field for rapid, profitable sales.

Kits list at \$7 for 4 cyl. engines, \$9.50 for 6 cyl. engines, \$12 for 8 cyl. engines. Each kit contains necessary spark plug suppressors, distributor suppressor and special ignition filter condensers, with complete instructions for installation.

Ex-Stat is guaranteed to be effective, or money promptly refunded. Never a dissatisfied customer.

Jobbers, Dealers, Service Men! Write at once for descriptive folder and liberal discounts.

Approved by Radio News Laboratory and auto-radio manufacturers after extensive tests. Endorsements of leading engineers accompany each kit.

If there is no distributor of EX-STAT PRODUCTS in your locality full information can be had from us.

TILTON MFG. CO., (Dept. RN-10)
15 East 26th Street, New York

Latest data on radio receivers for Dealers, Servicemen and Amateurs

The Radio Construction Library

WRITTEN by two widely known radio engineers, these three books cover every phase of building, repairing and "trouble-shooting" on modern receiving sets. This practical library includes: PRACTICAL RADIO—The fundamental principles of radio, presented in an understandable manner. Illustrated with working diagrams. PRACTICAL RADIO CONSTRUCTION AND REPAIR—Methods of locating trouble and reception faults, and making workmanlike repairs. Discusses modern Short Wave Receivers fully. RADIO RECEIVING TUBES—Principles underlying the operation of all vacuum tubes and their use in reception, amplification, remote control and precision measurements.

Three Volumes, 6 x 9—993 pages, 561 illustrations.

See this Library FREE!

No Money Down



McGraw-Hill

FREE EXAMINATION COUPON

McGraw-Hill Book Company, Inc.
370 Seventh Avenue, New York

Send me the new RADIO CONSTRUCTION LIBRARY, three volumes, for 10 days' free examination. If satisfactory I will send \$1.50 in ten days, and \$2.00 a month until \$7.50 has been paid. If not wanted I will return the books postpaid.

Name
Home Address
City and State
Position
Name of Company RN-10-30

Facts About "B" Batteries

(Continued from page 379)

ating conditions. They will not apply under such conditions as:

Leaving the set turned on for a week and then forgetting that you did so.

Using tubes that have abnormally high plate current.

Failing to renew the "C" battery, with the result that the drain on the "B" batteries increases far above normal.

Leaving a pair of scissors resting across the battery terminals overnight.

Testing batteries by shorting them to see if you get a big fat spark.

Tax Law Enjoined

Charleston, S. C.—A temporary restraining order against enforcement of the South Carolina law taxing owners of radio receiving sets has been issued by Federal Judge Ernest F. Cochran, after a hearing on a petition filed by Station WBT of Charlotte, N. C. The order was made in test proceedings instituted by the Radio Manufacturers Association.

Laboratory Report

(Continued from page 373)

The cost of production of a battery-operated receiver following the lines here described should not be materially greater than the average present battery set, while the many advantages are readily apparent. The accompanying photographs show a suggested chassis plan of simple construction. Arrangement of the various units is such that wiring is reduced to a minimum.

Estimated costs of "A" and "B" battery maintenance shows a figure of approximately 1½ cents per hour on the No. 18 Receiver, against 4 to 5 cents per hour for the average present receiver.

Report prepared by Don H. Mix and W. H. Hoffman, Engineering Department.

Parts List

- 3 .00035 mfd. variable condensers, C.
- 5 .1 mfd. low-voltage condensers, C1.
- 2 .1 mfd. 200-volt d.c. condensers, C2.
- 4 1 mfd. condensers, C3.
- 1 2 mfd. condenser, C4.
- 1 .002 mfd. condenser, C6.
- 1 .0002 mfd. condenser, C7.
- 1 10-ohm resistor (5 amps), R1
- 1 75,000-ohm resistor (.0005 amps), R2.
- 1 50,000-ohm resistor (.001 amps), R3.
- 1 18,000-ohm resistor (.0025 amps) R4.
- 1 ½ to 1 megohm resistor, R5.
- 1 980-ohm resistor (.018 amps), R6.
- 1 435-ohm resistor (.018 amps), R7.
- 1 267-ohm resistor (.018 amps), R8.
- 1 100,000-ohm potentiometer, P.
- 1 audio transformer, T.
- 1 audio transformer, T2.
- 1 audio transformer, T3.
- 1 two-circuit switch, S.
- 2 r.f. chokes, L.
- 1 audio choke, L2.

Filtered Aerial

Master Engineering Company, 771 Mathers Street, Chicago, Illinois, an-



nounces a new aerial (¾ inches diameter) which can be mounted quickly with one wood screw anywhere in the radio cabinet, either inside or outside. This aerial has a capacity equal to a 50-foot outside aerial. It is made of polished bakelite and is non-directional and non-corrosive. The Master Filtered Aerial is not a light-socket aerial nor is it in any way connected to the light socket. It requires no lightning arrester.

Dry Electrolytic Condensers

A new type of dry electrolytic condenser for comparatively high-voltage filter work has been announced by the Aerovox Wireless Corp., 70 Washington Street, Brooklyn, N. Y. These new condensers have a maximum peak voltage rating of 500 volts d.c. and have a desirable self-healing characteristic which makes them prove against momentary high voltage surges. The filtering action per microfarad of this type of condenser is equivalent to that of paper condensers of similar capacity ratings, but the sizes of the units are much smaller than for equivalent capacities and voltage ratings of paper condensers. They may be had in all peak voltage ratings up to 500 volts d.c.

Home Recording

A new form of home entertainment that bids fair to be "the life of the party" will soon be placed on the market by the Victor Division, it was disclosed today. Home recording apparatus which will permit anyone to make his own records is incorporated in the new Victor radio-electrola instrument that will soon make its bow to the public.

Describing the new invention, a Victor executive said that home recording "will immortalize the life of the American family." Records can be reproduced electrically "as easily as dictating a letter in your own living room."

Recording is done by a special type of microphone developed by the RCA Victor Company, Inc. Each of the new records will have two playing surfaces of six inches and will be inexpensive in cost. Early in September is the date set for their appearance on the market, it was said.

Superheterodynes

(Continued from page 378)

fideliy. In these stages the amplification at 175 kc. ranges from 65 to 78, depending upon the mutual conductance value of the screen-grid tube used.

The overall selectivity of the intermediate-frequency amplifier, measured from the first to the second detector input, is shown in Fig. 2. This indicates a high order of selectivity and more side-band cutting than can be tolerated for excellent fidelity even with audio compensation in the single a.f. stage. In local position, the intermediate amplifier is made very much less selective, and the fidelity is made at least comparable to that of the best receivers of other designs.

The high adjacent channel selectivity of the superheterodyne is clearly shown in Fig. 3. Here it will be noticed that the band width at "10,000 times down" is only 30 kc., which is very much better than can be gotten in even a six-tuned circuit t.r.f. receiver. Curve "B" shows the overall selectivity in local position when the fidelity is extremely good and it will be noted that even here the selectivity is very much better than can be gotten in the conventional t.r.f. receiver.

Interference Filter

(Continued from page 376)

standard wall socket while the plug of the receiver or appliance can be plugged into the receptacle of the interference filter.

Amplifiers

The Kelly-Wiegand Co. of New York announces a complete line of amplifiers for phonograph, radio and public address work. These amplifiers are all built under the patents of Loftin-White on amplifiers of this nature.

The unit shown in the cut is a two-stage outfit using a -45 tube in the output stage, and a -24 tube in the first stage. The rectifier tube is an -80. The voltage amplification of this little job is



about 450, with a practically flat amplification curve from 40 cycles to 9000 cycles, and is down about 2 db. at 10,000 cycles. This unit is particularly adaptable to phonograph amplification for the home.

This company also builds a complete radio receiver using the Loftin-White system in the audio channel.

SM SUPER-HETERODYNE

Radio's NEWEST SENSATION

at regular **WHOLESALE** discounts

NOW—A SUPER-HET BY SILVER-MARSHALL!

Radio's newest and latest sensation is here—a brand new, 9 circuit, screen grid, custom-built Super-heterodyne by Silver-Marshall (licensed). This great new receiver embodies every modern engineering advancement made famous by the name Silver-Marshall.

A DOUBLE ASSURANCE OF QUALITY

Wholesale Radio Service Company, another great name in Radio, offers the new S-M Super-Heterodyne at regular "Wholesale" discounts. Lowest prices—finest service—your added assurance of quality! Buy S-M equipment from Wholesale Radio Service Company and **SAVE MONEY!**

SEND FOR FREE CATALOG!

The new 1931 Wholesale Radio Catalog is just out! The finest selection of Radio merchandise ever offered—at prices amazingly low. Sent for your copy TODAY—it's free.

WHOLESALE RADIO SERVICE COMPANY, Inc.
"The Reliability House of Radio"

36 Vesey Street Dept. K-12 New York, N. Y.

New 1931 Catalog **FREE**

RADIO NEWS SHORTWAVE SUPERHET

Will Work Right with

OCTOCOILS

Set of 4 Coils \$5.00

2 sets required for this circuit. Covers the shortwave band. The most efficient coils made. If your dealer cannot supply you, we will send, postpaid, on receipt of price. Write for big 32-page Booklet on Television—Free

Shortwave & Television Lab., Inc. Dept. 50
Owners of Station WIXAV
64-76 Brookline Ave., Boston, Mass.



Fascinating-Profitable LEARN TELEGRAPHY This Easy Way—



Thomas A. Edison—Andrew Carnegie—most of the presidents of railroads and other world leaders got their start as Telegraphers. Today—on land—on—in the air—men who know the code are commanding big money—in the world's most fascinating profession.

Learn At Home with TELEPLEX—P. L. E. K.—1st & 6th Master Teacher. Write for Folder E-10.



Teleplex Co. 76 Cortlandt St., New York

Read Classified Advertising—It Pays!!!

Advertisements in this section twenty-six cents a word for each insertion. Name and address must be included at the above rate. Cash should accompany all classified advertisements unless placed by an accredited advertising agency. No advertisements for less than 10 words accepted. Objectionable or misleading advertisements not accepted. Advertisements for these columns should reach us not later than 1st of 2nd month preceding issue.

Agents Wanted

Guaranteed Genuine Gold Leaf Letters anyone can put on store windows. Large profits, enormous demand. Free samples. Metallic Letter Co., 422 N. Clark, Chicago.

Business Opportunities

Amazing screw-holding screw drivers! Remove, insert screws, inaccessible places! Parlors, garages, electricians, mechanics, auto, radio owners buy on sight! Exclusive territory. Free Trial! 1067 Spring Lane, Boston.

Correspondence Courses

Used correspondence school courses sold on repurchase basis. Also rented and exchanged. Money-back guarantee. Catalog free. (Courses bought.) Lee Mountain, Pisgah, Alabama.

For Inventors

UNPATENTED INVENTIONS PROMOTED, protection guaranteed. Sales made on commission basis. Write Box 530, Pasadena, California.

Have you a radio invention or patent to sell? We obtain buyers for radio patents and inventions. Harry G. Green Co., 180 W. Washington St., Chicago.

Help Wanted—Male—Instruction

Detectives—Earn Big Money. Experience unnecessary. Write, American Detective System, 2190K Broadway, N. Y.

Inventions

INVENTIONS WANTED—Patented, Unpatented. If you have an idea for sale write, Hartley, Box 928, Bangor, Maine.

Male Help Wanted

GET outdoor government jobs: \$135-\$200 month; vacation. Patrol forests and parks; protect game. Details free. Write DELMAR INSTITUTE, B-37, Denver, Colo.

Patent Attorneys

PATENTS—Write for Free Instructions. Send Drawing or Model for Examination. Miller & Miller, Registered Patent Attorneys (former Patent Office Examiners), 262 McGill Building, Washington, D. C.

Inventors—Should write for our Guide Book, "How to Obtain a Patent," and Record of Invention Blank, sent Free. Send model or sketch of inventions for our inspection and instructions free. Radio, Electrical, Chemical, Mechanical and Trademark Experts. Terms Reasonable. Victor J. Evans & Co., 922 Ninth, Washington, D. C.

Patents—Advice and booklet free. Highest reference. Best results. Promptness assured. Watson E. Coleman, Patent Lawyer, 724 9th Street, Washington, D. C.

Pocket Radio

Guaranteed "Pocket" Radio \$2.00. Particulars FREE. C. O. D. Shipments made. Nell Tasker, Shamokin, Pennsylvania.

Radio

Majestic model 70 power units, speakers, transformers cheap. Hanch, Florida, Ind.

Wanted—Men to work with National Radio Service organization. No selling phone. Radio Doctors, Inc., Dept. N, Essex St., Salem, Mass.

Song Poem Writers

COMPOSERS—VERSE OR MUSIC. Brilliant opportunity. Write at once. Van Buren, 2141 Michigan Bldg., Chicago.

SONG POEM WRITERS—"REAL" proposition. Hubler, D-191, 2104 Keystone, Chicago, Ill.

WRITERS—Poems, Melodies—opportunity. Tommie Malie, ERG4215 North Ave., Chicago.

Wireless

Learn Wireless (Radio) and Morse telegraphy. School, oldest and largest; endorsed by Telegraph, Radio, Railway and Government officials. Expenses low—can earn part. Catalog free. Dodge's Institute, Cour St., Valparaiso, Ind.

BUILD YOUR POWER-PACKS WITH PUNCTURE PROOF FILTER CONDENSERS

AND ELIMINATE, ONCE FOR ALL TIME, THE DANGER OF HIGH-VOLTAGE BREAKDOWN

Prominent Radio Manufacturers, who have been using Mershon Electrolytic Condensers for years (over 3,000,000 of them in use today), continue to do so, for they provide better filtering, greater reliability and almost unlimited life—at lower cost.

In building power-packs for receivers, transmitters or power-amplifiers (or in repairing them) your problems closely parallel theirs.

You Can Profit from their Experience

THIS NEW BOOKLET SHOWS YOU HOW



It is the most complete, helpful booklet on Electrolytic Filter Condensers ever published. In successive chapters it deals with voltage surge effects, condenser life limits, moisture, safety-valve action, cost and size, and carefully and completely analyzes them from a very practical point of view.

It contains complete descriptions of the newest types of Mershon Electrolytic Condensers, and shows effective circuits for their use. Although priced at 10 cents, it will be sent FREE on request to Radio News readers.

(Sole Manufacturers of Mershon Condensers)

THE AMRAD CORPORATION
340 College Avenue
MEDFORD HILLSIDE MASS.

SEND FOR FREE COPY TODAY

The Amrad Corporation
340 College Avenue
Medford Hillside, Mass.

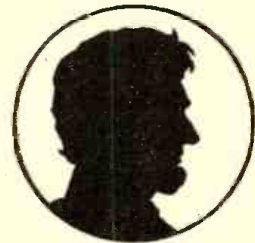
Please send me a FREE copy of your new booklet, "Puncture Proof Filter Condensers."

NAME.....
STREET.....
CITY.....
STATE.....

INDEX TO ADVERTISERS

A	
Acme Wire Co.	365
Aerovox Wireless Corp.	377
Allied Radio Corp.	Inside Front Cover
American College	376
American Sales Co.	365
American Transformer	356-357
Amperite Corp.	364
Amplex Instrument Laboratories	369
Amrad Corp. The	382
Automatic Radio Mfg. Co., Inc.	360
B	
Blan the Radio Man	382
Burgess Battery Co.	291
C	
Central Radio Laboratories	366
Champion Radio Works	355
Chicago Radio Apparatus Co.	374
Chicago Salvage Stock Store	384
Clarostat Mfg. Co.	362
Classified Advertising	381
Columbia Specialty Co.	376
Cornish Wire	366
Coyne Electrical School	293
Crosley Radio Corp.	364
D	
DeForest Radio Co.	351
Drake, Frederick J., & Co.	371
E	
Electrad, Inc.	361
Electric Soldering Iron Co.	383
Ellis Electrical Laboratory	365
F	
Federated Purchaser	374
Flechheim & Co., Inc.	370
F. & H. Radio Laboratories	364
H	
Hammarlund Mfg. Co.	365
Hammarlund-Roberts, Inc.	349
High Frequency Labs.	347
Hoodwin Co., Chas.	377-382
I	
International Correspondence Schools	383
International Resistance Co.	367
J	
Jensen Radio Mfg. Co.	373
J. M. P. Mfg. Co., Inc.	371
K	
Keeley Institute	377
L	
LaSalle Extension University	376
Lincoln Hotel	382
Lincoln Radio Corp.	363
Lady Hotel	377
M	
Mason, Fenwick & Lawrence	365
McGraw-Hill Book Co., Inc.	380
Metal Cast Products	374
Midwest Radio Corp.	345
N	
National Carbon Co., Inc.	371
National Co., Inc.	343-367
National Radio Institute	Back Cover and 359
Nelson Electric Co.	371
New Bismark Hotel	374
Nubor Radio Company	376
P	
Pilot Radio & Tube Corp.	353
Pitman, Isaac, & Sons	368
Plapao Laboratories	376
R	
R. C. A. Institutes, Inc.	339
Racon Electric Co.	362
Radex Press	368
Radio Surplus Corp.	371
Radio & Television Institute	295
Radio Training Association of Amer.	289
Radio World's Fair	355
Readrite Meter Works	379
Rider, John F.	363
Rim Radio Mfg. Co.	377
Roll-O Specialty Company	377
S	
Samson Electric	Inside Back Cover
Sec-lay Battery Co.	371
Shalleross Mfg. Co.	360
Shortwave & Television Laboratory, Inc.	381
Silver-Marshall, Inc.	340-341
Stuyvesant Electric Co.	362
T	
Teleplex Company	381
Tilton Mfg. Co.	380
Triad Mfg. Co., Inc.	358
U	
Uron Associated Industries	374
V	
Van Nostrand Co., Inc., D.	375
Von Hoffman Aircraft School	368
W	
Washington Hotel	376
Wellston Radio Corp.	369
Western Radio Mfg. Co.	374
Weston Electrical Instrument Corp.	370
West Side Y. M. C. A. Radio Inst.	374
Wholesale Radio Service	381
Y	
Yaxley Mfg. Company	365

NEW YORK'S NEW HOTEL LINCOLN



Where modern scientific planning and management make possible rates surprisingly moderate. 1400 Rooms, each with bath and shower.

\$3-5 For One \$4-7 For Two

Telephone Lackawanna 1400

Eighth Ave., 44th, 45th Sts.
Times Square · NEW YORK

WORLD-WIDE SHORT WAVE RECEIVER

ONLY \$6.45

Span the World with this Set!

A new radio thrill for you! Listen in DIRECT to London, Paris, Berlin, Buenos Aires and other broadcasting stations throughout the world via short waves. Enjoy unique foreign programs from strange lands. Your ordinary receiver cannot tune in these low wave stations. WORLD-WIDE RECEIVER gets 14 to 550 meter stations with surprising clarity. **SEND NO MONEY!** Just write your name and address on a postcard and ask us to send you this wonderful guaranteed short wave set. Pay postman \$6.45 plus a small delivery charge. All orders West of Rockies must be accompanied by \$1.00 deposit. Foreign countries must remit in full. Write today!

CHAS. HOODWIN CO.
4210 Lincoln Ave., Dept. K-30, CHICAGO

ALUMINUM BOX SHIELDS

Genuine "ALCOA" stock, silverclad finish \$4.95 \$1.85—General wire \$4

ANY SIZE TO ORDER.

Coil Shields, Coil Hole Cover, Shielded Wire, Dabulier Duratrona, Neon Test Light, 51.00, Midget 3-Plate Condenser, 50c, New 2-colt Tubes, New Hammarlund L.W.T. 4 rolls, Navy Surplus Telegraph Keys 75c, Insulating Washers, 10c 10z., Soft Rubber Grommets, 3 for 5c, Octo Coils, Pilot Coils, Kits and Parts, 65 Other items. Please include postage.

BLAN, the Radio Man, Inc.
890 Cortlandt Street New York City

In Science and Invention For OCTOBER

Win Your Share of \$3,250. . . . Read Our New Contest Announcement

"Hunting Sharks for Meat, Shoes, and Vitamins"—Uthai Vincent Wilcox explains how the terror of the deep is made to yield profits.

"Wonder What a Soaring Pilot Thinks About"—Wolf Hirth, Pioneer International Soaring Champion tells you just what he does think about when in the clouds.

"How to Build a Scout Secondary Glider"—The last installment in Lieutenant H. A. Reynolds' and Herr Martin H. Schlempp's construction series.

"Flashes from the Radio Lab," and "How to Construct the Home Builder's Four Radio Set" for our radio fans.

Chemical Experiments, Machine Shop Hints, Auto Helps, Workshop Kinks, Bedside Table.

A Broadcast Superheterodyne

(Continued from page 323)

outside of the secondary should go to the grid of the succeeding tube. The transformers, as these coils really are, are fastened to the front panel of the intermediate can by brass angles.

The second detector circuit is in reality a portion of the audio system. It is the first tube of a two-tube Loftin-White amplifier. The almost ideal detection characteristics of the Loftin-White system are thus utilized. If one uses a commercial form of the Loftin-White amplifier, as the writer did, the wiring should be removed from the first socket and moved bodily to the socket provided in the intermediate can. These leads should be just as short as possible. The only tricky part of the wiring lies in the input to the tube. Instead of the grid return going to ground, or B—, as is the case in the other stages, it goes to a point on the resistance arm of the amplifier, as shown in the wiring diagram. A by-pass condenser, C11, goes from this point to ground.

Alternate Method

In the event that one desires to place the audio amplifier at some distance from the rest of the assembly, an alternate method presents itself. That is, we may use a power detector in this stage instead of a Loftin-White detector. This system, of course, requires an additional tube. If a power detector is used a -27 type tube, self-biased by inserting a 10,000-ohm resistance in the cathode circuit. This resistance should be by-passed with a 1/2 mfd. condenser. The grid return of the preceding coil in this case goes to ground. The detector may then be coupled to the audio amplifier through an audio transformer. The older type Thordarson 2-to-1 transformer may be used, with the secondary used as the primary and the primary used as the secondary. This method of coupling has two advantages: one is that the step-down ratio tends to keep the hum from the detector stage at a low level, and the second one is that in this way we get high impedance in the plate circuit of the detector tube with correspondingly better bass response. One hundred and thirty-five volts should be applied to the plate of the detector tube.

The audio amplifier is a Loftin-White -45 job and, as has been said before, it may either be a commercial job or a home-built one. It is with the exception of the additional parts necessary to supply voltages to the rest of the set, just like the ones that have been repeatedly described in RADIO NEWS, so we will spend no time on the amplifier proper. The additional parts seen in the picture are those necessary to the adaptation of the amplifier to our purpose. The choke shown simply replaces the one that originally came with the unit, as it was too small to handle all of the current necessary. The Electrad "truvolt" resistance is seen standing on end so that it will have plenty of ventilation. The by-pass condensers are seen at the extreme left.

In wiring the receiver, the diagram

given this month should be followed instead of the one given last month, as there was one mistake in the previous diagram that has been corrected this month.

After the complete assembly is wired, and the various units connected together, the voltages from the power supply should be carefully adjusted. This is most readily accomplished by the use of a high-resistance voltmeter, measuring the voltage directly from the adjustable tap of the voltage divider resistance to ground, which is B—. The taps should be adjusted to read 135 and 67 volts respectively, and if this adjustment is carefully made the bias voltages throughout the set will be correct.

The first thing to do now is to ascertain if the first detector is working. Open the plate lead of this tube and insert a pair of phones in series. As the antenna is tuned, local stations should be received. If this is O. K., go to the oscillator. With the phones in series with the plate of the oscillator tube, one should hear a distinct "plop" when the moistened finger is placed on the grid connection to the tube. This should occur at all settings of the oscillator dial. If no such plop is heard, reverse the connection to the plate coil of this tube and make the test again. The receiver will be inoperative if the oscillator fails to work.

With the first detector and the oscillator working properly, signals should be received if carefully tuned to a local station. To adjust the intermediate amplifier, it will only be necessary to tune the last two stages to peak with the first stage. This can be done by ear, if the volume control is retarded until the signal is barely audible. If the intermediate amplifier shows any signs of oscillating, increase the distance between the primary and secondary of the intermediate transformers, until the condition corrects itself. This will give the most sensitive point at which to operate the amplifier.

The audio end will require no adjustment other than the hum bucker, which of course should be adjusted to a point of least hum.

Tuning

When all adjustments are made it will be noticed that the antenna dial and the oscillator dial tune several degrees off. If the builder desires to keep them in line, he may shunt a 150-mmfd. variable condenser across the main tuning condenser in the oscillator stage, and adjust it until the two dials are alike in the middle of the scale. This is not shown in the diagram, because it is not essential to the operation of the receiver.

The writer will be pardoned if he quotes a few golf scores on his personal receiver. Last evening, August 3, in New York City, Chicago, Fort Wayne and other distant stations were receivable at will, even though all of the New York locals were running full blast. Such reception as that in the midst of a typical heat wave speaks rather well for the sensitivity and selectivity of the receiver.



RADIO NEEDS YOU

Learn at home!

THOUSANDS of positions are opening up in the field of radio. It seems certain that for the next five years there will be more jobs than there are trained men to fill them.

This is your opportunity! Study radio now, at home. Train yourself for a position as radio operator on a ship or in one of the many new land communication stations. Get the knowledge you need to become a radio expert on installations or service.

Radio has only begun to grow. Get in now, and rise with this fascinating business.

You don't have to give up your present job, or spend your savings on tuition. The International Correspondence Schools plan lets you learn while you earn—at home, in spare time.

Famous radio authorities have prepared the great I. C. S. Radio Course. It is complete—up to the minute. Even the latest developments, such as television, are covered. Many graduates of this course are already earning big salaries in the various branches of radio.

Find out *today* just how the I. C. S. can train you for a radio position. There is no obligation in asking. Just mark and mail the coupon.

INTERNATIONAL CORRESPONDENCE SCHOOLS
Box 8282-J, Scranton, Penna.

Without cost or obligation, please tell me all about the
NEW RADIO COURSE

Name _____

Street Address _____

City _____ State _____

If you reside in Canada, send this coupon to the
International Correspondence Schools of Canada, Ltd.,
Montreal

ESICO Soldering Irons



Esico Soldering Irons are used in the largest radio factories in the country as well as in the U. S. Navy.

- Cordless Stand \$5.00
- 65 Watt Cordless Iron 5.50
- 85 Watt Cordless Iron 6.00
- 110 Watt Cordless Iron 6.00
- Esico Junior Cord Iron 2.75

ELECTRIC SOLDERING IRON CO., INC.
135 West 17th Street New York City

Everything in RADIO!

at *Lowest*
WHOLESALE PRICES

**THIS BIG
CATALOG
IS LOADED
WITH
BARGAIN
SPECIALS**

Get this . . . CATALOG

This big catalog . . . rich from cover to cover with astounding radio bargains . . . is yours for the asking. It contains all the newest and latest in radio receivers, accessories, parts and kits. No radio need is overlooked. Everything in this big book is available at wholesale prices, and many items are spotlighted as specials at truly astounding prices.

To be without this book is to miss your greatest buying opportunity in radio. Every page points the way to money saving. Never before have such startling values been offered . . . made possible by our tremendous buying power and low cost of operation. Quick deliveries and expert cooperation are assured on all orders. Send for your copy of this catalog today. See for yourself the many unusual values we are offering.

Clip the Catalog Coupon, and mail it today!

New SCREEN-GRID Models

Marvelous offerings in new, Humless, Screen Grid A. C. all-electric and battery operated sets; a wide range of beautiful consoles, from the small table model types to the most ornate and artistic of radio furniture; dynamic speakers of tremendous volume and richest tone; accessories, parts and kits in wide variety —in fact, everything that is standard, as well as everything that is new, in Radio. Get this book today!

Price-Saving COUPON

Chicago Salvage Stock Store
Dept. 510
509 So. State St., Chicago, Ill.
Kindly send me (free of charge and postpaid)
your new Book of Radio Bargains.

Name.....
Address.....
City..... State.....

CHICAGO SALVAGE STOCK STORE
World's Largest Radio Store
509 So. State St. Dept. 510 Chicago, Ill.



PAM 29—PRICE \$225.00—MEASURED POWER OUTPUT 24.5 WATTS

Why your dollar buys more in the NEW PAM

THE efficiency (low operating cost) of a PAM is so high that considerably less current is used for a given power output.

Hermetical seal of components assures continuous operation in tropical climates and on humid days. This is the same type of construction required by the U. S. government, to whom we supply similar units.

Condensers are built to our specifications calling for a life expectancy of 25 years of continuous operation. High-priced sockets are used that continue to make good contact year after year. A finish consisting of one coat of baked enamel followed by one coat of Duco ensures the PAM retaining its appearance after long years of service.

A temperature rise, exclusive of tubes, for continuous operation is so low (only 20° C above surrounding air) that no strain is put on component parts, and no fire hazard is present.

Power resistors are of a non-metallic type to assure freedom from open circuit. Built-in

variable voltage compensation (from 100 to 130 volts) is provided. Fuses and fuse protection covers give additional protection.

You are assured a frequency characteristic that is *exactly* as we specify (approximately flat between 50 and 10,000 cycles). If a flat frequency characteristic is not desired, use our Qualpensator to change it to suit any condition or ear.

Longer tube life (we have records of numerous PAMs that have used the original set of tubes for more than two years of continuous operation) keeps down operating cost.

Drawn extra heavy bases and containers of polished steel insure internal parts against physical damage which might occur in shipment or in use. Two values of output impedance (500 and 2000 ohms) assure maximum energy transfer without the usual loss.

A folder, No. RN9, "More Power per Dollar," gives all mechanical and electrical specifications of these new PAMs. Write for it.

Main Office:
Canton, Mass.

Samson Electric Co.
MANUFACTURERS SINCE 1882

MEMBER
RMA

Factories: Canton
and Watertown, Mass.

Here are a few examples of the kind of money I train "my boys" to make

Started with \$5. Now has Own Business



"Can't tell you the feeling of independence N.R.I. has given me. I started in Radio with \$5, purchased a few necessary tools, circulated the business cards you gave me and business picked up to the point where my spare time earnings were my largest income. Now I am in business for myself. I have made a very profitable living in work that is play."

HOWARD HOUSTON,
512 So. Sixth St., Laramie, Wyo.

\$700 in 5 Months Spare Time

"Although I have had little time to devote to Radio my spare time earnings for five months after graduation were approximately \$700 on Radio sales, service and repairs. I owe this extra money to your help and interest. Thanks for the interest shown me during the time I studied and since graduation."



CHARLES W. LINSEY,
537 Elati St., Denver, Colo.

\$7396 Business in two and one-half months



"I have opened an exclusive Radio sales and repair shop. My receipts for September were \$2332.16—for October, \$2887.77 and for the first half of November, \$2176.32. My gross receipts for the two and one-half months I have

been in business have been \$7396.25. If I can net about 20% this will mean a profit of about \$1500 to me."

JOHN F. KIRK,
1514 No. Main St., Spencer, Iowa.

My Free book gives you many more letters of N. R. I. men who are making good in spare time or full time businesses of their own



Rear view of 5-tube Screen Grid Tuned Radio frequency set — only one of the many circuits you can build with my parts.

You'll get practical Radio Experience with my new 8 Outfits of Parts that I'll give you for a Home Experimental Laboratory!

My course is not all theory. You use the 8 Outfits I'll give you, in working out the principles, diagrams and circuits used in modern sets and taught in my lesson books. This 50-50 method of home training makes learning easy, fascinating, interesting. You get as much practical experience in a few months as the average fellow who hasn't had this training gets in two to four years in the field. You can build over 100 circuits with these parts. You experiment with and build the fundamental circuits used in such sets as Crosley, Atwater-Kent, Eveready, Majestic, Zenith, and many others sold today. You learn how these circuits work, why they work, how they should work, how to make them work when they are out of order.

I will show You too

how to start a spare time or full time

Radio Business of Your Own

on extra money you can make while learning



J. E. Smith, Pres.,
National Radio Institute

The world-wide use of receiving sets for home entertainment, and the lack of well trained men to sell, install and service them have opened many splendid chances for spare time and full time businesses. You have already seen how the men and young men who got into the automobile, motion picture and other industries when they were young had the first chance at the key jobs—and are now the \$5,000 \$10,000 and \$15,000 a year men. Radio offers you the same chance that made men rich in those businesses. Its growth is opening hundreds of fine jobs every year, also opportunities almost everywhere for a profitable spare time or full time Radio business. "Rich Rewards in Radio" gives detailed information on these openings. It's FREE.

So many opportunities many make \$5 to \$30 a week extra while learning

Many of the ten million sets now in use are only 25% to 40% efficient. The day you enroll I will show you how to do ten jobs common in most every neighborhood, that you can do in your spare time for extra money. I will show you the plans and ideas that are making as high as \$200 to \$1,000 for others while taking my course. G. W. Page, 107 Raleigh Apts., Nashville, Tenn., writes: "I made \$935 in my spare time while taking your course."

Many \$50, \$60 and \$75 a week jobs opening in Radio every year

Broadcasting stations use engineers, operators, station managers, and pay \$1,800 to \$5,000 a year. Radio manufacturers continually need testers, inspectors, foremen, engineers, service men, and buyers for jobs paying up to \$15,000 a year. Shipping companies use hundreds of operators, give them world-wide travel at practically no expense and pay \$85 to \$200 a

month. Radio dealers and jobbers are continually on the lookout for good service men, salesmen, buyers, managers, and pay \$30 to \$100 a week. Talking Movies pay as much as \$75 to \$200 a week to the right men with Radio training. My book tells you of other opportunities in Radio.

I will train you at home in your spare time

Hold your job until you are ready for another. Give me only part of your spare time. You don't have to be a high school or college graduate. Hundreds have won bigger success. J. A. Vaughn jumped from \$35 to \$100 a week. E. E. Winborne seldom makes under \$100 a week now. The National Radio Institute is the Pioneer and World's Largest organization devoted exclusively to training men and young men, by correspondence for good jobs in the Radio industry.

You Must Be Satisfied

I will give you an agreement to refund every penny of your money if you are not satisfied with my Lessons and Instruction Service when you complete my course. And I'll not only give you thorough training in Radio principles, practical experience in building and servicing sets, but also train you in Talking Movies, give you home experiments in Television, cover thoroughly the latest features in sets such as A. C. and Screen Grid.

My 64-Page Book Gives the Facts

Clip and mail the coupon now for "Rich Rewards in Radio." It points out the money-making opportunities the growth of Radio has made for you. It tells of the opportunities for a spare time or full time Radio business of your own, the special training I give you that has made hundreds of other men successful; and also explains the many fine jobs for which my course trains you. Send the coupon to me today. You won't be obligated in the least.

Get my new book It points out what Radio Offers You



J. E. SMITH, President
Dept. OLS.
National Radio Institute
Washington, D. C.

THIS COUPON IS GOOD FOR ONE FREE COPY OF MY NEW BOOK

mail it TODAY

J. E. SMITH, President,
National Radio Institute, Dept. OLS.
Washington, D. C.

DEAR MR. SMITH:—Send me your book. I want to see what Radio offers. I understand this request does not obligate me and that no agent will call.

Name.....
Address.....
City..... State.....

Get the facts on my Lifetime Employment Service to all Graduates