

# RADIO NEWS

AUGUST  
25 Cents



SPEECH  
AMPLIFIERS

SUSTAINING  
PROGRAMS

RECORDED  
PROGRAMS

HOW TO  
SYNCHRONIZE  
FOR  
TELEVISION



# MERSHON

**ELECTROLYTIC** CONDENSER

## MERSHON — THE PIONEER

First patented in 1911. First publicly displayed for use in radio receivers in 1921—and in continuous development and production since then—the Mershon Condenser is unquestionably the pioneer practical, successful electrolytic condenser.

Now available for distribution in units for the constructors of transmitters, receivers and amplifiers—and also for power pack and B eliminator replacements.

*This handy pocket size booklet tells:*

- HOW THEY ARE MADE
- WHAT THEY DO
- HOW THEY WORK
- HOW TO USE THEM



### JOBBER'S

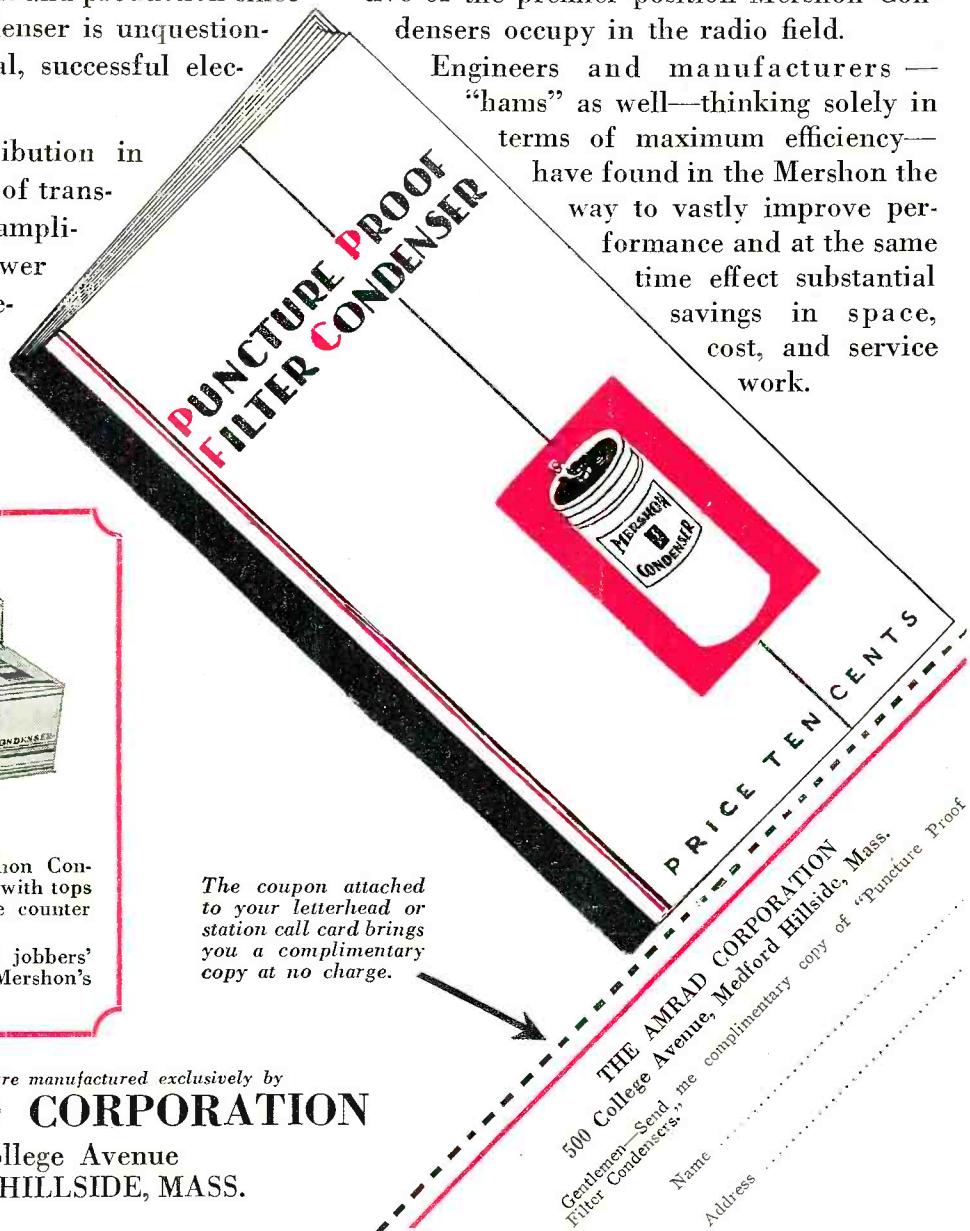
Six sizes and styles of Mershon Condensers are supplied complete with tops and brackets in this attractive counter display carton.

Write today for our special jobbers' proposition, so you profit by Mershon's world-wide popularity.

## MORE THAN 35 LEADING SET MANUFACTURERS

use Mershon Condensers as standard equipment in their receivers. This is proof positive of the premier position Mershon Condensers occupy in the radio field.

Engineers and manufacturers — "hams" as well—thinking solely in terms of maximum efficiency—have found in the Mershon the way to vastly improve performance and at the same time effect substantial savings in space, cost, and service work.



*The coupon attached to your letterhead or station call card brings you a complimentary copy at no charge.*

*Mershon Condensers are manufactured exclusively by*

**THE AMRAD CORPORATION**

500 College Avenue  
MEDFORD HILLSIDE, MASS.

254

# 5,000

## Radio Service Men Needed Now!

The replacing of the old battery operated receivers with all-electric Radios has created a tremendous country-wide demand for expert Radio Service Men. Thousands of trained men are needed quick!



### 30 Days of R.T.A. Home Training

*... enables you to cash in on this latest opportunity in Radio*

**\$40 to \$100**  
a week  
Full Time  
**\$3.00** an hour  
Spare Time

Ever on the alert for new ways of helping our members make more money out of Radio, the Radio Training Association of America now offers ambitious men an intensified training course in Radio Service Work. By taking this training you can qualify for Radio Service Work in 30 days, earn \$3.00 an hour and up, spare time; prepare yourself for full-time work paying \$40 to \$100 a week.

hour spare time or \$40 to \$100 a week full time, this R. T. A. training offers you the opportunity of a lifetime.

**We furnish you with all the equipment you need to become a Radio Service Man!**

**Radio Service Work a Quick Route to the Big-Pay Radio Positions**

Radio Service Work gives you the basic experience you need to qualify for the big \$8,000, \$10,000 to \$25,000 a year Radio positions. Once you get this experience, the whole range of rich opportunities in Radio lies open before you. Training in the Association, starting as a Radio Service Man, is one of the quickest, most profitable ways of qualifying for rapid advancement.

**More Positions Open Than There Are Trained Men to Fill Them**

If you were qualified for Radio Service Work today, we could place you. We can't begin to fill the requests that pour in from great Radio organizations and dealers. Members wanting full-time positions are being placed as soon as they qualify. 5,000 more men are needed quick! If you want to get into Radio, earn \$3.00 an

hour spare time or \$40 to \$100 a week full time, this R. T. A. training offers you the opportunity of a lifetime. investigate this R. T. A. training and the rich money-making opportunities it opens up. No special education or electrical experience necessary. The will to succeed is all you need.

## Mail Coupon for No-Cost Training Offer

Cash in on Radio's latest opportunity! Enroll in the Association. For a limited time we will give to the ambitious man a No-Cost Membership which need not . . . should not . . . cost you a cent. But you must act quickly. Filling out coupon can enable you to cash in on Radio within 30 days, lift you out of the small-pay, no-opportunity rut, into a field where phenomenal earnings await the ambitious. You owe it to yourself to investigate. Fill out coupon NOW for details of No-Cost Membership.

**The Radio Training Association of America**  
4513 Ravenswood Ave. Dept. RNA-8, Chicago, Ill.

THE RADIO TRAINING ASSOCIATION OF AMERICA  
4513 Ravenswood Ave., Dept RNA-8, Chicago, Ill.

Gentlemen: Please send me details of your No-Cost training offer by which I can qualify for Radio Service Work within 30 days. This does not obligate me in any way.

Name .....

Address .....

City ..... State .....

# Radio News

Vol. XII

CONTENTS FOR AUGUST, 1930

No. 2

ALBERT PFALTZ  
Associate Editor

ARTHUR H. LYNCH, Editorial Director  
JOHN B. BRENNAN, JR.  
Managing Editor

EDWARD W. WILBY  
Associate Editor

**R**ADIO NEWS for August, devoted especially to the serviceman in the sound amplifier and public address system field, contains quite a number of articles which are bound to command the attention of those men who have chosen occupation in this interesting field for a livelihood.

*George Fleming* tells about microphone and pick-up connection to Loftin-White amplifiers designed for public address work. Two pages of illustrated rack amplifiers and a page full of specifications and electrical characteristics of representative types of speech amplifiers supply a wealth of information.

*Ralph Batcher* explains at length the fundamental theory underlying the design and construction of electrodynamic reproducers.

*Fred Schnell's* first of a series of articles on the construction of the RADIO NEWS Short-Wave Superheterodyne appears in this issue. Next month he continues with the construction of the receiver.

### Next Month—

Specially collected data on tubes, their characteristics, the new tubes available, how to judge a good tube—in short, a tube issue. *Carl Dreher* writes on the obstacles which radio broadcast studio engineers who enter the sound or talkie field must overcome before they feel completely at home in their new surroundings.

\* \* \*

**W**E announce the departure of E. W. (Ted) Wilby, Associate Editor of RADIO NEWS, to his new work with the circuit development division of the Radio Corporation of America. Also the announcement of the appointment of *George E. Fleming*, formerly of Loftin-White Laboratories, to the Technical Editorship of RADIO NEWS.

To Wilby we wish every success and in doing so wish to express our appreciation for the excellent manner in which he has carried out his work with us. To *Fleming* we extend a hearty welcome.

	PAGE
Cover—From a Painting by David Hymes	100
Frontispiece: Television in the Theatre.....	102
Editorial .....	102
The RADIO NEWS Short-Wave Superheterodyne .....	104
<small>The first of a series of articles on its design and construction, by FRED H. SCHNELL</small>	
A Simple Stroboscope for Television Synchronization.....	107
<small>Describing the construction of this simple device, by H. N. BLISS</small>	
Recorded Programs.....	108
<small>What they are and how they are prepared, by A. J. KENDRICK</small>	
Electrodynamic Reproducers.....	111
<small>A technical discussion of their design and construction, by R. R. BATCHELOR</small>	
Transformer-Coupled Audio for the RADIO NEWS Cornet S. W. Receiver.....	113
<small>Directions for substituting transformers for the resistance-coupled channel originally described, by E. W. WILBY</small>	
A Loftin-White Public Address and Speech Amplifier System.....	114
<small>Installation hints for the serviceman, by GEORGE E. FLEMING</small>	
Interpreting Receiver Performance in Terms of Laboratory Measurement.....	116
<small>An outline of the rigid tests given commercial receivers, by ALFRED H. GREBE</small>	
Sustaining Programs.....	118
<small>Today's promise for tomorrow's entertainment, by P. H. W. DIXON</small>	
Sound Amplifiers for Servicemen.....	120
<small>Qualified radio men are finding new profits in this highly specialized field, by S. GORDON TAYLOR</small>	
Henry M. Neely, Radio's Old Stager.....	122
<small>A pen picture of a man who has brought a high order of radio entertainment to thousands of listeners, by LESTER S. ROUNDS</small>	
Shall We Use Grid- or Plate-Circuit Detectors?.....	125
<small>An article dealing with the relative merits of various kinds of detector systems, by JAMES MARTIN</small>	
Some Methods and Problems of Sound Recording.....	128
<small>By C. F. GOUDY and W. P. POWERS</small>	
The Hopkins Band-Rejector System.....	131
<small>New circuit possibilities present themselves in this latest of band-pass devices, by CHARLES L. HOPKINS</small>	
Operating the Short-Wave Supersonic Adapter.....	133
<small>The final article on the unit which makes a short-wave "superhet" of any broadcast receiver, by MANSON E. WOOD</small>	
How to Synchronize for Television.....	134
<small>A few of the systems which can be used are explained, by D. E. REPLOGLE</small>	
Manhunts by Radio.....	136
<small>How radio is aiding in the apprehension of criminals, by RALPH PETERS</small>	
Two Complete Auto-Radio Receivers.....	139
Sound-on-Film Reproduction .....	140
<small>The third in a series of articles on sound movie systems, by FRED E. JEWELL</small>	
Testing and Installing the Universal Auto-Radio Receiver.....	143
<small>By W. H. BULLOCK</small>	
Three Pages of Speech Amplifier and Public Address System Specifications and Illustrations for the Servicemen.....	145
Satisfying the Demands for Selectivity, Sensitivity and Quality in the Design of a Modern R.F. Tuner.....	148
<small>By GLENN H. BROWNING and JAMES MILLEN</small>	
RADIO NEWS Home Laboratory Experiments.....	151
With the Manufacturers.....	153
RADIO NEWS Manufactured Receiver Circuits.....	154
The Junior Radio Guild.....	156
RADIO NEWS Information Sheets.....	158
The Radio Forum.....	160

Published Monthly by the Experimenter Publications, Inc., at 184-10 Jamaica Ave., Jamaica, N. Y.

Member: Audit Bureau of Circulations

B. A. MACKINNON, President

H. K. FLY, Vice-President and Treasurer

Entered as Second-Class Matter at Jamaica, N. Y., under Act of March 3, 1879.

Executive and Editorial Offices, 381 Fourth Ave., New York, N. Y.

RADIO NEWS is published monthly, on the tenth day of each month preceding that of date. Entered as second-class matter at the postoffice, Jamaica, N. Y., under the act of March 3, 1879. Copyrighted 1930 by Experimenter Publications, Inc.; title

registered U. S. Patent Office. Subscription price \$3.00 a year; \$3.50 in Canada and \$4.00 in foreign countries. Single copies, 25 cents each. The contents of RADIO NEWS are indexed in the Industrial Arts Index.

# READ what BIG MONEY my MEN make in RADIO



### Over \$400 monthly

I had 15 years as traveling salesman and was making good money, but could see the opportunities in Radio. Believe me I have made more money than I ever did before. I have made more than \$400 each month and it was your course that brought me this. I can't say too much for your school.

J. G. Dahlstead,  
1484 So. 15th St.,  
Salt Lake City, Utah



### \$10,000 more in Radio

I didn't know a volt from an ampere at the time I subscribed to your course. My first position was with the Garod Corp. Since then I have been in engineering work, first with the Ward Leonard Electric Company and at present with the Conner Crouse Corp. I have made \$10,000 more in Radio than I would have made if I had continued at the old job.

Victor L. Osgood,  
St. Cloud Ave.,  
West Orange, N. J.



### \$700 in spare time

Although I have had little time to devote to Radio on account of illness in my family and extra time in my regular job, my spare time earnings for five months after graduation were approximately \$700 on Radio sales, service and repairs. I owe that extra money to your help and interest.

Charles W. Linsey,  
537 Elati St.,  
Denver, Colorado



### Found it all true

I had already been working with Radio since 1920. I thought that it would be useless for me to spend money for more training along the same line. From the first lesson on to the last I found out that there are hundreds of things about Radio that a person will never find out by experimenting. While I was taking the course I earned approximately \$2600.

Ronald I. McDonald,  
Box 23,  
Sturgeon Bay, Wisconsin



## My methods work—they're different

Ebert, Nichols, Winborne, Osgood, Linsey, McDonald, are only a few. Hundreds prove what I say is true

My methods do work. They are different. They do for you what I say they will do. Don't be satisfied just with my word or the word of the seven men whose letters you read on this page. Literally hundreds of men who have answered my ads have found that Certified Radio-Tricians are in demand and do make big money. Do you want a bigger salary? Some of my men double, even triple their salaries. Extra money? Many make \$10, \$15, \$20, \$25 and more in their spare time only each week. Easier work? Shorter hours? A clean job? Regular pay? Promotion? Why not?

### Find out for yourself

how these hundreds of men get all this in Radio and much more with my help? There is no magic about what I do. But the results are like magic. Maybe you are in Radio already and don't get ahead. Or you may have been wanting to get into Radio for years without knowing how to get started. I have helped men in your fix before. I help you find the difficulty, then help you overcome it. That's part of my method. My Vocational and Consultation Services are based on sixteen years of personal experience helping men get ahead in Radio. I help you get off on the right foot and help you keep step with Success.

### My hobby is results

I'm a practical man. What good is a system that doesn't get results? The only value to my methods is what they enable my men to accomplish. When I work with you I keep hammering on the practical side of Radio—making money at it. In order to make money you must know how to do all kinds of Radio jobs and do them all right. Take a look at the outfit illustrated directly below—notice the ship-shape, business-like job of design and construction called for in this modern Screen Grid A. C. circuit. My method gives you over 100 similar experiments covering hundreds of actual Radio problems. When you have completed these systematic experiments you have a background of experience the ordinary Radio man doesn't get in five years' 'hit-or-miss' tinkering.

The man who draws the big salary, who gets \$2, \$3 or \$4 an



Broadcasting needs trained men for jobs paying \$1800 to \$5000 and more yearly.



Ship Operators see the world. Get salaries of \$85 to \$200 a month besides.



Servicing pays big money in a spare time or full time business of your own.



Hundreds of operators will be needed for land stations and aviation Radio.

hour for his time instead of a fraction of that, is the man who knows the "why" as well as the "how." I give you the WHY right along with the HOW. It is what you understand thoroughly with your head and can work out expertly with your hands that puts you in the big money class. You get results with my methods because they are planned to get results for you.

### I help you get jobs

My life-time Employment Service works on this principle too. It must get results. It does get them. I don't leave you to "sink or swim." This service is free of extra cost. It not only helps you line up the first Radio job you want, but the second, the third—as long and often as you want to use it. My Employment Service helps you win promotions also. I spend thousands of dollars a year on this one service alone. I back you with all my influence and knowledge of the Radio Industry.

Maybe you'd rather be your own boss—run a paying business of your own. I show you how to get started without capital, give you detailed instructions on location, stock, turnover and profits—RESULTS. Notice my men can't get very far away from results.

### Get the Cold FACTS

Whatever has been keeping you from growing right along with Radio, there is a still better reason for going ahead with Radio—for finding out what I can do for you. I have helped men of forty-five and fifty, young fellows of sixteen and eighteen. I have helped men without full grade schooling. I have helped beginners and experienced Radio men make more money, be their own bosses, get better jobs. The chances are I can help you, too. "Rich Rewards in Radio" is a FACT for hundreds of my men. Over 100 of them tell you in their own words in this book exactly what I have done for them. This book is full from cover to cover with facts about opportunities and how you can get them. It will give you the positive proof you want that my methods do work—do get results. Send for this book today.



### Over \$100 a week

Your course has been a Godsend to me. My earnings in Radio are many, many times greater than I ever anticipated when I signed up for your course. For the month of November I made \$377 and for December over \$645, and January, \$465. My earnings seldom fall under \$100 a week. I'll say the N. R. I. course is thorough and complete. You give a man more for his money than anybody else.

E. E. Winborne,  
1430 W. 48th Street,  
Norfolk, Virginia



### \$3000 a year now

I am in the Radio business here. I can safely say that I averaged \$3000 a year for the past three years. Any man who really wants to advance cannot go wrong in Radio. I consider all the success I have obtained so far, due entirely to your training.

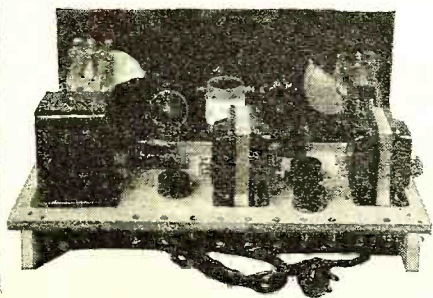
Fred A. Nichols,  
1920 Seventh Ave.,  
Greeley, Colorado



### Employment Service puts him ahead

Before I enrolled I was making \$18 a week in a shoe factory. My first Radio position as service man paid me \$40 to \$45 a week and the work was much easier and more interesting. After three weeks as service man I was promoted to Service Manager. Upon graduation, I passed for my first class licence and through your Employment Department, received a position with Station KWRC. Your Employment Department has again come to my aid and has placed me with the Inter-city Radio Telegraph Co.

Sylvanus Ebert,  
306 S. Capital Street,  
Iowa City, Iowa



## FREE INFORMATION COUPON

J. E. Smith, President  
National Radio Institute, Dept. OHS.  
Washington, D. C.

Dear Mr. Smith:

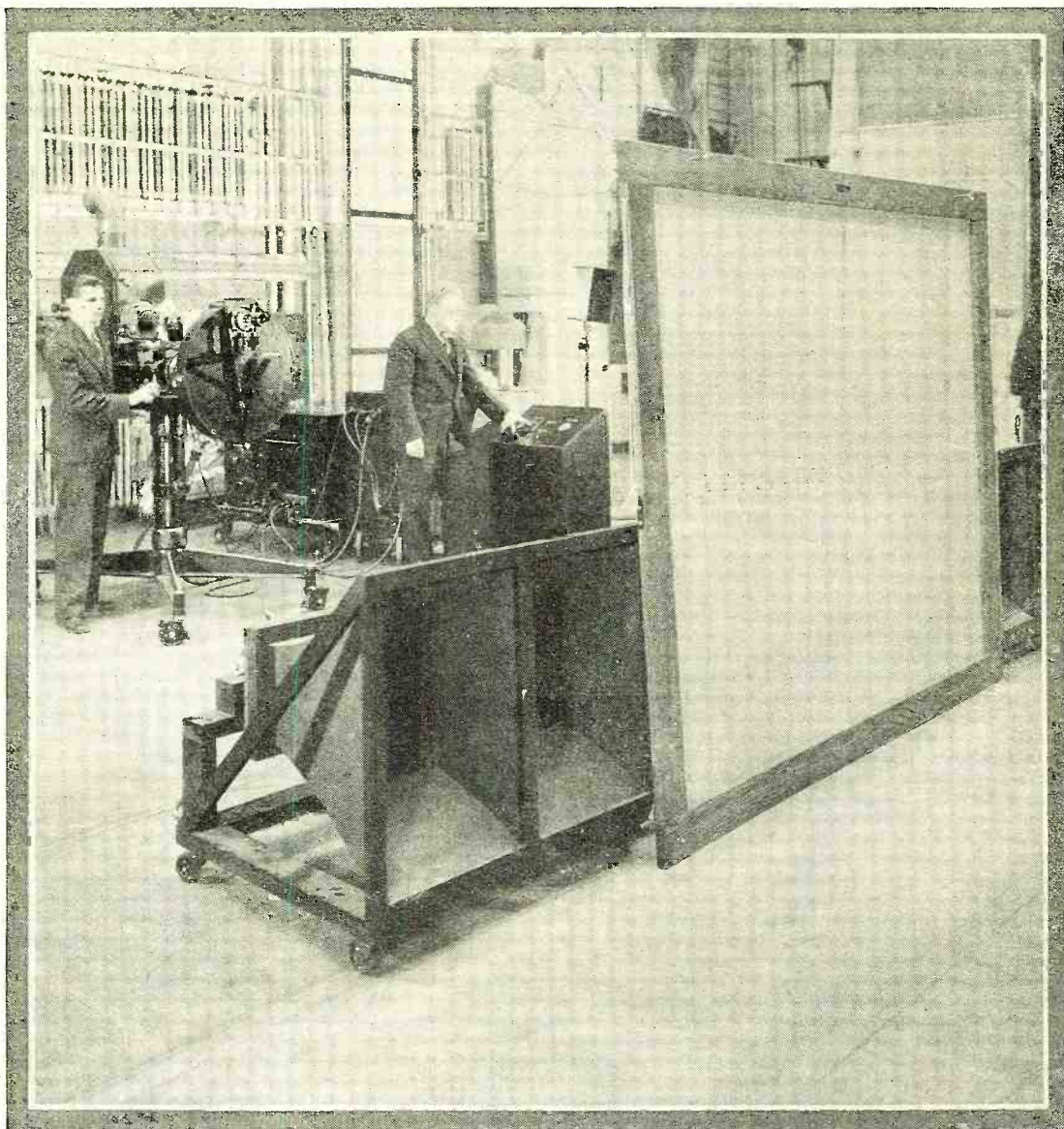
Send me without obligation on my part full details about your methods and free proof that they do what you say they do.

Name .....

Address .....

City ..... State .....





## TELEVISION IN THE THEATRE

**T**HE remarkable advance in television and a clear indication of what may be expected in the near future were recently demonstrated in a Schenectady, N. Y., theatre by the General Electric Co., using a system developed by Dr. E. F. W. Alexanderson. In the television studio the subject televised stood before an incandescent lamp and a microphone. A 48-hole revolving disc, about 28 inches in diameter, covered the subject twenty times per second, producing that number of complete pictures made up of light and shade. Four photoelectric cells were employed. In the theatre, electrical impulses received were passed on to a light valve which permits the passage of light in correspondence to the impulses received from the television transmitter. These light emissions were projected through a lens to a disc, corresponding in size, number of holes and rate of rotation, to the disc at the transmitting end. Additional lens passed the light forward 17 feet to the back of the screen. Two wavelengths were employed, 140 meters for the television impulses and 92 meters for the voice. The above picture shows the Schenectady theatre set-up with the screen, measuring 6 by 7 feet, a loud speaker and the television apparatus.

FACTORY TO YOU—SAVE to 50%—COMPARE WITH COSTLIEST OUTFITS BEFORE YOU BUY

# Enjoy a powerful new Miraco 30 DAYS FREE

Latest 1931 SUPER Screen Grid Outfit (No obligation to buy)



## NEWEST IN RADIO! TOP OPERATION

in this 1931 Miraco "Easy-Chair" model with magazine racks, each end. Place it anywhere in any room. Easily moved about. Small door in top conceals dial and controls when not in use. 26 in. high, 15 in. wide—yet it contains a complete full-size radio and Super-Dynamic speaker! No outside aerial or ground required. Many other new, clever models, obtainable nowhere else, shown in free literature.

Get Our "SEND NO MONEY" 11th Anniversary Offer!

Latest 1931 **Super Screen Grid** FULL YEAR'S GUAR.  
lighted dial steel chassis  
Vari-Tone and Automatic Sensitivity Control  
Also latest PUSH-PULL Amplification

Built like—looks like—performs like newest radios in many outfits much more costly. Latest, finest, heavy duty construction. Skillfully engineered to super-utilize a battery of "224" SCREEN GRID tubes—in addition to "245" PUSH-PULL POWER, "224" HUM-FREE long-lived POWER DETECTOR and AMPLIFIER and "280" A-C TUBES. Vari-tone feature gives any tone-pitch your ears prefer. Automatic Sensitivity Control reduces "fading," protects tubes. Phonograph pick-up connection. Built-in house wiring aerial and ground. Built-in plug for electric clock, lighter, lamp, etc. Super-sturdy power section. Razor-edge selectivity; Super-Dynamic Cathedral tone quality; marvelous distance-getter. Solid one-year guarantee if you buy! Wide choice of cabinets.

Easy Chair Model Only \$49.<sup>88</sup> COMPLETELY ASSEMBLED  
(as illustrated less tubes)  
Values possible because you deal direct with big factory

# MIRACO

TRADE MARK REGISTERED

CATHEDRAL TONED, SUPER SELECTIVE, POWERFUL DISTANCE GETTERS

You need not send us a cent! For its 11th successful year, America's big, old, reliable Radio Factory again sets the pace in high-grade, latest guaranteed radios direct to you. And

### Don't Confuse with Cheap Radios

With Miraco's rich, clear Cathedral Tone, quiet operation, razor-sharp separation of nearby stations, tremendous "kick" on distant stations, Vari-Tone and automatic sensitivity control, and other latest

EASY TERMS to reliable persons only

### USER-AGENTS WANTED

Exclusive Territory—Try it at Our Risk!

Spare or full time. No contract, no experience required. Big money! Send coupon now!

features—be the envy of many who pay 2 or 3 times as much!

Send for proof that delighted thousands of Miraco users cut through locals, get coast to coast, with tone and power of costly sets.

Miraco's are built of finest parts—approved by Radio's highest authorities. Our 11th successful year!

### Deal Direct with Big Factory

Miraco outfits arrive splendidly packed, rigidly tested, to plug in like a lamp and enjoy at once. No experience needed. Entertain yourself 30 days—then decide. Liberal year's guarantee if you buy. Play safe, save lots of money, insure satisfaction—deal direct with Radio's big, reliable, pioneer builders of fine sets—successful since 1920. SEND POSTAL OR COUPON NOW for Amazing Offer!



now—at history's greatest savings. With this newest perfected SUPER SCREEN GRID, push-pull, super-powered and humless electric AC set in clever, beautiful new Miraco-Mastercrest consoles obtainable nowhere else—you are guaranteed satisfaction, values and savings unsurpassed. Get Amazing Special Offer! At our risk, compare a Miraco outfit with highest priced radios 30 days and nights. Surprise, entertain your friends—get their opinions. Unless 100% delighted, don't buy! Your decision is final—no argument!

Only marvelously fine radios, of latest perfected type, at rock-bottom prices, can back up such a guarantee. Send postal or coupon for Amazing Special Factory Offer!

MIDWEST RADIO CORP., 804-AA Miraco Dept., Cincinnati, Ohio

BEAUTIFULLY ILLUSTRATED LITERATURE, TESTIMONY OF NEARBY USERS, PROOF OF OUR RELIABILITY—

All the proof you want—of our honesty, fairness, size, financial integrity, radio experience and the performance of our sets—including Amazing Factory Offer—sent without obligation!

MIDWEST RADIO CORPORATION  
Pioneer Builders of Sets—11th Successful Year  
804-AA Miraco Dept., Cincinnati, Ohio

THIS COUPON IS NOT AN ORDER

WITHOUT OBLIGATION, send latest literature, Amazing Special Free Trial Send-Now-Money Offer, testimony of nearby users and all Proof.  User.  Agent.  Dealer.  
 Check here if interested in an EXCLUSIVE TERRITORY PROPOSITION  
NAME..... ADDRESS.....

NEW LOW FACTORY PRICES SAVE to 50%

Similar Low Prices on Beautiful Variety of Latest Fine Consoles. Send Coupon!

### 30 DAYS FREE TRIAL

Electric Clock Model Medium-size "Hi-Boy." Built-in clock over dial. Latest drop-panel front. Rich design, fine woods, fine finish. Astonishingly low factory to you price.



Stylish small console with convenient magazine racks, each end. Another exclusive Miraco-Mastercrest, 1931 design. Bargain factory to you price!



Full-size wall console with latest 1931 features. Beautiful design and woods. Priced very low, factory to you.



These Consoles are Equipped with SUPER DYNAMIC CATHEDRAL TONE REPRODUCERS

Also: built-in aerial and ground—and built-in extra light socket!

Magnificent new 1931 Miraco-Mastercrest creation. Send coupon for complete showing including Radio-Phonographs. Low factory-to-you prices.



## Speech Amplifier's Service

**I**N little more than a year an entirely new form of radio business has emerged from nowhere to become a very important part of our national life. Speech amplification, little dreamed of a short while back, is rapidly finding its way into the theatres, restaurants, hotels, flying fields, etc.



This rapid growth, like everything else that comes to pass in a hurry, has been and still is accompanied by rather severe growing pains. The equipment used is based on the same fundamental principles which govern radio. Radio amplification is sufficiently different in appearance and practical application to cause bewilderment to the newcomer in the public address service field. Furthermore, this new business has expanded so rapidly that much of the practical knowledge necessary for its installation and effectiveness had to be developed with its youth and much of the work has to be entrusted and can well be entrusted to men who at present are not entirely familiar with its technique. In some instances the talking movies, as a whole, have been given a black eye by some inexpert installation and many another has suffered even more by poor maintenance, due to a lack of knowledge or inexperience on the part of its operator, even after a good installation may have been made.



Radio manufacturers who have seen the light and jumped right into this field with both feet have been making a great deal of money. The field itself is almost limitless and new uses for public address systems are coming to light almost daily. Poor equipment has found it has an unlimited sale because of the tremendous demand, but, on the whole, a vast improvement has been noticed in the general run of this product during the past year in every unit which goes to make up the system from the microphone to the loud

speakers. The new fad and increased use of public address systems and centralized radio have resulted in a volume of business of tremendous proportions, including the sale of such units as microphones, transformers, resistors, wire, loud speakers, panels, radio receivers, volume controls, conduits, sound absorption material and many other products. The great opening of this vast outlet provided for some of the more expensive types of tubes.



With all this activity there is a vastly increasing field for capable servicemen, installation men and acoustic specialists, to say nothing of the engineers in the laboratories where this equipment is developed and the factory in which it is produced. Furthermore, with rapid increase in competition which is keeping the manufacturers on their toes the engineers working with this product are recognizing that the ultimate judgment on their product is dependent almost entirely upon its performance and much of this performance depends upon initial installation, operation and service. The skilled serviceman can command a salary and position much superior in comparison to work in other fields that do not offer the same recognition.



There are many chief engineers of sound reproduction, sound recording and public address manufacturing companies, who, in the generally accepted meaning of the term, are not graduate engineers at all. This is a great credit to these men and an example for other young men to follow. Within two years there will be more men working in this field than there are at present engaged in the servicing of radio, and this greatly increases the field for the radio serviceman. Public address systems have provided us with a new and profitable form of development and another great opportunity.

*Arthur H. Lynch*



**R. T. I. QUALIFIES YOU TO MAKE MONEY AND ITS SERVICE KEEPS YOU UP-TO-THE-MINUTE ON THE NEWEST DEVELOPMENTS IN RADIO, TELEVISION, AND TALKING PICTURES R. T. I.**

*Easy to Get into  
this **BIG**  
Money Making  
Work*

**\$60 to \$125<sup>00</sup>  
A WEEK  
Radio  
Operator**

**\$8 to \$15<sup>00</sup>  
A DAY  
Servicing and  
Repairing Radio Sets**

**\$5000<sup>00</sup> A YEAR  
AND UP  
Radio Engineer  
for Broadcasting Station**

**\$85<sup>00</sup> A WEEK  
Installing and  
Repairing Talking  
Picture Equipment**

**GOOD JOBS Right at Your Finger Tips**  
WHEN YOU ARE R.T.I. TRAINED IN  
**RADIO-TELEVISION-Talking Pictures**

**BIG PAY JOBS! SPARE TIME PROFITS! A FINE BUSINESS OF YOUR OWN!** They're all open to you and other live wire men who answer the call of RADIO. The fastest growing industry in the world needs more trained men. And now come Television and Talking Movies—the magic sisters of Radio. Will you answer this call? Will you get ready for a big pay job NOW and step into a BIGGER ONE later on? You can do it EASILY now.

**R. T. I. Home Training**

**Puts You In This Big Money Field**

RADIO alone, pays over 200 MILLION DOLLARS a year in wages in Broadcasting, Manufacturing, Sales, Service, Commercial Stations and on board the big sea going ships, and many more men are needed. Television and Talking Movies open up other vast fields of money-making opportunities for ambitious men. Get into this great business that is live, new and up-to-date, where trained service men easily earn \$40 to \$50 per week, and trained men with experience can make \$75 a week, and up.

**Easy To Learn At Home—In Spare Time**

Learning Radio the R. T. I. way with F. H. Schnell, the "Ace of Radio" behind you is EASY, INTERESTING, really FUN. Only a few spare hours are needed and lack of education or experience won't bother you a bit. We furnish all necessary testing and working apparatus and start you off on practical work you'll enjoy—you learn to do the jobs that pay real money and which are going begging now for want of competent men to fill them.

**Amazingly Quick Results**

You want to earn BIG MONEY, and you want some of it QUICK. R. T. I. "Three in One" Home Training—Radio-Television-Talking Movies—will give it to you, because it's easy, practical, and



**FRED H. SCHNELL**  
Chief of R. T. I. Staff  
Twenty years of Radio Experience. First to establish two-way amateur communication with Europe. Former Traffic Manager of American Radio Relay League. Lieut. Commander U.S.N.R. Inventor and Designer Radio Apparatus. Consultant Radio Engineer. Now in charge of R. T. I. Radio Training—and you will like his friendly manner of helping you realize your ambition.

is kept right up-to-date with last minute information. In a few weeks you can be doing actual Radio work, making enough EXTRA MONEY to more than pay for your training. In a few short months you can be all through—ready to step into a good paying job or start a business of your own. A BIG JOB—BIG MONEY—A BIG FUTURE. There is no other business in the world like it.

**Investigate—Send For R. T. I. Book Now**

Don't waste a minute. Find out what the great Radio Industry, which has grown faster than the Automobile and Motion Picture business, has to offer you. Find out what other men are earning. SEE HOW EASILY YOU CAN GET STARTED. Get the facts about Radio, Television and the Talking Pictures, first hand, in the big R. T. I. FREE BOOK. Learn what this R. T. I. "Three in One" Home Training can do for you. Mail the Coupon for FREE BOOK NOW.

**Radio & Television Institute  
Dept. 84-C  
4806 St. Anthony Court, Chicago**



**R.T.I. Training  
Brings Big Jobs  
Like These!**



**Earned \$500 Extra Money in Two Months**

Your radio course has enabled me to earn over \$500 in two months' spare time work. Understand that this is all spare time work, as I have a permanent position with my father in our store. I give you all the credit for the above and as I said before, I wish to finish the entire course as soon as I can.—Your student, J. NOFFSINGER, Greenville, Ky. R 1, Box 37.



**Salary Raised 331-3% Since Enrolling**  
You may be interested to know that I am now Radio Service Manager for the H. N. Knight Supply Co. who are distributors for Eveready Radio Receivers in the State of Oklahoma, and Texas Panhandle, with an increase in salary of about 331-3%, since I enrolled with your school.

Thanking you for your interest you have shown in me, and your wonderful course, I am, EARL P. GORDON, 618 East 6th St., Oklahoma City, Okla.



**Makes \$25 a Day**

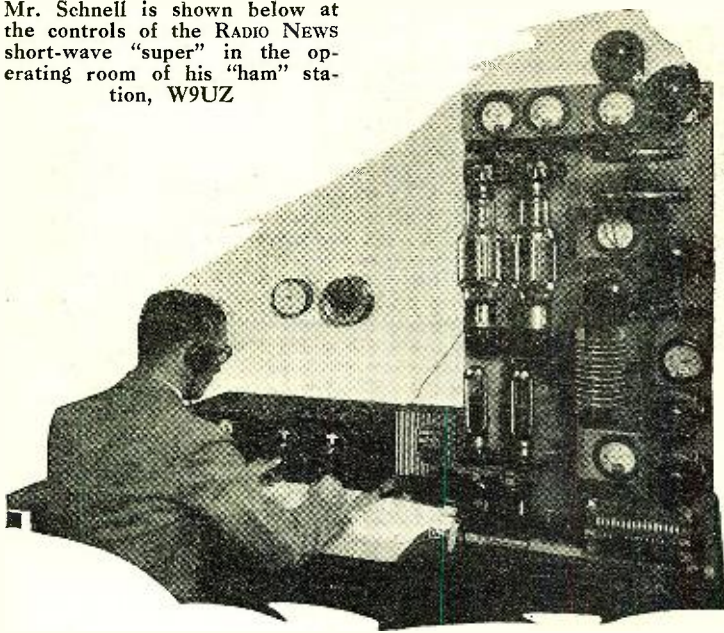
Haven't forgotten you. How could I when I make as high as \$25.00 per day and have made \$600.00 in two months from Radio work. That's not so bad when I'm only 19 and in a small town. I just looked over the catalog you sent me before I enrolled, and you did about all you said you would and about as much more.—FLOYD KRISLEY, R. F. D. 2, Box 91, St. Joe, Ind.

**RADIO & TELEVISION INSTITUTE**  
Dept. 84-C, 4806 St. Anthony Court, Chicago  
Send me Free and prepaid your BIG BOOK "Tune In On Big Pay" and full details of your three-in-one Home Training (without obligating me in any way).

Name.....  
Address.....  
City..... State.....

**R. T. I. TRAINS YOU AT HOME FOR A GOOD JOB OR A PROFITABLE PART TIME OR FULL TIME BUSINESS OF YOUR OWN**

Mr. Schnell is shown below at the controls of the RADIO NEWS short-wave "super" in the operating room of his "ham" station, W9UZ



# The Radio News Short-Wave Super-

ONE year ago, at the Chicago Radio Trade Show, we were talking to Fred Schnell. He told us of an idea he had for the construction of a short-wave superheterodyne. After hearing of the details of the plan we asked him to design such a receiver for readers of RADIO NEWS. After a year of careful work, during which the receiver has evolved from the breadboard stage to the finished product illustrated on these pages, and after a series of severe tests were given the receiver in many parts of the country, Mr. Schnell has prepared a series of articles describing the construction and operation of this highly desirable short-wave receiver. A conservative of conservatives, Mr. Schnell makes no claims for his receiver which have not been backed up actually by performance.

—THE EDITORS.

OFTEN is the remark heard that two heads are better than one. Frequently, the reverse is true. Not so in a radio receiver where two tubes are better than one. The reason—less is known about heads than is known about tubes. However, a properly designed and well constructed one-tube regenerative receiver will just about pick up the same signals which can be picked up on a three or four-tube receiver. The difference will be the volume produced by the three or four-tube receiver over that produced by the one-tube receiver. A two-tube receiver will produce greater volume than a one-tube receiver. Two stages of good audio amplification added to a one-tube regenerative receiver will produce reasonable room volume with a loud speaker. Of course, the transmitted signal must have sufficient power behind it. KGO, on a frequency of 12,850 kilocycles (23.35 meters) is heard in Chicago with fairly good room volume during the daylight hours on a regenerative receiver and two stages of audio amplification and a loud speaker. Using a pair of headphones and a one-tube receiver, KGO is heard, but with considerably less volume.

Every now and again somebody will say that he can hear stations on his one-tube receiver that so-and-so cannot hear on his three-tube receiver. Something is wrong with the three-tube receiver, but more generally the examination reveals that it

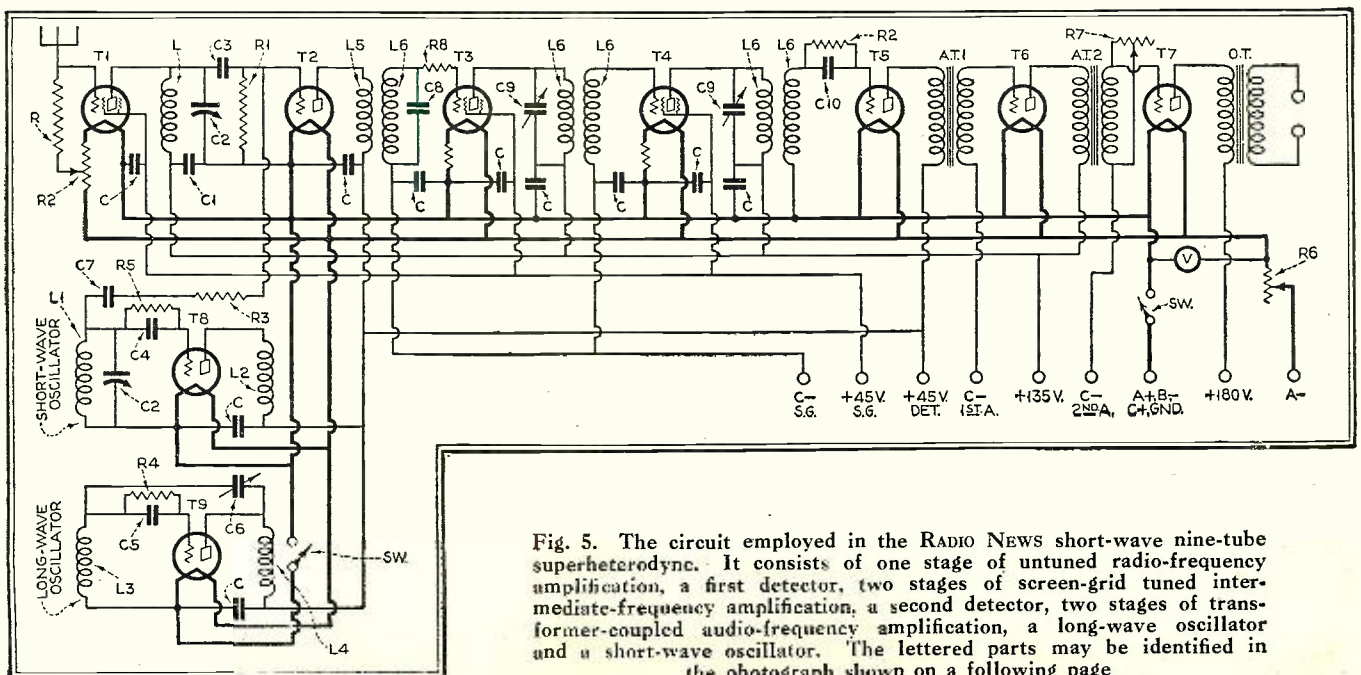
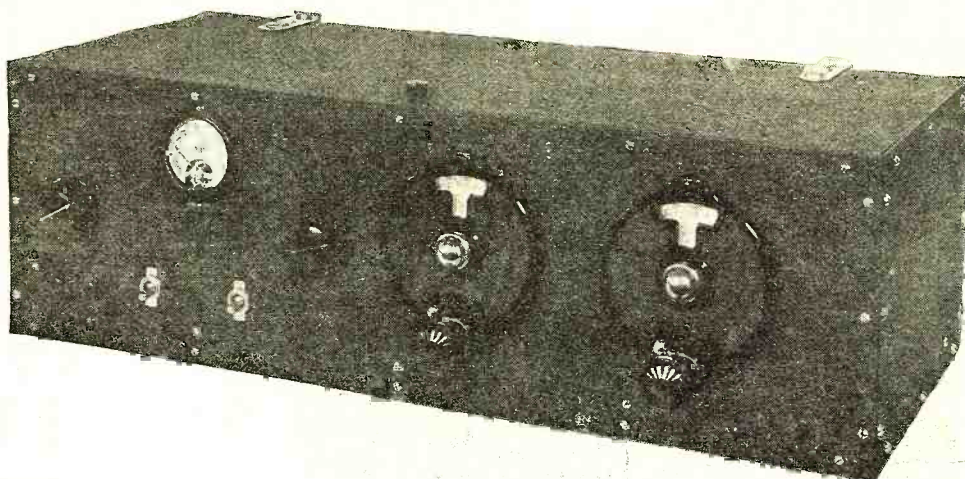


Fig. 5. The circuit employed in the RADIO NEWS short-wave nine-tube superheterodyne. It consists of one stage of untuned radio-frequency amplification, a first detector, two stages of screen-grid tuned intermediate-frequency amplification, a second detector, two stages of transformer-coupled audio-frequency amplification, a long-wave oscillator and a short-wave oscillator. The lettered parts may be identified in the photograph shown on a following page

By  
 Fred H.  
 Schnell\*  
 W9UZ

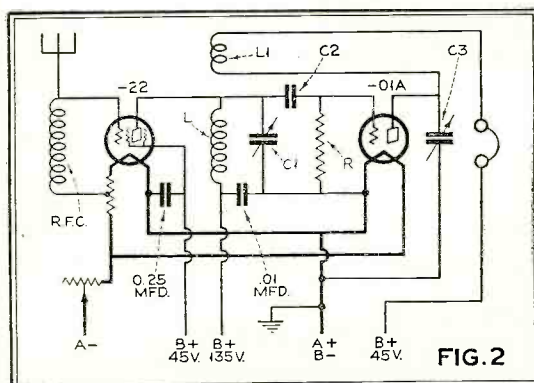
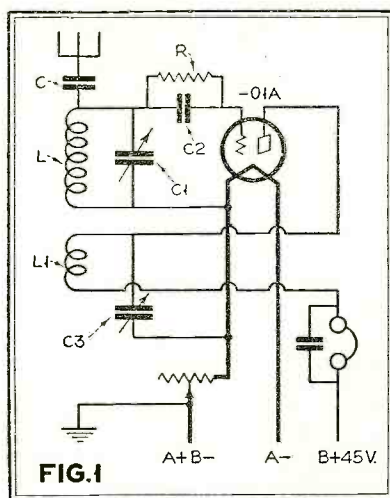


# Heterodyne Receiver

*The First Article of a Series on the Construction and Operation of a Short-Wave Super for Code or Broadcast. Plug-in Coils Permit Tuning to All the Amateur Bands in a Circuit Employing Nine Tubes. This Article Outlines the Limits Within Which the Accepted Types of Short-Wave Circuits Function. It Also Describes the Circuit Details of the New Short-Wave Superheterodyne and Provides Sufficient Data to Begin Construction*

isn't a question of receivers at all. It is the human ear that enters this picture and it must be given a great deal of consideration. Quite forcibly has this been brought to my attention in amateur radio. The one amateur who stands out in my mind as having not only the keenness of ear to hear weak signals but also to copy weak signals through strong interference is Don H. Mix, of Burgess Radio Laboratory. Mix was the first radio operator to accompany the MacMillan Expedition to the far north and there is no doubt but what his keen ears had much to do with the successful radio communication of WNP. I have sat right alongside of Mix at the same receiver and with double head-phones listened for the same signals. Mix was able to make fairly clean copy of telegraph signals that I barely could hear. Through the unusually heavy interference with which W9EK-W9XH is blessed during heavy fog or rain, no one of us could compete with Mix on reception. Mix is the rare exception and he probably could receive with the poorest type of receiver and do better than some of us with the most carefully constructed receiver.

For a number of years the radio amateur and the short wave broadcast listener have been in the habit of using a regenerative detector and one or two stages of audio amplification. There probably is nothing more sensitive in a one-tube receiver than a regenerative detector tube. The schematic diagram of such a receiver is shown in Figure

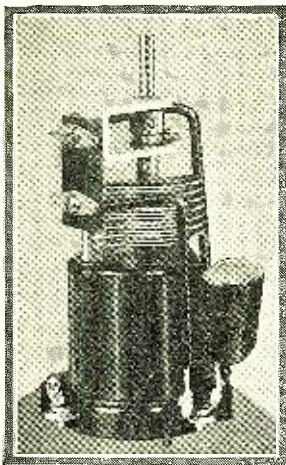


At the top, Fig. 1 shows the simplest form of short-wave receiver circuit while Fig. 2 below, shows the same circuit with a stage of untuned r.f. amplification added to it

1. In all of these schematic diagrams the audio amplifiers are left out for diagram convenience. Here we have a receiver that is capable of satisfactory reception with head-phones. To be sensitive it requires the careful selection of the grid condenser. C2 and the grid leak, R. For ease of tuning, the condenser, C1 should be about 50 mmfds. This type of receiver has been and still is one of the favorites of the radio amateur. He knows from experience that the grid condenser should be 0.0001 to 0.00015 mfd. when used with a grid leak of 9.0 to 15.0 megohms. Depending somewhat on the tubes, such a combination makes for very smooth regeneration control when the condenser, C3 has a capacity of about 125 to 150 mmfds.

The screen-grid tubes with their high amplification make possible a better receiver for short wave work. One of the undesirable features of the receiver shown in Fig. 1 is that when the secondary tuning circuit reaches resonance or near that of the antenna, the tube stops oscillating because of the close coupling. The diagram of Fig. 2 shows a screen-grid tube ahead of the detector, not so much for the additional signal gain as for the elimination of the undesirable feature mentioned above. This screen-grid tube acts as a coupling tube and prevents the close coupling of the antenna. The tuning control and the regeneration control maintain a smoothness which is very desirable. In addition, there is a small gain in signal strength. A grid leak type resistor can be used in place of the radio

\*Chief of Staff, Radio & Television Institute, Chicago.



The inside of one of the intermediate-frequency amplifier coil units, showing the coil, fixed condenser and tuning condenser

Fig. 3. A three-control short-wave receiver circuit employing a stage of tuned radio-frequency amplification ahead of a regenerative detector circuit using a variable resistance for the control of regeneration

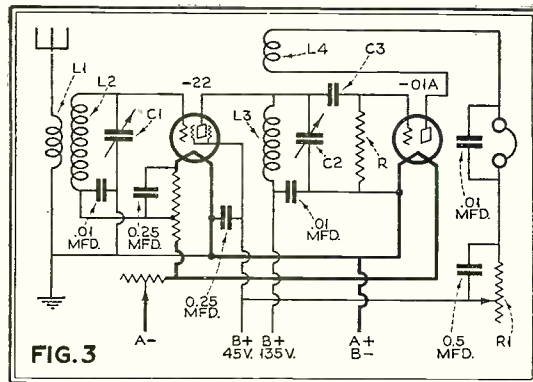


FIG. 3

frequency choke. R.F.C. is shown in the diagram in the antenna-grid circuit to the filament return of the screen-grid tube. The screen-grid lead must be bypassed with a condenser of about 0.25 mfd. Since the plate of the screen-grid tube is coupled to the grid of the detector tube through a condenser of 0.002 to 0.005 mfd., the precaution is taken to keep the plate voltage from the detector grid and filament by using a condenser of 0.01 mfd. between the secondary tuning inductance and the secondary tuning condenser. The grid leak R will be of the same value as that for any other short wave regenerative receiver, 8.0 to 15.0 megohms.

To go this far in a short wave receiver is a step in the right direction. There are no additional tuning controls over that in Fig. 1 and the additional tube for coupling is well worth the time and effort. The next step and probably one of more importance is the receiver in Fig. 3. The screen-grid tube not only acts as a coupling tube but it really gives additional signal amplification because this radio frequency stage is tuned. True, it means one more tuning control, but it is to be desired. For all practical purposes, the tuning condenser, C1 in the radio frequency stage can be set, let us say at 7.150 kilocycles (the middle of the amateur 7,000 to 7,300 kilocycle band) and the secondary tuning condenser, C2 operated as though it were a two-control receiver. For finer tuning and additional amplification, the radio frequency tuning condenser is brought to resonance after the secondary tuning condenser has been set. The receivers of Figs. 1 and 2 used the "throttle condenser" for regeneration and oscillation control. The Fig. 3 receiver uses the variable resistor, R1, 50,000 to 100,000 ohms. Otherwise, the circuit is the same beyond the screen-grid tube. This type of receiver seems to be the limit for ease of operation and handling, particularly for the radio amateur who makes use of both hands in handling message traffic. Even the broadcast listener may not care to go beyond this or any other receiver which has more than two or three tuning controls.

Now just see what happens when we add another tuned stage of radio frequency ahead of the regenerative detector.

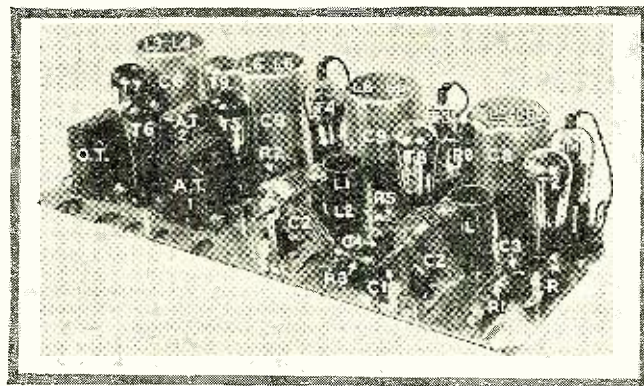
(See Fig. 4.) Is it worth while? There are now five controls. Antenna, first radio frequency, second radio frequency, detector secondary and regenerative controls. Surely not a receiver for ease of tuning and one which would be rather cumbersome for the message-handling radio amateur. For short wave broadcast reception, it would be somewhat better than the others because of the higher signal gain. Yet, something more than average skill would be required to tune it efficiently. The only advantage would be the possible increase in signal gain. This is apt to be misleading, particularly at short wavelengths. Where the tuning demands a wide range of frequencies, gang control of the condensers is impracticable.

The probable average voltage gain per stage at radio frequency in a broadcast receiver is about 20, in the better ones. Some of them use but two stages where the overall gain is 20 x 20 or 400. If there are three stages, the voltage gain becomes 20 x 20 x 20, or 8,000. Quite a considerable gain, especially if stability is maintained. The broadcast receiver covers a frequency range from 550 kilocycles to 1,500 kilo-

cycles. The voltage gain per stage is not uniform over the entire range, although it is fairly so. At frequencies of this order, such a gain is easily possible with the a.c. screen-grid tube, which has a lower plate impedance and a higher voltage amplification. However, when we use the d.c. screen-grid tube with a plate impedance of 850,000 ohms and which has a voltage amplification of 300, such voltage gains are somewhat above those which can be reached at high frequencies. More particularly is this true where a much greater frequency range is to be covered in tuning. For a single frequency of the order of 7,500 kilocycles, a voltage gain of about 30 per stage is possible. Two or three such stages incorporated into a receiver would require the utmost care in assembly. Thus, a short wave receiver using two radio frequency stages might have a voltage gain as high as 12 to 15 per stage. In the first case, the total gain would be 12 x 12, or 144 and in the second, 15 x 15, 225. These figures are given as approximate examples and must not be taken as measured gains. It is rather doubtful that voltage gains of this order can be obtained in the average short wave receiver. The voltage gain per stage is more likely to be less than 10.

Going further with radio frequency amplification, that is, to three radio frequency stages is going beyond anything the average radio amateur or broadcast list-

(Continued on page 170)



Compactness personified is illustrated in the photograph above showing the placement of the various parts on the sub-base of the "super." The lettered parts tie up with the circuit diagram shown in Fig. 5

Fig. 4. Too many controls for ease of operation. A regenerative detector employing two stages of tuned radio-frequency amplification ahead of it. A critical circuit to make function satisfactorily

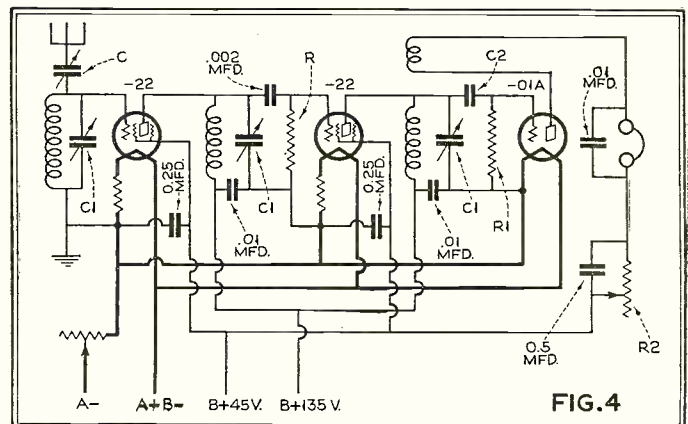


FIG. 4

# Building A Simple Stroboscope for Synchronizing Television Discs

*Synchronization Now Remains the One Big Problem in Television. Many Mechanical and Electrical Schemes Have Been Employed as a Solution and the One Described Here, a Mechanical System, Is One of the Simplest*

By H. N. Bliss

AT the present time there is nothing very difficult about obtaining good clear images with a television receiver which is equipped with an accurately drilled scanning-disc capable of reproducing pictures an inch and a half square, and fed by a high-quality amplifier; provided, of course, that the received signals are loud, and free from static and interference. The one outstanding difficulty experienced by the writer, and no doubt by everyone who has experimented with television at home, is that of managing to keep the received picture still long enough to make sure just what it is before it floats off out of the frame to be replaced by another higher up or lower down.

At this point the operator usually makes an over-adjustment either up or down in speed in his anxiety to keep the picture in the frame, with the result that the pictures spin rapidly around either to the left or right and when synchronism has again been obtained (for the moment) ten to one the legs of the image are visible in the top of the frame, while the head is moving around legless at the bottom. This necessitates changing the speed again very gradually until the pictures travel around into the frame and then doing it all over, again and again.

In casting about for a remedy the writer appropriated the idea incorporated in the well-known Victor sixty-cycle stroboscope. This is a small disc of white cardboard printed with ninety-two black segments, which, when placed upon a phonograph record and lighted by a sixty-cycle lamp appears to stand still when running at exactly seventy-eight revolutions per minute.

A little calculation evolved the formula:  $N = \frac{60}{r.p.m.} \times 120$  in which N equals the number of black segments needed, and R.P.M. is revolutions per minute of the disc desired.

For receiving standard television signals (48 lines 900 R.P.M.), eight segments are required and a six-inch disc of white cardboard was cut out and divided into sixteen equal parts by radial lines. Eight of these pie-shaped segments were blacked with india ink and the disc glued to the scanning-disc and illuminated by one of the small sixty-cent neon lamps attached directly to the house lighting circuit. Upon trial this was found to be a great help, making it possible to get the outfit up to proper speed with little loss of time, and to devote some time to experiment with speed control without wasting time during a broadcast. It was found that while watching the picture the black spokes were always visible to the eye even though one was not looking directly at them, and any tendency to creep could be instantly noted and a speed correction made before it became serious.

One may well ask why not use a synchronous motor and

be done with it and the answer is that unless you are lucky enough to be on the same power net-work as the transmitting station a synchronous motor geared directly to the scanning-disc will probably not provide sufficient accuracy, as here in Ithaca, N. Y., it is necessary to let the spokes of the stroboscope creep very slowly in an anti-clockwise direction in order to stay in phase with the Jenkins transmitter in Washington.

## Obtaining Illumination of the Disc

A more brilliant illumination of the stroboscope disc may be obtained by polarizing the neon lamp by means of a forty-five volt B battery inserted in series with the lamp and one of the a.c. leads to it. This will cause the lamp to flash only sixty times per second instead of one-hundred-twenty and will require only four black segments on the stroboscope disc.

The writer believes that the ideal combination consists of a synchronous motor driving the scanning-disc by means of a friction roller capable of sliding adjustment for speed regulation as has been described elsewhere, and a stroboscope as described above to show the correct amount of creep.

## The Television Receiver

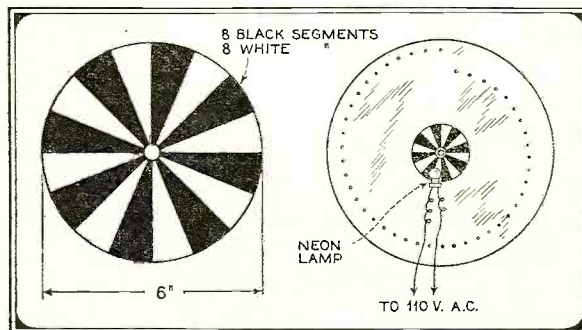
A word concerning the receiver and amplifier used by the writer for the reception of television signals may be of interest. A great deal has been written concerning the necessity of using

a special resistance-coupled amplifier in order to obtain undistorted pictures, and while this is perfectly true if absolute perfection is desired, surprisingly good results may be obtained by using any amplifier capable of first-class musical reproduction; in fact, the distortion due to static and interference of one kind or another is apt to be much more serious than any frequency distortion, especially for the man located one hundred and fifty miles from the transmitter.

It is unfortunate that the wave-band assigned to television seems to suffer a great deal from fading and interference due to broadcast station harmonics, but the patient operator will be rewarded quite often with the reception of strong, steady signals which will make it all worth while.

The writer uses a modification of the "Q.S.T. All-Purpose Superheterodyne," whose second detector is arranged for linear power detection. The output of this detector is fed through a high-grade transformer, having high primary inductance, directly into one 250 power tube supplied with six hundred volts on its plate and is capable of overloading it quite easily.

The Raytheon Kino Lamp used in the television outfit is fed from the plate of the -50 through a stopping condenser.



To the left is a stroboscope disc as described in this article. Its application to the scanning-disc is shown at the right

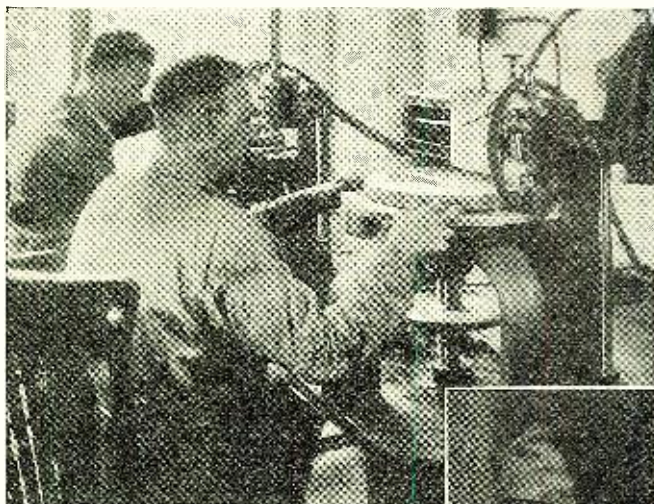


Frank Black, musical director of Sound Studios of New York, Inc., pianist and conductor of the Seiberling Singers

# Recorded What They Are

*Think of It . . . Under the Best of Conditions Artists Appear Before the Microphone, Render Their Numbers, Which Are Mechanically Recorded on Specially Prepared Discs, and Then These Discs Are Sent to Various Stations to Be Put on the Air, Reproducing with Just as Fine Tone Quality as if the Artists Had Appeared Personally Before the Microphone of Each of the Stations. Broadcasters Have Not Been Slow to Realize the Great Economical Value of Such a System Which Permits Them to Broadcast Such Talent as Would Otherwise Be Unavailable*

By A. J. Kendrick\*



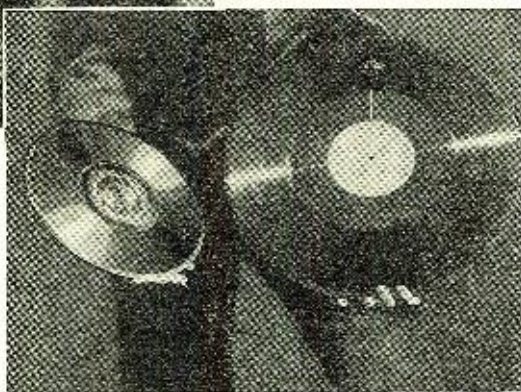
Shaving the master wax record, so as to obtain an absolutely smooth and perfect surface upon which to engrave sounds with their overtones and harmonics for a realistic production at the broadcast studio

**I**N 1929 more than half the broadcasting stations in the United States lost money, and they lost more than the others made. As in drug stores and groceries, so too in broadcasting, the trend seems to be in favor of a few large stations rather than many small ones. Many stations, both independent and affiliated with the networks, were growing anxious concerning their future when the recorded broadcast program came to their rescue.

Of course, the earliest broadcast programs, back in 1920 and '21, consisted chiefly of records. But these were phonograph records, quite unsuited to broadcast needs. For this reason the program originating in the broadcast studio soon took the place of records. As the networks grew and time thereon became more and more expensive, sponsors realized that the value of using the networks depended on super-quality programs. The cost

of the network was the same whether a poor or a good program was broadcast. Efficiency demanded fine material. The ever-increasing competition for listener interest also raised the quality of network programs. But these were expensive. The question arose how best to utilize these costly and beautiful programs, overflowing with good will potentialities, to the full. Certainly not by giving them but one performance, over the network. And so in December, 1928, the recorded broadcast program came into being. Since then the technique of recording and broadcasting these programs has been improved rapidly until today facilities are at hand by means of which programs may be faithfully recorded and adequately broadcast.

Before discussing the technique of recording let us review briefly the advantages of recorded broadcast programs. The broadcast station far removed from sources of entertainment talent cannot hope to compete with large-city stations in the matter of original programs. But by the use of recorded sustaining programs they may give their listeners the finest music, and entertainment of the finest talent throughout the country. The rental of the discs is far less than the cost of preparing a program, holding auditions, rehearsing and paying artists' salaries. And the programs are far superior. Station managers may receive recorded auditions or entire programs from which to choose the selections they desire. The wide range of talent thus available makes possible greater variety in program menus than might otherwise be



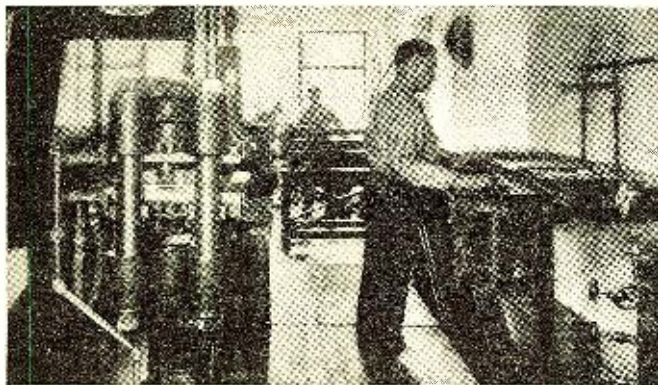
Contrasting a test pressing with an ordinary phonograph record. These test pressings are carefully examined for artistic and technical flaws. Upon their approval both "mother," "stamper" and final pressings are made. Unlike the commercial phonograph record, the radio recording disc plays from the center toward the rim. The vertical line on the large record indicates the point at which the selection starts

had. The recorded program gives the station manager an opportunity to build balanced programs to suit all occasions, hours and audiences. The artistic building of sustaining features is facilitated.

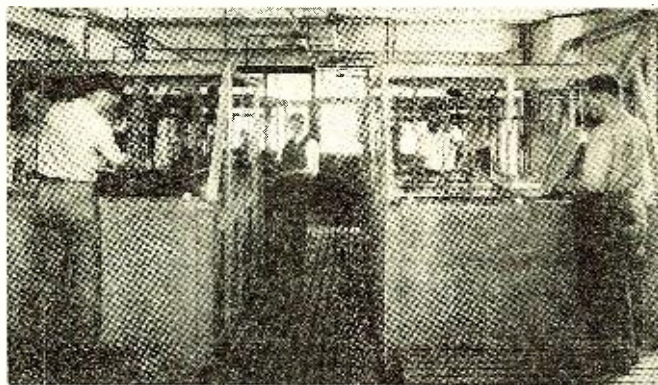
This leads to greater coverage or listener interest in the station, and increases the value of the station to the prospective sponsor. It also gives the public the finest of programs, whether the listener is tuned in to a network program or his

\*President, Sound Studios of New York, Inc.

# Programs— and How They Are Prepared



A view of the Pressing Department of the Sound Studios of New York, Inc., where test pressings are made. The earth wax compound is being heated at the right. To the left is the press, intense heat and pressure compound to make the pressing



A portion of the Galvano Department, where wax records are electroplated. The wax records switch back and forth through the baths on rods such as that held by the man at the right. To the right is a wax recently taken from the bath. In the rear, "the master," recently peeled from the wax, is being examined

local station, be it urban or rural. The public responds to the better programs with more-hours-per-day listening and in greater numbers than formerly.

Turning our attention to the sponsor, let us examine his problem. He is broadcasting over a large network at great cost for time and programs. However, he is well satisfied, the cost is more than paid for by increased sales. In fact, so enthusiastic is the sponsor for radio advertising because of his network results that he desires to increase his use of this medium. In the past he has been afraid to do so. He should have liked to use independent stations, but, on the other hand, after giving the public such fine network programs he was loathe to represent his firm and product over the air by any inferior material. His hands were tied. Much as he desired to use the independent stations, he could ill afford programs inferior to his network ones and the stations he desired to use could not furnish him with talent equal to that. So he let the matter drop.

Now the situation has changed. The sponsor still uses the network. But let us say that sales are not pulling in Texas, to which state the network does not reach. And, in addition, he is planning an intensive dealer campaign for Florida. He desires to supplement his network broadcasting with spot broadcasts from independent stations in these territories. The sponsor investigates the stations in these districts and finds that those with the greatest coverage are those who have facilities for broadcasting recorded programs and use them. He records his network program and the discs are played by the chosen stations in Texas and Florida. He has spent money for radio advertising which might otherwise have gone to newspapers or other media, or might not have been used at all.

Another advantage of the recorded program is the ability to reach a coast-to-coast audience at the same hour despite time differences between the east and the west. The inability of network programs to do this is a tremendous handicap. The recorded program fills this need.



Gustave Haenschen, music director of Sound Studios of New York, Inc., and director of the Palmolive Hour and the Champion Sparkers

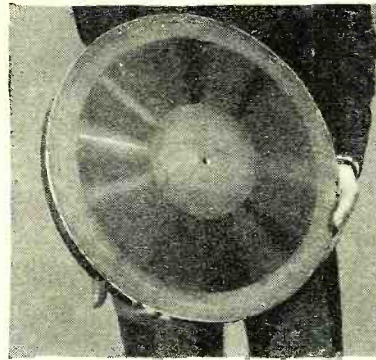
It might be thought that the recorded program would compete with the networks. This is not the case. Recorded broadcasts are not a substitute for the networks; they supplement the networks. Many potential network sponsors have remained away from broadcasting due to the fact that they have been unable to use the costly network programs for more than one performance, an economic waste if ever there was one. Now, networks have an added sales point, the fact that the prospective sponsor will be able to make full use of his network program by having it recorded and used for spot broadcasting from independent stations.

We might discuss the value of the recorded program for many pages. We will name but one more, the ability to edit the program. No matter how carefully a program is prepared, some untoward incident may slip into the performance to mar the effect. Artists and announcers are only human. They may mispronounce a name, give the wrong figures, open the program with "good morning" after dinner. Such things will happen. And when they do in the original program they cannot be recalled from the hundreds of thousands of loud speakers which reproduce the mistakes as they are made. In addition, an orchestra may play a selection slightly better on one occasion than on another, a singer may not be in the best of voice the evening of the program, someone may have a cold. These things cannot be avoided in the original broadcast.

But in the recorded program all mistakes are found and corrected before the discs are released for broadcasting. Vocalists may sing when their voices are at their best. Orchestras may play the selections several times and the best performances chosen for incorporation in the discs that are to be broadcast. One selection may be chosen from one performance, another from a second, to the end that the edited and final discs may represent only the finest work of soloists, orchestra and announcer.



At the left is the metal stamper from which the recorded broadcast program discs are stamped



At the right a huge slice of special wax which is shaved with the spiral groove representing the latent sound values

Let us turn our attention to the recording itself. We have said that ordinary commercial phonograph records are not suitable for broadcasting. For this reason the large electrical companies of the country have been working on methods by which broadcast programs might be recorded. Since the discs were to be broadcast by radio, the first step was to adopt radio technique to recording. Some of this technique is now also applied to the manufacture of phonograph records. The horn and mechanical pick-up were displaced by the microphone and electrical pick-up. The vacuum tube amplifier came into use and in general recording was made to follow as closely as possible the methods of radio.

The talkies, appearing about the same time as the beginning of the recorded broadcast program, lent added impetus to recording development. The Western Electric Company, for years pioneers in the field of sound reproduction and transmission, brought its tremendous research facilities, knowledge and experience in the field of telephone work to bear upon the problem. The result was the Vitaphone and the rapid development of talkie recording.

Having given sound pictures a good start, Western Electric, armed with the experience gained in this field also, turned its attention to radio. Its laboratories on the Pacific Coast helped. Another sound laboratory was established in New York City, the center of broadcasting activities. And several months ago Western Electric came forth with the announcement that it had perfected apparatus for the recording and broadcasting of programs.

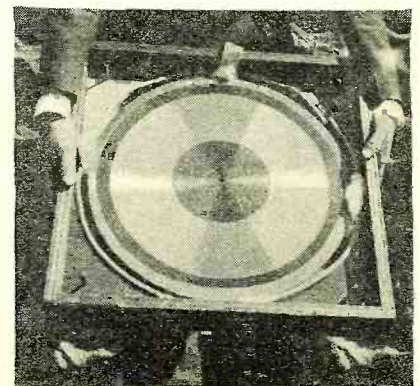
The first step was to install the broadcasting apparatus in stations. It was found that many stations, having attempted recorded programs with inferior equipment, or having accepted for transmission discs that were poorly recorded, were prejudiced against recorded programs in general. However, when they were shown the perfection to which such presentations had attained at the hands of Western Electric they eagerly sought equipment. To date Western Electric has equipped about forty stations throughout the country, assuring itself in advance that the stations had trained and intelligent personnel, and requiring the stations to use the equipment to broadcast only quality discs. More stations are continually being equipped.

Then Western Electric sought recording companies as an outlet for its recording machinery. Again they sought firms whose experience, training and general qualifications warranted the installation of its recording facilities. Their first and to date their only license for the recording of broadcast programs has been issued to Sound Studios of New York, Inc., which was chosen after a careful investigation of recording companies throughout the country. This investigation showed that there exist many bootleg recording companies, who, working on obsolete and unlicensed equipment, recorded on large discs selections from phonograph records, while the sponsor thought he was having a program prepared especially for him and recorded from an original performance. For this reason Western Electric is issuing li-



At the left are shown the bright metal stamper which stamps the records and a finished record ready for rebroadcasting purposes

At the right is the wax in a specially constructed case, lined with felt, and used in transportation from the recording studios to the Galvano Department



censes, so that sponsors and stations may know what companies have been approved.

Let us take a visit to one of these companies, Sound Studios of New York, previously mentioned as the first Western Electric licensee. Here we find the programs especially prepared under the personal supervision of Gustave Haenschen and Frank Black, well known in the musical

world for their phonographic and radio work. In the preparation of the program the sponsor's product is kept in mind and the audience he wishes to address. All music is specially scored, some taken from the huge library containing thousands of such pieces for every instrument and mood. Often numbers are composed to meet the requirements. Then the artists are chosen, rehearsed and the program is ready for network presentation. In this way Sound Studios of New York prepares the Palmolive and Ovaltine hours, the Wonder Bakers and the Chase and Sanborn Choral Orchestra, among other features.

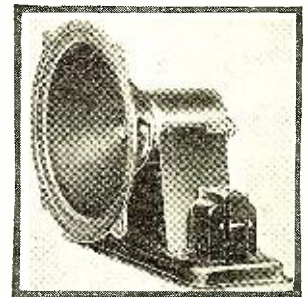
The recording studios of Sound Studios of New York are in the same building as the other departments. They resemble any fine broadcasting studio, the walls, floor and ceiling made of sound-proof materials, scientifically ventilated and with the usual draperies by which to adjust room reverberation. The latest type condenser microphones are used. A double glass window looks into the monitor room, from which the microphone output is controlled, raised, lowered and blended to give the best effects. So far there is no difference between the recording and the broadcasting studio. But the recording studio has another room in which are the turntables and faders by which one turntable is set going while the other stops, permitting the transfer of a program from one disc to another without interruption. The speed of the turntables is kept absolutely constant by vacuum tube controls.

The placing of the orchestra and the microphone differs somewhat in recording as compared with broadcasting. For in broadcasting the sound is converted into electricity, then back into sound again by the loud speaker at the radio receiving set. But in recording the sound is converted into electricity, then into mechanical energy in the stylus cutting the wax. These problems are studied by acoustic engineers and talent and microphone positions determined. For one thing, the strings must often be nearer the microphones for recording than for broadcasting.

When all is in readiness huge discs, called waxes—though they are really made of special soap material—are placed on the turntable. Let us say that it is to be a slow-speed record. The waxes, about  $1\frac{1}{2}$  inches thick, are placed on the 33  $\frac{1}{3}$  r.p.m. turntables and the pick-ups adjusted. These discs are of the lateral cut type, the grooves being of constant depth, and the vibrations of the stylus cutting the walls of the groove. This type of disc is in contrast to the "hill and dale" type, the name of which is self-explanatory. The pick-up is no ordinary phonograph affair. In the usual (Continued on page 170)



# ELECTRODYNAMIC REPRODUCERS



**M**ANUFACTURERS have applied design expedients (together with the theoretical considerations) so diligently in the construction of electrodynamic speakers that this type has become the standard reproducer of the year. Recently they were considered the aristocrat of speakers and were to be found only with de luxe receiver ensembles. Their efficiency is relatively high and, if well matched transformer design is assumed to be employed in the output circuit of the receiver with which the speaker is used, the frequency range is limited only by the radiation characteristics of the diaphragm or cone.

**I**T is of interest to review the fundamental principles upon which electrodynamic reproducer design is based, the technical problems involved, and selection of the proper type to match a given receiver together with installation procedure. Such information, while of but passing interest to the layman, may serve to clear up certain installation or repair problems.

The operation of this type of reproducer is based upon one of the earliest known electrical principles, *Ampere's Law*, which has been stated as follows: *When a wire carrying current lies at right angles to the lines of force in a magnetic field, it experiences a force action which is proportional to the field intensity, to the length of wire, and to the current which is flowing in the wire.*

$$\text{Force} = \text{amperes} \times \text{length of wire} \times \text{field strength}$$

While not of primary importance to the theory, it is often of interest to know the direction of the resulting force. Imagine a field represented by parallel lines as in Fig. 1, with a wire carrying current within it. Assume the field is directed across the page from left to right, the wire suspended vertical to the plane of the page with the current flowing toward the reader. Additional lines of force *due to the current in the wire* flow around the wire in the direction indicated. It will be seen that this additional magnetic flux strengthens the field below the wire and weakens it above. This effect of unequal fields on opposite sides of a wire pushes it aside in the direction of the weaker field (as shown by Fig. 1).

Thus in the application of this law to speaker design we must produce a strong field in a gap, design a coil of wire that can move in this gap without touching it, and furnish means for causing the greatest possible current to flow in the coil. We must then design a diaphragm that will generate the sound waves and furnish means for attaching this diaphragm to the moving coil.

For simplicity in obtaining the greatest length of wire in the smallest space it is generally wound in a coil. This necessitates the use of an annular magnetic gap. In order to obtain a strong field in the gap an electro-magnet is used, using a coil with a

large number of turns of wire, connected to a source of direct current. Speakers now available on the market generally have a field with about 1,000 to 2,000-ampere turns. In order to provide a very strong field in the gap

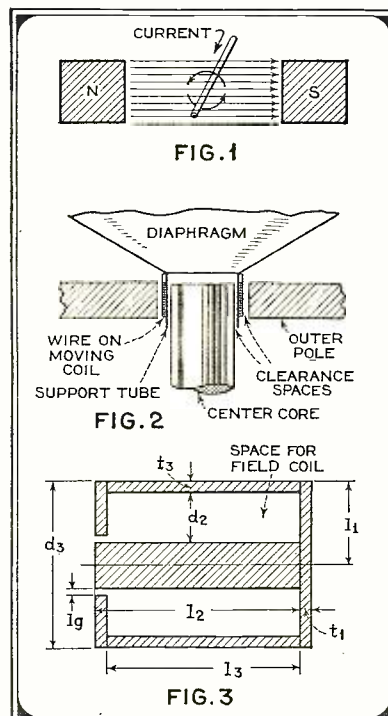
By R. R. Batcher

economically it is necessary to keep the air gap as short as possible. A few thousandths of an inch increase in the gap length will decrease the field considerably. Factors which determine the length of gap permissible will first be taken up before the field structure is studied. Referring to Fig. 2, it will be seen that the available space is taken up with the wire, the supporting form and two clearance spaces which allow the coil to vibrate without hitting the poles. Since the end turns must be taken off from the same end of the coil, an even number of layers

of wire are generally used, nearly always two or four. The size of wire and the number of turns is not very important, if other factors are selected to fit in with the values decided upon for these items. It is important from an efficiency standpoint that as much of the magnetic gap as possible be filled with wire. On the other hand, from the standpoint of ease in assembly and permanent adjustment, the clearance spaces should be ample, or the speaker will rattle badly.

Four layers of No. 36 wire will occupy about the same space as two layers of No. 30. The former will have four times as many turns and sixteen times the resistance. Either one, however, will operate practically the same, but the output transformer must have different specifications. The insulation (enamel) is a little thicker on the larger wire and there is a little greater amount of copper in a given volume of winding so that the odds are a little in favor of the larger wire from this standpoint. An illustration of a typical moving coil design is as follows:

Two layers No. 30 wire (note the second layer generally falls into the grooves between the wires of the first layer) are approximately .019 inch thick; coil form .004 inch thick; and two clearance spaces each .016 inch give a total of .055 inch gap length. This value will be used in further computations. Many speaker designs, however, use a somewhat greater gap length so that greater



The three figures above tend to illustrate the general principles involved in the construction and operation of electrodynamic loud speakers

manufacturing variations can be tolerated.

Two general types of field magnet structure are to be found, cast and stamped. Cast steel or malleable iron is usually used with the cast design, while ingot or Swedish iron is used in many cases when the stamped design is used. Ingot iron is a better magnetic material than the cast product so that a lighter field assembly is permissible. Any material of a magnetic nature can be used with equal results if sufficient weight is used. In the case of cast iron, for instance, the total weight required would be so much greater that it is uneconomical. The tendency toward stamped field pots of late is due to this higher efficiency and to the elimination of many machining operations necessary with the cast product.

The core or center pillar size must next be selected. The larger the diameter of the center pole, the greater the area of the gap and therefore the greater the length of wire in the gap. Due to the greater volume of iron, the large pole will carry the flux with less losses and a greater field is produced. The length of a turn of wire in the field winding is somewhat greater and a field wound to a certain resistance (as is generally the case) will have less turns than one wound about a smaller center pole. However, this factor is greatly overbalanced by the other effects noted above, and it is generally found that the efficiency is greatly improved with a large center pole, and moving coil.

The calculation of flux is best accomplished by computing the losses in each item of the magnetic structure. The field under consideration may be sketched in cross section and all the dimensions set down, as indicated in Fig. 3. Then the formula:

$$\text{Reluctance} = R = \frac{l_1}{\mu A_1} + \frac{l_2}{\mu A_2} + \frac{l_3}{\mu A_3} + \frac{l_g}{A_g}$$

must be applied. The values for  $l$  and  $A$  for each item represent the length and area of

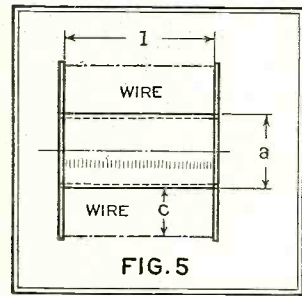


FIG. 5  
The core form for a typical field coil

the magnetic flux path. If we assume a flux density of 12,000 lines in the gap, the density in the other sections can be roughly determined, since the density in each portion of the circuit is inversely proportional to the areas of the magnetic path. The permeability can then be determined for each portion of the circuit from the curve Fig. 4.

The following example illustrates a typical solution (that sketched in Fig. 3) which should clear up any difficulty in applying the formula.

Let  $D_3 = 3$ ;  $D_2 = 1.5$ ;  $t_1 = .25$ ;  $t_3 = .125$ ;  $l_g = .055$ .

$$l_1 = \frac{d_3 - d_2}{3 - 1.5} = \frac{2}{2} = 1.18$$

$$A_1 = t_1 \pi (d_3 - d_2) = .25 \pi (3 - 1.5) = 1.18$$

$$A_2 = \frac{\pi d_2^2}{4} = \frac{\pi 1.5^2}{4} = 1.96$$

$$A_3 = \pi d_3 t_3 = \pi 3 \times \frac{1}{8} = 1.18$$

$$A_g = \pi d_2 t_1 = \pi 1.5 \times \frac{1}{4} = 1.18$$

Let  $B_g = 12,000$  lines of force, then from the permeability curve in Fig. 4

$$\mu_1 = 3,600; \mu_2 = 4,400; \mu_3 = 3,600$$

$$R = \frac{2}{3.5} + \frac{3,600 \times 1.18}{.055} + \frac{4,400 \times 1.96}{3.62} + \frac{1.18}{15,000 \times .06} = .0489$$

Several schemes for obtaining field excitation current from the B power supply of the receiver

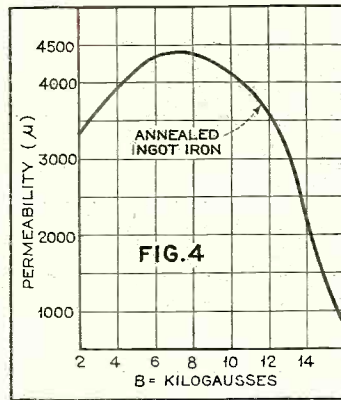


FIG. 4  
The permeability curve of annealed ingot iron

$$NI = \frac{BR}{4\pi} = \frac{12,000 \times .0489}{1.257} = 465$$

Thus 465 ampere turns are required to produce 12,000 lines of force (equivalent to 12 Kilogauss.)

Let  $B_g = 15,000$ , and again referring to Fig. 4

$$\mu_1 = 1,500; \mu_2 = 4,200; \mu_3 = 1,500$$

$$R = \frac{2}{3.5} + \frac{1,500 \times 1.18}{.055} + \frac{4,200 \times 1.96}{3.62} + \frac{1.18}{15,000 \times .06} = 0.60$$

$$NI = \frac{15,000 \times .06}{1.257} = 757 \text{ ampere turns}$$

The conditions which must be considered in the selection of the proper resistance for the field depends entirely upon the receiving set which must supply the current. In all systems the "B" supply system is tapped in some place, and the current is diverted through the field winding. Fig. 7 illustrates several of the most prominent schemes utilized in present receiving sets. Referring to this figure, circuits A and B indicate connections generally used with speakers having field resistances of 8,000 ohms or over. In some cases, however, values as low as 5,000 ohms may be used. These methods are not to be recommended, however, as the additional load upon the supply circuit, and in case B upon the filter circuit causes needless losses and a more difficult filtering problem.

Circuit C represents a common system and generally uses a field with a resistance of 500 to 1,000 ohms. All of the current supplied by the "B" supply circuit flows through the winding without any undue losses. In addition the field winding makes an excellent choke coil and this simplifies the receiver circuit, since the regular choke is eliminated. This feature is also found in the circuit D. Here the field generally has a resistance of 2,000 to 2,500 ohms, or in some cases up to 4,000 ohms. In this system the resistance that usually supplies the voltage drop to the intermediate tubes is also eliminated. Circuit E represents the type that supplies its own rectifying current, using a low-voltage rectifier and step-down transformer, similar to that found in trickle chargers. Here the field resistance is generally around 6 to 10 ohms. Circuit F represents a high-voltage rectifier that is utilized on many a.c. speakers this year. These rectifiers are connected directly to the line circuit and have an output around 60 volts. The field (Continued on page 166)

WIRE	TURNS/SQ. IN.	RES./CU. IN.	OHMS/LB.
13	570	.305	1.29
20	900	.766	3.24
28	5675	.30	132
30	8325	.75	332
31	10,600	.115	527
32	13,500	.184	835
33	16,700	.290	1330
34	20,700	.456	2100
35	26,500	.710	3350
36	32,500	1.100	5300

FIG. 6  
A handy wire table employed in the calculation explained in the text

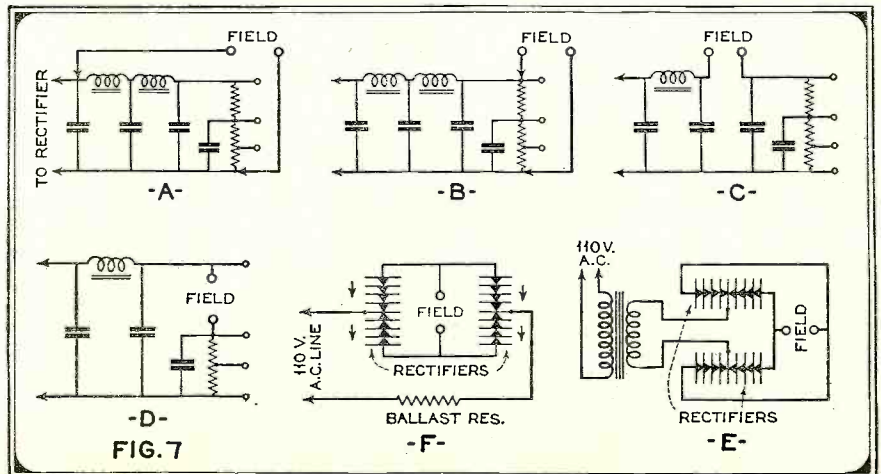
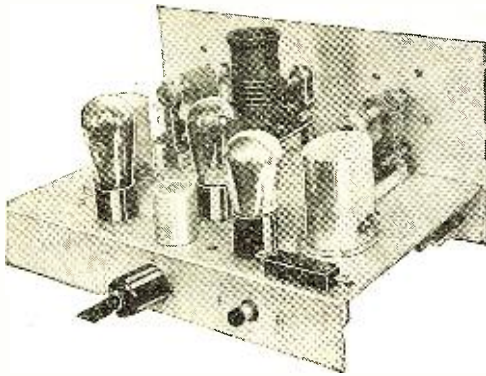


FIG. 7

# A Transformer-Coupled Audio Channel for the Radio News CORNET S-W Receiver



*Many readers have requested data on this now popular circuit using the conventional two stages of transformer-coupled audio-frequency amplification. The design of the receiver lends itself admirably to this alteration*

By Edward W. Wilby

**I**N RADIO NEWS for June was described the three-tube Cornet short-wave receiver employing two stages of resistance-coupled audio-frequency amplification, one of them a screen-grid stage. The Cornet receiver will be remembered as that used by Lieut. William H. Wenstrom in the many experiments he conducted and which was subsequently described by him in past issues of RADIO NEWS. So much interest was manifested in this receiver that the laboratory of RADIO NEWS designed its version of the Cornet receiver and described it last month.

In order to satisfy those who desire to employ some other type of audio channel, particularly transformer-coupled audio-frequency amplification, we have prepared the following information for the guidance of those who have already attempted the construction of this very excellent short-wave job. The new circuit, when finished, will consist of one tube functioning as a regenerative detector followed by two tubes in a two-stage transformer-coupled audio-frequency amplifier. The desirable features of design which were included in last month's receiver, such as the ability to change from one to two stages of audio amplification by means of a flip switch, are still contained in the new receiver described here. However, as will be noticed by a comparison between the circuit shown here and that published last month, the type of switch which is necessary for this work is somewhat different from that originally employed. What we require here is a three-pole double-throw jack switch wherein only seven of the nine blades are used.

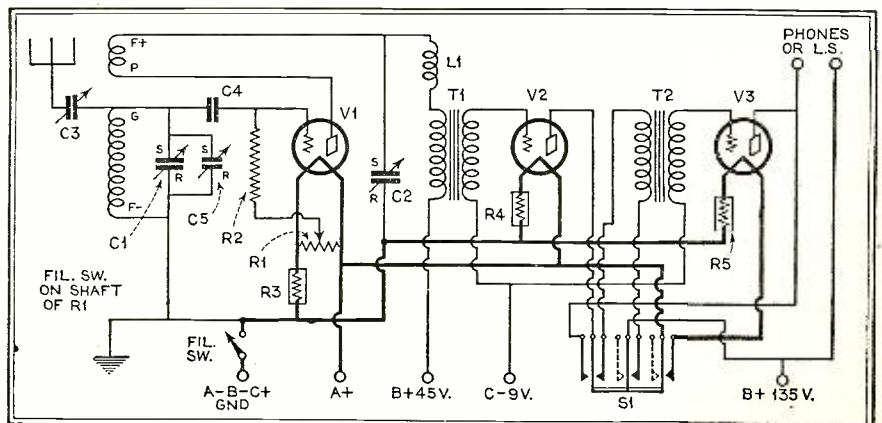
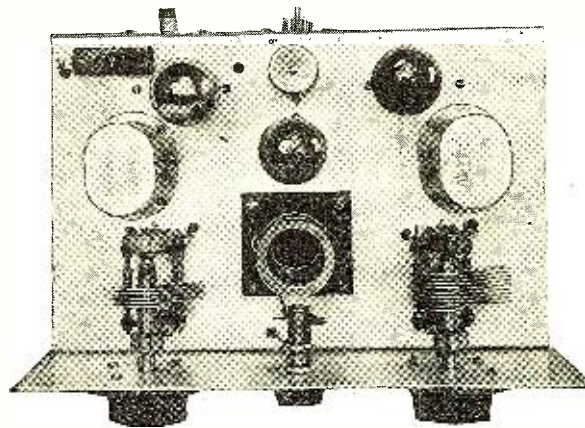
In the resistance-coupled receiver the resistance coupling units were supported by the wiring and were located under-

The detector circuit remains unchanged. Particular attention is called to the three-pole double-throw switch which is required for one or two-stage operation of the audio channel

neath the chassis. In the new receiver space will readily be found for the two transformer units on the top of the chassis. The location of these transformers may be immediately ascertained by inspecting the two photographs which appear on this page. Note that the symmetrical appearance of the receiver layout has been maintained even though the transformers have been added. Some changes in wiring are necessary when the transformers are substituted for the resistance-coupled stages originally employed. The new wiring will be immediately evident from inspection of the circuit shown here. If it is desired, further alteration may be made, substituting two phone jacks, one a double-circuit jack and the other an output circuit jack, for the first and second stages of audio-frequency amplification respectively. This to take the place of the flip switch S1. The layout of the receiver is such as to permit the substitution of even the largest dimension type of audio-frequency transformer.

In the original receiver the following parts are removed. C6, C7 and C8, R3, R4, R5 and R6. Also, as described heretofore, the switch S1 is taken out and a new type is substituted. The symbols as referred to here may be identified on the circuit diagram, Fig. 4, appearing on page 1080 of the June, 1930, issue of RADIO NEWS. The new parts which are to be employed are the audio transformers T1, T2 and the new switch S1.

A top view of the revamped receiver. Note how a symmetrical layout has been maintained



# A Loftin-White and Speech Amplifier

*For the Serviceman Who Must Make a Speech Amplifier System, Compactness, Mobility and a Certainty of Operation Mean Much in Providing a Satisfactory Installation at, Naturally, the Greatest Profit. The Loftin-White System of Direct-Coupled Audio-Frequency Amplification Lends Itself Admirably to This Sort of Work*

By George E. Fleming\*

**T**HERE is no system of audio amplification so particularly adapted to public address work as the Loftin-White system. It combines the necessary gain and power with extreme lightness of weight. Most transformer-coupled systems are shy on the high frequencies, and it is in these high frequencies that lie the overtones that give to speech its natural tones. That is the reason that a man's voice almost always sounds more natural over the radio than a woman's voice, and most women sound like contraltos. It is the faithful amplification of all frequencies in the audio spectrum that will best reproduce the original sounds.

No effort will be made in this article to describe the actual building of the amplifier proper, as this has been covered in great detail in several preceding articles in RADIO NEWS. Rather, the writer will confine himself to the use of the system in public address work. The amplifiers are available in commercial form from several manufacturers, or they may be constructed from constants given in the articles mentioned.

Reference to Figs. 1 and 1B shows two methods of coupling a microphone to the amplifier. In Fig. 1 the microphone current is taken from a bank of dry cells. Where absolute quietness of operation is necessary, this is the best method to use.



The elements of an easily constructed and amazingly simple "call" system for use in offices. Such an installation is also readily adaptable as a speech amplifier for school, dance hall and similar uses where large outputs of good quality are required. The system comprises a microphone, amplifier and speaker with the attendant coupling transformers and gain control

However, in many cases such quietness is not essential, so the microphone current may be taken from the filter system of the amplifier, as shown in Fig. 1B. R is a potentiometer of 300 ohms resistance, inserted in the "B" negative line so that the entire current drain of the amplifier flows through it. This will give about 9 volts drop in the case of the 45 job, which is sufficient voltage to apply to the microphone. The voltage is adjustable by the sliding arm, and should never exceed the manufacturer's rating.

A word of warning is in order here regarding the placement of the coupling transformer. If this is placed in the field of the power transformer it will pick up hum that will be very objectionable in the output, unless it is carefully oriented in respect to the power transformer. It will be best not to screw this transformer down to the baseboard until the entire system is working, and then try it in various positions until the hum is least. Remember, you are working into a high-gain amplifier whose response to 60 and 120 cycles is excellent. Heeding of this warning is essential if one expects good operation.

The next problem will be one of gain control. In case the microphone current is taken from the amplifier, varying the amount of current will give fairly good gain control. Much

\*Loftin-White Laboratories.

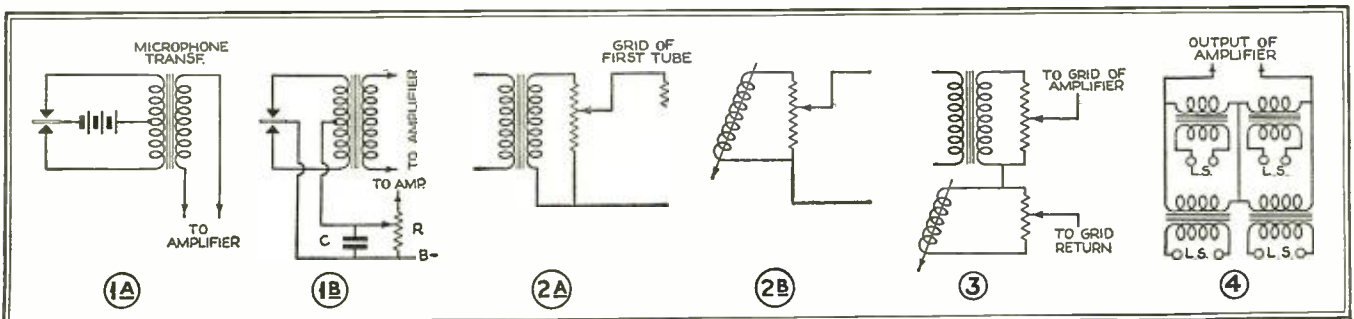
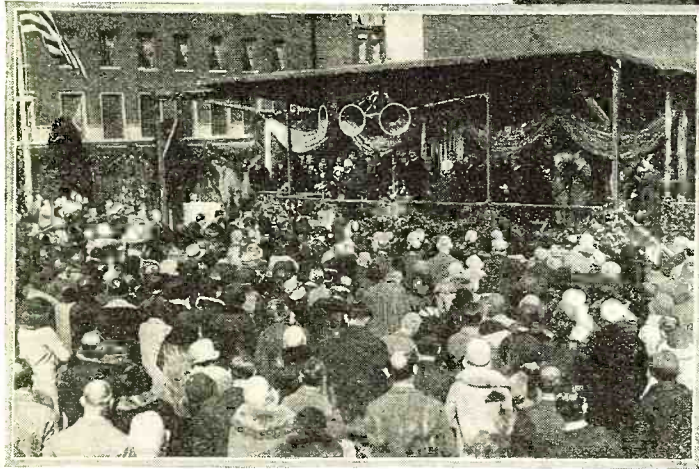


Fig. 1A shows how a double-button microphone is connected to the primary of a coupling transformer. Fig. 1B shows how, in place of the "mike" battery, current is obtained from the B power supply. Fig. 2A shows the generally accepted type of "mike" gain control, a resistance shunted across the transformer secondary. Fig. 2B shows a phonograph pick-up volume control system, while Fig. 3 shows how the "mike" and phonograph circuits are combined. In Fig. 4 the circuit is shown for connecting speakers in multiple in the amplifier's output

# Public Address System



Installed at the switchboard the speech amplifier becomes an integral part of the communication system of the well-conducted office, being particularly adapted to "call" work where the operator, by means of suitable switches, speaks over any one of several lines. To the left is an illustration of how necessary the public address system becomes in addressing large crowds. More and more, servicemen are learning that it pays to be equipped for this sort of work

better, however, is a potentiometer across the secondary of the transformer, with the sliding arm connected to the grid of the first tube of the amplifier, as is shown in Fig. 2. No definite value of resistance can be given because the secondary impedance of transformers varies so greatly. One should ascertain from the manufacturer what this secondary impedance happens to be, and use a resistance that approximately matches it. This will give excellent frequency characteristics, for if the impedances are matched the voltage from the transformer will be fully developed across the resistance. Any fraction of this voltage may be applied to the grid of the tube by adjustment of the sliding arm without disturbing the impedance relations. (The input impedance of a screen-grid tube, unless the grid is drawing current, is in the order of megohms.)

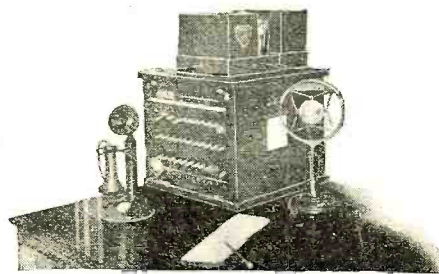
A phonograph pick-up is hooked up to the amplifier exactly like the secondary of the microphone transformer is hooked up. In this instance, the resistance of the gain control should match the impedance of the pick-up for the same reasons explained above. It is not the prerogative of the writer to advise what apparatus the reader shall use, but by all means use the best that you can afford, for the quality of the music and speech in the loud speaker can be no better than the quality fed into the amplifier from the phonograph pick-up or microphone.

It is frequently desirable to use both a microphone and a pick-up, "fading" from one to another as one wishes to reproduce music or to make announcements. This is readily accomplished, as shown in Fig. 3. The potentiometers shown here are the same as specified above, but placed so they may be varied simultaneously. With both controls in the full down position, as they are shown in the drawing, the pick-up is fully connected to the amplifier. In the full up position the microphone is connected. In a half and half position, one can make announcements with music in the background, and the proportion can be varied at will. Either gain control can be used independently of the other when the unwanted one is at full off position.

From the input we will go to the output side of the installation. Most of the dynamic speakers on the market have an output transformer built into them with an impedance of about 4,000 ohms, as this is correct to work out of a -45 or -50 tube. However, one will very often desire to use more than one speaker. If two speakers are used they may be connected in series with a little loss in efficiency. If more than two speakers are to be used, they should be used in even multiples and connected in series-multiple so that the resultant impedance is equal to one speaker. Fig. 4 makes this clear. There is no advantage in using a multiplicity of speakers when one or two will do the work, as the available signal will divide between them equally so that the actual energy in the air is the same. However, the average speaker overloads at about one watt, so that the full output of the tube cannot be used with the best quality unless more speakers are used. A -45 tube can drive two speakers very near to their overload point, and four speakers will be required to realize the full output of a 250 tube. Where more power is necessary than can be obtained from one output tube, two amplifiers may be used with their inputs in parallel and their outputs driving two different banks of speakers.

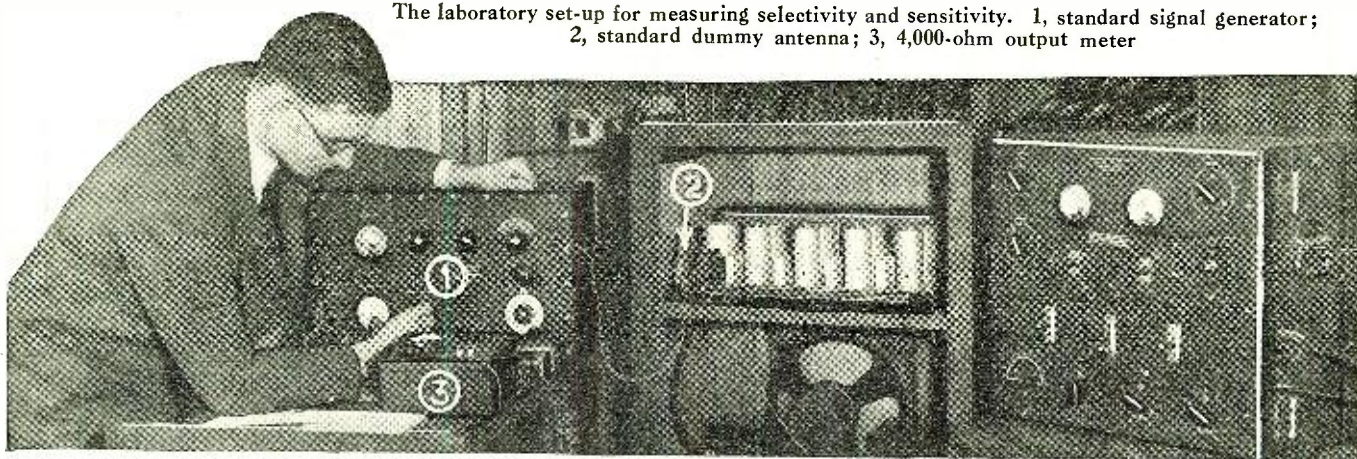
When it comes to the question of coverage, one -45 tube and one speaker will nicely cover a gathering of 500 people indoors. One -50 tube and four speakers connected as explained above will be sufficient for 1,500 people indoors. In this connection, remember that a filled auditorium presents quite a different problem than an unfilled one, due to the absorptive effect of the people gathered there. For outdoor coverage, too many variables enter to lay down any rules covering all cases. There is sure to be background noise, etc., which must be drowned out. The best policy here is to use the maximum power available, and cut down on the gain control.

The placement of apparatus in a public address system is highly important. To begin with, the speaker or speakers should be so (Continued on page 180)

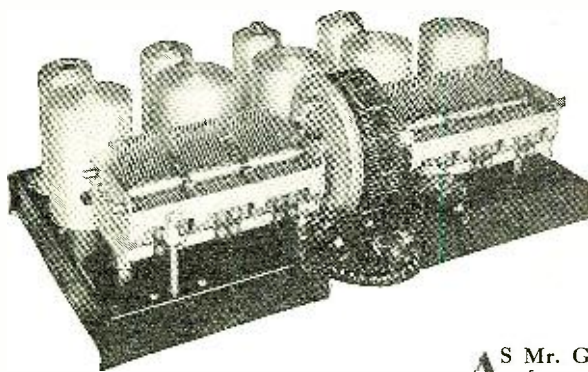


The units of a complete office call system

The laboratory set-up for measuring selectivity and sensitivity. 1, standard signal generator; 2, standard dummy antenna; 3, 4,000-ohm output meter



# Interpreting Receiver in Terms of Laboratory



The Grebe tuner, the embodiment of sound principles of receiver design

IF most radio advertising is to be believed, all radio sets, regardless of price, possess unbelievable selectivity, tremendous sensitivity and superb quality. Rarely indeed does any definite quantitative information appear in an advertisement by which the prospective buyer, the dealer, or the distributor may judge the characteristics of one set against another. To cover the lack of definite information trick phrases are concocted, supposed to impress the uninitiated, but which actually mean less than nothing.

A few years ago there was possibly some excuse for such advertising, for engineers themselves did not have any means of accurately determining the overall performance characteristics of a receiver. It was but a short while ago that receiver design consisted of building a model in the laboratory, after which it was taken home by the chief engineer, then the sales manager and other officers of the company, all of whom probably sat up till four in the morning trying to get the coast! If they were successful they came back and said the set was d— good. If the set didn't perform the way they thought it ought to, it went back into the laboratory to have some "tricks" tried on it. Actually a particular design that gave poor performance might have been fundamentally sound, requiring only slight changes to make it a good receiver, but without proper measuring apparatus quan-

AS Mr. Grebe points out, it is indeed a far cry from the days when receiver manufacturers first built a receiver and then put it through a haphazard test to determine its qualities of reception. Well-established companies with adequate laboratory facilities find it greatly to their advantage, in fact find it an absolute necessity, to first employ laboratory procedure in the design of a radio receiver, making measurements and tests similar to those outlined in this article. That such a procedure is well worth the trouble is an established fact, and for those manufacturers who are not equipped with suitable facilities for such design and measurement work RADIO NEWS is glad to offer its services gratis in acquainting these manufacturers with reputable engineering services adequately equipped to undertake such work.

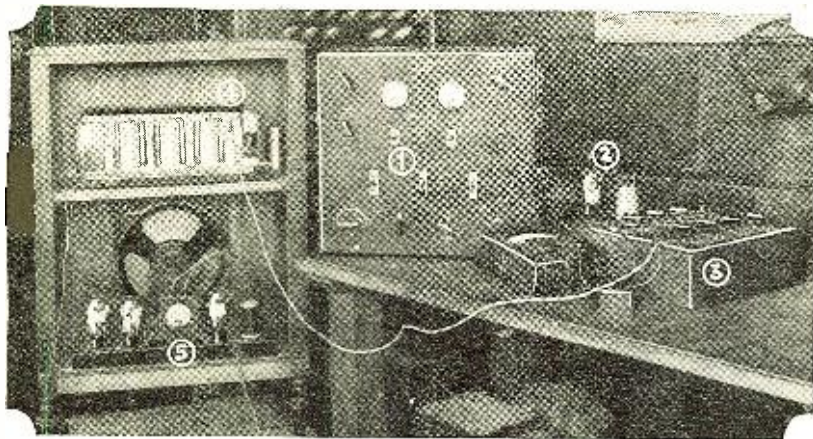
THE EDITORS.

*The Days for Excessive Use of Superlatives Receivers Are Certainly Numbered. The Discriminating Powers of an Intelligent Present Their Case in Terms of Performance acting Paces Through Which the Receiver Otherwise Technical Findings Into Facts Who Is Not*

tative tests were impossible, and as a result good designs were frequently thrown by the board. Even last year, let it be said, some companies took the chance of receiver manufacture without proper laboratory apparatus. But this phase of the radio industry has practically passed and we have only a feeling of pity for the manufacturer who, this year, attempts to produce a receiver without a complete laboratory set-up.

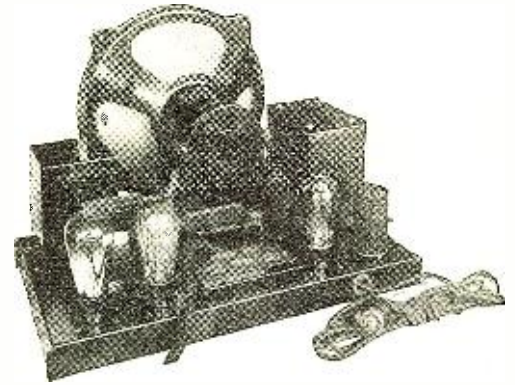
The fact that laboratory apparatus for the accurate measurement of the overall characteristics of radio receivers has come into wide use in the laboratory raises the point whether it is not possible to interpret these laboratory measurements in some manner that will be understandable to others than engineers—whether there isn't some way to bring the gist of these measurements to the public. For after

all, it is only careful design and production that insures the buyer of his money's worth. Real worth, built into a receiver by careful engineering and painstaking manufacture, are hardly ever conveyed to the reader of advertising. We have given considerable thought to this problem and feel that the solution is to publish as much definite data as possible, stated in terms understandable to the group the copy is aimed at. This desire to find a sound basis upon which to write Grebe copy has led to a new type of advertisement by our company, based on a series of measurements on a number of standard makes of radio receivers. The laboratory measurements have been converted to simple percentage ratings and the basis of the formulas used to determine these ratings is the subject of the following paragraphs.



The set-up for measuring the frequency range of the audio system of a receiver. 1, audio-frequency oscillator; 2, push-pull amplifier; 3, resistance boxes and meter for measuring voltage input to receiver; 4, detector tube; 5, output meter

Compact yet accessible is the power supply-audio channel-speaker chassis of the Grebe audio unit



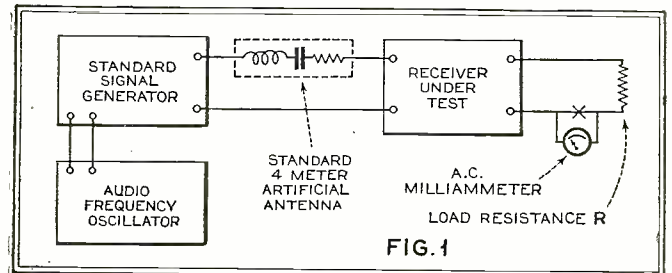
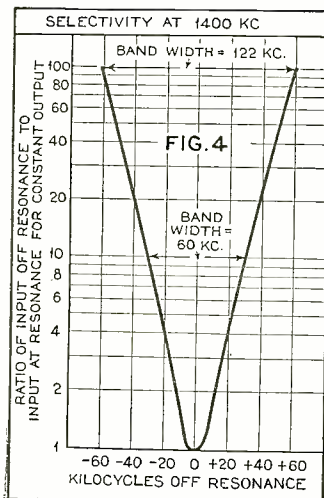
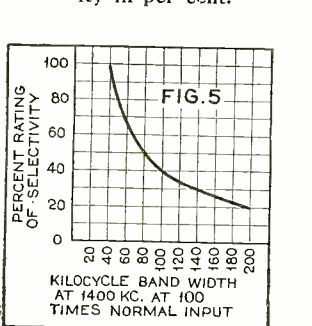
# Performance Measurements

*in Describing the Merits of Radio Nowadays Manufacturers Recognize Buying Public and Are Taking Steps to Alone. This Article Describes the Ex-Is Put in the Laboratory and Reduces Easily Understandable by the Fellow Technically Inclined*

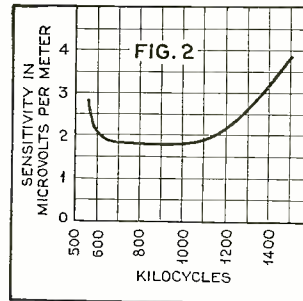
By Alfred H. Grebe

The three most fundamental characteristics of any radio receiver are the sensitivity, selectivity and fidelity, and quantitative answers to these points have been the stock in trade of all engineers. Methods of determining the characteristics of coils, condensers, transformers and other individual units that go to make up a "radio" have been known to engineers for years. But while these "piecemeal"

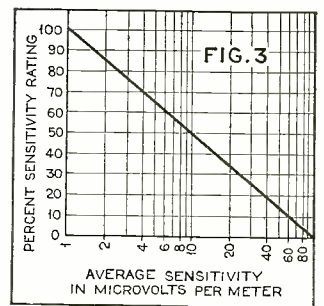
Right—The selectivity at 1,400 kc. forms the basis for a rating of a receiver's selectivity. Specifically, the band width at 100 times normal input is determined (in this particular case it is 122 kc.) and the per cent. selectivity is then determined from Fig. 5



The fundamental circuit arrangement for measurements of the overall characteristics of radio receivers. The a.f. oscillator is used to modulate the r.f. voltages produced by the standard signal generator. The input to the radio receiver is adjusted to give the standard output of 50 milliwatts in the load resistance R



A sample sensitivity curve. This curve shows the relation between the number of microvolts per meter input required to produce standard output of 50 milliwatts at various frequencies throughout the broadcast band



The per cent. sensitivity rating of a receiver is determined from this curve. The average sensitivity obtained at 600, 1,000 and 1,400 kc. is calculated and, knowing this average sensitivity, the per cent. rating is determined

measurements are necessary in the process of designing a receiver, they are no substitute for overall measurements of the final model—and overall measurements are the only type that are of any use to a prospective purchaser.

Stating the sensitivity of a receiver as 10 microvolts per meter means a great deal to an engineer but nothing to the average radio buyer. For this reason the formulas we have worked out make it possible to state all the characteristics as percentages so we can say, for example, that a particular set has a sensitivity of 50 per cent., a fidelity of 70 per cent. and a selectivity of 30 per cent., or any other figures obtained by the use of the formulas and the characteristics of the receiver. The formulas by means of which the ratings are determined are not simple averages, but take into (Continued on page 164)



A rising family known as the Goldbergs. Mama Goldberg is experimenting with a smoke-screen much to the annoyance of young Ischikloob—but then she sees the desperado on the opposite roof garden and naturally does not want to be shot. Ho boy, iss dis a seestem?

WHAT can the listener expect from his radio set five years from today?

It is a question that even the most imaginative person in broadcasting would hesitate to answer. Had a prophet five years ago foretold accurately what might be expected from radio in 1930 he would have been laughed at, if not declared a silly dreamer. Radio broadcasting grows rapidly, learns and unlearns technique every month, and is constantly discovering new and impressive methods of presenting dramatic spectacles through the one medium of sound.

Although broadcasting's development has been closely linked with the experimental laboratory, the human personality is playing an increasingly important part in broadening its scope. The engineers and scientists have given the creators and interpreters of entertainment almost perfect facilities, and now it is the creative artists' day.

In the studios of the National Broadcasting Company, where some of the best minds in radio work and plan programs, there have been several interesting developments in program technique in the past year. These developments have not been extensively publicized or exploited, yet their effects on future programs will be far-reaching.

The public has been permitted to share in these interesting experiments, and programs without precedent or parallel have gone on the air and have become popular.

One of the important conclusions obtained from a number of experiments in dramatic programs was that material prepared for the air interested more listeners for a greater length of time than radio adaptations of plays already made famous in the theater. Thus unknown young writers discovered that in their own medium, radio, they were able to compete successfully for public interest against such internationally known writers as Ibsen, Pinero and others.

This discovery meant much, for it was a positive indication that radio was developing its own art technique, and was not having to rely on an older and more firmly established method of treatment.

The makers and producers of programs also discovered the dramatic value of sounds other than the human voice. When listeners wrote in that they could smell the bacon cooking during a sound effect that simulated the sputters of rashers in a broiler, the radio people knew that they were succeeding in their task. That task is easy to sum up, by the way. It consists of giving the listener a complete mental picture of any scene, although his imagination is merely stimulated by his sense of hearing.

"Harbor Lights," one of the most popular of the NBC sustaining features, has been out of the experimental stage for many months and has established itself as one of the outstanding dramatic programs. It is a program in which sound effects

# Sustaining

today's promise for

*The Comparatively Youthful  
Given Added Scope by Recent  
ploying the Sustaining Program  
tory to Perfect*

By P. H. W.

*Illustrations by*

are as important as spoken words.

The construction of "Harbor Lights" is not complicated. It is built around a character known as Captain Jimmy Norton, skipper of a ferryboat running between New York and Staten Island. Captain Jimmy, a veteran salt-water sailor, has many tales to tell of adventures at sea and a young friend is always there to encourage him in his yarn-spinning.

The listener is taken by degrees into deep-water atmosphere. Through sound effects he boards the ferry; he hears the jingle of bells signaling the engineer, and the snort of the whistle as the ferry moves from its slip. Then Captain Jimmy starts his story and almost before the listener realizes it, the old sailor's voice is silent and the story he has started to tell is being enacted by all the characters in it. The transition from the ferryboat to the fo'c'sle of a barkentine off the Azores is dramatic in its contrast and is an example of one of the things possible in radio and not possible in the theater; the practically instantaneous change of scenery.

Burr Cook, author of "Harbor Lights," and incidentally author of another radio series, "The Eternal Question," is one of the outstanding young radio writers. His background includes



Believe it or not, the wild beast perched atop the mike is not a flag-pole sitter, but is actually contemplating a trans-Atlantic hop. Said bird will doubtless land plump in one of Algernon Thistlewit's large cuffs, designed especially for that purpose



# Programs—

tomorrow's entertainment

*Art of Radio Broadcasting, Engineering Advances, Is Emphasizing Experimental Laboratory Broadcasts*

Dixon

G. Ricca

newspaper work, the theater and miscellaneous adventuring, but when he came to radio he came with an idea carefully planned for broadcasting, and with a broad understanding of some of the problems he was facing.

He is included in the limited list of men and women now writing radio material who are expected to develop a new form of literature, the radio dramatic form.

Raymond Knight of the NBC production staff is another writer who has added much to broadcasting lore. Knight is essentially a humorist, and his favorite forms of expression are satire and burlesque. To his credit he has four of the funniest broadcasts ever to go on the air. They are "Embarrassing Moments in History," "Triadramas," "Hello, Mars" and his current series, "Station KUKU."

He makes extensive use of comedy voices and can so phrase his dialogue that each character stands out as distinctly as if actually visible in trick costumes and exaggerated make-up. In "Station KUKU" the listener sees Mrs. George T. Pennyfeather, who talks on beauty or what have you, as clearly as if she were seated on the radio speaker. Where five hundred words would not suffice to describe Mrs. Pennyfeather, one can visualize her perfectly the moment her voice comes from the speaker.



The young lady with the Hollywood approach is giving the big, bold, bashful bull-thrasher the right steer—right back into a cactus plant. Yes, folks, the shirt came from Rears Showbuck, designed especially for "Frontier Days"



"Giv 'em de woiks," screams the master-mind of the "Mystery House," pointing his elongated forefinger at Goldberg père. And don't let the evening attire fool you—he's not a radio announcer. The tough guy at the left knows his elbows—and that's no crook, either

Knight has borrowed the familiar "black-out" technique of the Broadway revue and uses it in virtually all of his productions. The last spoken line is always the funniest or most startling speech in the production, and he usually manages to leave the listener laughing.

"The Silver Flute" is a good example of the romantic type of presentation. It presents folk tales of many lands, and the introduction is somewhat similar to that used in "Harbor Lights," for the story always is introduced by a character known as Marco, wandering gypsy. John Alcorn of the NBC staff is the author, and he has based his series on extensive research into the folk lore of many lands and his own wanderings in strange corners of the globe. Direction plays an important part in this series, for in place of the melodramatic accents of the seafaring men in "Harbor Lights," or the comic voices of Knight's productions, the voices heard in "The Silver Flute" are musical and their phrases are romanticized. The tone of the broadcast is poetic.

The continued-story broadcast has proved intensely popular. Included in the dramatic programs with the plot moving along from week to week are "The Rise of the Goldbergs," "Mystery House," "The Jameses," "The Family Goes Abroad" and "Frontier Days."

In each of these series the basic plot is simple. "The Rise of the Goldbergs" tells of the struggles of a Jewish family up from poverty in New York's teeming East Side.

So intense is interest in the struggles of the Goldberg family that when there was a substitution in the cast owing to the illness of the woman playing the mother part, the NBC received more than five hundred complaints from listeners.

"Mystery House" is sheer melodrama, with a sneering villain, a detective and all the conventional characters. "The Jameses" is another series of episodes built about the everyday life of an average family, and "The Family Goes Abroad" reveals its plot in its title.

"Frontier Days," a comparatively new dramatic program, has won wide favor with the radio audience. It describes life on the Bar-X ranch in Texas back in the '80's—in the days when men were "gal-shy," but otherwise "quick on the trigger." Lawrence Holcomb, who recently joined the NBC staff, is the author of this hour.

While these radio plays apparently please hundreds of thousands of listeners, they are also serving as experimental laboratories for the young dramatists who are developing this new form. Despite the short history of radio drama, already there are certain definitely recognized principles involved in writing for the air.

The radio writers realize that while numerically their audiences are the greatest in the world, they actually are writing to groups that seldom number more (Continued on page 172)

# New Profits for Servicemen in Sound

*Qualified Radio Men Are Finding a New Outlet for Profitable Service in an Ever-Increasing Field of Application on Sound Amplification. The Problem Before the Serviceman is Discussed in Detail Here*

By S. Gordon Taylor

**M**ANY things have been conspiring to make the sound amplifier field one of constantly increasing importance. Perhaps the most important of these has been the creation of public acceptance for electro-mechanical reproduction—a feat made possible by the improvements in the amplifier and reproducing equipment and demonstrated to the public through the agency of the modern radio receiver and particularly the talking movies.

The development and organization of radio programs has been another factor in encouraging the use of sound amplifiers. For instance, educational broadcasts are now so organized that hundreds of schools are equipped for the reproduction of the programs in individual class rooms as a part of the regular class work. The excellent band concert programs put on the air during the summer have encouraged the installation of amplifiers and loud speakers in parks and other public places. Then, too, the general excellence of available broadcast programs has encouraged the equipment of hotels to provide radio in every room.

That these and other factors are contributing to the growing use of sound amplifiers is evident from the increased number of companies now manufacturing such equipment and the variety of the equipment available. If any further evidence is needed it is found in the frequency with which we come in contact with sound amplifiers in operation. In theaters, churches, restaurants, sports arenas, swimming pools, halls and even in department stores we find loud speakers in operation.

## The Equipment

The most common practice followed by sound amplifier equipment manufacturers in the design of their equipment to meet this varied demand is to follow the "unit assembly" plan. This means the production of the various components of the system as separate units, each self-contained, completely wired and built to uniform size to permit two or more units to be mounted on a standard rack provided for the purpose. Thus, it is possible to purchase only such input, control and amplifier units as may be needed for a particular installation, and to assemble them on a rack to have what in effect is a custom-built system. Custom-built, but with the advantage that the system can be enlarged at any time by simply adding additional units.

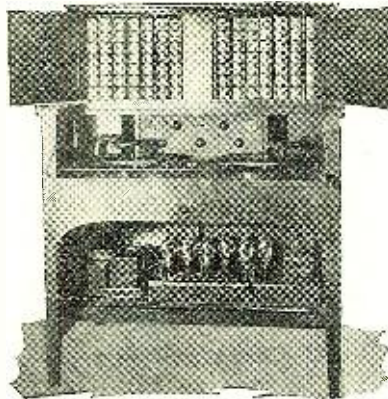
The adaptability of modern amplifier equipment is largely due to the fact that each unit provides its own plate and filament supplies independent of all other units. This is a decided improvement over former systems in which all units were dependent upon a central plate voltage supply unit. Not only does the new method provide greater flexibility but one of the main causes of feed-back in amplifiers is eliminated through the provision of plate voltages from different sources for the different portions of the system.

Sound amplifier systems are used primarily for the amplification and reproduction of programs picked up (1) directly by microphones, (2) by radio or (3) from phonograph or film records—and many installations provide for all three. In school installations, for instance, the radio is used to pick up the regularly scheduled educational broadcast programs; the phonograph in connection with music, dance and gymnasium instruction—and also for shorthand dictation practice; the microphone pick-up primarily to permit the principal to address any number of classes in their own rooms, but sometimes also to carry auditorium programs to some of the other parts of the building.

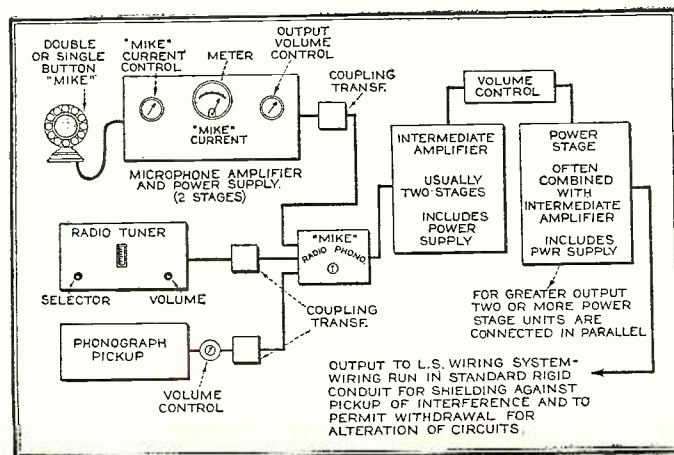
The input portion of the sound amplifier installation may or may not be a part of the main assembly. In some cases it is practical to mount the radio receiver, the phonograph unit or the speech amplifier right on the rack with the main amplifier but in others it is desirable to separate them for the sake of convenience in operation and control.

The amplifier usually consists of three stages and it is becoming the common practice to build this as two separate units. The first one is in itself a complete two-stage amplifier, usually employing three general purpose or medium power tubes with the second stage of the push-pull type. The third stage is a heavy-duty power stage employing in most cases a pair of -50 type tubes in push-pull. This plan of dividing the amplifier into two units has the advantage that several output stages may be connected in parallel to the output of the two-stage amplifier to provide as much output power as is required. Another advantage of considerable importance in a three-stage amplifier is the reduction of feed-back obtained by employing separate plate current supply for the power stage.

The output portion of the system consists of the loud speakers and may also be considered to include the

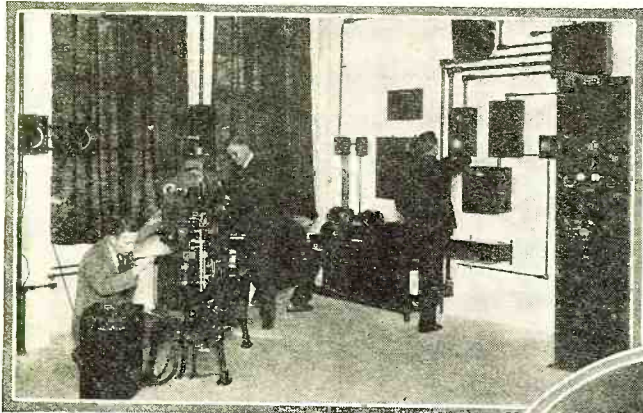


A commercial Electrola. At the lower left a two-stage intermediate amplifier and at the right a power output stage with eight 250 tubes

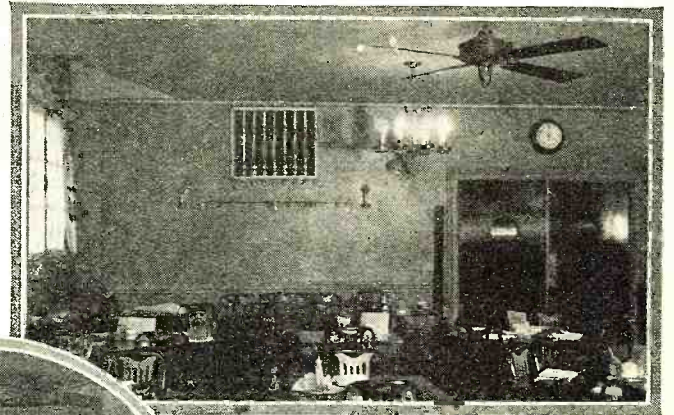


A typical one-channel system

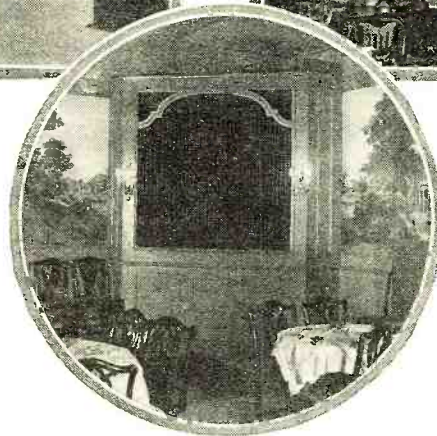
# Amplifier Installations



(Above) One of the first public training schools for instructions of motion picture projection with sound, utilizing the Western Electric sound system, has been opened in the West Side Y. M. C. A. in New York



The sound amplifier system of the Walt Whitman Hotel, Camden, N. J., operates a giant speaker concealed within a curtained enclosure in the main dining room, replacing an orchestra



At the left is shown the coffee shop of the Walt Whitman Hotel, which is loud speaker equipped with a twin-dynamic unit concealed behind the Spanish grille

volume control, volume level indicator, wiring to the loud speakers and the switching arrangement, if any is employed to control the loud speakers. The requirements for the output portion of the installation vary greatly with individual jobs. In some installations the system is employed to operate a single dynamic speaker. This, of course, constitutes the simplest form of output circuit. But in other cases there may be as many as several hundred loud speakers operating from the amplifier and in such cases the distribution wiring may become rather complex.

In many instances sound amplifiers include anywhere from two to five channels—which means from two to five separate amplifiers. In a hotel, for instance, where radio is provided in every room, three-channel systems are common. The loud speaker wiring systems of all three channels are carried to each individual room, permitting the occupant a choice of three programs. In school installations at least two channels are usual—and sometimes as many as five—to permit different programs for different grades simultaneously.

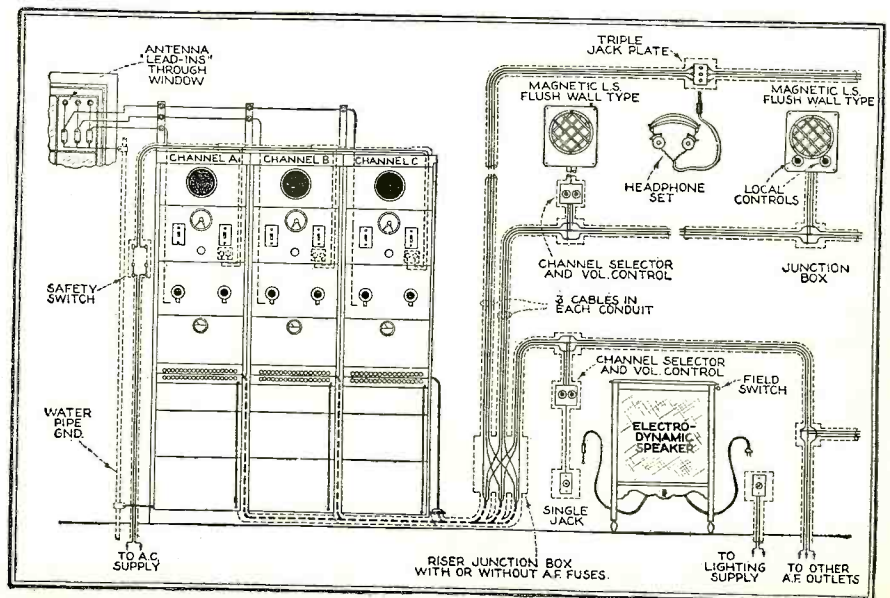
## Planning the Installation

In planning an installation the first thing is to determine the input and output service requirements. In many cases where the system is desired primarily for one type of service, it is worth while to provide for other inputs as well. Thus if an installation is being planned for an auditorium, to bolster up speakers' voices, it may be well worth while to provide a radio receiver or phonograph or both, so that the system can provide music or entertainment as well. On the other hand, where the system is wanted primarily for radio entertainment, the provision for phonograph pick-up is highly important because when static is bad or when for any reason radio programs are unsatisfactory or temporarily not available the phonograph can be switched in.

The number, locations and types of loud

speakers and the volume level required are important factors because they determine the amplifier power requirements. Not the least of these is the volume level required. Quite often different parts of the output system will have different volume requirements. In a hotel, for instance, the volume level available to guest rooms must be maintained at a low maximum to prevent a loud speaker operating in one room from annoying guests in adjoining rooms. But in the public rooms dynamic speakers may be required for operation at high volume. Obviously under such conditions the speakers must be wired in separate circuits so that the volume level of the magnetic speakers in guest rooms will be under separate central control. Also, amplifier power capable of operating 100 magnetic speakers at hotel room level will operate perhaps only one-quarter this number at schoolroom level. Magnetic speakers require about one-quarter (Continued on page 182)

At the right is shown a typical three-channel radio system



# Henry M. Neely— Radio's "OLD STAGER"

By Lester S. Rounds



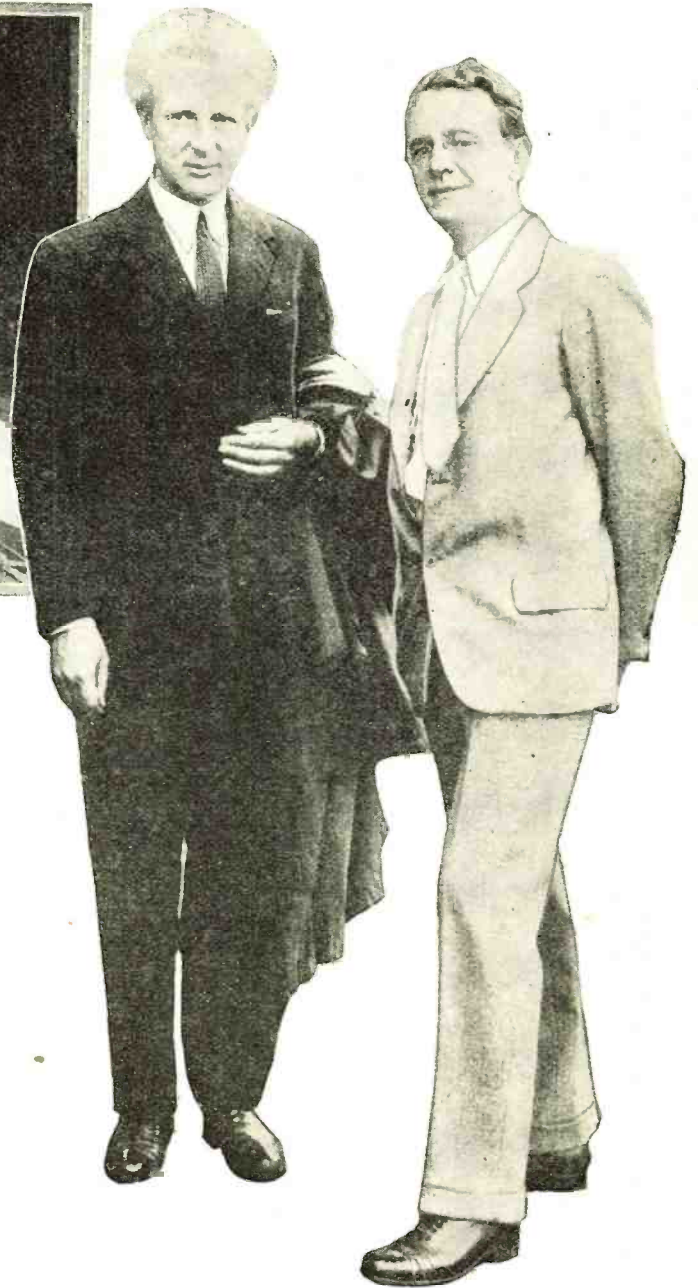
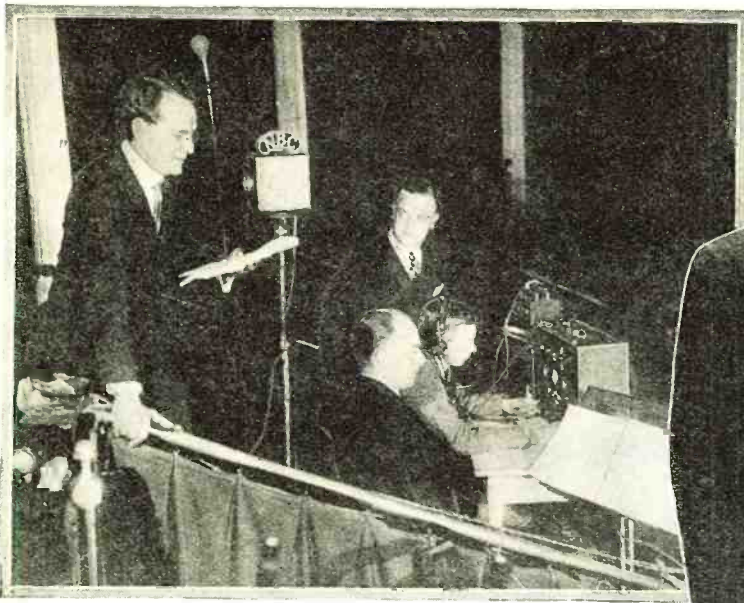
**T**ED HUSING, ace announcer of the Columbia Broadcasting System, stands before a microphone in the largest studio in the new Columbia Building on Madison Avenue, New York City. Above him on the conductor's platform is the slight figure of Harold Barlow, brilliant young radio conductor, who moistens his lips nervously as he catches Husing's eye.

Fifty musicians stir restlessly in their seats. Clarinets trill tentatively, horns burble. The audience, set off from the musicians by velvet ropes, hums and buzzes; the black and white of male evening attire contrasts strongly with the brilliant gowns of women. This is a first-night audience, awaiting the première of a great radio program, and some of Gotham's best-known names are numbered among those present.

Husing turns to the man beside him with a smile. The latter, as much at ease as the young announcer resplendent in a blue dinner coat, smiles back, and the smile scores deep lines in his face. It is a strong face, weather-beaten and browned from exposure, and the lines give it the rugged aspect of granite.

Husing motions to Barlow, and the conductor taps the stand with his baton. Instantly there is silence, oppressive

Henry M. Neely and Lois Bennett, Philco's new star, studying the script of their next show. Miss Bennett deserted Broadway and later a chance for a classical musical career for broadcasting



*The Soft Voice of the Old Stager Has Endowed the Classics with a New Charm and Popular Appeal—an Outstanding Accomplishment in Radio and One Made Possible by Neely's Unfailing Personal Quality—the Human Touch*

silence. "Sixty seconds," says a quiet voice. The audience takes the last cough it will be permitted for an hour. "Thirty seconds!" The string section raises its bows. The man beside Husing raises a finger.

"For the past several years," Husing reads softly into the taciturn black instrument, "it has been the privilege of Philco to dedicate some contribution to the greater enjoyment of the radio audience. Tonight we bring you a new institution of the air, the Philco Symphony Orchestra, which will give you the world's finest music. And now I turn you over to our guest announcer, the man you have known for so many years as Philco's Old Stager—Henry M. Neely."

And in such fashion, several months ago, the man with the deep-cut smile stepped into still another great rôle. As this issue of RADIO NEWS goes to press word is received that Neely will take over direction of the Mobiloil hour.

Philco's Old Stager. So he has been known to millions of radio listeners-in, from Portland, Maine, to Portland, Oregon, from Canada to the Gulf. No more fitting title could be applied to him than that of Old Stager, for under his shock of wavy dark hair is a storehouse of stagecraft, of radio showmanship. There are few men in the world of broadcasting who would put their own knowledge on a par with his. He is a superb showman, one who lives his part.

Innis Osborn, playwright and radio continuity writer, tells a story about him that he insists is true. And Neely, at least, does not deny it. Osborn was Neely's best man at the latter's wedding last June, and a great crowd of radio celebrities was present. Jessica Dragonette, Mary Hopple and the New Yorkers' Quartette sang several numbers.

"I'll never forget that day," Osborn told the writer. "I could hardly forget it—it was a hot day, and Mrs. Osborn had given me a 15 collar instead of the 15½ I wear. We stood in the chancel, Henry and I, and suddenly he tugged at my sleeve.

"Innis," he said, as the organ swelled, 'have you rehearsed these numbers?'

"I have," I assured him.

"Did you clock them? Do they run off according to schedule?'

"Well, we're about two minutes long," I admitted.

The Old Stager is shown here in the control room set up in the balcony of the Academy of Music in Philadelphia for the broadcast of the Philadelphia Symphony Orchestra during the Philco hour. Immediately above he is standing beside Leopold Stokowski, conductor of the Philadelphia orchestra

"'Cut a chorus, Innis, cut a chorus somewhere,' he replied. 'I've never run a show overtime in my life, and I want this thing to be perfect!'"

And throughout the ceremony, Osborn said, Neely made him keep a stop-watch in his hand!

While the microphone has exerted the strongest lure of the many constituent parts that have made up Henry Neely's life, he is far from a one-profession man. After receiving his education in his native Philadelphia, he entered the newspaper business in 1896 when still a youngster, and carried a reporter's pencil during the stirring days of Cuban strife.

When he was not out covering a beat, Neely devoted himself to the music. He studied voice, violin and musical composition—training which proved its value when radio surged into popularity. So intense was his interest in music that he was one of the founders of the Philadelphia Operatic Society in 1904, and served as that organization's first secretary and treasurer.

Around that time he ceased being a newspaperman and became a journalist. There is, he insists, a subtle difference.



This picture was taken at Neely's farm at Beverly, N. J. Left to right are: Harold Sanford, Kitty O'Neil, Jessica Dragonette, Colin O'More, Mrs. Neely, Henry Neely, Muriel Wilson, Walter Preston, Mary Hopple and Charles Robinson

Various newspapers employed him as music critic, dramatic critic, and, later, motion picture critic; it was in the latter field that he made his greatest success, for at one time he wrote a syndicate motion picture article that was published in hundreds of papers. Every so often today he receives offers to do a similar column on radio, which he turns down with mellow thanks.

Literature lured him, however, from the clatter of the newspaper press. *Blue Book*, *Collier's*, *Adventure*, and other magazines have had material appearing under his by-line.

"Writing adventure stories is not as easy as it would seem," he told me recently. "You put your hero into the various gripping situations that occur to you. And then, sooner or later, you run out, not of situations, for it is always the same hero beset by the same peril, but of backgrounds. I was talking over my next story with an editor some years ago, and he made me the first writer of aviation stories.

"What is the setting for your next piece?" he asked me.

"I don't know!" I confessed. "I'm completely in the air!"

"There you are!" he exclaimed. "Put it in the air, and make it an aviation story!"

Perhaps it was a search for story material that prompted the next period in which Neely wandered all over the globe. For four or five years he traveled on tramp steamers, passenger liners, fishing boats, as wireless operator, his first experience with radio. Wireless was a hobby that took as much of his attention as music. In 1910, having passed his examination for wireless operator's license, he organized the Wireless Association of Pennsylvania, the second such organization in the country.

During each winter he roamed the seven seas, earning his keep by tapping out wireless messages and writing short stories

in the long hours off watch. In the spring he would quit his ship to board his own motorboat, to cruise about all summer. His last trip was an eight months' voyage on a Norwegian whaling ship, during which he reached nearer the South Pole than any living American had been at that time. He spent four months at anchor at Deception Island, where Wilkins established his airplane base last year. Perhaps, he says, that is why he likes Florida and the semi-tropics so well.

The war cut short his globe-trotting. Irregular heart action kept him out of active hostilities, but he managed to get across as a Y. M. C. A. man. After the armistice he spent six months in England as assistant director of a motion picture company.

When broadcasting raised its infant wail—how true!—owners of early set chime in—Neely's training and background made him ideally suited for a prominent place in the new industry. He had been a working wireless operator, his speaking voice was suave and mellow, he knew music from A to Z, and his Y. M. C. A. and amateur dramatics experience helped him in program work. So, when Gimbel Brothers in Philadelphia started Station WIP, Neely was made director, a position he held for two years. He started a radio magazine of his own, *Radio in the Home*, and after disposing of his interest in the publication did extensive research work throughout the Middle West for the *Farm Journal*.

Always an outdoors man, agriculture made a more lasting impression on him than the sea. Eighteen different state agricultural colleges listed him as a student in one course or another, and his research work resulted in the purchase of a 30-acre farm at Beverly, New Jersey.

Here he has his home. He specializes in perennial (Continued on page 178)



An interesting portrait study of Henry M. Neely—the Old Stager

# Shall We Use Grid or Plate Circuit DETECTORS?

By  
James Martin

*Both Systems Have Their Particular Advantages, as Is Brought Out in This Article, Which Attempts to Give Some Fairly Definite Comparisons Between the Two. The Practical Information Presented Here Includes A.C. and D.C. Detector Circuits, Power Detectors and C Bias Rectifier Systems*

**R**ADIO knowledge doesn't come easy—it necessitates the careful reading of books and articles and probably quite a bit of experimenting on one's own hook. And even when reading articles that seem to have some background of knowledge one must be careful, for the author is liable to fall into some careless errors—like the writer did in an article entitled, "What Do You Know About Audio-Frequency Amplifiers?" published in the January, 1930, issue of RADIO NEWS.

There are probably few subjects in radio that the experimenter has found more interesting—and perhaps baffling—than the problem of detection. Its importance is fully realized, but the differences between the various circuits, the effect of changing the circuit constants, and of changes in the voltages have not been altogether clear—but this is largely justifiable for radio engineers themselves are still discussing the subject and new and important data is continually being published in the proceedings of the various engineering societies—and much of the data presented here is taken from the proceedings of the I. R. E. In this article we try simply to bring together some of the loose ends. An attempt has been made to make the article practical and to give some fairly definite comparisons between the different circuits, but because of the many factors involved the task is almost as difficult as trying to make one's check

**T**HE detector is the nucleus of a radio receiver. Around it we build up multi-stage r.f. or a.f. amplifiers, in one case to bolster the signals before they reach the detector, in the other to take the detector's output and amplify it at audio frequencies. Mr. Martin, in another of his elementary yet enlightening articles, draws a comparison between the two main systems now universally employed.

account balance with the monthly statement from the bank.

It seems natural to start a discussion of detectors by asking, "Why do we have to use a detector?" In answer to this we have space only to state simply that a detector must be used because a radio set receives the signal at a radio frequency—anywhere from 500,000 to 1,500,000 cycles per second—and impressed on this received signal is the audio current we want to hear. To get the audio current from the radio-frequency signal we have to use a rectifier—and "detector" is just a special name for a "rectifier."

Any device which has a characteristic such that the current through it is not proportional to the voltage across the device can be used as a detector. Some general forms of detector characteristics are shown in Fig. 1. And incidentally, the characteristic shown at C is the ideal characteristic for the detection of the ordinary modulated r.f. signal used in all broadcasting—no device with exactly these characteristics has been produced, although with some special crystal detectors it has been closely approached. The modern tendency is to use tube detectors and make their operating characteristics such that a fair approach to the ideal is obtained. The distortion then produced is sufficiently small as not to be serious.

The two fundamental types of detection in most common use today are grid circuit detection and plate circuit

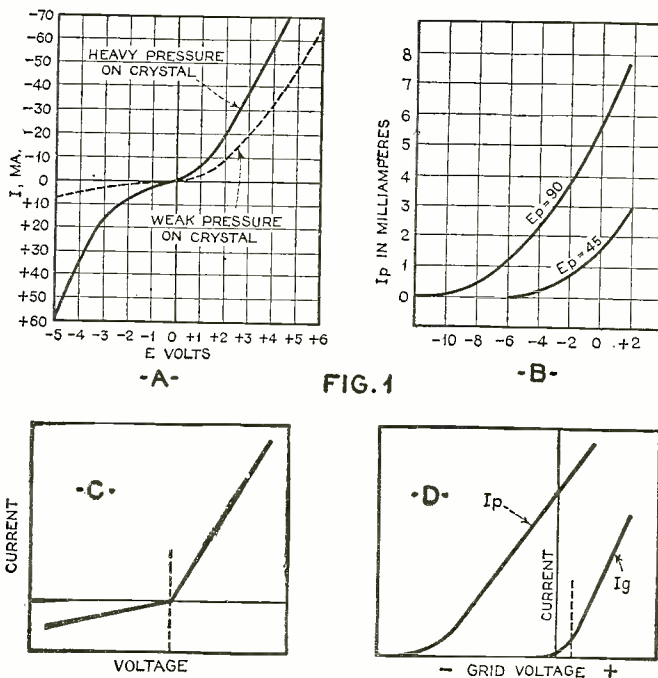


Fig. 1. Some typical detector curves: A—Crystal detector characteristic. The crystal is a more efficient detector with weak pressure. B—Operating conditions for the plate circuit detector with the -01-A tube. C—The ideal detector characteristic consists of two straight lines meeting at an angle. D—Grid circuit detector operates on the low bend of the  $I_g$  curve, as indicated in the drawing

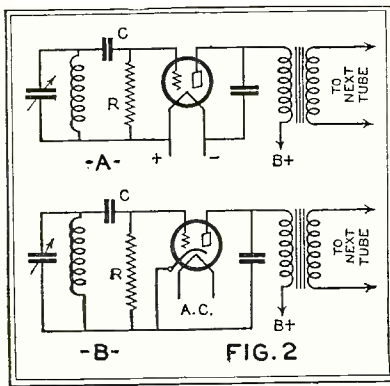


Fig. 2. Grid leak and condenser circuits, showing typical arrangements for use with d.c. and a.c. tubes. A shows the circuit for all types of d.c. tubes, and B is the circuit for the type -227 a.c. tube

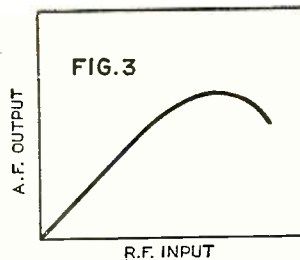


Fig. 3. This curve gives a qualitative idea of how overloading occurs in the grid leak and the condenser detector. The overloading point depends on the circuit constants as described in the article

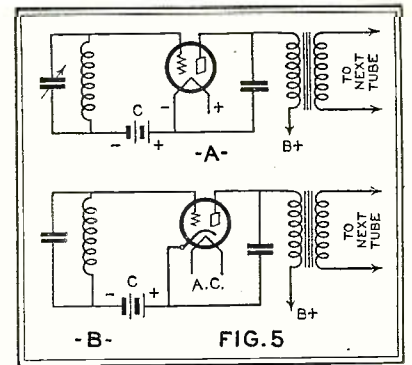


Fig. 5. Circuits for plate circuit detection, showing typical arrangements for use with d.c. and a.c. tubes. A is the circuit for d.c. tubes and B is the circuit for a.c. tubes

detection. Let us try to state concisely the difference between them.

**Grid Circuit Detection:** A grid circuit detector is one in which the rectification (detection) of the signal takes place in the grid circuit of the tube. As a result the audio-frequency component of the modulated signal is impressed on the grid and this audio-frequency component is amplified by the detector tube. This class of detector is therefore known as a "rectifier-amplifier" because the signal is rectified and then amplified by the detector tube. The most common circuit of this type of detector uses the ordinary grid leak and condenser. This circuit was for many years practically the only one in use—and it is still not altogether out of date. Some broadcast receivers still use it and most short-wave sets use it, but in the broadcast field it is being gradually replaced by the plate circuit detector.

**Plate Circuit Detection:** A plate circuit detector is one in which the rectification takes place in the plate circuit of the tube. The modulated r.f. signal impressed on the grid is amplified and appears in the plate circuit, where it is rectified. This type of detector is therefore known as an "amplifier-rectifier" because the signal impressed on the grid is first amplified and then rectified by the detector tube. To produce plate circuit detection it is simply necessary to place sufficient bias on the grid of the tube as to bring the operating point down to the curved portion of the tube's characteristic—this point is discussed in further detail later in this article.

Let us now discuss in detail the grid circuit detector, to find out all we can about its essential characteristics and how they depend with the circuit constants, the voltages, and so forth. Then we will work out the details of the plate circuit detector and as we go along give as many direct comparisons as possible—the comparisons will not be as complete as we would like, but they will at least be helpful, we hope.

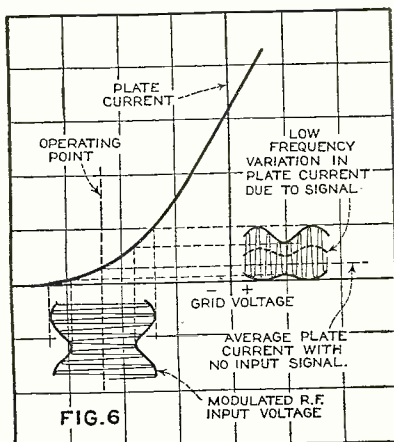
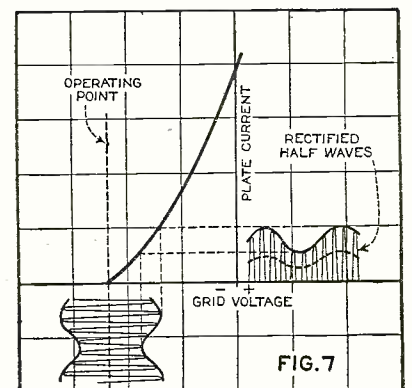


Fig. 6. How the plate circuit detector works. The modulated r.f. impressed on the grid causes the plate current to vary along the curved portion of the plate current curve

Fig. 7. Simplified circuit of the plate circuit detector. In this drawing the rectified half waves of plate current are shown clearly. The heavy dotted line is the desired audio current



being that for a d.c. tube and the circuit at B for an a.c. tube of the heater type.

In these two circuits C is the grid condenser, which almost always has the sacred capacity of 0.00025 mfd. R is the grid leak resistance which generally has a value of from some 3 megohms down to about 1 megohm. But there is nothing magical about these values and in many cases other values will give better results.

The grid leak and condenser has held its popularity largely because of its greater sensitivity in comparison with other types of detectors.

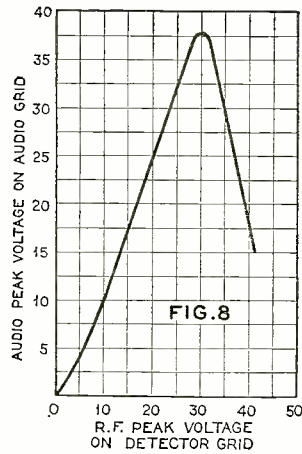
But with a plate voltage of about 45 volts and ordinary values of grid leak and condenser (0.00025 and a 1 or 2 megohm leak, for example) the output of this type of detector is only about 0.3 volts—and this is hardly sufficient. For example, if the detector is followed by a two-stage transformer-coupled audio amplifier consisting of a 3:1 first-stage transformer, a tube with an effective mu of 8, then a push-pull input transformer with a total turns ratio of say 5, then the total audio gain from detector output to the input to the power tubes is  $3 \times 8 \times 5 = 120$ . If the two power tubes are of the 245 type operated with a bias of 50 volts each, then the peak value of the audio-frequency voltage across the push-pull input transformer must be twice this

value, or 100 volts. The output voltage required, 100 volts, divided by the gain of the amplifier, 120, gives the required output from the detector, which in this case comes to 0.83 volts peak. If we know the peak value of an a.c. voltage, the effective value is found by dividing by the factor 1.4. Therefore in this case the effective value of the voltage required from the detector is 0.83 divided by 1.4, or 0.6 volts approximately. This is probably a somewhat greater voltage than the ordinary grid-leak and condenser detector can supply, and if we want to use this type of detector we will have to alter the circuit constants so as to obtain higher output voltages.

Assuming that in the case of the d.c. circuit the grid leak always returns to A+ and to the cathode in the a.c. circuit (Fig. 2), the only things we can change

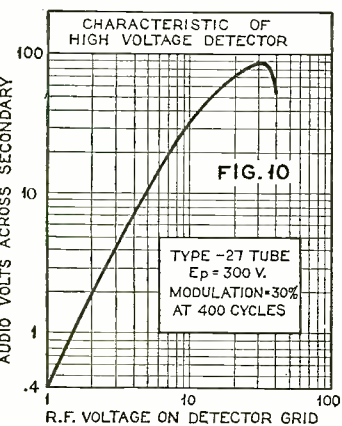


Fig. 8. Detector curve for a C bias detector using a type -227 tube with 180 volts on the plate and a bias of -25 volts



are the plate voltage, the capacity of the grid condenser and the resistance of the grid leak. From the standpoint of power output the plate voltage is evidently important, and it is generally advisable to operate the grid leak and condenser detector at fairly high plate voltages, say 90 volts, for ordinary types of tubes. A qualitative idea of the sort of overloading that occurs in the detector when the plate voltage is insufficient can be obtained by referring to Fig. 3. In considering the use of higher plate voltages, however, one must be sure that the plate current is not so large as to effect the characteristics of the transformer connected in the plate circuit of the tube, assuming that a transformer-coupled amplifier follows the detector. But if the transformer will stand the higher plate current without injury the higher plate voltage should be used. The suggestion that higher voltages be used is perhaps somewhat surprising, since the detector has almost invariably been operated at about 45 volts. But the decision to use 45 volts was made when we didn't have the power tubes that are now used and under those circumstances this low detector plate voltage was able to deliver enough output. But with push-pull circuits that require up to about 160 peak a.c. volts for full power output we need to consider carefully the detector circuit and be sure that its output is sufficient for our purpose.

The values of the grid condenser and grid leak also have some effect on the maximum output from the detector, although they have a greater effect on the quality. When fairly large radio-frequency signals are impressed on the input of the grid-leak and condenser detector the circuit may tend to block, not sufficiently to produce a noise like "motor-boating," which is a form of blocking, but sufficiently to effect the frequency response of the detector. To give the detector circuit a good frequency characteristic it is essential to use a small grid condenser and a low value of grid leak resistance. The reason for this isn't difficult to see. As we indicated previously in the grid leak and condenser detector the signal is rectified in the grid circuit so that finally there is an audio-frequency voltage across the grid circuit which is amplified by the tube. Now from the standpoint of this desired audio-frequency voltage the detector input looks like Fig. 4. Here we see that the input circuit is shunted by four things, the grid-filament resistance,  $R_{gf}$ , the effective input capacity of the tube  $C_i$ , the grid leak  $R$  and the grid condenser  $C$ . If the tube is to give a uniform response with respect to frequency we must make the change in the total impedance of this circuit as small as possible between the lowest and the highest desired audio frequency. This means that the capacity of the grid condenser must be made as small as possible and the resistance of the grid leak must be as low as possible. However, as we make the grid condenser capacity small and the leak resistance low the circuit loses its sensitivity and



we must therefore compromise between sensitivity and quality. In cases where only a small a.c. voltage is required from the detector it would seem best to use a coupling condenser of about 0.0002

Fig. 10. The high voltage plate circuit detector, obtained using a -227 tube,  $E_p$  equals 300 and  $E_c$  is obtained from a 15,000 ohms resistance in the cathode circuit

Fig. 11. A group of curves for various types of circuits at different levels of modulation. Note how the grid detector—curves 1 and 2—overloads

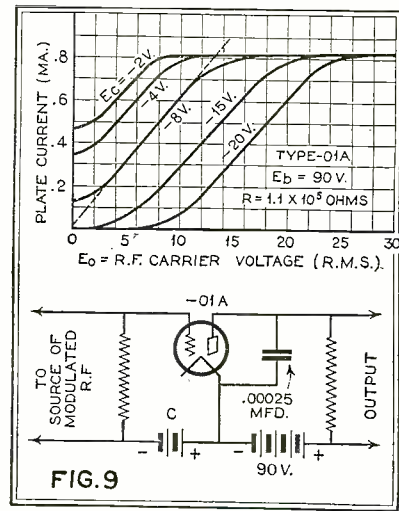


Fig. 9. The diagram may be used to determine the correct operating point for least distortion. The center point of the straight portion of each curve is the best operating point

mfd. (except for the type 240 tube use about 0.0001 mfd.), a 1 megohm leak and 45 volts or so on the plate where maximum sensitivity is desired, and an output of not much more than 0.3 volts is required. If more output is needed the plate voltage

should be increased and the grid condenser can advantageously be reduced to about 0.0001 or 0.00015 mfd. and the grid leak to about 0.5 or even 0.25 megohms. Although ear tests are not very reliable, the writer feels that he has detected some improvement in the high-frequency response of a receiver by the use of a small grid condenser, 0.0001 mfd., and a low resistance leak, about 0.25 megohms. The use of these values is recommended where sensitivity is not the prime requisite.

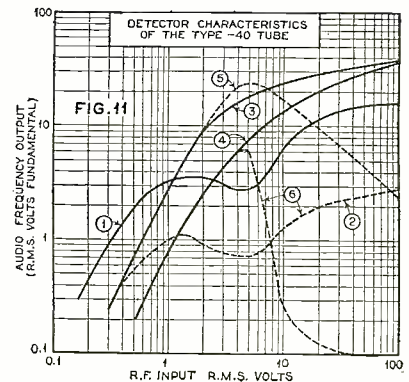
From the standpoint of uniform frequency response certain tubes have been found to be much better than others. Terman lists them as follows in the January, 1929, issue of the I. R. E.

Type	Highest undistorted audio frequency
201A	3,500
200A	11,500
240	3,500
199	4,250
120	4,250
171A	2,600
112A	3,500
226	3,500
227	11,500
12	11,500

(NOTE: Highest undistorted frequency is the highest frequency reproduced at least 70 per cent. as well as the low notes.)

From this table it is evident that the 227 is the best tube for use as a grid leak and condenser detector. The figures in the above table were obtained, however, with fairly large values of grid condenser and better high-frequency response can be obtained by the use of values in the neighborhood of those suggested above.

Although under some conditions the output of the grid leak and condenser detector is apparently proportional to some value between the first and second power of the input voltage, in most cases the detector follows a square law—that is, the output is proportional to the square of the input. Therefore doubling the input produces four times the output. This looks like a big advantage and, from the standpoint of sensitivity, it is—but from the angle of quality it's a disadvantage. When a detector follows a square law it produces some second harmonic (Continued on page 186)



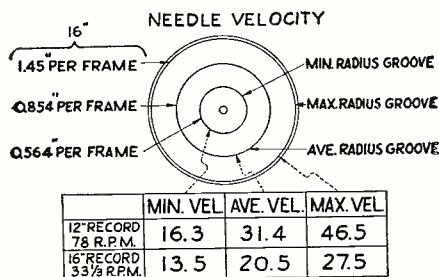
# Some Methods and Problems

**T**HE subject to be presented may seem to be somewhat out of line with the usual radio topics.

Recently, however, a new and rather important industry has come into existence which is demanding attention. I refer to the talking motion pictures. Here we have an industry of already tremendous proportions, although it is but a few months old. It is interesting to note that this new field of activity is

*Being a Detailed Account of the Various Employed in the Recording of Sound. Both Dealt with in a Most Complete Fashion of the Practical Problems Encountered Particularly*

**By C. F. Goudy\***



VEL. IN INCHES PER SEC.  
NOTE: FILM SPEED IS USUALLY 18 2/3 sec.  
**Fig. 1**

here as the natural result of progress in scientific research.

Recording of sound on film and disc has been highly developed. These processes are the result of recent advances in photography and the application of electrical recording. Pick-up devices have been developed to meet both types of recording. The photoelectric cell is one of the outstanding developments of the day. Electrical pick-ups for disc records have been improved with great strides.

### FREQUENCY-WAVELENGTH RELATION OF 16" RECORD

FREQUENCY	Average Radius 5.875 * λ in Inches	Radius 5 1/2 9/16 in. λ in Inches
35	0.5860	0.5150
50	0.4100	0.3600
100	0.2050	0.1800
500	0.0410	0.0360
1000	0.0200	0.0180
5000	0.0041	0.0036
8000	0.0025	0.0022
10000	0.0020	0.0018

\* LENGTH OF WAVE IN GROOVE OF AVERAGE RADIUS (5.875)  
**Fig. 1A**

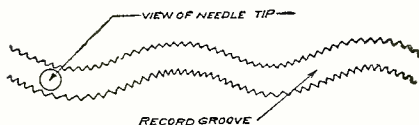
Amplifiers and speakers have arrived quite naturally, having come along with the progress of radio. These developments have been running concurrently and as a result we have the talking pictures. This new industry is already demanding the attention of many from our field of radio. Those of us who are so engaged find it necessary to study these new problems carefully.

There is naturally quite a gap between the motion picture and the field of the radio engineer. If these two industries are to come in contact we must devote some time to the subjects which fall specifically in this gap. This paper relates

\*Chief Engineer, Pacent Electric Co.

to recording, which is obviously one of the contact points between the picture industry and the electrical (or radio) industry.

The recording process may briefly be described as follows: A suitable microphone is connected to the recording device through an amplifier. When possible, the set-up is such that no distortion is contributed by the recording equipment. The air waves hit the microphone and the pressure variations are faithfully reproduced at the recorder. The amplitude of motion of the recorder element is supposed to be a perfect copy of the air pressure wave at the microphone. In the

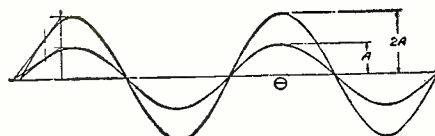


**Fig. 2—Path of needle tip**

case of film recording, regardless of type, the sound positive film has a distribution of density which will control the light entering the photoelectric cell, so that the instantaneous intensity is proportional to the sound pressure on the microphone diaphragm.

We have, therefore, for both disc and film recordings, a record corresponding to the air pressure at the microphone. Because of this fact, it is interesting to compare corresponding recordings on disc and film. In many cases we find a very striking similarity. The disc recording, of course, is modulated within narrow limits, whereas the film (variable area) is modulated through wide limits.

Commercial records for home use are ten and twelve inches in diameter. Obviously, the larger record accommodates more recording than the smaller record. The minimum groove diameter for both records is approximately 4 inches; the outer diameters are approximately 9 3/8 inches and 11 3/8 inches for the ten and



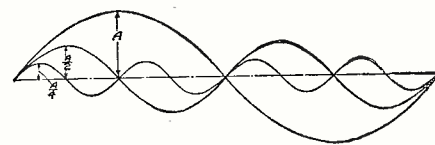
**Fig. 3**

**T**HIS article, reprinted from the Proceedings of the Radio Club of America for April, 1930, is by far one of the most authentic all-embracing dissertations on the processes by which sound is recorded on both disc and film. The detailed treatment accorded this absorbing subject makes the article doubly valuable as a source of reliable information for present and future reference.

twelve-inch records respectively. The normal speed of these records is 78 r.p.m. As the result of these figures, the following needle velocities are given for the twelve-inch record:

#### Approximate tangential velocities (Inches per second)

Inside groove.....	16.3
Middle groove.....	31.4
Outer groove.....	46.5



**Fig. 4**

The records as furnished for picture work are sixteen inches in diameter and operate at 33 1/3 r.p.m. The needle speeds are given below:

#### Approximate tangential velocities (Inches per second)

Inside groove.....	13.51
Middle groove.....	20.49
Outer groove.....	27.47

(See Fig. 1.)

It is noticed that the needle speed is much lower on the sixteen-inch record. Because of this fact, the recording and reproducing problems are somewhat increased. Naturally, the lower the needle speed, the shorter will be the total available distance for a given recording. This

# of Sound Recording

*Systems Which Are Now Universally Sound-on-Disc and Sound-on-Film Are To Servicemen Who Would Know More in This Field of Work This Article Is Recommended*

and W. P. Powers†

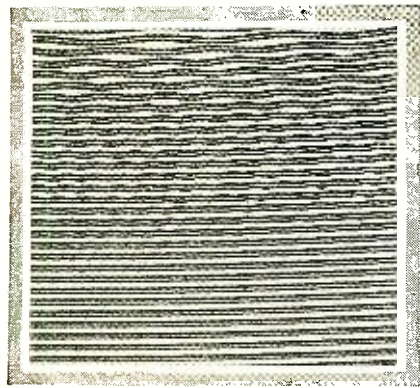


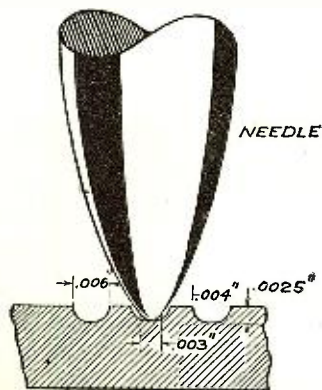
Fig. 4A—Frequency record

fact is illustrated by the following fundamental equation:

$$\text{Tangential needle velocity} = \text{wave-length} \times \text{frequency.}$$

The cutter used in disc recording is triangular in shape and is capable of recording relatively high frequencies. This shape could not be applied to needles for obvious reasons, the most important being the consequent destruction of records. We are compelled to replace needles frequently in order that the needle point diameter may be small enough to follow the high-frequency modulations. Let us not be upset about this apparent defect or shortage of high-frequency response. Very little amplitude is necessary at these frequencies to cause them to register. Obviously, considerable energy is represented in high-frequency impression, even though the amplitude is low.

Recording is more difficult on the inner groove because of the decreased velocity.



†Technical Director, Patent Reproducer Corp.

A detail study of the groove and needle dimensions will show that difficulty is to be expected in reproducing high frequencies because of the physical limitations of the parts concerned. (See Fig. 1A.) By consulting this table, it becomes apparent that the higher the frequency the more difficult it becomes for the needle to faithfully follow the groove modulations. In fact, it is quite possible to record frequencies which cannot be reproduced by the ordinary needle. (See Fig. 2.) This figure roughly illustrates the inability of the needle, owing to its large diameter (approximately .003 inch) to faithfully follow the minute high-frequency variations as recorded. (Fig. 2 is purposely exaggerated to convey the point under consideration.) However, when the needle is new it is capable of doing its best work. It is possibly for this reason that the large records are always cut from inside to outside.

The instantaneous generated voltage of a pick-up device (for disc) is directly proportional to the instantaneous radial velocity of the needle (armature). This statement is readily appreciated when we consider that no generated voltage exists when we have no modulation of the

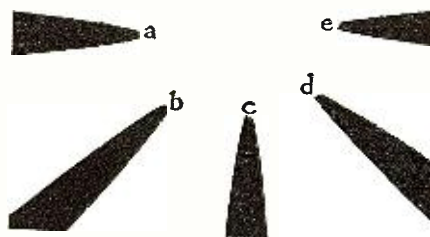


Fig. 5 (at left)—Cross section of record grooves

Fig. 8 (above)—a, Unused; b, 5 min.; c, 10 min.; d, 15 min.; e, 20 min.

Fig. 7 (at right)—Behavior of a phonograph pick-up with various types of needles

groove. (Strictly, however, the groove is never absolutely free from modulation owing to the imperfections in material structure.)

It is interesting to note that the amplitude of the generated voltage wave is dependent only upon the rate of change of the needle position, radially, with respect to time. The amplitude of the recording groove, however, determines this rate; that is, the higher the amplitude for

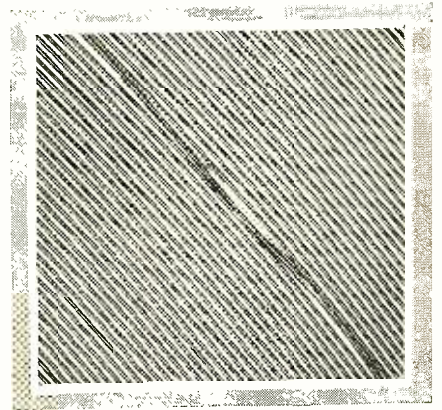


Fig. 6—Cross-over

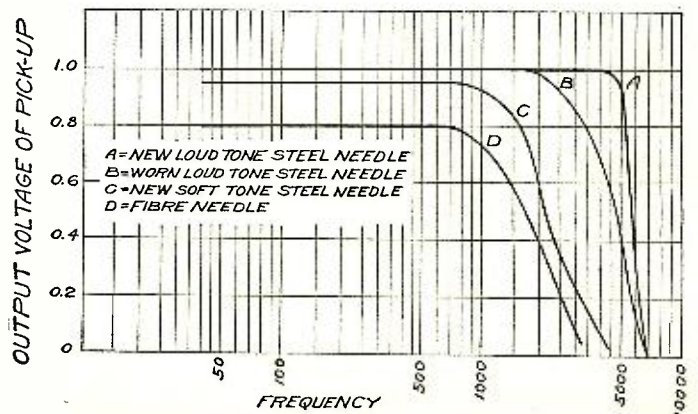
a given frequency, the greater will be the slope of the curve at a given point. This is readily understood when we consider the expression for a sine wave having an amplitude equal to A, and a similar wave having an amplitude equal to TA. The slope of this curve is determined by the derivative of the expression for the curve, and in the above case, the solution shows a 2:1 ratio for the slopes at all points along the curves. (See Fig. 3.)

$$\text{If } y = A \sin \theta, \frac{dy}{d\theta} = A \cos \theta$$

$$\text{If } y = 2A \sin \theta, \frac{dy}{d\theta} = 2A \cos \theta$$

For uniform generated voltage at all frequencies the amplitude of the groove modulation must vary inversely as the frequency.

Fig. 4 shows several sine wave grooves



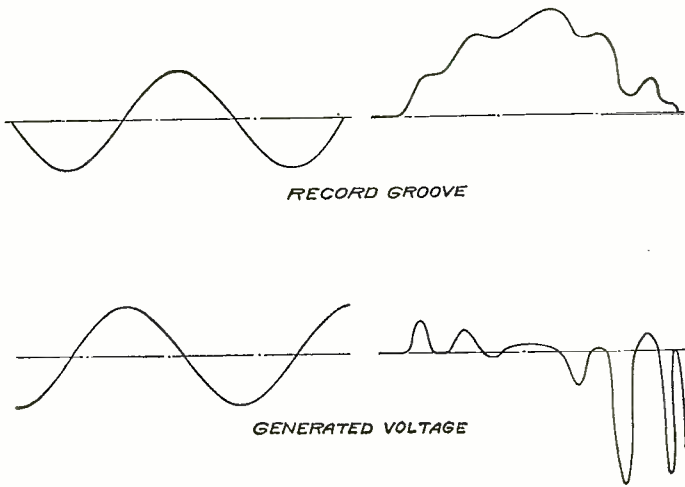


Fig. 9—Groove relation to voltage generated

fulfilling the requirements for constant generated voltage. It will be noticed that for the lowest frequency the needle travels radially (vertically in the figure) a distance of  $4A$  for the period of one cycle. For the double frequency wave the needle travels radially a distance of  $8 \times \frac{A}{2}$

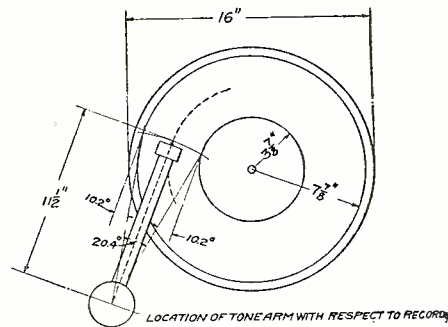


Fig. 10

in the same period of time. For the wave having four times the fundamental frequency, the needle travels radially a distance of  $16 \times \frac{A}{4}$  in the same period of time. The average generated voltage,

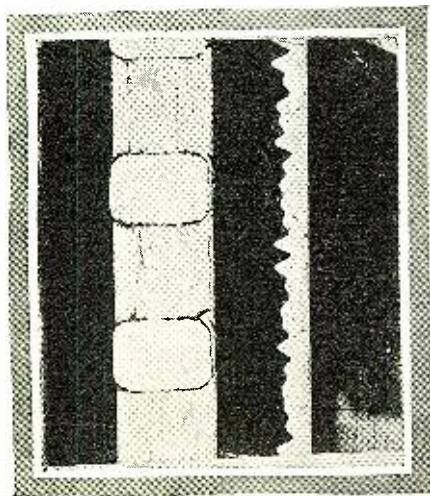


Fig. 12A—Fundamental approx. 154 cycles per second with pronounced harmonic

therefore, in each case is the same, inasmuch as the radial distance covered over the period of time in question for each wave is  $4A$ . (See Fig. 4A.)

The maximum permissible amplitude of modulation in disc recording is approximately .002 inch. (See Fig. 5.) This amplitude is seldom exceeded in order to prevent the possibility of cutting into the adjacent groove. Because of this physical limitation, the voltages corresponding to the frequencies below 250 cycles (approximately) will be relatively reduced. Occasionally, however, recordings have been released which show modulation amplitudes in excess of the above figure. No great difficulty results in producing these records, providing extreme amplitude points do not come adjacent on successive grooves. In reproducing, however, difficulty is frequently experienced as a result of the consequent weakened condition of the side wall. Fig. 6 illustrates a "cross-over," which is the obvious result of over-modulation in recording.

It might be of interest, at this time, to consider the unit pressure existing at the needle point. Assuming the diameter of the needle to be .003 inch and the needle

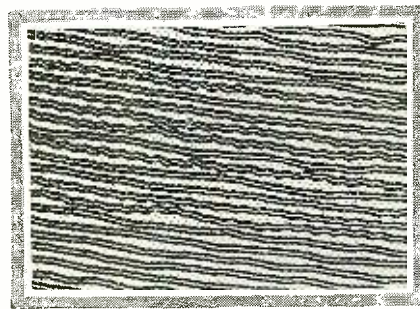


Fig. 13—Difficult recording

pressure 5 oz., the resulting vertical unit pressure is roughly 44,000 lbs. per square inch. If one were to determine the normal drag on the needle point along the direction of motion, startling values would result for the unit pressure perpendicular to the direction of motion when a change in direction is encountered.

A certain amount of vertical needle pressure is necessary to provide proper tracking. As a consequence, records must be made of hard material and they must

f	λ (inches)	f	λ (inches)
8000	0.0022	800	0.0225
5000	0.0036	500	0.0360
4000	0.0045	400	0.0450
2000	0.0090	200	0.0900
1000	0.0180	*96	0.1875

\*CORRESPONDS TO SPROCKET HOLE HUM.



Fig. 11 (at right) Frequency-wavelength table

be abrasive enough to grind the needle in order to reduce the unit pressure at the needle point. This of course results in better coupling between the record and needle. Ordinarily, the unit pressures are sufficiently reduced after one minute of operation. Curves A and B of Fig. 7 show the relative voltages generated by the pick-up using new and worn loud tone steel needles. It is evident that as the needle wears, its response favors the low frequencies, thus reducing the quality of reproduction. Curve C shows the re-

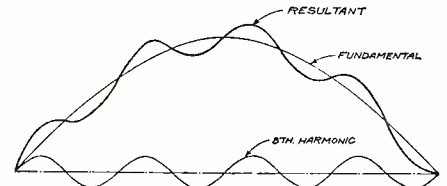


Fig. 12—Resultant of fundamental and 8th harmonic

sponse using a soft-tone steel needle. The somewhat reduced response of this needle is because of its filtering effect. Curve D shows the response obtained when using fibre needles. However, owing to their poor frequency response characteristic, they are not used in commercial sound reproduction. Fig. 8 is an actual photomicrograph of needles showing the amount of wear after service of 5, 10, 15 and 20 minutes. It will be noticed that the most pronounced deformation occurs during the initial period of service.

(Continued on page 185)

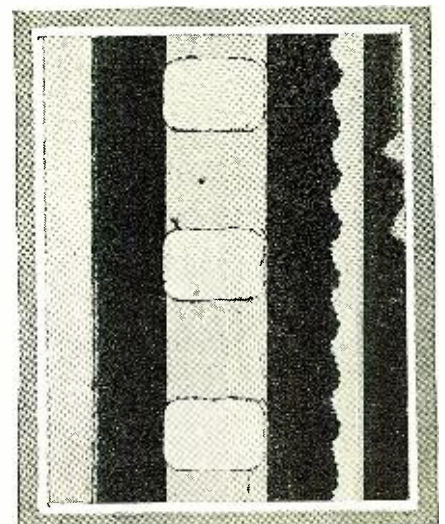


Fig. 12B—Fundamental approx. 330 cycles per second with 8th harmonic

# A New Circuit for Tuner Construction Employing The Hopkins Band Rejector System

## Technical Details and Theory of Operation Described for First Time

*Here's a New Idea in Tuner Circuit Design Embracing the Band-Pass Filter Principle. During Recent Months the Subject of Pre-Selector Circuits Has Received Much Attention, This System Being Incorporated in Some of the Season's Outstanding Receivers. The Circuit Arrangement Which Is Described Here Is Novel and Ingenious, Commanding the Attention of Serious-Minded Experimenters*

By Charles L. Hopkins\*

**W**HILE the superiority of the band-pass filter has been recognized by the majority of radio engineers, the orthodox band-pass filter has the fault of creating, instead of the desired flat top resonance curve, one having two distinct "humps" so that a signal of greatest intensity will be found at two settings, whereas between the two adjustments there is a decided drop in the amplification. It is also found that the desired steepness of cut-off is not realized unless the band adjustment is relatively wide. Investigations in my laboratory were made with a view to removing the mid-point drop in amplification and to create a circuit that would give a true band pass *with a single channel width*.

The Hopkins circuit is actually an impedance-coupled amplifier in which the impedance of the output circuit of one tube is common to that of the input circuit of the succeeding tube. Of course, one object of the amplifier is to give as much increase in the voltage impressed upon the grids of successive tubes as possible, and in order to do this it is necessary that the voltage drop across the elements of the external plate circuit be as great as is compatible with stable operation.

With screen-grid tubes the high plate resistance makes it necessary to greatly increase the impedance of the external plate circuit, over that necessary with the -27 type, in order to create a high voltage drop for impression upon the grid of the following tube. A parallel resonant circuit of the type sometimes called a wave-trap was selected as the best means for supplying the high impedance, in spite of the fact that such a system, as usually employed, presents problems due to the tendency of such circuits to oscillate and become decidedly unstable when as many as three stages are used.

Fig. 1 shows a form of coupling means which may be used in the Hopkins system. The plate circuit is seen to consist of a combination of a choke coil in series with a parallel tuned circuit, with plate return through these

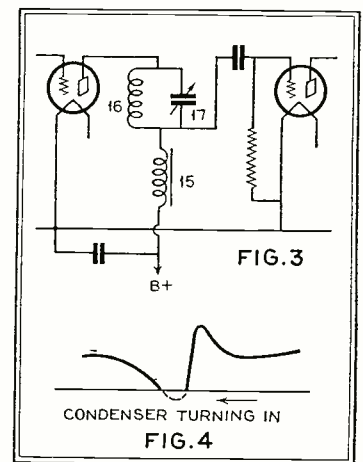
impedance elements and a fixed condenser. 14. The fixed condenser, 18, between the plate of the first tube and the grid of the second, is for the sole purpose of isolating the grid from high plate voltage. A leak, 19, is provided to prevent blocking of the second tube.

The choke coil, designated as 13 in the diagram, is so designed that it has a large value of inductance with a very small distributed capacity. At the same time the capacity is sufficient to tune the circuit to a frequency much lower than the frequency used in the amplifier, so that the choke acts as a capacitive reactance to the intermediate frequency, and functions as a very small condenser; that is, a condenser having high capacitive reactance.

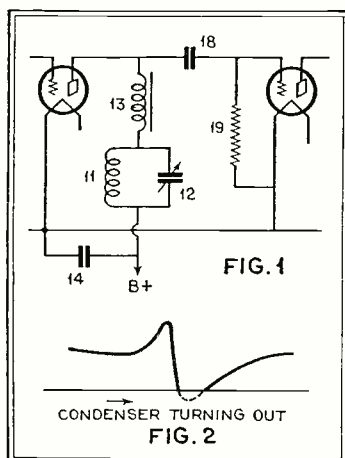
Two fundamental electrical laws enter into the analysis of the working of this system. The first is that when a capacity and an inductance are in series and the reactances are mutually balanced at some particular frequency, the current at that frequency meets with no impedance other than the ohmic resistance of the circuit, and consequently no voltage drop will occur across them. The second law is that when a circuit, such as that incorporated in inductance, 11, and condenser, 12, is brought into parallel resonance at a certain frequency there is no reactive impedance at that frequency, but the ohmic resistance is extremely high.

Now, if the trap circuit comprising the inductance, 11, and capacity, 12, are tuned slightly higher than the frequency of the radio signal, the impedance across the circuit becomes highly inductive, and, if it is tuned slightly lower in frequency, the impedance becomes highly capacitive. The combination of elements in the plate circuit, when arranged as shown in Fig. 1, therefore offers to the amplifier plate current either inductive reactance, capacitive reactance, or series resonance (no reactance) because of the fact that one of the elements is variable.

Due to the fact that the adjustment may be such that the reactance of the plate circuit cancels out, there will be a frequency at which there is no voltage drop and consequently



In this circuit the position of the plate element has been reversed, the tuned circuit being placed above the choke. Such a circuit gives rise to the production of a tuning response as shown in Fig. 4, the exact opposite of that shown in Fig. 2



When employing the circuit in which the tuned element in the plate circuit is below the choke then a curve indicating tuning response such as that shown in Fig. 2 is obtained. Note that as the condenser turns out after the "bump" of the curve has been passed there is a sheer drop

Fig. 1 shows a form of coupling means which may be used in the Hopkins system. The plate circuit is seen to consist of a combination of a choke coil in series with a parallel tuned circuit, with plate return through these

\*Consulting Engineer, High Frequency Laboratories.

no voltage swing impressed on the grid of the second tube. In other words, the signal may be shorted out or shunted back to the input of the first tube. Under these circumstances the ohmic resistance of the choke coil, the only remaining coupling impedance, would not be sufficient to afford a voltage drop great enough to pass the signal to the following tube. At the same setting of the tuning element there will be another frequency at which the trap circuit offers extremely high resistive impedance, and the voltage drop across the trap is all impressed on the succeeding grid.

To study these effects, the circuit shown in Fig. 1 may be set up with suitable means for either hearing or measuring the output of the second tube, with a standard frequency applied to the first tube, and with the condenser set at maximum capacity. Slowly turning the condenser out from its maximum value, the strength of the signal will be seen to increase gradually to a certain point and then rise much more rapidly until at another setting it will drop sharply, and again gradually rise until eventually it will approximate the first value. Fig. 2 shows the form of the response curve obtained by adjusting the capacity of condenser 12. It is evident that the impedance of the plate circuit is very high at the setting that gives the peak in the curve so that a high voltage amplification is obtained.

It will be seen that with the arrangement of Fig. 1 signals of one frequency are passed along to the second tube, while signals of another and higher frequency will be shorted out, or shunted back. There is thus provided a circuit which has a high degree of selectivity on one side of the desired band of frequencies, but, because of the non-symmetrical shape of the curve, has a less than normal degree of selectivity on the other side. Therefore, the system must include a circuit to give a means for eliminating stations on the other side of the band.

Fig. 3 shows a circuit arrangement which gives a curve which is the reverse or complement of the curve shown in Fig. 2. Here again we shall consider the tubes as the first and second, although they are actually the second and third tubes of the circuit. Note that the resonant circuit, 16, 17, and the choke coil 15, are connected as in Fig. 1, except that their relative positions are reversed. The lead to the grid of the second tube is taken from the common connection between the trap circuit and the choke, instead of from the plate of the first

tube, as in the previous stage. Here it is the voltage drop across the choke, 15, that is impressed on the second tube.

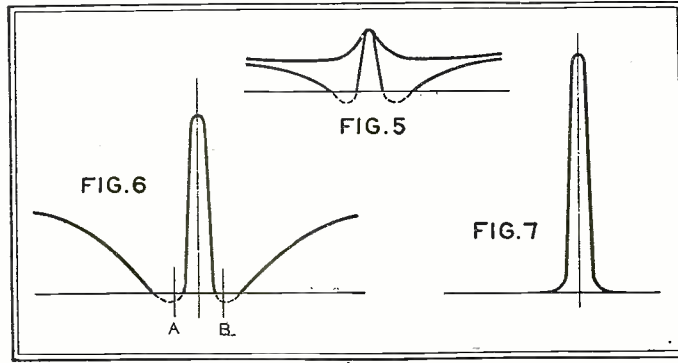
If the adjustment of the trap is such that its reactance is inductive, it is apparent that it will tend to cancel out the capacitive reactance of the choke coil in the same manner as discussed in connection with the circuit of Fig. 1, but it is fundamental that when a capacity and an inductance are brought into series resonance for a given frequency, a very great voltage drop occurs across either of these reactance elements.

If the circuit shown in Fig. 3 is set up and the condenser is rotated, the signal strength will change in just the same manner as it did in the case of the arrangement shown in Fig. 1, except that the steep cut-off occurs on the other side of the "hump." The curve for this second stage is shown in Fig. 4. In this case the reason for the drop in the response curve is that the trap circuit, 16, 17, blocks or rejects signals of the frequency to which it is tuned. The parallel tuned circuit, instead of being in a path which is common to the plate circuit and the grid circuit, is in but one of these circuits, and it, therefore, prevents the signal current from flowing in the choke. As a consequence

of this trapping action there is no current in the common impedance element (the choke) and, therefore, no voltage drop to be impressed on the next tube.

Superimposing the curves shown in Figs. 2 and 4, one upon the other, the resulting curve will be as shown in Fig. 5. The portion of the spectrum which is transmitted through the tubes is seen to form a comparatively straight-sided, narrow band.

The width of the band or channel can be narrowed or widened by adjusting the settings of the condensers 12 and 17. Experiments have shown that the band can be made so narrow that the quality of the reproduction is greatly impaired by side-band trimming, to such an extent, in fact, that a violin can nearly be tuned out due to the narrowness of the band, which will not allow the higher frequencies of the violin to pass through. Therefore, it will be seen that it is readily adjusted so as to obtain ten kilocycle station separation. The shape of the curve of Fig. 5 shows plainly that an adjustment for band width of 10 kc. will afford extremely high reactivity for channels on each side of the desired one. It will also be seen that the top of the curve maintains (Continued on page 176)



In Fig. 5 the final response, resulting from the employment of two circuits, one as in Fig. 1 and one as in Fig. 3, is depicted by the vertical section of the curve. Fig. 6 shows points A and B denoting where cutoff of the signal begins, Fig. 7, the overall response curve of the receiver shown in Fig. 8

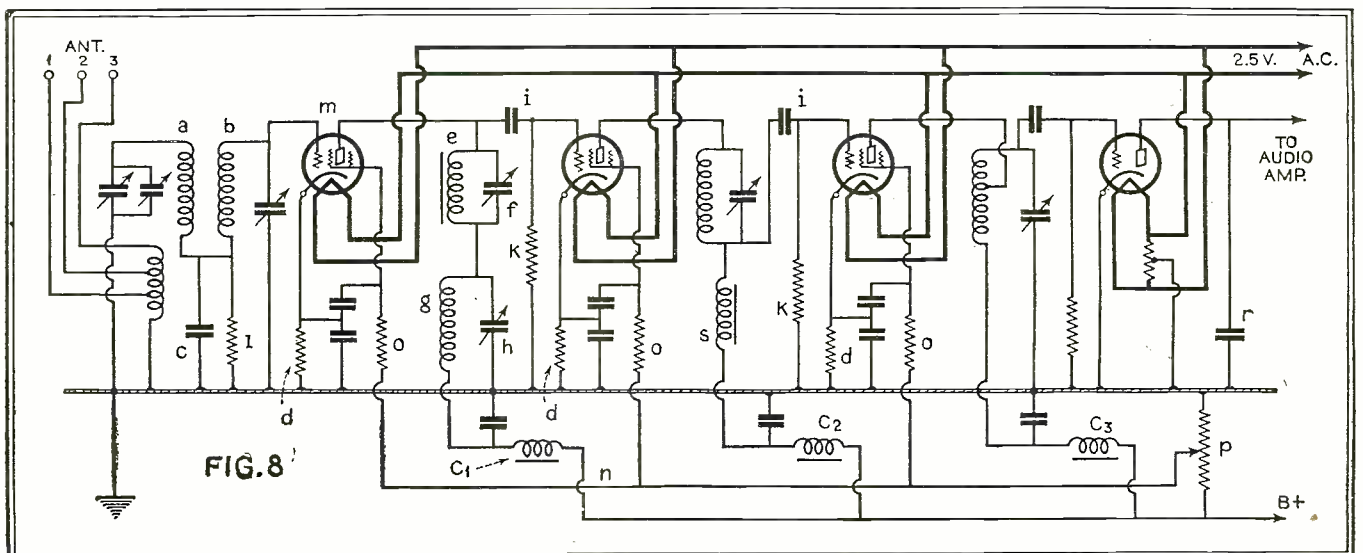
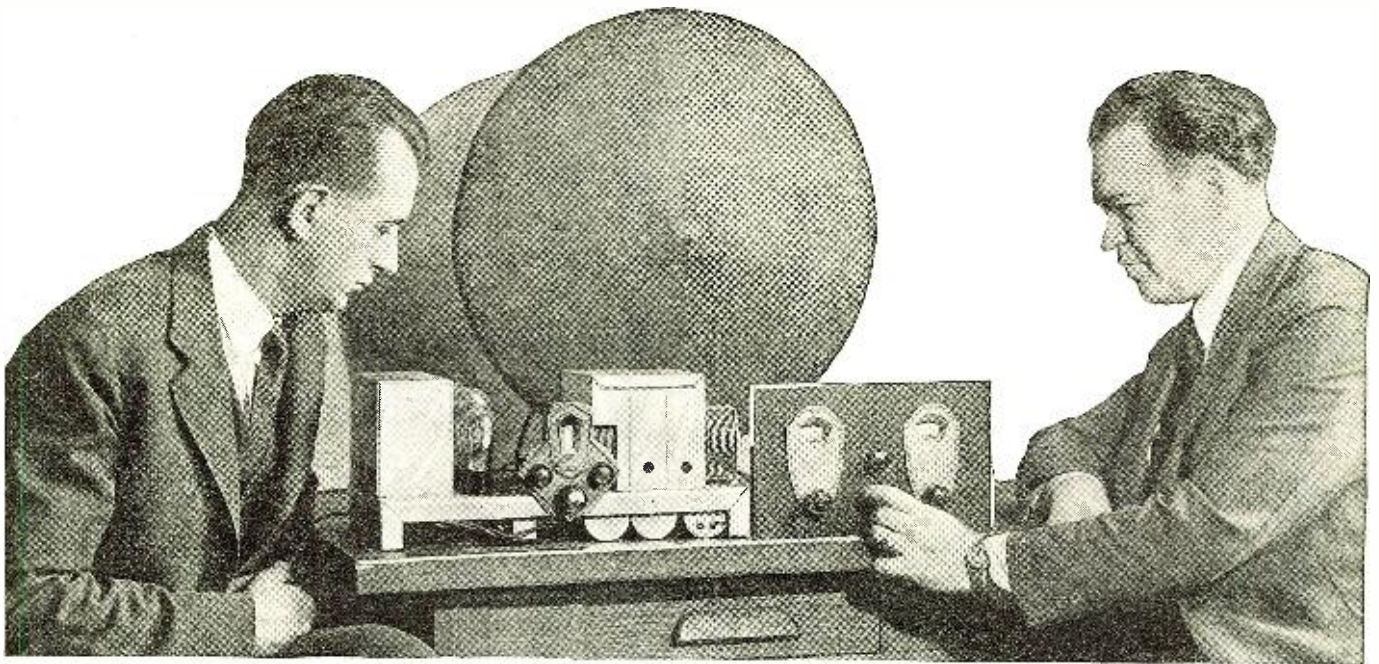


Fig. 8. The circuit of a four-tube tuner employing three stages of tuned r.f., two of which employ the band-pass system described here, while the antenna stage makes use of one of the standard pre-selector circuits



Manson E. Wood, designer of the Supersonic adapter, and Volney Hurd, shown operating the unit in conjunction with a standard broadcast receiver

# Operating the *Short-Wave* SUPERSONIC ADAPTER

*Full Instructions for Connecting This Converter Unit to a Standard Broadcast Receiver, Together with Pointers on Tuning in Short-Wave Signals*

By Manson E. Wood

**T**HE description of the short-wave unit and method of operation has the ear-marks of a page taken from the ancient history of the use of the double detection methods for the reception of short waves. We are told that the earliest receivers of this type were made up of what might be called an adapter for wave changing and a radio-frequency amplifier in the form of a powerful receiver covering the commercial wavelengths. With the powerful broadcast receivers available as i.f. amplifiers, this old and reliable method of short-wave reception stands way to the fore in comparison with other methods. In this age of mighty words and phrases the name "Supersonic" serves to dress up an old friend for a new start in the world of radio.

The magnitude of short-wave signals received and general results obtained depend entirely upon the broadcast receiver used with the Supersonic unit. It has been used with representative types of modern receivers, including superheterodynes. Those who wish to operate the unit with their home-made receivers should be sure that no regeneration exists in the receiver. The presence of regeneration in the broadcast receiver will cause a squeal on the short-wave signal received and may also build up an audio howl.

The unit should be connected to the broadcast receiver so that the leads to the unit are not too long. Transfer the antenna from the receiver to the unit.

The reader may find that better results are obtained with the ground wire disconnected, which can be determined

after a few signals are received.

Any wavelength within the range of the broadcast receiver can be used for an intermediate frequency. The reader will undoubtedly find that his receiver is more sensitive in the range of wavelengths from the upper middle to the lower side of the broadcast band; in other words, from two hundred to three hundred and fifty meters.

After the unit is connected, turn on the broadcast receiver and with the volume full on tune to some point on the receiver dial within the above-mentioned range of wavelengths where no regular broadcast signal can be detected even faintly in the loud speaker. The lowest side of the broadcast band of wavelengths will probably be useless because there are so many stations in this region. The presence of signal energy of a regular broadcast station in the receiver when the converted short-wave

stations are being received will result in distorted music. When using this unit the author tunes his receiver to some point on the dial near 1,000 kilocycles. The best point on the dial to use can be found by experiment and depends upon the broadcast receiver and its geographical location.

There is usually something on the air in the 35 to 60-meter band of wavelengths. The lower bands (Continued on page 175)

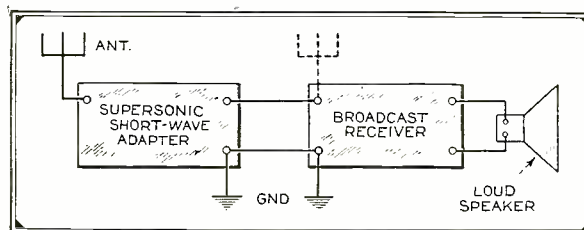


Fig. 1. A diagrammatic representation of the circuit arrangement employed in connecting the Supersonic short-wave adapter to a broadcast receiver

# How to Synchronize

*One of the Problems Which Still Confronting and, Once Obtained, the Maintenance of Receiver Scanning Disc and the Transmitter Outlines Some Practical Systems Which*

*\*By D. E.*

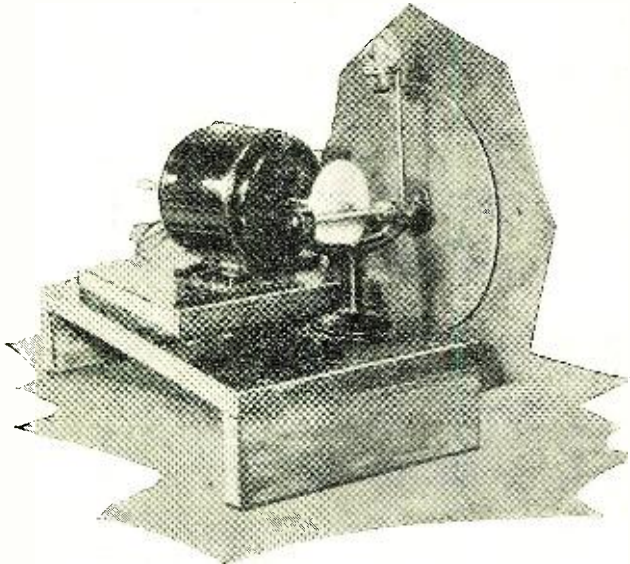


Fig. 1. Televisor with an adjustable friction drive motor to vary the speed of the disc. See Fig. 7 for schematic layout

**I**F you have been one of those whom the television "bug" has bitten, you have built up your television receiver and have been able to get the characteristic buzz-saw signals of the television picture on your loud speaker. If so, the next thing in line is your televisor. If you are on the same power system as some television broadcasting station and you have plenty of money, the easiest thing to do is to buy a complete televisor unit or a kit-televisor, both of which are now on the market. If, however, there are no broadcasting stations on the power system to which you could connect, or if you happen to be supplied by direct current, you will naturally be at a loss to know how to synchronize a scanning mechanism or a disc with any transmitter you wish to receive.

Synchronization, of course, is obtained when the scanning mechanism runs at exactly the same speed as the scanning mechanism at the television transmitting station, but we must go even farther and obtain what is called "isocronism." By this is meant that the receiving and transmitting scanning mechanisms are not only running at the same speed, but are in phase with each other, namely, that each light impulse at the receiving end is made to appear in its correct position in the picture and that the whole mechanism has been corrected for any phase displacement between the transmitter and receiver.

*Synchronizing means*—There are three general methods of

\*Assistant to President, Jenkins Television Corp.

obtaining synchronism for television. The first requires some sort of manual adjustment to vary the driving speed of the receiver scanner. The second method can be called semi-automatic synchronism which requires no manual adjustment but can be used in limited territories only. The third is full automatic synchronism which requires no manual control to maintain synchronism, it merely being necessary to push a button and tune in the signal. In general two types of power supply also have to be considered, namely, direct current and alternating current and we will consider each of the three methods of synchronizing in respect to the two types of power supply available.

1. *Variable Method—Manual Control.*

(a) Using this method an eddy current motor which we have met before in the electrical phonograph and in the electric watt-hour meter can be used to drive a scanning mechanism. This motor consists of a set of magnets, which set up current in an aluminum disc. These currents then interact with the magnetic field of these magnets or others to furnish driving torque. By proper design its speed can be controlled by varying the current through the motor, by varying the phase relationship between the magnets either electrically or by mechanical means, or by varying the gap between the magnets and the driving disc. Its speed can also be varied by friction on the disc. Fig. 2 shows a televisor driven by an eddy current motor as described above. The eddy current motor will only operate on alternating current.

(b) A direct current or Universal motor can be used to drive the disc with a manual control which varies the applied voltage. This is most usually accom-

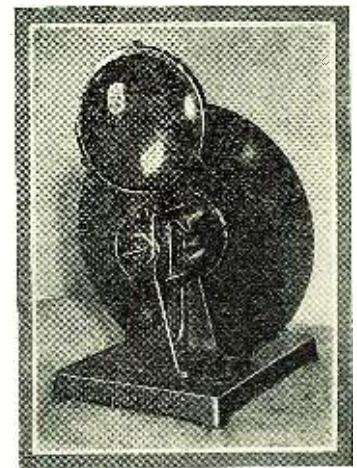


Fig. 2. Televisor driven by eddy current motor with 60-cycle synchronizing phonic wheel. The wheel is on the back of the disc

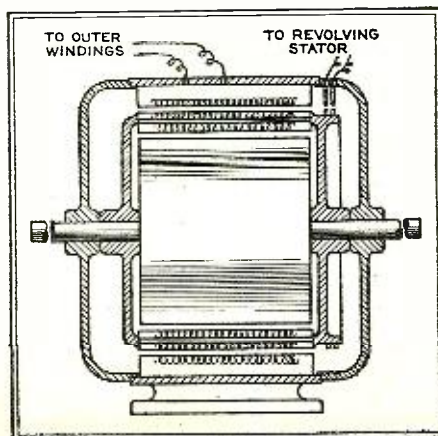
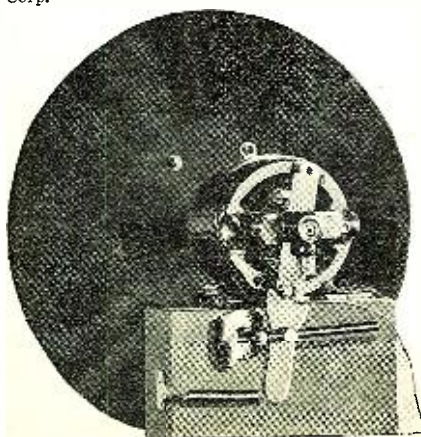


Fig. 3. The scanning disc is driven by a universal motor. Its speed can be controlled by shifting the brush position, which varies the back voltage generated by the armature

Fig. 4. Diagram showing two motors in one. The inner motor is a synchronized motor and its field is rotated backward or forward to control the overall speed



# for TELEVISION

*the Television Experimenter Is the Obtain-Satisfactory Synchronization Between the Scanner. An Authority on This Subject Are Now Being Satisfactorily Employed*

## Replogle

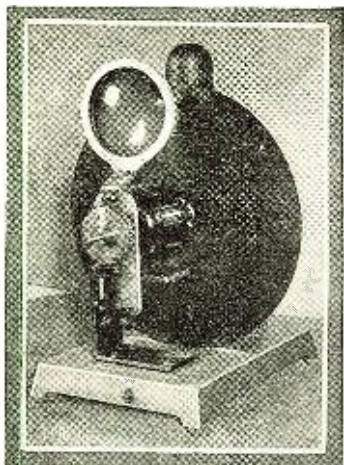


Fig. 5. Televisor driven by a d.c. motor and held in synchronism by the phonic wheel shown in the foreground. Synchronizing pulses are obtained at picture line frequency, 720 cycles

the motor shaft. By shifting the position of the motor at right angles to the disc this rubber drive will touch the scanning disc nearer or farther from its center and thus vary the speed at which the disc is driven. A very fine adjustment of speed can be obtained by a small movement of the motor base. The scanning disc load is usually light and hence varying its speed does not appreciably change the speed of the motor and as long as the voltage supplying the motor remains fairly constant, very accurate speed control can be obtained by this method.

(d) On both a.c. and d.c. motor drives a flutter type of contact governor can be arranged to throw in or short-circuit a series resistance if the speed is too slow or too fast. These

plished by means of a resistance in series with the motor supply. The back voltage generated by a motor may also be used to vary its speed by shifting the angle of the brushes (see Fig. 3), shifting an adjustable third brush, or changing the resistance of the field by means of a rheostat. This method can be used on a.c. or d.c. voltage supply, depending upon the type of motor selected.

(c) An induction or d.c. motor which has nearly constant speed can be used to drive a scanning disc in the manner shown in Fig. 1. Here the motor is mounted on an adjustable base and the power is applied to the scanning disc by means of a light rubber disc mounted on

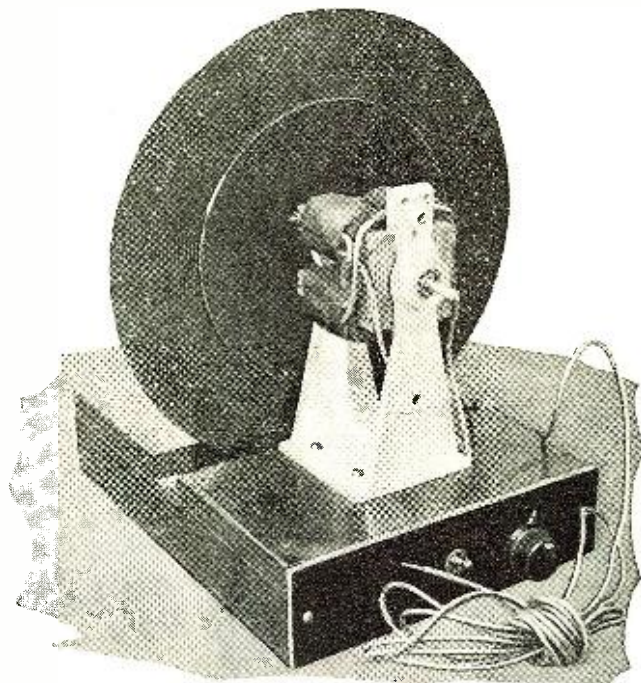


Fig. 8. Home televisor made from the Jenkins kit. A magnifying lens is also supplied as optional equipment

devices maintain an over-all constant speed but there is considerable hunting or fluctuation in speed which is usually experienced even with the most carefully designed governor.

The phonic wheel or simplified synchronous motor has offered a means of manually obtaining constant speed. Power can be applied to this wheel from a tuning fork through a suitable amplifier which is usually constructed using vacuum tubes. The period of vibration of the tuning fork can readily be changed by varying its length or its inertia through the use of a weight. The power to drive the phonic wheel may be supplied by another motor and it can be held in step by means of a tuning fork generator.

Still another method is by using a d.c. motor to drive an alternator. A d.c. motor field should be supplied by rectifying the alternator output through an adjustable tuned filter and by adjusting this tuned filter the speed of the system can be maintained fairly constant.

A still further variation is to use one synchronous motor, the field of which is driven by an easily variable speed induction motor so that by changing the speed of the induction motor by a large amount, only a small variation will result in the compensated speed of the synchronous motor. A sketch of such a motor is shown in Fig. 4.

### 2. Semi-Automatic Motors.

Among semi-automatic motors we have the synchronous motor which, when connected to (Continued on page 184)

Fig. 6. A schematic layout of a d.c. motor-driven televisor synchronized by a phonic wheel (immediately to right)

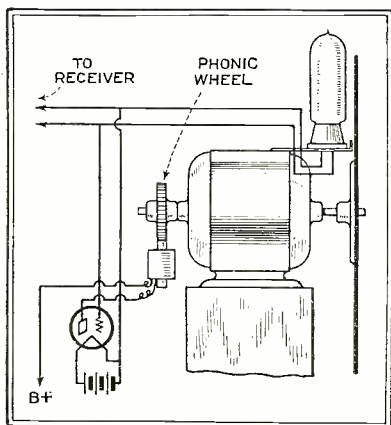
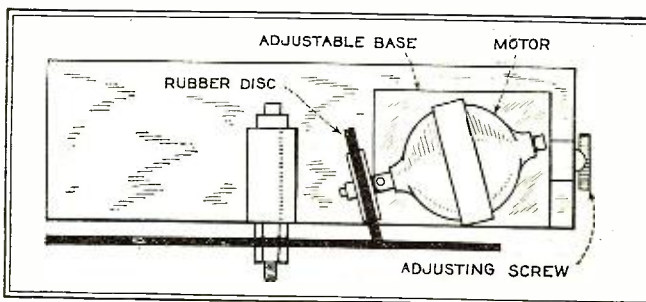
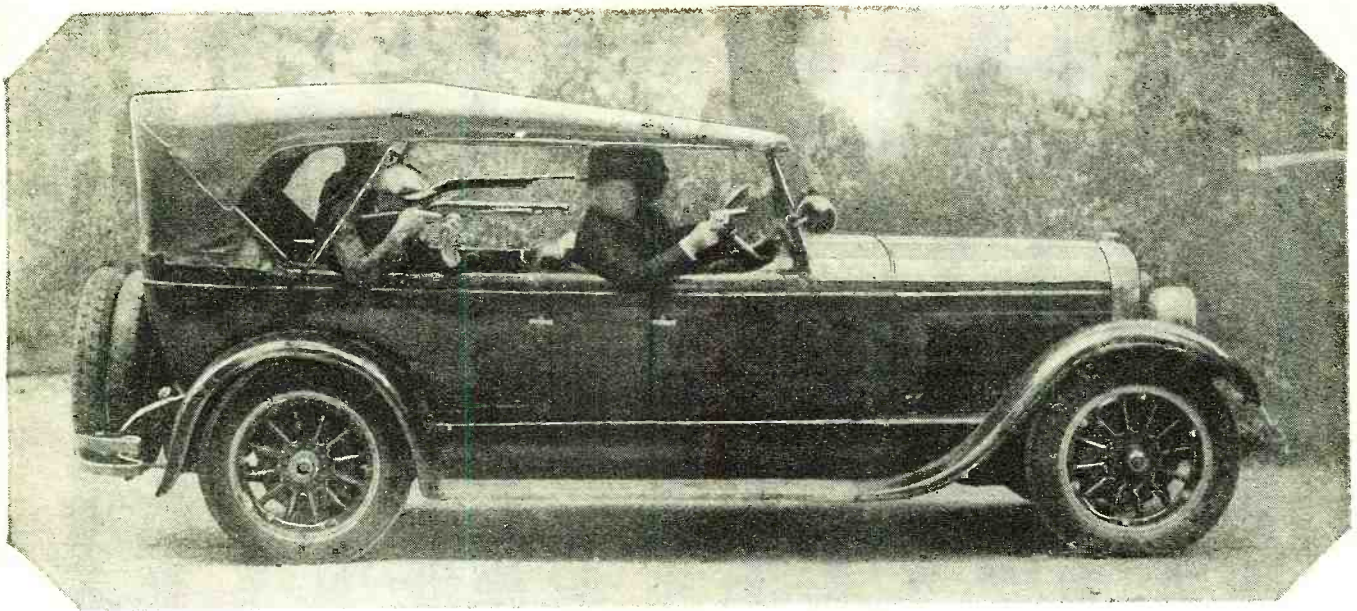


Fig. 7 (extreme right). Schematic layout of a televisor with motor being adjustable on a sliding base to vary the disc speed





A typical radio-equipped police car



Former Police Commissioner William P. Rutledge, the man who first championed the cause of police radio in Detroit

# Manhunts

*Radio is proving an invaluable aid to the police in the speedy apprehension of criminals—the average time for arrest being ninety seconds*

**M**ANHUNTS by radio—through the successful adaptation of radio as an efficient unit of modern crime fighting equipment—are becoming the rule rather than the exception in the activities of many law-enforcing agencies.

City after city is equipping its police department with a radio system. Orders are being broadcast from radio stations devoted entirely to police work to patrolling automobiles equipped with receiving sets and loud speakers. Every radio-equipped car and its crew are subject on an instant's notice to the directing voice of the police dispatcher or radio station operator.

Bank robbers, bandits, thugs, burglars, "peeping toms," drunk drivers, slayers—all of these and other enemies of society have learned that police work has entered a new era—an era of hitherto unequalled speed and efficiency.

Police chiefs in cities that have not yet seen fit to provide for police radio systems are chafing at the dallying of those who hold the purse strings. They stand by as they watch other departments marching onward, armed with this new weapon that science has provided.

Temporarily, at least, they must curb their impatience and await the providing of funds and equipment that will enable them to face the criminal on the new front. They must wait

unless the citizens themselves take a hand—as they did in Indianapolis—and raise funds through a public campaign with which to install a police radio system.

But what can be expected in the way of results if a police department is equipped with radio? What will be the effect on crime? What will the installation of such a system mean to the average citizen and his family? What effect does radio have on the morale of the police departments? What has radio done to and for police work?

These and other questions were put to men who have had years of experience with police work and who know from that experience what radio will do for the police. Their replies were based on results, on personal knowledge and observation. They spoke with a background of long contact with police methods against law breakers.

Crime has been reduced. Radio is the most efficient instrument at the disposal of the police. The policeman is more alert. People are more secure in their homes and places of business than ever before. There is better cooperation between the citizens and the police. There is a better understanding. Police work is faster than ever before.

These were some of the replies voiced by men who have made police work their calling—their profession—for profession it is coming to be regarded, as science more and more lends its support.

William P. Rutledge was the first man approached. For thirty-five years a member of the Detroit Police Department, a past president of the International Association of Chiefs of Police, a member of that organization's committee on radio, and chairman of the association's committee on uniform crime records—he knows police work from the beat to the commissioner's office.

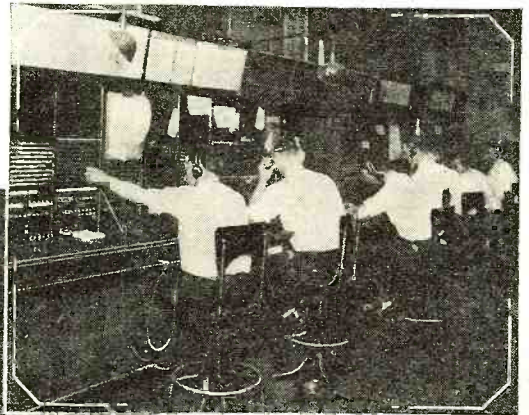
**P**OLICE chiefs in cities that have not yet seen fit to provide for police radio systems are chafing at the dallying of those who hold the purse strings. They stand by as they watch other departments marching onward, armed with this new weapon that science has provided.



Leaping out at the scene of the crime

# oy Radio

By  
Ralph L. Peters



(Above) The dispatcher gets an alarm, and two and a half seconds later is broadcasting it to the cruisers and scout cars



(Left) The radio station—WCK—of the Detroit police. The operator, before a microphone, is sending a message to officers in patrolling cars

William P. Rutledge undoubtedly has been responsible more than any other one man for the adaptation of radio as a police weapon. Not from the technical standpoint, but from the standpoint of a prophet who foretold what radio would mean to police work and was determined to see his prophecy fulfilled. And it has been.

"Time," he says, "is the big factor in crime detection and solution. The elimination of as much time as possible between the commission of a crime and the arrival of the police is the constant goal of efficient police officers. Seconds mean escape or capture for the crook.

"Thirty-five years ago, when I entered police work, we never dreamed there would be a scientific development or an instrument such as radio that would bring about the speed with which police work is being carried on today.

"In the early days, when the patrolman went out on his beat he went completely away from the control of his officers. There was no way of communicating with him save by locating him in person on the beat. Then came the telephone and the call-box. That was better but still not enough. The officers could not communicate with the men until the men called in to their stations to report. Then came the installation of signal lights on top of the call-boxes to notify the patrolman he was wanted. That too was insufficient, for still the officers had to wait until the men called from the box. We placed men on the streets in patrolling automobiles but we had no way of communicating

with them until a member of the crew called in for his orders.

"Then came the adaptation of radio to police work. Now we have almost instantaneous communication with every man in a radio-equipped car throughout the city. Two and a half seconds after an alarm reaches headquarters it is flowing out through the air to the radio-equipped cars. All of them get the message, and simultaneously.

"I regard the use of radio by the police as one of the greatest developments of police work, and I give due consideration to the scientific laboratory and the fingerprint system which play such an important part in our work today.

"Celerity and certainty of arrest and punishment act as the greatest crime deterrent. It is in the field of apprehension that radio enables the police to score. Radio aids in the elimination of circumstantial evidence. It catches the crook with the goods.

"Protection of the citizen, his dependents, home and property through radio has been made possible beyond even the fondest dreams of police officers a few years ago. Police work has been made more interesting to the men in the cars. They are not isolated any longer. They learn through radio's warning



The radio-equipped Belle Isle police station at Detroit

voice what is happening not only in their own precincts, but throughout the city.

"I hope to see the time when radio will enable the police to be within 45 seconds running time of any scene of trouble. That may seem impossible, but the records of the Detroit Police Radio Station show more than 2,000 arrests at an average time of 90 seconds each. Some of the arrests, because of the distance the cruisers and scout cars had to run, were made in considerably more than the average time, but even so the runs were made much faster than they would otherwise have been.

"State wide police radio systems will be the next step, and I believe that it will eventually be possible to communicate with every man in a police department directly by radio."

Chief William I. Cross, of Highland Park, Mich., was next. Highland Park is a city of 75,000 inhabitants, and is entirely surrounded by Detroit. It has an area of approximately three square miles.

Chief Cross, his men and the citizens take pride in the declaration that the Highland Park Police Department is "the first completely motorized and radio-equipped police department in the world." Other cities have motorized their departments and plan to equip their cars with radio. Chief Cross stands ready to back up his assertion that the Highland Park Police Department was the first to do both.

The Highland Park police have nine radio-equipped cars, three to every square mile. There are no men walking beats, with the exception of a few in the heart of the business district, and here too the radio-equipped cruisers do patrol duty. The system was placed in operation in August, 1929. Up to Jan. 1st, 1930, the crews of the cars had made 443 arrests as the result of orders received by radio.

"We estimate," Chief Cross observed, "that crime has decreased fifty per cent since we have been equipped with radio. There is no doubt of it. And this has been true in a period of industrial depression when we have had every right to expect an increase in crime.

"Radio is the most effective instrument at the disposal of the police to combat crime and the criminal. We are able to assemble all of our cars and men at a given point in approximately two minutes. Radio enables the police to have as even a start with the criminal as possible. People are more secure in their homes than ever before. We are giving them ten times better protection than was possible before we had radio.

"Through radio there is better cooperation between the citizens and the police. There is a better understanding. There is a pride in the police department. The men themselves are more alert. They never know when the operator's voice is going to send them hurrying to the scene of some crime. It may be within the same block. It may be a mile distant.

"The policeman can cheat no longer—even if he should want to do so. That day is past. He can not hide-out from radio. It is up to him to see that the set on his car is working. Frequent tests

enable him to be certain. If something is wrong the set is serviced immediately. The responsibility of seeing that he gets the broadcast orders is his. He has no alibi.

"We have had some swift arrests. One morning at about four o'clock, one of the scout cars had stopped in front of a restaurant. One of the men went in to eat while the other remained in the car to 'listen in' in case of calls. The policeman in the car noticed a suspiciously acting man. He stopped him for questioning. The man fled. The patrolman fired but the suspect escaped. The patrolman called headquarters and a report was placed on the air, coupled with a hasty description. Two other cars and their crews were dispatched to the neighborhood. A few seconds later the suspect was captured. He was armed, had a mask, an extra cap and an extra hat in his possession.

"Two patrolmen noticed a man slip into an alley. They called headquarters and radio sounded a warning. Another cars was sent to the opposite end of the alley where the man had been seen. He was captured, found to be armed, and later identified and convicted as a burglar. This happened in short order.

"A new clerk in a bank accidentally stepped on an alarm button. Two minutes later ten men and five police cars were at the scene. He was still standing on the button.

"Three men attempted to hold up a drugstore. One remained near the door as a lookout while the others held up the clerks. A customer came to the door, sensed what was happening and turned abruptly away. The lookout saw him. He yelled to his confederates, 'Beat it! Don't you know they've got radio in this town?' The trio fled. Within a few seconds three police cars were at the scene. The thugs escaped, but they went empty-handed.

"A window-peeper had annoyed a woman resident for six months. We tried time after time to trap him. The radio system had been in operation but a few days before he was up to his old tricks. The woman called the police. A police car and crew were two doors away and got the flash. The peeper was caught at the window almost before she had hung up the phone. He got ninety days.

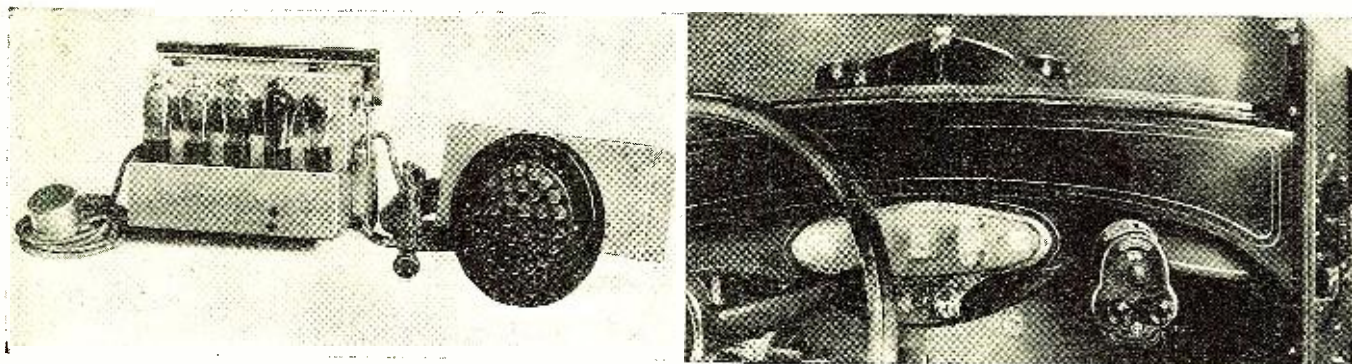
"There is no doubt but that the crook fears radio. He would be foolish if he didn't. We had a man under arrest recently with whom I talked about radio. He remarked to me, 'This stuff (radio) is just a little too fast for us.'

"One of the most effective results we have noted has been the apprehension of drunk drivers. A drunk driver is a menace not only to himself but to everyone else on the street. The crews of our radio-equipped cars have captured more than fifty drunk drivers, an average of over ten a month.

"The cost of constructing our station, equipping nine cars with receiving sets and loud speakers, and extra parts was \$1,800. The station has never lost an hour since it began operation. We have replacement parts (Continued on page 182)

Receiving a radio message from headquarters





To the left we have the entire group of apparatus—except batteries—which make up the American Bosch auto-radio system. To the right is shown the control panel, the only visible sign of radio inside the car

# Two Complete Auto Radio Receivers

*Latest Developments of the American Bosch and O-E Simplex Companies Show Trend of Sales Policies and Incorporate Many Important Features*

By Roy Davies\*

By Louis W. Stierlin\*

**T**HE American Bosch Magneto Corporation of Springfield, Mass., builders of precision automotive electrical devices for a long period of years, have introduced the Bosch motor car radio receiver. It is a precision-built instrument, carefully engineered for automobile installation, either at the time of manufacture of the vehicle or later.

The receiver utilizes the screen-grid type tubes, is thoroughly shielded from outside interferences and from the electrical system of the automobile. A cone type electro-magnetic speaker and the receiver chassis itself are contained in one small compact unit which is mounted out of sight on the dash behind the instrument panel. A solid shaft operates the receiver from an unobtrusive tuning control unit which can be mounted in any convenient position on the dash.

This control unit, no larger than a man's hand, contains a key switch to prevent unauthorized operation in the absence of the owner. One knob operates the single dial tuning control; the other controls volume. The station selector dial is electrically lighted independently of other lights on the car and tuning is made simplified by a line of light which is directed across the center of the dial when the receiver is in operation.

The receiver is operated from the storage battery of the car and from dry cell B batteries which are carried in a weather-proof steel container mounted underneath the car. No mutilation of the dash, top, or

*(Continued on page 187)*

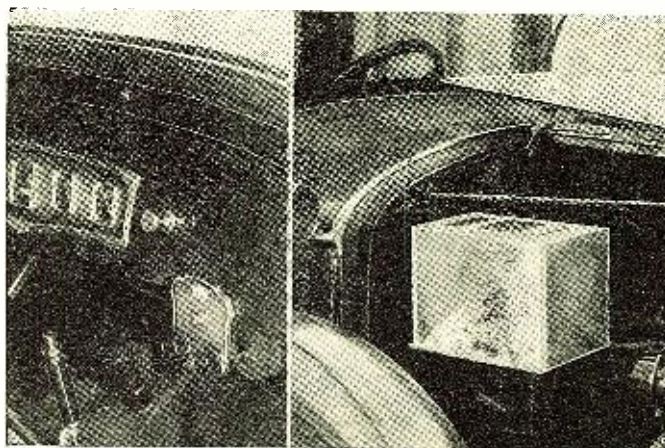
**W**HEN designing an automobile receiver, an engineer must know the conditions under which the receiver must operate and requirements; i.e., the size of the antenna, lack of good ground, ignition interference, quality of tone, volume, selectivity and sensitivity. He must design to meet all these requirements. He has several circuits from which to choose. In order to derive sensitivity he must choose as many tuned stages as are necessary to achieve sufficient sensitivity. In this connection he will consider the method of detection he intends to use and the type of tube he will employ as a detector. His next step is to design the audio amplifier that will follow his tuner.

Tone quality and volume will be factors in his calculations. Types of tubes to be employed in the amplifier must have his attention. Shall he derive tremendous gain from his design at the sacrifice of quality? Shall he derive good tone quality with a sacrifice of volume? Here the acoustics of the car have a bearing on the tone quality. One point of interest is that the low notes of the music are lost in the rumble of road and motor noises. Why, then, achieve quality when the listener is not deriving any benefit?

### Shielding

The total receiver must be completely shielded against electrical and dust interference. A receiver incorporating all these advantages is illustrated diagrammatically. Three tuned stages employ-

*(Continued on page 188)*



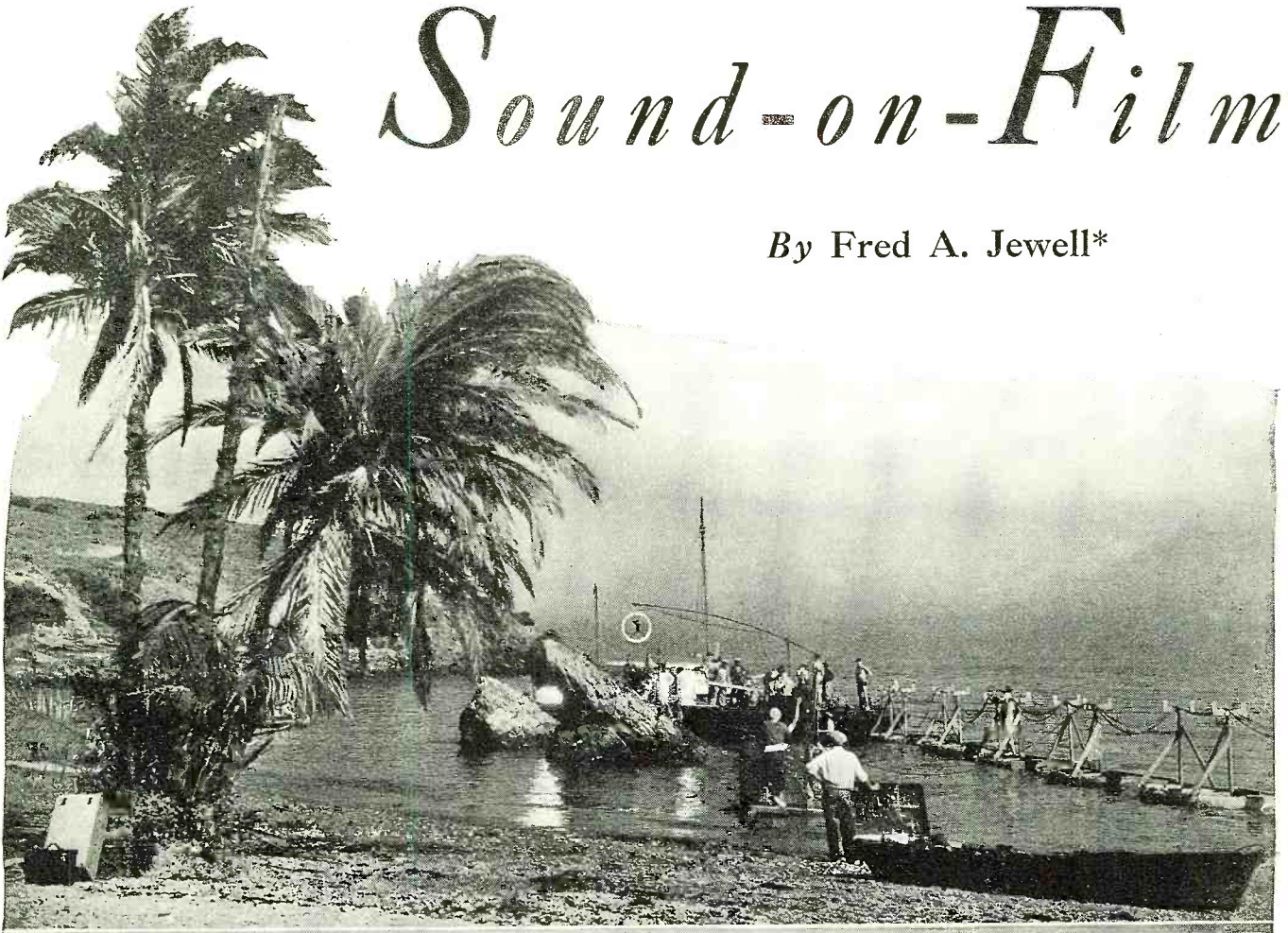
The O-E Simplex installation is made as shown here and it is a very workmanlike job which requires a minimum of alteration in the car

\*American Bosch Magneto Co.

\*O-E Simplex Automobile Radio Laboratories.

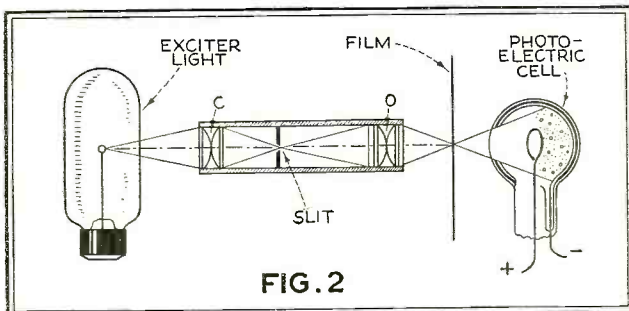
# Sound-on-Film

By Fred A. Jewell\*



Courtesy Paramount Pictures

Some idea of the care taken to take a sound scene is illustrated in the above photograph, a shot from "Flesh of Eve," a Paramount picture starring Nancy Carroll. The "mike" is circled. Note the floats for supporting the cables which lead from the "mikes" to the amplifiers

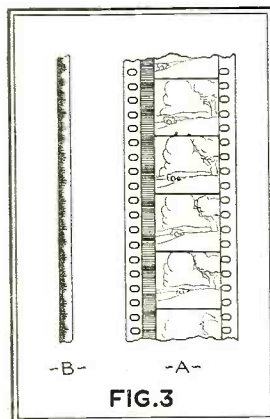


A general idea of the optical system of a reproducer is given in the above drawing showing the exciter lamp, the lenses and the photoelectric cell

**S**OUND-ON-FILM reproduction has several advantages over the sound-on-disc system and its future possibilities are much greater. One of the greatest assets of sound-on-film is the elimination of the problem of synchronization, as the sound is recorded on the film itself and consequently is in synchronism with the picture at all times. Also the nuisance of shipping separate records with the film print is eliminated.

As far as the sound itself is concerned, a much wider band of frequencies can be recorded on the film track than on the disc. Also the scratch of the needle is absent, giving a more quiet and natural reproduction with less foreign noises than can be obtained with disc recording.

\*General Manager, Projectionist Sound Institute.



Two types of sound-on-film: A shows the variable density constant width type, and B the variable width constant density type

In all fairness to sound-on-disc, it must be admitted that when records begin to wear they can be replaced with new ones without the discarding of the film too, which is the case when the sound track of the film gets scratched or dirty. When this occurs, the print becomes very noisy and the entire print has to be discarded at an earlier date than otherwise. Also the photoelectric cell hiss must be considered, but this can be filtered out without any noticeable sacrifice of the quality of reproduction. Most of the photoelectric cell hiss lies in a very high frequency range above 5,000 cycles and there is no recording on film that reaches a higher frequency than this.

There is considerable room for improvement in sound-on-film reproduction, but even in its present stage of development it is equal or superior to the reproduction obtained from disc. As this system is bettered, the writer is firmly convinced that it will surpass sound-on-disc to the extent that it will eventually replace the older method. One of the main reasons for this is that disc recording is confined to studio "shots" due to the fact that disc recording equipment is very complicated and bulky and cannot be hauled around on trucks, as can film recording apparatus. When disc recording is absolutely essential, the sound is first recorded on film and then recorded from the film on disc, this process being called "duping." Naturally, the reproduction of the "duped" recording cannot hope to compete, even in its highest stage of development, with the original recording. The only difference in the equipment for the

# Reproduction

*In This, the Third of a Series of Articles on Sound Recording and Theater Acoustics, the Subject of Recording and Reproducing Sound-on-Film Is Compared with the Sound-on-Disc Method. Some of the Practical Problems Which Arise in This Work Are Discussed from the Student's Angle. Future Articles of This Series Will Discuss the Problems of Theater Treatment for Acoustical Perfection and Kindred Subjects*

reproducing of the two systems is the pick-up device and an extra amplifier, from the fader on to the loud speakers being the same. As this latter portion of the equipment was described in the previous issue of RADIO NEWS, we will consider in this article only the apparatus up to the fader.

Referring to Fig. 1, it will be seen that the sound-on-film attachment is connected to the projector just below the projector head and the film from the projector passes through the sound attachment and then into the lower magazine. In Fig. 2 is shown the arrangement of the optical system, the exciter light and the photoelectric cell for transforming the light energy into electrical energy.

The exciter light is for the purpose of creating light energy, which is collected and concentrated to a very narrow beam by a set of condenser lenses. These lenses focus the light to a small point at the aperture plate, in which there is a slit approximately 0.0015 inch in width. An image of this slit is focused on the film by a high-quality object lens, and the light passing through the sound track on the film falls on the photoelectric cell in varying densities, conforming to the sound waves recorded on the film as it passes this point. This varying amount of light falling on the cell will cause a varying current to flow in the photoelectric cell circuit, which current will conform with the sound recorded on the film.

This minute current is passed on to the "peck" or "head" amplifier (see Fig. 4). This amplifier magnifies the current up to about the same level as the output of an electromagnetic pick-up with sound-on-disc and from this amplifier the current is passed on to the fader for modulation.

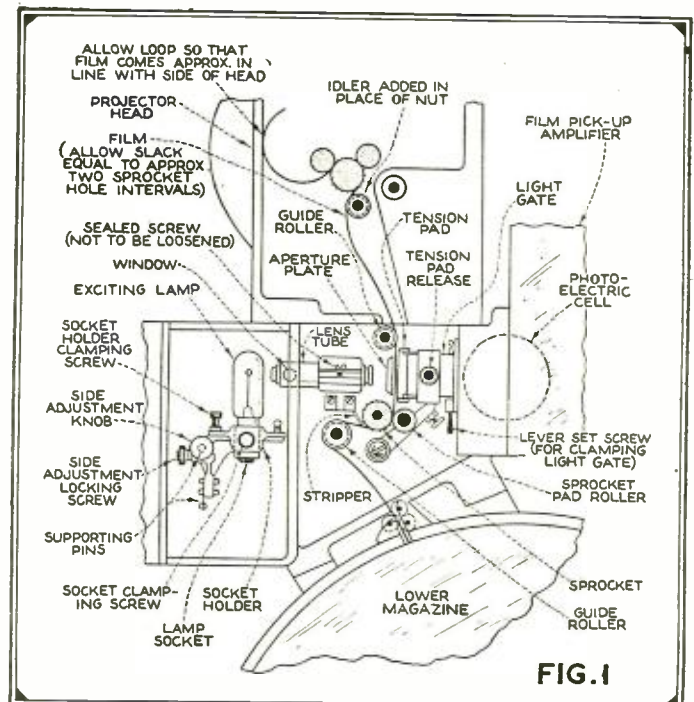
In Fig. 3 are shown the two types of sound-on-film recording. That of A shows the variable density, constant width type. This means that the condensations and rarefactions of the sound waves are recorded as light and dark variations in the sound track and that the entire width of the track is used. It will be noticed that there are light and dark areas. Now when this sound track passes between the concentrated beam from the exciter light and the photoelectric cell, some of the light energy is passed on to the cell, a certain amount being absorbed by the dark portions of the film. This variation in light energy varies the resistance of the photoelectric cell, which in turn varies the amount of current flowing in its circuit. As these light and dark spaces pass rapidly between the light and the cell, there is a corresponding rapid change of current.

Fig. 3B shows the other type of sound track, which is shown as constant density, variable width. Here the degree of shading is the same, the difference being in the amount of the sound track that is darkened. However, this dark portion varies the amount of light energy going to the photoelectric cell in the same manner as the film of Fig. 3A does.

**The Exciter Light.** As this portion of the circuit is of the greatest interest, let us consider its various parts. First, the exciter light. This is a small incandescent lamp, having a relatively high current and low voltage capacity and consuming between 32 and 75 watts. The current for lighting the filament must be pure direct current, because any variation in the



Courtesy Paramount Pictures



Above:  
The sound-on-film mechanism in the recorder is placed just below the projector head. The drawing, above, is self-explanatory

At the top:  
Mary Brian, a Paramount star featured in "The Children," listening to a recording at the mixer panel

current will cause a corresponding change in the photoelectric cell current. For instance, if 60-cycle a.c. were used, a 120-cycle roar would come from the loud speakers, due to the fact that the filament of the exciter light would cool and heat at the rate of 120 times per second, which, while unnoticeable by the human eye, is easily detected by the electric eye of the

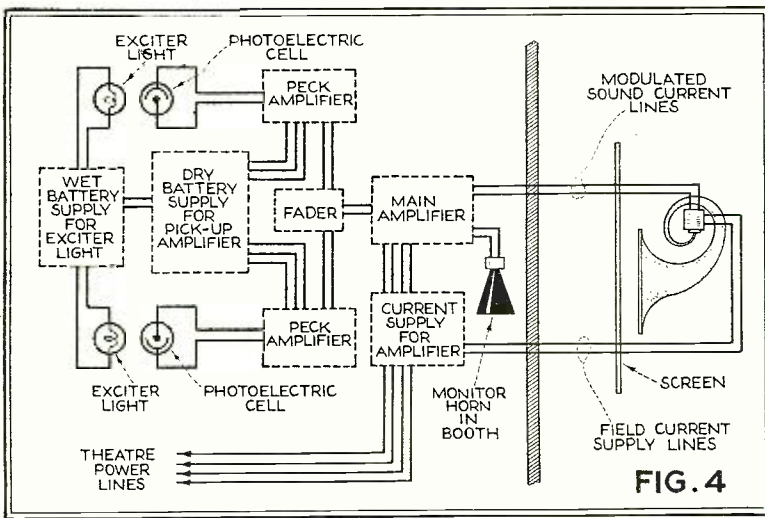
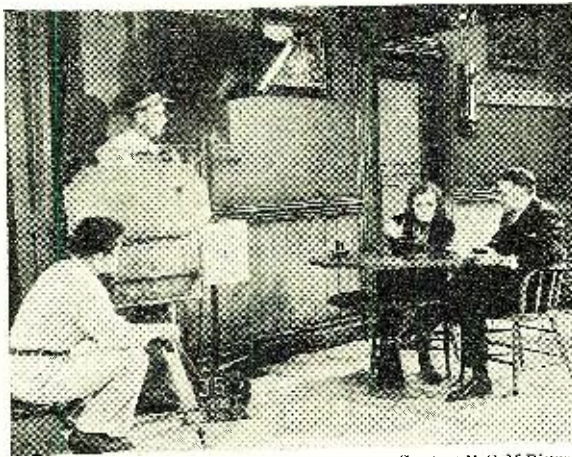


FIG. 4

A diagrammatic representation of the various units in a sound-on-film amplifier, taking in all the units from the exciter lamp to reproducing loud speakers

Greta Garbo, the M-G-M star, goes over her lines with the director preparatory to a "take" in the picture "Anna Christie." The overhead microphone is out of the field of the camera's vision



Courtesy M-G-M Pictures

photoelectric cell. Even the armature ripples of a d.c. generator are reproduced by the cell, if such a current is used for supplying the current for the exciter light.

**The Optical System.** The optical system comprises two sets of lenses and an aperture plate, the whole being simple in detail but must be accurate in adjustment. The first set of lenses, C in Fig. 2, are for condensing the light energy emitted from the filament of the exciter light and concentrating it to a point at the aperture plate, which carries the slit. It is necessary to collect as much light as possible and focus it to as narrow a beam as possible by means of the slit, which is quite a bit less in width than the paper of this magazine is thick.

The image of the slit is collected by the second set of lenses, O in Fig. 2, called the objective, and focused to a narrow beam on the sound track of the film. This very narrow beam of a relatively great intensity is then varied in its intensity by passing through the dark and light spaces of the film's sound track.

**The Photoelectric Cell.** From the sound track the light impinges on the sensitive surface of the photoelectric cell, this surface being the cathode and the centrally located electrode being the anode. The metals of the alkali group possess the ability to emit electrons under the influence of visible light, these metals being lithium, rubidium, sodium, potassium and caesium. Therefore, the inside of the cell is coated with a hydride of one of these metals, leaving a small clear space in the glass of the tube for the varying light energy from the exciter light and film to enter and excite the cell's surface. When the anode and cathode of the cell are connected to the positive and negative terminals of a battery respectively and when the light from the exciter light falls on the sensitive surface, this surface emits electrons which flow in varying amounts to the central anode, this being positively charged and so attracts the electrons. This flow of electrons from the cathode to the anode and through the exterior circuit comprises the photoelectric current.

If the surface of the photoelectric cell is exposed to a strong light a great number of electrons are emitted, creating a relatively large current flow in this circuit. If the light is cut off from the cell the current drops to zero immediately, there being no lag to speak of. Now it is easy to perceive that if the light from the exciter light is concentrated by means of the optical system through the window of the photoelectric cell, and if there were nothing in the path of this light, considerable

current would flow in this circuit. However, if an opaque material is placed in the path of this light the current will immediately stop flowing. As the film intercepts this light at its focal point, it will govern a varying amount of light to the photoelectric cell, as it passes through this light beam.

As the sound track is of varying intensity, having light and dark spaces on the surface, more or less light will pass to this cell, depending upon the sound waves that are photographed on the film, which causes a variable current to flow in the photoelectric cell circuit that will conform precisely with the waves that are photographed on the film.

**The Peck Amplifier.** The energy output of a photoelectric cell is extremely weak, being measured in microwatts (millionths of a watt). This feeble current naturally has to be amplified so that it is at the same level as an electrical pick-up for discs, the output of which being measured in milliwatts before it can be passed on to the fader for modulation.

The function of this amplifier is to magnify this feeble current from 100 to 200 times so that it will bring it up to the level of the pick-up. The amplifier consists of two or three stages of cascade amplification, using various types of coupling. In Fig. 5 is shown a resistance-coupled amplifier, this being a good type because there is no frequency cut-off as there would be if transformer coupling were employed. The current for operating this amplifier must be pure d.c. and must be supplied from storage batteries or dry-cell batteries. Due to the minuteness of the current from the photoelectric cell, any variation in the power supply, no matter how little it

may be, will express itself many hundreds of thousands of times in sounds from the loud speakers.

The greatest care must be exercised in the design and construction of this amplifier to overcome such things as microphone noises, audio feed-back or oscillations, or the picking up of strays. The noises that would ordinarily be inaudible in the average type of amplifier would be picked up by the Peck amplifier and be expressed in very objectionable noises from the loud speakers. In the general wiring diagram of Fig. 4 will be seen the various sources of power needed.

**Film Speed.** It is quite essential that the speed at which the film is run through the projector be constant, otherwise the pitch of the sound will change, in the same manner as when the speed of a phonograph turntable varies. As a rule, a large flywheel is directly coupled to the sound sprocket for the purpose of insuring a steady rotation of this sprocket, carrying the film by the beam of light from the exciter light steadily. The speed at which the film is run is the same as that of sound-on-disc apparatus, *i.e.*, 90 feet per minute.

The reason that this particular speed was chosen is as follows: If the speed of the film is 90 feet per minute, this means that 18 inches of film will pass through the light beam every second. Therefore, one inch of film will pass through the beam in 1/18 second. (Continued on page 176)

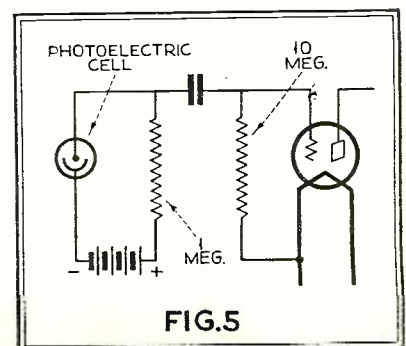


FIG. 5

The diagram of a resistance-coupled photo-electric cell amplifier, otherwise known as a "peck"



# Testing and Installing the Universal Auto-Radio Receiver

*Much Time and Labor Can Be Saved if a Methodical, Intelligent Bench Test Is Given the Home-Built Auto Receiver Before It Is Finally Installed. Some Methods of Dashboard Tuning Control Are Described Here*

By Walter H. Bullock

WITH the motor-car radio set completed, in accordance with the instructions given in the May number of RADIO NEWS, the instrument should be carefully tested and adjusted before attempting to install it. If anything is wrong, it will be much easier to rectify the trouble on a bench than in the cramped quarters of a car.

In addition to the instrument itself, we will require three 45-volt "B" battery units, a 6-volt supply, four -24 tubes, one -12A tube, a loud speaker, a tuning dial, and a 100,000-ohm Royalty resistance for a volume control—with battery switch unless the user prefers a separate switch that can be operated only by a key.

The "B" batteries may be of the medium-sized standard units, as the set will not ordinarily be used enough to justify the purchase of the heavier, larger and more costly heavy-duty type. For a bench test, the "A" supply should be as nearly as possible the equivalent of that to which the set will ultimately be connected in the car.

Whenever possible, it is a good idea to buy tubes from a dealer with whom you are acquainted, as the more complicated -24's often reveal variations in characteristics that only a friendly dealer may recognize.

Incidentally, it has been found that the -24 tubes do not have to give standard readings in order to function efficiently. For instance, the auto set that we have described has given its best performance with tubes that were factory rejects, because of low amplification constants. Instead of the standard 420 amplification factor, the tubes ranged from 180 to 260. But their plate resistances were so low that the mutual conductance readings ranged from 1,200 to 1,450 micromhos in place of the 1,050 standard. So don't refuse to accept tubes with such readings—just get permission from the dealer to return them if actually they prove unsatisfactory.

The loud speaker used for the bench test of the auto set may be of the ordinary variety, but, for the car installation, a smaller one of a higher pitch will give more satisfactory performance. Where the set builder is in a position to construct a suitable horn, a speaker made of a Baldwin or other telephone unit will not only give good reproduction, but can be built into some comparatively unused space of the car. Fig. 3 illustrates a late type of commercial speaker designed especially for motor car use by Amplion. It is a metal-encased cone of unusual compactness. The drawing Fig. 5 shows how the total depth is kept within 3½ inches.

The tuning control to be used will be determined by the individual installation. That will be taken up in a later paragraph, but, for the purpose of our initial test, we can employ almost any dial, having a ¼-inch hole, for attaching to the condenser shaft.

As a volume control we selected a Royalty 100,000-ohm variable resistance, used in series with the amplifier screen grids and the 112½-volt tap of the "B" battery. In a.c.-operated sets

it is customary to use this resistance as a potentiometer shunted across a portion of the plate supply. That is undoubtedly preferable where the "A" and "B" circuits are opened by a single switch, but in a set operated from batteries it would be necessary to break the heater and plate circuits with separate switches to keep from running down the batteries when the set was not in use. On the other hand, the series arrangement provides the necessary control of volume without the necessity of employing a switch in the "B" battery circuit.

A point to be decided by the owner is whether he wants a lock switch or a simple means of turning the set off or on. Royalty resistance can be obtained with a battery switch mechanically connected to the adjusting knob, so that when the control is tuned for minimum volume the set is automatically shut off. This is an ideal arrangement where the "A" supply is taken from the car's battery circuit at a point where the key to the electrical system will control the radio set as well as the ignition of the motor. Otherwise, it might be preferable to employ a separate key-operated switch to prevent the operation of the set by unlicensed hands.

When it has been established that all of the battery connections and circuits are as they should be, the tubes can be inserted in their sockets, and the caps applied to the -24's. The case itself should be grounded, and the loud speaker cord tips inserted in the twin jacks. The aerial may consist of perhaps ten feet of wire run outward from the set.

Rotate the condenser shaft slowly, and listen for a station on which adjustments can be made. The tuning adjustment will be found to be quite sharp, so some care should be exercised in obtaining the exact point of resonance. When this has been done, adjust the volume control for signal strength. Then shift the connection from the volume control to another tap on the battery, and readjust it until the best position is found.

The lead from the detector screen grid should also be changed about, as not all tubes work best with the same screen potential. Usually 45 volts is found to be the proper potential. With the best battery taps determined, place the cover over

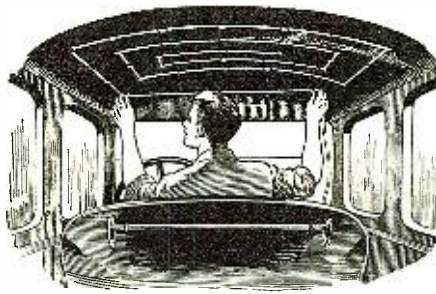


Fig. 1. Showing how wire or metalized tape may be tacked to the roof of a car to furnish satisfactory antenna for the auto-radio receiver

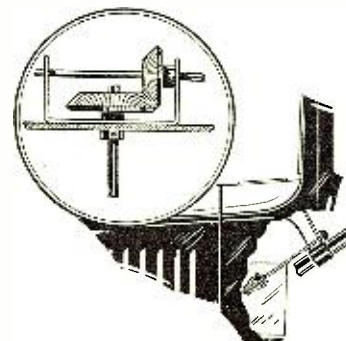


Fig. 2. Pair of beveled gears, as shown to the right, provide a satisfactory means for turning the shaft of the condensers from the dashboard

the face of the set, except for a narrow space at the top to give access to the slotted hex screws of the trimming condensers. With a screwdriver adjust these for maximum signal strength, move the tuning knob slightly for a possibly better setting and recheck the trimming units. See Fig. 4. If the set has a tendency to oscillate with the tuned circuits thus placed in resonance, press the "B" piece of the inductance shields nearer the coils. In case the usual slight rushing or "live" sound is not noted at resonance, move the pieces farther from the coils. Tune in stations at each end of the wavelength range, and see that oscillation is absent over the entire band. When the proper positions of the "B" pieces have definitely been determined, a drop of solder will hold them in place. Try shifting the positions of the tubes to find their best locations, for if there is any variations in them certain arrangements will work better than others.

Up to this point we have assumed that the set performs satisfactorily. When this is not the case, check the potential of the heaters by means of a voltmeter connected across their terminals. If the indications are very far from the desired readings, correct them by shifting the terminals on the filament resistances or by replacing a tube that may have an improper heater resistance. Next check the potentials applied to the screen grids. This is done by bringing the voltmeter between the screen grid and cathode of each tube. Control grid voltages are determined by the drop between the cathodes and their respective grid terminals. In the case of the first and last tubes, the grid resistances will have to be shortened while these measurements are taken. If it is found that any of these readings are not what they should be, a comparison between the circuit diagram and the wiring of the set should be made to discover and eliminate the cause.

Should this method fail, prove one stage at a time. Connect the aerial to the plate terminal of the third radio-frequency tube. This will give a system of but one tuned circuit, detector and audio amplifier. Head telephones should be used in place of the speaker, and the dial rotated for a station. It might be necessary to employ a larger aerial, with such a hook-up, affording no radio-frequency amplification. Work over this limited section of the instrument until it is made to operate, then add a stage of radio-frequency by moving the antenna to the plate terminal of the preceding tube socket. If the change does not give the expected increase in signal strength, the stage just added requires attention. The present arrangement permits the removal of the first two tubes, which can be substituted—one at a time—for each of the other

-24's as a method of checking their efficiency. Wait a full minute after each change in tubes, so that their cathodes may acquire a proper temperature before a comparison of results is attempted. By following this stage-by-stage procedure, almost any sort of trouble can be

Fig. 3. The photograph of an all-metal loud speaker of small dimensions especially suitable for automobile use

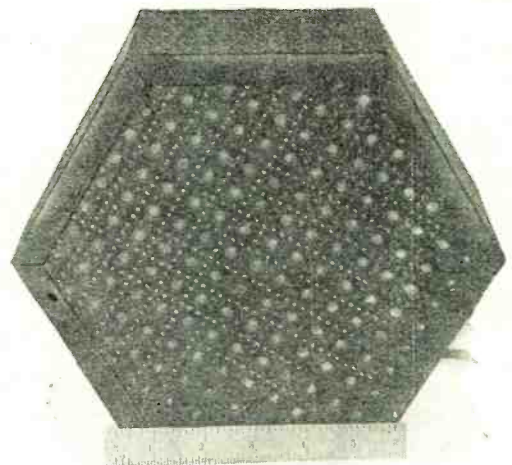


Fig. 4. When aligning the several tuned stages of the Universal auto-radio receiver the side shield should be slipped down only enough to permit the screwdriver-shaped piece of bakelite rod to engage with the control screws of the equalizer condensers as shown below

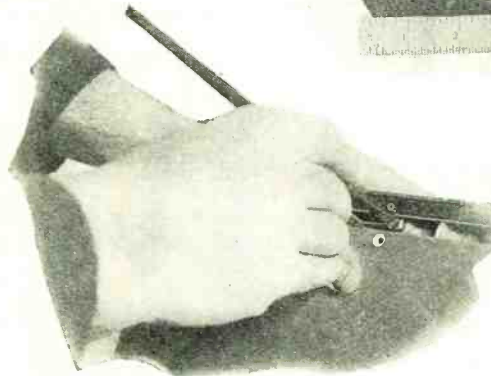
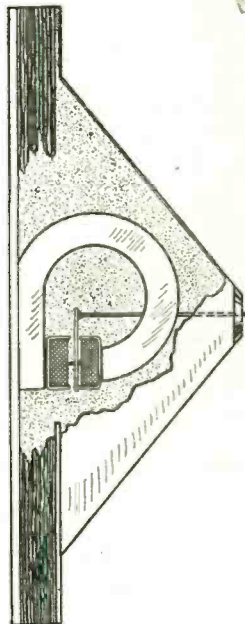


Fig. 5. In auto-radio installations compact assembly is essential. The sketch to the left shows how this is obtained in speaker construction for this work



located and subsequently corrected.

Reference to the actual installation of the automobile receiver cannot be as definite as some other topics we have covered, for the make and model of car to be equipped are the chief factors in determining the location of the receiver, the controls and method of support.

The wide variety of machines that must be considered limits us to rather general comments which it is hoped may be of some assistance in the majority of cases.

In studying the car for a suitable location of the receiver, the principal consideration to keep in mind is convenience of control. It is simpler, less expensive and generally more satisfactory to employ a rigidly connected tuning control than a flexible connection between the knob and the variable condenser shaft. Of course, the flexible arrangement gives greater latitude in the receiver location and oftentimes is a necessary system. One difficulty with the flexible shaft is the twist that takes place in it, especially where it has much mechanical resistance to overcome in operating the condenser. It is not unusual to find that the dial has to be turned two or three degrees before the condenser will respond, and after the movement of the dial has ceased at a desired point the condenser may continue to move through the several degrees of twist that were initially stored up in the shaft.

Where something other than a straight shaft must be used, it is better to employ straight sections of as great lengths as possible, with their ends coupled by a type of universal joint that allows little, if any, play. The shaft arrangement used on some motorcycles to connect the control grips with the spark and throttle adjustments is as good a system as any.

But by confining our set to the dimensions we adopted, it should be possible, in most cases, to place it where direct control can be used. Wherever the receiver will fit behind the instrument board, a short and direct connection of the tuning dial is certainly possible. The axis of the knob may have to be at right angles to the condenser shaft, yet this can be provided for through the use of the device shown in Fig. 6. These receiver controls can be purchased with drum dials, so arranged that visual indication of the condenser adjustment is shown on the car's instrument board. The volume control and switch will be located close by.

Whenever the set has to be located so far from the tuning knob that a drum dial on the set cannot be conveniently read, try to turn the set so that a straight extension of the condenser shaft can run to a disc-type tuning dial. If a right-angle hook-up must be employed in this case, the device shown in Fig. 3 will not be satisfactory, for without the aid of a visible drum dial it is impossible to tell where the set is tuned from the appearance of the knob, which may (Continued on page 189)

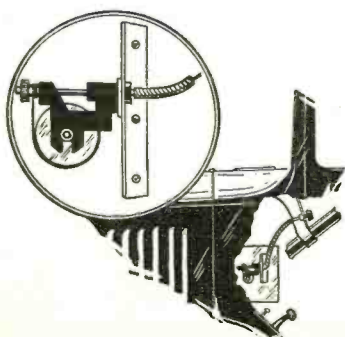


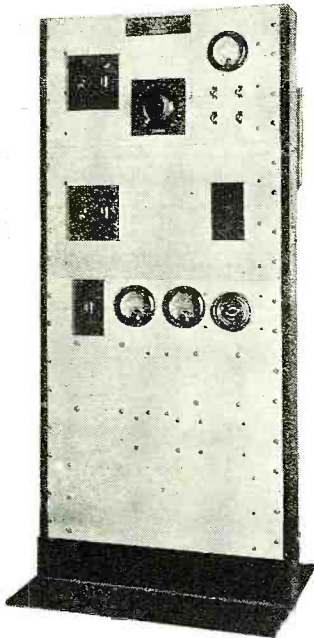
Fig. 6. Another type of flexible drive and shaft control, utilizing a standard drum dial mechanism

# Public Address Amplifier Specifications

MANUFACTURER	TYPE NUMBER	TUBES REQUIRED	NUMBER OF STAGES	GAIN AT 1000 CYCLES (IN DB.)	FREQUENCY CHARACTERISTIC VARIATION BETWEEN 50 AND 5000 CYCLES (IN DB.)	MAX. UNDISTORTED OUTPUT (IN WATTS)	INPUT SIGNAL VOLTAGE FOR MAX. OUTPUT	POWER CONSUMPTION (IN WATTS)	MAXIMUM TEMPERATURE RISE, CONTINUOUS OPERATION	HUM LEVEL BELOW MAX. OUTPUT RATING IN DB.	INPUT IMPEDANCE	OUTPUT IMPEDANCE	POWER SUPPLY	OVERALL SIZE
AMERICAN TRANSFORMER	PA 51	2-227 1-245 1-280	3	68	1.5*	44	.005	90	-	58	500	500	50-60~ 102-125 V.	19"X21"X9"
"	25 A	1-227 2-226 1-250 1-281	3	75.4	1.25*	12	.013	160	-	52	"	"	"	RACK 72"X21"X10"
"	29 A	1-227 2-226 4-250 4-281 1-280	3	75.4	1.25*	24	.026	320	-	58	"	"	"	"
"	38 A	1-227 2-226 2-245 1-280 2-866	3	72	1.25*	56	.03	350	-	58	"	"	"	"
"	39 A	1-227 2-226 2-211 2-866 1-280	3	82	1.25*	28	.009	310	-	60	"	"	"	"
AMPLEX	45	1-224 1-245 1-280	2	49	1.0	1.6	.26	40	5°C.	46	200 TO 50,000	4000	50-60~ 100-130 V.	10"X8 $\frac{1}{4}$ "X8"
"	50	1-224 1-250 1-281	2	55	1.5	6	.26	60	15°C.	52	"	"	"	15"X8 $\frac{1}{4}$ "X8"
"	50 B	1-224 2-250 2-281	2	62	2	15	.26	100	20°C.	59	"	"	"	20"X8 $\frac{1}{4}$ "X8"
"	350 A	1-224 1-245 2-250 2-281	3	70	2	15	.14	160	20°C.	63	"	"	"	24"X10"X8"
"	M 27	1-227 1-280	1	36	1	-	-	30	-	33	DB. MIKE	"	"	11"X11"X8"
AMPLION	PA-50	1-424 2-545 2-566	2	60	.5	45	1.5	500	-	20	3000	4000 16	60~ 110 V.	30"X10"X6"
ELECTRAD	A-245	1-224 1-250 1-280	2	50	3	1.6	.2	30	20°C.	52	-	4000	60~ 105-120 V.	8 $\frac{1}{2}$ "X8"X7"
GENERAL AMPLIFIER	GA-15A	1-227 2-245 1-280	2	54	4	4	.4	55	-	48	4000	4000	50-60~ 105-120 V.	18 $\frac{1}{4}$ "X10 $\frac{3}{4}$ "X5 $\frac{3}{4}$ "
"	GA-25	2-227 2-245 1-280	3	59	4	4.5	.2	120	-	48	"	"	"	18 $\frac{1}{4}$ "X16 $\frac{3}{4}$ "X5 $\frac{3}{4}$ "
"	GA-35	2-250 2-281	1	71	6	10	.2	135	-	59	"	"	"	18 $\frac{1}{4}$ "X10 $\frac{3}{4}$ "X6"
"	GA-30	2-227 2-250 2-281	3	67	5	12	.25	160	-	46	"	"	"	18 $\frac{1}{4}$ "X12 $\frac{1}{4}$ "X6"
"	GA-20	1-227 2-226 2-250 2-281	3	71	3	15	.2	160	-	50	"	"	"	"
OPERADIO	252	1-226 1-171A 2-250 2-281	3	66.5	2.6	10	.4	210 VA.	60°F.	60	"	"	60~ 110 V.	UPRIGHT DESK TYPE 20"X12"X39"
PILOT	W 145	3-227 2-250 2-281	4	-	-	15	.106	154	35°C.	-	80,000	2000 500 500	50-60~ 110-135 & 200-240 V.	22"X22"X9"
RADIO RECEPTOR	P-50W	2-845 2-866	1	87	25~-1 $\frac{1}{2}$ 8000~ +1 $\frac{1}{2}$	50	45.0	325	-	60	4000	10, 20, 50 100, 200 500	60~ 110 V.	21"X19"X10 $\frac{3}{4}$ "
SAMSON	PAM-59	1-224 1-250 1-281	2	53.5	9.4	4.65	.94	75	18°C.	41	0 TO 100,000	500 2000	50-60~ 110 V.	12 $\frac{3}{8}$ "X12 $\frac{1}{8}$ "X7 $\frac{1}{2}$ "
"	PAM-39	2-224 2-250 2-281	2	61	2	9.3	.385	135	20°C.	52	0 TO 5000	500 2000	50-60~ 100-130 V.	18 $\frac{3}{8}$ "X11"X7 $\frac{1}{2}$ "
"	PAM-29	2-224 4-250 4-281	2	65.6	.2	24.5	.39	270	22°C.	45.7	0 TO 5000	500 2000	50-60~ 100-130 V.	20 $\frac{3}{4}$ "X16"X7 $\frac{1}{2}$ "
SILVER-MARSHALL	679	1-227 1-250 2-281	2	44	2	6	.6	95	22°C.	41	200 8000- 16000	3600	50-60~ 105-125 V.	21"X5 $\frac{3}{4}$ "X5 $\frac{1}{4}$ "
"	692	1-224 1-245 2-250 2-281	3	72	2	15	.056	145	25°C.	46	200 100,000	5-125 INDUCTIVE. 340-7200 CONDUCTIVE	"	9"X17 $\frac{1}{8}$ "X10"
"	69034	1-227 2-226 2-250 2-281	3	64	3.5	15	.15	152	28°C.	45	200 MIKE 1800-4000 8000-16000	"	"	21"X14"X8"
WEBSTER CO.	RA-245	2-226 2-245 1-280	3	58	-	4	.2	80	20°C.	47	7000	8000	50-60~ 105-130 V.	17 $\frac{3}{8}$ "X10"X7"
"	D-250	3-227 2-250 2-281	3	64	-	13.8	.2	150	25°C.	48	"	"	"	14"X19 $\frac{1}{2}$ "X7"
WEBSTER ELEC.	PA-11	1-227 2-245 1-280 4-250 2-866	3	64	4	25	1.0 .1	275	20°C.	56	500 200	4000 500, 2, 4 8, 16	50-60~ 95-130 V.	64"X24"X12"
WESTERN ELEC.	32-A	3-231 D 2-205 E	4	-	-	-	-	-	-	-	20,000 2000	2000 500	-	20"X12 $\frac{1}{2}$ "X14"
"	43-A	4-211 E	1	-	-	-	-	300	-	-	500	500	-	19"X24 $\frac{1}{2}$ "
WHOLESALE RADIO	245	1-224 1-245 1-280	2	50	3	1.5	.2	40	10°C.	52	-	4000	60~ 110 V.	8"X9"X9"

\* BETWEEN 40 AND 10,000 CYCLES

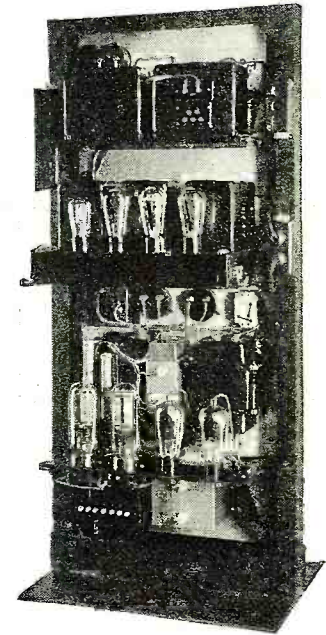
# A Serviceman's Speech Amplifier *and*



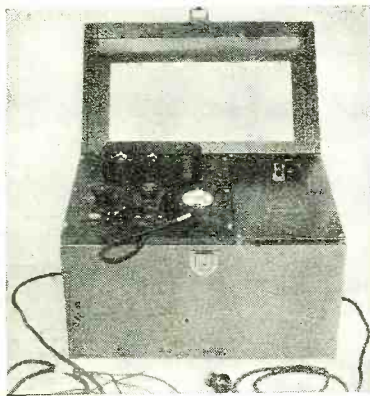
Radio Receptor Co.



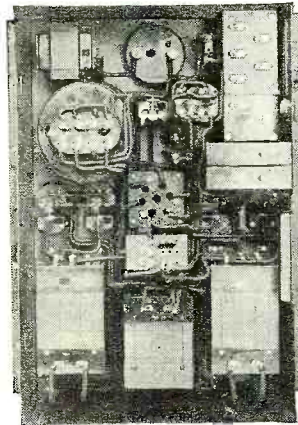
Western Electric Co.



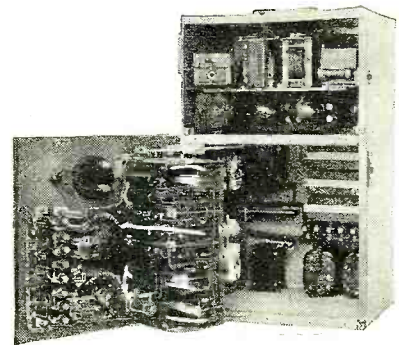
Radio Receptor Co.



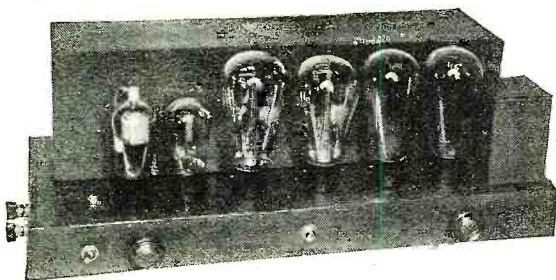
Western Electric Co.



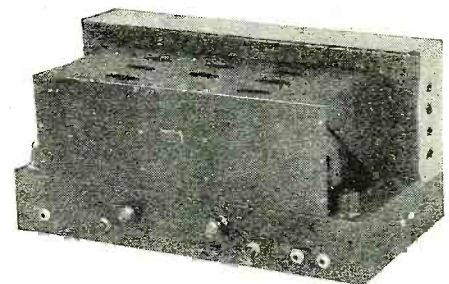
Western Electric Co.



Western Electric Co.

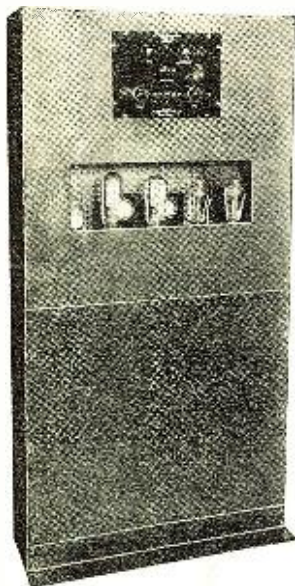


Amplex Instrument Laboratories



Silver-Marshall, Inc.

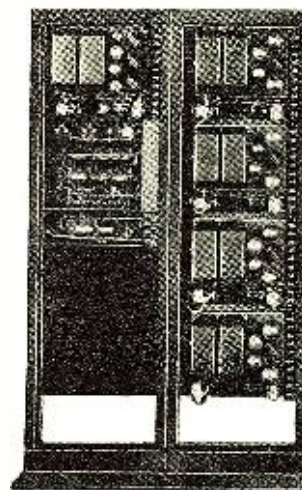
# Selection of Public Address Systems



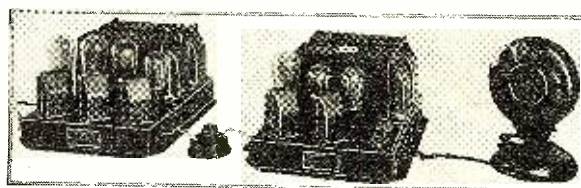
Amplion Corp. of America



Amplion Corp. of America



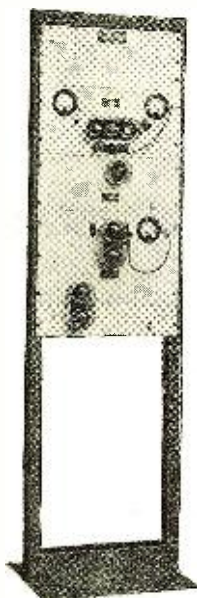
Samson Electric Co.



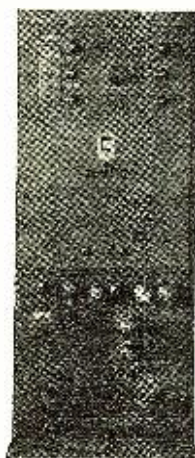
Samson Electric Co.



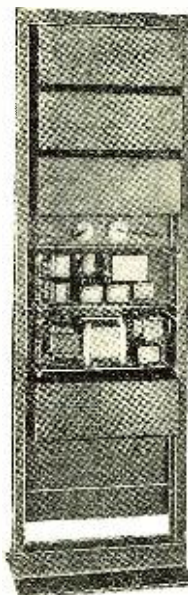
Operadio Mfg. Co.



American Transformer Co.



Silver-Marshall, Inc.



Silver-Marshall, Inc.



Webster Electric Co.

The equipment illustrated on these pages, and the data on the preceding page, does not by any means represent the complete line which manufacturers are offering to the servicemen for sound installation jobs. The amplifiers which have not been included do not appear for the simple reason that either information was not forthcoming from the manufacturer or was received too late for publication

# Satisfying the Demands for SENSITIVITY in the Design of

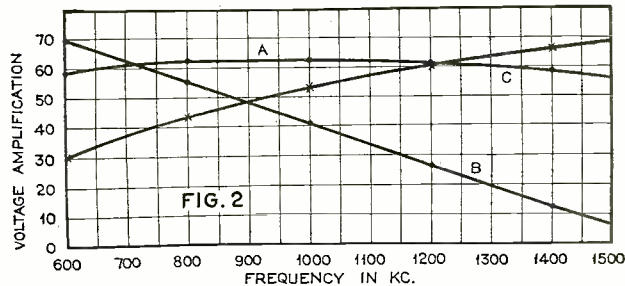
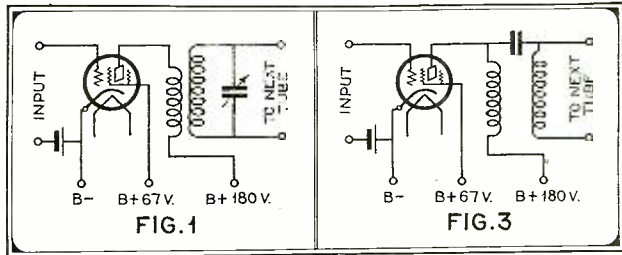


Fig. 1 (top, left). The fundamental circuit of a tuned stage of radio-frequency amplification. By means of the tuning condenser the circuit is tuned to resonance with an incoming signal. Fig. 3 (top, right). The circuit for an untuned stage of r.f. amplification

Fig. 2, above, shows three curves, A, B and C. Curve A shows the performance in amplification of a tuned stage, while curve B shows the same thing for an untuned stage. In one case the high frequencies are amplified greatly, while in the other it's just the opposite. Curve C shows how equal amplification is obtained when both tuned and untuned stages are employed

**W**HAT are the problems that confront those designing a modern radio set, what are the standards that the radio engineer sets for himself, and how does he build up to them?

These, and many more questions, have often been asked by the radio fan whose interest in the art is more than casual. Thus, in this article, it is proposed to describe some of the tools with which the engineer works, his analysis of the problems involved in the construction of a radio-frequency tuner and detector system, and the final outcome of his efforts.

The three determining factors of any radio set, which depend entirely or in part on the radio-frequency and detector system, are so well known that they have become the criterion upon which radio sets are sold. Yet selectivity, sensitivity and quality are so interwoven that, where the question of design is concerned, the mutual effect of each on the other must be considered. Almost everyone knows that the selectivity of a receiver depends upon the number of tuned circuits employed and the sharpness in the individual circuits. Likewise, the sensitivity or distance-getting ability is determined by the num-

\*Consulting Engineer. †Chief Engineer, National Co.

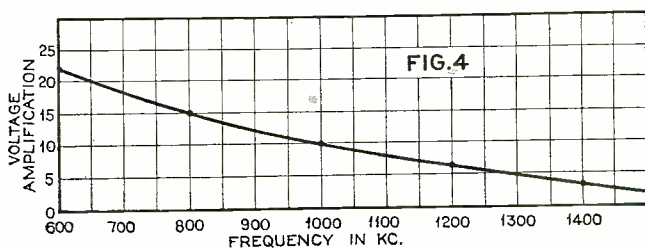
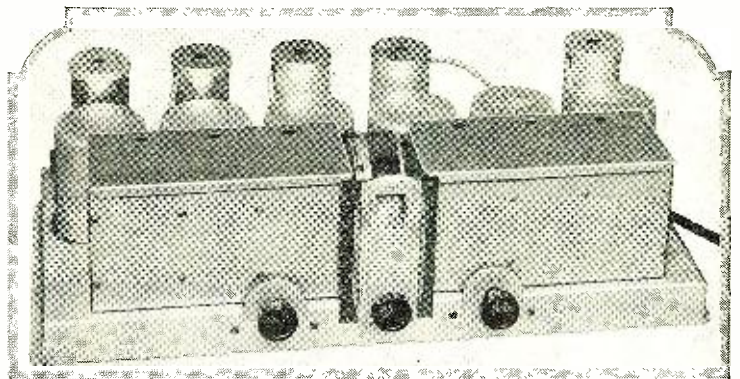


Fig. 4. The "gain" curve for a stage of radio-frequency amplification employing an untuned transformer coupler

*No Longer Do We Rely on Hit-and-Miss, Cut-and-Try Methods in the Evolution of New Receiver Circuits. Today Engineers in the Country's Foremost Laboratories Tackle These Problems on a Scientific Basis, Employing the Most Up-to-Date Measuring Equipment and Following a Methodical and Sometimes Tedious Routine. The Receiver Described Here Is an Example of This Painstaking Care and Engineering Thought*



This is a photograph of the receiver which incorporates the design features outlined in the text. It was found necessary, in order to obtain maximum efficiency, to completely shield not only the coils, but also the tubes and tuning condensers

ber, type, and design of the radio-frequency stages. Sensitivity and selectivity are dependent entirely on the radio-frequency circuit in the receiver, while the quality is not only dependent on the radio-frequency and detector systems but also on the audio amplifier, loud speaker, and even the "B" supply.

In order to obtain sufficient sensitivity with even the screen-grid tube it is necessary to use from two to four stages of radio-frequency amplification, unless some type of regeneration is employed. By sufficient sensitivity is meant that on a good night the radio set will pick up signals which are louder than static and other interference (which is always present in the ether). There are two or three general methods of amplifying signals at radio frequencies other than the superheterodyne principle. A tuned radio-frequency amplifier may be employed, as is generally the case, or, in some special cases, coupling between tubes if made by means of an untuned transformer, impedance, or even a resistance system. The tuned radio-frequency transformers not only act as coupling devices which, combined with a tube, give greater gain than the other systems, but every tuned stage adds selectivity to the receiver.

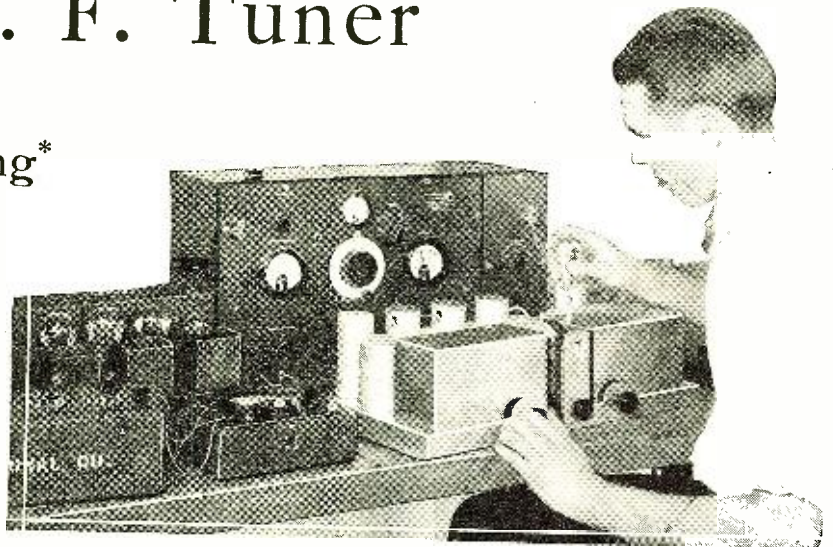
The choice of tubes for the radio-frequency amplifier is not difficult, for the screen-grid tube not only has a high amplification factor, and a very small feed-back from plate to control grid, but the mutual conductance is large. If the feed-back from plate to control grid were reduced to zero, and the plate resistance of the tube reduced from a value of about 400,000

# SELECTIVITY and QUALITY a Modern R. F. Tuner

By Glenn H. Browning\*

and

James Millen†



ohms down to 15,000 or 20,000 ohms, the screen-grid tube would be almost a perfect radio-frequency amplifier. However, this tube at the present time, though far from ideal, is certainly a step in the right direction and adds another tool to the kit of the design engineer.

There are several ways to construct a tuned radio-frequency transformer to operate in conjunction with the screen-grid tube. At first, because of the high plate resistance of the tube, it would seem advisable from the standpoint of amplification per stage to use an auto-transformer, commonly called a tuned impedance unit. However, there are many practical difficulties involved, due to the necessity of isolating the grid of the following tube from the positive charge applied to the plate. Also, when gang condensers are employed their frames must all be at the same potential—usually ground. Thus the tuned radio-frequency transformer with a separate primary and secondary, as shown in Fig. 1, was chosen. The next question to be considered is the type of primary to be used. Because of the high plate resistance of the screen-grid tube, a large number of turns should be used on the primary to obtain maximum gain. However, there is, in the tube itself, a large capacity between plate and ground due to the presence of the screen grid. This capacity, which may be 25 mmfd., or even more, is placed directly across the primary, so that if too many primary turns were used, the primary itself would be tuned to some frequency in the broadcast band. Using a primary with few enough turns so that this tube capacity does not tune it to a frequency in the broadcast spectrum gives rise theoretically to an amplification curve such as shown at A in Fig. 2. Of course, with this type of primary, the coupling between primary and secondary should be made as large as possible, for the larger it is, for a given number of primary turns, the greater the amplification.

Another type of primary consists of a large number of turns. In fact, its inductance is so great that it is tuned to some frequency below the broadcast band (a wavelength above 550 meters). This construction gives rise to an amplification curve, shown at B in Fig. 2. It will be noted that the gain is good at 545 k.c. but very poor at 1,500 k.c. This falling off on the high frequencies can be remedied by placing the primary, which is a small choke coil, at the grid end of the secondary and thereby introducing a capacity coupling, due to the difference of potential between the grid end of the secondary and

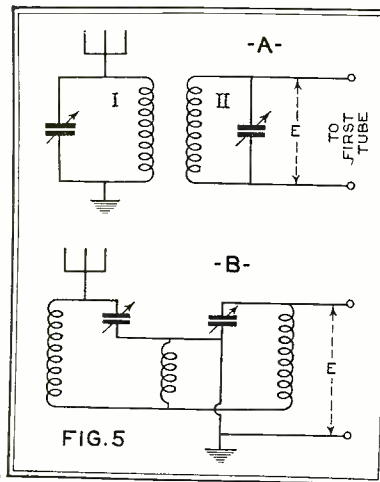


FIG. 5

By means of a standard signal generator tests were made on the receiver described, resulting in the data and curves presented in this article

Fig. 5. Two systems of band-pass pre-selector circuits. A modification of "B" has been employed in the receiver whose design characteristics are described here

the primary. This capacity coupling, of course, is more effective at the higher frequencies. By careful designing, a transformer may be obtained producing almost even amplification over the broadcast band. (See Curve C, Fig. 2.) Thus, it would seem from those considerations that the large turn primary was superior. However, let us not make any hasty decision, for only amplification per stage has been considered so far. It has been found that the capacity between the primary and secondary windings affects the capacity tuning the secondary, so that carefully matched radio-frequency transformers with high-turn primaries are considerably more difficult to manufacture than those using low-turn primaries. Of course, one might suggest a combination of high and low-turn primaries, as the amplification of one is greatest at the frequencies where the other falls off. This cannot be done in a radio set with gang condensers, for the reason stated above.

Let us now examine the selectivity of the two systems. Fundamentally, the selectivity of a tuned circuit depends upon the resistance in the tuned circuit per unit of inductance, or  $R/L\omega$ .

Where

$R$  is the resistance at a frequency  $f\omega = 2\pi f$

$L$  is the inductance of the coil being tuned with the condenser  $C$

Three curves which illustrate the band-pass effect of the pre-selector circuit. Curve A illustrates loose coupling between the two inductances, curve B shows the effects of closer coupling, while coil "C" shows coupling effects producing the desired band-pass resonance characteristic

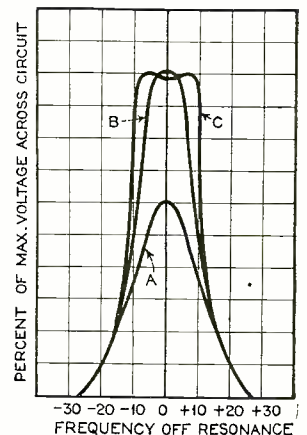


FIG. 6

In the case of a tuned radio-frequency transformer, Fig. 1, there appears in the secondary circuit not only a resistance due to the loss in the inductance and tuning condenser but also an additional resistance reflected from the primary circuit. This may be expressed mathematically by:

$$R_s^1 = R_s \frac{M^2 \omega^2}{Z_1^2} R_p \quad (1)$$

$$\tau_s^1 = \tau_s + t/\tau_1 \quad (1A)$$

Where:

$R_s^1$  is the apparent resistance in the secondary due to its own resistance and that reflected from the primary  
 $R_s$  = resistance of the secondary circuit alone.

$R_p$  is the plate resistance of the amplifier tube connected to the primary  
 $M$  is the mutual inductance between primary and secondary

$Z_1$  is the impedance of the primary circuit

$$\tau_s^1 = \frac{R_s^1}{L_s}$$

$$\tau_s^2 = \frac{R_s}{L_s}$$

$$t = \frac{M}{\sqrt{L_1 L_2}}$$

$$\tau_1^1 = \frac{R_p}{L_1 \omega}$$

IN THE AUGUST RADIO NEWS

- ☞ Construction, installation and servicing of easily built speech amplifiers for public address work.
- ☞ Fred Schnell's short-wave superheterodyne.
- ☞ More data on the talkies.
- ☞ Recorded program technique.

Equation 1 does not give much information about the selectivity of a tuned radio-frequency transformer with a fixed gain,

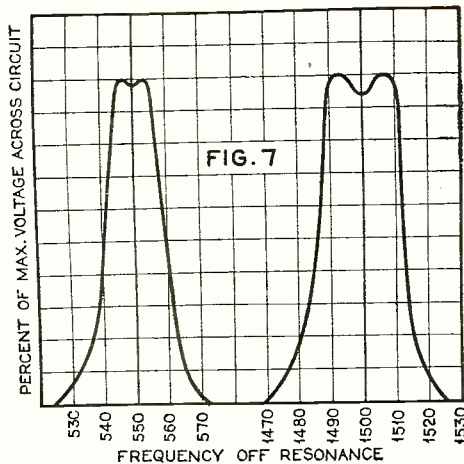
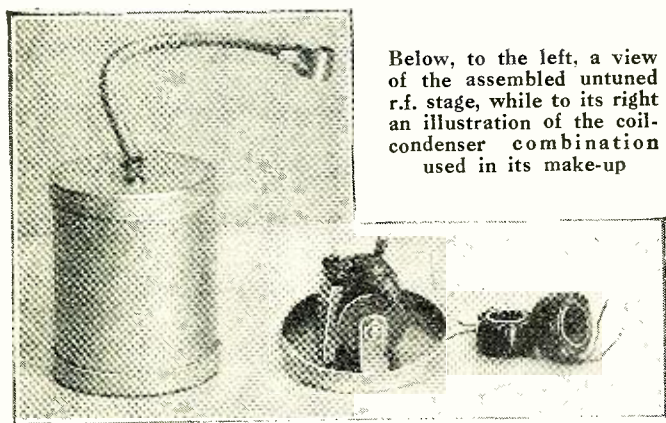


Fig. 7. These two curves illustrate the effect, when the pre-selector circuits are coupled magnetically or inductively, of how the tuning response curve becomes wider as the frequency is increased

for there are certain relations between  $\tau_1^1$ ,  $\tau_s^2$  and  $t$ . When  $L^2 = \pi \tau_1^2$  the transformer is designed for maximum possible amplification. However, if the transformer has a definite gain,

$$t^2 = k \tau_1^1 \tau_s^2 \quad (2)$$

where  $k$  is a factor representing the percentage amplification compared to the maximum obtainable.

Substituting 2 in 1A gives

$$\tau_s^1 = \tau_s + k \tau_1^1 / t \quad (3)$$

This gives the selectivity of a tuned radio-frequency transformer with a constant gain and a fixed secondary winding (fixed  $\pi_s^2$ ) in terms of the coefficient of coupling  $t$ . The equation's statement, put into words, is that the selectivity of two tuned radio-frequency, working out of the same tube and having fixed secondary windings and equal amplification, is greater if the coefficient of coupling is large.

(The coefficient of coupling can never be greater than 1.) It also says that

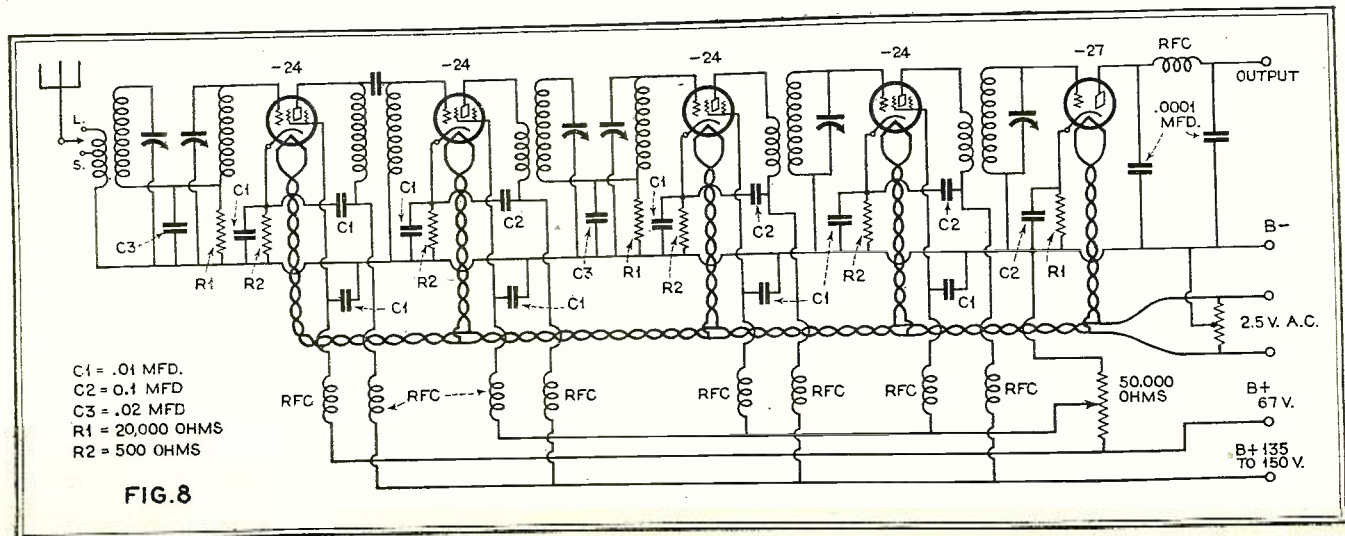
if the coefficient of coupling is unity and the transformer is designed for maximum amplification ( $k = 1$ ) the selectivity is just half as great as the tuned circuit without the primary. In other words, the reflected resistance under the above conditions just equals the resistance already present in the tuned circuit.

In the case of using the high tuned primary, the coupling in almost all cases is materially reduced and therefore the selectivity is diminished. This seems to be noticed most in the lower part of the resonance curve and causes the selectivity to fall off considerably in the case of a number of powerful broadcasting stations whose frequencies are not greatly separated.

In view of the foregoing facts, it was decided to use low-turn primaries in the MB-30, and in order to obtain about equal amplification over the entire broadcast band to insert an untuned stage such as shown in Fig. 3. By so designing this radio-frequency transformer that its primary is resonant with the tube capacity below frequencies in the broadcast band, an amplification curve such as shown in Fig. 4 may be obtained.

Now let us consider the problem of selectivity. It is a well-known fact that most receivers, consisting of a number of stages of tuned radio-frequency amplification, have fine selectivity at say 500 k.c. but at 1,500 the selectivity is relatively poor. What can be done to get almost equal station selection all over the band (and at the same time not have the tuning so sharp that side bands will be materially "cut off," with the result that the high audio overtones are almost missing)? It has been pointed out already that the (Continued on page 168)

Fig. 8. The complete five-tube circuit evolved from the research which was conducted in the investigation of the design considerations treated in this article

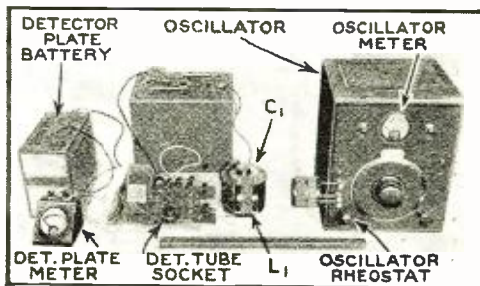




# ~RADIO NEWS HOME LABORATORY EXPERIMENTS~

## Experiments with Detector Circuits

This Home Experiment Sheet is devoted to a discussion and some experiments on detector circuits. The first part is a general discussion, the second part describes some simple home laboratory experiments and the third part discusses the results of the experiments. To perform the experiments certain laboratory apparatus is required but even though you haven't built the necessary instruments or haven't available the meters that are required a careful reading of the discussion, experiments and results will give one a good idea of how the detector operates and how its characteristics can be easily determined.



The important factor is the *change* in plate current, not its original value or its value with the signal tuned in. For example, we might use a small power tube as a detector and the plate current without a signal might be 10 milliamperes and with the signal 9.9 milliamperes, giving a change of 0.1 milliampere. Even though the actual plate current of this detector is much larger than that of the previous detector, it is less sensitive, for the signal only produced a change of 0.1 milliampere in comparison with a change of 0.3 milliampere with the first tube.

When a signal is being detected by a grid leak and condenser circuit the plate current is decreased and with a "C" biased detector the plate current is increased, but in both cases the important factor is the *change* in plate current. We can therefore compare all types of detectors by considering the change in plate current. Keeping this fact in mind, we can now proceed with the experiments.

### Experiments

THE detector is one of the most essential parts of any radio receiver—in fact, we cannot build a set without a detector. If we wanted to we could build a set without any audio amplifier or without any r.f. amplifier, but a detector we must have. We must have a detector, for it is the device which takes the inaudible radio waves picked up by the antenna and changes them to audio frequencies which we can hear by connecting a pair of telephones in the detector plate circuit, or which we can amplify by means of an audio amplifier. In considering different types of detectors we are therefore especially interested in how well—that is, how efficiently—they accomplish their task of changing radio frequency to audio frequency.

The detector which will produce the largest audio signal from a given r.f. signal is the most sensitive detector. However, most detectors vary in sensitivity depending on the strength of the r.f. signal impressed on the input of the detector. The grid leak and condenser detector, for example, is very sensitive to small values of signal but not very sensitive to large values of signal—also the grid leak and condenser detector has a rather low "overload" point. That is, beyond a certain point increasing the r.f. input will not increase the audio output. When this condition exists the detector is said to be overloaded and it is essential that the detector circuit we use does not overload on ordinary signals. All these characteristics of the grid leak and condenser detector—high sensitivity to small values of signal, lower sensitivity to large values of signal, and early overload—are illustrated by a simple experiment to be described in the following sections of this sheet.

The "C" biased detector—sometimes called a plate circuit detector—is less sensitive to weak signals, more sensitive to powerful signals, and has a higher overload point than the grid leak and condenser circuit. The higher overload point means that more powerful r.f. signals can be handled. These characteristics of the "C" biased detector are also easily illustrated by a simple experiment.

The comparative efficiency of various detectors can be determined in a number of ways, but one of the simplest methods is to determine the *change* in detector plate current that occurs when a signal is tuned in. For example, suppose we set up a grid leak and condenser circuit and find that without any signal tuned in the plate current is 1 milliampere. Then we tune in a signal and the plate current decreases to 0.7 milliampere, the change in plate current is 1 — 0.7 or 0.3 milliam-

per. To perform the following experiments the following apparatus is necessary:

(1) A radio-frequency apparatus is necessary: A satisfactory circuit is given in Fig. 1. Those experimenters who constructed the modulated oscillator described in the February, 1929, issue of RADIO NEWS may use it, for it is very well suited for use in the following tests. It is essential that the oscillator be arranged with a 1.5 milliammeter in the grid circuit in order that the output of the oscillator may be held constant. The variable condenser in the oscillator should be fitted with a good dial so that accurate adjustments can be made.

(2) Simple detector circuits as shown in Fig. 2. The meter in the plate circuit should have a range of 1.5 or 5 milliamperes—the 1.5 range is preferable. The coil L1 and the condenser C1 may be any standard r.f. tuning coil and variable condenser. We used a General Radio wavemeter type 247-W, since it was conveniently at hand, but it is just as satisfactory to mount a coil and variable condenser on a small panel or other firm support.

(3) Tubes for the oscillator and detector. Necessary batteries. A ruler to measure the distance between the oscillator and the detector.

Set up the apparatus on a bench as shown in the photograph. The detector circuit is given in Fig. 2A. Use 45 volts on the plate, a 0.00025 mfd. grid condenser and a 0.5 megohm grid leak. After you are sure you have all the proper connections connect the plate meter in the circuit. Note the meter reading on a piece of paper.

Now turn on the oscillator and note the reading of the meter in the oscillator circuit. Vary the oscillator rheostat and note how the meter reading changes. Then adjust the rheostat to give some medium value. For example, with our oscillator adjusting the rheostat gave a variation in meter reading from about 0.1 to 1.0 milliampere. We therefore used a medium value of 0.5 milliampere. In the following tests this meter reading must be held constant. If, as we vary the distance between the oscillator and the detector, the meter reading changes, it must be brought back to its former value by adjusting the filament rheostat.

Now adjust the distance between the center of the oscillator

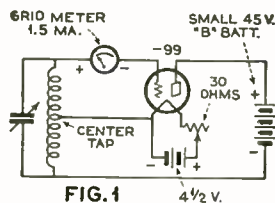


FIG. 1

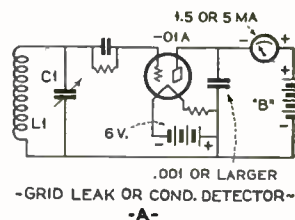
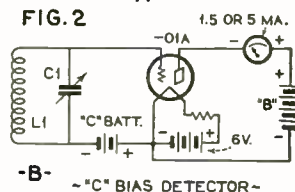


FIG. 2



coil and the center of the detector coil to give a separation of about five inches. Vary the tuning condenser on the detector circuit to bring this circuit in tune with the signal being produced by the oscillator. This can be done by watching the detector plate meter reading. As the detector is brought into tune the detector plate current will gradually decrease and the tuning condenser should be adjusted to the point which gives the minimum reading of the plate meter—the detector is then exactly in tune with the signal from the oscillator. Measure the distance between the oscillator coil and the detector coil. Mark down this distance in column 1 of Table 1. In column 2 mark the reading of the detector plate meter. Now move the oscillator 2 inches farther away from the detector. Mark down this new distance in column 1. If necessary, adjust the oscillator filament rheostat to keep the oscillator meter reading the same. It may be necessary to slightly readjust the detector tuning condenser to keep this circuit in exact tune. Then note the detector meter reading in column 2. Continue to move the oscillator farther away, maintaining the oscillator current constant and readjusting the detector variable condenser to make certain that the circuit is always exactly tuned, until the oscillator is so far away that the detector plate reads practically the same with the oscillator turned off or on. When we made this test we obtained the reading shown in columns 1 and 2 of Table 1.

Now subtract the readings shown in column 2 of your table from the detector plate meter reading with the oscillator turned off, and put these values in column 3. For example, in our own case the meter reading was 1.5 milliamperes with the oscillator turned off. When the distance was 5 inches the plate meter read 0.8 milliamperes and the difference is therefore 0.7 milliamperes, which we put down in column 3. Next take a piece of cross-section paper and plot a curve as shown in Fig. 3. Along the lower edge mark the distances in inches and along the vertical left-hand edge the change in plate current. The various dots on the curve of Fig. 3 correspond to the distances given in column 1 and the changes in plate current shown in column 3. Draw a curve connecting all the points.

Next determine the effect of varying the value of the grid leak resistance. Proceed as follows. Adjust the distance between oscillator and detector to give a medium change in plate current. Remove the grid leak and replace it with one of a different value. Note the change in plate current. If possible use various values of grid leak resistance from 0.1 to 5 megohms. Mark down all the data as in Table 2. Plot a curve as in Fig. 4.

The "C" bias detector circuit should now be tested. The detector circuit is given in Fig. 2B. Turn on the oscillator, adjust its meter reading to the same value as in the previous tests and then proceed as before, varying the distance between the oscillator and the detector, each time noting the detector plate meter reading. Put down the data as in Table 3. Plot a curve as in Fig. 5.

### Discussion of Results

In discussing the results we should first realize that moving

DISTANCE IN INCHES	DETECTOR METER READING	CHANGE IN PLATE CURRENT
5	0.8	0.7
7	0.8	0.7
9	0.8	0.7
11	0.87	0.65
13	1.05	0.45
15	1.18	0.32
17	1.3	0.2
19	1.35	0.15
21	1.38	0.12
23	1.4	0.1

DETECTOR PLATE CURRENT WITH OSCILLATOR TURNED OFF = 1.5 MA.

GRID LEAK RES. IN MEGOHMS	DETECTOR METER READING	CHANGE IN PLATE CURRENT
0.1	1.3	0.2
0.5	1.05	0.45
3.0	0.8	0.7
5.0	0.7	0.8

DETECTOR PLATE CURRENT WITH OSCILLATOR TURNED OFF = 1.5 MA.

DISTANCE IN INCHES	DETECTOR METER READING	CHANGE IN PLATE CURRENT
5	OFF SCALE	
7	1.5	1.4
9	0.85	0.75
11	0.44	0.34
13	0.24	0.14
15	0.17	0.07
17	0.15	0.05
19	0.13	0.03

DETECTOR PLATE CURRENT WITH OSCILLATOR TURNED OFF = 0.1 MA.

the oscillator nearer to or farther away from the detector was simply a convenient method of applying signals of various values to the detector tube. When the distance was small a very large signal was impressed on the detector and when the oscillator and detector were widely separated a comparatively small signal was impressed on the detector.

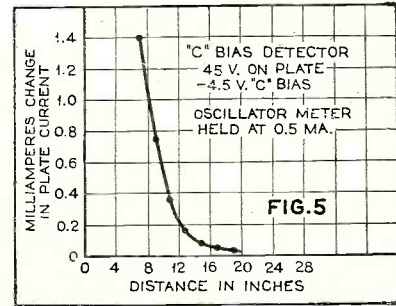
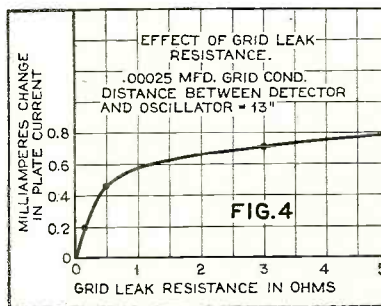
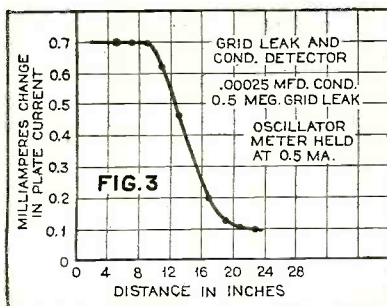
First let us examine Fig. 3, which is the curve for a grid leak and condenser circuit. This curve shows that the change in plate current was constant at 0.7 milliamperes at all distances up to 9 inches. Over this portion the detector was overloaded, for changing the input signal by moving the oscillator farther away produced no difference in change of plate current and this, as was explained in the first part of this sheet, constitutes overloading. At distances beyond 9 inches the plate current change becomes gradually smaller. Comparing this curve with that of Fig. 5 for the "C" bias detector we note that the latter curve does not show such overloading. Also note that at 9 inches Fig. 3 shows a change of 0.7 milliamperes and Fig. 5 shows a change of about the same value. At this point the two circuits therefore have about equal sensitivity—that is, with equal signals they both produce the same change in plate current. At 7 inches, however, Fig. 5 shows a change of 1.4 milliamperes and Fig. 3 a change of 0.7 milliamperes. With large amounts of signal the "C" biased detector is therefore better than the grid leak and condenser, for the former circuit gives twice as great a change in plate current. To see how they compare with very small signals, look at the currents corresponding to a distance of say 17 inches. At this point the grid leak and condenser detector (Fig. 3) gives a change of 0.2 milliamperes and the "C" biased detector a change of only 0.05 milliamperes. At weak signals the "C" biased detector is therefore much poorer in sensitivity.

The curve of Fig. 4 showing the effect of the resistance of the grid leak indicates that the sensitivity gradually increases as the resistance becomes higher. One megohm gives a change of 0.6 milliamperes and 5 megohms a change of 0.8 milliamperes. For high sensitivity at small signals we should therefore use a grid leak and condenser circuit with a high resistance grid leak.

RADIO NEWS HOME LABORATORY EXPERIMENT SHEETS are intended to be as helpful, instructive and full of facts as it is possible to make them.

The Editors have planned a rather comprehensive series of Experiments, taking up in turn topics ranging from antenna systems to loud speakers. However, if there is any particular subject you would like to have treated in this department, or, if you have any suggestions as to how the department can be improved, we want you to tell us.

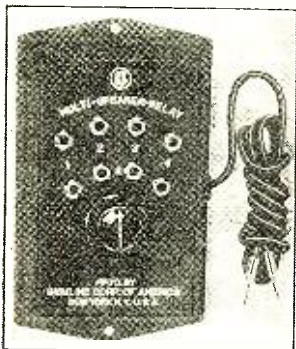
Send in your letters of suggestion or criticism.



# NEWS from the MANUFACTURERS

## Multi-Speaker Relay

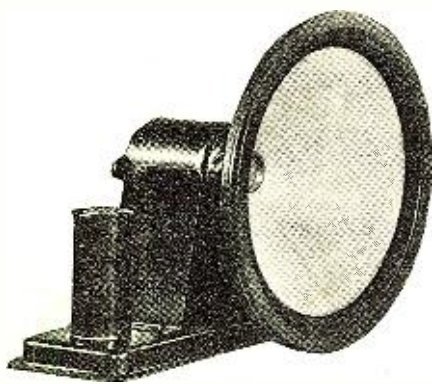
The Insuline Corporation of America, 78 Cortlandt Street, New York City, is marketing a new multi-speaker relay for testing and comparing from one to four speakers, also to play two speakers at one time. If it is desired to play two speakers



at one time, the speaker tips of the first speaker are inserted into upper and lower corresponding jacks and then tips of the next speaker are inserted correspondingly into adjacent jacks. The pointer of the knob is then placed between the corresponding jacks where tips were inserted and phone tips of the cord of the speaker relay inserted into the speaker connection of the radio set.

## Electrodynamic Speaker Units

Jensen Radio Manufacturing Company, 6601 S. Laramie Avenue, Chicago, Ill., announces a line of new electrodynamic speaker units, one of which has a 12-inch cone. This model is known as the 1930 Auditorium Model. This unit will handle



the output of amplifiers delivering 20 watts of undistorted energy and is equipped with input transformer designed for inputs of 30 watts or less, accommodating any type of power tube. In the model of this unit, used with a.c. to energize the field, a -80 rectifier tube is employed, this being enclosed in a screened housing. The unit is regularly

equipped with an input transformer designed for operation with 250 or smaller power tube. Binding posts are arranged on the back of the speaker so that it may be properly connected for amplifier tubes in push-pull, parallel or singly.

## Burgess SnapLite Flashlight

Burgess Battery Company, Chicago, Illinois, announces its SnapLite Flashlight which, because of its small size, is particularly adapted for use by radio servicemen.



The lamp is lighted when the lid is snapped up and turned off when closed. The lamp is removable, being always protected against breaking by the snapper top and is only exposed when actually in use.

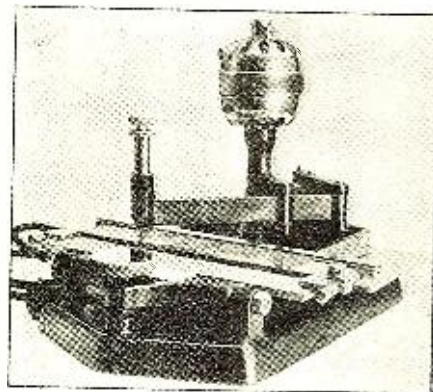
## Precision Wire-Wound Resistor

Lynch Manufacturing Co., Inc., 1775 Broadway, New York, is marketing a new precision wire-wound resistor. It is specially designed for precision and semi-precision use in radio work where accurate, non-inductive, high-value, low distributed capacity resistors are required. The wire employed is of nickel chromium alloy carefully gauged and is put through a special enameling process that gives it unusually great insulation resistance. Resistance values up to a maximum of 500,000 ohms are obtained. The terminals consist of a cylindrical body and a conical end to take either of the two more general types of clips; also, a No. 4 machine screw molded directly to each end.

The resistors are specially designed for laboratory purposes, resistance-coupled amplifier plate resistors, high-voltage regulators, multipliers for converting microammeters and milliammeters into high reading voltmeters, for experimental work in connection with vacuum tube circuits and resistors for use in "faders" and attenuation volume controls. The tolerance is 1/2 to 1 per cent. Capacities 500 to 500,000 ohms. Rating 1 watt.

## Engraving Machine

Simplex Tool Company, Woonsocket, R. I., is manufacturing an engraving machine for the marking of flat gauges, making of name plates, engraving serial num-



bers on panels, etc., made of soft steel, brass, aluminum, hard rubber or bakelite. Pieces any width up to 14 inches in height can be engraved up to 7/8 of an inch in thickness. The engraving is done on the pantograph principle by which individual letters set up on the table of the machine to form words are engraved by the cutter attached to the motor. The engraved letters are approximately 1/3 the size of the master letters on the table.

## Electrodynamic Speaker

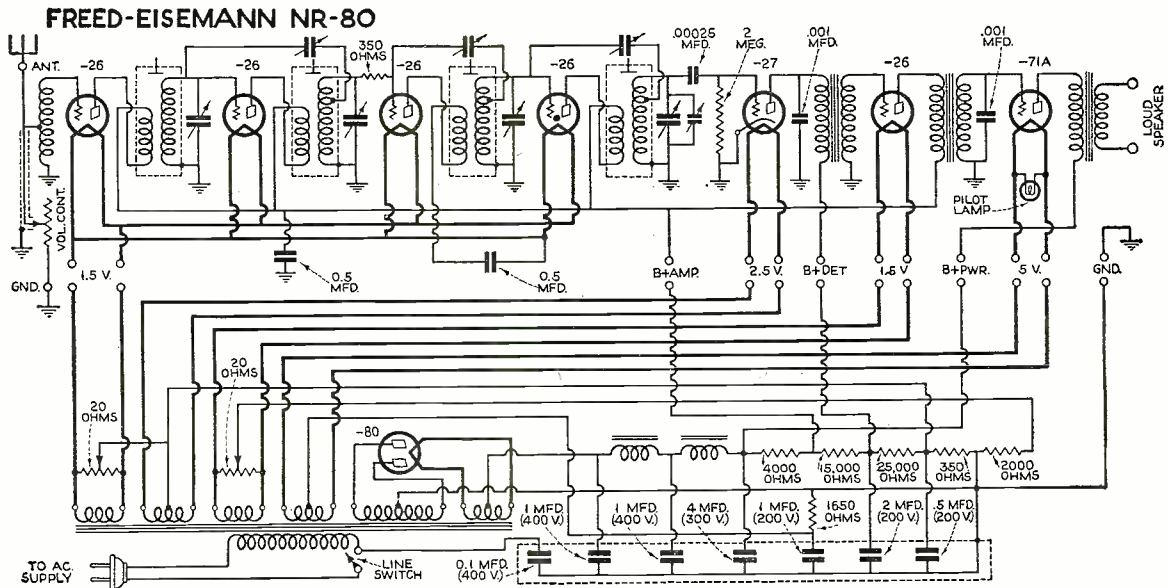
The Rola Company, 45th and Hollis Streets, Oakland, Calif., is manufacturing a new electrodynamic speaker known as Model "S." The speaker, complete with



transformer, weighs less than 3 lbs. It is compact, the overall diameter of the cone housing being 8 1/4 inches and the depth of the entire speaker measuring 4 3/8 inches. The frequency response covers a range of from 80 to 6,000 cycles per second. Working at 100 to 125 volts, it draws from 45 to 50 milliamperes. The field can be wound to other resistances to meet other voltage requirements.

(Continued on page 191)

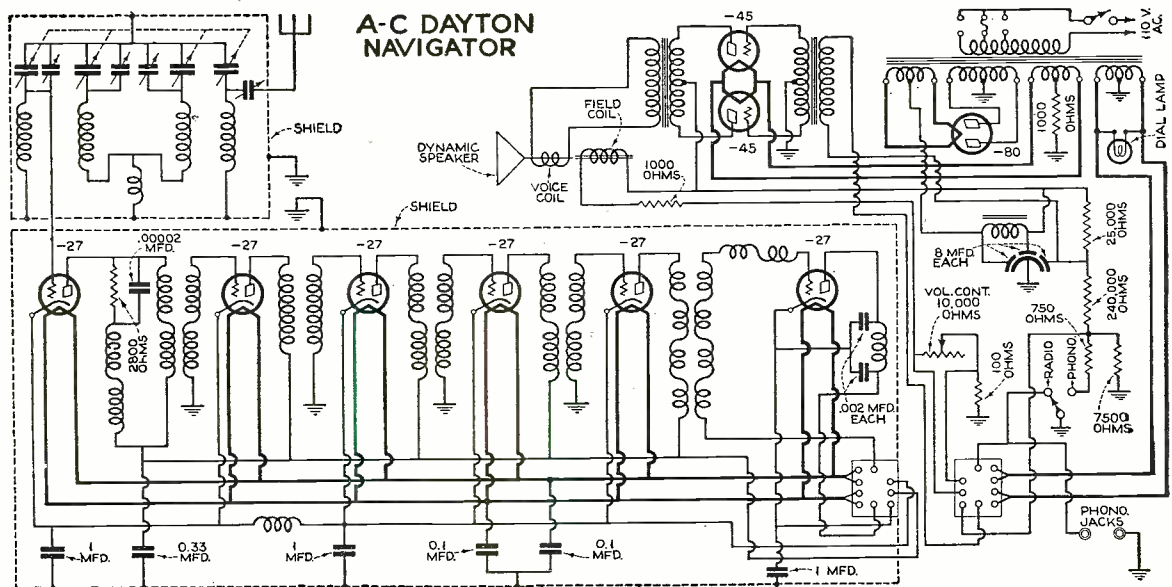
## Radio News Manufactured Receiver Circuits



**E**IGHT tubes make up the tube requirements for the Freed-Eisemann NR-80 radio receiver and power supply. In the untuned antenna stage of the circuit is a -26 a.c. tube followed by three tuned neutralized radio-frequency stages employing -26 tubes and a tuned grid-leak-condenser detector having a heater type -27 tube. The first audio stage requires a -26 tube, while a -71A tube is used in the second, or output audio-

frequency stage. The power pack supplying A, B and C potentials to the receiver requires a -80 tube, the full-wave rectifier type. Single dial control is effected by using the first radio-frequency stage untuned and a small equalizing condenser in the detector stage. Audio hum is minimized by balancing the 20 ohm center-tapped resistor in the filament circuit of the first audio tube.

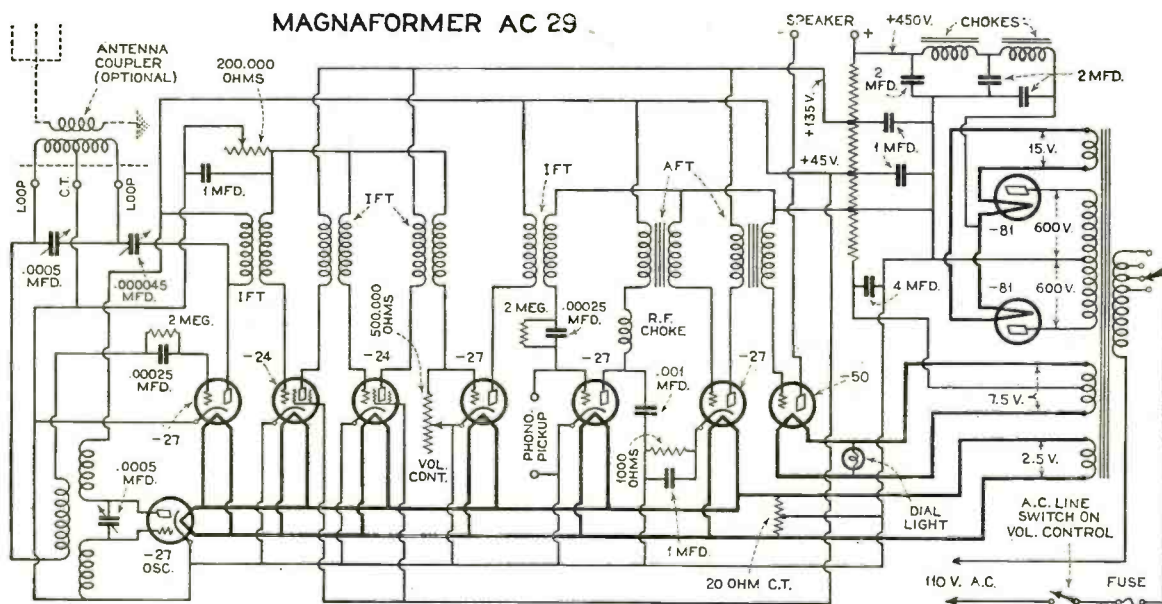
## Radio News Manufactured Receiver Circuits



**T**HE circuit employed in the A-C Dayton Navigator receiver is that known as the Technidyne. It is a pre-selection circuit and consists of three parts, the selector, the amplifier and the power pack. The selector is composed of four-ganged condensers and four sets of inductance coils. The inductance coils are wound on two coil tubes, each coil tube containing one-half of the windings necessary for the tuning of one stage.

The principle of the amplifier is that of self tuning accomplished by the correct design of the input and output circuits of the tubes, to take advantage of the change in capacity of the tubes, due to a change in frequency of the impressed signals. The tube requirements for this receiver are: six -27 heater-type; two -71A and one -80 full wave rectifier tubes.

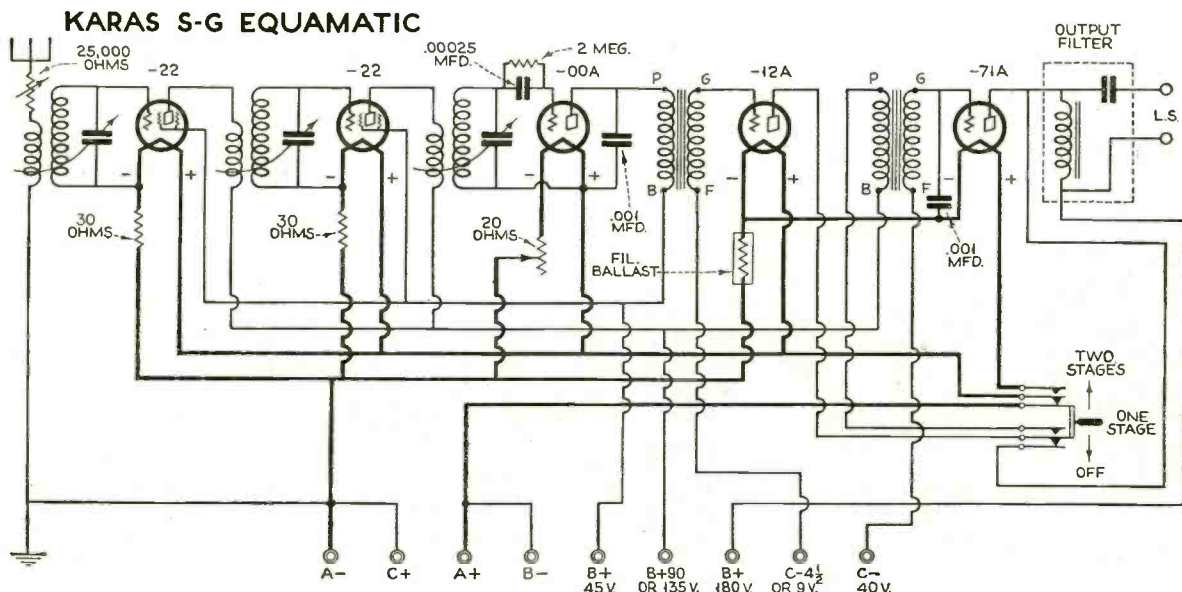
# Radio News Manufactured Receiver Circuits



THIS Magnaformer receiver, known as the Magnaformer AC-29, is a ten-tube all-electric, containing two -24 AC screen-grid type tubes for high amplification, five heater-type -27 tubes, one -50 power tube, and two -81 rectifier tubes. The set is designed for loop operation on account of the directional factor of the loop, but with a suitable antenna coupler, a regular antenna may be employed. Two controls are employed for the sensitivity and volume. The first, a 200,000

ohm variable resistor connected in series with the grid-returns of the first, second and third intermediate-frequency amplifier stages and ground, acts as the sensitivity control, and is of special benefit in the tuning of distant stations. The volume control is a special tapered variable resistance of 500,000 ohms in the third intermediate-frequency tube grid circuit and ground. One dial control without harmonic repeat point is one of the features of this circuit.

# Radio News Manufactured Receiver Circuits



THE Karas Screen-grid Equamatic receiver employing five tubes makes use of the well-known King variable primary radio-frequency circuit. The feature of this circuit being the aiding effect obtained by varying the relation of the primary coil to the secondary coil when tuning the receiver. Two -22 screen-grid tubes and a super-sensitive 00A tube provides high sensitivity in the tuned stages. The first audio stage employs a -12A tube, followed by a -71A tube in the second stage.

The controls for this receiver are as follows: Two dials for the tuning (the first and second radio frequency stages being ganged), a multiple contact switch for switching from one to two audio-frequency stages, a volume control of 25,000 ohms in the antenna circuit and a 20 ohm rheostat for controlling the detector filament voltage. Fixed resistors are employed in the negative filament leads for the remaining four tubes.



# The Junior RADIO Guild



## LESSON NUMBER ELEVEN

### Circuit, Constructional and Operating Details of a Low-Power Transmitter

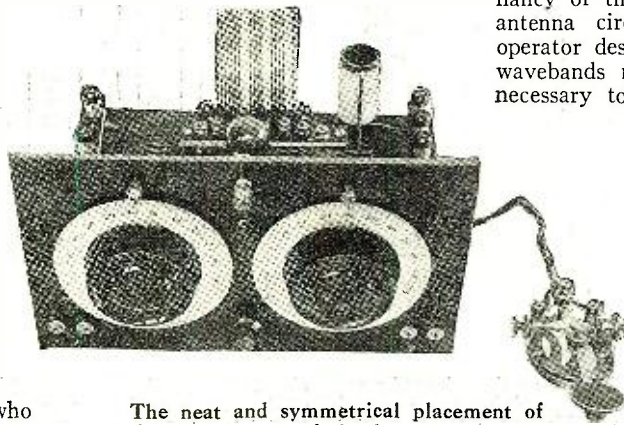
IN lesson number 10, in the June issue, was described an easy method of connecting up a buzzer, key and battery, permitting one or more beginners to practice the continental code. The next step in "getting started" in the amateur field is the obtaining of station and operator's licenses. The operator's license is proof of his knowledge of (1) the code (at least ten words per minute) and (2) the operation and adjustment circuit of the transmitter. The station license permits the station to be operated. The party who holds the license, of course, is responsible for the proper operation of the station, under the terms of the license. It is the purpose of this lesson to describe the circuit, constructional and operating details for a simple low-power transmitter for an amateur station.

In all radio work tuned circuits are used a great deal. Amateur short-wave receivers and transmitters, as well as commercial apparatus alike, make use of tuned circuits. Tuning a transmitter simply means changing the value of the tuning inductance and tuning condenser so that the "resonant point" of the circuit is adjusted to the wavelength it is desired to work with. A transmitter is usually tuned to one wavelength by the means of a condenser C1, Fig. 1, and the circuit adjusted for maximum effectiveness by slowly tuning a second condenser, C2, Fig. 1, and at the same time watching the bril-

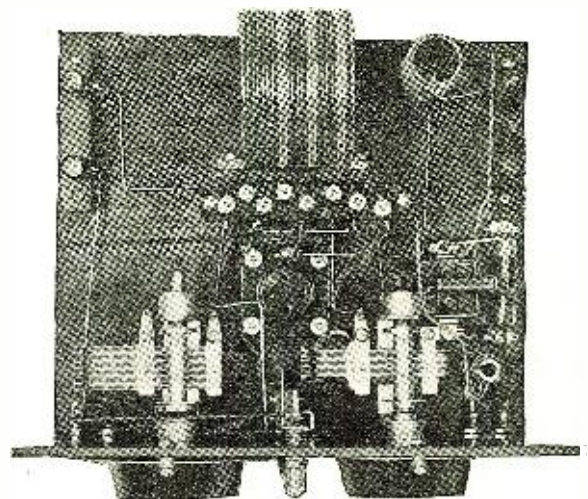
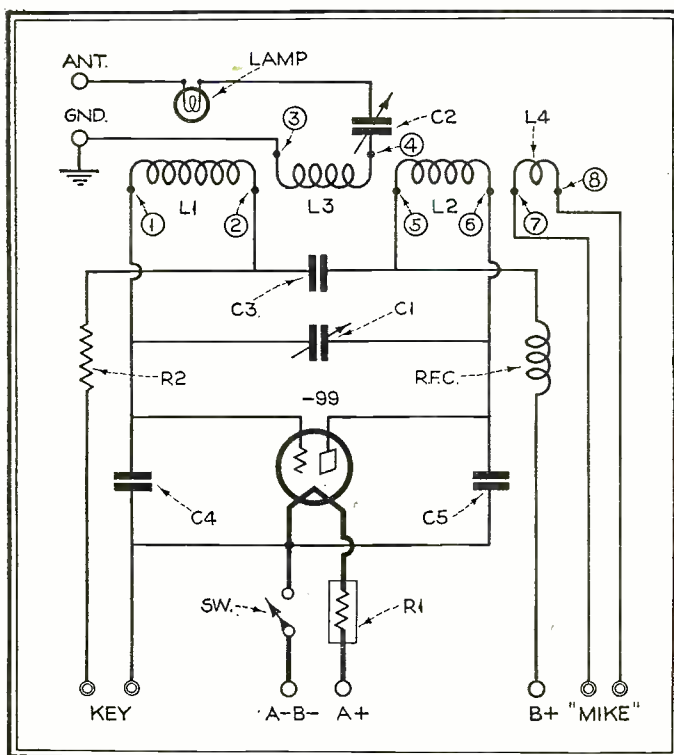
liancy of the resonant indicating lamp in the antenna circuit. If, however, the amateur operator desires to use more than one of the wavebands now open for his use, it will be necessary to construct and employ additional inductances, L1, L2, L3, and L4 (see Fig. 3). The tuning for best efficiency on the various wavebands is conducted in the same manner as above and should, of course, be checked frequently by a reliable calibrated wavemeter.

The circuit to be described is the series-fed Colpitts, often known as the Hoffman split Colpitts, and is shown in Fig. 1. After conducting a number of tests with oscillating circuits, it was found that as far as efficiency was concerned they were all about the same.

The Colpitts, however, has been chosen for this low-power transmitter because of its advantages over other simple oscillator circuits. First, one variable condenser absolutely controls the oscillator frequency over a wide range without guesswork inductance clips, swinging out or stopping oscillation, as well as providing extremely sharp signals due to the absence of plate current acrobatics. Second, two large mica fixed condensers connected directly across the tube elements keep the signals as steady as that of an oscillator-amplifier circuit. In addition, in a series-fed circuit the plate supply and grid bias leads are brought into the radio-frequency circuit at points of low potentials. Now that the advantages of this circuit have

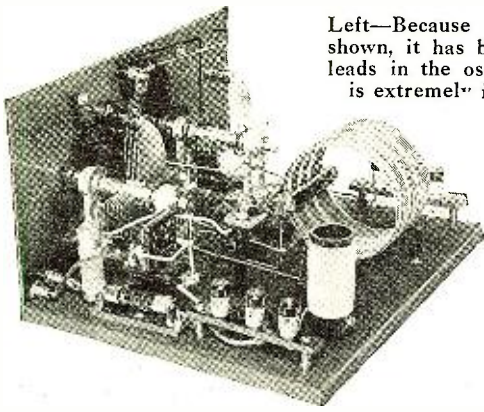


The neat and symmetrical placement of the components of the low-power transmitter improve the business-like appearance of any amateur station



Above—Photo graphically showing the placement of the units on the sub-panel. It is important to note that the radio-frequency choke and inductance are placed at right angles to each other

Fig. 1, left—The schematic diagram of the low-power transmitter. When using the "mike," care should be taken that the key circuit is closed



Left—Because of the placement of parts, as shown, it has been possible to use very short leads in the oscillatory circuits. This feature is extremely important for stable operation

Fig. 2, right—Drilling details of the front panel. The size of the panel indicates the compact layout and general dimensions of the transmitter

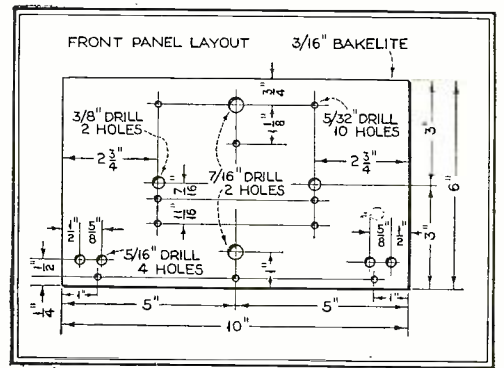
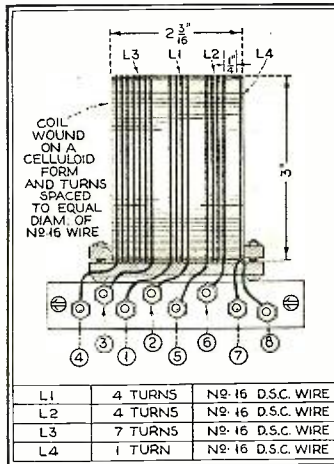


Fig. 3, below—Details of the inductance for the low-power transmitter for operation in the 80-meter amateur band. The coils may be identified as follows: L1, grid; L2, plate; L3, antenna, and L4, loop modulation



mounting strip, 4 1/4" x 3/4", for the binding posts which hold the inductance in place. While the scrap bakelite is in the vise, we may as well cut two strips 3 1/2" long by 1/2" wide which are used later for mounting the binding posts for the antenna and ground and the "A" and "B" battery binding posts. The actual winding of the coil may at first seem somewhat difficult; such, however, is not the case. Two lengths of No. 16 double cotton wire are wound side by side over the three-inch length of our form. There are two methods of binding the wire to the form. The first, and better method, is to moisten the celluloid form with acetone just before winding. The celluloid softens slightly, allows the wire to form a groove and in drying binds the wire in place. The second method is the painting of the form, after the winding has been completed, with collodion. When the coil form is thoroughly dry, one length of wire is unwound from the form, leaving one winding of approximately

24 turns, equally spaced, by the diameter of the wire just removed. Starting at one end of the form, we count off 8 turns and, using a pair of diagonal cutting pliers, cut the wire, unwind one turn which serves as lead No. 3 on coil L2, Fig. 3. Advancing up the coil, unwind turn No. 9, which is used for lead No. 1, L1, count five turns and repeat the process in making L3. Coils L2 and L4 are completed (Continued on page 188)

been pointed out, it may be well to mention that the one and only disadvantage is that there is no grid feedback, as evidenced by heavy plate current. This, however, is nullified somewhat by using a high value grid leak on the order of 12,000 ohms.

The next step to consider is that of the type of power supply which may be available. This point may here seem out of place, but it must be remembered that the type of tubes to be used in the transmitter is dependent on the "A" and "B" potentials. As the station is to be operated on low power at first, dry "A" and "B" batteries, being readily obtainable, were chosen and for intermittent transmitting provide long life and reliable power supply. Limiting the "A" supply to three dry cells necessarily limits the tube to the -99 type, which, by the way, performs very nicely. One amateur station, heard recently, using the -99 type with a "B" potential of 135 volts, was chatting with a fellow amateur 1,100 miles away. Although the low-power transmitter is intended primarily for code work, provision has been made for phone transmission, employing loop modulation.

### Constructional Details

The construction of a low-power transmitter for best efficiency is somewhat more exacting than higher powered installations. It will be noted from the photographs and the picture wiring diagram that very few parts are required. These should, however, be of very high quality. First let us consider the inductances—Fig. 3, which consists of four sections. The form on which the wire was wound in the original transmitter was made from a sheet of celluloid 3" x 12". The sheet of celluloid was wound over a 3" diameter cardboard tube. The overlapping edge of the celluloid is painted with acetone and held in position till dry. While our coil form is drying, work can be started on the bakelite strips that are used as binders. Two of these are required. These strips, 3" long by 3/8" wide, were cut from a scrap piece of bakelite 3/16" thick, as was also the

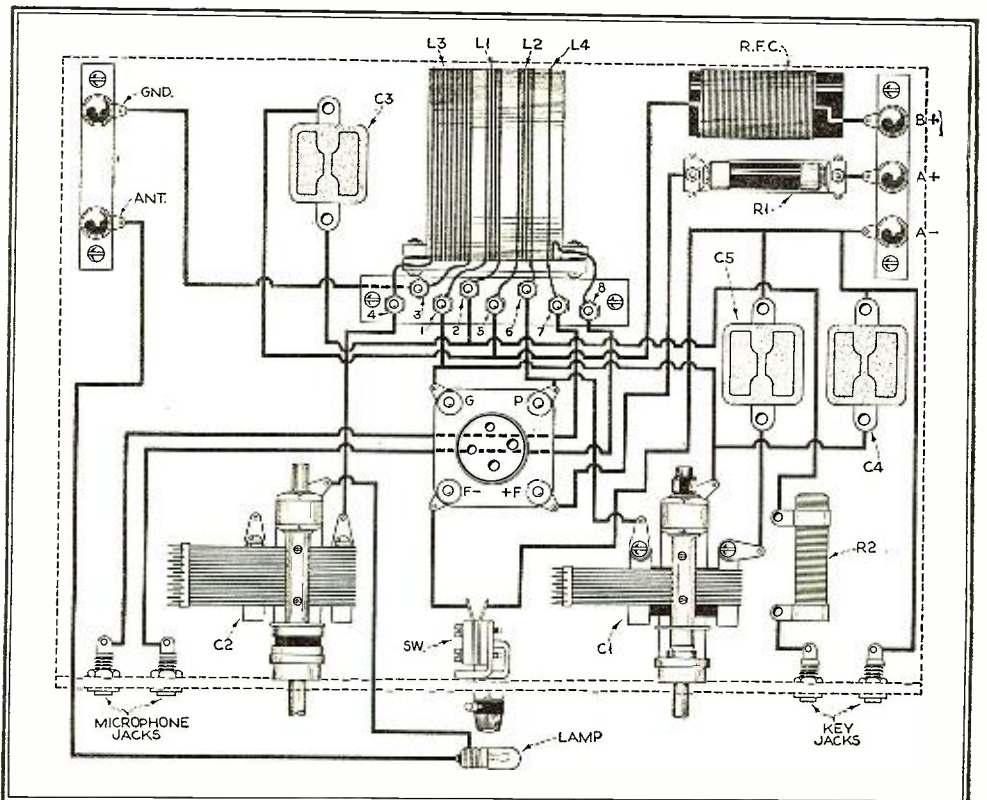


Fig. 4—The picture wiring diagram of the transmitter. The various parts are shown in the relative position they will occupy in the finished transmitter

# RADIO NEWS INFORMATION SHEETS

By Elmore B. Lyford

## Electrical Filters—Part 2

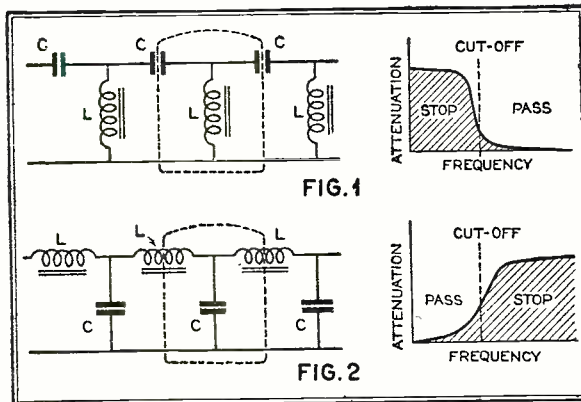
Index No. R-386

**I**N the Information Sheet dealing with the first part of this subject (Electrical Filters—Part 1), published last month, the general principles of filter operation were given. This second instalment deals with two particular cases of the general type—the high-pass and the low-pass filter.

A high-pass filter, as its name indicates, allows all frequencies above a predetermined cut-off point to pass through, but impedes or stops entirely all currents having a frequency below the cut-off point. Such a filter is shown by the hook-up of Fig. 1, with the filtering action expressed by the accompanying sketch. By comparing with the Information Sheet of last month, it may be seen that this filter is of the same general arrangement, except that it is made up of fewer inductances and capacities.

The filter shown is called a three-section filter, the middle section being shown by the dotted lines. Since all of the inductances and capacities are the same, the cut-off point is determined by the resonant frequency of any one.

The sharpness of the cut-off of a filter such as this is determined by the amount of resistance in the circuit,



panying sketch.

In this filter, as in the one previously described, all the inductances and capacities are identical, and one section is shown by the dotted lines. The cut-off frequency for this low-pass filter is equal to

$$f = \frac{1}{2\pi\sqrt{LC}}$$

As in the high-pass filter, the sharpness of cut-off of this type is also determined by the number of sections which make up the filter, and by the amount of resistance in the coils and condensers.

# RADIO NEWS INFORMATION SHEETS

By Elmore B. Lyford

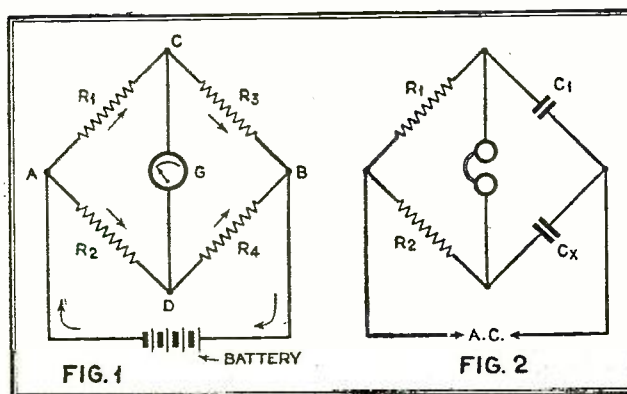
## Bridge Circuits

Index No. 621.374.2

**S**O-CALLED "bridge" circuits are much used in radio, both in the laboratory and in the construction of radio receivers. In the laboratory these "bridge" circuits are utilized for the measurement of resistance, inductance and capacitance, and in our radio receivers they appear in such familiar forms as the Hazeltine neutrodyne and the Rice circuits.

All bridge circuits have their origin in the original Wheatstone bridge for the measurement of resistance, which is illustrated in Fig. 1 and from which an understanding of all such circuits may be gained. The underlying principle is simple. The incoming current from the battery divides at A, part of it going through R1 and part through R2. If the bridge is "balanced," these currents will continue on through R3 and R4 respectively, recombining at B and going back to the battery. No current will flow through the galvanometer G if the mid-points C and D are at equal potential, i.e., if

$$\frac{R1}{R2} = \frac{R3}{R4}$$



regardless of what these ratios may be.

To use the bridge for the measurement of resistance, the unknown may be substituted for any one of the resistances, and then any other one varied until the galvanometer G again reads zero current. Knowing three of the resistances, the value of the fourth may always be computed.

For the measurement of capacity, a circuit like Fig. 2 must be used. This is similar to the all-

resistance circuit of Fig. 1 except that a known capacity C1 has been substituted for R3, and the unknown capacity Cx takes place of R4. Direct current will not flow through a condenser, so an alternating current of audio frequency is used instead of the battery, and balance is obtained when there is no sound in the headphones. The known capacity C1 should be of about the same value as the known Cx.

A similar circuit to this is used for the measurement of inductance, the unknown being connected in place of Cx and a known inductance of about the same value being connected in place of C1.



# RADIO NEWS INFORMATION SHEETS

By Elmore B. Lyford

## Letter Symbols Used in Radio

Index No. R-030

**T**HE Institute of Radio Engineers has formally adopted the "Letter Symbols for Electrical Quantities" proposed by the A. I. E. E. in 1928 and approved by the American Standards Association in 1929. No one can do any work in radio, or even much reading of technical articles without first becoming familiar with this system of "radio shorthand."

The accompanying table does not include the complete list of approved symbols, but it does give all those which find frequent use in radio literature. The symbols in parentheses, while not adopted as standard by the above-mentioned bodies, are nevertheless frequently used, and are therefore included here for the sake of completeness.

In the second section of the table is a shorter list of symbols which, though not yet adopted as standard, are commonly used and should be familiar to every radio experimenter.

SYMBOLS ADOPTED AS STANDARD	
ANGULAR VELOCITY	} $\omega = 2\pi f$
ANGULAR FREQUENCY	
CAPACITY	C
CONDUCTANCE	$G, g = \frac{1}{R}$
CURRENT	I, i
DIFFERENCE OF ELECTRIC POTENTIAL (VOLTAGE)	} E, e (V, v)
DIELECTRIC CONSTANT	
FREQUENCY	f
IMPEDANCE	Z, z
INDUCTANCE	} L
SELF-INDUCTANCE	
MUTUAL INDUCTANCE	M
NUMBER OF CONDUCTORS OR TURNS	N
PERIOD (TIME)	T
REACTANCE	X, x
RESISTANCE	R, r
OTHER SYMBOLS COMMONLY USED	
AMPLIFICATION CONSTANT	$\mu$ or $M\mu$
OHM	$\Omega$
MEGOHM	$\Omega$ or $M\Omega$
FILAMENT	F
PLATE	} OF A VACUUM TUBE
GRID	
SCREEN-GRID	

In order to avoid confusion when it is necessary to use these symbols more than once in reference to a particular circuit or mathematical expression, they are commonly used with subscripts. For example, if there are three inductances in the circuit under discussion they would be designated as L1, L2, and L3, and if there were two capacities they would be designated as C1 and C2.

In referring to vacuum tubes, the symbols representing the tube elements are also commonly used as subscripts—for example, grid voltage is written as Eg, plate current is written Ip, and the grid-plate capacity is symbolized Cg-p.

Though it all looks complicated, it is in reality a simple and logical system, and one with which it is important to be familiar.

The majority of these symbols belong to long-established electrical terminology, and have simply been carried over to similar applications in radio engineering.

# RADIO NEWS INFORMATION SHEETS

By Elmore B. Lyford

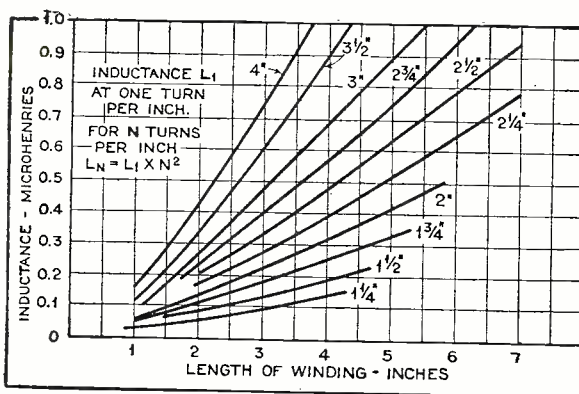
## Inductance Charts—Part 2

Index No. R-230

**T**HE Information Sheet published last month (Inductance Charts—Part 1) gave curves to assist in determining the inductance necessary to use with any given tuning condenser to reach any given wavelength. The curves given in this Information Sheet may be used to determine the number of turns, length of winding, etc., which will be needed to give the necessary inductance value.

In order to make the curves applicable to all cases, they have been calculated on the basis of one turn of wire per inch of coil length. For more than one turn per inch, the inductance will be equal to that for one turn multiplied by the square of the number of turns.

For example, if we have a coil three inches in diameter, wound twenty turns to the inch for three inches, its inductance will be the



WIRE SIZE B. & S. GAUGE	TURNS PER LINEAR INCH OF COIL			
	SINGLE COTTON	DOUBLE COTTON	SINGLE SILK	DOUBLE SILK
12	11.5	10.9	--	--
14	14.3	13.5	--	--
16	17.9	16.7	18.9	18.3
18	22.2	20.4	23.6	22.7
20	27.0	24.4	29.4	28.0
22	33.9	30.0	36.6	34.4
24	41.5	35.6	45.3	41.8
26	50.2	41.8	55.9	50.8
28	60.2	48.6	68.5	61.0
30	71.4	55.6	83.3	72.5

value for one turn per inch (0.47 micro-henries) multiplied by 20 squared ( $20 \times 20 = 400$ ) or

$0.47 \times 400 = 188$  micro-henries = .188 milli-henries

By figuring backwards from the chart we can compute in advance how many turns our coil should have, knowing the diameter of the coil and the number of turns per inch we can get on. The accompanying table of wire sizes will be helpful in determining how many turns per inch (close wound) we can get on with the more common wire sizes.

In making use of these curves, it is important to remember that the inductance values come out in micro-henries, and that they must be divided by 1,000 to obtain the value in milli-henries. Inductance values of the order of those used in radio receivers are generally expressed by this latter term.

# The Radio Forum

*A Meeting-Place for Experimenter, Serviceman  
and Short-Wave Enthusiast*

## The Experimenter

### Improving the Magnetic Speaker

Good operation of a magnetic speaker depends on the maximum of magnetic flux furnished by the permanent magnet. If the magnet is strong in flux, the volume of the speaker is boosted, while low magnetic flux will result in a noticeable decrease in volume, and sometimes producing distortion. writes Mr. D. A. Brown, of Marion, Ohio.

Many folks cannot afford the purchase price of a dynamic speaker, so the improvements to their magnetic type, as here described, will be of interest.

Magnetic speakers of the popular types have a large permanent magnet to furnish the magnetic flux. As the clearance between the U of the bar and the speaker coil is about two inches, there will be plenty of room to mount two field coils which are wound on the magnet's pole pieces, and increase the output volume of the speaker approximately 50%. As shown in the drawing, Fig. 1, the addition of coils A and B will enable the experimenter to better his present speaker.

Both coils, wound with No. 18 double cotton covered wire, require about 425 turns on each magnet leg to permit operation of the field supply from three dry cells. Build the coils as follows:

Make a cardboard form as shown in Fig. 1, holding the core and ends together with gum paper. After the form is completed whittle down a small block of wood until it fits tightly in the core opening. Then into the end of the block pound a nail which is clamped in the chuck of a hand drill to enable faster winding of the wire.

After coils are wound, they should be painted with shellac and allowed to dry overnight. Then they are placed on the magnet legs and are ready to connect together and increase the flux for the speaker.

Hold a small compass near one of the magnet poles and note the polarity. Then, by applying the battery current, if it is connected in respect to the magnet polarity, the compass will retain its same position. If, on the other hand, the compass should move around to the opposite pole, the flux induced by the coil is bucking that furnished by the magnet and the coil connection should be reversed. The same test should be applied to the second coil in respect to its polarity also, and after the poling of the magnets is completed, the units can be assembled and put in operation.

Adapting this field supply to speaker units in which the field magnets are low will result in increased volume far in excess to the original. The only precaution to observe is to be sure to connect the coils so that the induced flux will

former whose primary coil was still perfect, I found that the signal was distorted when the volume was loud. On placing a .001 mfd. mica condenser across the primary, the distortion was slightly reduced. On increasing the capacity of the fixed condenser to .005 mfd. it was found that the distortion was almost eliminated. Finally, on discarding the condenser and shorting the primary of the transformer across the terminals P and B, the distortion disappeared entirely and the amplifier performed faithfully with marvelous tone quality. The transformer used for these experiments was of an inferior quality and had a turn ratio of 6 to 1.

It was found that the quality of the audio amplifier could be further improved by the use of a radio-frequency choke coil and a by-pass condenser inserted in the plate lead of the detector, between the plate of the detector and the input to the impedance.

Fig. 2. With an amplifier of this type, an ideal volume control consists of a variable resistor between the audio impedance and the "B" plus detector lead. This resistor should have a range of from 0 to 200,000 ohms.

### A Tone Control for New or Old Radio Sets

Several leading radio sets this season are provided with a tone control, consisting of a fixed condenser and a variable resistor connected in series between the grid terminals of the two -45 type tube sockets.

Any radio receiver, new or old, states Mr. Charles Golenpaul, of the Clarostat Manufacturing Company, Brooklyn, New York, may be provided with a tone control. All that is necessary is a .25 mfd. fixed condenser, together with a volume-control clarostat arranged in series across the output of the set, or across the loud speaker terminals. This arrangement serves to by-pass more or less of the higher frequencies, thereby preventing them from reaching the loud speaker, wherein they would be converted into that sharp, crisp touch which may not be desirable for certain conditions. Of course, the tone control cannot actually introduce bass notes which are not present in the amplifier output, but by eliminating the higher frequencies which it does, the tone control provides an accentuated bass effect which is often pleasing.

(Continued on page 189)

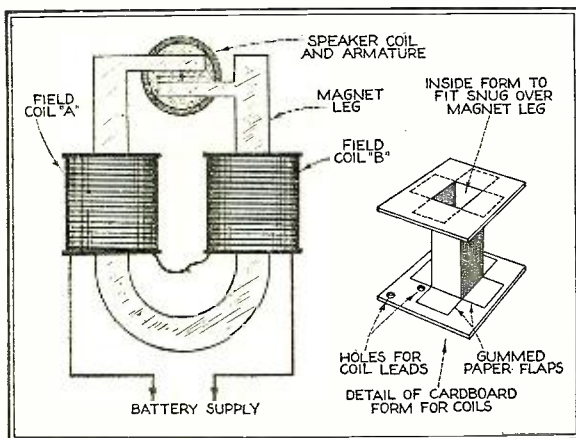


Fig. 1

boost that already furnished by the magnet, which is comparatively easy if the compass test method is used.

### A "Kink" of Audio Impedance

A number of experimenters claim that when the secondary of an audio transformer is used as an audio impedance, it is better to use an audio transformer whose primary is burnt out, although a transformer with a good primary may be used. The reason seems to be, writes Mr. Han Te-Chan, of Peiping, China, that the primary coil may set up stray currents

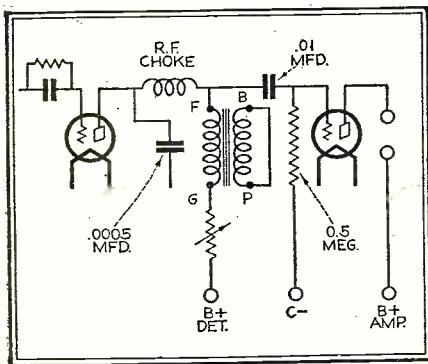


Fig. 2

by induction, which will undoubtedly cause distortion. Having built one stage of impedance-coupled audio amplification, using the secondary of an audio trans-

# The Serviceman

## Practical Kinks for the Serviceman

**P**RACTICAL tricks" that take years of experience to learn can usually be told in comparatively few words. The serviceman who makes use of not only his own methods of procedure but the accumulated practical experience of others, can accomplish more in less time. Kinks that are invented by one serviceman may not occur to another. The wide-awake repairman can save considerable time and expense by employing some of the servicing tricks used by the writer, Mr. Clyde A. Randon, Oakland, Calif., in eliminating the ills of broadcast receivers, thus amplifying the happiness of customers in less time and, of course, with a showing of greater profits.

"One of the most common jobs for a serviceman is the lining up of stages of a multi-tuned receiver, so that all of the tuned circuits in the radio-frequency stages are resonant at the same frequency. There are various methods of doing this, but some of these leave much to be desired, in the way of convenience and cost of equipment.

One good method of adjusting the various stages is shown in Fig. 1. This method requires an oscillator with a grid meter in series with its grid leak. The circuit and construction of such a grid dip oscillator are shown in Fig. 2.

In Fig. 1, the tuned circuits of the re-

ceiver are represented as parallel circuits of inductance and capacity, having also in parallel the trimming condensers and the minimum capacity of the tube, condenser and wiring. The objective to be attained is to adjust the tuned circuit consisting of a total shunt capacity and the coil in parallel in each stage so that when the condensers are varied, all three tuned

should be the one having no auxiliary capacity adjustment. That is, if the set employs three tuned stages and only two are provided with trimmers, the condenser without a trimming condenser should be clicked on the oscillator first, the other stages being lined up to the first with respect to it. With the grid current at minimum, move the test clip to the condenser of the succeeding stage and vary the trimmer until the grid current again is at a minimum. This procedure is repeated until all stages have been lined up, then the whole process should be repeated for best results.

The method described above is, in principle, the same as an oscillator feeding an antenna by the voltage-feed method. When the tuned circuit is in resonance with the oscillator, maximum power is absorbed from the oscillator, the voltage across the oscillating circuit decreases and consequently also the grid current which flows into the grid during the positive portion of the cycle, which depends upon the voltage. This current flows through the grid-leak resistance, causing a voltage drop which biases the grid of the oscillator when the tube is oscillating.

In the usual receiver, one side of each of the condensers in the tuned circuit is connected to the filament, so all three tuned circuits are connected together through a common filament lead or ground. The tuning of each stage is not

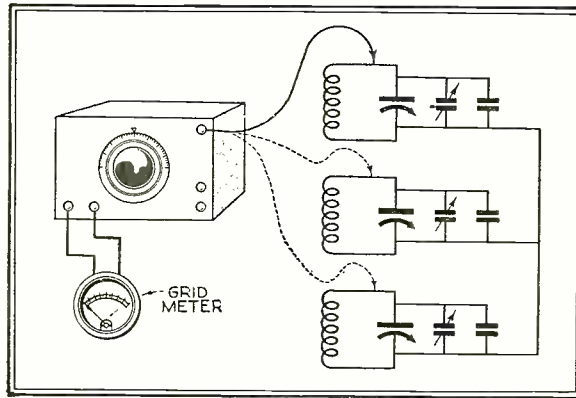
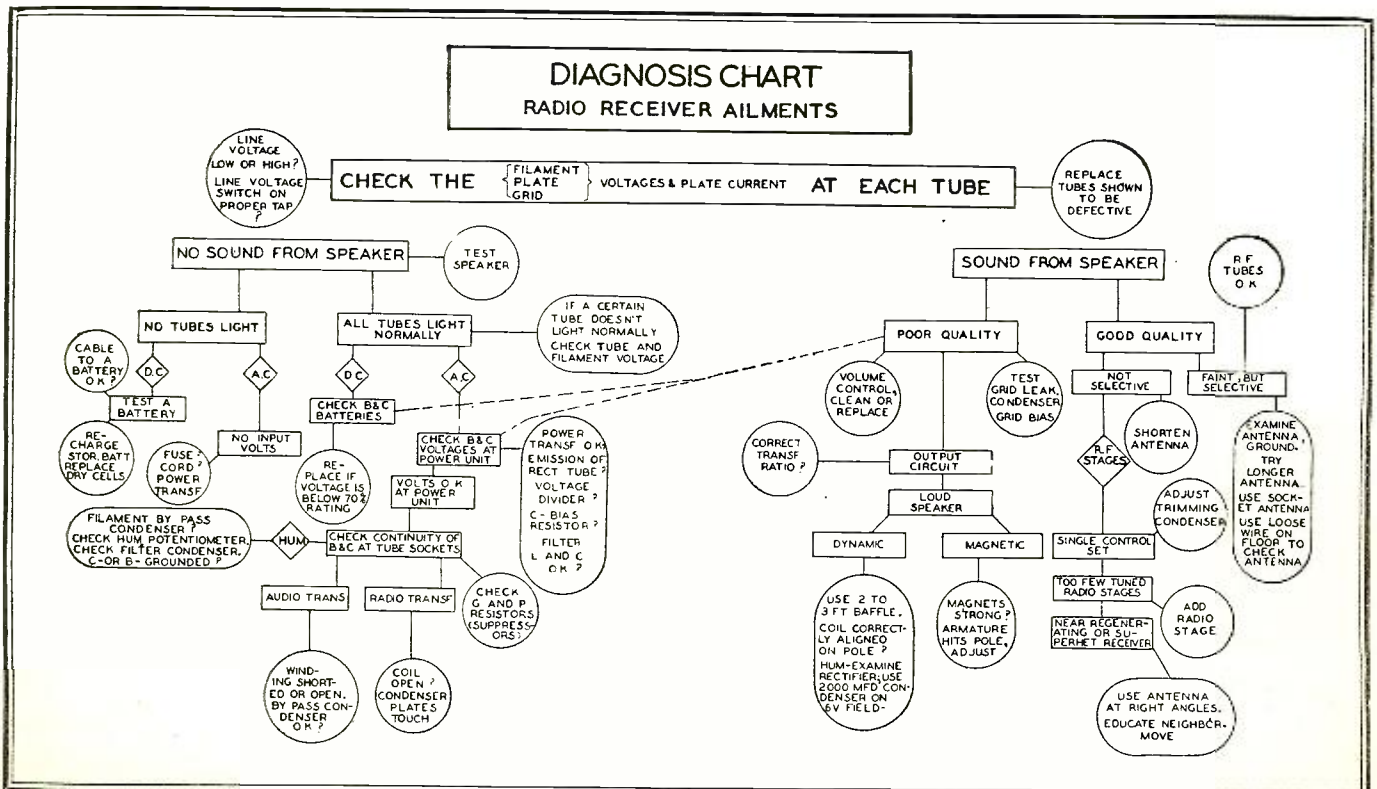


Fig. 1

circuits are at resonance at the same frequency at the same setting of the main dial. The discussion here, however, should be considered as general. Some sets may have only two tuned circuits and trimming condensers on all three stages are not, in general, employed.

The procedure in lining up the stages is to connect the test clip to one of the condensers and vary the oscillator frequency until the grid current drops to a minimum. The first condenser used

(Continued on page 173)



An excellent example of a trouble-shooting chart for diagnosing common receiver ailments, prepared by R. C. Hitchcock

# On Short Waves

## Frequency or Wavelength Measurement for the Short-Wave Fan

With the good quality factory-built receivers available for operation on the broadcast band, there is little to warrant either the interest or the time it may take to construct a wavemeter or frequency-meter. However, with the advent of short-wave broadcasting, along with the many homemade receivers built for operation on wavelengths as low as 14 meters, the wave-meter, here described by Mr. J. E. Watson of Sioux Lookout, Ontario, Canada, becomes a very useful and inexpensive piece of equipment. Many new stations can be heard almost nightly on the higher frequencies, and with the aid of this simple device, their wavelengths, or frequencies, can be quickly determined. Before proceeding further, first let us make clear the relation of wavelength to frequency. When we wish to state the exact position of any station in the broadcast band, we can either say a station is operating on a frequency of so many kilocycles, or a wavelength of so many meters. The above can be considered as being two means to one end. Although frequency and wavelength are related, they are by no means the same thing. Frequency is the number of complete waves occurring in one second of time, while wavelength denotes the length of one complete wave. The speed, or the velocity of radio waves, is always constant, regardless of length or frequency, and is given as 186,000 miles or about 300,000,000 meters per second. In that case it can easily be seen that if it takes one wave or one cycle one second to occur while traveling at the above speed, then the wave must be approximately 300,000,000 meters in length. Also we see that if 300,000,000 waves occur in one second traveling at this speed, one wave must be one meter in length.

Frequency and wavelength can be said to be inversely proportional to each other and if either is known, the other can be easily found by substituting,

$$\text{Frequency} = \frac{\text{velocity}}{\text{wavelength in meters}} \div 1,000 = \text{kilocycles.}$$

$$\text{Wavelength} = \frac{\text{velocity}}{\text{frequency in kilocycles}} \div 1,000 = \text{meters.}$$

The position of any station on radio channels can be measured in either wavelength or frequency. Engineers and scientists have practically discarded the term wavelength and are now speaking in terms of frequency, claiming thereby a greater degree of accuracy.

A wavemeter or frequency-meter is the same instrument entirely, the only difference being that one is calibrated in

meters and the other in kilocycles. A simple wavemeter hook-up is shown in A, Fig. 1. This merely consists of a coil L and the .00015 mfd. variable condenser C. The condenser is mounted in a box about 6" x 6" x 6" in size and preferably made of aluminum or copper. The two condenser connections are brought out to two tip jacks at the side of the box. It is important that neither the condenser nor tip jacks touch the metal box. Many methods of avoiding this will, of course, suggest themselves to the builder. Several different size coils will be required to cover the different ranges of wavelengths. It is advisable to make each coil to cover a comparatively small range, as this will result in more accurate measurement. The construction of the coil is very important in so far as they must be made sturdily, so that there is no danger of the turns being disturbed by constant handling and thereby changing the characteristics of the meter. These coils and their pins are made to fit into the two tip jacks on the wavemeter, and can be wound with No. 20 d.c.c. wire on bakelite or fibre forms about 2" in diameter. The first coil should be wound with three turns spaced about 1/8" between turns. This will allow the meter calibration to start at 14 or 15 meters. The remaining coils can be increased in size progressively by 2 turns each and sufficient coils can be made to cover whatever wavebands desired. The meter constructed, the short-wave fan can now proceed to calibrate it very carefully.

receiver oscillating and tune the carrier wave to its lowest pitch. Then move the wavemeter close to the set and turn the wavemeter dial until a loud click is heard. If the meter is too close to the receiver, two clicks will be heard, in which case move the meter slowly away until just one click is heard. Be sure to set the wavemeter condenser dial exactly on the point of the click and note the reading. Suppose the reading is 50, now find the wavelength (the bottom figures on the squared paper), which in this case is 19.56 meters, then move up in a straight line until the cross line marked "50" is reached in the dial reading figures. Place a dot at the point where the two lines meet. This is shown at X in C, Fig. 1. This process is repeated with various stations until the graph sheet has several dots on it. When this is done, take a pen and join the dots by a thin curved line which will look like that in C, Fig. 1. It is quite probable that some of the dots will be out of line, in which case just ignore them and make a smooth curve. The above procedure should be repeated with each coil, using a separate sheet for each and advancing the wavelength reading by 5 or 10 meters in each case. The calibrations finished, it is an easy matter to measure the wavelength of any unknown station, providing, of course, the station is within the range of the coils calibrated.

To read the wavelength of any unknown station, tune the station by the click method and note the wavemeter dial reading. Find this reading on the graph sheet and trace across to a point on the plotted curve and at this point trace downward to the wavelength reading, which will be the wavelength of the station being received. Assuming the dial reading is 40, this is shown by the dotted line in C, Fig. 1, and gives the wavelength at 18.5 meters. If desired, the meter may be calibrated for frequency by substituting kilocycles for meters at the bottom of the chart. However, do not forget that frequency varies inversely to the wavelengths, so that the kilocycles must commence at the opposite side of the sheet.

This is also shown in C, Fig. 1.

Short-Wave Editor,  
RADIO NEWS,  
Sir:

I have built the Junk Box Short-wave Receiver from blueprint No. 58 and have had good luck with it. If anyone building the "Junk Box" receiver will faithfully follow the instructions, they will have a real set. The following are a few of the phone stations I have heard: 9FM, 3MM, 9MFB, WTHA, W9C, W2BL, W9RS, 9RE, W8M, WHRW, CBYB, W8BY, W8OO, W9ATA, WPXA, 8BLO, 8KS, W9WA, HHW, HHLL, HOJ.

OSCAR CORWIN.

Frankfort, Ind.

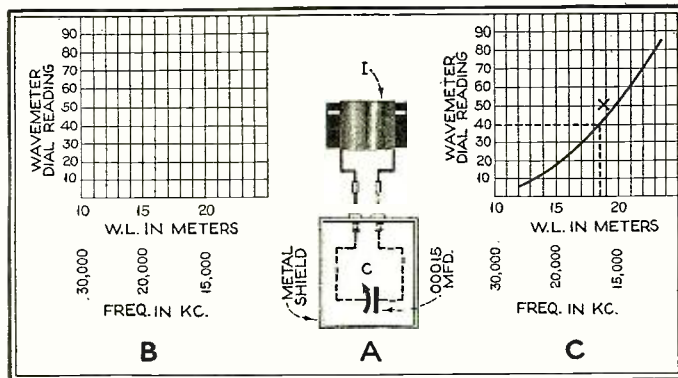


Fig. 1

First obtain a list of short-wave stations in which the wavelengths are given and also several sheets of squared paper. Take one of the sheets and mark on the top "Coil No. 1," then start at the bottom left-hand corner and number the lines, as in B, Fig. 1. The vertical lines represent the dial readings of the wavemeter condenser from 0 to 100 and the horizontal lines are the wavelength readings from 10 to 25 meters. The squared paper is now ready for the calibration curve. First tune the receiver to anywhere between 10 and 25 meters and listen for some station. Suppose the first station heard is W2XAZ at Schenectady, whose wavelength will be found in the list as 19.56 meters. Do not tune the station right in, but leave the



## ASTOUNDING! THE IMPROVEMENT IN YOUR RADIO WITH EVEREADY RAYTHEON TUBES ◀◀

WITH a set of new Eveready Raytheon 4-Pillar Tubes in your radio, a full-fledged orchestra no longer filters through the loud speaker like a tea-room trio. If there's a French horn there, you can hear it, and that "banjo" you've been listening to now sounds like the piano it really is. To keep your radio at its best, put a new Eveready Raytheon Tube in each socket, *whenever the tone begins to sound fuzzy.*

### A SOUND improvement

Examine the illustration. It shows the patented Eveready Raytheon 4-Pillar construction. Follow the arrows to the solid, four-cornered glass stem — and to the four rigid pillars imbedded in it, bracing the elements hard and fast.

While the elements of other tubes can be knocked out-of-line by even ordinary bumps and

jolts, Eveready Raytheon elements always stay *anchored* — at the spot where they give you rich, clear, *real* reception.

No other tubes are like Eveready Raytheons. No others can be — the 4-Pillar construction (a SOUND improvement) is patented!

Eveready Raytheon 4-Pillar Tubes come in all types. They fit the sockets in every standard, A. C. and battery-operated receiver now in use.

\* \* \*

The Eveready Hour, radio's oldest commercial feature, is broadcast every Tuesday evening at nine (New York time) from WEAJ over a nation-wide N. B. C. network of 30 stations.

NATIONAL CARBON COMPANY, INC.

General Offices: New York, N. Y.

Branches: Chicago Kansas City New York San Francisco

Unit of Union Carbide  and Carbon Corporation

## YOU CAN HEAR THE DIFFERENCE AND SEE THE REASON

# Interpreting Receiver Performance

(Continued from page 117)

consideration practical problems involved in the design of a radio receiver.

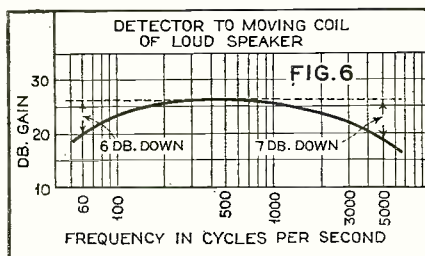
Before considering in detail the method worked out for rating receivers a brief description will be given of the manner in which the laboratory measurements are made. In the first place, the overall tests are made in accordance with the standard methods recommended by the Institute of Radio Engineers. These methods make use of a standard signal generator, from which very small modulated radio-frequency voltages can be obtained, and devices for measuring the power in a fixed resistance connected across the output of the receiver. For sensitivity and selectivity measurements the fundamental circuit of Fig. 1 is used. The signal generator is connected, in series with a standard four-meter artificial antenna, across the antenna-ground system of the receiver. The signal from the generator is modulated 3 per cent. at 400 cycles. The output voltage from the signal generator required to produce the standard output of 50 milliwatts in the load resistance R gives the total microvolts input for standard output. Dividing by four gives the sensitivity in microvolts per meter. Measurements of sensitivity are made at a sufficient number of points between 550 and 1,400 kc. to permit the plotting of an accurate curve. A sample of such a curve is given in Fig. 2.

Selectivity is measured by first adjusting the generator to give 50 milliwatts in the load resistance and then gradually varying the frequency either side of the resonant frequency, always adjusting the generator output to give 50 milliwatts in the load resistance. This is continued until the input must be 100 times greater than its value at resonance to produce the standard output of 50 milliwatts. This test is made at 1400 kc. for reasons to be explained later.

Fidelity measurements are made from the detector tube to the moving coil of the electrodynamic loud speaker. The audio amplification is expressed in decibels.

Now we will explain how these laboratory measurements have been used as a basis for the rating of receivers on a percentage basis. First we will consider the method of rating sensitivity.

The smaller the input voltage required from the standard signal generator to give standard output the more sensitive is the receiver. For example, if a particular receiver gives 50 milliwatts output with an input of 10 microvolts per meter, it is a much more sensitive receiver than another set which requires 40 microvolts per meter input for standard output. According to our method of rating sensitivity, a set requiring only one microvolt per meter input for 50 milliwatts output has a rating of 100 per cent. No receiver we have measured has been found to be this sensitive. A rating of zero has been given to a receiver requiring 100 microvolts per meter input, for with such a set it would be possible to get only a very few out-of-town stations and in fact it would be difficult to get satisfactory re-



A fidelity characteristic measured between the detector and the moving coil of the loud speaker. This curve in conjunction with that in Fig. 7 determines the fidelity rating

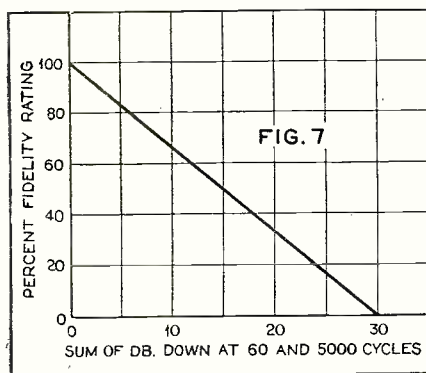
ception from weak local stations. But some receivers have excellent sensitivity at some parts of the broadcast band and very poor sensitivity at other parts of the band. We therefore take an average of the sensitivity at 600, 1,000 and 1,400 kc. And since the ear hears according to a logarithmic law, the per cent. rating as a function of sensitivity is arranged to follow a logarithmic law. The curve showing how the rating is determined from the average sensitivity is given in Fig. 3. An example will make clear exactly how this curve is used. Suppose a set is measured and the following data obtained:

Frequency	Sensitivity in microvolts per meter
600	60
1000	5
1400	20

The average sensitivity of the above receiver would be

$$\begin{aligned} \text{Average sensitivity} &= \frac{60 + 5 + 20}{3} \\ &= \frac{85}{3} \\ &= 28.3 \text{ microvolts per meter} \end{aligned}$$

Then referring to the curve of Fig. 3, we find that a set with an average sensitivity of 28.3 microvolts per meter gets



The fidelity rating is determined by measuring the loss in db. at 60 and 5,000 cycles, adding them together to obtain the overall loss and then using this figure of overall loss to determine the fidelity rating from this curve

a rating of 27 per cent. A set with an average sensitivity of 10 microvolts per

meter would be rated at 50 per cent., and so forth.

The selectivity rating is determined as follows: The selectivity of all receivers is approximately the same at the low broadcast frequencies, but at the higher frequencies the selectivity becomes much poorer and there is a wide variation between different receivers. We therefore use the selectivity at 1,400 kc. as a basis of comparison. What we do is determine the band width at 100 times normal input. Exactly what this means can be understood by referring to the curve of Fig. 4 which is a sample selectivity curve. This curve shows the ratio of the input voltage off resonance and the input voltage at resonance required to produce the standard output of 50 milliwatts. Referring to Fig. 4, at 20 kc. off resonance the input had to be increased 3.5 times; at 40 kc. off resonance the input had to be increased about 22 times; at 60 kc. off resonance the input had to be increased 100 times. For this particular set the band width at 10 times normal input is 60 kc.; at 100 times normal input the band width is 122 kc. These two points are indicated on the curve. As a basis of comparison we take the band width at 100 times normal input. Therefore if a set has a band width of 40 kc. it means that if our signal were 20 kc. off resonance on either side, the input to the set would have to be one hundred times greater to give the same loud speaker output that we would have obtained were the set tuned to the signal. Since the sides of the selectivity curve are quite straight, a set with a band width of 40 kc. at 100 times normal input would have a band width of about 20 kc. at 10 times normal input. This means that a station of equal strength on an adjacent channel (10 kc. off) would only produce one-tenth the signal in the detector, and this is not enough to interfere with reception of the station to which the set is tuned. Therefore a set with a band width of 40 kc. can be said to have "10 kc. selectivity." Consequently, we have given a receiver with a band width of 40 kc. at 1,400 kc. a rating of 100 per cent. in selectivity. The curve Fig. 5 of per cent. rating against band width has been made steeper in the neighborhood of 40 kc., for a given improvement in band width here is much more difficult to obtain and is also worth much more than the same improvement at a band width of, for example, 100 kc. Specifically, the per cent. selectivity rating is therefore determined by adjusting the set to 1,400 kc. and measuring the band width at 100 times normal input. Knowing the band width, the per cent. rating can then be easily determined from Fig. 5.

The fidelity curve is measured from the detector to the moving coil of the loud speaker. The overall audio-frequency amplification is expressed in decibels, which is a logarithmic unit, chosen because it bears a direct relation to the characteristics of the ear. The useful frequency range is taken as from 60 to 5,000 cycles per second and a set

(Continued on page 166)

# SENSATIONAL!

Scientist perfects long sought device



- Hopkins'
- amazing
  - new invention
  - approved by experts

## Now an exclusive feature of the 1931 HFL Mastertone

At last! Radio perfection is realized. After three years of intensive research work, assisted by a corps of laboratory experts, Mr. Charles L. Hopkins, noted radio scientist, has actually developed the first practical band rejecting amplifier. This miraculous new system, long the dream of radio designers, permits the construction of a remarkably efficient receiver which is ideally perfect in operation. Stations over the entire continent may now be received with an ease of tuning, unprecedented clarity of tone and total lack of interference that astonishes engineers and fans alike.

### • Interfering Stations Rejected

Application of the Hopkins principle to the 1931 HFL Mastertone has immediately resulted in three outstanding improvements. Now, for the first time in radio history, it is possible to tune in an exact 10 kilocycle channel to the complete exclusion of everything else on the air. Not 9 or 11 or 16 kilocycles, but 10—with mathematical accuracy. Stations on each side of the selected band are sharply cut off and *actually rejected*. This heretofore unattainable action now takes place over the entire tuning range. The set does not "go broad" even on the highest wave lengths.

### • Tonal Perfection Realized

The salient feature of the Hopkins band rejector system is that it handles all musical frequencies with an absolutely even intensity. No sacrifice in selectivity is made in order to obtain these marvelously realistic tonal reproductions. Although the 1931 HFL Mastertone maintains a precise 10 kilocycle signal channel at all times, every note and each delicate overtone *right up to 5000 cycles* comes through with a life-like quality that is a revelation. Far distant stations have the same superb tones due to the complete elimination of all local interference.

### • 12,500 Mile Reception

Engineers the country over proclaim the 1931 HFL Mastertone to be the greatest long distance receiver ever designed. Its range is easily 12,500 miles (world-wide reception) whenever weather conditions permit such distances to be covered. Five 224 screen grid, two 227, two 245 and one 280 tubes are employed. A tremendous reserve power of *over 400 per cent* is available. The Mastertone is unconditionally guaranteed to receive any station on earth that can be heard with a radio set.

### • Ultra Modern

In addition to the Hopkins RF amplifying system the 1931 HFL Mastertone incorporates every modern improvement known to science. One dial, one spot, 180 K.C. intermediate amplifier. Resistance coupled, push-pull phonograph amplifier, controlled from panel. Puncture proof, high voltage, humless Electrofarad filter condensers. Self contained, all steel heavily cadmium plated chassis. Doubly shielded radio frequency circuits and dozens of other entirely new features. Our FREE literature gives complete information and prices. *Send for it today!*

DEALERS: The New Mastertone is the sensation of the century. Get in on the biggest radio boom ever known. Rush this coupon attached to your business letterhead for special proposition. **ACT QUICKLY!**

## HIGH FREQUENCY LABORATORIES

Dept. C, 3900 N. Claremont Ave., Chicago, U.S.A.

HIGH FREQUENCY LABORATORIES, Dept. C  
3900 N. Claremont Ave., Chicago, U.S.A.

Gentlemen: Please send me your FREE literature and photos of the 1931 HFL Mastertone.

- Check here if your name is *not* on our mailing list now.
- Check here if you have been receiving mail from us.

Name.....

Address.....

City..... State.....

(PLEASE PRINT PLAINLY)



**Send This Now!**

This coupon is not an order  
... you incur no obligation

# HFL

## Book Review

### *J' Ai Compris La T. S. F.!* (I Have Understood Wireless)

By E. Aisberg, Radio Engineer

Published by Etienne Chiron, Paris, France. 146 pages.

This book is a simplified explanation of radio more or less in theory as well as in practice. The copy we have received is a translation from Esperanto. It has also been translated into Portuguese, Roumanian, Bohemian and Bulgarian. The French edition which lies before us was published in Paris and it is altogether a very charming work. It comprises 16 dialogues. They are supposed to take place between an investigating young man called Curiosus, who is of the interesting age of 16 and is supposed to know a little of physics and mathematics. The other participant in the dialogue is his uncle, Radiol, 35 years old and a radio engineer. He is supposed to be a little sarcastic, imperturbably calm, but not at all the school teacher. It is left to the reader to judge whether he is really lazy or whether he only puts it on, to make his young associate do some thinking for himself.

The text starts at the very beginning of the subject, gives numerous analogies with bewildering figures when it comes down to atoms in a gram of hydrogen, and it soon takes up the subject of waves. It goes on to give a very clever talk on the subjects of wireless and of telegraphy Edison effect, and after this starting off, the subject of wireless and of telegraphy are taken up. In the sixth dialogue, now that the general elementary theories have been talked over by the two, we come to the heterodyne, a word which puzzles the young man, Curiosus, and then for an analogy snowballs are brought in. The current increases, but not indefinitely, because the saturation point is reached, while the snowball fails in the analysis because it might increase indefinitely except for melting, so melting is used in the comparison.

We now come to diagrams and hook-ups, the Morse alphabet is given and in consequent chapters the same system is carried right through, making it as popular as possible, but sacrificing no particle of accuracy in the popular treatment. Even in the 16th, the last chapter, the same system is kept up. Inertia is illustrated by a pile of checkers and a ruler. At last, in the closing section, we do run across in footnotes some simple algebraic formulas; otherwise mathematics are omitted. Finally, quite a complete heterodyne hook-up is given in a diagram.

The book is printed on heavy mat surface paper, which spares the eyes of the reader and seems to make it a sort of an *edition de luxe*. It is to be wished that more books were printed in this most attractive style. The illustrations are of the attractive sketchy type, in many cases giving the book a decidedly French aspect, a nation that excels in this very charming system of illustration. Many of the pictures are given on the margins.

## Electrodynamic Reproducers

(Continued from page 112)

winding may have a resistance of 250 to 300 ohms.

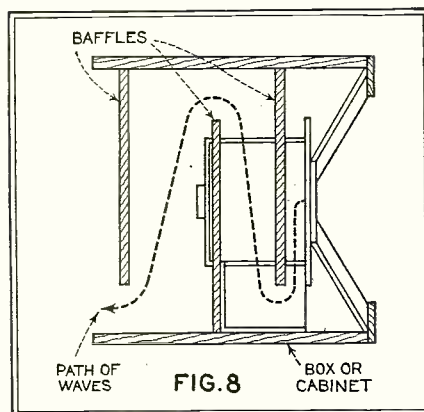
Due to the low impedance of the moving coil winding on the dynamic reproducer and the high impedance of the plate circuit of the power tube, a corrective transformer must be inserted between the two. (This transformer is often called an output transformer when referring to the receiving set, and an input transformer when referring to the speaker.)

The design of this transformer involved the solution of several problems, the core dimensions, the primary winding impedance, the ratio, and the size of wire.

The shape and size of the core depends largely on whether the transformer is to be used in the plate circuit of a single output tube or in a push-pull circuit. In the latter case the plate current of one

the resistance of the moving coil winding.

In conclusion, it will be well to bring out a few points concerning the installation and care of this speaker. It is necessary that the moving coil be free to move in and out of the gap at all times without touching any part of the field structure. In cases where the coil touches, a loud buzzing or scratching sound destroys the quality of the speaker. The cone should be supported to swing rather easily. In many cases the cone on a well designed speaker will move a total distance of three-sixteenths of an inch or more. This motion occurs at the low frequencies, and causes a large variation in the air pressure at a given instant between the front and back of the cone. To prevent this pressure from pushing the air around the edge of the cone and its housing, a baffle-board or its equivalent is necessary. This article was thoroughly discussed in a recent issue of this publication. In cases where an electrodynamic reproducer must be used in a small cabinet a multiple baffle as outlined in Fig. 8 has been designed by the author and gives excellent results. The diagram is self-explanatory as to the construction. By proper location of the baffle plates some "horn" effect may be added and the speaker will handle a greater amount of signal energy without increasing the cone dimensions.



A sketch showing the general constructional details of a proposed dynamic speaker baffle, showing the obstructed path to the rear which confronts the back sound wave

tube produces a flux in the core which balances out the flux due to the current through the other tube. In the case of a single-tube output the plate current tends to saturate the iron unless ample in size, or provided with an air gap in the magnetic path.

Two factors to determine first in the design or selection of a transformer are: the impedance of the plate circuit of the output tube, and the resistance of the moving coil. The ratio of these values represents the square of the proper ratio. The actual number of turns that will give best results, however, depends somewhat upon the size and shape of the core, the magnetic saturation, that material used in the core, and several other less important items. It is beyond the scope of this general article to take up these details. However, as an approximation, using a core of ordinary size for audio transformer use, 3,000 to 4,000 turns give excellent results. In the case of a push-pull circuit, about 40% more turns should be added and a tap brought out at the center of the winding. Having computed the correct ratio and decided upon the number of turns on the primary, the turns required on the secondary can be determined. The size of wire on the secondary can be large, and the secondary winding should have a resistance much lower than

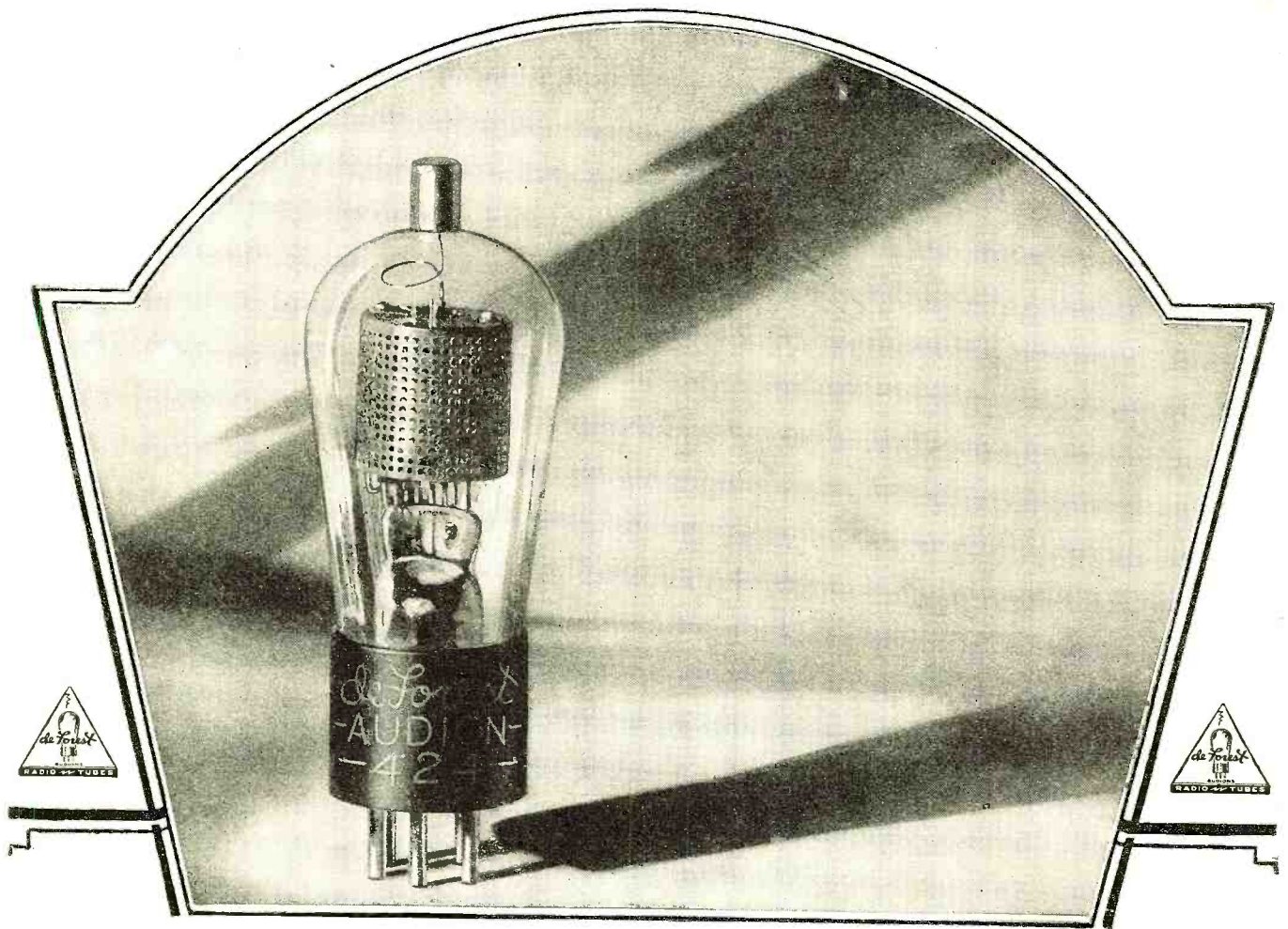
## Interpreting Receiver Performance

(Continued from page 164)

is given a 100 per cent. rating if it amplifies all these frequencies equally well. Most sets do not give uniform amplification, however, and as an indication of how much it varies we take the difference between the amplification at 60 and 600 cycles expressed in db. and add to this the difference in amplification at 500 and 5,000 cycles. This gives the total variation in db. from uniform amplification. A set with a total rating of 30 db. has been given a rating of zero and, as stated previously, a set with no variation has been given a rating of 100 per cent. The curves of Fig. 6 and Fig. 7 indicate graphically how the per cent. fidelity rating is determined. In this particular case the characteristic Fig. 6 is down 6 db. at 60 cycles and down 7 db. at 5,000 cycles, giving a total variation of 13 db. According to the curve of Fig. 7, a set with a total variation of 13 db. is rated at 57 per cent.

A careful reading of the preceding discussion will indicate that these methods of rating receivers take into consideration practical problems involved in the design of good receivers—they are *not* arbitrary standards set up without reference to present-day commercial design. The characteristics required to give a 100 per cent. rating in any one of the three characteristics are better than are to be found in any existing receiver—the 100 per cent. rating represents an ideal toward which an engineering department can aim.





## The prestige of selling the original radio tube

**T**HE retailer is known by what he sells—particularly merchandise like radio tubes. For after all, the average listener does not understand or appreciate the technical differences between tubes.

There are two factors which largely influence his choice of tubes—your recommendation and his faith in the name of the maker.

The radio owner knows the name De Forest. He recognizes it as evidence of standard, uniform quality and dependability.

It is to your advantage to recommend De Forest Radio Tubes. These high-vacuum, long-life tubes improve reception and increase the satisfaction of your customer. And the recent De Forest price reduction cuts the cost to him from 20 to 25%.

Push De Forest Radio Tubes—produced under the supervision of the man who invented the first radio tube in 1906, Dr. Lee De Forest. It will bring you more business, added good will and greater prestige—which means that De Forest Radio Tubes are the most profitable tubes you can handle.

• DE FOREST RADIO COMPANY • PASSAIC, N. J. •

*Branch Offices Located in*

Boston • New York • Philadelphia • Atlanta • Chicago  
Pittsburgh • Minneapolis • St. Louis • Kansas City • Los  
Angeles • Denver • Seattle • Detroit • Dallas • Cleveland  
Export Department : 304 East 45th Street, New York City

**de Forest**  
AUDIONS

**RADIO TUBES**

# Sensitivity, Selectivity and Quality

(Continued from page 150)

tuned radio-frequency transformers are not as selective as they might be, due to the presence of the primary. Thus it would seem natural to use a number of tuned circuits before the first amplifier tube. The idea of pre-selection and band-pass filters is not new, as it dates back to the John Stone "Stone Tuner," where a number of tuned circuits were coupled together to obtain sharp tuning and the signal then amplified through an untuned system.

The idea of pre-selection, or at least two tuned circuits before the first amplifier tube, has several advantages. First, as has been indicated, it gives additional selectivity. Second, it eliminates cross-talk or cross-modulation. This phenomena of cross-talk or cross-modulation occurs where a receiver is located near a powerful local station. Apparently the receiver will be very sharp; however, if a semi-distant station is tuned in, the local is heard in the background. The cause for this lies in the fact that there is not sufficient selection before the first radio amplifier tube, consequently sufficient signal from the local is present on the grid of the first tube to overload the tube and make it operate as a detector, thus mixing the local signal with all others that are tuned in. During the past year many commercial sets located near powerful stations have been considerably troubled with cross-talk and unless some type of pre-selection is used more trouble will be caused in the future because of the steadily increasing power of the transmitting stations. Third, by coupling two tuned circuits together in the correct manner, a tuning curve will be obtained which has a comparatively flat top with relatively straight sides. Moreover, this tuning curve may be made sharper on the high frequencies than it is on the lower ones, thus compensating for the inverse selectivity characteristics of the tuned radio-frequency transformers.

To get a better idea of the selectivity and band-pass effect in two coupled circuits, let us consider the arrangement shown in A of Fig. 5. A current is set up in circuit I due to a signal from an antenna-ground system. Some of this signal tuned in on circuit I can be transferred to circuit II in a number of different ways. First, the two coils might be close together so that the magnetic field set up by a current in one links with the other, in which case the two are magnetically coupled. Second, there may be some inductance common to the two circuits, Fig. 5-B, in which case they are inductively coupled. Third, a capacity may be common to both, and in this case they are said to be capacitatively coupled. If the coupling between the two is small, a resonance curve is obtained, such as shown in Fig. 6, curve A, where voltage across circuit II is plotted against frequency. If the coupling is increased, the resonance curve changes to that shown by B, while further increasing coupling gives rise to curve C. It will be noted in this curve that there are two distinct peaks, and that these give somewhat the effect of a band-pass filter. When the coupling

was small (called deficient coupling), the voltage built up across circuit II was small, and as the coupling was increased, this voltage increased up to a certain point (critical coupling). Increasing the coupling to a value greater than critical simply had the effect of giving two resonance peaks very close together and did not increase the voltage across circuit II. Thus two tuned circuits with coupling between them of a sufficient value have the property of making an imperfect band-pass filter.

The next thing to consider is the width of this band-pass effect, as the circuits are tuned to incoming signals whose frequencies vary over the broadcast band. It is found that if the two circuits are coupled magnetically, or inductively, that the band gets wider as the frequency is increased. This is shown in Fig. 7. However, if the coupling is due to a common condenser, the band width narrows as the frequency is increased. Therefore, if it is desirable, a combination of these two types of coupling correctly chosen would result in the band width remaining practically constant all over the broadcast band.

It remains now to consider detector circuits. There are three main methods of detection: grid leak-condenser, "C" bias detection, and what is commonly known as power detection. The grid leak and condenser method is sensitive but introduces some distortion and overloads readily; the "C" bias method is less sensitive but will give very little frequency distortion; while the power detection method, though not so sensitive, is extremely hard to overload.

Having thus discussed at some length the advantages and disadvantages of the various systems which might be employed in a radio-frequency tuner, it remains to choose those most suited and to carefully design the individual pieces of apparatus so that each will fit satisfactorily into the complete tuner. Fig. 8 shows the complete circuit evolved. As will be noted, it consists of two band-pass circuits; two ordinary stages of tuned radio-frequency amplification; one stage of impedance-coupled radio-frequency amplification, and a power detector system with the -27 tube. In this article it is impossible, because of limited space, to go into the details of the design of band-pass circuits, radio-frequency transformers, and the untuned stage. It suffices to say that the band-pass circuits are so designed that when working in conjunction with the two tuned stages they give almost uniform selectivity all over the broadcast spectrum, without cutting side bands. The untuned stage was designed to bring up the amplification on the low frequencies, thus making the sensitivity of the tuner approximately equal all over the tuning range.

Very complete shielding was necessary to keep the circuits from oscillating. In this connection, a number of interesting things were discovered. For instance, the tuner would oscillate unless the variable condensers, as well as the tubes and the coils, were completely shielded. In the

first experimental model, a center resistance with a small amount of inductance was used across the filament circuits of the -24 tubes. The receiver oscillated, and no changes in arrangement of apparatus or by-pass condensers had the desired effect of eliminating this oscillatory condition. By some lucky chance, a by-pass condenser was placed from the filament circuit to ground and cured the trouble. Further experimentation to determine the effect of this condenser resulted in changing the center-tap resistance to one with practically no inductance. It was also found that unless the tube shields extended above the top of the screen-grid tubes that considerable signal was picked up on the exposed grip cap, and, in the case of the first tube, this meant that the signal thus introduced into the tuner did not pass through the first tuned circuit, thus causing an apparent broadness of tuning. By a step-by-step process it was found necessary to almost completely shield all parts carrying high-frequency currents, in order to obtain the extreme sensitivity desired and at the same time have a very stable tuner.

Unless the tuner is very close to a local station it is found that after placing a shield over the exposed antenna post that no signals whatever can be picked up. However, by removing this shield, locals can be tuned in due to the pick-up on the antenna post itself.

As a whole, the MB-30 is particularly well adapted for those who enjoy distance getting, as well as for those who require selectivity combined with natural reproduction.

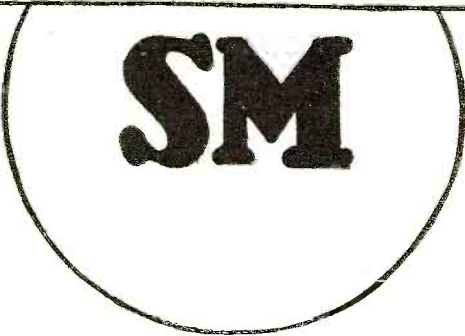
In the next article performance curves will be shown and some of the detail of design.

## Radiophone Links Hawaiian Islands

Washington, D. C.—Linking the telephone systems of four islands of the Hawaiian group by radio, and thence via Honolulu with the Trans-Pacific radio-telephone which within a year or two will connect Hawaii, the Philippines, Japan, Australia and New Zealand with North America, South America and Europe, is the ambitious undertaking upon which the Mutual Telephone Company of Hawaii has embarked.

Just as radio has made it possible to converse from almost any telephone in the United States and Canada with most of the telephones of Europe and a large portion of those in South America, the Hawaiian system has been projected to make inter-island conversations an everyday possibility.

Employing ultra-short waves for commercial telephony for the first time, the Hawaiian concern reports excellent results in five months of experimentation. Now it is asking the Federal Radio Commission for authority to use eight frequencies in the band from 35,000 to 54,000 kilocycles (8.75 to 5.56 meters) for a permanent inter-island service, which will be joined to the trans-Pacific system as soon as it is completed.

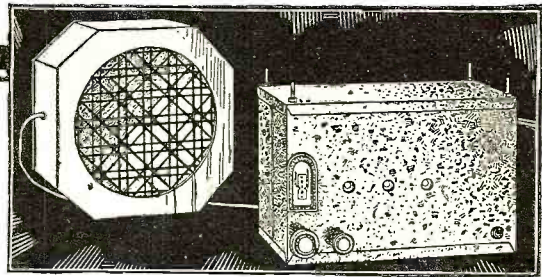


# You'll Put This Auto-Set In Your Own Car.

## S-M 770 Auto-Set

On the market the first of June, the S-M 770 Auto-Set has proven itself to have *everything!*

1. SENSITIVITY—2.5 to 14 microvolts per meter (an average of 8 over the broadcast band). That's one of the things that makes possible real console-model reception.
2. THREE SCREEN-GRID TUBES—giving you console-model wallop.
3. SCREEN-GRID POWER DETECTION—as you know, *five times* better than a '27 detector!
4. ABSOLUTE TUNING—directly through a regular S-M810 illuminated drum dial, eliminating dubious control through a "remote" shaft—another feature exactly like the finest console.
5. SMALL SIZE—12 inches long by 7½ inches high and 6¼ inches deep—a pocket edition expressly designed for its job.
6. NO CUTTING UP THE CAR—mounts on brackets under the cowl to the right of the driver's seat where the dial and controls are easily seen and accessible.
7. VIBRATION-PROOF—tests over hundreds of miles of rough back-country roads have proven this Auto-Set to be trouble-proof and shock-free.
8. SPECIALLY DESIGNED SPEAKER—9½ inches wide and only 3 inches deep, magnetic, with matched



impedances, fitting under the cowl to the left of the receiver.

9. STURDY—cabinet built of heavy sheet steel.
10. RESISTANCE-COUPLED DETECTOR—giving fidelity fully equal to modern full-size receivers.

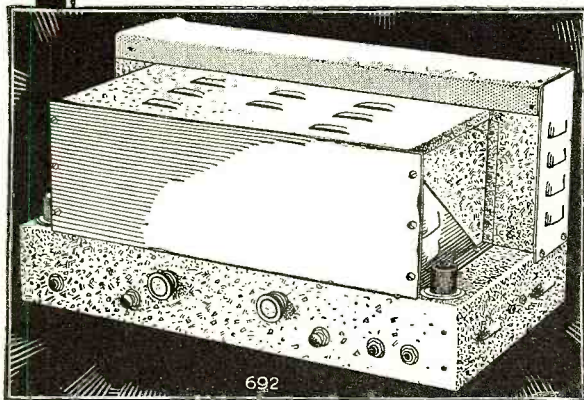
The Auto-Set was designed by the world-famous Silver-Marshall laboratories to give absolutely *everything* regardless of price—but the price is remarkably low:

770 Auto-Set, completely factory wired and tested, less tubes (3—'24, 1—'12A, 1—'71A) and speaker. Price \$79.50 list. Parts total \$61.40.

771 Auto-Set Accessories, including all installation equipment but batteries and speaker. Price \$17.50 list.

870 Automotive Magnetic Speaker (9½" wide by 3" deep). Price \$15.00 list.

## There's *Twice* the Wallop in the 692 Amplifier!



692  
S-M 692 Power Amplifier

The S-M 692 Amplifier combines perfect fidelity of tone with twice as much amplification as any other three-stage amplifier available today! Its unusual fidelity is due to uniform amplification of the higher harmonics in the 5000 to 10,000 cycle range. While most amplifiers cut off fairly abruptly around 5000 cycles, the 692 has as much amplification at 10,000 as at 400. The low-frequency end is exceptionally good, too, the curve going below 30 cycles and giving no peak in the 60 to 300 cycle range.

The 692 gets its power from any 105-120 volt, 50-60 cycle, a. c. source and has a voltage amplification of 4000 (72 d. b.) which comes primarily from the use of an a. c. '24 screen-grid tube in the first audio stage. It has a "Universal" input and will operate directly out of a 200-10,000 ohm pickup.

S-M 692 Amplifier completely factory wired and tested, less tubes, \$245.00 list.

S-M 872 Magnetic Speaker Unit is a chassis only with 10½" cone and has a special extra-large electric motor unit. Price \$20.00 list.

S-M 873 Low Impedance Magnetic Speaker is a flush-mounting wall type magnetic with volume control and three-station selector on panel. 11½" wide by 13½" long. Price \$35.00 list.

S-M 860 Auditorium Dynamic Speaker is designed for 110-volt, 60-cycle operation with built-in input transformer. Price \$60.00 list.

S-M 861 Auditorium Dynamic Speaker is the same as the 860 but for d. c. operation. Price \$48.50 list.

S-M 862 Auditorium Dynamic Speaker is the same as the 860 but without input transformer. Price \$55.00 list.

S-M 863 Auditorium Dynamic Speaker is same as 861 but less input transformer. Price \$43.50 list.

The Radiobuilder, Silver-Marshall's publication telling the very latest developments of the laboratories, is too valuable for any setbuilder to be without. Send the coupon for a free sample copy. If you want it regularly, enclose 50c for next 12 issues.

4000 authorized S-M Service Stations are being operated. Write for information on the franchise.

**SILVER-  
MARSHALL**  
Inc.  
6405 West 65th Street  
Chicago, U. S. A.

Silver-Marshall, Inc.  
6405 West 65th St., Chicago, U. S. A.

... Send your latest catalog (with new June first supplement) and sample copy of the **RADIOBUILDER**.

... 2c enclosed; send Data Sheet No. 22 on 770 Auto-Set and Installation.

... 2c enclosed; send Data Sheet No. 19 on the 692 Power Amplifier.

Name.....

Address.....

## Recorded Programs

(Continued from page 110)

phonograph pick-up the fulcrum is at the end and the weight of the arm is on the point, which is so fine that the pressure is equal to about 50,000 pounds per square inch. The electrical pick-up of the recording machine is delicately balanced. In addition, to maintain the correct depth of the cut, an advance ball rolls lightly on the surface of the wax, supporting the stylus. Another peculiarity of the broadcast disc is that it plays from the center towards the rim, exactly the reverse of commercial records, which start at the rim and play towards the center. The director is in the studio, the monitor in the control room. Another man is at the amplifiers and a recorder is at the turntables. So the program is recorded.

For the sake of economy of time, and that more work may be done each session, the program is not usually recorded in the order in which it is to be released, any more than are the scenes of a motion picture filmed in their proper sequence. All the shots in a certain scene are filmed first, then all the scenes at another location. Then they are placed in their proper order. The same takes place in recording. The soprano does some of her numbers. Then the orchestra plays many of its selections. The quartet sings its pieces at one session.

The waxes having been cut, they are taken to the galvano baths. Great care must be taken that the delicate lines cut in the soft wax are not spoiled. To avoid any mishap in transportation, the galvano baths of Sound Studios of New York are located in a building adjoining the recording studios. The cut side is prepared for plating and the disc attached to the end of one of the long arms which are suspended about the baths. On the end of the pendulum-like rod it swishes back and forth through the baths, which coat the cut side with a copper plate. This is called the "master," and when peeled from the wax is a negative, the lines being raised above the surface, whereas in the wax they were indented. The copper master is then placed in the press preparatory to making two test pressings. These pressings are made of an earth-shellac material, which is heated to the consistency of dough and placed with the master. Then under enormous heat and pressure the test pressings are made. These are taken to the review room and played before all the interested parties. The director, either Mr. Haenschen or Mr. Black, listens for artistic flaws. Mr. Charles Lauda, chief engineer, listens for distortions or other technical shortcomings. The sponsor or his representative is on hand. The test pressings having been approved, we are ready for the next step.

It might be thought that the next step would be to make the final pressings from the master as the test pressings were made. But this procedure is not used. If, in the pressing, the master should for any reason be marred, no impression of the performance would remain from which more pressings could be made. For the wax has been spoiled when the master was taken from it, and has already been shaved for use in recording other programs. So the master is electroplated,

the resultant copper disc being called a "mother." But this disc, like the wax, has its lines indented, having been made from the negative master. And since the final pressings also have indented lines, the mother cannot be used to produce the pressings. The master is filed for emergency or for filling future orders for discs of the same selections, and the mother is in its turn electroplated. The negative copper disc which this process produces is called the stamper. This is carefully ground and buffed and otherwise prepared.

Then the stamper is placed in the press, together with material for pressings, and the final discs are pressed out to the desired number. If many pressings are ordered, several stampers are made, since the use of one stamper for too many pressings lessens the clarity and sharpness of the discs after a time. These final pressings are then sent to the stations for broadcasting on Western Electric appa-

ratus similar to that used at Sound Studios for recording. So the fidelity is preserved.

In addition to the procedure outlined above, there are all manner of variations by which odd effects are gained. A detailed discussion of all these methods would be endless, for these tricks of the trade, similar to trick photography in motion pictures, is a thing which is constantly being developed.

Suffice it to say that recording apparatus and technique has advanced to the point where by the use of licensed recording companies, the preparation of fine programs and recording on the latest Western Electric equipment, results may be obtained so perfect as to be undetectable from the original performance when both are heard through the radio loud speaker. And the editing and effects that may be gained by dubbing make the recorded program so flexible that almost any desired effect may be gained.

For this reason is the recorded program coming into its own as the perfectly controlled vehicle for the presentation of programs over the air.

## Short-Wave Superheterodyne Receiver

(Continued from page 106)

ner would attempt. Such a receiver (commercially constructed) requires the skill of an experienced radio operator. Each and every inductance for each frequency band is shielded and the receiver takes up more room than two average size broadcast receivers. The tuning system is complicated and while the receiver is highly sensitive, it would be unsatisfactory for amateur or broadcast use.

Summing up and taking all these things into consideration, the task appears to be a hopeless one. The ideal type of receiver should embody many things and when these things are carefully set down, we find this list: Sensitivity, selectivity; ease of control; minimum controls (not more than two); to receive continuous waves as well as modulated waves and voice or music with good quality reproduction; smooth volume control; good mechanical design; good appearance; compactness and a receiver which can be moved from place to place if so desired. Certainly a large order! And yet, not so large when due consideration is given to the superheterodyne and the possibilities it presents. One of the very serious drawbacks of the short wave superheterodyne has been the difficulty of elimination of oscillation in the intermediate radio frequency stages of amplification. With the three element tubes, a variable resistor was provided to control oscillation. The voltage gain per stage was something between 6 and 8. Hence, everything that could be done made only for a fair receiver at the broadcast frequencies and considerably less than that at high frequencies. The screen-grid tube has been an answer, in a large measure, to all this.

At the lower frequencies a much higher gain can be obtained. For example, a voltage gain of 75 per stage is easily pos-

sible. Two such stages would give a total voltage gain of 5,625. The gain would be constant since the intermediate stages remain at some fixed frequency. This means a highly sensitive receiver and one which will be capable of picking up extremely weak signals which are not heard on the regular type of short wave receiver. The fidelity in reproduction should be better since no regeneration would have to be used. The intermediate stages can be made stable. For continuous wave reception, the use of a separate oscillator can be made to beat on the intermediate frequency—providing unmodulated or modulated reception at the flip of a switch. There need be but two controls, one for the detector and one for the oscillator. Volume control is not considered as being a part of the tuning control system.

The detector circuit in a superheterodyne receiver as in all other straight detector circuits, inherently is broad tuning. This can be sharpened to some extent by the addition of a preselection stage of radio frequency, untuned. The successful and efficient operation of a short wave superheterodyne most certainly hinges on the intermediate frequency amplifiers. Once this problem is thrashed out, it is only a question of careful assembly to complete a real receiver that has incorporated in it all the desirable things outlined above. This particular short wave superheterodyne receiver has these features:

It is highly sensitive, using a preselection radio-frequency stage ahead of the first detector.

The intermediate-frequency amplifiers have a gain of 69 per stage and there are two intermediate stages. The frequency is about 200 kilocycles (1,485 meters).

There are two tuning controls, detector  
(Continued on page 176)

# The NEW NATIONAL A. C. Thrill Box

DESIGNED BY NATIONAL ENGINEERS IN COLLABORATION WITH ROBERT S. KRUSE.

The NEW National SW-5 Thrill Box—a laboratory product for general use, bringing foreign short-wave broadcast reception within the reach of everyone.



**NATIONAL Precision Built Short Wave Apparatus is used by**

- General Electric Co.
- Westinghouse Electric and Mfg. Co.
- R. C. A.
- Tropical Radio (United Fruit Co.)
- Federal Tel. & Tel. Co.
- Western Electric Co.
- American Tel. & Tel. Co.
- Canadian Marconi
- U. S. Naval Research Laboratories
- U. S. Navy
- Signal Corps U. S. Army
- Jenkins Television Corp.
- Press Wireless, Inc.
- DeForest Radio Co.
- Universal Wireless Communications, Inc.
- U. S. Dept. of Commerce (Lighthouse Service)
- Pan-American Airways
- Curtiss-Wright
- Boeing Airplane Co.
- Western Air Express
- Roosevelt Field, Inc.
- Southern Air Transport

**T**UNES as easily as a broadcast receiver. Complete A.C. operation. No A.C. hum. Double screen grid. Single dial tuning. Push-pull audio loud speaker reception from foreign short-wave broadcast stations. Range from 14 to 115 meters. Can be readily adjusted for wide spread of different amateur bands. Sturdy construction. Attractive appearance. Projection dialing facilitates accurate logging. Special tuning condensers and dial construction eliminates "clicking" on higher frequencies.

Also available in battery-operated models with new UX-230, 231 and 232 tubes.

## NATIONAL Precision - Built SHORT-WAVE APPARATUS

and by thousands of leading Amateurs, Experimenters, Colleges, Universities, Schools and Research Laboratories the world over.

Power-pack License under R C A Patents

NATIONAL COMPANY, Inc. Sherman, Abbott and Jackson Sts. Malden, Mass.

NATIONAL COMPANY, Inc. Sherman, Abbott & Jackson Sts. Malden, Mass.



Gentlemen: Please send me complete information on the NEW National SW-5 Thrill Box  AC  Battery operated. If you are interested in SW apparatus for amateur and experimental purposes, check here .

Name.....

Address.....

# SERV CE MEN—



**RECOMMEND  
MAJESTIC  
RADIO TUBES**

**Their Rugged, Accurate  
Construction Insures  
Satisfaction**

**D**EALER profit is built into every Majestic tube. Stronger, finer materials, greater testing accuracy, 50% lower gas content, longer-lasting power and tone—these mean satisfied users and profit to the man who sells this finer tube.

Majestic Radio Tubes are built to give Majestic owners the very best in radio. Greater power and truer Colorful Tone than other tubes can give. A million Majestics are already equipped. Another million are waiting for tube replacements.

Here is a real opportunity. A million Majestic-equipped homes waiting for service men to recommend Majestic tubes and get the profits that only a service-free tube can give. Half your selling is already done by Majestic tube advertising in newspapers and national magazines. The other half is easy.

Find out today how much Majestic Radio Tubes can add to profits. Write or phone your Majestic distributor.

GRIGSBY-GRUNOW COMPANY  
CHICAGO, U. S. A.  
World's Largest Manufacturers of Complete  
Radio Receivers

**Majestic**  
RADIO TUBES

**Unconditionally Guaranteed Against  
Manufacturing Defects**

## Sustaining Programs

(Continued from page 119)

than five and usually are less. Instead of having as an audience a thousand well-fed and comparatively prosperous people who have paid money to be amused and will get their money's worth if possible, they are entering homes more or less as unknown guests, and they are putting on the show in the parlor. Anyone who attends the theatre has had the experience of laughing uproariously over some story or situation in a play, only to come to the realization that it isn't so funny when retold at the family fireside.

The line that brings a laugh from the listener is more often a subtle phrase—one in which accent and timing are of great importance. Thus many radio writers test their scripts by reading them to small groups of people. If the three or four who first hear the script think it amusing, then its chances for success on the air are good.

Smut has never been successful on the air. The same man who will laugh at an off-color joke in a musical comedy will

sumed that the future of radio is charted along a dramatic route alone. While there probably is a greater field for development in dramatic forms of entertainment, a definite progress in musical programs is certain.

The National Grand Opera Company has established itself as firmly with listeners as the Metropolitan has established itself with lovers of New York City. The National company has been conservative in its policy. It has presented the world's best known operas and the majority of its presentations include music familiar to everyone. At times little-known operas have been successfully broadcast and there have been two instances of world premières of operas in the broadcasting studios, but as a general rule the schedule is made up of operas that have been thoroughly tested by time and public approbation.

M. H. Aylesworth, in his annual report to the advisory council of the NBC, commented on this situation and expressed



This is known as "taking a sight," or "staying with the ship." The sword-fish got tired of posing for Mr. Beebe's sub-surface investigations, so wiggled over to the Jersey coast, where a little thunder-storm is in progress. At the moment he, she or it is just waiting around. All of which goes to prove that "Harbor Lights" is a darn good program

write an indignant letter if the same joke comes into his home via radio. Cleanliness in every line and situation is absolutely necessary. This rule, by the way, has not been made by any board concerned with public morals, but by the listeners themselves.

Simplicity in plot, too, is important in radio writing. The radio writer has learned that through bitter experience and through watching the failure of broadcast adaptations of noted plays in which the plots are involved. The popularity of the average program can usually be gauged in direct ratio to its simplicity of story. The one outstanding example is Amos 'n' Andy.

It would seem that the listener can look ahead a few years and see a day when he will be able to tune in the broadcast dramatic program and get as complete a bit of entertainment as at the theater or motion picture house. The story will be told clearly and concisely and he will not find it difficult to recreate the setting, the costumes and the physical aspects of the actors in his mind.

So far this article has treated only with dramatic programs. It is not to be as-

the hope that within a short time operas would be written expressly for radio. He pointed out that the ideal length for an opera on the air is an hour, and that this time limitation would have its bearing on the composition. Already composers have given some attention to this new medium, and there are indications that radio will have its own library of operatic scores.

The same thing holds true in operetta and musical comedy, although what are virtually radio musical comedies already have been produced after having been written exclusively for broadcasting.

Though cartoons and humorous magazines still publish the conventional radio bedtime story joke, the radio bedtime story for children has passed out of existence on the NBC networks. In its place has come a children's program presented with a dramatic continuity.

"The Lady Next Door," a just-before-supper offering of the NBC, is an example of this program form. "The Lady Next Door" is the principal character in the series, and is played by Miss Madge Tucker of the NBC staff, who also writes and directs the program.

(Continued on page 173)

### Sustaining Programs

(Continued from page 172)

She selects her cast from a group of available children, and while the same youngsters are not used every day, they all become familiar characters to the young listeners. Instead of telling stories direct to children at the home receiving sets, the Lady Next Door tells them to her young friends. The result is a very natural technique in story-telling, for with an actual audience in the studio to which to talk, the narrator gets a reaction impossible from a million invisible boy and girl listeners. The old style of forced cheerfulness and the patronizing tone so often affected by the story-teller are gone and forgotten—except by the writers for humorous publications.

This matter of providing interesting programs for children is being taken more seriously than ever before by the radio program makers. Children are the most enthusiastic of listeners and also very severe critics. Thousands of letters come from them daily, and the fact that they represent a future adult audience is not overlooked. Nor has the possible influence of radio on the child's mind been overlooked, and every effort is made to

(Continued on page 181)

### Serviceman

(Continued from page 161)

independent. If one stage is carefully tuned to resonance with the oscillator, it will be found that varying the trimming condenser in an adjacent stage changes the grid current value, or influences the resonance frequency of the first stage. Thus, when one has lined up three stages, for example, it will be found that the first stage has been slightly detuned, while the others are in the process of adjustment. In a good tuned circuit the amplification

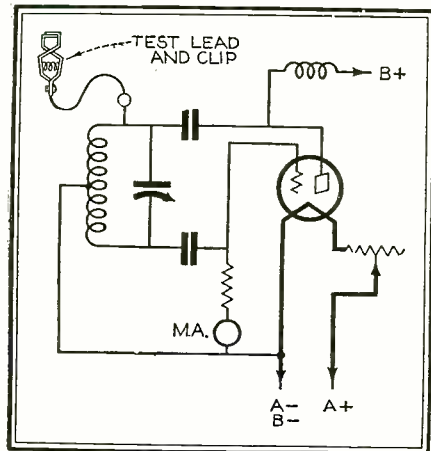


Fig. 2

decreased greatly on resonance so that amplification will often suffer greatly. In some sets, the stages may have to be staggered to produce the desired results in the over-all amplification curve. The usual problem, however, is to adjust all stages to the same frequency. Should it be necessary to stagger the stages in any way, manufacturers' instructions should usually be followed. This is usually not difficult to do, as will be evidenced later.

(Continued on page 174)

# Open this BOOK

## and you open the door to SUCCESS IN RADIO

**YOU**, too, can be trained for a worthwhile radio job... Clip this coupon now and send for this FREE BOOK... Read it page by page... see for yourself why thousands of fellows just like you are now on the road to success in Radio... why hundreds of men are now cashing in on RCA Institutes' practical training. This free book gives you 40 fascinating pages of pictures and text, all about RCA Institutes, the only school that is endorsed by the Radio Corporation of America... The school that actually is a part of the great world-wide radio industry.



### Easy to Learn Radio At Home in Your Spare Time

Let the RCA Institutes' Home Laboratory Training Course give you the real inside facts of radio... quickly and easily. Use your spare time to train for success with the remarkable outlay of screen-grid apparatus given to every student of this course. You learn how to solve every radio problem such as installing, repairing and servicing fine sets. You also learn ship, shore and broadcast station operation. This is the training that will help you to make money in radio!

### RCA Graduates in Big Demand

For more than 20 years, there has been a well-paid position in Radio waiting for

practically every graduate of RCA Institutes—mechanics, operators, service men, etc. Only the vast resources of RCA could give you this practical training...

### Send for this Free RCA Book

#### "Radio... the Field of Unlimited Opportunity"

Start today on the road to Success in Radio... Send for this FREE BOOK. Every page is packed with pictures and text telling you all you want to know about RCA Institutes, the oldest and foremost Radio training organization in the world. Radio can easily be YOUR ROAD TO SUCCESS... That's why you should

### Clip this Coupon NOW!

# RCA INSTITUTES, INC.

A Division of Radio Corporation of America

RCA INSTITUTES, Inc.  
Dept. Exp-8, 75 Varick St., New York  
Gentlemen: Please send me your FREE 40-page book which illustrates the opportunities in Radio and describes your home laboratory method of instruction.

Name.....  
Address.....  
.....  
Occupation.....

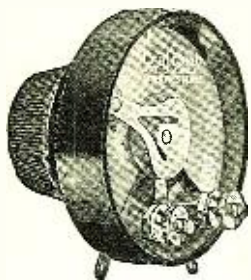
# “Whoa! FLORADORA”

... and being a good ol' mare she threw herself in high whenever traffic became halfway profitable.

The controller box on the modern street car puts Floradora to shame.

In your radio the control makes all the difference between raucous, crackly noises and smooth, velvety reception.

CENTRALAB performance explains why you will find these volume controls in millions of modern sets.



Write Dept. 225-G for Free Booklet, "Volume Control, Voltage Control and Their Uses."

## Centralab

CENTRAL RADIO LABORATORIES  
Dept. 225-G 22 Keefe Ave. Milwaukee, Wis.

### YAXLEY Push Button Switches

In a wide range of multi-spring combinations. Yaxley construction throughout. Now, in the following numbers:

No. 2001—Make Contact	1.00
No. 2002—Break Contact	1.00
No. 2003—Single Pole, Double Throw	1.15
No. 2004—Two Make Contacts	1.30
No. 2005—Two Break Contacts	1.30
No. 2006—Double Pole, Double Throw	1.60

**YAXLEY MFG. CO.**  
Dept. N 1528 W. Adams St. Chicago

## Make big money AS A SALESMAN

Learn selling—fix your own hours—choose your own field—control your own income—be independent! As a salesman your income depends only on results. Many LaSalle-trained salesmen, in every section of the country, earn from \$5,000 to \$10,000 a year; many much more. A great number started without experience—doubled their incomes the first year. Train in your spare time by the LaSalle Problem Method, under the supervision of expert salesmen. Low cost; easy terms. 64-page booklet, "The Modern Salesman, Ambassador of Progress," free. Send for it today.

**FREE**

LaSalle Extension University, Dept. 894-S, Chicago

### MASON, FENWICK & LAWRENCE PATENT LAWYERS

600 F St., N. W., Washington, D. C.

Estb. over sixty years. Send sketches. Electrical, Aeronautical and Chemical inventions carefully handled. Practice before the U. S. Courts and the Patent Office. Prompt and careful service. Write us. Protect your inventions.

**TRADE MARKS REGISTERED**

## Serviceman

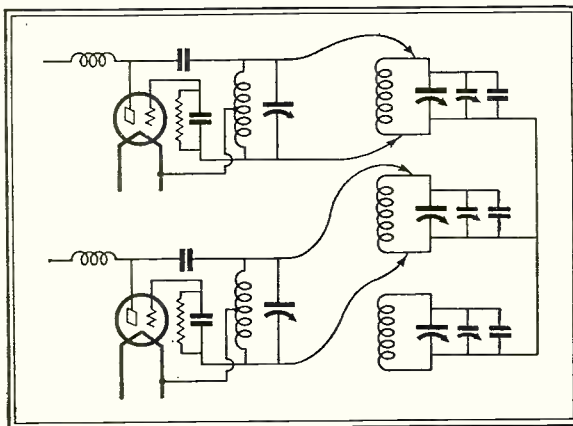
(Continued from page 173)

When all stages are adjusted to the same frequency it is necessary to go over the work to approach closer to the desired results. However, if it were possible to adjust say two stages simultaneously to the same frequency, greater accuracy would be possible and time would be saved. The writer has developed a simple method which can be used for adjusting two stages at the same time and the apparatus required is also usually less expensive than the necessary parts for a grid-meter driver, or similar equipment.

The essentials of the arrangement are shown in Fig. 3. Two simple Hartley oscillators are required. Each oscillating circuit is provided with two leads and

Tubes are cheap enough, so are condensers and chokes. It is the grid meter, or the plate meter in the usual oscillator which constitutes quite a fraction of the total cost. Cheap meters can be purchased, but the scales are usually cramped and inaccurate, so a good meter is ordinarily used, which increases the cost. No meter is used in the method described above.

Both oscillators should employ matched coils and condensers. The coils should be matched by any of the usual methods. Each oscillator should be adjusted with the tuned circuit, so that the minimum constants of each oscillator is the same and with matched coils, one of the condensers can be adjusted with a trimmer,



Two Hartley type oscillators are employed so that two stages of radio frequency may be ganged simultaneously

clips for attaching these to the rotors and stators of the condensers in the to-be-lined-up circuits. Both oscillators are mounted in the same small cabinet, but shielded from each other, and are carefully adjusted to cover the same frequency range, as will be described later.

With the clips on the condensers of the two adjacent stages, as shown in Fig. 3, the trimming condenser on one of the stages is adjusted until zero beat is obtained in the loud speaker, or in the telephones connected to the plate circuit of one of the oscillators. Since each oscillator, before the clips are connected to the condensers in the receiver, are oscillating at the same frequency, they will still oscillate at the same frequency when the tuned circuits in the receiver are connected in parallel with the oscillating circuit, provided each tuned circuit in the receiver is tuned to the same frequency. Thus if the tuned circuits are properly lined up, zero beat will be obtained between the two oscillator frequencies and this can be picked up in the loud speaker, if desired, the set being in operation during the process. Obviously, the signal will be loud in the loud speaker, making for easy adjustment, but the volume control should be turned down and small tubes, such as the -99 type, employed in the oscillators.

When the first two stages are properly lined up, the leads to the tuned circuits can be interchanged and then the next pair of circuits can be adjusted. It is clear that a closer approach to the desired condition will result by adjusting two stages at a time.

The cost of this equipment is less.

or by adjusting the plate. Extreme accuracy is not necessary. The serviceman usually has some definite point along the dial of the receiver at which the stages are lined up. One of these, say at the top of the dial, is selected and one of the oscillators is then adjusted to some definite frequency near the natural frequency of the tuned circuits in the receiver. A pair of headphones is then connected in the plate circuit of the other oscillator and the dials adjusted until zero beat is obtained with the first oscillator which can be heard in the phones.

Both oscillators are thus operating at the same frequency. The leads are then clipped on the tuned circuits in the receiver and the trimmer in one stage adjusted for zero beat in the loud speaker, or in the telephones in the plate circuit of one of the oscillators, if the receiver is not operating. When the leads are clipped in the tuned circuits, the frequency of the oscillators will, in general, change. It will be noted that the oscillator and the receiver coils are in parallel, as are also the oscillator and the receiver condensers. The total inductance is thus halved and the capacity is doubled, leaving the frequency of the oscillation nearly the same.

Often it will be found, especially in home-made sets, that one of the condensers of a gang has been set back somewhat to compensate for the half-scale setting of the trimmer condensers which are connected in parallel with each of the stages. Often the amount by which the particular stage has been set back is guessed at and even when the trimmers are operated the correct adjustment can-

(Continued on page 175)



## Serviceman

(Continued from page 174)

not be reached. The trimmer can be reduced in size if a reduction in its capacity is necessary, by removing a few plates of the stator, or the proper condenser can be readjusted.

In using the method of Fig. 1, a better grid-meter dip is obtained by running the test lead to the plate end of the oscillator inductance, rather than the grid end. The test clips should be connected to the grid end of the receiver inductance for best results.

An interesting set of curves for an oscillating circuit in which two tuned circuits are connected in parallel is shown in Fig. 4. These curves were taken by setting the oscillator condenser at various points along its scale and then varying the dial in the receiver tuned circuit. For small values of capacity in the oscillator, the receiver dial covers a large wavelength range (s.l.f. .00035 mfd. size in the receiver), but as the capacity in the oscillator is increased, the wavelength range covered becomes smaller and smaller. These curves illustrate an effect which is quite important in practice. The range of a given condenser depends upon the total capacity in the circuits. If, for an example, in a short-wave receiver, the two condensers are connected in parallel, the trimmer must be of a larger size for a comparatively large value of shunt capacity, but may be comparatively small if little shunt capacity is used. The range covered by a given condenser capacity in general will depend upon the L/C ratio used in the receiver. The reader will immediately see the application to practical work and receiver design.

## S.-W. Supersonic Adapter

(Continued from page 133)

are more susceptible to weather conditions. When the unit is used for the first time coils to cover this band should be used.

After the unit has been connected and the proper position of the dial of the broadcast receiver found in the above manner, the unit is ready for operation. The tuning of the left-hand dial is fairly sharp and should be used to log the short-wave stations for future reference, keeping in mind the setting of the dial of the broadcast receiver. The setting of the dial of the broadcast receiver determines where the short-wave station will come in on the left-hand dial of the unit. Also the range of wavelengths covered by the coils will be determined somewhat by the setting of the receiver dial.

Turn the two dials of the unit in unison until a signal is received. It does not make any difference what kind of a signal is picked up for the first time, for it will be useful in adjusting the unit. There are many code and television signals available on the short wavelengths and these signals outnumber those of speech and music. The volume of the signals received is sometimes no indication of the distance

(Continued on page 178)



## Here's the Solution of Your Condenser Troubles!

**D**ON'T worry about condenser problems. If they involve 8 MFD or more—let the Sprague electrolytic condenser take care of them. For this new, perfected condenser is the most adaptable and efficient unit you ever saw. Only 1 3/8" in diameter and only 5" height overall. Yet it rates 8 MFD capacity with peak voltage of 430 DC.

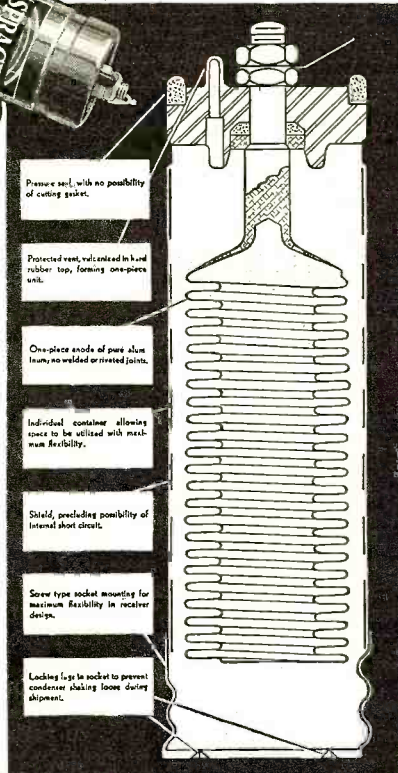
It has an exclusive, one-piece, round-edged anode without a single soldered or welded joint anywhere. The individual screw socket mounting makes it easily adaptable to use in any set.

And because of the Sprague standardized unit construction—you buy just the amount of capacity you require, without paying a premium for useless excess or for "special built" jobs.

Write for illustrated folder on the Sprague electrolytic condenser.

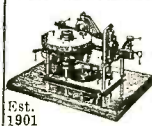
SPRAGUE SPECIALTIES COMPANY  
QUINCY, MASS.

Manufacturers also of the well-known  
SPRAGUE PAPER CONDENSER



# SPRAGUE Electrolytic CONDENSER

Capacity 8 MFD  
Peak Voltage 430 DC  
Can Negative



**LEARN AT HOME**  
WITH AUTOMATIC  
**OMNIGRAPH**

## RADIO AND TELEGRAPHY

Has Helped Thousands To Better Positions  
U. S. Govt. Depts., Colleges, Scientists, and Schools use it  
NOW! On Land, Ships, and Air—Your Career Future is Secure. Know Code. The Auto-Omnigraph teaches you easily and quickly. Learn by Listening. Models \$15-\$40. Catalog Free.  
THE OMNIGRAPH MFG. CO., 810 E. 39th St., N-5, Brooklyn, N. Y.

## Learn All About AUTOS

**6 BIG All Shipped AUTO FREE BOOKS**

If you want to qualify for garage owner, repair expert or wish to know how to keep your own car 100% efficient, write for particulars of this great offer.

ON APPROVAL American Technical Society  
Dept. A-C25, Drexel at 58th Street, Chicago, Illinois.



## Radio Dealers—Service Men

New issue of "Radio Bargain News" now ready. Send for your free copy. Hundreds of bargains.

## FEDERATED PURCHASER

16 Hudson St., Dept. N, New York City

## Hopkins Band Rejector System

(Continued from page 132)

practically the full band width, which means that the fidelity will not suffer even with such great station separating ability.

This system for securing station separation is also in use in t.r.f. receivers, and it will be understood that in such sets the condensers which tune the trap circuits are ganged to tune together over the broadcast band, whereas in a superheterodyne, using this system in the i.f. stages, these stages are set permanently so as to give the desired band width. This latter arrangement is employed in the 1931 H.F.L.

Evidently, when the amplification of the stages is taken into account the response curve of the two stages combined will be somewhat different from what is shown in the curve, Fig. 5. Fig. 6 shows what might be expected from two stages, and it will be seen that the cut-off at each side of the signal becomes steeper as the high part of the curve goes up. The low or no-signal parts of the curve remain fixed at the same distance from the signal frequency, regardless of the amplification or the strength of the signal. This is because the low points *a* and *b* are positioned by the wave traps, and these points cannot be moved apart or nearer each other by changes in signal strength.

It will be seen that we have here a means for eliminating undesired signals which are on frequencies close to the frequency of the desired signal, and that strong signals do not broaden the response curve, but merely raise it.

At points on the curve of Fig. 6 somewhat distant from the frequency of the desired signal the curve rises to perhaps one-third or one-half of its height at the signal frequency. In the sets which have been built using two stages such as shown and described above, one or more additional tuning circuits of the usual types have been employed. When the input to the first tube is tuned in the usual way frequencies somewhat removed from that of the desired signal are "tuned out" ahead of the first tube, while those close to the desired signal are prevented from passing through the receiver by being trapped or rejected in the amplifying stages. In some cases it has been found practical or advisable to employ a band-pass type of tuning ahead of the first tube.

Fig. 8 shows a circuit diagram of a practical receiver using a.c. screen-grid tubes in the radio-frequency stages, these tubes being of the indirectly heated cathode type. In this particular set two stages of audio-frequency amplification are used, but there is sufficient amplification ahead of the detector to permit the first audio-frequency stage to be omitted if desired.

In this receiver it will be noted that double tuning is used ahead of the first tube. The two coils *a* and *b* are shielded from each other, the coupling between the two tuned circuits being given by the fixed condenser *c* which is common to both tuned circuits. A leak resistor is provided across the condenser to prevent blocking of the grid of the tube.

The grids of the radio-frequency tubes are biased by means of the resistors *d* between the cathode and "B" minus or ground, as usual with heated type tubes. In the plate circuit of the first tube is located a choke coil *e*, with a small variable condenser *f* connected across it. The purpose of this condenser will be explained later. In series with the choke coil is a trap consisting of coil *g* and condenser *h*. The connection to the grid of the second tube is made through a fixed blocking condenser *i*. The condenser is connected directly to the plate of the first tube. A grid leak *k* is provided because the condenser *i* would otherwise block the grid. The screen grid *m* of the first tube is connected to line *n* through a resistor *o*. The screen grids of the other radio-frequency tubes are also connected through resistors to this line, and a potentiometer *p* controls the voltage applied to the screen grids and acts as a volume control.

By reverting to Fig. 1, referred to in the first part of this discussion, it will be seen that the arrangement of elements in the plate circuit of the first tube of this set is such as to give a response curve similar to Fig. 2. The purpose of the small variable condenser *f*, however, needs to be explained. This condenser is usually placed on the shaft of the tuning condensers and thus forms a part of the gang, but if more convenient it may be placed at some point distant from the condenser gang and operated by means of a belt or link movement. This condenser turns in, so as to increase in capacity, as the set is tuned to longer wavelengths. It will be remembered that choke coil *e* acts as a small condenser. It has been found that in order to maintain the shape of the response curve the same at all wavelengths to which the set may be tuned, it is necessary to add extra capacity across the choke as the set is tuned up the scale, that is to say, to longer and longer wavelengths.

Going now to the plate circuit of the second tube, it will be seen that the arrangement is the same as that shown in Fig. 3. The response curve of this stage by itself would be the same as Fig. 4.

The coupling means employed between the third radio-frequency tube and the detector may be the familiar tuned impedance coupling, or it may be of an untuned impedance type or it may be the usual tuned secondary with untuned primary. The detector and audio amplifier need no explanation, as they may be of conventional types.

Fig. 7 shows the overall response curve of the complete receiver. With the input to the detector tuned as shown in Fig. 8 the curve tends to become somewhat peaked at the top, but not to such an extent as to noticeably impair the tone quality.

As has been pointed out, the system of band-pass tuning as described here is applicable not only to t.r.f. receivers but also to superheterodyne construction and in one instance in particular has been employed to good advantage.

## Sound-on-Film

(Continued from page 142)

Now if the sound waves are recorded on the film, it will take one light and one dark space of sound track to compose one complete cycle from light to dark to light again. Now the beam is .0015 inch in height, completely covering the width of the sound track. Therefore, it will require .003 inch of film to record one cycle, as the beam covers one-half a cycle at once. Now as the speed of the film is one inch for 1/18 second and one cycle comprises .003 inch, we find that by dividing 18 by .003 it is only possible to reproduce as high a frequency as 6,000 cycles.

If a higher recording than this is required, the speed of the film would have to be greater than 90 feet per minute. With the old speed of projection for silent pictures, the highest frequency obtainable would have been only 4,000 cycles, which would have been insufficient. It is quite true that 6,000 cycles sometimes is inadequate for faithful reproduction, but if straight-line reproduction is obtained the differences will be unnoticeable.

**Conclusion.** It is quite impossible to cover the whole subject of sound-on-film reproduction in an article of this length; we can merely touch a few of the high spots. However, it is not the purpose of this series of articles to go into all the technicalities of sound projection—we want to give our readers a general idea of the subject.

And the interesting part of it all is this: moving pictures have adopted sound as their own—they have made it an essential and today people in nearly every country in the civilized world know that at last moving pictures have learned to speak. Moreover, they are just learning; they are just about past the one-syllable stage now and learning to talk with more or less intelligence.

## Short-Wave Superheterodyne

(Continued from page 170)

and short wave oscillator.

The volume control is smooth from a bare whisper to maximum volume.

Two audio stages of amplification are used with an output transformer.

A switch (on-off) provides modulated (I.C.W. and phone) or unmodulated (C.W.) reception instantly. Carrier frequencies of short wave broadcasting stations are located with the switch in the "on" position. By flipping the switch to the "off" position, the modulated or voice frequency is heard.

This receiver (see Fig. 5) uses 9 tubes; three type -01A, three type -22, two type -12A and one type -71B. The intermediate frequency transformers are completely shielded as are the screen-grid tubes. The entire receiver is built into an aluminum case.

# NOW! Ribbon Labels for Dating!

Now Champions offer the radio set owner **PROOF** of their extremely long lives. Every single tube that leaves the giant Champion factories is now **RIBBON LABELED** for Dating by the dealer when the tube is sold.

Thus, profits on additional sales take the place of replacements and satisfy set owner, retailer and jobber of the fair value received and delivered.

Dealers will particularly appreciate the **RIBBON LABEL** for Dating. Its date—clearly marked—absolutely eliminates costly and annoying arguments over replacements.

Servicemen, too, are assured of less trouble. First, because these tubes are so consistently satisfactory. Second, because the serviceman's arguments over guarantees are eliminated.



Champion Radio Works, Inc.  
1136-1143 Pine St., Danvers, Mass.

## Champion

RADIO TUBES

**Champion**

Sturdiest Construction Gives Longer Tube Life.

**Champion**

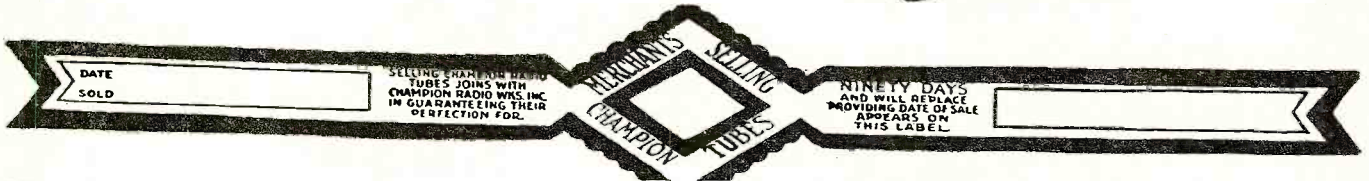
Boxed so you can see what you buy...

**Champion**

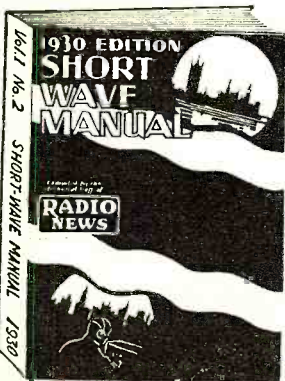
You Can Test Every Tube Without Removing it from the Individual Carton.

**Champion**

Every Tube Guaranteed Completely Non-microphonic.



# 4 Radio Books at Magazine Price or FREE with RADIO NEWS!



### NEW SHORT WAVE MANUAL

Experience the thrills of the Short Waves—of hearing Europe, Africa or Australia direct as clearly as native stations. This big book, replete with illustrations and How-to-Build diagrams and plans, crowded with 28 chapters by Lieut. Wenstrom, Marshall, Spangenberg and other foremost S-W authorities, represents the last word in authentic S-W data. The most complete up-to-the-minute short wave manual ever published. Brings you more information than books selling at ten times its price. Shipped, prepaid, to your home for only **50c**

### RADIO TROUBLE FINDER & SERVICE MANUAL

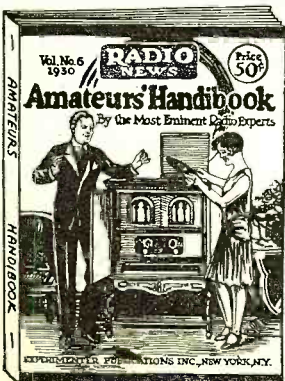
Ever have your radio reception fail or become distorted just when a big program was on and you wanted to hear every delicate inflection of tone distinctly? That's when this big, new book is worth its weight in gold. In simple words and easy to understand charts and pictures, it shows you how to find and correct any radio trouble quickly. Just the book you need for improving the reception of your set, or for starting a profitable repair business of your own. Shipped, prepaid, to your home for only **50c**

### RADIO AMATEURS' HANDBOOK

Sometimes called the Radio Amateurs' Bible. 30 profusely illustrated chapters bring you 10 How-to-Build articles, with complete instructions and diagrams; new radio wrinkles, DX hints, data on the new tubes, answers to AC problems, and helpful, money-saving ideas for the radio service man. 96 illustrated pages. Large 9 by 12-inch size. Beautiful colored cover. Shipped, prepaid, to your home for only **50c**

### 1001 RADIO QUESTIONS and ANSWERS

If you own a radio, you need this book. Everything you want to know about radio is in it, from "How to Kill Outside Radio Noises," to a clear description of the newest tubes and how to use them. If you have a question on radio, here is your answer and a thousand more. 96 illustrated pages. Large 9 by 12-inch size. Beautiful colored cover. Shipped, prepaid, to your home for only **50c**



Clip and Mail TODAY!

EXPERIMENTER PUBLICATIONS, INC.,  
Dept. 2408, 381 Fourth Ave., New York, N. Y.

Gentlemen: Please ship me postpaid the Radio Books I have checked below. Remittance is enclosed.

- New Short Wave Manual     Amateurs' Handbook  
 Radio Trouble Finder and     1001 Questions & Answers  
Service Manual

Name .....

Address .....

City and State .....

## FREE!

You may have any one of the above Radio Books **ENTIRELY FREE** with RADIO NEWS at a reduced price. To accept this offer check square below.

Ship me **ENTIRELY FREE** the Radio Book I have checked above and enter my subscription for the next eleven big issues of RADIO NEWS at the special price of only \$2, which I enclose. (Regular newsstand price of RADIO NEWS \$2.75.)

# S-W Supersonic Adapter

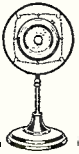
(Continued from page 175)

**AMPLION**

Announces New High Power

**Group Equip**

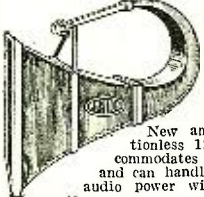
*of enduring quality*



**Address ment**

*and enormous volume*

Amplion supplies everything in sound equipment from the microphone to the horn. We offer many new and original improvements not heretofore obtainable in high power sound reproducing equipment. For example, Amplion's new 12-ft. air column speaker, built on new standardized lines is now obtainable at considerable less cost than formerly.



New amplion vibrationless 12-ft horn accommodates 2 horn units and can handle 50 watts of audio power without distortion.

**Amplion 50W-Power Amplifier**

Amplion new power amplifier, is made under Loftin-White patents with new amplion developments. It is possible to modulate two 50-watt power tubes with one type 224 Radio tube, the 224 tube operating from the standard phonograph pick-up.

**We Supply GROUP ADDRESS SYSTEMS**  
for Theatres, Hotels, R. R. Depots, Skating Rinks, Swimming Pools, Amusement Parks, Fair Grounds, Auditoriums, Race Tracks, etc. Catalog on request.

**AMPLION CORPORATION OF AMERICA**  
135 W 21st St., N. Y. C.



**The LOFTIN-WHITE System**  
*At its Best*

Now you can enjoy the famous Electrad Loftin-White Direct-Coupled Amplifier with the Electrad One-Dial Screen-Grid Tuner. Superb Performance—easy assembly—low up-keep. Amplifier Kit, \$35.00 (less tubes). Tuner Kit, \$40.00 (less tubes).

Write Dept. RN-8 for complete data.  
175 Varick St., New York, N.Y.

**ELECTRAD**

**The HAND That Encircles The WORLD**



**There's ROMANCE IN TELEGRAPHY**

The man who knows the code is in touch with the world. Become an expert operator, make big money. Learn IN YOUR OWN HOME—easily, quickly with TELEPLEX—the Master Teacher.

Write for Folder "E-8"



**TELEPLEX CO.**  
76 Cortland St.  
New York

**Teleplex**

**A L U M I N U M**

**BOXES FOR SHIELDING**—Genuine "ALCOA" stock. Dip finish, 5x9x6 \$1.88—9x14x7 \$4.65.

ANY SIZE TO ORDER

**COIL SHIELDS, COIL HOLE COVERS, PANELS—**BAKELITE tubing and panels. Pilot and Octo-Coils and forms. Magnet wire. Celluloid sheets. Acetone. Microphone transformers, etc. 48-hole scanning disk. \$6.95. Telephoto cells and neon tubes, \$5.95. Hammarlund E. C. 35 equalizers, 22c. Radio Frequency Chokes, 30c. Amertran A.F. ST Transformer. Hammarlund Parts. Pilot lamp, brackets and bulbs, 25c. 4 in. Bakelite Diels, 25c. Telegraph Keys, U. S. Navy surplus, 75c. Murdock Phones, 3000 ohms, \$2.25. Insulating washers, doz., 10c. G. R. type stand-off insulators, 4 colors, 17c. Test Prods for service men, 49c, 65c, \$1.00. Yaxley Tip Jacks and Switches. Please include postage.

**BLAN, the Radio Man, Inc., 89X Cortland St. New York City**

of the transmitting station from the receiver's location.

After the first signal is received, adjust the left-hand dial for best volume and turn the dial on the right up and down the scale to see if the best volume is obtained with both dials reading about the same. The tuning of the right-hand dial will be fairly broad. If the best volume is received with the right dial reading much different from the setting of the left one, readjust its position to the same reading as the right dial and tune the antenna condenser (C4) until signals come in with both dials reading about the same.

The volume of the received music may be varied by turning the volume control on the broadcast receiver. Some radio sets tend to hiss when the volume control is turned full on and the best position in this case, when maximum sensitivity is desired, is just below the hiss point. Also if the broadcast receiver tends to approach oscillation with the maximum volume control setting this may be remedied by turning down the volume control until this condition is eliminated. In this system of short-wave reception the volume of the signals received depends upon the amount of amplification you can get with your broadcast receiver. The center knob of the unit controls the voltage supplied to the -99 tube and may be used turned to the extreme right position except when it is necessary to decrease this voltage to clear up the music received. It will be found that it is not necessary to touch this control very often. A comparatively few moments are necessary to become familiar with the operation of the unit. After the unit is used for a short time no difficulty will be encountered in picking up the favorite station, weather conditions permitting.

If the unit is located on top of the broadcast receiver where audio vibrations are strong, an audio howl may build up when full power is being used if one or both of the tubes used in the unit are highly microphonic. A grounded metal shield over the -99 tube will kill any tendency of this tube to build up a bothersome audio howl. Very excellent non-microphonic -99's and -22's are available at the present time.

The tuning of the short-wave unit is much broader than the tuning of the usual type of short-wave set. The sharpness of tuning of the left-hand dial will depend on the natural selectivity of the broadcast receiver used. Broadness here makes for ease of tuning and clarity of music. The receiver should not tune too broadly, however, for trouble due to lack of sufficient selectivity in the short-wave unit will show up in the inability of the unit to separate stations. Some of the modern a.c. receivers using the band-pass effect in the tuning network do not tune with the same sharpness over the whole range of the dial. Some broadcast receivers tune with a ten-kilocycle definition on the high wavelength side of the dial and broaden to about thirty kilocycles at the lower end. It has been the author's experience that the best average position of the dial

of the broadcast receiver, when using the Supersonic unit, is some position about in the middle of the tuning range of the receiver. In this manner a happy medium between possible selectivity and sensitivity may be chosen.

The natural broadness of tuning of the unit will permit greater swinging of the short-wave signals without distressing results. Sometimes the signals swing badly, but this cannot be helped. It is a good plan to see that the antenna wire is taut so that any swinging of this wire will not cause false fading of the station received. A long loose wire for an antenna that has been entirely satisfactory for ordinary broadcast reception can be a source of bother on a windy evening when short-wave stations are being received. The writer uses a small inside antenna with very good results. Have the tubes tested, if possible. A poor -99, for example, will not permit the unit to function properly, if at all.

When short-wave broadcast signals are tuned in they should "slide" in and out without a trace of a squeal in the same manner that stations are tuned in on the regular receiver. It is not necessary in this method of receiving short waves to work a whistle into discernible speech or good music, as the case may be. It is, therefore, much more pleasant to tune in on the short waves with this system, which will appeal at once to those listeners who are not technically inclined. The shorter the wavelength received the sharper the tuning will be.

A new field of adventure is open to the listener using this unit and a good broadcast receiver.

The author will be pleased to lend a helping hand if any difficulties are encountered in the construction of this unit.

—♦♦♦—

**Henry M. Neely**

(Continued from page 124)

flowers and fruit, and the place is blooming at this time of the year. Most of his continuity work is done in his garden, where he dictates into a machine under the shadow of apple blossoms.

Neely made his return to radio in an unexpected fashion. He was sitting in the lobby of a New York hotel when Sayre M. Ramsdell, sales promotion manager for the Philadelphia Storage Battery Company, makers of Philco radios, entered with bag and briefcase, just in from Philadelphia. Ramsdell sat down beside Neely, greeted him and said, "We're going on the air. How would you like to draw up our program?"

From that day, Neely has been known to the great audience of the air as the Old Stager.

He shared honors with Jessica Dragonette in the first Philco Hour, letters to him equaling in number and fervency the fan mail of the popular soprano. When, after two years of re-staging the world's best light operas, it was announced that Philco planned a change in its type of

(Continued on page 179)

## Henry M. Neely

(Continued from page 178)

broadcast, a flood of letters inquired anxiously if the Old Stager were to be a part of the new program. And he was, of course, for a Philco Hour without the Old Stager would hardly be natural.

In the new hour his success was equally spectacular. As the Old Stager he introduced Belle Baker over the Philco Hour, as the Old Stager he let Fanny Brice show how Milt Gross conceived the character of Juliet.

With Harold Sanford, conductor of the first Philco Orchestra, he wrote the signature song of the Old Philco Hour. Sanford and he were sitting in a restaurant discussing the new broadcast, over a glass of beer, when Sanford said, "I don't like the signature song you've got."

"Constructive criticism, Harold," said Neely, flicking the long cigarette holder he affects, "is always preferable to rabid tearing-down of established customs. What do you suggest?"

"Writing a new one," growled Sanford, who is given to harmless growling.

An old envelope was pulled out, a stub of a pencil produced, and in a haze of blue cigarette smoke the creative labor begun.

"It was quite a job," says Neely. "We didn't get it finished until the twenty-seventh beer."

The organization of the new Philco Symphony Orchestra, called the ideal radio symphonic group, means a big step forward in the radio life of Henry M. Neely. The orchestra, the largest symphonic organization on the air, with the exception of such mammoth groups as the Philharmonic and the Philadelphia, was designed solely for perfect symphonic broadcasting. Each instrument is in proper proportion to the rest of the organization, so that maximum tonal effects can be obtained without over-emphasis or distortion of reception. Neely will introduce each number in his inimitable fashion.

One of his proudest boasts is that he has been listened to regularly by more people than probably any other man. Each week he has broadcast on a nationwide network for the Philco Hour on Wednesdays and the Maxwell House Melodies Hour on Thursdays. The Physical Culture and the Wahl Eversharp Pen broadcasts have carried his voice over the country two other nights of the week, in the latter hour under the guise of the Wahl Penman.

His is one of the greatest names in radio today. Throughout the country his listeners are legion. As the radio columnist of the *Boston Post* said at the close of the first Symphonic concert, "Henry M. Neely is tremendously important to broadcasts seeking popular appeal and employing the material of the classics. He helped to bring this kingly performance within the range of common touch by merely talking humanly."

The human touch—that is the basis of Neely's appeal to the public. Neely himself analyzed the situation most closely when he said, "Why, Lord bless us, we've got to be natural to make friends with the other fellow. A high topper looks so lonesome on the hat-rack!"

# SERVICE MEN WANTED

to install and service sound equipment in theatres, schools, lodges, etc.

If you have a background of radio we can soon train you in this new field of sound. We have scores of highly trained efficient sound engineers located in key cities. We are in need of men in every town and city in the country to work under the direction of these men while preparing themselves for one of these highly paid key positions.

### USERS

of sound equipment. Our service is available to you. We maintain competent men available immediately, day or night.

WRITE US  
AT ONCE  
FOR FULL  
DETAILS

### MANUFACTURERS

of sound equipment. Our organization of sound men is available to service and install your equipment anywhere, any time. Write us.

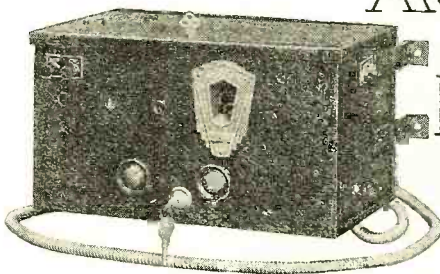
## NATIONAL SOUND SERVICE BUREAU

Executive Offices - 1457 Broadway - New York City

*A nation-wide organization of sound equipment manufacturers, users of sound equipment, and hundreds of installation and service engineers located in every part of the country.*

Announcing a new

## AUTOMATIC MOTOR CAR RADIO



### Junior Model

### Featuring

THREE TUNED CIRCUITS  
TWO SCREEN GRID  
POWER DETECTOR  
THREE AUDIO  
SIX TUBES



LIST  
PRICE

4950

LESS ACCESSORIES

Completely shielded and easily installed in any make car. Direct turning and volume control with double lock to prevent tampering with lock.

POWERFUL - SUPER SENSITIVE - AMAZING DX RECEPTION

**THE CHEAPEST and yet THE BEST**

MODEL S. G. 224 (Senior Model)

Complete set with speaker—battery box—remote and turning controls—spark plug and distributor—suppressors—filtering condensers—antenna—and all necessary hardware for mounting.

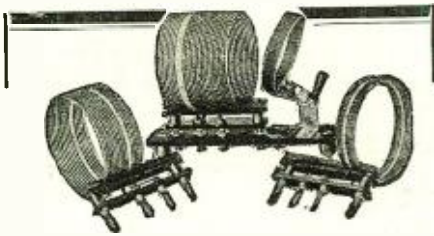
**\$9500**

LESS TUBES  
AND  
BATTERIES

Write or Wire for Complete Details

**Automatic Radio Manufacturing Co.**

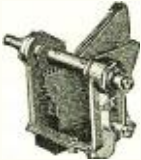
112-118 Canal Street Dept. R Boston, Mass.



## Build a Short-Wave Receiver for WORLD-WIDE RECEPTION

HAMMARLUND Short-Wave Coils and Condensers, built into a short-wave receiver or adapter, will let you in on world-wide reception.

They represent the experience gained through 20 years of making precision telegraph, telephone and radio apparatus.



Hammarlund Plug-in Coils completely cover wavebands from 15 to 215 meters.

HAMMARLUND SHORT-WAVE CONDENSERS

Write Dept. RN8 for "Set Builders' Guide of Outstanding Radio Circuits." Brimsful of useful construction data and diagrams.

Available in 5-, 7- and 11-plate sizes with either "Midline" or "S F L" tuning curve.

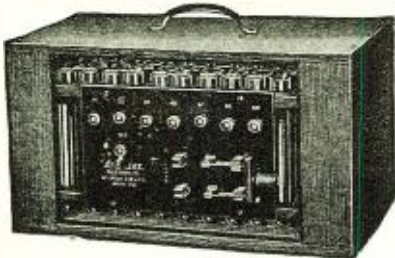
HAMMARLUND MFG. CO.

424-438 W. 33rd Street New York, N. Y.

For Better Radio  
**Hammarlund**  
PRECISION  
PRODUCTS

## "Dependable 'B' Battery Power"

For long and short wave receivers. Prices reasonable. Also "B" batteries operating from 32 to 110 volt D. C. farm lighting systems.



Write for our free interesting booklet. See Jay Battery Co., 911 Brook Ave., N. Y. C.



## MICROPHONES

Seven Types from \$10.00 to \$350.00

Also parts, accessories and cables. Microphone repairs. Universal Microphone Co., Ltd. Inglewood, Calif.

N. Y. Rep.—Smith, 142 Liberty Chicago—Cushing, 9 So. Clinton S. F.—Hermans, 585 Mission

The **CROSLY**  
**ROAM O**  
AUTOMOBILE RADIO  
RECEIVING SET

## Loftin-White P. A. System

(Continued from page 115)

placed that there is no chance of the sound wave from the speaker getting back to the microphone. Unless this precaution is taken, a howl will be set up that will render the entire system useless. A good plan is to place the microphone so that the side toward the speakers is somewhat shielded by intervening objects, and placing the speakers at a reasonable distance from the mike. Where these precautions do not suffice, there is nothing to do but cut down on the gain control until the howl ceases. There will be little difficulty from this source out of doors.

Just as important is the placement of speakers, if more than one is used. It is not infrequent that with several speakers in operation in a given space, there will be points that the signals tend to cancel out, and a very distorted sound results. It would be impossible to give definite data on this subject, due to the fact that the acoustical effect will vary greatly with each installation. At times there will be a shadow effect noticeable due to the relative distance one may be from two different speakers. Sound travels about 1,100 feet per second, and if one is within hearing distance of two widely separated speakers, both of which are reproducing the same sound, one will hear one a fraction of a second before hearing the other, thus producing this shadow effect. It is better practice to group speakers in the centre of an assemblage and direct them toward different points. If this will not cover a wide enough area, another group may be used, provided it is widely enough separated from the first group to give satisfactory results. A practice should be made of testing each installation before use, being sure to allow for the absorption of the crowd when assembled.

While it is not exactly a public address system, the writer cannot refrain from describing a call system that should prove a lucrative source of income in the amplifier field. In stores and factories where the personnel is in widely scattered portions of the building, most firms have a call system installed that rings a bell, with certain signals for different persons who may be desired. This has numerous disadvantages, inasmuch as every time the bell rings everyone must count the strokes lest the call be for him. This is highly disconcerting and causes a great deal of lost time.

In this age of efficiency, how much better it would be to hear the well-modulated voice of Miss Jones at the telephone desk say "Mr. Smith is wanted in the president's office." No matter how absorbed Mr. Smith may be in his work, he will instinctively respond to his own name. In practice it has been shown that it is rarely necessary to repeat the call more than one time, or two times at the most.

The apparatus required for such a system is simple. An amplifier with the output of a -45 tube suffices for about twenty speakers at the volume level desired. These should be wired in series parallel as was described in the first part

(Continued on page 181)



## Famous

For years as the hotel where courteous service, unexcelled food and comfortable rooms make a visit to Chicago a memorable event. The atmosphere prevailing is surprisingly homelike. Directly adjoining principal office buildings, shops and theatres.

Rooms, \$2.50 up—  
with bath, \$3.50 up.

NEW  
**BISMARCK**  
HOTEL CHICAGO

Write for Booklet with city map.

## In SCIENCE AND INVENTION for August

"Hocus Pocus!" Cried the Ancient Medicos—Professor Carl Holliday elaborates on the methods of medieval doctors.

What to Do When Your Outboard Balbs—J. Phillips Dykes, Secretary and Rear-Commodore of the American Outboard Association, contributes the first of a series of helpful articles on outboard operation.

How to Build a SCOUT Secondary Glider—The second article in a construction series by Lieutenant H. A. Reynolds and Herr Martin H. Schempp.

Searching for the Essence of Madness—A thrilling story of an eight-months' quest in South America for plants that bring dreams and death.

Flashes from the Radio Lab—Monthly hints for the home radio fan, by Radio Editor George R. Brown.

Many How-to-Make-Its, including: A Merry-Go-Round, A Pontoon Boat, An Etching, A Garden Chair, A Malted Milk Shaker, A Scroll Saw, and A Work Bench and Tool Chest in Combination. . . Chemical and Electrochemical Experiments.

## LARGE-SIZE BLUEPRINTS

"THE JUNK BOX SHORT-WAVE RECEIVER"—No. 58

A low cost, efficient receiver for portable or home use.

"THE DRY-CELL FOUR"—No. 77

An economical receiver employing dry batteries in operation. Ideally suited for home and camp use.

"THE HOME-BUILDERS' SEVEN"—No. 78

A super-het for a.c. or d.c. operation.

A complete new supply for these blueprints are on hand, 25 cents each is the price, postage paid.

**RADIO NEWS**

Blueprint Department

381 Fourth Avenue, New York City

## Sustaining Programs

(Continued from page 173)

keep the programs on a high cultural plane without sacrificing their interest or freshness.

There are a half dozen programs definitely planned for children now being broadcast by the NBC. That the programs of the future will show more and more presentations with a juvenile appeal is expected by people familiar with the situation.

Radio has developed a new thought in a religious type of program, though this particular program is not connected in any way with any sect or religious organization. The program is the widely known "Sunday at Seth Parker's." It uses the dramatic form to give a picture of a cottage hymn-sing in a Maine village. There are old hymns, prayers, little bits of homely philosophy and spiritual lectures by Seth Parker. Listeners in letters have pointed out the deeply religious nature of the program. They explain that this intimate glimpse into the lives of a group of people who are sincerely religious and who interpret religion by incidents from their every-day lives is more potent as an urge to spirituality than the exhortations of eloquent preachers.

Just how far this idea for giving something to the spiritual nature of the listener will be developed cannot be predicted. It requires special talent and a marked degree of reverence and sincerity. The man who is Seth Parker—he is Phillips Lord in real life—and the people who work with him take their program very seriously. So do the listeners.

In its other broadcasts of a religious nature, the NBC has adhered to the policy of keeping all sectarianism, all denominational propaganda, and all controversial opinions on religion off the air.

One development of the future—a development now taking place—is the improvement of programs broadcast during the hours before dark. There was a time, and it was not so long ago, when almost anything was used to fill the daytime hours. That day has ended, and the daytime listener now hears the stars featured in evening hours, and in addition is able to hear programs as carefully planned and as expertly presented as those on the air at night.

Among the outstanding daytime features offered by the NBC are The Radio Guild, an hour's broadcast of a radio adaptation of some famous play; the Damrosch Musical Appreciation concerts, planned for school children; Evening Stars, a program featuring some of the best-known artists in radio; programs of special interest to farmers; concerts by the United States Marine Band, the Army Band and other noted musical groups, and various important musical events that take place during the day.

The daytime hours now are being considered as the magazine of the air, and the editorial contents of this magazine will be carefully planned and balanced in order that there will be something to appeal to every distinct group of listeners.

The future of the sustaining program, despite the fact that there is a growing demand on the part of sponsors for in-

creasing time on the air, is bright. It will continue to be an experimental laboratory, and from the sustaining programs will come the finest radio presentations of the future.

There is no danger of the sustaining program passing out of existence. The radio executives are too conscious of their obligations to the listening public and would no more sacrifice their own time on the air than would the directors of a national magazine sell all space in their publication to advertisers.

Sustaining features of the future will be the first to broadcast many plays, musical comedies and operas written especially for radio. The growing tendency to use radio in keeping listeners informed on current events is a function of the sustaining program. More and more funds are being made available for the development of sustaining features, and a friendly rivalry between the advocates of various types of programs will undoubtedly react to the benefit of the listener.

## Loftin-White P. A. System

(Continued from page 180)

of this article, and distributed at strategic points about the building. Either magnetic or dynamic speakers may be used, and the output transformer chosen accordingly.

The amplifier may be placed at the telephone operator's desk, as is shown in the illustration, with the microphone at a convenient distance from the operator's chair. With modern tubes, there is no reason why the amplifier may not operate twelve or more hours a day. It would be good practice to use some simple sort of switch to cut off the microphone when not desired, or every sound originating at the switchboard will be reproduced throughout the building. A push-button wired to connect the microphone into the circuit as long as it is depressed makes a very satisfactory and inexpensive switch. There are no particular precautions to be observed in an installation of this nature, and any executive will be pleased with the results obtained.

Such a system is being manufactured by one of the New York firms that combines in one unit the amplifier, input and output transformers, and the necessary facilities for obtaining microphone current from the amplifier.

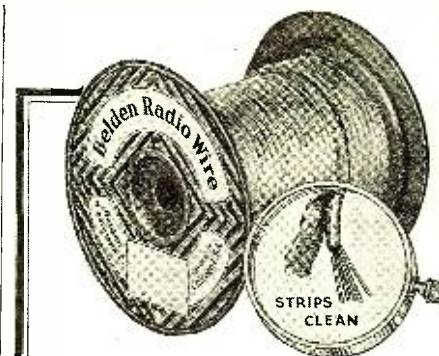
We have seen that, to be satisfactory, the apparatus used in public address systems should combine gain, power, portability and dependability. The Loftin-White amplifiers measure up in all these respects, and the associated apparatus should be chosen with these points in mind.

Sources of supply:

Amplifiers—Amplex Instrument Co., New York; Electrad, Inc., New York.

Microphones—Wholesale Radio, New York.

Transformers—American Transformer Corp., Newark, N. J.; Wholesale Radio, New York.



Reduce Troublesome Interference by using

## BELDEN SHIELDED LEAD-IN WIRE

Much interference with radio reception caused by high tension wires, household appliances, and similar sources can be eliminated through the use of Belden Shielded Lead-in Wire.

Belden Shielded Lead-in Wire consists of a stranded copper conductor, with easy strip rubber insulation and an overall braid of tinned copper.

When this wire is used the aerial proper is installed out of the zone of interference. The lead-in conducts the signal energy through the zone of troublesome impulses. This lead-in is shielded so that the interfering impulses are grounded and are not permitted to interfere with the signals.

Radio service men everywhere report remarkably successful results through the use of this interference reducing lead-in wire. Mail the coupon for descriptive literature.

Belden Manufacturing Company,  
4671 W. Van Buren St., Chicago, Illinois

I want to know all about Belden Shielded Lead-in Wire. Mail your bulletin.

Name \_\_\_\_\_

Address \_\_\_\_\_

## MILES

Horns and units, with double or triple outlets for Public Address and Music Reproduction Systems. Loud, Clear and Powerful. You hear MILES ahead of others. Used successfully the world over. Unbreakable, Weather-Proof, Water-Proof, Guaranteed.



**MILES REPRODUCER CO.**  
45 West 17th Street, New York  
Branches in Principal Cities and Countries

## RADIO BARGAINS

Low Power Transmitter adaptable for phone or code. With plug-in coils ..... \$14.75  
Short Wave Sets, one tube complete with 5 coils, 14 to 550 meters ..... 6.45  
B Eliminator, Bone Dry with 280 tube, 180 volts, will operate up to ten tube set, fully guaranteed. 6.75  
AC—A B C power packs for 225, 227 and 8.75  
Power and Filament Transformers for 225, 227 and 171 tubes, with double choke ..... 4.00  
Tubes: UX type, 30-day replacement guarantee, No. 210, \$2.25; No. 250, \$2.35; No. 281, \$1.85; No. 245, \$1.25; No. 224, \$1.25; No. 227, 75c; No. 226, 65c; No. 171, 75c.  
CHAS. HOODWIN CO. 4240 Lincoln Ave. Dept. H-3, Chicago

# SERVICE MEN!

Here's a  
**Money Maker**

and a life saver for tubes and sets. You can add many dollars to your weekly pay envelope if you will carry a supply of the

**Automatic Line Voltage Regulator**  
**CLAROSTAT**



It is really an automatic ballast or self-compensating type of resistor offering high resistance to high line voltages and low resistance to normal or below normal line voltages.

It fills a much needed want for the Big army of Radio Set Users. Easy to attach—just plug in the socket. Send for free circular. Price ..... **\$1.75**

**CLAROSTAT MANUFACTURING CO.**  
281 North Sixth St. Brooklyn, N. Y.

## "VOICE OF THE ROAD"

"A better auto radio could not be made."

Send for our information sheets before buying elsewhere.

**CONTINENTAL WIRELESS SUPPLY CORP.**

120 LIBERTY STREET  
NEW YORK CITY

## Service Men— Set Builders— Dealers

We have a very interesting proposition for you about the

**BROWNING-DRAKE**  
screen-grid RADIO

Browning-Drakes always appealed to technical radio men. More Browning-Drake kits were sold than any other make.

Send for this new proposition

**Browning-Drake Corporation**  
224 Calvary St., Waltham, Mass.

SEND NOW FOR OUR LATEST

## RADIO BARGAIN BULLETIN No. 31

CHOCK FULL OF REAL  
LIVE BUYS AT  
REMARKABLY BIG  
SAVINGS TO YOU

**AMERICAN SALES CO.**  
19-21 Warren St., New York, N. Y.

# Manhunts by Radio

(Continued from page 138)

for everything. Our average time per arrest is sixty seconds.

"I am positive that within the next five years all cities with modern police departments will have radio as a part of their police equipment."

Former Chief Claude M. Worley, of Indianapolis, is just as enthusiastic.

"Radio," he said, "has placed in the hands of the police one of the most formidable and powerful weapons for law enforcement known in police history, I believe. Its primary purpose is to reduce the time element to a minimum. Time is the criminal's salvation, and when the time for his escape is lessened to minutes, even seconds, through the use of radio, he is going to discover that his racket is no bed of roses.

"Station WMDZ, of the Indianapolis Police Department, has been in operation since Dec. 23, 1929. All of our cars are not yet equipped with receiving sets, but work is going forward rapidly. The radio system has not been completely developed. We are learning more about it every day and how to use it effectively. We are still in what might be termed the testing stage, and our forces are gradually being coordinated and our methods readjusted to this tremendous speeding up of police work. But we are learning rapidly.

"The first day our station went into operation we made an important arrest through its use. A call came in that a man had been shot. Our emergency car was started to the scene from headquarters. Several minutes later another telephone call came from a man who said he had followed the man who did the shooting to a vacant house quite distant from the scene of the shooting. The emergency squad was directed by radio to head for this vacant house instead of the scene of the shooting. The man was captured within ten minutes of the time the first telephone call came in. That instance removed all doubt from the minds of many as to the worth of the system."

The records of the Cleveland Police Department's radio station show that 230 arrests were made from the time the station opened in September to Dec. 31, 1929. Nearly 5,000 messages were transmitted to the radio equipped cars in that period. The arrests included some startling ones that aroused widespread public interest in police radio.

Chief Jacob Graul, who is enthusiastic over its use, said recently in commenting on the use of radio by the police:

"This is the new era in crime detection. The installation of radio for police work is an achievement, and the wisest step ever taken by any city. Allying radio transmission with vehicles of motive power and speed has unmistakably proved a deterrent to crime.

"The tremendous results derived thus far by the Cleveland Police Department from the use of radio are far-reaching and have their beneficial results in routing the criminal in his rendezvous with crime. Pessimists, when shown facts of the success of radio, become optimists.

"Undermanned as we are, the situation would have reached an extremity that

would have perhaps gone beyond control without the radio. This, of course, does not necessarily mean that the installation of radio will make up for man power, but the effect it has on the criminal who knows that the radio cruiser is only a matter of seconds away from him is that he loses heart and he hesitates before committing a depredation. This is instrumental in reducing crime to a minimum.

"We are now able to produce indisputable evidence as proof of guilt and the result is conviction. It is apparent that radio broadcasting has many advantages over the telephone and other means of communication in the department, and has proved itself a long stride towards effective law enforcement."

It results such as these that have led to the rapid expansion of radio's use by the police. Fully a score of other cities either have stations in operation, near completion or plan to include them.

## New Profits for Servicemen

(Continued from page 121)

watt for operation at maximum volume but only about one-twentieth watt for hotel room volume. Dynamics, for full volume, require from one to three watts each, depending on make and type. Headphones, of course, require very low power—around 1/200 watt each.

After all decisions are made relative to the input and output requirements, plans for the equipment to meet these requirements can be made. If a microphone is to be used, a microphone amplifier will be needed, and if more than one microphone is to be used at one time a "mixer" unit will also be needed to provide balanced pick-up. If radio or phonograph are to be used they do not require pre-amplification as does the microphone output. Regardless of the type or types of input employed, impedance values throughout must be properly matched. The impedance values of different makes of microphones vary, as do the impedance values of phonograph pick-ups. If the impedance of the phonograph pick-up differs materially from the rated input impedance of the amplifier selected, a separate impedance-matching transformer may be used between the two, or if the amplifier is to be used only with records the manufacturer will usually provide his amplifier with a suitable input transformer to provide the desired input impedance value. This also applies to the impedance values of other units.

Some manufacturers provide output transformers in their power stages with several taps to match the impedance values of different types or combinations of loud speakers. Thus, where dynamic and magnetic speakers operate from the same amplifier, they can be connected to different taps so that each type will be operating under the best conditions.

The location of the amplifier equipment in a building will depend entirely upon local conditions. In large buildings such as the larger hotels, which employ a radio

(Continued on page 183)



**"An Address of Distinction"**



**Greater Value . . . Too**

LIGHT, airy and spacious rooms, luxuriously appointed . . . tempting foods. Overlooking the quiet shores of Lake Michigan . . . quickly accessible to vacation pleasures and business activities. Value - for - your-money in every detail of service. Rates begin at \$5 a day. Permanent Suites at Special Discounts.

**THE DRAKE HOTEL, CHICAGO**  
Under Blackstone Management

**FREE RADIO BARGAIN CATALOG**

**ALSO FREE RADIO GIFT**

Send now for this new free radio catalog which saves you many dollars on radio outfits, kits, parts, tubes and accessories! Also TIME CONVERSION CHART FREE. Tells you instantly what time it is in any part of the world! Given free if your request for catalog reaches us this month.


**20th CENTURY MAIL ORDER CORP.**  
200 Jackson St., Chicago, Ill.  
Genuine PILOT Products

**QUIT TOBACCO**

Don't try to banish unaided the hold tobacco has upon you. Thousands of inveterate tobacco users have, with the aid of the Keeley Treatment, found it easy to quit.

**KEELEY TREATMENT FOR TOBACCO HABIT** Quickly banishes craving for tobacco. Successful for over 50 years. Write today for FREE BOOK and particulars of our MONEY-BACK GUARANTEE.

**THE KEELEY INSTITUTE, Dept. L-666, Dwight, Ill.**  
Home of the famous Keeley Treatment for Liquor and Drugs. Booklet Sent on Request. Correspondence Strictly Confidential.



**BOW LEGS**

are not noticeable if you use new patented T Garter. Keeps trousers straight whether legs bend in or out. Write for FREE BOOK. Mailed in plain, sealed envelope.

**THE T GARTER CO.**  
Dept. W South Bend, Indiana



Write for booklet  
**"Opportunities in Radio"**

**West Side Y.M.C.A. Radio Institute**  
113 West 64th Street, New York City

## New Profits for Servicemen

(Continued from page 182)

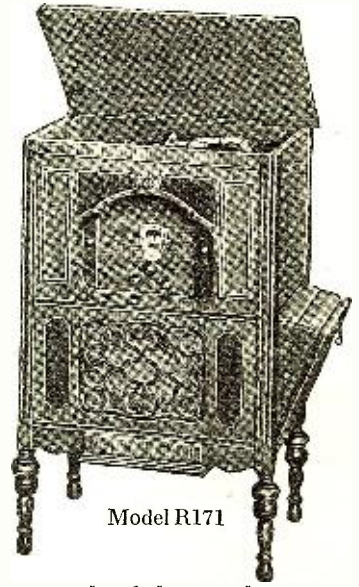
input, a location close to the roof where an outdoor antenna with short lead-in are possible, is frequently favored. In other hotels equipment is located in the basement with a special antenna system to overcome the obstacle of a long lead-in. This arrangement seems to be a common one where there is no special operator in charge of the equipment and it falls to the lot of the engineer to operate the system. There are other considerations, too, of course. The extent of the input and output wiring systems is in many cases sufficiently important to dictate the location of the amplifier in relation to the other parts of the system. In auditoriums and the like it may be advisable to locate the equipment just off-stage so that the operator will be within audible range of the loud speakers and can therefore maintain more direct control.

Needless to say the wiring of sound amplifier systems assumes great importance particularly where the circuits are extensive, as in hotel, school and similar systems. The practices of installation men and also the recommendations of equipment manufacturers vary considerably as to the wiring specifications and requirements for sound amplifier installations. No. 18 wire is probably the most commonly used size. In some installations it takes the form of twisted pairs, in others telephone cable and in still others the wiring system is made up of shielded pairs, each pair being sheathed in a metallic wrapping to eliminate any possibility of cross talk where the wiring of two or more channels is carried in the same conduit. Other companies contend that cross-talk is not bothersome in amplifier lines and there is one company at least that employs plain insulated wire, neither cabled, twisted nor sheathed, and carries as many as five channels (10 of these wires) in one conduit.

One point of agreement both among the manufacturers of equipment and among installation contractors seems to be on the advantages of standard rigid conduit to safeguard the wiring. One reason for this universal recommendation is the absolute protection this type of conduit provides against all possible forms of physical injury to the wiring. Another is the complete electro-magnetic shielding provided, preventing the pick-up of hum or other interference from neighboring electrical circuits. The third and an especially important reason for the use of rigid conduit in sound amplifier installations is that it provides the only type of wireway from which the wiring may be withdrawn for circuit alterations or into which additional wires may be drawn at any times without damage to the plaster. Thus, if additional channels are later added the new wires may be drawn into the same conduit with the old.

It has not been the purpose of this article to provide detailed data on sound amplifiers, but more to point out the general practices and trends both in manufacture and installation. For those desiring more detailed information, much of interest will be found in the literature of some of the manufacturers.

**EXCELLO Radio Consoles**



**Model R171**

An example of the superlative art of Excello Radio both in appearance and performance.

This genuine screen grid radio with dynamic speaker and phonograph combination perfectly meets the highest standards of program recreation.

Excello Radio Means Excellent Reproduction.

Write for free illustrated catalog of complete line—Excello Radio, Radio-Phonograph Combinations and Radio Consoles.

**EXCELLO PRODUCTS CORPORATION**  
4832 West 16th St., Cicero, Illinois

**EXPLORE THE SHORT WAVES**

WITH THE  
**EXPLORER PLUGLESS CONVERTER**

**\$14.50**

**NO PLUG-IN COILS!** Wave length range 15 to 200 meters; CHANGES WAVE LENGTH BANDS BY THE TURN OF A KNOB. The EXPLORER enables you to explore the wonders of modern short wave reception with your broadcast receiver. Stations all over the world are at your disposal on the short waves.

The EXPLORER is a 1930 model, efficient and scientifically improved converter. Beautiful appearance; illuminated vernier dial; shielded; tube inserts inside of cabinet; and absence of plug-in coils make it the most convenient of all converters.

Best performance at the lowest price. GUARANTEED. Sold Direct From Factory. Order now! A. C. or D. C. model only \$14.50. Sent postpaid upon receipt of price or C. O. D. plus postage upon receipt of \$1. State whether A. C. or D. C. model is desired. SEND FOR FREE LITERATURE.

**RIM RADIO MFG. CO.**  
695 Grand Street Brooklyn, N. Y.



**SPECIAL SOCKET**

For the  
**211 Type Tube**  
(50 Watt Capacity)  
Bakelite Base

List Price, \$5.00

**GENERAL FABRICATING CO.**  
165 Greenwich Street New York City  
(Phone Cortlandt 1352-3)





To eliminate "static" from motors, street cars, telephones and electrical appliances, plug in a Falck Claroceptor between wall socket and radio set. This new improvement by a pioneer manufacturer grounds and thus blocks out line interference noise and radio frequency disturbances. Also improves selectivity and distance. Requires no changes in set. Measures just  $3\frac{1}{2} \times 5\frac{1}{2} \times 2\frac{1}{2}$  inches. Thousands all over America now use the Claroceptor for clearer A.C. reception. Get one right away—at radio parts dealers. Write for descriptive folder.



**\$7.50**  
with cord and plug

**Falck**  
**CLAROCEPTOR**

Manufactured by ADVANCE ELECTRIC CO.  
1260 W. Second Street Los Angeles, Cal.  
JOBBER AND DEALERS, GET OUR PROPOSITION



**ONLY \$6.45**

**Span the World with this Set!**

A new radio thrill for you! Listen in DIRECT to London, Paris, Berlin, Buenos Aires and other broadcasting stations throughout the world via short waves. Enjoy unique foreign programs from strange lands. Your ordinary receiver cannot tune in these low wave stations. **WORLD-WIDE RECEIVER** gets 14 to 550 meter stations with surprising clarity. **SEND NO MONEY!** Just write your name and address on a postcard and ask us to send you this wonderful guaranteed short wave set. Pay postman \$6.45 plus a small delivery charge. Write today!

CHAS. HOODWIN CO.  
4240 Lincoln Ave., Dept. H-30, CHICAGO

## HOTEL WASHINGTON

PENNA. AVE. 15th &  
F STREETS N.W.

WASHINGTON, D. C.

400 ROOMS — 400 BATHS

Opposite the United States Treasury and  
the new \$17,000,000.00 Department of  
Commerce Building

Easy of access yet located  
at the very center of  
life in the Capital City

Rates no higher than any other  
first class hotel

BOOKLET SENT UPON REQUEST  
S. E. BONNEVILLE, Managing Director

## How to Synchronize for Television

(Continued from page 135)

the same power system as the transmitter, will maintain the speed of the Radiovisor at the same speed as the transmitter. The limitation here, however, is that the supply must be a.c. and from the interconnecting power system. Under these conditions this method of synchronizing is ideal if the proper precautions are taken. Adjustments are made necessary by differences in phase angle between the receiver and the transmitter. This phase angle at times is variable, although in 90 per cent. of the cases it remains constant throughout residential districts. For this, compensation means must be provided to shift the field of the synchronous motor through a 90-degree arc.

Another variation of the synchronous motor may be a phonic wheel driven by any means of power. In the Jenkins Model 100 Radiovisor this means of power is an eddy current motor as shown in Fig. 3, or a direct current motor as shown in Fig. 8. All of the power necessary to drive the mechanism is thus supplied by an external force. The phonic wheel for receiving 60-cycle impulses from the interconnected power system acts merely as a break or speed control on the whole device. It is obvious that the semi-automatic systems of synchronizing described above will not operate on d.c. and can only be used where the same interconnected power system is available between the receiver and the transmitter. If these devices are used on other power systems the television picture will be found to drift from side to side, sometimes slowly and sometimes swiftly, depending upon the variations between the frequencies of the power systems.

### 3. Fully Automatic Synchronizing Means

Fully automatic synchronism is obtained when an impulse sent out simultaneously with the picture is used to control the speed of the receiving mechanism. This impulse can be a separate frequency which controls the speed of both receiver and transmitting mechanism. It can be an impulse generated by the transmitter and sent out separately to control the receiver or it can be a frequency which is part of the picture frequency which occurs with sufficient strength and regularity in the television signal itself to control the speed of the receiving mechanism. In Fig. 5 is shown a Jenkins Model 100 Radiovisor with a synchronizing device. The power is supplied by a driving motor which may be either an eddy current motor or a direct current motor and the speed of the whole mechanism is controlled by the frequency which is applied to the coil shown in the immediate foreground. This coil controls the speed of the phonic wheel and hence that of the whole mechanism.

In every picture which has 48 lines and 15 frames per second as sent out by the Jenkins transmitters, there is a very strong 720-cycle component. This frequency can be used to drive a resonant tuned circuit feeding a vacuum tube amplifier. The output of this tube can then be used to supply the braking power on the phonic wheel. This has been tried out very thoroughly and works very satisfac-

torily for the type of picture we are now transmitting by television.

Another type of fully automatic device is a d.c. or a.c. motor driving a generator. This generator can then be loaded with a vacuum tube circuit. The vacuum tubes act as rectifiers and when the grids are excited with the proper frequency they will maintain the motor system at constant speed.

**General Considerations**—Of the above systems that which is by far the most inexpensive and simplest is shown in Fig. 1 where the position of the motor is varied. This, however, requires manual control. If you are fortunate enough to be located on an a.c. power system which supplies a television transmitter, then the simplest way to obtain good pictures is to secure a televisor which will operate on the a.c. systems and which can be made to maintain synchronism throughout the television program. If you are located on a d.c. system or on some other a.c. power system from that supplying the transmitter, you are advised to secure a televisor which has a full automatic synchronizing mechanism with it. This will require the use of the phonic wheel with other driving means and a special adapter for your receiver for the necessary phonic wheel control. This, however, can be made to give full automatic synchronism on any picture signal which has enough power to modulate the usual television lamp.

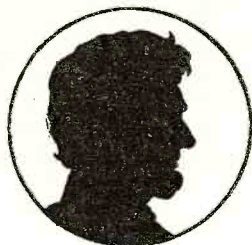
Synchronism will probably continue to be a problem for some time, but the methods outlined above, especially the latter ones, have been found to be entirely satisfactory and there is no reason why any experimenter, by adopting one of these methods best suited to his needs, cannot solve this problem.

It is recognized that as the detail of the pictures increases this problem of synchronism will become more important and it is possible that the use of 60 cycles for synchronism will not be sufficient to prevent blurring of the images due to phase shift and other variations in the mechanism. It has been estimated that for a 100-line picture at least a 1,000 cycles per second synchronizing signal be utilized to maintain correct synchronism. We have not, however, yet reached the 100-line stage and 60 cycles per second synchronizing impulses are amply sufficient to bring in really good and clear pictures in the televisor.

The amateurs will be very much interested to know that the Bureau of Standards is planning to put on the air a 5,000-cycle synchronizing note with 10 kilowatts of power on 10 meters, from Washington. It is entirely possible that the future may see a powerful station sending out a synchronizing frequency to which receivers and transmitters alike can be tuned.

Let me say in conclusion that if this television "bug" has bitten you, you will find it extremely fascinating, for into this art enters not only electricity but much more in the realm of physics, as it deals with mechanical, optical and intricate electrical problems. What more can the experimenter ask?

NEW YORK'S NEW HOTEL  
**LINCOLN**



Where modern scientific planning and management make possible rates surprisingly moderate. 1400 Rooms, each with bath and shower.

\$3-5 For One \$4-7 For Two

Telephone Lackawanna 1400

Eighth Ave., 44th, 45th Sts.  
Times Square · NEW YORK

**ADDS TO ANY INCOME**

Costs Next to Nothing. Without Personal Selling make immediate, immense, endless profits. Using spare-time start vacuum cleaner building and service factory at home. New, ever-growing field. Expert instruction free. All needs supplied. Learn valuable secrets. End uncertainty forever. Literature tells how.

**ASSOCIATED INDUSTRIES**  
1311 Engineers Bldg. Cleveland, Ohio

*In August*  
**AMAZING STORIES**

"Skylark Three," by Edward E. Smith, Ph.D. (A Serial in three parts.) Part 1. Just about two years ago—specifically two years ago in the August issue—we began that much lauded story, "The Skylark of Space." Since that story was completed there were innumerable requests for a sequel. Beginning with the next issue—August—we begin the sequel in a serial in three parts. "Skylark Three" is more magnificent, swifter and more thrilling than the other.

"South Pole Beryllium, Limited," by Peter van Dresser. Beryllium is a metallic base of the emerald and it is a metal which bids fair to enter into industry, in a sense, the last development in metallurgy, or about to be such. This story is particularly opportune at this time.

"When Inca-Land Revolted," by Woods Peters. Almost all great discoveries have been due to accidental findings, often during experiments made in domains of science seemingly far removed from the field of discovery. It can hardly be considered beyond the realm of possibility, therefore, that some enterprising and imaginative young scientist might accidentally discover a means for transmitting personality. It would prove a minor matter to devise a means for accompanying such transmission with the voice. This is a fascinating story of future achievement in science; of startling events in a hidden land.

"World Atavism," by Edmond Hamilton. We know that the sun's rays play an all-important part in life processes, and in the present story it is taken that they are constantly improving and evolving a higher race of man. In this short story, Mr. Hamilton uses, for him, an unusual theme, which he weaves dexterously into a tale of considerable importance.

"The Last War," by Capt. S. P. Meek, U. S. A. Who should be more authorized to write a story on the wars of the future than an army man? Capt. Meek is an army man. He has evolved a most ingenious treatise on what man may do in the future to conquer nations. It seems almost prophetic.

**Sound Recording**

(Continued from page 130)

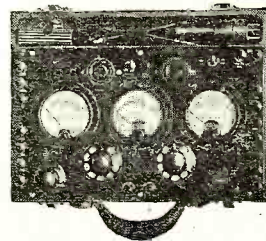
The tracking of the needle through the groove causes the peaks of the recorded waves to become worn, thus changing the wave shape which produces distortion. This wearing of the groove wall affects the reproduction quality in an ever increasing amount as the record is used. Prior to the arrival of sound pictures, the question of record wear, and the consequent decrease in record life, was of no great importance. In fact, it was probably considered a desirable feature from the point of view of the producer. Today, however, in the motion-picture industry the producer is interested in prolonging the life of records, because he obtains a return in the form of rental from the exhibitor. It is hoped that record wear will soon be overcome, not purely from the financial phase of the problem, but because of the improved quality of reproduction which will result.

For faithful reproduction it is obvious that distortion must not be introduced by the pick-up. It is clear, therefore, that a stiff needle is required for faithful reproduction, otherwise movements at the armature end of the needle will not represent movements at the groove end. In fact, a soft-tone needle may be considered as a mechanical filter. A magnetic pick-up requires damping in order to smooth out resonant points, and at the same time maintain the proper neutral position of the armature. With this design, considerable inherent stiffness is present in the mechanism of the pick-up. If too much stiffness exists, relative motion of the armature and field will be reduced, thus defeating the idea of the pick-up. The entire pick-up will be somewhat compelled to follow bodily the modulation of the groove. Under this condition, the side pressure at the needle will be excessive (on account of the reduced cushioning action) and breaking down of the groove wall may occur.

We desire to have the natural frequency of the system somewhat above the highest frequency to be reproduced. In a mechanical system the mass corresponds to inductance, the compliance to capacitance, and the stiffness to the reciprocal of the capacitance. In the electrical circuit, LC must be kept low; therefore, in the mechanical system we must keep the mass low and the stiffness high. It is desirable to confine this stiffness as far as possible to the needle itself.

The use of half-tone needles has become common among projectionists when reproducing over-modulated records. In fact, many records as released are marked "Use half-tone needle."

This ends the first part of the article on "Some Methods and Problems of Sound Recording," by C. F. Goudy and W. P. Powers. The concluding installment will appear in the September issue.



**MODEL 547**

*The Radio Service Man's Testing Standard*

Preferred by all leading dealers and service men because of its dependability, ingenious design providing ease of operation, compactness, and light-weight portability.

The Model 547 makes all the required tests on any A. C. or D. C. receiving set. Durable Bakelite case and fittings. 3/4" diameter instruments.

Valuable loose-leaf Instruction Book containing electrical data for practically every set on the market furnished with this instrument. All purchasers of the Model 547 receive this free additional service—kept up-to-date as new information is published. Write today for full description of this instrument and accompanying service.

**WESTON ELECTRICAL INSTRUMENT CORPORATION**  
615 Frelinghuysen Ave. Newark, N. J.



**Dealers and Servicemen**

**Keep Posted On Prices**

**S. S. Jobbing House**

150 W. 26th Street  
New York City, N. Y.

Without obligation add my name to your list so that I get your Radio and Electrical Merchandising Bargains regularly.

Name .....

Street .....

City..... State.....

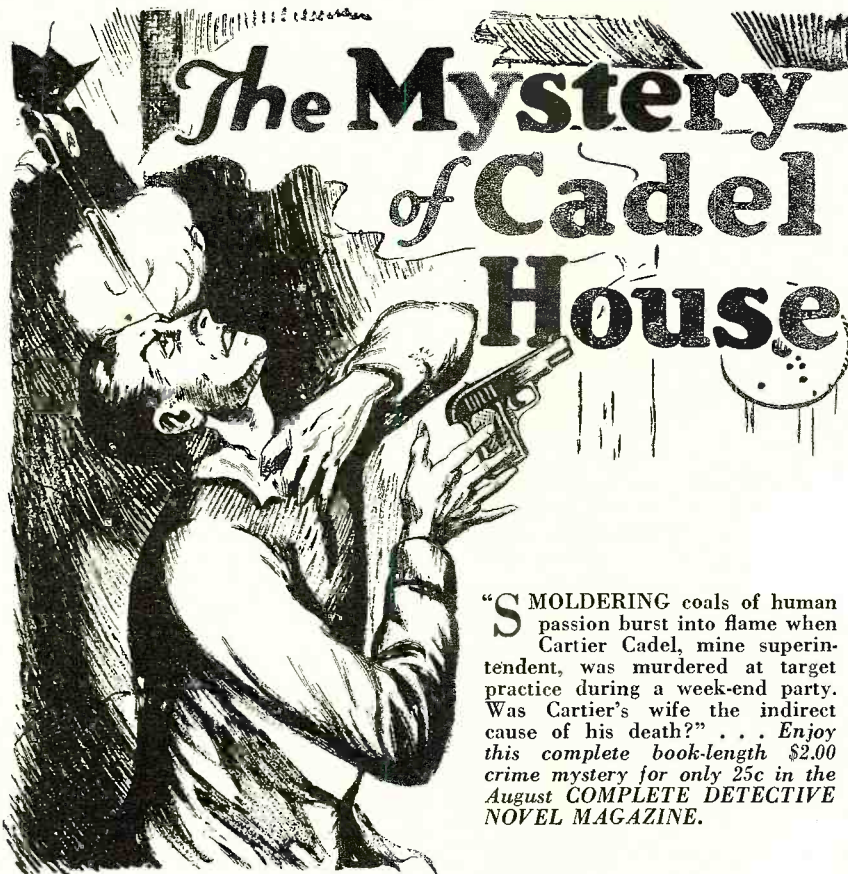
**ACME WIRE PRODUCTS**

Parvolt Filter and By-Pass Condensers, Magnet Wire-All Insulations, Varnished Insulations, Coils.

**THE ACME WIRE CO.**  
NEW HAVEN, CONN.

*Dealers, Repair and Servicemen*  
*Send for our*  
*Latest Bargain Bulletin*

**RADIO SURPLUS CORPORATION**  
56-N Vesey Street New York City



# The Mystery of Cadel House

"SMOLDERING coals of human passion burst into flame when Cartier Cadel, mine superintendent, was murdered at target practice during a week-end party. Was Cartier's wife the indirect cause of his death?" . . . Enjoy this complete book-length \$2.00 crime mystery for only 25c in the August COMPLETE DETECTIVE NOVEL MAGAZINE.

**A \$2.00 Novel Only 25c!**

**C**ARTIER CADEL, host of a house party, is shot while at target practice. His shooting partner is mysteriously kidnapped and regains consciousness in a Pittsburg hotel room! All the other guests have ironclad alibis. But an unknown hideous face is seen at the kitchen window. A ghastly voice shrieks something of revenge! There is a weak link in the killer's plot! Can you find it?

Practically every crime novel published in previous issues of COMPLETE DETECTIVE NOVEL is now a best-seller in book stores at \$2.00 per copy. If you haven't already enjoyed these exciting, intriguing COMPLETE DETECTIVE NOVELS—you are missing rare treats and big bargains! Enjoy this full book-length story, "The Mystery of Cadel House," by the famous Louise Rose Eppley, in the August issue. **BUY IT TODAY—BEFORE THE STANDS SELL OUT!**

**COMPLETE  
DETECTIVE  
NOVEL  
MAGAZINE**

**At All Newsstands—Buy It Now!**

## Grid or Plate Detectors?

(Continued from page 127)

distortion, the amount of distortion being proportional to  $m/4$  where  $m$  is the percentage modulation of the r.f. signal. When the signal is modulated 100 per cent. the harmonic distortion is 25 per cent.

In summary of the preceding discussion it seems fair to say that the grid leak and condenser detector has probably been considered somewhat too harshly and that if we use fairly high plate voltages, small capacity grid condensers and low resistance grid leaks the circuit will give good results. We have expected too much. We have wanted a detector that was very sensitive and which also gave good quality. Evidently we can't have our pie and eat it too. If we want very high sensitivity we must sacrifice some fidelity—if we want good fidelity we will have to lose some of the sensitivity. But the fact remains that most modern receivers use the plate circuit detection (we surmise that the reason many experimenters still use grid leak and condenser detection is because they cannot afford to lose the sensitivity this arrangement gives) and since it is so widely used it must have some advantages over the grid leak and condenser circuit.

Some of the factors accounting for the wide use of the plate circuit detector are the possibility of getting large values of audio output voltage so that only one audio stage may be used with resultant less hum, its linearity at high signal levels so that the distortion due to the factor  $m/4$  is not present, possibly improvement in overall frequency response quality, etc.

The plate circuit detector is much simpler to understand than the grid circuit detector. For the plate circuit detector the only important variables are the grid bias and the plate voltage and the changes in the characteristics of the detector with changes in the voltages are quite readily determined.

The fundamental circuit of the plate circuit detector is given in Fig. 5. In Fig. 6 we show how the circuit operates. This picture of the operation of the circuit has been printed many times and needs but a brief explanation. The curves of Fig. 6 show the plate current grid voltage characteristic of a tube and in operation as a bias, *i.e.*, plate circuit detector, the tube works around the lower bend of the characteristic, the vertical dotted line showing the point at which the tube might be biased. The modulated radio-frequency signal is impressed on the input and because of the curvature certain parts of it are amplified more than others. This increases the average plate current and the variations of this average current with the modulation is the desired audio-frequency current. This diagram becomes somewhat clearer if it is indicated as in Fig. 7—although this diagram is not strictly accurate, it serves to indicate the process of detection more clearly. In this diagram the negative parts of the r.f. input do not appear in the plate circuit and we obtain the familiar half-wave peaks similar to those obtained from a type 280 rectifier in a "B" power unit.

(Continued on page 187)

## Grid or Plate Circuit Detectors?

(Continued from page 186)

Now the plate circuit detector can be divided into various types which can be conveniently classed and defined as follows.

**Small Signal Detector:** When so used the plate circuit detector is used to rectify comparatively small r.f. signals, say about 0.5 or 1 volt r.f. Over this range the detector follows a square law exactly as in the case of the grid circuit detector—as a result we find that the plate circuit detector also produces second harmonic distortion proportional to the factor  $m/4$ .

**High Voltage or Power Detector:** When used in this manner the plate detector is used to rectify comparatively large r.f. voltages—several volts or more. Frequently but not necessarily the high voltage detector is followed by but a single stage of audio-frequency amplification.

**High Voltage Linear Detector:** This type of detector is called upon to handle voltages of the same order as the simple high voltage detector but also an attempt is made to make the output from the detector directly proportional to the r.f. input, rather than proportional to the square of the r.f. input. If the detector follows a linear law the second harmonic distortion due to the factor  $m/4$  is eliminated.

### Plate Circuit Characteristics

The characteristics of the plate circuit depend largely on plate and grid voltages and the r.f. input at which the detector normally functions. In Fig. 8 is shown the characteristic of the power detector used in the Radiola 60 series of receivers. This particular curve was taken with a plate voltage of 180 volts and a grid bias of -25 volts. The curve shows the relation between the peak value of the r.f. input to the grid and the peak value of the audio voltage across the secondary of the first audio transformer, the r.f. input being modulated 15 per cent. at 100 cycles. The tube begins to overload with an r.f. input of 30 volts.

In the July, 1929, issue of the *I. R. E.* there was published an article that gave some data on the characteristics of the 201A tube as a bias detector. A group of curves from this article are shown in Fig. 9. This curve, termed a "detection diagram," shows the relation between the d.c. plate current of the tube and the effective value of the r.f. signal impressed on the grid. The essential circuit is shown on the diagram.

It will be noted that part of each of these curves is straight between about the following limits:

Bias	Range of straight portion of curve
2	2 to 6 volts r.f. input
4	3 to 7 volts r.f. input
8	4 to 10 volts r.f. input
15	8 to 17 volts r.f. input
20	13 to 21 volts r.f. input

If the r.m.s. value of the unmodulated wave is made to fall on the point midway between the two limits indicated

above the detector will give linear operation up to the point where, when the signal is modulated, the peak values equal the limits indicated. Practically, however, we will find it difficult to adjust the r.f. input to give best results; that is, least distortion, for we ordinarily control the volume by varying the r.f. input to the detector. Under these conditions we cannot hope that the circuit will be linear under all conditions, although such a condition can be approached by automatically biasing the detector tube. An idea of how well the circuit works in practice can be obtained by reference to Fig. 10, which shows the characteristic of an automatically biased high-voltage detector, the tube in this case being a type 227 with 300 volts on the plate and bias obtained from a 15,000-ohm resistor connected in series with the cathode and by-passed by a 1.0 mfd. condenser. An idea of the overload characteristics of the ordinary grid leak and condenser detector, the fixed bias and automatically biased plate circuit detector at various percentages of modulation can be obtained by reference to the curves of Fig. 11. In connection with the grid leak and condenser curves it will be noted that the audio output is somewhat greater than that mentioned at the beginning of this article. This is due to the fact that the curves were made with a plate voltage of 135 volts and to the fact that a type 240 tube was used. The  $\mu$  of this tube is of course somewhat greater than that of the 201A or 227, for example, and somewhat more output is therefore obtained.

It would appear from all this discussion that one can safely say that in a majority of cases where sensitivity is important the grid leak and condenser detector can be used with circuit constants about as indicated in the preceding pages. Although possibly there are conditions under which the grid leak and condenser detector can be used to give a linear output and sufficient voltage required by the particular set, it would seem that generally these results can be obtained more simply and effectively by the use of a plate circuit detector.

## Auto-Radio Receivers

(Continued from page 139)

upholstery is necessary in the installation of Bosch Motor Car Radio. The aerial is not contained in the roof of the car. A revolutionary type of antenna is employed. The entire installation is exceedingly simple and merely the work of a few minutes for a good mechanic.

The new Bosch Motor Car Radio is built by a manufacturer with long experience in building motor car accessories, and five years' experience in building and merchandising household radio receivers. The nation-wide organization of authorized Bosch Service Stations which will render installation and maintenance service in their "drive-in" establishments is of particular interest to the public.

## AUTO RADIO

is now made possible  
by the use of

## EX-STAT

### Ignition Filter Systems

THE EX-STAT Ignition Filter System effectively overcomes Ignition and Generator noises—AT THEIR SOURCE, and makes it possible to use the starting battery for operating radio while the vehicle is in motion. Scientifically designed in co-operation with the country's leading radio and automotive engineers, EX-STAT Filter Systems are prepared in standard kits for use with 4-6-8 cylinder motors. Special types for other cars, aircraft and motorboats on request.

Each kit contains necessary spark plug suppressors, distributor suppressor and special ignition filter condensers together with instructions for installation. Booklet describing EX-STAT Ignition Filter Systems for all types of cars packed with each kit.

When installed in accordance with instructions EX-STAT Ignition Filter Systems are guaranteed effective or your money will be cheerfully refunded, as provided for by the guarantee packed in each kit.

(ORDER WITH THIS COUPON)

<p>TILTON MANUFACTURING COMPANY Ignition Filter Department EX-8 15 E. 26th St., New York, N. Y., U. S. A.</p> <p>Gentlemen: Enclosed find cash or money order for EX-STAT Ignition Systems for <input type="checkbox"/> 4 cylinder cars (\$7.00), <input type="checkbox"/> 6 cylinder cars (\$9.50), <input type="checkbox"/> 8 cylinder cars (\$12.00).</p> <p>Name .....</p> <p>Address .....</p> <p>Make of Car (Important) .....</p>	<p>Approved by Radio News Laboratory and auto-radio manufacturers after extensive tests. Endorsements of leading engineers accompany each kit.</p>
--	--

## NEW NATIONAL SHORT-WAVE AC & DC RECEIVER

In Kit Form or Completely Constructed.

## AUTO-RADIO TELEVISION

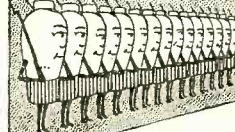
Kits and Sets and Accessories.

Kits and Supplies.

### 1930 CATALOG FREE

Set Builders! Write for your copy. Complete line of short-wave supplies, standard parts and accessories.

CHICAGO RADIO APPARATUS CO.  
415 S. Dearborn St., Dept. RN, Chicago, Ill.



MAKES TUBE VOLTAGE

TOE THE LINE

Stops voltage variations which ruin radio tubes. AMPERITE assures correct voltage automatically. Increases efficiency. \$1.10 with mounting (in U. S. A.).

This symbol in a radio diagram means—

AMPERITE Corporation

661 BROADWAY, NEW YORK

FREE—"Amperite Vest Pocket Tube Chart." Write Dept. RN-8.

AMPERITE

REG. U. S. PAT. OFF.

The "SELF-ADJUSTING" Rheostat

## Auto-Radio Receivers

(Continued from page 139)

ing screen grid tubes and a heater type detector meet the foregoing requirements in a satisfactory manner.

Special transformer design is employed to obtain maximum efficiency from the a.c. type No. 224 screen grid tube which is used in preference to the type No. 222 because of its ruggedness. The heaters of the No. 224's and the 227 are connected in series across the six-volt supply. After intensive research on the subject, it was found that the low heater voltage did not affect the efficiency of the heater type tube. It was found that a longer period was required for the tubes to warm up than is normally the case. When the automobile motor is running it will be found that the tubes will warm up in a shorter period due to the fact that when the generator is charging, the voltage at the storage battery terminals is raised to 7.5 volts.

The design of the heater type tubes is such that it will absorb normal fluctuations in filament voltage. A heater type tube was employed as a detector because of its ruggedness and freedom from microphonic action. The conventional No. 171A power tube is used in the power output circuit. Three stages of a.f. are employed, the first being resistance coupled, the second and third transformer coupled, resulting in the production of more than adequate volume. The No. 201A was found adequate in the first and second a.f. stages.

Damping resistors are used in the plug and distributor circuits when ignition interference becomes objectionable. Generator ripple is eliminated by the use of a by-pass condenser across the brushes.

## Junior Radio Guild

(Continued from page 157)

in the same manner as that used in making L3 and L1. On completing the inductance, the next winding job is that of the radio-frequency choke, which consists of a 1" diameter bakelite tube  $2\frac{1}{2}$ " long on which is wound 105 turns of No. 32 double cotton-covered wire. Mounting of this radio-frequency choke coil is simplified by using a brass angle piece which is  $\frac{3}{8}$ " wide and 1" long. Measuring off  $\frac{1}{2}$ ", we bend it at right angles and drill 2 holes; one of these holes is to be used for the screw for mounting the coil to the sub-panel, while the other is for the screw passed through a hole in the coil form and tightened up by means of a nut. The inductance coil is held in place by means of the eight leads which terminate at screw binding posts, mounted in the large piece of bakelite strip we have already cut. This was raised above the sub-panel by two brass sleeve pillars, each 2" long. Directly under this mounting strip is the mica condenser C3, being held in position by the busbar wiring. The two variable condensers are mounted centrally on the front panel, C1 being the oscillator control, while C2 is for tuning the antenna circuit. Between these two condensers, and at the lower part of the panel, is the "off-and-on" switch; directly

(Continued on page 189)

new . . . . this

## LOFTIN-WHITE

Sound Systems Unit by

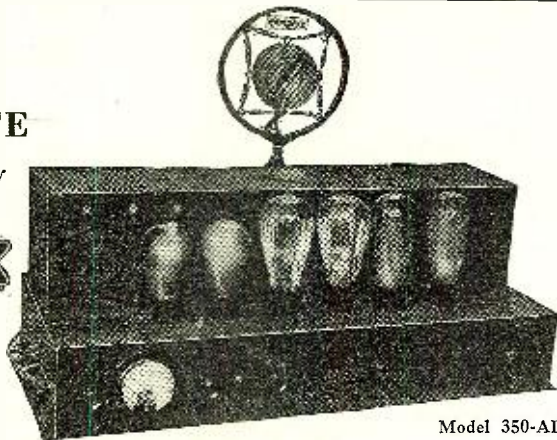
# Amplex

Here, in one super-AMPLEX Amplifier, the foundation of a complete sound system. Model 350-AD contains almost everything except input source and speakers. Quality—well, it's all Loftin-White by AM- PLEX, a flat fidelity curve (within 2 db.) from 50 to 10,000 cycles. Gain—plenty, over 4000. Supplies filtered variable mike current. Built-in mike transformer. Switch for mike to phonograph or radio input. Distortionless volume control. Acoustical Compensator (exclusively AM- PLEX)—a tone control with an extremely wide frequency range. Universal input up to 100,000 ohms. Output to meet any condition. All built into model 350-AD—three stages, combination Loftin-White "push-pull," using 1-24, 1-45, 2-50 and 2-81 tubes. List Price, laboratory tested (less \$295.00 tubes) . . . . .

Licensed Under



Patents Pending



Model 350-AD

### Markedly Superior—and lower in cost

AMPLEX continues to make commercially useful the sensational amplification system of Loftin and White! Working with these brilliant inventors, we are producing a line of power amplifiers superior to any other known system—hissless, distortionless, and with a straight line fidelity curve—eleven table models, from a single '45 to a "push-pull" 250 output—rack and panel systems including a "push-pull" 50 watt tube output. And none have been produced until after months of field tests—your guarantee of stability and service. Unquestionably audio amplification at its best—and lower in cost.

#### An Interesting and Profitable

proposition for responsible, experienced Installation Engineers, Custom Builders, Service Men, Dealers, Contractors. AM- PLEX will help you sell and install super-AMPLEX L-W sound systems for parks, airports, schools, hotels, theatres, etc. . . . You can bid lower, make more sales and profits, and get better results than with any other known system. Protected territories. Write in detail to our General Manager.

#### AMPLEX COUNSEL

As recognized amplification authorities AM- PLEX offers a complete engineering council service, WITHOUT CHARGE. Send sketch and details of your proposed installations—we will give you expert council and quotations—FREE.

### AMPLEX INSTRUMENT LABORATORIES

132-E West 21st Street

New York, N. Y.

## Read Classified Advertising—It Pays!!!

Advertisements in this section twenty-six cents a word for each insertion. Name and address must be included at the above rate. Cash should accompany all classified advertisements unless placed by an accredited advertising agency. No advertisements for less than 10 words accepted. Objectionable or misleading advertisements not accepted. Advertisements for these columns should reach us not later than 1st of 2nd month preceding issue.

#### Agents Wanted

**BIG MONEY AND FAST SALES.** Every owner buys Gold Initials for his auto. You charge \$1.50; make \$1.45. Ten orders daily easy. Write for particulars and free sample. American Monogram Co., Dept 133, East Orange, N. J.

**Guaranteed Genuine Gold Leaf Letters** anyone can put on store windows. Large profits, enormous demand. Free samples. Metallic Letter Co., 422 N. Clark, Chicago.

#### Business Opportunities

**Talkie and Movie Producers** are clamoring for New short story ideas, plots, etc. Perhaps you can write one that we can shape and sell for you. One writer (V.M.) received \$3000. New York best market. Write for full particulars. Daniel O'Malley Company, Suite K, 1776 Broadway, New York.

**Amazing Screw-Holding Screw Drivers!** Remove, insert screws inaccessible places one-handed! Factories, garages, electricians, auto, radio owners buy on sight! Exclusive territory. Free trial! Manufacturer, 1619 Winthrop Bldg., Boston.

**Amateur Cartoonists:** Sell your cartoons, new plan. Smith's Service, EX1194, Wenatchee, Wash.

**Free Book.** Start little Mail Order business. Hadwil, 54-74 Cortlandt Street, N. Y.

#### Correspondence Courses

Used correspondence school courses sold on repurchase basis. Also rented and exchanged. Money-back guarantee. Catalog free. (Courses bought.) Lee Mountain, Pisgah, Alabama.

**CORRESPONDENCE COURSES—Sold, Bought, Exchanged.** Rented. Barrain Catalogue Free. Hanfling, C-799 Broadway, New York.

#### Detectives

**Detectives.** Work home or travel. Experience unnecessary. Particulars free. Write George Wagner, 2190 Broadway, N. Y.

#### Help Wanted and Instruction

**Wanted—Men and Young Men** that can solder to make Bird cages at home. \$36 a dozen. No selling. Complete proposition 25c (coin or stamps), write plainly. All Wire-Cage Mfg. Co., 3115 Madison St., Chicago, Ill.

**Detectives—Earn Big Money.** Experience unnecessary. Write, American Detective System, 2190K Broadway, N. Y.

#### Inventions

**INVENTIONS WANTED—Patented, Unpatented.** If you have an idea for sale write, Hartley, Box 928, Bangor, Maine.

#### Patent Attorneys

**PATENTS—Write for Free Instructions.** Send Drawing or Model for Examination. Miller & Miller, Registered Patent Attorneys (former Patent Office Examiners), 262 McGill Building, Washington, D. C.

**Inventors—Should write for our Guide Book.** "How to Obtain a Patent," and Record of Invention Blank, sent Free. Send model or sketch of inventions for our inspection and instructions free. Radio, Electrical, Chemical, Mechanical and Trademark Experts. Terms Reasonable. Victor J. Evans & Co., 922 Ninth, Washington, D. C.

**PATENTS—Send for form "Evidence of Conception"** to be signed and witnessed. Form, fee schedule. Information free. Lancaster, Allwine and Rommel, Registered Patent Attorneys in United States and Canada, 269 Ouray Building, Washington, D. C.

**Patents—Advice and booklet free.** Highest references. Best results. Promptness assured. Watson E. Coleman, Patent Lawyer, 724 9th Street, Washington, D. C.

#### Pocket Radio

**GUARANTEED "POCKET" RADIO.** \$2.00. Particulars FREE. Neil Tasker, Shamokin, Penna.

#### Songwriters

**COMPOSERS—VERSE OR MUSIC.** Brilliant opportunity. Write at once. Van Buren, 2081 McClurg Bldg., Chicago.

#### Telegraphy

Learn Morse and wireless telegraphy. Big salaries. Tremendous demand. Expenses low, can earn part. Catalog free. Dodge's Institute, Cour Street, Valparaiso, Indiana.

## Junior Radio Guild

(Continued from page 188)

above this switch is located the resonance indicating lamp. Here we used a discarded pilot light receptacle to which was added a homemade brass bracket 1½" long and ½" wide. This was shaped so that when the lamp was screwed in its base it projected by the length of the glass bulb in front of the panel. Also on the lower part of the front panel were mounted four pin jacks. These are to be used for taking the leads of the microphone and the transmitter key. Soldered directly to one of the key pin jacks was the 12,000-ohm resistor, which is in series with the key and terminal No. 2 of inductance L1. So as to conserve space, the mica fixed condensers C4 and C5 were soldered directly to soldering lugs on the variable condenser C1, while slightly to one side and under these two condensers was mounted the filament ballast resistor. Studying the photographs and picture diagram, the beginner should have no trouble in duplicating the transmitter described here.

First of all, connect the "A" battery and see that the tube filament lights. It may also be well to check the voltage across the terminals of the socket. Providing everything is o. k., it is now permissible to connect the "B" potential to its respective binding posts. Before connecting the antenna and ground to their binding posts, it will be well to short this circuit with a piece of No. 18 bell wire about 12" long. Set the oscillator condenser at about 50; close the key, and vary the series antenna condenser, C2, for the best brilliancy of our resonance indicating lamp. Bring the wavemeter in close proximity to the bell-wire loop so as to check the wave-length of the signal being emitted by the transmitter. Reset the oscillator and antenna series condenser until the transmitter is tuned to the amateur 80-meter band on which it is to operate. (The grid-dip meter described in the July issue is ideal for checking the wavelength adjustment of your transmitter.) Having arrived at this waveband, we are now ready to connect the antenna and ground to their respective binding posts, resetting condenser C2 and again checking the wavelength. With the short-wave receiver alongside our transmitter, we are now ready to send out our first CQ and sign the call letters allotted to our new station by the Federal Radio Commission. Next month's Junior Guild lesson will describe types of efficient antenna systems which may be employed with short-wave transmitters.

### List of Parts

- 1 Tuning inductance, homemade, L1, L2, L3, L4.
- 1 R.F. choke coil, homemade. RFC.
- 1 .00025 mfd. Midline condenser, Hammarlund, C1.
- 1 .0005 mfd. Midline condenser, Hammarlund, C2.
- 2 .0005 mica fixed condensers, Aerovox, C4, C5.
- 1 .006 mica fixed condenser. Aerovox. C3.
- 1 filament ballast resistor 699, Amperite, R1.
- 1 1,200-ohm resistor, Electrad, R2.

- 1 socket, Benjamin 9040.
- 1 battery switch, Yaxley, SW.
- 4 pup jacks, Yaxley.
- 3 engraved binding posts, X-L.
- 1 indicating lamp, 1½-volt flashlight type.
- 2 dials, 4" diameter. General Radio.
- 1 bakelite panel. 6" x 10".
- 1 sub-panel, 5-ply wood, 10" x 8".
- 3 Corwico solid braidite.

## Experimenter

(Continued from page 160)

A tone control is just as essential to satisfactory radio rendition as a volume control. Tone control permits of balancing room conditions, musical tastes and the selection being reproduced and, fortunately, this feature may be readily added to any set, irrespective of type, vintage, or cost.

## Universal Auto Receiver

(Continued from page 144)

be on any one of several revolutions. To overcome this difficulty, some commercial outfits have the tuning control geared to an indicating dial which makes no more than one revolution in covering the wavelength range of the set. While this is a good arrangement, it is not so easily made up by the home set-builder. A much simpler method is to rig up a set of bevel gears on the end of the receiver case, as indicated in Fig. 2.

Due to the limited space in which the aerial must be constructed, and the present metal car frame which must serve as a ground, it is practically impossible to approach the energy pick-up qualities of the antenna employed in the average home. To attain the best reception, we should, therefore, strive to erect the most efficient aerial that the construction of the car will permit. Two general rules to guide us are (1) locate the conductors as high as possible, and (2) keep the antenna and its leads as far from metal portions of the frame as it is practicable to do. But since few of us care to have a conspicuous network of wires strung over the top of the car, we shall neglect the possibility of such construction in favor of an aerial of the more concealed type.

Some car owners have found that an aerial strung beneath the running boards is quite satisfactory in spite of the fact that it would seem that the effective height would be too small for efficient reception. Where it will work, it is a neat way of getting the antenna out of sight. Other methods have taken the form of parallel wires or copper mesh in the top of the car.

An idea that does not appear to have been used so far, but which affords one of the simplest and neatest methods of auto aerial erection, is to use a flexible metallic tinsel tape and upholstery tacks. It can be stretched around the top of the car body either inside, as shown in Fig. 1, or outside, and held in place by tacks having relatively large heads. Another type of tape has one surface metallized and the other gummed much like friction tape.

## The Radio Construction Library

[Latest Data on Radio Receivers for the Dealer, Serviceman and Amateur]

WRITTEN by two widely known radio engineers, these three books cover every phase of building, repairing and "trouble-shooting" on modern receiving sets. This practical Library includes: PRACTICAL RADIO—The fundamental principles of radio, presented in an understandable manner. Illustrated with working diagrams. PRACTICAL RADIO CONSTRUCTION AND REPAIR—Methods of locating trouble and reception faults, and making workmanlike repairs. Discusses modern Short Wave Receivers fully. RADIO RECEIVING TUBES—Principles underlying the operation of all vacuum tubes and their use in reception, amplification, remote control and precision measurements.

Three Volumes, 6 x 9—993 pages, 561 illustrations.

See this Library FREE!



No Money Down

McGraw-Hill FREE EXAMINATION COUPON

McGraw-Hill Book Company, Inc. 370 Seventh Avenue, New York

Send me the new RADIO CONSTRUCTION LIBRARY, three volumes, for 10 days' free examination. If satisfactory I will send \$1.50 in ten days, and \$2.00 a month until \$7.50 has been paid. If not wanted I will return the books.

Name .....  
 Home Address .....  
 City and State .....  
 Position .....  
 Name of Company ..... I.R.N. 8-30

## Enjoy SHORT WAVE reception on your radio.



### "THE SUBMARINER"

Short wave reception from all parts of the world is now possible with the SUBMARINER. No need to buy a special short wave receiver when the SUBMARINER will bring in reception at a fraction of the cost. Plugs in on your present broadcast receiver. Versatile tuning device with a ratio of 64 to 1 makes tuning exceptionally easy, thus enabling you to pick up stations otherwise impossible to get. The SUBMARINER made since 1926 is completely shielded—a quality product throughout.

Prices: Regular model AC or DC, fixed wave band 19-50 meters, \$17.50. Interchangeable coil, 13-145 meters \$25.50. The "I" feature, an exclusive "Submariner" achievement, gives five times the volume of any other adapter. AC or DC, prices as follows: Fixed wave band, 19-50 meters, \$27.50. Interchangeable coil, 13-145 meters, \$27.50. In ordering give model of set and numbers on tubes in it. Five-prong tube for AC receivers recommended for short waves, \$2.50.

Will be sent prepaid on receipt of price, or C.O.D. if \$1.00 accompanies order. Foreign orders, add 60c postage, no C.O.D.  
**J-M-P MANUFACTURING CO., INC.**  
 3416 Fond du Lac Ave. Milwaukee, Wis., U.S.A.

## CHANCE TO START YOUR OWN BUSINESS

Manufacturing Metal Toys and Novelties As Our Representative

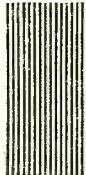


Big demand for 5 and 10c Store Novelties, Ashtrays, Toy Soldiers, Animals, Auto Radiator Ornaments, etc. We co-operate in selling goods you make; also buy these from you. Small investment needed to start and we help you build up. WE FURNISH COMPLETE OUTFITS and start you in well-paying business. Absolutely NO EXPERIENCE and no special place needed. A chance of a lifetime for man with small capital. Write AT ONCE if you mean strictly business and want to handle wholesale orders now being placed.

**METAL CAST PRODUCTS COMPANY,**  
 Dept 12, 1696 Boston Road, New York City.



There's one live-wire radio construction magazine that 60,000 radio fans, custom-set builders and advanced experimenters look forward to, eagerly, expectantly!



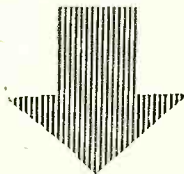
And 60,000 radio fans can't be wrong! You too will find "Radio Design" written by practical men who know what it's all about! Each quarterly issue packed tight from cover to cover with real radio meat!



Short-wave enthusiasts will find latest dope hot from the laboratory and ultra-modern broadcast receiver hook-ups direct from the brains of Robert S. Kruse ("LQ"), David Grimes, Zeh Bouck, John Geloso, Sylvan Harris, Robert Hertzberg, and Alfred A. Ghirardi.



For only 50c per year you will receive "Radio Design" and membership in the Radio International Guild—a world-wide organization of radio experimenters and constructors. Where else can you get so much for so little? Return the coupon and receive immediately current issue Radio Design, your Guild membership certificate, card, and handsome lapel pin.



**JOINING THE RADIO INTERNATIONAL GUILD**

Costs only 50c and includes lapel pin, certificate and "Radio Design" Construction Quarterly, the Guild's Official Organ. Enclose 50c coin or stamps to Radio International Guild, 103 Broadway, Brooklyn, N. Y.

Name \_\_\_\_\_

Address \_\_\_\_\_

City \_\_\_\_\_

RADIO DESIGN R.N.

## Index to Advertisers

	A	PAGE
Acme Wire Co.		185
Advance Electric Co.		184
American Sales		182
American Technical Society		175
Amperite Corp.		187
Amplex Instrument Laboratories		188
Amplion Corp.		178
Amrad Corp.	Inside Front Cover	
Associated Industries		185
Automatic Radio Mfg. Co.		179
<b>B</b>		
Belden Mfg. Co.		181
Blan the Radio Man		178
Browning-Drake Corp.		182
<b>C</b>		
Central Radio Laboratories		174
Champion Radio Works		177
Chicago Radio Apparatus Co.		187
Clarostat Mfg. Co.		182
Classified Advertising		188
Continental Wireless Supply Co.		182
Coyne Electrical School	Back Cover	
Crosley Radio Corp.		180
<b>D</b>		
DeForest Radio Co.		167
Drake, Frederick J. & Co.		190
Drake Hotel, The		183
<b>E</b>		
Electrad, Inc.		178
Excello Products Corp.		183
<b>F</b>		
Federated Purchaser		175
<b>G</b>		
General Fabricating Co.		183
Grigsby-Grunow		172
<b>H</b>		
Hanmarlund Mfg. Co.		180
High Frequency Labs.		165
Hoodwin Co., Chas.		181-184
<b>J</b>		
J. M. P. Mfg. Co., Inc.		189
<b>K</b>		
Keeley Institute		183
<b>L</b>		
LaSalle Extension University		174
Lincoln Hotel		185
<b>M</b>		
McGraw-Hill Book Co., Inc.		189
Majestic Radio Tubes		172
Mason, Fenwick & Lawrence		174
Metal Cast Products		189
Midwest Radio Corp.		101
Miles Reproducer		181
<b>N</b>		
National Carbon Co., Inc.		163
National Co., Inc.		171
National Radio Institute		99
National Sound Service Bureau		179
New Bismarck Hotel		180
<b>O</b>		
Omnigraph Mfg. Co., The		175
<b>R</b>		
R. C. A. Institutes, Inc.		173
Radio International Guild		190
Radio Surplus Corp.		185
Radio & Television Institute		103
Radio Training Association of America		97
Rim Radio Mfg. Co.		183
Roll-O Specialty Co.		190
<b>S</b>		
Samson Electric Co.	Inside Back Cover	
See Jay Battery Co.		180
Silver-Marshall, Inc.		169
Sprague Specialties Co.		175
S. S. Jobbing House		185
<b>T</b>		
T. Garter Co., The		183
Teleplex Co.		178
Tilton Mfg. Co.		187
Triad Mfg. Co., Inc.		191
20th Century Mail Order Corp.		183
<b>U</b>		
Universal Microphone Co.		180
<b>W</b>		
Washington Hotel		184
Weston Electrical Instrument Corp.		185
West Side Y. M. C. A. Radio Institute		183
<b>Y</b>		
Yaxley Mfg. Co.		174

## ✓ FREE BOOKS of BUSINESS HELPS

We publish over 200 Home Study Books, each a complete treatise of its subject. We have one or more for you. Books on

- |  |   |
|--|---|
| <input type="checkbox"/> Commercial Art      | <input type="checkbox"/> Decoration       |
| <input type="checkbox"/> Lettering           | <input type="checkbox"/> Automobiles      |
| <input type="checkbox"/> Advertising         | <input type="checkbox"/> Battery Work     |
| <input type="checkbox"/> Sign Making         | <input type="checkbox"/> Electricity      |
| <input type="checkbox"/> Radio               | <input type="checkbox"/> Carpentry        |
| <input type="checkbox"/> Aviation            | <input type="checkbox"/> Building         |
| <input type="checkbox"/> Painting            | <input type="checkbox"/> Contracting      |
| <input type="checkbox"/> Silk Screen Process | <input type="checkbox"/> Sheet Metal Work |
- and many other subjects. All fully described in our FREE CATALOG. Check the subjects in which you are interested and write today.
- FREDERICK J. DRAKE & CO., Publishers**  
 Room 510—179 N. Michigan Blvd., Chicago  
 Drake books are for sale in all book stores

### See the Craters in the MOON!

**Astronomical and Terrestrial TELESCOPE**

**Magnifies 30 Times**

Own a genuine Astronomer's Telescope. See thousands of miles away. Make Sun, Moon Planets. Stars your next door neighbors. Moon Craters, Sun Spots, Eclipses, Comets enlarged 30 times. Strange thrills!

See Landscapes, Games, Ocean Scenes, Enlarged 30 Times!

Diameter 2 inches. Special friction adjustment for focusing. Adjustable bracket, and clamp can be fastened to chair, fence, branch, etc. Finest material. Will last a lifetime.

**Price Only \$3.95**

**Five Days' Free Trial**  
Rush only \$1.00 now. Pay balance (\$2.95 plus postage), when postman delivers. Keep 5 days. If not delighted, return telescope and money will be refunded.

**EARN \$10 A DAY**  
Charge 25c to look at the moon

**ROLL-O SPECIALTY CO.,**  
Dept. J-335  
220 E. 3rd St., Cincinnati, O.

## Be Financially Independent

WOULDN'T you like to have your own spare-time business? To have an extra independent income in addition to your salary or allowance? To have money to buy the 101 things you've always wanted, but felt you couldn't afford?

Then our easy money-making plan is just what you want. This type of business needs no experience. It has enabled one young man in Ohio to earn \$300 in a single month's spare-time. A young Canadian found it paid better than his regular full-time job. Hundreds of high school students and men and women in all walks of life are earning substantial sums this way.

### Immediate Profits

What they have done and are doing, YOU CAN DO, TOO! Let us show you how to earn as high as \$3.00 an hour. Your profits start as soon as you do. Mail coupon for free outfit now!

#### Mail TODAY

Mackinnon-Fly Publications, Inc.  
 Dept. 2408-W, 381 4th Ave.  
 New York, N. Y.

Without obligation to me, please send me full details of your easy money-making plan.

Name \_\_\_\_\_

Address \_\_\_\_\_

City & State \_\_\_\_\_

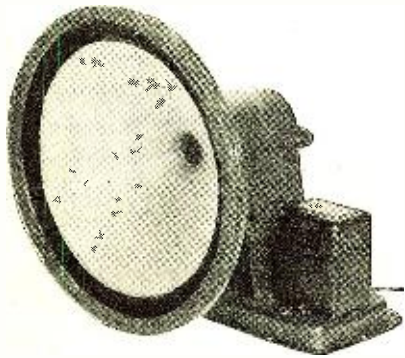


## News from the Manufacturers

(Continued from page 153)

### Electrodynamic Speaker Units

Silver-Marshall, Inc., 6401 W. 65th Street, Chicago, is manufacturing a line of electrodynamic speaker units—the 860 series, having a voice coil impedance of 12 ohms and a 12-inch cone. This series of auditorium speakers have a curve which rises slowly from 30 cycles, when used with a suitable baffle, to well over 8,000 cycles with no pronounced peak.



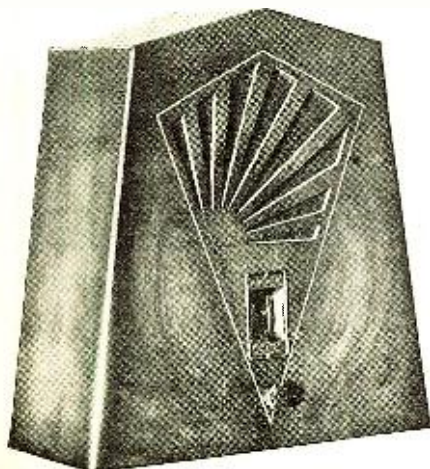
The company is manufacturing other electrodynamic speaker units, some of which are built without input transformers to eliminate the cost of the transformer, its distortion and power loss and distortion in the speaker supply line.

### Radio Bulletin

The American Sales Company, 19 Warren Street, New York City, has issued a radio bargain bulletin, No. 31, which describes power and filter equipment and radio receivers.

### A New Compact Receiver

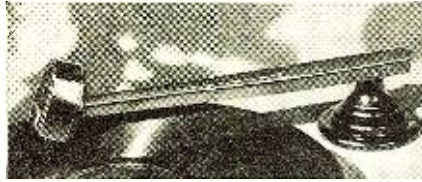
Keller-Fuller Mfg. Co., 1573 W. Jefferson Street, Los Angeles, Calif., have brought out an all-electric set with built-in speaker called the "Radiette." The set



is 16 inches high, 7 inches deep and 14 inches wide. It has one tuning dial and one control for volume and current.

### Electromagnetic Pick-Ups

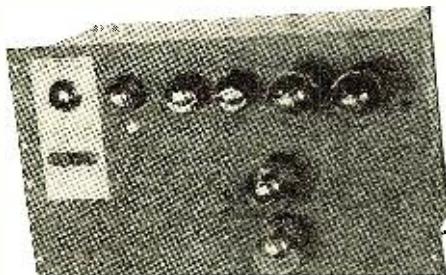
Presto Machine Products Company, Inc., 70 Washington Street, Brooklyn, N. Y., has added a line of electromagnetic pick-



ups. The arm and head are finished with statuary bronze and the needle pressure is spring compensated.

### Power Amplifiers

Silver-Marshall, Inc., 6401 W. 65th Street, Chicago, is marketing three-stage a.c. dual push-pull power amplifiers of modified rack and panel design. These amplifiers have a three-circuit input for radio, record pick-up and microphone with a three-way selector switch and fading volume control. They obtain their operating power from any 105-120-volt, 50-60 cycle source, and have a uniformly high gain of 64 decibels. They develop an un-



distorted power output of approximately 15 to 16 watts and will operate from 1 to 20 auditorium or other electrodynamic speakers, or up to 300 magnetic speakers.

### Electrodynamic Units

Miles Reproducer Company, 45 W. 17th Street, New York City, is now manufacturing a dynamic air-column unit used principally for theatre and outdoor work.

The company has also perfected a new line of 3½, 5, 6 and 9-foot Exponential Trumpets, the new 5-foot Exponential Trumpet and the Giant 10-foot square horn with a bell 42 by 42 inches. In addition, the company announces the single and double carbon button microphones for broadcasting and public address work. The product illustrated here is the Desk Model.



## Now— the new improved TRIAD LINE

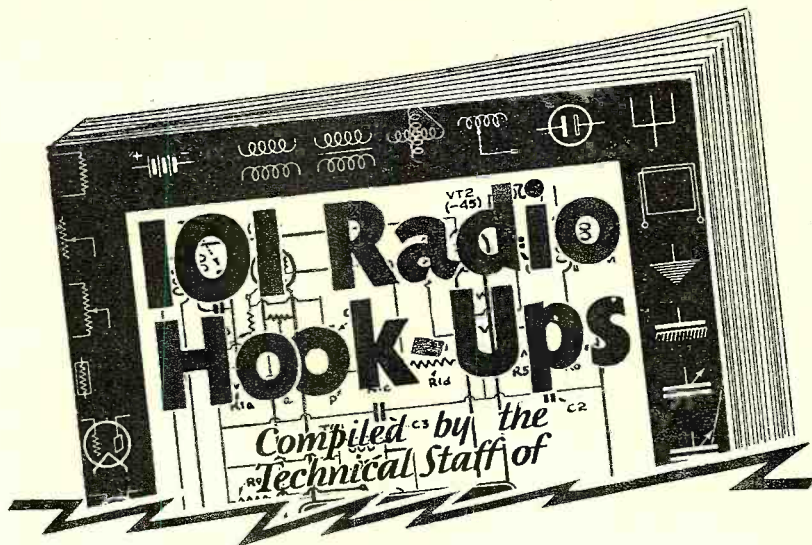


Now—skilled research has developed for TRIAD T-24 a more rigid construction that practically eliminates microphonics and burn-outs. The same painstaking effort has discovered a new carbonizing process that renders TRIAD T-45 free from gas—has evolved improvements that give to this tube longer life—greatly increased range and undistorted output—ability to stand materially higher plate voltages—and super-clear and amazingly realistic tonal quality. These advantages mean—greater satisfaction for your customers—bigger sales and greater profits for YOU!

Triad Radio Tubes are manufactured under R. C. A., General Electric, and Westinghouse Electric patents.

TRIAD MFG. CO.  
Pawtucket, R. I.

**TRIAD**  
RADIO TUBES



# FREE This Big New Radio Book with 6 Months of RADIO NEWS *only*

*Special Summer Offer Good for One Month Only!*

**H**ERE'S a big brand new book that every radio fan, set owner, set builder, service man and experimenter has been eagerly looking for! In it we present a cross-section of the latest progress made in every phase of radio reception, to serve both as an ideal source of reference and as a stimulant for even greater achievement.

As the book's title indicates, it contains complete schematic diagrams and thorough descriptions of Short-Wave Transmitters and Receivers, all the most popular types of Manufacturers' and Home-Built Receivers, Serviceman's Test Apparatus and a Group of the New Loftin-White Direct-Coupled Amplifiers. Below are a few of the more than 101 sets included in this invaluable book, which will be shipped to you **ENTIRELY FREE!**

Radiola No. 33  
HFL Mastertone  
Colonial Model SG32  
The Stromberg-Carlson Screen-Grid Receiver  
Zenith 34P and 342P.  
Hammarlund Roberts HiQ 30  
Grebe D.C. No. SK-4  
Atwater Kent No. 35  
Silver Marshall Automobile-Radio Receiver  
Lincoln 8-80 Superheterodyne 10-Tube  
Silver Marshall Auditorium Power Amplifier  
National Screen-Grid Short-Wave  
4 Loftin-White Direct-Coupled Amplifying Systems  
Cornet Short-Wave Receiver

A Short-Wave Adapter for Use on an A.C.-Operated Receiver  
Bosch No. 48  
Fada No. 35B  
Freshman Q15  
Jackson NJ-30  
Pilot A.C. Short-Wave Super-Wasp  
Kolster K-21  
Majestic No. 180  
Stewart-Warner Series 950  
Victor Radio Models R32 and RE45.  
Test Panel for Radio Serviceman or Radio Laboratory  
Tube Tester Eliminating Need of Batteries  
An Audio-Frequency Oscillator  
A High-Power Crystal-Control Short-Wave Transmitter

Other diagrams and descriptions cover complete receivers or units thereof used in virtually every field of radio activity.

**Other Radio Book Bargains on Page 177**

## The New Loftin-White System

No single radio development in recent years has received the attention now being given the Loftin-White System. It has provided us with a new, cheaper and better method of reproduction and one which, from the standpoint of true radio and mechanical engineering, offers some really astounding possibilities. Their ingenious system has been incorporated with remarkable results in many of the circuits contained in this publication. As RADIO NEWS has the exclusive right to the publication of articles by Messrs. Loftin and White, this information is not obtainable from any other source.

## Get Your FREE Copy NOW!

As you can readily see from the copy you are now reading, RADIO NEWS is deservedly the outstanding leader of all radio magazines. Of course, you want it every month. Here's your opportunity to get 6 big issues (\$1.50 single copy value) for only \$1.00—and to have this big new manual, "101 Radio Hook-Ups," shipped to your home, postpaid, entirely free. You save 50 cents on RADIO NEWS and get the book **WITHOUT COST!** Risk nothing—

### -----Mail Coupon TODAY!-----

RADIO NEWS, Dept. 2408,  
381 Fourth Avenue, New York, N. Y.

Gentlemen: Send me, **ENTIRELY FREE**, postpaid, the new completely revised 1930 edition of your book "101 RADIO HOOK-UPS" and enter my subscription for the next Six Big Issues of RADIO NEWS at only \$1, which I enclose (regular price \$1.50). I understand you will cheerfully refund my \$1 and I may keep the "101 RADIO HOOK-UPS" if I am not perfectly satisfied after reading the first issue.

Name .....

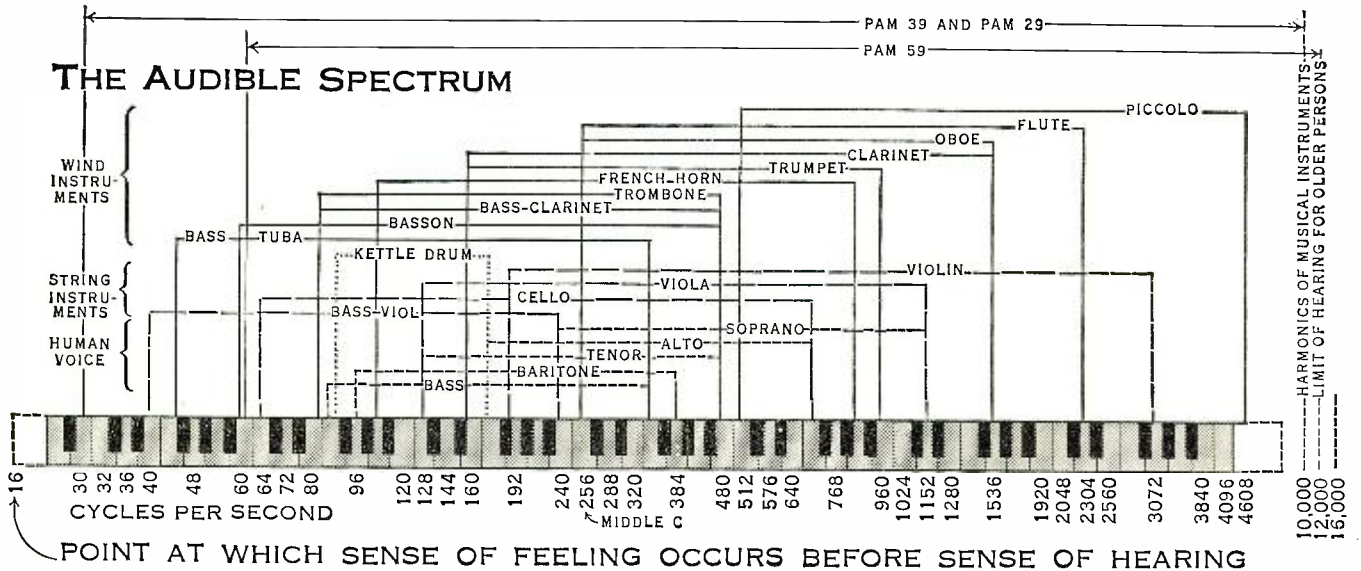
Address .....

City and State .....

Are you a Service man ? Engineer ? Dealer ? Experimenter ?  
Present subscriptions will be extended from expiration.

# PAM

THE VOICE OF THE NEW "GREAT SPIRIT"



The ranges of the new PAM amplifiers are considerably greater on both ends of the audible spectrum than shown above. The ranges shown are those over which the new PAMs will amplify without discrimination noticeable to the human ear.

## EQUAL Amplification over entire musical and vocal scale

YOU will be surprised at the new brilliance of tone due to equal amplification of harmonics, as well as fundamentals. The high notes and the rich deep low ones come in as never before with perfect fidelity. Nothing is there except *undiscriminating* amplification of original signal.

Greater compactness, improved appearance, less weight, longer life, two values of output impedance, and hum voltage cut to one-fourth are but a few of the many features built into these new PAMs, which are the products of a company nearly half a

century old with years of experience in amplifier construction and with financial stability to insure that your PAM amplifier will not be an orphan.

The NEW Samson PAMs demonstrated in Atlantic City during the recent Show created a sensation.

For those who were not fortunate enough to have heard the NEW Samson PAMs at the Show, we have prepared an attractive folder, No. RN-8, called "More Power per Dollar," descriptive of these NEW PAMs. This folder will be sent promptly on request.

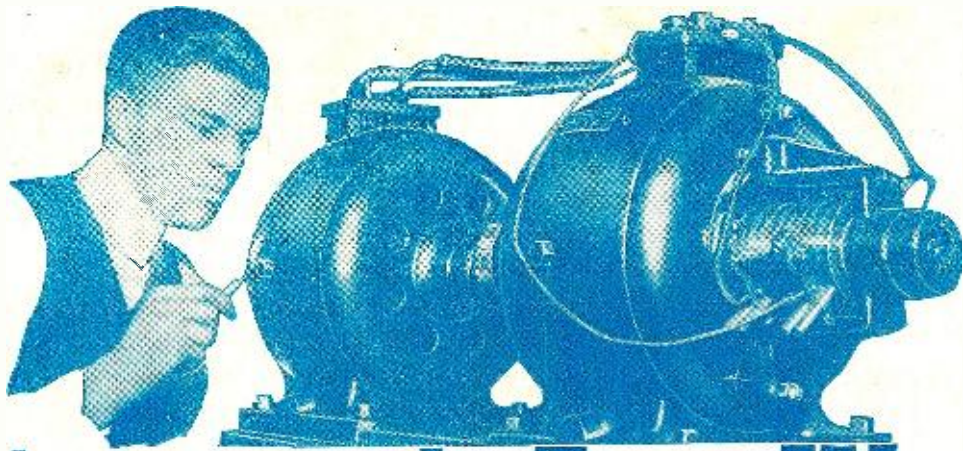
**Samson Electric Co.**

MANUFACTURERS SINCE 1882



Main Office:  
Canton, Mass.

Factories: Canton and  
Watertown, Mass.



# Amazingly Easy Way to get into **ELECTRICITY**

Don't spend your life waiting for \$5 raises in a dull, hopeless job. Now... and forever... say good-bye to 25 and 35 dollars a week. Let me show you how to qualify for jobs leading to salaries of \$50, \$60 and up, a week, in Electricity—NOT by correspondence, but by an amazing way to teach, **RIGHT HERE IN THE GREAT COYNE SHOPS**. You become a practical expert in 90 days! Getting into Electricity is far easier than you imagine!

## Learn Without Lessons in **90 DAYS** By Actual Work—in the Great Shops of Coyne

Lack of experience—age, or advanced education bars no one. I don't care if you don't know an armature from an air brake—I don't expect you to! I don't care if you're 16 years old or 48—it makes no difference! Don't let lack of money stop you. Most of the men at Coyne have no more money than you have.

### Railroad Fare Allowed

I will allow your railroad fare to Chicago, and if you should need part-time work I'll assist you to it. Then, in 12 brief weeks, in the great roaring shops of Coyne, I train you as you never dreamed you could be trained on a gigantic outlay of electrical apparatus... costing hundreds of thousands of dollars... real dynamos, engines, power plants, autos, switchboards, transmitting stations... everything from doorbells to farm power and lighting... full-sized... in full operation every day!

### No Books—No Printed Lessons

No books, no baffling charts... all real actual work... right here in the great Coyne school... building



### Prepare for Jobs Like These

Here are a few of hundreds of positions open to Coyne-trained men. Our free employment bureau gives you lifetime employment service.  
 Armature Expert, to \$100 a Wk.  
 Substation Operator \$60 a Week and up  
 Auto Electrician \$110 a Week  
 Inventor... Unlimited  
 Maintenance Engineer up to \$150 a Week  
 Service Station Owner up to \$200 a Week  
 Radio Expert up to \$100 a Week

real batteries... winding real armatures, operating real motors, dynamos and generators, wiring houses, etc., etc. That's a glimpse of how we make you a master practical electrician in 90 days, teaching you far more than the average ordinary electrician ever knows and fitting you to step into jobs leading to big pay immediately after graduation. Here, in this world-famous *Parent school*—and nowhere else in the world—can you get this training!

### Jobs—Pay—Future

Don't worry about a job, Coyne training settles the job question for life. Demand for Coyne men often exceeds the supply. Our

employment bureau gives you a lifetime service. Two weeks after graduation, Clyde F. Hart got a position as electrician for the Great Western Railroad at over \$100 a week. That's not unusual. We can point to Coyne men making up to \$600 a month. \$60 a week is only the beginning of your opportunity. You can go into radio, battery, or automotive electrical business for yourself and make up to \$15,000 a year.

### GET THE FACTS

Coyne is your one great chance to get into electricity. Every obstacle is removed. This school is 30 years old—Coyne training is tested—proven beyond all doubt—endorsed by many large electrical concerns. You can find out everything absolutely free. Simply mail the coupon and let me send you the big, free Coyne book of 150 photographs... facts... jobs... salaries... opportunities. Tells you how many earn expenses while training and how we assist our graduates in the field. This does not obligate you. So act at once. Just mail coupon.



### Get This FREE Book

Mr. H. C. LEWIS, President  
**COYNE ELECTRICAL SCHOOL, Dept. CO-27**  
 500 S. Paulina St., Chicago, Ill.

Dear Mr. Lewis:  
 Without obligation send me your big free catalog and all details of Railroad Fare to Chicago, Free Employment Service, Radio, Aviation Electricity, and Automotive Courses, and how I can "earn while learning."

Name.....  
 Address.....  
 City..... State.....

### Now in Our New Home

This is our new, fire-proof, modern home wherein is installed thousands of dollars' worth of the newest and most modern Electrical Equipment of all kinds. Every comfort and convenience has been arranged to make you happy and contented during your training.



**COYNE ELECTRICAL SCHOOL**  
 H. C. LEWIS, Pres. **Established 1899**  
 500 S. Paulina Street • Dept. CO-27 • Chicago, Illinois