

CIRCULATION LARGER THAN THAT OF ANY OTHER RADIO PUBLICATION



RADIO NEWS

25 Cents

JULY

Over 200
Illustrations

Edited by HUGO GERNSBACK



"ALONE
AT LAST!"

RADIO'S GREATEST MAGAZINE

EXPERIMENTER PUBLISHING COMPANY, NEW YORK, PUBLISHERS OF
SCIENCE and INVENTION RADIO REVIEW AMAZING STORIES RADIO INTERNACIONAL

Cunningham

RADIO TUBES

Since 1915—
Standard for all Sets



Stamina--

There is no wavering, no swerving, in Cunningham's original steadfast purpose of creating radio tubes to bear successfully the brunt of hour upon hour of

the severest service. But endurance has never been the sole aim. Today you find combined with it in these tubes that quality which makes for absolute fidelity to the pure source-tone.—

Sensitiveness

E. J. Cunningham Inc.

New York

Chicago

San Francisco

Manufactured and sold under rights, patents and inventions owned and/or controlled by Radio Corporation of America.

The new Tower Cone

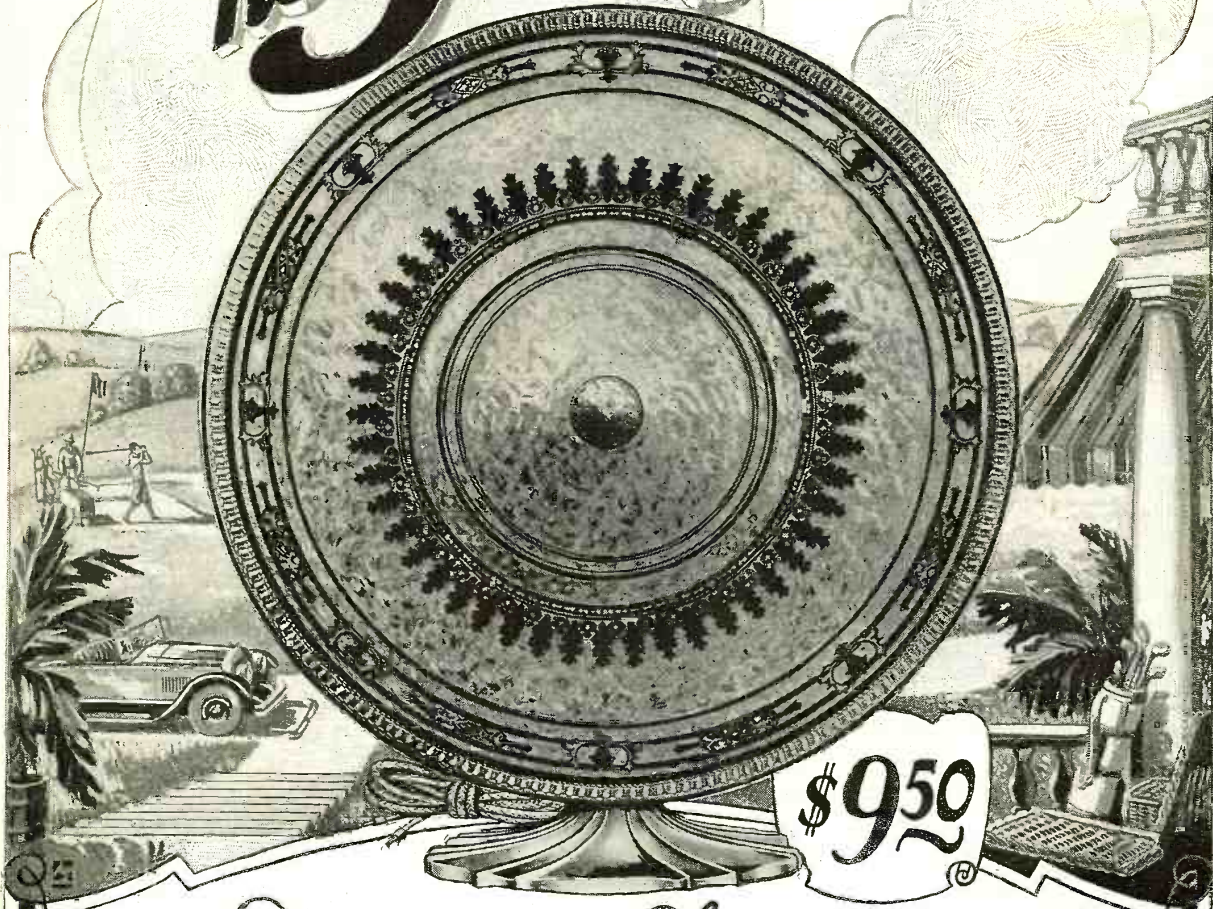

\$950

America's Favorite

WHEREVER good reception is essential the new Tower Cone is fast replacing more expensive Speakers, as it exemplifies the supreme combination of all that can be desired in a radio reproducer. Its refreshingly superior tone quality and volume is winning new and lasting friends everywhere.

Only in Tower will you find the direct-drive unit with eight points of contact from unit to cone, plus an acoustically perfect, non-warping parchment cone—full 17 inches in diameter.

All can view its beauty. But only those who actually hear it can know its truly wonderful capabilities

Ask Your Dealer to Demonstrate
ON SALE FROM COAST TO COAST

TOWER MFG. CORP. ~ BOSTON, MASS.

RADIO NEWS

Published by EXPERIMENTER PUBLISHING COMPANY, Inc., Publishers of "Radio News," "Science and Invention," "Radio Internacional," "Radio Review" and "Amazing Stories."
 Editorial and General Offices: 53 Park Pl., New York City
 H. GERNSBACK, President. S. GERNSBACK, Treasurer. R. W. DEMOTT, Secretary
 Member: Audit Bureau of Circulations Radio Magazine Publishers Association

VOLUME 8

JULY, 1926

NUMBER 1

Contents of This Issue:

Portable Radio Sets, By Hugo Gernsback	7	The Latest Advance Toward Television, By Lucien Fournier	36
The Ideal Radio Set—Results of the \$1,000.00 Prize Contest	8	"Wireless" Receivers and Transmitters, By Edmund T. Flewelling	38
The Air Service Radio Laboratories, By Lieut. Harry F. Breckel	12	A Three-Foot Cone Speaker, By Clyde J. Fitch	39
Radio Broadcasting in Japan,	14	The "Dyadyne" 4-Tube Receiver, By Joseph Bernsley	40
New Radio Developments,	15	Constructing a Cone Speaker, By Albert T. Lo Curto	43
Radio News of the Month Illustrated, By George Wall	16	Everyman's Receiver, the Fenway—Part II, By Leo Fenway	44
Sam Jones, Radio Tube Bootlegger, By Volney G. Mathison	17	A Portable Super-Heterodyne, By Cecil W. Preston	46
WRNY Broadcasts Synchronized Musicale	18	The Reflex Five, By Joseph Riley	48
Radio for Every Sick Bed, By Ashur Van A. Sommers	19	Radio Set Directory,	49
Set Owners' Information	20	A Departure in Radio Tube Design, By H. K. Huppert	50
Great Composers in WRNY Programs, By Charles D. Isaacson	21	How Should Transformer Curves Be Plotted? By Sylvan Harris	52
Meters for Radio Receiving Sets, By A. P. Peck	22	Awards of the \$50 Radio Wrinkle Contest.	54
All About Aerials,	24	Radiotics,	56
List of Broadcast Stations in the United States,	29	Standard Hook-Ups	57
Tubes Within Tubes, By G. C. B. Rowe	30	Down with the Power! By Henry Lamonte	59
New Radio Devices of Fixed Precision	32	RADIO NEWS LABORATORIES,	60
Radio Makes Factory Work Congenial, By John J. Morgan	33	I Want to Know, By Joseph Bernsley	62
New Developments in Radio Apparatus, By G. C. B. Rowe	34	Broadcast Station Call Crossword Puzzle,	64

In Our Next Issue

All About Tubes, By M. L. Muhleman
 A comprehensive article describing all the vacuum tubes for radio purposes now available to the set owner or builder: their characteristics and functions, and how to select them for different requirements.

Radio Broadcasting of Pictures, By Dr. Walter Friedel

The latest developments in the transmission of pictures, which has lately been made commercially practicable; together with information on the method in which receivers are constructed.

Audio-Frequency Transformers, By Sylvan Harris

A continuation of this series on methods of amplifications, which will deal more intimately with the problem of obtaining quality reproduction from the audio end of your receiver.

RADIO NEWS is published on the 10th of each preceding month. There are 12 numbers per year. Subscription price is \$2.50 a year in U. S. and possessions. Canada and foreign countries, \$3.00 a year. U. S. Coin as well as U. S. Stamps accepted (no foreign coins or stamps). Single copies, 25 cents each. Checks and money orders should be drawn to order of EXPERIMENTER PUBLISHING CO., INC.

All communications and contributions to this journal should be addressed to Editor, RADIO NEWS, 53 Park Place, New York, N. Y. Unaccepted contributions cannot be returned unless full postage has been included. All accepted contributions are paid for on publication. A special rate is paid for novel experiments; good photographs accompanying them are highly desirable.

RADIO NEWS, Monthly. Entered as second class matter, July 12, 1924, at the Post Office at New York, N. Y., under the Act of March 3, 1879. Additional entry at Long Island City, N. Y. and San Francisco, Calif. Title registered U. S. Patent Office. Copyright, 1926, by The Experimenter Publishing Co., Inc., 53 Park Place, New York. The Contents of this magazine are copyrighted and must not be reproduced without giving full credit to the publication. Copyrighted in Germany. Reproduction of articles in Germany is reserved for Radio, Berlin 42. RADIO NEWS is for sale at all newsstands in the United States and Canada.

New York City
 General Advertising Dept.
 53 Park Place

Western Advertising Representatives
 Finucan & McClure
 720 Cass St., Chicago, Ill.

Pacific Coast Advertising Representatives
 A. J. Norris Hill Co.
 5 Third St., San Francisco, Calif.
 412 West 6th St., Los Angeles, Calif.

Kansas City Advertising Representatives
 Davies and Dillon
 15 W. Tenth St., Kansas City, Mo.

New England Advertising Representative
 T. F. Magrane, Park Square Building, Boston, Mass.

Detroit Advertising Representative
 Roy Buell, Donovan Bldg., Detroit, Mich.

and at Brentano's, Ave de L'Opera, Paris, France. European agents: S. J. Wise & Co., 40 Place Verte, Antwerp, Belgium.

HOW TO SUBSCRIBE FOR RADIO NEWS. Send your name, address and remittance to Experimenter Publishing Co., 53 Park Place, New York. Mention the name of the magazine you are ordering. We also publish SCIENCE AND INVENTION, RADIO INTERNACIONAL, RADIO REVIEW and AMAZING STORIES. Write clearly.

RATES AND TERMS. The subscription rate for RADIO NEWS is \$2.50 per year (12 numbers). When remitting do so by check, money order, or registered letter if cash is enclosed. Avoid sending cash through the mail if possible. Subscriptions for less than one year are not accepted. Subscription may be made in combination with SCIENCE & INVENTION, RADIO INTERNACIONAL, RADIO REVIEW and AMAZING STORIES.

POSTAGE. We prepay postage in all parts of the United States, Mexico and island possessions. For foreign or Canadian subscriptions we require 50 cents in addition to the subscription price for additional postage charges.

CHANGE OF ADDRESS. Notify us as far in advance as possible. It requires several weeks to make an address change on our records. Always write clearly. ON EXPIRATION of your subscription we enclose a renewal blank in our last number to you; we stop our delivery to you on expiration.



Better now for \$9⁷⁵ than it was in 1920 for \$85

Recall that in 1920 a one-tube radio sold for \$85. Today Crosley makes a better one for \$9.75 (The Crosley Pup). There's the picture of Crosley manufacturing genius.

This year will see the millionth Crosley radio set produced. And somewhere, the first hundred still bring joy and satisfaction to their owners. Only this winter, one of Crosley's early one-tube radios won a nationwide radio reception contest, in which one-tube sets of all makes and dates were entered.

Powel Crosley, Jr., has so improved tuned radio frequency circuits in the present Crosley sets, that experts the country

over have grown wildly enthusiastic over their performance.

"The first set to beat my pet——", says one fan. "The only set I have ever seen that would tune out our local station in our building", writes another. "How can Crosley do it for the money!" is one exclamation, typical of hundreds of letters.

These new Crosley sets are truly wonderful for they not only represent a tremendous forward step in radio development, but are offered for even less than the closing-out prices of questionable and obsolete sets.

See and hear the new Crosley sets at your nearby Crosley dealer's.

Prices slightly higher west of the Rockies—For descriptive catalog write Dept. 22

THE CROSLLEY RADIO CORPORATION, CINCINNATI, OHIO

Powel Crosley, Jr., President

Owning and Operating WLW, first remote control super-power broadcasting station in America

CROSLLEY RADIO

Better—Costs Less

Manufactured under Armstrong U. S. Patent No. 1,113,149, or under patent application of Radio Frequency Laboratories, Inc.



Mass manufacturing operations on the million scale has so saved pennies in production that the public sees them reflected in dollars saved on the retail prices of Crosley radios.

One great example of this is the Crosley Musicone.

Its success created so great a demand that a saving to the public of \$2.75 was soon effected through increased production. Today it is the fastest moving item in radio—its quality of reproduction and its low price is inducing the rapidity by which it is replacing thousands of other type speakers.



INDEX TO ADVERTISERS

	Page		Page		Page		Page
A		D		K		S	
Acme Apparatus Co.	91	Daven Radio Corp.	79	Karas Electric Co.	84	Radiogem Corp., The	72
Acme Electric & Mfg. Co., The.	85	DeWitt LaFrance Co., Inc.	84	Kelleradio, Inc.	87	Radio Institute of America	82
Acorn Radio Products Co.	82	Distantone Radios, Inc.	93	Kellogg Switchboard & Supply Co.	88	Radio Specialty Co.	69
Aerovox Wireless Corp.	68			Kenilworth Inn	95	Randolph & Co.	80
Alden Mfg. Co.	88			Klosner Radio Corp.	84	Randolph Radio Corp.	88
All Radio Co.	93			Konite Corp., The	72		
Allen-Bradley Co.	68					L	
Amplion Corp. of America, The.	77					Lancaster & Allwine	87
Amsco Products, Inc.	70					Lynch, Inc., Arthur H.	66
Arrow Battery Co.	84						
Atwater Kent Mfg. Co.	89					M	
						Marko Storage Battery Co.	95
B						Mason, Fenwick & Lawrence.	77
Bakelite Corp.	84					Midwest Radio Corp.	66
Barawik Company, The	85					Miller Rubber Co. of N. Y., The.	76
Birnback Radio Co.	68						
Bogue, B. N.	80					N	
Bradley Institute	70					National Carbon Co., Inc.	67
Brady, John B.	95					National Co., Inc.	68
Brant Battery Co.	83					National Radio Institute	5
Bremer-Tully Mfg. Co. ...Back Cover						New York Institute of Photog- raphy	66
						Norden-Hauck, Inc.	73
C							
C. E. Manufacturing Co.	91					O	
Camfield Radio Mfg. Co.	89					Omnigraph Mfg. Co., The	93
Carter Radio Co.	77					Owen, Richard B.	95
Central Radio Labs	85						
Chemical Institute of N. Y., Inc.	96					P	
Chicago Radio Apparatus	75					Parker, C. L.,	85
Chicago Salvage Stock Store.	88					Press Guild, Inc., The	95
Columbia Print, The	6						
Cornish Wire Co.	84					R	
Coyne Electrical School	77					Radiall Co.	84
Crescent Radio Supply Co.	93					Radio Association of America	88
Crosley Radio Corp., The	3					Radio Corp. of America	65
Culver-Stearns Mfg. Co.	70-76						
Cunningham, Inc., E. T. Inside Front Cover							
						X Y Z	
						X-L Radio Laboratories	82
						Y. M. C. A. Radio Institute	81
						Yaxley Mfg. Co.	80

RADIO NEWS READERS' BUREAU

TEAR ALONG THIS LINE

Time and Postage Saver

IN every issue of RADIO NEWS you undoubtedly see numerous articles advertised about which you would like to have further information.

To sit down and write an individual letter to each of these respective concerns, regarding the article on which you desire information, would be quite a task.

As a special service to our readers, we will write the letters for you, thus saving your time and money.

Just write the names of the products about which you want in-

formation, and to avoid error the addresses of the manufacturers, on the coupon below and mail it to us.

If the advertiser requires any money or stamps to be sent to pay the mailing charges on his catalog or descriptive literature, please be sure to enclose the correct amount with the coupon. We will transmit to the various advertisers your request for information on their products.

This service will appear regularly every month on this same page in RADIO NEWS.

TO: READERS' SERVICE BUREAU,
Experimenter Publishing Co., Inc., 53 Park Place, New York, N. Y.

RN7-26

FROM WRITE YOUR NAME and ADDRESS HERE:
NAME _____
ADDRESS _____ CITY, STATE _____

Gentlemen: Please advise the firms listed below that I would like to receive detailed information on their product as advertised in the _____ issue of RADIO NEWS.

This form should not be used for technical questions		List here specific article on which you wish literature.	If Catalogue of complete line is wanted, check in this column
NAME	ADDRESS (Street — City — State)		

Check here if you are a dealer
Your Dealer's Name _____
Address _____



STATION WOC
DAVENPORT

**HERE'S WORK THAT IS
ALMOST ROMANCE!**

**These
Instruments
Given FREE of
Extra Cost**

All instruments shown here and others sent to all my students free of extra cost under short time special offer. Clip coupon now—find out all about this big unequalled offer while you still have time to take advantage of it. This training is intensely practical—these instruments help you do the practical work.

**My Radio Training is
the "Famous Course
That Pays for Itself"**

Make more money quick when you take up this practical course.

I show you how to increase your earnings almost from the start of your course through practical pointers I give you.



**\$70 in one Day
for T. M. Wilcox**

"I am in business for myself and recently made \$70 in one day. I was an electrician of rich experience and was occupying a splendid position as telephone superintendent when I enrolled with your course believing it would open up greater opportunities—have not been disappointed. Estimate that Radio will be worth tens of thousands of dollars to me in the next few years." T. M. Wilcox, Belle Island, Newfoundland.

**Howard B. Luce of
Friedens, Pa., made \$320 in 7
weeks during his spare time.**
D. H. Suitt of Newport, Ark., writes
"While taking the course I earned in
spare time work approximately \$900."
Earl Wright of Omaha reports making
\$400 in a short time while taking his course
—working at Radio in his spare time only!
Sylvester Senso, 207 Elm St., Kaukana, Wis.,
made \$500. These records not unusual—these
men are a few of hundreds.

And when you graduate, my big Free Employment Department helps you get the job. You get just the same preparation and assistance toward success we gave C. C. Gielow, Chief Operator of the Great Lakes Radio Telegraph Co., E. W. Novy, Chief Operator of Station WRNY, Erie Chambers, Radio Engineer for Stewart-Warner, J. E. Fetzler, Chief Engineer of Station WEMC. The National Radio Institute, established 1914, today offers you the same opportunity these men had under a bond that guarantees you full satisfaction or money refunded. It's your big chance to get into the great Radio field—mail coupon TODAY for my big Free Book and proof!

Originators of Radio Home Study Training

**Kimball With WMAQ
Chicago**

"Accepted a position with the Chicago Daily News Station WMAQ. My income practically doubled, thanks to your fine course. I handle all consultation also do operating." Keith Kimball, Station WMAQ, Chicago, Ill.



**Now Owns a Radio
Store**

"The Radio business is rushing just now. Building many Super Heterodynes, also doing installation and repairing. To your course I owe all my success in the Radio profession." A. J. Ommodt, Bowman, N. Dak.

**Controls First Car by
Radio**

"I operate the portable broadcasting station in rear car, driving front car by Radio control. Will operate this car from New York to Frisco—13 months trip. Then we take the car around the world—a three years' tour. I owe it all to you." Leo Paul, New York City.



You Can Do What These Men Did!

I Will Train You at Home to Fill a Big-Pay Radio Job

Get into the great new Big-pay Industry—Radio. If you're earning a penny less than \$50 a week, clip coupon now. Send for AMAZING FREE BOOK, "Rich Rewards in Radio." Why go along at \$25 or \$35 or \$45 a week, when you could earn \$50 to \$250 in the same six days, as a Radio Expert? Hundreds of N. R. I. trained men are doing it—why can't you? I'll train you just as I trained them—just as I trained the men whose letters you see on this page. I'll teach you quickly at home in your spare time to be a Radio Expert, and draw down big money for the easiest and most fascinating work in the world.

**\$50 to \$250 a Week as
a RADIO EXPERT**

It's the trained man, the Radio Expert, who gets the big jobs of this profession—paying \$75, \$100, \$200 a week and up. Free book gives all the facts. Every day N.R.I. trained men are taking good places in the Radio field—men like you—men like those whose stories I show you here. You can prepare just as they did by new practical methods, learn right at home in your spare time. Lack of experience no drawback—common schooling all you need. Our tested clear methods make it easy for you. We guarantee to train you successfully. Big Free Book contains all the proof.

**Clip Coupon Now
for FREE BOOK**

Most amazing book on Radio ever written—full of facts and pictures—tells all about the great Radio field, how we prepare you and help you start. You can do what others have done—GET THIS BOOK. Send coupon today—no obligation.

**J. E. Smith, Pres.
NATIONAL RADIO
INSTITUTE
Dept. CW-1
Washington, D. C.**

**Read the true
stories printed
in this border-
of men who got
out of the rut**



**Chief Operator
at Station WGR**

"Am sending a photograph of station WGR where I am now Chief Operator. I am proud to say that your course is the reason for my success." Edward Stanko, Hotel Statler, Buffalo, N. Y.



Photo shows Graduate E. F. Spadoni in his own Radio store at Chicago, Ill. "Your course gets the credit," says Spadoni.

**RADIO
NEEDS
TRAINED
MEN!**



**J. E. Smith, President
NATIONAL RADIO INSTITUTE
Dept. CW-1 Washington, D. C.**

Dear Mr. Smith: Without obligating me in anyway, send me your free book "Rich Rewards in Radio" and all information about your practical, home-study Radio course.

Name..... Age.....

Street Address.....

Town..... State.....

Promoted to Big Job

"Just been made Sales Manager of this Radio firm—received a very good increase in pay. Up to present have been getting salary which in 3 months enabled me to purchase a new car." R. Jones Bay City Mich.



The Newest Up-to-the-Minute Radio Set—It Has Never Been on a Dealer's Shelf—Most Selective. A Wonderful DX Getter. Sold on a Guarantee of Satisfaction or Money Back.

Volume Control—Perfect Calibration—Range 180-550

BST-6

*B - for Beauty
S - for Selectivity
T - for Tone purity
6 - its 6 tubes for distance*



The BST-6. 2 Feet 4 Inches Long. 9 Inches Inside Depth. 8 3/4 Inches High.

THIS marvelous six-tube tuned radio frequency receiver is Self-Equalized and built of low-loss materials throughout. Its clear, rich tone of astonishing volume is a revelation. The circuit consists of two stages of tuned radio frequency, tube detector and three stages of balanced audio amplification. Air cooled rheostats and universal sockets are used.

Modified straight line frequency variable condensers are employed, insuring separation of the low wave length stations. **PERFECT CALIBRATION—STATIONS ONCE TUNED IN CAN ALWAYS BE LOGGED AT THE SAME DIAL POINT.**

The balanced amplifier gives absolutely natural reproduction of all overtones. The universal sockets permit the use of all the popular tubes, either dry cell or storage. The set does not oscillate, thereby preventing the reradiation of signals and reducing interference to a minimum.

Specifications

- Bakelite Panel, Walnut Finish—
- With Etch-O-Gravure and Gold Decorations—
- Bakelite Sub-Base—
- Kurz-Kasch Bakelite-Walnut Pointers; Gold-filled, to Match—
- Kurz-Kasch Bakelite Gold-filled Rheostat Knobs—
- Lubree Straight Line Frequency Condensers—
- Special Coils; Double Silk Solenoids—
- Shore Audio Transformers—
- Caswell-Runyan Two-tone Walnut-Finished Cabinet.

LOG OF BST-6

Taken on a Fifteen Foot Aerial in One-half Hour by Al. Kraus, 996 Aldus Street, New York City.

WSBC	10	WGY	50
WBBR	16	WMAK	51
WEBH	49	WMSG	11
WHT	55	WOC	85
WCCO	61	WFAA	78
WSB	66		

SELECTIVITY

I live within four blocks of WLWL, and since the opening of this station have had great difficulty in choking them off my old set. Even after employing a wave trap I could still hear WLWL around the entire dial and was told by several friends that living so near this powerful station it would be impossible to entirely cut them out with anything less than a super-het. It was a very agreeable surprise, therefore, when I installed my new BST-6, to find that while WLWL came in on 25 I could tune in WRNY on 21 and entirely cut out WLWL. This is certainly real selectivity.—F. S. Clark, 350 West 55th Street, New York City.

Guarantee

Satisfaction or Money Back

Each receiver is tested and retested, boxed and inspected before leaving factory, and guaranteed to reach you direct in perfect condition.

Workmanship throughout guaranteed the best. Assembled by experts.

Immediate Delivery

**Direct from factory to you
No dealers' or middlemen's profits**

\$40.00

SAFETY FIRST!—Why buy obsolete models, or radio failures at department store "bargain sales" when a BST-6, the latest achievement in radio, can be bought direct from the factory with no department store profit added? Here is a real bargain, sold you with a guarantee of satisfaction or money back.

Send Check or P. O. or Express Money Order to

THE COLUMBIA PRINT, Radio Division, 141 West 45th St., New York City



RADIO NEWS

H. GERNSBACK, Editor and Publisher
SYLVAN HARRIS, Managing Editor

EDITORIAL AND GENERAL OFFICES, 53 PARK PLACE, NEW YORK

Vol 8

JULY, 1926

No. 1

PORTABLE RADIO SETS

By HUGO GERNSBACK, F. R. S.

THE portable receiver in radio is not a new thing. We have had portable sets for some fifteen years or more; but only since broadcasting came into vogue have portable sets really come into extensive use.

The surprising thing, however, is that, at least in this country, such sets have not attained the great popularity which they deserve.

There is really no reason why every automobile, every motorboat, and, for that matter, every home or office, should not have its portable receiver, because its utility is paramount.

While, of course, untold numbers of portable receivers have been constructed, either by private builders or by companies making sets commercially, it is surprising how few such sets are actually in use.

As to the sets themselves, they may be divided roughly into four classes, as follows:

- (1) Sets requiring the use of head phones;
- (2) Sets with loud speakers;
- (3) Either of the above, used in connection with an aerial;
- (4) Either of the sets, used with a loop or concealed antenna.

In the first class we may include even the modest crystal set, which is excellent up to a distance of fifty miles from the nearest broadcasting station. In order to use it, it is necessary to have a regulation aerial, because a crystal will not work with a so-called "loop." A portable crystal set, particularly for vacation purposes, is really most excellent, because it requires so very little room, and neither A nor B batteries. Reception up to 50 miles is surprisingly good, and where low cost is of prime importance, nothing better can be had.

In the same group falls also the set which uses up to three tubes; this, as a rule, is not powerful enough to operate a loud speaker. However, there are some reflex sets which, if well constructed, are able to bring in stations on the loud speaker up to 50 or 75 miles; but in very rare cases with sufficient strength to really be called good loud speaker volume. On phones, however, in connection with an aerial, such sets are excellent. It is even possible for the constructor to build a 1-tube reflex set, using a crystal and one tube, that will bring in local stations with a middling-to-fair volume on the loud speaker; while on the 'phones, such a 1-tube is known to bring in stations within a radius of 800 to 1,000 miles without much trouble. Such a single-tube reflex set is excellent where room is at a premium, low first cost is desired, and weight is a consideration. Such a single-tube reflex set can be built so that it will weigh hardly more than five or six pounds, complete with batteries and 'phones. A set of this kind, it should be understood, requires an aerial of from 50 feet up to 100 feet for best results.

In order to produce comfortable loud speaker reception, it is necessary, as a rule, to have a set with at least four tubes, in order to bring in stations from 50 miles and over with good loud speaker volume. 4-, 5-, and 6-tube sets then really become necessary. Such sets can be built to work on the regulation aerial, as well as with loops. Roughly speaking, the loop set requires at least two more tubes to get the same volume as with the usual aerial. The simple reason for this is that the longer aerial collects vastly more energy on its surface than the small loop; and as a rule the smaller the loop the more tubes we must add in order to get the required volume.

If you are satisfied to use headphones, a 2-tube reflex set with regeneration,—for instance the very excellent set described in the June, 1926, issue of Radio News—will serve the purpose. Such a set is good for 'phone reception up to 100 miles, and more, under good conditions.

The thing that is of greatest importance, and which few people realize at all, is the great difference made by the locality in which a set is operated. I have frequently had portable sets that would

hardly perform at all in our big cities; but the same sets, taken out into the country or the wilderness, became remarkably good. Loop sets, as a rule, do not work well in congested centers where there are many steel buildings; whereas the same sets out in the country, away from such obstruction, will do wonders.

Here again we must make a distinction, and we should remember that the same set that performs well on a country road, in a flat country, will not work as well in a mountainous region, unless it be on top of the mountain; nor will it work so well, either in denser forests. As a matter of fact most sets, when operated in forests which are at all dense, do not perform well, because the trees, being conductive, absorb the radio frequency energy in the same manner as do the tall buildings in the city.

But in the forest we can have recourse to the well known and time-honored trick of General Squier, who found out that a tree itself can be used as an excellent aerial. He discovered, many years ago, that if you drive a fairly large nail into the trunk of a good-sized tree, about three or four feet above the ground, and

connect your aerial wire to this nail, excellent reception can be had; the tree in this instance becoming the aerial, while the ground connection is made in the usual manner. Even loop sets can be made to operate in this way, in the forest, by attaching one of the binding posts from the loop to the nail driven into the tree trunk. You will have to experiment to find which of the two binding posts gives the best results.

As to the ground, when using a regulation aerial, I wish to say here that this is of the utmost importance; and the direct cause for failure is to be sought here in most cases when the set does not perform right. Most people have an idea that, if they drive a metallic stake into the ground, this will make for good reception. This is not true. As many experimenters have

found, there is a huge difference between grounds in the open country. For instance, one of the most difficult things in connection with portable set reception is to find a good ground on top of a hill or mountain. Usually such localities are devoid of moisture, and a rocky, dry ground is just as effective as any other insulator. Moisture, or a good wet ground, should always be obtained for best reception.

There is no better ground than a metallic rod driven near a spring or in the bed of a small creek, or, in the case of a river, right into the bank, where the river water actually inundates the spike or stake used for the ground connection. If a metallic rod, which should be at least four feet long, can not be had conveniently, then a piece of wire chicken netting, or other metallic netting, thrown right into the water, or buried in the river bank, is the best thing to use.

One thing is sure, that a portable receiver taken into the country is a great source of joy if only because there is no man-made static there, and unless there is natural static, reception, even in the summer time, is usually surprisingly good. Outside of excellent reception and giving you a lot of free entertainment, the portable set for camping purposes will keep you in touch with civilization as nothing else will do.

And as for the bugaboo of lightning, I would much rather be in a forest with an aerial strung between a number of trees than without the aerial; because so long as you keep away from the aerial while the lightning is playing around, the chances are that if a tree in the neighborhood is struck, the aerial will divert the charge.

The safest and best thing to do during a thunderstorm is to disconnect the aerial from the set and attach the wire to a tree trunk, about ten or fifteen feet away from your tent; so that if lightning strikes it will surely follow down the aerial wire, leaving the tent unharmed. Thus your radio becomes an actual protection.

... wherein the Editor makes an analysis of the various kinds of portable sets and what can be expected of them,—how far such sets will receive,—why locality makes a great difference in reception,—how you can use a tree for an aerial,—why the ground connection is of prime importance,—and how your portable set can be made a protector against lightning

Mr. Hugo Gernsback speaks every Monday night at 9 P. M. from Station WRNY on various radio and scientific subjects.

The Ideal Radio Set

Results of the \$1,000.00 Prize Contest

HERE are the results of RADIO NEWS' great \$1,000.00 Prize Contest, which was announced in our March, 1926, issue. The Contest has been a tremendous success, a total of 15,181 entries having been received.

This was not a technical contest, as it had to do only with the appearance and the type of set.

WHAT SORT OF RADIO SET DOES THE WORLD WANT?

Here is the answer:

A single-control set, either for table use or console, with a built-in loop, built-in loud speaker, sloping panel, and with two extra controls, one to change the direction of the loop and the other a tone control.

This, then, is the ideal set, because the greatest number of people voted for it, and according to the law of averages this must be the set that the public wants.

—EDITOR.

"WHAT type of a radio set does America want? What type of a radio set does the world in general want?" These are the questions which RADIO NEWS has asked of its enormous army of readers in this and other countries; and our readers have answered—thousands of them.

There are, of course, many types of set users, each with their own ideas and their pet hobbies; but the tremendous majority given to certain features, for inclusion in the ideal radio set, shows where the great demand will be found among the set buyers.

Two out of every three, and more, demand that the loud speaker shall be built into or contained within the receiver. Four out of seven demand that there shall be only one tuning control; and in fact, one out of five wishes that not even a volume control shall be used. A large majority desire wave-length calibration of the tuning devices, with large, plain figures and logging facilities such that finding a station shall be as nearly instantaneous as possible. The enclosed loop antenna is favored by a large number; and together with those who wish the option of using the loop or switching to an outside aerial for distance reception, they make up a majority.

In addition, the great majority desire the source of current supply enclosed within the receiver; and most of these specify either battery chargers or eliminators, supplied from house lighting current.

Description of the FIRST PRIZE WINNER (Men's)

"There are many who object to the high type of cabinet. This has the top hinged to get at tubes and set, and has the horn placed as high as possible. A cone or a long type speaker may be used. The cabinet may be built in any of the period styles of design.

"A figured wood panel is used instead of the usual composition.

"The loop is controlled from the front panel, the little window showing its location. The set should have a one-dial control for stations, and a separate control for the volume. The little window at the right shows the station settings."

WALTER LYON,
25 Edna Street,
Plymouth, Wisconsin

SIMPLE AND SELF-CONTAINED

Everybody's radio set, therefore, has maximum simplicity in operation and is entirely self-contained, except for the cord by which it is connected to the lighting circuit plug. It is simple and neat in appearance, not over-ornamented nor mechanical in its exterior. The fact that it is a piece of radio apparatus is not disguised, but neither is this obtruded upon the attention. It is so constructed that it may be closed for protection and shielding from dust, etc.; and when opened, it affords facilities and convenience to the operator for both tuning and recording results.

The demand is not large, in comparison, for receivers which will go beyond the broadcast range for high- and low-wave reception. A few entrants, comparatively, have considered and made provision for the installation of television receivers when they are commercially available. But as a whole, the receiver which will cover the whole width of the broadcast band with good selectivity, clear reproduction, and good distance reception will fill the bill.

The division, however, of votes received between console and floor-type cabinets, on the one hand, and receivers requiring a table or other support, on the other, was almost even. The advocates of the latter presented reduced cost and greater portability; those of the former the conveniences found in the console type, and its greater attractiveness as an article of furniture. And, as this was a vote for ideal sets, the console type won the day. An almost exact tie between perpendicular and sloping panels was recorded, though advocates of the latter usually declared their opinion that these were handier.

As to controls: horizontals, verticals, standard-graduation dials, inclosed dials, pointers, levers, and many other forms were specified; but the general demand, as said before, is that they shall be large, well-illuminated, either from the front or rear, and calibrated according to wave-length, with a provision for recording stations. Many, indeed, expect the manufacturer to provide the receiver with the station calls as well.

A little over one-quarter of the entrants voted for the inclusion of meters on the panel, and a considerable number placed them on an auxiliary panel, concealed from the front, but readily accessible.

The inclusion of a small but accurate clock, in order that it might be consulted by the operator; of some appliance for holding radio programs for ready reference; and, in console receivers, of desk shelves, which would serve both as arm rests and for writ-

ing, and of drawers for radio books, literature, and newspapers, as well as for hand phones, was particularly frequent.

THE VOTE FOR THE IDEAL SET

As in every election, many votes were cast which did not go into more than one or two details; and many entries specified two or more options, or were drawn so sketchily that the writer's intention could not be accurately determined. Many designs, for instance, omitted the panel entirely, others gave no information concerning the aerial, or failed to indicate whether the loud speaker was separate or enclosed.

Here is a resumé of the main points which were tallied off from the enormous mass of sketches and descriptions received at this office:

FEATURES	Number of Votes		Total
	Men	Women	
Type of Cabinet			
Console or Table	6122	657	6779
High (From floor up)	971	118	1089
Low (for shelf or table use)	6436	415	6851
Portable	323	4	327
Miscellaneous	127	8	135
	13979	1202	15181
No. Tuning Controls			
One	7854	730	8584
Two	3833	275	4108
Three	2058	189	2247
More	37	2	39
	13782	1196	14978
No. Other Controls on Panel			
None	2904	304	3208
One	3526	153	3679
Two	6247	617	6864
Three	856	108	964
More	222	5	227
	13755	1187	14942
Type of Dials			
Horizontal	1007	37	1044
Vertical	2234	258	2492
*Regular or Pointer	6056	625	6681
*(Including all indicated only by circle on panel.)			
None	771	13	784
	10068	933	11001
Loud Speaker			
Built-In	9843	1034	10977
Separate	3408	158	3566
None	41	13	54
	13292	1205	14697
Antenna			
Built-In Loop	4992	507	5499
Separate Loop or Indoor Aerial	1586	27	1613
Outdoor Aerial	4369	406	4775
	10947	940	11887
Panels			
Vertical	4093	555	4648
Sloping	4213	505	4718
Horizontal and Misc.	201	31	232
	8507	1091	9598
Miscellaneous Features			
Battery Eliminators	3174	211	3385
Battery Chargers	2129	87	2216
Meters on Panel	3655	182	3837
Desk Shelf	1390	254	1644
Pilot or Dial Lights	1313	156	1469

Men's Prize-Winning Entries in the \$1000 Ideal Set Contest

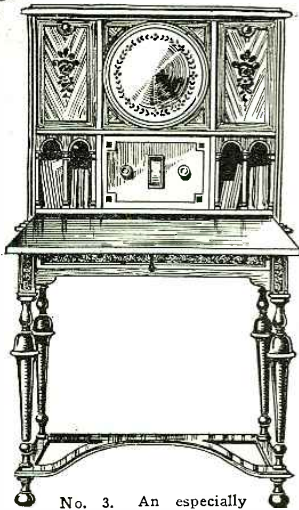

No. 3. An especially attractive entry.

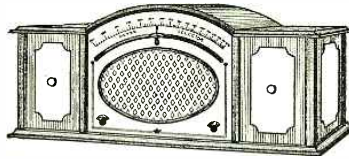

No. 4 uses an outside aerial. This is the only exterior feature. One vernier control.

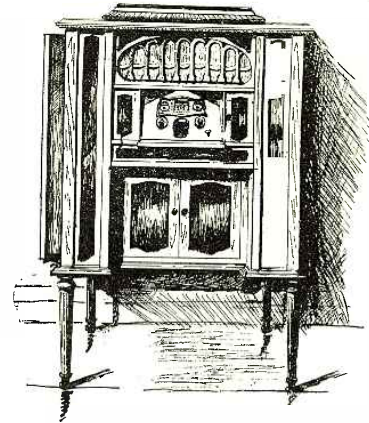

No. 12. Above. A fine cabinet design. Loop hinged to left panel and revolves.

The first prize winner, below, is entirely self-contained.

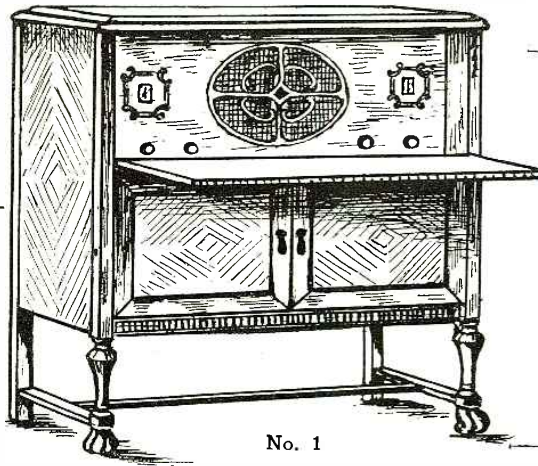

No. 1

FIRST PRIZE WINNER (MEN'S) in the Ideal Set Contest. Description on page 8. A handsome, serviceable cabinet.

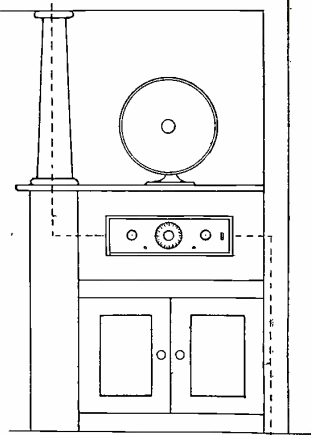

No. 6. One of many plans for building in a radio set. The receiver slides out and in, connections being automatic.

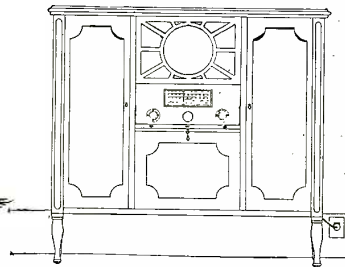

No. 8. Entirely self-contained, except for lighting plug connection.

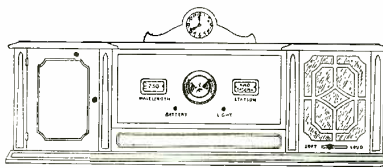

No. 7. Contains a clock, desired by many fans for ready reference. Outside aerial.



No. 9. A single-control type, with double speaker to distribute sound better.

Below, the second prize winner, showing house-lighting connection.

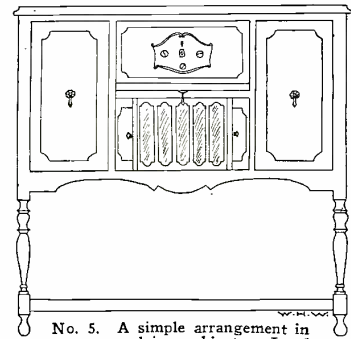

No. 5. A simple arrangement in a very plain cabinet. Loud speaker in lower center.

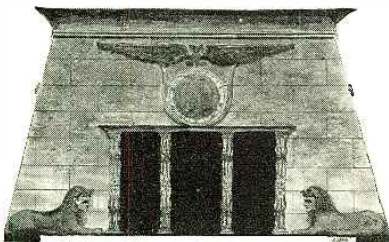

No. 11. Another novel mantel set. The tuning is done by the end knobs.

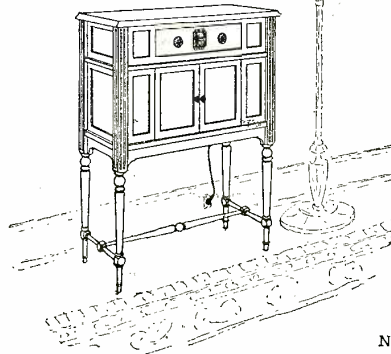

No. 2. A very fine specimen of design. Single control, self-contained.

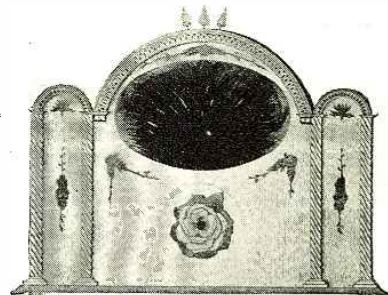

No. 10. An ornamental mantel set. Single-control from the rose dial.

MEN PRIZE WINNERS

First Prize	\$200.00
WALTER LYON, 25 Edna St., Plymouth, Wisc.	
Second Prize	\$150.00
JOHN F. SWENSEN, 9 So. 39th Ave. W., Duluth, Minn.	
Third Prize	\$100.00
KARL OTTO, 1015 Maple St., Saginaw W.S., Mich.	
Fourth Prize	\$75.00
VICTOR I. DUDLEY, 49 Vine St., North East, Pa.	
Fifth Prize	\$50.00
WILFRID WORLAND, Jasper, Ind.	
Sixth Prize	\$40.00
P. G. EHRET, 346 West 25 St., Erie, Pa.	
Seventh Prize	\$35.00
E. J. BULLER, Box 652, Monroe, Wash.	
Eighth Prize	\$30.00
HAROLD CRIPPEN, Clarksville, Iowa	
Ninth Prize	\$25.00
PHIL G. KRIPPNER, Green Bay, Wis.	
Tenth Prize	\$20.00
PETER VANDERVOED, 327 E. 51st St., New York, N. Y.	
Eleventh Prize	\$15.00
RAYMOND GREGG, 319 E. 30th St., New York, N. Y.	
Twelfth Prize	\$10.00
F. R. GALLION, 1023 N. Sixth St., Logansport, Ind.	

The educational value of this information should be very great. The number of radio set owners who are experts, or at least, fairly well informed regarding the technicalities of radio, although large in the aggregate, is very small in comparison with the total number of potential set owners. These are many millions in number in the United States alone; and though the circulation of RADIO NEWS has reached, of course, readers already interested in radio, it is evident that their demand for increased simplicity in apparatus will be even more forcefully repeated by the great radio market which is yet to be cultivated.

DIFFERENT CLASSES OF OWNERS

As one entrant (Joe D. Cellman of Des Moines, Iowa) put it pithily:

"Radios are now in the same class as the old 'exposed' auto with its dash cluttered by many highly-polished knobs, levers, etc. The use of such a machine was more for novelty and show than for practical utility. Now we jump in our auto and direct it where we want to go, with scarcely a thought that we are being moved by mechanical mechanism. So our modern radio must be enclosed, fool-proof and with a single knob that will bring us what we want to hear.

"Sorry, but there will have to be classes of radios just as there are classes of autos. Maybe a ——— is the best car made, but let's talk about it after you have tried to pilot it over some of Southern Iowa's muddy inclines. The average farmer can't afford them, or the juice to feed a radio set that looks like an electric sign. Regardless of how good eliminators are developed, they are useless if there is no '110' at hand to plug into. So, on the farm (radio's real service) we must retain the outside antenna."

No single type of radio receiver will supply the entire demand among a group of thirty or forty million possible purchasers, with differing tastes, pocketbooks and living conditions. But the indications point strongly

toward the type which will be most attractive to the great majority, with or without the necessary modifications to adapt it to individual preferences.

On the adjacent layout pages are shown prize-winning designs submitted in this contest, from all parts of the country: although the influence of the great Middle Western population, living in small cities or towns under somewhat similar conditions, was reflected strongly in rolling up the vote for the majority design of set.

AWARD OF PRIZES

As clearly explained in the announcement of this prize contest, the award of prizes was based upon the vote of our readers. The entries received were divided according to types; those of each similar combination were placed together, and from the group which represented the greatest popular demand, the best designs and descriptions were selected for first, second, third and fourth prizes. In the groups which showed a popularity somewhat less, the best entries were selected for lower prizes, taking into consideration not only the large demand for sets differing slightly from the highest prize winners, but also valuable ideas and originality. Besides the illustrations of all the prize winners, we give also the brief descriptions in which the two winners of the first prizes outlined the requirements of their ideal sets.

As specified in the rules of the contest, while neatness and attractiveness of design went far to influence the judges in favor of certain sketches, it was not absolutely controlling. Several of the illustrated designs have therefore been redrawn for better reproduction, but the style and character of the entry has been faithfully followed.

SOME INTERESTING SUGGESTIONS

Combinations of pieces of furniture, such as bookcases, desks, tables, phonograph cases, and even pianos, with the radio were among the "different" designs. The ladies incorporated their radio sets with kitchen cabinets, with sewing tables, piano stools, and other articles of furniture, but it is evident that their idea of a radio set is not something to stand over or sit up to.

On the other hand, the men like to sit up to the set and try for stations—as shown by the fact that hundreds specified that there must be comfortable knee room; and often-times a double loud-speaker chamber, with an opening on each side of the operator. One

WOMEN PRIZE WINNERS

First Prize	\$100.00
MRS. FLOYD AHRENS, 2308 40th St. Pl., Des Moines, Ia.	
Second Prize	\$50.00
MRS. HAROLD BARCK, 529 Case St., St. Paul, Minn.	
Third Prize	\$25.00
MISS MARY ZELNIG, 28 Catherine St., Saranac Lake, N.Y.	
Fourth Prize	\$20.00
MISS CLOIE I. VAN HOOSER, 3507 Askew St., Kansas City, Mo.	
Fifth Prize	\$15.00
MRS. MAE B. DEVINE, 3052 Kingsbridge Ave., N. Y., N. Y.	
Sixth Prize	\$10.00
MRS. JULIA KOZAK, 252 Third Ave., Rankin, Pa.	
Seventh Prize	\$5.00
MRS. CLARA ABRAMOWITZ, 1474 Park Place, Brooklyn, N. Y.	
Eighth Prize	\$5.00
MISS MAE D'ERRICO, 1744 74th St., Brooklyn, N. Y.	
Ninth Prize	\$5.00
MRS. H. M. BLAIR, 1574 East 17th St., Brooklyn, N. Y.	
Tenth Prize	\$5.00
MRS. CHAS. W. COTNER, 4 E. Mildred St., Logansport, Ind.	
Eleventh Prize	\$5.00
MRS. P. WOLF, Comayagua, Honduras, C. A.	
Twelfth Prize	\$5.00
MRS. MARY E. WOOD, 1610 Gaylord St., Denver, Colo.	

devoted fan placed a smoking cabinet, with electric cigar lighter, at his left hand.

It might be noted that a considerable number of men dwelt on their types of receivers as easy to keep clean and sweep under, with no projecting loop or horn to catch dust; while the ladies voted (very considerably) that a non-blooming set which will not annoy the neighbors with its squeals must be provided.

The type of set with exposed tubes received less than two hundred votes: breakage seemed generally feared; though easy access to the tubes and other apparatus of the receiver, either by swinging door, sliding panels, or hinged top, was generally insisted upon. The possible breakage of a separate loud speaker was feared by many.

By the terms of the contest, technical details of the receiver were not to enter into the design. Many entrants disregarded this by specifying the type of set desired, without harmonizing the panel arrangement to their ideas. Others demanded non-directional loops and inexhaustible batteries, which may necessitate much study by radio engineers before their desires can be accommodated.

Not only were nearly two hundred sets designed with two separate loud speakers, the better to amplify both high and low tones; but a considerable number of the sets with built-in speakers were provided with jacks for plugging in separate speakers, when desired. There were many ingenious arrangements for built-in radio sets, placed in the wall or partition of a room, yet convenient of access; and proposals for wiring a house with conduits, so that phones or a speaker could be plugged in anywhere, as easily as a light is turned on.

In a subsequent article, RADIO NEWS will show you some of the designs which are of interest, either for their oddity, or for novel or original ideas embodied in their conception. Many of them may provoke only a

(Continued on page 66)

Description of the FIRST PRIZE WINNER (Women's)

"Unless a radio is incorporated within a piece of furniture, it is always in the way when not in use. It should therefore be built with the furniture idea in mind. Desirable essentials are:

"Concealed controls when not in use.

"Only one critical control.

"A pilot light illuminating panel.

"Control calibrated into wave-lengths.

"Loud speaker built in, having long air column.

"Radio mechanism cushion-supported and insulated from speaker with cork.

"Current supply contained within cabinet.

"All this contained within a piece of furniture that will enhance a room, and yet be useful as furniture, other than just to contain a radio."

MRS. FLOYD AHRENS,
2308 Fortieth Street Place,
Des Moines, Iowa.

Winners of Women's Prizes in the Ideal Set Contest

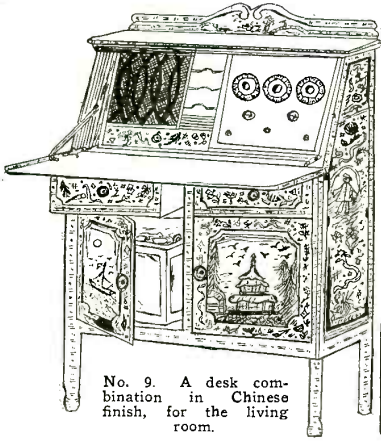

No. 9. A desk combination in Chinese finish, for the living room.

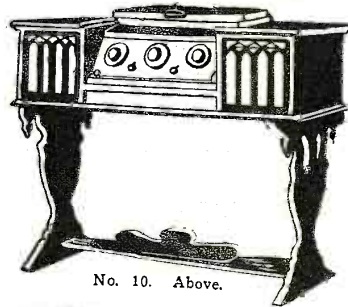

No. 10. Above.

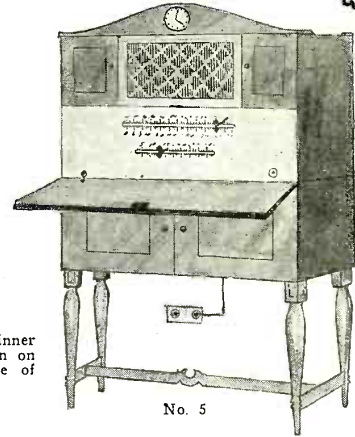

No. 5

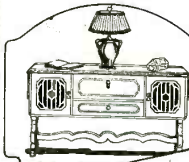

No. 1. The First Prize winner is shown below. Description on page 10. A splendid piece of work.

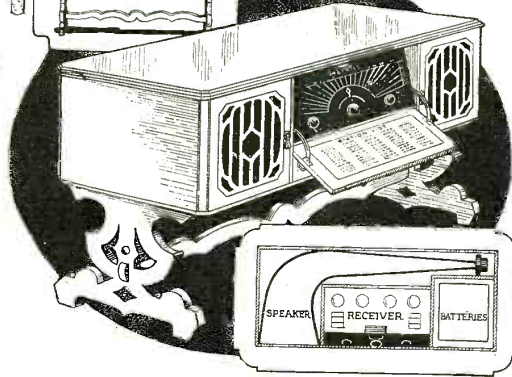

No. 11. Another self-contained set from Central America.

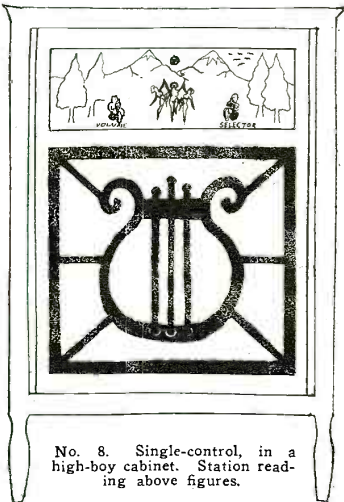

No. 8. Single-control, in a high-boy cabinet. Station reading above figures.

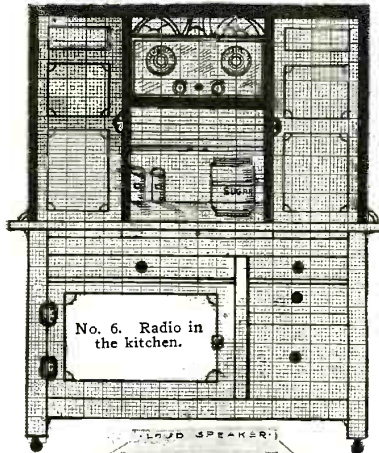

No. 6. Radio in the kitchen.

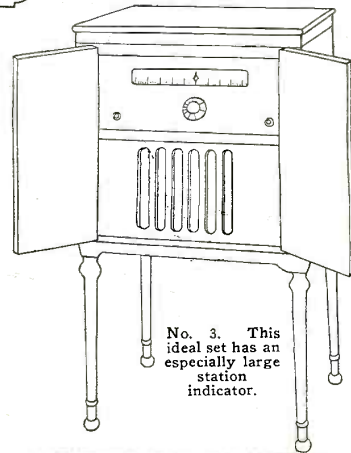

No. 3. This ideal set has an especially large station indicator.

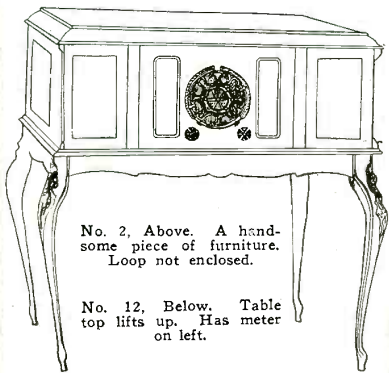

No. 2. Above. A handsome piece of furniture. Loop not enclosed.

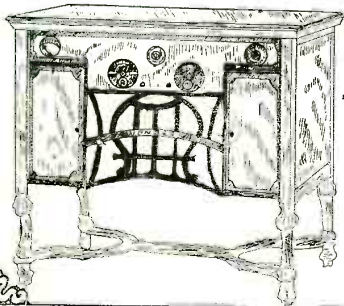

No. 12. Below. Table top lifts up. Has meter on left.

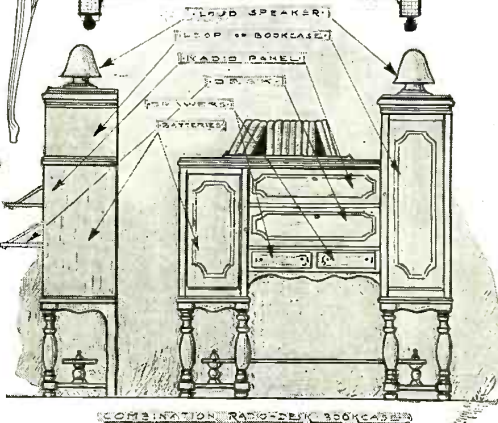

No. 4. Above. A very handsome entry. Designed for quality reproduction.

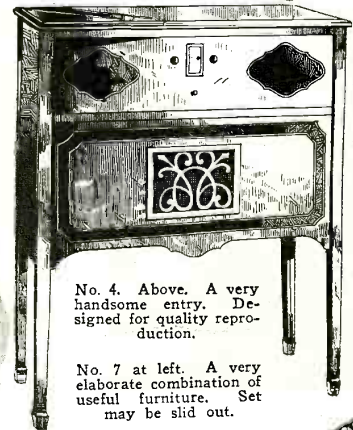

No. 7. At left. A very elaborate combination of useful furniture. Set may be slid out.

The Air Service Radio Laboratories

By **LIEUT. HARRY F. BRECKEL**

In the January 1926 issue of RADIO NEWS appeared an article telling of experiments with an automobile controlled by radio. In this article the experiments with radio-controlled airplanes are described, together with the radio beacon for airplanes.

WHEN inspecting the Air Service Radio Laboratories at McCook Field, Dayton, Ohio, one is immediately impressed with the vast network of radio antennas, suspended from various towering supports and bearing mute testimony to the important part that radio plays in the functioning and development of one of our most important measures of national defense.

We observe that almost every known type of aerial is used; a huge "umbrella" is suspended from a tall water tower; a "directional" antenna of the Belin type is located in an open space at one side of the laboratory for the purpose of taking bearings of radio signals; while above the laboratory building proper we see numerous others either undergoing tests or being actually used for the regular reception of official communications from such points as Washington, or other Air Service fields.

On entering the Laboratory office we meet Captain Murphy, U. S. A., the officer in charge, who informs us that a very interesting study of the effects of the inductive and electrostatic disturbances, set up or created by the ignition systems of aeroplane motors, on the operation of radio receiving sets used on board aircraft, is being conducted by the engineering staff; and "Would we like to observe the experiment?" We accompany him to a large open room in one section of the laboratory, where we are greeted with the high-pitched whine of an airplane type generator used for supplying current for operating an Air Service radio telephone transmitter and the familiar long,

drawn-out "hello-o-o-o-o" of a radio engineer engaged in testing the apparatus. Gazing about, we look upon a veritable maze of radio equipment of every description and the thought strikes one that this room would prove a sort of fairyland for the average radio experimenter; for with the equipment gathered here unlimited numbers of circuits could be tried out.

The aerial torpedo plane, shown on the right, has made trips of ninety miles without a human being sitting at its controls; in fact the plane carried only radio apparatus. This apparatus, which controlled all the movements of the airplane from the time it rose from the ground until it returned after its ninety-mile flight, was operated by radio from the beacon station shown on the opposite page.



REPRODUCING FLIGHT CONDITIONS

Passing over to the opposite side of the room, we note a group of radio experts busily engaged in studying the records of an oscillograph used in connection with the experiment. Laid out on the floor is a complete ignition system, such as are used in connection with airplane motors, including spark plugs, distributor, ignition coil and storage battery, all properly wired and functioning. Close by and mounted on a table is a complete receiving equipment of the latest and most sensitive variety, which is connected to a loud speaker of the conventional type. This set is connected to a small aerial of the general dimensions of those used on board airplanes and to a "ground" of the so-called counterpoise type, which is merely a system of wires used in lieu of the regular ground connection which, of course, cannot be obtained on a plane in flight.

In the experiment being conducted the ignition system, as laid out on the floor, represents the motor ignition system on a plane in flight; the receiving apparatus and loud speaker representing the radio receiving equipment in use on the same plane by the operator and the radio telephone transmitter on the far side of the room taking the place of a field radio station trying to establish communication with the plane presumed to be in flight.

Upon starting up the transmitter and connecting the receiver to the loud speaker, the voice of the operator could be clearly and loudly heard about the room without the least sign of interference, but the instant the ignition system on the floor was thrown into action the interference became terrific and of such magnitude that it became impossible to hear the desired signal at all.

When it is realized that some of the larger planes have as many as four propelling motors with their individual ignition systems, and that the necessity for uninterrupted radio communication with planes in flight (a virtual impossibility under the above handicap) is of paramount importance in modern warfare, it will be seen that the overcoming of this problem is vital, and constitutes a very distinct step forward in furthering the efficiency of our air force radio system.

SHIELDING THE IGNITION

With the interfering ignition system going full tilt, one of the engineers covered it entirely with an insulating cloth covering capable of withstanding high voltages and over this, in turn, he placed a copper gauze screen which was grounded to the motor frame. The instant this was done the objectionable interfering disturbance set up in the radio receiver, through induction or electrostatic effects, was entirely eliminated. Thus this experiment very definitely located the source of, and provided a remedy for, the terrific interference encountered by air force radio operators, which has made it next to impossible to copy any signals save those of the strongest audibility. The outcome or final result of the experiment will be that all air service planes having radio receiving equipment on board will have their motor ignition systems completely shielded by a metallic covering which will be grounded to the motor frame. Each connection to the spark plugs, the connections from the magneto or spark coil to the distributor, the distributor proper, the leads from the storage battery, the storage battery proper, every conducting part of the ignition system, will be encased in a copper screening which will effectually absorb and prevent induction strays or currents from interfering with the reception of radio signals on planes in flight.

AIRPLANE RADIO SETS

We next inspected the latest type of radio receiver used on planes in the Air Service, which was one of the most compact forms of super-heterodyne receiver ever observed by the writer. The design of the receiver is very unique, in that it comes in two sepa-

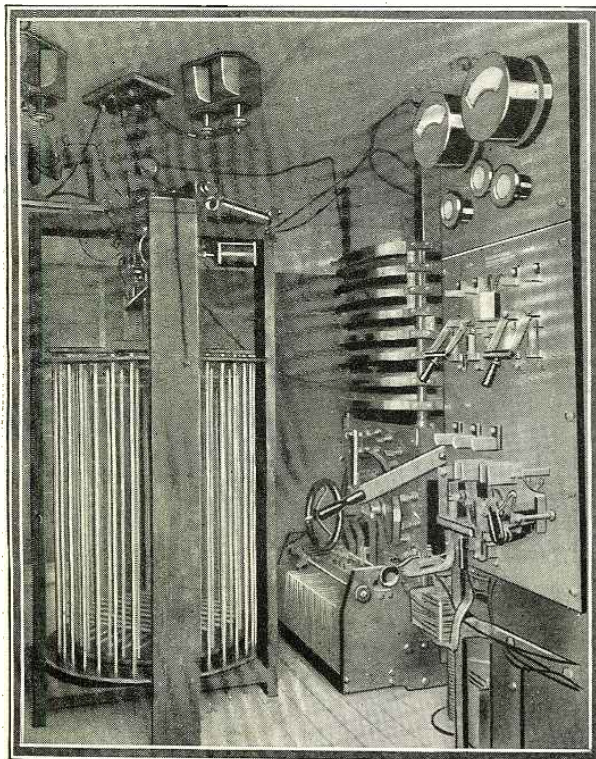

The interior of the beacon station which contains the apparatus for energizing the loop.

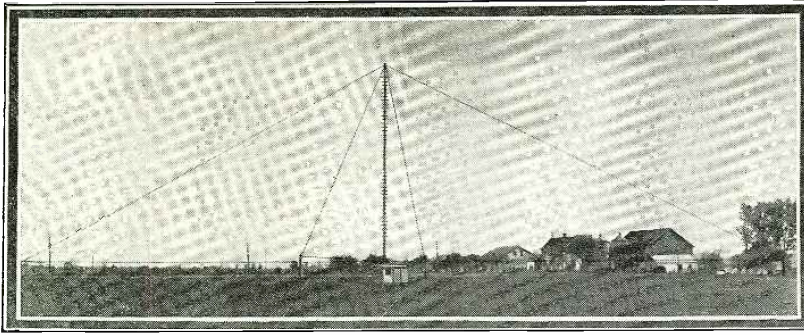

The radio beacon at Wilbur Wright Field, showing the directional triangular loop.

rate units; the larger of which contains the radio and audio amplifiers, including tubes and batteries, and the other and smaller cabinet incorporating the necessary controls for tuning to the various wave-lengths, and the detector tube and control therefor. The larger cabinet is only 12 inches square and about 6 inches deep, while the smaller is only 6 inches square and about 5 inches deep. Special tubes of the so-called "peanut" variety are employed, and the complete receiver is one of the most rugged and yet most sensitive in existence. For actual performance it is unsurpassed, it being possible to copy certain powerful broadcast stations located at varying distances up to 400 miles or so without the use of an aerial.

The larger cabinet, containing the radio and audio amplifiers, is out of the way in the rear of the cockpit; while the smaller control cabinet is mounted directly in front of the pilot or observer, which method aids materially in the conservation of space, a factor of importance in aircraft.

Special sound-proof head telephones are used with the receiver, these being mounted directly in the pilot's or observer's helmet. The ordinary hard rubber receiver caps are covered with a soft layer of felt, which helps to exclude extraneous noises and makes it possible to wear the receivers for long periods during sustained flights without tiring the ears.

TRANSMISSION FROM PLANES

The standard transmitter for planes is also a masterpiece of radio design. Although of sufficient power to cover a range of several hundred miles, it occupies a space not much larger than that taken up by the average receiving apparatus aboard. It is of the vacuum-tube type, the circuits being so arranged that the operator can use it for voice, buzzer-telegraph, or straight continuous-wave telegraph transmission. The last-named is used when it is necessary to carry on communication over long ranges which cannot be covered when the voice or modulated method is employed. Current for supplying the transmitter is furnished by suitable generators, which are driven by means of small propellers mounted directly on their armature shafts.

The aerial used on board the planes in connection with the receiving and transmitting apparatus described is of the widely used standard type; namely, a single multi-strand phosphor bronze wire of high tensile strength which is lowered from the fuselage of the plane while in flight by means of a hand-reel, a weight being affixed to the end of the wire to keep it in a position as nearly vertical as possible. The wave-length of the transmitted signal is varied at will by simply changing the length of the wire, by means of the hand reel. It is increased by letting out more wire, or decreased by reeling in a portion of it.

The ground is, of course, of the "counterpoise" type, comprising a system of wires

mounted on the wings of the plane or even built directly into them; and all other metal parts of the plane are also connected to this system to further improve its efficiency.

OPERATING A PLANE BY RADIO

Recalling that experts at this field had been successful in applying the art of radio control to a "radio car," the movements of which could be controlled at will by means of radio impulses transmitted on various wave-lengths, or by certain groups of code characters, the question was asked: whether or not the method had ever been applied to a plane actually in flight? We were then shown a small plane of the pursuit type and told that it has been flown for varying periods, totalling some ninety hours, without a pilot on board! Its movements during this period were entirely controlled by means of gyroscopes which governed the balance of the plane, as well as its movements to the right or left, which were, in their turn, regulated by means of radio impulses sent by the operator of a specially designed transmitter of the tube type.

This plane, it was stated, actually "took off," made a perfectly controlled flight through the air for a lengthy time period and then was successfully landed without a pilot on board, without mishap. Space does not permit of a detailed explanation of the radio receiving devices on the plane which made this feat possible; but, in general, the apparatus comprised a special form

of receiver, along with a group of very delicately balanced relays which controlled the currents flowing in other electrically operated control devices which, in turn, operated the plane's controls.

A FEAT IN RADIODYNAMICS

The significance of this achievement and its possible effect on modern warfare should not be overlooked; for it means that it would readily be possible to load a plane so equipped with either gas or explosives and, without risking the life of a man, send it hurtling into enemy territory, there to wreak destruction. It could also be made to return to its base, if it were not destroyed by an enemy during the flight. However, it is not believed that flights of this nature would be successful in attaining the desired objective if located at great distances from the base; unless the movements of the plane were controlled by radio impulses transmitted by an accompanying plane, which could hover out of danger, yet keep it in view. This procedure would be advantageous in that specific, more important, military objectives could be singled out and destroyed, with the risk to pilots and observers minimized to a great degree. It is more than apparent that the art of radio control is destined to play an increasingly important part in the exercise of modern warfare. This branch of the radio service should be given much attention and practical methods of offense as well as defense developed; for it seems certain that a force with an efficient arm of this description at its disposal would possess a very distinct advantage over an enemy not so equipped.

THE RADIO BEACON

Asking "What the Air Service considered the most important and outstanding radio development of the year?" we were informed that the "Radio Beacon" method of guiding airplanes on long flights over unfamiliar territory, or at high altitudes above clouds preventing the observance of landmarks as an aid to navigation is the most valuable development to date. This is accomplished by means of directional radio transmission.

The transmitter, or "beacon," comprises two large aerials of the loop type mounted on a common pivot. This beacon can be likened to a book which is stood on end and opened in the middle, the pages on the one
(Continued on page 68)

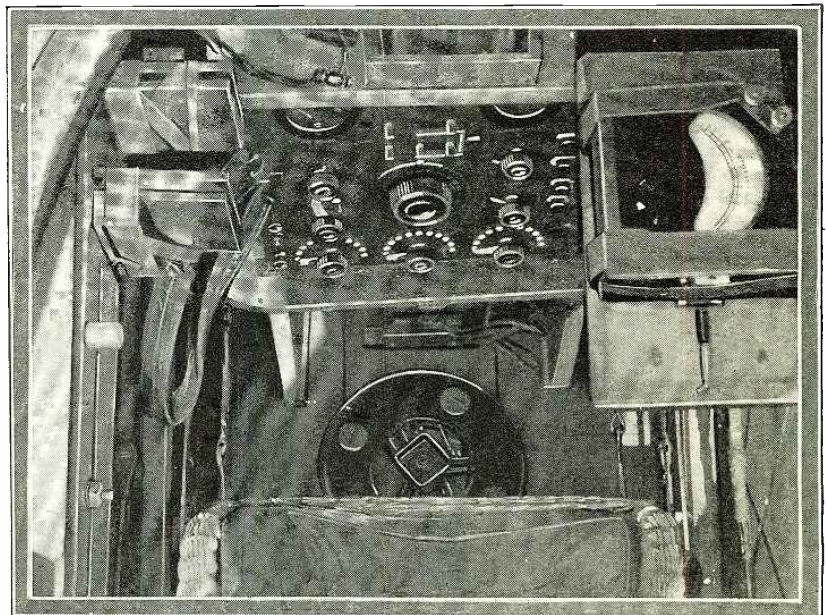

The radio set installed in an airplane. The reel containing the antenna is under the pilot's seat.

Radio Broadcasting In Japan

東京無線放送の景



↑ Above, scene in Hibiya Park on the evening of Radio Day. The futuristic building in the center was erected by the Radio and Experiment Magazine of Japan. Here thousands witnessed the demonstrations of radio apparatus and listened in. Right, exterior view of Station JOAK, on Atago Hill, Tokyo.

The Japanese caption at the left side of the page says: "Radio Night at Hibiya Park, Tokyo (This is the Central Park of the Japanese Capital); Thousands Listen to Broadcasting by Dignitaries, Artistic Stars and Others."



At right, stars of the Japanese stage, broadcasting the classical drama, "Shinmon and Koganei." These programs from JOAK are heard with much interest throughout the Flowery Kingdom.

Below, at left, Mr. Tamoamai Odan, broadcasting "Shibarbanoshi."



Below, Mdlle. Gidayu, famous singer of classical Japanese music, accompanied by a player of the Samisen, the characteristic musical instrument of Japan.

Below, the control room of Station JOAK, with Mr. J. Ohara, the control operator.



New Radio Developments

THE RADIO-OPERATED HIGH-TEMPERATURE FURNACE

This furnace is heated by the use of radio waves whose length is in the neighborhood of 1,000 meters; and is used by the Bureau of Standards at Washington for the purpose of melting platinum and other refractory metals. The inductive effect from these high-frequency currents produces enormous temperatures, which are, however, very easily controlled. Great possibilities are seen in this method of applying electric heat without direct contact.

© Harris & Ewing.

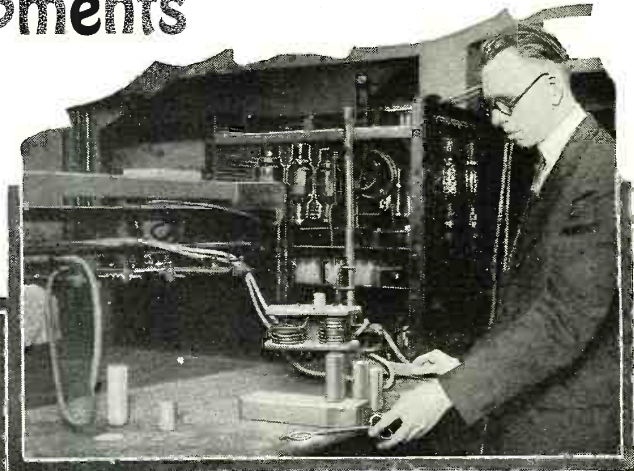

RADIO WRITES MESSAGE WITH A PEN

This latest wonder of radio is shown in the illustration at the left. By means of this appliance, the message which is written at one radio station is simultaneously duplicated in fac-simile at another.

© Harris & Ewing.

HEART BEATS ANALYZED BY RADIO APPARATUS

An improvement in the radio stethoscope has been effected by Dr. George K. Fenn. The internal sounds of the body, by this means, are separately recorded, so that the listening physician can single out any of the separate sounds of the heart and lungs. A permanent record is also made by means of the movement of a fine wire, carrying the audio-frequency current, suspended between two magnets. This combines the stethoscope with the radio-cardiograph, both in previous use.

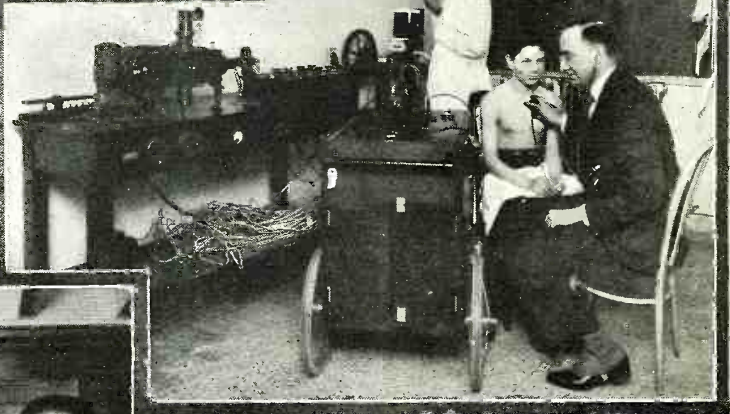

PHOTOGRAPHING THE AUDIO-FREQUENCY WAVES

The horizontal tube shown below is a "cathode ray oscillograph," which shows the wave form in such manner that it can be recorded by the camera. A test is thus made of audio-frequency amplifiers by photographing the wave before and after it has passed through them.

It is easy to see whether any appreciable distortion has been caused.

© Foto Topics.

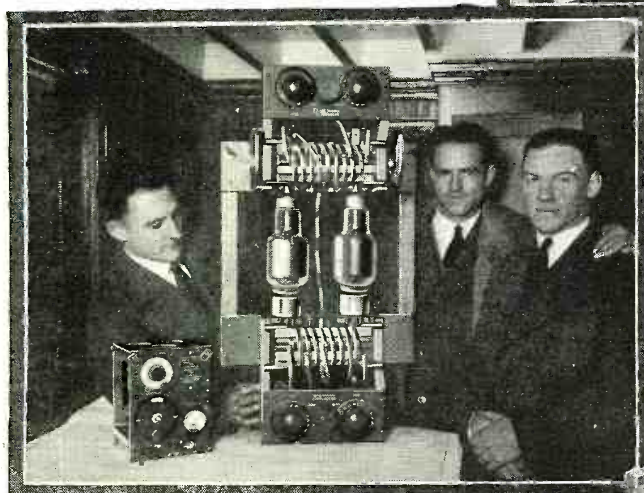

TRANSMITTER USED BY BYRD POLAR EXPEDITION

The short-wave transmitter used by Commander Byrd, U. S. N., in his polar flight is shown above. This set enabled him to communicate with his base, and its messages will be picked up by many amateurs. It operates on wave-lengths of 13, 20, 40 and 80 meters. The small transmitter at the left is for aeroplane use, on 41 and 61 meters.

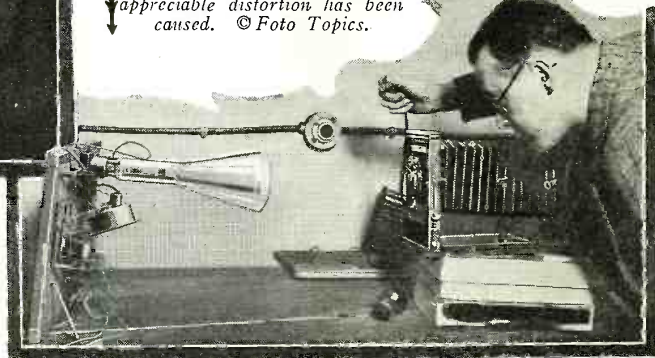

Radio News of the Month Illustrated

By GEORGE WALL

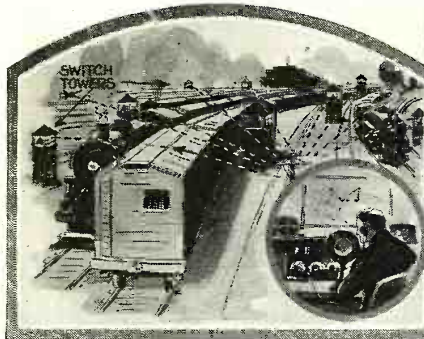

The Illinois Central Railroad has reduced one yard crew from 228 to 27 men by the use of twelve microphones and a central power circuit operating loud speakers, together with an automatic braking system. The dispatchers' orders and switchmen's answers are heard throughout the yard.



The profession of banditry in New York will be made more hazardous by the wireless police reports, broadcast from the municipal station WNYC. All police posts will be informed simultaneously of crimes and stop the fugitives. There are 106 radio sets in the system.

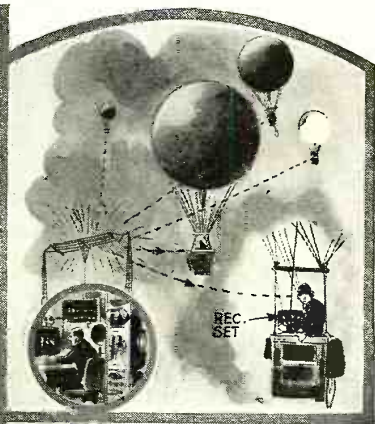

The balloons in the national elimination race received detailed weather reports from WJZ during their journeys. Their position also was regularly broadcast.



There seems to be nourishment in radio; Herr Jolly, a professional faster, sustained himself during a 44-day exhibition in a German city on water, cigarettes, and radio programs, which kept him up during the ordeal in his glass case.

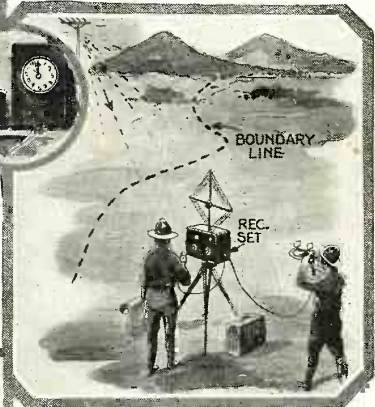

Radio may be used to correct the boundary between Chili and Peru. The time signals from Washington will enable the surveyors to determine their longitude more accurately than has ever before been possible.

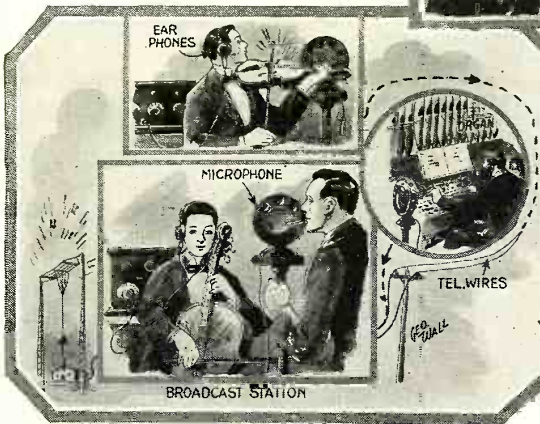

A joint radio recital was recently broadcast in the Twin Cities, by a method similar to that described in the article on page 18 of this issue. The violinist was in St. Paul, the organist in Minneapolis, and the cellist in the transmitting room of WCCO, eighteen miles away. Synchronism and modulation were successfully maintained, so that the program went out as if the musicians were side by side.

A "radio parish" of nine denominations has been formed in Portland, Maine. The Rev. Howard O. Hough addresses his congregation over station WCSH.



A spirit medium has asked the co-operation of a Western broadcast station in putting the voices of departed persons upon the air, so that they may be heard by all who are interested in psychic research.

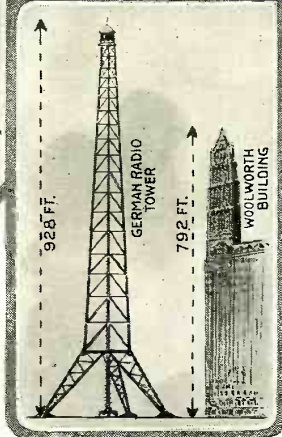

The steel aerial tower at Konigs-wusterhausen, near Berlin, Germany, just erected, is 928 feet high; with its mast it will reach higher than the Eiffel Tower. A one-passenger elevator runs to the top.

Sam Jones, Radio Tube Bootlegger

By VOLNEY G. MATHISON

WELL, folks, I hear there's some rumors goin' around th' country that I, th' oldest, toughest, and most thoroughly case-hardened wireless operator that ever sat in a radio shack, am to be seen swashbucklin' around on the briny deep no more. I understand that various theories is bein' advanced as to th' cause of my disappearance, and that some unfriendly porcupines is even up to sayin' that I am in jail, or have died of the small-pox, or got married—or some other disaster like that. But there ain't no truth in any such reports, as you shall see.

Th' thing all starts one evenin' when I am sittin' up in my comfortable wireless-shack on the big tramp-steamer *Steel Bobolink*, lazily thumbin' th' pages of the latest 10-cent radio magazine. Herein, I runs across a picture of a big, fat-bellied guy wearin' a silk plug hat an' sittin' in th' back of a Rob-Rolly limmerzeen, with a long black cigar stuck between his teeth. Underneath the picture is these inspirin' words,—“Six weeks ago, this man was a can-opener-sharpener in a cafeteria—now he has a private manicurist, and wears gold-plated b-v-d's! You can do it, too! Write for details! Do it now! The Three-R Radio Corporation.”

What the three R's signifies is a secret; I figure now they must a' stood fer Royal Red Raspberry. But read on, an' judge fer yourself.

Well, I writes in, an' when I gets my Royal Red Raspberry Radio Corporation literature an' reads at it a couple hours, I finally digs out of it th' information that the gold-plated underwear proposition is to go into the bootleg radio tube business; which business—speakin' now from ample later experience at first-hand—is the flat-chested sister of th' bootleg liquor business.

This was the time when radio tubes was sellin' at six dollars and fifty centy a blink—also, it was th' time when tubes was tied up with so many patents that I couldn't see how anybody could get by with bootleggin' 'em.

However, bein' of highly criminal tendencies, as is quite well known in some quarters, I fancies that the lay-out looks kind of attractive, and I decides to pry a little further into it. When the big intercoastal freighter on which I am chief an' only wireless operator arrives in New York, for two weeks dischargin' of her cargo of Puget Sound flour, I fights my way by main strength into a subway-train that goes shootin' like a runaway torpedo under th' Hudson an' up through several million acres of railroad-tracks, to the grimy, smoke-fogged metropolis of Newark, which sooty city, as I learns in time, is the Babylon of the bootleg tube-makers.

The hangout of the Royal Red Raspberry Radio Corporation ain't none too easy to find. Their address is 13 Cliff Street; but there ain't no Cliff Street in the pocket-directory gadgets of the traffic-cops. I goes up to th' city hall, where all hands turns out to look through th' town maps—an' finally a clever young city engineer locates my street, an alley one block long, down in a part of the town that looks ramshackle an' hard-boiled, even on the map.

Cliff Alley is a gloomy cobblestone-paved gash between two rows of old two-storied brick buildin's. Their faces are like dirty cliffs; so I figures maybe the street is named after them.

Number 13 is a dark, narrow signless stairway, leadin' up to a second floor. I clambers up, cautious-like in the dusk. At the top, I runs against a barred door, on which

I proceed to knock. Somewhere, I hears a board, or a shutter in the well slidin' back; and overhead a light flashes down on me. Then it goes out again, after which a door slowly opens.

“Whatcha want?” says a harsh, troubled voice.

I speaks a little piece about the private manicurist an' the gold-plated underwear and am let into a big, gloomy office full of filin' cases an' old battered desks. Before me stands a big, fleshy, bald-headed youngish man, whose cordial smile uncovers a flock of dirty black-lookin' teeth.

“Ah, Mr. Jones, I am ever so pleased to have you call on us,” he purrs, friendly-like, when I have introduced myself. “Almost all our contact with our people is by mail, you know.”

“By mail, you know,” comes a gentle-voiced echo, from behind him. Then I sees a little angel-eyed gink sneakin' out from behind a door which opens into another room full of rubbish an' packin'-cases. He looks so sweet an' innocent, I feels like he would sure drop dead in his tracks, if somebody was to let out a good mouth-fillin' cuss-word, like damn.

“This, Mr. Jones, is Mr. Love, the president of the Three-R Corporation. I am Mr. Horgan, the secretary. Ah, Mr. Jones, your arrival is most opportune; we are much in need of a good man to take over some of our most valuable California territory.”

“Now, about that private manicurist,” I begins. “How do I get her?”

“We set you up in the mail-order radio tube business,” explains Mr. Horgan, genial-like. “We furnish you tubes for only two dollars apiece, and you advertise them in your locality and sell them for three dollars. There's nearly a dollar apiece profit—and you can sell a thousand a week with both eyes shut; because the patented and licensed radio tubes on the market cost six-fifty each. ‘J'ever hear of anything like it?”

“Ever hear of anything like it!” echoes little Angel-Face, th' president.

“I dunno,” I replies, pretty doubtful-like.

“If I could dump a couple carloads of 'em, before the police throw the hooks into me fer runnin' a bootleg-tube joint—”

“Bootleg!” exclaims Mr. Horgan.

“Bootleg!” echoes Angel-Face, lookin' as

if even that kind of a bad word jars his delicate soul.

“Yes—bootleg,” I retorts, puzzled-like. “What else is it?”

Mr. Horgan pats me on the shoulder, smilin'.

“No, my dear boy,” he says, “we don't infringe on the big corporations' patents. We don't sell new tubes. We—ahem—we only repair *their* tubes. You see, er—you advertise that you repair radio tubes that are burnt out. Then, when the dead tubes are sent in to you, you ship back corresponding tubes from the stock we furnish you.”

I grins back, real crook-to-crook like. “Fine dope!” I says. “How many tubes should I take, to begin?”

Mr. Horgan looks at me, very kindly an' appraisin'-like. He seems to regard the quality of th' cloth in my suit; an' he stares hard at my scarfpin, like he wonders if it's solid gold or fifteen-cent-store plate.

“Why, as I said you ought to be able to shove them—to sell them at a rate of a thousand a week, without the least effort,” he replies, carefully. “However, it is well always to make a modest beginning—and grow. Start with say a couple of hundred.”

“Couple of hundred,” gently echoes Angel-Face, beside him.

So I places my order for a couple of hundred assorted radio tubes.

“It really is none too many,” says Mr. Horgan. “In fact, most of our people begin with three hundred —”

“I'll stay with two, I guess,” I cuts in. “Now, about openin' up an account. Since I'm just goin' into business, I ain't listed yet in the big red book of ‘Who's He & Vot's He Got?’—but I can give you a string of high-class references. My barber —”

I stops, for Mr. Horgan looks troubled, and Angel-Face seems to be getting real sick.

“We ship only C. O. D.,” says Mr. Horgan, kind-like, but firmly. “We work on such a narrow margin of profit that we simply have to do all business with everybody strictly C. O. D.”

“C. O. D.” echoes Angel-Face, perking up again a little.

“Yes, of course,” I agrees, apologetically.

“It's a system that we find saves us a lot

(Continued on page 71)

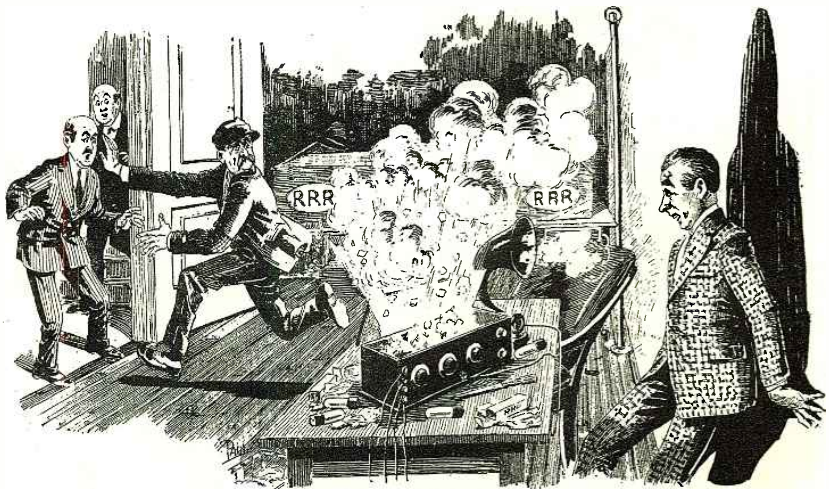

“The whole outfit lights up with a brilliant white light; there is a terrific bang! a shower of flying glass, and a lot of shootin' fire and smoke. ‘Help!’ squawks the Skipper—and he streaks it for the door.”

WRNY Broadcasts a Synchronized Musicale



An orchestra keeping in time with an organist four miles away and the two going on to the air as one was a feat recently accomplished at WRNY. This scheme has opened up new possibilities in broadcasting.



ON Tuesday evening, April 27, at 8 o'clock there was put on the air from the RADIO NEWS station, WRNY, at the Hotel Roosevelt, New York, the first synchronized radio musicale broadcast in the metropolis. Radio listeners heard the simultaneous transmission of music from the organ at the West Side Unitarian Church, 550 Cathedral Parkway, and Orlando's Concert Orchestra, playing from the Palm Room of the Roosevelt at 45th Street and Madison Avenue. The organ and the orchestra were separated by an air distance of some four miles.

HOW IT WAS DONE

The leader of the orchestra, Herbert Soman, in order to hear the organ, wore a special set of light headphones which were plugged into the wire line, thus enabling him to receive every note as it was sounded by the organ uptown. At the same time he had to listen to his own violin as well as to his orchestra, to make sure that all were in perfect synchronism. Through his direction, the orchestra had no difficulty in maintaining the proper time.

On the other hand, the organist, Rock Ferris, had also to wear

headphones so that he, in turn, could cooperate with Mr. Soman.

Every precaution was taken by the engineers of WRNY, not only to have a perfect balance of volume of the different instruments, but to have the operator at the control board electrically balance the two wire lines against each other, in order that one concert should not drown out the other.

Technically, the "output" of WRNY's speech amplifiers was fed by direct line to the organist at the church, who "monitored" both his own program and also that of the Orlando Orchestra. Another direct line to the Palm Room in The Roosevelt fed the amplifier output of the organ to the orchestra director, who, by wearing headphones, "monitored" the organ and directed his orchestra at the same time.

The synchronism was so perfect that the

radio listener, unless he knew in advance, could not tell that the organ and orchestra were actually playing four miles apart. When the balancing of the lines is done skilfully, the radio audience need never know that music from two or more points is being combined to form a single unit of harmony.

The need for skill was well distributed. Without the joint co-operation of the operator at the control board of WRNY, the director of the orchestra and the organist, the scheme would not have worked out as successfully as it did. All three had to be "on their toes" every minute of the time.

There is a distinct utility for simultaneous musicales of this kind. Very often it is necessary to create special musical effects which, up to the time of the presentation of this unique scheme, could not be obtained;

The illustration shows how the synchronized musicale was conducted. The organist was connected with the studio by wire and so was able to hear the orchestra which similarly was enabled to keep time with him.

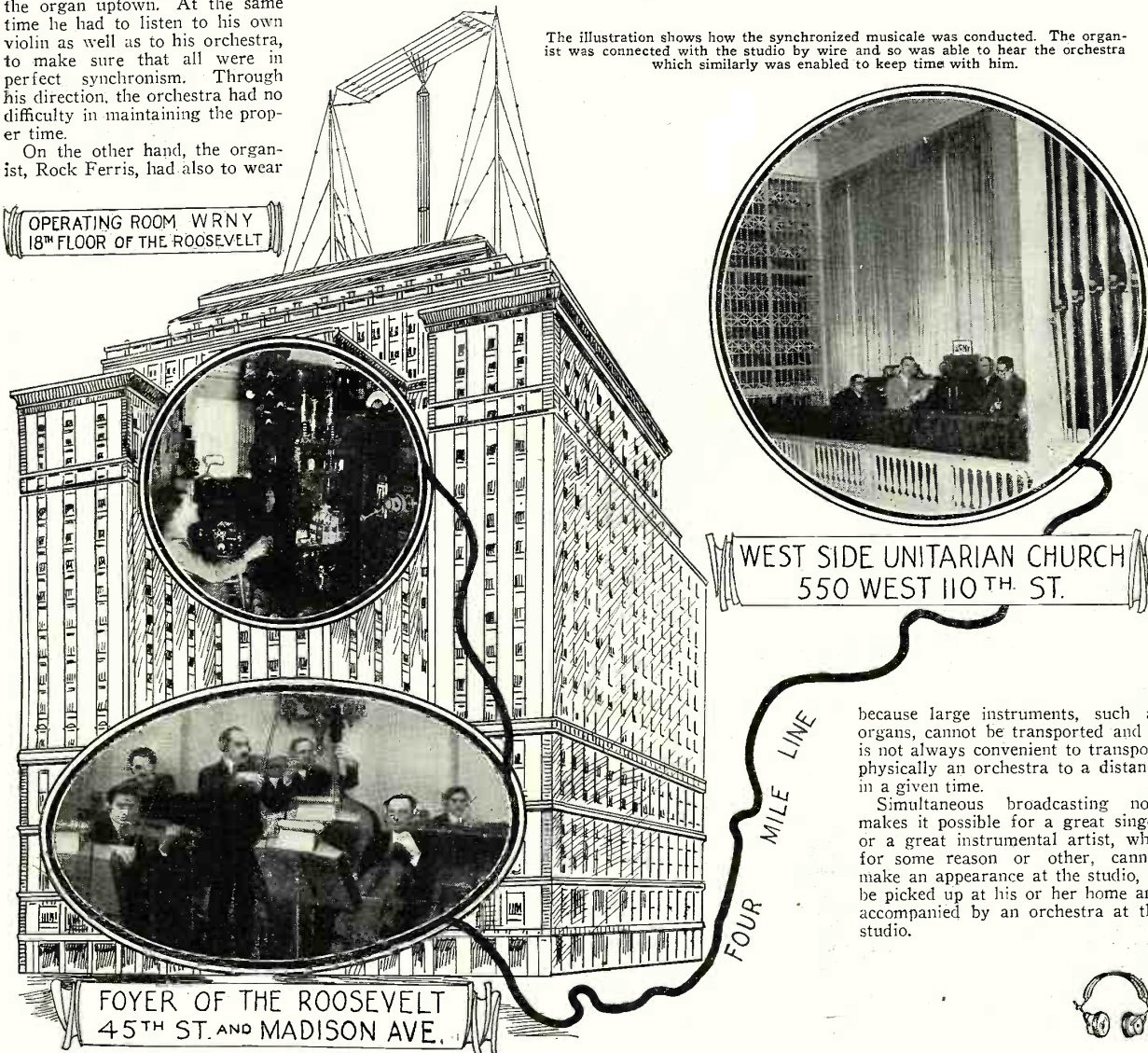

because large instruments, such as organs, cannot be transported and it is not always convenient to transport physically an orchestra to a distance in a given time.

Simultaneous broadcasting now makes it possible for a great singer or a great instrumental artist, who, for some reason or other, cannot make an appearance at the studio, to be picked up at his or her home and accompanied by an orchestra at the studio.



Radio for Every Sick Bed

By ASHUR VAN A. SOMMERS



To the person who is confined to bed or room, the programs broadcast by radio are indeed a god-send. A London daily paper has conducted a campaign for raising funds to equip every hospital with receivers. This great work is progressing wonderfully well.



A RADIO set to soothe every bed of pain and dispel the loneliness of every shut-in! That is the ultimate goal of charitable activities which have already brought sunshine to thousands of unfortunates. The wonders which radio has worked already, by putting the dwellers in isolated places in touch with their kind, have been told many times; but none are so isolated as those in great cities whom walls shut out from multitudes, and who are denied by sickness or injuries the freedom of movement. Their nerves are strained keenly by suffering, while they are left alone for hours at times in a mental and moral loneliness which the strong and healthy need not suffer even in a wilderness. It is to these unfortunates that radio is bringing a boon of incalculable consolation.

An endeavor, upon a huge scale, to alleviate this misery was recently undertaken and is being brought to a most successful completion, as regards the hospitals of London, by the Daily News, one of the large newspapers of that city. The possibilities of radio as a relief, and indeed as a treatment, because of its encouraging and enlivening effects, for patients had long been apparent; but the difficulties in the way of its general adoption seemed prohibitive to hospital authorities. In fact, the governing body of one large hospital had refused the offer of a radio installation; because, against the pleasure to one group of patients, must be set off the irritation to the nerves of others who might not be at the time in the mood for listening. This had been the barrier preventing the use of radio as its merits deserved.

Undismayed by the magnitude of the task, the Daily News initiated a campaign to equip every hospital bed in the metropolis with an individual headset; thus giving to each patient an ever-present companion "who will be talkative or silent at will."

The News began with a subscription sufficient to equip the Royal Ophthalmic Hospital at Moorfields with such an installation; as patients suffering from affections of the eyes are deprived, more than others, of resources for self-entertainment. The patronage and support of the British royal family was given at once, the public responded liberally, and very generous contributions—some \$40,000 worth of equipment—were made by the radio industry. The campaign started in May, and by Christmas about \$150,000 had been raised in London, and fifty-two hospitals completely equipped with individual telephone attachments for each bed; while work had been started, or contracts let for installations, in a third of the remaining sixty-six. The splendid example thus set had been followed generally throughout the island, similar funds being established, in sixty-eight other cities and towns, to provide a similar convenience for each patient in the local hospitals.

The B. B. C. (British Broadcasting Company) which controls all broadcasting in that country, lent its co-operation, and especially in solving the technical problems. The cost of each installation ran from \$10.00 to \$12.50 per bed: the wiring coming to about \$5.00. In addition to this, it was found necessary to devise a suitable distributing system, nothing of the nature requiring so many individual lines having been previously attempted. In the London Hospital, for

instance, it was necessary to provide no fewer than 842 extensions from the receiving set to individual phones: as well as for a few loud

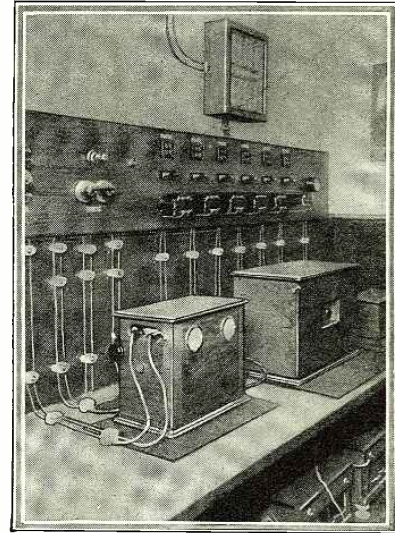

The receiving equipment in Guy's Hospital, showing the distributor lines to the wards

speakers, suitably placed where they were available for assemblies of patients who had more freedom of movement.

SPECIAL INSTALLATION DESIGNED

Professor Eccles, well known as an investigator of radio waves, and Mr. B. F. Crossfield were called into consultation with Captain Eckersley, chief engineer of the B. B. C., and standard specifications were prepared for the necessary hook-ups. Of these a great number of copies have been distributed by the News, throughout Europe, America, Asia and Australia, as well as in the British Isles. As constructed, this equipment furnishes uniform reception to each headset throughout the building, regardless of whether every one is in use, or whether but a handful of patients are availing themselves of the service at one time.

"This Christmas time," said the News, with justifiable pride, "will be unique in the hospitals' history. With a wave of her wand the good fairy, Wireless, has summoned all her gloom dispellers to the aid of the suffering. Into the wards where the little children lie her sprites will be dancing, full of magic tales and fancies. And the seasonable good cheer of carols, songs, merriment and companionship will be brought to each bedside, just as though the hospital walls had melted away.

"The good work goes on. What it means can hardly yet be assessed. Some of the most responsible hospital authorities in London, both medical and lay, have expressed the conviction that wireless equipment is a definite factor in the more speedy recovery of the patient to a full measure of health and strength. This means that the time spent by the average patient in the hospital will be lessened, which again means that more hospital beds will be available for sufferers. It would be shortsighted, however, to esti-

(Continued on page 79)

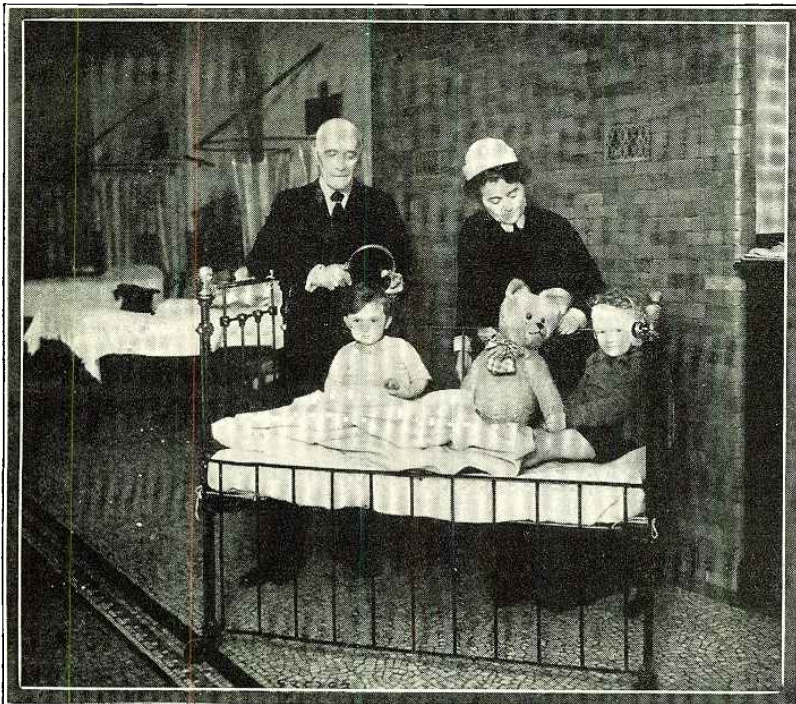

Lord Revelstoke and the Matron of Guy's Hospital, in London, adjusting the headphones on two of the tiny patients. Photos © Kadel & Herbert.

Radio Set Owner's Information

RINGING NOISE IN LOUD SPEAKER

(19) Harold C. Frank, of Philadelphia, Pa., asks:

Ques.—I am having trouble with a ringing noise in my cone speaker. This noise invariably appears when I attempt to turn up the "volume control" on my five-tube set more than half way. In consequence, the stations I receive are very weak. I have had this trouble from the very day I purchased the outfit. How can I remedy this?

Ans.—This is a common occurrence, particularly in sets having built-in loud speakers. It is due to a mechanical vibration. Vehicles passing in front of your house, movements in the room where the radio set is installed or the sound vibrations emitted from the loud speaker may be the cause. These vibrations in one manner or another impinge on one or more of the vacuum tubes; causing, in turn, the vibration of the "elements" of the tubes (filament, grid, plate). In this way the mechanical vibrations are converted into electrical vibrations, these traveling through the circuits and finally reaching the loud speaker. A very small noise, created in this manner, will build up to tremendous volume.

A loud speaker is the most common offender, particularly if it is placed directly on top of the radio set where the vibration resulting from its operation may be trans-

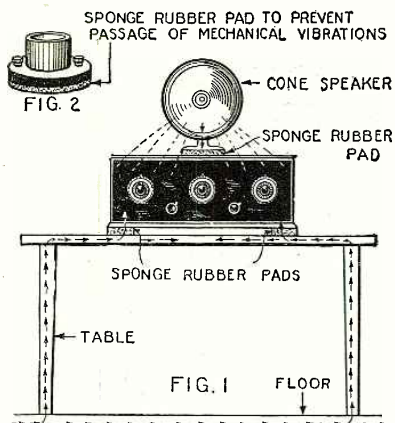

Vibrations from the floor, or from the loud speaker in operation, are often sufficient to affect the tubes and produce a ringing noise. The use of rubber pads will usually curb it.

mitted to the tubes through the wood of the cabinet. The loud speaker should instead be placed in such a position that the sound waves emitted from it are directed away from the set.

Of all the tubes, the detector is the one most affected by mechanical vibration; and where a ringing noise cannot be eliminated by re-locating the loud speaker, changing the detector tube will usually bring about the cure. Try all the other tubes in the detector socket. You should find at least one that will remain quiet.

The use of sponge rubber or thick felt pads, under the four corners of the cabinet, is another effective means of keeping a set quiet. The pads "damp out" mechanical vibrations before they can reach the tubes. Likewise tube sockets with sponge rubber pads underneath them are a great help. "Noiseless" tube sockets can be purchased in almost any radio store.

The accompanying illustration shows the various channels by which vibrations can reach the tubes, and the usual means resorted to for curbing them.

THIS page constitutes what is to be known as the SET OWNERS' INFORMATION department, and is to be conducted regularly each month in RADIO NEWS. The purpose of the department is to furnish assistance to those readers who have not yet acquired any extensive knowledge of radio, but who are the possessors of radio receivers and wish to know how to handle them.

There is always new blood coming into the fraternity of radio enthusiasts; and it is obviously unreasonable to expect that they can intelligently read the articles which are written for the more experienced fans. Consequently this new department has been started for their benefit; and we invite anyone who desires to do so, to write an account of his troubles to the editor of this department. No letters will be answered by mail. The editor will select from the letters which he receives those queries that seem to be of most practical interest to all, and will answer them fully and in detail each month. There will be no charge for this service. Simply write to SET OWNERS' INFORMATION DEPARTMENT, RADIO NEWS, 53 Park Place, New York City.

COMPARATIVE COST OF "B" BATTERIES AND ELIMINATORS A CORRECTION

In our May issue we published the following question and answer:

Q. When does a "B" eliminator begin to save money? Is it more economical than batteries, all things considered? For example, over a two-year period, what would be the comparative cost, including all features of upkeep in each case, of the two methods of obtaining plate voltage for a five tube set, assuming an initial cost of \$50.00 for the "B" eliminator?

A. The average "B" eliminator draws about 15 cents worth of current per month. Its total cost of upkeep in two years would be \$3.60. This makes a cost over a period of two years \$53.60.

The average owner of the same type of set finds it necessary to install new batteries about once in five weeks. The replacement cost for 90 volts averages about \$6.00. Thus the price of "B" batteries at this rate would run well over one hundred dollars. It is apparent, therefore, that the average "B" eliminator will pay for itself in about a year; and within two years will have reduced plate voltage expense 50% for the whole period. Thereafter the cost is the negligible amount on each month's electric light bill.

It is regrettable that the obviously incorrect statement of "B" battery life should have appeared in our columns. If the average set owner were obliged to replace his "B" batteries every five weeks, at an annual cost of \$50.00 or more, radio would never have become the popular institution it is.

Using 90 volts of a heavy duty "B" battery of reliable make, the average five-tube receiver can be operated for less than \$15.00 a year. At this rate, it would require more than three years for the \$50.00 eliminator to pay for itself, without taking into account upkeep expense, tube renewals and cost of current. In making any comparison of the relative economy of "B" batteries and eliminators, several such items must be taken into consideration.

We wish also to amend the statement, given in answer to Question No. 17, published in the June issue, that the life of a dry-cell "B" battery is shortened if it is not maintained in an upright position.

This statement is contrary to the usual fact: i. e., that any reliable make of dry-

cell "B" battery is unaffected by the relative position in which it is placed. It may be operated as well on its side as in the upright position.

POOR OPERATION OF SET

(20) C. J. Wilkens, of Peru, Ind., asks:

Ques.—Results from my set have been very unsatisfactory this past winter. Formerly it was sensitive and powerful; at present it is not even satisfactory for local reception. I know my batteries and tubes are O. K. as I have had them tested. Why should this be?

Ans.—We are certain that your set needs a spring cleaning. More trouble comes from the accumulation of dust and dirt than is usually supposed. Furthermore, time always injures metallic surfaces. Oxidation is the result of moisture. Dust, dirt or oxidation on a contact surface is, in effect, equal to a high resistance introduced into the circuit. Thus it amounts to an impediment to the normal flow of current. Since there are minute particles of metal in dust and dirt, a deposit of this sort on an insulating surface (such as the hard rubber strips supporting a variable condenser) will allow the leakage of current, diverting it from its normal course and dissipating it in work of a character not at all beneficial.

As to cleaning, disconnect all the batteries first and, if possible, take the set out of its cabinet. Use a piece of cheesecloth for wiping the dust off the instruments. If there is a thick deposit of sticky dirt it is advisable to dampen the rag with either benzine or alcohol. A pipe cleaner can be used for cleaning between the plates of the variable condensers.

Next clean the spring contacts in the tube sockets and the prongs on the tubes with a piece of No. 000 sandpaper. Go over them whether they look dirty or not; in nine cases out of ten they have been oxidized. Before replacing the tubes make sure that none of the socket contacts have been bent out of their normal position; it is very im-

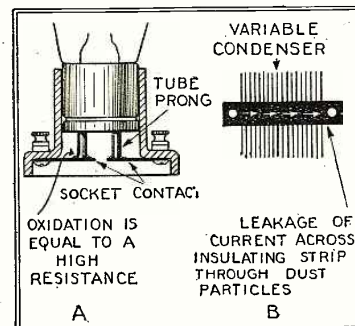

Grease, dust and grit on apparatus will impair the operation of any set. Keep them clean by regular attention.

portant that they make perfect contacts with the tube prongs.

Before putting the set back in the cabinet and connecting up the battery wires, it is best to go over all the wiring in the set very carefully to make sure that there are no loose connections. Any soldered connections that have become corroded should be wiped clean with the dampened rag and, if possible, resoldered. If this is done, use very little flux and a good, hot iron.

FAILURE OF LAST AUDIO AMPLIFIER

(21) John F. Patterson, of Peekskill, New York, asks:

Ques.—I have a radio set with three jacks on the front panel for varying degrees of

(Continued on page 83)

Great Composers in WRNY Programs

By CHARLES D. ISAACSON



EVELYN HIRSH
Pianiste, who puts plenty of pep in jazz selections over WRNY.

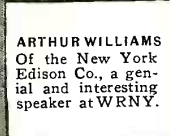

ARTHUR WILLIAMS
Of the New York Edison Co., a genial and interesting speaker at WRNY.



Marguerite Namara
Prima Donna, and Star of "Pinafore" sang at WRNY to aid a charity.



Harry T. Burleigh
Finest of negro singers and composers, sang his spirituals at WRNY.



IDA GEER WELLER
Gives "The Message of the Hymns," a sacred music series, at WRNY.

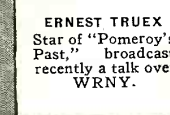

ERNEST TRUEX
Star of "Pomerooy's Past," broadcast recently a talk over WRNY.



RUTH NUGENT
Youngest of the well-known dramatic family, was a recent WRNY visitor.

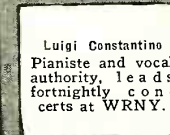

Luigi Constantino
Pianiste and vocal authority, leads fortnightly concerts at WRNY.



THE Editor of RADIO NEWS has asked me to begin a new feature this month: that is to tell you in every issue about some great composer or great work in music. So I am going to tell you just a word or two about the greatest of the Italian grand opera writers, Giuseppe Verdi. My reason for taking him is that we had a very beautiful program of selections from his operas in one of the series of Ferruccio Corradetti.

The fact that everybody remembers about Verdi is that he came of the poorest of families, starved when he was a boy, and during the writing of his first operas, which were considered utter failures. He was living in a garret in Milan when his first success was heralded, and this came only after the tragedy of the death of his wife and baby. For half a century Verdi wrote operas, every one of which is practically immortal. To me the greatest of his operas is "Aida," with its Egyptian atmosphere, but the one I prefer for popular melody is "Rigoletto," the story of the deformed villain whose plot came back like a boomerang upon his young, innocent daughter, Gilda. There is the opera "Traviata," with the great love sacrifice of Violetta; and "The Forces of Destiny," whose title explains the tale.

From the point of box-office popularity, "Il Trovatore" leads, with "The Troubadour," the "Miserere," "Home to Our Mountains" and melodies familiar even to every school boy in the United States. The quality which marks Verdi's popularity is that his melodies quickly caught the people's fancy, yet have such sincerity and depth that one never tires of them. Verdi had an original sense of dramatic effects, generally written to texts of characters which seem to live and breathe.

Signor Corradetti, who is conducting the Sunday afternoon "Operatic Composer" series, is a man who has had a very brilliant career. He has appeared on the leading operatic stages of Italy and other countries, and has won high honors by creating and interpreting important parts.

Another composer series which we are running at WRNY is that of Herbert Soman, conductor of Orlando's Roosevelt Concert Orchestra, every Monday night. We have had programs of Brahms, Beethoven Debussy and McDowell, and in this series I am going to tell you something about the orchestral composers from time to time.

If you have any operatic story in mind that you would like to have me tell, or if there is any particular composer about whom you would like to know, just write to me at WRNY, and I will gladly comply with your request.

THE EDISON HOUR

We have had a very interesting month at WRNY. The biggest happening is the acquisition of the New York Edison Hour, with Edison ensemble, unsurpassed by any
(Continued on page 80)

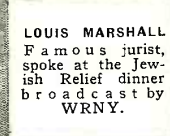

LOUIS MARSHALL
Famous jurist, spoke at the Jewish Relief dinner broadcast by WRNY.



THEODORA IRVINE
Director of the Irvine Players and Irvine School, directs radio drama at WRNY.



GRANT MITCHELL
Star of "One of the Family" and of the Edison Prize Play, is a frequent WRNY visitor.



Capt. George Fried
Of the "President Roosevelt," was an honored guest of WRNY recently.

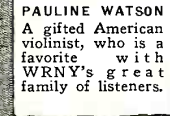

PAULINE WATSON
A gifted American violinist, who is a favorite with WRNY's great family of listeners.



Swami Yogananda
Indian mystic, who began his tour of America with an address over WRNY.

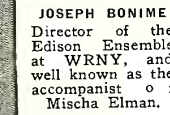

JOSEPH BONIME
Director of the Edison Ensemble at WRNY, and well known as the accompanist of Mischa Elman.



CLIFFORD ODETS
"The Rover Reciter," who gives an entertaining feature on WRNY's regular programs.



The Radio Beginner

By A. P. PECK

HOW many automobile drivers would think of using a car without at least one or more indicating instruments on it, so that they might keep a check upon the operation of the various units? Even the cheapest cars on the market today are equipped with an ammeter; so that the rate at which the storage battery is being charged can be constantly watched, and immediate notice given if anything goes wrong with the generator or its driving system. Furthermore, this ammeter will show up short circuits in the lighting or ignition systems. More elaborately equipped cars have instruments for indicating oil pressure, quantity of oil, amount of gasoline in the tank and motor temperature. In view of the precautions taken to safeguard the

great changes. The following paragraphs will shed some light upon this subject and may help you along in getting the best out of your set.

The measuring instruments used in electrical work are of various types; and the two main ones dealt with in this article are called voltmeters and milliammeters. It must first be understood that electricity is measured in two ways, just as the flow of water in a pipe is measured. First we have the pressure of water, and then we have the quantity flowing through the pipe. So in electricity also we have pressure and quantity. The first of these terms is known as voltage and expressed in volts; the second is known as amperage and expressed in amperes. In radio receiving sets the current or amperage handled is so very small that the unit known as the ampere is far too large for accuracy. Therefore, the unit known as the ampere is divided into one thousand equal parts, known as milliamperes. The instruments known as milliammeters, whose uses are described below, are rather delicately built and designed to be used only where a very small current is present in the circuit. If they are used in a place where the current is comparatively high, they will be damaged and probably burned out.

found far superior to the vane type. The choice of meters will depend upon the amount of money that you desire to spend for the "watch dogs" of your radio set.

FILAMENT VOLTAGE

As mentioned before, every electrical current has two properties to be measured, termed voltage and amperage. In the operation of vacuum tube receiving sets we have either two or three batteries, each of which supplies both voltage and amperage, which are known as the "A," "B," and perhaps "C" batteries. The "A" battery supplies the electricity that lights the filaments of the vacuum tubes and we will consider the meters that are used in connection with this battery first.

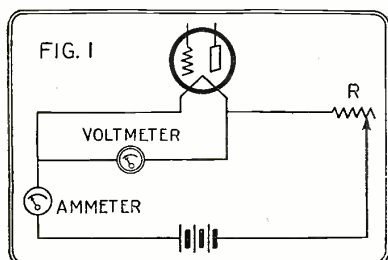

FIG. 1
Meter connections for ascertaining condition of the filament.

various parts of automobiles, is it not surprising to find that the average radio receiving set in use today seldom has any similar indicating instruments? It may seem to the uninitiated user of a radio receiving set that indicating instruments are unnecessary, and that they are mere ornaments which make the set look nice, but do not aid in its operation in any way whatsoever. This is as far from the truth as it is possible to be. The judicious placement of indicating instruments in a radio receiving set, and the knowledge of their use, will often not only enable you to operate your set far more economically but assist you in getting the very best of results from the particular instruments that are used and without any

TYPES OF METERS

Voltmeters and milliammeters, such as are used on the low voltages and currents employed in radio receiving sets, are in general made in two different forms, the moving vane and the moving coil types. The moving vane type is the cheaper to make and is to be found in the various small battery-measuring voltmeters sold for prices ranging from 50c to \$3.00. Such an instrument is not particularly accurate; but for voltage measurement, and for checking the condition of storage and dry "A" and "B" batteries, will be found accurate enough. The second type of instrument, employing a moving coil, operates upon a somewhat different principle, and can be made highly accurate. The more expensive small measuring instruments, and the so-called laboratory types, are made in various degrees of precision; but in any event, a moving-coil type of meter will be

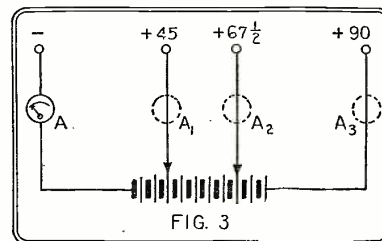
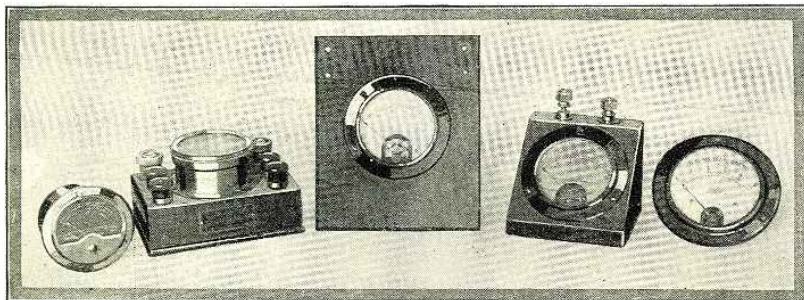

FIG. 3
Ammeter connections for use in the "B" battery or plate circuit.

Both the voltage (or pressure) and amperage (or quantity of current per unit of time), as applied to the filaments, can be easily measured and regulated. The manufacturers of various types of radio-receiving vacuum tubes state that it is far more desirable to operate a vacuum tube filament at a constant voltage than at a constant current. To measure the voltage applied to the filament of a vacuum tube, a voltmeter is connected in the circuit as shown in Fig. 1. Note that the voltmeter is connected directly across the socket terminals and not across the battery terminals. This is done so that the resistance of the rheostat R will be in the outside circuit; for if the voltmeter were to be connected directly across the battery, it would measure only the battery voltage, and not the actual voltage applied to the filament of the tube. Fig. 1 also shows the connections of an ammeter. This is placed in series with the filament circuit; but its use is not necessary as it is of little value to the receiving set operator. It is shown merely in order to make this explanation of the filament circuit complete.

You are undoubtedly wondering at this time just what is the value of the reading of the voltmeter. It is great and the rheostat R should always be adjusted so that the voltmeter will show the exact number of volts called for by the manufacturer of the particular type of vacuum tube that you are employing. For instance, the ordinary type of UX-201A tube is designed to be operated at 5 volts across the filament terminals. Therefore, if you are using these tubes,



Several high-precision meters, suitable for the demands of laboratory work, are shown above. Photos courtesy of Cellokay Mfg. Corp., Hoyt Elec. Inst. Works, Weston Elec. Inst. Corp., Roller-Smith Co.

adjust the rheostat R until the needle of the voltmeter V indicates exactly 5 volts; and you will know that you are operating your filament in exactly the correct way.

A very slight increase in the voltage applied to the filament will result in an enormous decrease in the life of the vacuum tube. It can easily be seen, therefore, that the use of a voltmeter for checking the filament voltage will quickly pay for the cost of that instrument in the lengthening of tube life. This method of checking the voltage applied to the filament of the tube, rather than the amperage in the same circuit, is known as the constant-voltage method of control; whereas that by which the filament circuit is regulated according to the current drawn is known as the constant-current method. The latter-mentioned method may be disregarded in connection with radio receiving sets.

Though Fig. 1 deals with the measurement of the voltage applied to the filament of only one tube, it is often found desirable to measure the various voltages applied to different tubes in a set. If, for instance, a five-tube set is employed in which one rheostat controls all five tubes, the voltmeter connection will be the same as that shown in Fig. 1. If, however, separate rheostats are used for the various tubes or combinations of tubes, some different method must be employed; and probably the simplest is the use

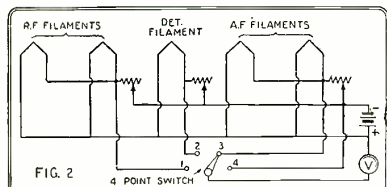

When more than one rheostat is used for tubes, voltmeter connections should be made as shown above.

of a switch on the order of that shown in Fig. 2. Here the filament circuit of a standard five-tube receiver is shown, wherein the two R.F. filaments are controlled by one rheostat, the detector by another and the A.F. filaments by a third. Therefore, we can hook up a switch as shown, connect the switch arm to the voltmeter and the voltmeter to the "A" battery. By placing the switch blade on point 1, the voltage applied to the R.F. filaments is measured. By moving the blade to point 2, the detector filament voltage is indicated. Point 3 enables the operator to measure the filament voltage of the A.F. tubes, and by switching to point 4, the exact voltage of the "A" battery will be measured. In this way it is possible to

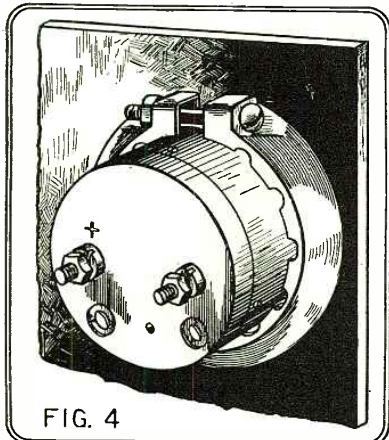
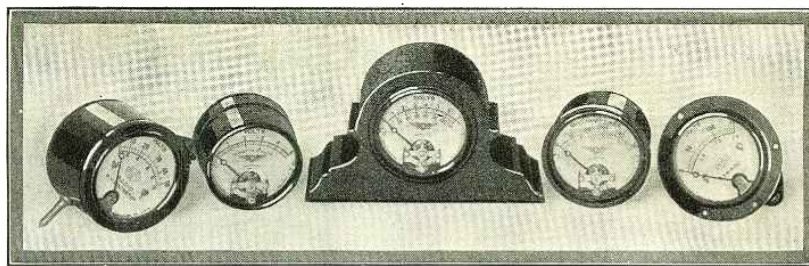

FIG. 4

By using a clamp around the back of this meter, only the one large hole is needed in the panel.



The meter at the left is for battery testing and the one in the middle is for placing atop a receiver. The others are for panel mounting.
—Photos Courtesy of Jewell Elec. Inst. Co. and Roller-Smith Co.

regulate the filaments of all of the tubes to exactly the required terminal voltage; and also to measure the "A" battery voltage and thus determine its condition. For further data on this subject see the article entitled, "All About 'A' Batteries and Chargers," in this department in the April, 1926, issue of RADIO NEWS.

DOUBLE-RANGE METERS

One of the handiest combinations ever placed on the market for the use of the radio fan is the double-range voltmeter, reading from 0 to 10 and 0 to 50 on two different scales, or similar instruments with higher reading scales. For instance, some of the instruments shown in connection with this article have double scales, reading from 0 to 7½ volts and 0 to 150. The purpose of the higher-reading scale is to measure the entire over-all voltage of a "B" battery. Such instruments as these are equipped with three terminals, one of which is common to both circuits, the "-" terminal. This is employed whenever the meter is being used for testing "A" or "B" batteries and is connected to the negative side of the battery under test. The other connection to the meter is determined by the battery to be tested. If the battery is of high voltage, "B," the high-voltage positive terminal is employed. If a low-voltage battery, such as an "A" or "C" battery, is to be tested, the low-voltage positive terminal is used. Some of these double-range voltmeters as illustrated here, are equipped with small switches that are integral parts of the instrument itself. By using this switch and making permanent connections to the batteries as described in the circulars supplied by the manufacturers of the meters, the voltages of any battery in the set can be quickly and easily read on merely turning the switch. This applies particularly to "A" and "B" batteries; though at least one instrument is made with which the voltage of the "C" battery can also be read. This instrument is also shown.

The main use of one of these double-range instruments is to measure the exact conditions of the various batteries employed. For instance, on checking up on the "B" batteries, if you find that they have dropped to a point 30 per cent. below their voltage when new, it is time to discard those batteries and install new ones. Also the storage "A" battery needs charging when it drops to a terminal voltage of 5.5 volts. A 4½-volt "C" battery which has deteriorated to 3 volts must be replaced. A like ratio holds for higher or lower voltage "C" batteries. With one of the double-range voltmeters on hand, all three of the batteries employed in a set can be quickly checked over periodically and thus replaced when they are nearly dead. By doing this, the resulting annoyance of having to give up the use of your radio receiving set for a day or so while buying new batteries to replace discharged ones will be avoided.

MILLIAMMETERS

While the most practical method available to the average radio fan for checking the

condition of radio batteries is the voltage test described above, yet the use of a milliammeter in the "B" battery circuit is often of great advantage in other ways. A milliammeter is an instrument which measures thousandths of an ampere and, therefore, must be made rather delicate in construction and accurate in operation. It must never be connected directly across any source of current, for to do so will undoubtedly result in its ruin. It is always connected in series as in Fig. 3. Always be careful in employing a milliammeter in any circuit, for it is such a delicate instrument that it is very easily burned out. This is particularly true of the

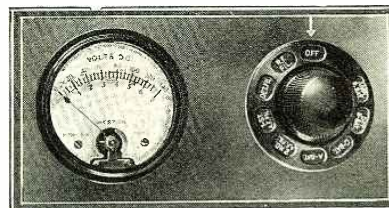

The rotary switch on the right designates the circuit whose voltage is indicated on the meter. Photo courtesy Weston Elec. Instrument Corp.

low-range meters employed in radio receiving sets.

For the user of small sets employing not more than three tubes, a 0-to-25-milliamperere meter will be found quite satisfactory. For four- and five-tube sets, an 0-to-50-milliamperere instrument is to be preferred; and one having a scale reading of 0-to-100-milliampereres will be the type for use by the super-heterodyne fan. The radio enthusiast who does a lot of experimental work with different types of sets will find a 0-to-100-milliamperere unit quite satisfactory, providing it is equipped with a fairly large scale and accurate divisions. By taking this precaution, you will have an instrument that will read quite accurately on a current of only 5 or 6 milliamperes. Thus this instrument will be of value on practically all types of sets from those employing three tubes up to 8- and 10-tube super-heterodynes.

A milliammeter, used in the plate circuit of a vacuum-tube receiver, indicates the amount of "B" battery current flowing in the circuit at any given instant. If the meter is connected in the negative lead to the "B" battery as shown at A in Fig. 3, its reading will denote the amount of current flowing through the entire "B" battery circuit and will indicate the total drain upon the "B" battery. If, however, the instrument is connected as shown at A 1 in Fig. 3, it will indicate only the amount of current being consumed by the tube or tubes connected to the + 45-volt tap. At A 2 the meter will indicate the current consumed by those tubes being supplied with 67½ volts, and at A 3, that part of the circuit connected to the + 90-volt terminal of the "B" battery. Thus it is possible to check the current consumption of all of the tubes. By reference to the charts provided by the

(Continued on page 85)

All About Aerials

An aerial is more than a mere stretch of wire to be erected and immediately forgotten. It requires as much consideration as the receiver to which it is attached. We are sure you will benefit by the pointers given in this article.

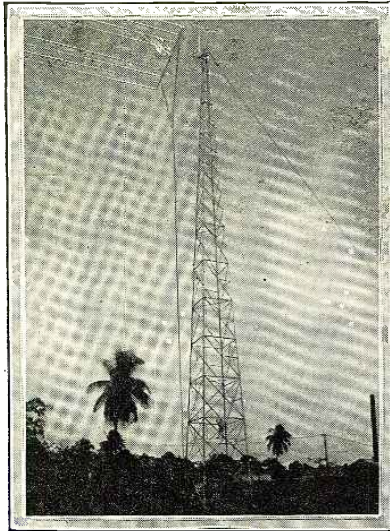

A typical steel construction radio tower. All members are galvanized to protect them from deterioration through climatic influences. Photo courtesy of Milliken Brothers Mfg. Co.

THE best season of the year in which to replace or overhaul the antenna, is the present summer time. Still, many of us would rather let the task go undone, due to sheer inertia. And so, it is not until after the aerial comes down on someone's head—generally the neighbor's—that attention is finally directed toward the necessity of repairs.

The summer time is also most auspicious

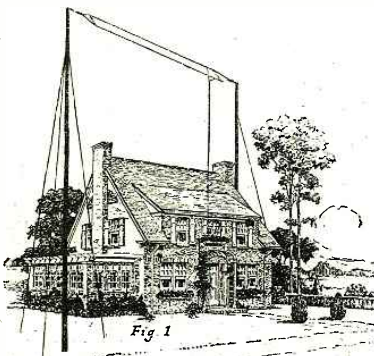

The inverted L type antenna suspended between two steel masts.

for erecting a substantial antenna for the coming winter season, when the cold and snow will prevent such work from being properly done. This article has for its purpose the simplest explanation of antenna construction and maintenance; and as the subject has been covered in a most thorough manner, the attention of the reader is invited to a careful scrutiny of the common faults and troubles.

FIRST CONSIDERATIONS

The erection of an antenna is controlled by the available space and environment. Thus, a big back yard offers a fine location, provided there are no large metallic structures in the immediate vicinity. In a crowded location, such as an apartment house district, where one encounters numerous difficulties in the presence of other antennae, and finds no obvious support for the contemplated one, the best judgment must be exercised.

The purpose of the antenna is to collect the radio-frequency energy that is sent out from the broadcast stations. The amount of this energy, when it reaches the antenna is very small; in fact, so small that it cannot be measured except by the most sensitive devices. If the length of the antenna is decreased, still less energy is picked up, if it is increased, the tuning of the receiver becomes noticeably broader. Hence, a happy medium must be arrived at; and for good all around results, a single wire (solid, stranded, braided, ribbon or tape) measuring 60 feet in the horizontal portion, 40 feet for the lead-in, and 20 feet for the ground connection will serve the purpose.

The first question is concerned with the kind and size of wire that one should use.

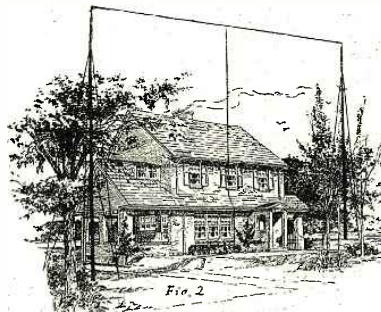

A single wire T-type antenna. Note that the lead-in is taken from the exact center.

This depends for the most part on one's own preference, though in certain instances one form will prove more satisfactory than another. Such cases will be covered later. For the present, it is enough to remember that all types are practically equal so far as electrical efficiency is concerned.

ANTENNAE

However, there is a decided difference in their mechanical strength, as the table below will point out:

Size of Wire	Tensile Strength	Resistance in ohms per 100 ft. at 68° F.
7/24 Stranded Copper	85 lbs.	0.4 ohms
7/22 Stranded Copper	132 lbs.	0.23 ohms
14 Solid Copper	124 lbs.	0.25 ohms
12 Solid Copper	197 lbs.	0.16 ohms

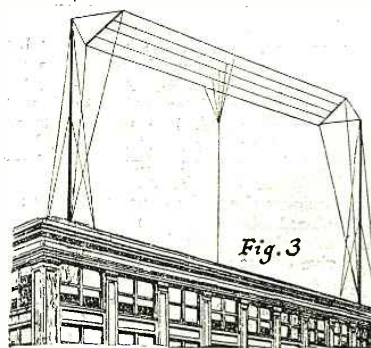

A multi-wire T-type antenna supported by two steel masts of simple construction. Illustrations (Figs. 1 to 5) courtesy of S. W. Hull & Co.

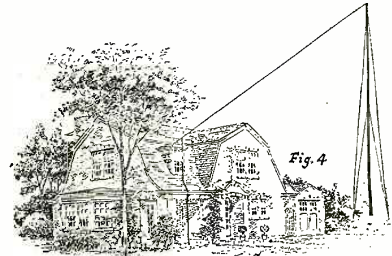

A straight-line antenna supported by a single mast. The lead-in is actually a continuation of the aerial wire.

These figures are practically the same, whether the wire be bare, tinned or enameled. See illustration showing the various kinds and sizes of commercial antenna wire.

NECESSARY MATERIAL

It is essential that the builder assemble before commencing work all the material he needs for the construction of the antenna so that he will not have to stop in the middle and run to the store to get something more. Here is a complete list of the parts:

1 roll of antenna wire one or two hundred feet long;

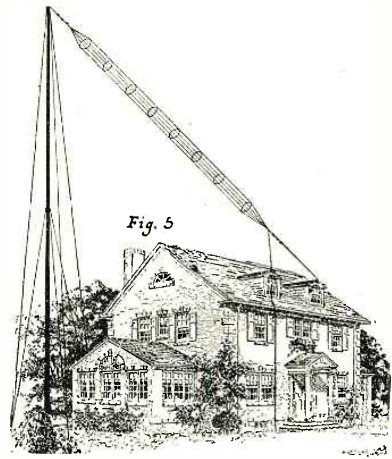

A cage antenna composed of a number of wires attached to a series of metal rings. The lead-in is taken from the low end.

1 roll of lead-in wire, 75 feet (either No. 14 rubber covered, or the same wire as the antenna);

2 insulators (glazed porcelain, glass, or pyrex);

2 or 3 knobs (porcelain stand-off insulators);

1 lightning arrester, (outdoor or indoor);

1 lead-in strip;

2 ground clamps;

1 roll of wire for lightning and radio set ground connections, 50 feet No. 14 rubber covered;

1 roll of bell wire, for connection from lead-in strip to receiver;

1 small box of insulated staples;

1 roll of friction tape;

16-penny nails;

Solder and solder paste;

1 roll of galvanized guy wire, 50 feet;

(Refer to illustration showing complete antenna equipment.)

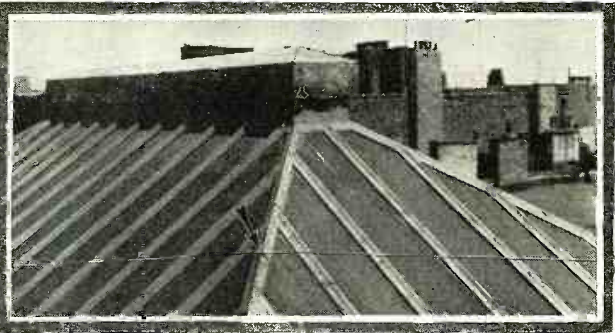
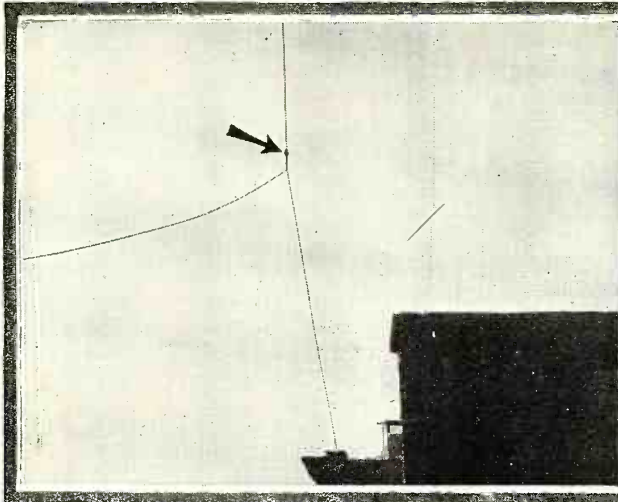

Above: As an aerial this is a good ground. It will be noted that the wire touches the metal framework of the skylight. In consequence very little current reaches the set.
 Left: This man's aerial was too long so he shortened it by inserting an insulator as indicated by the arrow. Good, but the lead-in should have been taken off at the insulator eye, to relieve the strain on the wire.

EFFICIENT ANTENNA INSTALLATION

A highly efficient antenna is erected with the following details in mind:

- (1) Over-all length not over 125 feet;
- (2) No close approach to trees or buildings;
- (3) Horizontal part as high as possible;
- (4) Lead-in away from building;
- (5) Absence of joints (where possible);
- (6) As few insulators as possible;
- (7) Ground wire to be connected to water pipe;
- (8) Set not far from window where lead-in enters;
- (9) Wire fairly heavy and rigid;
- (10) Clean connections throughout;
- (11) Straight well-secured masts.

The most efficient antenna is of the outside type, which should be placed as high as possible where it will not come in contact with trees and other obstructions.

While the past years have seen many styles of receiving antenna grow in favor, the old-style outside antenna still holds its own. The inverted-L, the T and the single-straight line antenna are the commonest forms.

THE L-TYPE ANTENNA

The inverted-L antenna, gets its name from its shape. (See Fig. 1). It is widely used and with good results, though it has one fault, its directional effect. However, this defect sometimes is turned to advantage. It receives loudest when the end to which the lead-in is connected is pointing towards the transmitting station.

The most satisfactory antenna of the inverted L type employs two horizontal

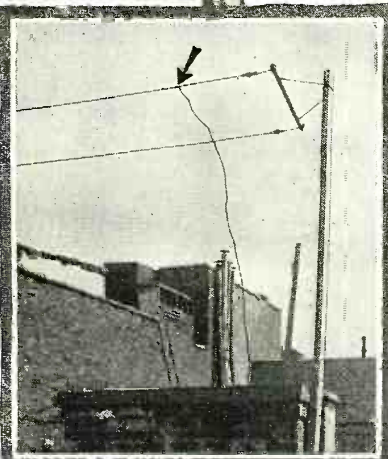

Above: The lead-in should have been taken off from the end of the aerial and the aerial itself guyed with ropes.
 Right: This ribbon aerial is well fastened to the pipe with a piece of rope but is not insulated.

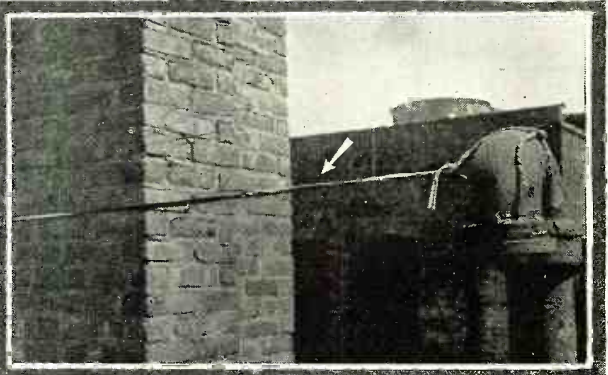

This aerial is well insulated from surrounding objects and is securely fastened. However, the lead-in is merely twisted around the aerial wire instead of being soldered thereto.

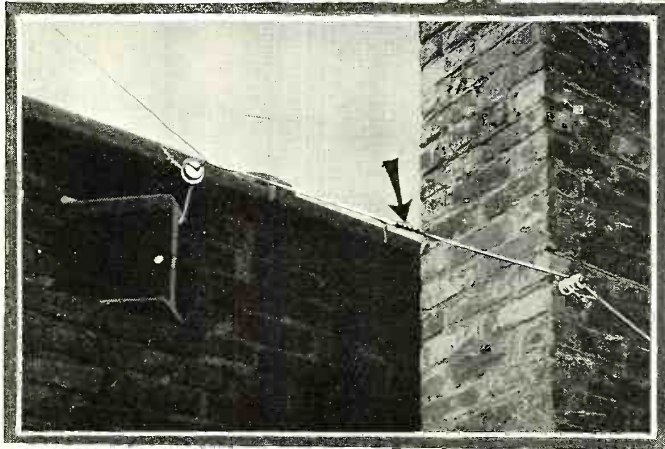

(“aerial”) wires when the space between the insulators does not allow the use of a single wire of fifty feet or more. When two wires are used, they should be spaced three feet apart. Two light pieces of wood may be used for spreaders.

Such an aerial should be at least thirty-five feet above the ground, and is better if it is fifty or sixty feet high. The lead-in should be taken from the end nearest the receiving set.

THE T-TYPE ANTENNA

The T antenna, as the name implies, is T-shaped (see Fig. 2). It is free from the directional properties of the inverted L type. It receives from any direction with equal ease.

A single wire T-type antenna should be a hundred feet long. If conditions prevent putting up a single-wire antenna of this length, then a multi-wire construction is used. (See Fig. 3.) Four or more wires should be

placed at least two feet apart. The lead-in should be taken from the exact middle of the antenna.

The lead-in should always have the same area or cross-section as the horizontal wire, to avoid cutting down the conductivity of the antenna. Generally the multi-wire type is used on apartment houses or other buildings. In such cases it is best to place it above any other antennas there may be on the roof.

THE STRAIGHT-LINE ANTENNA

The straight-line antenna (see Fig. 4) has but a short lead-in, coming as it does almost direct to the set. Generally one end is higher than the other and is placed above the roof and treetop interference. This arrangement is favored by many, as it is simple and efficient. The aerial and the lead-in are one piece of wire as a rule, which therefore obviates any resistance that a joint might cause. Also but one aerial mast is required.

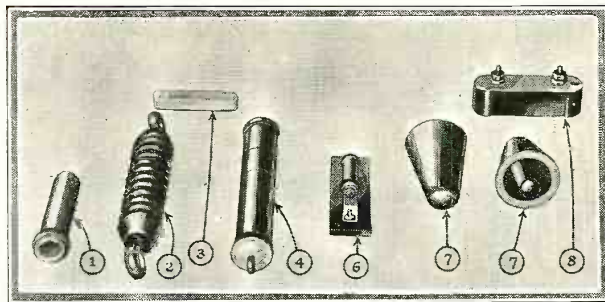
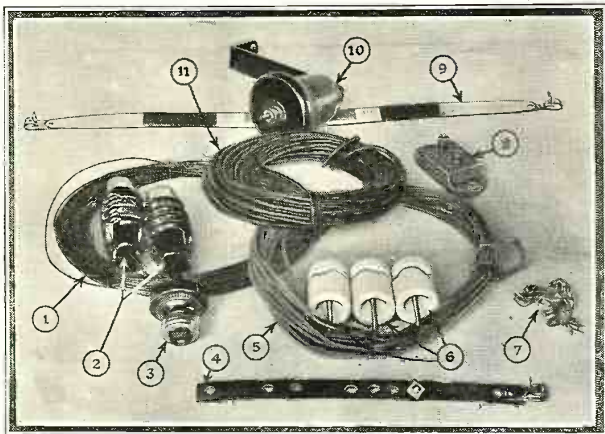

Left: A complete aerial kit. The parts are: 1, aerial wire; 2, aerial insulators; 3, auxiliary aerial; 4, ground clamp; 5, supporting cable; 6, wall insulators; 7, staples; 8, lightning arrester; 9, lead-in strip; 10, lightning arrester (different type); 11, insulated ground wire.
 Above: A group of accessories. They are: 1, lead-in insulator; 2, aerial insulator; 3, wall insulator; 4, strain-relieving device; 5, lightning arrester; 7, aerial insulator; 8, lightning arrester.
 Illustrations courtesy of Electrad Co., Electro Insulator Co., Cleartone Radio Co., Globe Phone Mfg. Co. and L. S. Brach Mfg. Co.

Such an antenna should be about a hundred feet long.

THE CAGE ANTENNA

The cage antenna (see Fig. 5) is built like a cage. Generally six wires are used and are spaced on rings about twelve inches in diameter. The advantage of the cage is its

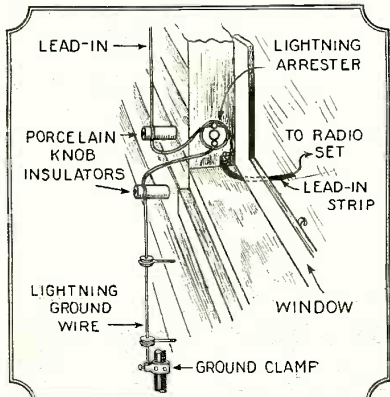

Details of an aerial and lightning-ground installation on the side of a house.

low resistance. It can be made into a T-type or L-type or a straight-line antenna as desired.

Generally it is about seventy-five feet long and the wires are continuous, no break being made to attach the lead-in unless the T-type is used. In that case care must be taken to solder the joints, and if possible the lead-in also should be of the cage design.

The cage has come into prominent use during the past year in cases where record distance was desired and every detail needed for efficiency was carried out. Members of the American Radio Relay League have long known the advantages of the cage antenna for both transmitting and receiving. Some of the best records have been made with this type.

METHOD OF PROCEDURE

Having chosen the site of the antenna and having been assured that it will be clear

of all metallic surroundings as well as trees, the supports are fastened rigidly and guyed tightly. The aerial, or horizontal portion of the antenna, is then strung between two insulators which are fastened to the supports. The lead-in may be a continuation of the same wire; or else soldered to the aerial. One is as good as the other, but emphasis is placed on properly soldering and taping the joint. The lead-in should be taken off at the insulator; and not a foot or two away, as shown in one of the illustrations. This is

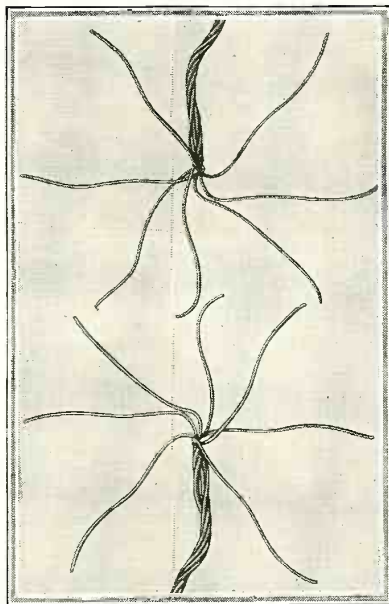

The manner in which stranded wire should be separated to make a connecting joint.
 Illustration courtesy of Acme Wire Co.

for the reason that greater strength is given to the installation when the lead-in is anchored to the eye of the insulator itself. If this procedure is not followed the constant swaying of antenna may break off lead-in.

In bringing the lead-in down to the window, care must be taken to see that the proper insulation is used. If the building is of steel structure, it is best to keep the lead-

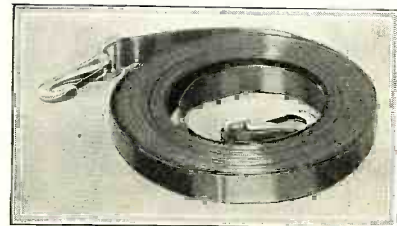

A copper ribbon indoor aerial. The same, enameled, is made for outdoor use.
 Illustration courtesy of Acorn Radio Products Co.

in away from the walls, at least three or four feet. If, on the other hand, the building is of frame structure, ordinary porcelain knobs can satisfactorily be used.

(Text continued on page 28)

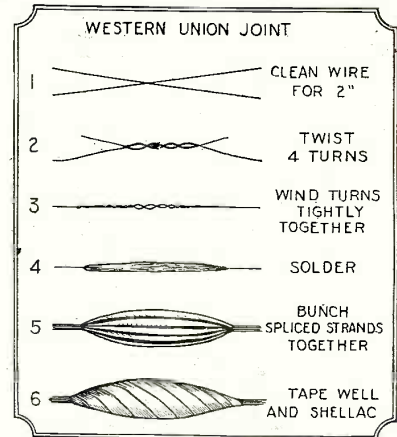

Details in the making of a "Western Union joint." If it is possible, make all your connections this way.

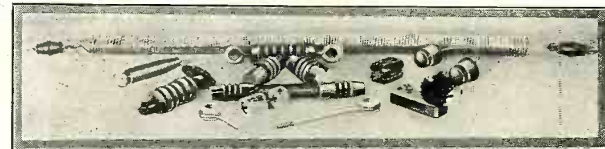
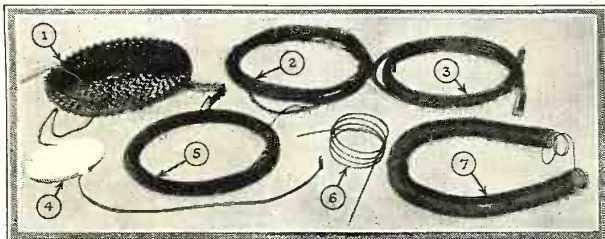

Left: Aerial and ground wire. They are: 1, stamped copper ribbon; 2, stranded copper; 3, lightning ground wire; 4, copper ribbon; 5, enameled-stranded; 6, heavy-duty copper ground wire; 7, indoor spring aerial. Above: a complete spring aerial and a group of insulators for use in conjunction with outdoor aerials.
 Illustrations courtesy Parker-Acolus Corp., Radear Mfg. Co., Acme Wire Co.

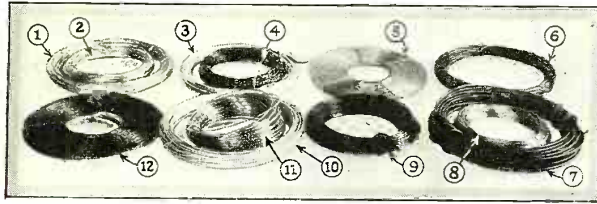

An assortment of aerial wire. 1, stranded; 2, braided; 3, solid; 4, enamel-covered stranded; 5, braided tape; 6, enamel-covered solid; 7, heavy insulated ground wire; 8, guy wire; 9, flexible enamel-covered; 10, stranded tinned copper; 11, enameled-stranded and 12, enameled braided tape.



Right: A glazed porcelain aerial insulator. Illustrations courtesy of R. Thomas & Sons Co.

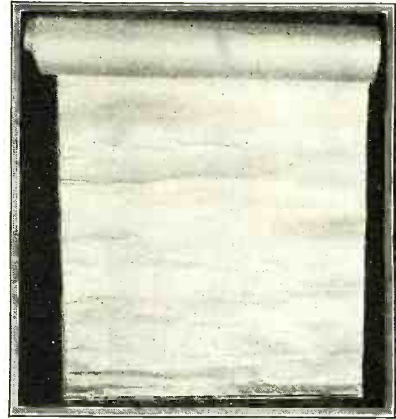

Here is a complete aerial made into a window shade, a very convenient form for homes where there is no space for a regular installation. Illustration courtesy of Fishwick Radio Co.

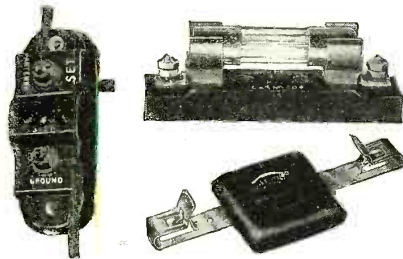

Three typical lightning arresters. Illustrations courtesy of Heinemann Electric Co., Barkelew Electric Mfg. Co. and Micamoid Radio Corp.

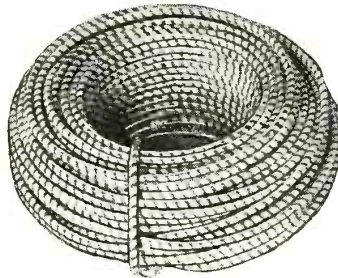

A new type of aerial wire similar in appearance to electric conduit. It is hollow and flexible and has a large surface.

Illustration courtesy of Belden Mfg. Co.

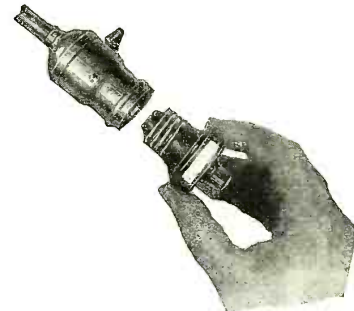

A lamp-socket antenna. No wires are necessary. The device, which can be plugged into any lamp socket, enables the use of the electric light wires as the aerial.

Illustration courtesy of Electrad Co.

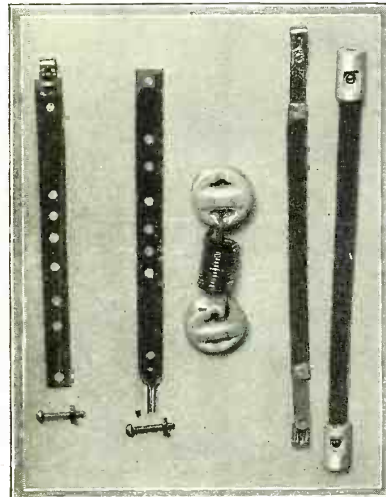

To the left are shown two simple ground clamps, one of which is made to take a soldered connection. The device shown in the center will take up any strain placed upon an aerial, if attached between the wire and the supporting cable. On the right are shown two lead-in strips which, being flat, will fit underneath the window frame.

Illustration courtesy of Permenco Mfg. Co.

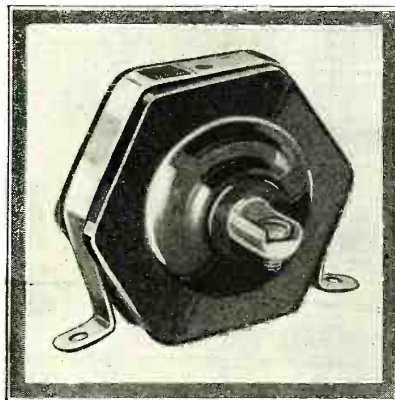

Another form of lightning arrester, which can be mounted directly on the sill or frame of a window.

Illustration courtesy of Electric Service Supplies Co.

ANNOUNCEMENT IN JULY, 1926 ISSUE:

"STATION X," by G. McLeod Winsor. A wonderful radio serial, describing in vivid language a titanic struggle between Lunarians and Martians.

"THE EGGS FROM LAKE TANGAN-YIKA," by Curt Siodmak. A new German story which we consider the best scientific short story for 1926.

"THE MOON METAL," by Professor Garrett P. Serviss. One of the greatest scientific stories ever written.

"DR. OX'S EXPERIMENT," by Jules Verne. A little-known but amazing scientific story.

"THE MAGNETIC STORM," by Hugo Gernsback. The inner secret of how the Great World War was really won by Tesla currents—if you can believe this unusual story.

"THE SCIENTIFIC ADVENTURES OF MR. FOSDICK," by Jacque Morgan.

"THE SPHINX," by Edgar Allan Poe. A little-known story by the great writer.

"SOLANDER'S RADIO TOMB," by Ellis Parker Butler, one of the best yarns from the pen of the great humorist.

Another powerful story by H. G. Wells, "DR. HACKNSAW'S SECRETS," by Clement Pezandic.

PRICE 25c PER COPY AT ALL NEWSSTANDS



A complete aerial kit, including all the necessary equipment for the installation of an antenna system. Illustration courtesy of Heinemann Electric Co.



A very simple form of lightning arrester that can be attached to the sill or frame of a window. Illustration courtesy of Jewell Electrical Instrument Co.

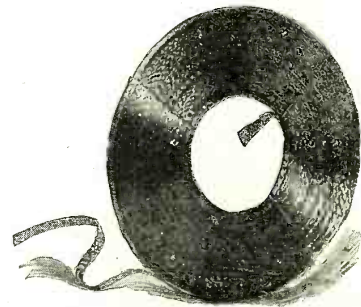

A roll of copper web-braided-ribbon aerial wire. The ribbon, which is 3/8-inch wide and composed of 25 strands of fine copper wire, is very flexible and has a large surface. It may be used for either an indoor or an outdoor aerial. Illustration courtesy of Ross Antenna Co.

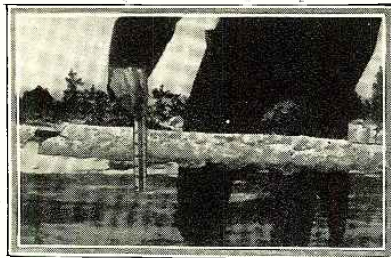

An aerial wire with a four-inch coating of ice. The aerial, having been well installed, and equipped with a safety device, was able to withstand the strain.

Illustration courtesy of Milliken Brothers Mfg. Co., Inc.

THE LIGHTNING ARRESTER

The lead-in is connected first to the lightning arrester, which is mounted on the side of the window sill, out of the rain and snow. The heavy terminals, with which all types of these devices are provided, enable good connections to be made. The other terminal of the arrester is connected directly to the pipe driven into the ground; the latter being at least six inches away from the side of the building and equipped with a weather-proof (non-corroding) ground clamp. If this condition is not obtainable, the No. 14 rubber covered wire which makes this lightning-ground connection should be run as directly as possible to a good ground connection in the cellar—on the water pipe.

The antenna and lightning protection have now been taken care of; and our attention is turned to the interior connections, to the radio receiver. The receiver having been placed in the most desirable place (not too near a window) bell wire of the proper coloring scheme to please the fastidious eye is used to run from its "Antenna" post to the lead-in strip. This is fastened down on the window sill, through which it protrudes to make connection with the "Antenna" post on the lightning arrester. Ordinary carpet tacks or un-insulated staples are to be avoided, since they are responsible for heavy leakage of incoming currents. Use only insulated staples, and fasten the wire to the upper part of the walls, the best place being on top of the moulding.

Returning to the radio set, the ground wire,

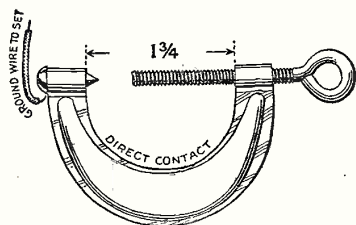

A unique type of ground clamp which, though it has not the surface contact of other types, insures a perfect contact by nature of its pointed stud which will bite through rust or paint.

Illustration courtesy of The Ekko Co.

which is of the same kind as the lightning ground (because it should be well protected against abrasion) is run around the foot-board of the room to the nearest radiator, steam or (preferably) cold water pipe, and

terminated into a ground clamp on the pipe. The same ground which is used by the lightning arrester should not be connected to the radio set, if this can be avoided. In fact, the National Board of Underwriters is highly opposed to this, and cautions against the practice. Although there is little real danger, still the lightning-ground wire should not be brought into the house, but run directly, by itself to a separate outside ground.

The antenna installation is now completed, but it will be necessary to go over the entire antenna to see that everything is right.

THE PROPER WAY

Bare copper wire, solid or braided, will be best for an aerial in a location free from smoke, soot and excessive dust. However, where these troubles are experienced, recourse should be had to enamel or tinned

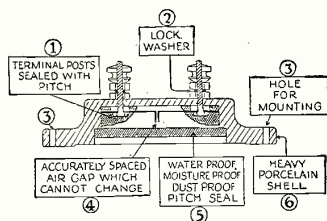

Sectional view of a serviceable lightning arrester, designed for use with any form of aerial. Illustration courtesy of Electrad Co.

wire, the former having the advantage of remaining impervious to the ravages of the elements. Measurements show that the conductivity of copper wire, at radio frequencies is greatly decreased by a deposit of soot, dust or dirt. This is accounted for by the fact that radio-frequency currents travel on the

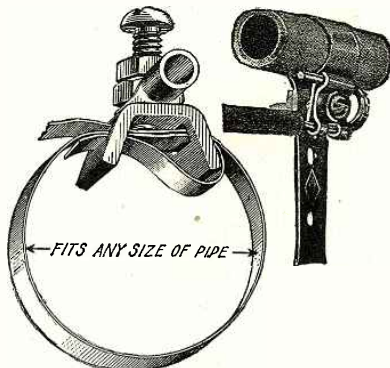

Two types of ground clamps having a large surface contact. Being adjustable, they will fit almost any size of pipe.

Illustration courtesy of Heinemann Electric Co. and Cameron Appliance Co.

surface of conductors and therefore any higher-resistance material on the surface of the wire will affect conductivity. Tinning the wire helps to some extent to keep it from oxidizing too rapidly, but enameling is best.

As for the consideration of solid wire versus stranded or braided, the latter two types offer a little greater mechanical strength and slightly better conductivity for the same equivalent size of wire.

The insulators offer the next objective for attention. There are a great variety to choose from—long, short, skinny, stout,

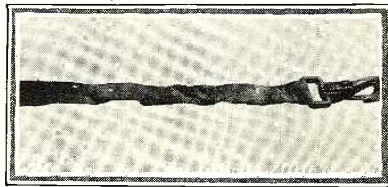

Effects of the atmosphere on a tape aerial designed for indoor use. This was the fault of the person using it, as the same type is made with a protective coating for outdoor use.

strong, weak and colorful. The difference between glazed porcelain and glass or pyrex is hardly worth mentioning. A well-designed insulator, if not well made, is as bad as none at all; so it is important when buying them to see that they are free from detrimental cracks and chips. A short one, if well made, is as good for receiving purposes as a much larger one. Size is not as important as quality of insulation. Size, however, is to be considered only from the standpoint of mechanical strength. The larger insulators are generally made stronger in proportion.

If a 200-foot roll of antenna wire is used, the lead-in can be part of this wire, it being



One year's accumulation of dirt and oxide on an aerial insulator. Note the contrast between section A and section B which has been cleaned.

necessary only to loop the wire through the insulator and continue on down to the lightning arrester. If, however, a separate lead-in wire is used, it will be necessary to solder the two wires together and tape the joint. The lead-in wire should be anchored to the insulator to keep the strain off the horizontal portion of the antenna.

As mentioned before, a lightning arrester

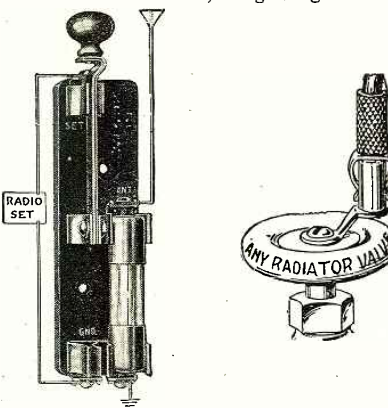

Left: A combination lightning switch and lightning arrester which can be mounted on the frame of a window.

Illustration courtesy of Barkeley Electric Mfg. Co.

Right: A simple ground connection which can be attached to the bolt on a radiator valve knob.

Illustration courtesy of Rajah Auto Supply Co.

of an approved type is well worth the small expenditure. It must be mounted where it will be out of the rain.

(Continued on page 83)

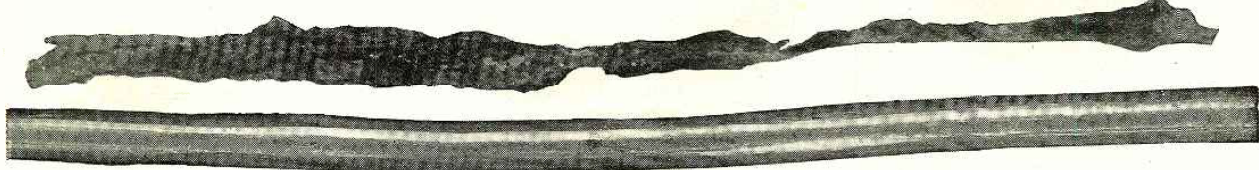

A photograph of two sections of solid aerial wire subjected to extreme climatic conditions. It is clear that the upper wire had no protective coating. One should not expect such damage under normal conditions; but it goes to show what corrosion the atmosphere can effect on metallic objects.

Tubes Within Tubes

By G. C. B. ROWE

It is with great pleasure that RADIO NEWS presents to its readers the new type of vacuum tubes developed by Dr. Siegmund Loewe of Berlin. Circuits in which these tubes are used will be shown in a forthcoming issue

DURING the past year some very remarkable inventions have been given to the radio public for the betterment of both broadcasting and reception. These inventions have come so thick and fast recently that it is nothing out of the ordinary to pick up the morning newspaper and find that someone has perfected a device which will perform something that yesterday was deemed impossible. Yet no matter how many more sensational inventions are developed, there is always an interest in those by which better and cheaper reception of radio broadcasting may be obtained.

Among other great advances in the design of apparatus for radio receiving sets that have been made during the first half of 1926 is the development of two new vacuum tubes by Dr. Siegmund Loewe of Berlin. These tubes will be of interest to the majority of radio fans, who have a thought for the future, for their design throughout is one which has untold possibilities.

It is possible with two of these tubes to have the equivalent of a five-tube receiver; i.e., two stages of resistance-coupled radio-frequency amplification in one tube, and in the other, the detector and two stages of resistance-coupled audio-frequency amplification. In the tube first mentioned there are two sets of filaments, grids and plates, two resistances and a condenser, the latter for coupling the tubes. In the second tube there are two sets of amplifier elements, as in the first; but there is also a third set of elements, which serve as the detector. In the amplifier tube (which the first really is) each set of elements has a second grid for control purposes. These are not needed in the other tube.

In the accompanying illustrations are several views of these two tubes. Some of the

most remarkable components of the apparatus are indicated on the illustrations as resistances. These high resistances are of an entirely new type; as they consist of glass rods, with welded connections, on the surface of which is deposited a fine transparent, almost invisible metallic film, which serves as the resisting element. The whole is enclosed in a glass tube, which is highly evacuated. Thus, the element cannot be affected by atmospheric changes which would tend to alter the resistance. Furthermore the element functions as a pure resistance only, being absolutely non-inductive and free from capacity effects.

IF radio did not improve continuously, we would not have broadcasting today, and we would not be on the road to television.

In this important article is fully described, for the first time in any American magazine, an invention of German origin and of the greatest importance.

You remember the days, away back in 1910 and up to 1920, when it used to be the custom to scatter the radio apparatus all over the table. From our detectors to our loose couplers, including binding posts and wiring, all instruments were loosely spread out, with no thought of a compact single unit, such as our present-day radio sets.

When we look at our present radio receiving sets we are apt to think of them as the last word in perfection. What will the radio set be five years hence? For all we know, it may be incorporated in a single tube, similar to the new Loewe tubes shown here for the first time. These new tubes mark another milestone in radio, because they have incorporated in them practically a complete radio set, except the variable condenser and inductance. Everything else is within the tube, where it is out of harm's reach, and where moisture and air can not get at the sensitive parts.

Not only that, but the tube actually contains three vacuum tubes, all under one glass housing.

Great things are predicted for a complete unit of this kind, and only time will tell how much further this innovation will lead us into radio advancement. —EDITOR.

ELIMINATING UNDESIRABLE CAPACITIES

One of the greatest drawbacks to the proper functioning of many radio receivers is that the leads, connecting the various instruments in the sets, have certain capacity effects, which are difficult to eliminate. However, in the tubes of Dr. Loewe, the length of the leads is reduced to a minimum; inasmuch as tube elements, resistances and condensers are all contained in one glass shell. It goes almost without saying that this is a tremendous advantage.

A problem that must be overcome by vacuum tube manufacturers is the evacuation of the tubes; and this is rendered more difficult by the gases that remain in the different

The Loewe vacuum tubes are six inches from prongs to tip of the glass shell, which is one-and-three-quarters inches in diameter. These tubes require a special socket having six connections.

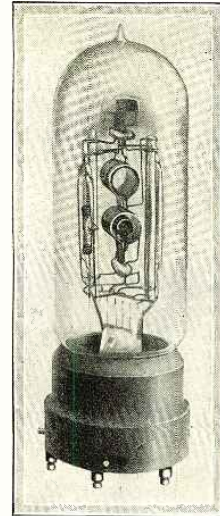

elements after the vacuum pump has done its work. These "residual" gases often interfere seriously with the correct operation of the tube; as the degree of vacuum is gradually lessened during its life. It is a well-known fact that, if a vacuum tube is to function at maximum efficiency, there must be as little interference as possible in the paths of the electrons between the filament to the plate; and any quantity of gas, however minute it may be, will reduce the over-all efficiency of the tube. Therefore, in these multi-element tubes the resistances are enclosed in glass tubes, and the metal parts, such as the tube elements, condensers, and connecting wires, are reduced in size and length as far as is practical.

In the tube which has two stages of resistance-coupled amplification, the condenser is placed between the two sets of tube elements. It is shaped like the plate elements of the tubes (i.e., cylindrical) and its dielectric is mica. However, in the other type of Dr. Loewe's tubes, the condensers separating the stages of amplification are enclosed in glass tubes; to reduce as much as possible the escape of the gases into the glass shell.

It may be seen upon inspection of the

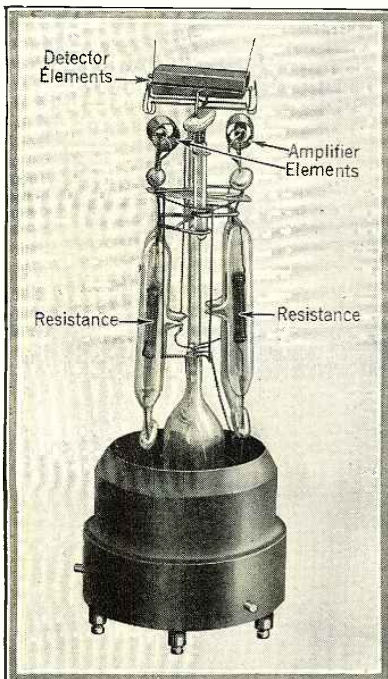

In this tube there is a detector and two stages of A.F. amplification.

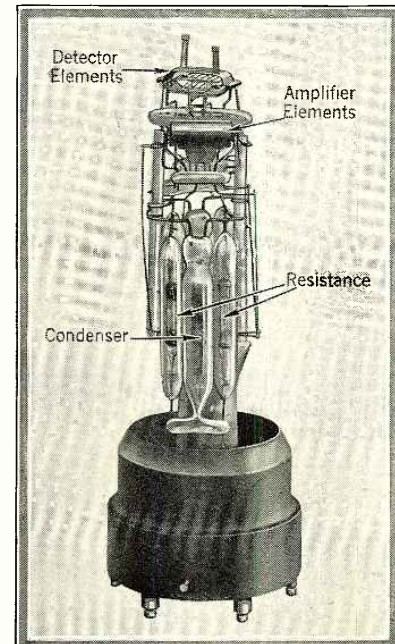

Side view of the tube shown at the left, showing the position of the different parts.

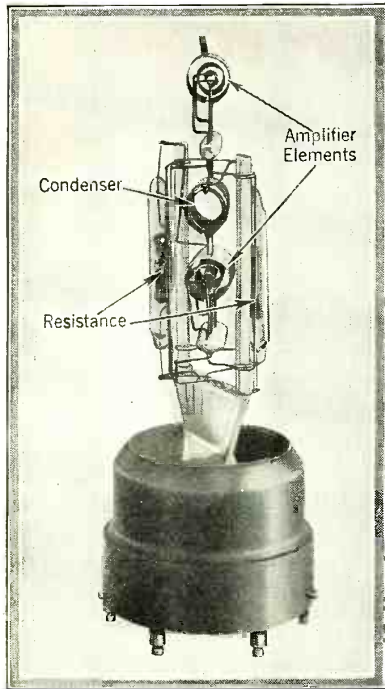

Dr. Loewe's tube containing two stages of resistance-coupled radio-frequency amplification.

illustrations of the tubes, that the one which contains the three tube elements is of construction quite different from the other; although both tubes have six prongs on the base for external connections. It is claimed by the inventor that the former tube, if connected into any tuning circuit, will give distortionless reception at loud speaker strength, and that interference from static is reduced to a minimum. The two sets of

amplifier elements are arranged in approximately the center of the tube, the resistances and condensers being placed vertically below the tube elements. The elements of the detector tube are in a horizontal position at the very top of the tube.

INTERNAL CONSTRUCTION

In the tube which has two stages of resistance-coupled amplification, there is an extra grid element in each of the amplifier elements. This extra element can be seen by closely inspecting the illustration in the upper left corner of this page. In the top "tube" will be found three concentric rings, which show the plate of the tube (the outside circle); the regular grid element, and the control grid, which is the inside circle and therefore the one that is nearest the filament. This second grid stabilizes the two stages of amplification to a remarkable extent, by the introduction of a negative bias of anywhere from 9 to 18 volts. The filament of the tube is a single stretch of wire that is run parallel to the axis of the cylindrical plate and through the middle of the control grid. The two filaments in this amplifier tube are connected in parallel and operate from a battery of 4 volts, which is almost universal practice in European tubes, just as in this country the great majority of our tubes are operated from a 6-volt battery.

The interior of the second type of tubes invented by Dr. Loewe, which are shown at the bottom of the preceding page, is quite different from that of the first type. The two sets of amplifier elements have but one grid each, instead of a control grid, and the construction of the detector elements is unlike the others both in shape and size. The plate element of the detector is more or less rectangular in shape, the grid and filament being suspended horizontally within this rectangle. As in the other tube the three filaments of the tubes are connected in parallel, the necessary potential being 4 volts for their operation.

These tubes of Dr. Loewe will doubtless

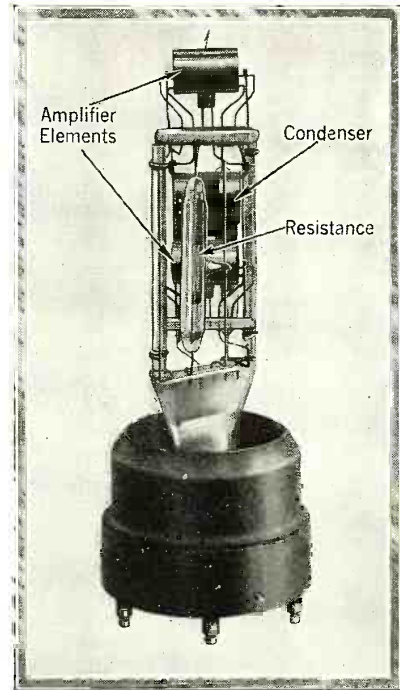

Another view of the vacuum tube shown at the left of this page. The resistances used are of the type shown on page 32.

be forerunners of a new race of vacuum tubes. Of course, even though they operate at a very high efficiency at the present time, yet as more experiments are made there will be refinements and improvements that will make the tubes even more efficient. Certainly the inventor of these tubes is to be congratulated on his achievement in bringing the radio art a step further towards perfection.

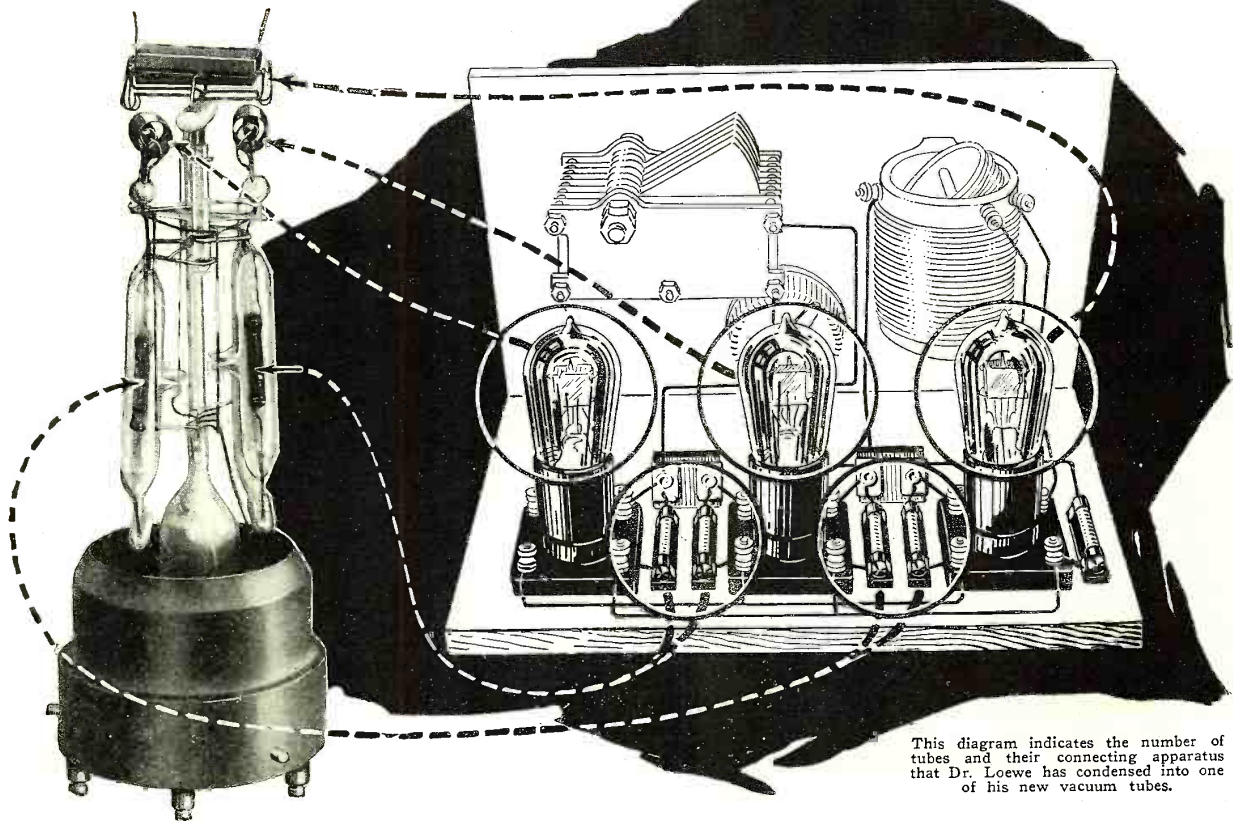

This diagram indicates the number of tubes and their connecting apparatus that Dr. Loewe has condensed into one of his new vacuum tubes.

New Radio Devices of Fixed Precision



In addition to packing the parts of a radio receiving set into two vacuum tubes, Dr. Siegmund Loewe has constructed tiny apparatus which is hermetically sealed, and therefore does not vary, to measure wave-frequencies with an error less than a hundredth of one per cent.



NOT only has Dr. Loewe devoted a great deal of time to the development of his new vacuum tube, but he has turned his attention to other phases of radio as well. In this article are described two more of his inventions that will be instrumental in furthering the science to which he has devoted such a great portion of his life.

A NEW FIXED RESISTANCE

The resistances, mentioned elsewhere in connection with the coupling of the amplifiers, are also made separately. The external tube is of the same size as the grid leaks and resistances, with which the American radio fan is familiar, and so fits the holders, such as are used in this country. The outside glass tubes are evacuated, so that there can be no variation in the resistance value, due to changes in atmospheric conditions as previously mentioned.

These resistances can be used in any place where fixed resistances are required; and, due to their construction, there is little chance that the values will change. These resistances can carry a continuous load of 0.1 watt and will stand a peak load of 0.5 watt.

A TUBE FOR MEASURING WAVE-LENGTHS

In previous issues of RADIO NEWS there have been various articles concerning "piezo-electric" crystals and the nature of their vibrations. For instance, quartz in the form of a rod may be made to vibrate mechanically at a very high frequency under the influence of an alternating electrical field; if this frequency corresponds to one of the elastic natural frequencies of the crystal.

This effect is obtained by placing a specially-formed quartz rod between two condenser plates of an electrically-oscillating circuit. The occurrence of resonance between the electric and elastic oscillations may be found by measuring the current strength in the oscillating circuit; a sudden decrease of the current occurring just before the resonant point is reached. It has been discovered that the elastic oscillation of the quartz crystal, which takes place in the condition of resonance, may be made visible by a luminous effect. This effect is obtained by placing the two condenser plates together, with the quartz crystal between them, in a glass tube and evacuating this to a pressure in the neighborhood of 10 or 15 mm. of mercury. The condenser plates are connected to the

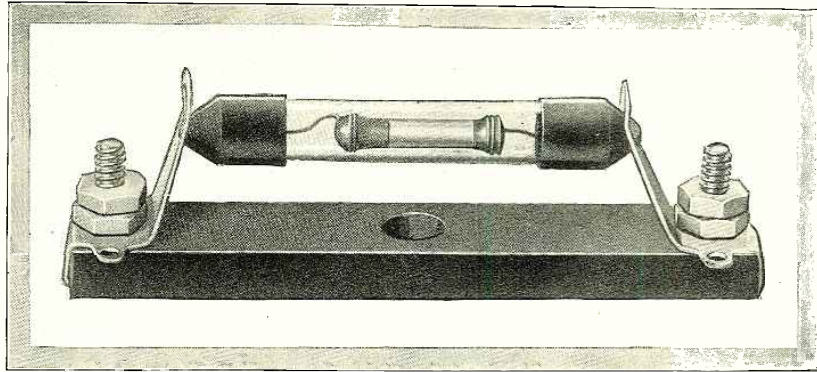

Another of Dr. Loewe's radio developments, a new type of high resistance. The small glass tube suspended in the larger one is covered with a metallic film, which acts as the resistance element.



One of the quartz-crystal tubes for the measurement of the frequency of radio-frequency currents.

external circuit by means of lead-in wires, which are run through the prongs in the base of the tube.

The alternating electrical field of such an oscillating circuit will cause, by reason of the electrical polarization of the quartz rod, alternating deformations in the latter. These, in the condition of resonance, will have the effect of generating the elastic oscillations. The deformations due to these oscillations will give rise to secondary alternating voltages upon the quartz rod, which bring the rarified gas contained in the tube to luminescence.

The resonance is extremely sharp and therefore the luminous effect may be adjusted down to one hundredth of one per cent. (.0001) of the wave-length. By the proper choice of the condenser plates and the degree of vacuum, the discharge is made to occur throughout the discharge space. A quartz resonator of this type affords a very accurate indicator for the measurement of wave-lengths. One of the accompanying illustrations shows a quartz resonator tube, which is filled with a special gaseous mixture, including helium and neon.

Extraordinary accuracy of wave-length measurements can be obtained with this instrument. Although the frequency may be easily calculated from the given wave-length, there will be some uncertainty because of possible errors in computing the exact velocity of light. For this reason these tubes are calibrated so that they will give readings in frequencies instead of wave-lengths, thus making them independent of the velocity of light.

ELECTRICAL MEASUREMENTS

By means of indirect methods, capacities and inductances may be measured very exactly by means of these resonators. Since the calibrated quartz crystal is placed within an evacuated glass tube, the measuring instrument can be regarded as absolutely unvarying, so long as the quartz and the glass tube remain uninjured. Since it has been found practically impossible to detect any influence of the variations in temperature, these "frequency standards" can be regarded as being entirely independent of the temperature.

The resonators will respond, if excited by a potential as low as thirty volts; but only in case the exciting current has a frequency (within 1/100 of 1 per cent.) identical with the resonance frequency of the quartz crystal. On account of the low potential used, the

(Continued on page 91)

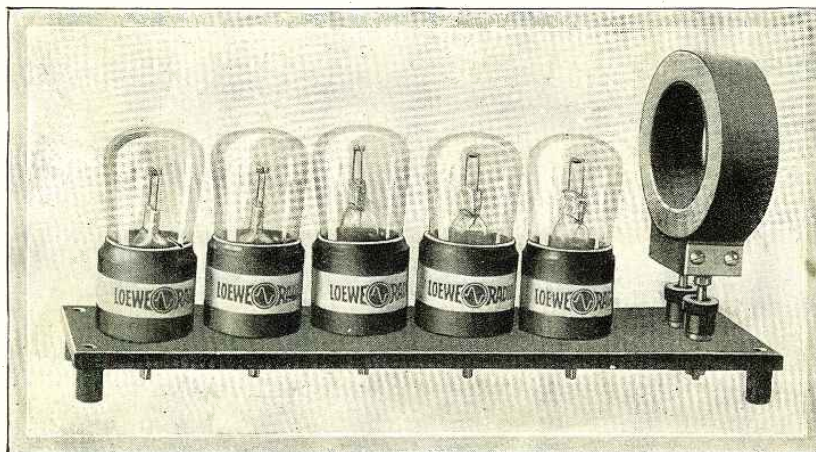

The coil on the right is for coupling the wave-meter to the oscillating circuit to be measured.

Radio Makes Factory Work Congenial

By JOHN J. MORGAN

For a long time factory heads have been looking in every direction for some means to speed up production. By chance radio was tried and, as related in this article, it worked wonderfully well.

THEY were trying out a new 36-inch loud speaker in the laboratory of a big radio apparatus factory one afternoon during the last World's Series, when the president of the company dropped in. The report came over with such tremendous volume that he put his fingers in his ears. "Shut it off—you'll lift the roof of the 'lab!'" he exclaimed. "This isn't the place to try it out. Take it over to the factory and set it up in the press room. Put it in competition with the roar and racket of the stamping machines. That will be a real test."

"And besides," he added, "every girl and

ceased. The efficiency experts who read this are probably saying: "Yes, and all the work stopped, too." Well, there was a good deal of excitement, it's true. And, of course, it distracted attention from the work. It was right in the midst of the busy season. The factory was running two shifts in the effort to catch up with orders. Any let-up by the workers would be costly. The production strategy board shook their heads. "They're crowding us for production," they said worriedly, "and here they are putting on an entertainment. It's a nice how-de-do."

For a while it appeared as if they had reason to be gloomy. The pent-up feelings

of the girls and the men broke out in whoops every now and then, as the favorite team scored. But when the game was over they quieted down. They were satisfied.

Settling down to work once more, they began to speed things up. The effort to exert themselves became contagious. It was a caution the way things moved along. If one worker seemed to lag, her fellows egged her on. The entire room had gained a new tone. A feeling of social pleasure aroused by the radio broadcast had replaced the fatigue and irritation of the early afternoon. The foreman noted the difference, and marvelled.

"Maybe there is something in this radio stuff," he said to himself. "Let's see." So he tuned on a local station and brought in a violin solo. This time there was no distraction. And he observed that parts seemed to be assembled more quickly and with rhythmical transition. The music acted as a restorative.

THEY KNEW WHAT THEY WANTED

When the night shift came on, the day workers eagerly poured out to them their enjoyment of the series broadcast. The night workers wanted radio, too. The night foreman was from Missouri. He was running a factory—not an entertainment. But when the evening programs came on, he tuned in

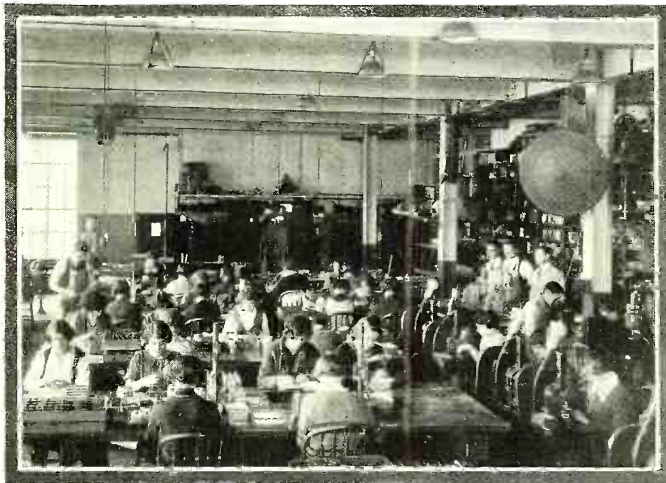

The loud speaker as it was installed in the factory, where it brought happiness to many workers during the working hours.

man in that room is a baseball fan and they'll be eager to get the score. They are all on edge, wondering how the game is going."

So they set the big speaker up, in the midst of the din and clatter of the machines, and tuned in on the series. It worked splendidly. The announcer's picturizations of the exciting contest could be heard clearly and distinctly in every part of the room, over and above the din of the machinery.

DID IT STOP PRODUCTION?
Immediately, all conversation in the room

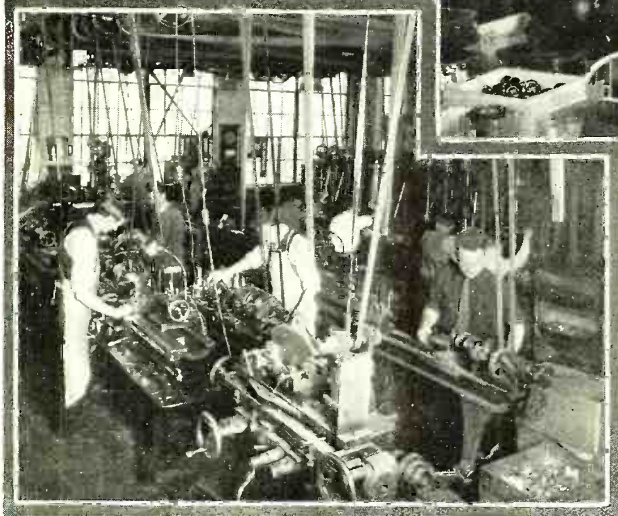
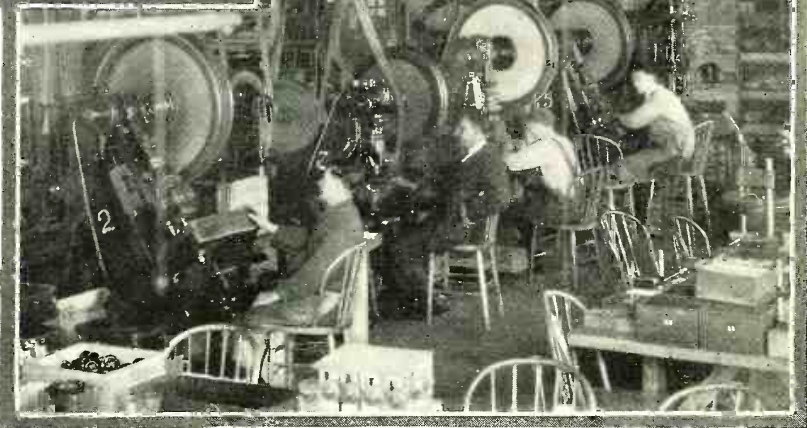

Above and to the left are two views of the factory where radio has played such a prominent role in the production end. Photos by courtesy of National Co., Inc.

to try out the idea. And that night, he broke the record for production. There was no longer a monotony in their tasks for the workers. Increased output was the result.

The next morning the foreman of the assembly floor approached the president: "The folks in my room want to listen on the radio, too," he said. "My girls say it isn't fair for the press room girls to have that all by themselves." And the press room girls upstairs were clamoring for the morning program. Of course they had to set up a loud speaker for the assembly room girls.

When the production statements were put on the president's desk the following day, he was happily surprised to note a very gratifying increase in the number of units produced.

(Continued on page 77)

New Developments in Radio Apparatus

By G. C. B. ROWE



During the first half of the year 1926 there have been vast improvements in the design and workmanship of radio apparatus. The instruments described in the following article are the latest developments in their particular line.



THE past few years have been full of interest for any person who has been sitting on the side lines and watching the remarkable progress in the design of radio receivers and their constituent parts. Do you remember way back when (three or four years ago) you would not look twice at a receiver unless it had at least ten or a dozen dials and knobs scattered over its shining panel? Everything had to be tuned from the antenna coil down to the wire on the filament rheostats; and the tuning in of the evening's entertainment was as much work as you had put in during your eight-hour day at the office.

This complexity was not confined, by any means, to the sets which were offered in the radio shops; for the amateur set builder evidently thought that the manufacturers had the right idea; and so there were many, many controls on the receivers built in the cellars and attics of thousands of American homes.

Yet there was this difference: the man who admittedly knew nothing of radio, and who bought his receiver in a store, or from some kind (?) friend, had much more difficulty in tuning in the stations than did our home constructor. That is easily explained; for after a man has spent hours and hours soldering condensers, coils, sockets and what you will, into a radio set, the chances are good that he will have a much better knowledge of the creature's workings than the man who simply went into a store, threw down his money on the counter, and took home what the dealer offered him.

SIMPLICITY IS AT A PREMIUM

However, due to the rapidly increasing number of people who become radio owners in just this way, and who suppose that there might be a battery for every letter of the alphabet, as well as the first three, the manufacturers have listened to their pleas for simplification; and it will be observed

that the sets which have appeared during the past year have come out with fewer and fewer controls. The trend of the times is surely toward a receiver with but one control for selecting stations, and perhaps one, or two or three adjustments for volume regeneration or antenna.

Not only in manufactured sets is this trend toward simplicity evident, but many of the home-built sets have shed some of their controls in the process of evolution. The manufacturers, realizing that the home constructor also is now anxious to reduce the complexity of operating his set, have been experimenting with various pieces of apparatus, particularly condensers; so that accessories are now available which the constructor may use to build a receiver with as few controls as he may reasonably require.

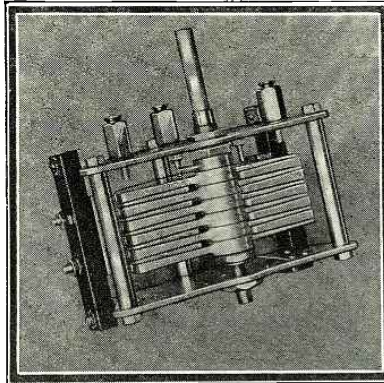

The S.L.F. condenser completely meshed, showing the small separation between the plates.

For example, there is a novel gang or triple condenser shown in the accompanying illustrations. Hitherto, when the movable

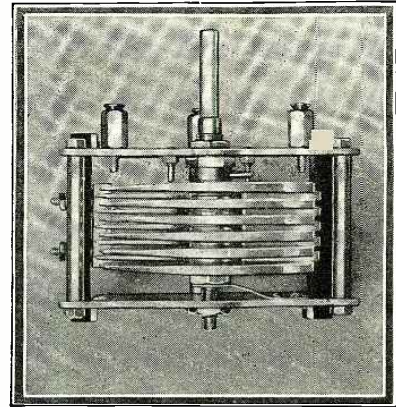

The tapered plates S.L.F. condenser, showing how the plates vary in thickness to give the S. L. F. effect.

Photos by courtesy of Allen D. Cardwell Mfg. Corp.

or rotor plates of more than one condenser were mounted on a single shaft, more or less trouble was always experienced because of the inequalities in the electrical capacities. That is, the plates of one condenser, at certain points, should have been turned to a greater or less degree than those of the others. This necessitated the use of some type of compensating device; either a small variable condenser in the circuit, or some mechanical adjustment of the plates. These devices were not always as efficient as they should be; the mechanical adjustments were subject to wear, and the electrical ones were difficult to adjust.

The condenser illustrated here, however, does away with the need of these compensating features. The three sets of rotor plates may be moved together with one touch of the hand; or they may be varied independently. The three composition disks by which they are turned and which are knurled to give a surer hold, project through a rectangular window in the panel (provided the end plates attached to the stators of the condenser are in contact with the panel) and may be provided with strips of paper for logging the station call-letters or wave-lengths. This is easier than logging dials which are provided only with calibration in degrees.

This instrument may be mounted in three ways; either set of end plates may be attached to the panel, or its base may be fastened to the baseboard, making it unnecessary to drill the panel for mounting.

Each condenser is of a straight-line wave-length type, with a capacity of .00035- μ f. The middle disk rotates upon a hollow shaft, through which it connects with and drives the plates of the condenser which is furthest of those paired. The two outer disks control the plates nearest to them. Condensers of this type will be very useful to set constructors who desire compactly-arranged receivers which can be tuned with an easy operation.

A WEDGED-PLATE CONDENSER

The two illustrations of a second type of variable condenser show a novelty which will interest the fans who have been watch-

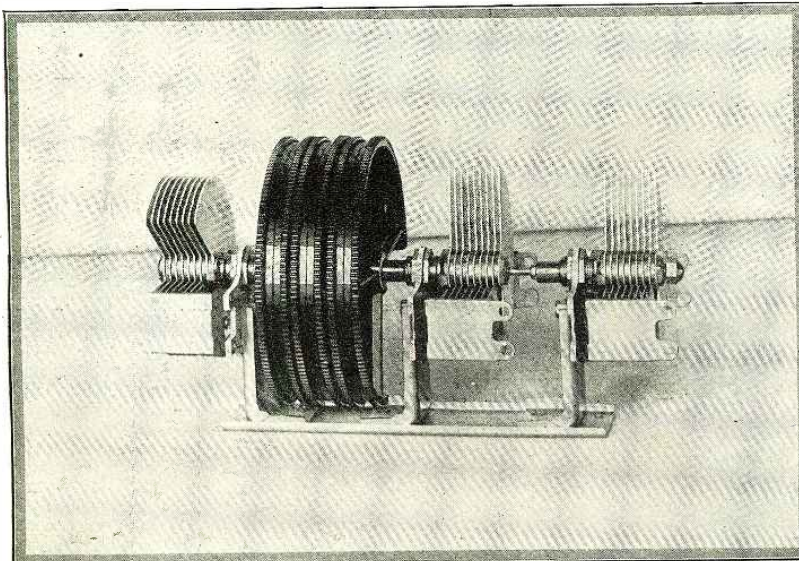

The large discs which operate the straight-line-wave-length condensers project through the front of the panel, making adjustments easy.

Photo by courtesy of Alden Mfg. Co.

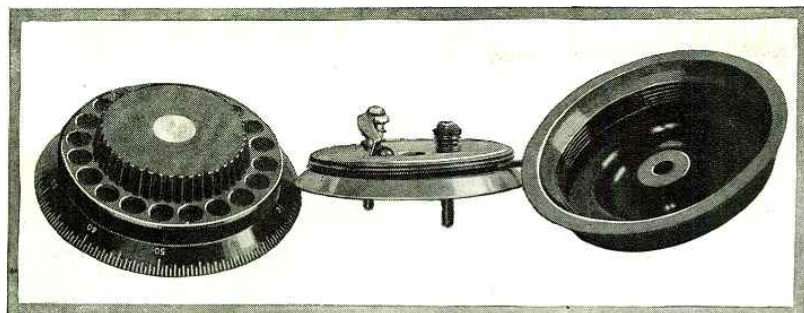

An English combination of variable condenser and dial, which releases for other uses some of the space hitherto taken up behind the panel by instruments.
Photos courtesy of General Radio Co. (London)

ing developments in such apparatus. Before the days of S. L. F. condensers, when we were lucky to find one whose plates did not short in a dozen places, a condenser like this would have been considered a physical impossibility, and the idea embodied in it ridiculous. Instead of cutting the plates of this condenser to the usual S. L. F. shapes, the manufacturer has made them thick and tapering; the rotor plates in one direction and the stator plates in the other. The thick sides mesh very closely together when the capacity is at maximum; and because of the thickness of the cast aluminum, there is very little possibility of varying the small air space between them or shorting the condenser. The shape of the plates is the same as those of the old-fashioned straight-line-capacity condenser; but an S. L. F. variation is obtained by the gradual widening or narrowing of the air space as the tapering plates are rotated. This condenser has the advantage of compactness, as its plates have not a wide sweep and it therefore requires less panel

bushing, maintain an even pressure on the gears, thus preventing any lost motion.

A CONDENSER WITHIN ITS DIAL

A very simple, and at the same time, effective combination is shown in the illustration

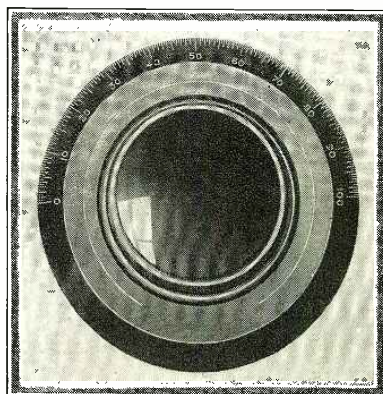

The vernier dial is almost a necessity on the present day receivers and the one shown above is an excellent type.
Photo Courtesy of Karas Electric Co.

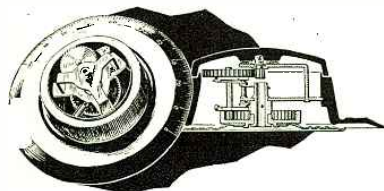

The gears in this vernier dial are cleverly arranged so that there is no chance of any backlash in the dial's movement.

space. This type can be made in any size, its S. L. F. curve is said to be superior to that of many of those which have hitherto appeared, and its ruggedness makes it very desirable for experimental work, as there is little danger of bending the plates.

AN IMPROVED VERNIER DIAL

Having considered two of the latest novelties in condensers, let us look at their important adjuncts, the dials. Within the past year there have been many different styles introduced, with several types of vernier control, some of which have a varying ratio, giving the effect of a straight-line-frequency movement to the plates of the condenser which they control. One of the greatest disadvantages of vernier dials has been that looseness in the gears or reducing mechanism has resulted in lost motion, or "back-lash," when the dial was rotated.

The sectional view shows the gearing of the vernier dial illustrated. The front of the dial turns, transmitting its motion to the pinion, or small gear, by means of a friction drive between two metal plates; the pinion drives the large gear shown at the top of the cross-section, and this in turn drives the second pinion which moves the larger gear to which the shaft of the condenser is directly coupled. The two small wire springs, shown at the left of the central

of the inside and outside of a dial. It is a combination, because under the dial itself there is a variable condenser operating on the "book" principle. The idea is very ingenious, as the workmanship is attractive, for the top plate of the condenser is threaded to engage with the cover, or dial front, which is made of insulating composition. The dielectric used between the plates is mica. When the front of the dial is re-

olved, it engages more threads of the movable plate, and forces this down upon the lower or fixed one, thus increasing the capacity.

The great advantage of this condenser is that its plates take up no space behind the panel. The movement of the dial is sufficiently slow so that there is practically a vernier effect in the variation of the condenser. It is extremely easy to turn, for the small depressions in the rim give a good hold for the tips of the fingers, as well as the knurled portion of the top. This novel piece of radio apparatus is an English product.

TUNED R.F. RECEIVER

In the illustrations below is shown a new receiver which has for its circuit one that has been tried and found to be satisfactory in every way. There are two stages of tuned radio-frequency amplification, detector and two stages of audio-frequency amplification. Although the circuit is not new, and there is nothing that can be called startling in the make-up of this receiver, its operation and reproduction can be said to rank among the highest.

The appearance of this receiver is excellent, both inside and outside. The two R.-F. transformers are placed at an oblique angle to each other, so that there will be no interference due to stray fields. The greater portion of the connecting wires are run beneath the sub-panel, which is a feature adding greatly to the attractiveness of the set. Under the sub-panel are placed the transformers for the audio amplifier, fixed condensers and other apparatus needed in the circuit. Upon inspection of the lower illustration it will be seen that from the four binding posts on the right of the set are run wires which terminate in a cable that leads to the "A" and "B" batteries. This receiver is an interesting example of good engineering design and workmanship.

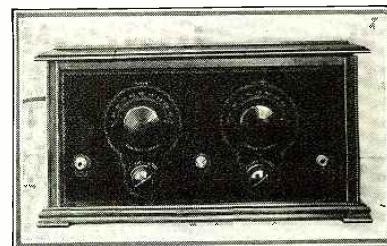

The panel view of the receiver shown below. The two controls make for simplicity in tuning.

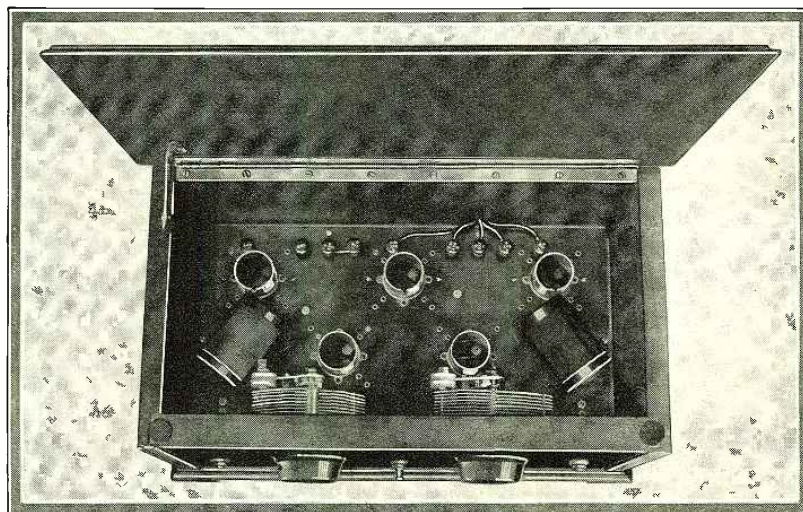

The ample space allowed in this five-tube receiver for the various instruments. is made possible by the use of a sub-panel.
Photos courtesy of De Witt La France Co.

The Latest Advance Toward Television

By LUCIEN FOURNIER



Radiotelegraphy now sends not only news, but pictures to illustrate it. To receive and reproduce a moving scene with continuity of action, however, requires an apparatus which will cover ten complete images in one second. Prof. Belin's ingenuity has devised such.



THIS article is devoted to an explanation of recent experiments made by Edouard Belin for the purpose of determining the influence upon the "persistence of vision," of the length of time during which light is emitted. These experiments present a new point of departure in the attempt to solve the problem of practical television—which must be *radio* vision, because the lag caused by electrical conductors prevents the transmission by wire to great distances of modulated currents which are produced by extremely rapid variation in the luminous intensity of a point.

The art of invention may be compared to that of a prospector for gold, who drives

varying size obtained by reproducing the photograph through a very fine screen. The effect of light or shade is obtained by the use of very small or very large dots in the various areas of the illustration. It will be seen that by transmitting impulses in any regular order, each corresponding in its magnitude to that of one of the points between the white lines of the screen, it is possible to reproduce any picture in all its details at any distance. This is the fundamental principle of the transmission of pictures, first by land telegraphy and then by radio, which has so lately been placed on a regular commercial basis.—EDITOR.)

The luminous ray of the television appa-

18x25 millimeters (about the size of a postage stamp) composed of points divided by five lines to the millimeter (1/125 of an inch apart, about the fineness of the photo-engraving illustrations used in RADIO NEWS) will contain 11,250 points. All this must be transmitted in one-tenth of a second to produce in the eye the effect of a continuous image. To transmit a complete scene, in detail, perhaps double the number of points will be required; each of which must be recorded in 1/225,000 of a second.

The effectiveness of so short an impression upon the retina might be doubted. It seems hard to believe that it would be perceptible by the optic nerve, and even more so that the effect should persist for a tenth of a second. The apparatus which we shall proceed to describe was especially devised with this end in view.

THE BELIN APPARATUS

The diagram, Fig. 1, is a schematic view of the mechanism illustrated on these pages. The interior of the projecting lantern contains an electric arc, A, a convex lens, and a slide carrier, O, into which an ordinary positive photograph upon glass is inserted, as if for projecting the image or picture upon a screen in the usual manner.

The rays from the arc pass through the positive slide and project its image through a second or objective lens upon a plane mirror, B, which is attached to a drum completely surrounded by such mirrors, those at the ends of each diameter being parallel. The drum is connected by gears to a motor, by which it may be rapidly revolved. When it is in a state of rest, the image from the lantern slide may be projected by reflection from the mirror B to a diaphragm or screen, C, on which it is reproduced with all its gradations of light and shadow.

If we make a hole, 1/25 of an inch in diameter, in this screen, a luminous ray will pass through it, and fall upon the fixed mirror, D. The point of light it forms will have a diameter larger than the perforation in the screen, because of the spreading of the rays: and the mirror itself will accentuate this effect. Accordingly we place another lens, E, in the path of the reflected ray, which is thus caused to converge. From this it passes to the mirror F, which again reflects it to the drum of mirrors. Here it

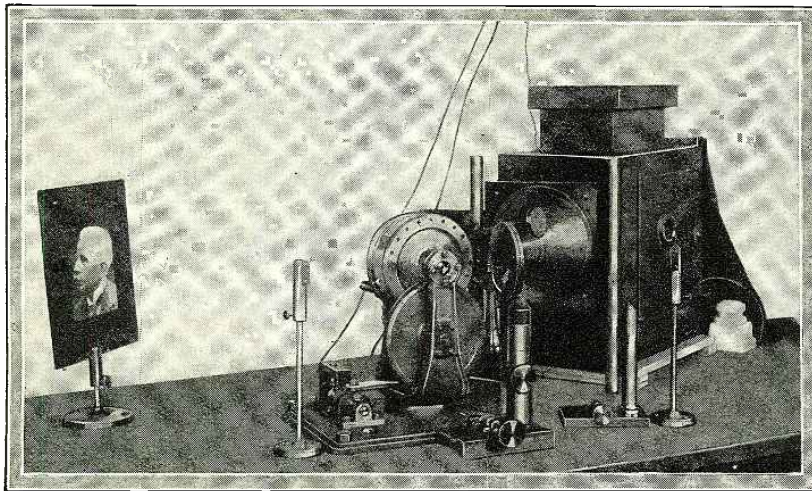

This apparatus is diagramed below: the projecting lantern at the right; the drum of mirrors, center; and the adjusting stands for diaphragm and fixed mirrors in front. At the left a continuous image appears on the screen, although only 1/25,000 of it is actually projected at any instant.

his pickaxe everywhere, until he uncovers the vein of gold of whose existence he has been certain. This is the present procedure in the endeavor to establish television. Our readers have doubtless heard how Edouard Belin succeeded, after patient and laborious research, in transmitting between two radiotelegraph stations, first the changes in a luminous point, and then a circle which was complete or broken in accordance with the variations at the transmitting station. This was the first positive result obtained, and was a direct accomplishment of radio vision.

ANALYZING THE VISUAL IMAGE

In viewing an ordinary moving picture, the impression on the retina lasts one sixteenth of a second. But, when we transmit the image of an entire scene, the whole of it cannot be covered at once by a ray of light. The scene or picture must be separated into distinct points; as if it were composed of a fine screen, over which a sharp brush would pass, covering one vertical line after another, parallel and extremely close, until every point has been covered.

(An examination of the illustrations, or "halftones," used to reproduce photographs in this and other publications, will illustrate this idea. They are composed of points of

ratus moves in a similar manner; but, instead of leaving ink upon the image at the receiving end, as does the apparatus used to reproduce pictures, it only sweeps over the screen in vertical lines, each almost touching the next, at such a tremendous speed that it must cover the whole field in one-tenth of a second, or less.

An image whose surface is, for instance,

Fig. 1. This diagram is fully explained in the text. The cylinder is covered with plane mirrors, revolving downward on the side toward the lantern. One ray at a time, from 1/25,000 of the area of the image, passes through the opening in C. The fixed mirrors D and F send it back to the mirror G, opposite B on the cylinder, and it is finally reflected against H in a position corresponding exactly to the portion from which it was first taken. The effect of continuous vision is produced.

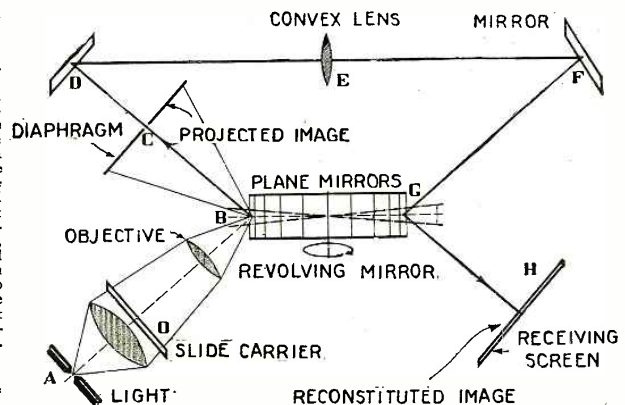

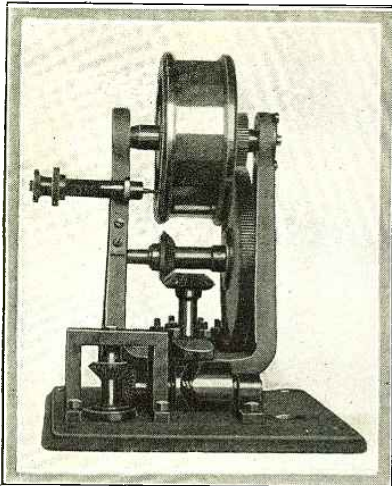

This is a front view of the cylinder or drum of mirrors. It is turned by an electric motor, and at the same time swung from side to side by the gear at its base.

impinges on the mirror G, which is diametrically opposite to B, and thence finally to a screen H, where it appears as a luminous point, corresponding to that which fell originally on the spot on C through which we made the opening.

Now we start our motor and set the mirror-encased drum revolving: with what result? So long as the first mirror B remains stationary, the image which it projects upon the screen H is motionless; but when we set it in motion, in the direction indicated by the arrow, the image reflected by it will be deflected downward upon the diaphragm C. Over the hole in C all the points constituting a vertical line in this

image will pass, and be projected in succession upon the mirror B. Through the reflecting system which has been set up, these will be reproduced in succession upon the receiving screen H. Each mirror which succeeds B in position on the revolving drum will receive the image in the same manner and make it pass through the opening in the diaphragm C.

THE IMAGE REPRODUCED

We now are able to transmit a luminous vertical line, traversing the image from top to bottom, and always composed of the same succession of points. They will not be of equal intensity; because the ray will be very luminous when it represents a transparent portion of the slide on O, and more obscure when it passes through a part representing a darker portion of the image.

Now the problem is to cover the whole area of the image on the slide, by causing the luminous line to be displaced at each movement over the screen, taking a course very close and perfectly parallel to the preceding stroke. This is accomplished by giving the mirror-drum a horizontal movement, alternating from right to left; which is accomplished by the use of a double spiral cam attached to its base, which gives it the necessary reciprocal action from right to left and back. These movements, communicated to the revolving mirrors, deflect the image from side to side upon the diaphragm C. In this manner the image is made to cover the opening in this screen with every successive point of which it is composed. The revolving mirrors thus transmit to D and its train of reflection all the points of the projected image, in vertical lines, which by means of the oscillation of the drum, are delineated so close together that each practically touches the preceding one; and no perceptible portion of the image fails to be projected through the opening in C.

As the mirror G and those which succeed it reproduce, in reverse direction, the motions of B, the reflected ray at H reconstitutes one by one, in the same order, all the points of the image on C which pass over the opening in that screen. As the entire screen is covered in a tenth of a second, or less, the image will appear clearly upon the receiving screen, as if reflected over its whole surface at once.

This ingenious experiment has proved that every luminous emission of sufficient intensity which lasts for 1/250,000 of a second is perfectly registered by the retina, the impression on which persists for 1/10 of a second. This brings out clearly the curious property of the eye, "the persistence of vision," by which the sight of an image is preserved for a period of 25,000 times longer than the duration of the impression.

APPLICATION TO RADIO

To transmit the image by radio waves, we have only to replace the mirror D by a photo-electric tube, such as have already been described to our readers (See "The Vacuum Tube and Photo-Electric Cell," October, 1925, issue of RADIO NEWS.) All luminous points in the image will be projected upon the tube, creating impulses which will be transmitted by means of ethereal (Hertzian) waves through space. By means of a properly synchronized corresponding mechanism attached to a receiver, they will be reproduced and projected in the same order upon a screen corresponding to H, producing the phenomena of television.

It must be pointed out that the luminous ray is not displaced upon the mirror D of our diagram, any more than it will be upon the photo-electric tube. If it passed through transparent glass, instead of through the picture on the lantern slide, it would have an unvarying intensity, and the current transmitted would be a continuous one. It

(Continued on page 84)

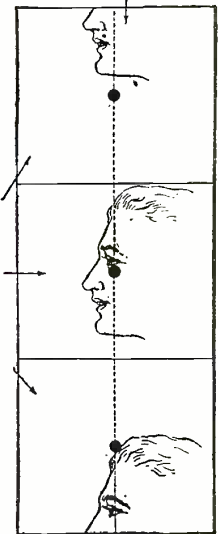

The moving image on the fixed diaphragm (C).

tion of the ray in the apparatus from B to G is always the same, no matter to what portion of the image it corresponds.

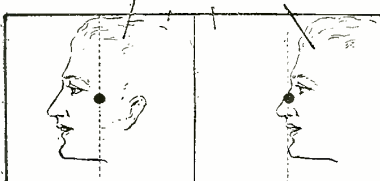

These motions, also, are reversed by the opposite motions of the parallel mirrors so that the entire image is reproduced in its proper form on H.

The illustration at the right shows the interior of the T. S. F. "wireless transmission" station at Malmaison, near Paris, which has been utilized by Prof. Belin in television experiments. Overhead is the large antenna coil; and the grid coil is beneath, in a vertical position. Above the frame at the right are shock coils; and just below them the modulating tubes. The screen for the reproduction of the image is just above the grid coil. In the center of the frame at the right is a reel of rubber tubing, through which cold water flows to cool the "Holweck tube", shown in a vertical position, connected to a cylindrical "molecular" air pump just below. In the lower right is an oil-operated "fore pump" to which the molecular pump is connected; and between this and the grid coil, a case containing the antenna condenser.

Fig. 2. At the left are shown the successive positions of the reflected image upon the diaphragm C. The portion of the image indicated by the (greatly magnified) dot in the center passes through this to the train of succeeding mirrors. In the upper illustrations is shown the effect of the downward rotation of the mirror B. The image passes vertically from top to bottom of the screen, every point in the vertical line shown being successively transmitted to the final screen H. By reason, however, of the upward rotation of the mirror G, these points, instead of remaining in the center of the field, are reproduced in a similar vertical line from the top to the bottom of H. For when B reflects the point at the bottom of the image (as in the top view) down to the center of the screen C, G reverses the motion and throws it up again from the center to the top of the screen H; and vice versa. The position of the ray in the apparatus from B to G is always the same, no matter to what portion of the image it corresponds.

Fig. 3. This shows, in a similar manner, the effect on the image of the oscillation from side to side of the mirrors. It is swung from side to side on the perforated screen or diaphragm, until every part of it has been covered by the vertical lines traced by its movement over the central opening.

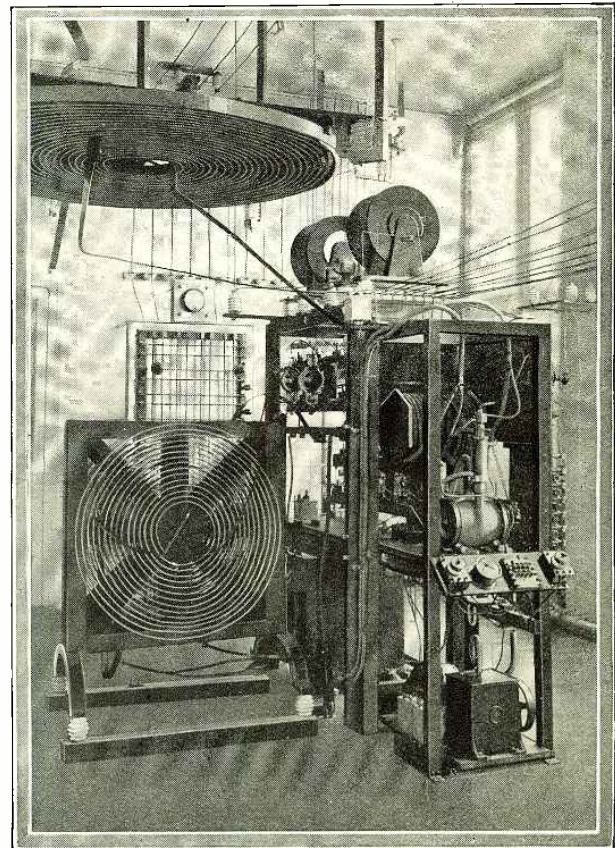

"Wireless" Receivers and Transmitters

By EDMUND T. FLEWELLING

This is the third of Mr. Flewelling's series of articles dealing with the trials and tribulations to which radio fans are heir. In this he deals with the troubles encountered from poor wiring and placing of parts.



MR. FLEWELLING in this article touches upon a subject that has always been close to the heart of the Editor. In many past issues of RADIO NEWS we have pointed out how important it is to know what the wiring is doing in a set and what Mr. Flewelling has to say in this article could not be said much better. It is about time that someone made a real study of the subject. We highly recommend this article to our readers.

—EDITOR.

RADIO, in common with other arts and crafts, has two aspects: the theoretical and the practical, the mathematical and the mechanical. For several years the writer has been studying the mechanics of radio receivers and, as can well be imag-

ined, has found it an extremely interesting field. The mathematics of radio can never be slighted, but it would seem that the mechanics of the thing certainly have been.

Take, for instance, the general subject of feed-back in a radio receiver. As we all know, feed-back (energy fed from one part of one circuit to another) may be for or against oscillation, may be for or against a louder signal. Everyone knows the average amount of capacity existing between the plate and grid, plate and filament, etc., of the popular tubes. Mathematical analysis has been carried to a fine point when considering these capacities in, for example, circuits of the neutralized or bridge types, and have been checked very closely with actual prac-

ice. In banking practice one cent out in ten million dollars would be considered rough work, but in radio approximations of one in ten are often put up with; so it is easy to say that the mathematics check very closely with actual practice.

There is perhaps no commercial article today that is surrounded with as much mystery as a radio receiver. I say mystery, because of the thousand and one things about the radio receiver of which practically nothing is known. Did you ever read, for instance, anything about the minimum safe distance for spacing various types of tubes? About adding or subtracting for the length of grid or plate leads? Of the characteristics of the field surrounding the coils, condensers, wiring, etc., of a receiver? These are the things that cause feed-back. These are the things that "make" or "break" your receiver, absolutely regardless of the wonderful hook-up that you are using. One may read a little

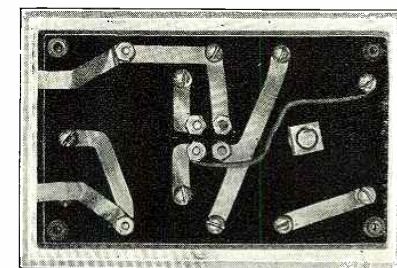

Several years ago strip connections were tried instead of wire in order to introduce capacity at certain points. The bottom view of a one-tube set built in 1920.

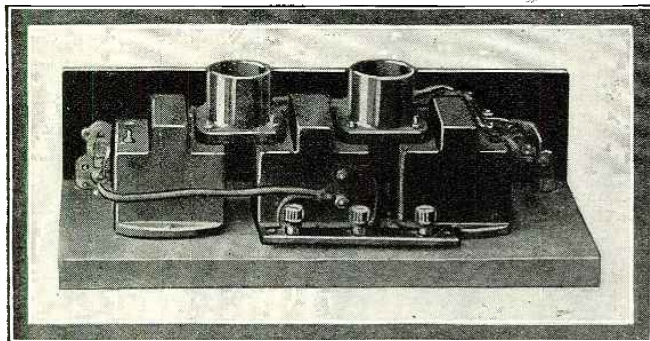

Fig. 2. By properly spacing the socket and transformer terminals, the sockets were mounted directly on the transformers, thus eliminating a great amount of wiring, soldering, etc. This is a method that is heartily recommended to all constructors.

worthy of being reduced to a point where they can be dealt with a mathematical certainty. Unquestionably they will be so reduced in time. Hasten the day!

In Fig. 1 is an illustration of the sub-panel

wiring in a commercial receiver, just as it left the factory. Does anyone see any prospect of applying mathematics to these wires, etc? This receiver is no worse than lots of others of its type; in fact is known as a very excellent receiver. One point for consideration is just this—it is conceded that no mechanical, to say nothing of mathematical, certainty can be approached when so many small wires with all of their soldered joints are used and so much uncertainty concerning the electrical effect of such construction exists. I am afraid that my pen lacks the ability to put over to my readers the tremendous importance of this point as I see it. More and more we are realizing that we must build radio receivers with as much precision and certainty as we build our automobiles.

here and there of these and kindred things, but the writer has felt that such things are

here and there of these and kindred things, but the writer has felt that such things are

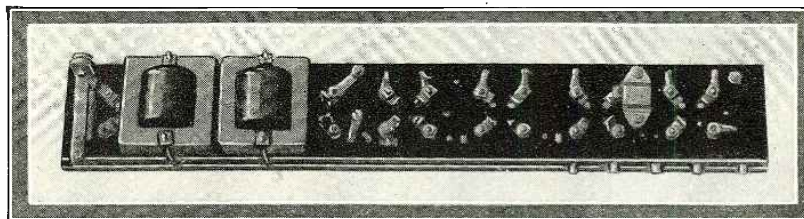

Fig. 3. By careful selection of parts and their positions in a receiver, the length of wiring can be reduced and the efficiency increased.

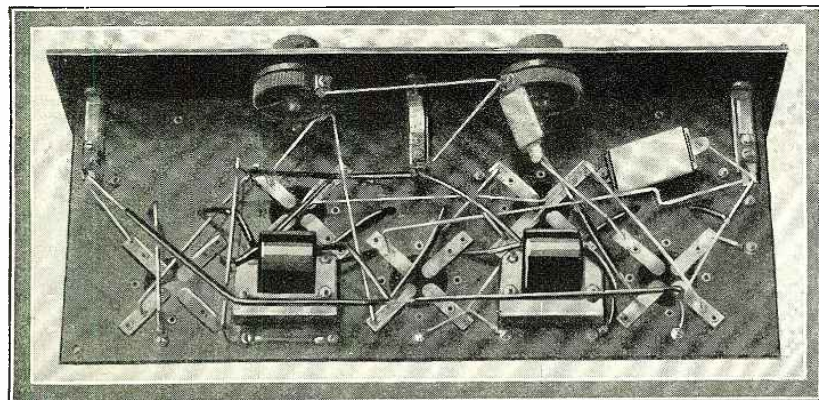

Fig. 1. What chances are there of applying mathematics to this jumble of wires under the sub-panel of a commercial receiver?

"TRIAL AND ERROR" METHODS

Pick up any article on how to build a radio receiver. All of these articles leave a large part of the mechanics of the receiver to the individual builder. Your chances of constructing a really high-grade receiver of the type described are very small, if you confine yourself simply to building the receiver and turning on the switch. You must set and reset, place and replace, cut and try before you are prepared to claim ownership of the "finest ever." The receiver's vital mechanics are lacking in the description, because no one knows just what they are. Attempts have been made to build receivers so that the various parts would all co-ordinate with each other. More power to such attempts! For one thing, because they will surely sound the death knell of that atrocity which we are using in our receivers; namely, the interleaving-plate condenser. The authors of

(Continued on page 88)

How To Build A Three-Foot Cone Speaker

By CLYDE J. FITCH

A three-foot cone speaker gives remarkable reproduction. By mounting one in a large cabinet sufficient space is provided for the batteries and the set.

THE average person thinks that a cone speaker three feet or more in diameter is entirely too large for his home, and he hesitates to buy or build one. But by combining the speaker with a radio table, it may be used in a small apartment room without occupying any more space than is ordinarily required for the set alone. Thus, in the speaker illustrated here, the cabinet or table is so designed that the radio set may be placed on top, and the "A" and "B" batteries and other accessories on the lower shelf. This convenient arrangement is clearly shown in the illustrations.

Those who have heard a good three-foot cone operating, with a well-designed audio amplifier, will never be satisfied with any other type of speaker. The quality and depth of tone is so far superior to that of any of the present-day horn or small-cone type speakers that there is no comparison.

5-and-10-cent store. The unit and paper may be obtained from cone-speaker manufacturers. It seems needless to say that the ordinary horn speaker unit can not be used successfully for driving a large cone. From the list of parts it will be seen that the entire speaker-table will not cost more than about \$17.00. In performance it is comparable with speakers costing four to five times as much.

The entire structural details of the table may be obtained from the illustrations and further comment is unnecessary. All dimensions are given in Fig. 4.

MAKING THE CONE

Extreme care should be taken in cutting out and gluing up the paper cone. Any folds or creases in the finished cone will decrease the volume of sound given out.

First, lay the sheet of paper face down

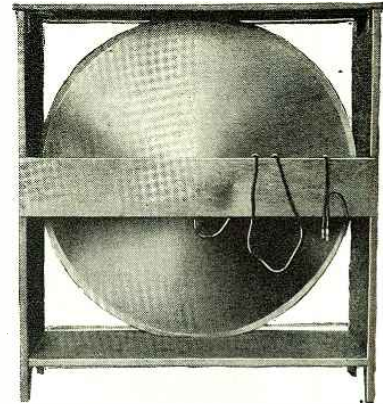

A rear view of the completed cone speaker. The unit is mounted on the wooden cross member.

Photo courtesy of Engineers' Service Co.

on the floor and fasten each corner with a thumb tack. Then locate the center of the sheet; and with a 19-inch radius draw a circle. This may be done with a lead pencil attached to a string fastened to the center with a thumb tack. Using an 18 3/8-inch radius, and a nail instead of a pencil, scratch a circle on the paper as shown by the dotted line in Fig. 1. The paper is to be bent back along this scratch after the cone is finished.

A segment is cut out of the paper as shown in Fig. 1. It is very important that the long dimension of the segment be parallel with the grain of the paper, as this prevents wrinkling of the paper where it is glued. If the glue runs along the grain, the paper does not wrinkle; if it runs across the grain, considerable wrinkling results. Paper is usually furnished in rolls with the grain running parallel to the axis of the roll. The grain should be marked on the sheet before cutting out the segment.

After cutting, the paper is glued in the shape of a cone and allowed to dry. The rim is then bent back along the scored line as shown, which holds the cone in shape and also provides a means for fastening the cone in the table.

A small conical metal washer, usually furnished with the cone unit, is glued to the apex of the cone; and over this is glued a small paper cone cut out according to Fig. 2. The complete assembly is shown in Fig. 3.

(Continued on page 79)

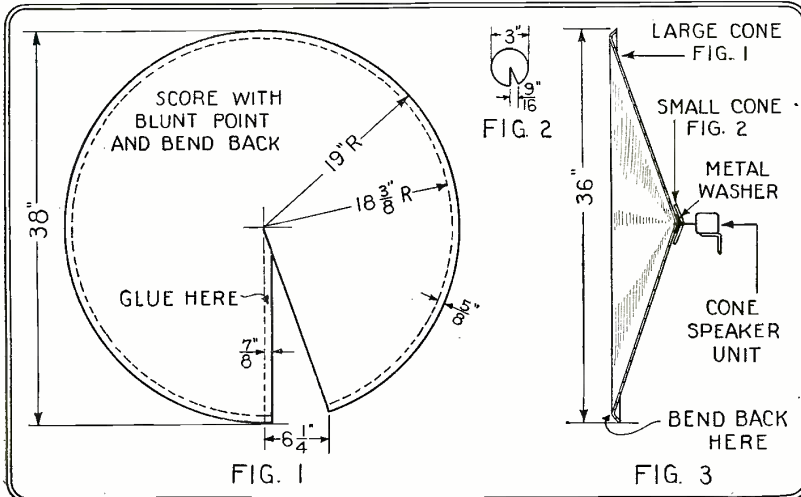

Details of the paper cone. Great care should be exercised in forming the "skirt" around the edge of the cone.

Contrary to the general opinion among radio fans, push-pull, resistance coupling, or power amplification is not necessary for the successful operation of a three-foot cone. The writer prefers the standard two-stage audio amplifier. Two of the best make of 2:1-ratio audio transformers are used. No condensers or resistances are connected across the secondaries of the transformers. The by-pass condenser across the primary of the first transformer should not be greater than .0005- μ f., while a condenser not larger than .002- μ f. may be connected across the speaker. A 90-volt "B" battery and a 4 1/2-volt "C" battery are used. A 1.0- μ f. condenser is recommended across the "B" battery, to by-pass its internal resistance and eliminate amplifier squeal. While a power tube in the last stage, with corresponding changes in "B" and "C" battery voltages, may give a slight improvement, it is not required for average results.

The lumber may be obtained from any carpenter shop, cut to size and finished, for about \$5.00, and stained and varnished to harmonize with the furniture in the room. The curtain, curtain rods, iron brackets, etc., may be obtained from any department or

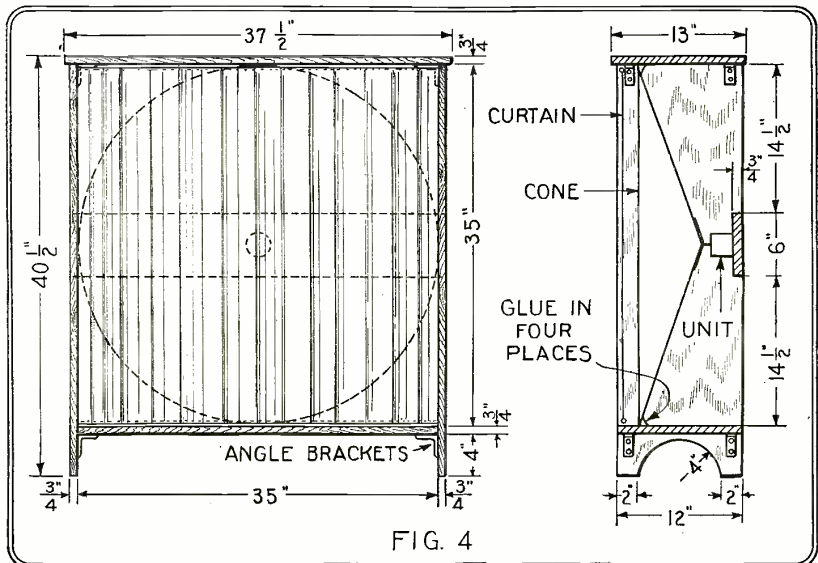

Constructional details of the loud speaker cabinet-table. The skirts of the cone are glued to the boards at four places, as indicated.

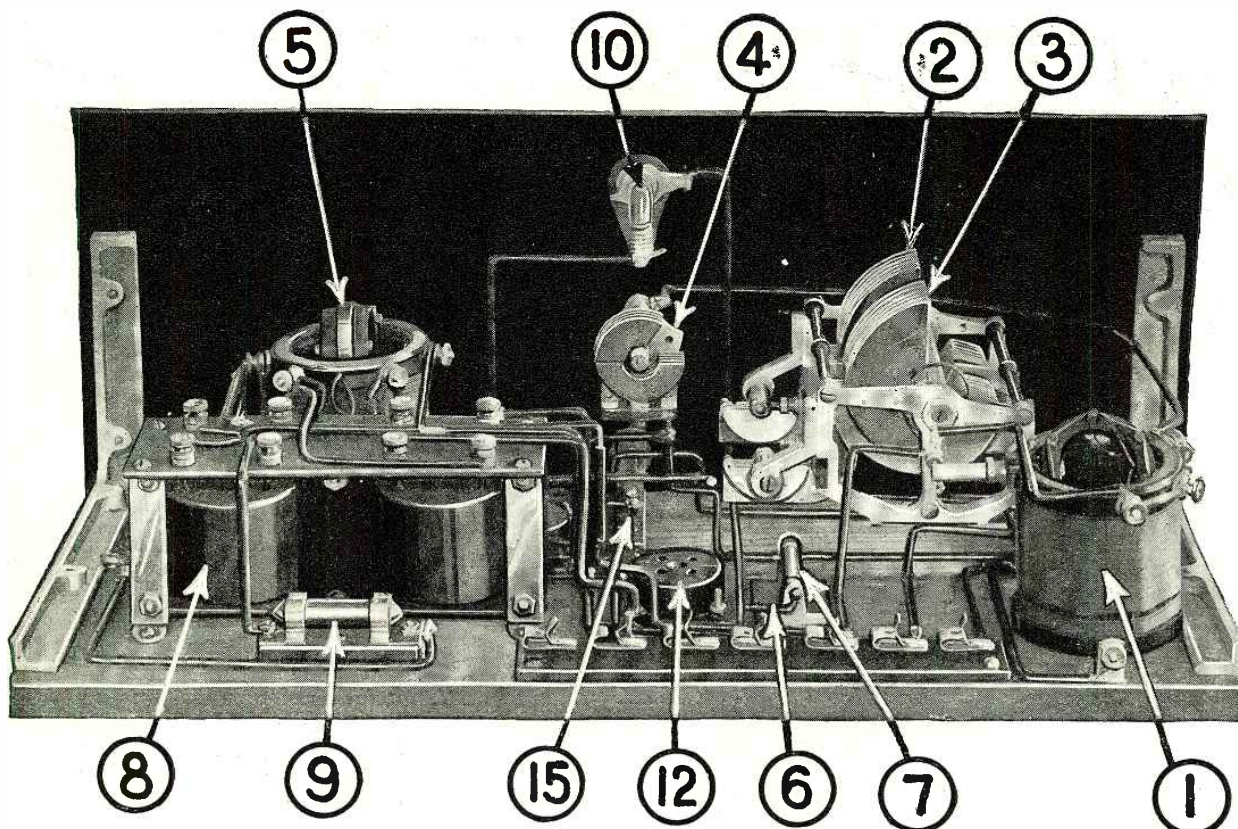

Interior view of the Dyadyne 4-tube receiver. The placement or position of the various instruments used in this receiver is very clearly shown. A more convenient "layout" may be adapted, but too great a deviation is not advisable. As shown, symmetry and electrical efficiency are the highest possible. The numbers correspond to those in the wiring diagrams.

The Dyadyne 4-Tube Receiver

By JOSEPH BERNSLEY

This simple and efficient construction produces a receiver of great power and sensitivity at comparatively low cost. This name is given to it because of its use of regeneration in two stages. It is easy to construct and has remarkable distance-getting ability.

IT is questionable whether at the present stage of radio development, and by means available now, it is possible to build a more sensitive set than the Dyadyne described in these columns. This receiver makes use of double regeneration, a thing that heretofore has been considered a most tricky accomplishment at best.

In the circuit described here, the usual difficulties have been ironed out to a point where the set becomes remarkably stable on all wave-lengths, once a station is tuned in. The tuning is exceedingly simple, and the power that the set delivers with its four tubes is something to be marvelled at.

It is our opinion that there are few sets that are superior, at the present time of writing. The set has proven sharper and more sensitive than many supposedly good Super-Heterodynes. It will pay you to build the Dyadyne if you want a set of tremendous volume, exceeding sharpness, and wonderful sensitivity. —EDITOR.

THERE is an ever-increasing demand for a new circuit that will satisfy the desires of the most "hard-boiled" constructor, as well as the radio engineer on the one hand and the ordinary broadcast listener on the other. The super-heterodyne is increasingly popular because of its power to bring in far-distant stations on the loud speaker; but even this powerful circuit is waiting for the improvements and simplification which will make it more universally popular. The needed requirements will perhaps occur at once to those who have studied the super-heterodyne receiver; but a repetition of the considerations which influence every prospective set owner or constructor will not be amiss at this time.

The first and most important of the requisites that make a receiver successful is maximum efficiency with a minimum number of tubes.

The second, low initial expenditure.

Third, low upkeep (determined by "A" and "B" battery consumption).

Fourth, extreme selectivity. This merit of the super-heterodyne is considerably impaired by the repetition of stations (harmonic or "two-place" effect) on the oscillator dial.

Fifth, compactness and simplicity. The super-heterodyne receiver, to operate efficiently, must of necessity have its various units, such as the oscillator circuit, inter-

RECEPTION WITH THE DYADYNE

In the following list are a number of stations, heard during two evenings of reception. Notwithstanding that summer thunderstorms were raging on both occasions, it will be seen that a number of distant stations were heard.

We give the logging of the condenser dial reading for each station; although the dial reading may be slightly different when the station is desired again, because a variation in the regeneration control will alter the condenser dial setting. Nevertheless, these readings will be found approximately correct, as an indication of where certain wave-lengths may be tuned in.

The regeneration control also will differ somewhat in its setting each time a station is tuned in, because of the variation caused by the condition of tubes, batteries, etc., and for that reason this dial reading is omitted.

WEAF 99, WJZ 83, WHN 58, WGBS 49, WFBH 36, WMCA 53, WAHG 49, WMSG 19, WBNY 18, WAAM 34, WGPC 32, WRNY 33, WLWL 38, WOR 78, WODA 30, WSB 80, WLWV 79, WTAM 61, WEEI 56, WHAZ 60, WCCO 79, WCAE 84½, KDKA 46, WBZ 51, WSAI 50.

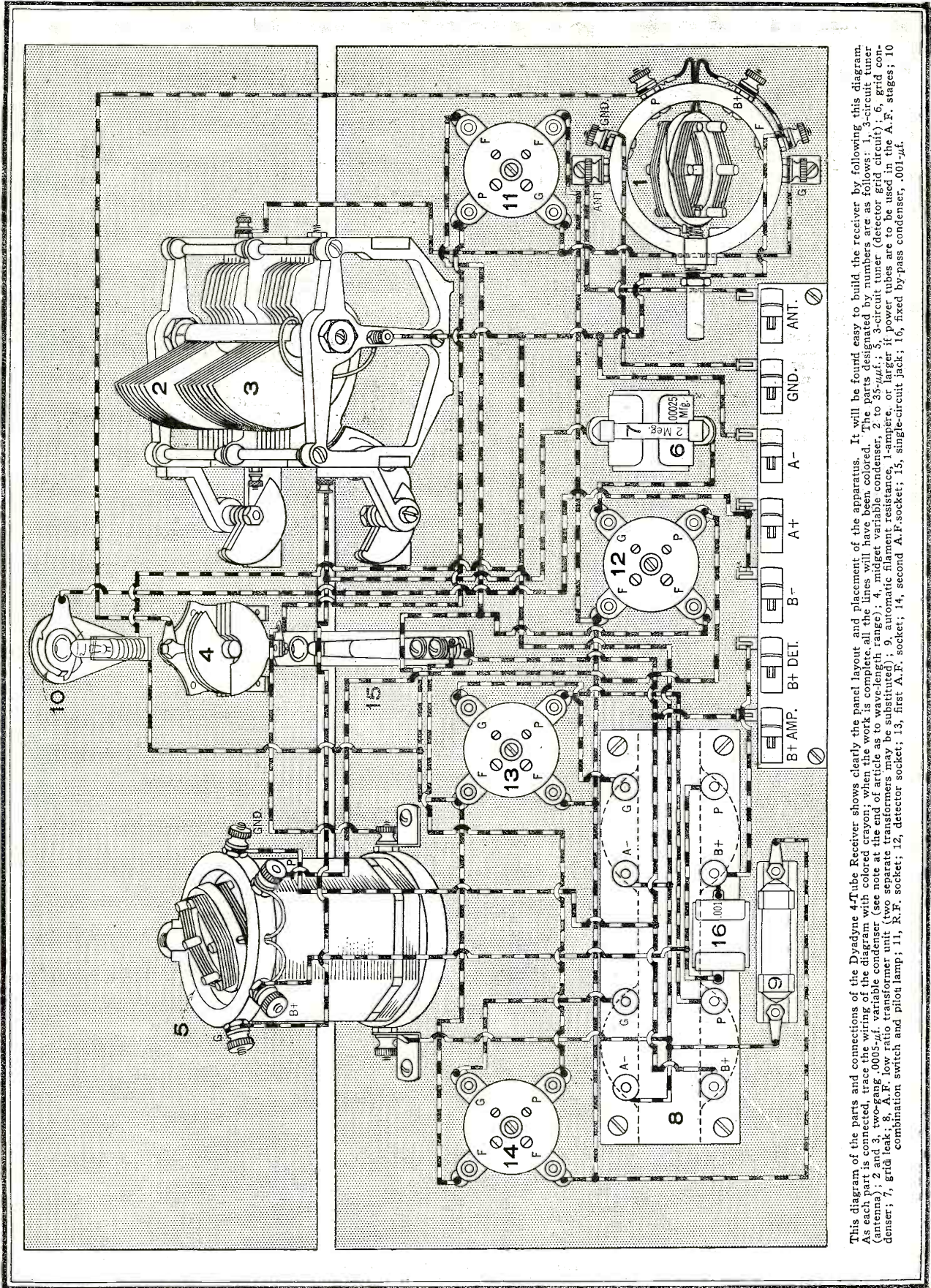

This diagram of the parts and connections of the Dyadine 4-Tube Receiver shows clearly the panel layout and placement of the apparatus. It will be found easy to build the receiver by following this diagram. As each part is connected, trace the wiring of the diagram with colored crayon; when the work is complete, all the lines will have been colored. The parts designated by numbers are as follows: 1, 3-circuit tuner (antenna); 2 and 3, two-gang .0005- μ f. variable condenser (see note at the end of article as to wave-length range); 4, midgeet variable condenser; 5, 3-circuit tuner (detector grid circuit); 6, grid condenser; 7, grid leak; 8, A.F. low ratio transformer unit (two separate transformers may be substituted); 9, automatic filament resistance, 1-ampere, or larger if power tubes are to be used in the A.F. stages; 10 combination switch and pilot lamp; 11, K.F. socket; 12, detector socket; 13, first A.F. socket; 14, second A.F. socket; 15, single-circuit jack; 16, fixed by-pass condenser, .001- μ f.

mediate stages, etc., well separated and shielded.

REGENERATION CONTROL

Realizing the defects of the so-called "Rolls-Royce" of radio, the writer started out to experiment with a receiver which would satisfactorily meet the requirements of the most "discriminating," have the efficiency and sensitivity of the "super," and eliminate those defects which handicap the popularity of that set. The *DYADYNE 4-TUBE RECEIVER* is capable of reproducing distant stations on the loud speaker to the entire satisfaction, we believe, of any radio set constructor who has operated or built a super-heterodyne receiver. This, of course, will not be true if the receiver is inefficiently constructed, or if poor material is used.

R.F. AND REGENERATION CONTROL

The "Dyadyne" receiver is not a "super," nor does it employ the super-heterodyne principle. It consists simply of a stage of radio-frequency amplification (employing regeneration in such a manner that it may be either controlled or neutralized over the entire broadcast range by a small, simple control on the front of the panel) with a detector stage which also employs regeneration and a simple control of the same, and two stages of transformer coupled audio frequency.

Everybody has heard, and doubtless realizes, the extent to which the efficiency of a receiver is increased by the use of regeneration. (The nature of this is very well explained in the articles, "What Is Regeneration?" in *RADIO NEWS* for April and May, 1926). A great deal has been heard of the work of research engineers and inventors, who have been trying to incorporate this principle in receivers; so that very few tubes would be necessary, while enormous amplification would be obtained from the "plate-to-grid feed-back," or circulation of energy derived from the receiver itself to strengthen the signal, as it may non-technically be explained. All of us have seen, and many have constructed, four-tube circuits embodying neutralized tuned amplification and a regenerative detector. This type of receiver has become popular throughout the entire country, because of its high efficiency.

Imagine, then, a receiver which incorporates a stage of tuned R.F. amplification, with no direct attempt to neutralize or stabilize this stage, as neutralization is almost always detrimental to its efficiency; but instead we encourage regeneration, or strengthening of the signal from plate current supplied by the set, having a means of controlling this, so that we reach maximum efficiency with this particular stage. The amplified output of the R.F. stage is

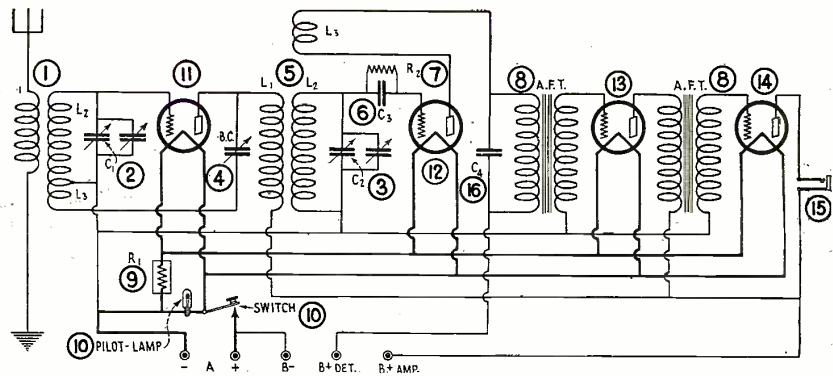

The schematic diagram of the receiver, numbered like the others. Two different, but both very popular methods of obtaining regeneration are employed in the R.F. and detector stages, although three-circuit tuners are used. C-1 and C-2 represent a tandem .0005- μ f. variable condenser, with separate vernier units, preferably of the S.L.F. type.

then passed on to the detector stage, which also incorporates regeneration and a means of controlling it, so that we further amplify the signal before the process of "demodulation" or "detection" takes place. It is easy to see how highly the radio-frequency signal will be amplified; so that we are justified in expecting, as a natural result, considerable power from this receiver.

The Dyadyne has a tremendous "kick" on local stations—and on distant ones as well when it is used in connection with an efficient aerial and ground system (the antenna should be, including the lead-in, from 135 to 150 feet in length) when efficiently built, both electrically and mechanically. The constructor is advised to adopt a layout as similar as possible to that of the original set, illustrated in this article, which was built in the *RADIO NEWS* laboratories. Also, as the parts necessary are very few, he should be careful to obtain the highest available grade of material, in order to assure best results from this receiver.

CONSTRUCTION OF THE RECEIVER

In assembling, drilling and wiring the Dyadyne try and make as near a duplicate of the original, as possible. Mount your parts in the order shown in the illustrations of the receiver. For those who desire to construct the three-circuit tuner, the following are the desired specifications:

Outside diameter of the tubing on which the primary and secondary windings are wound should be $2\frac{3}{4}$ inches. The secondary (L2) consists of 55 turns of No. 22 D.S.C. wire; the primary (L1) 10 turns of the same wire wound $\frac{3}{8}$ of an inch away from the secondary. The tickler (L3) or rotor winding, which is placed on a shaft or brass rod $\frac{1}{4}$ -inch in diameter, should be 2 inches in diameter and approximately $1\frac{1}{4}$ to $1\frac{1}{2}$

inches in length. Twenty-six turns of No. 26 or 28 D.S.C. wire are wound on this tube, 13 on each side of the shaft. This winding should be continuous. Both tuners are wound exactly alike.

ADJUSTMENT OF THE RECEIVER

The large dial on the left shown on the photograph of the front of the receiver is the actual tuner or "wave-length changer." The large dial at the extreme left acts as a volume control, and also controls regeneration in the detector stage. The small dial in the center controls regeneration on the R.F. stage. The small knob, underneath the large left dial, is the compensator or

LIST OF PARTS

- 2 3-Circuit Tuners, L1, L2, L3;
 - 1 Tandem Variable Condenser, .0005- μ f. for each unit. (Preferably of the straight-line-frequency type, and having a vernier on each unit; so that any difference in capacity or inductance which might prevent a balance of the two tuned circuits, may be compensated);
 - 1 Automatic Filament Resistor. (R-1, 1-ampere type to control the filament temperature of all four tubes);
 - 1 Combination Pilot Lamp and Switch;
 - 1 Variable Condenser, balancing or neutralizing type, range 2- to 35- μ f.;
 - 1 Grid Condenser, C-3, .00025- μ f.;
 - 1 Grid Leak, R-2, 2-megohm;
 - 1 Fixed Condenser, C-4, .001- μ f.;
 - 2 Audio Frequency Transformers. (If different ratio types are desired a 5:1 should be placed in the first stage and a 3 or $3\frac{1}{2}$:1 in the second stage);
 - 1 Single-Circuit Jack;
 - 1 Terminal Strip, with binding posts;
 - 1 7x18 Panel and 7x17x $\frac{1}{2}$ baseboard;
 - Miscellaneous, such as wood screws, nuts, bolts, etc.
- The cost of this material should not exceed \$25.00, not including tubes, batteries, etc. It is advisable to use good standard material throughout, as very annoying incidental troubles may develop when one fails to use "proven" merchandise.

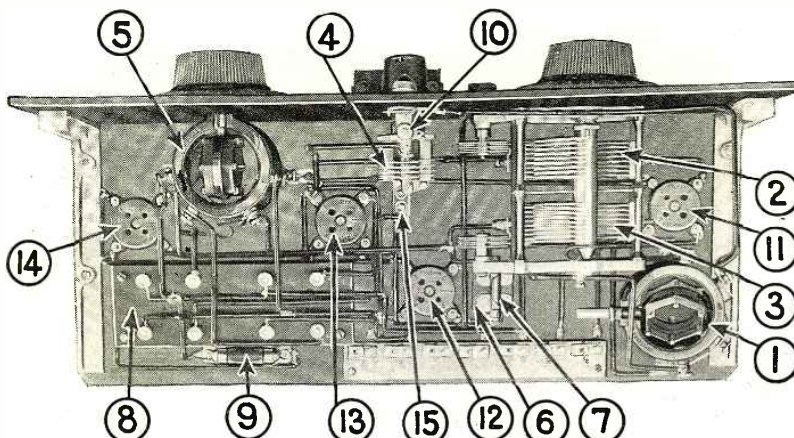

Top view of the Dyadyne receiver, numbered like the rear view and circuit diagrams. No. 8 is a twin unit, but two separate A.F. transformers may be used.

vernier condenser adjustment used to bring the two tuned circuits into balance. Regeneration may be produced by rotating the tickler coil of the detector stage towards maximum coupling; by rotating the small balancing condenser until regeneration is produced in the R.F. stage; or by means of both of these controls. On the other hand, if the receiver oscillates, or "whistles"

and "squeals," when tuning in, the tickler coil of the detector stage should be rotated toward minimum coupling, until oscillation stops. Sometimes reception will seem to be somewhat "hazy" in this particular instance, in which case the small balancing condenser must be rotated until oscillation in the R.F. stage ceases.

In adjusting the receiver, the rotor coil of the first stage, or first three-circuit tuner, should be set at such an angle that regeneration in that particular stage may be controlled over the entire broadcast range by means of the balancing or mid-gate variable condenser. This adjustment can be obtained only by actual experimenting; setting the rotor coil of the first tuner at one angle, then tuning in various stations at high wave-lengths, medium, and then low (approximately 225 to 250) and noticing whether the small condenser satisfactorily controls regeneration **IN CONJUNCTION WITH THE REGENERATION CONTROL FOR THE DETECTOR STAGE.** The proper amount of "B" battery voltage to be used in this receiver is 90 volts for the amplifiers and from 22½ to 45 volts for the detector tube; the latter being dependent upon the type of detector tube used. It has been found that 22½ volts will satisfactorily operate detector tubes of the 201-A or 301-A type.

TUNING IN THE DYADYNE

Reception of stations with this receiver may be obtained through first making the set oscillate by turning the regeneration control of the detector stage towards maximum. Every whistle heard as the condenser dial is slowly rotated means some station has been passed or tuned in. To obtain the station simply stop when the whistle is received at maximum intensity; then slowly rotate the above mentioned regeneration control towards

The neatness and symmetry of the panel is shown here. The tubes are "turned on" by means of the small pilot knob at the top, which is of a peculiar construction. The center dial controls regeneration in the R.F. stage. The small vernier knob beside the left (condenser) dial will aid in tuning in DX and getting stations at their maximum value, just before the point of regeneration.

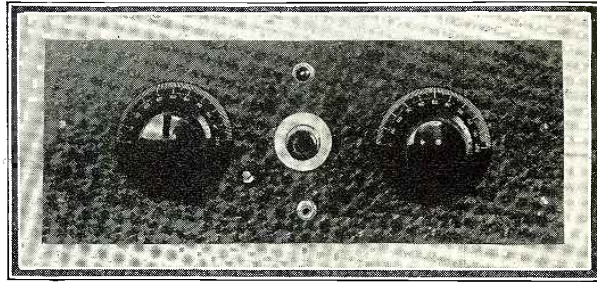

minimum until the whistle ceases and the station is heard. The signals may be made louder and clearer by re-tuning with the small balancing condenser and the large tandem or small vernier. The tuning condenser dial may be logged; that is, the position of each station may be recorded on the scale. The positions of the other controls are dependent upon several factors which are variable, thus preventing any logging of these readings. However, these dial indications are not very important, as the tandem condenser does practically all of the tuning; the entire process being very simple after the receiver's peculiarities are mastered.

Those who desire to improve upon the reception obtained may substitute the resistance-coupled, or impedance-coupled, type of audio amplification in place of the transformer type used in the original model. As these types of amplification do not produce as much volume per tube as the transformer-coupled type, it will be necessary to use three stages of either the resistance or impedance coupling. It is also essential, with the latter type of amplification, that at least 135 volts "B" batteries be used in conjunction with the proper amount of "C" battery, to obtain best results.

The receiver illustrated is designed to cover a wave-length range from 150 to 500 meters; that is to say, it covers an amateur wave-band, but not the upper broadcast range. This was done to obtain reception from amateur stations; but as many listeners are unfamiliar with the code, the specifications in the article are given for a receiver to cover the broadcast range. Those who wish to tune in below 200 meters may easily construct the set to do so by substituting a condenser of two .00035 units instead of the .0005 capacities listed. The dial readings on page 40 were obtained using .00035 condensers, which cover more satisfactorily the low-wave-length range.

It is against the policy of RADIO NEWS to publish the names of manufacturers or of makes of instruments in connection with the apparatus described in these pages, but this information will be gladly given privately. If you are interested in any special instruments described here, address a letter to the I WANT TO KNOW DEPARTMENT, enclosing stamped return envelope. The names and addresses of the manufacturers will be given free of charge. —EDITOR.

Constructing a Cone Speaker

By ALBERT T. LoCURTO

THE thrill of accomplishment, obtained after you successfully complete a radio set and listen to the music pour forth from the loud speaker (or rather we shall say cone speaker, since we are going to try to induce you to construct your own cone speaker, still further to enhance that thrill), more than compensates the constructor for his pains, both mental and physical, and results in a complete sense of satisfaction and familiarity with the radio receiver, even though it may be a complicated Super-het. A cone speaker may be just as readily constructed, with even less pains (no soldering irons necessary) and will enable the con-

structor to become more familiar with the subject of cone speakers and their construction.

The various items necessary are shown in the illustration, including among the essential elements:

One good loud speaker unit, with stylus connected to center of diaphragm;

Two circular pieces of parchment, or heavy manila paper;

One stylus holder as shown;

Base, 9 inches of ¾-inch galvanized pipe, which is threaded on both sides and gilded.

Miscellaneous, such as glue, cement, wood screws, felt, etc., etc.

It might be advisable to purchase the material necessary complete in kit form, somewhat similar to that put up for a radio set in the various kit units. There are a number of reliable manufacturers of cone speakers who sell the necessary material in this form; thus decreasing the expenditure,

which in many cases is fairly high for a good cone speaker assembled, and enabling those with even slight technical ability to save on the labor charges. The speaker when finished looks exactly like the factory-made product; the cone shown at the sides was put together by an ordinary set constructor without any former experience of this work, and is *prima facie* evidence supporting this statement. The diagram shown in the back ground of the center and some typewritten instructions were all that he found necessary; and so simplified the entire process that the speaker was completed in less than three hours, allowing time for the cement and glued parts to dry.

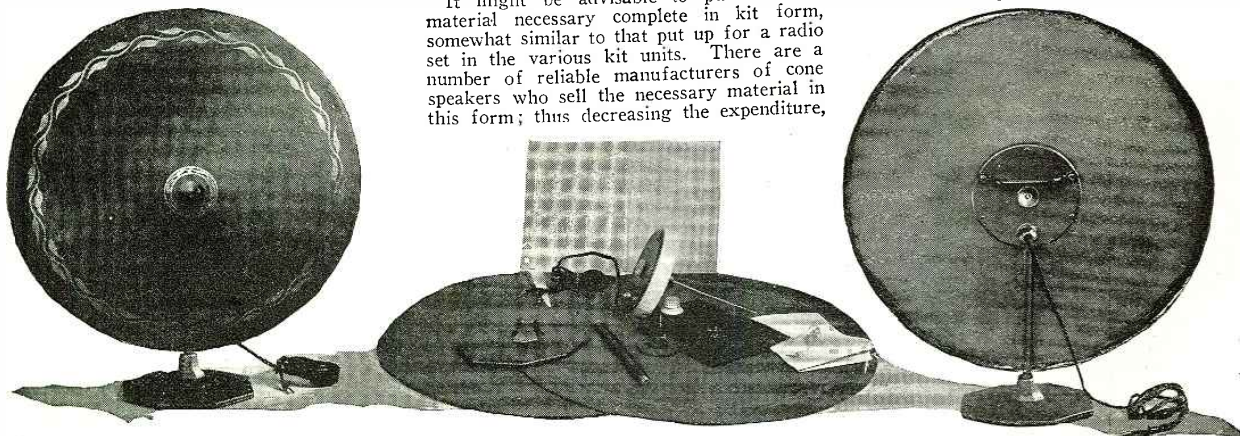

The items necessary and the blueprints or instructions which facilitate the assembly of a very simple and efficient cone loud speaker. It may be seen how neat the speaker looks after it is completed, even though assembled by one with very little mechanical ability. The list of parts necessary, and where they can be obtained, will be furnished upon request by our "I Want to Know" Department. Photo courtesy Scientific Radio Laboratories

Everyman's Receiver—The Fenway

By LEO FENWAY

This second installment contains directions for the construction of the intermediate-amplifier stages and the second detector of the Fenway super-heterodyne receiver. The first installment appeared in the June, 1926, issue of RADIO NEWS.



ACT II

THE body of the drama, the dramatist tells us, is the story proper. It shows the principal characters doing their stuff, creating interest and suspense and making the playgoer wonder as to the final outcome. Whether one is building a drama or a radio set, once these structural essentials are clearly understood, the builder's progress ceases to be haphazard.

Let us now assume a comfortable posture while we permit the second act to unfold itself before our eyes.

The props—or, if you will, the parts—for these acts are:

- Three Medium-Frequency Transformers, 75- to 15-K.C.
- One Tuned-Stage Transformer, 30-K.C. to 60-K.C. preferred.
- Six Vacuum Tube Sockets.
- Six Standard Vacuum Tubes.
- One Potentiometer, 400-ohm.
- One High-Resistance Unit, 1,500- to 100,000-ohm.
- One Filament Single-Control Jack.
- One Double-Pole, Double-Throw Switch.
- One Grid Condenser, .0005- μ f. capacity. (Note capacity!)
- One By-Pass Condenser, .005- μ f.
- Three By-Pass Condensers, .5- μ f.
- One Grid Leak, 5-meg.
- Two Audio-Frequency Transformers.
- One Double-Circuit Jack.

The plot, or circuit, for Act II is indicated by that portion of the hook-up diagram from the "input transformer" to the input of the first grounded core audio transformer. The "business" of examining this diagram is on. The high resistance is shown connected into the circuit of the "B" battery + 67½ volts.

When the set is in operation this resistance will be advanced from one-half- to three-quarter-way on, as will be indicated by the reading on the voltmeter—it is shown by the diagram that this resistance is connected to No. 2 on the voltmeter.

The oscillator circuit is now tested. If the oscillator is not working distant stations will be conspicuous by their absence. First of all, are you quite sure that you

connected the oscillator coil into the electrical circuit correctly? Well, that's fine; because if you reversed any of the connections the chances are that your trouble lies right there.

The only other possible sources of trouble in the oscillator circuit are: (1) a short-circuited turn in any of the coils; (2) a short circuit or high resistance in the con-

effect over the entire tuning range. If the oscillator fails to "mush" the signal over the whole range it indicates that one or both of two things are wrong. Either the range of the oscillator coils and condenser does not agree with the other two units (L and C1 and L1 and C2), or the oscillator tube is not working satisfactorily. The remedy

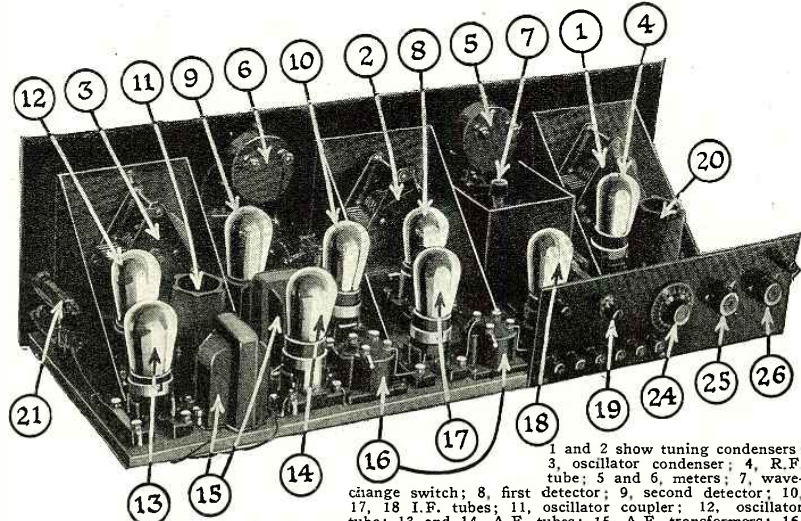

1 and 2 show tuning condensers; 3, oscillator condenser; 4, R.F. tube; 5 and 6, meters; 7, wave-change switch; 8, first detector; 9, second detector; 10, 17, 18 I.F. tubes; 11, oscillator coupler; 12, oscillator tube; 13 and 14, A.F. tubes; 15, A.F. transformers; 16, long-wave transformers; 19, jack switch; 20, antenna inductance; 21, phone jack; 24, potentiometer; 25 and 26, rheostats. Parts shielded by copper cans when in use are seen here.

denser C3; (3) grid and plate connections reversed; or (4) a "dud" tube.

Now place the oscillator tube in the socket, and with the temporary connections still attached to the jack (as explained in Act 1) put on your phones and listen again for a local station.

Tune the two dials, condensers C1 and C2, from 0 to 100. Somewhere on these dials, and at a certain setting of the oscillator dial, the signal will become "muffled." In fact, this oscillating condition will be apparent at both the upper and lower ends of the two tuning condensers, C1 and C2, and should be in

is to add or to take away turns of wire (only a few!) from the oscillator coils or put a new tube in the oscillator socket. You must get those first three tubes working before going farther. Otherwise you will likely be trying later on to amplify signals that the first tube does not receive, or that the oscillator does not heterodyne. The average super is a flop right at this early stage of the game. You who build this super can profit from the mistakes of others—get these first three tubes working! The rest of the set will almost take care of itself. If you have been figuring out how you can save one tube by reflexing the first two or the first and third, forget it. It takes a genuine radio engineer one year to make a second-harmonic-super work, and even then the results are far from satisfactory.

THE MIDDLE SECTION

You should now mount the parts for the intermediate-frequency amplifier. Directly behind the special coupler mount the input transformer. (Whether you use 30 K.C. or 60 K.C. the input must be tuned—not the output. Research work has proven that in the proper place for the filter transformer is in the input circuit of the intermediate-frequency amplifier, not the output.)

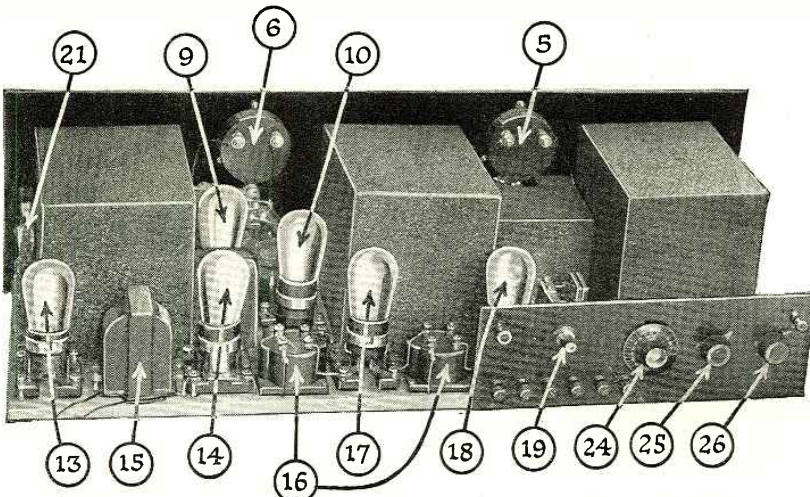

The shielding cans are shown in place. The numbers in this illustration correspond to those in the other on this page.

IT is against the policy of RADIO NEWS to publish the names of manufacturers or of makes of instruments in connection with the apparatus described in these pages, but this information will be gladly given privately. If you are interested in any special instruments described here, address a letter to the I WANT TO KNOW DEPARTMENT, enclosing stamped return envelope. The names and addresses of the manufacturers will be given free of charge.

—EDITOR.

Next mount the sockets and the intermediate transformers. (The primary side of each transformer should face the sub-panel.) Before mounting the last transformer the potentiometer should be screwed to the panel. If the wires that must be attached to this instrument are put in place before mounting it will save time and trouble. After the potentiometer, a 0.5- μ f. condenser should be soldered to the last can, either inside or outside; another should be placed in the center can and soldered.

The grid condenser, .0005- μ f. capacity, should now be soldered with a short piece of bus to the grid terminals of the last transformer and the second detector tube socket. The filament-control jack comes next. Then, on the sub-panel, the 6-ohm rheostat and the resistance. Once these last two instruments have been set they will not need to be changed—that explains why they have been placed on the sub-panel instead of on the main panel. The .005- μ f. fixed by-pass condenser should now be mounted from the plate of the second detector to the "A+" battery. Insert the grid leak, which should be 5 megohms. Now mount the double-pole double-throw switch on the sub-panel. The connections for this switch are clearly shown.

CABLING AND CONNECTING

The intermediate-frequency amplifier should now be ready for wiring. It is advisable to use round bus on the grid and plate leads; and these leads should be clear of all other wires and free from spaghetti or other covering. All the filament wires, and all the wires not connected to live grid leads, should be cabled or bunched together and tied very tightly with string. The plate lead that runs from the D.-P. D.-T. switch, to the first audio transformer (for the four tubes), should be included in this cable.

If you "hate" the job of soldering, make an eyelet in the wire with round-nose pliers and trust it to a binding post. Most binding posts are capable of making perfectly good contact, and remember that contact is the thing desired. Mechanical strength and security are needed, of course; but, electrically, it makes no difference whether you use solder or a paperweight to hold two wires together.

For the most part the leads will be very short, with low interaction among the radio circuits.

The intermediate-frequency amplifier and the second detector are usually tested at the same time. If the intermediate-frequency amplifier is wired correctly and the tubes are O.K., there is very little likelihood of trouble, when the proper battery voltages have been applied. If there is trouble of any nature in the amplifier it can be located through the process of elimination.

Beginning with the input transformer, test

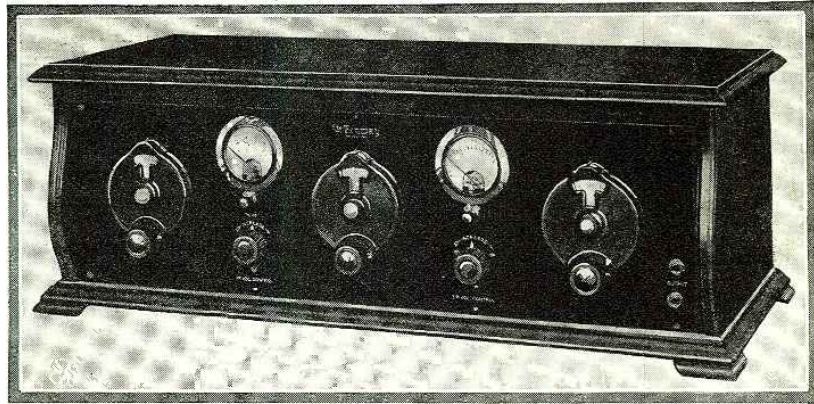

The panel appearance of this Super-Heterodyne is well balanced, the meters indicating the operating conditions of the set.

the primaries and secondaries for continuity of circuit. The voltmeter on the panel can be utilized for this purpose. With the "A -" connected to the minus post on the voltmeter connect another wire to the "A +" through the part to be tested. It is possible, by noting the reading, if any, on the voltmeter, to tell the condition of all transformers. If a 6-volt battery is used the reading will be slightly less than 6 volts.

If there is no reading on the voltmeter either the primary or secondary windings are defective. Fixed condensers can also be tested with the voltmeter, only, of course, there will be no reading when the condenser is O. K. Large by-pass condensers tested in this way will give the voltmeter a slight kick as the condenser charges, but this does not indicate a defective condenser.

Test all the connections on the intermediate-frequency amplifier; see that those between the transformers and sockets are not reversed. (The terminals marked "G" on the transformers must be connected to the grids of the tube sockets.) The plate leads can be connected to either of the primary terminals; it is customary to connect a plate to the terminal at the extreme opposite end of primary from grid. Test the intermediate-frequency amplifier together with the rest of the set, as before.

REACHING THE CLIMAX

Almost before we realize it the second act is over and we discover that the set not only operates a loud speaker on locals but that distance up to 1,500 miles is clearly brought in. We have a radio set thus far capable of great performance; if we were to walk out before the end of the show we would still have something worth while.

As you still retain your position in the audience, you will readily imagine that the

last act will consist of three stages of resistance-coupled audio amplification; the fellow next to you believes that three stages of impedance-coupled will be used; but the man back stage knows that two stages of transformer-coupled audio is the thing. At any rate, you are now convinced that the construction of a super-heterodyne ought to be as simple as that of a three-circuit tuner. In fact it is simpler, only there is more of it. For example, a wire leaves a tube socket (plate) and goes to a transformer (plate), it leaves that same transformer (grid) and goes to a tube socket (grid), and so on to the next transformer and the next tube. Could anything be simpler than that? As often as not the parts used are O. K., the circuit itself is efficient, but the trouble lies in the man who assembles the instruments. He hasn't learned to visualize his different circuits in scenes. He has entirely forgotten that when he built his first set he wired up one tube—then added more as his radio fever increased. Imagine a dramatist producing his play all in one act! Of course it has been done; and just like the radio that is constructed in one lump, it has lived for but a day, then flopped.

ACT III

And so we come to what the dramatist calls "The end of the play." And, being the last act, it is necessarily the shortest. As the final curtain rises we see the same props—or parts—that were used in creating the first setting, with the added parts of the second act. By tossing upon the stage—or baseboard—a couple of good low-ratio audio transformers, two sockets, two tubes, either power tubes or otherwise, the action for the close of the show is begun.

(Continued on page 71)

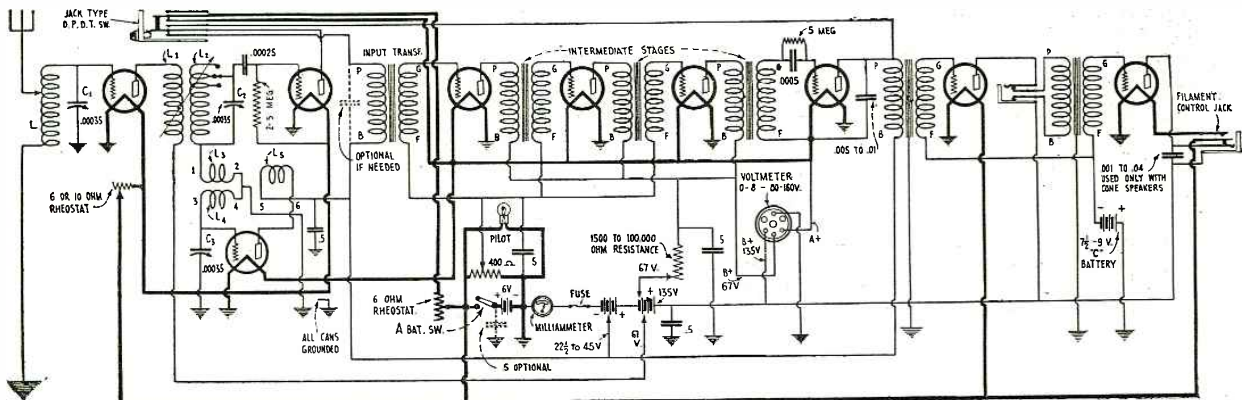

The nine-tube Super-Heterodyne has an audio-frequency amplifier that is made of standard apparatus. The grid and plate voltages must be determined experimentally.

A Portable Super-Heterodyne

By CECIL W. PRESTON



When one hears of a super-heterodyne receiver, the first thought generally is of a set of gigantic proportions. This "super-het," however, is one that can really be made within portable dimensions.



FOR at least two years past, the portable or semi-portable super-heterodyne has offered a tremendous allure-ment to the home-building radio enthusiast; inasmuch as this particular type of receiver can be built quite compactly and is supposedly extremely efficient. The word "supposedly" is used intentionally, for many of the small, ultra-compact "super" de-signs developed have been capable of far less than the extreme sensitivity attributed to the super-heterodyne system in general. However, it is only fair to say that some

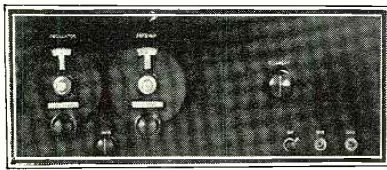

There are only the usual two tuning controls that need be adjusted when picking up a station, besides the filament control.

have been quite satisfactory—in particular a seven-tube portable design now two years old, employing a bank of R.F. transformers, instead of the conventional separate long-wave transformers.

Aside from the difficulties of design in-volved in the construction of a portable receiver (which are really no more aggravat-ed than those influencing the development of any set of this type, regardless of size) another factor has militated against the super, just as it has against all other types of portable sets. This factor is the volume, which requires generally greater amplifica-tion from a portable receiver than from any other type. This becomes evident when it is realized that the portable must operate under unfavorable conditions quite frequently, with a very small collector system (antenna or loop); and further, must frequently deliver sufficient power, despite adverse conditions, to be heard over a fair area—much larger than the average living-room, and without the helpful conserving effect of the walls upon the available reproduction. Were storage-battery tubes to be used, this factor would not be so serious; but with only a minimum number of dry cells available, to-gether with low-power dry-cell tubes, the task is indeed not to be sneezed at, despite the high sensitivity of the super. Using the new UX-120 power tube in the last audio stage, preceded by the new UX-199 tubes, and plenty of plate potential supplied from com-

compact, light batteries, seems to solve the prob-lem adequately; particularly if the super design itself is quite efficient.

DETAILS OF THIS SET

In the accompanying illustrations is pic-tured a portable super-heterodyne, developed by the writer from standard parts availa-ble at any radio store. The receiver is mounted upon a 7x18 inch composition panel, in addition to a 6x17 inch sub-base of the same material. Before considering the phys-ical dimensions of the receiver, and its portable aspect, it is best to review the electrical design, with an eye to determining definitely if it will meet the requirements imposed upon it, not only as a summer portable, but later on as a permanent home receiver, which must be capable of more than average results.

A loop is used as a collector, being tuned by a .00035- μ f. S.L.F. condenser which gives maximum ease of tuning even in the most congested areas. In order to provide highest selectivity and sensitivity, a regenerative cir-cuit arrangement is used; with regeneration controlled by a midget condenser, in the conventional three-tap loop circuit.

The oscillator output is coupled into the detector grid circuit; the oscillator itself consisting of the conventional grid-tuned circuit so much in favor. The coupling is

made up of standard long-wave transformers, having a very sharply-defined resonance peak. As iron-core, long-wave transformers shift their operating frequency with changes in tube or circuit capacity, it is necessary to buy transformers matched for use with a particular type of tube, such as the UX-199 or 201A.

While it is not recommended that the builder attempt to construct long-wave trans-formers, data is given herewith to enable him to do so. Matching data is not given, as this operation requires laboratory equipment, the cost of which is many times that of the portable receiver itself.

USE OF "C" BATTERY

While the first detector employs a grid-condenser-leak combination for rectification, the second detector operates with a negative grid bias. The reason is that the condenser-leak provides greater sensitivity, particularly at the high frequency handled by the first detector, though its handling capacity for strong signals is quite limited. This is not important in the first detector, though it is vitally so in the second due to the tremen-dous amplification occurring between the detec-tors. Therefore the second detector employs a negative grid bias of about 1½ volts. This not only allows handling a larger current, as the tube will not be overloaded as easily

The intermediate trans-formers and the filter as they should appear when completed. At the left is shown a section of the core. Data for their con-struction are given on the next page; but it is rec-ommended that matched transformers be purchased.

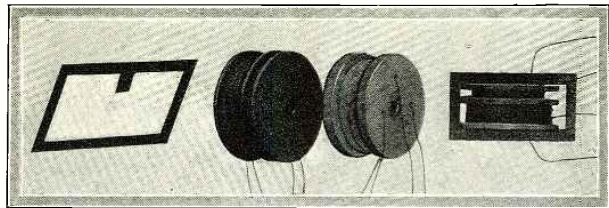

adjustable, by means of a small removable rotor coil, held on springs inside the stator coil form. The stator or grid winding, tuned by a second .00035- μ f. S.L.F. condenser, is made up of enameled wire wound upon a threaded, moulded composition form; so that the uniformity of this inductance, and consequently the dependability of logging, remains quite unchanged over a long period of time. While the oscillator circuit losses are of no great importance, it seems only fitting to state that the plug-in coil system used is surprisingly efficient, aside from al-lowing the interchange of coils for different wave-length bands when desired.

The intermediate amplifier, which is indeed the most critical portion of the entire set, is

by strong signal inputs, but further increases selectivity.

It is unnecessary to go into an explanation of the reasons here, but suffice it to say that a grid-condenser-leak at 45 kilocycles simu-lates very much the effect of a resistance shunted across the filter- transformer second-ary on the order of several thousand ohms; whereas the transformer is designed to work into a tube resistance of several hundred thousand ohms or more. Obviously, selec-tivity as well as amplification will be very poor if a condenser-leak is used at these fre-quencies; whereas it will be very good if a negative bias is used to effect rectification.

The audio amplifier uses two standard 3½: 1 audio transformers of a thoroughly satis-factory type. While their amplification at low frequencies is not what might be desired, it is more than satisfactory for portable work, and the over-all amplification is quite high. If 2:1 transformers are used, the am-plification will fall off; so they are not rec-ommended for portable work. Suggestions will be given further along for improving the audio quality where an excess of volume is developed in home reception.

DRY CELL TUBES USED

UX-199 tubes are used for first detector, oscillator, R.F. amplifiers, second detector, and first audio stage. The second audio stage uses a UX-120 power tube with the proper negative bias. The first audio stage uses no "C" battery, in order to keep down the tube's plate impedance and consequently improves quality and volume. While the plate current

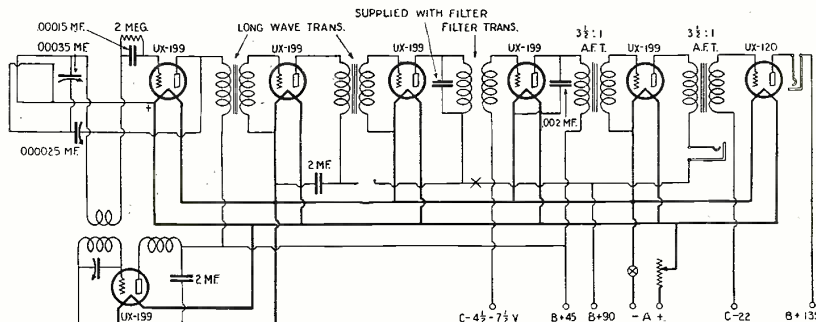

Although there are but two stages of intermediate-frequency amplification, this "super-het" gives remarkable volume because of the audio amplifiers. Dry cell tubes may be used in this receiver for transportation; and storage battery tubes (with a 200,000-ohm variable resistance at X) when it is set up in a more permanent location.

drawn by the tube is more than if a "C" battery were used, the increase is so slight as to be of little consequence even in a portable.

The R.F. amplifier is inherently stable with 199 tubes, but not so with 201-A tubes. However, in order to keep the plate impedance of the amplifier tubes down and amplification high, the grid returns are run to the negative filament line. Then, if by any chance the R.F. amplifier should tend to oscillate, this may be overcome by shunting the first transformer secondary with a 1/2 or 1/4 megohm grid leak. This simplifies the receiver further, in that best amplification will be obtained at 3 volts on the tube filaments; so that there is little tendency to overload even if no voltmeter is used. Thus the receiver simplifies down to two tuning controls, a regeneration control, and the non-critical filament adjustment.

The actual construction is quite simple, involving as it does the use of only a few tools, even if the containing case is to be home-made.

CONSTRUCTION OF THE SET

The panel and sub-panel layout is not dia-

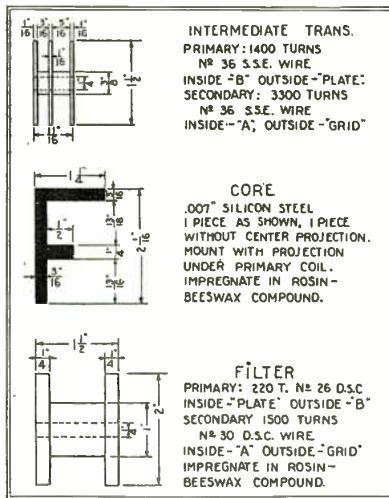

Details for the construction of the intermediate and filter transformers.

gramed, but can easily be determined from the illustrations. Further, the constructor may wish to substitute parts of his own choice. All holes are drilled with a regular hand-drill and countersunk where necessary. The front panel may be finished with fine sandpaper and oil, rubbing in one direction only.

The actual mounting of the parts is very clearly shown and little need be said, except that they are all fastened in place with 6/32 round-head machine screws and nuts. The variable condensers used strengthen the mechanical assembly very considerably as they are fastened to both the front panel and the sub-panel. This is a rather important feature in portable work and suitable condensers are to be strongly recommended.

The wiring is all done by means of flexible-cable hook-up wire, soldered either to the lugs on the instruments themselves or to small lugs placed under instrument binding posts where necessary. One unusual feature in the wiring of the receiver is that, where wires must be carried through the sub-panel for connections, in practically all cases some of the fastening screws running through the instruments are used for this purpose. This is particularly noticeable in the case of the inductance coil where two of the mounting screws are used to bring leads out on the bottom of the panel. The same is also true of the plate post of the first detector socket and three of the mounting screws for the

long wave transformers. In mounting, the two 2- μ f. by-pass condensers are fastened beneath the sub-panel, using the screws holding down the first two intermediate-frequency transformers.

All battery leads are knotted for identification, twisted together into a common cable and then led away from the receiver. They consist merely of extensions of the set wiring, say three or four feet long. The loop leads also are braided together and run directly to the cabinet cover so that no binding posts whatsoever are used.

ADJUSTING THE RECEIVER

It is assumed that the builder of this receiver is somewhat familiar with receiver operation, and that he is able to connect up batteries satisfactorily. This having been done, the various tubes should be inserted in their sockets, the loop connected to the receiver and testing started—with the small midget condenser turned all the way out and the rheostat turned about half way on. It would be best, at the start, to check the proper adjustment with a filament voltmeter in order that the dry cell tubes may not be damaged. If the oscillator tuning dial is now adjusted, no squeals should be heard in the receiver. If any squeals are heard it indicates that the intermediate amplifier is oscillating. This may be very easily overcome by connecting grid leaks of 1/4- to 1/2-megohm across the secondary of the first intermediate transformer, as explained previously. This is, however, a very improbable condition.

If the midget condenser is now turned in, say about half, squeals will be heard in the receiver, indicating oscillation of the first detector and oscillator. This is an incorrect adjustment and the midget condenser should be kept set always far enough out so that the receiver does not squeal.

In tuning, the two large condensers are adjusted, starting with the loop condenser which is moved over its scale in steps of two degrees at a time. The oscillator condenser is then varied from about 10 degrees below the loop condenser setting to 10 degrees above it, slowly, before the loop condenser is again moved, provided no station has been heard.

Once the receiver has been logged, it will retain its logging quite definitely, providing that the position of the small coupling coil in the oscillator coil is not shifted very much. The actual position of this coil is not very critical and will be found to be approximately that where the axes of the stator and rotor coils coincide.

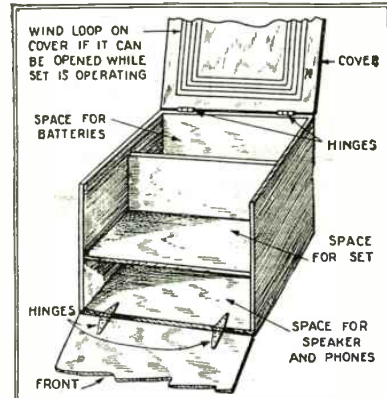

A cabinet of this type will be found excellent for a portable super-heterodyne, which may thus be entirely self-contained.

OBTAINING A CABINET

So far, no consideration has been given to the matter of a portable cabinet. This is something which the average builder will probably wish to settle for himself, inasmuch as individual conditions vary from one extreme to another. It is suggested, however, that a case be procured from a luggage maker, which will have a compartment at the top for the receiver, behind which will be located another capable of taking six dry cells, six medium-size "B" batteries, and one "C" battery. This should be separated from the set compartment by a wooden partition. Below this there should be another compartment large enough to take the loud speaker and a pair of headphones: A folded loop can also be placed here very easily, though the constructor will probably prefer to wind the loop on the back of the cabinet. If this is the case, it should consist of 22 turns of suitable loop wire fastened to the back of the cabinet with small tacks so that the turns form the spiral, each 3/16-inch from its neighbor.

If, at the end of the portable season, it is desirable to install the receiver for home operation, no change will be required except in the event that storage battery tubes are to be used. If this is done, 201-A tubes should be used in all sockets except the second audio, where a UX-112 tube will perform most efficiently. The "B" battery should, of course, be larger and a storage "A" battery should be used. The loop and the operation

(Continued on page 93)

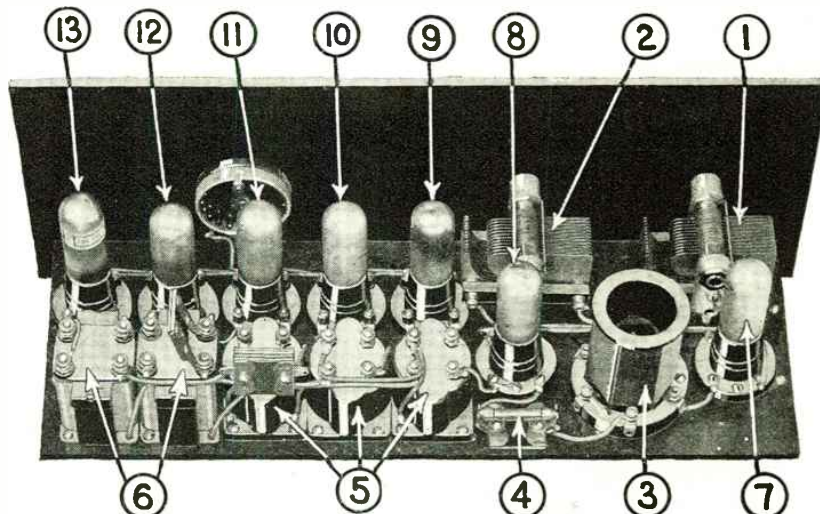

Nos. 1 and 2 show the tuning condensers; 3, oscillator coil; 4, grid leak and condenser; 5, I.F. transformers and filter transformer (with condenser mounted); 6, A.F. transformers; 7, oscillator tube; 8, first detector; 9 and 10, I.F. tubes; 11, second detector; 12 and 13, A.F. tubes. Photos by courtesy of Silver-Marshall, Inc.

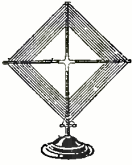

The Reflex Five

By JOSEPH RILEY

Here is a new idea in reflex receivers, which presents an innovation in the types of radio-frequency transformers used.

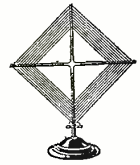

THE reflex idea in radio circuits still reigns supreme for the production of maximum distance and volume from a given number of tubes. But in this, as in all other circuits, the law of compensation holds true. You can't get something for nothing; and the crowding of double frequencies through a series of tubes is apt to cause instability. In addition, untuned transformers in the radio frequency stages are less efficient than those which are tuned; yet almost all of the usual reflex circuits employ these untuned transformers throughout.

The diagram on this page shows a reflex circuit which combines the best features of tuned transformer-coupling, aperiodic transformer-coupling, and reflex. Five tubes are used to do the work of six. Thus only one tube carries dual frequencies, and instability is done away with.

the detector, is made to serve as a volume- and clarity-control, by means of a 2000-ohm rheostat shunted across its secondary. From the plate circuit of the detector the rectified wave is fed back to the grid circuit of the third tube through an audio frequency transformer. This third tube is the only one which is reflexed. From its plate circuit the audio frequency signals are passed through the second iron-core transformer to the grid of the fifth tube, which acts as the second audio frequency amplifier.

A NOVEL R.F. TRANSFORMER

An inspection of the circuit diagram reveals the fact that the coupling, in the first inter-stage R.F. transformer, and the capacitance of the condenser shunted across the loop are varied simultaneously by single-shaft mounting. In the half-tone showing the top view

windings, so arranged that the coupling and inductance may be varied simultaneously. Due to the fact that its inductance does vary, a larger capacitance is needed across this coil than across the others in the set, and the minimum must be higher than usual. For this reason the second tuning condenser is equipped with a fixed shunt capacitance of .0004 μf , and the total variation is from slightly over .0004 to slightly more than .0009 μf .

The 6-ohm rheostat controls the detector tube only, which is of the UV-200 soft variety. A fixed ballast resistance of one ohm is used in series with the battery lead to the other filaments. Both rheostats, the 6-ohm and the 2000-ohm, are varied by knobs on concentric shafts

ASSEMBLY OF THE REFLEX FIVE

If the parts for this receiver are bought as a complete kit, the first condenser and D-coil will come mounted as a single unit, and a drilled metal panel will be supplied as part of the equipment. In any event, it is not recommended that the home constructor try to make the D-coil himself, as its construction is quite complex; entailing, among other things, a contact bushing with four flexible pigtail connections to the rotor.

SUGGESTIONS FOR BUILDERS

The top and rear view of the completed set shows the arrangement of parts. If the kit is purchased complete, the metal panel will come completely drilled, and the mounting of the condensers, twin rheostat, etc., will be a simple matter. If, on the other hand, a panel of some insulating material is to be used, a shield of copper foil should be fastened to it and the holes for mounting drilled through both panel and shield. It is not necessary to insulate the mounting posts on the condensers from the shield. They should be connected to it, and the shield grounded. It will simplify wiring if the radio frequency components are mounted and wired before the audio frequency parts, or the binding post strip. This will tend also

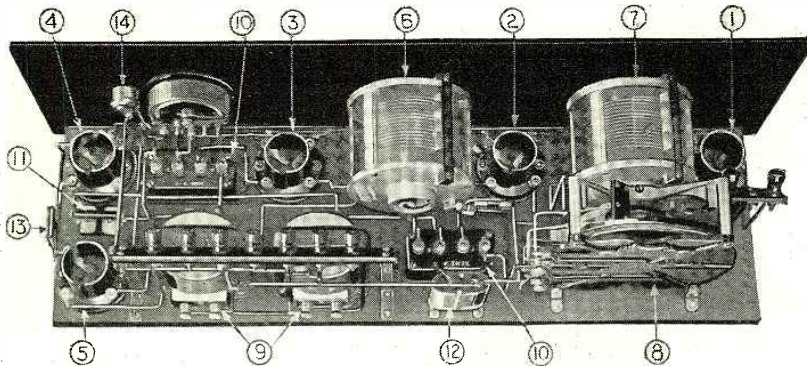

1, 2, and 3 are R.F. tube sockets; 4, detector; 3 and 5, A.F. sockets; 6 and 7, tuning condensers; 8 and 10, R.F. transformers; 9, A.F. transformers; 11, grid leak and condenser; 12 and 13, by-pass condenser; 14, filament switch.

Photo by courtesy Acme Apparatus Co.

As an inspection of the diagram will show, the first three tubes are radio frequency amplifiers; the grid circuits of the first two are tuned by means of condensers. The transformer, which couples the plate circuit of the third R. F. amplifier to the grid of

of the completed receiver, this method of mounting may be seen at the right. No. 7 is the loop condenser and No. 8 the first radio frequency transformer, or D-coil.

The D-coil is the most interesting feature in this set. It is composed of eight separate

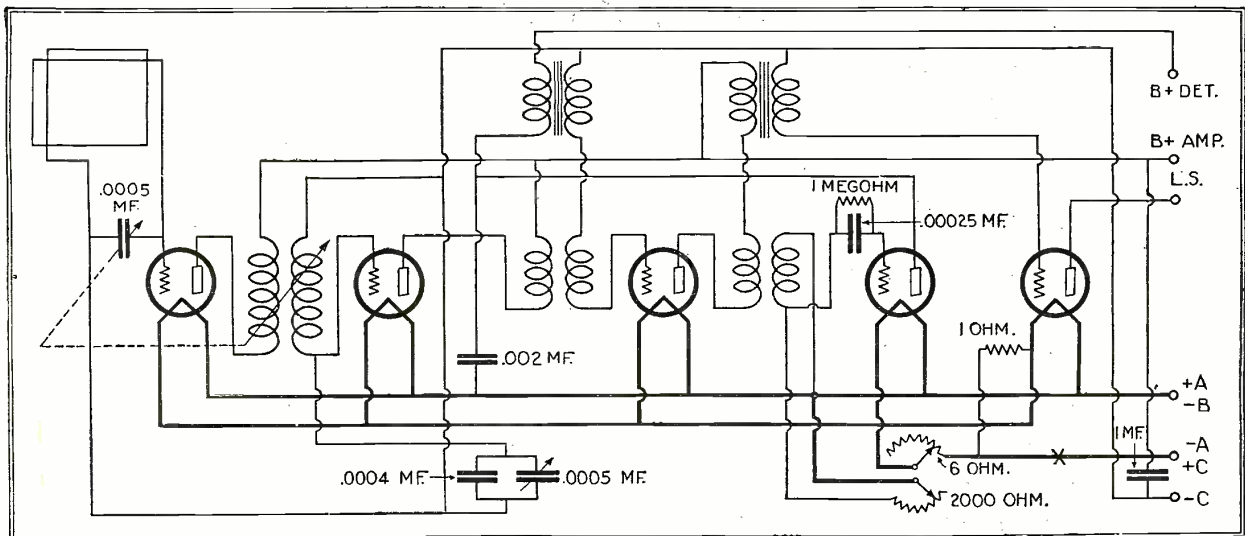

This five-tube reflex receiver combines the best features of tuned and aperiodic transformer coupling, as well as reflex.

RADIO SET DIRECTORY

IN presenting various sets in a directory of this kind, it is naturally possible to touch only the high points. We have therefore listed all outfits under a simple classification that will, we hope, be of great service to the public, as well as to the trade. We have attempted in this directory to list every set manufactured in this country, but although we have written a number of letters to all manufac-

turers, not all have replied. In order to make the directory complete, all sets manufactured by any one manufacturer listed have been included.

The Directory will be kept up to date, month by month. All manufacturers are invited to send monthly corrections as to the various features of the sets which they produce.

Manufacturer: F. A. D. ANDREA, Inc., 1581 Jerome Ave., New York City
Trade Name: FADA "Neutroceiver"
Circuit: Neutrodyne
Batteries: Dry cell or storage
Antenna: Outdoor or Indoor (outdoor preferred)
Loud Speaker: Separate
Controls: Three
List Price: \$125.00

Trade Name: FADA "Neutrola"
Circuit: Neutrodyne
Batteries: Storage or dry cell
Antenna: Outdoor or indoor (outdoor preferred)
Loud Speaker: Built-in
Controls: Three
List Price: \$175.00

Trade Name: FADA Neutrodyne Phonograph Panel
Circuit: Neutrodyne
Batteries: Storage or dry cell
Antenna: Outdoor (designed for outdoor)
Loud Speaker: Separate
Controls: Three
List Price: \$100.00

Trade Name: FADA Davenport Table (Console)
Circuit: Neutrodyne
Batteries: Dry cell or storage
Antenna: Outdoor or indoor (designed for outdoor)
Loud Speaker: Built-in
Controls: Three
List Price: \$225.00

Trade Name: FADA Queen Ann Desk
Circuit: Neutrodyne
Batteries: Storage or dry cell
Antenna: Outdoor or indoor (designed for outdoor)
Loud Speaker: Built-in
Controls: Three
List Price: \$300.00

Trade Name: FADA Console
Circuit: Neutrodyne
Batteries: Dry cell or storage
Antenna: Outdoor or indoor (designed for outdoor)
Loud Speaker: Built-in
Controls: Three
List Price: \$275.00

Trade Name: FADA Beethoven Grande
Circuit: Neutrodyne
Batteries: Dry Cell or storage
Antenna: Outdoor or indoor (designed for outdoor)
Loud Speaker: Built-in
Controls: Three
List Price: \$250.00

Manufacturer: KELLOGG SWITCHBOARD & SUPPLY CO., 1066 W. Adams St., Chicago, Ill.
Trade Name: Wave Master (Table Type)
Circuit: Tuned radio frequency
Batteries: Storage or dry cell
Antenna: Outdoor
Loud Speaker: Separate

Controls: One
List Price: \$125.00

Trade Name: Wave Master (Console) without battery table
Circuit: Tuned radio frequency
Batteries: Storage or dry cell
Antenna: Outdoor
Loud Speaker: Built-in
Controls: One
List Price: \$225.00

Trade Name: Wave Master (Console) with battery table
Circuit: Tuned radio frequency
Batteries: Storage or dry cell
Antenna: Outdoor
Loud Speaker: Built-in
Controls: One
List Price: \$235.00

Trade Name: Kellogg R.F.L. Receiver
Circuit: Balanced tuned radio frequency
Batteries: Storage or dry cell
Antenna: Indoor
Loud Speaker: Separate
Controls: One
List Price: \$400

Manufacturer: KEN-MAR RADIO CORPORATION, Danvers, Mass.
Trade Name: International Babydyne Model No. 10
Circuit: Regenerative
Batteries: Dry Cell
Antenna: Outdoor
Loud Speaker: None
Controls: One
List Price: \$10.00

Trade Name: International Babydyne Model No. 11
Circuit: Regenerative
Batteries: Dry Cell
Antenna: Outdoor
Loud Speaker: None
Controls: One
List Price: \$13.50

Trade Name: Kenmar 4
Circuit: Tuned radio frequency
Batteries: Both
Antenna: Both
Loud Speaker: Separate
Controls: Two
List Price: \$85

Trade Name: Lincoln
Circuit: Tuned Radio Frequency
Batteries: Dry or wet
Antenna: Outdoor
Loud Speaker: Not enclosed
Controls: Three
List Price: \$30. DeLux Model: \$35
Tubes: Five

Manufacturer: COLIN B. KENNEDY CORP., 2017 Locust St., St. Louis, Mo.
Trade Name: Kennedy Royal Sixteen
Circuit: Balanced tuned radio frequency
Batteries: Optional
Antenna: Loop or outdoor
Loud Speaker: Built-in
Controls: Two
List Price: \$235

Trade Name: Kennedy Model 20
Circuit: Balanced tuned radio frequency
Batteries: Optional
Antenna: Outdoor

Loud Speaker: Separate
Controls: One
List Price: \$80

Trade Name: Kennedy Model 30
Circuit: Balanced tuned radio frequency
Batteries: Optional
Antenna: Indoor or outdoor
Loud Speaker: Separate
Controls: Two
List Price: \$145

Manufacturer: KODEL RADIO CORPORATION, 507-521 E. Pearl St., Cincinnati, Ohio
Trade Name: Logodyne Big 5 Cabinet
Circuit: Tuned radio frequency
Batteries: Either
Antenna: Outdoor preferably
Loud Speaker: None
Controls: Three
List Price: \$90

Trade Name: Logodyne Standard 5 Cabinet

Notice to Readers

Detailed information respecting the following sets, or any other receiving sets, may be had on inquiry by addressing a letter to the Editor of the Set Directory, RADIO NEWS.

Circuit: Tuned radio frequency
Batteries: Either
Antenna: Either
Loud Speaker: None
Controls: Three
List Price: \$70

Trade Name: Logodyne Big 5 Console
Circuit: Tuned radio frequency
Batteries: Either
Antenna: Either
Loud Speaker: Built-in
Controls: Three
List Price: \$275

Trade Name: Logodyne Standard 5 Console
Circuit: Tuned radio frequency
Batteries: Either
Antenna: Either
Loud Speaker: Built-in
Controls: Three
List Price: \$165

Trade Name: Kodol Gold Star
Circuit: Kodol
Batteries: Dry cell
Antenna: Either
Loud Speaker: Separate
Controls: Two
List Price: \$30

Trade Name: Kodol Gold Star Cabinet
Circuit: Kodol
Batteries: Dry cell
Antenna: Both
Loud Speaker: Separate
Controls: One
List Price: \$20

Trade Name: Kodol
Circuit: Kodol
Batteries: Dry cell
Antenna: Either

Loud Speaker: Separate
Controls: One
List Price: \$12

Trade Name: Kodol Gold Star Crystal
Antenna: Outdoor
List Price: \$60

Trade Name: Logodyne Unitrola Universal Phonograph receiving set
Circuit: Tuned radio frequency
Batteries: Either
Antenna: Either
Loud Speaker: Separate
Controls: Three
List Price: \$87.50

Trade Name: Kodol Four-Tube Portable
Circuit: Kodol
Batteries: Dry cell
Antenna: Either
Loud Speaker: Built-in
Controls: Two
List Price: \$75

Trade Name: Kodol Two-Tube Portable

Circuit: Kodol
Batteries: Dry cell
Antenna: Both
Loud Speaker: Separate
Controls: One
List Price: \$25

Trade Name: Kodol One-Tube Portable
Circuit: Kodol
Batteries: Dry cell
Antenna: Both
Loud Speaker: Separate
Controls: One
List Price: \$18

Trade Name: Logodyne Panel Assembled Kits
Circuits: Tuned radio frequency
Batteries: Either
Antenna: Either
Loud Speaker: None
Controls: Three
List Price: \$65, \$50

Manufacturer: K O L - S T E R RADIO, Woolworth Bldg., New York City, N. Y.
Trade Name: Kolster Model 8-B
Circuit: Tuned radio frequency
Batteries: Dry Cell A and B
Antenna: Indoor or outdoor
Loud Speaker: Built-in
Controls: One
List Price: \$280.00

Trade Name: Kolster Model 8-C
Circuit: Tuned radio frequency
Batteries: Dry cell
Antenna: Indoor or outdoor

Loud Speaker: Built-in
Controls: One
List Price: \$375.00

Trade Name: Kolster Model 6-A
Circuit: Tuned radio frequency
Batteries: Dry cell or storage
Antenna: Indoor or outdoor
Loud Speaker: Separate
Controls: Two
List Price: \$175.00

Trade Name: Kolster Model 6-B
Circuit: Tuned radio frequency
Batteries: Dry cell or storage
Antenna: Indoor or outdoor
Loud Speaker: Built-in
Controls: Two
List Price: \$225.00

Trade Name: Kolster Model 6-C
Circuit: Tuned radio frequency
Batteries: Dry cell or storage
Antenna: Indoor or outdoor
Loud Speaker: Built-in
Controls: Two
List Price: \$250.00

Manufacturer: LEICH ELECTRIC CO., Genoa, Ill.
Trade Name: Leich
Circuit: Tuned radio frequency, special method of neutralizing.
Batteries: Storage
Antenna: Outdoor
Loud Speaker: Separate
Controls: Three
List Price: \$100.00

Manufacturer: LE MOR RADIO, Inc., P. O. Box 517, Asbury Park, N. J.
Trade Name: Le Mor Uni-Control Receiver
Circuit: "Pretuned" radio frequency
Batteries: Storage A-B, battery space in cabinet
Antenna: Indoor or outdoor
Loud Speaker: Separate
Controls: One
List Price: \$145.00

Manufacturer: MACHINE SPECIALTY CO., Summit and Wildt Sts., Ann Arbor, Mich.
Trade Name: Arbor-Phone Cabinet
Circuit: Tuned radio frequency
Batteries: Storage
Antenna: Outdoor
Loud Speaker: Separate
Controls: Three
List Price: \$55.00

Trade Name: Arbor-Phone Console
Circuit: Tuned radio frequency
Batteries: Storage
Antenna: Outdoor
Loud Speaker: Built-in
Controls: Three
List Price: \$88.00

Manufacturer: MAG-NAVOX CO., 2725 East 14th St., Oakland, Calif.
Trade Name: Magnavox Model 10

Circuit: Magnavox tuned radio frequency
Batteries: Storage
Antenna: Outdoor or indoor
Loud Speaker: Separate
Control: One
List Price: \$110 without accessories

Trade Name: Magnavox Model 25
Circuit: Magnavox tuned radio frequency
Batteries: Storage
Antenna: Outdoor and indoor
Loud Speaker: Built-in
Control: One
List Price: \$145 without accessories

Trade Name: Magnavox Model 75
Circuit: Magnavox tuned radio frequency
Batteries: Storage
Antenna: Outdoor and indoor
Loud Speaker: Built-in
Control: One
List Price: \$200 without accessories

Trade Name: Magnavox Junior
Circuit: Magnavox tuned radio frequency
Batteries: Storage
Antenna: Outdoor and indoor
Loud Speaker: Separate
Control: One
List Price: \$85 without accessories

Manufacturer: MARTIN RADIO & ELECTRIC CO., 130 West 52nd St., New York City
Trade Name: Packard 5
Circuit: Tuned radio frequency
Batteries: Storage
Antenna: Outdoor
Loud Speaker: Separate
Controls: Three
List Price: \$45

Manufacturer: MID-WEST RADIO CORP., 410 E. 8th St., Cincinnati, Ohio
Trade Name: Miraco Model R
Circuit: Regenerative
Batteries: Dry cell or storage
Antenna: Outdoor
Loud speaker: Separate
Controls: Two
List Price: \$13.75, without accessories

Trade Name: Miraco Model R3
Circuit: Regenerative
Batteries: Dry cell or storage
Antenna: Outdoor
Loud Speaker: Separate
Controls: Two
List Price: \$27.35, without accessories

Trade Name: Miraco Ultra 5
Circuit: Tuned radio frequency
Batteries: Storage
Antenna: Outdoor
Loud Speaker: Separate
Controls: Three
List Price: \$59.50, without accessories

(To be continued in the August issue.)

A Departure in Radio Tube Design

By H. K. HUPPERT*



Two new vacuum tubes make their appearance; one designed particularly for use as a radio-frequency amplifier—the other the “Quadrotron”, a four-element tube, no doubt, will allow us a step further in the development of circuits.



WITH the advent of popular interest in radio broadcasting, many of the peculiarities of radio science previously known only to the highly technical engineer and in a degree to the so-called amateur have in the last few years become matters of common experience. Through actual use and the many articles written on the subject, the broadcast listener has been educated to such an extent that he has learned to discriminate, not only between sets as efficient receivers and good looking

which is thereby lost. The writer has recently designed a tube which by its peculiar construction overcomes this difficulty, through minimizing the grid-plate capacity and reducing it to almost one half that of the so-called standard 201-A type tube. Fig. 1 illustrates that the area of the grid in this tube is cut down about one-half, and with it the grid-plate capacity. The general characteristics of this tube make it very desirable as a radio-frequency amplifier, especially on short wave-lengths where the

frequency is so tremendously high and the capacity effect such a great detriment. The plate resistance or impedance of this tube is only about 9,000 ohms and its amplification factor about 8.5.

DETECTORS

In designing a special detector tube, many factors must be considered. First, it should operate on a low plate voltage and be non-critical in filament adjustment and non-microphonic. Second, the resistance or impedance

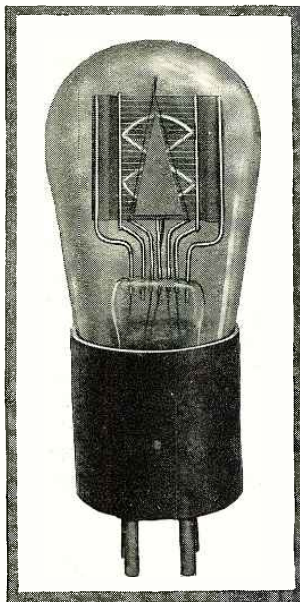

The “Quadrotron” tube. The triangular object mounted in the center of the assembly constitutes the fourth element or “control grid.”

furniture, but also between the accessories, especially tubes. It is common experience to see a radio fan change his tubes around in the set to get better results, both for distance and quality. He has learned that there is a difference in principle and operation between the radio-frequency tubes, detectors and audio-frequency tubes.

RADIO-FREQUENCY TUBE CAPACITY

In the past, tubes were designed to meet all general requirements and made to function fairly well in all positions in the receiving set. The writer has made a study of the general tendencies and ultimate requirements, particularly in vacuum tubes. He has found that one of the most important factors in amplifying received signals or broadcasting programs is to make full use of all the very minute energy received and suffer no loss in the process. The greatest amount of energy is no doubt lost in the so-called radio-frequency part of the circuits, particularly in the tubes. Those who have studied this subject to any extent will agree with the writer that the condition known as capacity effect is the greatest “bug-bear” in radio-frequency tubes.

The plate and grid in the usual radio receiving tube have a capacity of about nine to ten micro-micro-farads. This capacity bypasses the greater amount of radio energy.

IT is difficult to understand why engineers have repeatedly cast aside the four-element tube; since it is apparent that the device, from the theoretical, if not the practical standpoint offers advantages not to be derived from the common form of “triode” or three-element tube.

Four-element tubes have been used in European countries for some time and with considerable success, as explained in an article in the December, 1925, issue of RADIO NEWS. Their advantages are particularly evident in circuits requiring means for stabilization. But their effectiveness does not end here for the tubes can play a dual role where required. Therefore they are adaptable to reflex and super-regenerative circuits and, in this respect, offer new fields for experimentation. It is quite probable that the extent to which radio-frequency amplification is obtained will be increased above the present maximum by developing new circuits around a four-element tube.

Mr. Huppert, who is far-sighted enough to realize the value of a tube of this sort, has diligently pursued the subject of its design; and he offers us at this time, not only an original type of four-element tube, but also a tube with a very low inter-element capacity, designed particularly for use as a radio-frequency amplifier. —EDITOR.

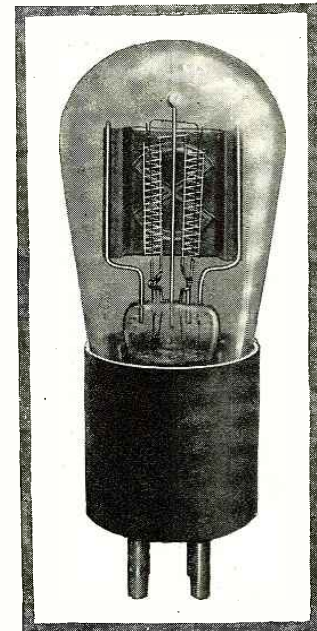

A tube so designed that it has a very low inter-element capacity. Note the slender two-section grid.

between filament and plate of the tube must approximate the reactance of the transformer primary into which it feeds. This, of course, must hold for all good tubes, but particularly in detectors. The third, and most important, factor in a detector tube is the grid construction and function. The applied voltage changes on the grid of the detector are often so great, on account of the radio-frequency amplification preceding it, that a detector cannot handle the power without distortion. This is due to the fact that this tube has a double function. It must rectify and amplify the received impulses.

Bearing the above factors in mind, the writer has designed a tube that is especially desirable as a detector and it is surprising to note just how much difference it makes in a set for quality and volume.

AUDIO FREQUENCY

A really good audio-frequency amplifier must fulfill one most important condition. It must produce in the output circuit an enlarged and most exact copy of the original signal impressed on the grid. It must be able to handle a great amount of energy without distortion, and yet consume not too much “B” battery energy. The efficiency of an audio-frequency tube is conveniently

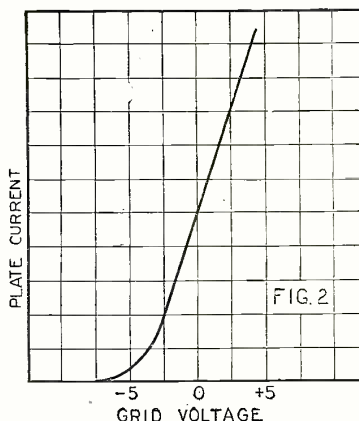

The graph of a good audio-frequency amplifier tube. It will be noted that any slight change of grid voltage produces a large flow of plate current.

*Consulting Engineer, Baker-Smith Co.

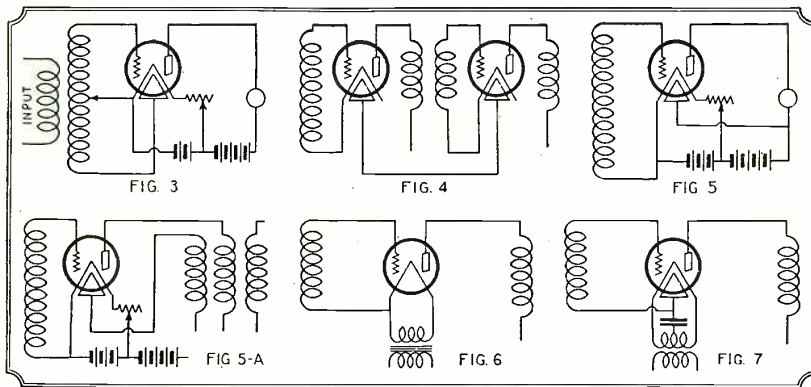

Circuits wherein the "Quadrotron" is utilized. Fig. 3 represents a form of push-pull amplifier. Figs. 4, 5 and 5-A depict two methods of equalizing tube capacity by means of the fourth element. This "control grid" is of particular advantage in a circuit using filtered A.C. for heating the filaments of the tubes. The circuit is outlined in Fig. 7.

tested and charted as shown in Fig. 2. It shows the characteristics of a good amplifier graphically. The steepness of this curve, plotted from meter readings, is a direct measure of the value of the tube as an amplifier because it shows how small a change in grid voltage will cause a great change in plate current. That is, the steeper the curve, and the more change in plate current with a definite small change in grid voltage, the louder the signal will be amplified. This also illustrates the amplification factor of the tube, from which other constants may be computed.

THE "QUADROTRON" OR 4-ELEMENT TUBE

As stated above, the writer has been active in electron research work for a number of years. On analyzing the general radio industry and condition, he found that a most peculiar psychological condition exists in this field for some time. It seems that, with a few exceptions, nobody has really tried to improve upon the most essential part of the radio set: "the three-element tubes."

European engineers, by virtue of their training and mode of reasoning, have not stopped where Dr. de Forest did with his most original and important addition of the third element in the tube, the grid, but have continued to experiment with various additional elements to increase the efficiency and adaptability of the tubes. However, none of their tubes have found favor in the eyes of the American manufacturers and radio fans, because it seems that the American industry has accepted the three-element tube as a sort of fundamental hypothesis. They have built around this three-element tube thousands of wonderful circuits, but in the end have always found that they are limited by the construction of this tube. Still nobody seems to break away from their pet circuits and overcome these limitations.

The writer has recently perfected a four-element tube which may be adapted to any standard circuit or set advantageously. The various advantages and improvements are the result of diligent study and experiments, trying to bring out a tube of improved characteristics with a higher amplification constant, without increasing the impedance of the tube. A tube that will neutralize or balance the capacity effect automatically is a great factor in neutrodyne sets. Another advantage is that any set may be made regenerative or a reflex without extra equipment. Self-oscillation in the set can be easily controlled by means of this fourth element. Another novel feature in this tube is that it may be operated on the alternating current without the usual annoying hum.

EFFECT OF THE AUXILIARY GRID

Fig. 3 illustrates how this tube operates as a sort of push-pull amplifier. You will note

that there are the usual three elements with a fourth added, so spaced within the tube and circuit that the fourth element will at all times be of opposite polarity from the grid. In this way, both impulses of the received cycle are utilized as a control factor. When the usual grid is charged with a negative potential, no electrons should reach the plate. Those that do leave the filament are absorbed by the fourth element, called the auxiliary grid. During the other half of the cycle, the auxiliary grid is charged negatively and accelerates the flow of electrons to the plate.

The difficulty of neutralizing the capacity in neutrodynes is easily overcome with this tube; by simply connecting all the fourth elements, or auxiliary grids of the tubes, and taking advantage of the capacity coupling between the auxiliary grids and the other elements, as shown in Fig. 4.

The principles underlying the regenerative and reflex circuits are just these: An amplified copy of the input energy is coupled back inductively to the input circuit from the audio or plate circuit. This same result is achieved by connecting the auxiliary grid to the audio-frequency or plate circuit, as shown in Fig. 5. This acts the same in all respects as in Fig. 3 except for a higher potential as a control factor.

To control oscillations the auxiliary grid can be connected to any part of the circuit, depending upon the general design.

OPERATING ON A.C.

The reason a hum is caused in the set, when operating tubes on alternating current, is that the grid return is usually connected directly to one side of the filament; and thereby receives either a negative or positive charge, as shown in Fig. 6, which is amplified in the plate circuit. Fig. 7 illustrates how this difficulty is overcome with this new tube. There is no actual connection of the grid return to the filament, but it goes instead to the auxiliary grid, which is completely surrounded by the filament and is, therefore, uni-potential. The grid-filament circuit is still operative by means of capacity coupling between the filament and auxiliary grid. Should this be insufficient, a condenser of the correct capacity may be connected between the center tap of the filament transformer and the auxiliary grid.

A number of new special circuits have been built around this tube, and it is causing some interest among amateurs and manufacturers of sets. There are so many ways of using this versatile tube that it is hard to enumerate them all. To the radio fan in general, suitable information for all standard sets and circuits will be given by the writer in the near future in RADIO NEWS. There is no question that this unique development will abridge many gaps in radio.

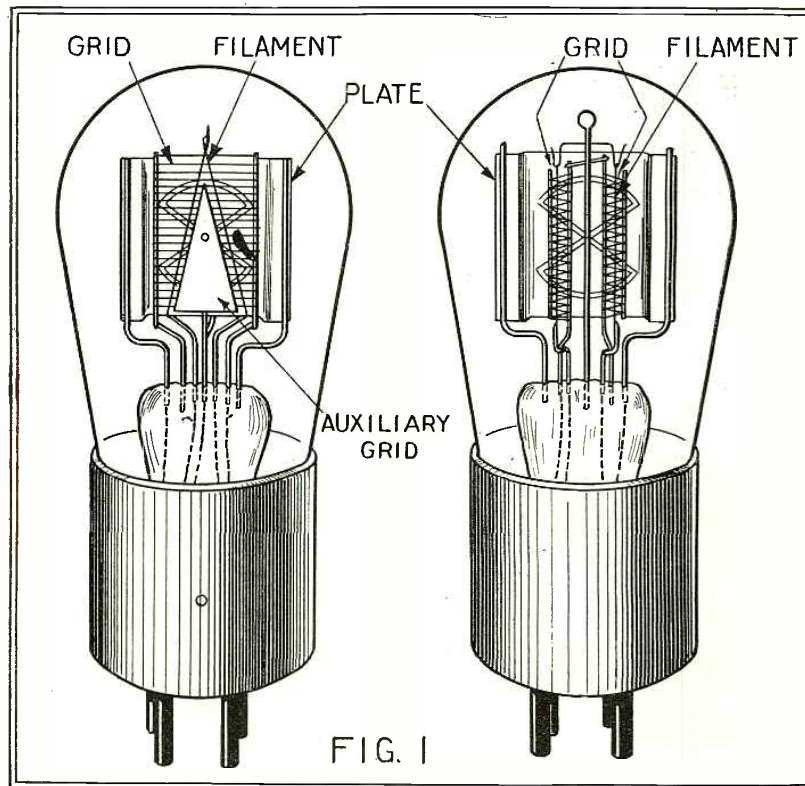
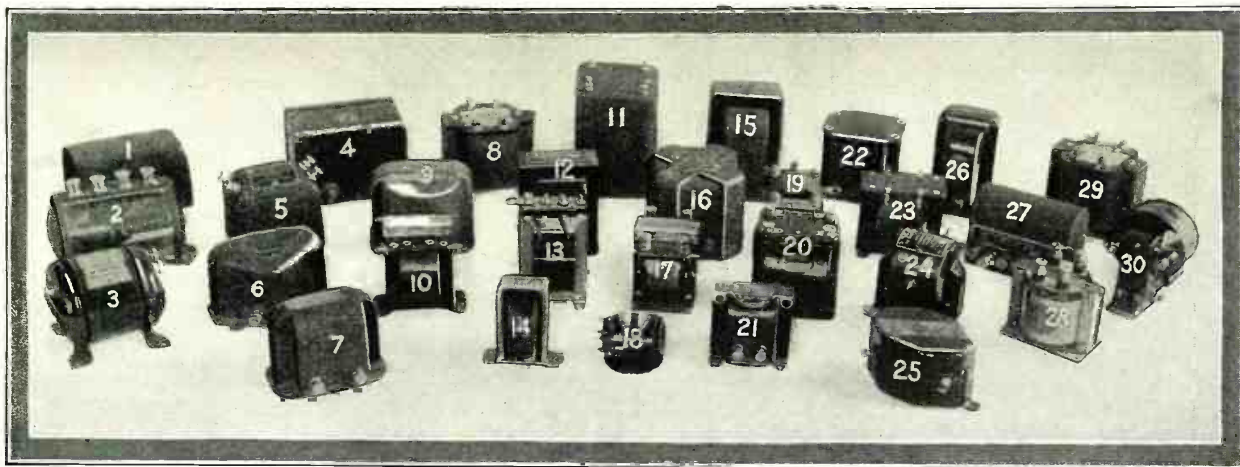

FIG. 1

Constructional details of the two vacuum tubes described in this article. The auxiliary grid shown in the left-hand tube functions as a control element. A number of circuits particularly adaptable to this tube are shown above.



A group of the commercially-manufactured A.F. amplifier transformers which are being studied in the RADIO NEWS laboratories: 1, Como (push-pull); 2, General Radio (English); 3, Karas; 4, Jefferson; 5, Modern Symphony; 6, Precise; 7, Perry; 8, Wagner; 9, Acme; 10, Quality; 11, Marlefer; 12, Thordarson; 14, Thompson-Levering; 16, Erla; 17, Supertran; 18, Hedgehog; 20, Samson; 21, Dongan; 22, Amertran; 23, Kellogg; 24, All-American; 25, Bremer-Tully; 26, General Radio (American); 27, Como (variable ratio); 28, Foster; 29, Magic; 30, Hart & Hegeman.

How Should Transformer Curves Be Plotted?

By SYLVAN HARRIS



The question of the best scale to use, when drawing the "characteristic curve" of an audio-frequency amplifier on a diagram, has been given much attention recently by writers and experimenters. As often happens, the radio laymen have not yet been given full information. Mr. Harris treats the matter thoroughly and completely below, presenting some ideas which will be new to the fraternity.



THE first article in this series on Audio-Frequency-Amplifier Transformers, which appeared in the June issue of RADIO NEWS, contained a short outline of the requisites and functions of transformers, coupled with an explanation of the frequencies which they must be designed to amplify. It was shown how necessary it is, for satisfactory reproduction, that the factor or ratio of amplification should be constant over the entire range—in other words that neither high nor low tones should be exaggerated or suppressed—because radio programs, musical ones especially, are composed of very complicated sound waves; and unequal amplification produces a distortion of the reproduced sounds, which alters their quality.

The reader of this and subsequent articles should not fail to refer to the previous discussion, if he has not already familiarized himself with its contents; as it is a necessary introduction to those which follow. There is much more to be said about the requirements

for good amplifiers; but sufficient proof has been given already of the value of "characteristic" curves, in the design and choice of transformers. Parenthetically, much which has been said of transformers is of equal value in the consideration of other amplifier-coupling devices, such as impedance and resistances, etc.

There was also given, in the previous issue (June) referred to, a short article describing the method used in the RADIO NEWS Laboratories for the purpose of testing amplifiers and determining their characteristics. That article was written for the technically-informed reader; but the series of which the present one is a part is intended for the general public.

We come now to the question "How shall the characteristics be represented, so that the transformers and their properties may be most easily studied and compared?"

This article, in its dealing with this subject, is not mere repetition of what has previously been placed before the radio pub-

lic; but presents ideas which have hitherto received the attention of only a few engineers and technical writers.

HOW DIAGRAMS ARE MADE

When it is desired to illustrate the ratios existing between two or more variable quantities, so that the eye can comprehend them at a glance, a "graph" is made, by plotting the quantities on cross-section paper. The latter, commonly called graph paper, is ruled in various styles, of which the simplest is made by ruling parallel lines, vertical and horizontal, spaced equally apart. This style of ruling is shown in Fig. 1, on which is drawn a sample "frequency-voltage-characteristic curve" of an amplifier-transformer.

In all styles of graph paper, the distances measured on the vertical lines are called *ordinates*; and the distances measured on the horizontal lines are called *abscissas*. The latter is derived from a Latin word signifying "cut off."

Generally speaking, the ordinates and abscissas are called "co-ordinates"; although this term is more accurately applied to the location of particular points. The co-ordinates, for instance, of the point A in Fig. 1 are 1100 (cycles per second) and 22.2 (voltage-amplification ratio). The term "voltage ratio" is used throughout these articles in preference to "amplification."

Where the ordinates and abscissas are equally spaced (for equal numbers) and are at right angles to each other, they are called *Cartesian* co-ordinates, after the inventor of the system, the French mathematician, Rene Descartes—in Latin, *Cartesius*.

Returning to Fig. 1, it will be noted that both ordinates and abscissas are plotted in simple arithmetical progression, without giving any thought to the relation which the numbers bear to physiological sensations. But, in dealing with amplifiers used in radio receivers, we must not lose sight of the paramount fact that their action is connected intimately with the conversion of electrical impulses into sound waves. Therefore, if we are to consider the whole matter from a physiological standpoint, we should use the sense of sight to convey to our minds ideas

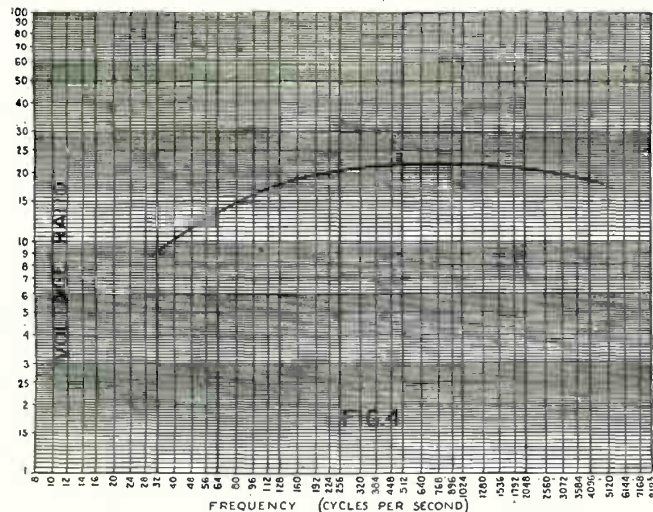

Here is an example of the manner in which Mr. Harris says that amplifier characteristics should be plotted. A special "logarithmic scale" is used for the horizontal distances, giving each octave an equal space—that between the heavy vertical lines. The vertical scale, that of voltage step-up, is logarithmic also, but on a different scale based on a study of the sensation of loudness, as explained elsewhere. The resulting curve shows most intelligently the effect on the ear of the tones emerging from the phones or speaker when the A.F. currents of the frequencies causing them have passed through this amplifier.

corresponding to those impressed upon it by the sense of hearing.

WHY OTHER SYSTEMS ARE USED

Other writers, in attempting to accomplish this purpose, have employed various systems of co-ordinates, well known and often used by mathematicians, but little known to the average reader. The interesting fact is that so far no writers of popular radio articles have gone far enough to finish the job; and it is the purpose of this article to do so, if possible.

It will be noted in Fig. 1, which shows the characteristic curve of a fairly good transformer, that the ratio of output voltage to input voltage is zero at zero frequency, and rises very rapidly as the frequency increases; until it attains its maximum at about 600 cycles, and from that point falls off gradually as the frequency increases. The lower-frequency range of a transformer is very important in reproducing music. As illustrated in the first article of this series, the frequency range of the instruments of an orchestra is from about 32 cycles to about 4,000, without taking into consideration the overtones of the higher notes, which, although weak, have some effect in determining the quality of reproduction. This range is that of the *fundamental* tones of the piano, while the organ has an even greater range.

Again consulting Fig. 1, the lower part of the curve is found rather closely squeezed together, with regard to the acoustic considerations. A tone having a frequency of 1,100 cycles is rather high; referring to the piano, we find it a little more than two octaves above middle C. It is apparent that the lower portion of the curve is extremely important: a curve as steep as that in the low-frequency region of Fig. 1 is difficult to read, and certainly not accurate. Furthermore, it does not tell us what we want to know.

WHY THE "LOGARITHMIC" SCALE

In Fig. 2 is the key to the solution of our problems. In this chart is shown part of the piano-keyboard as the "axis of abscissas," and above it, as *ordinates*, are plotted the numerical frequencies of the various notes. It will be seen that the Cartesian system of uniform spacing is not used in the vertical scale of ordinates or frequencies. The reason for this is a little difficult to explain in non-technical language, but we will do our best.

Suppose we consider middle C on the piano keyboard, indicated in the diagram as *c'*. The next octave above this, or *c''* has a frequency twice that of *c'*. In other words, although the distance along the axis of abscissas (horizontal) increases in equal amounts as we go from C to *c'*, from *c'* to *C''*, from *c''* to *c'''*, in each case the frequency is doubled; because the frequency is multiplied by two, from each octave to the next.

Thus, let *f* indicate the frequency of any note at which we start, and the octaves will be *f*, *2f*, *4f*, *8f* and so on. This is a *geometrical* progression in powers of 2; and if we plot it on a *logarithmic* scale, which is the vertical scale of Fig. 2, a straight line results. This is the case in the diagram, except for the arbitrary manner in which the piano keyboard is laid out. Incidentally,

it may be said that the piano's musical scale is about as unscientific a thing as one can imagine. There are many approximations, and many slightly inharmonious chords and dissonances which result from them. However, so accustomed are we to this that we do not notice it, especially in orchestral music. The effect, however, is often noticeable in group singing without an accompaniment.

The "curve" of Fig. 2, therefore, is not exactly a straight line; there are kinks in it, due to the half-tones in the scale of the piano. However, the principle is correct, even if the pianoforte is not; so that we can use the logarithmic scale for our frequencies in plotting the frequency-voltage characteristics of transformers or other A.F. coupling devices. Note that we are proceeding step by step in this discussion.

In Fig. 3 we have the same characteristic as that in Fig. 1, but now we have used the "common or Briggs logarithmic" scale for the abscissas. The Briggs scale uses the number 10 as its *base*; in other words, each block in Fig. 3, going horizontally, has values in it which are the values of the preceding block multiplied by 10. Note how the curve

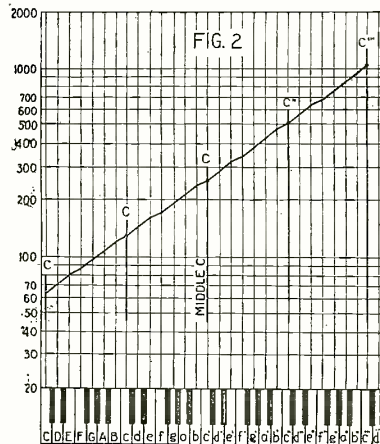

The piano scale is awkwardly arranged for our purposes; for its line of frequencies is not straight, but kinked by the presence of half or semi-tones. The line between points an octave apart, however, is straight, and we begin here, with our discussion.

is spread out in the lower-frequency range. This portion of the curve is beginning to show its true importance by its visual appearance.

EVEN DIVISIONS FOR OCTAVES

Having satisfied ourselves that a logarithmic scale is required, we have now to determine what kind of logarithmic scale to use. The one shown in Fig. 3 is "to the base 10." We have seen above that the musical octaves advance by a power of 2; it seems therefore, that 10 is the wrong base to use.

The human ear perceives octaves by extremely similar physiological sensations; each of the various notes in the scale of each octave is an octave of similar notes in other octaves, furnishing other likewise similar physiological sensations. There is good reason, therefore, why each octave should be

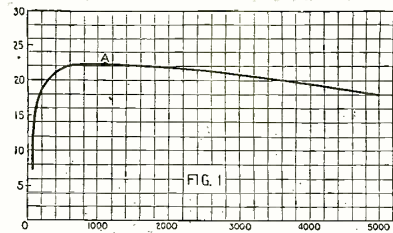

This is the curve of a transformer (the same as in Fig. 3 and 4) plotted in the ordinary manner, with an equally-spaced scale. See how nearly vertical the curve is at the low frequencies.

represented graphically in exactly the same fashion as any other octave. For this reason the writer has constructed a graph in which the frequency scale has been plotted logarithmically to the base 2. This is shown in Fig. 4, and it will be seen that each heavy vertical line represents one of the *c's* of the musical scale. The distance between adjacent heavy vertical lines represents an octave, each exactly similar to all the others. All the various notes in the octaves are not shown, as this would require a complicated scale, on account of the half-tones or semi-tones. The octaves are divided sufficiently, however, to enable us to plot the characteristics satisfactorily.

This plan is not original with the writer; it has been used before by Dr. Harvey Fletcher in his papers on the "Physical Measurements of Audition," presented in the *Bell System Technical Journal*, October, 1923, and July, 1925.

We have not quite finished with our system of plotting the curves. We have yet to consider how the physiological sensation of *loudness* depends upon the voltage ratio which we are plotting. In radio, as well as in the telephone business, according to the words of Dr. Fletcher, "the commodity being delivered to the customers is reproduced speech. One of the most important qualities of this speech is its loudness, so it is very reasonable to use a *sensation scale* to define the volume of speech delivered."

The problem is to decide what scale of sensation to use. The reader will begin to understand the nature of the problem when he asks himself "What do we mean when we say that one sound is twice as loud as another?" If we ask a similar question regarding the pitch of the sound, we can give an answer readily, because we have the octaves to use as mileposts. In the matter of loudness, however, we have no such simple criterion; so the choice of a scale of loudness must necessarily be somewhat arbitrary.

THE TELEPHONE SCALE OF LOUDNESS

However, the telephone companies have adopted a logarithmic unit for measuring the efficiency of their transmission apparatus; and the matter of chief interest in the latter, as with a radio set, is the effect upon the loudness of the speech reproduced at the receiving end. As a matter of convenience, tied up with certain intricate transmission-line calculations, they have adopted a scale such that the loudness difference is plotted as a *function of the common logarithm of the intensity ratio*.

This choice of scale is practically independent of the electron tube and the telephone receiver used in the last stage of audio-frequency amplification in a radio set; for, barring certain elements of distortion, the pressure on the diaphragm is proportional to the plate current in the unit; and this again is proportional to the voltage on the grid of the same tube.

In Fig. 4, therefore, we have what the writer believes to be the best method of representing graphically the frequency-voltage ratio characteristic of a transformer. So

(Continued on page 79)

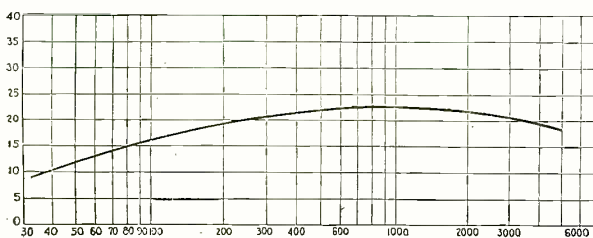

FIG. 3

This is the curve of the same transformer characteristics shown in Fig. 1, but it is here plotted on a paper ruled to a "common logarithmic" scale for its horizontal measurements. It will be seen how it opens up at the lower frequencies. Even more informative results are obtained by using the special scale, shown in Fig. 4 on the opposite page.

Awards of the \$50 Radio Wrinkle Contest

First Prize

SAFETY DEVICE FOR VACUUM TUBES

By W. A. AGNEW

All of us, at times, are a bit too careless in our manner of poking into a radio set, and in consequence at times we blow tubes. Though there are, presumably, numerous precautions we can take, such as disconnecting the batteries, there are those times when we forget.

It is less expensive, and far more satisfactory, to employ a protective device rather than to rely on our own senses; particularly if the device we employ will give a warning signal in the event that the "B" battery voltage is impressed on the "A" battery circuit.

Such an arrangement is the simplest thing imaginable and not at all expensive. A wooden board, an old door bell, a .002- μ f. fixed condenser and two binding posts complete the device. The connections are clearly

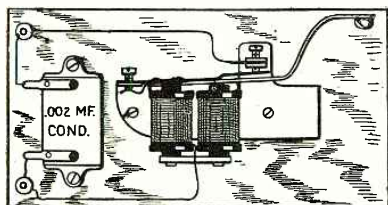

Details of the Vacuum Tube Safety Device.

shown in the accompanying illustration; both the condenser and the bell are wired to the binding posts.

The device is connected in series with the positive "B" battery lead. Then, should the plus "B" wire come in contact with one of the "A" battery leads, our safety device will buzz. At the same time the filaments of the vacuum tubes will dim but no harm will come to them. The reason is simple. The impedance of the bell magnet windings is too great to allow a sufficient amount of "B" battery current to pass to damage the tubes; yet does not, in any respect, retard the normal flow of "B" battery current. Furthermore, the normal "B" current is not great enough to cause the contact on the bell to make and break, as it will do when there is a short circuit. Consequently, a good contact is maintained at this point under normal operating conditions.

The fixed condenser functions as a by-pass for the radio-frequency currents.

Second Prize

TEMPORARY TUBE SOCKET

By HOMER E. HOGUE

Ever find yourself in need of a temporary tube socket? More than likely. But if

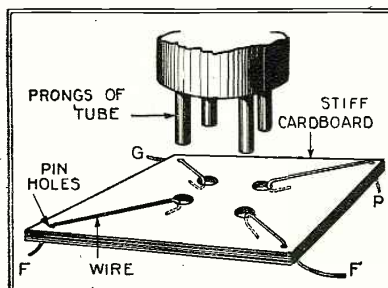

A simple tube socket made from a square of cardboard and four pieces of wire.

Prize Winners

First Prize \$25

Safety Device For Vacuum Tubes

By W. A. Agnew

14 Garry St., Cathcart, Glasgow, Scotland

Second Prize \$15

Temporary Tube Socket

By HOMER E. HOGUE

1726 Pennar Ave., Venice, Calif.

Third Prize \$10

Improving The Horn Speaker

By PAUL E. HAUG,

Box 74, Vernon, New York

The next list of prize winners will be published in the September issue.

you haven't, you will, some time in the future; and I know of nothing more admirable for the purpose than the arrangement shown in the accompanying sketch.

An experimental hook-up required another tube. The contributor had the extra tube, but no socket; so he cut a small square of stiff card-board, punched in it four holes, positioned and spaced to correspond to the tube prongs, and four pinholes near the corners. Four wires were put through the pin-holes and their bared ends pushed down through the tube prong holes. These ends were bent back so that there was no possibility of their pulling out. Each hole was marked, the makeshift socket connected in the circuit and the extra tube inserted. All four prongs made excellent contact with the wires.

One thing should be kept in mind; make the center holes smaller than the outside diameter of the tube prongs so that there will be a snug fit.

Third Prize

IMPROVING THE HORN SPEAKER

By PAUL E. HAUG

Great improvements have been made in loud speakers recently. The new ones reproduce the lower notes far better than the old. The cone seems to have superseded the horn, and where the horn remains it has been changed in contour and lengthened considerably, all for the prime purpose of getting through the lower notes and overtones.

Today, many people would purchase new loud speakers were it not for the fact that they own console sets with a built-in speaker. In consequence tonal quality is sacrificed and preference given to convenience and appearance.

Most built-in horn speakers are constructed of wood, or a similar material, having resonant qualities. And in every case actual resonance is found to be at the lower frequencies. Aside from enclosing a column of air, to be vibrated by the diaphragm of the loud speaker unit, the horn is supposed to function somewhat like a sounding board. But whatever action of this sort there may be is so small that it is practically valueless as a medium for the reinforcement of the lower frequencies. However, if the base of the horn is caused to vibrate by the utiliza-

tion of a lever action, the lower frequencies will show up handsomely. For in this way the base of the horn is acting as a true sounding board.

It is to be understood that the original arrangement cannot be done away with; we still require a diaphragm for vibrating the air column. Nor can we successfully use this diaphragm or any part of the unit for the movement of the horn base, as the damping will be too great. But we can very easily use another loud speaker unit for the express purpose of vibrating our natural sounding board. The second unit will be as incapable of reproducing the higher frequencies, due to the extreme damping, as the original unit is in respect to the lower frequencies. But each will work to maximum efficiency in its restricted frequency range.

It is advised that the second unit be one designed for use with a cone speaker, since this type already has a driving rod attached to the armature. The free end of the driving rod is threaded, and has lock nuts, so that the matter of fastening it to the horn is simple. A small hole drilled through the base of the horn, for anchoring the drive rod, and suitable holes for fastening the unit will complete the job. The accompanying sketch shows all details.

If the second unit is of the diaphragm type, a drive rod will have to be soldered or bolted to the center of the diaphragm, not at all an easy task. Units for cone speakers can be purchased separately so there is no reason for complicating matters by utilizing a unit with a diaphragm.

The two loud speaker units should be connected in parallel. It is quite important that No. 2 have the same resistance (impedance) as No 1. Some units designed for cone speakers are of fairly low resistance, being intended for use with tubes with low plate impedance, such as the W. E. 216-A.

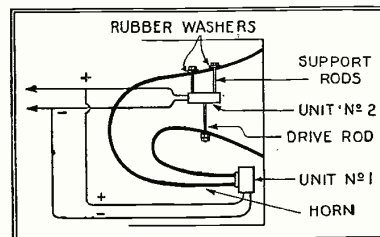

The tonal qualities of a horn speaker can be improved by the addition of another loud speaker unit.

The results obtained from a reconstructed speaker of this type are quite remarkable. Music is given "perspective," with the support of a low-frequency background.

TO MEASURE HOUSE CURRENT USED

With the increasing use of house lighting current in connection with radio sets and apparatus, it is often desirable to know with reasonable accuracy the cost of the current consumed. It is particularly important to know the cost of operating home-made apparatus, to check against possible errors in design or defects in workmanship.

Of course, meters are expensive, but there is no need to buy one if the registering meter for the house is of the usual type. Most of these recording meters have a rotating disk, with an arrow or mark on its surface which can be observed without difficulty.

In order to make use of the house meter, cut off all lights and other electrical devices in the house and observe the disk, which should be motionless. Now turn on one elec-

tric light, say a 50-watt size, and observe the mark on the disk, timing it for one revolution. Suppose the time for one revolution is 30 seconds. Now cut off the light and turn on the radio device, perhaps a "B" battery eliminator, and time the disk for one revolution. Suppose the time taken here is two minutes and thirty seconds, or 150 seconds. The disk then rotates only one-fifth as fast for the "B" eliminator as for the 50-watt light, and the current consumed is about ten watts.

If the house current costs the consumer ten cents per kilowatt hour (1,000 watts for one hour), the 50-watt light will cost one-half cent an hour to run. The "B" eliminator taken as example would cost only one-fifth as much to run, or one-tenth cent an hour.

House current is very cheap compared to batteries when considerable quantities of current are used. However, it is seldom so cheap that the use of inefficient apparatus is justified. It is well to check up the efficiency of storage battery chargers and other apparatus, and it is easy for anyone to determine to his own satisfaction that efficient and satisfactory devices are well worth more than the devices offered at the cheapest first cost.

—Contributed by P. H. Greeley.

TWO "B" ELIMINATORS

The two eliminators diagrammed here have been found satisfactory by test for supplying current from the 110-volt A.C. house line. The principal advantage is in the ease with which the necessary parts may be ob-

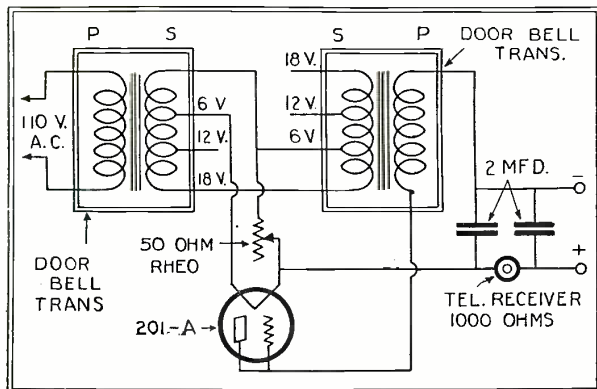

tained and assembled. Many of them will undoubtedly be found by the radio experimenter in his collection of old apparatus.

The needed transformers may be purchased at any electrical shop, and the radio parts are standard. The constructor prefers the eliminator which uses the three door-bell transformers for satisfactory operation; although that using the two 6-12-18 transformers actually delivers a higher voltage to the set.

—Contributed by George Beckerson.

SECTIONAL STAND-OFF INSULATOR

The other day, while re-arranging his transmitter lead-in, the contributor fell in need of a stand-off insulator about eight inches long. He found, however, several porcelain receiving insulators in stock, and struck upon the idea of making them into a stand-off insulator, as shown in the accompanying illustration.

After fastening them together, end to end, with No. 12 copper wire run through the holes, a large, flat staple was made from

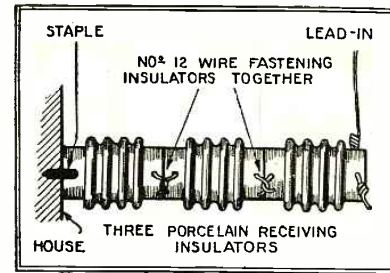

A simple sectional stand-off insulator.

a tennypenny nail and passed through the hole in the end of the last insulator before being bent. The staple was then driven into the side of the house, the insulator standing out rigidly at right angles. The lead-in wire was then passed through the hole on the end insulator and fastened.

A stand-off insulator of this type can be made any length desirable, if the support is securely fastened.

Contributed by Y. M. Hoag.

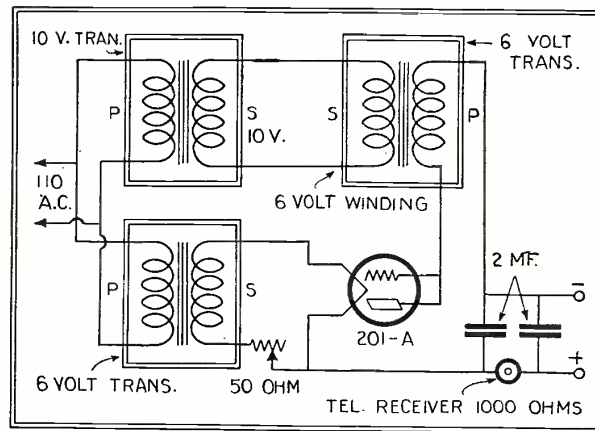

Left: Of the two arrangements shown, this one will give the highest voltage output.

VACUUM TUBE REMEDY

A tube will sometimes become loosened from its base, usually from rough handling when inserting it or removing it from a socket. Then the owner trusts to luck that the delicate connecting wires will not short or twist off. Yet it is quite a simple matter

(Continued on page 70)

LIST OF BROADCAST STATIONS IN THE UNITED STATES

(Continued from page 29)

Radio Call Letter	BROADCAST STA. Location	Wave (Meters)	Power (Watts)	Radio Call Letter	BROADCAST STA. Location	Wave (Meters)	Power (Watts)	Radio Call Letter	BROADCAST STA. Location	Wave (Meters)	Power (Watts)
WLTS.	Chicago, Ill.	258	100	WOAX.	Trenton, N. J.	240	500	WRAM.	Galesburg, Ill.	244	100
WLW.	Harrison, Ohio	422.3	500-5000	WOC.	Davenport, Iowa	453.6	5000	WRAY.	Yellow Springs, Ohio	263	100
WLWL.	New York, N. Y.	288.3	3500	WOCL.	Jamestown, N. J.	275.2	15	WRAX.	Reading, Pa.	238	10
WMAC.	Cazenovia, N. Y.	275	100	WODA.	Paterson, N. J.	224	250	WRXC.	Gloucester City, N. J.	268	500
WMAF.	Dartmouth, Mass.	440.9	1000	WOI.	Ames, Iowa	270	750	WRBC.	Valparaiso, Ind.	278	500
WMAK.	Lockport, N. Y.	266	500	WOK.	Homewood, Ill.	217.3	5000	WRCC.	Washington, D. C.	468.5	1000
WMAL.	Washington, D. C.	224	100	WOO.	Philadelphia, Pa.	508.2	500	WRCD.	Raleigh, N. C.	252	100
WMAN.	Columbus, Ohio	278	50	WOOD.	Grand Rapids, Mich.	242	500	WRCE.	Coldwater, Miss.	254	10
WMAQ.	Chicago, Ill.	447.5	1000	WOQ.	Kansas City, Mo.	278	1000	WRCL.	Lansing, Mich.	285.5	500
WMAZ.	Macon, Ga.	281	500	WOR.	Newark, N. J.	405.2	500	WRFM.	Washington, D. C.	256	50
WMBC.	Chicago, Ill.	250	500	WORD.	Batavia, Ill.	275	5000	WRH.	Hamilton, Ohio	270	100
WMBS.	Detroit, Mich.	256.4	100	WOS.	Jefferson City, Mo.	440.9	500	WRK.	Urbana, Ill.	273	500
WMBF.	Miami Beach, Fla.	384	500	WOW.	Port Wayne, Ind.	227	500	WRM.	Richmond Hill, N. Y.	236	100
WMC.	Memphis, Tenn.	499.7	500	WPAK.	Agricultural Col., N. Dak.	275	50	WRNY.	New York, N. Y.	253.5	500
WMCA.	Hoboken, N. J.	340.7	500	WPCC.	Chicago, Ill.	258	500	WRST.	Bay Shore, N. Y.	246	500
WMAB.	Boston, Mass.	250	100	WPDD.	Buffalo, N. Y.	205.4	57	WRVA.	Richmond, Va.	215.7	250
WMAC.	Boston, Mass.	280.2	500	WPG.	Atlantic City, N. J.	299.8	500	WRW.	Tarrytown, N. Y.	273	500
WMAD.	Norman, Okla.	254	500	WPRC.	Harrisburg, Pa.	215.7	100	WSAJ.	Mason, Ohio	325.9	5000
WMAL.	Omaha, Nebr.	258	50	WPSC.	State College, Penna.	261	500	WSAN.	Grove City, Pa.	229	250
WMAT.	Philadelphia, Pa.	250	100	WPWL.	Parkeburg, Pa.	220	500	WSAX.	Allentown, Pa.	229	100
WMAX.	Yankton, S. Dak.	244	100	WQAC.	Amarillo, Tex.	234.2	100	WSAR.	Fall River, Mass.	254	100
WMNH.	New Bedford, Mass.	248	100	WQAE.	Springfield, Va.	246	50	WSAX.	Chicago, Ill.	268	100
WMNJ.	Newark, N. J.	252	150	WQAM.	Miami, Fla.	263	100	WSAZ.	Pomeroy, Ohio	244	50
WNQX.	Knoxville, Tenn.	268	100	WQAN.	Scranton, Pa.	250	100	WSB.	Atlanta, Ga.	428.3	1000
WNRC.	Greensboro, N. C.	224	10	WQAO.	New York, N. Y.	360	100	WSBC.	Chicago, Ill.	209.7	1000
WNYC.	New York, N. Y.	526	1000	WQJ.	Chicago, Ill.	447.5	500	WSBT.	St. Louis, Mo.	273	250
WQAI.	San Antonio, Tex.	394.5	2000	WRAF.	Lafayette, Ind.	224	100	WSBF.	South Bend, Ind.	275	250
WQAN.	Lawrenceville, Tenn.	282.8	500	WRAC.	Escanaba, Mich.	256.3	100	WSDA.	New York, N. Y.	263	250
WQAW.	Omaha, Nebr.	526	1000					WSKC.	Bay City, Mich.	261	100
								WSM.	Nashville, Tenn.	282.8	1000
								WSMB.	New Orleans, La.	319	500
								WSMR.	Owosso, Mich.	240	20
								WSMK.	Dayton, Ohio	275	500
								WSOE.	Milwaukee, Wis.	246	500
								WSRO.	Hamilton, Ohio	252	100
								WSRH.	Boston, Mass.	261	100
								WSUL.	Iowa City, Iowa	485.8	500
								WSVS.	Buffalo, N. Y.	213.8	50
								WSWS.	Wooddale, Ill.	275	100
								WTAB.	Fall River, Mass.	266	100
								WTAB.	Carthage, Ill.	236	50
								WTAB.	Worcester, Mass.	368	500
								WTAL.	Toledo, Ohio	352	10
								WTAM.	Cleveland, Ohio	389.4	3500
								WTAP.	Cambridge, Ill.	342	50
								WTAQ.	EAU Claire, Wis.	254	100
								WTAR.	Norfolk, Va.	261	100
								WTAW.	College Station, Texas	270	500
								WTAX.	Streator, Ill.	231	50
								WTAX.	Lambertville, N. J.	261	15
								WTIC.	Hartford, Conn.	475.9	500
								WWAD.	Philadelphia, Pa.	252	500
								WWAE.	Plainfield, Ill.	242	250
								WWAO.	Houghton, Mich.	263	250
								WWGL.	Richmond Hill, N. Y.	212.6	500
								WWJ.	Dearborn, Mich.	266	500
								WWJ.	Detroit, Mich.	352.7	1000
								WWL.	New Orleans, La.	275	100

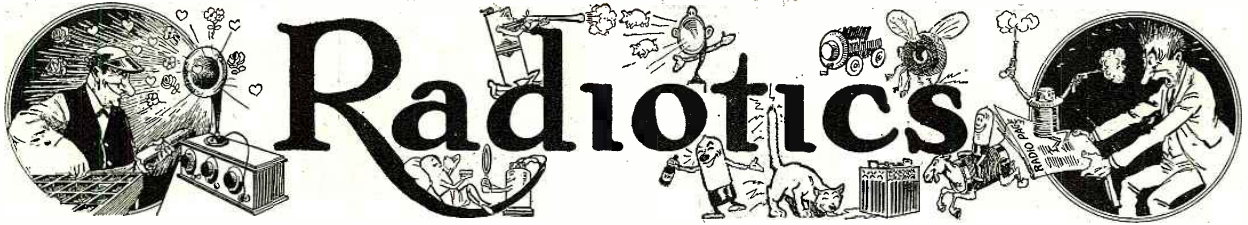

FAT AND THIN AND ???

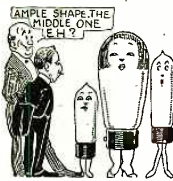

Beauty contest item from the April issue of Radio Industry...

Contributed by Richard Young.

ONLY EXPERT SETS HAVE 'EM



gadgets.

Contributed by R. G. Black.

GOOD-BYE, OLD SOLDERING IRON!



Contributed by Willard M. Fogle.

WHERE IS MY WANDERING TUBE TONIGHT?

Job for the local police, as mentioned in the Rochester, N. Y., Times-Union...



Contributed by John C. Heberger.

FOR YOUR VAUDEVILLE ACT

In the Minneapolis Journal of Jan. 1 we find this gem: "4-tube radio set, loud speaker, SKATES WITH SHOES, size 9."

Contributed by Ernest P. Lommel.



HOW TO GET ENAMEL (?)

Advice to home constructors of radio sets as given in the March Radio Magazine: "A small POT of Enamel is scraped off the center of the diaphragm."

Contributed by L. J. Laska.



GOING AFTER REAL DX



Authoritative quotation from the Portland, Oregon, Sunday Journal of April 11...

Contributed by L. Long.

THOSE COLD-MOLASSES WAVES

Another type of radio wave, as related in the Radio Review of last November...



Contributed by Egie Norkus

IT'S TOO LATE NOW!

An advertisement that should have appeared during the recent coal strike was found in the Radio World of March 27: "Necessary low loss COAL... 2.50."

Contributed by E. I. Coon.



SUPER-SUPER "BBB" BATTERY!

Monster battery described in the Cincinnati Enquirer of April 4: "The plate battery will probably have 90 volts and deliver 10 MILLION amperes."

Contributed by Anonymous.



RING ME, I'M A BELLE



Cruel instructions as given in the January issue of Radio Review "WRING diagram of receiver showing how "X" wire is installed in the immediate R.F. part of the circuit."

Contributed by Wm. J. Easson.

MONEY IS A REAL LOUD SPEAKER



A marvelous offer made in the Evening Telegram of Toronto, Canada, of March 30: "Radio sets repaired or rebuilt from \$2, good workmanship and service."

Contributed by Jack Goldberg.

SOME WOULD MAKE FILES AND SAWS

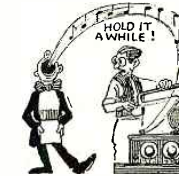

Wonders of science in a Universal Service dispatch to the New York Evening Journal of March 22: "The light arc produces violet rays capable of IRONIZING the voice, and iron, being a conductor, could easily convey the sound to a radio receiver."

Contributed by John M. Fishell, Jr.

HOW ABOUT THE WHEELS?

Great opportunity for a swap as advertised in the Cincinnati, O., Post of Feb. 6: "3-tube radio set—FORD SLIP-ON BODY."



Contributed by Herman Korte.

YOO HOO, 309.1 METERS, C'MON IN!

Scientific announcement from Cornell, through the columns of the Troy, N. Y., Sunday Budget of April 11: "Existence of a definite relationship between WADING... and fluctuations in the direction from which the signals come..."

Contributed by Chas. H. Lee.



HARD ON WJZ

Dirty crack in the March 27 issue of the Radio World: "I live about one mile from WJZ, and I would like to know if my set will be selective enough to tune this STATIC out."

Contributed by J. E. Wiltshire.



STANDARD HOOK-UPS

EVERY month RADIO NEWS presents in this convenient form a selection of circuit diagrams, with constructional and other data, on standard hook-ups, which the editors have tried and found to give excellent results. Every radio experimenter should preserve these for their reference value, as they are selected to cover the complete range of radio apparatus, from the simplest to the largest and most complicated. Requests for special or additional advice and information should be addressed to the I WANT TO KNOW Department of RADIO NEWS. (A charge of 25 cents is made for answering each question which requires a reply by letter.)

Handy Reference Data for the Experimenter

MUSIC LOVER'S AMPLIFIER

Circuit No. 170. For those who desire to construct an amplifier capable of unusual reproduction, something akin to a victrola, the accompanying type is offered. This amplifier may be constructed in unit form, so that it may be attached to any receiver which does not incorporate more than one stage of audio-frequency amplification. The amplifier consists of one stage of a special type of combination impedance- and resistance-coupled amplification, one stage of transformer-coupled type, and again one stage of a special impedance-resistance audio amplification. In the last stage, the resistance of the secondary, combined with its impedance characteristic, tends to produce an unusual last stage—which will not introduce distortion.

The parts necessary are as follows:

- 2 Rheostats, 10-ohm;
- 2 Impedance or Choke Coils, designed for audio amplifier (Z2);
- 1 Audio Transformer, low ratio type (MA2);
- 2 By-Pass Condensers, 1.0- μ f.;
- 1 Audio-Frequency Transformer, of approximately 4:1 ratio. (This transformer's primary winding may be open, as the secondary only is used);
- 1 Fixed Resistance, 10,000-ohm;
- 1 Fixed Resistance, 0.5-megohm.

Better results might be possibly obtained by changing the 0.5-megohm resistance to one of other various sizes. Also, a power tube preferably should be used in the last socket or stage, to prevent any possibility of distortion. The correct amount of "C" battery will be found between minus 3 to 9 volts.

"B" BATTERY SUBSTITUTE

Circuit No. 171. Most experimenters hesitate to construct the average "B" eliminator unit which employs a rectifying tube. This is undoubtedly due to both the initial expense of the tube and the further upkeep of replacing the tube whenever it is burnt out. The advantage of this "B" eliminator is that ordinary inexpensive chemical-rectifier jars are used.

Parts necessary are as follows:

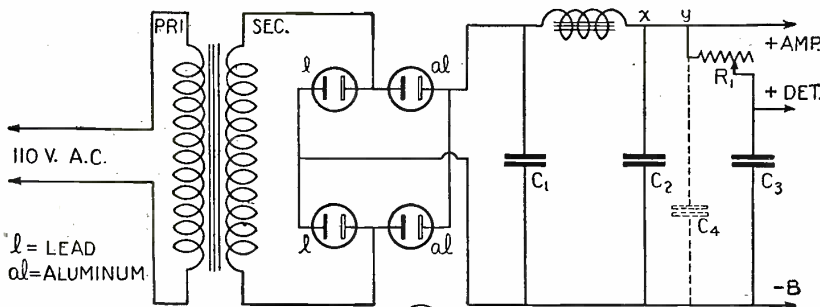

A very efficient "B" eliminator employing chemical rectification. The cost of construction of this eliminator is very small and the current output obtained is as pure "D.C." as can ever be obtained from any similar type of instrument. The step-up transformer should be purchased.

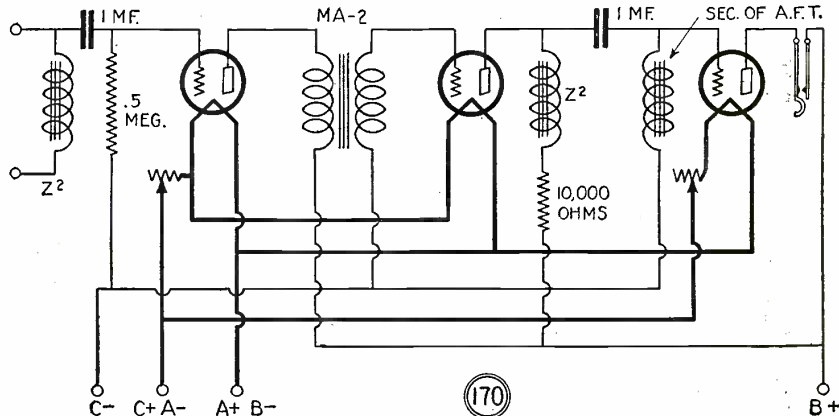

A special type of audio amplifier which, when efficiently constructed with a good grade of apparatus, is capable of meeting the most exacting requirements of any "music-lover." A power tube should be used in the last stage or socket for highest efficiency.

- 4 Small Glass Jars, approximately 4 inches in height and 1 1/2 inches in diameter;
- 4 Aluminum Rods, 4 inches long and 3/8-inch in diameter;
- 4 Lead Rods, same size;
- 1 Step-Up Transformer, designed for "B" eliminator;
- 1 Choke Coil designed for "B" elimination;
- 3 Fixed Condensers, 2.0- μ f.;
- 1 Variable Resistance, 0- to 100,000-ohm.

The current output of this eliminator should be fairly smooth direct current and entirely satisfactory. However, should there be a slight hum, an additional choke coil may be connected at the points indicated at "X" and "Y" in the circuit diagram. Also a fixed by-pass condenser, approximately 2.0- μ f., should be connected when the additional choke coil is used (C-4).

COMBINED TRANSMITTER AND RECEIVER

Circuit No. 172. This circuit was derived by one of our readers from diagram No. 156, published in the April issue of RADIO NEWS, which illustrated a simple loop

transmitter. By means of a double-pole double-throw switch the operator is able to convert the instrument to the type either of a transmitter or receiver. Two sets of switches are necessary, one disconnecting the phone circuit when transmitting is desired; the other cutting in or out the radiation ammeter, which should be used only for transmitting purposes.

The parts necessary for the construction are as follows:

- 2 Double-Pole Double-Throw switches;
- 1 Radiation Ammeter, 0-to-1 or 1 1/2-scale;
- 1 Variable Condenser, .0005- μ f.;
- 1 Loop, dimensions dependent upon the wave-length to be operated on. This loop should be made as large as possible. Approximately four or five turns, four feet square, will be satisfactory for ordinary purposes (200-meter work);
- 1 Transmitting Key;
- 1 Pair of Headphones;
- 1 Phone By-Pass Condenser, .001- μ f.;
- 1 Grid Condenser, .00025- μ f.;
- 1 Grid Leak, 2-megohm;
- 1 Rheostat, 10-ohm;
- 1 Power Tube.

As this type of combination receiver and transmitter will be primarily used under special conditions (hikes, trips, and automobile tours), it is advisable that a power tube of the dry cell type be used. The UX- or CX-120 tube is one of the many that will satisfactorily fulfill the requirements. The entire device may be constructed in a small suit case or portable typewriter case. A "B" battery voltage of approximately 125 volts for the above-mentioned tube, will permit a transmitting range of at least 15 miles under fair conditions. This "B" voltage should be decreased when the switches are thrown for receiving purposes; 45 volts will be sufficient. The radiation ammeter may not indicate due to the exceeding small amount of energy generated. For this reason, a radiation ammeter (thermocoupler type preferably) of as low a scale as possible should be obtained.

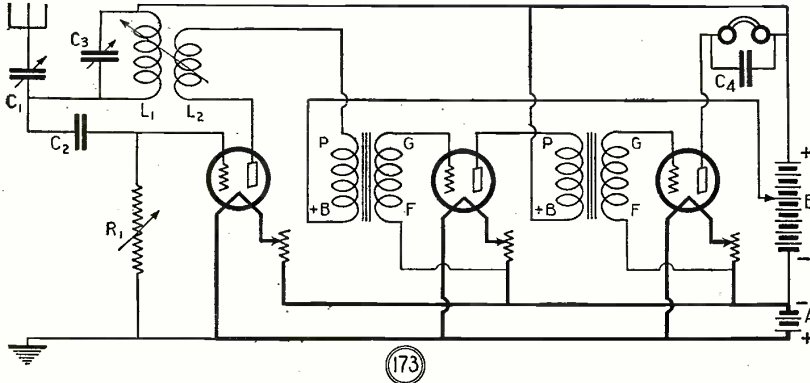

A 3-tube receiving circuit designed by an Australian amateur. It is of an extremely flexible nature. The wave-length range of this receiver may be easily altered to any desired range, by simply changing two coils of plug-in type.

A "3-VALVER" FROM SOUTH AUSTRALIA

Circuit No. 173. This receiving circuit was submitted by an Australian amateur, who claims remarkable results. Its flexible and desirable feature, that of easy conversion from short waves to broadcast or commercial reception, makes this diagram both interesting and simple. But two coils are used for inductances, both of the honey-comb-coil type, which plug into a double coil mounting. The following is Mr. Luxon's description of this receiver:

"L-1 and L-2 are the two coils plugged into two-coil holders. It is a good all-wave receiver, which is being used by many of my local friends and 'hams,' in separating several high power stations on close wave-lengths. A glance at the diagram will reveal it very selective. I claim it as my own design. In Australia, after broadcasting hours numerous amateurs may be heard testing on phone and key with terrific punch.

"The valves (tubes) used are UV-199 type, with three 1½-volt dry cells "A" battery, and a high tension voltage of up to 90 volts, supplied by two 45-volt dry batteries. The variable condenser C-1 is a 43-plate, and C-2 is a 23-plate condenser. The three separate rheostats are needed as the filament control is critical. The grid condenser C-3 must be of good make, as I stake the reputation of the circuit on that one part, for tuning out interfering stations. A variable grid leak (R-1) is also employed, as on certain wave-lengths it helps considerably in the tuning. Any good make will do for the audio stages. A two-coil holder

with ordinary plug-in honeycomb coils will tune up to 20,000 meters or more. On the longer waves PKX, NPG, NPO, OXI, NPN, FLI, POZ, and numerous other stations scattered all over the map can be heard with good kick. The detector voltage I use is about 30 volts. The fixed mica condenser across the phones gives the set a good tone,

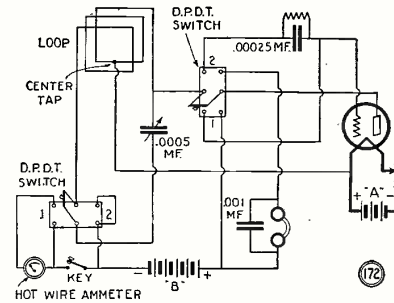

A combination transmitter and receiver using only one tube, employing switches to change from transmission to reception, or vice-versa.

which means everything when entertaining other 'hams,' or friends.

"The necessary apparatus for the construction of the circuit is:

- 1 Double-Coil Holder;
- 1 Variable Grid Leak, and Mica Condenser, .0025- μ f.;
- 3 Tubes and Standard Sockets;
- 7 Terminals;
- 1 Single-Circuit Phone Jack, and 2 Plugs;

- 2 Variable Condensers, .001- and .0005- μ f.;
- 2 Audio Transformers, (5:1 ratio used);
- 3 Dry Cells for "A" battery, and 90 volts, "B";
- 1 Set Plug-In Honeycomb Coils;
- Square bus wire, spaghetti tubing, and sundry screws, etc.

"This set has proved very efficient over this part of the sphere; so if any 'ham' overseas would give it a try-out I would be pleased to hear from him. The tuning is fairly sharp, but with a little experimenting the 'DX' fiends will soon learn the ways of it."

"GEORGE W. LUXON,
8 Brook St., West Mitcham,
South Australia."

A RELIABLE EFFICIENT RECEIVER

Circuit No. 174. From time to time we see numerous circuits that are modifications of old stand-bys, with some little frills attached to them. These supposed improvements many times turn out to be tricky and instable receivers. Although the possibilities are considerable with some of these circuits (being dependent upon the amount of time and experimentation spent) yet, to insure best results, it is advisable that one of those circuits that are known to be consistently reliable be constructed. Such a circuit is here shown. Resistance-coupled audio amplification is used to obtain the highest possible degree of reproduction. The receiver's operation is controlled by means of a potentiometer, which varies the grid bias on the radio-frequency tubes.

Parts necessary for the construction are as follows:

- 3 Variable Condensers, .00035- μ f., preferably the straight-line-frequency type;
- 3 Radio-Frequency Inductances, designed for above condensers;
- 1 Potentiometer, 400-ohm;
- 1 Grid Condenser, .0025- μ f.;
- 3 Fixed Condensers, .006- μ f.;
- 4 Resistances, ¼-megohm;
- 1 Resistance, 0.1-megohm;
- 1 Resistance, 1-megohm;
- 2 Fixed Condensers, .002- μ f.;
- 1 Fixed Condenser, .001- μ f.;
- 2 Rheostats, 10-ohm;
- 2 Grid Leaks, 2-megohm;
- Panel and Baseboard, 7x21.

Better results may be obtained by some little experiment on the value of the various resistances used in the resistance-coupled audio amplifier, as some tubes work best with one combination of grid and plate resistance, and some with others.

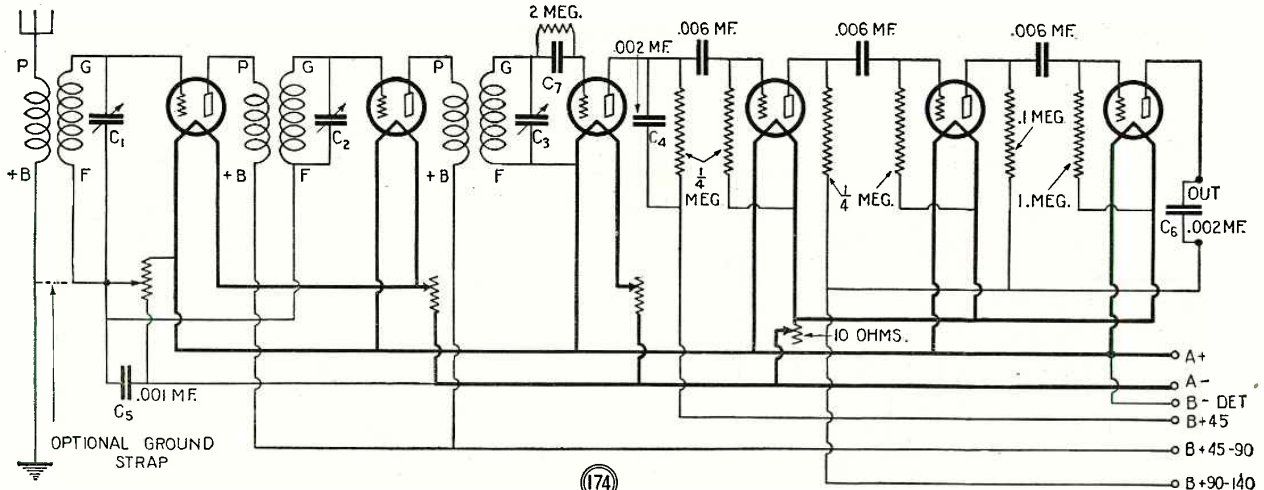

A receiving circuit with none of the frills which usually result in troublesome adjustments, complicated tuning, critical results, etc. Stations received by a set employing this circuit are loud, clear and consistent and are tuned in with ease. Clarified reception is obtained, due to the resistance-coupled audio amplifier employed.



RADIO manufacturers are invited to send to RADIO NEWS LABORATORIES, samples of their products for test. It does not matter whether or not they advertise in RADIO NEWS, the RADIO NEWS LABORATORIES being an independent organization, with the improvement of radio apparatus as its aim. If, after being tested, the instruments submitted prove to be built according to modern radio engineering practice, they will each be awarded a certificate of merit, and a "write-up" such as those given below will appear in this department of RADIO NEWS. If the apparatus does not pass the Laboratory tests, it will be returned to the manufacturer with suggestions for improvements. No "write-ups" sent by manufacturers are published on these pages, and only apparatus which has been tested by the Laboratories and found to be of good mechanical and electrical construction is described. Inasmuch as the service of the RADIO NEWS LABORATORIES is free to all manufacturers whether they are advertisers or not, it is necessary that all goods to be tested be forwarded prepaid, otherwise they cannot be accepted by the Laboratories. Apparatus ready for the market or already on the market will be tested for manufacturers, as heretofore, free of charge. Apparatus in process of development will be tested at a charge of \$2.00 per hour required to do the work. Address all communications and all parcels to RADIO NEWS LABORATORIES, 53 Park Place, New York City.

BATTERY RECHARGER

The battery recharger shown in the illustration was submitted to the

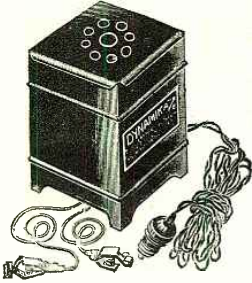

RADIO NEWS LABORATORIES for test, by the Wilson Electrical Laboratories, 1416 Morse Avenue, Chicago, Ill. This battery recharger was found to give a uniform charging current. Its current output is similar to that of the rating of the manufacturer. It uses a two-element valve for the rectifying.

AWARDED THE RADIO NEWS LABORATORIES CERTIFICATE OF MERIT NO. 1139.

VOLTMETER

This voltmeter was submitted to the RADIO NEWS LABORATORIES for test by the Weston Electrical Instrument Corporation, Newark, N. J.

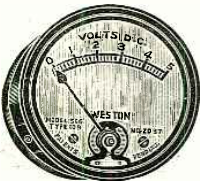

This voltmeter, having a range of from 0 to 5 volts, is readily adaptable to radio receiving sets and furnishes a means of checking up on the proper filament voltage.

AWARDED THE RADIO NEWS LABORATORIES CERTIFICATE OF MERIT NO. 1219.

VARIABLE CONDENSER

This S.L.F. variable condenser was submitted to the RADIO NEWS LABORATORIES for test, by the Pilot Electric Mfg. Co., 323 Berry St.,

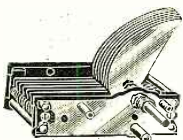

Brooklyn, N. Y. It is substantially made and covers the entire broadcast range satisfactorily.

AWARDED THE RADIO NEWS LABORATORIES CERTIFICATE OF MERIT NO. 1377.

R.F. TRANSFORMER KITS

This kit, comprising three T.R.F. coils, was submitted to the RADIO NEWS LABORATORIES for test, by the Daven Radio Corp., Newark, N. J.



The inductances are wound on tubes of small diameter to reduce to a minimum the external field, and still maintain solenoidal efficiency.

AWARDED THE RADIO NEWS LABORATORIES CERTIFICATE OF MERIT NO. 1302.

LOUD SPEAKER UNIT

This loud speaker unit was submitted to the RADIO NEWS LABORATORIES for test, by the Holliday Radio & Mfg. Co., Salt Lake City,

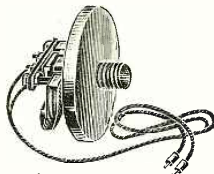

Utah. It is well made and gives fine reproduction.

AWARDED THE RADIO NEWS LABORATORIES CERTIFICATE OF MERIT NO. 1306.

ANTENNA INSULATOR

This antenna insulator was submitted to the RADIO NEWS LABORATORIES for test, by J. H. McCarthy, 39 Church St., Whitehall, N. Y. It



is a glazed porcelain insulator designed to withstand sudden and heavy strains.

AWARDED THE RADIO NEWS LABORATORIES CERTIFICATE OF MERIT NO. 1270.

SPACE WOUND COILS

This two-circuit inductance was submitted to the RADIO NEWS LABORATORIES for test, by the Hammar-



lund Mfg. Co., 424 West 33d St., New York City, and found suitable for covering the broadcast range.

AWARDED THE RADIO NEWS LABORATORIES CERTIFICATE OF MERIT NO. 1285.

TOROID COIL

This toroid coil was submitted to the RADIO NEWS LABORATORIES for test, by the All-American Radio Corp., 4201 Belmont Ave., Chicago,

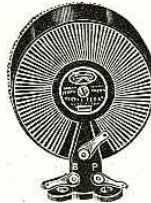

Ill. It was found to have the advantages of this type of coil and to cover the broadcast range suitably.

AWARDED THE RADIO NEWS LABORATORIES CERTIFICATE OF MERIT NO. 1274.

VARIABLE CONDENSER

The condenser shown was submitted to the RADIO NEWS LABORATORIES for test, by the All-American Radio Corp., 4201 Belmont Ave.,

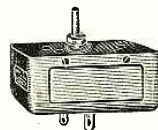

Chicago, Ill., and found suitable for covering the entire broadcast range.

AWARDED THE RADIO NEWS LABORATORIES CERTIFICATE OF MERIT NO. 1312.

VARIABLE CONDENSER

This condenser was submitted to the RADIO NEWS LABORATORIES for test, by Bremer-Tully Mfg. Co., 532



S. Canal St., Chicago, Ill. It was found to cover the entire wavelength band when shunted by a suitable inductance.

AWARDED THE RADIO NEWS LABORATORIES CERTIFICATE OF MERIT NO. 1328.

CRYSTAL HOLDER AND CRYSTAL

The "Detex" crystal detector was



submitted to the RADIO NEWS LABORATORIES for test, by George J. Fitzpatrick, 5562 Jackson Blvd., Chicago, Ill. The mounting is designed to give good contact between crystal and holder.

AWARDED THE RADIO NEWS LABORATORIES CERTIFICATE OF MERIT NO. 1241.

CHOKE COIL

This choke coil was submitted to the RADIO NEWS LABORATORIES for



test, by the Dongan Electric Mfg. Co., 2987 Franklin St., Detroit, Mich. It is a heavily-constructed choke, used in connection with a B-battery supply unit.

AWARDED THE RADIO NEWS LABORATORIES CERTIFICATE OF MERIT NO. 1288.

CROWE PANELS

These metal panels submitted to the RADIO NEWS LABORATORIES for test, by the Crowe Name Plate & Engraving Company, 1749 Grace Street, Chicago, Ill., serve also as

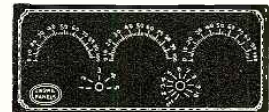

metal shielding for stray radio frequency coils, thus preventing hand capacity effect, and are extremely neat in appearance, being made in both plain black and crystalline finish, with numerical indications for dial and filament readings. Shaft holes are already drilled.

AWARDED THE RADIO NEWS LABORATORIES CERTIFICATE OF MERIT NO. 1078 and 1079.

SOCKET

This socket was submitted to the

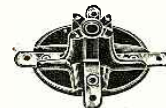

RADIO NEWS LABORATORIES for test, by the Burroughs Co., Newark, N. J. It is substantially made and is adaptable for UV or UX type tubes.

AWARDED THE RADIO NEWS LABORATORIES CERTIFICATE OF MERIT NO. 1338.

DOUBLE-SECTION CONDENSER

This double-section condenser was submitted to the RADIO NEWS LABORATORIES for test, by Bremer-Tully Mfg. Co., 532 S. Canal St., Chicago, Ill. It employs a main shaft and shows itself efficient in tuning two

circuits simultaneously. Vernier adjusters are incorporated.

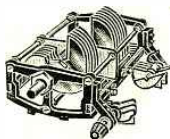

AWARDED THE RADIO NEWS LABORATORIES CERTIFICATE OF MERIT NO. 1327.

VERNIER DIAL

This vernier dial was submitted to the RADIO NEWS LABORATORIES for test, by Bremer-Tully Mfg. Co., 532 S. Canal St., Chicago, Ill. It

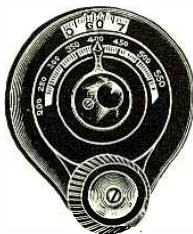

was found suitable for sharp tuning. AWARDED THE RADIO NEWS LABORATORIES CERTIFICATE OF MERIT NO. 1332.

CAPACITY ELEMENT

This capacity element was submitted to the RADIO NEWS LABORATORIES for test, by the Hanscom

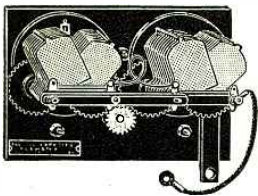

Radio Devices, Woonsocket, R. I. This unit has a method of connecting condensers so that "single-control effect" is obtained.

AWARDED THE RADIO NEWS LABORATORIES CERTIFICATE OF MERIT NO. 1155.

TWIN CONDENSER

The tandem condenser shown was submitted to the RADIO NEWS LABORATORIES for test, by the U. S. Tool

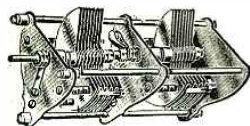

Company, Ampere, N. J. This apparatus may be used in any receiving set, having been tested and found to have accurate capacity, compared very favorably with that stated by the manufacturer. It is of rigid and neat construction.

AWARDED THE RADIO NEWS LABORATORIES CERTIFICATE OF MERIT NO. 1133.

COIL-WINDING MACHINE

The winding machine shown in the illustration was furnished by the Wizard Wire Winder Co., 3812 Central Avenue, Los Angeles, Calif., and submitted to the RADIO NEWS LAB-

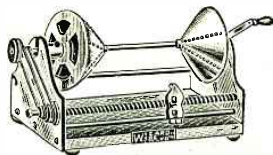

ORATORIES for test. This machine is a very handy addition to the radio workshop. Tubing of any size may be wound with any size wire.

AWARDED THE RADIO NEWS LABORATORIES CERTIFICATE OF MERIT NO. 954.

VERNIER DIAL

This Vernier Dial was submitted to the RADIO NEWS LABORATORIES for test, by Pilot Electric Mfg. Co., 323 Berry St., Brooklyn, N. Y. It was found suitable for sharp tuning.



AWARDED THE RADIO NEWS LABORATORIES CERTIFICATE OF MERIT NO. 1405.

NEUTRALIZING CONDENSER

This neutralizing condenser was submitted to the RADIO NEWS LAB-



ORATORIES for test, by C. E. & H. T. Hargraves, 1103 Warwick Ave., Lakewood, R. I. It is of good design and easily adjustable.

AWARDED THE RADIO NEWS LABORATORIES CERTIFICATE OF MERIT NO. 1277.

A.F. TRANSFORMER

This transformer was submitted to the RADIO NEWS LABORATORIES for test, by the General Radio Co., Radio

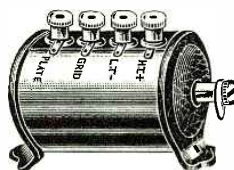

House, 235 Regent St., London, W. 1, England. It was found to have a fine amplification curve.

AWARDED THE RADIO NEWS LABORATORIES CERTIFICATE OF MERIT NO. 1255.

R.F. TRANSFORMER

The "Doughnut" Toroid Coil was submitted to the RADIO NEWS LABORATORIES for test, by Radio Founda-



tion, Inc., 25 West Broadway, New York City, and found suitable for covering the entire broadcast range.

AWARDED THE RADIO NEWS LABORATORIES CERTIFICATE OF MERIT NO. 1294.

WIRING HARNESS

The "S-C" Wiring Harness was submitted to the RADIO NEWS LABORATORIES, for test, by Belden Mfg.



Co., 2314 So. Western Ave., Chicago, Ill. This is a neatly made cable used to supplement busbar.

AWARDED THE RADIO NEWS LABORATORIES CERTIFICATE OF MERIT NO. 1344.

RESISTANCE-COUPLED AMPLIFIER UNIT

This amplifier unit was submitted to the RADIO NEWS LABORATORIES for test, by Allen-Bradley Co., Mil-

waukee, Wis. It is an audio-frequency resistance-coupled amplifier unit, giving even amplification of the audio-frequency currents.



AWARDED THE RADIO NEWS LABORATORIES CERTIFICATE OF MERIT NO. 1307.

CRYSTAL SET

The "Talking Book" Crystal Set was submitted to the RADIO NEWS LABORATORIES for test, by the Listen-In Publishing Co., Cambridge, Mass.

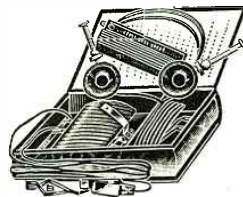

This is a toy novelty which is a really practical article.

AWARDED THE RADIO NEWS LABORATORIES CERTIFICATE OF MERIT NO. 1284.

VERNIER DIAL

This vernier dial was submitted to the RADIO NEWS LABORATORIES for test, by Mydar Radio Co., 9 Campbell St., Newark, N. J. It affords means of sharp tuning.



AWARDED THE RADIO NEWS LABORATORIES CERTIFICATE OF MERIT NO. 1323.

TOROID COIL

This T.R.F. transformer was submitted to the RADIO NEWS LABORATORIES for test, by the Radio Service Laboratories, 1606 Newberry St.,



Appleton, Wis. When tuned by a suitable capacity, the coil was found to cover the entire band of broadcast wave-lengths.

AWARDED THE RADIO NEWS LABORATORIES CERTIFICATE OF MERIT NO. 1305.

VARIABLE CONDENSER

The condenser shown was submitted to the RADIO NEWS LABORATORIES for test, by Thompson & Levinger, 57th and Westminster Ave.,



Philadelphia, Pa. It is well made and covers the broadcast range satisfactorily.

AWARDED THE RADIO NEWS LABORATORIES CERTIFICATE OF MERIT NO. 1220.

RADIO FREQUENCY TRANSFORMER

The Torostyle Transformer was submitted to the RADIO NEWS LABORATORIES for test, by Bremer-Tully Mfg. Co., 532 S. Canal St., Chicago, Ill. As is characteristic of this type of coil, the external field creates very little inter-action between successive stages and the coil covers the broadcast range.



AWARDED THE RADIO NEWS LABORATORIES CERTIFICATE OF MERIT NO. 1329.

VARIABLE CONDENSER

This low-loss condenser was submitted to the RADIO NEWS LABORATORIES for test, by the Baltic Radio Company, Stockholm, Sweden. It is well made and covers the broadcast range, with a suitable inductance.



AWARDED THE RADIO NEWS LABORATORIES CERTIFICATE OF MERIT NO. 1280.

VARIABLE CONDENSER

This variable condenser was submitted to the RADIO NEWS LABORATORIES for test, by Signal Electric Mfg. Co., Menominee, Mich. It was



found suitable for covering the broadcast range.

AWARDED THE RADIO NEWS LABORATORIES CERTIFICATE OF MERIT NO. 1252.

VARIABLE CONDENSER

The condenser shown was submitted to the RADIO NEWS LABORATORIES for test, by the Condenser Cleaners Mfg. Co., 422 First Ave., Pittsburgh, Pa. It was found to

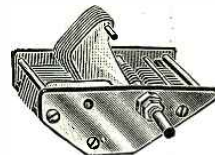

cover the entire broadcast range satisfactorily.

AWARDED THE RADIO NEWS LABORATORIES CERTIFICATE OF MERIT NO. 1276.

VARIABLE CONDENSER

The S.L.F. condenser shown was submitted to the RADIO NEWS LABORATORIES for test, by Silver-Marshall, Inc., 848 W. Jackson Blvd., Chicago, Ill. It is substantially made.

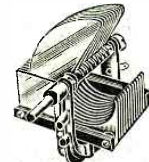

AWARDED THE RADIO NEWS LABORATORIES CERTIFICATE OF MERIT NO. 1243.

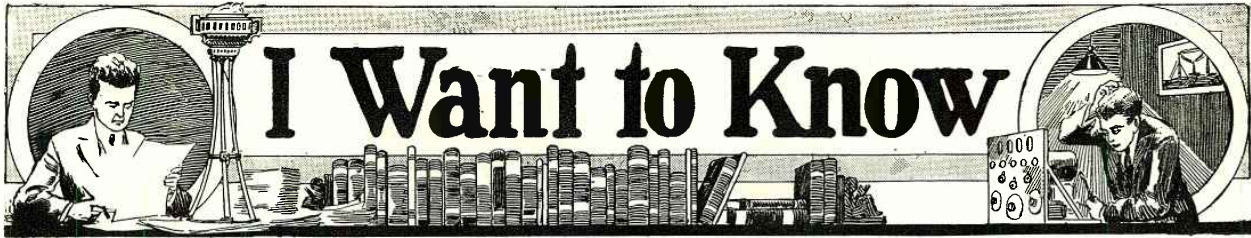

Conducted by Joseph Bernsley

This Department is conducted for the benefit of our Radio Experimenters. We shall be glad to answer here questions for the benefit of all, but we can publish only such matter as is of sufficient interest to all.

1. This Department cannot answer more than three questions for each correspondent. Please make these questions brief.
2. Only one side of the sheet should be written upon; all matter should be typewritten or else written in ink. No attention paid to penciled matter.
3. Sketches, diagrams, etc., must be on separate sheets. This Department does not answer questions by mail free of charge.
4. Our Editors will be glad to answer any letter, at the rate of 25c. for each question. If, however, questions entail considerable research work, intricate calculations, patent research, etc., a special charge will be made. Before we answer such questions, correspondents will be informed as to the price charge.

Mr. Bernsley answers radio questions from WRNY every Thursday at 8:15 P. M.

INTERMEDIATE-FREQUENCY TRANSFORMER DATA

(2176) Mr. R. Contini, Niagara Falls, N. Y., asks:

Q. 1. Due to present legal entanglements and injunction suits restraining the manufacturers from commercially producing Super-Heterodyne material, I am having difficulty in obtaining an ef-

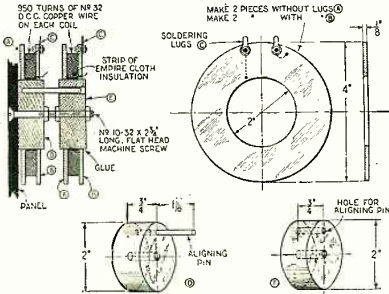

Circuit No. 2176-A.—The design and constructional data including all necessary dimensions of an intermediate frequency transformer, air core type, having an amplification peak at 10,000 meters.

ficient Super-Heterodyne kit, or at least the intermediate and filter transformers. Don't you think it would be a good idea to publish constructional data of various types of intermediate transformers and filters designed to operate in conjunction with them? Many constructors who "roll their own" would be glad to obtain this data; I for one would. In fact the information that you will publish, I hope, contains the constructional data of the transformer I am going to use in my Super-Heterodyne receiver.

A. 1. The following are the constructional data for various types of intermediate transformers and filters. We are also including oscillator-coil design, thus making the necessary information complete; with the source of the information, so that more complete data and illustration may be obtained by referring to the original article.

The following are constructional data for an efficient 10,000-meter intermediate transformer, filter transformer and oscillator coupler, obtained from "The Radio Constructor" series of blueprints; the title of this particular one being "A Genuine Standard Super-Heterodyne." Incidentally, this blueprint is no longer being published, though it is possible that copies are obtainable from some dealers.

THE TUNED FILTER

"A very important part of the Super-Heterodyne is the tuned-filter coupler. This coupler is very simple and yet must be accorded much care in construction. Practically all filters for this purpose consist of two coils placed close together. Each coil is tuned by a condenser, either fixed or variable, and is arranged to have a certain "tune" or wave-length which, once adjusted, is not touched again after the set is in operation.

The tuned-filter coupler determines the "intermediate frequency." One of the simplest and most convenient form for this purpose will be two standard "duo-lateral" or honeycomb coils, each having 750 turns. The wave-length advocated is 10,000 meters; and, in order to bring the coil up to this level, two fixed mica condensers, each of .0005- μ f. capacity, are connected across the terminals of both coils.

As a great deal of the selective quality of the set depends on the filter, it will be necessary to arrange it so that the coupling between these two coils can be varied to the best position. The best efficiency will be obtained only if the intermediate-frequency transformers give maximum amplification at the particular wave-length for which the filter is designed. Therefore, when using the two duo-lateral coils as explained above, it will be a good

plan to purchase or construct three intermediate-frequency transformers that will give best amplification at about 10,000 meters. There are several types on the market which will give excellent results. If the builder desires to construct a special filter it can be made according to the following plans. Fig. 2176-A shows details of the disks and cores necessary.

First assemble the disks on the cores and glue them fast, as indicated in the illustration. Now wind on each form 950 turns of No. 32 D.C.C. copper wire. Have these windings as near uniform as possible; that is, wind in layers from one side to the other. The windings are insulated from the core, as shown, by means of a strip of empire cloth or insulating tape.

The aligning pin shown in the illustration, Fig. 2176-A, of the complete coupler, is merely a piece of wood driven into the first core. A hole about twice as large as the pin may be drilled in the other core to offer a recess in which the pin is to fit as shown.

The ends of each coil are brought out, as shown, connected to small machine screw terminals fastened to the metal. This furnishes a convenient means of connecting to the coupler when wiring the set. In assembling the coupler, a brass screw (do not use iron) about $\frac{3}{4}$ inches long and just large enough in diameter to fit the holes drilled in the cores, is used. This screw should be of the flat-head variety, and fits through a hole in the panel. It is then pushed through the hole in the core of the first coil unit of the filter coupler and a nut adjusted to hold it tight to the panel.

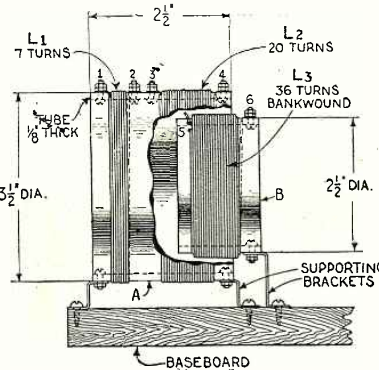

2176-B.—The design of an oscillator coil to operate in conjunction with a .001-mfd. variable condenser for a 10,000-meter type super-heterodyne receiver.

In placing the second coil on the shaft or screw remember that the windings on both coils must be in the same direction. This is a most important feature, and must be taken into careful consideration when making the coupler. The second coil can now be fitted. Place another nut on the shaft and leave it about half an inch from the other. Then place the second coil in position, by adjusting the core so that the aligning pin fits the hole and the core can be forced up to the second nut. The final nut for clamping may now be put on, and the coupler is finished except for adjusting of coupling.

It is apparent that by turning the second nut on the shaft the second coil can be placed nearer to the first coil. The best operating position, that is, the proper coupling, will be found by test, as described later, and the second coil can then be clamped permanently in place.

Both primary and secondary coils are brought up to proper wave-length by placing .00025- μ f. mica fixed condensers across the terminals of both coils.

Building the Oscillator Coupler

Fig. 2176-B shows the constructional details of the oscillator coupler and it will be noted that, in

effect, it consists of a primary, secondary and also a coupling coil. The coupling coil is used to pick up the necessary energy from the oscillator; it is what is usually known as a "pick-up" coil. This entire circuit is tuned by the .001- μ f. condenser. The illustration, Fig. 2176-B, shows a bakelite or fiber tube $\frac{3}{4}$ inches in diameter, $\frac{1}{2}$ inches long

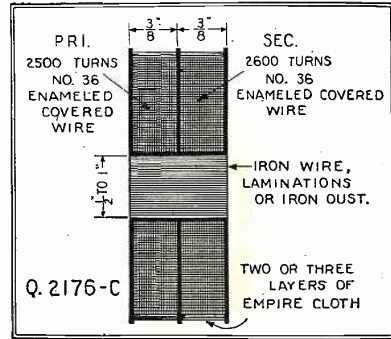

Design of an intermediate transformer which operates with maximum efficiency at 50 to 60 K.C. The correct amount of iron core must be determined experimentally.

and $\frac{1}{8}$ inch thick. A hole is drilled about $\frac{3}{16}$ of an inch from one end and the brass-angle supporting-bracket mounted as shown. Directly above this mounting screw hole, another small hole is drilled to hold a small round-head machine screw and nut, terminal No. 1. Now take a spool of No. 20 or 22 double covered copper wire and wind 7 turns as close as possible. The end of this coil is then connected to a screw terminal, 2, in the tube in the same manner as done at the beginning. This is coil L1.

Use the same size wire to wind a second coil on the tube. Wind 20 turns, fastening both ends to screws, terminals 3 and 4, as shown. To each of these screw terminals a lug can be attached if desired. These will serve for making permanent connections. This will be coil L2.

Coil L3 is wound on a separate form. For this purpose a bakelite or fiber tube, $\frac{1}{4}$ inches in diameter by $\frac{1}{4}$ inches long and $\frac{1}{8}$ inch thick, is used. Use the same size wire and wind 36 turns in what is known as "bank winding." This coil must be wound in the same direction as coil L2 in order to form a continuous winding through the fixed condenser.

One end of this bank winding can be connected to a screw terminal, shown as terminal 6 in Fig.

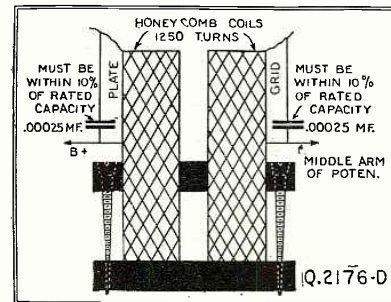

The design of the filter or input transformer. Although these coils may be wound similarly to ordinary transformers, ordinary honeycomb coils may be used with the same efficiency.

2176-B, and the other end fastened by threading it through two small holes drilled close to the other end of the tube. This coil is then fastened to the baseboard by means of an angle supporting-bracket as shown. Fig. 2176-B also shows the method of placing coil L3 in proper relation to coils L1 and L2. The distance between coil L1 and L2 is not a very critical detail and the windings may be placed about 1/2 inch apart.

The relation of coil L3 to L2 is best determined after the set has been placed in operation. Fig. 2176-B shows the smaller form on which coil L3 is wound, mounted only temporarily on the baseboard.

50 to 60 K.C. Filter and Intermediate Transformers
 Fig. 2176-C shows the design of an efficient intermediate-frequency transformer which operates very efficiently at a peaked efficiency of between 50 and 60 kilocycles (6,000 to 5,000 meters). The correct amount of iron core to be used must be determined experimentally.

Fig. 2176-D shows the design of a filter transformer which is very easily constructed and designed to operate in conjunction with the above mentioned intermediate-frequency transformer. The coil consists of two ordinary 1250-turn honeycomb coils mounted as illustrated.

Fig. 2176-DO shows the construction and details of an oscillator coil for the above-mentioned.

Tropaformer

The tropaformer is an efficient tuned intermediate-frequency transformer; its amplification peak may be varied between 2,000 and 7,000 meters (150 to 43 kilocycles).

The complete details of this transformer are shown in the illustration Fig. 2176-E. It will be noted that a variable condenser is permanently mounted on each transformer. This condenser is connected across the secondary winding; and in this way each transformer may be accurately tuned, making the intermediate-frequency amplifier very selective and efficient. Mica-insulated variable condensers are used because they occupy less space than those employing air as the dielectric. These condensers have a maximum capacity of .0005- μ f. and, in connection with the coils used, the transformers may be tuned to any wave-length ranging from 2,000 to 7,000 meters. Although the coils used in these transformers were wound by machine, they may easily be wound by hand, haphazardly, on a suitable form, or spool. The number of turns, which in this case is 440 in each coil, is not critical. Two coils connected in series form a secondary, and one coil forms a primary. It is important to separate the coils at least a quarter inch. The core iron used is exceptionally thin, japanned silicon steel. This steel, which may be obtained from manufacturers of iron-core radio-frequency transformers, is not the same as that used in the construction of audio-frequency transformers. When constructing these transformers, it is important that all coils be wound in the same direction and placed on the core, as shown in the illustration. The leads are lettered to correspond to the vacuum tube connection.

The design for an oscillator coil to operate in conjunction with the above-mentioned intermediate-frequency transformer, and which combination may be used for the construction of the popular Tropadyne receiver, is as follows:

The two windings (plate and grid) are wound in the same direction on a tube 3 inches in diameter and 4 inches in length. The plate winding consists of 24 turns of No. 20 S.S.C., whereas the grid coil consists of 29 turns of No. 20 S.S.C., and has a center tap (14 1/2 turns). For exact specifications and details refer to Fig. 2176-F.

TWO-STAGE AUDIO-FREQUENCY AMPLIFIER CIRCUIT

(Q. 2177) Mr. J. L. Sherman, Logan, Ohio, asks:

Q. 1. I have at present a one-tube regenerative receiver which operates remarkably well. I would like to add a two-stage amplifier to it so that a loud speaker may be used. Can you supply me with a diagram showing the method of connecting the various instruments together?

A. 1. The diagram you request is shown in these columns (Fig. Q-2177). Jacks are used after the detector, first, and second stages, so

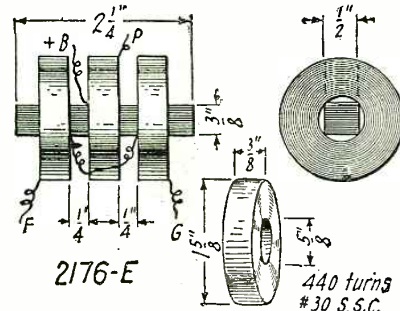

The design of a tuned intermediate frequency transformer, employing an iron core. A small variable condenser, approximately .00025- μ f., is connected across the secondary and varies the wave-length range from approximately 2,000 to 7,000 meters.

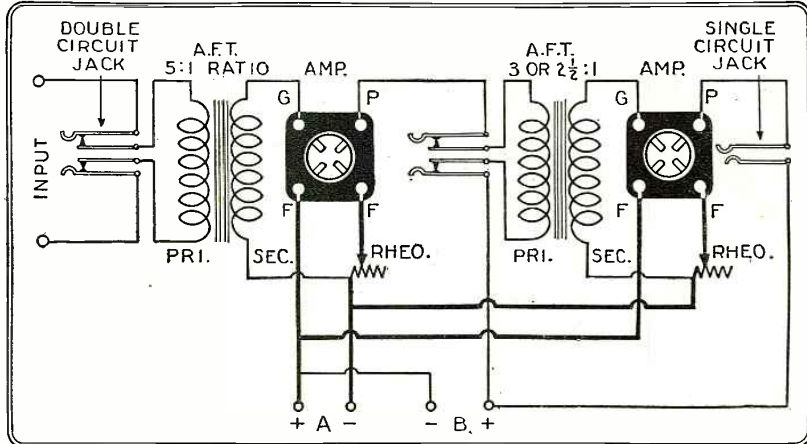

Q. 2177.—The circuit diagram of a conventional two-stage audio amplifier, with jack connections after each stage. This amplifier may be added to a one-tube receiver, or any other type in which audio-frequency amplification is desired after a detector tube.

that any number of tubes within the receiver may be used.

Q. 2. Would it be advisable to add a stage of radio frequency amplification so that greater distance may be obtained, or would you advise constructing an entirely different receiver? The present receiver's range is limited to approximately 1,000 miles, varying with conditions. Would like something more consistent.

A. 2. Radio frequency amplification will enable your receiver to obtain stations that are far distant, its range being dependent upon the number of stages of this type of amplification that are employed, besides several other minor factors. We refer you to the Browning-Drake receiver published in the February, 1926, issue of RADIO NEWS, which incorporates a stage of neutralized

obtain greater selectivity. The secondary winding of this coil is connected to the above-mentioned posts; whereas the primary winding should connect to the antenna and ground. These two may be wound on a 3-inch tube; the primary consisting of 10 turns of No. 22 DCC wire and the secondary 44 turns of the same, wound half an inch away from the primary winding. A filament-control jack is used after the third tube, so that when the plug is placed in this jack the fourth tube automatically goes out.

RADIO OSCILLATOR FOR MEASUREMENT WORK

(Q. 2179) Mr. Barratt, Brookville, Ind., wants to know:

Q. 1. I would like some information relative to the construction of a radio-frequency oscillator to be used for calculation work, measuring of transformer curves, amplification peaks, etc. The conventional radio-frequency oscillator employs two tuning controls; it is, therefore, unsatisfactory for my purpose. Can you furnish me with a circuit diagram of a device of the type, which only employs one tuning control; preferably something akin to the one you used in your laboratories, as I assume yours must be a simplified affair, from what I read of it in your articles dealing with your calculation work?

A. 1. A circuit diagram of a radio-frequency oscillator, similar to that used in the Radio News Laboratories is published in these columns. But one tuning control is used for changing the frequency generated by the oscillator, unless an extremely radical change of 300 or 400 meters is desired; in which case the position of the switches on the various taps leading to the coils, should be changed. The variable condenser is of .0005- μ f. capacity. The inductance coil's size is dependent upon the frequency range to be covered. For ordinary purposes, (coinciding with present broadcast range) a 44-turn winding, on a 3-inch tube with No. 22 DCC wire, and tapped every fourth turn, will be entirely satisfactory.

Q. 2. Can you furnish me with the formula for determining the capacity of parallel-plate condensers, also recommend some particularly good book which deals with radio principles and calculation work?

A. 2. A very good book in which radio principles and calculations are thoroughly dealt with is "Principles of Radio Communication" by J. H. Morecroft.

The formula for determining the capacity of parallel-plate condensers is:

$$C = \frac{2.246K \cdot S(N-1)}{D} \times 10^{-2} \mu f.$$

S is the area of one plate; N, the number of

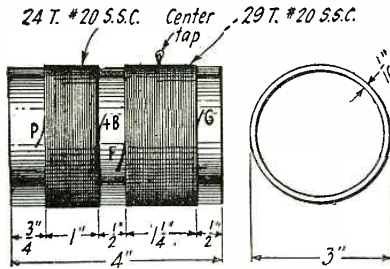

2176-F

Constructional data of an oscillator coil to operate in conjunction with the tuned intermediate-frequency transformer; designed so that it may be used in the Tropadyne, which receiver incorporates both detector and oscillator in one tube.

radio frequency amplification along with a regenerative detector, and two stages of audio frequency amplification. Perhaps you can rebuild your present receiver into this type which is unusually efficient and popular. We cannot advise exactly, since you do not state the particular circuit characteristics of your set.

DeFOREST D-10 REFLEX RECEIVER

(Q. 2178) Mr. S. M. Marks, Salina, Kansas, wants to know:

Q. 1. Last summer I met a traveling man who always carried around with him a portable four-tube set, entirely self-contained, with batteries, loop, tubes, and headphones, although loud speaker reception was easily possible. The receiver, he told me, was manufactured by the DeForest Radio Company, and was of the D-10 type. From the unusual way it operated, it seemed to be tremendously efficient; and I would like to construct a receiver similar to this, so that I can use it on vacations, trips, automobiles, tours, etc.

A. 1. The D-10 DeForest receiver is a portable reflex set constructed so that it may be used for just the purposes that you enumerated. The circuit diagram of this receiver is shown in these columns.

The transformers indicated as R.F.T. are of the ordinary untuned type, such as the Acme, Erla, DeForest, All-American, etc. The audio-frequency transformers should preferably be of the low-ratio type, 5:1 for the center A.F.T. and 3 1/2:1 for the end A.F.T.'s. The variable condenser used is an ordinary .0005- μ f., preferably of the straight-line-frequency type, as this type of condenser will allow greater selectivity on the shorter wave-lengths. The vernier condenser is an ordinary 3-plate condenser; although the midget balancing condenser made for neutralizing purposes may be used successfully. When the set is to be used with an antenna and ground, it is necessary that an antenna inductance be connected to the posts marked "A" and "G" to

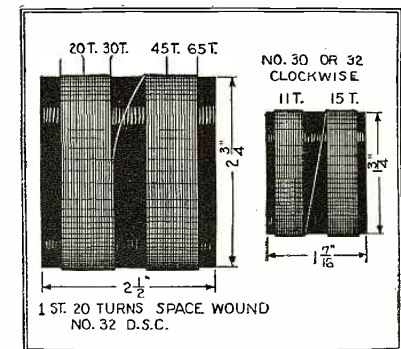

2176 DO.—The design of an oscillator and an oscillator coil in conjunction with a .0005- μ f. condenser, in a super-heterodyne receiver employing 50 to 60 KC type intermediate frequency transformer.

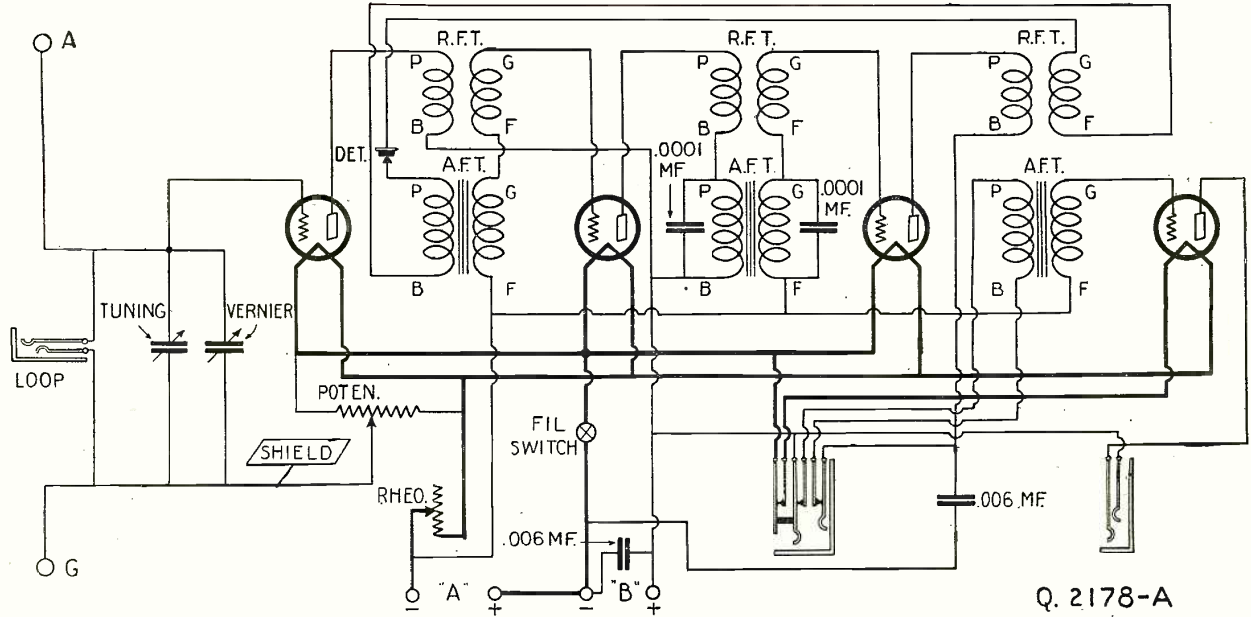

Q. 2178-A

The de Forest D-10 reflex circuit, employing 3 radio-frequency stages of amplification, crystal detector rectification, two stages of reflexed audio-frequency amplification and one straight stage of audio amplification. This is an excellent combination for portable types of receivers; and will be found to be exceedingly satisfactory and efficient when used in conjunction with a loop.

plates; D, the distance between them; K, the dielectric constant of the material between the plates. S is in square inches and D in inches.

Values of K (Dielectric Constant)

Air	1.0
Glass	4 to 10
Mica	4 " 8
Hard rubber	2 " 4
Paraffin	2 " 3
Paper	1.5 " 3
Sulphur	3 " 4.2
Shellac	3 " 3.7
Wood, maple, dry	3 " 4.5
Wood, oak, dry	3 " 6
Molded insulating material, shellac base	4 " 7
Molded insulating material, phenolic base ("Bakelite")	5 " 7.5
Vulcanized fiber	5 " 8
Castor oil	4.7

The maximum capacity of a variable condenser of semi-circular plates is given below; in which R_1 is the outside radius and R_2 is the inner radius of the plates. The other symbols are as in the formula above. (R_1 , R_2 and D in inches)

$$C = 3.53K \frac{(N-1)(R_1^2 - R_2^2)}{D} \times 10^{-7} \text{mf.}$$

CAPACITY OF TWO CO-AXIAL CYLINDERS

This is included because of the interest in Hazeltine's neutralizing capacity, which consists of two wires separated at their ends by a narrow space and having a co-axial cylinder around them.

$$C = kl \times 10^{-6} \text{mf.}$$

where l is the length and K is a constant as given in the following table. r_1 and r_2 are the radii of the outer and inner cylinders.

r_1/r_2	k	r_1/r_2	k	r_1/r_2	k
1.01	142.5	1.10	14.8	2	2.04
1.02	71.3	1.2	7.75	4	1.02
1.04	36.1	1.4	14.33	6	.79
1.06	24.2	1.6	13.00	8	.68
1.08	18.4	1.8	2.40	10	.61

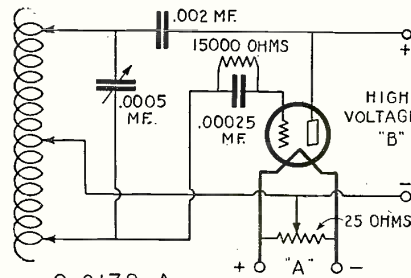

Q. 2179-A

Schematic circuit diagram of a laboratory type oscillator. This instrument is employed extensively for measurement and calculation work of radio apparatus. It can also be calibrated and used as a wave-meter.

The I Want to Know Department cannot undertake to supply picture diagrams of the circuits which it publishes; the schematic diagrams, which are standard, are made as plain as possible and full information is given with them. When picture diagrams are requested we will, however, give information where they may be had, in case they are available elsewhere.

Broadcast Station Call Crossword Puzzle

KEY TO STATION CALLS

Horizontal:

Location of Stations	Wave-Length
1. Tacoma, Wash.	250
2. Los Angeles, Calif.	468.5
3. Yankton, S. D.	244
5. Harrison, Ohio	422.3
5. Oakland, Calif.	240
6. Los Angeles, Calif.	336.9
9. Dallas, Tex.	475.9
11. Chicago, Ill.	447.5
12. Everett, Wash.	224
13. New York, N. Y.	405.2
14. Portland, Ore.	491.5
15. Toledo, Ohio	252
16. Baltimore, Md.	246
17. Yellow Springs, Ohio	263
18. Cedar Rapids, Iowa	278
19. Fall River, Mass.	266
20. Lawrenceburg, Tenn.	282.8
22. Harrisburg, Pa.	275
23. Minneapolis, Minn.	416.4
25. Chicago, Ill.	226
26. El Paso, Texas	267.7
27. Des Moines, Iowa	526
28. Dallas, Texas	246
29. Stevens Point, Wis.	278
30. Denver, Colo.	323.4
31. New York, N. Y.	360
32. Spokane, Wash.	273
34. New York, N. Y.	240
35. Chicago, Ill.	447.5
36. Indianapolis, Ind.	268
37. St. Louis, Mo.	248
38. Springfield, Mass.	331.1

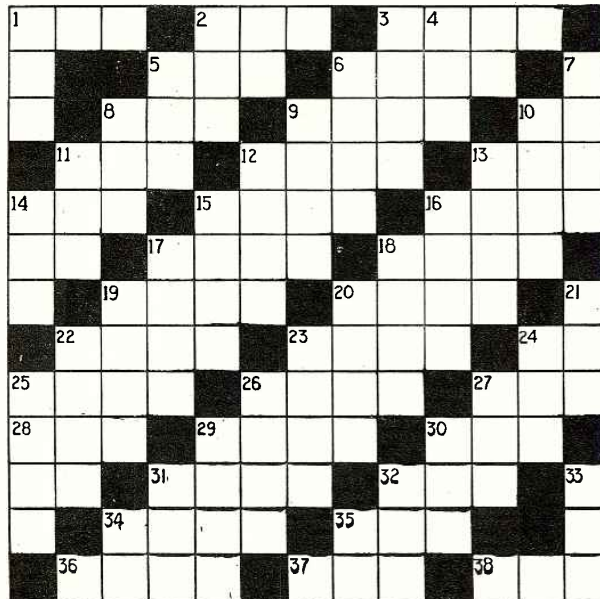

KEY TO STATION CALLS

Vertical:

Location of Stations	Wave-Length
1. Lacey, Wash.	246
2. Oakland, Calif.	508.2
3. Toledo, Ohio	252
4. Arlington, Va.	434.5
5. Newark, N. J.	252
6. Everett, Wash.	224
7. Salt Lake City, Utah	246
8. San Jose, Calif.	231
9. Lincoln, Nebraska	275
10. Providence, R. I.	305.9
11. Chicago, Ill.	302.8
12. Oakland, Calif.	240
13. Chicago, Ill.	266
14. Clarinda, Iowa	242
15. Escanaba, Mich.	256.3
16. Houghton, Mich.	263
17. Cleveland, Ohio	389.4
18. Omaha, Neb.	258
19. Rossville, N. Y.	273
20. Northfield, Minn.	356.9
21. Philadelphia, Pa.	508.2
22. Birmingham, Ala.	248
23. Winter Park, Fla.	240
24. Madison, Wis.	535.4
25. Richmond Hill, N. Y.	212.6
26. Louisville, Ky.	275
27. Kansas City, Mo.	278
29. Miami, Fla.	263
30. Los Angeles, Calif.	405.2
31. Kansas City, Mo.	365.6
32. San Jose, Calif.	231
33. New York, N. Y.	434.3

RCA power Radiotrons
**bigger
 volume**
 without
 distortion



Radiotron UX-112, storage battery power tube . . . \$6.50

Radiotron UX-120, dry battery power tube . . . \$2.50

One of these tubes, in the last stage, uses extra batteries and gives greater volume of tone.



DRIVE a car uphill beyond its power—and the motor knocks. Drive a radio set beyond its power—and the last tube chokes, the loudspeaker blasts. The RCA power Radiotron has just one function—to stand the strain the last tube gets. More *power* can flow through it without choking or blasting and it means a decidedly clearer, finer tone—at a greater volume.

Use quality you know

You would not use any but a MAZDA lamp. Why use any but an RCA Radiotron? They are made by the same skilled workers, backed by the same research laboratories. But the Radiotron is far more delicate to make. Be sure all the tubes in your set are Radiotrons. And keep a spare handy.



RADIO CORPORATION OF AMERICA
 New York Chicago San Francisco

RCA Radiotron

MADE BY THE MAKERS OF RADIOLAS

The LYNCH METALLIZED RESISTOR

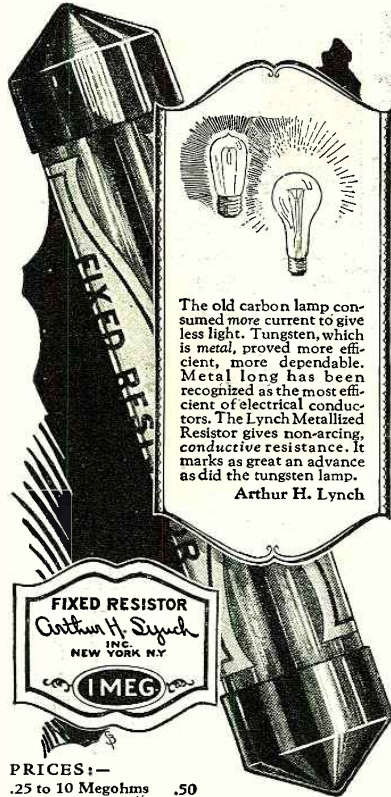

The old carbon lamp consumed more current to give less light. Tungsten, which is metal, proved more efficient, more dependable. Metal long has been recognized as the most efficient of electrical conductors. The Lynch Metallized Resistor gives non-arcing, conductive resistance. It marks as great an advance as did the tungsten lamp.

Arthur H. Lynch



PRICES:—
 .25 to 10 Megohms .50
 above .01 to .24 " .75
 .001 to .01 " \$1.00
 Single Mounting .35

**Warranted—
 Absolutely Noiseless
 Permanently Accurate
 Dependable !**

COMPRISING a concentrated metallized deposit one-thousandth of an inch thick upon a glass core and sealed within a glass tube, each LYNCH METALLIZED FIXED RESISTOR wins in the exacting tests of time and service. This better-built product has been endorsed by leading engineers and experimenters and the test laboratories of the leading magazines.

If your dealer cannot supply you, it will pay you to wait for the mail—we ship postpaid, and Lynch products are sold on a money-back guarantee.

Dealers—Write us!
ARTHUR H. LYNCH, Inc.
 Manufacturers of Radio Devices
 Fisk Bldg., Broadway & 57th Street
 New York, N.Y.

The Ideal Radio Set— Results of the \$1000.00 Prize Contest

(Continued from page 10)

smile; but there will be found in others the germ of a feasible improvement in efficiency or convenience, or the suggestion of a hitherto unvoiced want.

REMARKABLY WIDESPREAD RESPONSE

The distribution of the participants in this contest was surprising even to the editorial staff of RADIO NEWS; among the replies which poured in were letters from Madras, India, Shanghai, China; from the Philippines, as well as Hawaii, Alaska and the Canal Zone; from all parts of South and Central America and from all over Europe, as well as the United States, Canada and Mexico. Notwithstanding the widespread nature of this plebiscite, the entries which came the farthest did not show any striking contrast to the others; except that a much larger percentage of the replies from the Spanish-speaking countries expressed a

RULES OF THE CONTEST

- (1) Anyone may enter this contest, with the exception of the employees of the Experimenter Publishing Company and their families.
- (2) It is not necessary to draw the design upon the blank on the front cover of this magazine. The design may be traced or copied or drawn from imagination.
- (3) Any style of radio set is eligible, whether sloping panel, straight panel, set without a table, console type, portable, etc. The set may be for aerial or for loop, with or without built-in loud speaker, as fancy dictates. Sets may have any kind of control, whether by regular dial, vernier dial, dials behind the panel, or new vertical dials.
- (4) Any number of designs may be submitted by contestants.
- (5) No design can be submitted in pencil drawing. It must be executed either in ink or india ink, water colors, oil colors, etc.
- (6) A description of 100 words or less, stating your reason, why you think your particular design is best, must be PASTED on the back of the design. This description to be either typewritten or penned in ink. No pencil matter can be considered. Your name and address must be included in this description. Descriptions or letters attached with pins or clips are ruled out.
- (7) All designs must be sent in flat. Those received rolled will be rejected.
- (8) This contest is NOT a technical one. The judges are not concerned with what is behind the panel. Thus, for instance, a single dial may control three or more condensers, but no technical description of what is behind the panel is wanted or can be included in the description. It is up to the set manufacturers to build sets according to the wishes of the American public.
- (9) Where a concealed loop or concealed loud speaker would not show on the face of the drawing, it is desired that you include this in your written description of the set. If an unusual design is submitted, the location of the loop aerial or loud speaker can be indicated by dotted lines on the face of the drawing, or by indicating arrows, etc.
- (10) It is permissible to use colors on the designs, if desired, although the judging of designs will not be affected thereby.
- (11) In case of a tie, identical prize-winning answers being submitted by different contestants, identical prizes will be awarded to those tying for the prizes.
- (12) Entries submitted in this contest cannot be returned to contestants.
- (13) This prize contest closes April 20, 1926, at noon, which time all answers must have been received at this office.
 Prize entries not adhering to the rules will be disregarded and thrown out from the contest.

preference for a very light and conveniently portable set.

A very large number of entries showed that much time and thought had been spent on them, although their senders had not al-

FREE!
 To Each Purchaser of a WORLD "A" Auto or Radio BATTERY

12-Cell — 24-Volt Storage 'B' Battery
 Positively given free with each purchase of a WORLD "A" Storage Battery. You must send this ad with your order. WORLD Batteries are famous for their guaranteed quality and service. Backed by years of successful manufacture and thousands of satisfied users. Equipped with Solid Rubber Cases, an insurance against acid leakage. You save 60 per cent and get a

2-Year Guarantee
Bond in Writing "I hereby own and sell their friends." That's our best proof of performance. Send your order in today.
 Solid Rubber Case Radio Batteries:
 6-Volt, 100-Amperes . . . \$11.25
 6-Volt, 130-Amperes . . . \$13.25
 6-Volt, 140-Amperes . . . \$14.00
 Solid Rubber Case Auto Batteries:
 6-Volt, 11-Plate . . . \$11.25
 6-Volt, 13-Plate . . . \$13.25
 12-Volt, 7-Plate . . . \$16.00

Send No Money Just state battery wanted and we will ship day order is received, by Express C. O. D., subject to your examination on arrival. **FREE "B" Battery** included. Extra Offer: 5 per cent discount for cash in full with order. Buy now and get a guaranteed battery at 60 per cent saving to you.

WORLD BATTERY COMPANY
 1219 So. Wabash Ave., Dept. 10 CHICAGO, ILL.

World STORAGE BATTERIES
 Set your Radio Dial at 210 meters for the new 1000 w. World Storage Battery Station WSBBC, Chicago. Watch for announcements.
 WGBA—WEAF—WGN—WJZ—KHJ—KGO—KFAP—WJY—KOP

Why Don't YOU Earn This Money?

Many Earn \$50 to \$250 a Week Let us start you making big money with a camera. No experience needed. Spare time work, big-paying positions, or a business of your own. Opportunities everywhere in all branches: Motion Picture Camera Work, Portrait and Commercial Photography.

CAMERA GIVEN
 Your choice of real Motion Picture Camera or professional View Camera, genuine Anastigmat lens. Experts train you at home to become Professional Photographer. Free Employment Service.

Write for Book
 Tells how to earn big money in this fascinating work. Send for Book NOW—IT'S FREE!

NEW YORK INSTITUTE OF PHOTOGRAPHY
 12 W. 33rd St., New York City (Dept 56)

LATEST "COAST TO COAST" FULLY GUARANTEED RADIO'S-10 DAYS FREE TRIAL
 SAVE 1/3 TO 1/2
 Users everywhere report Miraco Radios get program coast to coast on loud speaker outperform sets three times as costly. Many hear foreign countries. Radio's most amazing values in unconditionally guaranteed, factory-built long distance sets—let testimony of users convince you.

MIRACO RADIO GETS 'EM COAST TO COAST
 Powerful New Multi-tube Miraco Gets long distance on loud speaker. Set, ONLY \$27.35 retail
 FREE! Literature on latest improved 1 to 5 tube models, new low prices, testimony of users and SPECIAL OFFER. Write: **MIDWEST RADIO CORP'N** Pioneer Builders of Sets 404W E. 8th St. Cincinnati, O.

NOTE: If you prefer to come to our New York or Chicago Studios for personal instruction, day or evening classes, write for Catalog R-56 to nearest address: 10 West 33rd St., New York, or 630 So. Wabash Ave., Chicago, Ill.

AGENT USERS WANTED
 Write for discounts.



"We give our sets about the same amount of use, but your 'B' batteries always last longer than mine. What's your secret?"

"WHY, there's really no deep, dark secret about it. It's simply knowing what are the right size batteries to buy for your set."

"Yes, but what do you mean by right size?"

"The right size depends on the number of tubes in your set. The more tubes you have, the bigger the 'B' battery you need to give you long, economical service. Just follow the rules laid down by Eveready and you can't make a mistake." These are the rules and the results:

On all but single tube sets—connect a "C" battery. The length of service given below is based on its use.*

On 1 to 3 tubes—use Eveready No. 772. Listening in on the average of 2 hours daily, it will last a year or more.

*NOTE: A "C" battery greatly increases the life of your "B" batteries and gives a quality of reception unobtainable without it. Radio sets may easily be changed by any competent radio service man to permit the use of a "C" battery.

On 4 or more tubes — use the Heavy-Duty "B" Batteries, either No. 770 or the even longer-lived Eveready Layerbilt No. 486. Used on the average of 2 hours daily, these will last 8 months or longer.

The above rules will give you the maximum of "B" battery life and

economy. Of course, if you listen in more than 2 hours a day, which is the universal year-round average, your "B" batteries will not last quite so long, and if you listen less they will last longer. Eveready "B" Batteries give a pure, steady, noiseless current, the kind of current that is absolutely essential if you prize pure tone.

Send for booklet, "Choosing and Using the Right Radio Batteries," sent free on request. There is an Eveready dealer nearby.

Manufactured and guaranteed by
NATIONAL CARBON CO., INC.
 New York San Francisco
 Canadian National Carbon Co., Limited
 Toronto, Ontario



LEFT - No. 486, for 4, 5 or more tubes. \$5.50.
 RIGHT - Eveready Dry Cell Radio "A" Battery, 1½ volts.

EVEREADY
Radio Batteries
—they last longer

Tuesday night means Eveready Hour—8 P. M., Eastern Standard Time, through the following stations:

- | | |
|------------------|--------------------|
| WEAF—New York | WSAT—Cincinnati |
| WJAR—Providence | WTAM—Cleveland |
| WEEL—Boston | WWJ—Detroit |
| WTAG—Worcester | WGN—Chicago |
| WFI—Philadelphia | WOC—Davenport |
| WGR—Buffalo | wcco { Minneapolis |
| WCAE—Pittsburgh | { St. Paul |
- KSD—St. Louis



Bradleyunit PERFECT FIXED RESISTOR

RADIO circuits frequently call for a fixed resistance unit. This is particularly true for B-battery eliminators which provide several B-battery voltage taps for the radio set.

Be sure to use Bradleyunits for this service, because Bradleyunits are solid molded fixed resistors calibrated with great accuracy and fitted with silver-plated terminal caps which can be soldered without damage to units. These units are made in more than 20 different ratings, and will not deteriorate with age.

For experimenters who prefer to build their own resistance-coupled amplifiers, a special set of Bradleyunits has been prepared and sold in a convenient carton ready for use in a resistance-coupled amplifier.

Be sure to order Bradleyunit Amplifier Resistors from your dealer, today.



ALLEN-BRADLEY COMPANY
287 Greenfield Ave., Milwaukee, Wis.

Please send me your latest literature on Bradleyunits and Bradleyunit Amplifier Resistors.

Name.....

Address.....

.....

ways been careful to observe the rules under which this contest was held. These, which appeared in the March, 1926, issue of RADIO NEWS, are reprinted here.

In addition to this, many of the most elaborate entries were decidedly freak sets; and, as our announcement of the terms of the contest explicitly stated, the chief prizes were to be (and have been) awarded to entries which are truly typical of the best type of receiver design in majority demand. To some entries, very little inferior to the prize winners; or meritorious, but of a type which had but a few advocates; or which were very attractively prepared, but "freakish"; or which showed real originality in ideas, we take pleasure in giving honorable mention.

HONORABLY MENTIONED

For Excellence of Entry or Originality of Idea

- M. Mayo, 193 Steinway Ave., Long Island, N. Y.
- J. Reed Golden, 3337 West 126th St., Cleveland, Ohio.
- John H. Ellison, Kramer-Crasselt Co., Milwaukee, Wis.
- F. D. Van Volkenburg, 419 S. Westnedge Ave., Muskegon, Mich.
- Alberto Fariña Rice, Buenos Aires, Argentina.
- Raymond F. Devine, 3052 Kingsbridge Ave., New York, N. Y.
- C. Irwin Thiele, 558 Northampton St., Buffalo, N. Y.
- Walter Rankin, SS. San Zoticco, Anglo-Mexican Petroleum Co.
- Mauricio Vicens, Barcelona, Spain.
- E. E. Burr, 1840 Calumet Ave., Chicago, Ill.
- Luis A. Moguel, 146 W. 105th St., New York, N. Y.
- P. S. Young, Coolidge, N. C.
- H. Brand, Saranac Lake, New York.
- J. L. Thouvenel, Tunnel City, Wis.
- Floyd Ahrens, Des Moines, Iowa.
- Linus Adams, 112 Falconer St., Jamestown, N. Y.
- Ray O. Brown, 11 Farrand Park, Highland Park, Mich.
- Aloysius Day, 2117 West 4th St., Chester, Pa.
- George Rutan, New Market, N. J.
- Elliott Zerman, 302 Eighth St., West New York, N. J.
- Albert M. Reager, Birmingham, Alabama.
- J. Charles Riley, Elmira Heights, N. Y.
- R. S. Miller, 3120 Broadway, New York, N. Y.
- Jacob E. Salie, 1407 N. 33 St., Birmingham, Ala. (Entry received too late).
- Fred Uncles, Newcastle, New Brunswick (for excellence of description in the form of a salesman's talk).
- Mrs. L. T. Schults, Long Valley, N. J.
- Miss Mary Fulton Mitchell, Tunbridge, Vt. (The youngest entrant—aged nine).

The Air Service Radio Laboratories

(Continued from page 13)

hand representing one loop aerial and the pages on the other hand representing the other loop. These two loops are mounted at an angle with respect to each other in the form of a "V" and are alternately energized, one loop transmitting the letter "N" and the other the letter "A."

The pilot of the plane in flight, equipped with a standard receiving apparatus, may maintain a fixed course by simply listening in to the two code signals and guiding the plane so that the intensity of the transmitted signals is of equal strength. No matter what the weather may be, whether in strange territory or not, and regardless of drift due to cross winds, the pilot of a plane navigating by the aid of a "beacon" will be able to hold a true course; for if he should deviate from it the difference in the intensity of the code signals with respect to each other will instantly warn him and tell him whether he is off his course to the right or left, and he can take the necessary steps to correct it.

This method has been tested repeatedly with planes in flight over long ranges, such as between McCook Field and Washington, and has proven to be highly successful, the greatest error in course never having been

AEROVOX

"Built Better"

RESISTOFORMERS

Tested and approved by M.I.T., Yale, Radio News, Popular Radio, and Popular Science. Used by over 200 of America's leading set manufacturers.

AEROVOX WIRELESS CORP.
489-491-493 Broome St., New York

Branch Offices:
St. Louis, Mo., Syndicate Trust Building
Cincinnati, O., 304 Palace Theatre Bldg.
Chicago, Ill., 53 W. Jackson Boulevard
Boston, Mass., 94 Portland Street
Los Angeles, Cal., 324 N. San Pedro St.

National Velvet Vernier

DIALS and CONDENSERS

YOU control the reduction ratio with this new NATIONAL, Type B, Velvet Vernier Dial. You'll be astonished at the difference in the tuning of your set. Price \$2.50. Write for Bulletin 109-RN.

NATIONAL COMPANY, Inc.
W. A. Ready, President
110 Brookline St., Cambridge, Mass.

6-Volt Storage Radio "A" Battery

Most amazing battery value ever offered! A genuine World 6-Volt Radio "A" Battery with 25 ampere capacity for only \$5.00! Just the thing for Truckle Charger. Famous World Quality assured. Equipped with Solid Rubber Case

\$5.00 C. O. D. Send No Money

an assurance against acid and leakage. Order Now. We ship same day — by express C. O. D. subject to your examination on arrival. Dealer Offer: 5% discount for cash in full with order. ACT TODAY!

World WORLD BATTERY CO.
STORAGE BATTERIES Dept. 110,
1219S. Wabash Ave., Chicago

KDKA - WEAZ - WGN - WJS - KHJ - RGO - KFAZ - WJY - KOPJ

don't move your set

BIRNBACH EXTENSION CORD

will move your speaker from room to room or to porch and lawn

20 FEET COMPLETE WITH CONNECTOR \$1.40
30 FEET COMPLETE \$1.80
50 FEET COMPLETE \$2.80 Postpaid

BIRNBACH RADIO CO.
370 SEVENTH AVE. NEW YORK CITY

BUILD YOUR OWN RADIO SET!

FREE THIS VALUABLE 68-PAGE BOOK

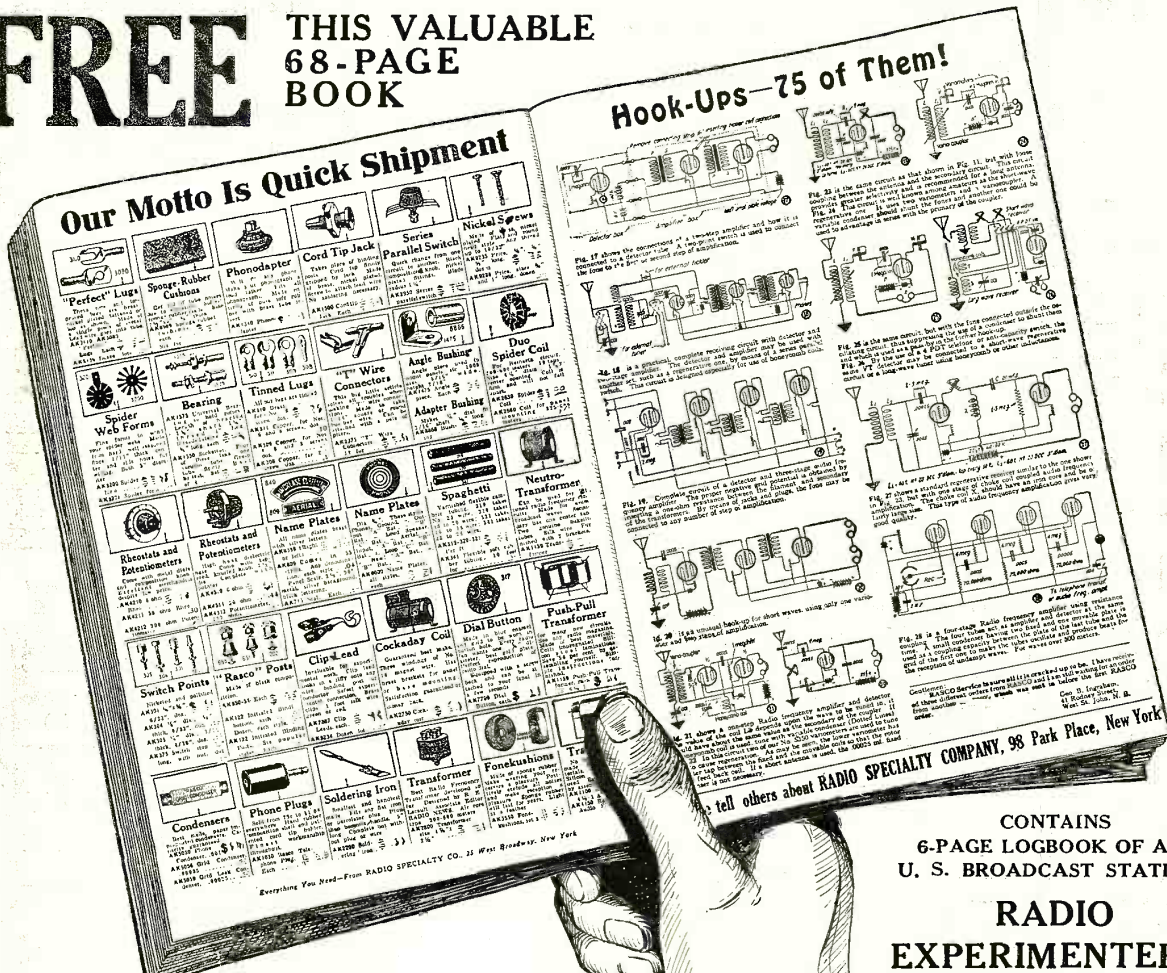

THE BIG 1926 SPRING CATALOGUE No. 16
68 Pages—600 Illustrations

CONTAINS
6-PAGE LOGBOOK OF ALL U. S. BROADCAST STATIONS
RADIO EXPERIMENTERS, SEND FOR THIS FREE BOOK TODAY

Buy from Radio's Oldest Mail Order House

THE NEW RASCO CATALOG No. 16
 Contains the Following Hookups.

All Armstrong Circuits: These important circuits are explained clearly, all values having been given. Just to name a few of the Vacuum Tube circuits: The V.T. as a detector and one-step amplifier; Super Regenerator; one-step radio frequency amplifier and detector; three-stage audio frequency amplifier; short wave regenerative circuits; 4-stage radio frequency amplifier; radio and audio frequency amplifier; Inductively coupled amplifier; all Reflex Circuits.

This catalog is crammed full of small parts and radio findings, literally thousands of them. In addition there is much useful information contained herein.

WE are the oldest established, exclusive radio mail order house in the country. Our motto is "Quick Shipment." All orders are shipped within 24 hours. Quick, prompt, courteous service. We carry a larger variety of radio parts and findings than any other radio house in the country.

"RASCO HAS IT"

If you are in need of certain small radio parts that other radio and mail order houses do not bother to carry, get the Rasco parts catalog, and you will find them there. Anything from a screw to copper ribbon and telephone diaphragms, as well as thou-

sands of other small radio findings. Just to mention a few:
 Lugs, nuts, dials, vernier dials, jacks, plugs, every kind of knob, cords, panels, screws, sliders, washers, selenium, tinfoil, switches, crystals, cap nuts, Litz wire, cord tips, brass rods, resistances, name plates, spring binding posts, switch parts, metal ribbon, carbon balls, binding posts, all types switch points, switch levers, lock washers, carbon grains, ground clamps, metal pointers, insulated tubing, low melting metal, antenna connectors, bus bar wire, as well as thousands of others.

WE CARRY THE LARGEST VARIETY OF SMALL RADIO PARTS IN THE WORLD.

If you will paste this coupon on a post card and mail today, we will be pleased to send you our new Catalog at once.

RADIO SPECIALTY CO. R. N. -7-26
 98 Park Place, New York
 You may send me, without charge or obligation, your NEW CATALOG No. 16. (Write on margin if you desire).

.....
 Name
 Street
 P. O. State.....

RADIO SPECIALTY CO.
98 Park Place New York City

The Radio Trouble Finder

—by the Staff of **RADIO NEWS**

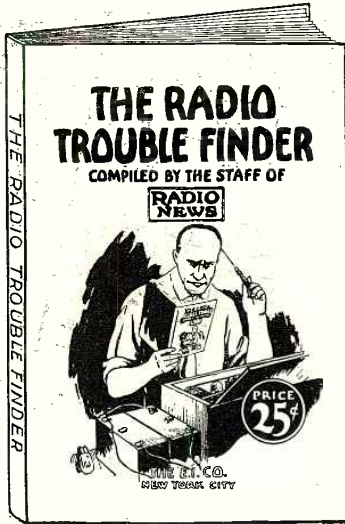

PRICE
25^c

64 PAGES
200 ILLUSTRATIONS
Size 6 x 9
Inches

No matter how much or how little you know of your radio receiver, this new "Radio Trouble Finder" book is going to be a big help.

It explains the common and special faults of all the standard receivers of today; tells how to recognize instantly, by various sounds, where the trouble lies and also gives special simple tests by which you can determine what is wrong with your receiver. Then for each particular fault there is explained the proper procedure for correcting it. All troubles and their remedies are arranged in simple charts so that even the most inexperienced radio user will have no trouble in keeping his set at all times in first class condition.

All parts of the radio set are illustrated to show the layman how to proceed in correcting faults.

Published by
THE E. I. COMPANY
Distributed by
THE CONSRAD CO., INC.,
64 Church St., New York, N. Y.

SOLD ON ALL NEWSSTANDS

MORE PROFITS for the Professional SET BUILDER

We have an unusually interesting proposition to make to the man who is now building (or has the ability to build) radio receiving sets for resale. This is a real opportunity. Write today for full information.

Gearhart Schlueter Radio Corp.
715 Voorman Ave., Fresno, California

Learn Watchwork, Jewelrywork and Engraving. A fine trade commanding a good salary, and your services always in demand. Address Horological, Dept. 5, Bradley Institute, PEORIA, ILLINOIS, for our latest catalog.

Rubber Covered Insulators



Neat and efficient. For antenna, ground and for lead in wires. Small screw starts readily and makes finished job. Great improvement over ordinary large, unsightly insulators. They keep the wires in place and out of the way. Packed 10 in a box, 25c at your dealers or direct from us.

CULVER-STEARN'S MFG. CO.
Worcester, Mass., U. S. A.



Write for Booklet
AMSCO PRODUCTS Inc.
Broome and Lafayette Sts.
New York City

more than four degrees, considered remarkably small for the distance flown. This valuable aid to aerial navigation is a joint development of the U. S. Bureau of Standards, the Army Signal Corps and the Air Service and will do much, it is believed, to further the efficiency of planes in flight.

The "beacon" method of navigation should be of especially great help during sustained flights at night or during adverse weather conditions when it is not practicable to observe landmarks for correction of the course.

Finally, our inspection completed, we bid adieu to our host and left the laboratories, the high-pitched whine of the transmitter generator singing in our ears as the engineer radioed the plane roaring through the blue above to "Come down, I want to try a change in that control."

And so the development of the radio art goes on and on unceasingly in this arm of our country's military defense. After what we have seen we cannot but wonder what new device the morrow will bring forth; but of one thing we feel certain, that if the Air Service is ever called into action it will not be lacking the last word in modern radio devices, for the Air Service Laboratories are on the job to develop the best equipment for which it has need.

(Editor's Note. Illustrations of airplane receiving sets and the latest shielding methods, as well as a description of the new visual beacon for air pilots, will be found in March RADIO NEWS, page 1277.)

\$50 Radio Wrinkle Contest

(Continued from page 55)

to mend a tube in such a condition. A good length of friction or adhesive tape wound around the tube, so that it binds a portion of both the composition base and the glass,

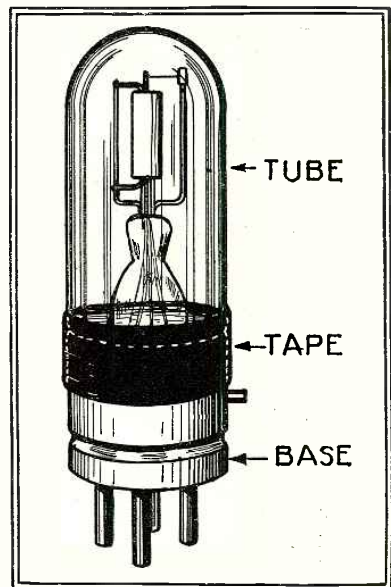

A tube that has become loosened from its base can be repaired by winding friction tape around the section where the tube and base meet.

will do the trick. There will be a certain amount of flexibility or "play," but not enough to place any strain on the connecting wires inside.

Contributed by Russell Bassett.

Everyman's Receiver— The Fenway

(Continued from page 45)

The instruments mentioned are connected into the circuit, as indicated in the right end of the diagram. Once again the batteries, the aerial and ground—or a loop—are connected, the speaker plugged in and—there you are!

What's that you say? There is no climax to my drama! Oh, yes, there is! It comes after you readers have constructed my set. It comes right in their own home, where all good climaxes should come. When the readers of RADIO NEWS discover that this set will function on either four tubes or nine, when they learn that it will cover wave-bands of from 50 to 600 meters, when they know that the quality of reception leaves not the slightest indication of the mechanical—when they hear 3,000-mile stations with the volume of locals—and "maybe" doesn't enter into the scheme of things—when all these events come to pass, that's the climax.

LIST OF PARTS FOR FOUNDATION UNIT OF THE FENWAY

- 1 Antenna coil (for waves from 35 to 550 meters) L₁, L₂
 - 1 R.F. coupler (details page 1657, June)
 - 1 Oscillator coupler (L3-L4-L5)
 - 2 Mounting bases for couplers
 - 3 Variable condensers, S.-L.-W., .00035- μ f (C1, C2, C3)
 - 1 Panel, 8x28x3/16 inches
 - 1 Rheostat, 6-ohm
 - 3 Vacuum tubes, 201A type, and sockets
 - 3 Vernier dials
 - 1 Filament switch
 - 1 D. C. jack
 - 1 Grid condenser, .00025- μ f., and grid leak, 2-megohm
 - 1 Fixed condenser, 0.5- μ f.
 - 1 Sub-panel, 4x12 inches
 - 1 Piece insulating material, 2½x2½x3/16 inches
 - 1 Tap switch and 3 taps
 - 1 Safety fuse and mounting
 - 1 Milliammeter, 0-50
 - 1 Voltmeter, 0-8-80-160 (special type)
 - 8 Binding posts (A, G, -A, +A, -B, +B Det., two + B Amp.)
 - 1 Baseboard, 9½x27½x½ inches
 - 4 Copper cans (3 are 5x6x6½; 1 is 4x4x4)
 - 50 feet No. 14 or 15 rubber-covered flexible wire
 - ¼ pound No. 32 copper wire, D.S.C. or D.C.C.
- The constructional details of the foundation unit will be found on page 1656 of the June issue of Radio News. The material for the complete Fenway receiver is estimated at \$133.

Sam Jones, Radio Tube Bootlegger

(Continued from page 17)

of money," says Mr. Horgan. "So it's better for everybody."

* * * *

Six weeks later, at San Francisco, I carries my personal belongings off the *Steel Boholink*, an' takes 'em up to my shore-leave headquarters, an apartment-house hangout over in Oakland. In th' basement of this dump I rents a vacant storeroom, which is to be my place of busines. Here I sets up a board on a couple of soap-boxes; thereby makin' a combined counter an' stock-shelf; then I gets a old battered table, a comfort-chair with a cushion in it, an' a nice new silver-plated letter opener. My bootleg radio tube layout is now complete—except for th' tubes.

These, havin' been ordered, soon arrive. They come by parcels post, in four big cartons with a tag for a hundred plunks lashed onto each carton. One of Uncle Sam's post-office's hired hands delivers 'em, an' separates me from four-hundred dollars for 'em

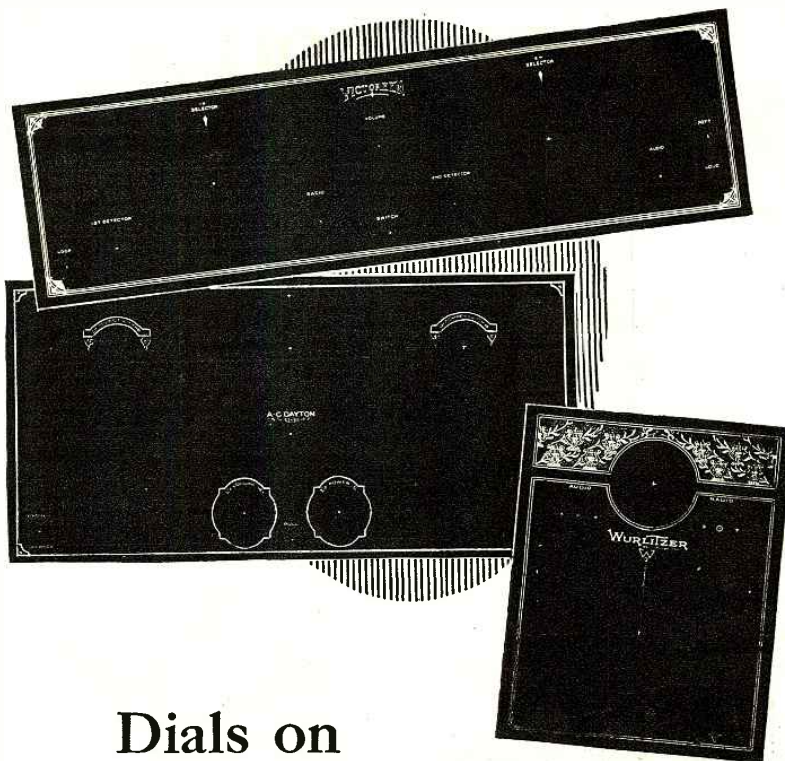

Dials on Formica Panels Do Not Bind!

Any material which absorbs moisture and warps will cause the dials to bind when used as a panel—but Formica once mounted in the set, stays flat for a life time.

Formica panels decorated in Veri Chrome are available this year in a wide variety of designs—both simple and ornate. A new satin finish of remarkable dignity and beauty is being offered to set makers. Completely punched base panels and shelves are also available to quantity buyers.

Formica Panels for Kits

Panels in gloss black Formica decorated in gold by the Veri Chrome process are available for the following well known kits: Victoreen Superheterodyne, Madison Moore Superheterodyne, Best's Superheterodyne both 7x20 and 7x26 inches; Browning Drake National; L. C. 26 Cockaday; General Radio Broadcast Receiver. See your dealer or jobber or write us direct. Individual Formica panels of any size are furnished in neat craft paper envelopes.

Write for booklet "What Formica Is"

The Formica Insulation Company

4618 Spring Grove Avenue, Cincinnati, Ohio



FORMICA

Made from Anhydrous Bakelite Resins
SHEETS TUBES RODS

RADIO TOOLS



NO. 202
Combination Plier, Wire Cutter, Wire Former and Wrench. Drop forged, slender but exceptionally strong. 6 inches long.
No. 202—Combination Plier.....Price 75c



NO. 201
Side Cutting Nipper Lap Joint. For cutting all kinds of wire. Jaws hardened and oil tempered. Natural steel finish with polished jaws. Length 6 inches. No. 201.....Price 75c



NO. 701
Radio Tool Set. Contains the following: 1 Ratchet Screw-driver, 6 1/2 in. long holding all attachments; 1 Blade, 5 1/2 x 3/16; 1 Blade, 3 1/2 x 1/4; 1 Blade 2 1/2 x 1/4; 1 Countersink; 2 Socket Wrenches for all small nuts; 1 Reamer to enlarge holes in panel from 1/8 to 1/2; 1 Wrench, one end 5/16 in. square or hex. for jack, other 1/2 in. hex., etc.
No. 701.....Price per set \$3.00



NO. 401
Circle Cutter. It does three things at once. It drills its own pilot, cuts out plug and puts bead or scroll around the hole in one operation. Cuts holes 3/4 to 4 in. in diameter. No. 402 Price \$3.00
No. 401.....Price \$2.00

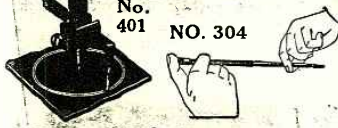

NO. 304
Screw Starter and Driver. Holds any screw by its slot with a firm grip, makes it easy to place and start screws in difficult places. All parts heavily nicked and polished. No. 304.....Price \$1.00



NO. 800
Electric Soldering Iron. Operates either on 110-volt A.C. or D.C. The heat element is of Nichrome which prevents overheating and assures the desired even temperature. Size of iron, 10 1/2 in. long. A 4-ft. cord and plug is furnished.
No. 800.....Price \$2.00



NO. 302
Hand Drill. A beautiful balanced, small, powerful drill with 4 to 1 ratio of gears for speed. Special chuck 9/32 in. capacity, to take largest drill, mostly furnished with drill or tool sets. Length over all, 9 1/2 in. Weight 1 1/2 lbs. No. 302 Price \$2.75

Order all tools by order number. All goods are shipped free of transportation charges to all parts of the United States and possessions the same day as the order is received.

MONEY REFUND GUARANTEE—If you are not satisfied money will be refunded on return of goods.

THE RADIOGEM CORPORATION
66-R West Broadway New York, N. Y.

so speedy an' efficient-like that it fairly makes my head swim. Openin' up the four boxes, I finds my tubes safely inside, bright an' sparklin' like a bunch of African diamonds—each one wrapped in mineral cloth and packed in a small white carton without no name or anything on it.

A couple o' days later, my hundred-dollar radio tube repair ad blossoms out in a convenient radio-fan magazine; whereupon I leans back in my soft cushioned chair, armed with my silver-plated letter-opener, an' joyful-like awaits a blue shower of money-orders.

At last, however, a mail-truck does stop in front of my basement door; an' the driver drags into my bailiwick a big oaken box, about two feet long, high, an' wide, addressed to "Mr. Adonis P. Hawkins & Co."—this bein' my prudent business alias.

"Attaboy, Charlie!" I exclaims t' th' fisty little old' bird I calls th' Skipper, who I have hired to help me handle th' expected deluge of boxes of dead radio tubes for repair. "Must be about fifty burnt-outs in this young piano case!"

Gettin' a hammer an' a crowbar, we fights half-an-hour with th' box, an' both works up a big sweat, before we even get th' corner of th' lid loose. But finally we conquers it. Underneath the cover, we finds a tightly-packed mass of crumpled newspapers. Wadin' through about a foot of these, we comes to a large cardboard carton, about twelve inches square, which is lashed up with a hunk of rope long enough and stout enough to hang a gun-man. Cuttin' this carton open, we digs through some more newspapers and excelsior packing; then we comes to another box in the center, about six inches square. Inside this is more paper and excelsior; and, at last, in the very middle, is still another small carton; and in

AND NOW COMES THE "NO-HUM"!

\$10⁵⁰

COMPLETE ALL PARTS



DEALERS

We have an excellent proposition for those who desire to handle our line. Write or wire for territory.

There are many excellent high priced "B" Battery Eliminators on the market today. I sincerely hope that among these there may be some that are better than I, the popular priced KONITE "NO-HUM" "B" ELIMINATOR. At any rate, I wish to be truthful in my statements rather than claim the impossible.

Although I have been christened "No-Hum", I admit right here that on some sets you will get a hum on phone reception. This, incidentally, is the case with nearly all other "B" Eliminators, whether good, bad, or indifferent. But on loud speaker operation I give absolutely no hum, hence my name.

I am not the prettiest looking, not the smallest, and not the greatest "B" Eliminator that was ever made. BUT, I am a real, hard working, honest-to-goodness low-priced "B" battery substitute, and will do the work efficiently, without frills or trouble.

You can trust me to perform my duty at a price so low that you can not afford to let the opportunity go by to acquire me. And here is what I do:

I come to you complete at the price mentioned. There is nothing else to buy or to get. I use no vacuum tube, because it is my firm belief that the chemical full wave rectifier system is the best in the long run. The chemicals are never changed. A little distilled water is added once in six months. There are no other adjustments, and there is never any difficulty with me. There are, however, many new improvements in my rectifier system.

I replace your usual "B" batteries, and I operate directly from your ordinary electric light socket. Yes, I work on either 60-cycle Alternating Current. I am absolutely noiseless. I give full-wave rectification. I have three taps for 90, 45, and 22 1/2 volts. My maximum voltage is just a little over 100 volts. There is nothing in my anatomy to get out of order—no materials to be replaced—you never need a doctor for me.

My operating cost is considerably less than \$1.00 per year, as I draw very little current. I have a convenient carrying handle, and I take up less room than your 6-volt storage battery. I am enclosed in a neatly finished metal case, and I have 4 binding posts, rubber-covered cable, and a connecting plug. All this is included in the price.

My makers supply all the parts separately for those of my friends who wish to "make their own." I come completely assembled at a little higher cost.

Use the coupon if you can not procure me from your dealer.

My Price List

No. 100—Konite "NO-HUM" "B" Eliminator, all parts ready to assemble..... **\$10.50**

No. 101—Konite "NO-HUM" "B" Eliminator, completely assembled, ready to operate..... **\$12.00**

IF YOUR DEALER CAN'T SUPPLY ME—USE COUPON

The KONITE CORP., 25-27 WEST BROADWAY NEW YORK, N. Y.

Name

Address

City..... State.....

it, wrapped in soft cotton wadding, is one solitary burnt-out radio tube!

Snapped onto it with a rubber band is a scrap of paper bearin' this brief scrawl,—
"Mr. Adonis P. Hawkins & Corporation,
Dear Sirs:—After using this tube only three years, it has burned out. Please fix it; so it won't do this again, and return by C. O. D. Your truly, Roach P. Hogg."

"One tube—well, it's a starter, anyway," I observes, hopeful-like. I has th' Skipper pack one of my Royal Red Raspberry tubes an' forward it to Mr. Hogg, who lives up at Petaluma, the Egg City, thirty miles away.

About three days later, somethin' like a thunder-storm or a' explodin' bomb busts loose out in front of our basement-door—an' in flies an enraged-lookin' little fat guy with a belly like a clam.

"Hey, you blasted crooks!" he howls at me, ferocious-like. "Where's my tube? Where's my tube? Hey, Hey! Where's my tube?"

"What tube?" I exclaims, starin' at him.
"My tube! My precious tube!" he half yells an' half screams. "The one I sent you to be repaired! Where is it?"

"Why—er—we made an exchange," I explains, uneasy-like. "You see, we don't repair 'em right here; we send 'em over to Rumania, an' it takes six months to get 'em back. We carry a big stock—ahem—a big million-dollar stock of repaired tubes on hand; and when the burnt-outs come in, we simply send back somebody else's repaired tubes; then somebody else later on gets yours. It saves time."

"Don't you dare give my tube to somebody else!" screams Mr. Hogg. "I tell you, I want my tube back! Hey, Hey! My tube, and no other!"

He jerks out of his pocket the white cardboard box with the tube I sent him.

"This thing! This!" he quavers, wild-like. "With this rotten thing I can't even hear KOOP, whose aerial hangs over the back of my chicken-yard! When I put this devil of a tube in my set, all my other tubes blew up, and my storage-battery burst into flames. Hey, Hey! I want my tube and my money back! Both!"

Gettin' alarmed, I hunts around in my waste-basket, and fortunately I digs up Mr. Hogg's dead tube. When he catches sight of it, his eyes begin to shine, joyous-like.

"Ah—there it is!" he cries, an' snatches it out of my hand and hugs it to his breast. "My own tube! The tube I heard Copenhagen and Patagonia with! Hey, hey! Now, give me my money back!"

"But I ain't even got it yet from th' post office," I replies, sulky-like.

Then in walks th' mail-man, an' lays a letter on my table. It is an official post office envelope, and is marked in the corner, "C. O. D. Money-Order."

Mr. Hogg's eye lights on it.
"There it is, now!" he exclaims.

Slittin' the brown envelope with my silver-plated letter-opener, I pulls out a pale blue money-order. It reads in favor of Adonis P. Hawkins Corporation; remitter Mr. Roach P. Hogg, Petaluma.

"That's it!" chortles Mr. Hogg. He grabs it from my fingers, and puts it in his pocket. "Hey, hey! Good bye!" he says; an' still fondlin' his old dead tube, he goes out.

"Well," I says, "I'm gettin' a hunch I better put in a radio set to test out my tubes with."

No sooner thought of than done. I goes uptown; buys a nice five-tube set, which I brings back with me an' sets up in my basement. With this, I proceeds to do some testin'.

The receiver already has some tubes in it, when I set it up; and I soon have a local broadcast station roaring in, nice and loud.



A New and Advanced Model— Norden-Hauck Super-10

Highest Class Receiver in the World

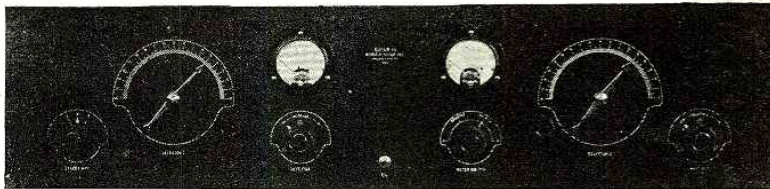

Panel Size: 36"x9"x1-4"

Weight: 55 lbs.

THE NORDEN-HAUCK SUPER-10 is an entirely new and advanced design of Receiver, representing what we believe to be the finest expression of Modern Radio Research Engineering. It is the product of years of experience devoted exclusively to the attainment of an ideal Broadcast Receiver—regardless of cost.

Results obtained in every respect will upset all your previous ideas of good radio reception.

Here are only a few of the host of features that place the NORDEN-HAUCK SUPER-10 far in advance of competition:

- 10 tubes employed to give perfect reproduction with unlimited range and volume power.
- Super selectivity on all wave lengths.
- Built to Navy Standards.
- Wide wave length range without change of coils, etc. (Adaptable 35 meters to 3600 meters if desired.)
- Use Loop or Antenna.
- Simple to operate, having only two major tuning controls.
- No Harmonics. Signals are received only at one point.
- Special Power Audio Amplifier, operating any loudspeaker and eliminates necessity of external amplifier.
- Can be operated directly from house current if used with NORDEN-HAUCK POWER UNIT AB-2.

The NORDEN-HAUCK SUPER-10 is available completely constructed and laboratory tested, or we shall be glad to supply the complete engineering data, construction blue prints, etc., for those desiring to build their own receiver.

Upon Request A complete catalog, attractively illustrated, will be gladly mailed without charge, or full size constructional blue prints, showing all electrical and mechanical data, will be promptly mailed postpaid upon receipt of \$2.00

Write, Telegraph or Cable Direct to

NORDEN-HAUCK
Incorporated
ENGINEERS
MARINE BUILDING
Philadelphia, U. S. A.

TEAR OFF AND MAIL TODAY

NORDEN-HAUCK, Inc.
Philadelphia, U. S. A.

Gentlemen:—

Please send me without cost or obligation on my part, attractive illustrated literature describing the new Norden-Hauck Super-10.

I enclose \$2.00 for which please send me, postpaid, complete full size constructional drawings and all data for building the Super-10.

Name _____

Address _____

60,000 Newsdealers are now selling the big new

JUNE ISSUE

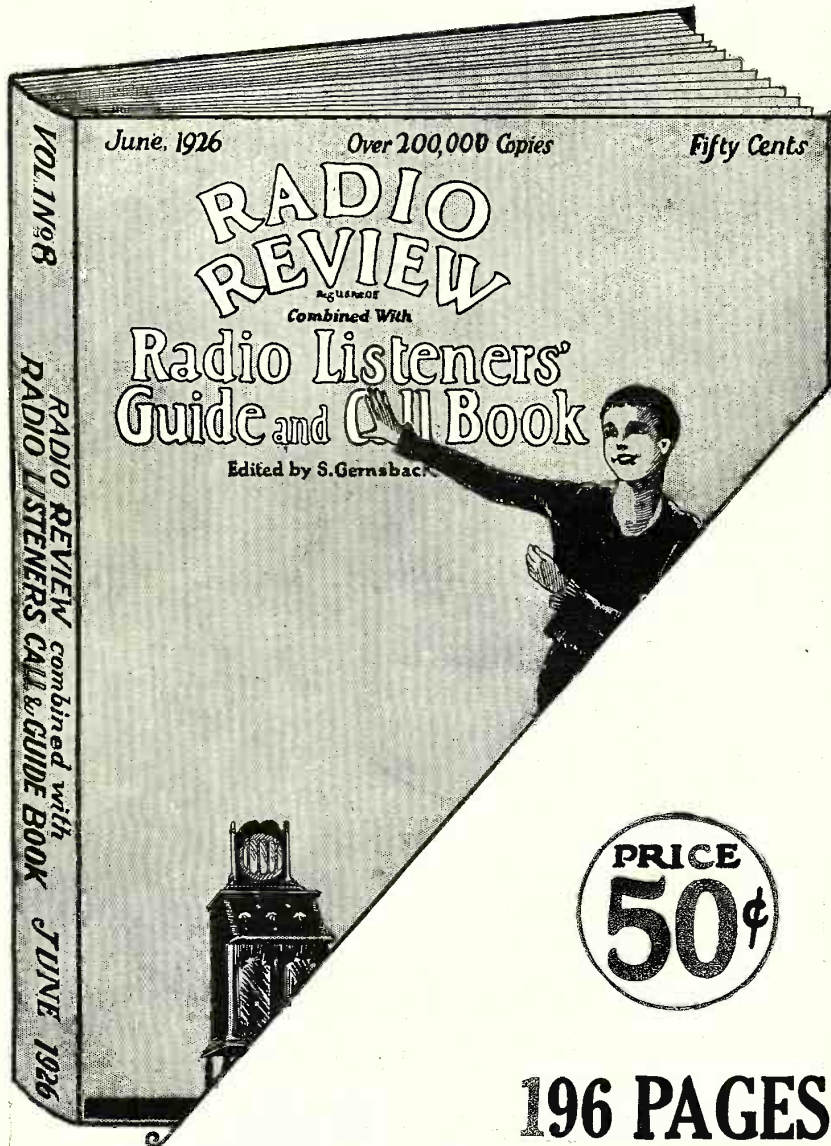

**JUST OFF THE PRESS—
Fresh and New—Containing**

The finest and most up-to-date list of Broadcast stations obtainable—listed by Call Letters, Wave Length and cities, together with the broadcast schedule of each station for every day of the week. The book also lists all Canadian and Foreign Broadcast stations.

The second part of the magazine is devoted to articles of interest to the Radio Set Owner, giving him information on all subjects he ought to know, to better understand the operation of his Radio Set.

The third part contains a great number of constructional articles to delight the fancy of the hookup fan on many modern receivers.

The fourth part contains a new supplement of S. Gernsback's Radio Encyclopedia, profusely illustrated and complete in every respect.

In all a tremendously valuable book to have on hand by every user of a radio receiver. The *Call Book* for ready reference to stations received. The *constructional articles* for data on your new set. The *Encyclopedia* for an intimate and authentic knowledge of Radio and the *Listeners information* for first hand knowledge on how to care for your set and operate it properly.

This big June issue is now sold everywhere by 60,000 newsdealers and radio dealers. *Buy a copy NOW.*

For those who have no ready access to a newsdealer or radio dealer use the coupon on this page for ordering.

PRICE
50¢

**196 PAGES
LARGE SIZE
9 BY 12 INCHES**

Hundreds of
Illustrations

Published and Distributed by

**The Consrad Company, Inc.
64 Church Street New York, N. Y.**

If your dealer cannot supply you,
USE THIS COUPON

THE CONSRAD COMPANY, Inc.,
64 Church Street, New York, N. Y.

Gentlemen—I am enclosing 50c. Please send me at once one copy of "Radio Review" as advertised above.

Name

Address

City, State

Then, openin' the cabinet, I pulls out a tube, an' shoves in one of my Royal Red Raspberry tubes. Instantly, the music is gone! The set is as dead as a Fiji-Island mission-church on a man-eatin' Sunday night. I pulls out my tube, an' tries another one. From my loud-speaker comes a beller an' a howl, like a' animal-circus in a train wreck. Yankin' that tube out, I sticks in a third one. Instantly, from my horn comes a gratin' crashin' noise, like somebody grindin' nails in a coffee-mill, followed by a loud *pop!* Then silence.

Peerin' down into the set, I sees that the tube has gone out.

"Three men down!" I mutters.

I slips in another tube.

"Whroooo-o-o-o-o!" screams my set, like a' oncomin' cyclone. The whole outfit lights up with a brilliant white light; there is a terrific *bang!* a shower of flyin' glass; an' a lot of shootin' fire an' smoke.

"Help!" squawks th' Skipper—an' he streaks it for th' door; while from upstairs again comes a patterin' of stampeidin' footsteps.

Three hours later, I have finished testin' my two-hundred radio tubes. Out of the lot, forty-six will light, but make about as much music as one of King Tut's candlesticks; while most of th' rest don't even blink at all, or tear loose with howls and screams like a couple of Chinese wild-cats with their tails tied together an' slung over a clothes-line. When I gets through, I have fifteen tubes that seem to be good.

"Four hundred dollars!" I mutters, savage-like.

Besides, I had spent a hundred plunks for my ad, and three berries for my silver-plated letter-opener.

About this time, I looks up to see a tall, well-dressed, quiet-lookin' man standin' in the doorway.

"Mr. Adonis P. Hawkins?" he inquires.

"Yes, I replies; then I glances toward a window out of the tail of my eye, and wonders if I can bust out through it without cuttin' my throat on th' glass—for this bird has pulled back the flap of his coat and revealed a U. S. post office inspector's badge.

"What," he inquires next, "is your connection with the Three-R Radio Corporation of Newark? Are you a member of that company, or are you a—"

"Sucker," I finishes for him.

"Oh, I see," he says, droppin' a pair of clinking handcuffs back into his pocket. "Then you may be interested to learn that a Mr. Horgan and a Mr. Love of that concern are in jail for fraudulent use of the mails. They are soon going to be private manicurists to a rock-pile—and their striped b-v-d's won't be gold-plated either. You'd better stop doing business here."

"That suggestion sounds like a last week's newspaper," I replies. "This dump is closed."

A RADIOPTIMIST



For the Musical Epicure

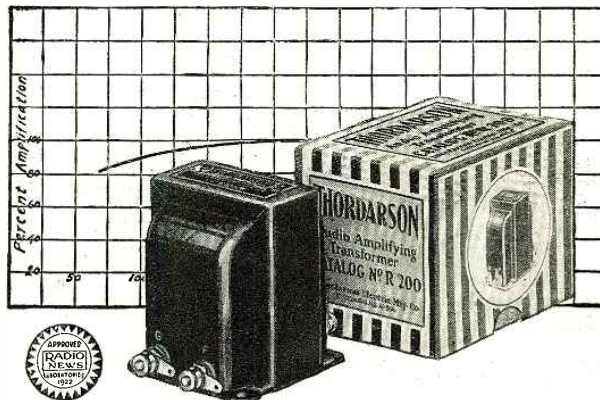

R-200 Price, \$8.00

WHEREVER tone quality, timbre, and perfect reproduction are paramount, Thor-darson amplifying transformers predominate. The better receiving sets of today are musical instruments of the highest order. More than fifty of these leading set makers specify Thor-darson transformers as standard equipment. The R-200 is used in sets costing up to \$2500.00. A superlative transformer giving good bass note reproduction. Ideal for use with cone type speakers.

THORDARSON

ELECTRIC MFG. CO.

Transformer Specialists Since 1895
World's Oldest and Largest Exclusive Transformer Makers
CHICAGO, U. S. A.

Marvelous Radio Invention Increases 100% Summer Reception

Effarsee
ANTENNAE
REG. U. S. TRADE MARK
PATENT PENDING

Enjoy your radio set even in the hottest weather. This marvelous new inside antenna makes Summer reception a pleasure. Increases selectivity and brings in distant stations with greater clarity. Portable—hang it anywhere. Endorsed by Radio engineers and set owners. Sent prepaid for \$2. Money back GUARANTEE. Write for testimonials and complete information.

FISHWICK RADIO CO.
Elm & 137 Central Parkway West, Cincinnati, O.

Hang it anywhere
Greater Selectivity
Better Tone
Less Static
Use Indoors or Outdoors

FREE!—
Radio Catalogue

Radio Parts of the Best Quality

1. Right Prices
2. Quick Delivery
3. Dealer Cooperation
4. Complete Stock
5. National Advertising

CHICAGO RADIO APPARATUS
415 South Dearborn Street, Chicago
Dept. RN

Insure your copy reaching you each month. Subscribe to Radio News—\$2.50 a year. Experimenter Publishing Co., 53 Park Place, N. Y. C.

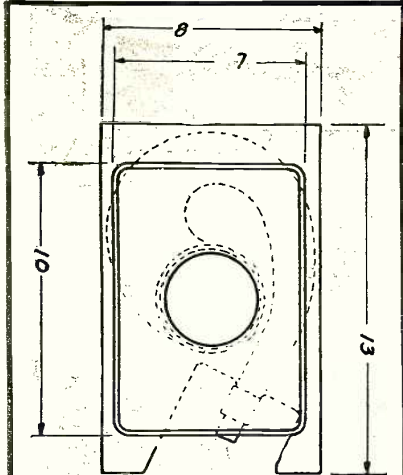

Synchronized Amplification

With the Miller system this is precisely what the term implies. And this result is obtained by the use of a horn properly planned, and balanced with the speaker unit.

Miller

Amplifying Horns

have air columns carefully designed to attain the correct exponential curve. Such horns reproduce notes of both high and low frequencies with extreme evenness of amplitude, full volume, definition and superb color.

MILLER HORNS are made of an ideal material—a rubber composition which can be molded into any shape. Light, strong, immune to atmospheric conditions, inert. Practically eliminating horn distortion and vibration, they assure your set full justice.

Our engineers are at your service. Send data: we'll submit specifications.

The MILLER RUBBER CO.
of N. Y.

AKRON, OHIO

U. S. A.



B-POWER UNITS \$11.00 List

In attractive Steel Case

Get facts from our engineering dept. Quotations to Set Mfrs. on mounted and unmounted types.

Fans—Improve your reception and lower your cost. If your dealer cannot supply you send order direct. Mail orders filled now.

Dongan Electric Manufacturing Co.,
2977-3001 Franklin St., Detroit, Mich.

TRANSFORMERS of MERIT for FIFTEEN YEARS

Down With the Power

(Continued from page 59)

so much of a standard camping equipment today that we merely mention them in passing.

The antenna for a short-wave transmitter need only be 25 or 35 feet in length and certainly that should not prove very difficult to erect at a camp site. There is no need of installing an elaborate antenna system when a single wire will answer the purpose very well.

FOR THE COUNTRY BOY

If there are prospective hams who would like to get into the old game of brass pounding, but who live in a community where there is no electric power available, we can think of no better way to start out than with a short-wave low-power transmitter, such as we have outlined herein. There is no necessity whatsoever for 100-volt lines with which to run a motor-generator set, when storage batteries or even dry cells can just as well be used. All too often in isolated districts there are inadequate communication facilities; for even though the telephone is almost universal, there are thousands of homes that are equipped with no type of communication whatsoever. Now for a comparatively small outlay of cash and very little trouble a short-wave transmitter may be installed. The learning of the code and the examinations that must be passed are not very difficult tasks and the results, pleasure and convenience, are most assuredly worth while.

BREAKING INTO THE CROWD

A word now concerning the experimental stages of a low-power transmitter. Do not try to work your set when there are thousands of hams jamming up the ether, especially at first. This is because the low "peep-peep" is more or less difficult to distinguish until you have established a reputation. By getting a reputation we mean that until you are known on the air the average ham will not listen for any weak "peep-peep," as the natural thing to do is for any listener to tune in to the loudest sigs he hears. However, if you work when there are not so many fellows pounding the old brass, the chances are much better that someone will pick up your "peep-peep," and in a little while he will be listening for you, even though you work during rush hours. You know as well as we do that there are always hundreds of fellows who are only too glad to help out the ham who is starting work on a new set.

It might not be amiss to mention at this point that unless any organization continually gets new blood into its circle, that institution will suffer; and, so far as we can see, the ham fraternity is no exception to the rule. The type of low-power transmitter, which has been outlined briefly above, is a very simple means toward the desired end of new blood being introduced. The cost is low, when compared to the relatively high cost of the installation and maintenance of a 100-watt; and we are willing to bet that with a low-power transmitter the ham will have as much fun and pleasure as he could with one that costs a great deal more. Besides cost considerations there is the added thought that he is doing something, in an experimental way, because there are many, many facts that are still a mystery to the men who are supposed to know, in connection with low-power transmission on short waves. Go to it, fellows, let the old power plant be reduced in output; bust out a 201-A, dig out a couple of coils and condensers, and see if you don't have a lot of fun playing around the shorter wave-length on low power.

ELECTRAD



Better
Summer
Reception

with

ELECTRAD Lamp Socket Antenna

THOUSANDS have found the way to better summer reception with this simplest of all antennas. Just screw it into any lamp socket in the house and get volume, distance, clarity, with a minimum of static and of interference from neighboring sets. End lightning worries.

Consumes no current. Absolutely safe. Tested and certified electrically. At most good radio stores, price 75c; in Canada, \$1.10.

ELECTRAD Inc.

New York City

FOR CLEAR, QUIET "B" POWER



RADIO Storage "B" Battery

12 Cells Lasts Indefinitely—Pays for Itself

Economy and performance unheard of before. Recharged at a negligible cost. Delivers unflinching power that is clear, pure and quiet. Approved and listed as Standard by leading Radio Authorities, including Pop. Radio Laboratories, Pop. Sci. Inst., Standard, Radio News Lab., Lefax, Inc., and other important institutions. Equipped with Solid Rubber Case, an insurance against acid and leakage. Extra heavy glass jars. Heavy rugged plates. Order yours today!

SEND NO MONEY wanted and we will ship day order is received. Extra offer: 4 batteries in series (96 volts), \$10.50! Pay expressman after examining batteries. 5 per cent discount for cash with order. Mail your order now!

WORLD BATTERY COMPANY
1219 So. Wabash Ave., Dept. 75 Chicago, Ill.
Makers of the Famous World Radio "A" Storage Battery
Prices: 6-volt, 100 Amp. \$11.25; 120 Amp. \$13.25; 140 Amp. \$14.00.
All equipped with Solid Rubber Case.

World STORAGE BATTERIES

Set your Radio Dials at 210 meters for the new 1000 watt World Storage Battery Station, WSDC, Chicago. Watch for announcements.

KDKA WEAF WGN WJS KFJ KGO KFAT WJY KCF

A NEW RADIO PLUG

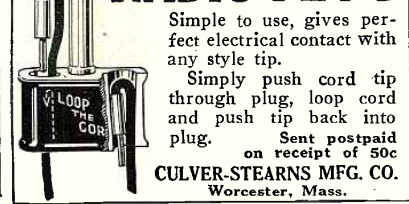

Simple to use, gives perfect electrical contact with any style tip. Simply push cord tip through plug, loop cord and push tip back into plug. Sent postpaid on receipt of 50c CULVER-STEARN'S MFG. CO. Worcester, Mass.

NEW QRA's

2AUA, Dramin Daniel Jones, 453 W. 152 St., New York, N. Y. 180-meters phone and CW. All cards answered promptly.
 2AYD, Michael Solomon, 1455 Minford Place, (Bronx) New York, N. Y. Will appreciate reports on signals and QSL all.
 5AGT, Marcus C. McKenney, P. O. Box 115, Waldo, Ark. 5 watts CW, 80 meters. Reports appreciated.
 7MH, Oliver D. Perkins, RFD 1, Box 113, Milwaukie, Oregon. 7½ watts, CRAC, 40 meters. All cards QSLd immediately.
 9DBC, Joseph B. Tomczyk, 312 Fourteenth Ave., N. E. Minneapolis, Minn. 10 watts on 40 and 80 meters. WI QSL all reports
 9DYA, Earle W. Mitchell, Newark, S. D. Low power CW and fone. All eds answered and appreciated.
 G-6YD, Chas. H. Green, 3, Hobmoor Road, Small Heath, Birmingham, England, would be very grateful for reports on his 43-meter transmissions. All cards answered by return post.

Radio Makes Factory Work Congenial

(Continued from page 33)

That set him thinking. He is an engineer—a graduate of Massachusetts Institute of Technology—as well as a business man, and possesses not only the engineer's point of view, but also that of the business man who has to meet commercial conditions; and, above all, that also of his personnel.

Competition is forcing radio manufacturers to seek new economies. All radio plants are approaching similar levels of competition in machinery, equipment, methods of purchasing, price of raw materials and promptness in deliveries. And every radio manufacturer knows that the varying grades of competitive success will be decided by the savings made through the elimination of waste due to a high labor turnover.

TAKING FATIGUE OUT OF FACTORIES

The significant increase in production after the radio was installed in the factory seemed to demonstrate the worth of Hugo Münsterberg's theory that there is a close relation between economic output and the psychological factors of fatigue and monotony. Most of his workers were devoting themselves to making a minute part of a part, which they had to cut, shape or polish in endless repetition. Such work could not awaken any real interest among them. The demand for products had grown until he was literally swamped with orders. More room, more machines and more workers. And still they couldn't catch up.

Then came the day when the loud speaker was installed. Let the president of the company which tried this radio experiment tell you how the quantity and quality of the output increased—how radio became a reinforcement in industrial efficiency. He says:

"When a task is made pleasant, it is more readily performed. Radio programs during working hours keep our workers happy and contented. The freedom and contentment which accompany home life are brought into the factory. The workers show a personal interest in their work and this, of course, has a distinct bearing on production. The cost of supervision is lessened because they give us their best performance. Our records show that with the increase in output the quality of workmanship has been steadfastly maintained.

"You may doubt it, but it's true nevertheless, that the radio entertainment has made conversation unfashionable during working hours. We have proved that radio has a decided effect on the physical well-being of our employees and that it has brought about a more favorable attitude of the worker toward his work. In other words, it makes work more like play"

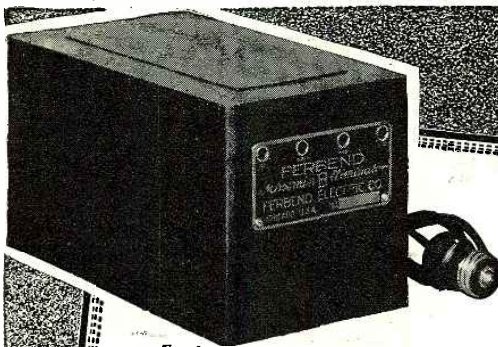

Complete, nothing else to buy. Replaces "B" Batteries. Operates Direct from Electric Light Socket. A. C. Model, \$12.50 D. C. Model, 9.75

\$12.50

FERBEND "B" ELIMINATOR

Superior Results!

Costs scarcely more than new "B" Batteries. You get results combined with first-cost economy.

Operates at maximum efficiency at all times. Noiseless—no hum. A. C. Model gives FULL WAVE RECTIFICATION. Taps at 22½-45-90 volts. Maximum voltage, 100. (Add "B" Battery for higher voltage.) Cost of operation less than 50¢ a year. Lasts indefinitely. Manufactured, not assembled. Order yours today.

Ask Your Dealer or Send Direct

If you prefer, we will make shipment direct to you upon receipt of price, or C. O. D., if desired. Use for 10 days to convince yourself, and if unsatisfactory, return within that time and your money will be refunded. Use the coupon now.

FERBEND ELECTRIC CO.
425 W. Superior St., Chicago, Ill.

FERBEND Wave Trap
This Company also manufactures the famous Ferbend WAVE TRAP—the instrument which has been widely imitated but never equalled. It is the only original and genuine. Priced at **\$8.50**

FERBEND ELECTRIC CO., 425 W. Superior St., Chicago
 Send at once. Payment enclosed.
 Send C. O. D. Send literature.
 Send A. C. Model. Send D. C. Model.

Name.....
 Address.....
 City.....
 State.....

What Users Say:

"246 Florence Ave., Highland Park, Mich. Ferbend Electric Co. April 20, 1926
 Gentlemen: My reception is greatly enhanced at least 50% since the installation of the Ferbend Eliminator and naturally I am a very enthusiastic "Satisfied customer." Performance is far in excess of excellence that I have ever before experienced with the use of batteries. I am using a 5 tube R. F. (Feedback) circuit, employing a "C" battery and am at all times pleased that I can improve it since using your Eliminator. In fact, I am so pleased that I solicit inquiries from such as may be your prospects. I have compared the performance of the "Maxim" with others of the far greater price and find that none produce the clarity of reception as does your instrument. (Signed) Wilson E. Rogers"

"San Francisco, April 20, 1926
 Ferbend Electric Co. Dear Sir: I have been using your "B" Eliminator steadily since I received it, and must say that it lives up to all the claims you make for it. This letter is sent in the least I could do to thank you for it. (Signed) Philip A. Reilly, 1107 Valencia St."

"17 Sewall St., Framingham, Mass. April 12, 1926
 Ferbend Electric Co. Dear Sir: I have tried the "B" battery Eliminator which purchased some time ago and find it works satisfactorily in every way. I have recommended this to several radio friends in this locality. I have had it on three different sets of 5 tubes each. Two of these sets are the tuned radio frequency and the other is a standard frequency circuit and fully neutralized. (Signed) Edw. A. Browning"

CARTER NEW "SHORT" JACKS



Small—sturdy. Carter quality. Takes up minimum space in set. Solder lugs widely spaced, permit easy soldering. All possibility of short circuiting and leakage eliminated. Write for illustrated folder. Any dealer can supply.

25c ea. Closed circuit 30c. ea.

In Canada: Carter Radio Co., Limited, Toronto
Carter Radio Co.
 300 S. MICHIGAN AVENUE
 CHICAGO, ILL., U.S.A.

RADIO INVENTIONS

Protected by U. S. and Foreign Patents,
MASON, FENWICK & LAWRENCE
 Patent and Trade Mark Lawyers,
 Washington, D. C., New York, Chicago

Established Over Sixty Years

References: Life Savers, Inc., Port Chester, N. Y.; Stephen F. Whitman & Son, Philadelphia; Pacific Coast Riscuit Co., Seattle, Wash.; Loft, Inc., New York City; Sprague Warner & Co., Chicago; The Warren Co., Atlanta, Ga.; K. Baldwin Co., New Orleans, La.; Joseph Burnett Co., Boston.
 Send Description and Sketch.

Insure your copy feaching you each month. Subscribe to Radio News—\$2.50 a year. Experimenter Publishing Co., 53 Park Place, N. Y. C.

“NOVELTIES”

How to Make Them

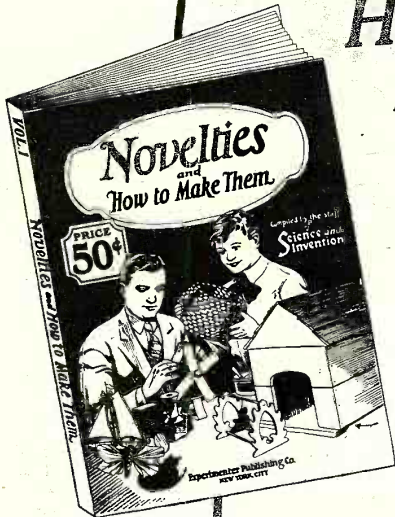

Almost every home has an old clock around— Do you know that a great many surprising, fun making, and useful novelties can be made just from the old springs, the gears, etc.

NOVELTIES, the new book, compiled by the staff of SCIENCE & INVENTION shows you how to make hundreds of wonderful Novelties, mostly out of old scrap things laying around the house. 116 Pages, in this book, show pictures, diagrams and explanations of remarkable, interesting things to make in your spare time.

Every page has a big, wonderful surprise for you. There is no end to the simple, magical things you can make at home.

It is sold on all newsstands. Buy your copy now. If your dealer cannot supply you use the special coupon below.

PRICE
50
CENTS

NOVELTIES, contains 116 Pages, hundreds of illustrations and is published in the big magazine size 9x12 inches

PER COPY

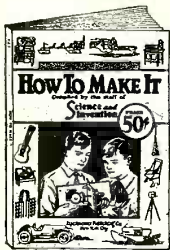

MAKE HUNDREDS OF USEFUL THINGS AT HOME WITH “HOW TO MAKE IT”

Building your own home furniture, cameras, radio cabinets, sport devices, etc., is easy if you know what materials you need, and have an illustrated explanation on how to proceed. Then, too, you can save a good deal of money by making these valuable things yourself.

“How to make it” a big book compiled from the great magazine “Science and Invention,” is full to the brim with hundreds of up-to-date things to make at home. Things that can be made by any man with only a few simple tools.

Contains 116 Pages, 300 Illustrations. Large Size 9x12 Inches. PRICE 50c

SURPRISE YOUR FRIENDS MASTER MYSTERY Read “POPULAR MAGIC”

POPULAR MAGIC contains thousands of simple, entertaining parlor tricks, as many puzzling magical stunts and a whole book full of mystic spirit novelties. A new set of tricks for every day of the year. Compiled from the great magazine “Science and Invention.”

GET THIS GREAT BOOK TODAY. Chock full of Tricks, Novelties, Mystic performances, Master sleights-of-hands, Gags, Disappearing acts. All kinds of fun. Buy a copy or order direct. PRICE 50c.

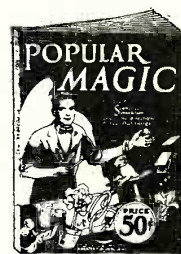

Contains 116 Pages of Tricks, Hundreds of Illustrations, Size 9x12 Inches

EXPERIMENTER PUB. CO., Inc.,
53 PARK PLACE, NEW YORK

Gentlemen: I am enclosing \$..... for one copy of NOVELTIES; HOW TO MAKE IT; POPULAR MAGIC

NAME

ADDRESS

CITY, STATE

(Check Books Desired)

SOLD ON ALL NEWSSTANDS

Experimenter Publishing Co., Inc.
53 Park Place New York, N. Y.

Radio for Every Sick Bed (Continued from page 19)

mate the results of the work in terms of statistics. The true measure of its worth lies in the alleviation of human suffering it has brought about.

FOR THE LONELY SICK

Not alone to hospital patients, however, has radio been such a boon. Many invalids and aged persons are left alone in homes when the breadwinners are abroad. It has been often made known to the staff of RADIO NEWS, as to other radio editors, what a deep interest the shut-in takes in radio, when fortunate enough to have it available as a hobby and a helper during long days and evenings. It is a veritable life-saver. In many homes, whose poverty is such that there is little or nothing left from the family budget above the bare necessities of life, the simplest of radio sets would be a godsend to a member of the family, young, middle-aged, or old, who is confined by ill-health to its narrow walls. In this city, during the last Christmas season, a thousand radio sets were given through the New York World to as many shut-ins; and the stories of wonder and gratitude elicited were most pathetic.

A similar theme, revealing the possibilities of such a gift, and its value above anything else to the unfortunate, was selected as the subject of the play, "A Radio Christmas Carol," the third prize-winner in RADIO NEWS' Radio Play Contest, which was published in May, 1926. It may be hoped that it will serve as a reminder, to the generous and well-to-do, that such an act of kindness is seasonable at any time.

How Should Transformer Curves Be Plotted? (Continued from page 53)

far as the designer of the transformer, or the expert mathematician, is concerned, it makes little difference what scale is used. But, in order to give the average reader a better idea of the effect of a transformer on the current impulses flowing through it, this scale will be found helpful and useful; for it will enable him better to imagine the changes in sound which will be caused at the output of his radio receiver by employing the transformer whose curve is shown in diagram form. In other words, the scale employed gives a curve whose height above the horizontal scale at any given pitch is most nearly proportional to the effect on the ear of the reproduced tone.

In our next article we will consider in detail some of the requirements to be met, from the practical standpoint, by transformers and other audio coupling devices.

A Three-Foot Cone Speaker (Continued from page 39)

The cone may now be attached to the unit and tested on the radio set. Care should be taken in doing this as the cone is heavy and it is apt to bend or break off the connection link of the unit. It is advisable first to position the cone in the table; and then fasten the unit at the proper place on the back strip. The bent-back rim of the cone is then glued, or fastened with thumb tacks, to the top, bottom, and sides of the table. It is there draped by an ornamental curtain, suspended by rings from the rod across the top of the stand, and similarly fastened at the bottom.

In conclusion, this three-foot cone-speaker occupies no more space than is required for

A N N O U N C I N G

A New
DAVEN
Discovery!



GLASTOR

THE TRANSPARENT RESISTOR

A DISCOVERY that makes for greater accuracy, for absolute permanence, and for the abolishment of receiver noises.

In Glastor we have entirely eliminated the use of impregnated fibre, paper or similar substances for the resistance unit. We have replaced it with an entirely new Daven discovery—

DAVEN PROCESSED GLASS

The result—a resistor that will carry the highest current known in the field of radio resistances. A resistor whose resistance can be accurately fixed and which does not change—even with rough handling. Radio engineers have tested Glastor for resistance—then abused it, shaken it. In testing again, they find the resistance unchanged.

Glastor comes in a complete range of resistance, .0025 to 10. megohms. Try it in your own set. You'll notice the difference. Leading Radio Dealers are now selling Glastor.

N. B. Glastor though embodying this vital new principle and though it has cost us thousands of dollars and more than three years of laboratory and field work to develop and perfect, is no higher priced than the old type Daven Resistors.

THE DAVEN FAMILY OF RADIO ACCESSORIES

DAVEN SUPER AMPLIFIER
Revolutionizes Reception

DAVEN LEAKANDENSER
Resistor and Condenser in One

DAVEN RESISTOR MOUNT
Bakelite. For all types of sets.

DAVEN D R F COILS
For the Daven "Bass Note" and other Tuned Radio Frequency Circuits

DAVEN AMPLIFIER KIT
Complete set Daven Resistance Coupling Units

DAVEN BALLAST RESISTOR
Eliminates Rheostat, Needless Controls, etc.

DAVEN TUBES
MU-6 and MU-20, for Clear, True Tone

DAVEN RESISTOR-COUPLES
Unit Mounting for Limited Space

DAVEN RESISTO CONDENSER
Type A. Space Saving. Moisture-Proof



FOLDER FREE
This Folder tells in detail what Glastor is and what it will do for your radio set. Write for a copy today. It is Free.

"The One of Merit"
DAVEN RADIO CORPORATION
Resistor Specialists
Reg. U. S. Pat. Off.
159 SUMMIT ST. NEWARK, N. J.

RESISTOR MANUAL
A complete authoritative Handbook on Daven Amplification, 25c at Dealers. 9c sent by mail for 30c.



GEM TUBE

A Guaranteed Radio Tube Within Reach of All

A tube for a dollar of \$9 value. A trial order will convince you as it has thousands of others. (Blue or Silver with Bakelite Base). Send your orders at once. Orders sent C.O.D. parcel post.

Types \$
401A Each
400
499
499A Each

With Standard Base All Tubes with UV or UX Bases

GEM TUBE CO.
(Dept. N.) 200 B'way, N. Y. City
220 So. State St., Chicago, Ill.
Lafayette Bldg., Detroit, Mich.

AMPLION

FOR BETTER RADIO REPRODUCTION

FREE RAILROAD FARE TO CHICAGO
When You Enroll

Earn \$60 to \$200 a week in wonderful Electrical Field. Complete Electrical Training in a few happy weeks at Coyne. Earn while you learn. You don't need advanced education or experience. Not a correspondence course. All practical training under the most expert instructors.

COYNE ELECTRICAL SCHOOL
Dept. B-384 1300 W. Harrison St., Chicago, Ill.

SEND THIS COUPON NOW

H. C. Lewis, President Coyne Electrical School
Dept. B-384 1300 W. Harrison St., Chicago, Ill.
Dear H. C.: Send FREE Electrical Book and Railroad Fare Offer without obligating me.

Name _____
Address _____
Town _____ State _____

FREE RADIO BOOK
Science has invented a new kind of coil. Now have it on your present set. Gives 4 great advantages otherwise impossible. Write for new book just published showing many new ideas. Also 5 new circled circuits. Address Electrical Research Laboratories, Dept. 177, 2500 Cottage Grove Ave., Chicago, Ill.

It's Easy to Build a Powerful Set

Using the New and Improved FRESHMAN "TRF" Low Loss Kit

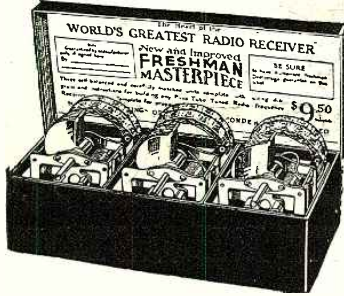

Straight Line Wave Length Condensers With Low Loss Self Balanced Coils . . .

These are the identical units which have made the FRESHMAN MASTERPIECE factory built Receivers the World's Greatest Radio Sets.

Complete instructions for building this powerful five tube receiver, written in plain everyday English, together with actual size schematic wiring diagram, are furnished with every FRESHMAN "TRF" Kit.

Sold by Authorized Freshman Dealers Only!

CHAS. FRESHMAN CO., Inc.
Freshman Building, New York
2626 W. Washington Blvd., Chicago

\$9.50

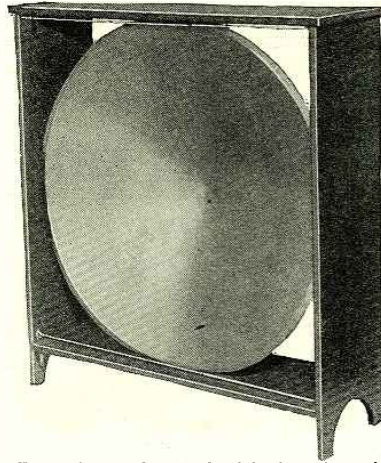

Front view of the completed loud speaker. A curtain suspended over the front will improve the appearance.

the average radio set, is ornamental and inexpensive, and gives remarkable quality of reproduction. The sound, coming from a large surface, is not penetrating. The low tones come out with exceptional volume, sometimes causing the entire floor of the room to vibrate; the high tones are not impaired, and the carrying power or volume of the sound is very great. The writer will gladly answer any questions pertaining to the construction and operation of this speaker.

The following parts are required for building the three-foot table-speaker:

- 1 Sheet Cone Paper, 38x38 inches;
 - 1 Cone-Speaker Unit;
 - 1 Top, 37½x13x¾ inches;
 - 2 Sides, 39¾x12x¾ inches;
 - 1 Bottom, 35x12x¾ inches;
 - 1 Back, 36½x6x¾ inches;
 - 8 Iron Brackets, 2x2x⅛ inches;
 - 2 Curtain Rods;
 - 1 Cloth Curtain;
 - 32 Wood Screws for Brackets;
 - 2 Wood Screws for Unit;
 - 6 Wood Screws for Back;
- Total cost about \$17.00.

Great Composers in WRNY Programs

(Continued from page 21)

now broadcasting. It is under the direction of Joseph Bonime, who is best known perhaps to the American public for his work as accompanist to Mischa Elman. The solo violinist is David Robinson, and in my opinion there is none better playing in any symphony orchestra. The Edison Ensemble ranges from ten to twelve instruments, and renders programs of popular classics every Tuesday night from 8.30 to 9.30.

Arthur Williams, vice-president in charge of Commercial Relations of the New York Edison Company, is a constant visitor. He speaks fortnightly in a fascinating vein; in the alternating weeks prominent soloists are featured. Among others, Henri Scott, former leading baritone of the Metropolitan Opera Company, has appeared, and H. T. Burleigh, the famous composer of "Deep River" and many other of the now popular Negro "Spiritual" melodies.

UNUSUAL EVENTS AT WRNY

The biggest recent novelty at WRNY was the broadcast of a simultaneous musicale by

RADIO REVIEW

Combined With

Radio Listeners' Guide and Call Book

JUNE ISSUE

NOW ON ALL NEWSSTANDS

Contains—List of all American Broadcast Stations—with call letters, etc.

Set Owners Information.

Circuit Information.

Radio Encyclopedia.

50c THE COPY

THE CONSRAD COMPANY, Inc.,
64 Church St., New York, N. Y.

22½ VOLT

unacid
everlasting
rechargeable
"B"
STORAGE
BATTERY

\$2.95

Includes
chemical

45 volts, \$5.25; 90 volts, \$10.00; 112½ volts, \$12.50; 135 volts, \$14.75; 157½ volts, \$16.80. Truly the biggest buy today. Easily charged on any current including 32 volt systems. Any special detector plate voltage had. Tested and approved by leading authorities such as Popular Radio laboratories. Over 3 years sold on a non-red tape 30-day trial offer with complete refund if not thoroughly satisfied. Further guaranteed 2 years. Knock-down kits at greater savings. Complete "Hawley" "B" Battery Charger \$2.75. Sample cell 5c. Order direct—send no money—simply pay the expressman cost on delivery. Or write for my free literature, testimonials and guarantee. Same day shipments.

B. HAWLEY SMITH
314 Washington Ave. Danbury, Conn.

YAXLEY

Approved
Radio Products

are Vital Parts of the Most Popular Sets of Leading Radio Manufacturers. The Wonder

AIR-COOLED RHEOSTAT

Along with Yaxley Jacks, Jack Switches and Midget Battery Switches is the choice of careful factory and home set builders.

at Radio Dealers
YAXLEY MANUFACTURING CO.
Dept. N
9 So. Clinton St. Chicago

You can be quickly cured if you

STAMMER

Send 10 cents for 288-page book on Stammering and Stuttering. "Its Cause and Cure." It tells how I cured myself after stammering 20 yrs. B. N. Bogue, 6957 Bogue Bldg., 1147 N. Ill. St., Indianapolis.

FENWAY for DX!

The Year's Most Remarkable Receiver! Why Postpone Building It?
Official Blueprints FREE!
Write for details.

FENWAY RADIO & RESEARCH LABORATORY
890 Eighth Ave., New York, N. Y.

PATENTS

If you have an invention and desire to secure a patent, send for our Evidence of Invention Blank and free guide book, "HOW TO GET YOUR PATENT." Tells our Terms, Methods, etc. Send model or sketch and description of your invention for INSPECTION and INSTRUCTIONS.

No Charge for the Above Information

RANDOLPH & CO., Dept. 459 Washington, D. C.

Rock Ferris, organist, who was playing at the West Side Unitarian Church, and Herbert Soman's Orchestra at The Roosevelt, where WRNY has its headquarters, in the manner described on a previous page.

Another novelty was the broadcasting of a Bar Mitzvah, which is the orthodox Jewish confirmation of a thirteen-year-old boy. Rabbi Hoffman, who conducted the first orthodox Jewish wedding over the air, officiated and Nathan Ratner was the youthful confirmer.

WRNY has been highly commended for its simultaneous broadcasting of the dinners of the United Jewish Relief Society. Here is the picture: on the nineteenth floor of the Biltmore Hotel a great gathering of men had come to hear Louis Marshall and Felix Warburg speak, while on the first floor a great gathering of women had come to hear Fannie Hurst among others. WRNY undertook to broadcast both dinners, and so scheduled the speakers at both of these dinners that all the important speeches were alternated on the microphone, without the slightest hitch.

Perhaps some of you heard the "Phantom Ship" which sailed out of port at WRNY, manned by "The Buccaneers," under the direction of J. Kenneth Jones. The captain's daughter was none other than Joan Lowell, prominent actress, who, herself, belongs to the sea. The ship went through storm and calm, and encountered a pirate. All the sounds developed in the studio gave the illusion of a ship tossing through wind and sea.

Perhaps you also listened in when WRNY gave Captain George Fried a memorial of his visits to WRNY, and in tribute to the part radio played in the rescue of the crew of the "Antiope" by the "President Roosevelt." Captain Fried received the gift with modesty and gratitude. A copy of the memorial was given also to each member of his heroic crew, as well as to all the radio editors in this city and in London.

Everyone interested in the Little Theatre movement has complimented WRNY on its ingeniousness in getting together all the participants in the Little Theatre Tournament. It was the first time they had ever come together and all their plans were discussed. Representatives were present from many states of the Union and from England.

On Good Friday, Remo Taverna conducted the tragic and immortal oratorio, "The Seven Last Words of Christ." Because of the manner in which it was given, this event will go down as one of the finest things ever broadcast.

Easter Sunday, WRNY began with chimes at Grace Church and had many special services.

HOW NEWSPAPERS ARE PRINTED

Early one Sunday morning WRNY carried its microphones into the great building of the "New York Times," broadcast the sounds of the press rooms, and carried its listeners on a tour through the different offices, news, editorial and business.

Speaking of newspapers, WRNY has effected permanent relations with the "New York Sun," which is now responsible for the sports and the commercial digest news every night. If you want the best reports on sports, just tune in WRNY, and her Joe Vilas's report direct from the Sun. This comes every night at 7 o'clock.

The Theatre Press Agents had the time of their life at their revel given at WRNY on the eve of their great big benefit performance. They produced an original sketch showing the trials of the press agents, in which there appeared the leading men and women of the fraternity.

It would be unseemly to allow this month to pass by without mentioning some of the

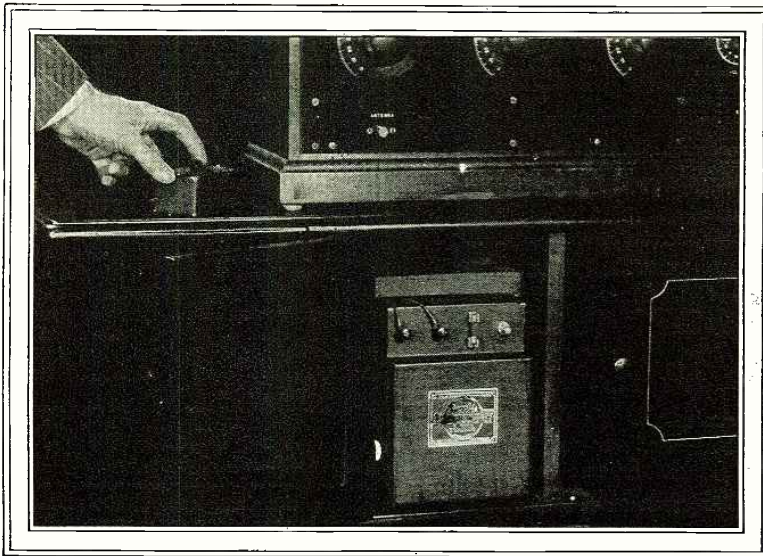

Eliminate bother and inconvenience

Always buying batteries—set running down—acid spilt on carpets. These are frequent complaints of radio owners—and all absolutely needless.

There's one "A" power device—Unipower—that will completely cure your "A" power troubles. It replaces "A" batteries and runs from the light socket, recharging itself automatically from the house current.

Unipower is economical—it will pay for itself over and over in a short time. No parts to replace—no bothersome running down and recharging.

With Unipower, there is never the

loss of power that is occasioned by the running down of a storage battery. Its rich, full power is constant, never-failing. Let the nearest radio dealer demonstrate it for you today.

Unipower contains a Balkite charging unit of special design.
6-volt model, 60 cycles, 110-125 volt A. C. \$40.
Designed for radio sets using 201-A tubes or equivalent.

4-volt model, 60 cycles, 110-125 volt A. C. \$35.
Designed for radio sets using 199 tubes or equivalent.

Prices west of the Rockies slightly higher. Special models, 25-50 cycles, are available.

THE GOULD STORAGE BATTERY CO.
Incorporated
250 Park Avenue, New York
Branches: Chicago, Kansas City, San Francisco

Unipower

Off when it's on—On when it's off

It's fine to be a Radio Operator!



So says Albert C. Gould, 21 years old, a Y. Institute graduate, now Radio Operator on the big S. S. American Shipper, running New York to London. You too can enjoy yourself at good pay as a radio operator. Send for booklet, "Opportunities in Radio."

HOME STUDY OR CLASS INSTRUCTION
Y.M.C.A. RADIO INSTITUTE
158 East 86th St., New York, N. Y.

Three "E" Straight Line Rheostat

Patent Pending Perfect Control of Filament Temperature

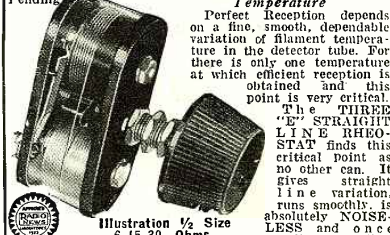

Perfect Reception depends on a fine, smooth, dependable variation of filament temperature in the detector tube. For there is only one temperature at which efficient reception is obtained and this point is very critical. The "THREE 'E' STRAIGHT LINE RHEOSTAT finds this critical point as no other can. It gives straight line variation, runs smoothly, is absolutely NOISELESS and once set "stays put!"

Illustration 1/2 Size 6-15-30 Ohms

By all means secure this precision instrument at once. Ask Your Dealer or order direct, giving us his name.

Price \$2.50—Postpaid
ELECTRICAL ENGINEERS EQUIPMENT CO.
Radio Division, 708 W. Madison St., Dept. 6,
CHICAGO, ILL. Circulars on Request

— SEND THIS IN —

Radio Institute of America
324 Broadway, New York City (G)

Please send me full information about your Home Study Course of radio instruction.

I am interested in the complete course, including code instruction, which qualifies for the U. S. Gov't Commercial or Amateur Radio License.

I am interested in the technical course for radio dealers, jobbers and salesmen.

Name.....

Address.....

Your Chance Is Here!

There is a dearth of radio operators—and our graduates are in greater demand than ever!

Radio Institute of America offers you a thorough radio course that secures your Government License—leads right to your first job. Classroom or home study instruction. *That means you can study in your own home.*

For full information
mail the coupon.

RADIO INSTITUTE OF AMERICA

Formerly Marconi Institute Established in 1909
324 Broadway New York City

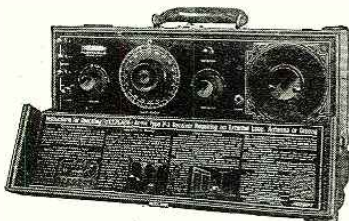

The Famous Truly Portable TELMACO P-1 Receiver

Four Tubes Do the Work of Seven

The peer of portables in size, weight, ease of tuning, selectivity, distance, volume, workmanship and price. Aerial, loud speaker and batteries self contained. Complete with tubes and batteries, \$125.00 \$141.50. Receiver only

P-1 Kit Saves You Money!

Our offer of the Telmaco P-1 Receiver in kit form has met with enthusiastic reception. This contains all parts, as built by us, including case, drilled and engraved panel, and illustrated instructions. \$80.00 Complete kit. Ask your dealer or write us. Descriptive folder free.

Radio Division:

Telephone Maintenance Co.
20 So. Wells St. Dept. B Chicago, Ill.



Quality Radio Exclusively Established 1918

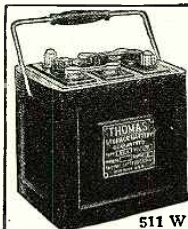

100 AMP. \$10.50 RADIO BATTERY

SEND NO MONEY
2 Yr. Guarantee by
Thomas Witherbee
THOMAS BATTERY CORP.
511 W. 50th St., New York, N.Y.

Insure your copy reaching you each month. Subscribe to RADIO NEWS—\$2.50 a year. Experimenter Publishing Co., 53 Park Pl., N.Y.C.

prominent people who have been here, such as Col. Roosevelt, Bishop Manning, Sophie Irene Loeb, Clara Clemens, the daughter of Mark Twain; the cast of the "Alias the Deacon" company, which brought Burton Churchill, Virginia Howell, and John B. Hymer; also Ernest Truex, Bide Dudley, Phil Baker, J. C. Nugent, Ruth Nugent, Mona Morgan, Grant Mitchell, Marguerite Namara of "Pinafore," and many others.

Another thing that should be recorded is that every Saturday night the Drawing Room Players are heard in original plays based on "Face to Face With Great Musicians." For each performance one composer is selected, and a dramatic scene from his life enacted. First came Bizet with his drab existence of "one must live," then the laughing Rossini; then the temperamental and selfish Wagner.

The Reflex Five

(Continued from page 48)

to keep the short leads in the part of the circuit in which they are most essential. For convenience in wiring, the 1-ohm resistance unit should be mounted upon the negative filament post of the last audio frequency amplifier socket. Referring to the picture, the socket arrangement is as follows: 1. First stage R.F.; 2. Second stage R.F.; 3. Third stage R.F. and first stage A.F.; 4. Detector; 5. Second stage A.F.

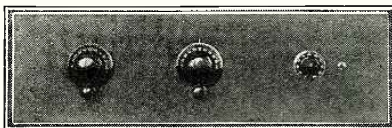

The panel view of the Reflex Five, showing the two tuning, and one volume, controls.
Courtesy Acme Apparatus Co.

The two units marked 10 are the aperiodic radio frequency coupling transformers. It is not advisable that the location of these be changed appreciably, as feed-back between them or, more frequently, between the leads which run to them, is the main cause of oscillations in reflex receivers.

OPERATION

The operation of the Reflex Five is similar to that of any tuned radio frequency receiver; although it is simpler, due to the elimination of the usual third tuning dial, which is replaced in this case by an aperiodic transformer. The two main dials run nearly in synchronism, and may be logged, if the user wishes. The 6-ohm rheostat is used merely to bring the detector filament to the right temperature. With loud signals it will be found an aid in controlling quality; but under normal conditions it need be changed only when the battery voltage shifts.

The 2000-ohm rheostat acts both as a

The complete list of parts required follows:

- Loop antenna, 6- μ h.,
- D-coil mounted on .0005 μ f. condenser,
- Variable condenser, .0005 μ f.,
- 2 aperiodic radio frequency coupling transformers, designed for use in second and third stages respectively,
- 5 Vacuum tube sockets,
- 2 Audio frequency amplifying transformers,
- Fixed condenser, .0004 μ f.,
- Fixed condenser, .002 μ f.,
- Fixed condenser, 1 μ f.,
- Grid condenser and leak, .00025 μ f.,
- .5- to 1-megohm,
- Twin rheostat, 6-ohm and 2000-ohm,
- Fixed resistance unit, 1-ohm,
- Filament battery switch,
- 9 Binding posts,
- Panel, base, screws, etc.

ROPE-CORE AERIAL

The last word in aerials—embodying the most advanced principles of aerial design. Consists of pure copper ribbon, heavily enameled, wound around sturdy, weather-proof rope. The Rope Core is guaranteed to improve the summer reception of any receiver, to secure greater distance with easier tuning and more perfect selectivity.

50 ft. \$3.00 | 100 ft. 5.00
75 ft. 3.85 | 150 ft. 7.00



Window Lead-In

The Acorn fits into sash as pictured. Made of pure copper ribbon, 1/2-inch wide, heavily enameled by special process. Triply insulated with water-proofed fabric. Thousands of users recommend them for satisfactory service.

Each Unenameled 35c
25c

Acorn Enameled Ribbon Aerial

Finest copper ribbon—heavily enameled—cannot corrode—Special new snap ends that permit easy adjustment and eliminates soldering and solder corrosion. Approved and endorsed by leading Radio Authorities for design and starting performance.

50 ft. \$1.75 | 100 ft. \$3.25
75 ft. 2.50 | 150 ft. 4.75

ORDER DIRECT If your dealer cannot supply you.
DEALERS write for prices JOBBERS

Acorn Radio Products Co.
708 W. Madison St. Chicago, Ill.

For the Season 1926-27

At a price for the home of moderate means

GOLD-MEDAL RECEIVERS CONSOLES "B" ELIMINATORS

Distributors, Agents and Dealers

Write for Territory.

GOLD MEDAL RADIO CORPORATION
1038 1/2 Longwood Ave., New York, N. Y.

SEE THAT SCREW



A Screw-Driver adjusts an X-L in crowded places

X-L VARIO DENSER

Results in easier tuning, more distance, volume and clarity—greater stability. Indorsed by leading radio authorities.

MODEL "N"—A slight turn obtains correct tube oscillation on all tuned radio frequency circuits. Neutrodyne, Roberts two tube, Browning-Drake, McMurdo Silver's Knockout, etc. Capacity range 1.8 to 20 micro-micro farads. PRICE \$1.00

MODEL "G"—with grid clips obtains the proper grid capacity on Cuck-ay circuits, filter and intermediate frequency tuning in heterodyne and positive grid bias in all sets. Capacity range .00018 to .00055 and .0003 to .001 micro farads. PRICE \$1.50

X-L PUSH POST—Push it down with your thumb, insert wire, remove pressure and wire is firmly held. Releases instantly. PRICE 15c

X-L RADIO LABORATORIES
2426 Lincoln Ave. N. Chicago, Ill.

Insure your copy reaching you each month. Subscribe to RADIO NEWS—\$2.50 a year. Experimenter Publishing Co., 53 Park Pl., N.Y.C.

volume control and a clarity regulator. When receiving stations in the vicinity of 300 or 400 meters, this rheostat may be left at maximum most of the time; but in receiving stations on the higher and lower waves it will be found desirable to decrease the shunt resistance about fifty per cent. Other adjustments will depend upon the characteristics of the individual station being received. All tubes except the detector should be of the 201A type. The detector must be a soft tube. The UV-200 type is recommended.

IT is against the policy of RADIO NEWS to publish the names of manufacturers or makes of instruments in connection with the apparatus described in these pages, but this information will be gladly given privately. If you are interested in any special instruments described here, address a letter to the I WANT TO KNOW DEPARTMENT, enclosing stamped return envelope. The names and addresses of the manufacturers will be given free of charge. —EDITOR.

Set Owners' Information
(Continued from page 20)

volume. Up until last week they all worked properly; but now the last one is of no service. I can plug head-phones into the first or second jack and get the usual results, but when I plug them into the last jack I get either a loud whistle or very faint music. I have tried other tubes in the last socket in the set but there is no improvement. Why do you suppose this is?

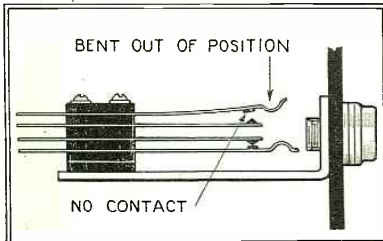

A bent jack spring is a common cause of amplifier trouble. All springs should be inspected regularly.

Ans.—There is a possibility that the last audio-frequency transformer is burnt out; in which case you will have to have it replaced with a new one. More than likely, however, the trouble is in the second jack. One or both of the outer blades had become bent; so that when you take out the phone plug they fail to spring down and make contact with the inner blades. This is delineated in the accompanying sketch. Bending the blade down with a pair of pliers will again put it in its normal position. Disconnect all of the batteries from the set before attempting to do this.

All About Aerials
(Continued from page 28)

When attaching the ground clamp to the pipe, the latter must be cleaned free from all paint, enamel or dirt, and the clamp must be fastened as tightly as possible. It would be well to wrap a few layers of tape around the clamp, after the connection has been made. This will protect it against corrosion.

CARE OF ANTENNA

After the antenna has been up a season or two, it is time to overhaul it. The insulators become dirty and conductive on the surface; the bare wire begins to corrode, and the other

“MOST POWERFUL IN THE WORLD”

Navy Model
UNIVERSAL TRANSOCEANIC

Design by
CHAS. R. LEUTZ

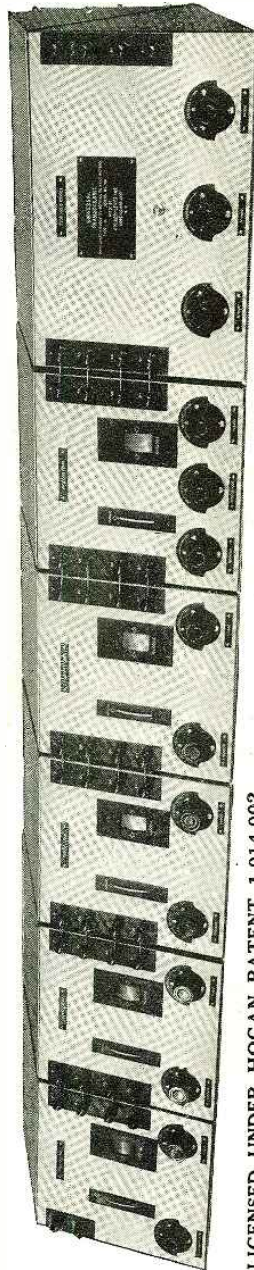

LICENSED UNDER HOGAN PATENT 1,014,002

Wavelength Range 35 Meters to 3600 Meters

Full details are given in our 88 Page Catalog Free.
Wire or write for your copy today.

MANUFACTURED BY

GOLDEN-LEUTZ, Inc., Sixth & Washington Aves., Long Island City, N. Y.

CABLE “EXPERINFO”

Why Pay Fancy Prices for Radio Cabinets?

Hardwood and Solid Walnut. Full length piano hinge, lid support, etc. Free base-board. Free Catalogue.

THE SOUTHERN TOY COMPANY, Inc., Dept. N. HICKORY, N. C.

WHOLESALE
LUDWIG HOMMEL & CO
929 PENN AVENUE PITTSBURGH, PA.
SATISFIED DEALERS BECAUSE WE HELP THEM
Catalog 466-S is free to Dealers

BRANT BATTERY COMPANY

Manufacturers of the

BRANT CHARGEABLE BATTERIES

1622 W. Venice Bldg., Los Angeles Cal.

Insure your copy reaching you each month. Subscribe to Radio News—\$2.50 a year
Experimenter Publishing Co., 53 Park Place, N. Y. C.

NOW—ANY SET CAN GET LOW WAVE

Stations—Amateurs

Experience a new radio thrill! Explore the short waves on which super-power stations are experimenting daily and amateurs are talking from all parts of the globe. Enjoy a new radio delight with the



SUBMARINER

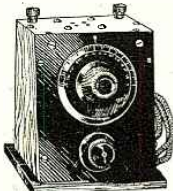

Converts Any Set Into a Low Wave Receiver Gets the Short Wave Experiment Stations broadcasting on 41 meters, 63 meters, etc., and a wide band of Amateurs' Stations. Price, \$15. No extras needed. Anyone can attach in one minute, ready to operate.

Everywhere—
a Sensation!

No jumble of stations in the low waves—no disagreeable noises. Ideal for summer reception. Hear KDKA talking to Europe. Listen to an A. R. R. L. operator speaking to Australia! The low-waves abound with new wonders and strange voices from far-off places. The SUBMARINER brings them all to you. Send for this marvelous new instrument today. Sent post-paid upon receipt of \$15, or C.O.D., plus postage. State type of detector tube in your set. Money back if not delighted. Order at once.

ORDER DIRECT MONEY-BACK GUARANTEE

J. M. P. MFG. CO.

Deot. 115-X Milwaukee, Wisc.



Use any tubes

Any type or combination of Tubes can be used with AMPERITE. Insures filament regulation to meet each tube's individual needs. Specified in all popular construction sets. Price \$1.10.

Radiall Company

Dept. R.N. 7 50 Franklin Street, New York City



Write for FREE Hook-ups

AMPERITE

The "SELF-ADJUSTING" Rheostat

PATENTS WRITE for our Four Guide Books and "RECORD OF INVENTION

BLANK" before disclosing inventions. Send model or sketch and description of your invention for our INSPECTION and INSTRUCTIONS FREE. TERMS REASONABLE. Electrical and Radio Cases a specialty.

VICTOR J. EVANS & CO.
919 NINTH ST., WASHINGTON, D. C.

For "UV" or UX Type Tubes
NEW KLOSNER UNIVERSAL SOCKET

Hexagonal shaped holes for large prongs, spring grip terminal lugs, and ease in mounting make it the socket leader for 1926.

KLOSNER RADIO CORPORATION
1022 East 178th Street New York

Have your tubes tested on the
Superadio-Dynameter

MODEL 5 WATCH FOR THE B and C RECEIVER \$56 BATTERY ELIMINATOR
De Witt-La France Co., Cambridge, Mass.

kinds lose their tensile strength, as well. Guy wires work loose, supports become rotten and rickety, the ground connection may become loose, and the antenna may be in actual contact with nearby objects such as trees, roofs or other antennae.

The illustrations show some actual conditions which may exist in your antenna instal-

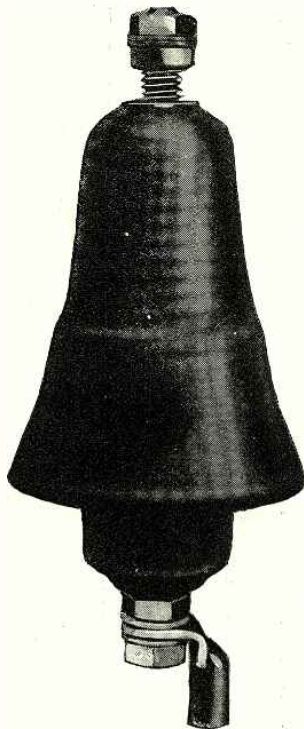

A lightning arrester which can be attached to the lead-in wire at some distance from the house. Illustration courtesy of Chas. A. Branton, Inc.

lation. Go over it carefully and convince yourself that you are getting the best results from your antenna.

If you are erecting an aerial for the first time, go over this article carefully first and make sure that you have all the necessary equipment. Don't be like the man who installed two steel masts, firmly embedded in the earth and strung a most beautiful aerial between them, composed of gold-plated wire, and entirely forgot the little matter of using insulators.

It is advised that the layman purchase a complete aerial kit, as these include all the essential equipment. A number of kits are illustrated in connection with this article.

Remember, "No radio receiver will function better than the antenna to which it is connected."

The Latest Advance Toward Television

(Continued from page 37)

is necessary to move the mirrors in order to cause the displacement of the entire image which they reflect over the aperture in the diaphragm. The slide remains fixed in the projecting lantern, and the magnified movements of its image are obtained by the rotation and oscillation of the drum. It would be theoretically possible to move the image in the lantern, or the screen C, to obtain the same result: but not practicable.

Let us wait but a little longer; and Edouard Belin will soon present to us practical television apparatus, although it may have very different features from the experimental system which this article has described.

FROM THE GROUND UP USE



Just a few samples
100 ft. COILS

No. 56, 7 Strand No. 22 Enameled, \$1.00
No. 61, No. 12 B. & S. Solid Enameled, \$1.25
No. 67, Flat Braided Enameled Ribbon, . . . \$1.75
At your dealers, otherwise send purchase price and you will be supplied postpaid. Free literature on request.

CORNISH WIRE COMPANY

30 Church Street New York City

WRITTEN 2-YEAR GUARANTEE

ARROW BATTERY

Battery Prices SMASHED!

To Consumers Only

Here is a real battery quality, guaranteed to you at prices that will astound the entire battery-buying public. Order Direct From Factory. Put the Dealer's Profit in your own pocket. You actually save much more than half, and so that you can be convinced of true quality and performance, we give a *Written 2-Year Guarantee*. Here is your protection! No need to take a chance. Our battery is right—and the price is lowest ever made. Convince yourself. Read the prices!

Auto Batteries Radio Batteries

6 Volt. 11 Plate, \$8.50 6 Volt. 100 Amp. \$8.50
6 Volt. 13 Plate, \$10.25 6 Volt. 120 Amp. \$10.25
12 Volt. 7 Plate, \$11.75 6 Volt. 140 Amp. \$11.75

Buy Direct—Send No Money

We ask no deposit. Simply send name and address and style wanted. Battery will be shipped same day we receive your order Express C.O.D. subject to your examination on arrival. Our guarantee accompanies each battery.

We allow 6% discount for cash in full with order. You cannot lose! Send your order today—NOW!

ARROW BATTERY CO.
Dept. 6 1215 So. Wabash Ave., Chicago

MARVELOUS NEW AUDIO TRANSFORMER adds a musical quality to any set far beyond anything you ever heard before. **KARAS HARMONIK** Amplifies low, middle and high tones—all to the same big volume, thus eliminating distortion. Brings out the vital harmonies and overtones of music. Price \$7.00. Write Karas Elec. Co., 1020 Ass'n. Bldg. Chicago

BAKELITE KNOBS

permanently hold their color and finish. Write for Booklet 24

BAKELITE CORPORATION
247 Park Avenue, New York, N. Y.
Chicago Office: 636 West 22nd St.
BAKELITE CORPORATION OF CANADA, Ltd.
163 Dufferin St., Toronto, Ontario, Canada

FREE Write for complete data on the most advanced method of calibrating and matching intermediate frequency transformers and filters together with newest reports on **DX-WORLD RECORDS.**
SCOTT RADIO LABS. Grilly Bldg., CHICAGO

Insure your copy reaching you each month. Subscribe to **RADIO NEWS** — \$2.50 a year. Experimenter Publishing Co., 53 Park Pl., N.Y.C.

Meters for Radio Receiving Sets

(Continued from page 23)

manufacturers of tubes, you can quickly ascertain whether or not your set is functioning at its greatest efficiency.

DETERMINING "C" BATTERY VOLTAGE

One of the greatest uses of a milliammeter and, in fact the only one to which the average experimenter will put it, is to determine the correct "C" battery voltage. Let us suppose that you are using a standard set employing an audio-frequency amplifier, and that there is no "C" battery in the circuit. Now the reading of a milliammeter connected as at A in Fig. 3, will be rather high and the needle will fluctuate over a wide range in accordance with the variations of the received sounds. If a "C" battery is added in the circuit, though it has a voltage of only 1½, the plate current will be reduced to a certain extent and the fluctuations of the meter when the set is in use will not be so great. By increasing the voltage of the "C" battery, a point will be found where, with a certain applied "C" voltage, the needle of the milliammeter will indicate a rather low current consumption and it will not fluctuate very greatly. On increasing the "C" voltage past this point, it will be found that the needle of the milliammeter will again start to fluctuate decidedly in accordance with the received sounds, but that the fluctuations will be in the opposite direction from those found with a low "C" voltage. You have now passed the point of correct "C" bias, and should adjust your "C" battery to the point where the milliammeter fluctuations are at their lowest.

With the voltage fixed at this point, it will be found that the audio-frequency amplifier is operating at its greatest efficiency, and is producing the clearest signals with the least distortion that it is possible for it to give forth. It has often been found, in "shooting trouble" on radio receiving sets, that the use of a milliammeter for determining the correct "C" bias has enabled the user to place his "C" battery voltage at the correct point and thus obtain far better results than were ever obtained from the same set before.

A milliammeter of standard manufacture and sensitive type, such as those illustrated

40 Non-Technical Radio Articles

every month for the beginner, the layman and those who like radio from the non-technical side.

SCIENCE & INVENTION, which can be bought at any newsstand, contains the largest and most interesting section of radio articles of any non-radio magazine in existence.

Plenty of "How To Make It" radio articles and plenty of simplified hook-ups for the layman and experimenter. The radio section of SCIENCE & INVENTION is so good that many RADIO NEWS readers buy it solely for this feature.

Radio Articles Appearing in the July Issue of "Science and Invention" Magazine.

- Circuits for the Experimenter.
- New European Radio Apparatus.
- Variable High Ohm Resistances.
- An Unusual One Tube Receiver.
- By Herbert Hayden
- Broadcast Station Calls.
- Radio Questions and Answers.



Reel Out the Aerial

Pull in the Programs

NO DELAY. No wires to untangle. No lead wire to bother with. Simply fasten a long cord and weight to insulator on Reel Aerial. Toss weight over limb of tree. Reel out as long an antenna as you wish. Place Reel Aerial on or near set. With cord which you plug into center of Reel Aerial—connect to set. When through, reel in antenna. Simple as ABC! Just what every tourist, camper or picnicker needs. Also for traveling men, set demonstrators, experimenters. Fits in pocket. Order yours today!



Tested and approved by Radio News, Popular Science Institute, Popular Radio and Radio Broadcast. Weighs only 21 ounces. Nicked case 4 1/2" dia. Contains 100 ft. 1/2" flat copper wire—best antenna known. Illustration below is Actual Size.

When Through Reel It In



Provides a 100% Efficient Antenna in a Jiffy Anywhere—Outdoors, Indoors

DEALERS! JOBBERS!

No more \$5 to \$10 expense to a dealer each time he erects an aerial to make a free trial home demonstration. Reel Aerial enables anyone to make quick, satisfactory demonstrations with an aerial that's 100% right. Length and direction easily adjusted to best advantage. Also sell Reel Aerials for portable sets, to experimenters, etc. Write for attractive literature and proposition to the trade. Jobbers—list Reel Aerial in next catalog.

Attach weight to insulator and lower antenna from window, any desired length. No holes to drill in sash. Window can be closed tight over the flat wire. Or erect Reel Aerial on roof and bring in same way. Or hang Reel Aerial around room or just reel it out on floor wherever convenient. In halls, schools, clubs, at fairs, etc., Reel Aerial Antenna can be strung up in a moment—and so quickly reeled in. Fine for testing sets on different length aerials. Nothing better for permanent aerial.

FULLY GUARANTEED

Money back if not as represented. You are dealing with an old, reliable firm. Send coupon today!

SEND NO MONEY, JUST MAIL COUPON

HAWKEYE RADIO CO. Division of Hawkeye Lightning Rod Co., Dept. 1407, Cedar Rapids, Iowa. Ship me—on your MONEY BACK GUARANTEE—one Reel Aerial C.O.D. I will pay postman \$5 plus few cents postage (postage prepaid when money accompanies order).

NAME ADDRESS



Chargers



Acme Dreadnought Type A-D-6, capacity six—6 volt batteries, charging rate 5 amperes. Transformer type. Automatically restarts on line interruption. Sheet steel case finished in black lacquer. Very efficient and economical to use. Price \$50 complete with bulb—\$60 West of the Rockies.

Acme Chargers are the only quality chargers on the market selling at such low popular prices. Ideal for the home and the radio shop. Built on the principle advised by leading battery authorities which the Acme proves to be Best By Test.

Delivers maximum charging current with minimum current consumption.

Order today. Satisfaction guaranteed.

We offer Jobbers an interesting proposition.



Acme Trickle Charger Type AT-1 delivers a charging current of 1/2 to 3/4 amperes and consumes 25 to 40 watts of energy. Uses a two ampere bulb. Has a specially designed transformer with independent windings. Enclosed in a sturdy, attractive case of sheet steel, finished with crystallized lacquer and mounted on rubber feet. Price with cord attachment and without bulb only \$8.00. 2 ampere bulb \$4.00 extra.

The Acme Electric & Manufacturing Co.

1412 Hamilton Avenue, Cleveland, Ohio

Send me without obligation full information on your complete line of Acme Chargers.

Name
Address
Town State

PATENTS

C. L. PARKER Formerly Member Examining Corps, U. S. Patent Office. PATENT LAWYER McGill Bldg., Wash., D. C.

Patents, Trade Marks, Copyrights, Patent Litigation Handbook for Inventors, "Protecting, Exploiting and Selling Inventions," sent upon request.

Centralab Radiohms, Modulators, Potentiometers or Rheostats are standard on 69 leading radio sets. Ask your dealer, or write for descriptive literature.



Centralab Laboratories 19 Keefe Avenue Milwaukee, Wis.

RADIO Five-Tube Set Only \$22.50

Free circular. Guaranteed Tubes—95c SEMINOLE RADIO 427 East 16th Street New York



1926 FREE RADIO GUIDE

NEWEST 1926 EDITION Shows the latest circuits, the newest developments in radio at startlingly low prices. Get the parts you want here and save money. The best in parts, kits, sets and supplies. Orders filled same day received. Write for free copy NOW; also please send names of one or more radio frns. BARAWIK CO., 102-145 So. Canal St., Chicago, U. S. A.

Insure your copy reaching you each month. Subscribe to Radio News—\$2.50 a year. Experimenter Publishing Co., 53 Park Place, N. Y. C.

MAGINATION

PLUS

SCIENTIFIC KNOWLEDGE

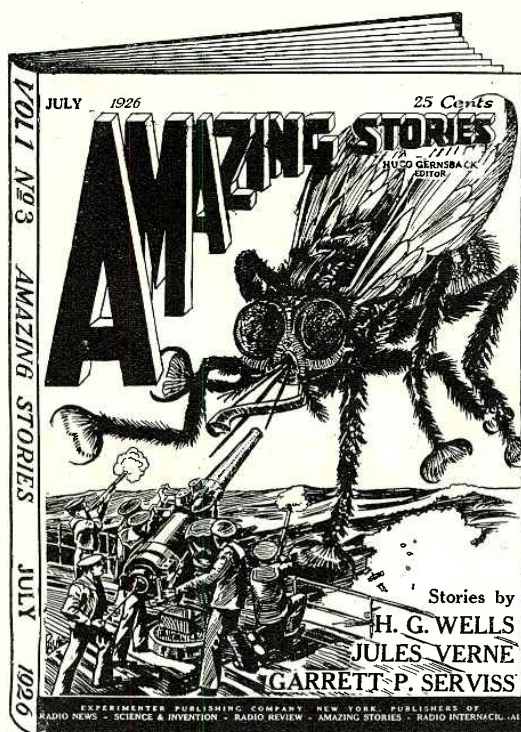

HERE ARE THE BIG STORIES IN THE JULY ISSUE

"THE EGGS FROM LAKE TANGANYIKA," by Curt Siodmak. A new German story which we consider the best scientific short story for 1926. It is the cleverest and, without doubt the most amazing thing that we have seen in years.

"THE MOON METAL," by Professor Garrett P. Serviss. One of the greatest scientific stories ever written, with a most astonishing and intriguing plot that will hold your interest to the end.

"DR. OX'S EXPERIMENT," by Jules Verne. A little-known but amazing scientific story, wherein a sleepy town suddenly bursts forth in an amazing fashion.

"THE MAGNETIC STORM," by Hugo Gernsback. The inner secret of how the Great World War was really won by Tesla

currents—if you can believe this unusual story.

"THE SCIENTIFIC ADVENTURES OF MR. FOSDICK," by Jacque Morgan, wherein "The Feline Light & Power Company" is organized, and in which you will again meet the great inventor in a most mirth-provoking story.

"THE SPHINX," by Edgar Allan Poe. A little-known story by the great writer, which again shows how our senses are sometimes fooled by the simplest of things.

"DR. HACKENSAW'S SECRETS," by Clement Fezandé. The secret of "The Invisible Girl." This new Hackensaw story is as astonishing as its predecessors, and shows you what happened when the hunters tried to locate the invisible girl. An excellent short story.

are the reasons why world famous writers such as Jules Verne, Prof. Garrett P. Serviss, H. G. Wells and others have produced the most amazing stories of the present and future that the world has known.

BIG JULY FEATURE

"STATION X," by G. McLeod Winsor. A wonderful radio serial describing in vivid language a titanic struggle between Lunarians and Martians, waged by the development of future means of warfare. A tale of hair-raising terror and suspense.

Many of these stories are
being printed for the first
time in this country

Every story in the great, new magazine "Amazing Stories" is partly scientific—Every story is doubly interesting—because it combines intense, gripping imagination with a touch of pure scientific flavor.

The man who reads the famous stories of the immortal Jules Verne, never forgets them, they take you away from the world on marvelous flights of fancy. Yet there is a possible plausible scientific basis throughout.

If you haven't seen a copy of "Amazing Stories" you've missed the most interesting story magazine published today.

Ask your Newsdealer.

25c for single copy.

Subscription \$2.50 the year.

Published by

Experimenter Publishing Co., Inc.
53 Park Place
New York, N. Y.

25^C ON ALL NEWSSTANDS

in this article, is an instrument that is very handy around the experimenter's laboratory; and if it is never used for anything else than determining the correct "C" bias it is well worth buying. However, after you become more interested in radio and start to conduct experimental work of your own, you will find that a good sensitive milliammeter is an invaluable part of your equipment.

METER MOUNTING

Some of the standard super-heterodynes in use today are equipped with two small cord tip jacks into which a filament voltmeter can be plugged. Several manufacturers of meters are today placing filament voltmeters on the market, equipped with short cord tips which can be plugged directly into these jacks; and thus the filament voltage applied to the tubes of the super-heterodynes of this type can be quickly and readily determined. In the case of other receivers, however, where these cord tip jacks are not supplied, it becomes necessary to mount a voltmeter in some other manner. One particularly pleasing method of doing this is shown in one of the illustrations; the meter is mounted in a small case, closely resembling that of a standard mantel clock. This instrument can be placed directly on the cover of a radio receiving set; and the long flexible leads provided with it can be connected to the parts of the circuit which it is desired to test. Still other meters are made so that they can be mounted in a large hole drilled in the panel and fastened in place by three or four screws. A fourth very interesting method is shown in Fig. 4. A hole of the correct size is provided for the insertion of the meter and a split ring is clamped around the back of the instrument and tightened up. This prevents the meter from moving in its mounting hole and holds it firmly in an upright position. It also does away with the necessity of using mounting screws.

RESISTANCES OF VOLTMETERS

The reader will undoubtedly have noticed by this time that most of the things said relative to meters in radio receiving sets have been said about voltmeters. Voltmeters are the instruments most often used, and lend themselves to a variety of purposes. There is, however, one thing that must be carefully watched in the selection of a meter (particularly when it is to be used to read the voltage of "B" batteries), and this is the resistance of the instrument. If a meter having a comparatively low electrical resistance is employed, it will inflict a heavy drain on the battery under test; and when measuring the voltage of "B" batteries, you will take several days off the life of the battery if you use a low-resistance voltmeter. Practically all cheap voltmeters selling for prices ranging from \$3.00 down are of the low-resistance type; and because of this fact they should never be left in any battery circuit for any appreciable length of time. Merely connect an instrument of this type across the current-carrying line, note the voltage and disconnect it immediately. However, well-made high-resistance meters may safely be left connected to the filament ("A") circuit of the radio set at all times when the set is in use. However, it is not advisable to leave any voltmeter connected across the "B" battery for any appreciable length of time, even though the voltmeter be of a high-resistance type.

If a milliammeter is employed, it can be left in the circuit at all times. The current flowing through it is automatically cut off when the filaments of the tubes are turned off.

The resistance of the voltmeter is particularly a governing factor when measuring the output of "B" battery eliminators. Up to a very short time ago there was no reasonably-priced instrument on the market that could be employed for determining accurately the output volt-

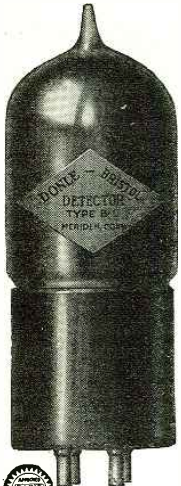

The DONLE-BRISTOL DETECTOR Type B-6

*The Most Sensitive Detector
in the World*

Manufactured and Sold by
The DONLE-BRISTOL CORPORATION
Tremont Street
Meriden - Connecticut

PRICE
FIVE DOLLARS

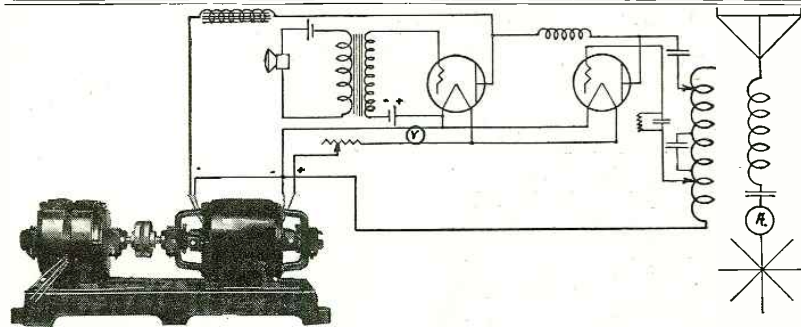

Item 37. 2 unit four bearing set, delivering 1000 volts, 600 watts for plate and 12 volts, 300 watts for filament. The "ESCO" Set is shown here furnishing Power Supply for 4-50 watters in a phone or telegraph set. This is the Item used by CB28 in pioneer achievement of the first two way amateur wireless communication between North and South America.

ELECTRIC SPECIALTY COMPANY

Manufacturers of Motors, Generators, Motor-Generator Sets, Dynamotors and Rotary Convertors for all radio purposes. Have you got your copy of Bulletin 237B and ESCO Filter facts? If not, write for them.

TRADE "ESCO" MARK

211 South Street

Stamford, Conn.

"ESCO" Engineers will help you solve that Generator problem.



"Lighting Fixtures"

READY TO HANG

(Direct from Manufacturer)
Completely wired including glassware
Send for new Catalogue No. 27
(Just reduced prices)
Special Proposition to Dealers
ERIE FIXTURE SUPPLY CO.
STATION R ERIE, PA.

BUILD IT WITH KELBRACKETS!

Only \$1.50 Per Pair



Make a sturdy, efficient, good-looking set. Kelbracket Booklet shows how, giving actual size and many uses. Mailed Free.
KELLERADIO, Inc.
821 Market Street,
San Francisco, Calif.

FOR REAL SATISFACTION
AND PERFORMANCE!

Sylvania Tubes

SYLVANIA PRODUCTS CO.
EMPORIUM, PA.

PATENTS

DON'T LOSE YOUR RIGHTS
Before disclosing your invention to anyone send for free blank form "EVIDENCE OF CONCEPTION" to be signed and witnessed.
LANCASTER & ALLWINE
Res. Pat. Attys. in U. S. and Canada
276 Gurry Bldg., Washington, D. C.
Originators of the form "Evidence of Conception"

Insure your copy reaching you each month. Subscribe to Radio News—\$2.50 a year
Experimenter Publishing Co., 53 Park Place, N. Y. C.

An easy way to clearer radio

Clip a No. 112 Power Tube to your Set without Rewiring With a Na-Aid Connectorald

IN OBTAINING clear reception, the tubes are as important as your loud speaker. Almost perfect reception can be had by installing a No. 112 Power Tube in the last stage of your storage battery set. This tube reproduces the most delicate sound wave as clearly as the original. Strain and thin, hollow notes are removed, and the voice of your radio becomes full, vibrant and life-like.

Installed in a moment by a Na-Aid No. 112 Connectorald

Take the tube, clip a Na-Aid No. 112 Connectorald to its base and it will fit any storage battery set. Connectorald has attachments for "B" and "C" batteries. No rewiring necessary. So designed that the tube is not raised in socket. Made of Alden Processed Bakelite by the world's largest manufacturer of sockets and dials. Price, \$1.25. If your dealer is unable to supply you send coupon to Alden Mfg. Co., Dept. K19, Springfield, Mass.



Alden Mfg. Co., Dept. K19, Springfield, Mass.
 Send C. O. D. No. 112 Connectoralds at \$1.25 each.
 Name
 Town State.....
 Dealer's Name

\$75 A WEEK BUILDING RADIO SETS In Your Spare Time

Join the Radio Association of America. Learn how to build and repair sets. The Association will train you—start you out in business, if you wish. Be the radio "doctor" of your community. \$3 an hour upwards easily made.

EARN \$500 IN SPARE HOURS

"I have at last found myself," writes Lyle Follick, Lansing, Mich. "I have already made over \$500." Werner Eichler, Rochester, N. Y., writes, "...have made over \$50 a week in my spare time." Our members are starting radio stores, increasing their salaries, securing better positions, passing radio operator examinations, earning big money in spare time.

JOIN ASSOCIATION NOW!

Are you interested in Radio for pleasure or profit? Join now because we have a Special Plan whereby your membership need not cost you a cent. Only limited number of these memberships acceptable. Write now for details—before it is too late.

Mail This Coupon
 Radio Association of America,
 Dept. 156, 4513 Ravenswood Ave., Chicago
 Send me details of your Special Radio Association Membership Plan.
 Name
 Address
 City State.....

Wade Square Law Condenser and Dial

All sizes, complete with 4-inch vernier dial, for:
 Capacity .000125 mfd. \$6.00
 Capacity .00025 mfd. 6.25
 Capacity .00035 mfd. 6.35
 Capacity .0005 mfd. 6.50

At your dealers, otherwise send purchase price and you will be supplied postpaid.
THE VIKING TOOL AND MACHINE CO., Inc.
 747 65th Street, Brooklyn, N. Y.

Insure your copy reaching you each month. Subscribe to RADIO NEWS—\$2.50 a year. Experimenter Publishing Co., 53 Park Pl., N.Y.C.

age of a "B" eliminator. This is because the resistance of the average meter was so low that connecting it across the output introduced such a load in the circuit that the voltage dropped considerably; and, therefore, the meter registered a much lower voltage than was actually being applied to the plates. However, there has recently been developed a high-resistance voltmeter that is of considerable value to the "B" eliminator enthusiast. It is of resistance so high that it creates only a very slight drain on the "B" battery eliminator, and the resulting voltage drop is so low that it is practically impossible to detect. Therefore, a reading taken on a "B" battery eliminator with a meter of extremely high resistance, such as this, will be found very accurate.

CARE OF METERS

As has been mentioned several times in this article, good measuring instruments are rather delicate. They should never be handled roughly or dropped. To do so may not only break the glass which protects the dial, but may also injure the mechanism and thus render the instrument unfit for further use until it is completely overhauled and repaired. Never leave unmounted meters lying around in places where they are liable to be knocked to the floor. Keep your unmounted meters in boxes at all times when they are not in use.

Never connect the low-range scale of a meter in a circuit of unknown voltage. If you are not sure whether the circuit to be measured carries a high or a low voltage, connect the high-voltage side of the meter. If the needle then indicates that the voltage in the circuit under test is so little as to fall within the low-range scale, then you can connect the low-range part of the instrument in the circuit and measure the exact voltage more accurately. If you will always first ascertain what approximate voltage is in the circuit to be measured and connect your meter accordingly, you will find that the instrument will have a very long life, and you will not be subjected to the disappointment of burning out a valuable meter.

"Wireless" Receivers and Transmitters

(Continued from page 38)

these attempts have recognized, whether they knew it or not, the need of reducing the mechanics of radio to a mathematical certainty. Fig. 2 illustrates one such effort. This type of construction was shown by the author at New York during the first Radio World's Fair in 1924. It will be noted that the socket terminals were spaced some distance apart, as were the transformer terminals. This allowed the sockets to be mounted directly upon the transformers, thus eliminating a large amount of wiring, soldering, etc. Fig. 2 is a speech amplifier used in broadcasting from 9XBG. If one compares Fig. 1 with Fig. 2, it will be easy to see that considerably more certainty as to duplication of results will obtain with the type of construction shown in Fig. 2.

LOCATION OF CONDENSERS

Every article or paper that we read concerning the design of a receiver will emphasize the importance of by-pass condensers in the receiver. None of them tell us in inches just where these condensers are to be placed. Receivers operate from "A," "B" and "C" batteries, A.-C. converters or battery eliminators. The internal resistance of these current supply devices varies as much as a chameleon's coat. Yet it plays an important part in the action of the receiver. I know of one very successful dealer in radio receivers here in Michigan who has discovered how to make his receivers stay sold. He handles a very popular make of receiver; but,

ELECTRAD

New!



ELECTRAD Heavy Duty Metallic Resistor

Specially developed for B eliminators and power supply units.

Special Features Are:

- 1—High current-carrying capacity.
- 2—Non-inductive. Accurate calibration.
- 3—Low temperature coefficient.
- 4—Resistance element fused to inside of Lavrock tube.
- 5—All standard high resistance sizes.

Price \$1.00; in Canada \$1.40

Ask Your Dealer For Detailed Circular

ELECTRAD

New York City Inc.

9 Circuits-1 Tuning Dial!

A Separate Circuit for each 40 Meter Wavelength Band. A single tuning dial, yet greater selectivity. Let our nearest dealer show you the great Kellogg.



Or write for complete descriptive folder No. 1-G today. KELLOGG SWITCHBOARD & SUPPLY COMPANY, 1041 W. Adams Street, Chicago, Ill.

FREE Radio Catalog

Just off the press. Our second catalog for 1926. 100 pages of parts, accessories, kits and sets—all the best and the latest. A copy is yours for the asking. Just drop us a line—do it today!

CHICAGO SALVAGE STOCK STORE
 Dept. R.N. 509 S. State St., Chicago, U.S.A.

64 Illustrated Pages of Radio Bargains! Write for Catalog Today **RANDOLPH RADIO CORP.** 159 N. UNION AV. Dept. 2 CHICAGO, ILL.

Don't Miss!

The Greatest Radio Story Ever Written

Published this month in

AMAZING STORIES

The Magazine of SCIENTIFICTION

25c

On All Newsstands

not content with the manufactured product as it is, he studies and changes the by-passing on each receiver to fit the actual conditions under which it is to be used.

FIELDS OF CAPACITIES

I have spoken of the interleaving-plate condenser as an atrocity, not as a criticism in any sense of the word because such are standard accepted practice, have grown up with the art; and, so far as efficiency from the low-loss standpoint is concerned, are really present-day marvels—an outstanding mark of the effort of American manufacturers to turn out the very best. Buy a foreign-built condenser if you doubt this. I say atrocity, because of their inherent ability to spray their field promiscuously around our radio sets, and because of their ability to change their calibration under commercial conditions, almost at will. The placing of two or three or more of these condensers on a single shaft, for simultaneous control of various circuits, is certainly flying right into the face of old man Precision. One of the best receivers that I have used during the last year was a one-dial three-gang condenser job; so you must recognize that I am speaking in generalities or perhaps a little bit in advance of the times.

And inevitably comes the question, "All very well, but how are you going to stop it?" I do not know the answer, but I may be able to help a bit toward it, judging by my work along this line for the last four or five years.

First, build condensers with little or no surrounding field, that's not so hard.

Second, build coils likewise, a bit harder to do of course, but more familiarity with iron is showing us the way here. For instance, Fig. 3 shows two audio transformers but a quarter inch apart, but which show no objectionable reaction even when they are mounted on a single core. Single-core audio mounting is logical and will be with us more every day now.

Third, eliminate promiscuous wiring. This means the entire elimination of wiring, or the use of only such that we can directly measure its effect. Fig. 2 shows that the third requirement is not impossible and Fig. 3 will illustrate it even better.

Fourth, we must let our radio-frequency power do its useful work; and then, before it has any opportunity for promiscuous action on its own hook, we must suppress it once and for all.

Fifth, in order to comply more fully with the foregoing requirements, we must employ shielding, imperfect though it may be. A casual survey of present receivers shows that shielding is used more to distort the fields advantageously than to stop them from creating an influence. This does not seem to be the proper employment for shielding.

Station
WRNY
NEW YORK
258.5 Meters - 1160 kilocycles
is owned and operated by the publishers of this magazine
Our Editors will talk to you several times every week—
See your Newspaper for details
TUNE IN ON
WRNY

An Instant Indicator of Storage Battery Conditions!

TELLS AT A GLANCE

1. When the battery needs charging.
2. When the battery on charge has been charged enough.

Shows instantly whether your "A" Battery will operate the radio set. It also warns of approaching discharge—tells you whether the battery is good for a few hours' emergency reception.

Sterling Charge Indicator

You can't go wrong with it. It can't get out of order or mislead you. It keeps you fully informed of your "A" power supply—**vital to correct radio reception.**
No acid to spill or bother with. No time lost. No confusion. There is only one real Charge Indicator—a **Sterling**. Ask for it at your dealer's. If you can't be accommodated write direct to factory.

Price No. 32 Sterling Charge Indicator \$2.00

THE STERLING MANUFACTURING CO.,
Cleveland, Ohio Dept. H



Sterling Charge Indicator

Goodrich Silvertown Radio Panels

For greatest range and selectivity

- 1 Easier to drill and machine.
- 2 Better color, lasting lustre.
- 3 Lower free sulphur—no discoloration.
- 4 Higher softening point—no warping.

Goodrich V. T. Sockets Spaghetti Tubing
Radiophone Ear Cushions Battery Mats
Hard Rubber Tubes for Coils

The B. F. Goodrich Rubber Company
Established 1870 Akron, Ohio

RADIO PANELS
OF GENUINE BAKELITE

Cut, drilled and engraved to order. Send rough sketch for estimate. Our New Catalog on Panels, Tubes and Rods—all of genuine Bakelite—mailed on request.

STARRETT MFG. CO.
520 S. GREEN ST. CHICAGO

Immediate Shipment from Stock
HAVE MERCHANDISE
WHEN YOU NEED IT
Catalog 466-S is free to dealers.

WHOLESALE
LUDWIG HOMMEL & CO.
929 PENN AVENUE PITTSBURGH, PA.

ATWATER KENT RADIO

Reserved for the
CAMFIELD RADIO MFG. CO.
829 Harrison Street
Oakland California

PHILIPPINES - PORTO RICO - PORTUGAL - SALVADOR - SAN DOMINGO - SPAIN - URUGUAY - VENEZUELA

CHILE

BRAZIL

BOLIVIA

ARGENTINA

MR. MANUFACTURER:---
Boost Your Summer Radio Sales!



(RADIO NEWS in Spanish)

- Serves twenty-three Spanish-speaking countries
- an immense market embracing over 140 millions who are now enjoying winter radio reception.

THESE PEOPLE PREFER AMERICAN RADIO APPARATUS

RADIO INTERNACIONAL is the only International Radio magazine reaching and appealing to these people in their own language. Advertise your products to them now.

ASK YOUR ADVERTISING AGENT FOR RATES

RADIO INTERNACIONAL is of standard size, 9 x 12 inches, printed entirely in Spanish.

PRICE 30c THE COPY. Subscription \$3.00 the Year.

EXPERIMENTER PUBLISHING CO., Inc., - 53 PARK PLACE, NEW YORK, N. Y.

COLOMBIA - COSTA RICA - CUBA - ECUADOR - GUATEMALA - HONDURAS - MEXICO

PERU

PANAMA

PARAGUAY

NICARAGUA

One Hundred Dollars in Cash
IF YOU CAN BEAT THIS

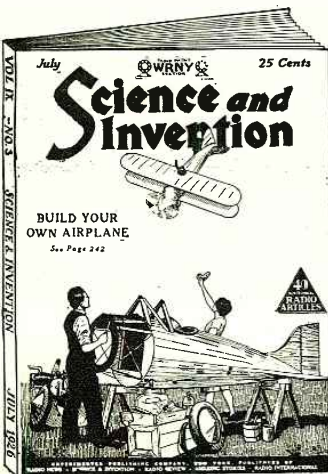

ENTER THE \$5,000.00 MATCHCRAFT CONTEST

The photo on the right is a remarkable Replica of "General Ulysses S. Grant's Tomb" in New York City, complete in the smallest detail and made entirely of matchsticks—It won first prize of \$100 in the \$5,000 matchcraft contest under the auspices of SCIENCE & INVENTION.

BUY the July issue of SCIENCE & INVENTION now and enter the new contest—You may not win first prize but there are many other prizes well worth winning.

Full details are in the July issue, 25c the copy. Now on sale at all Newsstands. Don't miss this fascinating, big prize contest.

Published and Distributed by

Experimenter Publishing Co., Inc.
53 Park Place, - New York, N. Y.

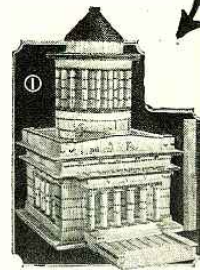

FIRST PRIZE

Winner of the April Matchcraft Contest. Built completely of matches—size 2 ft. high, by 1 ft. 10 in. long, by 1 ft. 2 in. wide.

SOLD ON ALL NEWSSTANDS

The sixth and last requirement must necessarily deal with the use of by-passing condensers and the varying impedance or resistance of the battery supply. You will agree that if all six of these requirements can be met, the question would be at least partly answered.

Fig. 3 will serve to show the idea in mind. We will try very shortly to illustrate the idea more clearly as applied to various types of hook-ups and layouts. In the receiver shown in Fig. 3 the coils and condensers have been removed to display more clearly the construction; as has been said these will be discussed later. The filament connections for every tube are integral parts of metal strips, so constructed that rheostats or potentiometers may be placed at will, and that whatever capacity is needed may be obtained between the strips.

For whatever good it may do me, I suppose it is best to say that the apparatus, etc., disclosed in this article are the subject of patent application, and that all rights thereto are reserved by the writer.

New Radio Devices of Fixed Precision

(Continued from page 32)

strain imposed upon the quartz is reduced to a minimum; and the life of these resonators is, therefore, practically unlimited. In the case of higher voltage the cell will also become luminescent, this phenomenon being due solely to a glimmering discharge between the electrodes. By means of an interposed oscillatory circuit, which is tuned approximately for the proper wave-length, it is easy to tune the transmitting station exactly to its prescribed wave. First the coupling is made somewhat closer and a preliminary tuning is made by means of the glimmering effect. If the coupling is made looser, the "luminescence" property of the quartz will be obtained; which takes place only in case the tuning is accurate within a frequency limit less than that specified above.

A bank of five of these resonators (one of which is calibrated exactly to the required frequency, two others to frequencies slightly above, and the remaining two to frequencies slightly below the prescribed frequency) may easily be used in the determination of the exact frequency of a transmitter or oscillator. The condenser controlling the frequency of oscillations is slowly varied until the outside tubes become luminescent. The condenser is varied, more slowly still, until only the middle tube, which is the one having the exact frequency desired, is luminescent. This indicates that the oscillatory circuit is at the same frequency as that to which the middle tube is calibrated.

This brief description of Dr. Loewe's new apparatus will give the reader a rough idea of just how important these inventions are. The possibilities that the new vacuum tubes afford are also limitless; for it is entirely within the realms of possibility that sometime we shall have entire radio sets within a comparatively small space instead of the cumbersome boxes and cabinets such as we know today. Even now, with the detector and amplifier tube in its present state of development, the space needed in the cabinet of a portable receiver has been much reduced, due to the elimination of two vacuum tubes.

As for the quartz-crystal frequency resonator, this, too, is an important step forward. Broadcast stations, and also receiving sets, can now be tuned to an accuracy hitherto unobtainable; and at the same time these tubes act as a danger signal when there is a variation from the assigned wave-length of the station.

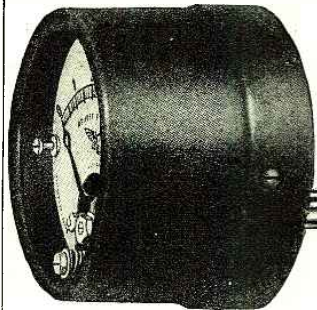

Instruments Are Necessary

Many set manufacturers realize the necessity of instruments and mount them on the panels of their sets.

Other manufacturers are providing two Pin-Jacks on their panels into which the special prods on the back of instruments can be inserted.

Circular No. 739 Describes the Jewel Pin-Jack Voltmeter

Jewell Electrical Instrument Co.

1650 Walnut St. - Chicago
 "26 Years Making Good Instruments"

Steinite Low Loss Interference Eliminator

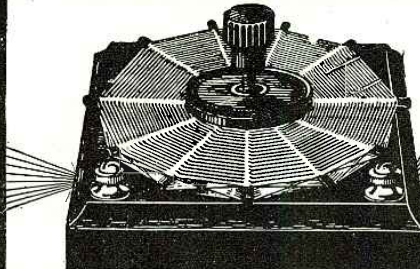

Give Your Receiver a Chance

Day by day radio reception is becoming more involved—few sets are built for wide distribution of stations—crowding results. This amazing eliminator attached to your aerial wire, gives your set a chance, it enables you to select stations at will. You get one station at a time, the one you want and tuned in loud and clear. Helps in all sets.

Mrs. Famous 1,500 Mi. Steinite I-Tube Set, \$6; Long Distance Crystal Set, \$6; Steinite Crystal 50c—Three for \$1

Steinite 5-Tube Set \$29.75

Free Descriptive Literature on Request.

Requires no extra tubes or batteries. Put this eliminator on your set today and note the amazing improvement. Installed in a moments time. Price \$1.00 Post-Paid. Money Back Guarantee

Steinite Laboratories
 128 Radio Bldg. ATCHISON, KANS.

\$1 POSTPAID

Separates crowded wave lengths

Cuts out bothersome interference

Connects from aerial wire to set

\$1 POSTPAID

Make any Good Receiver BETTER



BETTER

C.E. MFG. CO.
 Providence R.I.



G-S SILK CORE CRYSTAL DETECTOR

PRICE \$2.00

Write for new descriptive folder. Dealers Write for Proposition. Manufacturers G-S RADIO RESEARCH LAB. 1269 Cochran Ave., Los Angeles, Cal.

HEATH CONDENSERS

For Real Radio Reception

Write for Literature

HEATH RADIO & ELECTRIC MFG. CO.,
 206 First St., Newark, N. J.

ACME for amplification

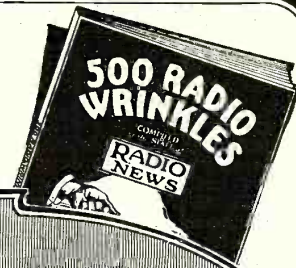

YOU NEED THESE BOOKS

Every Owner or Builder of Radio Receivers should know how they operate and how to care for essential parts. These books make it easy!

Compiled
-by the Staff of **RADIO NEWS**

1001 QUESTIONS AND ANSWERS

A brand new book filled to the brim with a priceless array of selected Questions and Answers that are necessary to everyone in the construction, care and maintenance of modern sets, including information on hundreds of simple and complex circuits in common use today.

In presenting this most valuable assortment of questions and in answering them in the best and most understandable way, the staff of Radio News feels that it has created a book in which appears the cream of every radio man's problems and the best method of coping with them. There is contained invaluable information on every phase of radio. Information on hundreds of simple and complex hookups is given in clear and concise language. Information on practically every type of receiving set, manufactured receivers, vacuum tubes, miscellaneous circuits, and in short just what the radio enthusiast needs as an unerring guide and aid. This book abounds in priceless data that is worth far more than the nominal price at which it sells.

Contains 116 Pages, 300 Illustrations and is published in the large Magazine Size 9 x 12 inches.

PRICE 50c

RADIO NEWS AMATEURS' HANDIBOOK

The "RADIO NEWS" Amateurs' Handbook is a large 116 page magazine size book containing a wide, varied and carefully selected array of the finest and most helpful radio articles that have appeared in the pages of Radio's Greatest Magazine, RADIO NEWS.

The cream of practical, up-to-the-minute, circuits and miscellaneous information and data is culled from RADIO NEWS and presented in compact form in this book. It embraces every phase of radio, but particularly the new and more practical receivers and circuits developed for modern reception.

Contains 116 Pages,
Illustrated

PRICE 50c

500 RADIO WRINKLES

A big book full of short cuts, hints and practical ideas. The 500 RADIO WRINKLES BOOK is a very comprehensive compilation of the best time and money saving hints that can be effected. Under fifteen separate and distinct headings, the entire field of radio apparatus and instruments has been covered in simple, understandable language. It is divided into sections covering Antennae, Batteries, Coil Mountings, Condensers, Crystal Detectors, Inductances, Lightning Protectors, Loop Antennae, Loud Speakers, Resistances, Sockets, Switches, Transformers, Vernier Dials. There are no ifs nor buts to complicate directions. The Beginner as well as the more advanced radio man will soon find that this book contains a veritable storehouse of practical, inexpensive hints toward improving his radio apparatus.

Large Size 9 x 12 inches,
100 Pages Illustrated

PRICE 50c

AT ALL NEWSSTANDS

IF YOUR DEALER CANNOT SUPPLY YOU, OR IF THERE IS NONE NEAR YOU, ORDER DIRECT.
THE EXPERIMENTER PUBLISHING COMPANY, Inc., - - 53 Park Place, New York

A Portable Super-Heterodyne

(Continued from page 47)

of the set will be exactly the same as with dry-cell tubes except in the matter of stabilizing the R.F. amplifier. With storage-battery tubes it will be necessary to connect an adjustable resistance with a maximum of not over 200,000 ohms in at point "X" as shown in the circuit diagram to control the amplifier stability.

ELIMINATING "HARMONICS"

A method which will eliminate practically all harmonics on the oscillator dial has been developed by a prominent engineer, Mr. Kendall Clough. It consists of running the oscillator grid positive to a point where there is no change in plate current whether the oscillator tube is oscillating or not. The simplest way to find this point is to connect a "C" battery in the oscillator grid circuit with its positive side to the return of the condenser and inductance. Its negative side should go to a potentiometer connected across the "A" battery. With all tubes turned out except the oscillator, and a low reading milliammeter put in its plate circuit, this positive bias should be adjusted up to 10 or 12 volts, possibly more, until the plate current of the tube with the tuning condenser, short-circuited or not, remains substantially the same. When this adjustment is reached, it means that the oscillator plate current is fixed.

It would not be profitable to go into the theory of the arrangement here; but suffice it to say that it operates to reduce the "even harmonics" of the oscillator to a small fraction of their original value.

LIST OF PARTS

- One Panel, high-insulating composition, 7x18x3/16, and Sub-Panel of the same, 6x17x3/16;
 - Two Vernier Dials;
 - One Midget Variable Condenser;
 - Two Variable Condensers, .00035- μ f., S.L.F.;
 - Two Long-Wave Transformers;
 - One Long-Wave Filter;
 - Seven Universal Tube Sockets;
 - One Grid Condenser, .00015- μ f., with clips and 2-megohm Grid Leak;
 - Two Fixed Condensers, 2.0- μ f.;
 - One Fixed Condenser, .002- μ f.;
 - Two Audio Transformers, 3 $\frac{1}{2}$:1;
 - One Socket, Special, for plug-in coils;
 - One Oscillator Coupler, plug-in;
 - One Rheostat, 6 ohm;
 - One Filament Switch;
 - Two Jacks, one single, one double-circuit;
 - One pair Mounting Brackets;
 - One Co. Hook-Up Wire.
- Approximate cost, \$57.80.

ACCESSORIES

- One Portable Case;
- One Loop Antenna;
- Three or Six Dry Cells;
- Seven "B" Batteries, 22 $\frac{1}{2}$ -volt;
- One "C" Battery, 7 $\frac{1}{2}$ -volt;
- One Loud Speaker;
- One Pair Head Phones;
- Two Phone Plugs.

IT is against the policy of RADIO NEWS to publish the names of manufacturers or of makes of instruments in connection with the apparatus described in these pages, but this information will be gladly given privately. If you are interested in any special instruments described here, address a letter to the I WANT TO KNOW DEPARTMENT, enclosing stamped return envelope. The names and addresses of the manufacturers will be given free of charge. —EDITOR.

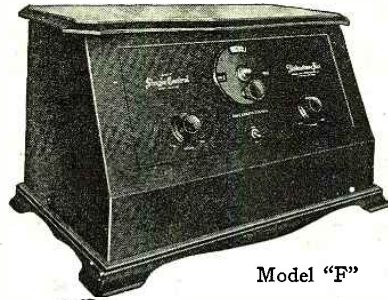

Model "F"

Flawless Tone One Dial Control

Six . . \$115
Tubes

Beautiful solid mahogany cabinet. Control board panel of genuine walnut burl Bakelite, artistically engraved in gold. The long distance range of this set, its flawless reproduction, and the one dial control operation make it one of the biggest radio values to be had.

Distantone

Built By Craftsmen

TO DISTRIBUTORS

There are some unallotted territories in which we can offer a highly profitable proposition to reliable and financially responsible distributors and jobbers. Write for particulars or sample.

Other Models from \$37.50 to \$150

The Distantone line includes five tube receivers of two and three dial control and five and six tube sets with single dial control; all Tuned Radio Frequency type. Every model a superior value for the price.

DISTANTONE RADIOS, Inc., LYNBROOK, LONG ISLAND, NEW YORK

100 Volt Storage "B" Battery \$10

Everybody can now enjoy the benefits of Storage "B" Batteries—more power, quieter reception, greater economy. Rubber case prevents leakage or shorting. Easy to recharge. Will last for years with ordinary care.

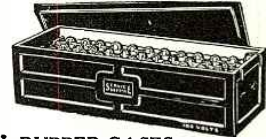

SERVICE "A" AND "B" CHARGER



Charges 9-volt "A" or Auto Batteries or up to 125 volts of "B" Battery IN SERIES. Noiseless in operation. Extremely economical. The height of convenience.

Complete with Bulb, \$14.50

SERVICE STORAGE "B" BATTERIES IN ALL RUBBER CASES

50 Volts \$5.50 100 Volts \$10.00 125 Volts \$12.50

Prices in Canada

50 Volts \$7.75 100 Volts \$14.50 125 Volts \$17.00

SERVICE "A" BATTERIES

Indestructible rubber case. Two year guarantee

6 Volt 100 Amp. hr. \$14.00, 6 Volt, 120 Amp. hr. \$16.00

SERVICE BATTERY CO. of Canada 137 Roncesvalles Ave. Toronto, Ontario

SERVICE BATTERY CO.

704 EAST 102nd STREET CLEVELAND, OHIO

LEARN THE CODE AT HOME

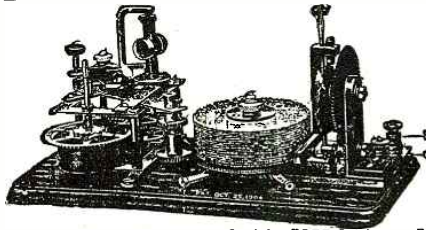

WITH THE OMNIGRAPH

THE OMNIGRAPH Automatic Transmitter will teach you both the Wireless and Morse Codes—right in your own home—quickly, easily and inexpensively. Connected with Buzzer, Buzzer and Phone or to Sounder. It will send you unlimited messages: at any speed, from 5 to 50 words a minute.

THE OMNIGRAPH is not an experiment. For more than 15 years, it has been sold all over the world with a money back guarantee. The OMNIGRAPH is used by several Depts. of the U.S. Govt.—in fact, the Dept. of Commerce uses the OMNIGRAPH to test all applicants applying for a Radio license. The OMNIGRAPH has been successfully adopted by the leading Universities, Colleges and Radio Schools.

Send for FREE Catalog. DO IT TODAY

THE OMNIGRAPH MFG. CO., 15 HUDSON STREET, NEW YORK CITY

If you own a Radio Phone set and don't know the code—you are missing most of the fun

A Laboratory Product



CRESCENT LAMPE RESISTANCES

For Distortionless Amplification
Insure distortionless amplification and a clarity of tone not obtained through any other resistances. All capacities 12,000 ohms and up. List price \$1.50. Special sizes to order. Write for full information.

Crescent Radio Supply Co., 1-5 Liberty St., Jamaica, N. Y.

"AMERICA" RADIO TUBES

Are Better Than You Expect Fully Guaranteed ELITE RADIO TUBE CO., Inc., Mfrs. 409 S. 8th St., Newark, N. J. Dealers Write for Proposition

1.00

LIST PRICE

PATENTS TRADE-MARKS

Edward C. Sasnett, Attorney at Law
Ex-Principal Examiner U. S. Patent Office:
Personal Service
544 McGILL BLDG. WASHINGTON, D. C.

EVERYTHING IN RADIO

AT ATTRACTIVE PRICES

SETS OR PARTS

Mail order only

ALL RADIO COMPANY, 417 North Clark St., Chicago

OPPORTUNITY AD-LETS

Follow these advertisements every month. Reliable advertisers from all over the country offer their most attractive specials in these columns.

Classified advertising rate twenty-two cents a word for each insertion. Ten per cent discount for 6 issues, 20 per cent discount for 12 issues. Name and address must be included at the above rate. Cash should accompany all classified advertisements unless placed by an accredited advertising agency. No advertisement for less than 10 words accepted.

Objectionable or misleading advertisements not accepted. Advertisements for the September issue must reach us not later than July 1st.

CIRCULATION LARGER THAN THAT OF ANY OTHER RADIO PUBLICATION

EXPERIMENTER PUBLISHING CO., INC., 53 Park Place, New York, N. Y.

Agents Wanted

Big Money and fast sales. Every owner buys gold initials for his auto. You charge \$1.50; make \$1.35. Ten orders daily easy. Write for particulars and free samples. American Monogram Co., Dept. 135, East Orange, N. J.

Guaranteed Genuine Gold Leaf Letters anyone can put on store windows. Large profits, enormous demand. Free samples. Metallic Letter Co., 422 N. Clark, Chicago.

Big Money—fast sales; every owner buys gold initials for his auto. You charge \$1.50; make \$1.41. Ten orders daily easy. Samples free. World Monogram, Dept. 27, Newark, N. J.

Wanted—Agents to sell Oracle 5 Coast to Coast Receiver. Dealers Discount. Free Radio Catalog to Fans. Radio Specialty Shop, 525 Park Ave., Kent, Ohio.

Agents—our super embossed display signs for all stores are tremendous sellers. \$75 to \$100 per week easily made. Write now for details. Artistic Signs, 799-A Broadway, New York.

Architecture School

Wanted—Building-Draftsmen. Train at home, in spare time, to be a Building-Draftsman. Big demand means big salaries and steady work. Get into Building, America's \$7,000,000,000 industry. Keep right on with your present work. We train you by mail. Free Trial Lesson and Blue Print plans to show you how easily and quickly you can learn. Get into the \$3,000 to \$10,000 salary class. Write for Free Lesson, Blue Prints and catalog. All free, no obligation. Chicago Technical College, Dept. 1855, 115 E. 26th St., Chicago, Ill.

Books

Mystify Your Friends, become a master of magic. Popular Magic, 116 page book contains hundreds of magic and spirit tricks, 500 illustrations. Price 50c. Sold everywhere. Experimenter Pub. Co., Inc., 53 Park Place, N. Y.

Amazing Stories, the newest story magazine. Scientific Novels, issued every month, size 9x13 inches. Special yearly subscription offer, \$2.50. Experimenter Pub. Co., Inc., 53 Park Place, N. Y.

Radio Trouble Finder, a new book to keep near set, simple charts tell how to locate and correct all troubles. 52 Pages 6x9. Illustrated. Price 25c. The Conrad Co., Inc., 61 Church St., N. Y.

Builders School

Become a Builder. The World's Big Pay Field—Building. Be an estimator, superintendent, or have a contracting business of your own. Train at home, in spare time, to earn \$5,000 to \$20,000 a year, or more. No matter what your job is now—there's a big opportunity for you. A virgin Blue Prints, actual Blue Print Plans and Catalog sent free. See how quickly and easily you will learn this fascinating big-pay profession. If you are earning less than \$75 a week, write us now. Send for free books and Blue Print Plans today! Chicago Technical School for Builders, Dept. 2773, 118 E. 26th St., Chicago, Ill.

Business Opportunities

Free Book. Start little Mail Order Business. Pier, 996 Cortland Street, N. Y.

Responsible manufacturer wants competent men to manage office and salesmen. \$300 to \$1500 necessary; will allow expenses to Trenton if you qualify. Address Manager, 536 Forst Richey Bldg., Trenton, N. J.

Free Booklet describes 52 plans for making \$20.00 to \$100.00 weekly in home or office, business of your own. Downs Co., 2336 Myrtle, St. Paul, Minn.

Chemistry

Learn Chemistry at Home. Dr. T. O'Connor Sloane, noted educator and scientific authority, will teach you. Our home study correspondence course fits you to take a position as chemist. See our full page ad on page 96 of this issue. Chemical Institute of New York, 66 W. Broadway, New York City.

Educational

Used Correspondence School courses save over half. Bargain Catalogue 1000 courses free. Used courses bought. Students' Exchange, Dept. A, 47 West 43d St., New York.

Help Wanted

Detectives Needed Everywhere. Travel. Experience unnecessary. Write, George Wagner, former Government Detective, 1968 Broadway, N. Y.

Incorporations

Delaware Incorporator, Charters; Fees Small; forms. Chas. G. Guyer, 901 Orange St., Wilmington, Del.

Insects Wanted

Why not spend Spring, Summer and Fall gathering butterflies, insects? I buy hundreds of kinds for collections. Some worth \$1 to \$7 each. Simple outdoor work with my instructions, pictures, price-list. Send 10 cents (not stamps) for my illustrated Prospectus before sending butterflies. Mr. Sinclair, Dealer in Insects, Dept. 40, Box 1424 San Diego, Calif.

Instruction

Learn Chemistry at Home. Dr. T. O'Connor Sloane noted educator and scientific authority, will teach you. Our home study correspondence course fits you to take a position as chemist. See our full page ad on page 96 of this issue. Chemical Institute of New York, 66 W. Broadway, New York City.

Miscellaneous

Art Photos 4 \$1.00. Names, Cuts. GPO Box 471, N. Y.
Forms to Cast Tin Soldiers, Indians, Marines, Trappers, Animals. Send 10c for Catalogue. Henry T. Schiercke, 1031-72nd St., Brooklyn, N. Y.

I catch from 45 to 60 Foxes in from 4 to 5 weeks' time. Can teach any reader of this magazine how to get them. Just drop me a card for particulars. W. A. Hadley, Stanstead, Quebec, Canada.

Motion Pictures

Films for Toy Machines. Hart—Mix—Chaplin. Complete stories 1000 feet \$3.50. Special 200 foot lengths \$1.50 postpaid. Big Boys list free. Monarch Films, Department 3, Memphis, Tenn.

Motorcycles, Bicycles

Don't Buy a Bicycle Motor Attachment until you get our catalog and prices. Shaw Mfg. Co., Dept. 6, Galesburg, Kansas.

Old Coins

German Gov't Bond 5,000,000 Mk. 1924. \$1.50, 2,000,000 Mk. Bond 1923, \$5.00, 500,000 Mk. Bill and Catalogue, 10c. Norman Shultz, Colorado Springs, Colo.

California Gold Tokens—Quarter Size 27 cents; half dollar size 53 cents. Catalogue and 500,000 German Mark Bill 10 cents. Alexis Menselle, Colorado Springs, Colorado.

Old Money Wanted

\$2 to \$500 each paid for hundreds of Old or Odd Coins. Keep all old money, it may be very valuable. Send 10c for New Illustrated Coin Value Book, 45c. Guaranteed prices Get posted. We pay Cash. Clarke Coin Company, 14 Street, LeRoy, N. Y.

Patent Attorneys

Inventors—Should write for our Free Guide Books and "Record of Invention Blank" before disclosing inventions. Send model or sketch of your invention for our Free Inspection and Instructions. Radio, Electrical, Chemical, Mechanical and Trademark experts. Terms reasonable. Victor J. Evans & Co., 922 Ninth, Washington, D. C.

Patents. Send drawing or model for examination and report as to patentability. Advice and booklet free. Highest references. Best results. Promptness assured. Watson E. Coleman, Patent Lawyer, 644 G Street, N. W., Washington, D. C.

Patents—Send for form "Evidence of Conception" to be signed and witnessed. Form, fee schedule, information free. Lancaster and Allwine, Registered Patent Attorneys in United States and Canada, 269 Ouray Bldg., Washington, D. C.

Patent Attorneys (Continued)

Inventors—who derive largest profits know and heed certain simple but vital facts before applying for patents. Our book Patent-Sense gives those facts; free. Write Lacey & Lacey, 651 F St., Washington, D. C. Established 1899.

Edward C. Sasnett, Attorney at Law; Ex-Principal Examiner U. S. Patent Office. Personal Service. 545 McGill Bldg., Washington, D. C.

Patents. My fee in installments. Frank T. Fuller, Washington, D. C.

Patents

Inventions Commercialized. Patented or unPatented. Write Adam Fisher Mfg. Co., 275 Enright St. Louis, Mo.

Patents For Sale

Mr. Inventor. If you have a patent or invention for sale. Write Hartley, 38 Court St., Bangor, Me.

Printing Outfits and Supplies

Print your own cards, stationery, circulars, paper, etc. Complete outfits \$8.85; Job Presses \$12. \$35; Rotary \$150. Print for others, big profit. All easy, rules sent. Write for catalog presses, type, paper, etc. Press Company, A-13, Meriden, Conn.

Radio

Amateurs Handbook, contains best radio articles from "Radio News" 128 pages, size 9x12 inches, valuable, instructive. Price 50c. Sold everywhere. Experimenter Pub. Co., Inc., 53 Park Place, N. Y.

500 Radio Wrinkles. Just off the Press. Hints, helps for every Radio User, 100 pages, illustrated, size 9x13 inches. Price 50c. Sold everywhere. Experimenter Pub. Co., Inc., 53 Park Place, N. Y.

Free a sample of Ivorlite, the new ivory radio panel. It's the finest, most beautiful panel made. And LOOK it can be cut any size you want and only costs 3c square inch. Write today for FREE sample and complete description. Ivorlite Radio Panel Co., 3222 Ave. F, Fort Worth, Texas.

Build a Lifetime "B" battery from my better Edison Elements. With welded connections 7c pair. Sample cell 10c. Paul Mills, Woodburn, Oregon.

Building, repairing. Roberts circuit—forty dollars. Albert Taylor, Greenwich, Conn.

Boys! Don't Overlook This. The "Rasco" Baby Detector. Greatest detector ever brought out with molded base. Fully adjustable. See former advertisements in this publication, or our catalog. Detector with Galena Crystal, complete 50c, the same detector with Radiocite Crystal, 75c pre-paid. Send for yours today. Radio Specialty Company, 96-98 Park Place, New York City.

Attention!—50 Vacuum tube hook-ups. The greatest collection of vacuum tube circuits ever brought under two covers at such insignificant cost. These diagrams will be found in the great "Rasco" catalog, which contains raw materials and parts in a greater profusion than any other catalog. 15c in stamps, or coin, will bring the catalog to you. Radio Specialty Co., 96-98 Park Place, New York City.

Wanted—Distributor and Dealer propositions for radio merchandising. Ottawa Radio Service, Port Clinton, Ohio.

No More Batteries—Build "A" and "B" eliminators— operates any set on AC or DC, no hum, satisfaction guaranteed. Complete plans \$2. Engineers' Service Company, Suite 203-15 Park Row, New York.

Salesmen Wanted

A Salesman wanted in every town or city within 25 miles of a broadcasting station to sell Radiogem, the complete radio receiving set that retails for \$2.50. With Radiogem there is nothing else to buy—the outfit includes the Radiogem receiving apparatus, 1,000 ohm phone, and aerial outfit. The cheapest radio outfit on the market—yet as practical as the most expensive. Big money to the right men. Send \$2.00 for sample outfit. The Radiogem Corp., 66-R West Broadway, New York City.

Sell Groceries Under New Plan. Wholesale prices direct to the customer, quality guaranteed. Sure repeat business. Earnings \$35 to \$125 per week with no capital required. Good the year round. Send quick for free instructions to the E. C. HARLEY COMPANY, Department E-2532, Dayton, Ohio.

Kenilworth Inn

Asheville N. C.

Comfortable rooms - best sports excellent food
REASONABLE RATES
Write for Booklet

ROSCOE A. MARVEL
Manager

The HOME of HOSPITALITY
"In The Land of The Sky"

PATENTS

To the Man with an Idea

I offer a comprehensive, experienced, efficient service for his prompt, legal protection and the development of his proposition. Send sketch, or model and description, for advice as to cost, search through prior United States patents, etc. Preliminary advice gladly furnished without charge. My experience and familiarity with various arts frequently enable me to accurately advise clients as to probable patentability before they go to any expense. Booklet of valuable information and form for properly disclosing your idea free on request. Write today.

RICHARD B. OWEN
PATENT LAWYER
2 Owen Building, Washington, D. C.
41A Park Row, New York City

Special Library of Information

on
RADIO PATENTS
and
TRADE MARKS

JOHN B. BRADY

Patent Lawyer
Ouray Building Washington, D. C.

Address: Telephone:
110 PAT Main 4806

MARKO
RADIO BATTERIES
are
ALWAYS DEPENDABLE
MARKO STORAGE BATTERY CO.
Brooklyn, New York

Salesmen Wanted—Continued

A Paying Position Open to representative of character. Take orders shoes-hosiery direct to wearer. Good income. Permanent. Write now. Tanners Shoe Mfg. Co., 5-468 C St., Boston, Mass.

Scenery to Rent

Settings for Opera, Plays, Minstrels. Plush Drops. Address Amelia Grain, Philadelphia.

School of Electricity

Electricity—Short day or evening courses in Electricity, Drafting, Engineering, and Architecture. In Chicago earn while you learn. Part Time positions pay expenses. Faculty of experts. Special short courses. Diplomas in 2 years. B.S. Degree in 3 years. Small classes, individual instruction. 23 year old institution with thousands of successful graduates. Enter any time. Employment bureau. Moderate tuition—monthly payments. New College building—all athletics. All details in 72 page "Blue Book." A copy will be sent to you free. Write today. Chicago Technical College, Dept. 27, 118 E. 26th St., Chicago, Ill.

Song Writers

Songwriters: Let me furnish the music for your songs, guaranteeing you absolute satisfaction. Copyrights secured. Submit your scripts for estimate and free advice. Walter W. Newcomer, 1674 Broadway, New York.

Songwriters—An honest proposition at last. Notary Public signs all guarantees to you. Write immediately. Richard Best, Room 313, 1355 Broadway, New York.

Stammering

Stop Stammering. All speech defects successfully corrected. Samuel Robbins, 399 Boylston St., Boston, Mass. St-tut-t-tering and stammering cured at home. Instructive booklet free. Walter McDermott, 121 Arcade, 1126 Granville Avenue, Chicago, Ill.

Telegraphy

Telegraphy—Both Morse and Wireless taught thoroughly. Big salaries. Wonderful opportunities. Expenses low; chance to earn part. School established fifty years. Catalog free. Dodge's Institute, Cour St., Valparaiso, Ind.

Wanted

Cash Paid for Dental Gold, False Teeth, Discarded Jewelry, Diamonds, Platinum. Mail. Florida Gold Refining Co., 21 Adams, Jacksonville, Fla.

Wanted to Buy

Full Value Paid for Old Gold, Jewelry, Watches, Diamonds, crowns, bridges, dental gold, silver, platinum, gold or silver ore; magneto points, old false teeth. Packages returned if our offer is not satisfactory. United States Smelting Works (The Old Reliable) 39 So. State St., Dept. 16, Chicago, Ill.

Attention!
HIGH SCHOOL STUDENTS

We have a big money making proposition that requires no cash investment—only an hour or two of your spare time necessary.

If you live in New York City or surrounding local territory call in person to see M. B. Murray

For Full Particulars, write
M. B. MURRAY

EXPERIMENTER PUBLISHING COMPANY, Inc.

53 Park Place New York, N. Y.

**How to Make Your Own
SPEECH AMPLIFIER**

MICROPHONE Transmitter Buttons have been used for a number of years to make powerful sound transmitting elements. These very sensitive amplifiers offer every "Radio Fan" the means of building his own powerful speech amplifier. We offer herewith to the constructor these special Amplifier Units.

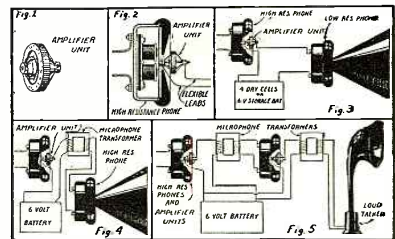

Fig. 1 shows the amplifier unit.

Fig. 2, shows how the unit is attached to a telephone receiver. The first procedure is to mount the unit on the diaphragm of a telephone receiver, which usually is a high resistance telephone, either 1,000 or 1,500 ohms.

Next we select the loud speaking telephone. If a low resistance telephone is available, it should have for maximum efficiency an impedance equal to the resistance of the amplifier unit, or about 10 ohms; it is connected up as shown in Figure 3. A 5 ohm telephone receiver is used in this circuit with a 6-volt storage battery.

Two telephones taken from a good double headset of 2,000 to 3,000 ohms which do not rattle on strong currents, are employed in Fig. 4, one at the receiving end, the other as loud talker. In this hook-up there is one instrument which must absolutely be used with this combination, the transformer. As stated before in connection with Fig. 3, the impedance of the telephone, if used in direct connection, should equal the resistance of the unit. But as the impedance of the telephone in Fig. 4 is much higher than the resistance of the unit, it may be 200 times as great, a transformer having a step-up ratio is used to match up the resistance of the unit with the impedance of the loud speaking telephone. In other words, the primary coil of the transformer should have an impedance (which is sometimes called "A. C. resistance") equal to the resistance of the unit, or about 10 ohms, and the secondary coil should have an impedance equal to the impedance of the high resistance telephone. This transformer may be purchased in any Radio Store and is called a microphone transformer or modulation transformer, designed primarily to use in radio transmitting sets. A 6-volt battery gives the best results. The current passing through the unit will vary from .1 to .25 ampere.

Fig. 5 shows a circuit for further increasing the volume of sound. This is simply two of the circuits, such as shown in Fig. 4, linked together. This arrangement is highly sensitive and the telephones on which the units are mounted should be packed in a box of cotton, as the slightest vibration or sound in the room will be picked up and heard in the loud talker. Any sensitive radio loud talker may be used in this particular circuit.

THESE and innumerable other interesting experiments are possible with these amplifiers. Every amateur should have at least one or two in his "Lab" or workshop. A four-page instruction pamphlet is sent with every unit.

SPECIALLY PRICED **95c**
While they last Per Unit
OR TWO FOR \$1.75

PRESS GUILD,
66-R W. Broadway, New York City, N. Y.
Enclosed find 95c—\$1.75 for which send me postpaid one—two amplifier units as advertised.

Name

Address

Town State.....

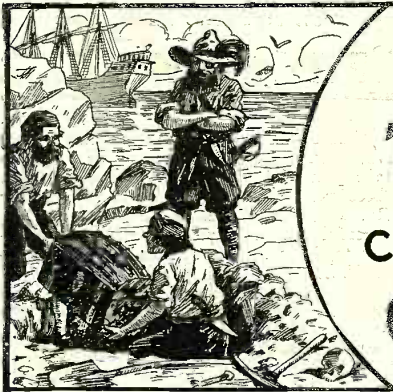

BURIED TREASURE can still be found in CHEMISTRY



Good Chemists Command High Salaries

and you can make yourself independent for life by unearthing one of chemistry's yet undiscovered secrets.



T. O'CONNOR SLOANE,
A.B., A.M., LL.D., Ph.D.
Noted Instructor, Lecturer and Author. Formerly Treasurer American Chemical Society and a practical chemist with many well known achievements to his credit. Not only has Dr. Sloane taught chemistry for years but he was for many years, engaged in commercial chemistry work.

Do you remember how the tales of pirate gold used to fire your imagination and make you want to sail the uncharted seas in search of treasure and adventure? And then you would regret that such things were no longer done. But that is a mistake. They *are* done—today and everyday—not on desert islands, but in the chemical laboratories throughout your own country. Quietly, systematically, the chemist works. His work is difficult, but more adventurous than the blood-curdling deeds of the Spanish Main. Instead of meeting an early and violent death on some forgotten shore, he gathers wealth and honor through his invaluable contributions to humanity. Alfred Nobel, the Swedish chemist who invented dynamite, made so many millions that the income alone from his bequests provides five \$40,000 prizes every year for the advancement of science and peace. C. M. Hall, the chemist who discovered how to manufacture aluminum made millions through this discovery. F. G. Cottrell, who devised a valuable process for recovering the waste from flue gases, James Gayley, who showed how to save enormous losses in steel manufacture, L. H. Baekeland, who invented Bakelite—these are only a few of the men to whom fortunes have come through their chemical achievements.

What Some of Our Students Say of This Course:

I have not written since I received the first set. I can still say that it far exceeded my anticipations. Since I have been studying with your school I have been appointed chemist for the Scranton Coal Co. testing all the coal and ash by proximate analysis. The lessons are helping me wonderfully, and the interesting way in which they are written makes me wait patiently for each lesson.—**MORLAIS COUZENS.**

I wish to express my appreciation of your prompt reply to my letter and to the recommendation to the General Electric Co. I intend to start the student engineering course at the works. This is somewhat along electrical lines, but the fact that I had a recommendation from a reliable school no doubt had considerable influence in helping me to secure the job.—**H. VAN BENTHUYSEN.**

So far I've been more than pleased with your course and am still doing nicely. I hope to be your honor graduate this year.—**J. M. NORKUS, JR.**

I find your course excellent and your instruction, truthfully, the clearest and best assembled I have ever taken, and yours is the fifth one I've studied.—**JAMES J. KELLY.**

From the time I was having Chemistry it has never been thus explained to me as it is now. I am recommending you highly to my friends, and urging them to become members of such an organization.—**CHARLES BENJAMIN.**

I shall always recommend your school to my friends and let them know how simple your lessons are.—**C. J. AMDAHL.**

I am more than pleased. You dig right in from the start. I am going to get somewhere with this course. I am so glad that I found you.—**A. A. CAMERON.**

I use your lessons constantly as I find it more thorough than most text books I can secure.—**WM. H. TIBBS.**

Thanking you for your lessons, which I find not only clear and concise but wonderfully interesting, I am—**ROBT. H. TRAYLOR.**

I received employment in the Consolidated Gas Co. I appreciate very much the good service of the school when a recommendation was asked for.—**OS. DECKER.**

Now Is the Time to Study Chemistry

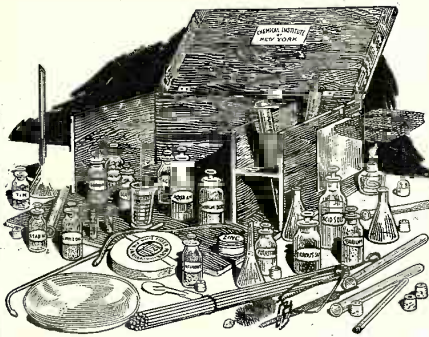

Experimental Equipment Furnished to Every Student

We give to every student without additional charge this chemical equipment, including forty-nine pieces of laboratory apparatus and supplies, and forty different chemicals and reagents. These comprise the apparatus and chemicals used for the experimental work of the course. The fitted heavy wooden box serves not only as a case for the outfit but also as a useful laboratory accessory for performing countless experiments.

Not only are there boundless opportunities for amassing wealth in Chemistry, but the profession affords congenial employment at good salaries to hundreds of thousands who merely follow out its present applications. These applications are innumerable, touching intimately every business and every product in the world. The work of the chemist can hardly be called work at all. It is the keenest and most enjoyable kind of pleasure. The days in a chemical laboratory are filled with thrilling and delightful experimentation, with the alluring prospect of a discovery that may spell Fortune always at hand to spur your enthusiasm.

You Can Learn at Home

To qualify for this remarkable calling requires elaborate specialized training. Formerly it was necessary to attend a university for several years to acquire that training, but thanks to our highly perfected and thorough system of instruction, you can now stay at home, keep your position, and let us educate you in Chemistry during your spare time. Even with only common schooling you can take our course and equip yourself for immediate practical work in a chemical laboratory. Dr. Sloane gives every one of his students the same careful, personal supervision that made him celebrated throughout his long career as a college professor. Your instruction from the very beginning is made interesting and practical, and we supply you with apparatus and chemicals for performing the fascinating analyses and experimental work that plays such a large part in our method of teaching, and you are awarded the Institute's official diploma after you have satisfactorily completed the course.

Easy Monthly Payments

You don't have to have even the small price of the course to start. You can pay for it in small monthly amounts—so small that you won't feel them. The cost of our course is very low, and includes everything, even the chemistry outfit—there are no extras to buy with our course. Our Plan of monthly payments places a chemical education within the reach of everyone. Write us and let us explain our plan in full—give us the opportunity of showing you how you can qualify for a highly trained technical position without even giving up your present employment.

Special 30 Day Offer

Besides furnishing the student with his Experimental Equipment, we are making an additional special offer for a short while only. You owe it to yourself to find out about it. Write us and let us explain our plan in full—give us the opportunity of showing you how you can qualify for a highly trained technical position without even giving up your present employment.

CHEMICAL INSTITUTE OF NEW YORK
Home Extension Division 7
86-R—West Broadway
New York City

CHEMICAL INSTITUTE OF NEW YORK, Inc.

HOME EXTENSION DIVISION 7
66-R—WEST BROADWAY NEW YORK CITY

Please send me at once, without any obligation on my part, your free Book "Opportunities for Chemists," and full particulars about the Experimental Equipment given to every student. Also tell me about your Plan of payment your special 30 day offer.

NAME

ADDRESS

CITY

STATE

SM



S-M Long Wave Transformers

They are tested, measured and guaranteed—made under the most careful supervision and subjected to the most stringent of laboratory tests. Actual amplification to a fraction of one per cent is predicted in tests that these transformers have to pass. Type 210 is an untuned iron core transformer—211 a sharply tuned filter, \$6.00 each.



POWER

The New S-M Raytheon "B" Eliminator Assembly



Embodied in its construction is a new principle in filter design developed by Silver-Marshall engineers. This new and patented feature makes this product better and more efficient, from every standpoint, than anything that has been attempted. The three major units are all built with one big idea in mind—to deliver power that is better than anything heretofore found in "B" eliminator construction. The 650-A assembly will deliver more power—more *constant* power than any other system. It is provided with two adjustable voltage taps and one fixed tap for power tubes. Compact and small in size—6 1-2 by 7-12 inches—it comes to you fully mounted—all that is needed are a few wires to complete it. The new 650-A, embodying the greatest single advance made in eliminator construction, sells for \$35.00.

220 Audio Transformers

It's better than anything else—and this statement is made without any reservations. It handles the deepest notes of the organ and the highest notes of the violin—all smoother and with more "true to color" tones than any other transformer or any other system. The 220 is husky, built to do a power job with real quality. It's the biggest transformer built—and it is *unconditionally guaranteed* to be better than any other practical audio amplifying device—including resistance or impedance coupling. The price is \$6.00. Type 221 is an output transformer, to be used optionally with 220's and power tubes.

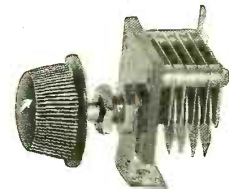

Compensating Condenser 340

The 340 condenser is a small .000025 mfd. adjustable condenser designed for compensating, balancing, or neutralizing. Its sphere of usefulness is not limited to these purposes, however. Supplied with brass plates, mounted on a bakelite head. Size, 1 1/8" wide, 1" deep and 1 1/2" high. Furnished with control knob for single-hole panel mounting, and also with bracket for base mounting. The price is \$1.50.

SILVER-MARSHALL, Inc.

848 W. JACKSON BLVD.

CHICAGO, U. S. A.

SNUBBED.

Snubbers on a Modern Automobile Are Indispensable

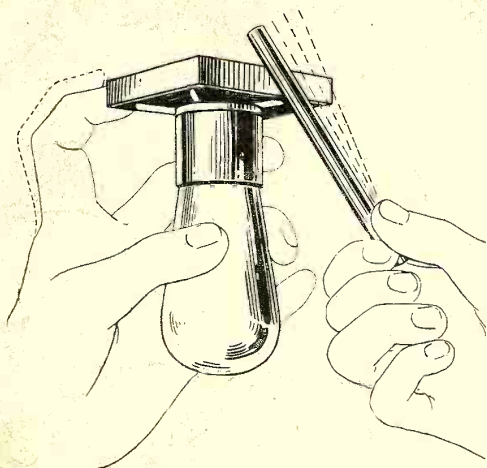

This experiment proves why B-T absorbers improve reception. Tap the base of the ordinary spring-suspended socket and feel the vibrations. Then touch the base with finger and feel them disappear. Vibrations never have a chance to start with the B-T method.

Your Tubes Deserve Protection

Lengthen their lives and Improve Reception by treating them fairly.

Use B-T sockets if you build. Insist on their use if you buy.

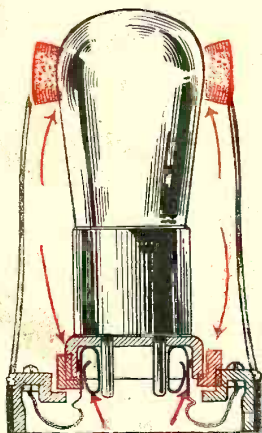

Showing double absorber for detector tube protection.

This is Type UX Detector, price \$1.00.

Springs promote riding comfort, but without absorbers the bouncing continues too long after the jolt occurs. Effective Snubbers damp out the oscillating spring action.

The delicate elements of a radio tube are in vital need of efficient shock absorption,—particularly the detector, where vibration often develops such "microphonic" noises as to actually ruin reception.

B-T Shock Absorbing Sockets are the only solution,—they are not spring suspended. Note the absorbing support **between** base and tube holder,—the damping side mufflers on the detector model, and the long yielding spring contact,—all designed for one purpose,—**QUIET RECEPTION.**



UX Absorber Socket 75c

The superiority of the spring contact is at once evident. It's positive, but causes no undue strain. The connecting link is for current, not spring tension.



From our experience with the B-T SILENT SOCKET (still available with Universal base, \$1.25) we are confident the new UX types will outsell all other sockets by 10 to 1.

Construction and shock absorbing features fully covered by patents pending.

No B-T product is ever offered unless it has fully demonstrated outstanding superiority.

That's why "Every B-T buyer is a B-T Booster."

B-T Authorized Dealers will soon be able to show you new B-Eliminators, Counterphase Set models, etc. Watch for them. Write for circulars.

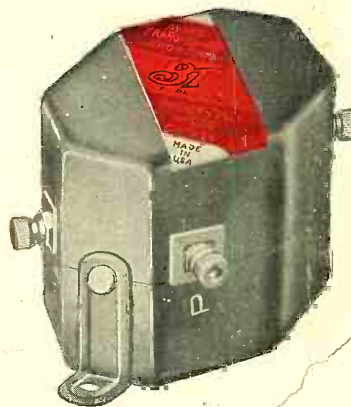

It took the Euphonic to prove how good an Audio Transformer could be.

We have never built a product that brought greater praise.

"No superior at any price" is the popular verdict.

2.2 to 1 \$5.00
4.7 to 1 \$5.75



Premier Audio
Manufacturing Company

Canal and Harrison Streets
CHICAGO