

CIRCULATION LARGER THAN THAT OF ANY OTHER RADIO PUBLICATION

RADIO NEWS

331 = 361
REG. U.S. PAT. OFF

OCTOBER
25 Cents

Over 200
Illustrations



Edited by HUGO GERNSBACK

THE RADIO BURGLAR ALARM

SEE PAGE 340



RADIO'S GREATEST MAGAZINE

EXPERIMENTER PUBLISHING COMPANY, NEW YORK, PUBLISHERS OF

SCIENCE and INVENTION RADIO REVIEW AMAZING STORIES RADIO INTERNACIONAL

Cunningham

RADIO TUBES



is the one word that best describes that type of service rendered by Cunningham Radio Tubes in millions of receivers and the type of service rendered by Cunningham dealers in thousands of communities.

These tubes are winning new friends every day and are holding old friends year after year. The enormous increase in the number of Cunningham Radio

Tube users has not been brought about by magic. It has been brought about by the fact that only quality materials, quality workmanship and advanced scientific ideas are exemplified in the Cunningham product.

For new heights of efficient sensitivity, install Cunningham Radio Tubes in every socket of your receiver.

*Since 1915—Standard for All Sets
All Types C & CX*

E. J. Cunningham Inc.

New York

Chicago

San Francisco

Manufactured and sold under rights, patents and inventions owned and/or controlled by Radio Corporation of America.

The Tower Cone



*A Remarkable Achievement
in Quality and Price!*

DUE to its original and exceptionally ingenious design, the Tower Cone is setting a new and better standard in radio reproduction—approximated only by the most expensive speakers. Its refreshing naturalness of tone, with greatly increased volume, creates an entirely new conception of the capabilities of ANY receiver.

*Ask Your Dealer to Show You the
exclusive Tower features.*

On Sale from Coast to Coast
TOWER MFG. CORP., BOSTON, MASS.

\$9.50

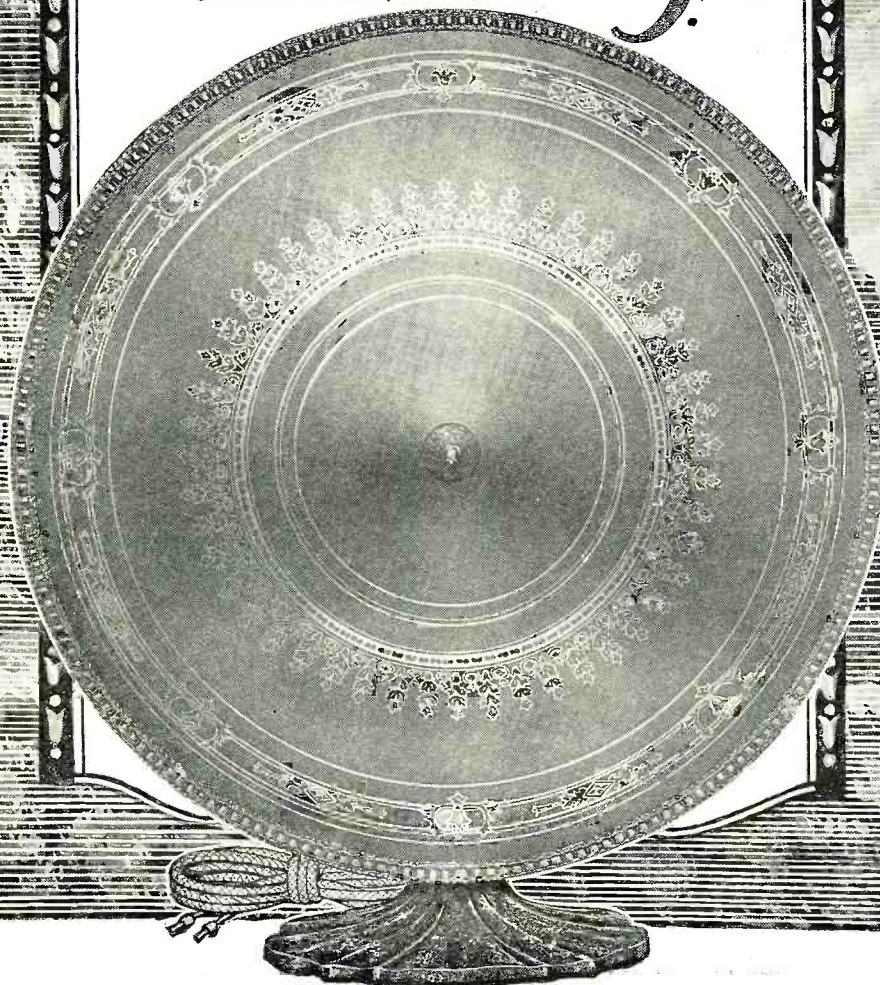

RADIO NEWS

Published by EXPERIMENTER PUBLISHING COMPANY, Inc., Publishers of "Radio News," "Science and Invention," "Radio Internacional," "Radio Review" and "Amazing Stories."
 Editorial and General Offices: 53 Park Pl., New York City
 H. GERNSBACK, President. S. GERNSBACK, Treasurer. R. W. DEMOTT, Secretary.
 Member: Audit Bureau of Circulations Radio Magazine Publishers Association

VOLUME 8

OCTOBER, 1926

NUMBER 4

Contents of This Issue:

The Broadcasting Situation, By Hugo Gernsback	323	Likes and Dislikes of the Radio Audience, By Charles D. Isaacson	350
"Wired Radio" and Its Applications, By M. L. Muhleman	324	Radio News of the Month Illustrated, By George Wall	351
A Symposium on the Present Broadcast Situation, By America's Radio Leaders	326	Radio Equipment for the Experts	352
"Ether Fleas," By Robert Hertzberg	327	An Autotransformer Receiver, By Theodore H. Nakken	353
The Radio Beginner—Assuring Safety in Radio Installation, By A. P. Peck	328	The Infradyne, By Herndon Green	356
Set Owners' Information	330	An Amplifier and "B" Supply Unit, By Arthur H. Lynch and R. R. Mayo	358
List of Broadcast Stations in the United States,	331	The "Excelsior" Receiver, By Sylvan Harris	360
"B" Battery Eliminators, By M. L. Muhleman	332	A "Five-in-Two" Receiver, By Clyde J. Fitch	362
A Perfect Static Shield, By Volney G. Mathison	336	Types of Audio Amplifiers, By Sylvan Harris	364
New Developments in Radio Apparatus, By G. C. B. Rowe	338	A Unique Nine-Tube Superheterodyne, By Mark Hinder	365
The Radio Burglar Alarm, The Manufacture of Variable High Re- sistances, By Joseph Riley	340	A Sub-Paneled Four-Tube Receiver, By Hy. Bayer	366
Radio-Frequency Amplification, By Edmund T. Flewelling	342	Methods of Oscillation Control in Sta- bilized Receivers, By Leon L. Adelman	367
A New Rectifier Tube for "A-B-C" Power Units,	343	Radiotics,	368
Permanent Radio Outlets, By J. K. McHenry	344	Standard Hook-Ups,	369
"Echoing Silence"—Part II, By George B. Ludlum	345	Radio Wrinkles,	371
Latest Products of Radio Ingenuity,	346	RADIO NEWS Laboratories	372
Radio Overseas,	347	With the Amateurs—The "Ham" Meets the "Egg," By "Bill" Schudt, Jr.	374
Radio in Transatlantic Flight, By Capt. Jack Irwin	348	I Want to Know, By Joseph Bernstey	375
		Calls Heard,	396
		Standard-Frequency Transmissions,	402
		Correspondence from Readers,	448
		Broadcasting in Australia, By Harold A. Reeve	451

In Forthcoming Issues:

**HOME-MADE COILS FOR THE BROWN-
ING-DRAKE AND SIMILAR CIRCUITS.**

By C. A. Oldroyd

A helpful article for the home constructor,
profusely illustrated.

A PORTABLE SUPERHETERODYNE.

By the Staff of Radio News Laboratories

Complete constructional data for a light-
weight, compact set of great power and sensi-
tivity.

**BATTERIES IN RADIO—THEIR TYPES
AND USES.**

By M. L. Muhleman

An article filled with useful information for
the set owner and data worthy of preservation.

RADIO NEWS is published on the 10th of each preceding month. There are 12 numbers per year. Subscription price is \$2.50 a year in U. S. and possessions. Canada and foreign countries, \$3.00 a year. U. S. Coin as well as U. S. Stamps accepted (no foreign coins or stamps). Single copies, 25 cents each. Checks and money orders should be drawn to order of EXPERIMENTER PUBLISHING CO., INC.

All communications and contributions to this journal should be addressed to Editor, RADIO NEWS, 53 Park Place, New York, N. Y. Unaccepted contributions cannot be returned unless full postage has been included. All accepted contributions are paid for on publication. A special rate is paid for novel experiments; good photographs accompanying them are highly desirable.

RADIO NEWS, Monthly. Entered as second class matter, July 12, 1924, at the Post Office at New York, N. Y., under the Act of March 3, 1879. Additional entry at Long Island City, N. Y., and San Francisco, Calif. Title registered U. S. Patent Office. Copyright, 1926, by The Experimenter Publishing Co., Inc., 53 Park Place, New York. The Contents of this magazine are copyrighted and must not be reproduced without giving full credit to the publication. Copyrighted in Germany. Reproduction of articles in Germany is reserved for Radio, Berlin 42.

RADIO NEWS is for sale at all newsstands in the United States and Canada,

and at Brentano's, Ave de L'Opera, Paris, France. European agents: S. J. Wise & Cie, 40 Place Verte, Antwerp, Belgium.

HOW TO SUBSCRIBE FOR RADIO NEWS. Send your name, address and remittance to Experimenter Publishing Co., 53 Park Place, New York. Mention the name of the magazine you are ordering. We also publish SCIENCE AND INVENTION, RADIO INTERNACIONAL, RADIO REVIEW and AMAZING STORIES. Write clearly.

RATES AND TERMS. The subscription rate for RADIO NEWS is \$2.50 per year. (12 numbers). When remitting do so by check, money order, or registered letter if cash is enclosed. Avoid sending cash through the mail if possible. Subscriptions for less than one year are not accepted. Subscription may be made in combination with SCIENCE & INVENTION, RADIO INTERNACIONAL, RADIO REVIEW and AMAZING STORIES.

POSTAGE. We prepay postage in all parts of the United States, Mexico and island possessions. For foreign or Canadian subscriptions we require 50 cents in addition to the subscription price for additional postage charges.

CHANGE OF ADDRESS. Notify us as far in advance as possible. It requires several weeks to make an address change on our records. Always write clearly. ON EXPIRATION of your subscription we enclose a renewal blank in our last number to you; we stop our delivery to you on expiration.

General Advertising Dept., 53 Park Place, New York City.

Western Advertising Representatives
Finnear & McClure
720 Cass St., Chicago, Ill.

Pacific Coast Advertising Representatives
A. J. Norris Hill Co.
5 Third St., San Francisco, Calif.
412 West 6th St., Los Angeles, Calif.

Kansas City Advertising Representatives
Davies and Dillon
15 W. Tenth St., Kansas City, Mo.

New England Advertising Representative
T. F. Magrane, Park Square Building, Boston, Mass.

Detroit Advertising Representative
Roy Buell, Donovan Bldg., Detroit, Mich.



□ The Crosley Musicone, announced little more than a year ago, introduced a revolutionary speaker principle and took the radio loud speaker market by storm.

Its overwhelming popularity, which has involved the replacement of hun-

dreds of thousands of old type loud speakers, establishes beyond challenge the Musicone's superiority.

And now Powel Crosley, Jr., announces... the Crosley Super Musicone!

This larger 16-inch cone utilizes the same Crosley patented actuating unit

as the smaller Musicone... and this, not the cone shape, is the secret of Musicone excellence.

It offers, by virtue of its larger proportions, still more superb volume. It produces, especially in the bass, still richer resonance!

The 12-inch Musicone has been reduced to \$12.50. Also at \$32 in the form of a beautiful Console, in which both receiver and batteries may be placed.

THE CROSLY RADIO CORPORATION, CINCINNATI, OHIO ... POWEL CROSLY, Jr., President.

CROSLY ^{Super} MUSICONE

BETTER • **\$14⁷⁵** COSTS LESS

Write Dept. 22 for illustrated booklet

All prices slightly higher West of the Rockies

INDEX TO ADVERTISERS

**INDEX
TO
ADVERTISERS**

A	D	J	R
Accessories Mfg. Co.369	Daven Radio Corp.447	J. M. P. Mfg. Co.384	Radex39
Acme Apparatus Co.320-321	Distantone Radios Inc.453	Jefferson Electric Mfg. Co.396	Radiall Co.4
Advance Electric Co.414	Dodge's Institute449	Jewell Electrical Instrument Co. 424	Radio Association of America ..43
Aero Products, Inc.388	Donle-Bristol Corp., Inc., The ..432		Radio Corp. of America, Back Cover
Aerovox Wireless Corp.420	Doolan Mfg. Corp., Jas. F.438		Radio Institute of America38
Alden Mfg. Co.407	Dubilier Condenser & Radio Corp.336	K	Radio Specialty Co.42
All Radio Co.382	Duke Radio Co.450	Karas Elec. Co.417	Randolph & Co.38
All-American Radio Corp.412	Duro Metal Products Co.444	Kelleradio, Inc.447	Randolph Radio Corp.41
Allen-Bradley Co. 402-410-429-440-455		Kellogg Switchboard & Supply Co.399	Raytheon Mfg. Co.39
Ambu Engineering Institute382	E	Klosner Radio Corp.438	Richter Bros.43
American Battery Co.444	Easton Coil Co.416	Kodel Radio Corp., The 439-441-443	S
American Bosch Magneto Corp. 395-408	Electrad, Inc.383	Kokomo Electric Co.410	Samson Elec. Co.40
American Electric Co.384	Electric Specialty Co.430		Scranton Glass Instrument Co., The45
American School Amplion Corp. of America, The388	Erie Fixture Supply Co.428	L	Service Battery Co.44
Amrad Corp., The438	Evans & Company, Victor J. ...390	Lacey & Lacey449	Shure Radio Co.41
Amsco Products, Inc.402		Lancaster & Allwine408	Silver-Marshall, Inc.38
Arrow Battery Co.450	F	Listen-In Co., The443	Smith, B. Hawley44
Autostrop Safety Razor Co. ...435	Fansteel Products Co.379	Lynch, Inc., Arthur H.387	Sonatron Tube Co.38
	Ferbend Electric Co.406		Southern Toy Co., Inc., The ...42
	Ferguson, Inc., J. B.420	M	Spartan Elec. Corp.43
B	Fishwick Radio Co.386	M. S. Syndicate448	Standard Radio Co.44
Bakelite Corp.438	Formica Insulation Co., The ..431	Magnavox Co., The385	Starrett Mfg. Co.42
Barawik Co. ...408-412-414-416-420- 422-428-436-438-444-447-450-455		Martin-Copeland Co.389	Sterling Mfg. Co., The44
Beiden Mfg. Co.427	G	Massachusetts Radio & Telegraph School408	Supertron Mfg. Co., Inc.44
Benjamin Electric Mfg. Co. ...433	Gearhart-Schlueter Radio Corp., 432	Metro Electric Co.377-448	
Birnbach Radio Co.442	Gem Tube Co.422	Midwest Radio Corp., Inside Back Cover	T
Bodine Electric Co.398	General Electric Co.451	Murray Distributor449	Tower Mfg. Corp.31
Bogue, B. N.442	General Instrument Corp.384	Muter Co., Leslie F.428	U
Boudette Mfg. Co.404	General Mfg. Co.447		U-Flex Mfg. Co.40
Bradley Institute443	Golden-Leutz, Inc.,449	N	Union Radio Corp.39
Brady, John B.396	Goodrich Rubber Co., The B. F. 438	National Carbon Co., Inc.381	
Bremer-Tully Mfg. Co.456	Gould Storage Battery Co., Inc., The412	National Company, Inc.418	V
	Gray & Danielson Mfg. Co.401	National Radio Institute319	Van Horne Co., The41
	Grigsby-Grunow-Hinds Co.414	New England Mills Co.450	
	Guaranty Radio Goods Co. ...419	Norden-Hauck, Inc.445	W
C	H		Walbert Mfg. Co.41
C. E. Mfg. Co.391	Hammarlund Mfg. Co.400	O	Wayne-Andrews Co., Inc., The, 42
Camfield Radio Mfg. Co.412	Hanscom Radio Devices398	Omnigraph Mfg. Co., The451	Western Radio Mfg. Co.40
Carborundum Co., The425	Harco Co., The449	Ozarka, Inc.322	Westinghouse Elec. & Mfg. Co., 40
Carter Radio Co.388	Hawkeye Radio Co.430		Willard Storage Battery Co. ...38
Central Radio Labs.383	Heins & Bolet448	P	Wirt Co.38
Chalfonte-Haddon Hall440	Heintz & Kohlmoos, Inc.443	Palmer & Palmer390	Wirthmore Co., The38
Chaslyn Co., The430	High Frequency Labs.382	Parker, C. L.436	World Battery Co.390-396-4
Chelsea Radio Co.416		Pfanstiehl Radio Co.317	
Chemical Institute of N. Y., Inc. 423	I	Pilot Elec. Mfg. Co.434	
Chicago Battery Works448	Illinois Stamping & Mfg. Co. ...390	Polymet Mfg. Corp.390	
Chicago Radio Apparatus384	Imperial Radio Corp.436	Ports Mfg. Co.447	
Chicago Salvage Stock Stores ..428	International Correspondence Schools448	Precision Electric Mfg. Corp. ...436	
Comrad Co., Inc., The .394-436-452	Ivorylite Radio Panel Co.443	Press Guild, The392	
Cooper Corp., The426		Prest-O-Lite Co., Inc., The403	
Cornish-Wire Co.442			XYZ
Ceyne Electrical School394			X-L Radio Labs.4
Crescent Radio Supply Co.436			Yaxley Mfg. Co.4
Crosley Radio Corp., The315			
Culver-Stearns Mfg. Co. ...430-440			
Cunningham, Inc., E. T., Inside Front Cover			

Pfanstiehl Gives Radio Users What They Want Most



The Wall Speaker

Designed for use on top of the console or to be hung on the wall. Looks like an old-fashioned wall clock, flanked by four graceful spindles and supported by a narrow shelf at the bottom. From the standpoint of acoustics there is a certain advantage in having the mouth of the speaker six or more feet from the floor. The tone vibrations are better distributed.

\$65



Model 202

Console "Single-tuned Six" with in-built speaker. Space for A & B batteries and charger or socket-power equipment.

\$210

An Exclusive Dealer Franchise

The Pfanstiehl line is sold through exclusive dealers who are thus protected against unfair competition and price cutting. Whatever good will the dealer builds up for Pfanstiehl is his own. He enjoys a liberal profit and is expected in return to push the line aggressively with the cooperation of the maker.

LIKE other mechanical and electrical discoveries, radio has had to go through a period of rapid change and experimentation. While radio engineers tried this and that, the public could not but be confused as to the substantial merits of various receivers.

From the first, Pfanstiehl avoided the complicated and devious circuits—and worked for efficient, simple control of the radio energy through the set. That is the source of dependable performance and tone quality. It is what the public always wanted.

Supreme Tone Quality with PRECISE Single Control

No set with complicated mechanism can be precisely single-tuned. There is too much unevenness in the radio stream. The circuits are unequal electrically. They might be tuned all at once, but not with precision.

With the Pfanstiehl precise single control, anyone can tune as accurately as an expert. There is no groping around adjusting dials. A single knob enables one to turn immediately to the wave length desired. The number registers in a small illuminated window.

The radio stream flows unhampered through the set and brings to the ear of listeners the full, true reproduction of overtones—which are the soul of music.

Something Really New in Cabinet Design

There is so little machinery in a Pfanstiehl, inside and out, that an extremely compact radio cabinet is possible. It is only twenty inches wide. The console model is even narrower and only forty-one inches high. And still it has room for every accessory needed to operate a radio: inbuilt speaker, A and B batteries and charger, or socket power-equipment. This makes a "petite" piece of furniture for the home; and it makes a nicely balanced and perfectly adjusted radio unit. The console is a space saver. It fits anywhere.

For further details, address
PFANSTIEHL RADIO COMPANY
 11 South La Salle Street, Chicago
 Prices West of the Rockies slightly higher

Pfanstiehl

Overtone Radio



The "Highboy"

A more elaborate console model, eighteen inches wide and seventy-four inches high. Speaker is contained in a tall, graceful superstructure extending six feet from the floor. There is nothing like it in a radio design. It is like a grandfather's clock or perhaps more nearly like a tall, slender cupboard of old English design.

\$235



Model 201

"Single-tuned Six" Console without speaker, but space for A & B batteries and charger or socket-power equipment. Six tubes.

\$170



Model 20

"Single-tuned Six" Table Set.
 \$125

RADIO NEWS READERS' BUREAU

Time and Postage Saver

IN every issue of RADIO NEWS you undoubtedly see numerous articles advertised about which you would like to have further information. To sit down and write an individual letter to each of these respective concerns, regarding the article on which you desire information, would be quite a task.

As a special service to our readers, we will write the letters for you, thus saving your time and money.

Just write the names of the products about which you want information, and to avoid error the addresses of the manufacturers, on the coupon below and mail it to us.

If the advertiser requires any money or stamps to be sent to pay the mailing charges on his catalogue or descriptive literature, please be sure to enclose the correct amount with the coupon.

We will transmit to the various advertisers your request for information on their products.

This service will appear regularly every month on this same page in RADIO NEWS.

If there is any Manufacturer not advertising in this month's issue of RADIO NEWS, from whom you would like to receive literature, write his name, address and the product in the special section of the coupon below.

TEAR ALONG THIS LINE

TO: READERS' SERVICE BUREAU,
Experimenter Publishing Co., Inc., 53 Park Place, New York, N. Y.

RN-10-'26

FROM WRITE YOUR NAME and ADDRESS HERE:
NAME
ADDRESS CITY, STATE.....

Gentlemen: Please advise the firms listed below that I would like to receive detailed information on their product as advertised in the.....issue of RADIO NEWS.

 DO NOT USE THIS COUPON FOR TECHNICAL QUESTIONS

NAME	ADDRESS (Street — City — State)	List here specific article on which you wish literature.	If Catalogue of complete line is wanted, check in this column
.....
.....
.....
.....
.....
.....
.....
.....
.....
.....

Check here if you are a dealer

Your Dealer's Name
Address

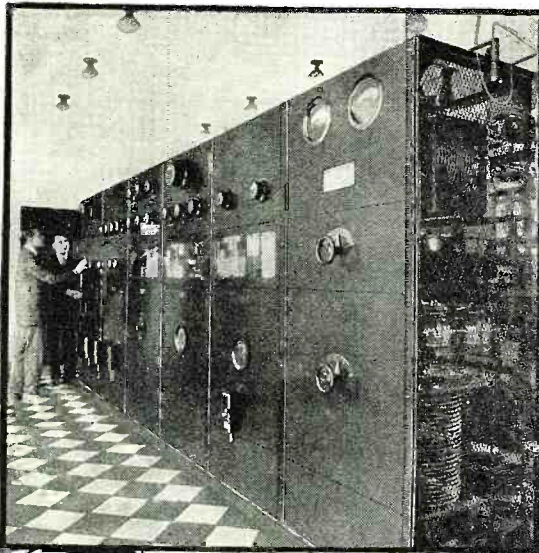

**\$50. to \$250 a week
IN WORK THAT IS
ALMOST ROMANCE**

Be a Radio Expert



Get into the great new Big-Pay Industry—Radio. If you're earning a penny less than \$50 a week, clip coupon now. Send for AMAZING FREE BOOK. Be a Radio Expert, and draw down big money for the easiest and most fascinating work in the world. Positions everywhere. Thoroughly-trained men are in big demand. Need for Radio Experts in every community. Short hours. BIG PAY. Free book gives all the facts. Astonishing opportunities—thousands of them! Every day N. R. I. trained men are taking good places in the Radio field. Free book tells all about their success. Send for it now!

**LEARN QUICKLY AND EASILY
AT HOME**

Master Radio Engineers will show you how to qualify quickly and easily at home, for Radio's fine jobs. We guarantee to train you successfully. Lack of experience no drawback—common schooling all you need. Our tested, clear methods make it easy for you. Send coupon now for free proof.

**Instruments Given
with Course**

All instruments shown here and many others given to students for practice work while learning. Receiving sets, from simplest kind to thousand mile receiver, an UNEQUALLED OFFER. Many other big features for limited time only.

**Famous Training That
"Pays for Itself"**

Spare time earnings are easy in Radio. Increase your income almost from the start through practical knowledge we give you. This is the famous practical training that pays its own way.



Operates WMAQ

"Accepted a position with Chicago Daily News—Station WMAQ. My income practically doubled, thanks to your fine course."
KEITH KIMBALL, Chicago.



Gets Big Job

"Just been made Sales Manager of this Radio concern—a big raise in pay. Regret I did not take course sooner."
R. E. JONES, Bay City.

**Get
this
Amazing
Book**

Most amazing book on Radio ever written—full, interesting facts about this great field and how we prepare you and help you start. You can do what others have done. GET THIS BOOK.

Send Coupon

Send coupon today for special limited offer, including all instruments—you'll get full particulars by return mail.

**National Radio
Institute**

Dept. MW1, Washington, D. C.

**You get
all of
these**

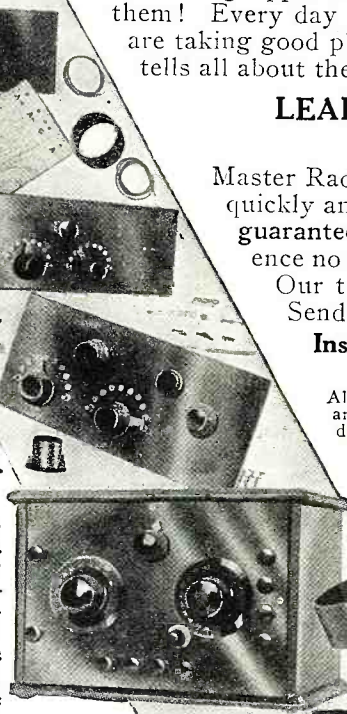

MAIL THIS NOW

NATIONAL RADIO INSTITUTE
Dept. MW1, Washington, D. C.
Washington, D. C.

Without obligating me in any way, send me your free book, "Rich Rewards in Radio," and all information about your practical, home-study Radio course.

Name Age.....

Address

Town..... State.....



LARGEST RADIO SCHOOL IN THE WORLD
ORIGINATORS OF RADIO HOME-STUDY TRAINING

QUALITY and are the twin keynotes

Acme announces new developments for better broadcast reception

BROADCASTING is better! Great artists and entertainers are on the air. Quality in programs has come to stay.

Now you want better reception. You want each note of the singer, the orchestra, the entertainer clear, true to life. High notes, low notes, the volume from the orchestra, the whisper from the actor must all come in equally truthfully.

In other words, the amplifier of your radio set must be quality, too; the loud speaker must be a faithful musical instrument.

Now you don't want the worry of batteries that may give out when you are in the middle of your favorite selections; that take away your fun as they weaken.

This year, Acme gives you new ways to make your radio set worth twice as much to you in fun. For, while others have been chasing distance, Acme has caught quality. Both quality and elimination depend on transformers and choke coils, in which Acme has specialized since 1921. Now new devices from our experimental laboratories based on the single thing in which Acme are specialists, will show you that reception is better, too.



Showing the Acme K-1 "double free edge cone" loud speaker, round model, 14" cone diameter, handsome tan casing, \$25



Showing the Acme K-3 "single free edge cone" loud speaker, 11" cone diameter. Finished in handsome green bronze. \$18.50

Living Voices from Acme Speaker

PROBABLY you know that the greatest development in speakers is the "free edge cone." It gives you living, thrilling, human voices. It helps you to know who's good and who's not so good on the program. It gives you the ability to discriminate. It helps you to recognize a good performer. It widens your list of radio favorites, adds the touch of personality to an otherwise flat selection.

Acme offers two new speakers of the "free edge cone" type. Ask any high class radio dealer to let you hear the new Acme speaker in competition with any other speaker he has in stock. You be the judge of the quality. The smart, beautiful new designs of Acme speakers this year will please you.

New Audio Amplifier

No matter what speaker you have, the audio amplifier must be right for best results. Acme's research in amplification has resulted in an audio amplifier which combines all the good qualities of resistance, transformer, and impedance coupling, really a combination of these three forms. See booklet for diagrams and how to make it.

Send for the 13th Edition of this Famous Acme Book

12 EDITIONS, 500,000 copies of the famous Acme book, "Amplification without Distortion" have been sent to Acme friends. Now the 13th and greatest edition is ready. It is written by a prominent radio engineer in a non-technical and interesting manner. It gives you a clear picture of radio reception, and shows exactly how you can eliminate distortion and improve the operation of your set. It also describes fully these wonderful new Acme loud speakers—and includes details of the complete Acme line of transformers, impedances, condensers, pot-rehos, choke coils, etc. Use the coupon at the left for convenience.

ACME APPARATUS CO., Dept. K-18, Cambridge, Mass.

Enclosed find 10c (stamps or coin) to cover costs of sending me one copy of "Amplification without Distortion," 13th edition.

Name

Street

City State

ACME ~for amplification

ELIMINATION

of radio now

No more batteries



Showing Acme E-3 Power Supply Unit ("B"-eliminator) with non-filament tube for one to six tube sets, 110 volts, 60 cycles. \$39.50

YOU have always wanted lamp socket operation. Acme were pioneers in the development of non-filament tube B Eliminators.

This year you can turn your set into a complete light socket receiver—overnight. Acme can supply you with the highest development of B Power Supply, and (new this year) A-supply and C-supply units.

If you want to eliminate forever the nuisance of batteries, the expense, the time, and most important of all, those famous "fading" concerts (the kind that die a slow, painful death due to aged, starved, or emaciated batteries), put your set on a lamp socket operation basis, and be up-to-date in radio.

Send for New Acme Booklet

ACME has a new booklet on lamp socket operation, "Power Supply for Radio Sets." Send 10 cents to Acme Apparatus Company, Cambridge, Mass., and learn how you can have what you have always wanted, dependable and practical lamp socket operation for your own radio set. Use the coupon below.

ACME APPARATUS COMPANY,
pioneer radio and transformer engineers and manufacturers
CAMBRIDGE, MASS.

ACME APPARATUS CO. Dept. K-181, Cambridge, Mass.

Enclosed find 10c (stamps or coin) to cover costs of sending me one copy of your new booklet, "Power Supply for Radio Sets," which I understand gives full details of lamp socket operation for my radio set.

Name

Street

City State

Here is a catalogue of what Acme offers for Quality and Elimination

Double free edge cone loudspeaker, round	\$25.00	EK-3 B Eliminator Kit with Tube 1-6 tube sets	
Double free edge cone loudspeaker, cabinet	38.00	110 volt 60 cycle	32.50
Single free edge cone loudspeaker	18.50	B-2 Single Choke Coil 50 m.a.	5.00
E-1 B Power Supply with Tube 1-12 tube sets		B-5 Double Choke Coil 50 m.a.	9.00
110 volts 60 cycles	50.00	B-4 Trans. for Tube 110 volts 60 cycles 60 m.a. ..	7.00
E-3 B Power Supply with Tube 1-6 tube sets		A-4 Trans. for A Supply Unit 110 volts 60 cycles	16.00
110 volt 60 cycles	39.50	MA-2 A. F. Trans. 5-1 ratio	6.00
E-2 B Power Supply 1-12 tube sets 110-220 volt		A-2 A. F. Trans.	3.00
D. C.	25.00	B-6 Trans. for Tube 110 volt 60 cycle 30 m.a.	6.00
A-1 A Power Supply without Tubes 2.25 amperes		F-1 Filter Unit 1-12 Tube Sets	20.00
110 volts 60 cycles	42.00	F-3 Filter Unit 1-6 Tube Sets	16.00
C-1 C Power Supply without Tube two voltages		A-5 Choke Coil for A Supply Unit	16.00
up to 50 volts 60 cycles	16.00	Z-2 A. F. Impedance 200 henries	4.50
EK-1 B Eliminator Kit with Tube 1-12 tube sets		Z-3 A. F. Resis-Impedance Stage	5.00
110 volt 60 cycle	39.50		

ACME ~for amplification

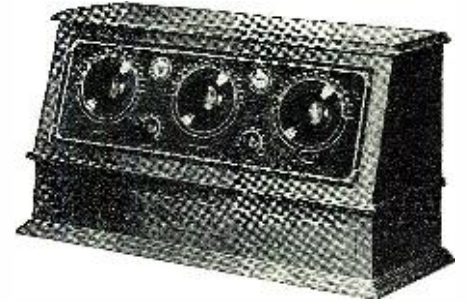
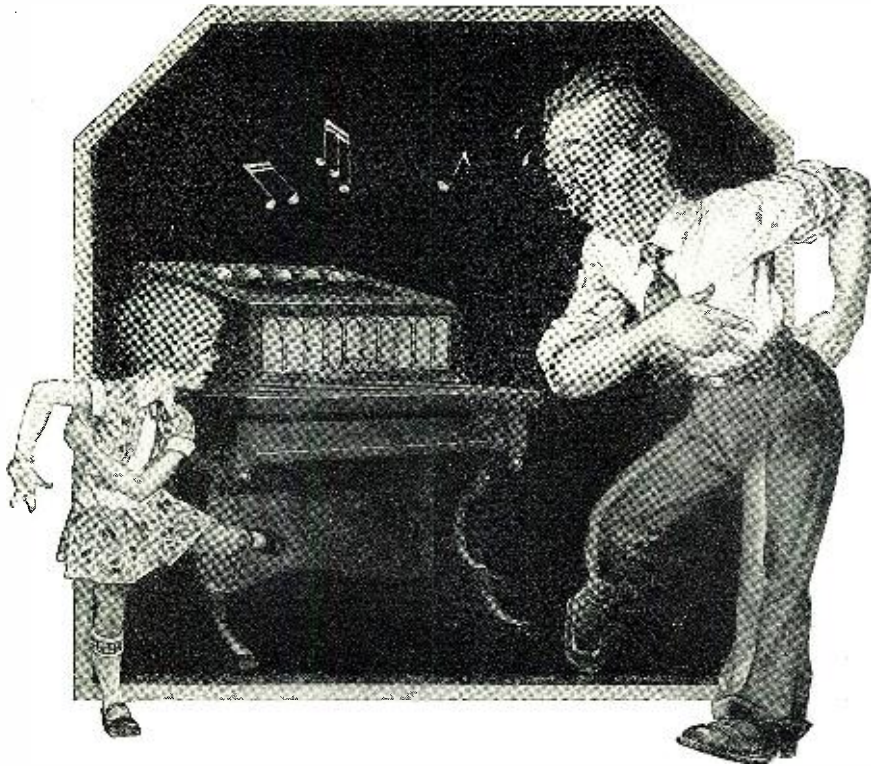

\$125 Plus installation and transportation
Ozarka Senior 5 Tube Model
complete with Loud Speaker and all accessories.

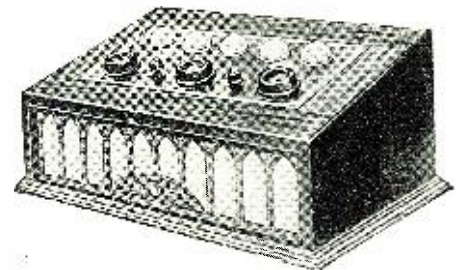

\$100 Plus installation and transportation
Ozarka Junior 5 Tube Model
complete with built-in speaker and all accessories.

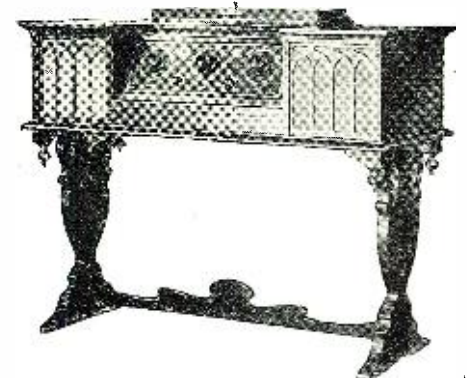

\$210 Plus installation and transportation
Ozarka Console 5 Tube Model, solid
walnut cabinet, complete with all accessories.

Some People Will never Learn — The Truth About Radio

MANY a new radio will perform perfectly. Whether it continues to do so or not will depend entirely on one thing—the very truth that is seldom discussed.

Do you drive a car?

Don't little troubles happen occasionally?

Do you depend on a handy man for service or do you prefer a mechanic who has been factory trained on *your* make of car?

Experience has, no doubt, proven to you that men who know *all* about *all* makes of cars generally don't make the best mechanics to work on *your* car.

You wouldn't think of buying any car, no matter how low its price, unless you knew you could receive service by men who know how.

Treat the purchase of a radio instrument in exactly the same manner if you wish lasting satisfaction.

Service is just as necessary, just as important on a radio instrument as it is on an automobile.

Occasionally little things will go

wrong. They will be serious to you and almost as serious to the handy man who can fix all radios but—

Such troubles will mean just a few seconds' time to a factory trained service man who knows that make of radio as he should.

While radio is rather a new industry, even now there are 4364 factory trained Ozarka service men—let us give you the name and address of the one nearest you.

Allow him to set up an Ozarka in your home.

He will let you do all the tuning so that you can satisfy yourself as to exactly what it will do for distance, volume, tone and ease of tuning.

His factory training enables him to keep every Ozarka which he sells, working just as it did when new.

Any radio, no matter what its price may be, will only be as satisfactory as the trained service behind it.

We have a few Openings for the Right Men

WHILE there are today 4364 Ozarka representatives, some territory is still open. We want men who believe in the future of radio—men who are tired of working for some one else—men who would like to add to their present income by devoting their evenings to Ozarka.

At the start you can keep your present position. Later on, after you have proven what you can do, then you will give us all your time because it will pay far more than your present position.

The man we want may not have much money but he is not broke. He has lived in his community for some time—he has a reputation that his word is good. He may not have made any startling success but he has never "put over something" just to make money. He may know nothing about radio or salesmanship but he will be successful if he is willing to study what we are willing to teach him, without cost.

The field in radio is wide open for the trained man. The success of the 4364 Ozarka representatives proves what men can do. If you are interested, ask for a copy of the Ozarka Plan, a 108 page book which tells a true story of how big money and a permanent business can be built in radio. It is a story of life; of why some men fail while others succeed. This book has shown many men how to start making extra money immediately and within a very short time establish a business of their own.

OZARKA

INCORPORATED

120 W. Austin Avenue A

CHICAGO, ILL.



RADIO NEWS

HUGO GERNSBACK.
Editor and Publisher

EDITORIAL AND GENERAL OFFICES, 53 PARK PLACE, NEW YORK

Vol. 8

OCTOBER, 1926

No. 4

THE BROADCASTING SITUATION

By HUGO GERNSBACK

EARLY in July the Department of Commerce announced, in accordance with the opinion of the Attorney General, that Mr. Hoover no longer could exercise authority over radio broadcast stations. It was held that the Act of August 13, 1912, made no provision for the Department of Commerce to arbitrarily select wavelengths for applicants, or to prescribe the power with which the broadcasters were to operate. According to this decision, under the law, any one desiring to go on the air has a legal right to do so, and the Department of Commerce has been instructed to issue a license to all that so applied.

This is the situation as it prevails today, and will prevail until Congress passes laws, to empower either the Department of Commerce, or a separate commission, to regulate radio broadcasting.

When the announcement was first made, two months ago, that radio broadcasting no longer was operating under any authority, it was freely predicted that immediate chaos would result, and that every station would either change its wavelength or operate under increased power.

While it is true that, up to this writing, a small number of stations have changed their wavelengths, no such thing as chaos, nor anything resembling it, has resulted, for very simple and fundamental reasons. The few stations which did actually change their wavelengths, did so probably because they had a grievance. In practically every instance they were stations which had been assigned crowded low wavelengths.

While it is a well-known fact that the low wave stations seem to be able to get out better than the higher wave stations, this advantage had been nullified by the fact that the Department of Commerce assigned the same wavelength to a number of stations to operate on, which made it practically impossible for such stations to be heard; and consequently their programs were nearly always ruined. Thus, for instance, among the lower-wave stations we find the following interesting condition, prior to the decision cited.

On 278 Meters there were operating 15 stations. On 275 Meters there were 24 stations. On 273 Meters there were 17. On 270 Meters there were 12. On 268 Meters, 14. On 263 Meters, 16. On 261 Meters, 15. On 258 Meters, 11. On 256 Meters, 14, etc., etc.

It follows that most of these stations, unless favorably situated and isolated geographically, usually had their programs ruined. The condition on the higher wavelengths was not so bad, for here the stations were not so crowded; and for that reason a number of broadcasters took to the higher wavelengths, wherever there was found to be a suitable opening in their various districts, and where the least interference was produced.

In fairness to these broadcast stations it may be said that they did not willfully appropriate their new waves, but duly applied to the officials of the Department of Commerce, and had their new waves officially assigned to them through the Radio Supervisors, this being the only authority that could grant them.

There is, however, another far more important and fundamental reason why there is no likelihood of any chaos, though it had been also freely predicted that, inasmuch as there were 600 applications from new broadcasters, all of these coming on at once would ruin reception of every other station. This has its humorous angle, because at this time of writing, less than half a dozen new stations have come on, and there is little likelihood that, even by January 1, next, there will be as many as thirty new ones—and the reason is very simple.

It costs anywhere from \$75,000 upwards to \$1,000,000 a year to operate a first-class station efficiently. No one is going to risk this much capital unless he has a pretty clear idea of what can be done; and whether there is a law passed or not will make little difference. Even without any law it is practically impossible to put on a new station at the present time without that station interfering with another. And here the Act of August 13, 1912 still holds good, because under Section 5 it is stated:

"That every license . . . shall prescribe that the operator thereof shall not wilfully or maliciously interfere with any radio communication. Such interference shall be deemed a misdemeanor; and upon conviction thereof the owner or operator, or both, shall be punishable by a fine of not to exceed \$500, or imprisonment for one year or both."

From this it will be seen that if any new station causes interference, the owner of such a station may become liable for damages, and he will, therefore, not be likely to trespass. Therefore, from a legal standpoint, it is impossible to operate a new station if it creates interference; and, secondly, no broadcast station owner in his right senses would wish to broadcast on some one's else wave,—unless sufficiently separated geographically—because he knows that he would not only ruin some other station's program, but his own as well.

There are some exceptions to this, because locations can still be found, in the United States, where one can operate a broadcast station of medium power—say 500 watts or less—on the wavelength of some other station without any interference, because of the geographical separation of such stations.

For instance, there is room, as yet, in the State of Nevada for broadcast stations (as well as in Alaska) and perhaps in several other states, where it would seem that little interference would be caused by new stations. But

the point is that most broadcasters find it necessary to conglomerate in the more thickly populated sections of the country, and it may be said that here it is almost impossible to set up a new station today without trespassing on some other stations' rights.

But as in all cases of this kind, there is usually cause for reassurance; because the tougher the radio problem becomes in America, the more quickly it is usually solved.

A European set could not perform in the United States at all because it would, very likely, not tune sharply enough. And the sets which we are building now far out-distance the sets which we had in 1922. We may be certain that the condition brought about will make for more sensitive and sharper sets as time goes on. So far, no radio problem has come up, with, perhaps, the exception of static, that has not been ultimately solved, to the benefit of the art.

When telephony was young, exactly the same thing that now confronts us existed in the telephone art, when it was almost impossible to pick up a telephone receiver without hearing continuous cross-talk, which spoiled all reception. But the art of telephony needed no laws, other than the common law, to rectify the situation. Ultimately the engineers solved the problem; and such will be exactly the case with radio broadcasting.

In the meanwhile radio broadcasting has not been ruined. Far from it. Radio has always been able to take care of itself, and will continue to do so in the future. To be sure, we all want a radio law to straighten out some of our present tangles, but in the end radio engineering will make the best law obsolete.

... in which the Editor reviews the present broadcast situation—in which he advances the reason why a number of broadcasters changed their wavelengths—why it will not be very simple to operate a new station at the present time, except in certain areas in the United States—why the much-heralded radio chaos has not materialized—and why Radio will probably work out its own salvation in the end . . .

Mr. Hugo Gernsback speaks every Monday night at 9 P. M. from Station WRNY on various radio and scientific subjects.

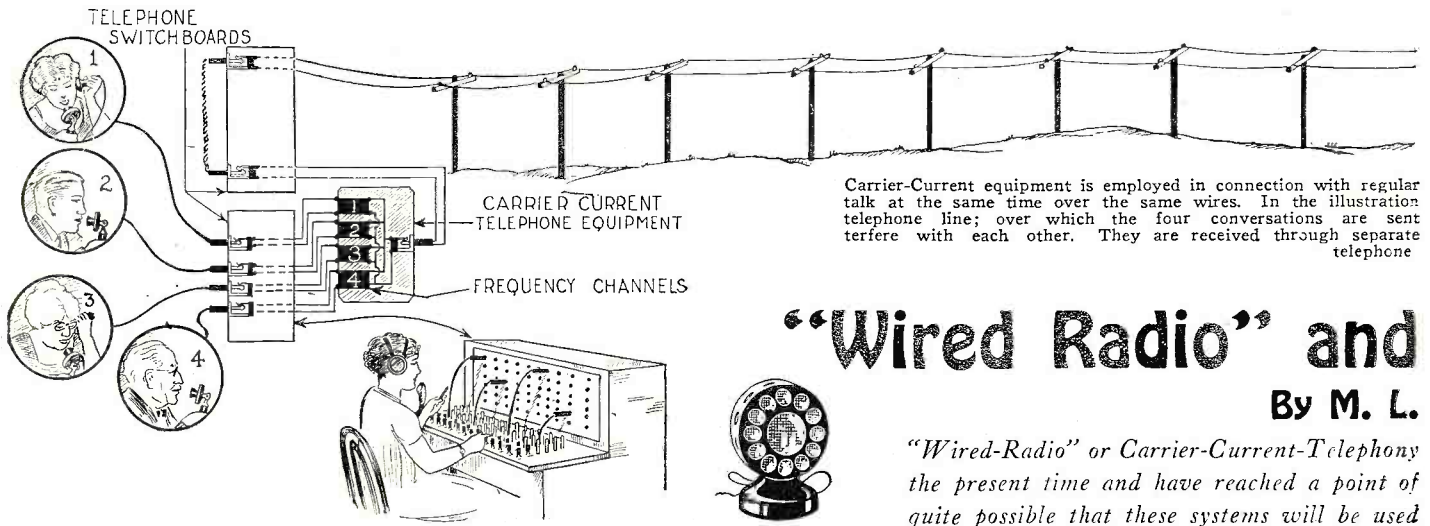

DURING the last few years communication engineers have made considerable headway in the development of “carrier-current telephony systems,” better known under the more popular name of “wired radio.” Very little information relative to these systems has been published in radio and electrical periodicals catered to by the radio fan; probably for the reason that no great interest has been shown. Evidently the whole matter sounds too commonplace to the average person and offers no more novelty than the house telephone.

Had the first strains of music been broadcast to the general public over electric-light wires, instead of “through the air,” the reaction might not have been great enough to put in motion a wave of popularity such as “space radio” has been favored with.

Homo sapiens invariably finds romance in mystery; it is one of those psychological manifestations which has remained within us from the time in the not-so-remote past when little was known of natural effects.

And what smacks more of the unknown than radio? Music and voices speeding through space at an unbelievable rate, to be caught by wire nets on house-tops and released again through a horn. Yes; it appeals very much to one’s imagination. But “wired radio” does not seem at all unusual. We are so used to things operated by electricity, fed to them by wires, that “wired radio” appears too much like the matter-of-fact manner in which water is piped to a house.

Yet, have you known that something quite marvelous takes place in wired radio systems, something far more interesting and unusual than the mere flow of water through a pipe or electric light current through wires? Imagine, if you can, two wires supplying electric light current to your house and at the same time carrying three different musical programs without the slightest mixing or interference of the four currents. Yet all four travel in the same two wires. Let us see just how this is accomplished.

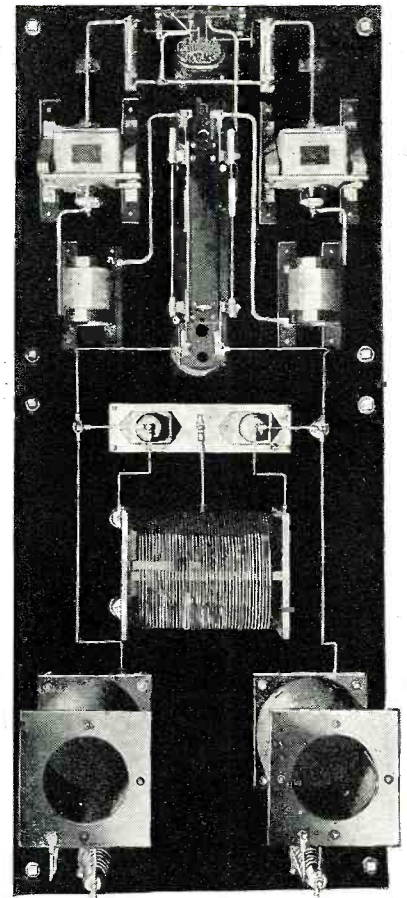

Fig. 3. A coupling and protection panel, which connects the carrier equipment with the power transmission lines.

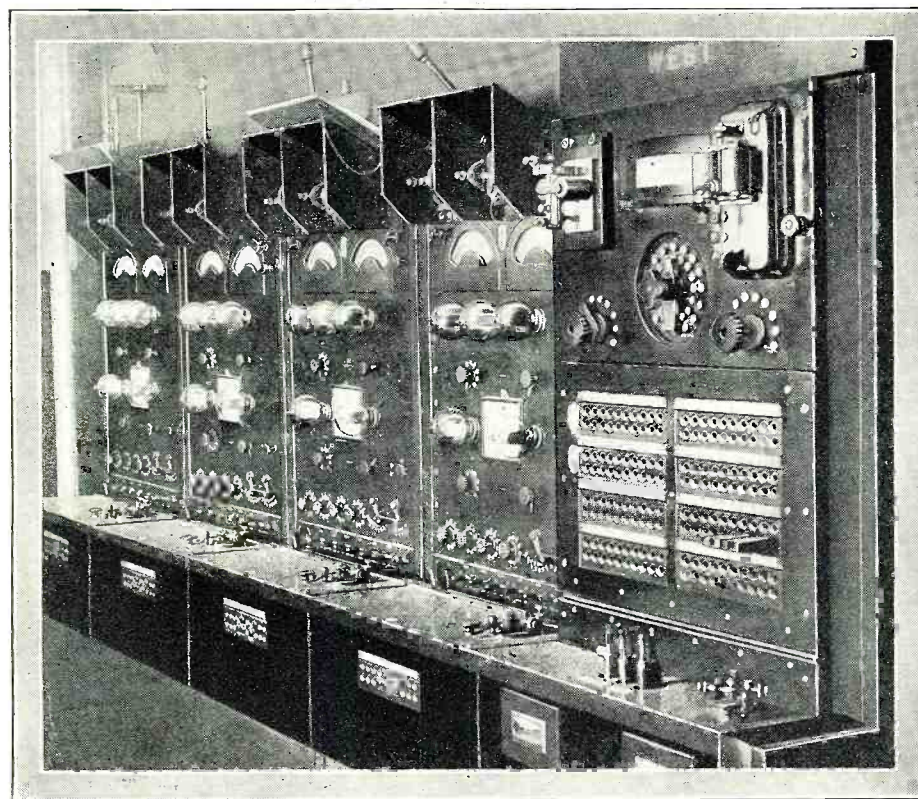
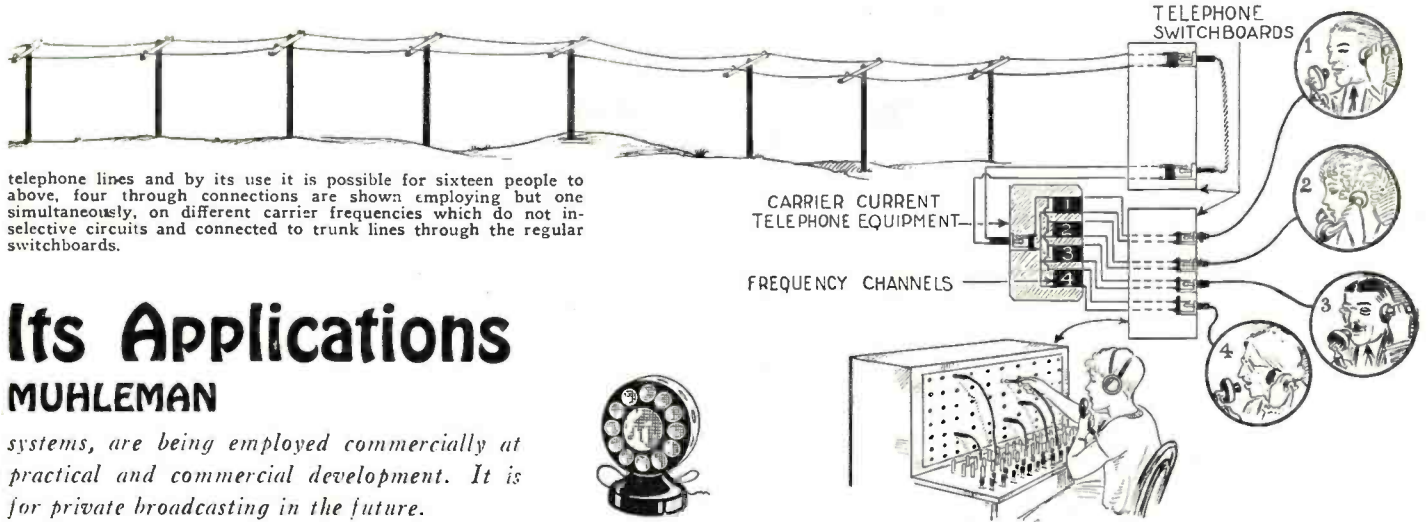

Fig. 5. A Carrier-Current Telegraph installation, including a test panel, and four panels for both sending and receiving.

(Photos courtesy of Western Electric Company)

WHAT WIRED RADIO IS

“Wired radio” refers to the use of radio-frequency currents, just the same as employed in radio broadcasting, in telegraph, telephone, electric light or power lines. The workability of the system depends on the fact that electric currents having dissimilar periods of vibration or frequency do not intermingle or interfere with each other. Consequently it is possible to superimpose a great number of currents of differing frequency on the same set of wires, without the possibility of any difficulties arising from “mixing.” This being the line of practicability, we can go a step further and superimpose music or voice vibrations on (“modulate”) each distinct radio-frequency current, and let them all go their way along the electric light, telegraph or telephone wires without any cause for worry. It is just as if we



telephone lines and by its use it is possible for sixteen people to above, four through connections are shown employing but one simultaneously, on different carrier frequencies which do not in-selective circuits and connected to trunk lines through the regular switchboards.

Its Applications

MUHLEMAN

systems, are being employed commercially at practical and commercial development. It is for private broadcasting in the future.



Fig. 4. A Carrier-Current Telephone panel for use in connection with high-voltage power-transmission lines.

collected the transmissions from say three broadcast stations operating on different wavelengths and bid them go by way of wire instead of spreading out in space.

WIRED RADIO BROADCASTING

Though the use of carrier-current telephony for long-distance communication over light power lines and telephone wires dates back many years, the use of the system for broadcasting entertainment was instituted for the first time but four years ago in and about Washington, D. C., and Cleveland, Ohio. In the early part of 1923 experimental operations were transferred to Staten Island, New York, where it was possible to serve some 25,000 people through the feeder lines of a single central power station. Though this unique service was discontinued a short time thereafter, it was reported that the public's reaction to the service was con-

sidered favorable. The idea, as instituted, called for the rental of special receiving sets which could be plugged directly into any electric light socket. The power company's customers were to be charged from two to four dollars a month and, in turn, they were to be provided with the best of programs from the studios located at the central power station.

Though there has been a great deal of skepticism aired whenever one has been so rash as to suggest that some day wired radio would supplant space radio, the question remains speculative. However, carrier-current telephony and telegraphy is being employed at the present time, on a commercial basis, and has met with complete success. It is through this commercial application that the system may, in the future be employed with equal success from all standpoints, to furnish entertainment to the public. When one considers the fact that the nature of carrier-current telephony systems is such that they are no more susceptible to interference and

distortion than are space radio systems, it can be assumed that it may be favored by the public in the future when the time is more ripe for its introduction.

THE "WIRED RADIO" RECEIVER

The developed system heretofore mentioned, which was put into operation on Staten Island, allowed for the simultaneous transmission of three programs over the electric light wires; although only two programs were transmitted when the station was first opened. The receiver provided the subscribers allowed them to select either program at will. It essentially consisted of a cord and plug to attach it to the 110-volt light socket, coupling coils similar in design to present-day tuned-radio-frequency transformers, a variable condenser for selecting the desired program, a crystal detector for rectifying the modulated radio-frequency currents, and a two-stage vacuum-tube audio-frequency-amplifier to provide sufficient

(Continued on page 404)

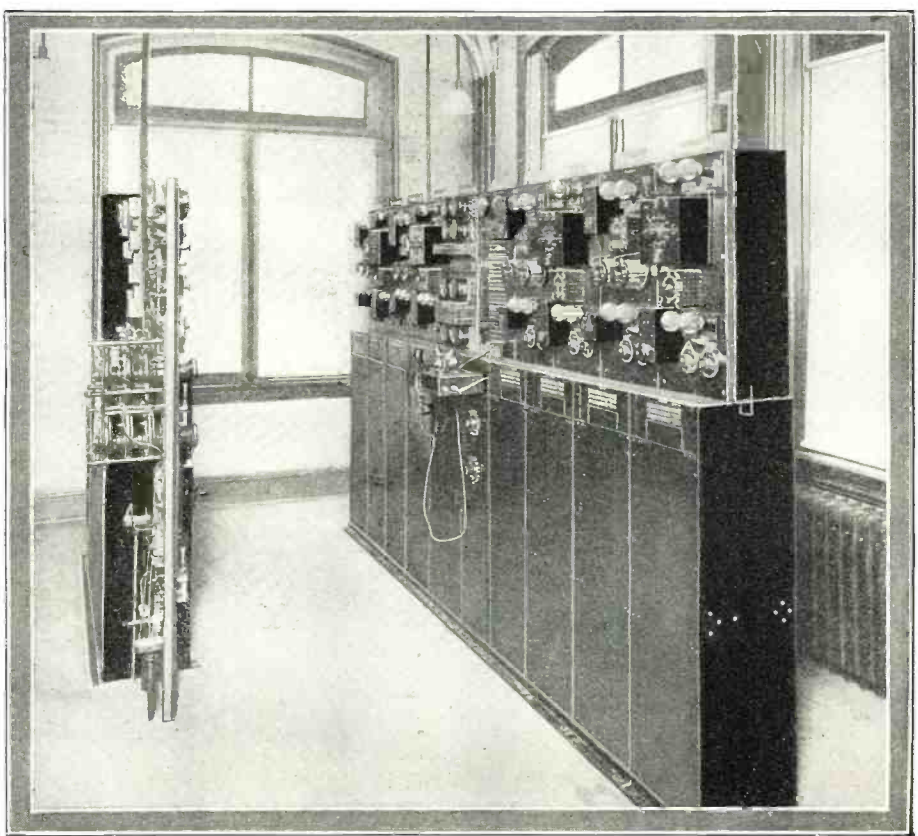

Fig. 6. A Carrier-Current Telephone installation with four sending and four receiving panels, one testing panel, and a voice-frequency panel.

A Symposium on the Broadcast Situation

By AMERICA'S RADIO LEADERS

RADIO NEWS has asked the foremost leaders of radio in the United States to comment on the present broadcast situation. As is well known, in the early part of July, the Department of Commerce let it be known that it no longer had any authority on the wavelengths or the power used by broadcast stations, due to a decision handed down by the Attorney General.

It was freely predicted that chaos would reign and that the

radio industry would be upset entirely. The leaders of radio in America, however, apparently do not see such a chaos at the present time. They also seem to be unanimous in declaring that a law should be passed to clear the present situation.

As a whole, the industry seems to be hopeful that no great damage has been done and probably will not be done. As it seems now, the industry is well able to govern itself until new laws have been passed.



DR. E. F. W. ALEXANDERSON
Inventor of High-Frequency Alternator

"If the majority of the stations observe the wavelength schedule laid out by the Department of Commerce, I do not think that we need fear any chaos."

—E. F. W. Alexanderson.



DR. LEE DE FOREST
Inventor of Audion Tube and Phonofilm

"I have been unable to observe any great amount of chaos in the radio broadcast situation since federal authority has been revoked. A few broadcast stations have certainly not benefited their position by grabbing off new wavelengths, squeezing into a jam between much more powerful stations; but I think such situations will usually correct themselves. I am, however, strongly in favor of intelligent and liberal governmental regulation, which unquestionably will be enacted into legislation next session."

—Lee de Forest.

EDMUND T. FLEWELLING
Inventor of Flewelling Circuit

"Broadcasters who are dependent upon the good will of the public will jealously guard their present favorable position. The broadcasters and the public would make the position of

pirates untenable. Hoover should be chosen temporary czar, backed by the radio industry and the public, until they can force proper legislation. I see no indications of chaos. This



is the United States of America."

—E. T. Flewelling.

GEN. J. G. HARBORD
President of Radio Corporation of America

"I am sure that responsible broadcasting interests will not depart from the accepted and efficient arrangements agreed upon between the Department of Commerce and the broadcasters themselves. The Radio Corporation of America will steadfastly maintain its policy of strictly observing the present wavelength assignments made by the Department of Commerce; and it seems reasonable to expect that all broadcasters



who are interested primarily in furthering the radio art and industry, and in furnishing the radio public with a satisfactory service, will do the same."

—J. G. Harbord.

A. T. HAUGH
President of Radio Manufacturers' Association

"Chaos and anarchy in air' have no foundation of fact. Quality of program, ease of reception and listeners' enjoyment have not been interfered with.

I regard the satisfactory operation of radio broadcasting since Secretary Hoover relinquished control as an important indication that the industry can govern itself. I recommend therefore cooperation on the part of broadcasters, manufacturers, technical and amateur societies to police the radio industry by the formation of an independent commission consisting of the heads of the Radio Manufacturers Association, the Association of Manufacturers of Electrical Supplies, National Radio Relay League and National Publishers' Association, in cooperation with and under temporary guidance of the Department of Commerce. I believe the radio industry is just as cap-



able of governing itself as the electrical industry and public utilities, such as the telephone and telegraph, light and power transmission. This procedure is in line with the Department of Commerce's attitude toward governmental non-interference in business."

—A. T. Haugh.



C. FRANCIS JENKINS
Inventor of Television

"There will be no chaos, although radio needs and must ultimately have a controlling hand. There is, however, little likelihood of serious interim disturbance, for radio can't afford to run wild."

—C. Francis Jenkins.

PAUL B. KLUGH
Executive Chairman of National Association of Broadcasters

"So fine has been the immediate response to the call of the National Association of Broadcasters for stations throughout the country to remain on their assigned wavelengths and hours of operation and stand by the rules and regulations prescribed by the De-



partment of Commerce prior to the Attorney-General's opinion, that we feel assured that no one needs to fear any kind of chaos due to the operations of those now in the field. With 536 stations now operating on 89 available wavelengths, simple arithmetic reveals the necessary division of time to avoid interference, and shows the impossibility of putting six hundred more stations on the air and still being able to justify an investment of from \$50,000 to \$250,000 necessary to build, equip and place in operation a new station. Few if any people will take this speculation, so there is little to be feared from outside sources."

—Paul B. Klugh.

DR. GREENLEAF W. PICKARD
Inventor of the Crystal Detector

"It is, I believe, good law



that they who slumber on their rights forfeit them. If the pub-

(Continued on page 453)

"Ether Fleas"

By ROBERT HERTZBERG

In this article Mr. Hertzberg pleads with the radio announcers to be a bit more considerate of their music loving audience. Do you agree with him?

RADIO announcers have been made the objects of so much scorn, ridicule and downright abuse for variegated, pernicious microphone habits, that many of them have mended their ways, applied icebags to their egos, and become highly popular gentlemen. However, even some of those who have self-sacrificingly yanked the word "I" out of their vocabularies still display a lack of sense in one small, but aggravating particular that may lose them their open entrance to the best family circles. It is their inane practice of leaping to the microphone almost before a performer has finished his recital, their insistence on keeping the mike in a constant state of agitation, whether the occasion demands it or not, that may bring upon their pomaded heads another round of tirades from the jaded critics.

So far as a listener can judge, some of these overlords of the microphone possess an abnormal sense of loyalty to the station employing them, and consider the performing artists as mere intruders who rob them of the time they would ordinarily spend in proclaiming the identity of the station to the wide world. They seem to disregard entirely the nature of the performance itself; and thereby too often completely destroy the effect of the music by driving it out of the listener's head too quickly.

FORTISSIMO AND PIANISSIMO

When you listen to a dance or concert orchestra, or to any massed group of players producing a comparatively great volume of sound, you need not concentrate very deeply, because the music is loud and constantly stimulates your sense of hearing. It leaves your mind wide awake, and you are not particularly jarred by a quickly following announcement. However, when you listen to a good instrumentalist or vocalist, producing

soft, soothing tones, you unconsciously fall into a slight reverie, with only your ears alive and with the rest of your body inactive. You are just a little affected by the suggestiveness of the music, and the end of the piece probably finds you completely relaxed and at peace with the world. You will then want a second or two to revive your resting muscles, to rouse yourself from your musing, before you are ready for anything that may follow. If you are not allowed these few precious moments of silence to readjust yourself, and instead have the quiet broken almost immediately by the glib voice of the announcer, you find the illusion of restfulness totally shattered, with an attendant reaction of disgust and anger setting in instead.

THE DISTRACTING INTERRUPTER

Imagine yourself an auditor at a concert. With a few hundred other people you are being lulled into abstract meditation by the sweet playing of a violinist on the stage. Your eyes are half closed, blurring out the image of the player himself, and as the last few notes drift across the aisles you feel a tingling, pleasant sensation traveling down the back of your spine. You remain immovable for several seconds before you realize that the selection is completed; and then you rouse yourself with a start to voice your approbation of the soloist's efforts with a spontaneous round of applause.

Now suppose that, at the very instant the violinist had raised his bow from the strings, a sleek-looking individual had sprung out of the footlights and announced in a gay and joyful voice: "Ladies and gentlemen, you have just listened to a violin solo by Ignatz Ignatius. The next number will be the Floor Scraping Scene from 'Backstage,' rendered by Ike and Mike, our piano shifters." Do you think you and the rest of the

audience could have restrained yourselves from seizing the man, impaling him on the proscenium arch, and then setting fire to the curtain?

Yet every day during the week some announcers insist on jumping upon the stage in your own home in this very manner, often spoiling the programs they are hired merely to enumerate for you. You can't murder the miscreants on the spot, because they are safe behind double doors in comfortable broadcast studios; though sometimes you feel the impulse to inflict some such violent punishment for their lack of discernment. As for them, they seem impervious to good music, possibly because they hear so much music, both good and not so good, during their working hours; but they should at least be taught to count five, or do a handstand, or something of the sort, before they step before the microphone to deliver their description of a previously-completed classical selection.

SAY IT WITH BRICKBATS

I do not intend to imply that all announcers deserve rebuke. Far from it. The majority of them are pleasant-voiced and unobtrusive enough, and fulfill their functions without exciting particular comment. We accept their good performances as a matter of course, as we are prone to accept all satisfactory service; and we become indignant and vehement only when we are aroused by the annoying tactics of their less discriminating brothers.

Why tolerate them, anyway, when it is so easy to prick their bubbles of conceit? The cure is simple; merely send them a few pertinent-ly-worded notes about their unpopular proclivities. A handful of such pointed missives will tend to overbalance the hundreds of mash notes, embroidered handkerchiefs, and boxes of candy showered on

(Continued on page 400)



you find the illusion of restfulness totally shattered, with an attendant reaction of disgust and anger setting in instead, by the glib voice of the announcer.

The Radio Beginner

Assuring Safety in Radio Installation

By A. P. PECK

GENERALLY speaking, radio as a pastime for the average layman is as safe as the proverbial church. Strictly speaking, however, the man who installs and maintains his own radio receiving set may ignorantly incur risks; but if he is warned beforehand, all these can easily be avoided. This is not written with the intention of scaring anyone; but rather to instill confidence into the average radio fan, and to help him in avoiding certain pitfalls that may beset his path, as he progresses with radio. If he will heed the precautions outlined in this article, he will avoid some annoying experiences.

FIRST, THE AERIAL

Obviously, when entering on our subject, the most natural place to start is with the aerial. An aerial is a simple arrangement, and looks as harmless as a clothesline. However, even here we have to watch our steps.

An aerial must never be erected so that it crosses any other wires whatsoever: particularly is this true of public-service wires. If it should happen that you place your aerial in such a position, and the wire breaks, it might fall across the current-carrying wire and cause a short-circuit. This would not only inconvenience the company owning the wires, but it might also injure your radio set.

Of course an aerial should never be placed *under* a power-carrying wire, as in this case the latter might break, fall upon the aerial and cause trouble. Avoid all wire of any kind, although it may be only the aerial used by one of your neighbors. Keep all aerial wires free and clear from all others and

from all entangling objects. If the aerial rubs against a tree limb or a part of a house, some of the energy that is received from the transmitting station will be lost, and your results will not be as good as they would be if the aerial were properly strung.

Never string your aerial wire across a street or pathway of any kind. Here the same danger of breakage is always present, with possible danger to passing vehicles or pedestrians.

PUTTING UP THE WIRE

If you put up an aerial mast and secure it with guy-wires or ropes, use a little thought in laying out the system. Do not fasten the lower ends of the guy-wires so that people will be liable to stumble over them and possibly injure themselves. Also do not have your guy-wires cross paths at low heights, or a passerby may run into them.

And then there is the ever-present necessity of climbing to a height to put up your aerial wire. If you must climb a tree, exercise the greatest care, particularly if you attempt to carry up the aerial wire with you. Place this so that it will not become entangled with the branches and so cause you to lose your grip. If you have to climb on the roof of the house, use a ladder. A ladder laid on a sloping roof, even though the slope be gentle, will enable you to climb safely and surely to the peak. This method is to be preferred to that wherein you have to rival a monkey in climbing ability, if you attempt to make the ascent without the assistance of a ladder. There are several cases on record of persons who had bad falls when

putting up radio aerials. See to it that your name is not added to this list.

LIGHTNING PROTECTION

There is also of course, the widely discussed danger from lightning. Some claim that this is a myth, and others that a radio aerial attracts lightning. They are both wrong. Any object, particularly if it is elevated, is subject to a stroke of lightning. If, however, a radio aerial is properly

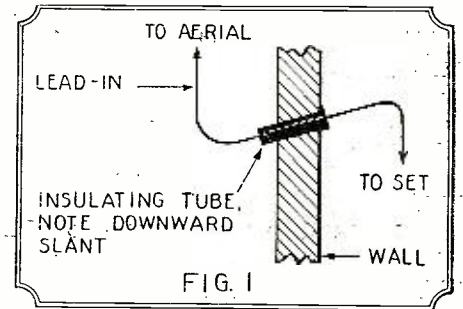

If an insulating tube is employed for running the aerial lead-in to the set, it should be placed through the wall on a downward slant so that water cannot follow it into the house.

grounded through an approved lightning arrester as required by the underwriters, and explained before in this department, it acts as a safeguard to the home.

A properly-grounded aerial will, during a lightning storm, act in exactly the same way as a lightning rod. It will serve to conduct atmospheric electricity to the ground, and cause it to pass off in a harmless manner, and therefore, will prevent it from accumulating until a lightning stroke results. Just read over these last few words again; and the next time that someone tries to tell you that your radio aerial is subjecting your house to danger from lightning, explain to him carefully that he is wrong and tell him just what a properly grounded radio aerial can do.

OBTAINING A GROUND

In certain sections of the country it is necessary to drive a long metal pipe or rod into the soil in order to obtain a good ground connection. Before selecting a spot for this purpose, it is wise to find out as near as possible, where the various underground pipes run and how deep they are buried. If you arbitrarily choose a spot for the ground rod, it is possible that you may drive it through a buried tile pipe or that it may soon be stopped by contact with an iron pipe. In either case, the results are bad.

Go to your cellar and you will in most cases find where the pipes enter the house; and then you can decide upon a good location out of doors, for driving your ground pipe.

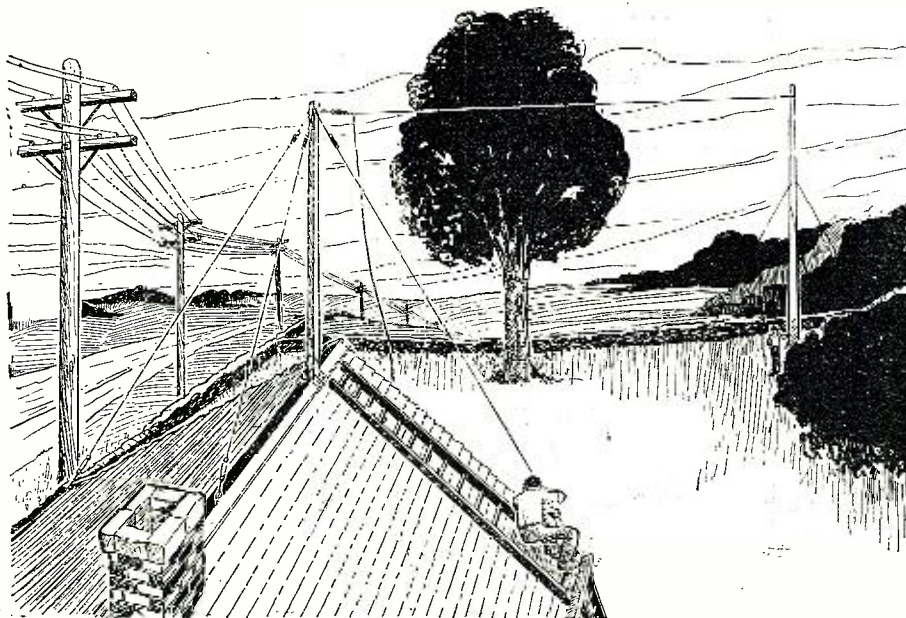

Thought has been given to this aerial installation. The wire has been run so as to be clear of the large tree and also at an angle to the light wires in front of the house. Stout poles have been used and these are well guyed with strong wires insulated at both ends.

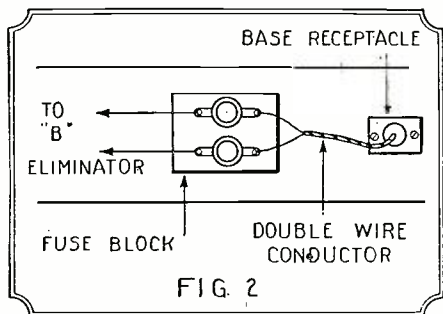

It is always desirable that a double fuse be used in connection with a "B" eliminator as a protective measure. This sketch shows how it is connected up.

THE LEAD-IN

A radio aerial without a lead-in is as useful as an automobile without a driving shaft. The lead-in is the wire that connects the aerial proper with the radio receiving set. It is necessary to bring this wire into the house in order to connect it with the set; and to do this a hole is often drilled in the wall. Be careful here or you may do some damage. If you are going to drill directly through a wall, and there is plaster on the interior, it is best to start from the inside and drill through the plaster very carefully to avoid chipping and breakage. When making the hole, be sure that you choose a drill or bit that is large enough; inasmuch as a small hole in plaster is hard to enlarge without damage to the surrounding wall.

If you are going to drill through a baseboard in order to bring the lead-in wire through, or for any other purpose, you will have to be quite sure that you do not drill into any electric conduit. It is usually quite safe to bore through a baseboard, if you are at a distance of several feet from the nearest electrical base-outlet. In such a case, you will probably clear all of the house wires.

EFFECTS OF RAIN

One of the favorite methods of protecting the lead-in wire at the point where it enters the house, is to use a porcelain tube inserted in the drilled hole, and to run the wire through this tube. This is all very well; it is a simple, good and cheap method of performing the required work. However, be sure that your tube is lower at the outside end than at the inside. (See Fig. 1.) If you reverse this angle, water running down the lead-in-wire during a rain storm will come right into the house through the tube. If course, if you use one of the sealed tubes, provided with a brass center rod, that are on the market today, this necessity of drilling the hole at a slight angle will be eliminated.

With certain radio instruments it is found that the volume of received music or voice is reduced during a rain storm. This is sometimes due to poor insulators on the aerial proper; but it can more often be traced to a defective or wet lead-in insulator. Some of the "window-strip" lead-ins are an abomination. Consisting merely of a strip of thin copper with a flexible non-water-proof casing, they are easily short-circuited to the window frame; and hence a lot of energy is lost. If, because the wall cannot be drilled, one of these window strips must be used, be sure that you get one that is covered with water-proof insulation.

PLACING THE RECEIVER

In choosing the location of a set in the home, certain dangers to good reception must be avoided. For instance, a set should not be placed with a table lamp immediately beside it or on top of it. It will very often happen that such an arrangement will result in the production of a loud hum in the loud-

speaker. This hum is due to the wires carrying current to the lamp; and if the lamp is removed, the hum will often immediately disappear. Neither should the lead-in run parallel to house-lighting wires.

For holding the radio set, select a strong table and one that is quite rigid. A table that is "weak in the knees" will make tuning difficult, and cause mechanical vibrations to be transmitted to the set; resulting in noises in the loud-speaker, particularly if one or more of the tubes in the set is slightly defective. When selecting a table for your radio set, it is well to remember that certain accessories must be cared for. A table with a compartment for batteries, spare tubes and tools is very handy; and usually such a table is amply strong enough for the purpose.

If the loud-speaker is placed directly on top of the receiving set, there is danger of producing noises, due to the loud-speaker

If the loud-speaker delivers tremendous volume, which is now possible with the power tubes that are available on the market, the speaker should be kept at least several feet away from the set. This will reduce the possibility of the air (sound) waves producing the above-mentioned trouble. With the average two-stage amplifier and loud-speaker, however, the volume is not so great but that the loud-speaker may be placed within a foot or so of the set; but still, not on it.

BATTERY PROBLEMS

Since radio receiving sets have come into general use, there are a great many people taking care of storage batteries, who never thought of performing this work before. Being unfamiliar with the proper procedure, in many cases they are liable to run into trouble. Therefore, the following hint on the care of batteries will be of assistance, and will keep a good many fans out of trouble.

The first thing to remember, in connection with storage batteries on charge, is that the vent caps, which cover the holes through which the water is introduced into the battery, must be removed when the charger is connected, to allow the free escape of the gases which are formed during the charging process, and prevent them from accumulating. This, if allowed to continue for any length of time, may result in an explosion; but by removing the caps, such a danger is absolutely avoided.

When a battery is on charge, the gas (hydrogen) that is given off is highly explosive. Therefore, keep all matches and open flame away from the battery while it is charging.

At a distance of a few feet from the battery the gases are so diluted with air as to be harmless. However, more than one tyro electrician has, to his sorrow, investigated the condition of his battery, while charging, by illuminating the scene with a match.

If the terminals of the battery are not clean, there is danger of the current suddenly ceasing to flow in the circuit when your set is in use; because the corrosion

(Continued on page 436)

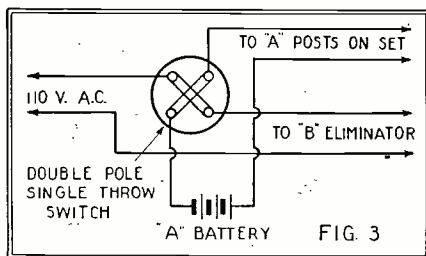

This diagram shows how to connect up a single-snap switch for turning on and off both the "B" eliminator and "A" battery.

vibrating the receiving set and the tubes within it. In such a case, a low hum will start to emanate from the horn, and will build up in volume until it reaches the proportions of a siren whistle. This can be immediately stopped by removing the loud-speaker and breaking up the rhythmic vibrations of the tube elements, by tapping sharply on the cabinet. When the loud-speaker is removed, do not replace it on top of the cabinet but provide another location for it.

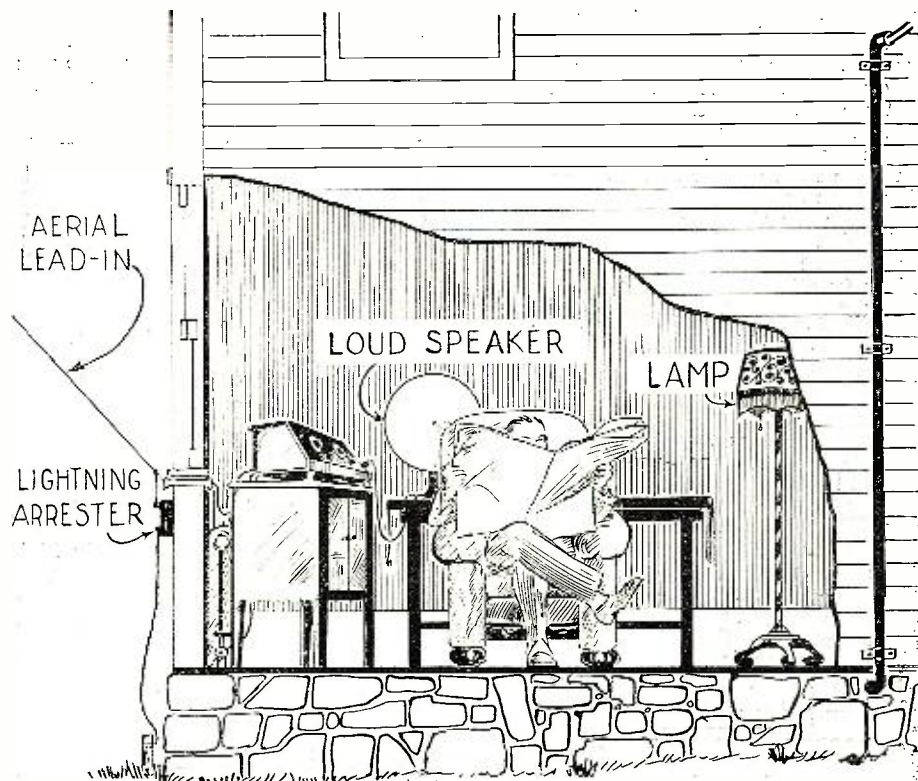

An excellent arrangement of apparatus. Both the floor lamp and the loud-speaker have been kept well away from the set, which otherwise might be affected. Also, the lead-in has been kept at an angle to the house-lighting wires, shown at the right.

Radio Set Owners' Information

VACUUM-TUBE PROTECTOR

(29) C. P. Manson, of Chattanooga, Tenn., asks:

Ques.—Is there any manner in which I can protect the tubes in my receiving set from burning out, in case of a short circuit?

Ans.—The accompanying illustration shows a method whereby the tubes in a receiver can be protected from the "B" battery voltage, should it happen to be impressed directly on the filaments. As will be seen, a 110-volt lamp is connected in series with the negative lead from the "B" battery. This lamp is of the common type, about 40-watt, employed for house lighting. In case of a short circuit, the lamp will light brightly but will not allow a sufficient passage of current to burn out the filaments of the vacuum tubes.

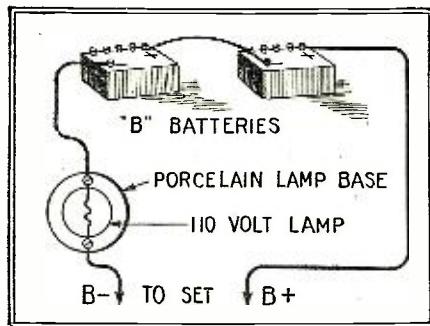

A 110-volt house lamp connected in series with the negative "B" battery lead, as shown will protect the vacuum tubes in the set, as well as provide a visual indication of a short-circuit.

We are not suggesting that this lamp be left in the circuit at all times, as its presence in the "B" battery lead is apt to affect the operation of the set. Use the arrangement only at such times as you are testing, experimenting, or changing about tubes.

ON PURCHASING A LOUD SPEAKER

(30) Henry W. Bossard, of Bridgeport, Conn., asks:

Ques.—I am contemplating the purchase of a cone-type loud speaker, to replace the unit I am using at present on my phonograph. The receiving set I have is of the five-tube tuned-radio-frequency type. Could you tell me what speaker or speakers would be best for this outfit?

Ans.—We can give no material assistance on this point. Most of the cone speakers on the market at the present time are good; but it is true that they won't all work the same on a particular set. This is due to the fact that the "output characteristics," or electrical constants of different makes of receiving sets, vary considerably; and that the impedance or "effective resistance" of all loud speakers is not the same. When the characteristics of both speaker and receiver are suited to one another, the best results will be obtained, assuming of course that the receiver itself is distortionless or nearly so. The fact that a certain speaker may not sound well when operated from a certain set does not indicate that the speaker is at fault—or the set for that matter.

We would suggest that you go to a radio dealer and listen to the different makes of speakers, operating from a set of the same make as your own. Purchase the one that pleases your ear the most.

AUTOMOBILE BATTERY FOR RADIO USE

(31) Gerald C. Fowler, of New Orleans, La., asks:

Ques.—I have been running my six-tube

THIS page constitutes what is to be known as the SET OWNERS' INFORMATION department, and is to be conducted regularly each month in RADIO NEWS. The purpose of the department is to furnish assistance to those readers who have not yet acquired any extensive knowledge of radio, but who are the possessors of radio receivers and wish to know how to handle them.

There is always new blood coming into the fraternity of radio enthusiasts; and it is obviously unreasonable to expect that they can intelligently read the articles which are written for the more experienced fans. Consequently this new department has been started for their benefit; and we invite anyone who desires to do so, to write an account of his troubles to the editor of this department. No letters will be answered by mail. The editor will select from the letters which he receives those queries that seem to be of most practical interest to all, and will answer them fully and in detail each month. There will be no charge for this service. Simply write to SET OWNERS' INFORMATION DEPARTMENT, RADIO NEWS, 53 Park Place, New York City.

radio set with an automobile storage battery of the regular six-volt type. For some reason, which I cannot determine, this battery does not last very long; yet the rated capacity is around 100 ampere-hours. Furthermore it seems to be getting worse as time goes on, yet I always test it and keep the electrolyte above the plates. What could be wrong?

Ans.—The trouble is that an automobile storage battery is not designed for radio use; or, putting it in other words, an automobile

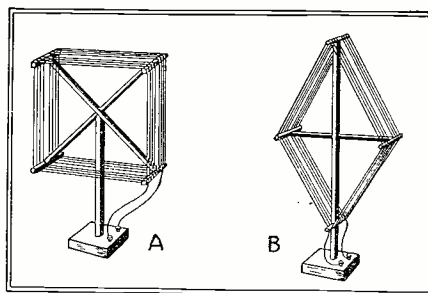

Two loop aerials of the "box" type which are very efficient. Both can be rotated to take full advantage of their directional effects. This type of loop is suitable for most purposes.

battery is so constructed as to supply high amperage momentarily and not low amperage for long periods of time. When an automobile battery is employed for lighting the filaments of vacuum tubes the plates are not sufficiently worked, and the active material takes on a state of stagnation. The charge and discharge rate for an automobile battery is high. Decrease one or both and the battery suffers in consequence. By all means purchase a radio storage battery having a capacity of 60 or 80 ampere-hours. If you use your set a great deal it is best to purchase an 80 ampere-hour battery.

BEST SIZE FOR LOOP AERIAL

(32) Bertram L. Roe, of Seattle, Wash., asks

Ques.—I have an eight-tube super-heterodyne receiver that I have been using for some time with an outdoor aerial about 100 feet long. I have been told that I will pick up less interference and local noises if I use a loop aerial and that, furthermore, I will be given the advantage of being able to eliminate a station by turning the loop. Will you tell me what size and shape of loop aerial would be most satisfactory for my purpose? I want to be able to pick up as much energy as possible, so that I will still be able to get the distant stations.

Ans.—A loop about six feet wide would prove the most satisfactory from the stand-

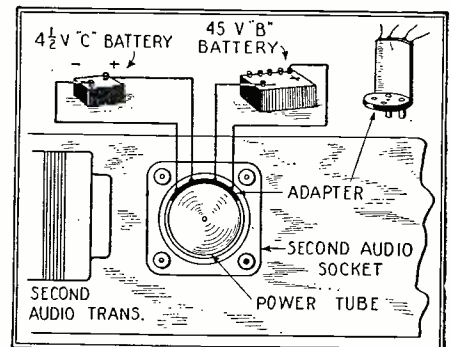

A power tube can be used in the last audio stage of any receiver, without changing the wiring, if an adapter of the type shown is used. The connections are indicated.

point of energy pick-up; but, more than likely, it would not prove of particular value to you, so far as its directional qualities are concerned. In the latter respect a two-foot loop would be of more service to you, but it would not be as efficient a collector. It is suggested that you purchase a loop aerial three or four feet in width, and that it be of the box type as shown at A in the accompanying sketch. Another very efficient form of loop aerial is shown at B. Either type will suit your needs.

ADDING POWER AMPLIFIER TO OLD SET

(33) Walter H. Tait, of New York, N. Y., asks:

Ques.—I have a five-tube neutrodyne set in which I would like to use one of the new type power-amplifier tubes which, I understand, will give me more volume and better quality. Since there is but one "B" battery and one "C" battery binding post for the two audio amplifiers I am at a loss to know how to get the right voltages on the last tube.

Ans.—Naturally you could change the wiring in the set to separate the two audio amplifier circuits; but we presume that you do not care to do this. At any rate, it is not at all necessary, as there are a number of power-amplifier vacuum tubes on the market which have binding posts attached to the base of the tube so that the separate connections can be made; and there are also a number of special adapters which accomplish the same thing. Purchase either a tube of this sort or one of the adapters. All radio dealers carry them.

It is suggested that you employ a tube of the 112 type, using 135 volts "B" battery and approximately 9 volts "C" battery.

Just how the adapter connections are made is diagramed in the accompanying sketch. The separate batteries shown are automatic-

(Continued on page 431)

List of Broadcast Stations in the United States

Table with 5 columns: Radio Call Letter, Broadcast Sta. Location, Wave (Meters), Power (Watts), and station name. The table lists numerous radio stations across the United States, organized in four main columns.

At the closing date of this magazine, the list of broadcast stations is subject to daily alterations, as regards wave-lengths, power, etc. We especially request stations making changes at this time to send a notification direct to RADIO NEWS, in order that broadcast listeners may be advised as soon as possible of the new conditions which they may expect in tuning in the stations.

(Continued on page 361)

"B" Battery Eliminators

By M. L. MUHLEMAN

This article deals with the design and construction of all types of eliminators, with descriptions of the various parts which go to make them up. The prospective buyer will find this treatise of particular interest.



A "B" eliminator designed for use on a 110-volt 60-cycle light line. It employs a full-wave rectifier tube of the filamentless type. There are four voltage taps: detector, variable from 20 to 60 volts; radio-frequency, variable from 67½ to 90 volts; and high- and low-voltage taps, controlled by a switch, for the audio amplifiers, giving a maximum of 180 volts for a power tube.

Photo courtesy of The Acme Electric & Mfg. Co.

ENGINEERS have worked patiently for a number of years in an attempt to contrive an efficient and reliable substitute for dry-cell or storage "B" batteries, a device that would supply plate voltage for the vacuum tubes directly from the house-lighting system.

Most of the early designs were exceptionally crude, as are most inventions in

the embryo stage; and though they were successful "B" battery eliminators insofar that sets could be operated by their use, there was an ever-present disagreeable alternating-current hum in the phones or loud-speaker. Naturally, no such device could be employed in connection with a set that was to receive broadcast programs.

Alternating-current hum has been the one

big stumbling block to the engineers. Their most important problem was to devise a means for doing away with this bothersome noise. Other problems were far less intricate, though there was an urgent need for a more suitable type of rectifying device than the earliest ones devised.

Very excellent forms of filter systems had been developed years before thought was ever given to "B" battery eliminators; more credit, probably should go to the telephone engineers for the design of filter and trap circuits, to suppress or by-pass undesirable frequencies, than to anyone else. Systems of this sort have been employed in telephone practice for many years.

Though our radio engineers were perfectly acquainted with the then existing forms of filter systems, which would have been quite satisfactory for the purpose of "smoothing" out the rectified currents, so that no hum would be present in the receiving set, they were hampered by the fact that such arrangements were so complicated and the equipment so expensive that the cost of a manufactured "B" eliminator would have been prohibitive from the point of view of the public.

ELIMINATORS FOR EVERYONE

Conditions have changed. Competition, stabilization and quantity production have brought down the price of radio apparatus. On the other hand, the public is in a more liberal frame of mind and are willing to spend more on apparatus than heretofore. Thus, we might say, the "B" eliminator has become practical and it has arrived at just the time the radio fan was ready for it.

The "B" battery eliminators on the market, the early part of last year, were by no means in that state of perfection where nothing is left to be desired. Quite the contrary, the majority of them (we are kind enough to take note of the fact that they were the pioneer eliminators) had no extraordinary



Left: Another A.C. "B" eliminator with three voltage taps, two being variable. A filamentless full-wave rectifier tube is used.

Photo courtesy of Valley Electric Co.

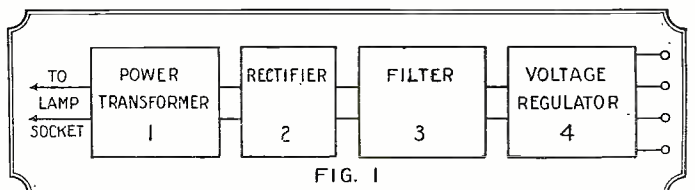
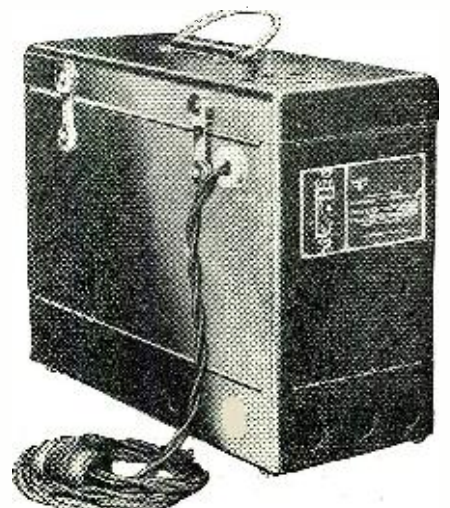

FIG. 1

Above: Showing the four requisite sections which make up a complete "B" eliminator.

Right: A "B" and "C" eliminator for alternating current, having four "B" voltage taps (45, 67½, 90 and 150 volts) and 4- and 12-volt "C" taps. Uses full-wave rectifier tube of filament type.

Photo courtesy of The Kodak Radio Corp.



efficiency when it came to suppressing the alternating current hum. Furthermore, the rectifying devices (most of them) passed only an anemic 20 milliamperes, more or less, and the receivers suffered in consequence. They were not exactly an inspiring success.

But the public wanted "B" eliminators, and good ones; and when the public wants something long enough and determinedly, it is provided.

There is as much difference between the new models of "B" eliminators of this year and those of last year, as there is between a 1926 automobile and the 1906 rattle-trap

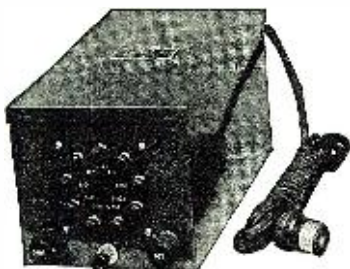

An A.C. "B" and "C" eliminator employing an electrolytic rectifier. The detector tap is variable from 0 to 80 volts. Other taps provide 45, 67, 90 and 135 volts. "C" voltages from 0 to 40 are obtainable.

Photo courtesy of DeWitt-LaFrance Co., Inc.

that long ago passed back into the scrap pile.

A great many advancements have been made in "B" eliminator design. As in everything dealing with electricity, the actual improvements amount to a large increase in efficiency throughout the various components. The rectifying devices are excellent; the filters effectively eliminate all

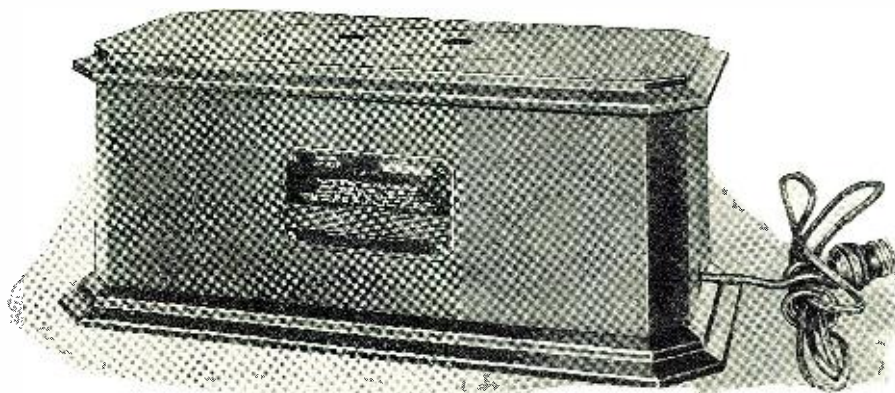

An A.C. "B" eliminator employing a full-wave rectifier tube and a voltage-regulator tube to compensate for irregularities in line voltage. There are four voltage taps; namely, 22½, 45, 90 and 135 volts. The maximum current obtainable is 50 milliamperes, sufficient for most purposes. Regardless of the load placed on the eliminator, the voltage remains constant.

Photo courtesy of Radio Corp. of America.

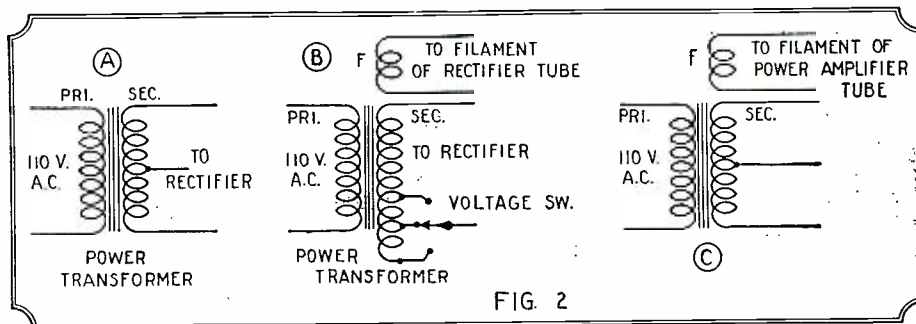

FIG. 2

Showing three different types of power transformers. A is for use with a full-wave rectifier tube of the filamentless type and has three secondary terminals. B is for use with a half-wave rectifier tube of the filament type and has a separate winding F for supplying the filament current for the rectifier tube. The secondary winding is tapped to obtain various voltage values. C is for use with a full-wave filamentless rectifier tube. The separate winding F is used for lighting the filament of the power amplifier tube (in the radio receiver) which requires in excess of one ampere.

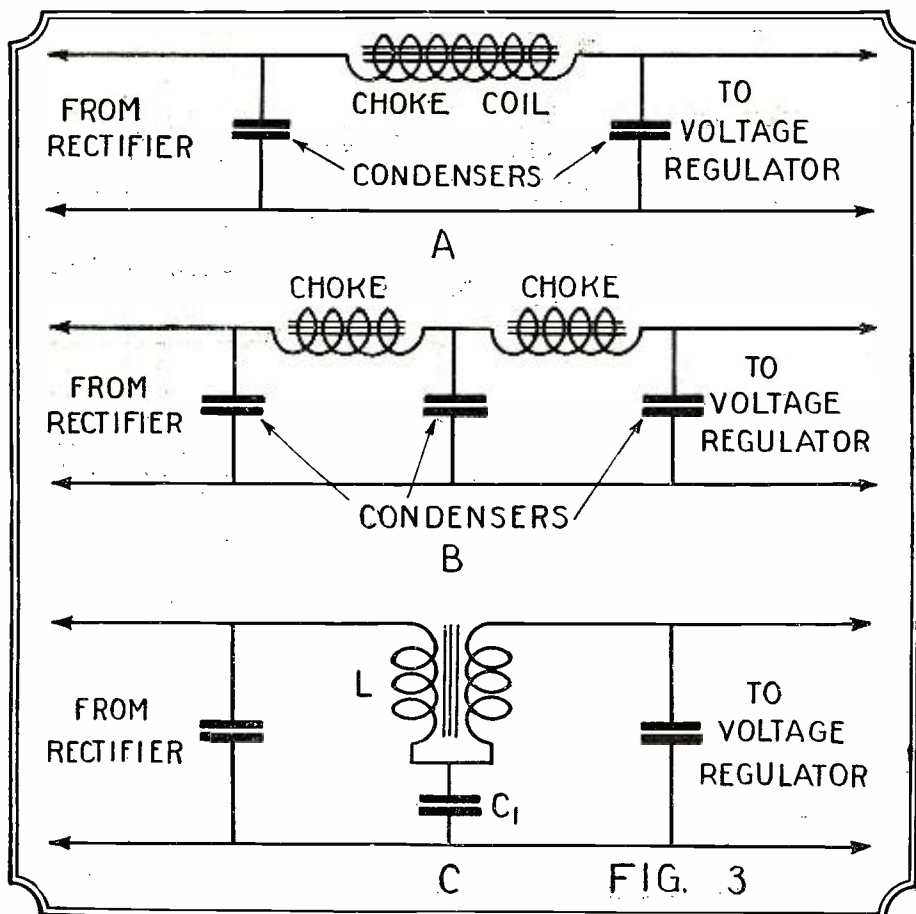
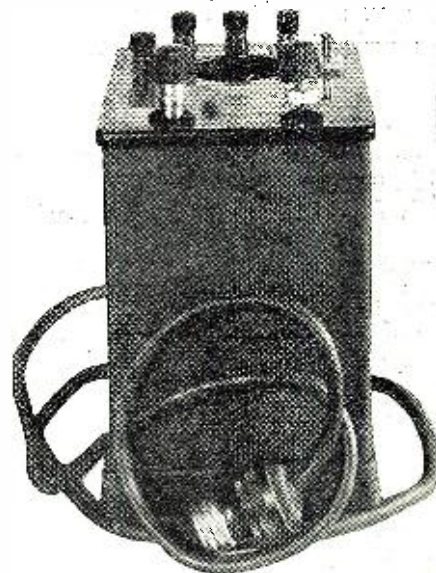

FIG. 3

Three types of filter systems employed in present day "B" eliminators. A is similar to B except that but one choke and two condensers are employed. C contains a double choke L with opposed windings and a condenser C-1, which form a resonant circuit of low resistance which eliminates the A.C. hum.

trace of the alternating-current hum in the receiver, and practically any desirable voltage can be had for the detector, radio-frequency and audio-frequency circuits. Present-day eliminators are capable of supplying sufficient plate current for the operation of a



An A.C. "B" eliminator using a half-wave rectifier tube with filament. There are three voltage taps, one variable, providing voltages from 0 to a maximum of 150. There is also a high-and-low voltage switch.

Photo courtesy of The Glenn L. Martin Co.

ten-tube set, or a set with a slightly less number of tubes plus a power amplifier. The most gratifying thing about them, however, is that they are practically fool-proof. All of these points combined make them highly desirable.

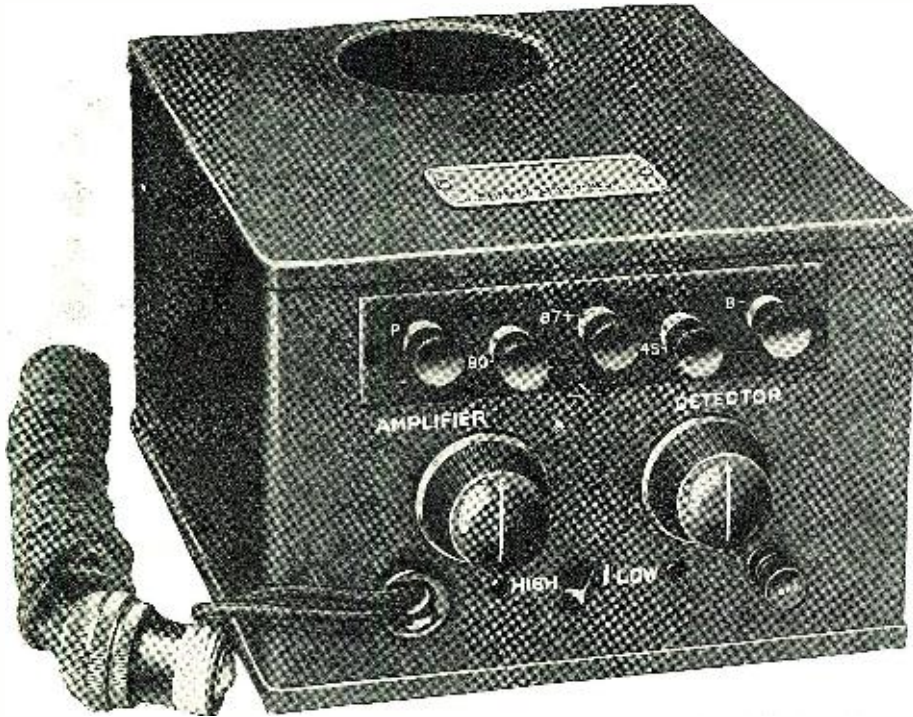

An A.C. eliminator using a full-wave rectifier tube. The detector voltage is variable from 10 to 60, the radio-frequency tap from 67 to 90. Maximum amplifier voltage is 135. A high-and-low voltage switch is also incorporated; the high-voltage side is used when 6 or more tubes are employed in the receiver.

Photo courtesy of All-American Radio Corporation.

HOW A "B" ELIMINATOR IS ARRANGED

A "B" eliminator is composed of four principal sections, which are indicated in Fig. 1. The first section consists of the power transformer, one side of which connects directly to the 60-cycle electric light line and the other side to the rectifier device. The function of the power transformer is to step up the 110-volt alternating

The circuit arrangement for a direct current "B" eliminator. It will be noted that there is no power transformer or rectifier tube, these being unnecessary. The filter system is the same as employed in an A.C. eliminator, though it can be of simpler form.

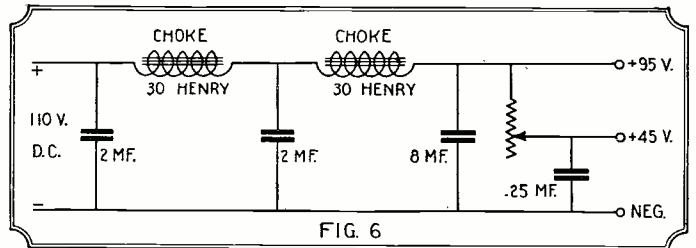

FIG. 6

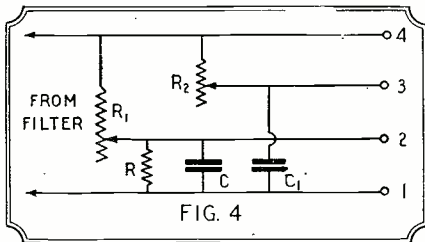

FIG. 4

Diagram of the voltage regulator section of an eliminator. Various voltages are obtained by the use of resistances R, R-1 and R-2.

The purpose of the filter system is to smooth out the pulsations, ripples, or hum, if you wish, that are still part and parcel of the rectified current; so that the output will be virtually a pure direct current, such as that supplied by "B" batteries.

The fourth section is composed of numerous variable resistances, of the non-induct-

same transformer is seen to have a third winding. This is employed to supply current for lighting the filament of the rectifier tube.

The transformer shown at C also has a third winding, though this transformer is designed for use with a full-wave rectifier tube of the filamentless type, as evidenced by

current to a value which will conform to the requirements of present day receiving sets and amplifiers. Some transformers have two 200-volt secondary windings in series, some two 300-volt windings; and others, which are not designed to supply the high voltages required by power-amplifier tubes, employ one or two windings of comparatively lower voltage.

The high-voltage alternating current delivered by the power transformer is converted into a pulsating direct current, in passing through the rectifier device in the second section. In other words, the alternating current is rectified. Just how smooth the resulting direct current will be, depends upon the excellence of the rectifying device. At any rate, it will not be a pure direct current, but will carry with it an alternating-current component or "ripple." Most of the rectifying devices offer full-wave rectification which, of course, is the most efficient, though some eliminators employ devices which give only half-wave rectification. Both however, are quite satisfactory.

The third section consists of the filter system, which we have already mentioned.

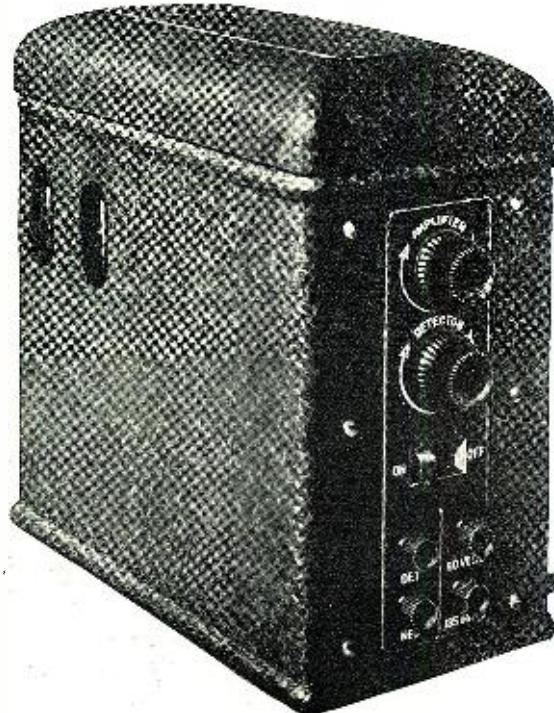

Another A.C. eliminator employing an electrolytic rectifier giving full-wave rectification. The control knobs permit varying detector voltages from 10 to 80, amplifier voltages from 45 to 90 and power voltages from 90 to 160. The maximum output is 60 milliamperes, which is sufficient for most purposes.

Photo courtesy of Willard Storage Battery Co.



An A.C. "B" eliminator employing a half-wave rectifier tube and supplying a variable detector voltage from 0 to 75, radio-frequency voltage 0 to 90, and amplifier voltage from 0 to 135.

Photo courtesy of U-Flex Mfg. Co.

the three connections from the secondary. The third winding in this case is for lighting the filament of a power-amplifier vacuum tube; the secondary winding provides sufficient voltage for the plate of a power amplifier

RECTIFIERS

A number of different types of rectifiers are employed in "B" eliminators. Those

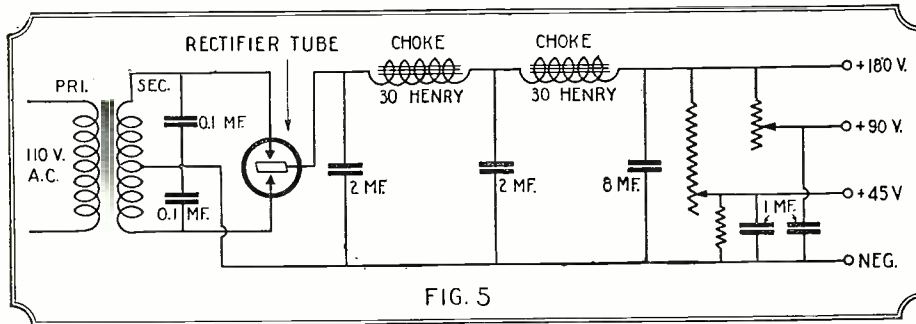

The circuit diagram of a complete A.C. "B" eliminator, including all four sections as outlined in the article. It is shown employing a full-wave rectifier tube of the filamentless type.

most commonly used are the vacuum tube having a filament, the filamentless tube, and the electrolytic rectifier. All three devices are efficient and can be counted on to operate satisfactorily under all conditions.

The vacuum tube rectifiers having filaments are operated from a three-winding power transformer, such as shown at B in Fig. 2, the third winding supplying the filament current. Some types of these tubes are full-wave rectifiers and others half-wave rectifiers; a half-wave rectifier actually passes but one-half of each alternation of the current ("cycle") from the light socket.

The filamentless tubes commonly employed nowadays are full-wave rectifiers; this type of tube will be found in most "B" eliminators.

The electrolytic type of rectifier consists of small jars in which are placed metallic plates. The jars are filled with a solution (electrolyte), whose action on the metallic plates allows the alternating current to flow in one direction only; thus producing rectification.

Most of the rectifying devices employed in present day "B" eliminators are capable of passing approximately 65 milliamperes which is sufficient for nearly all receivers.

FILTERS

As mentioned heretofore, the function of a filter in a "B" eliminator is to smooth out the pulsating direct current into some semblance of a pure direct current. The "purity" of the direct current at the output of the eliminator is dependent on the

At the right an A.C. "B" supply unit employing a filamentless full-wave rectifier tube. A special filter system is used. The detector voltage is variable from 20 to 45, the radio-frequency voltage from 60 to 90. A maximum of 300 volts can be obtained, which is required for a large power amplifier tube. The power transformer has a separate 7.5-volt winding which will supply in excess of one ampere and can be used for lighting the filament of a power-amplifier tube, or the filament of a full-wave rectifier tube if that type is employed in preference to the filamentless type.

Photo courtesy of Silver-Marshall, Inc.

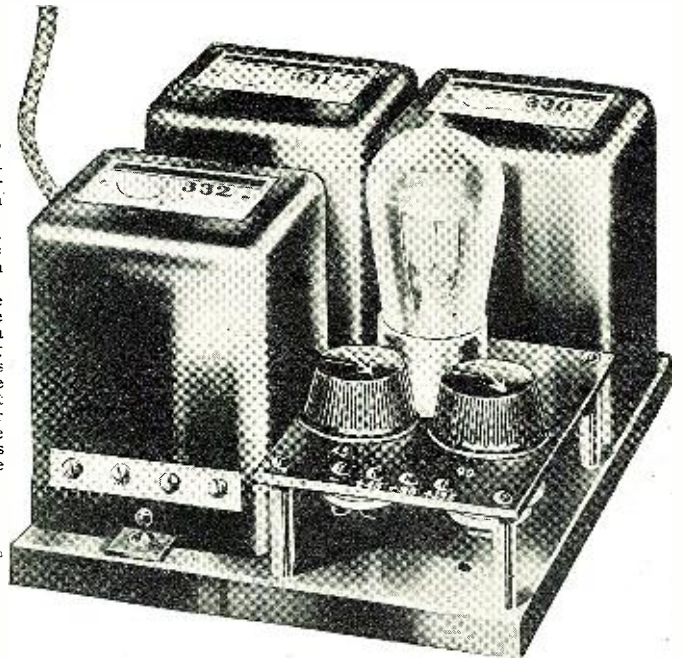

efficiency of the rectifier device plus the efficiency of the filter system.

A simple form of filter is shown at A in Fig. 3. It consists primarily of a choke coil and two high-capacity fixed condensers.

are analogous to water tanks in that they store up current from a very irregular source and release it, if one can view it that way, free from pulsations. Thus, the condensers tend to keep the voltage constant.

The type of filter commonly employed in "B" eliminators is shown at B in Fig. 3. It is seen that two chokes and three condensers are used. Some eliminators utilize a greater number of condensers, but very seldom more than two chokes. An improved form of filter circuit is shown at C in Fig. 3. There is the usual choke, but with two opposed windings, and the two fixed condensers. However, the windings L plus the condenser C1 forms a resonant circuit, which offers an exceptionally low resistance path to the alternating-current component which, one might say, is sidetracked. This functions similarly to a tuned circuit in a radio receiver.

VOLTAGE REGULATORS

Like the filter system, the voltage-regulator arrangement is more or less standard in all "B" eliminators. The circuit is shown in Fig. 4. The resistance R is fixed while the resistances R-1 and R-2 are variable. These are of the carbon compression type which is non-inductive. The maximum voltage of the eliminator is obtained from leads 1 and 4, 1 being the negative terminal. The voltage at terminal 2 is variable, usually from 20 to 45, and is regulated by adjusting the resistance R-1. The voltage at terminal 3 is likewise variable, the adjustment being made by resistance R-2. The fixed condensers C and C1 are radio-frequency bypass condensers.

Some eliminators have but one variable voltage tap, although most of those made today have two variable taps and one fixed. The fixed tap supplies the plate voltage for the audio amplifier or power amplifier which may be 135, 180, or as much as 300 volts. In addition to this a few eliminators include a voltage switch with three positions; high, medium and low. Voltage regulation in this manner is accomplished by tapping the secondary winding of the power transformer as was shown at B in Fig. 2.

The circuit of a complete "B" eliminator to operate from a 110 volt 60-cycle alternat-

(Continued on page 438).

A compact A.C. "B" eliminator using a full-wave rectifier tube and supplying variable voltages from 0 to 135. There are separate taps for the detector and radio-frequency circuits.

Photo courtesy of Timmons Radio Products Corp.



A Perfect Static Shield

By VOLNEY G. MATHISON



In this unique method of shielding, Mr. Mathison presents an idea which RADIO NEWS readers will doubtless find of great interest. Today, as never before, is shielding becoming more and more important in the proper functioning of certain types of radio receivers.



MA bella de la tomato, por que me has aplastado—oh, the old gray mare ain't what she uster be, ain't what she uster be, ain't what she uster be . . . many long years ago!"

"This interference business is getting to be simply terrible!" mutters Mr. Trifflebagger, crouching over his nine-tube super-whoopadyne and fumbling at the dials, with a frown on his face like that on the brow of a Chinese joss. "How in thunder am I going to listen to Mlle. Cucaracha back there in Chicago, when these confounded California prune-ranchers keep yelling all over my instrument about that miserable old shambling gray quadruped of theirs that ought to have been ground up for chicken-feed before they were born?"

"Here I've gone and spent three hundred dollars for a contrivance of which the salesman said, 'Turn the dials, and in they come,'—and in they do come, this KZOO crowd, with their old gray horse, and their minister who should have been an inflater of children's toy-balloons, and their ball-bearing-tongued females who instruct in the making of angel-food, while their husbands sit at home munching a sardine and a cracker."

"And," continues the disgruntled Mr. Trifflebagger, "of all the good-for-nothing interference eliminators I've indulged in, this matter of shielding has turned out the worst. I've paid forty dollars to a glib young telegraph amateur, who alleges he hears his friends in Australia on one tube and a curtain-rod, to fix my set so I can hear Chicago on nine tubes and a big aerial; and he has torn it to pieces and encased its parts in a sheath of gleaming brass, with the result that, whereas before I got this vociferous Mr. KZOO on only six places on the dials, I now get him almost all over them. I wonder if he's stopped yet?"

"—ain't what she uster be, many long years ago—"

With radio receivers steadily growing more refined in construction, there is an increasing tendency to employ metallic shielding, either on the front panel of the set or all around the apparatus. The purpose of shielding is two-fold—to prevent troublesome capacity effects when the operator's hands are near the receiver; and to make the set more selective and quiet (theoretically at least), by screening it from the

wave-motions set up by powerful nearby transmitters.

TROUBLES FROM ABSORPTIVE SHIELDING

It is a fact that the coils and wiring of a sensitive unshielded receiver, particularly of a super-heterodyne, will often pick up enough energy from big local broadcast stations to cause exasperating interference, in the form of pseudo-harmonics. The complete enclosure of the receiver in a metal-sheathed cabinet, which is grounded, will quite effectually prevent such undesirable pick-up of energy by the parts of the set itself; but the unscientific installation of such a shield sometimes causes new troubles which are almost as bad as the one that has been remedied.

Metallic sheeting placed in the field of an inductance-coil greatly increases the high-fre-

quency resistance, or virtually the high-frequency resistance, of the circuits, with consequent further losses. Not only that, but, in some cases where the shielding is placed very close to the high-frequency inductance-coils, the tuning of the receiver is so flattened out that the selectivity is actually made poorer, instead of better.

The eddy-currents set up in a metal sheet placed within the field of a coil carrying an alternating current are roughly sketched in Fig. 1, which will perhaps help to make the foregoing remarks clearer to the non-technical reader.

The resistance losses occasioned by metal shielding are usually not so excessive when dealing with long waves, say of one thousand meters and over; because at the lower frequencies corresponding to these waves, the impedance of the radio circuits is not so greatly increased by the adjacent sheets of metal. But on short waves the loss of energy is serious; and, the shorter the waves, the more is the signal strength reduced and the tuning flattened out.

A practical illustration of what this means will be seen in the following:

TEST OF SHIELDING WITH DX

Enroute to the Panama Canal from San Francisco, on a steamship, the writer arranged removable shielding on an eight-tube super-heterodyne. Nearly three thousand miles from San Francisco, he successfully brought in KGO with good loud speaker volume on this set, without shielding (there was, of course no local interference of any kind, except static); while upon installing the shield, the signal strength was reduced to about one-half or one-third of its previous value, even after the set had been carefully retuned.

Experiments made on the same vessel with a 40-meter regenerative receiver resulted in the absolute vanishing of some faint distant signals, upon the placing of copper shielding close about the apparatus; and the signals could not be tuned back in at all, until the metal sheets were removed.

The upshot of these experiments, and of others which have been made that are more scientifically conclusive, though less striking to the layman, is that shielding placed within the fields of the inductance-coils and wiring of a radio receiver will reduce the range and sensitivity of the instrument to a considerable extent; and sometimes to such a degree that weak distant signals receivable by the unshielded apparatus may, upon the installation of shielding become completely inaudible. At the same time, the sharpness of tuning is reduced.

Yet, in some form, shielding is not only desirable, but often essential; it is frequently required, not only to screen receiving apparatus from powerful local transmitters, but to isolate various circuits in the receiver itself—as, for instance, the oscillator unit of the super-heterodyne.

NEW TYPE SHIELDING

A New York experimenter recognizing the necessity for such screening, and fully aware of the losses suffered through the use of solid metal shielding, has developed an entirely novel screen, which completely

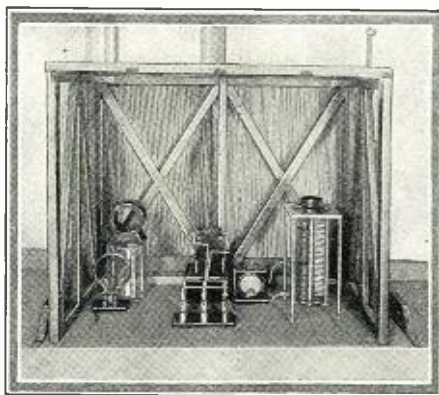

Fig. 4: A close-up of the screened cabinet, with front and bottom panels removed, showing low-loss capacities and inductances used in the tests.

quency resistance of the coil and its associated wiring; and, at the same time, such sheeting is a serious absorber of energy. That is to say, the metal shielding, both inductively and capacitatively, draws much of the feeble energy out of the high-frequency circuits of the radio receiver in which it is installed, and manifests this energy in the form of eddy currents, which are in turn dissipated in infinitesimal amounts of heat. Meanwhile, the interactions of the fields set up by these eddy currents with the fields in the wires and coils in the receiver increase

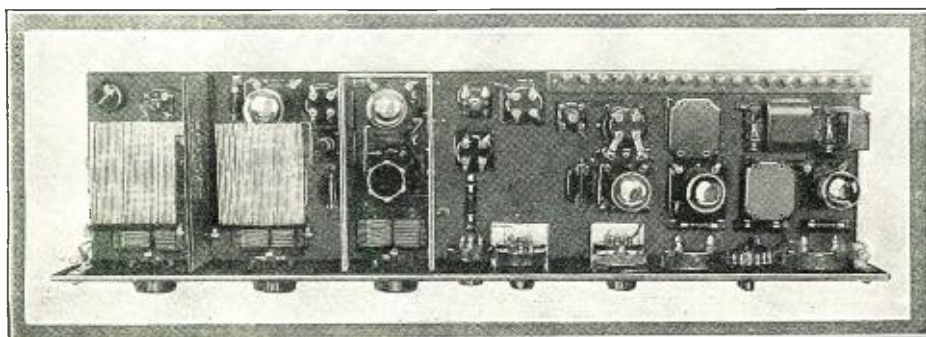
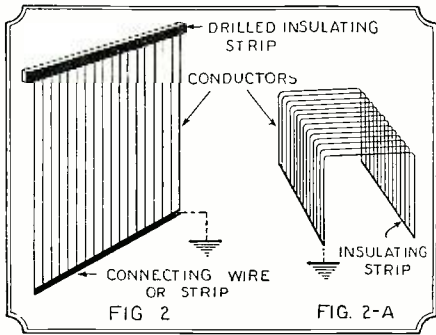

Fig. 5: A top view of a nine-tube super-heterodyne, showing use of new screen in shielded compartments containing tuned radio-frequency amplifier and oscillator coils. (Screens partly removed.)



Left: The new screen, consisting of parallel wires or rods connected and grounded at one end, and insulated elsewhere. Fig. 2-A, right: Method of bending screen-conductors to form the sides and top of a compartment in one piece. The conductors, which are connected and grounded along one end, may be separated at top and at the other end by drilled or notched strips of insulating material.

shields the receiver from outside interference, yet absorbs no energy from the circuits of the apparatus enclosed within it.

This new shield consists simply of an assembly of taut copper wires or small rigid copper rods spaced from 1/16 to 1/8 inch apart, which are all electrically connected together at one end, and insulated elsewhere, as shown in Fig. 2. The parallel conductors may be of almost any size, from No. 24 wire to rods of preferably not over 1/8 or 3/32 inch in diameter. The spacing of the parallel conductors may vary from 1/16 inch in a small shield to as much as 5/16 in a large one that does not come within three or four inches of the shielded apparatus. The electrical bond across the ends of the conductors may be either a piece of wire or a thin flat brass strip. This connector causes the complete structure to act as if it were a solid metal sheet; while the circular eddy currents that flow in metal sheeting, as sketched in Fig. 1, are effectually prevented by the gridiron construction of this new screen.

A careful test to ascertain the efficiency of this shield was made in the laboratories, using the apparatus shown in Figs. 3 and 4. A screened box was constructed, made up of six removable panels, each of which was a wooden frame supporting an assembly of parallel wires corresponding to the arrangement shown in Fig. 2. Inside this screened box was placed a radio-frequency circuit, consisting of a very low-loss inductance and capacity, which were connected to the exceedingly sensitive light-beam galvanometer shown immediately to the right of the shielded cabinet in Fig. 3.

Still farther to the right, may be seen a 50-watt tube-transmitter. With the screening partly removed, the low-loss pick-up circuit was accurately tuned to the wavelength of the transmitter, which was operating with an input of about five watts. The pick-up of the unshielded inductance and wiring was so excessive that a full-scale deflection of the beam-galvanometer was easily obtained. The panel-screens were then set up around the pick-up apparatus, with the result that the deflection of the light-beam in the galvanometer dropped to about one-tenth of the full scale reading; and when the screens were grounded it fell to zero.

APPLICATION OF SEVERE TESTS

At first glance, this would appear to demonstrate perfect shielding. But it really does not, so far; because there is a possibility that the shield may be passing energy to the enclosed apparatus and then reabsorbing it from the circuit to such an extent that the galvanometer will not deflect. Or, again, there was the possibility that the losses through resistance and leakage in the pick-up circuit itself might be dissipating the induced energy—though this contingency was guarded against as far as was practically

possible by using exceedingly low-loss apparatus. Tests were made with the transmitter and the pick-up apparatus tuned to a number of different wave-lengths, ranging from 10 to 500 meters; hence several sizes and combinations of coils were used.

In order to find out whether the zero deflection of the sensitive light-beam galvanometer was due to perfect shielding, or to absorption losses in the pick-up circuit and in the shield, the input of the vacuum-tube transmitter was gradually increased to fifty watts. If the shield were not perfectly screening the apparatus enclosed within it, the greatly increased intensity of the radiations from the transmitter only a few feet away would so increase the amount of energy in the pick-up circuit that there would again be more or less deflection of the delicate beam-galvanometer. However, the light-beam in that instrument still remained at zero, showing practically perfect screening of the low-loss apparatus within the cabinet from the powerful radiations of the fifty-watt transmitter operating scarcely six feet away, and tuned to the same frequency as the pick-up circuit inside the screen. Even when the transmitter input was forced up to more than 150 watts, the galvanometer remained undeflected.

Here we have, then, an almost perfect static screen—one that throws a real electrical shadow.

APPLIED TO A SUPER-HET RECEIVER

An actual application of this new kind of shielding is shown in Fig. 5. Here it has been used in the construction of three small compartments (the screens are partly removed for clearness of view) in an exceedingly sensitive laboratory-model nine-tube super-heterodyne, which uses a step of tuned radio-frequency ahead of the oscillator and frequency-changer. The antenna inductance of this tuned-frequency stage is enclosed in the first screened compartment, the radio-frequency transformer in the second, and the coils of the oscillator in the third. Solid copper shielding is also employed immediately behind the panel, to prevent troublesome hand-capacity effects; and no very serious losses occur here, because this shield is removed from the vicinity of any dense high-frequency fields by the interior screens.

In constructing small shielding-compartments, such as those used in this super-heterodyne, it is not necessary to build up six small panels to form the sides, ends, top, and bottom of a box, as was done in the case of the large laboratory cabinet shown in the pictures. The copper or brass wires

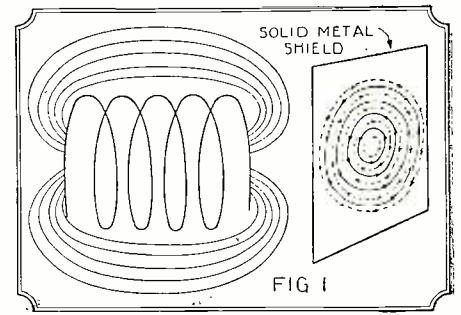

From a sketch showing eddy currents set up in solid metal shielding placed within the field of an inductance-coil.

or rods can be bent to some such form as that shown in Fig. 2-A, thereby forming the two sides and the top of the compartment. The bottom and the two ends will then require small separate panel-screens. Shielding for the interior of a good-sized cabinet, however, may be most conveniently made up in separate panels, which can then be screwed into place. Do not forget that all of these screens must be grounded.

SHIELDING A COIL

A fairly efficient enclosing screen, based on the same principle as the one I have just described, suitable for shutting in the field of a cylindrical inductance, as, for instance, a coil on a piece of tubing, can be easily made by winding a layer of double silk or double cotton-covered magnet-wire, of any convenient size from No. 18 to No. 24, immediately over the coil. One end of this outer screen-winding should be grounded; the other end is left open.

If it is desired also to screen the ends of the inductance, a flat pancake-shaped spiral may be cemented to an insulating disk which is fastened into the end of the coil tube. The outer end of the spiral is connected to the ungrounded end of the screen-winding on the coil, the inner end of the spiral being left open. This form of coil shielding, while good, is not equal to the panel-screens of parallel conductors previously described.

Metal cans, cylinders, or plates are liable to prove fatal absorbers of the feeble incoming energy on the aerial—energy so feeble, indeed, that it has been estimated that the total amount of power transferred from the big transmitter at KDKA, in Pittsburgh, to a vertical single-wire receiving antenna in California would, if continued without cessation for two thousand years, be equal to that required to lift a small fly (not an old fat one) a vertical distance of one inch.

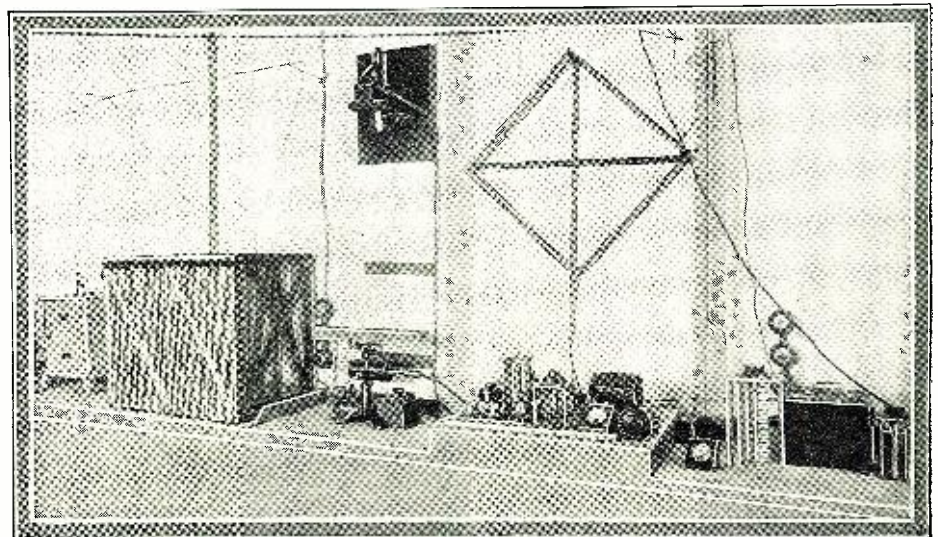

Fig. 3: Laboratory apparatus set up for testing the efficiency of the new screen. From left to right are screened cabinet containing pick-up circuits, light-beam galvanometer, 50-watt transmitter, and wave-meter.



New Developments in Radio Apparatus

By G. C. B. ROWE



ONE of the greatest gifts of Nature to mankind is dissatisfaction. This may sound more or less peculiar to many readers, but after a little thought will be found quite correct.

Let us consider for a moment and take a homely example. We will assume that the reader possessed a one-tube set several years ago. He was perfectly satisfied with it for some time, until he saw in some radio publication the specifications for a multi-tube receiver, which would do things that his would not. Dissatisfaction was thereby created. Now what happened? The chances are mighty good that the article was carefully read, some new parts purchased and a new receiver saw the light of day.

Or perhaps the set owner whom we are considering, was not so very handy with tools and did not "roll his own." In that case also dissatisfaction was created, but the reaction was different. Instead of rushing to the nearest radio store for some new parts with which to construct another and better receiver, he purchased a complete set. In either case the desire for a new set was created by the dissatisfaction induced by the article in the magazine or paper.

Then, too, there is another expression of dissatisfaction which has resulted in many wonderful things. This is the brand that has inspired inventors and research workers to delve into the unknown and produce something new. Stop a minute and think where radio broadcasting would be today, if six years ago the engineers had leaned back in their chairs, put their feet on the desk and with a satisfied sigh said, "Well, now we can send music and speech over the air, let's go shoot some golf." Or where would we be

now if thousands of men had not continued their research work on receivers and their many necessary accessories? Undoubtedly radio broadcasting and reception would be in just about the same stages that they were in back in the good old days of 1920.

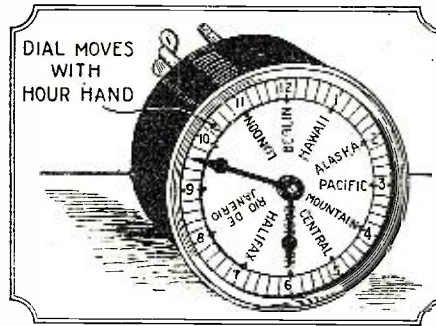

This clock is especially designed for radio fans; as it tells the time in all parts of the world. It may be mounted on a panel.

Courtesy of Geo. B. Gardner.

A RADIO CLOCK

In most of the papers which give the daily programs of the broadcast stations, the time is corrected to whatever section the paper has its largest circulation. However, in many cases, there are listeners who have to make some corrections in this time, because they live, for example, in a town where Mountain Time is used and the daily paper gives the programs in Central Standard Time.

In order to facilitate matters for the broadcast listener a special clock has been developed which will tell the time in ten dif-

ferent places. By glancing at the sketch of this clock it will be seen that there are ten locations indicated on the face. This face revolves with the hour hand of the clock and all that is necessary to do, in order to tell the time in Halifax, for example, is to use the word Halifax as the hour hand of a clock and the minute hand in the usual way. The clock is shown set for Eastern Standard Time, that is, the word Eastern is placed under the hour hand. If the clock was being used in San Francisco, for instance, the word Pacific would be placed under the shorter hand and the corrections would be automatically made.

A NEW ILLUMINATED DIAL

One of the latest results of engineering dissatisfaction is the illuminated dial shown in the accompanying illustrations. Those readers who have followed the trend of developments for the last three years are doubtless aware of the great steps forward that have been made in the design of tuning dials. Harking back again to the old days, the only dials that were available were those with a knurled knob and the degrees of a semi-circle marked on the edge. Vernier dials were undreamed of.

Then in rapid sequence came a number of dials which did many different things to the pieces of apparatus to which they were attached. Some slowed down the rotation of the apparatus, some gave the effect of a straight-line-frequency condenser with the ordinary type, and so on. Some of these dials fulfilled the claims of their makers; and some, due mostly to too complicated systems within the dial itself, did not. It seemed as if the simpler the dial the better its operation.

With this last thought in mind, apparently, the inventor of the dial shown in these columns has brought out this one. The divisions are in black on a translucent material. This translucent dial rotates behind the panel and is attached to the sleeve in which is fastened the shaft of the condenser or whatever instrument is to be rotated.

As may be seen from the illustration at the left, the figures on the rotating portion of the dial are large and therefore very easily read. However, if there is not sufficient light to read the numbers, what does it matter how easily they can be read? In order to overcome any such difficulty as this, small lights are arranged at the rear of the translucent dials so that they are illuminated and may be read in a room that is pitch dark. It need not be said that this is a great advantage, especially for the "DX hound."

Now the problem arises, how is the variable condenser or other instrument to be attached to the dial? It will be noticed that there is a slotted bar held in place by a nut and bolt, which in turn is in a slot. Also there is the sleeve in which the shaft of the condenser is fitted. The mounting holes of a variable condenser are generally placed in a triangle, and therefore two of these holes can be employed for mounting the condenser to the movable bar. The dial is fastened to the panel in two places: one at the top, where there projects a small knurled knob for turning on and off a small light for illuminating the dial; and the other is at the bottom where the knob projects which rotates

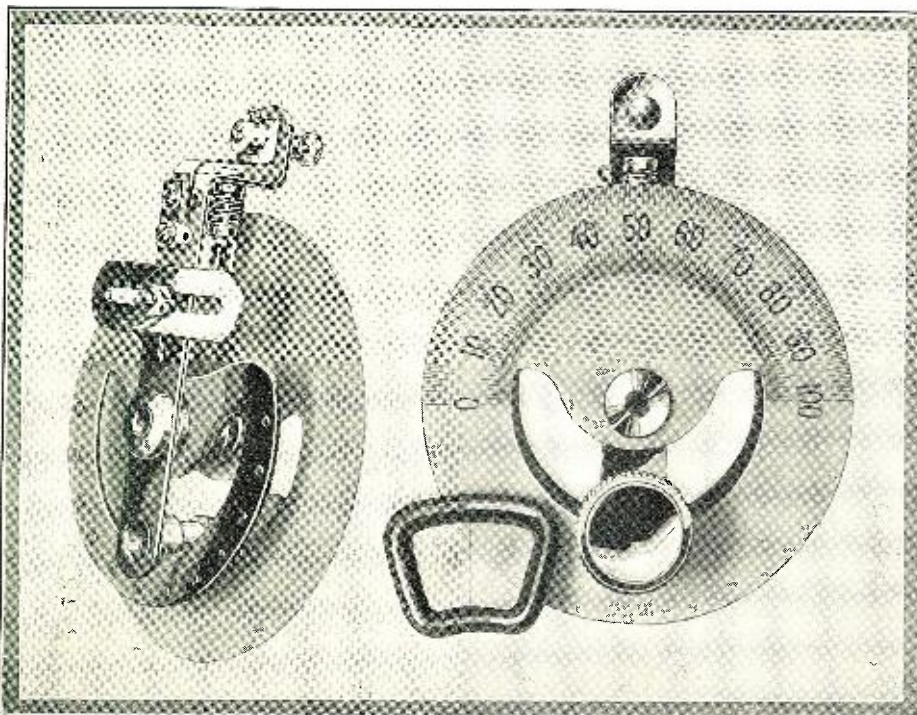

The variable condenser may be mounted on the rear of the dial, shown at the left, as described in the accompanying text. The small window is placed in the panel, behind which rotates the dial illuminated by the miniature lamp.

Photo courtesy of Martin-Copeland Co.

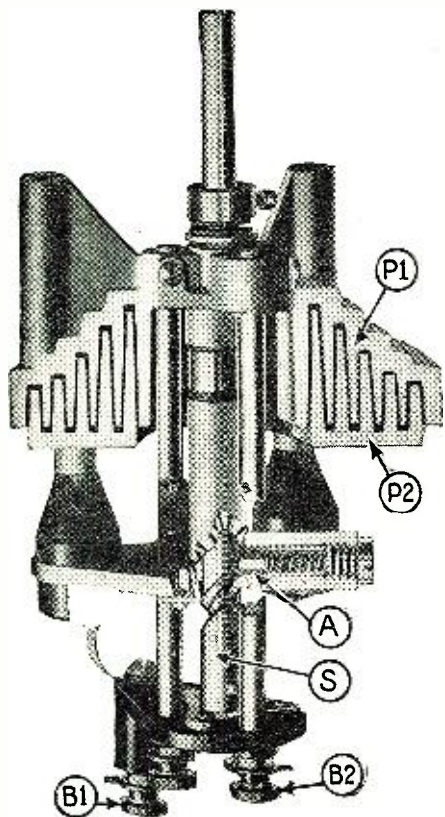

The movable plate, P2, slides in and out of P1 by turning the shaft, S. This motion is given by the stationary plug, A. B1 and B2 are the binding posts.

the dial. In this way the dial and condenser are attached to the panel with the drilling of but two holes.

As mentioned above, a fault prevalent in dials was slipping or "back-lash." This was

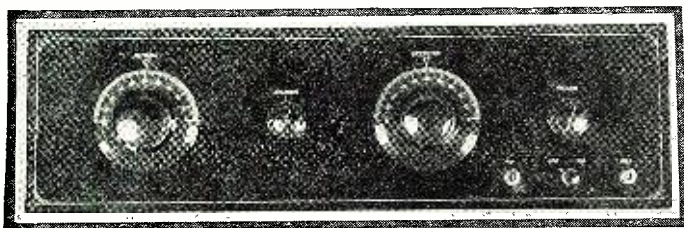

The usual three dials of a two-staged R.F. circuit are reduced to two, as shown in the accompanying illustration. On the right is the volume-control knob.
Photos courtesy of University Radio Co.

due to the play in gears, gradual wear of parts, etc., and was a real problem to the dial designer. However, in the dial under consideration, gears are dispensed with entirely. In the rear view of the dial is shown a semi-circular disc of metal; it is of two plates of metal riveted together along the outside edge, as may be seen. On the same shaft with the large knob is a small thin disc which runs between the two riveted plates and operates the system through friction.

In the illustration of the front of the dial will be seen, at the side, a small window frame, which fits into the front of the panel. On the rear of the panel behind the frame is a celluloid window on which is placed a hairline. By this means very accurate readings of the figures of the dial may be made. In order to facilitate the readings a small lamp, operating from the 6-volt battery, is placed behind the translucent dial. By means of a small switch this light can be turned off when the setting has been made.

A PLUG-IN COIL RECEIVER

In these days, when the average broadcast listener is interested chiefly in the quality of reproduction and the ease of control of a receiver, manufacturers have vied with one another to give him a set that will fulfill these and many other requirements. While

the receiver shown in the accompanying illustrations may not be the ultimate in sets, there are incorporated in it features that are quite worthy of notice.

Let us consider first the circuit used in this receiver. The five tubes are the conventional two stages of radio-frequency amplification, one of which is tuned; a detector and two stages of audio-frequency amplification. Instead of employing three tuning condensers, Henry and Lyford, the designers of the circuit, have used an iron-core radio-frequency transformer between the first and second tubes. This does away with any tuning condenser in this stage. The trouble heretofore with transformers of this type has been that there was a more or less definite peak at which, and only there, the instrument operated at maximum efficiency. This fact, when two or more transformers were used, was a great drawback, as there was only a narrow band of wavelengths where the set operated efficiently. However, with two condensers for tuning, the slight loss due to this transformer is absolutely unnoticeable.

Across the secondary of the first audio-frequency transformer there is placed a variable resistance, for controlling the volume.

An interesting feature of this receiver is the fact that there are employed plug-in coils, of a type which is unique in that they are wound on air as nearly as it is possible to do. With some type of windings it is a relatively simple matter to wind the coils "on air"; but it is another matter entirely, when it comes to winding a single layer solenoid in this manner. The wire of these coils is embedded in a very thin layer of a celluloid composition, and the whole mounted on a frame fitted with plugs which fit into sockets that are wired to the different pieces of apparatus. These coils make it possible for the fan to listen in, not only on the ordinary broadcast waveband, but to go down in the scale as low as 50 meters. It will be

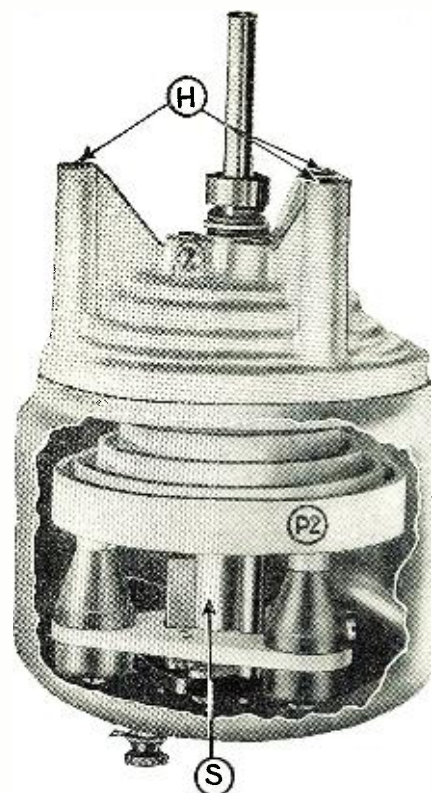

The aluminum plates of the condenser are covered by a dust-proof case in which are the mounting holes, H.

Photos courtesy of Furnell M'fg. Corp.

from that to time various types of variable condensers. An endeavor has been made to keep the reader fully informed on the progress made in the various types of condensers, in order that he may make intelligent selections when he goes into a radio store for parts for his new receiver.

In the accompanying illustrations are shown sectional views of a new type of variable condenser. The construction is interesting, as is also the manner of operation. There are two cast aluminum plates, P1 and P2, which, as may be seen from the illustration, fit into each other. The motion of P2, the movable plate, is controlled by the shaft, which is turned by the dial on the front of the panel. It will be noticed that there is a spiral groove in the shaft, in which fits the adjustable plug, A, which gives a forward and back motion to the plate, P2.

It will also be seen that the heights of the projections in the two plates are varied, those nearest the shaft being higher than those on the outer edge. This is done in order to give a straight-line-frequency effect. The movable plate is insulated from the shaft by the three pyramidal insulators. The

(Continued on page 440)

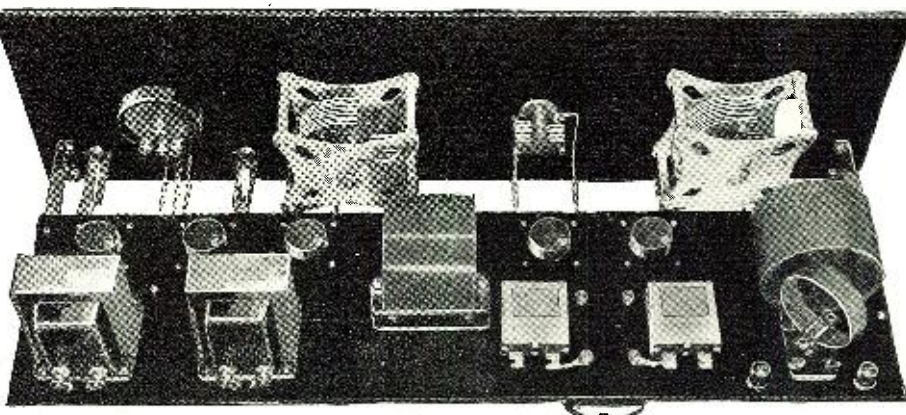

The iron-core R.F. transformer is beneath the panel and may be seen below the two fixed condensers. The coils are of the plug-in type, thus making the receiver capable of receiving on any wavelength.

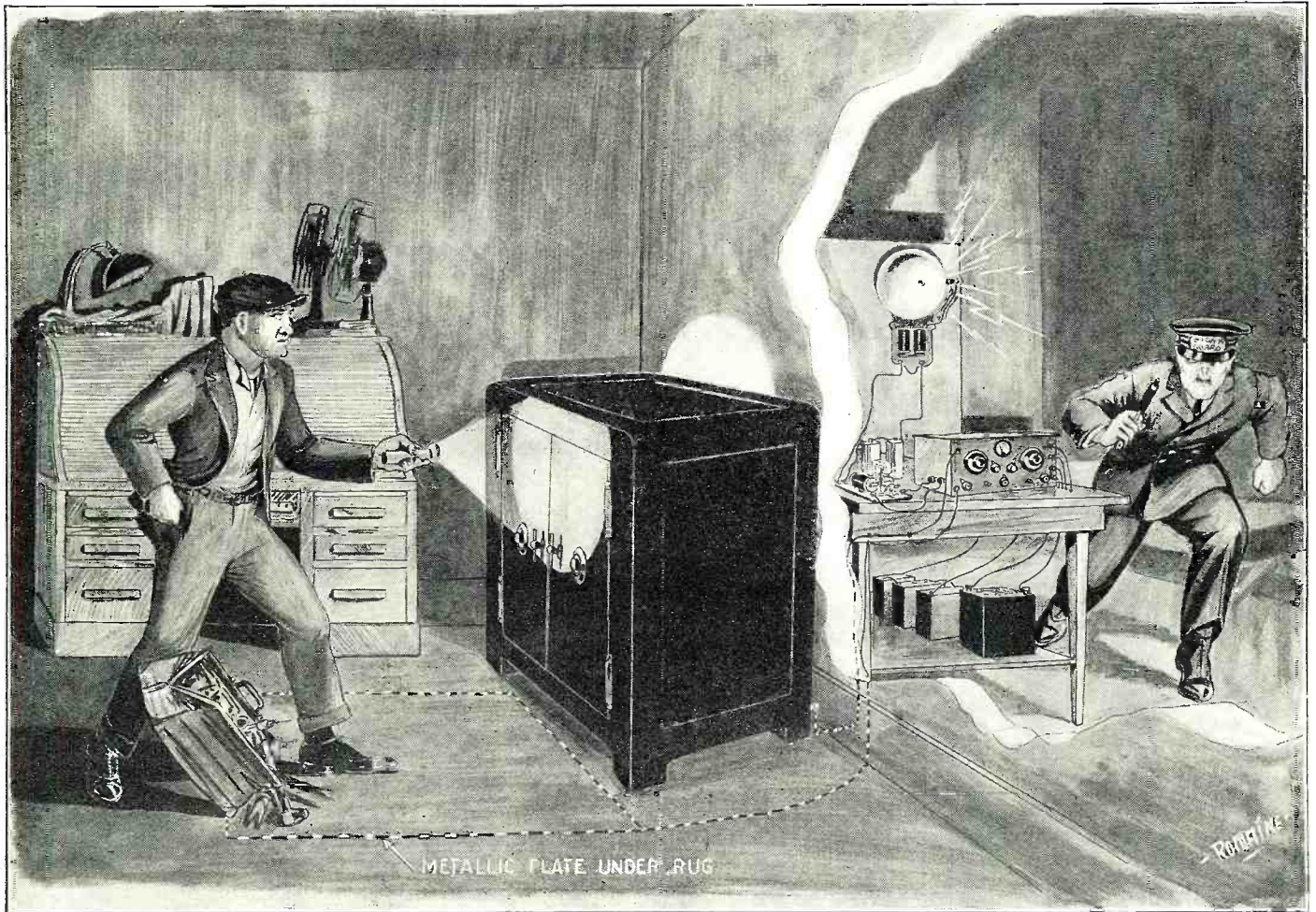

Unknown to the burglar he has altered the effective capacity of the combined safe and copper sheet under the rug, by approaching the safe. This change in capacity has in turn altered the frequency of an oscillator circuit sufficiently to function a sensitive relay.

The Radio Burglar Alarm

IT is now possible, by means of radio apparatus, to protect property effectually. By the method shown it is possible to wire safes or vaults in such a way that it is impossible to come near them without raising an alarm. Capacity effects are used throughout.

The wiring can be placed in such a manner that it is not possible even to come close to the wire without causing the alarm to go off. It is one of the cheapest and most effective burglar-alarm systems ever devised.

"How did the radio get you in your present difficulty?"

"Y' can search me, Warden. All I knows is I was a-working at my job quiet-like—there wasn't none of them electric protective signs around and it was an old-timer of a box, just as easy to open as nothing—and the lights goes on and the dick sticks a gat in my face. 'Put 'em up!' says he, and I does. 'How did you get hep to me?' says I. 'By radio' says he—and how it was done, Warden, I don't know, no more than the man in the moon! All I do know is that

radio and I ain't no friends, and I don't mean maybe."

THE INVISIBLE GUARDIAN

A new peril to the "profession," who make a living out of the safes and vaults of others, is presented by the recent invention of a radio alarm, which does not depend upon the breaking of wires to set it in operation. It is capable of concealment, so that its presence cannot be detected by the midnight visitor, no matter how thorough his preliminary survey may have been. Hereafter

(Continued on page 441)

"NO. 7146, you are charged with an unprovoked assault on No. 2214 in the performance of his duties as a trusty. What have you to say for yourself?"

"Say, Warden, that bum comes up to me an' he says, 'Well, I suppose you wants to get the radio put in your cell?' an' I just had to wipe that grin off his mug."

"What has that to do with it? All prisoners here are given the opportunity to have headsets installed for their entertainment."

"Oh, I see! Well, y' know, Warden, it was the radio that got me in here. All them New York papers had it 'Radio Traps Yegg' all over the front pages, and I just thought this bird was a-rubbing it in."

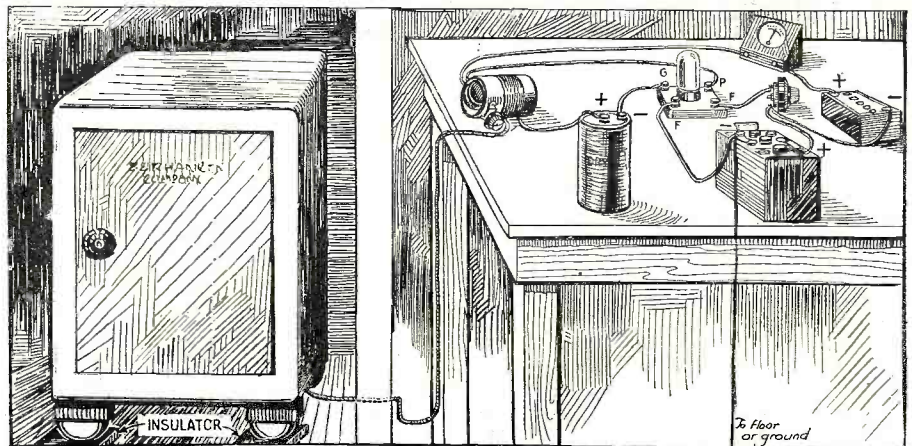

The burglar alarm described. The insulated safe and the floor of the room compose the plates of a condenser connected with the vacuum-tube-oscillator arrangement on the table.

The Manufacture of Variable High Resistances

By JOSEPH RILEY

Resistance is one of the most important factors with which we have to deal in electricity, and particularly in radio. The method of manufacturing high resistances is something that is of interest to all and Mr. Riley in this article explains how resistances of a novel type are made.

THERE is one factor in radio receivers which is at the same time a god-send and a curse—resistance. How many times have you heard the phrase, "Now we will assume that this has zero resistance—" And how often have engineers been heard to say, "If we could only get rid of this resistance we could do wonders." However, the sort of resistance in which we are chiefly interested is the former quality that was mentioned a few lines back; namely, the kind on which we like to be able to put our fingers when we want it in a hurry.

Such resistance is used in several forms, and is of both the fixed and variable variety. For instance, in series with the grid of almost all detector tubes in receivers, there will be found a resistance indicated as having a value somewhere in the neighborhood of two million ohms. The ohm, as is well known, is the unit by which resistance is measured and the megohm its big brother—a million times as big. Then we find also variable resistances employed as rheostats and potentiometers, which have values from six ohms up to many thousands.

SPECIAL DESIGN FOR RADIO

These last-mentioned resistances have undergone great modifications, along with the general advances made in radio apparatus as a whole. Formerly rheostats were of rather heavy wire, which was wound on a strip and then embedded in porcelain. They



Above is a view of the department in which the resistance strips are first tested. Much care must be exercised at this point, as the impregnated strip is the heart of the apparatus. At the left is the section where the rheostats and potentiometers are assembled.

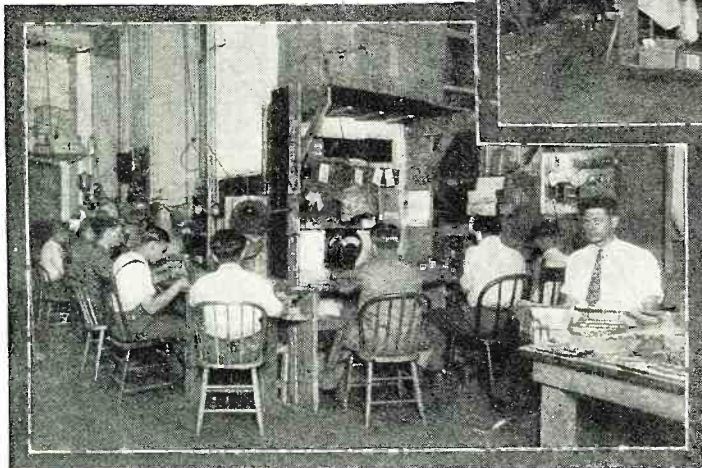

At the left are shown the operators again checking resistances when the rheostat has been finally assembled. Photos by courtesy of Electrad, Inc.

Several different types of potentiometers have been designed, but they can be divided into two main classes: those using wire for the necessary resistance and those using some other medium to obtain the same results. In the latter class may be placed the potentiometers and high resistances which employ the property of carbon which is its chief electrical advantage, i.e., its change of resistance with variation of pressure. These resistances are formed from a series of thin carbon wafers which, when pressure was applied to the ends of a pile of them, varied the resistance of the circuit.

(Continued on page 430)

were generally about four or five inches in diameter, which excluded them from incorporation in radio receivers, chiefly because of their size. Naturally engineers got busy designing new ones and found that bakelite could be substituted for porcelain and that the size could be reduced.

Potentiometers were even worse pieces of apparatus several years ago. There were many feet of comparatively fine wire, wound on a tube six or seven inches in length and about two inches in diameter. Along this wire was a rod on which a contact was slid, thus varying the amount of resistance in the circuit. It was almost an impossibility to install such an instrument in a radio receiver and therefore very soon appeared the types of potentiometer with which we are all familiar.

IMPREGNATED RESISTANCE STRIP



CONTACT WIRE WOUND AROUND STRIP

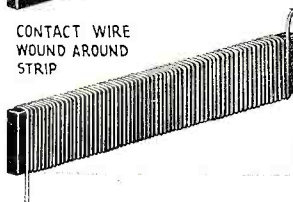

CONTACT WIRE CUT THROUGHOUT LENGTH TO AVOID SHORT-CIRCUITING RESISTANCE

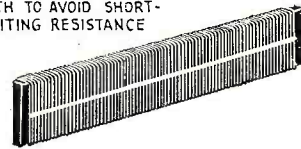

BAKELITE RING RESISTANCE STRIP CORE

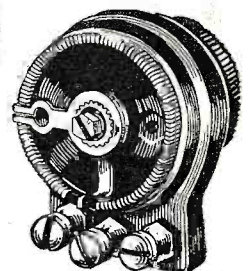
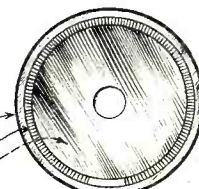

ASSEMBLED RESISTANCE

After the contact wire has been wound about the resistance strip, the wire is cut, to avoid short-circuiting the resistance. It is then assembled about a core, being held in place by a bakelite ring. The finished assembly is shown at the right.

Radio-Frequency Amplification

By EDMUND T. FLEWELLING

The author in this, the sixth of his series of articles, corrects some popular misconceptions of balancing radio-frequency circuits and shows the importance of the arrangement of parts in a receiver.

NO doubt, many who read this article have at one time or another compared reception with a single-circuit regenerator and that with two stages of tuned radio frequency; in other words, a three-tube regenerator against a typical five-tube T.R.F. set. The writer's impression is that some of them have wondered at the small difference between the two types of receivers; and also that, barring a few exceptional cases, radio frequency amplification has been rather a disappointment.

One should notice that the preceding paragraph is written in the past tense. The condition is being very rapidly improved, mostly because the American manufacturer is progressive and, of course, partly too because we are all learning more each day about R.F. amplification. This recalls an article written some time ago by Sylvan Harris, in which he referred to hashed and rehashed articles written by radio experts and others who admitted that they were engineers. The point was stressed, in this article, that every one should endeavor to secure his building and designing data from the most reliable sources. If the advice was followed by enough readers, many thousands of dollars should have been saved. The question immediately arises "How can we know that the source is reliable?" The answer is equally immediate—"When the author shows that his work is the result of measurements and not guess work, and when you know that he backs this up with sufficient experience and engineering contact."

This article is written in the hope that it too may be the means of saving a few dollars, for not only the amateur builder but, perhaps, a stray manufacturer or two. The writer has never seen the following things in print, yet they are absolutely vital to the design of radio receivers; and this article is justified because the chance is small that many of its readers have heard of these things.

BALANCING THE LOOP

Let us take, for our first example, Fig. 1. Here we have the first tube in the loop-type receiver, more commonly the first detector in one of the popular type super-heterodynes. The reader has, no doubt, in his file, many articles showing this type of connection. There are one or two in current publications. Note where the authors state, in so many words, that by connecting the center of the loop to filament and the end opposite the grid to the plate via the small variable condenser

C2, regeneration is secured, greatly sharpening the tuning and increasing the volume and distance.

As a matter of fact, the connection is designed, not for regenerative effect, but to balance the loop circuit. Fig. 2 will show upon examination how the side of the loop connected to the filament is greatly out of balance with the other side connected to the grid. The result is very poor directional properties, if any, for a loop so connected. Connections as in Fig. 1, which balance both sides of the loop, make possible the valuable direction-finding stations so much in use in marine service. If you build or own such a loop circuit, set condenser C2 at the point

neutralized circuits with this point in mind and you will readily see the point. It is much easier to get a 2- or 3-condenser T.R.F. receiver stabilized if one juggles the condensers about a bit. Move them a bit on your favorite receiver if you doubt this.

Another thing that is being impressed upon us all, more and more, is that every wire in a radio receiver has more or less effect upon that receiver's operation. This is true, no matter whether the wire be the ticklish lead to a grid, or a lowly carrier of filament current. So true is this that, unless the wiring of your receiver accidentally strikes more or less closely to a balance, the receiver will be a rank failure no matter how "low-loss" the parts used.

Commercial companies in more cases than one have the engineer or the office boy run wires in different directions, cut and try or bunch them in different formations until a more or less satisfactory result is obtained. This is especially true of receivers of the unneutralized type. The fact that 3- to 5-plate midget condensers are used ostensibly to neutralize or balance a capacity (plate-to-grid of the tube) that is but a fraction of their capacity seems to prove the point rather well. If it doesn't, however, experience soon does. Their ability to act as condenser plates and to cut and distribute, helter-skelter, lines of force around and about a radio receiver, through induction and capacity effects means the ultimate elimination of wires in receivers beyond all question to the writer's mind. His recent articles show one way in which this may be done.

Most of the above points may be of value to the average builder or experimenter; but to the more advanced builder or manufacturer we might well emphasize Lord Kelvin's saying to the effect that, unless we can measure and express our findings in numbers, we are in possession of but little knowledge and certainly have not brought our subject to a state worthy of being termed a science.

EXACTITUDE IN RADIO

The input to a tube. How much is it? The output of a tube. How much is it? Do we gain or lose in succeeding stages? Is our over-all gain what it should be? Do we gain by using low-loss parts? Do we gain by eliminating wires? Must we guess and cut and try, or can we actually measure these things and express our findings in numbers?

(Continued on page 400)

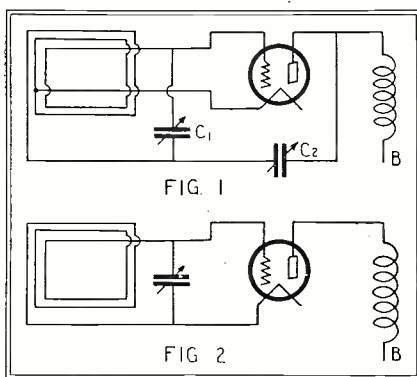

Fig. 1. The introduction of the condenser, C2, in the plate circuit is for balancing, not for regeneration. In Fig. 2 is made apparent the unbalanced condition in a super-heterodyne without such a condenser.

of best directional effects and forget about regeneration. Check this with various diagrams of neutralized circuits.

PLACEMENT OF PARTS

Next on your list comes the typical 3-condenser T.R.F. receiver. Your specifications show three dials evenly spaced along the panel. If the original receiver worked with such a layout, then the specifications should have stated the type of condensers used and the exact distances separating the condensers and between various parts in the receiver; for in no other way would you be able to duplicate at once the receiver.

Whether he knew it or not, the original designer of the receiver that you are trying to build, secured considerable neutralizing effects by the spacing or location of the three tuning condensers. Refer to some of your

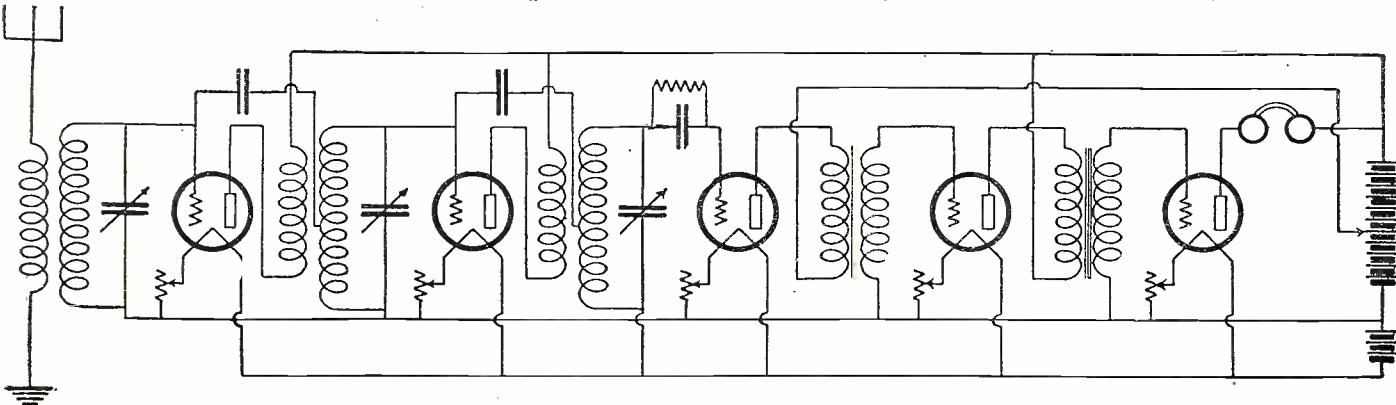

It is a T.R.F. circuit such as this to which reference is made, concerning the importance of proper placing of the variable condensers, to obtain the desired neutralization.

A New Rectifier Tube for "A-B-C" Power Units

Here is described another step forward in radio—a rectifier tube which will pass sufficient current to supply the power needs of every filament, plate and grid-bias in a receiver employing 199-type tubes.

THE development of a new type rectifier tube, termed the "BH," now makes it possible, for the first time, satisfactorily to obtain "A," "B," and "C" voltages from the A.C. light socket. The radio experimenter and set builder have long awaited the opportunity to obtain a rectifier which would have sufficient current and voltage capacity to light the filaments of 199-type radio tubes, in series, and at the same time supply sufficient plate voltage to operate a power amplifier.

The new type fulfills these requirements in a particularly satisfactory manner; and there still remains a reserve of power from which the radio set may draw at momentary overloads, without fear of burning out the tube or impairing the quality of reproduction.

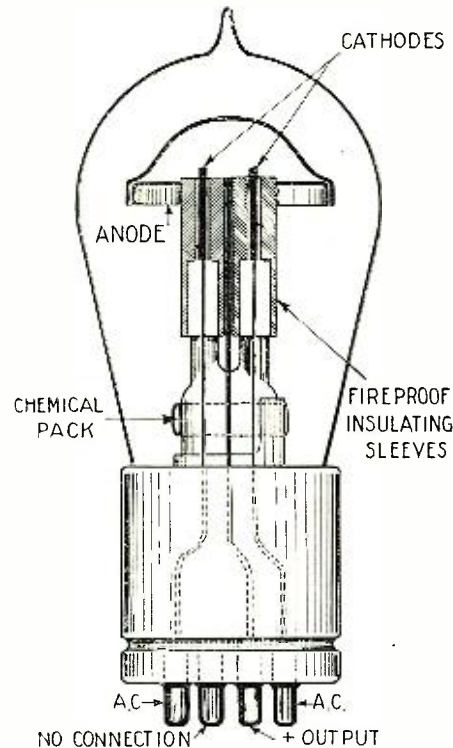

The arrangement of the elements in the new rectifier tube may be clearly seen from this sketch. The anode is connected by the center rod to the output prong; and the chemical pack to the glass stem.

Fig. 1 is a schematic drawing of an "A-B-C" power unit with the "BH" tube. The power transformer is built to supply 350 volts, on each side of the high-voltage secondary winding, at no load. The current-carrying capacity of this winding should be equal at least to 85 milliamperes; and in order to insure good regulation in keeping with that already determined by the tube, the regulation of the power transformer should be not more than 10 per cent. The power transformer has also a filament-supply winding which delivers five volts at .5 amperes for the filament of a 112 or a 171 power-amplifier tube.

FILTERING THE OUTPUT

The usual condensers of 0.1- μ f. capacity, C_1 and C_2 , are placed across each half of the transformer secondary as shown in Fig. 1. The filter circuit consists of two choke coils, L, L, capable of carrying at least 85 milliamperes D.C. and having an inductance of at least 25 henries per choke when passing this amount of D.C. Several manufacturers are now supplying such choke coils. The filter condensers are arranged as shown in Fig. 1: The first, C_3 has a 4- μ f. capacity, C_4 has 4- μ f. and C_5 has 6- μ f.

The resistance-control unit, which is used to determine the various "B" voltages for the receiver and to drop the "B+" maximum voltage to the value required by the filaments in series, presented quite a problem in its development, because practically no manufacturers of resistance units had conceived the demand for the types required particularly in the case of variable resistors. The great difficulty was to find resistors of sufficient current-carrying capacity and a wide-enough range of resistances to be of value.

The ideal unit for this service would be a variable resistor of at least 60-milliamperere current-carrying capacity with a resistance range of from 2500 to 5000 ohms. One arrangement which was used to achieve the degree of control required was a combination of a fixed 3000-ohm resistance, R_3 , in series with another fixed resistance, R_4 , of 5000 ohms, around which was shunted a third resistance, R_2 , which has a variable resistance of 2,000 ohms, maximum value.

Several potentiometers on the market will fill this requirement; although there are none yet which have been specifically designed for the circuit. The value of the remaining resistances of Fig. 1 are shown in the diagram, and are the customary "B" power-supply specifications.

The filament of the power-amplifier tube, being supplied with raw A.C. has a 400-ohm potentiometer, R_8 , connected across its terminals. The variable tap of this potentiometer is connected to "B—", and is set at such a position as to give minimum A.C. hum. The "C" voltage for the power amplifier is obtained from a variable resistor, R_7 ,

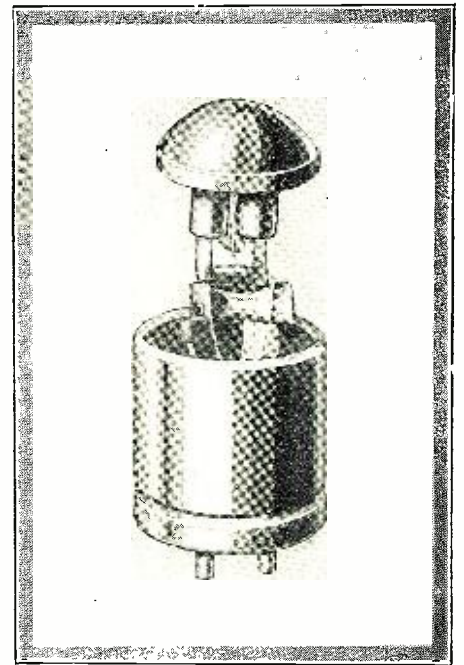

This illustration shows the elements of the new rectifier tube. The parts may be identified from the sketch at the left.

Photos by courtesy of Raytheon Mfg. Co.

connected as shown. In order to obtain 45 volts "C" from this source, it would be necessary that R_7 have a maximum resistance of at least 600 ohms.

ADDITIONAL VOLTAGE AVAILABLE

The performance of the "A-B-C" power unit is to a very great degree dependent upon characteristics of the new tube, which are of an extremely technical nature, and can best be appreciated from a comparison with other rectifiers designed for "B" power service.

For example, if a "B" power supply which has hitherto been equipped with a type "B" tube is now equipped with one of the new "BH" tubes, there will be an average increase in output from the power supply unit of 30 volts for any given radio set.

When adjustment of the radio-frequency and detector voltages is made, reducing them to their previous values, there will be a further increase in the voltage output of the power supply unit, of from five to fifteen volts. This high voltage is of course available and extremely desirable for use in connection with the power amplifier; and for this reason makes the new tube more valuable as a rectifier.

(Continued on page 447)

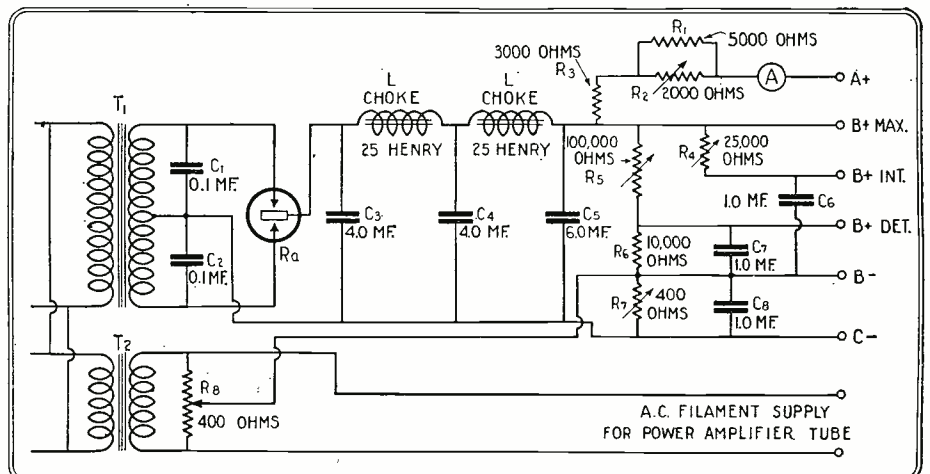

Fig. 1. The circuit diagram of an eliminator supplying "A, B and C" current to the receiving set. This is rectified by the new tube, shown above, from the 110-volt A.C. house circuit.

Permanent Radio Outlets

By J. K. McHENRY

Instead of having a long extension cord from the receiving set to an adjoining room where loud-speaker music is desired, it is a simple matter to install such attractive outlets as are described in this article.



THERE is no question that many readers find it quite desirable to operate a loud speaker at various points throughout the house; but they are not favorably impressed with the scheme of having the loud speaker on a long cord and draping the latter all over the house, when you want to listen to the speaker at a point somewhere removed from the radio receiver.

At the writer's home the radio set is located in the living room and, because the family is not always in that room, it is desirable that means be provided, at various points throughout the house, for operating a loud speaker, since we find that "radio" is an important part of our home life.

Of course, one answer is, to increase the output volume of the receiver, to such an extent that even though the loud speaker is located at one point, it can be heard all over the house, but this can hardly be expected to meet with the wholehearted approval of the neighbors. Right along this line of thought may be mentioned what one of the engineers in the same office has to say about his radio set: that his receiver provides so much pep that he had to put his loud speaker out in the kitchen and close the door on it and then go back in the living room and enjoy the concert. You see, he just couldn't hold the set back, it had so much pep. Maybe some of you have heard stories like that before.

PERMANENT SPEAKER CONNECTIONS

It seems to me that one of the best ways to take care of this problem is to have output jacks located at various desirable points throughout the house. This simply means running a twisted pair of wires from the set to the various points where you want to have an outlet. This installation should be made in a permanent manner and the outlet jacks should be made attractive.

A likely place to mount a radio jack is on the molding that runs around the door of the room in question; but in most cases the molding is not deep enough to accommodate the type of jack whose overall length is some three or more inches. There are some jacks

on the market at the present time which are ideal for the purpose at hand, however, due to the fact that they only have a depth of 1 3/8 inches.

Even with this small type of jack, it doesn't look well to mount it on the molding in an exposed condition, as this seems unfinished. For those who are interested in keeping the interior of their homes as pleasing in appearance as possible, the method used by the writer in mounting output jacks, will be most satisfactory.

What you want is a compact jack in a neat case. The illustration gives an idea of the single "outlets" and the diagram shows the method of construction.

in the construction of the "outlets" which are the basis of this short article.

- 1 Single- or double-circuit jack;
- 2 Insulating pieces, 2 1/2 x 1 3/4 x 3/4 inches (for front and back);
- 2 Insulating pieces, 2 1/2 x 1 1/2 x 3/4 inches (for the sides);
- 2 Insulating pieces, 1 1/2 x 1 1/4 x 3/4 inches (for top and bottom);
- 1 Piece of 1/16 inch brass strip, 3 1/2 x 1/2 inches;
- 14 1/2 inch No. 4-36 and 2 7-32 inch No. 4/36 flat-head brass machine screws;

On the right are presented the constructional details for a single outlet. As may be seen, the front of the outlet containing the jack, at the right, fits into the cover shown on the left.

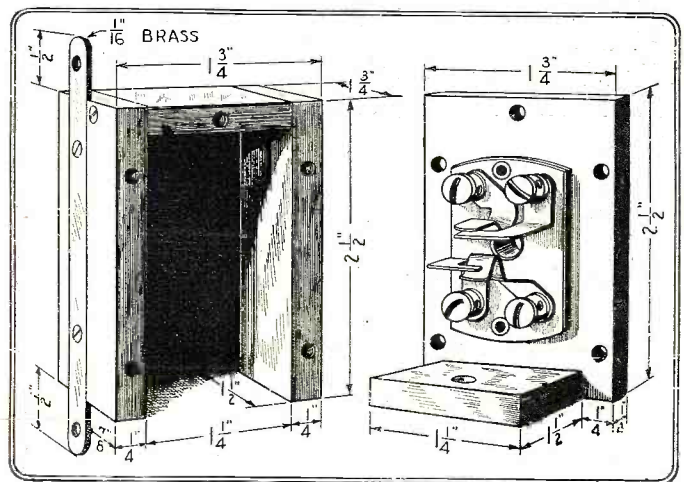

This type of jack was used because it was one of the smallest found in shopping around. There may be some that are smaller and if such is the case the writer simply didn't happen to locate them. The overall depth of this little jack is 1 3/8 inches as against 3 and 4 inches in the case of the types that have long springs for making contact with the plug.

The following is a list of the parts used

The above list is what is required for the single type of "outlet."

The edges of the pieces of composition which form the case must be "squared off" well, so that all edges will fit snugly and form square corners. This is necessary for a neat looking job since there is nothing very pleasing in the appearance of a lop-sided case.

The different insulating pieces which form the case are held together by means of the 1/2-inch No. 4/36 machine screws. The views shown give a general idea of the location of these screws, so that it is unnecessary to go into detail on this point. The holes for all these screws are drilled with a No. 31 drill and tapped with a No. 4/36 tap.

It is important to point out that the front and bottom pieces are arranged to form one complete part of the unit and the other pieces make up the second part of the assembly. This is to facilitate mounting and wiring. The bottom piece has no screws through from the sides; so all that is required, to take the completed assembly apart, is to remove the one screw which is common to the front and top pieces and the four screws that are common to the front and sides. When this is done, the assembly is separated into its two component parts.

The brass strip is attached to the surface that is to be located against the molding, the ends are rounded off and a hole drilled near each end for the mounting screws. The two 7/32 inch machine screws are used to hold the brass strip secure to the side of the case. The strip is fitted into a groove in the side of the case, so that the surface to be placed against the molding will be flat. It is necessary to drill a hole through the top or

(Continued on page 416)

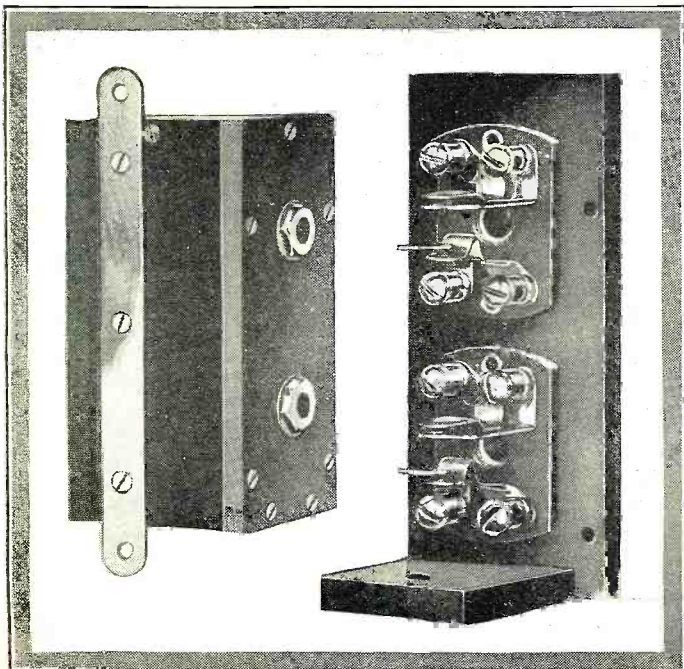

The illustration at the left shows the inside and outside of a double-jack outlet box, the details of construction being given in the accompanying text. By the use of outlets of this character and with very little effort on the constructor's part, music from the receiving set can be had in any part of the house.



“Echoing Silence”—Part II

By GEORGE B. LUDLUM

THE first part of this extraordinary story appeared in the September issue of RADIO NEWS. The narrator, a young business man, is detained by chance in a small Mid-Western country town. Attracted by the wonderful volume and quality of radio reproduction seemingly coming from a home near the outskirts of the town, he makes an investigation, and is accorded a cordial welcome by the young inventor, who tells him of an astonishing discovery in the realms of psychology.

By the waves which this unique radio set sends out from an attachment to its audio output, the sensation of hearing appears to be conveyed directly to the brain, without the intervention of the hearing organs. The waves can not be stopped nor impeded by closing the ears, no matter how tightly, so that all persons within their effective range are involuntary hearers. Music seems to fill the hearer's brain and head. Young Mr. Stebbins, the inventor, continues his explanation as this installment opens.

“ANOTHER thing that you have no doubt noticed, and which leads me to believe that the waves produced in the ether by this set are of an entirely different character from the ordinary audible sound wave, is the lack of any quality which would allow our senses to judge the directions from which the vibrations are originating. The point of origin of most ordinary sounds is determined more or less by our ears from the echoes which closely follow the disturbance, as well as by the physical shape of our ears. The fact that we cannot depend in the least upon our ears to determine from what direction these waves are coming, would indicate that they have no echo, that they lack the physical qualities of ordinary sound waves, and must

therefore be super-audible. I have not yet been able to determine the rate of their frequency, lacking as I do the micro-sensitive tools of test and measurement.

“I can safely explain a few of the salient features of my set which bring about these abnormal results without fear of your possibly duplicating my discoveries; for there is just one thing bothering me in my tests which seems to indicate that an unknown constant has entered into the make-up of one piece of apparatus, to which is due entirely the startling results you have experienced. I must frankly confess that, as with too many great discoveries, the actual results must be credited to a most fortunate accident.

“Practically all parts of the receiver, up to and including the detector are standard, and to be found in most sets of the same number of tubes. Beyond the detector but one or two minor refinements have been incorporated up to the third stage of the resistance-coupled amplifier; but it is between the second and third stages that I have branched away entirely from accepted principles with the insertion of a low-ratio audio transformer and an oversize by-pass condenser. Beyond the third stage even more radical changes and additions have been made, among which I might mention a special high-ratio transformer, a series of fixed condensers, and a special low-frequency

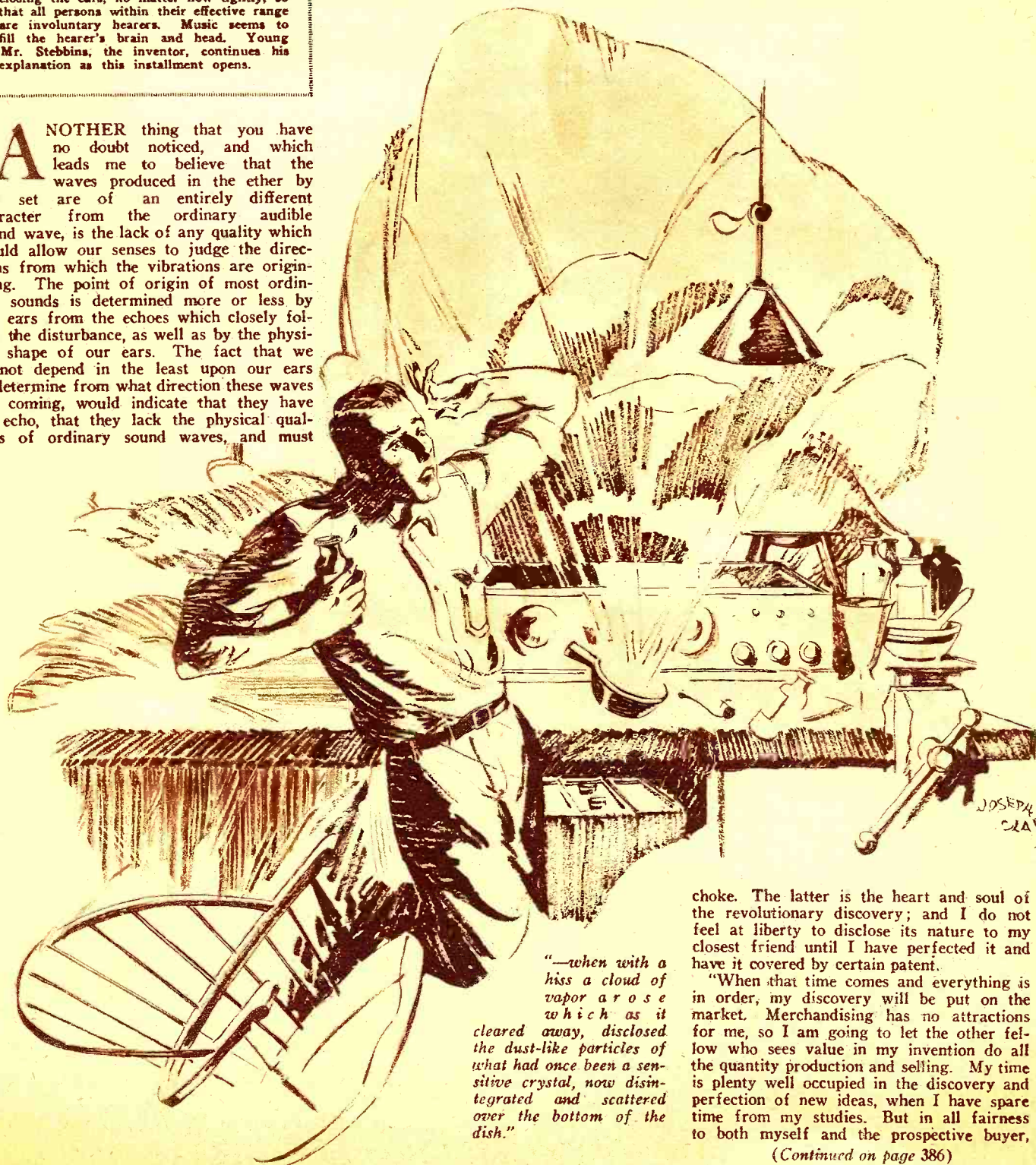

“—when with a hiss a cloud of vapor arose which as it cleared away, disclosed the dust-like particles of what had once been a sensitive crystal, now disintegrated and scattered over the bottom of the dish.”

choke. The latter is the heart and soul of the revolutionary discovery; and I do not feel at liberty to disclose its nature to my closest friend until I have perfected it and have it covered by certain patent.

“When that time comes and everything is in order, my discovery will be put on the market. Merchandising has no attractions for me, so I am going to let the other fellow who sees value in my invention do all the quantity production and selling. My time is plenty well occupied in the discovery and perfection of new ideas, when I have spare time from my studies. But in all fairness to both myself and the prospective buyer,

(Continued on page 386)

Latest Products of Radio Ingenuity

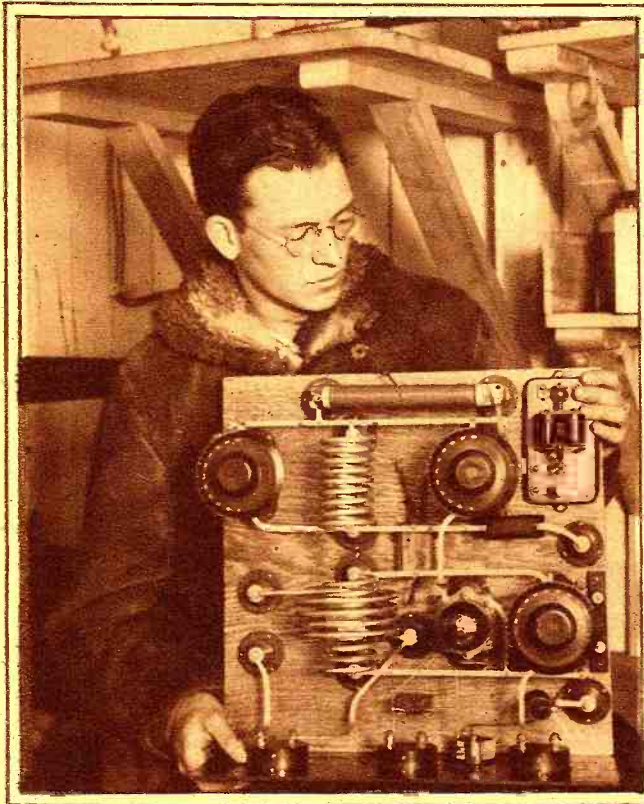

A typical Swedish radio installation is shown at the right. It is aboard the new motorship "Gripsholm," which carries a 1 kw. transmitter, designed for either code or telephone work. Notice the construction of the receiving apparatus, which is built in separate units; as shown, from right to left, they are a stage of radio-frequency amplification, detector, and two stages of audio-frequency amplification. The wavelength range is from 200 to 3000 meters.

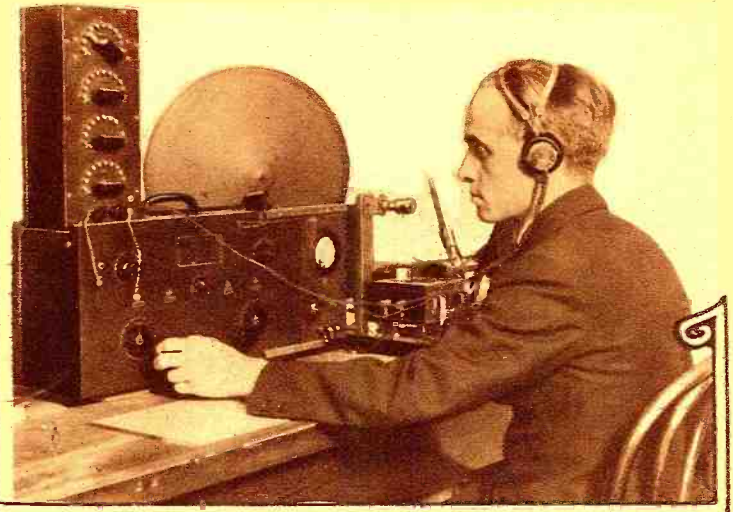

The fading of radio signals is being investigated at the Bureau of Standards. The apparatus for this investigation is shown being operated by S. S. Kirby, one of the many scientists working on radio at the Bureau. © Times Wide World.

The short wave transmitter shown at the left will be used in the Greenland Expedition of the American Museum of Natural History. This transmitter has 250 watts power and is built to operate between the wavelengths of 13 and 45 meters. © Herbert Photos.



The compact portable receiver with its loop mounted on the handlebars of the bicycle has, it is claimed, a range of 100 miles. The batteries for the set are carried in the metal case on the frame of the bicycle. Photos © Herbert, Inc.



The apparatus shown above was designed to eliminate the constant human watch for SOS signals and will respond automatically to a series of four-second dashes which, it is suggested should be used as a forerunner of all SOS calls. Above is the four-second sender, which is connected to the transmitter; at the left is the receiver and at the right the selector unit for interpreting the signals and ringing the bells in the center. © Herbert Photos.

Radio Overseas

The work of erecting a new radio tower at Tabriz, the principal business center of Persia, is shown at the upper left. Under the progressive regime of the newly-elected Shah, Reza Khan, industries are being speeded up, new factories erected, railroads and modern motor highways built; while the government will use radio almost exclusively for long-distance communications in the land of Dar-us-
© Ewing Galloway

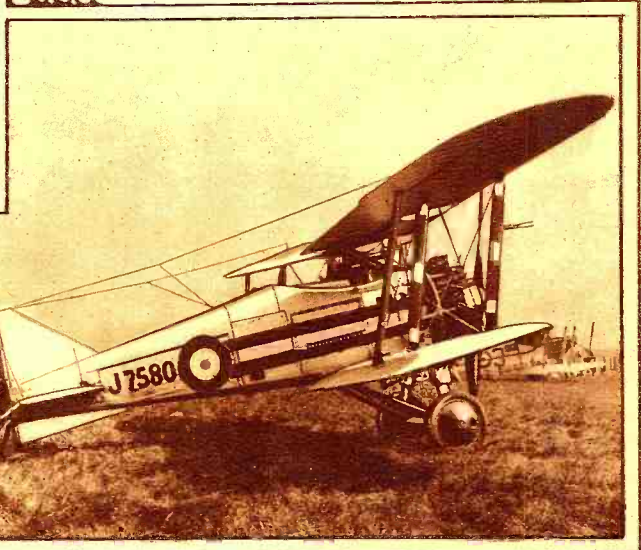
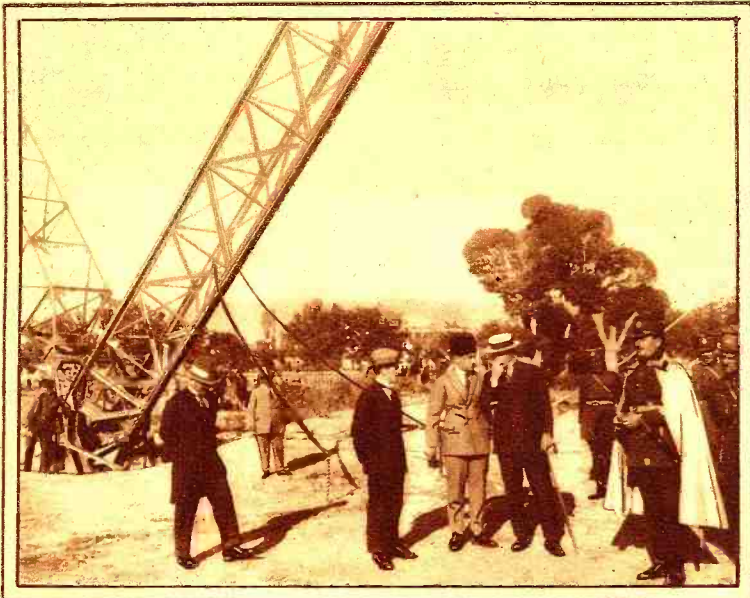

One of the planes (at right) used in a recent public demonstration at Hendon, England, of radio control of flight by aviators, commands being broadcast to the audience. This and other photos below © by Herbert Photos, Inc.

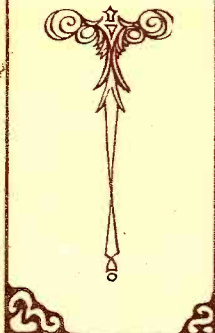
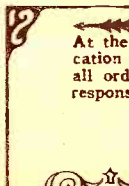

At the left, one of the loud-speaker units used at Hendon. The phone used for communication from the ground to the airplanes was connected with a system of amplifiers, so that all orders were audible to the crowd, who could watch the movements of the aircraft in response to them. At the right below is shown the battery of amplifier which furnished current to the loud-speaker units about the field.

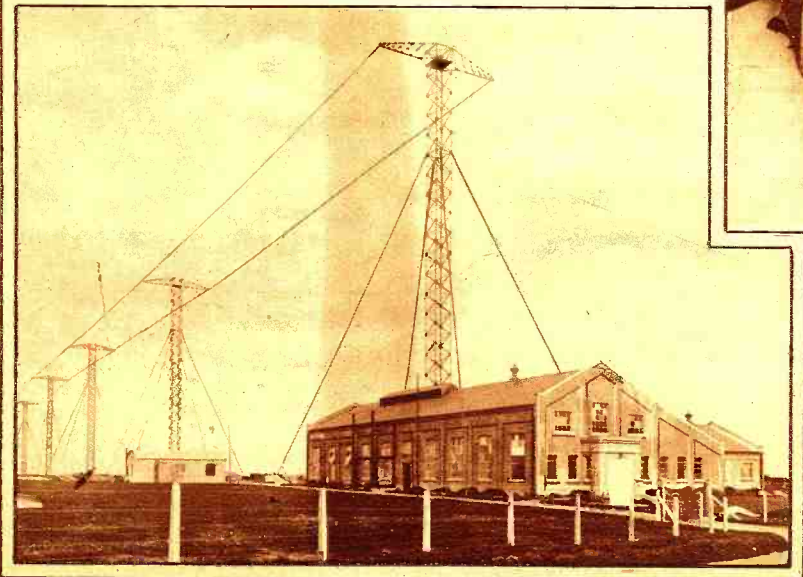
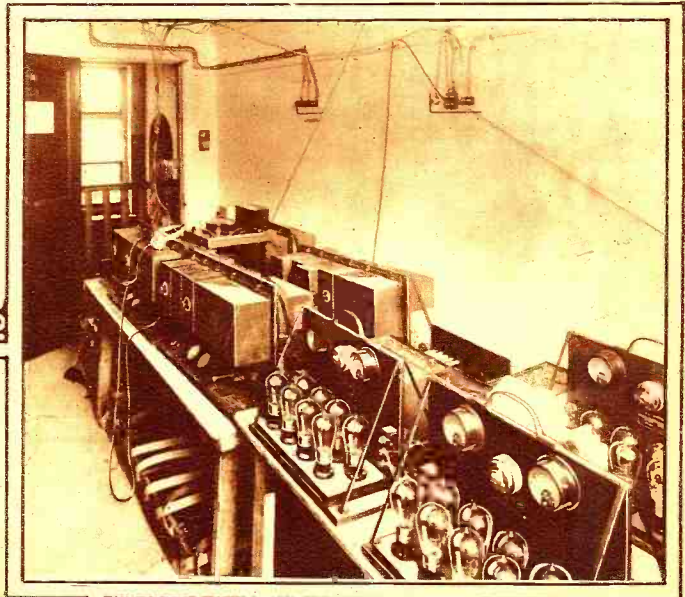

At the lower left is a view of the new Marconi beam-radio transmitting station at Dorchester, England, one of the units in a system which links Great Britain directly with her colonies. It has the largest antenna system in the world; the masts shown being 400 feet high, and spaced at distances of 600 feet. Separate stations are provided for transmission and reception. The arrangement of the system is permanent for communication between pairs of fixed stations.



CAPTAIN JACK IRWIN

Above, Captain Fonck (right) holding the antenna reel of the French transmitter which will be used; Dr. M. Lionel Stein (center) and Lieut. Snody (left). Beside the latter is the air-driven propeller and generator which gives power for the transmitter.



At left, the four-tube regenerative receiver which will be used by the party. It uses French 4-volt tubes, cushioned to absorb shock; 45 and 30 volts "B"; and has one R.F. stage, detector and two of audio.

Radio in Transatlantic Flight

By Captain JACK IRWIN, Air Corps. (Res.)

DURING the latter part of August, certainly not later than the early days of September, another attempt to cross the North Atlantic via air line will take off from Roosevelt Field, Long Island. This will be by far the most pre-tentious air journey yet undertaken since the advent of the flying machine, as its destination will be Le Bourget, Paris, a distance of 3,600 miles. The flight, if successful, will lift the standing prize offer of \$25,000, made by Mr. Raymond Orteig for a New York-Paris non-stop flight.

The expedition will be commanded by Captain René Fonck, who will be accompanied by three American Air Officers, Lieut. A. P. Snody, U.S.N., Captain Homer W. Berry and the writer. Captain Fonck is the leading French war ace, with 89 planes to his credit, while his companions on this voyage are all experienced pilots. Lieut. Snody will be responsible for the navigation and the writer will attend to radio matters.

The airplane has been designed by Mr. Igor I. Sikorsky and constructed by the company bearing his name. Its general specifications are: Span upper wing, 101 feet; span lower wing, 76 feet; total wing area, 1,095 square feet; height, 16 feet; weight empty, 8,000 lbs.

The total weight of the airplane as it takes the air for Paris will be 24,200 pounds being a loading per horsepower of 19 pounds. The weight distributed is: crew, 680 lbs.;

equipment, 490 lbs.; oil and fuel, 15,000 lbs.

The aircraft will be engined with three Gnome-Rhone-Jupiter engines of 420 H.P. each, driving tractor propellers. Owing to the use of self-compensating rudders, it is possible to fly the ship on any of three possible combinations of two motors without affecting the ease of control; while one motor will fly the ship, in the last four hours of flight.

HISTORY OF PREVIOUS FLIGHTS

Several attempts to cross the Atlantic

AS we go to press the giant airplane that will take Captain René Fonck and the writer of this story, Captain "Jack" Irwin, to Europe, has been completed, and is undergoing trial tests. By the time this issue is in your hands it is most likely that the flight across the Atlantic will have been made—we hope successfully.

Radio, as usual, has played a tremendous part in this venture. Special sets were built for the occasion, in France, and are shown here for the first time. If the trip is successful, Captain Irwin will report the complete Radio log of the trip, exclusively in next month's RADIO NEWS.

have failed, while four others have succeeded, two with lighter-than-air vessels (including one round trip) and two by heavier-than-air craft. The first attempt, resulting in failure, was that by Walter Wellman and five companions (including the writer) in the dirigible "America" in 1910. After 72 hours in the air and flying 1008 miles the airship was abandoned and the crew rescued by the steamer "Trent." The following year, 1911, under the leadership of Melvin Vaniman and sponsored by a large rubber manufacturing company, the "Akron" was constructed; but in the third test flight this dirigible exploded in the air and killed five of her crew. The writer was also a member of this crew, but fortunately for himself was absent on that fatal trial trip.

Then came 1914 and the commencement of the World War. No attempt to bridge the historic North Atlantic was made until after its termination. Then events moved rapidly. Sir Harry Hawker, an Australian, made a gallant attempt in 1919, which resulted in a forced landing at sea, when he had almost accomplished his mission. He and his navigator were rescued by the Danish fishing steamer "Mary," and turned up when hope of his survival had been lost. Following Hawker's flight, came the first successful crossing of the Atlantic by aircraft.

During the period May 16 to 27, 1919,

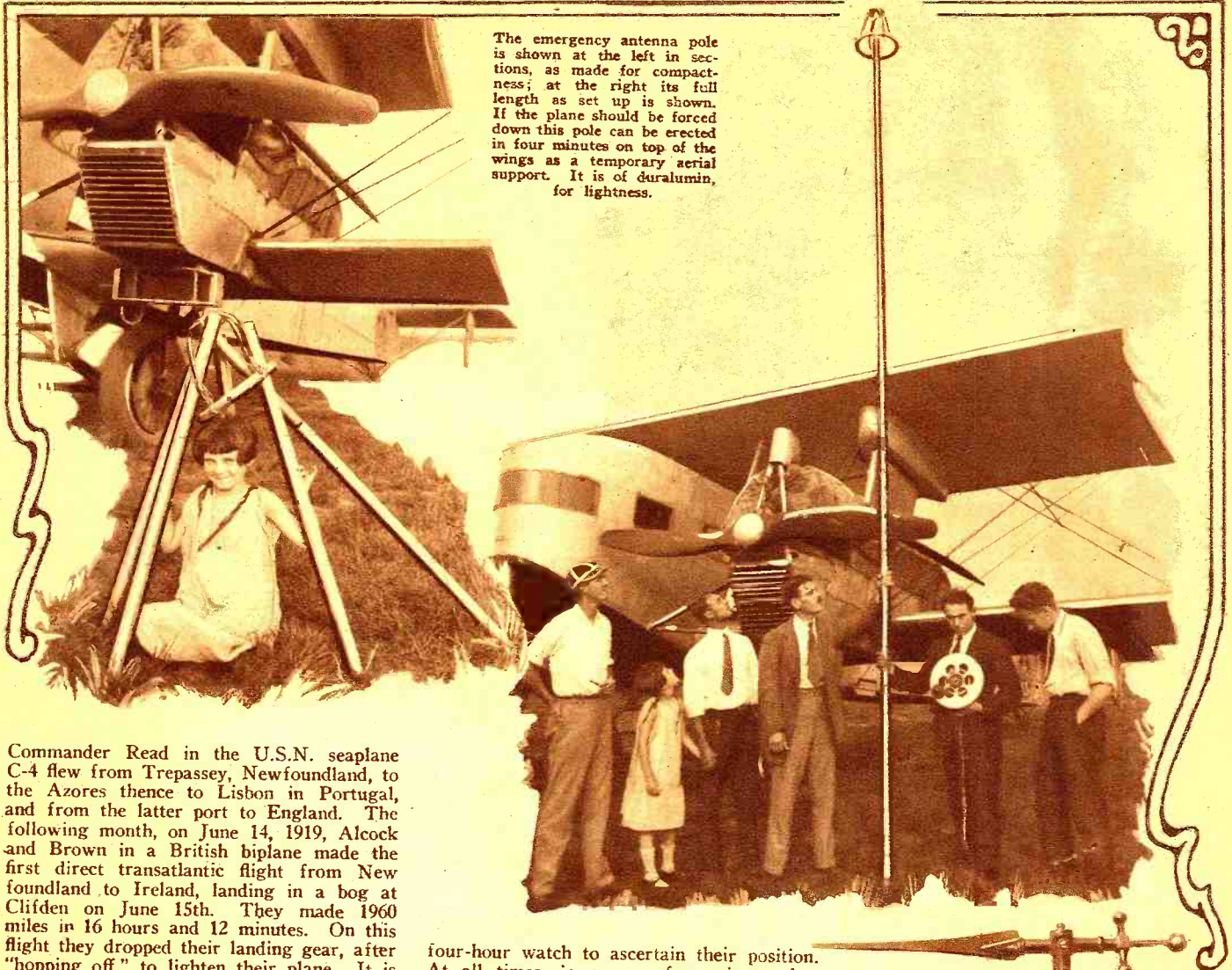

The emergency antenna pole is shown at the left in sections, as made for compactness; at the right its full length as set up is shown. If the plane should be forced down this pole can be erected in four minutes on top of the wings as a temporary aerial support. It is of duralumin, for lightness.

Commander Read in the U.S.N. seaplane C-4 flew from Trepassey, Newfoundland, to the Azores thence to Lisbon in Portugal, and from the latter port to England. The following month, on June 14, 1919, Alcock and Brown in a British biplane made the first direct transatlantic flight from Newfoundland to Ireland, landing in a bog at Clifden on June 15th. They made 1960 miles in 16 hours and 12 minutes. On this flight they dropped their landing gear, after "hopping off," to lighten their plane. It is a coincidence that Hawker, the first pilot to attempt this great feat, and Alcock, the first pilot to accomplish it, were later killed in unimportant flights.

Following Commander Read's success came the epochal round-trip of the R-34, a British dirigible commanded by Major Scott. Her flight was followed by her destruction in a routine voyage. The last successful trans-Atlantic passage through the air was by the U.S. dirigible "Los Angeles," known at the time of her flight as the ZR-3. She was constructed in Germany after the armistice and brought to this country under her own power by a German crew, accompanied by U. S. army and navy officers as observers.

USES OF THE RADIO

With the exception of the airplanes used by Hawker and Alcock, all these aircraft carried radio apparatus and used it more or less to great advantage. The airship "America" carried the first radio equipment that ever successfully maintained continuous service from aircraft to shore stations and sea-going vessels.

In the present expedition radio will be utilized to a greater extent than upon any previous occasion in the history of the art. Due to the increasing number of radio compass stations, both ashore and afloat, it will be used in an attempt to solve the ever-difficult problem of aerial navigation. Due to the great speed and the high altitudes of a transoceanic flight, the navigation of an airplane, when compared with that of a steamship, is necessarily crude. A liner, making a daily run of say 500 miles, has a dependable log to chronicle her speed and observations are made by the officers on each

four-hour watch to ascertain their position. At all times, in a very few minutes her actual position can be stated in latitude and longitude. Sights are made upon the steamer's bridge (the height of which above sea-level is accurately known) and worked out from convenient altitude tables.

Not so, however, with an airship. The same tables prepared for steamship navigation will not suffice for the high altitudes attained by an airplane. Although "altimeters" and "barographs" giving an estimate of the airplane's altitude are carried, and the tables used by sea-going navigators are extended

This is a close-up of the generator, and propeller which drives it, to furnish current for the main transmitting set. The single blade is used for better regulation of the speed, which must not vary with that of the plane.



CAPTAIN JOHN R. ("JACK") IRWIN, the writer of this story, has been associated with radio since its first application, first to seamanship, and then to aerial navigation. He served as a youth of eighteen with the Australian contingent in the Boer War, and later in Natal, emerging with three decorations.

In 1909, while at Seaconset, Mass., he received the famous "CQD" sent out by Jack Binns from the sinking "Republic," on the day that radio told the world that it had made good. In 1910 he was the radio operator on the "America" and the following year on the "Akron," in the first two attempts to cross the ocean by air, as told by him in his article. Later he was superintendent on the Pacific coast for the old Marconi Co., and during the war served in the U. S. Air Service. He has since then been engaged chiefly in radio journalism.

for use in higher altitudes, nevertheless the accuracy of sea-level navigation is unattainable in the air. Another factor is, that calculation of "drift" or "leeway" over water is more or less guess-work and its determination approximate only. Even if sights were reliable and "drift" accurately calculated, the speed of an airplane and the great distances quickly covered would necessitate constant figuring by the aerial navigator.

RADIO-COMPASS POSITION FINDING

Under the existing circumstances, therefore, we look to radio as a means of simplifying the navigational problem. During the war, and the years following, the use of the radio compass has become more universal. The coasts of the United States and the principal maritime nations are dotted with

(Continued on page 442)

Likes and Dislikes of the Radio Audience

By CHARLES D. ISAACSON, Program Director, WRNY



Florence Leshy
One of WRNY's most charming songsters and a frequent visitor.



Dick Hughes
Who, with his "uke," are regulars on WRNY programs.



Sara Bair
A lovely and melodious interpreter of song from WRNY



Harold Dart
A brilliant pianist presented at WRNY by John Adam Hugo.



Percy Memus
Great American baritone—an Edison Hour guest of WRNY



Madalaine Hunt
Star of the Radio Theatre Players who entertain you through WRNY



The SS. "Majestic" Scamps
Who provided a most enjoyable number when they went on the air recently over WRNY.

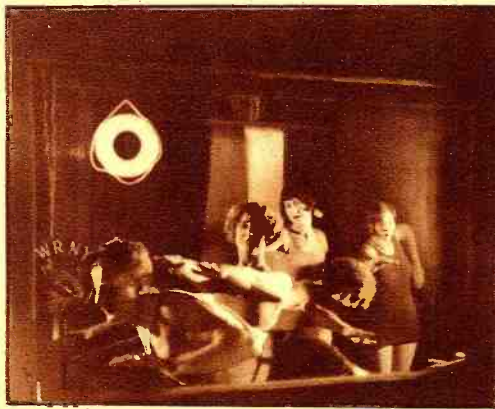

ON THE BEACH AT WRNY
Starlight Park bathers, with Comtesse Du Barry, in a frolic.



MasDowell Sisters
Who hail from Texas, often heard in soothing, soft Hawaiian music at WRNY.



Maurice Schwartz
Of the Yiddish Art Theatre, as he appears out of costume at WRNY.



Helen Hefria
A most attractive pianiste, who graces WRNY programs.



Dr. Sigmund Spaeth
has returned with his artists to WRNY.



Xavier Cugat
Violinist - artist, sketches himself for WRNY fans.



Commander Edward Ellsberg
Who told over WRNY about the raising of the S-51, is shown with Diver Nelson.

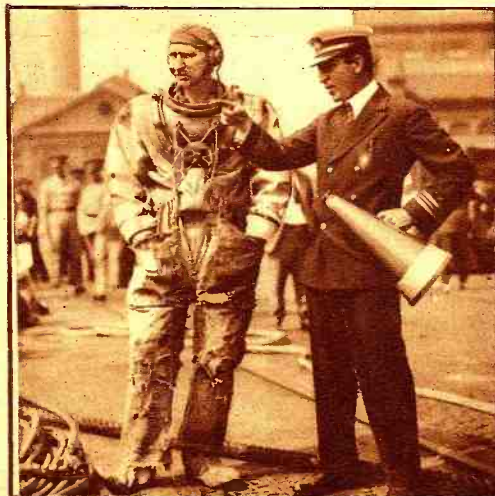

THE FIRST RADIO PRIZE FIGHT
Jimmie Rappaport and Bennie Martin, in an event staged by Starlight Park at WRNY.

THE other day a most eccentric gentleman insisted that he be given the privileges of WRNY's microphone, and assured me that there would be a great deal of money in it for me, if I would let him speak just once. He would not tell me the character of the speech, because once it was told the secret was out. He did not mistrust me, but that was the situation. Further he could not write it—once he had been nearly killed for writing something.

Of course you will at once realize that the gentleman was suffering from a very definite mental aberration. But what he said was nevertheless interesting and useful. The way I was to receive the money was this: his first speech would announce the program for his further talks. Then I would be besieged by important people who would say to me "I will pay you so much for him to be allowed to speak," and others would come with "I will pay you so much if you will prevent him from making those speeches;" and the side who offered me the most would win—there would be millions in it for me.

(Continued on page 433)

Radio News of the Month Illustrated

By GEORGE WALL

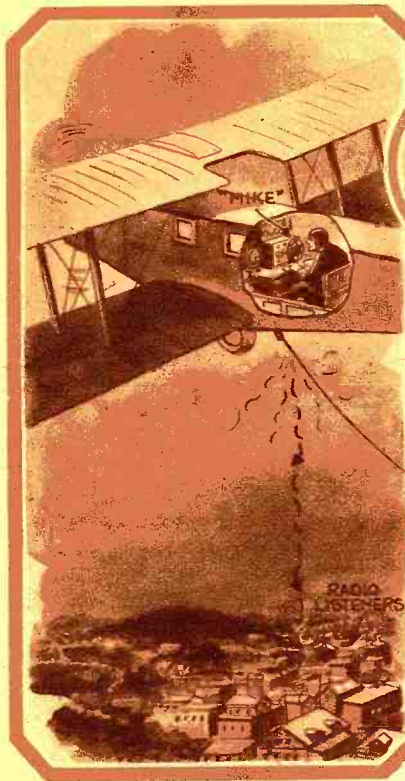

Train announcing by radio has been initiated, now that loud-speaker reception on trains is entirely successful. Entertainment furnished travelers will be punctuated by station stops.



The Milwaukee railroad system has installed a net of short-wave radio transmitters and receivers, over its lines between Chicago and Seattle, which will be especially important in emergencies.

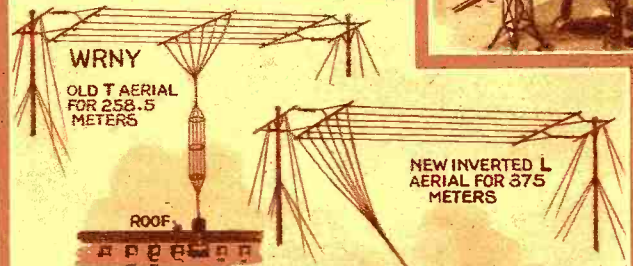

When WRNY, the RADIO NEWS broadcast station, lengthened its wave, the antenna on the Hotel Roosevelt, New York City, was lengthened proportionately by changing it to the inverted L type, in the manner shown above.

The U. S. Air Service now broadcasts from a plane in flight from McCook Field, Dayton, Ohio, where aerial radio is the subject of intensive study. These lectures, intended for the public, covered such subjects as aerial photography, the development and construction of airplanes, aircraft in peace and war, etc. Many broadcast fans have tuned in on them.

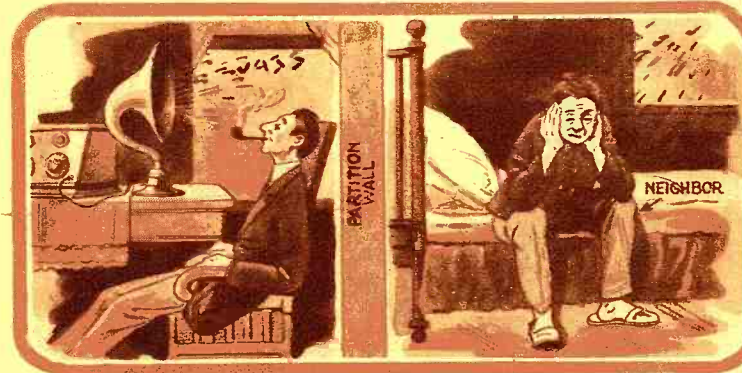

Many fans who give their neighbors the benefit of the jazz program on their loud-speakers forget that the other fellow's tastes may be for classical music, or vice versa. The municipal authorities of Reading, England, have passed an ordinance with a penalty of \$25 for disturbing the neighbors by radio.

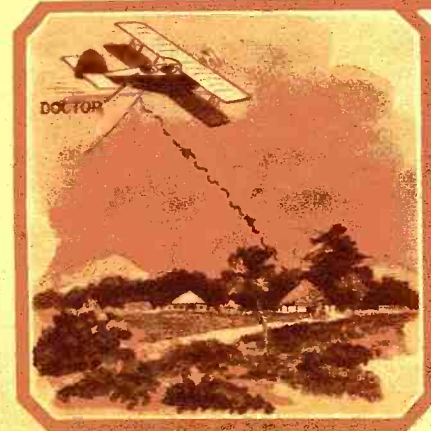

On the other hand, a Kansas farmer has attached his radio set to his wire fence, so that his neighbors may tap in with their loud-speakers. Surprisingly good results have been obtained at two miles from the receiver.



The latest development in the Coast Guard's war on Rum Row has been the use by the government forces of the radio detector. This device, which operates on the same principle as the radio compass, is used to detect vessels, which are sending suspicious messages in the neighborhood of the coast.

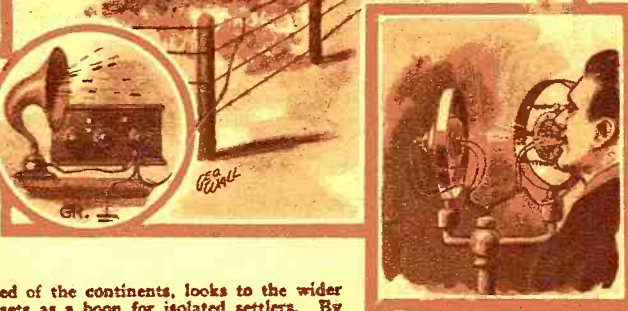

Australia, the most thinly populated of the continents, looks to the wider distribution of radio transmitting sets as a boon for isolated settlers. By these in emergency they can summon airplane assistance, which will in many cases save life.

Better transmission is obtained by the use of "binaural" microphones in broadcast stations as they receive voice or music more evenly. Two ears are better than one.

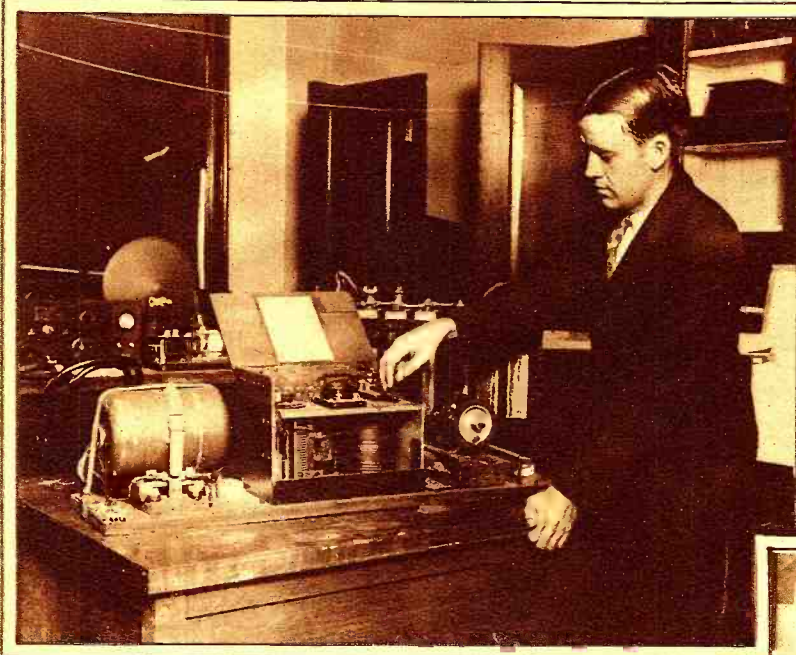

Radio Equipment for the Experts

The Bureau of Standards in its work on radio has developed a miniature transmitting station, which can be transported from place to place, for use in calibrating direction-finders on ships. This station is fully as complete in detail as a large transmitting station. F. M. Baer of the Radio Laboratory of the Bureau of Standards is shown operating the set. © P & A Photo.

Another development of the Bureau of Standards is the giant double-axis loop shown in the illustration below. Dr. Austin, the chief of the Radio Laboratory of the Bureau, has been making observations in the research into the direction changes of radio waves. © P & A Photo.

In 1922 F. W. Dunmore, of the Radio Laboratory of the Bureau of Standards, built a receiving set in a suitcase and exhibited it at an engineers' convention in Chicago. This is perhaps one of the first portable sets ever constructed. © Underwood & Underwood.

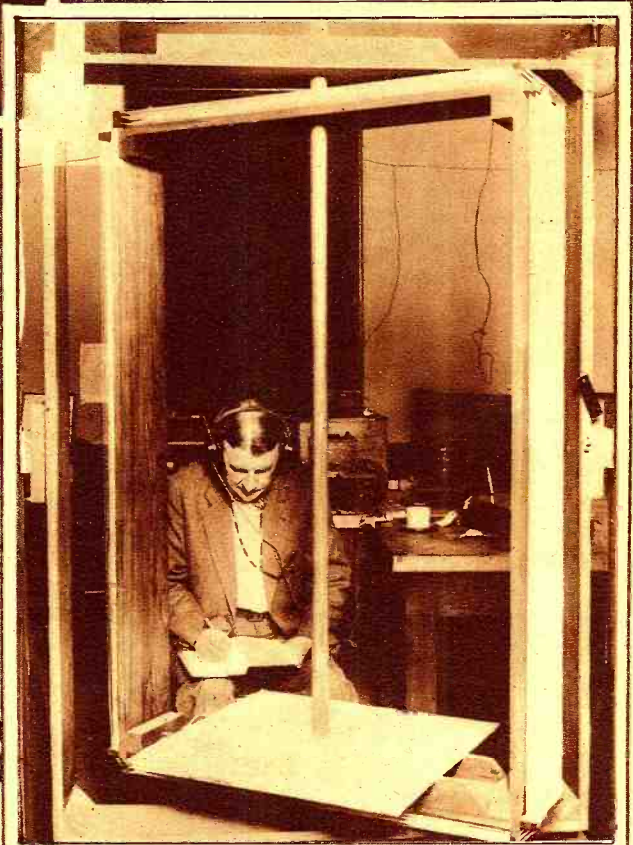

Amateur station 2-ABT is classed as one of the finest stations in the country. George Freisinger, of New York City, is the owner and he has been heard all over the United States and Europe. Mounted in the desk below is a 300-watt transmitter, at the left, and a powerful receiving set. A power-amplifier is included in the equipment, as well as an auxiliary receiver. © Herbert Photo.

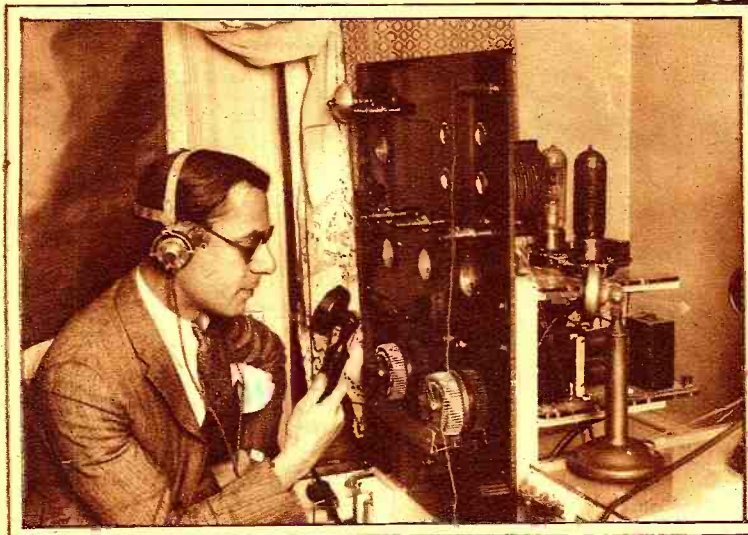

Above is a close-up of 2-ABT's 300-watt transmitter. Notice the fine workmanship in both the transmitter and receiving apparatus, in this and the illustration at the right. It is said that this station cost in the neighborhood of five thousand dollars. © Herbert Photo.

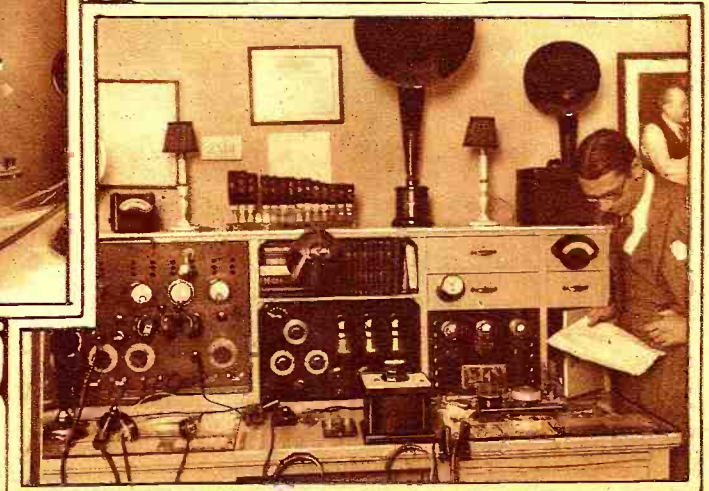

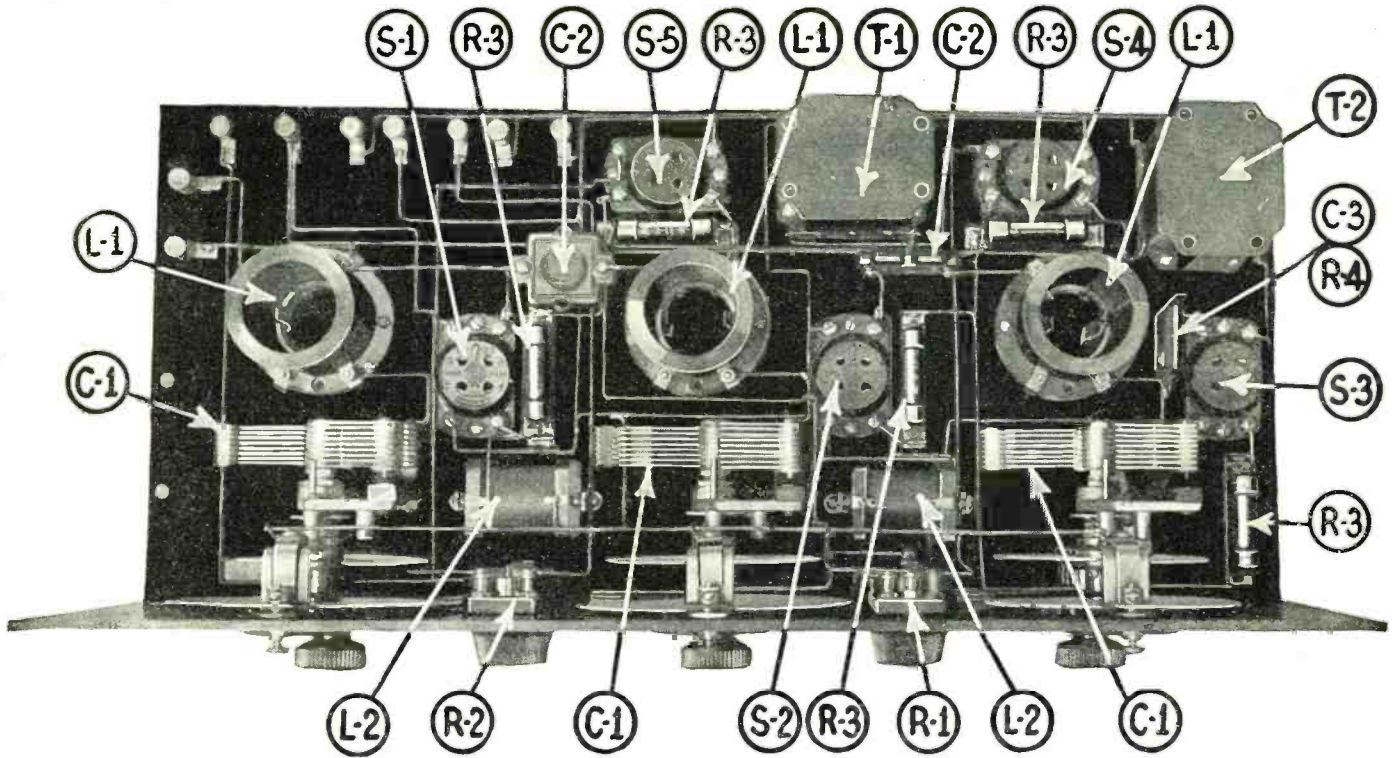

In the above illustration of the Autotransformer Receiver, C-1 indicates the variable condensers; C-2 the .001- μ f. fixed condensers; C-3 the grid condenser; L-1 the Autotransformers; L-2, the R.F. choke coils; T-1 and T-2, the A.F. transformers; R-1, the volume control, 0.5 megohms; R-2, 50,000 ohms; R-3, self-adjusting rheostats; R-4, grid leak; the various sockets marked S correspond to those in Fig. 3, which is similarly numbered.

An Autotransformer Receiver

By THEODORE H. NAKKEN

The use of autotransformers as radio-frequency transformers is a novel idea and the receiver, which Mr. Nakken has designed and described, is something new and an interesting circuit for experimentation.

FOR a long time it has been accepted generally that radio-frequency amplification must be accomplished by means of tuned-radio-frequency transformers. Such radio-frequency transformers are constructed by placing a small primary in close inductive relationship to a tuned secondary. Sometimes attempts have been made to tune both primary and secondary; but it has been impractical to apply such transformers in commercial, or even in amateur-built receivers, on account of the extremely large number of controls that would be necessary to tune such a receiver.

The generally-known explanation of the accurate functioning of such transformers lies in the fact, that the primary of the device is tuned inductively by the secondary. This causes the primary to behave as a tuned circuit and to transfer energy of the desired frequency, to which the secondary is tuned, to the latter.

EFFECT OF VARYING FREQUENCIES

However, there are different disadvantages in the use of such tuned transformers. When we calculate an inductance carefully, and construct a secondary which should, by itself, cover a certain waveband, when in conjunction with a given variable condenser, we will invariably find that the coil, when used with a primary, can not be tuned to as low a wavelength as we had calculated. This is the reason why most receivers on the market completely fail to reach the low-wavelength broadcasters.

Another, even more pronounced, disadvantage lies in the fact, that the coupling between primary and secondary decreases with the frequency. Hence it has become

almost universal practice, in commercial receivers, not to use a primary in the antenna coupling coil; but simply to make one or more taps in the antenna tuning coil, to which the antenna is directly attached. This practice affords, if anything, finer tuning and has the great advantage that the coupling of the antenna to the tuned circuit is equal at all frequencies or wavelengths for which the unit is designed; so that no falling off in volume at the lower frequencies (higher wavelengths) is experienced because of decrease in antenna coupling.

When one realizes this fact, it will become apparent why it is that, in so called neutralized receivers, there is such a decided

falling-off of volume from long-wave stations; and good reception, when attained at these wavelengths, is due to the greater power used by such stations, rather than to the efficiency of the receiver.

STABILITY VS. EFFICIENCY

Not only this, but all radio fans are familiar with the fact that almost all receivers are much more stable at the high wavelengths than at the lower ones. Now it should be realized that a perfectly stable receiver almost invariably is a highly inefficient one; because the vacuum tube is inherently an oscillator, as we all know to our great exasperation. If, then, a re-

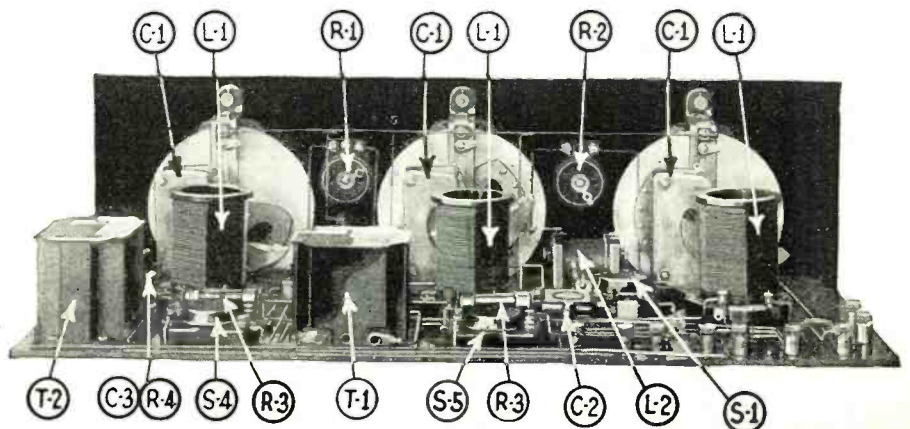

The symbols in the above illustration correspond to those on the circuit and layout diagrams. This view of the rear of the set gives an excellent idea of the arrangement of apparatus

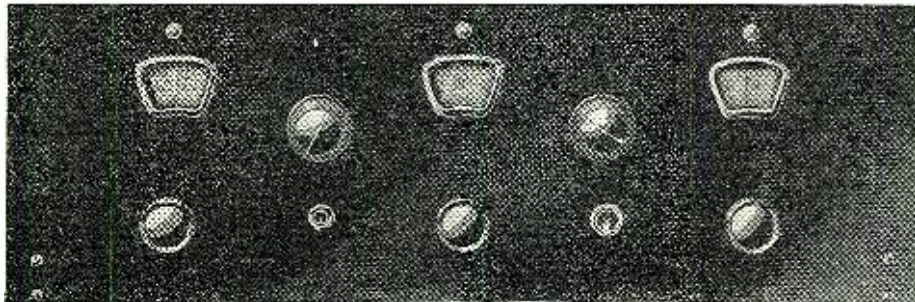

The three dials, which are seen through the small windows in the panel, are illuminated from the rear and are described on page 338. Notice the balanced panel layout.

ceiver is more stable at high wavelengths than at its lower range, it means only that at high wavelengths the receiver is less efficient. This inefficiency is directly traceable to the decrease in the coupling-factor between the primaries and secondaries.

If this is true, then it must follow that all stabilizing devices which may be used should be adjusted for the wavelengths where the receiver is most efficient—and this works almost invariably to the further disadvantage of the high wavelengths.

This remains true whether so-called

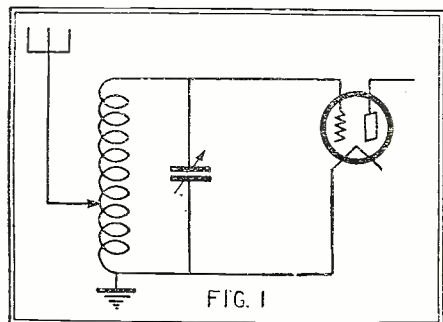

By the use of an antenna coil of this design, the coupling remains constant over the broadcast wave band.

neutralizing condensers or "lossers," as potentiometers and the like are employed. If the stabilizers are fixed, they must be adjusted for the lower wavelengths. Again, this varying coupling-factor is the reason why an adjustable balancer or stabilizer is to be preferred by far, because it enables the user to get at all wavelengths the utmost possible results from his receiver.

Yet, the adjustable stabilizing device in any of its forms is an added control, and most radio listeners would dislike to con-

stantly readjust such an additional control when searching for different stations. And this is the reason the receiver here described was designed. *No advantages other than equal efficiency over the entire wavelength range are claimed for it.*

As already mentioned, most manufacturers have adopted the practice of direct antenna coupling (see Fig. 1.) and the reason for this practice is that the coupling remains the same over the entire range. It should therefore be advantageous to adopt the same coupling method in the successive stages of the radio frequency amplifier.

However, if we were to employ such tapped inductances, we would, by the ordinary connections, apply the plate voltage directly to the grids of our various tubes; and the result would be that the receiver would be inoperative, and the tubes very soon destroyed on account of the tremendous drain on the filament. Now what we desire in the radio-frequency coils is not so much the plate voltage as the amplified radio-frequency currents; and luckily there are very simple means of forcing the latter through the circuits desired without allowing the steady plate battery current to pass through them.

THE AUTOTRANSFORMER PRINCIPLE

In Fig. 2 we have a simple circuit, which explains the method used to attain this purpose. We see a vacuum tube, the plate of which is connected to the "B" battery terminal through a radio-frequency choke, L 2. Such a choke prevents almost completely the passage of any high-frequency currents, which for this reason are compelled to find another path.

Now while a choke coil, or inductance, prevents the passage of high-frequency alternating currents, but freely allows the passage of direct current, a condenser or capacity of sufficient size, while stopping direct cur-

rents, offers very little resistance indeed to the passage of such alternating currents; so that in our sketch the radio-frequency currents, if any are present, will easily flow through condenser C 2. From this condenser a lead runs to a tap on the tuning inductance L 1. As this inductance, tuned by the variable condenser C 1, is connected to the second vacuum tube, it will be easily seen that its action will be similar to that of the antenna coupling coil in Fig. 1, and that the coupling between what might be termed primary and secondary is constant over the entire tuning range.

If, then, we build a receiver along these principles, we will have the assurance that an instrument has been constructed that is equally efficient over its entire range; and this means that once the receiver is stabilized it has not suffered in efficiency in one part at the expense of another, as invariably the case with transformer-coupled radio-frequency amplifiers.

MAKING THE COILS

After these introductory remarks, it will be very easy to understand the complete diagram of the receiver, which is shown in Fig. 3. We see three tapped inductances or autotransformers L 1, which are all of the same construction. In the receiver

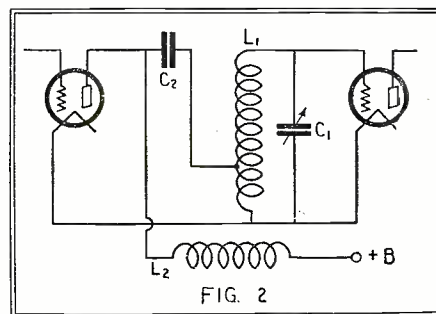

This circuit shows how plate voltage may be supplied to the tube without having it pass through the coupling device.

illustrated "plug-in coils" were used, with the winding as it is already provided on these coils for broadcast reception, except that the primary winding has been removed. If the set builder wants to construct the inductances himself, a very good autotransformer can be made by winding 70 turns of No. 26 DCC wire on tubing 2 1/2 inches in diameter and 2 1/2 inches long. As this amount of wire takes a space of 1 13/16th inches, this number of turns can be easily accommodated. The tap is made at the

(Continued on page 438)

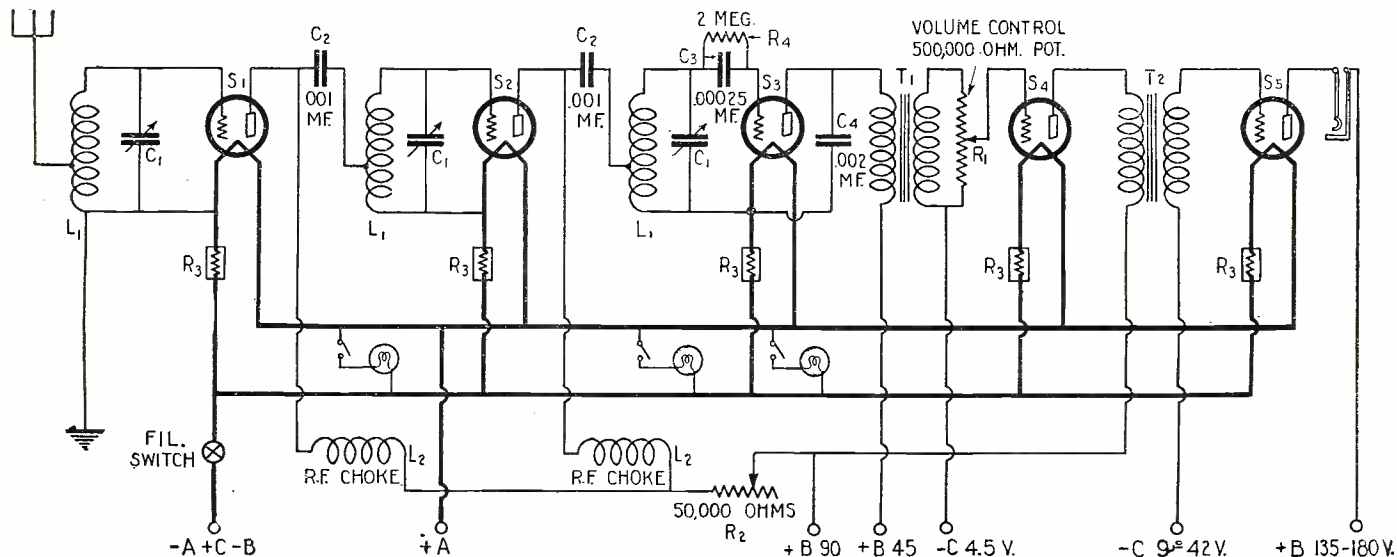
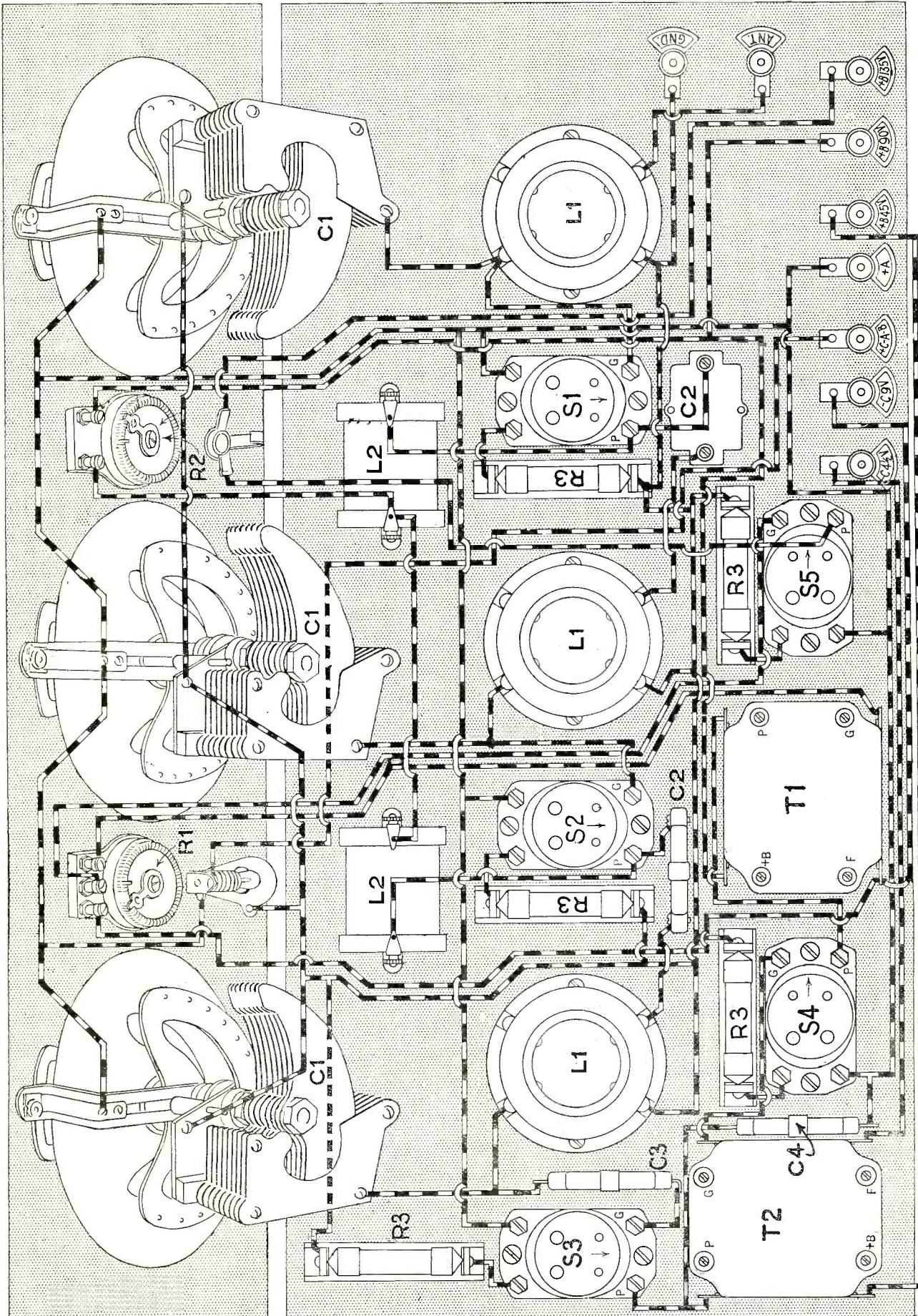
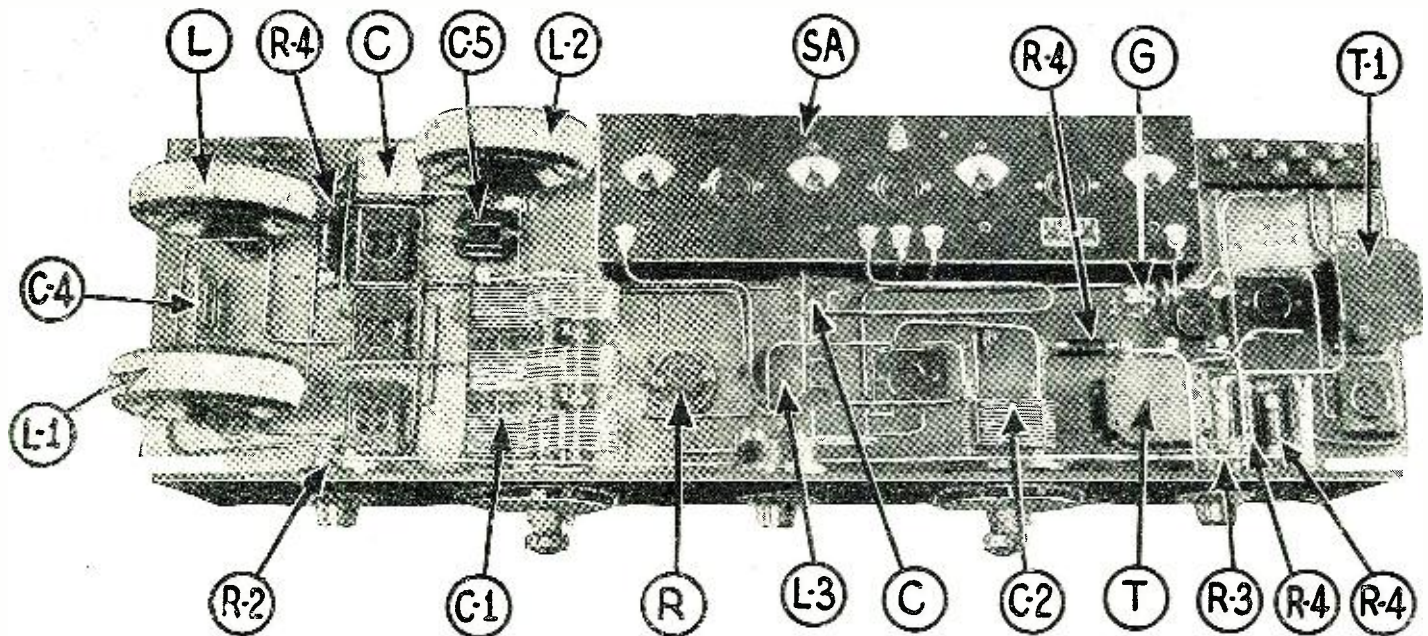

Fig. 3. This five tube receiver has, for its radio-frequency transformers, "autotransformers." The small lamps indicated across the filament circuit are behind the dials for illumination.



Panel layout view and picture wiring diagram of the Autotransformer Receiver. To obtain a symmetric effect, it would be advisable to place the three variable condensers so that their rotor plates all face in one direction. The artist changed the position of the first variable condenser. L-1 refer to the Autotransformer inductances. L-2 are .00035- μ f. variable condensers. L-3 are R.F. chokes. R-1 is a variable resistance 500 to 500,000 ohms. R-2 is a variable resistance 0 to 50,000 ohms in range. R-3 are automatic filament adjusters. R-4 is a 2-megohm grid leak. C-2 are .001- μ f. fixed condensers. C-3 is a .00025- μ f. grid condenser. C-4 is a .0005- μ f. bypass condenser. T-1 is the first stage and T-2 is a second stage audio transformer. The sockets are numbered in their respective order. S-3 is the detector.



Interior view of the Infradyne receiver. The parts are: L-1 first R.F. transformer; C-4, series antenna fixed condenser; L, antenna coil; R-4, self adjusting rheostat; C, by-pass condensers; C-5, first detector grid condenser; L-2, Second R.F. transformer; SA, Infradyne amplifier; G, grid leak; T-1, second A.F. transformer; R-3, 50,000-ohm variable resistance; T, first A.F. transformer; C-2, oscillator variable condenser; L-3, oscillator coupler; R, 30-ohm rheostat; C-1, R.F. tuning condenser unit; and R-2, 10-ohm rheostat.

The Infradyne

By HERNDON GREEN

RADIO NEWS takes pleasure in presenting to its readers a new circuit which, though similar to the super-heterodyne, has incorporated in it some striking features that immediately justify the use of the word "original."

The salient point of the Infradyne is that, instead of making use of the "difference" in frequency between the local oscillator and the incoming signal and amplifying this beat, the "sum-frequency" is utilized and amplification carried out on the very short wave of 95 meters, instead of between 3,000 and 10,000 meters as in the super-heterodyne. The result is total absence of interference from long-wave transmitting stations, arc "mush," stray heterodyning, and what is far more gratifying, the complete elimination of "harmonics," which are so prevalent in super-heterodyne receivers. A broadcast station is never picked up at more than one setting on the dials.

Combined with this circuit are two stages of tuned-radio-frequency amplification. This advantageous tie-up offers a receiver as sensitive and selective as one could wish for.

RADIO NEWS recommends this circuit to experimenters and constructors and feels sure that they will find it of extreme interest.

—EDITOR.

MANY really excellent receivers, in the last year or two, have been developed. In some of these extreme selectivity has been the aim; while in others quality of reproduction has been emphasized. All of these receivers have, however, left something to be desired; clearness and purity of tone have been perfected at the expense of selectivity, or extreme selectivity has been gained with a

sacrifice of quality. We must grant that a receiver offering extreme selectivity together with superior reproduction would have a most decided appeal to all of us. The writer believes that in the Infradyne such a receiver has been found.

ACCOMPLISHMENTS

The Infradyne is, first of all, remarkably selective. It has been easily possible to receive with this set at Oakland, California, through KGO (a 3,000-watt station transmitting on 361 meters from that city) CZE, Mexico City, on 350 meters, and KTHS, Hot Springs, Ark., on 375 meters. Likewise, WLW, transmitting on 422 meters from Cincinnati, and CFCN, a 435-meter station at Calgary, Alberta (Canada), can be received while KPO, a 1,000-watt station, is in operation on 428 meters at San Francisco.

Of equal, if not greater importance is quality of reproduction. In this connection it can only be said that this receiver is capable of well-nigh perfect reproduction, the only limitations being those which may be imposed by the loud-speaker or audio-frequency amplifier used. As large strides

have recently been made toward perfection of these very important parts of every receiver any such limitations must necessarily be slight.

A further very desirable feature of the Infradyne is quietness of operation. More will be said later of the elimination of "background noise," which has made this possible.

SHORT-WAVE AMPLIFICATION

It is natural to wonder what revolutionary departure could have been made from present practice to produce a receiver of such merit. The secret of success has been the employment of amplification at a *constant, very short wavelength*. The idea is not entirely a new one; but such amplification has heretofore been deemed impracticable, because of the difficulty of controlling energy transfer through parasitic tube capacities. While a certain amount of such energy transfer is not undesirable, lack of control has made the practical use of the method impossible. It has remained for E. M. Sargent to develop a simple and effective method to overcome obstacles which have until the present, been insurmountable.

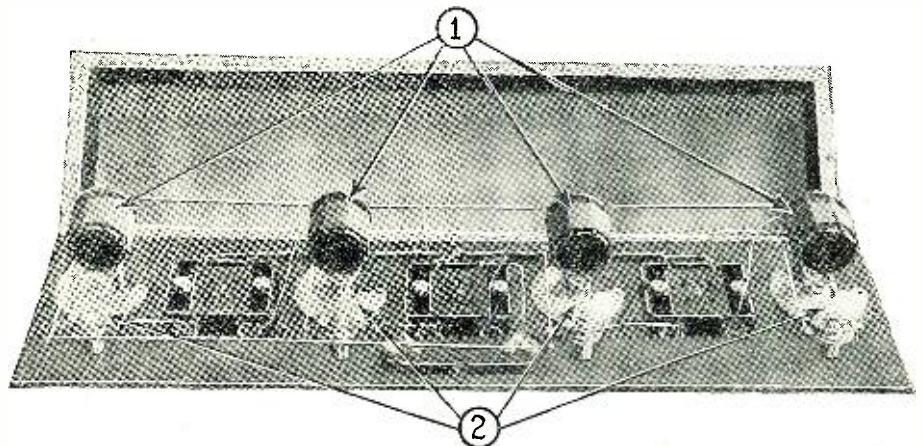

Interior view of the Infradyne amplifier, the schematic diagram of which is shown on page 380. 1 are short-wave transformers, and 2 low-capacity adjusting condensers.

The super-heterodyne and the tuned-radio-frequency receiver (in the latter of which provision is usually made for the neutralization of tube capacities) have recently enjoyed the greatest popularity. Of these, the super-heterodyne has, in the writer's opinion, offered the greatest degree of sensitivity and selectivity obtainable. A brief comparison of these circuits with the Infradyne will follow.

COMPARISON OF CIRCUITS

Let us first consider the fundamental differences in operation between the Infradyne and the super-heterodyne. As the result of the mixture of a locally-generated frequency with a received frequency, two new frequencies are generated. One of these is the *difference* or "beat" between the received and locally-generated frequencies; and the other is the *sum* of the locally-generated and received frequencies. It might be well at this point to call the reader's attention to the fact that both the "sum" and "difference" frequencies will be modulated *exactly as the incoming signal is modulated* and their amplification will therefore result in no distortion of the received music or speech.

The *beat-frequency* is that which is amplified in the super-heterodyne. It is relatively low and has been employed because it is comparatively easy to handle. The effect of parasitic capacities decreases as the frequency decreases and, therefore, fewer difficulties are met in the design of circuits to operate at the longer wavelengths. The beat-frequency, which has been chosen for

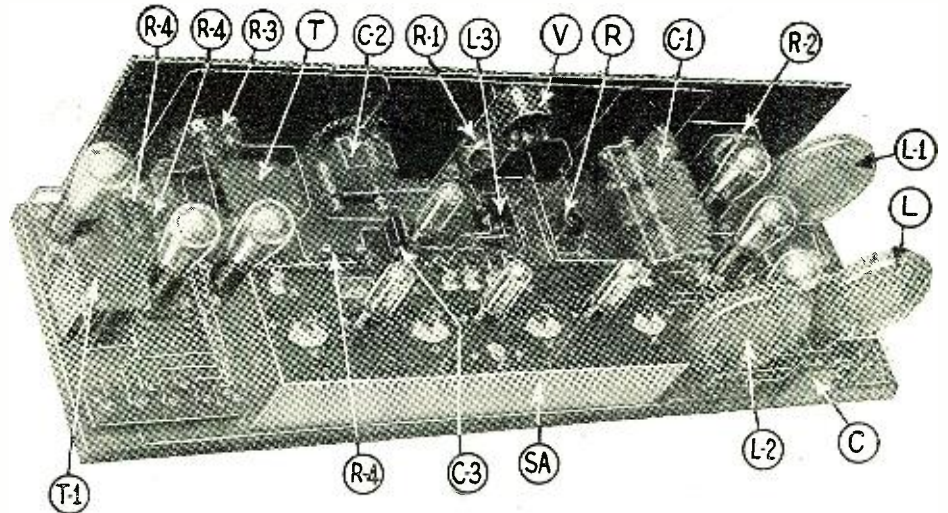

Rear view of the Infradyne set. The indicating letters correspond with those in the illustration on the opposite page, and the diagram below. Note that 199-type tubes are used in the short-wave amplifier and the oscillator.

normally, two settings of the oscillator dial for each station. Because of the value of the intermediate frequency chosen for use in the super-heterodyne, it is possible in these receivers, due to harmonics generated in the oscillator circuit, to receive certain stations in as many as six places on the dial. Additional interference and confusion have resulted through production of this relatively low intermediate frequency, as a result of

THE INFRADYNE PRINCIPLE

The "sum-frequency," resulting from the mixture of a locally-generated frequency with the received frequency, is amplified in the Infradyne. The sum-frequency employed is in the neighborhood of 3,200 kilocycles, which is equivalent to about 95 meters. The special circuit used permits maximum amplification at this frequency and perfect stability at all times. There is no tendency for circuits tuned to this very high frequency to pick up directly signals from local commercial or government long-wave stations. Because of the very high frequency of any harmonics, which might be generated in the oscillator circuit, they will not cause confusion, as in the case of the super-heterodyne.

A numerical example may serve to make this clear. The oscillator will be tuned to its highest frequency, when it is adjusted for reception of the station having the highest wavelength; and it will be tuned to its lowest frequency, when it is adjusted for reception of the station having the shortest wavelength. We will assume that the highest and lowest wavelengths to be received are, respectively, 526 meters and 200 meters. 526 meters is equivalent to a frequency of 570 kilocycles. Since the intermediate frequency to be employed is 3,200 kilocycles, the oscillator frequency will be 2,630 kc., whose second harmonic is 5,260 kc. This will obviously not *add* to any received frequency to

(Continued on page 380)

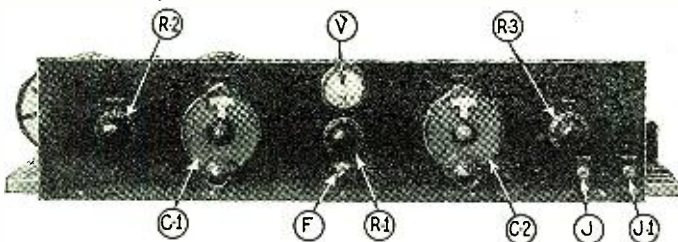

Front view of the Infradyne. V is the filament voltmeter; R-1, 30-ohm rheostat; F the filament switch; and J and J-1 the first and second stage audio stage jacks. The other letters correspond with those in the illustration above.

amplification in the super-heterodyne, has usually been in the neighborhood of 50 kilocycles. Its use has been responsible for several undesirable features common to receivers of this type.

It will be apparent that a difference of frequency equal to the intermediate frequency will be obtained for *two values* of locally-generated frequency. This condition will hold when the locally-generated frequency is 50 kilocycles *above* the received frequency and when it is 50 kilocycles *below* the received frequency. There are thus,

heterodyning between powerful stations on adjacent wavelength bands.

INTERFERENCE WITH I.F. CIRCUITS

Reception in these receivers, particularly in localities adjacent to long-wave commercial or government stations, has been further marred by direct pick-up by the intermediate amplifier circuit of long-wave signals or arc "nuish." In this connection it will be remembered that many of these stations are transmitting on wavelengths very close to those to which these intermediate amplifiers have been tuned.

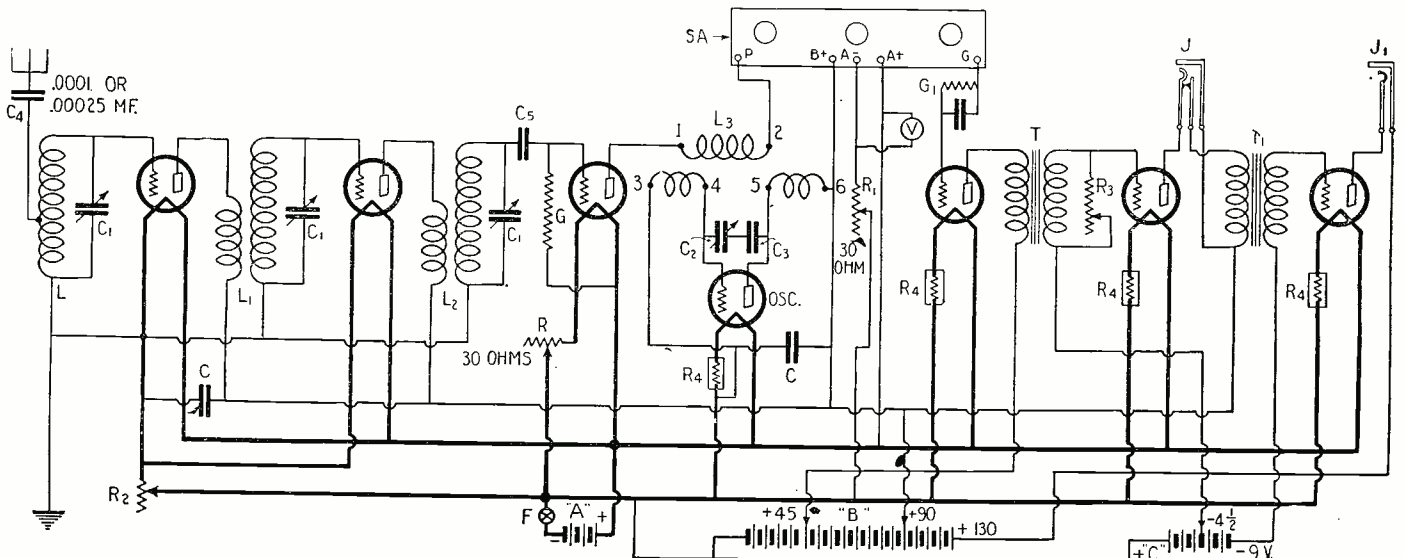

Complete circuit diagram of the Infradyne, employing a special short-wave amplifier S.A. (diagramed on page 380) and oscillator together with two stages of regular radio-frequency amplification. The indicating letters correspond to those in the illustrations.

A New Amplifier and "B" Supply Unit

By ARTHUR H. LYNCH and R. R. MAYO

It is a well-known fact that resistance-coupled amplification is one of the best types for obtaining good quality of reproduction. With an amplifier of this type is combined a "B"-supply unit, making the combination one of great utility.



THE name of Arthur H. Lynch is well known to readers of RADIO NEWS. When broadcasting first started in this country, RADIO NEWS published a great number of articles from his pen.

Mr. Lynch will be well remembered for carrying through the three International Radio Broadcast tests. He is a radio authority of note, having designed a number of meritorious radio devices for broadcast purposes.

R. R. Mayo, who collaborated with Mr. Lynch in the preparation of this article, has specialized on power-supply devices for a long time.

The staff of RADIO NEWS has made a thorough test of the power unit described here. It is an excellent device that will give satisfaction wherever used.—EDITOR.

THERE is at present but one practical method of securing well-nigh perfect audio quality. This calls for the use of a radio-frequency amplifier which does not tune sharp enough to cut side bands, and thus eliminate all the high audio notes and let only the low or bass notes come through; a radio-frequency amplifier which does not produce gain so excessive as to bring in all the local disturbances, generally known as "man-made static"; a radio-frequency amplifier that does not overload the detector; an audio-frequency amplifier with substantially straight-line-frequency characteristics and which will not be overloaded, when natural or full volume is being obtained; and a loud-speaker capable of good reproduction, when connected to a high quality audio output.

It is the purpose of this article to describe the construction and operation of a lamp-socket-operated audio-frequency amplifier, which not only gives exceptionally fine quality, but does so without resorting to the use of the high plate voltage employed in some

power amplifiers. A device of this type complies with the rules of the National Board of Fire Underwriters in that the effective value of the voltage of each of the high-voltage transformer secondaries is under 250.

POWER-AMPLIFICATION REQUIREMENTS

The last audio stage of any amplifier for broadcast reception should be of the so-called power-amplifier type, for at least two good reasons; to prevent overloading and to deliver enough actual power in watts to the

loud-speaker to operate it properly. As an amplifier of this type is not economically operated from batteries, the only practical thing to do is to construct it for lamp-socket operation. It is then but a small step further to use the same apparatus for simultaneously supplying the necessary "B" current to the rest of the radio set. In fact, the unit illustrated and described here has been used to supply the plate voltage for a super-heterodyne and has performed in a most satisfactory manner.

Fig. 4. The bottom view of the unit. Notice the constructional details of the metal base and sides. The condensers, C1 and C2, are placed beneath the base so that there will be no crowding of apparatus above. The simplicity of the cabled wiring is apparent.

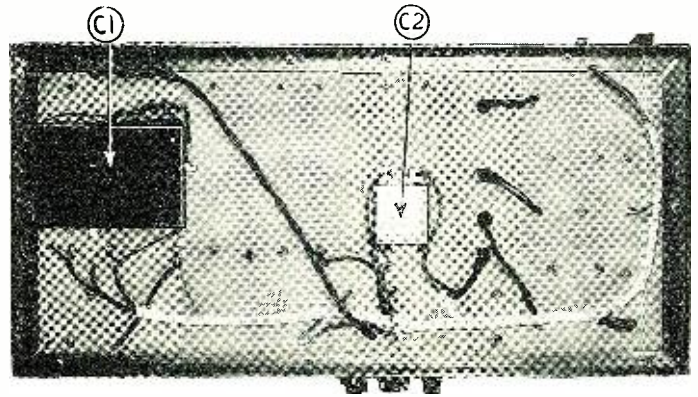

If the radio set with which the power amplifier is to be used has a high-quality first-stage amplifier, then of course the external amplifier-power unit need supply but an additional stage of amplification. There are, however, very few sets in use at present with high-grade first-stage audio ampli-

frequency amplifier and regenerative detector) Browning-Drake.

USE OF LOWER VOLTAGES

By the use of the new UX-171 or CX-371 tubes as a power amplifier, more than sufficient power to operate properly any loud-speaker at normal volume, and sufficient grid bias to prevent distortion due to overloading, is readily obtainable with the relatively low plate voltage of 180. If the larger UX-210 tube had been employed instead, a plate voltage of over 400 D.C., which is unsafe to have where anyone may accidentally come in contact with it, would have been required.

Not only is the higher voltage unsafe, but it is also more difficult to reduce to the lower values required to operate the remaining tubes, more likely to puncture the filter condensers, and is not obtainable from A.C. by means of the compact, long-lived and inexpensive double-wave rectifier tube.

Resistance coupling has been employed in the audio amplifier in order to insure the best of quality. The coupling or grid condensers are of high capacity in order to secure good amplification of even the very low notes of the musical scale.

QUALITY OF RESISTORS IMPORTANT

The use of metalized-filament or other equally good resistors is essential, if the best of quality and permanent results are to be obtained from a resistance-coupled amplifier. When the impregnated-paper grid-leak type of resistor is employed, not only is the amplifier likely to be noisy, but the ohmic resistance of the various units will be found to change gradually with use; so that after a few months the quality becomes noticeably poor. Thus, for the best of results, the resistors used in a resistance-coupled amplifier must be silent in operation and permanent in value.

An interesting experiment, which may prove to be very enlightening to some readers

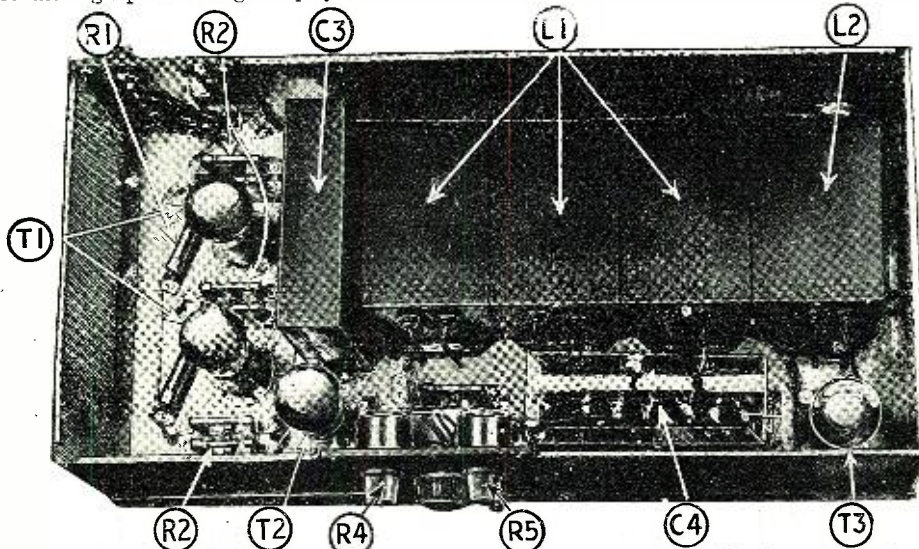

Fig. 3. Although there is much apparatus in a comparatively small space, by the arrangement used there is no crowding. The figures correspond to those on the schematic diagram and the list of parts.

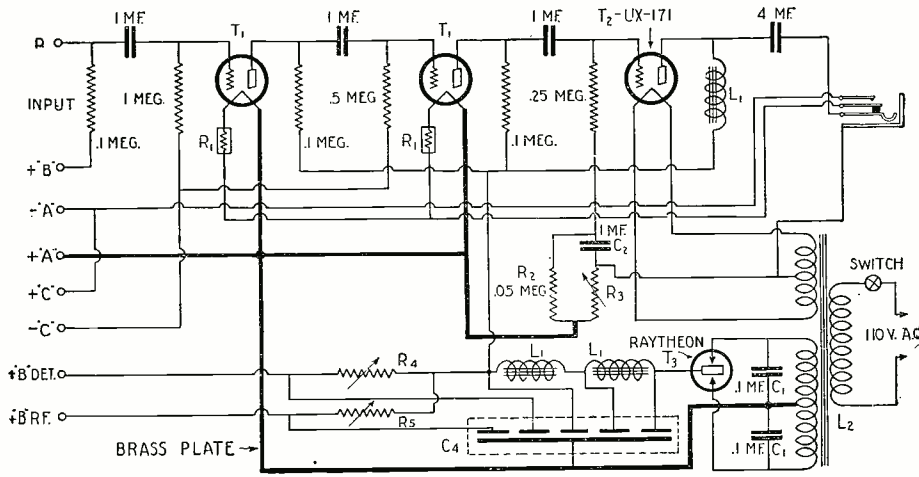

FIG. 1

The three amplifier tubes and the rectifier tube, together with the other apparatus, make this not only an excellent amplifier, but a "B" eliminator as well.

who are interested in securing noiseless resistors for radio use, is readily performed by connecting a resistor mounting and a 45-volt "B" battery in series across the input to a good audio amplifier. Different resistors are then inserted in the mounting and the resulting noises noted. It is quite obvious that in a test of this nature it is essential that all batteries as well as the amplifier itself, be in a noiseless condition.

There is another interesting experiment easily performed, which also very conclusively demonstrates the inferiority of some types of leaks. The ohmic value of the resistance of several units of both types is determined. Current is then passed through them for a few minutes and, after they have had sufficient time to cool off again, their resistance is measured. Those of high quality only will have the same resistance upon cooling as before being so used.

Filament current, for the high- μ tubes in the first two resistance-coupled stages, is obtained from the battery which heats the filaments of the radio-frequency and detector tubes in the set. Self-adjusting rheostats are used with each of the high- μ tubes to do away with unnecessary controls, and insure long tube life without the use of an expensive voltmeter. Filament current of the last audio, or power amplification, stage is obtained from the special 5-volt winding, with center tap, on the power transformer. The "B" current is obtained by means of a Raytheon-type double-wave tube, which is supplied with high voltage A.C. by the same transformer that heats the filament of the UX-171 power tube. The pulsating D.C. output of the rectifier tube is passed through a two-section filter, comprising two choke coils and a condenser block. This voltage is supplied to the plates of all three audio tubes. Lower plate voltages for the detector and radio-frequency amplifier tubes are obtained by means of the two variable resistors mounted on the small control panel. These resistors are bypassed with suitable condensers, to prevent undesirable coupling between the plates of the various tubes.

An output device, consisting of an impedance and a 4- μ f. condenser, is connected in the plate circuit of the last audio tube for several reasons. First, to secure better quality; second, to protect the speaker from damage; third, to protect anyone from a shock by contact with the exposed parts of the jack or speaker terminal; and fourth, to prevent danger of a fire, due to possible poor insulation employed in the extension cord.

NOVEL METHOD OF CONSTRUCTION

A rather novel, practical and exceedingly attractive method of construction is used in the amplifier shown in Fig. 2. It is strong mechanically, fireproof, easily constructed, and less expensive than a panel and cabinet.

In addition, the enclosed construction prevents all danger of a fire, due to short circuits, or of shock to anyone, who might otherwise touch an exposed high voltage lead. The perforated brass top and sides provide adequate ventilation. The wiring is also greatly simplified because of the brass base, which serves as a common ground connection to all transformer and condenser cases, as one of the filament leads, and as the negative side of the filter system. The heavy line in Fig. 1 indicates the lead which the brass base replaces.

Not only is the entire amplifier-power supply completely shielded by the brass case, so that it will not interfere with the proper functioning of a highly sensitive regenerative detector circuit when the amplifier and set are placed along side of each other; but, in addition the shielding of certain of the component parts, such as the chokes, power transformer and condenser blocks, with individual metal boxes, prevents these units from picking up stray magnetic flux from the power transformer. Besides acting as inter-unit shields, the metal cases greatly facilitate the assembly of the complete amplifier, as the process resolves itself, to a certain extent, to the mere placing of a number of small boxes within a larger one.

The writers wish to express their appreciation for the suggestions and assistance given them by James Millen in the construction of the model amplifier illustrated.

BUILDING THE BASE

The first step in the construction of the amplifier-power-supply unit is the hollow brass base, which is made from a piece of flat brass plate 21 x 10 x 1/16 inches, set in a frame made of one-inch angle brass. In order to obtain a neat bend at the corners, two cuts are made with a hack saw in the top part of the angle, as shown in Fig. 5. The side of the angle is then held in a vise and a square bend made. The corner is tapped gently with a hammer while bending, to secure a neat job. Care should be taken not to scratch the brass with the vise or the hammer. If the cuts in the upper side of the brass strip have been carefully made, the top of the corner will just close. If the edges do not meet, then the work has been carelessly done; but with a little more effort and some practice perfect corners will soon result. A poor corner on the base is of no great importance as it is not exposed to view; and by practicing on the corners of the base, very little difficulty will be had in securing a neat top. Any small irregularities in the cuts made at the corners may be readily concealed by filling with solder and then filing smooth.

Another frame of one-half inch angle brass, with horizontal side down, is made and placed on the top of the base. The base plate and two angle frames are then properly lined up, squared at the corners, and clamped together. A series of holes are then drilled, about three inches apart, around the entire edge of the base, for the 6-32 round head machine screws that are to hold the three pieces together.

ASSEMBLY OF PARTS

After the brass base has been completed, the various parts should be placed upon it in the manner shown in Fig. 3. It will be found that such an arrangement of the different parts will result in short leads and simplified wiring. When the parts have been arranged in their proper positions, the locations of the holes in the base for mounting and for leads to pass through are marked. The parts are then removed and all of the marks center-punched.

(Continued on page 426)

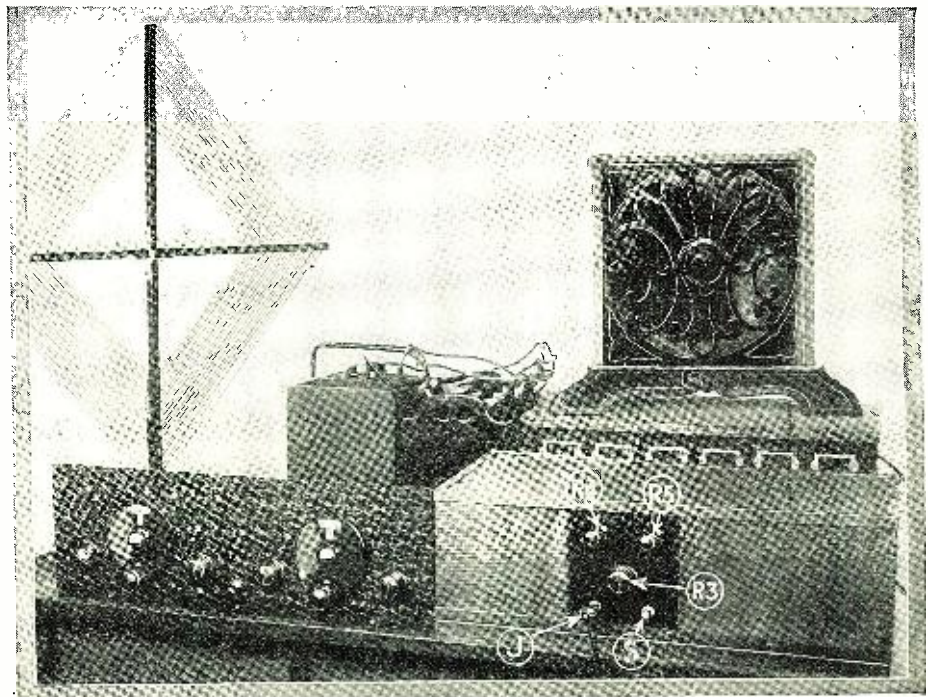

Fig. 2. All that is necessary for first-class reception of radio concerts. The amplifier and "B" eliminator on the right magnify the signals from the loop receiver on the left.

The "Excelsior" Receiver

By SYLVAN HARRIS

In the receiver described in this article, there has been incorporated the balanced-bridge system of radio-frequency amplification and a new type of audio-frequency amplifier. The reproduction of signals is indeed excellent.



WE have tested many receivers in RADIO NEWS Laboratories, but here is a real receiver for those who want one that has extreme sharpness. This set has a razor-like sharpness, and it is possible to cut out stations less than a mile away, and bring in DX stations operating on a differential of only a few meters.

In addition to this, the set has excellent quality, and gives a truly remarkable amount of volume—too loud to be listened to comfortably with full power at close range.

It is the ambition of all of us to have in our possession the "perfect" radio receiver, but of course, we are all forced to admit that there is small chance of our ever coming upon anything in this life that is perfect. Yet are all aware that certain admirable features are attached to each of many receivers; so the thought arises, "Why not take some of these points of individual merit from the various sets and combine them together into a single receiver? Then we will have something that is a decided improvement over what was before available."

We make no claims here that the receiver to be described in this article is the "perfect" receiver. It is, however, as good as one can build at the present time, and has very admirable characteristics with regard to selectivity, sensitivity, and quality of reproduction.

As everyone who is interested in radio knows, every radio receiver is composed of three important elements; viz., the radio-frequency amplifier, the detector, and the audio-frequency amplifier.

The selection of the radio-frequency amplifier depends upon several things: the first of these things is reliability of operation and stability; the second is selectivity; the third is sensitivity. None of these features can be considered to the exclusion of the others. Under the heading "reliability of operation and stability" must be included "freedom from the tendency to oscillate or regenerate";

for it is evident that any receiver which oscillates badly is undesirable, and any receiver which regenerates is more or less unstable under different conditions.

The selection of a radio-frequency amplifier which does not regenerate or oscillate is likewise tied up with the idea of sensitivity and selectivity. It is possible to build an ordinary cascaded radio-frequency amplifier which does not regenerate or oscillate; but unless special means are employed for preventing these faults the receiver must possess plenty of resistance or a few absorption circuits, and as a consequence will be more or less broad in the tuning and not as sensitive as it might be.

BALANCED RADIO FREQUENCY

These ideas lead us at once to the "balanced" circuits which employ the bridge system of balancing or "neutralizing". The next problem is to choose the proper neu-

We have learned by sad experience that on account of the capacity existing between coils coupled together, or even the capacity of a single coil by itself, the inductances of these coils do not remain constant with frequency. We are forced, therefore, to exclude from the bridge circuit all inductances, and to choose that bridge arrangement which employs only capacities in its various arms. The capacity of a condenser does not vary with frequency so we are safe in making this choice.

The choice of the radio-frequency amplifier, under these considerations, necessarily goes to the isofarad system, which was described in detail in the December, 1925, and February, 1926, issues of RADIO NEWS. This system permits easy neutralization at any wavelength or frequency, and remains balanced thereafter at all wavelengths or frequencies within a very wide range. The

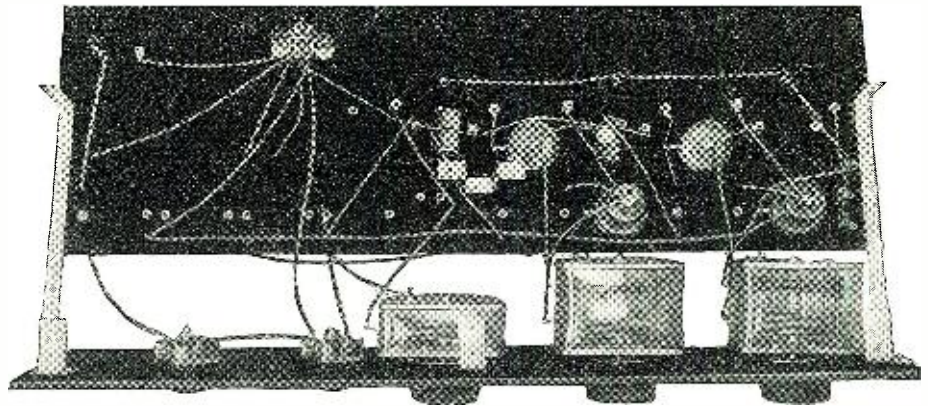

The under side of the sub-panel of the Excelsior receiver, showing the various balancing condensers used in the bridge circuit.

tralizing system. From our past experience we have come to realize that the bridge system required is one that, when once balanced, will remain balanced at all frequencies. Some of the systems that have been used could be balanced very nicely at any one wavelength or frequency, but were decidedly out of balance at other wavelengths or frequencies.

For a bridge system to remain balanced at all frequencies, it is necessary to have, in each of the arms of the bridge, elements which remain constant at all frequencies.

complete diagram of the isofarad radio frequency amplifier is shown in the first two stages of the complete wiring diagram given.

The choice of this kind of system enables us to build the tuned circuits to be very efficient. In cases where complete neutralization is not obtained it is impossible to design the coupling coils properly; for as we begin to approach a good design for these, the circuits go into oscillation. The efficiency, which this receiver can be designed to have, is evidenced by the necessity of using the radio-frequency chokes to furnish a leakage

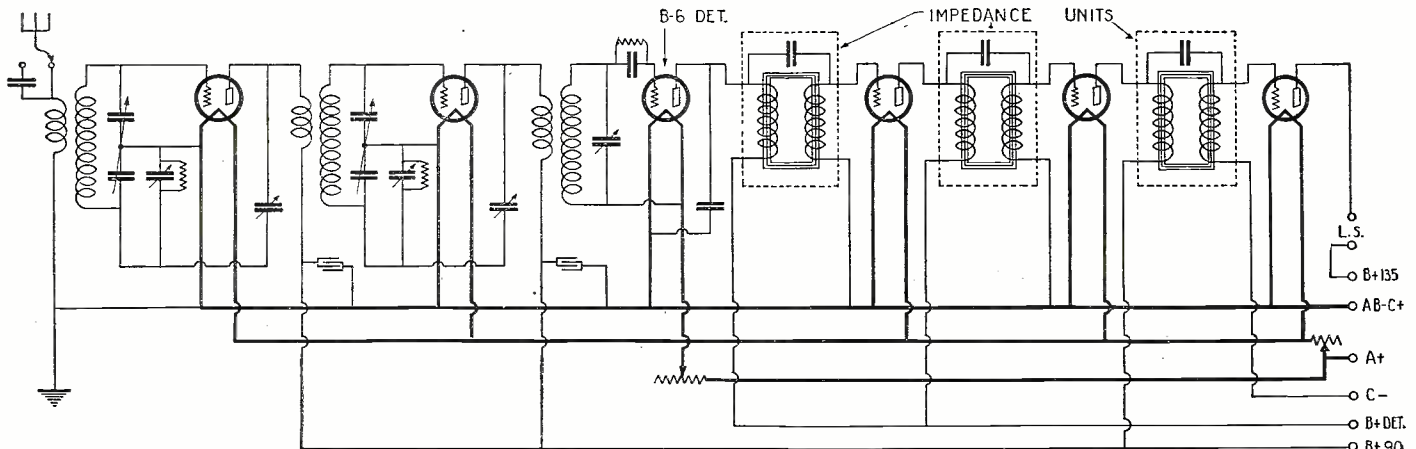

The circuit shown above employs a bridge system of balancing, using only capacities in its various arms. The dotted lines about the A.F. amplifier stages indicate shielding.

path to prevent overloading of the grids of the R.F. amplifiers. In other words this receiver is designed to get out of the R.F. tubes all that is in them.

SPECIAL DETECTOR TUBE

The detector tube chosen for this combination receiver is the well-known B-6 detector, designed by Harold P. Donle, which was described in detail in the May, 1926, issue of RADIO NEWS. This is a very sensitive detector, and will not regenerate or oscillate. It is not critical with respect to plate voltage, but requires a by-pass condenser in the plate circuit, as shown in the wiring diagram.

DONLE IMPEDANCE COUPLING

The audio-frequency amplifier chosen for this set is one that fulfills many of the requirements of A.F. amplifiers. This system was also invented by that prolific radio inventor, Mr. Donle, and was described by him in detail in the June, 1926, issue of RADIO NEWS. A brief description of this system is also included in the article entitled "Types of Audio Amplifiers," by the writer, in this issue of RADIO NEWS. The outstanding features of this amplifier include a very fine frequency-characteristic, freedom from the tendency to overload, and higher amplification than can otherwise be generally obtained without a sacrifice of quality.

The coupling device used in this audio amplifier comprises two coils on a single rec-

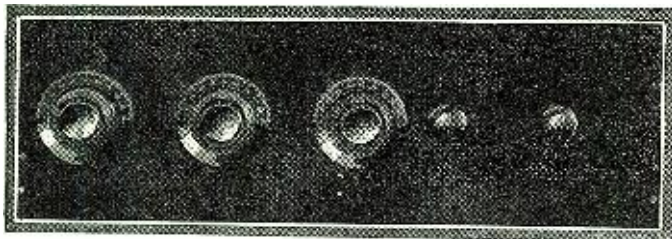

In the three shielding cylinders are the R.F. transformers; and at the right is the new audio-frequency amplifier.

plifier is built in the form of a unit, which includes the three complete coupling devices—coils and condensers. This arrangement facilitates the assembly of the receiver and simplifies the wiring.

NEUTRALIZING ADJUSTMENTS

The adjustment of the receiver is done very simply. The two neutralizing conden-

ers, nearest to the R.F. plates, are screwed down tight, to the position of maximum capacity, and then are unscrewed two complete turns. The first tube is then removed from its socket, and a piece of paper or adhesive tape fastened to one of the filament prongs; so that when the tube is replaced in the socket it will not light. In general any of the local stations can then be tuned in and will come in very loud.

After this the first resistance-shunted neutralizing condenser is adjusted until the sig-

nal disappears, balancing the first stage. The adjustment is not very critical, so that it is an easy matter to obtain a good balance. The second stage is then balanced in exactly the same manner, after removing the paper or tape from the filament prong of the first tube and applying it to the filament prong of the second tube.

When the circuits have been thus balanced it will be found that the set does not oscillate or regenerate under any conditions. High voltages can be applied to the radio-frequency tubes, if so desired. We suggest that our readers try out this combination receiver. They will find it to be all that is claimed for it; it is simple to build and operate, is stable under all conditions and very sensitive, and it reproduces with a high degree of quality, due to lack of overloading and the absence of regeneration.

The three tuning controls have the same dial readings; this being due to the "balanced-bridge" circuit employed in the radio-frequency amplifier.

Photos by courtesy of Walbert Mfg. Co. and Alden Mfg. Co.

tangular core, each of the windings having the same number of turns. The coupling is further assisted by the coupling condenser, which, contrary to the usual purpose, does not act as a blocking condenser. A blocking condenser is not required in this amplifier, for a leakage path for the grid charges is furnished by the low-resistance winding on the output side of the coupling device. It is this that prevents overloading of the amplifier and consequent distortion.

As seen in the illustrations, the audio am-

It is against the policy of RADIO NEWS to publish the names of manufacturers or of makes of instruments in connection with the apparatus described in these pages, but this information will be gladly given privately. If you are interested in any special instruments described here, address a letter to the READERS' SERVICE DEPARTMENT, enclosing stamped return envelope, and addresses of the manufacturers will be given free of charge. —EDITOR.

LIST OF BROADCAST STATIONS IN THE UNITED STATES

(Continued from page 331)

Radio Call Letter	BROADCAST STA. Location	Wave (Meters)	Power (Watts)	Radio Call Letter	BROADCAST STA. Location	Wave (Meters)	Power (Watts)	Radio Call Letter	BROADCAST STA. Location	Wave (Meters)	Power (Watts)
WMC	Memphis, Tenn.	499.7	500	WQO	Kansas City, Mo.	278	1000	WRBC	Valparaiso, Ind.	278	500
WMCA	Hoboken, N. J.	340.7	500	WOR	Newark, N. J.	405.2	500	WRC	Washington, D. C.	468.5	1000
WMRJ	Jamaica, N. Y.	227.1	10	WORD	Batavia, Ill.	275	5000	WRCO	Raleigh, N. C.	272	100
WMSG	New York, N. Y.	302.8	500	WOS	Jefferson City, Mo.	440.9	500	WREC	Whitehaven, Tenn.	254	10
WNAE	Boston, Mass.	280.2	100	WQWF	Edgewood, R. I.	440.9	500	WREO	Lansing, Mich.	285.5	500
WNAC	Roston, Mass.	430.1	500	WQWL	New Orleans, La.	270	100	WRHF	Washington, D. C.	256	50
WNAD	Norman, Okla.	258	500	WQWO	Fort Wayne, Ind.	227	500	WRHM	Minneapolis, Minn.	252	50
WNAL	Omaha, Neb.	254	500	WPAK	Fargo, N. Dak.	275	100	WRK	Hamilton, Ohio	270	100
WNAT	Philadelphia, Pa.	250	500	WPAP	Cliffside, N. J.	360	100	WRM	Urbana, Ill.	273	500
WNAX	Yankton, S. Dak.	244	100	WPCC	Chicago, Ill.	258	500	WRMU	Richmond Hill, N. Y.	236	100
WNBH	New Bedford, Mass.	248	250	WPDQ	Buffalo, N. Y.	205.4	50	WRNY	New York, N. Y.	374.8	500
WNI	Newark, N. J.	348.6	150	WPG	Atlantic City, N. J.	299.8	5000	WRR	Dallas, Tex.	216	500
WNOX	Knoxville, Tenn.	268	100	WPRC	Harrisburg, Pa.	215.7	100	WRST	Bay Shore, N. Y.	215.7	100
WNRC	Greensboro, N. C.	223.7	10	WPSA	State College, Penna.	261	500	WRVA	Richmond, Va.	256	1000
WNYC	New York, N. Y.	526	1000	WQAA	Parkesburg, Pa.	220	500	WSAI	Mason, Ohio	325.9	5000
WOAI	San Antonio, Tex.	394.5	2000	WQAC	Amarillo, Tex.	234	125	WSAJ	Grove City, Pa.	229	250
WOAN	Lawrenceburg, Tenn.	282.8	500	WQAE	Springfield, Vt.	246	50	WSAN	Allentown, Pa.	229	100
WOAW	Omaha, Nebr.	526	1000	WQAM	Miami, Fla.	363	500	WSAR	Fall River, Mass.	254	100
WOAX	Trenton, N. J.	240	500	WQAN	Seranton, Pa.	250	100	WSAX	Chicago, Ill.	268	100
WOC	Davenport, Iowa	483.6	5000	WQAO	Cliffside, N. J.	360	100	WSAZ	Pomeroy, Ohio	244	50
WOCL	Jamestown, N. J.	275.2	15	WQAJ	Chicago, Ill.	447.5	500	WSB	Atlanta, Ga.	428.3	1000
WOOD	Paterson, N. J.	391.5	500	WRAF	Laporte, Ind.	224	100	WSBG	Chicago, Ill.	209.7	1000
WOI	Ames, Iowa	270	750	WRAC	Escanaba, Mich.	256.3	100	WSBF	St. Louis, Mo.	273	250
WOK	Homewood, Ill.	217.3	5000	WRAM	Galesburg, Ill.	214	100	WSBT	South Bend, Ind.	275.1	500
WOKO	Peekskill, N. Y.	233	50	WRAV	Yellow Springs, Ohio	263	100	WSDA	New York, N. Y.	263	250
WOO	Philadelphia, Pa.	508.2	500	WRAX	Reading, Pa.	238	10	WSKG	Bay City, Mich.	261	100
WOOD	Grand Rapids, Mich.	242	1000					WSM	Nashville, Tenn.	282.8	1000
WOP	(Airplane)	300	100					WSMB	New Orleans, La.	319	500
								WSMH	Owosso, Mich.	210	20
								WSMK	Dayton, Ohio	275	500
								WSOE	Milwaukee, Wis.	246	500
								WSRO	Hamilton, Ohio	252	100
								WSSH	Boston, Mass.	261	100
								WSUI	Iowa City, Iowa	483.6	500
								WSVS	Buffalo, N. Y.	218.8	50
								WSWS	Wooddale, Ill.	275.1	1000
								WTAB	Fall River, Mass.	266	100
								WTAD	Carthage, Ill.	236	50
								WTAG	Worcester, Mass.	545.1	500
								WTAL	Toledo, Ohio	252	100
								WTAM	Cleveland, Ohio	389.4	3500
								WTAP	Cambridge, Ill.	242	50
								WTAQ	Eau Claire, Wis.	254	1000
								WTAR	Norfolk, Va.	261	100
								WTAW	College Station, Texas	270	500
								WTAX	Streator, Ill.	231	50
								WTAZ	Lambertville, N. J.	261	15
								WTIC	Hartford, Conn.	475.9	500
								WVAE	Plainfield, Ill.	242	500
								WWJ	Detroit, Mich.	352.7	1000
								WWL	New Orleans, La.	275	100

A "Five-In-Two" Receiver

By CLYDE J. FITCH

In the July, 1926 issue of RADIO NEWS there was a detailed description of the new type of vacuum tube developed by Dr. Siegmund Loewe of Berlin. We are now pleased to offer an article showing the practical application of Dr. Loewe's "tubes within tubes" in a broadcast receiver.

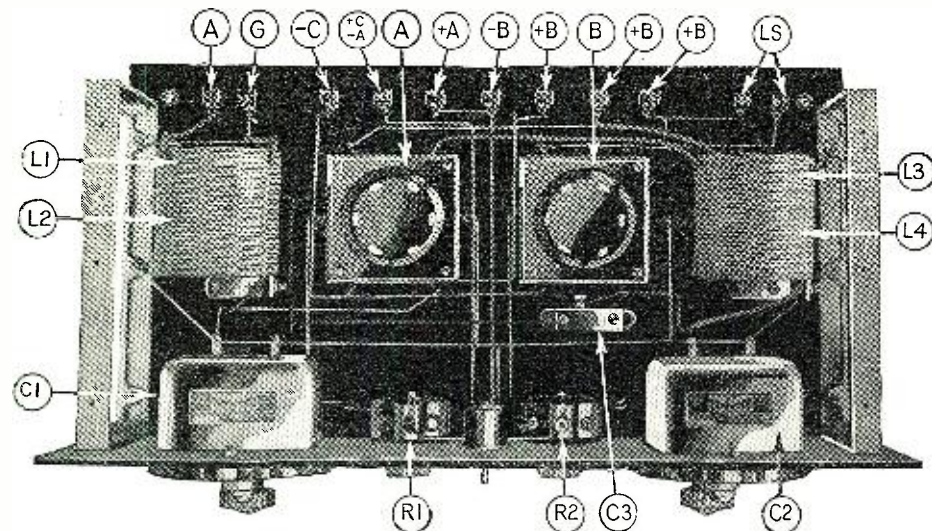

Interior view of the "five-in-two" receiver. L-1 and L-2 compose the aerial coupler and C-1 the aerial tuning condenser. L-3, L-4 and C-2 compose the tuned-radio-frequency amplifier stage interposed between the output of the first tube A and the input of the second tube B. R-1 and R-2 are the filament rheostats and C-3 the regeneration condenser. The battery terminals at the rear are all indicated.

nections of this tube are shown in the schematic diagram, Fig. 1, in which they are included in the circle, A, at the left. Note that double-grid tubes are employed, of the type which is quite popular in Europe.

The tube used for the detector and two-stage resistance-coupled amplifier is shown in Fig. 1 as the circle B, at the right. In this tube three sets of standard single-grid tube elements are employed. The coupling resistances, grid leaks, and grid condensers are also sealed in the bulb. The illustration, Fig. 2 shows the internal construction of this tube. Note that the elements used for the detector, are somewhat larger than those of the other two, and that its filament is connected directly to the four-volt filament battery; whereas the filaments of the other two units are connected *in series* to the same battery. A filament rheostat is included in the circuit (outside of the bulb, of course) to regulate the current for all three filaments. In Europe the standard filament voltage is four, whereas in this country six is the standard voltage. The experimenter who uses these tubes should therefore be careful not to connect them to a six-volt battery.

THE RECEIVER

The set shown in the various illustrations gave exceptionally good results on broadcast reception. The instruments were mounted on a 7 x 18 inch composition panel attached to a 9 x 17 inch composition baseboard with panel brackets, as shown. The antenna coil L1-L2, mounted at the left on the baseboard, may be of the standard type used in tuned-radio-frequency receivers. This coil connects to the input of the radio-frequency tube as shown in the diagram. The output of this tube connects to a tuned radio-frequency transformer L3-L4, which is of similar construction to the antenna coil. Thus we have, in the first tube, one stage of resistance-coupled amplification and one stage of tuned-radio-frequency amplification. The small condenser C3, connected between the input grid of tube B and the tap on the antenna coil L2, is installed to produce a small amount of regeneration. By the use of this condenser the signal strength is considerably increased; it is of the type ordinarily employed for balancing circuits such as the neutrodyne. This condenser is connected to the tenth turn from the bottom of coil L2.

Tube B as stated above, comprises a detector and two-stage audio amplifier. Usually a grid condenser and grid leak are used with a detector tube; but in the circuit supplied by Dr. Loewe with the tubes none are shown. We therefore have omitted the grid

RADIO NEWS is happy to present to our readers, for the first time in any magazine in America, a complete set built with the new multiple German tubes. The two special tubes shown in this set actually replace five tubes.

Excellent results have been obtained with this set, built in RADIO NEWS Laboratories. While the tubes in question are not cheap ones, the market price of them being, at the present time, about \$8.00, still the chances are that in the future such tubes could be produced at a considerably lower price.

It would mean a great economy in set building, and the set itself would of course function better, because all vital parts are contained right inside the tube. The parts being in a vacuum, there will, of course, not be any deterioration due to dust, air and moisture.

Whether this is a step in the right direction, and whether tubes of this kind will prevail in the future, we are not prepared to state, although we are inclined to believe that future developments will be along such lines.

The tubes at the present time are not on the American market, being manufactured exclusively in Germany.

amplifiers, both radio and audio, are also completely housed and wired within the glass envelopes of the tubes. Thus, the radio set builder has only two tubes to wire, although he gets the results of a five-tube set. And, furthermore, he gets a resistance-coupled amplifier, long known to be the best for quality reception, that is completely wired within the evacuated tube and unaffected by atmospheric conditions. It is through the efforts of Dr. Siegmund Loewe, of Berlin that these marvelous tubes were developed and it is hoped that they will soon be generally available in this country.

CONSTRUCTION OF TUBES

Although a detailed description of these tubes was published in the July, 1926, issue of RADIO NEWS, a brief resumé of their internal construction will no doubt be of interest to those who do not have this issue handy. There are two types of tubes. The one used for the radio-frequency amplifier comprises two sets of double-grid tube elements within one bulb. These two sets are coupled to each other by a resistance. This resistance, the grid condenser, and the grid leak are within the bulb. Ordinarily a resistance-coupled radio-frequency amplifier is very poor, due to the distributed capacities of the connections; but in this case good amplification is obtained, because very small connectors are employed. The internal con-

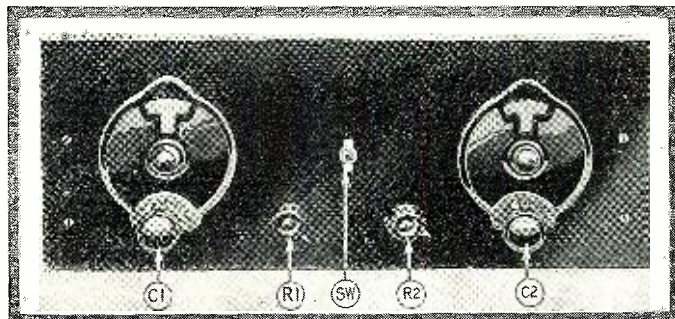

Panel view of the receiver. Showing the aerial tuning control C-1, the R.F. control C-2, the filament rheostat knobs R-1 and R-2, and the filament switch SW.

THE continued improvements and refinements in radio apparatus make it easier and easier for the radio fan to build his own set. In this "Five-In-Two" Receiver, not only have we five tubes combined in two, but the resistance-coupled

condenser and the leak in our diagram, and operated the detector tube by applying a negative bias on the grid. It was found in the course of the experiments that by connecting the grid return lead to the negative side of the filament, as shown in Fig. 1, sufficient grid bias for good detection was obtained. If, in some cases, a greater bias is required, the filament end of the coil, L4, may be connected to the negative "C" battery binding post. The experiment was tried of connecting a grid condenser and leak between coil L4 and the grid terminal G1 of the tube, but it did not improve results. The A, B and C battery voltages used,

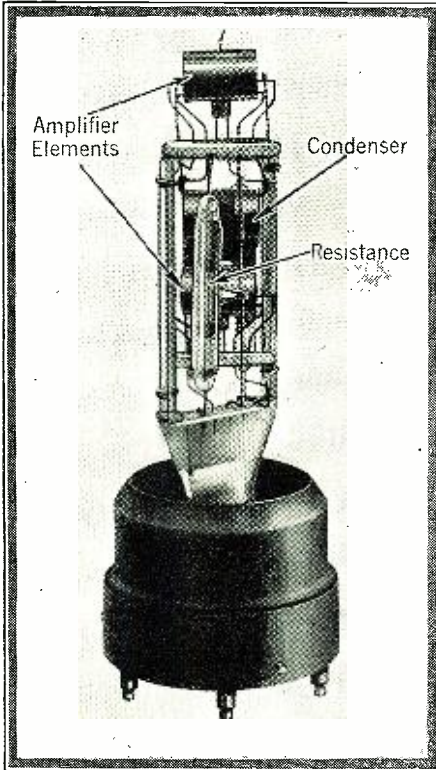
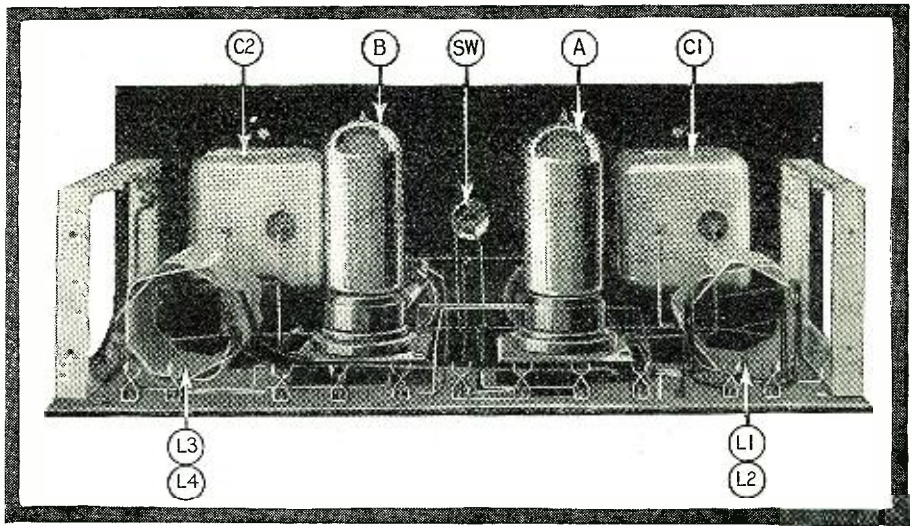

Fig. 2. This tube (B in the illustrations) consists of a detector and two stages of resistance-coupled audio-frequency-amplification.

which gave the best results, are indicated in the diagram Fig. 1. It may be advisable, when using different tubes, to try various "B" battery voltages until the best combination is found. Note that the two *inside grids* of tube A are connected together, and also



A rear view of the completed receiver. Tube A is the two-stage R.F. amplifier. Tube B is the detector and two-stage audio amplifier. The other letters correspond with those in the illustration on the opposite page and the circuit diagram below.

connected to a positive "B" battery terminal of 18 to 22½ volts. The plates of this tube are connected to a "B" battery of 60 to 90 volts. As a rule, the lower the plate voltage, the lower the inside grid voltage should be. The best values can be found by trial.

EXCELLENT PERFORMANCE

In view of the fact that the amplifiers and tubes are all self-contained in two glass bulbs, there is little additional apparatus required for the set. All the parts are clearly shown in the illustrations. In addition to the tubes with their special six-prong sockets, we have the two filament rheostats, filament switch, two .0005- μ f. variable condensers, two tuned-radio-frequency transformer coils and a small condenser used for regeneration. The eleven binding posts for the battery and loud-speaker connections are mounted on the rear of the base board.

While no tests were made with this set on distant reception, exceptionally good loud-speaker results were obtained on many local stations. The quality of the reproduced music was unusually good due, of course, to the use of the resistance-coupled audio amplifier. The selectivity was very good, despite the use of the resistance-coupled radio-frequency amplifier. Whether or not these "Tubes Within Tubes" will become very popular, remains to be seen. The disadvantage is obvious; if one filament burns

out the entire tube must be discarded; but if they can be manufactured on a quantity basis, to sell at a moderate price, this disadvantage will not be very serious.

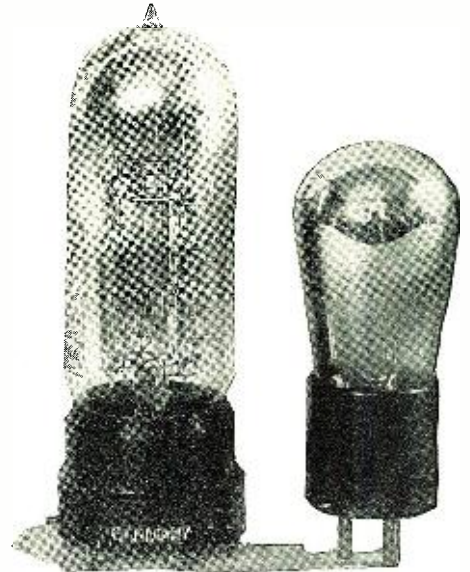

Comparative sizes of a 201-A type tube (right) and the Loewe multiple tube (left).

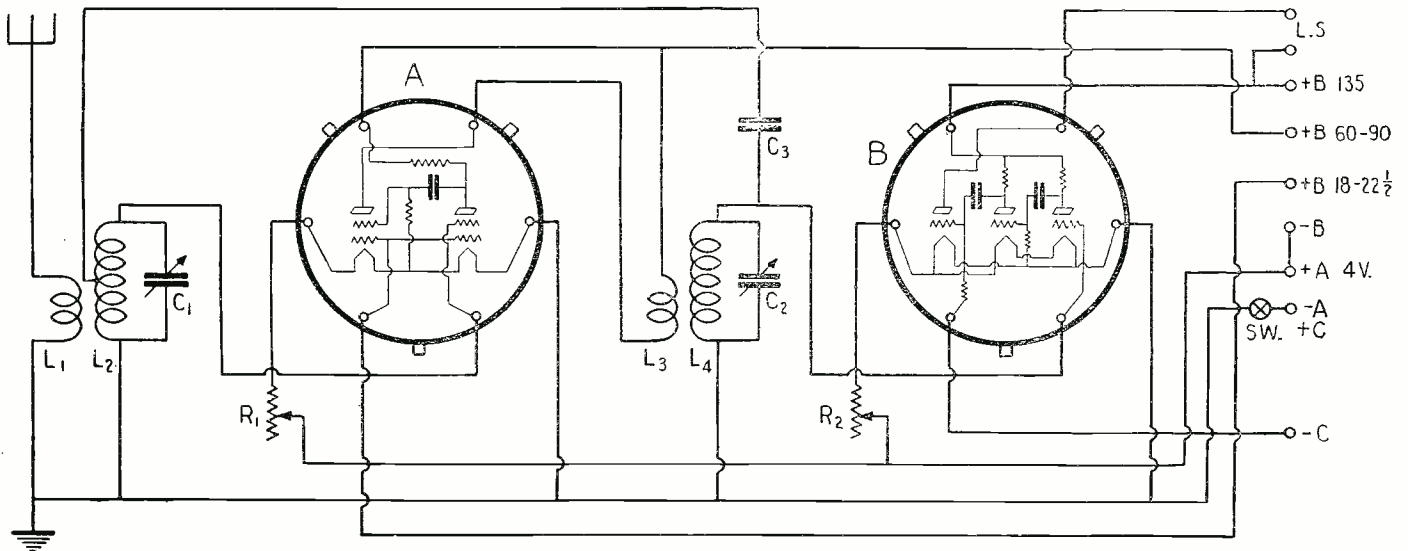

Fig. 1. The circuit diagram of the "five-in-two" receiver. Note that the two tubes are coupled through the tuned-radio-frequency transformer composed of coils L-3 and L-4 and the condenser C-2. The first stage of R.F. amplification is resistance-coupled.

Types of Audio Amplifiers

By SYLVAN HARRIS

An exceptionally valuable article covering the characteristics of all existing forms of audio frequency amplifiers, together with a technical explanation of their operations.



THUS far in this series of articles dealing with amplifiers (which began in the June, 1926, issue of RADIO NEWS) we have not considered the nature of the amplifiers themselves, but have devoted our attention solely to what ampli-

drop across the resistance is RI . In other words if the current is 0.2 ampere and the resistance is 1,000 ohms, the voltage drop in the resistance is $0.2 \times 1,000$, or 200 volts. It is evident that the voltage drop between any two points (a, b) on the resistance

In other words we can start out, with a battery having a voltage V_1 of 200 volts, and get any voltage we want by simply moving the variable contact on the resistance. The voltage V_2 would then be related to the original voltage V_1 by

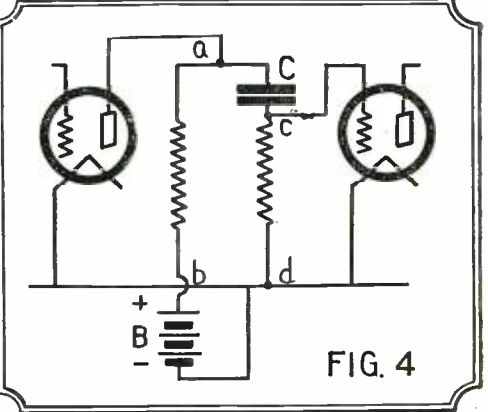
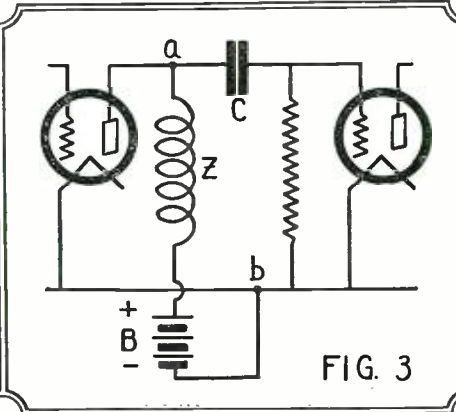
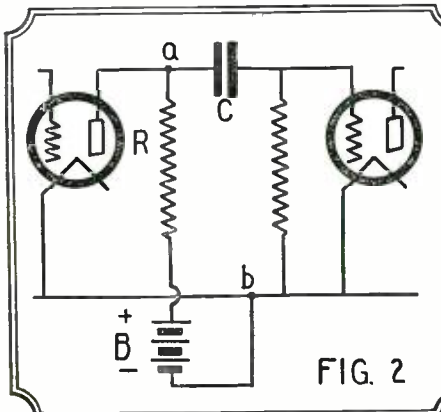

Fig. 2. An audio amplifier of the resistance-coupled type. The voltage drop across the resistance R is large. The voltage drop across the impedance Z in Fig. 3 is considerably less and the potential on the plate of the first tube is consequently higher. The same is true of the grid voltages as applied across the resistance $c-d$ (Fig. 4).

fiers are supposed to do and what they are supposed not to do. The present article, therefore, begins the second part of our study of amplifiers. We will now consider the amplifiers in a general manner, indicating the reasons for the various elements of which they are composed, and for the several circuit arrangements; and we will point out the extreme similarity of operation in all the different types.

Surprising as it may seem at first to the uninitiated reader, we begin the discussion with what is commonly known as the "potentiometer," but which, it is recommended by the Institute of Radio Engineers (Report of Committee on Standardization for 1926), should preferably be termed the "voltage divider." In accordance with this recommendation, this instrument is so designated here.

RESISTANCE AND VOLTAGE

The most common form of voltage divider is illustrated in Fig. 1 as a simple resistance connected in series with a source of electrical energy. A current, of the value I , flows through this resistance, which has a value R , so that by *Ohm's law* the voltage

R is proportional to the value of the resistance between these two points, with a given current flowing. In other words, if the resistance between points a and b is half the total resistance of R , then the volt-

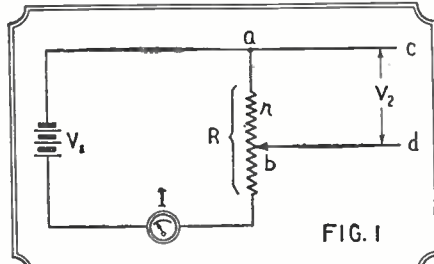

In this simple circuit the current in the resistance R is measured by the ammeter, I . The variable resistance or "voltage divider" permits the voltage, V_2 , across C and D to be varied.

age drop between a and b is half the voltage drop across the total resistance R . In the above example, if the resistance, between a and b, is 500 ohms, and the current in R is 0.2 ampere, the drop between a and b is 0.2×500 or 100 volts.

$$V_2 = \frac{r}{R} V_1$$

There is a very important point that must not be forgotten, however, and that is that the circuit to which the terminal points c and d are connected should not take any current from the system, for the above relation to hold. If current is taken by a circuit connected to c and d , the voltage relations become more complicated; in any case, however, the general rule applies, *vis.*, by increasing the resistance between a and b the voltage delivered by the voltage-divider is likewise increased.

On the other hand, if the circuit to which c and d are to be connected takes an appreciable amount of current, the voltage drop will not be as high as if no current at all were taken by this circuit. This can be easily understood by remembering that the greater the current through the resistance R , the greater will be the voltage drop between any two points on it. Any current taken away from R , therefore will cause this voltage drop to be lowered.

(Continued on page 418)

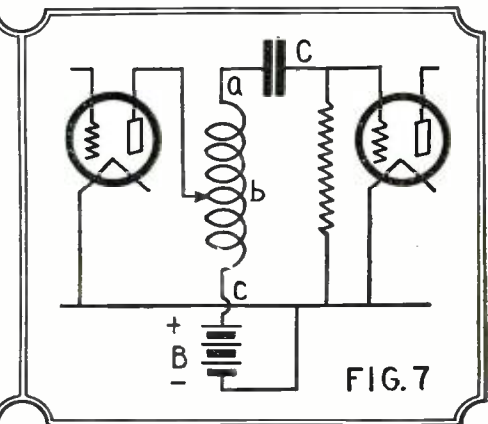
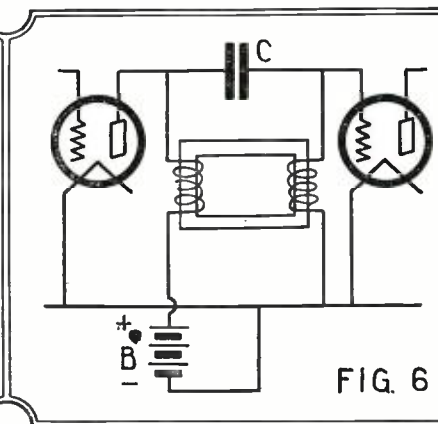
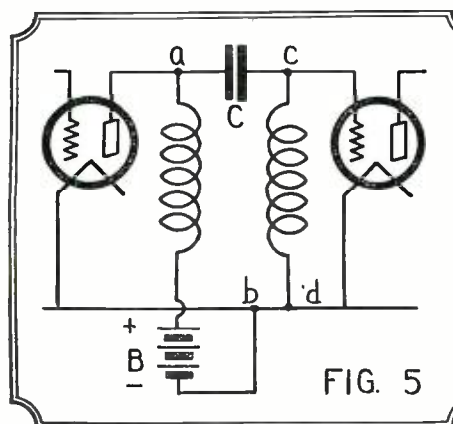

The impedance amplifier of Fig. 5 employs also an impedance in the grid circuit. This is superior to a resistance in that high voltages cannot accumulate on the grid and block the action of the tube. The arrangement of Fig. 6 is the same as that of Fig. 5 except that both impedances are on the same core. An "auto transformer" coupling arrangement is shown in Fig. 7.

A Unique Nine-Tube Superheterodyne

By MARK HINDER

A Superheterodyne receiver employing four stages of intermediate-frequency amplification of special design. The extra stage increases the sensitivity of the set perceptibly.

THE confusion in broadcasting conditions, and the concentration of many powerful broadcasting stations in a comparatively small area, in and about congested cities, will necessitate an extremely selective receiver. Within the building possibilities of an amateur, the superheterodyne is practically the only circuit which will satisfy this requirement. The characteristics of the superheterodyne circuit are so well known today, that it will not be necessary to describe here the principle of frequency change and cascade amplification of the intermediate wave.

Most experimenters have found it difficult to use more than three stages of intermediate frequency amplification in superheterodyne circuits. The average receiver of this type does not comprise more than one tuned stage and three untuned stage transformers; as the builder will hardly be able to find transformer units whose peak amplification factors will match.

FIVE I.F. TRANSFORMERS

Selectivity without sacrifice of tone was the principal thought in the design of the receiver to be described, which is a successful attempt to incorporate two tuned stages of

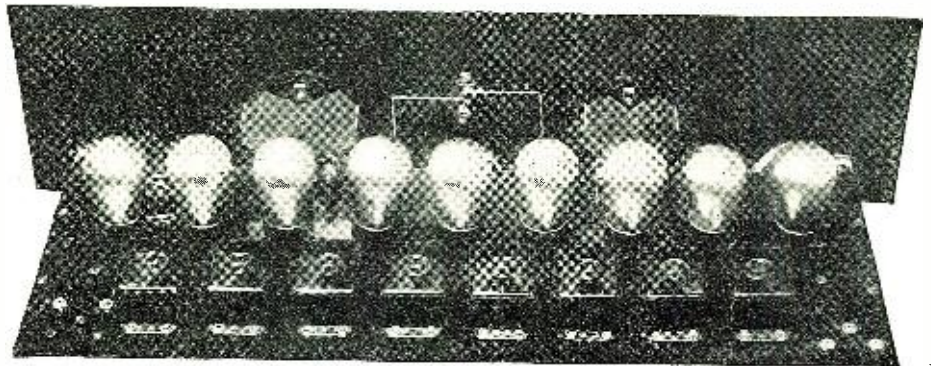

An interior view of a completed superheterodyne of this design. Note the extreme simplicity. The tuning and oscillator condensers can be seen on the front panel.

external field; the tuned-stage (air-core) transformers of this receiver are designed to be at a right angle to the iron-core transformers, so that their fields will not interfere with the latter.

The oscillator of this receiver is of a very well known type. Regeneration of the first detector is accomplished by a midget condenser. The windings of the oscillator

are for the receiver. The three iron-core intermediate-frequency transformers are very broadly tuned. However, it is necessary that the voltage amplification factor of these units be uniform, as the four intermediate-frequency tubes are operated from a common rheostat. The tuned transformers, of course, have to be very closely matched. The primary is tuned with a mica condenser. They operate best at a frequency of 37 kilocycles. This is the most favorable for avoiding interference.

AUDIO-FREQUENCY AMPLIFIER

Although the transformer-coupled audio-frequency amplifiers have suffered criticism in recent years, this was largely due to some products with unfavorable frequency characteristics. Resistance and choke-coil coupling was preferred in many cases. However, the amplification of two stages of audio-frequency with transformer coupling, using 3:1 ratio transformers, is about 50% higher than that of three stages of either resistance or choke-coil coupling. Besides, the "B" battery drain is lower.

Regarding uniform amplification of frequencies, it is comparatively simple to design a transformer with 90% uniformity over the entire audible waveband. In this receiver a very small transformer is incorporated, with the greatest possible number of turns of very fine wire and a comparatively heavy iron core of very thin laminations. It is thus possible to obtain a high primary-and-secondary impedance. The capacity effect of the

(Continued on page 444)

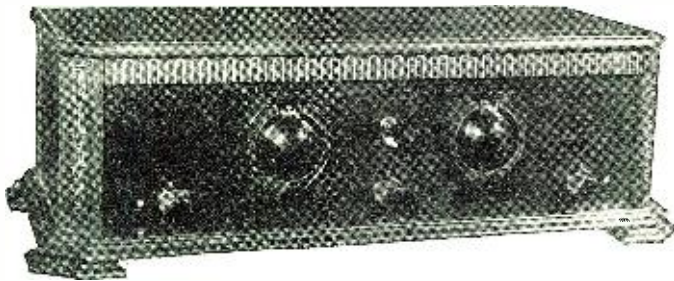

Front view of the receiver. The two large dials are the tuning controls. The two rheostat knobs and the volume control knob line the lower part of the panel. Photos by courtesy of High Frequency Laboratories.

intermediate frequency in the circuit. It was found that passing of highly-amplified intermediate-frequency signals through a second filter improved selectivity.

Nevertheless, more than three stages of intermediate frequency tend to oscillate, and to higher amplification of long waves will cause distortion. Intermediate-frequency oscillation can be avoided either by shielding, or placing the units sufficiently apart. However, an intermediate-frequency transformer with a sufficiently heavy iron core has a small

coil are of a special basket-weave type of very small dimensions, in order to keep its field as small as possible, and to avoid direct pickup of local stations. It was carefully designed for an output suited to the loop signal-strength. The 116 turns of No. 28 DCS wire will cover the wavelength of 195-575 meters, when tuned by a .0005- μ f. variable condenser. The primary coil of this oscillator coupler serves as a pickup coil, and is very closely coupled.

Two filter stages assure extreme selectiv-

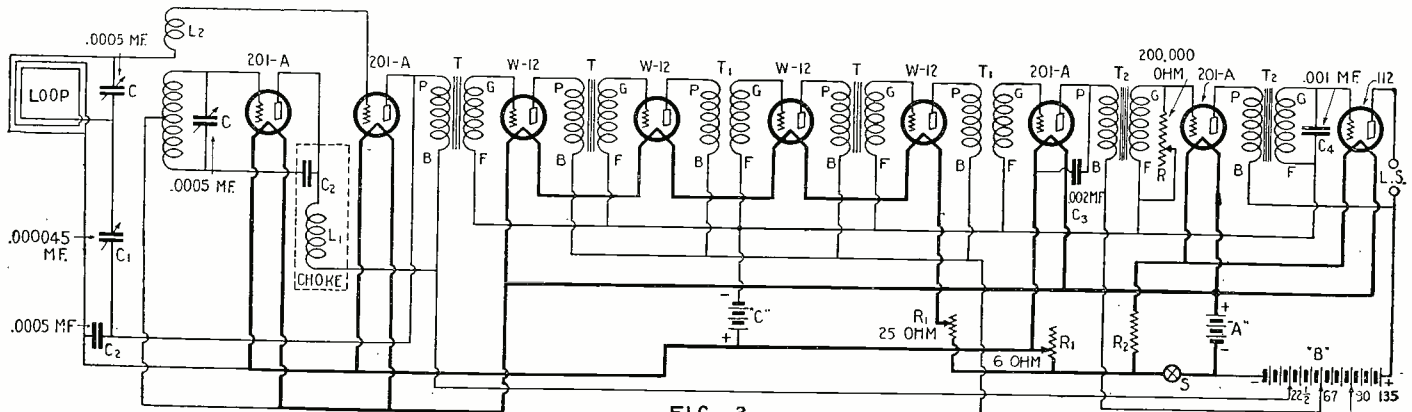
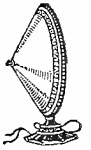

FIG. 3

The circuit diagram of this nine-tube superheterodyne, 1½-volt dry-cell tubes are indicated in the intermediate-frequency amplifier stages; though 201-A tubes may be used, in which case all filaments should be connected in parallel.

A Sub-Paneled Four-Tube Receiver

By HY. BAYER



For the enthusiast who wishes a compact receiver, it would be well if he were to consider the one described in this article. The sub-panel is used to full advantage.

THE era in which the home constructor thought of a receiving set in terms of cubic yards of space occupied by the installation has ended, fortunately. The sub-panel is one of the most important of the ideas which brought it to its close. A sub-panel, mounted a few inches above the bottom of the cabinet, provides mounting room for twice as many instruments as were possible under the old methods; and greatly simplifies as well the problems of arrangement and of wiring.

This principle of construction has been employed by the manufacturers of most of the best sets now on the market commercially. Its use is reflected in all of the best amateur installations, as well.

The receiver to be described in this article was designed primarily with sub-panel construction in mind. The result is unusual simplicity of assembly, which makes it a practical task even for the beginner who never before has attempted to make any kind of apparatus.

The instruments used are of standard manufacture and can be obtained easily at any well-stocked store dealing in radio parts. Coils of standard manufacture also have been employed; but for the experimenter who wishes to make as much of the set as possible from raw material, directions will be given for coils of similar design.

DETAILS FOR THE CONSTRUCTOR

The antenna coupler is wound on a tube 2½ inches in diameter and 2½ inches long. The primary consists of nine turns of Litz wire, No. 20-38. Spaced at a distance of half an inch, the secondary is wound with 55 turns of No. 26 D.S.C. wire. Care should be taken that both coils are wound in the same direction. The primary and secondary of the inter-stage transformer are of the same dimensions and number of turns as the antenna coupler. But the transformer carries, in addition, a tickler coil consisting of 30 turns of No. 28 D.S.C. wire on a tube 1½ inches in diameter and 1¼ inches long. This tube is mounted on a shaft, con-

trolled by a knob on the front panel, and can be varied 90 degrees.

The sub-panel may be made from any good insulating panel material; although a hard-rubber one will be easier to work, as large holes must be drilled for the sockets. It measures 4x16¾x1½ inches, and is sup-

ported by brackets of the same material, 2 inches high and 6¾ inches long. These may be made at home; but it would hardly pay, as they can be obtained ready-made for a very reasonable sum.

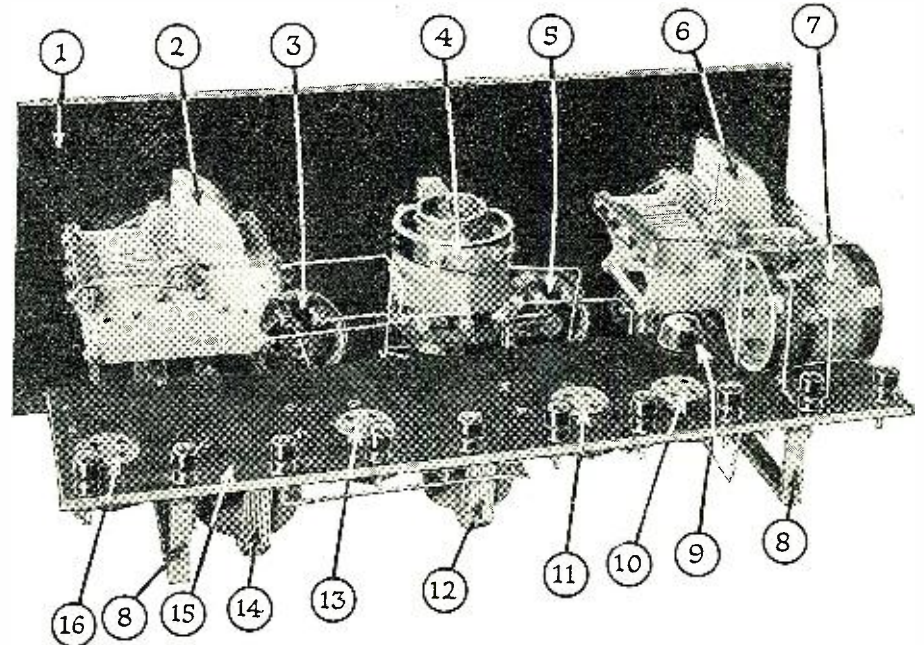

No. 1 is the 7x18 panel; 2 and 6, variable condensers; 3 and 5, rheostats; 4, 3-coil tuner; 7, antenna coil; 8, supporting brackets; 9, balancing condenser; 10, 11, 13, and 16, tube sockets; 12 and 14, A.F. transformers; and 15, 4 x 16¾ sub-panel.

ported by brackets of the same material, 2 inches high and 6¾ inches long. These may be made at home; but it would hardly pay, as they can be obtained ready-made for a very reasonable sum.

The new UX sockets are used, making it possible to employ either storage-battery or dry-battery tubes without the bother

Four holes, each 1⅜ inches in diameter, are drilled in the sub-panel to accommodate the sockets. Their location may be seen in both of the views. No exact dimensions for spacing any of the instruments will be given, as the exact arrangement will depend upon whether or not each builder uses a

(Continued on page 378)

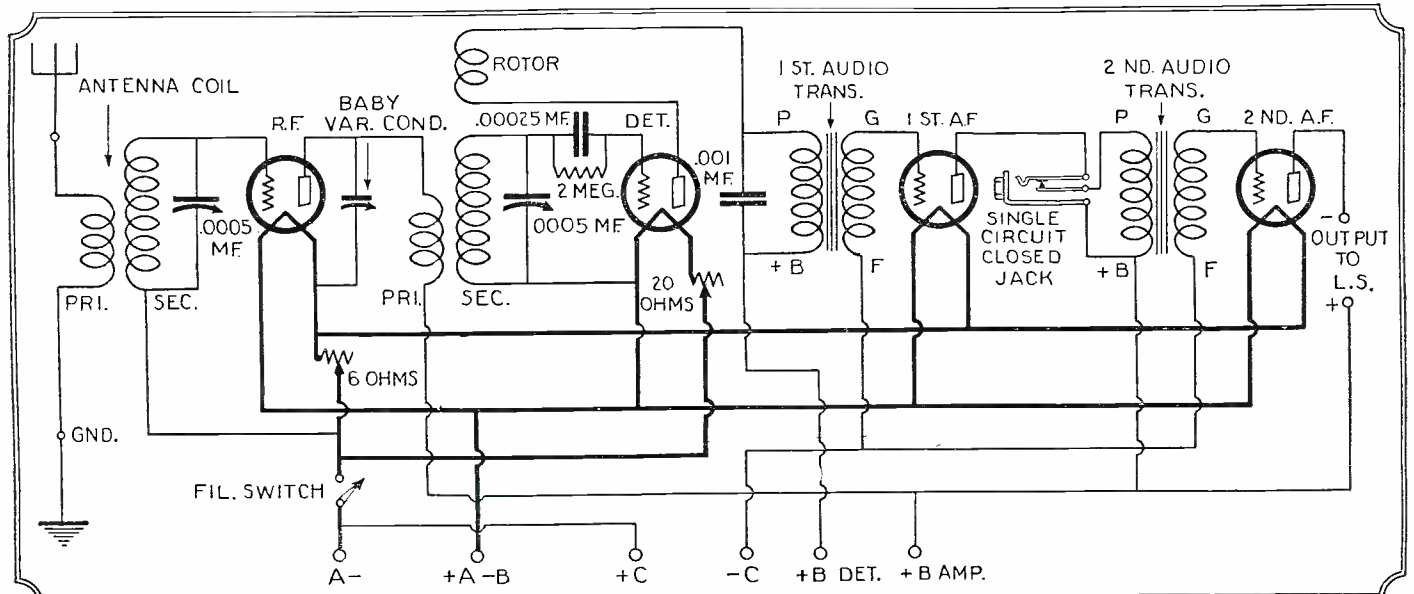

The small variable condenser in the plate circuit of the first tube is used for balancing in this excellent four-tube receiver.

Methods of Oscillation Control In Stabilized Receivers

By LEON L. ADELMAN*

There are numerous ways of controlling oscillation in a receiving circuit but they are not all good. Most of the existing methods are reviewed in this article. This material should be of particular interest to the set builder.

THE control of self-oscillation in radio receivers has been a serious problem to radio experimenters and engineers. As a result of the extensive research work which has been done, several methods have been evolved, some meritorious, others not very good.

REQUIREMENTS OF A RECEIVER

First, the circuit must be of such design that no matter in what position the tuning dials may be, there will be no manifestation of what is commonly known as "squealing," or howling noises, that so often upset the peace.

Second, a high degree of amplification must be obtained at all wavelengths, and not at only the lower wavelengths, as with so many of the ordinary variety of tuned-radio-frequency receivers.

Third, the quality of reproduction must be unblemished—true and harmonious tonal quality should be predominant, and all notes, overtones and harmonics should be present in the output of the loud-speaker.

loosen gradually the coupling as the tuning is changed for the lower wavelengths. This is done in order that maximum amplification may be obtained on the entire band of wavelengths from 200 to 575 meters, the broadcast band. If the tickler coupling is not varied, trouble from self-oscillation will occur and be manifest either as a howl or in badly distorted music or speech.

In Fig. 2, we have another regenerative circuit, a bit easier to control, so far as oscillation is concerned. This type of receiver is called the "tuned-plate regenerative circuit." It will be seen that, in order to obtain maximum amplification on all wavelengths, it will be necessary to vary the condenser in the plate circuit. With this system a much finer variation in regeneration can be obtained; and thus the circuit can be brought very close to the oscillation point where, as we all know, maximum amplification can be obtained.

A study of Fig. 3 which leads us on into (Continued on page 410)

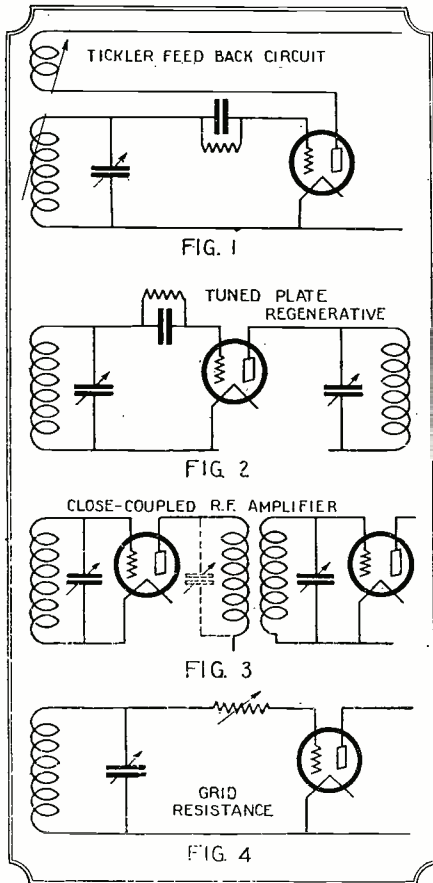

Figs. 1, 2 and 3 are conventional circuits addicted to oscillation. Fig. 4 shows how oscillation can be controlled by the use of a variable resistance.

There are two distinct classes of receivers in which oscillation control is of paramount importance. The first is the regenerative type; the second, the tuned-radio-frequency. Of these oscillation control is most imperative in the latter class, because there are more tuned-radio-frequency receivers in existence today than sets of any other type.

Tuned-radio-frequency receivers have been by far the most popular with manufacturers as well as with those who build their own. The reason is that it is possible to contrive so many various combinations with but few and simple changes. Again, there are many different modifications of this type of receiver; and for the layman to exercise good choice in the selection of a receiver, it is necessary that he should be well versed in the qualifications and outstanding features of each circuit. Thus, in order to understand thoroughly what factors must be taken into consideration, the requirements of a receiver must be clear in one's mind.

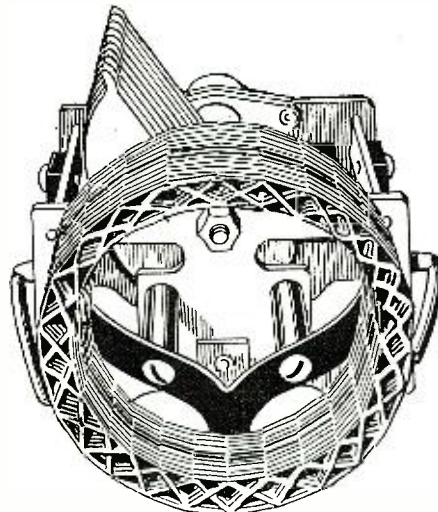

Fig. 17. Mounting the tuned-radio-frequency transformer on the rear of the variable condenser provides an absorption factor great enough to prevent oscillation.

Fourth, the ease of tuning, and the corresponding degree of selectivity or sharpness, should be in accord with the idea that any member of the family, from the 6-year-old to grandfather, should be able to tune in any station, without the slightest semblance of trouble.

Fifth, the general appearance as well as cost of upkeep and replacement must be and are considered by the prospective purchaser or builder.

OSCILLATION CONTROL IN REGENERATIVE SETS

Reference to Fig. 1 shows the common two-circuit or three-circuit regenerative receiver, also known as the "tickler-feedback circuit." A close study of this circuit reveals that the proximity of the tickler coil to the tuned grid circuit will affect, not only the volume of an incoming signal, but also the quality, the selectivity, and the sensitivity, and to some extent, create a variation in tuning. Unless the tickler coil is of proper size and construction, these changes are abrupt and very irregular, and invariably cause trouble in the reproduction of the signal.

It is necessary, in this type of circuit, to couple the tickler coil to the grid coil rather closely at the higher wavelengths and to

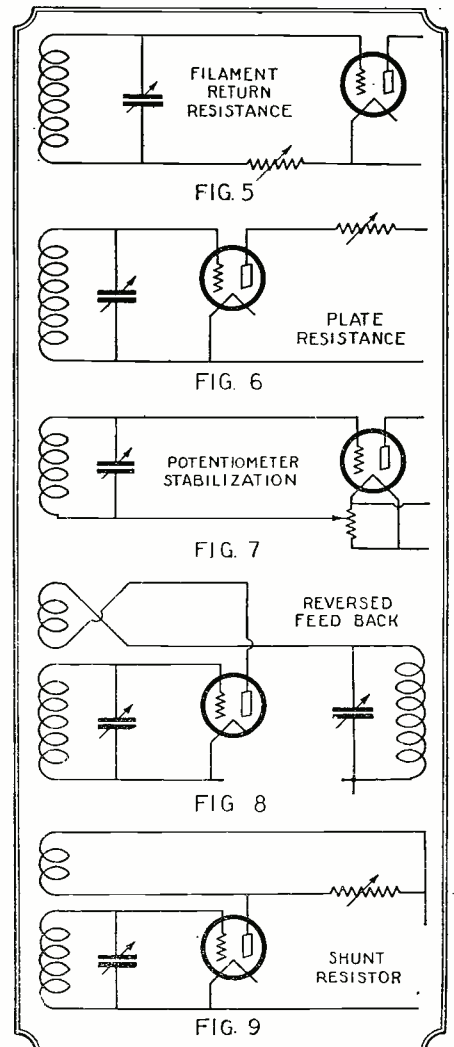

Figs. 5 and 6 show methods of controlling oscillation with variable resistances; Fig. 7, by a potentiometer; Fig. 8 by counter E.M.F.; and Fig. 9, by damping.

*Chas. Freshman Co., Inc.

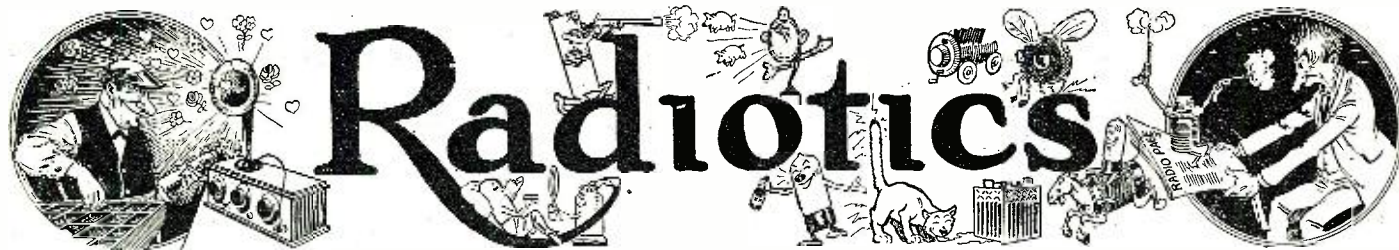

MUST GET TIRESOME

Sticky report from the New York Sun of June 29: "his ears GLUED to the RECEIVING TUBES."



Contributed by C. A. Brockaway.

THE LATEST GADGET

Announcement from the Springfield, Mass., Republican of May 2: "In practice you often utilize this effect by turning up the filament WHEOSTAT."



Contributed by Chas. S. O'Regan

ADDITION TO THE DAILY DOZEN

On July 9 the Boston Post ran this health item: "this type of flicker is apt to be of the long-period type and explains the type where you have TO HOP UP AND DOWN to keep the volume where you want it."



Contributed by A. Israel

THE ANZAC POWER SUPPLY

Latest war news from the Melbourne (Australia), Argus of May 27: "In these circuits both the plate and the inner grid are connected to the positive side of the filament FIGHTING BATTERY."



Contributed by Elias Spickvogel

WHERE THE ROARS COME FROM

Healthy wallop from the Cincinnati Enquirer of June 6: "About 300 persons, including the Crosley sales force, will attend this, the fourth of the ANIMAL conventions."



Contributed by Bruce Cline

DX AXLES FOR FORDS

A new use for that long distance receiver as divulged in an advertisement in the Denver Post of July 18: "Want distance radio set for rear Ford axles."



Contributed by Carl C. Bubenzer

HERE'S A NEW ONE

An innovation in clicks, as set forth by the Radio World of June 26: It says that one should distinguish "between the pronounced charging click and the LOUD SHIRT-CIRCUIT click."



Contributed by Frank E. Mitchell

PAGE MR. SHUBERT

Possible source of talent for our stages, as told in the July 4 issue of the New York Herald-Tribune: "if the resistances are overloaded ACTING will result."



Contributed by Ernest De Keukelaere

AS IT'S DONE IN ENGLAND

Startling item from Wireless Magazine, London, of July 10: "At last. 60-volt batteries 21/ each. CHARGE YOURSELF, NO ELECTRICITY NEEDED, just acid."



Contributed by Leslie Goldberg

WHERE'S YOUR TICKET?

Alarming news from the Sesquicentennial City, as set forth in the Philadelphia Inquirer of June 27: "It uses a TICKET feedback form of regeneration..."

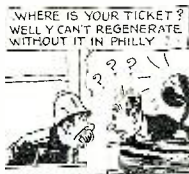

Contributed by O. Jaus

IF you happen to see any humorous misprints in the press we shall be glad to have you clip them out and send to us. No RADIOTIC will be accepted unless the printed original giving the name of the newspaper or magazine is submitted with date and page on which it appeared.

Editor RADIOTIC DEPARTMENT, c/o Radio News.

IT'S SO EASY

Pressing advertisement in the Chicago Tribune of July 21: "Five-tube Atwater Kent radio in TWO TUBE walnut console \$100."

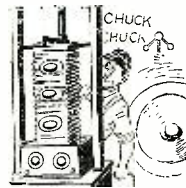

Contributed by Dr. Franklin W. Otto

POOR FUSSY!

Cruelty to animals related in the North-Western Daily Mail, Barrow, England, of June 22: "...tracing ink reproductions on a CAT SURFACE by radio."

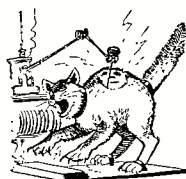

Contributed by C. A. Oldroyd

BEAT THIS FOR STRENGTH

In the July issue of Radio News Magazine there appeared an advertisement telling how "an extension cord will move your speaker from room to room or to porch and lawn."

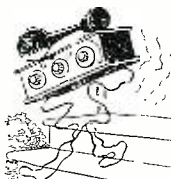

Contributed by Wm. B. Taylor

HAND IT BACK TO THE BROADCASTERS

Novel combination described on page 36 of the Standard Radio Company's catalog for 1926. In speaking of a receiver it says: "The new 'D' coil with which it is equipped is a tuned radio TRANSMITTER mounted on the same shaft of the condenser."

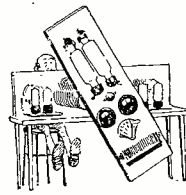

Contributed by F. Danic's

GET BEHIND ME, SATAN!

Devilish data from the Hartford, Conn., Daily Times of July 24: "You can see that in either case the magnetic FIEND around these coils of the TRANSFORMER is subject to a high rate of fluctuation."



Contributed by George L. Remond

WITH FITFUL KEROSENE

Another source of revenue for Socony is seen in this discovery reported by the New York Telegram Radio section of June 26: "In the recently exploited A.C. tubes the filament has given away to, or, rather, has become an OIL heater coil."



Contributed by A. Jacob

THEY'RE TOASTED!

In the June issue of the Radio Review and Call Book we find mention made of "the GRILL COIL of the oscillator." We assume that when the radio waves meander into the antenna that they have to be broiled before they are any use to the rest of the amplifiers.



Contributed by Sam Murtin

Standard Hook-ups

EVERY month RADIO NEWS presents in this convenient form a selection of circuit diagrams, with constructional and other data, on standard hook-ups, which the editors have tried and found to give excellent results. Every radio experimenter should preserve these for their reference value, as they are selected to cover the complete range of radio apparatus, from the simplest to the largest and most complicated. Requests for special or additional advice and information should be addressed to the I WANT TO KNOW Department of RADIO NEWS. (A charge of 25 cents is made for answering each question which requires a reply by letter.)

Handy Reference Data for the Experimenter

A REMARKABLE FIVE-TUBE SET

Circuit No. 184. This is the diagram of a very efficient five-tube set, using what are commonly known as "figure-of-eight coils." Another distinct feature of this receiver is that operation on a loop or with aerial and ground is entirely possible. The simplicity of the arrangements and wiring is obvious from the figure, and it is easy to construct.

Oscillation is controlled by means of a non-inductive variable resistance, as shown, with a range from zero to 200,000 ohms.

The coils may be wound in a self-supporting manner, the turns being held together by celluloid which is supplied in liquid form, or on pairs of 2½-inch insulating tubes. Each unit consists of two cylindrical coils, the turns of which are wound from one to the other and back, crossing in the centre at each turn, so that they are thus united. Half of the wire is wound on each form, so that two are needed to constitute one primary-and-secondary winding. The primaries consist of a total number of 18 turns, and the secondaries of 76 each; or 9 and 38 turns on each form.

In addition to the three R. F. transformers, described above, there are needed for this receiver:

- 1 Composition Panel, 7x24 inches, and baseboard, 8½x23;
- 3 Variable Condensers, .00035-μf., S.L.F.; and clockwise vernier dials;
- 5 Vacuum Tubes and Sockets;
- 2 A.F. Transformers 2:1 ratio;
- 1 Grid Condenser, .00025-μf., with mounting and 3-megohm Grid Leak;
- 2 Fixed Condensers, one .001-μf., one .5-μf.;
- 1 Rheostat, 6-ohm;
- 1 Variable Resistance, 0-200,000-ohm;

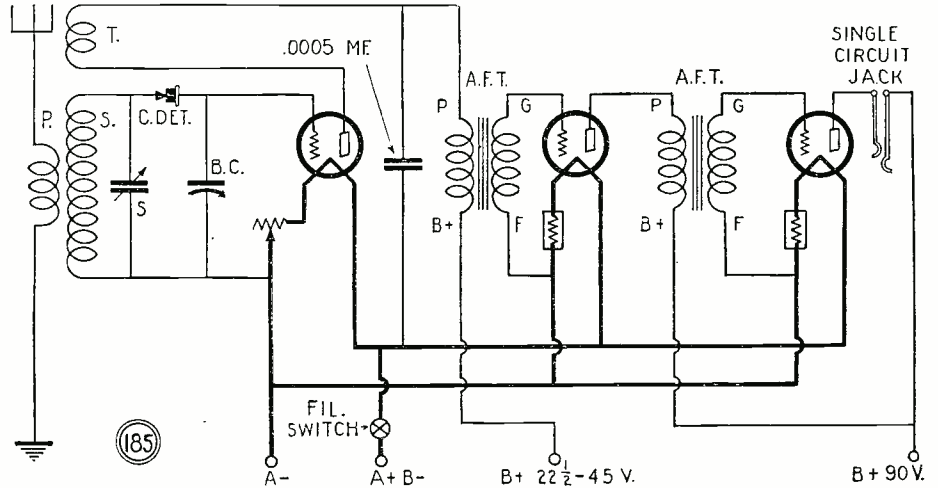

The Regenerative Interflex simplified. The filament control jacks are omitted, and a single-circuit jack is connected directly to the final output. A filament switch turns the tubes on or off.

- 1 S.C. Jack and one S.-T.-S.-P. Switch;
- 8 Binding Posts, Buswire, Spaghetti, etc.

With an aerial and lead-in which should have a combined length of 75 to 100 feet, plug in the loud speaker and turn the rheostat and high-resistance controls almost completely to the right. Turn the dials, keeping them in step, until a station whistle is picked up. Then turn back the high-resistance control to the left until the whistle stops, and adjust all condenser dials until the station comes in best. Log these readings for future reference. After you have the set thoroughly logged and are familiar with its tuning, you need never make it whistle. You then have but to set the dials to the proper readings and turn the volume knob until the reception is at its best.

For loop operation, connect the two outside terminals of the loop to the ground and loop binding posts of the set, from which the aerial and ground have already been disconnected. Open the loop switch so that the first or antenna coil is disconnected, and the first condenser is tuning the loop instead. This dial will, of course, have a somewhat different setting for a given station than when the aerial is in use; but the second and third dials will show the same readings as before.

The loop must, of course, be pointed approximately toward the station desired, some variation being occasioned at times from the exact compass point; and in tuning out an interfering station, the di-

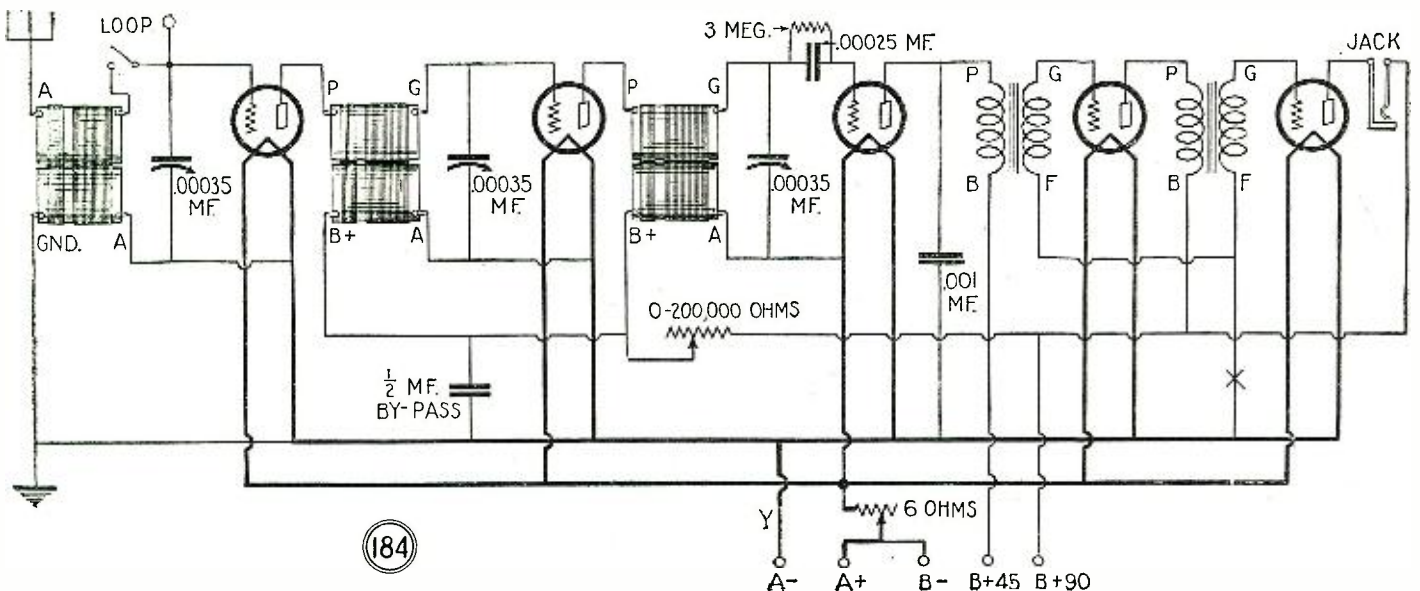

A standard 5-tube tuned-R.F. receiver, employing the "figure-8" type of inductance. A variable resistance, connected in series with the R.F. "B+" supply controls the oscillations within the receiver.

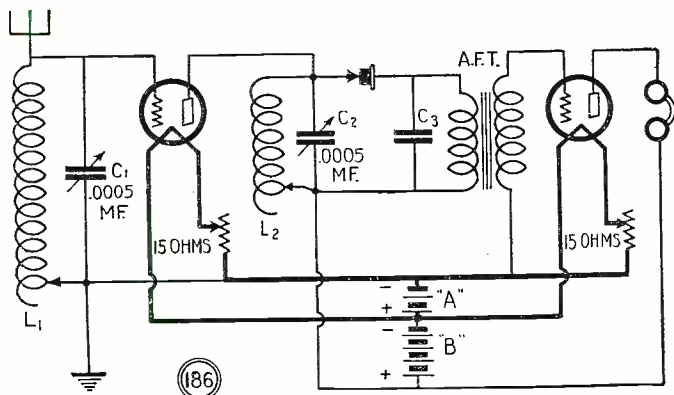

A simple small receiver that has both the desirable features of selectivity and quality. The output of this receiver is sufficient to fill a room, although if greater volume is desired a one-step audio amplifier can be conveniently connected.

rection of the loop must be varied carefully. More careful adjustment of the dials is necessary when tuning the set with the loop.

A SPECIAL REGENERATIVE INTERFLEX RECEIVER

Circuit No. 185. RADIO NEWS has received numerous requests for a three-tube Regenerative Interflex circuit diagram in which the filament-control jacks are omitted. The filament-control jacks, it is claimed, complicate the construction and wiring of the receiver, and sometimes their incorrect use results in burnt-out tubes. Herewith is presented the standard Regenerative Interflex circuit, from which we have eliminated the filament-control units and substituted in their place an ordinary filament switch.

The constructional data for the three-circuit Flexo-Coupler are as follows:

P has 8 turns No. 22 DCC wire on a 3-inch tube.

S has 42 turns No. 22 DCC wire wound on the same tube with P, but 1/2-inch away.

T is an ordinary 25-turn honeycomb coil.

More complete specifications in detail will be found in the article entitled, "The Regenerative Interflex Receiver," published in the December, 1925 issue of RADIO NEWS, or in the RADIO NEWS *Amateur's Handbook*, vol. 2.

gards both selectivity, clarity, and volume, considering the number of tubes employed.

Inductance L-1 consists of 45 turns of No. 22 DCC or DSC wire wound on a 3-inch form. The coil may be of either the tapped or fixed variety. If taps are desired, then the tens and units system may be employed; *i.e.*, a tap taken off every tenth turn for the first forty turns, and a tap taken off every turn after the fortieth, (for the next five turns). The variable condensers are .0005- μ f. The audio-frequency transformer should have a step-up ratio of approximately five-to-one. The crystal detector may be either carborundum or galena. Carborundum will be found slightly more stable in actual operation. Best results will be obtained when vacuum tubes of the storage-battery type (201-A or 301-A) are employed. The values of the rheostats indicated on the schematic diagram are for such tubes. C 3 is an .001- μ f. fixed condenser. L 2 is constructed exactly like L 1.

Varying the capacity of C 1 serves to tune in different wavelengths or stations. C 2 is more of a volume control, although it helps in the selection of a station. If too violent regeneration, or whistling and "squealing" as the layman calls it, is obtained, then the plate voltage or "B" battery should be reduced. The correct working voltage will be found somewhere in the neighborhood of 67 1/2 to 90.

A SIMPLIFIED RADIO RECEIVER

Circuit No. 187. The obvious advantage of resistance-coupled amplifiers is extraordinary quality or distortionless amplification, and the reasons for it need not be explained in detail. Numerous articles on this method which completely cover the subject may be found in the last few issues of RADIO NEWS. All circuit constructors must be aware of the superiority of this method of amplification over the transformer-coupling

method, in regard to quality of reproduction. The usual hiss or roar, which distorts reception and which is so often found in the ordinary amplifier, is always lacking in a perfectly-designed and constructed resistance-coupling unit.

This particular circuit is that of a novel five-tube receiver employing a stage of tuned-radio-frequency amplification to obtain selectivity, and four stages of resistance-coupled radio-frequency amplification. A switching system is incorporated for regenerative purposes. This serves as a volume control, and increases or decreases the receptivity of a receiver.

The following are the parts necessary for the construction of this set:

- 1 Variocoupler;
- 1 .0005- μ f Variable Condenser, (C 1) preferably of the straight-line-frequency type;
- 1 .0001- μ f. Variable Condenser (C 4);
- 3 .0001- μ f. Fixed Condenser (C 2);
- 1 .00025- μ f. Fixed Condensers, (C 3);
- 4 Resistances, 50,000 ohms each (R 1);
- 4 Resistances, 100,000 ohms each (R 2);
- 1 .001- μ f. Fixed condenser (C 5);
- 2 Switch levers;
- 1 7x18 panel;
- 10 Taps;
- 4 Switch stops;
- 5 Rheostats, 15-ohm if the 201-A or 301-A tubes are to be employed.

Honeycomb coils may be substituted for the variable coupler, a double-honeycomb coil mounting being employed for this type of coil. If this feature is used then a wavelength range of from 100 to 25,000 meters may be covered. Changing the values of the coils employed in the primary and secondary circuits, is all that is necessary. The values of the resistances and condensers in the resistance-coupled stages remain the same over the entire wavelength range. Approximately 150 volts "B" battery and storage-battery type tubes are required to obtain maximum efficiency.

Should loud-speaker reception be desired, a three-stage resistance-coupled audio amplifier is recommended, with a power tube in the last audio stage. A UX-112 may be satisfactorily employed for this purpose, in which case 135 to 150 volts will be found sufficient plate voltage for the entire receiver. Approximately 9 volts "C" battery, for the last audio stage only, will be found to give the most efficient results, and clarified reception.

The 201-A or 301-A type of tubes are recommended for the other stages, with the possible exception of the last tube illustrated in this diagram. A UX 200-A or CX 300-A will be best suited for detection purposes.

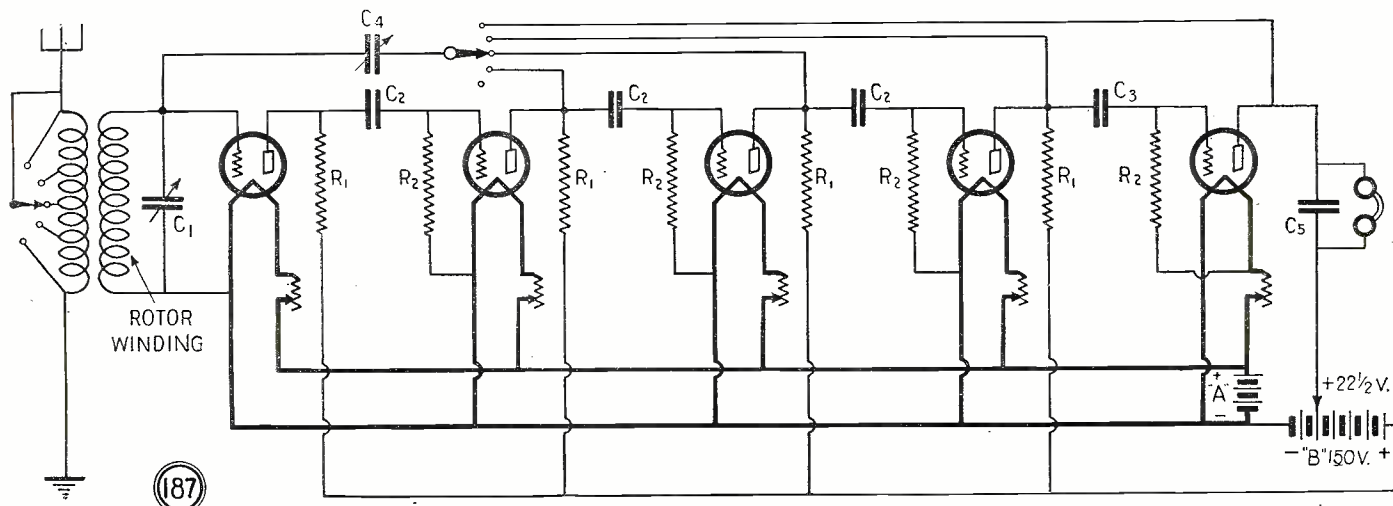

This particular type of circuit may be constructed by those desirous of reception that is free from noises. Resistance-coupled amplifiers are known for their ability to amplify without in any way contributing to the disturbance created by "atmospherics."

Radio Wrinkles

BATTERY INSTALLATION FOR EXPERIMENTAL WORK

It is nothing short of a nuisance to have the "A", "B" and "C" batteries strung out on top of the table on which you do your experimental work. They get in the way; and being where they are, which may be on the left side of the table one evening and the right side the next, they are apt to be short-circuited by mistake.

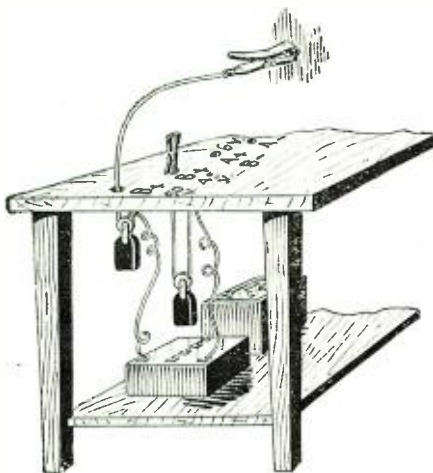

A simple and effective battery-connector arrangement for experimental work. The weights on pulleys underneath the table keep the wires down when not in use.

The idea of placing them on the shelf under the table appealed very much to the writer so he went about determining just how practical it would be. The experiment ended up by boring small holes through the rear of the table and running flexible leads from the batteries up through them. The clips on the ends of the leads prevent the wires from dropping through the holes, in addition to serving their usual purpose. In front of each hole is marked the nature of the lead coming through it and the respective voltage.

Later on the writer instituted a system of weights and pulleys, as shown in the accompanying sketch, so that when he has finished with a lead it will snap back out of the way.

Contributed by James Stimson.

A METAL BASEBOARD WHICH SIMPLIFIES WIRING

It is of the utmost importance nowadays to have the wiring in a receiver as simple as possible, if the best of results are to be had. Furthermore, the less the amount of actual wire employed the better.

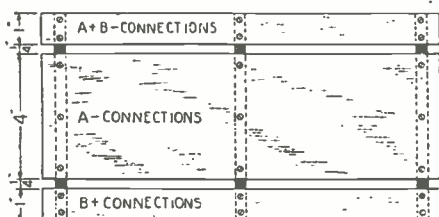

A three section metal baseboard that takes care of the common "A" and "B" connections. Connections to the metal are best made with bolts.

The layout of apparatus and wiring can be greatly simplified by using a sectional metal baseboard as shown in the accompanying sketch.

Obtain a piece of copper or brass sheeting of the correct dimensions for the set you are to build and cut it into three sections, making two of them about one inch wide; the third or center section will probably then be 4 or 5 inches wide. Now procure three pieces of insulating material, thick enough to provide sturdiness and 1/2-inch longer than the metal baseboard is wide. The metal sheets should be fastened to these insulating strips and 1/4-inch spacing left between each.

The apparatus is mounted on the center metal section.

All the "A+" and "B—" connections are made to the metal section to the rear, "A—" connections to the center section, and the "B+" connections to the front section of metal.

With this arrangement, it is possible, by the proper layout of apparatus, to have very short leads and at the same time actually provide a better path for the currents.

It is best to employ insulated wire in connection with this baseboard, so that there is no chance of a short circuit.

Contributed by Robert M. Anderson.

JOINING BUSBAR LEADS TO TERMINAL SHAFTS

Some fans will have found it difficult to make a neat and strong joint when soldering busbar leads to terminal shafts. The busbar should be centered on the stem end (A); but it is difficult to hold it steady in that

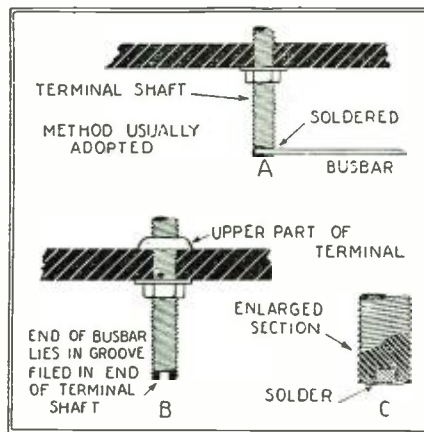

A much better connection to a terminal screw can be made by filing a groove, as shown, and soldering the bus-bar into it.

position while manipulating the soldering iron with the other hand.

The following method makes it, however, quite simple, and incidentally, greatly increases the strength of the joint. The end of the terminal shaft is filed down, at the center, with a thin file, used narrow edge

All published Wrinkles, not winning prizes, will be paid for at the rate of two dollars each.

The next list of prize winners will be published in the November issue.

on (B). The depth of the groove may be about 1/16 of an inch; the thickness of the file should be about the same as the thickness of the busbar.

The shallow groove locates the busbar definitely and the finished joint will be quite flush. The solder will now bind the busbar to the shaft on three sides (C); and even a severe strain will not break this type of joint.

Contributed by C. A. Oldroyd.

CHEAP AND EFFICIENT GRID CONDENSER

Since the capacity of a grid condenser is very small, it is a simple matter to make one at home from almost any material avail-

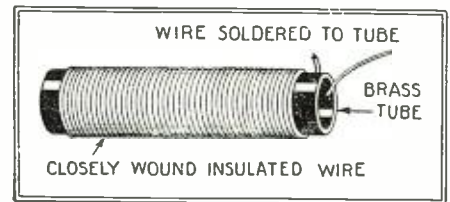

A simple grid condenser, composed of a copper or brass tube wound with insulated wire. The tube forms one plate, the wire the other.

able. Two copper or aluminum plates, mounted very close to each other, form a condenser of sufficient capacity to be used in the grid circuit of a vacuum-tube detector.

However, one of the simplest types can be made from a section of brass tubing, about 1 1/2 inches long, closely wound with No. 24 or 26 insulated wire. The tube acts as one plate of the condenser, the closely-wound wire as the other; while the insulation functions as the dielectric. A condenser of this type is shown in the accompanying illustration. Care must be taken that the wire does not come in direct contact with the tube; be sure the insulation on the wire is perfect before winding it on the tube.

Contributed by Edmund C. Woodard.

WHEN WINDING COILS

When winding coils and using silk or cotton-covered wire which has been bought on reels, it will often be found that it is not an easy matter to stop the wire from kinking, and also make it run smoothly on to the former with an even tension.

The little device shown in the accompanying sketch makes matters easy and a very neat result can be obtained.

The porcelain pulleys are of the ordinary (*Continued on page 416*)

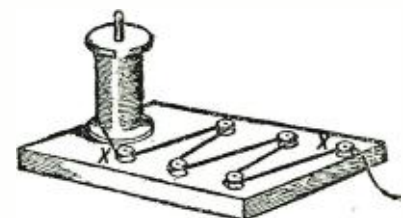

This device not only keeps the wire taut while winding, but also straightens it.



**APPROVED
RADIO NEWS
LABORATORIES
1922**

RADIO NEWS LABORATORIES



RADIO manufacturers are invited to send to RADIO NEWS LABORATORIES, samples of their products for test. It does not matter whether or not they advertise in RADIO NEWS, the RADIO NEWS LABORATORIES being an independent organization, with the improvement of radio apparatus as its aim. If, after being tested, the instruments submitted prove to be built according to modern radio engineering practice, they will each be awarded a certificate of merit, and a "write-up" such as those given below will appear in this department of RADIO NEWS. If the apparatus does not pass the Laboratory tests, it will be returned to the manufacturer with suggestions for improvements. No "write-ups" sent by manufacturers are published on these pages, and only apparatus which has been tested by the Laboratories and found to be of good mechanical and electrical construction is described. Inasmuch as the service of the RADIO NEWS LABORATORIES is free to all manufacturers whether they are advertisers or not, it is necessary that all goods to be tested be forwarded prepaid, otherwise they cannot be accepted by the Laboratories. Apparatus ready for the market or already on the market will be tested for manufacturers, as heretofore, free of charge. Apparatus in process of development will be tested at a charge of \$2.00 per hour required to do the work. Address all communications and all parcels to RADIO NEWS LABORATORIES, 53 Park Place, New York City.

VARIABLE CONDENSER

The variable condenser shown was submitted to the RADIO NEWS LABORATORIES for test, by the Wirt Company, Philadelphia, Pa., and found

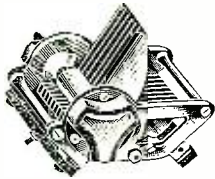

to be of very good construction. It has a maximum capacity of .00035-*mf*.

AWARDED THE RADIO NEWS LABORATORIES CERTIFICATE OF MERIT NO. 1441.

TOROIDAL COIL

The coil shown was submitted to the RADIO NEWS LABORATORIES for test, by the Russell Fraser Wire Co., Maspeth, Long Island, N. Y. It has a toroidal winding and therefore, a



consequent lower distributed capacity. These inductances are adaptable to any type of tuned-radio-frequency circuit.

AWARDED THE RADIO NEWS LABORATORIES CERTIFICATE OF MERIT NO. 1494.

UNIVERSAL SOCKET

The universal socket shown was submitted to the RADIO NEWS LABORATORIES for test, by the Klosner Radio Corp., 1022 E. 178th St., New York City. It is designed to take all



present types of UX vacuum tubes, and has been found to be of very good construction.

AWARDED THE RADIO NEWS LABORATORIES CERTIFICATE OF MERIT NO. 1429.

GLASTOR RESISTANCE UNIT

The resistance unit shown was submitted to the RADIO NEWS LABORATORIES for test, by the Daven Radio Corp., Newark, N. J. The effective element is a metallic substance



which is fused into a glass rod. The resistance value was found to be very accurate and free from any variation.

AWARDED THE RADIO NEWS LABORATORIES CERTIFICATE OF MERIT NO. 1473.

VACUUM TUBE

The vacuum tube shown was submitted to the RADIO NEWS LABORATORIES for test, by the Myers Radio Tube Corp., 1890 East 40 Street, Cleveland, Ohio. It is of the high- μ type. It was found to be excellent both as detector and amplifier. It is particularly adaptable to audio amplifiers of the resistance- and impedance-coupled type.



AWARDED THE RADIO NEWS LABORATORIES CERTIFICATE OF MERIT NO. 1495.

CRYSTAL SET AND HEADPHONES

The set and headphones shown were submitted to the RADIO NEWS LABORATORIES for test, by the C. Lorenz A.-G., Berlin-Tempelhof-Lorenzweg, Germany. It is found to be very efficient. The set employs a semi-adjustable crystal detector and inductance coil, and a small compression-type variable condenser. Small jacks are provided in the side of the case for two pairs of headphones.



AWARDED THE RADIO NEWS LABORATORIES CERTIFICATE OF MERIT NO. 1475.

RESISTOR UNIT

The resistor unit shown was submitted to the RADIO NEWS LABORATORIES for test, by Arthur H. Lynch,



Inc., Fisk Building, Broadway and 57th Street, New York City. These resistors, which employ a metallic substance as an element, were found to be very accurate and impervious to climatic conditions. These units come in various resistance values.

AWARDED THE RADIO NEWS LABORATORIES CERTIFICATE OF MERIT NO. 1427.

SOUND-ABSORBENT PAD

The sound-absorbent pad shown was submitted to the RADIO NEWS

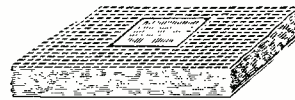

LABORATORIES for test, by the Wood Conversion Co., Cloquet, Minn. The pad shown herewith is made of balsam wool and will effectively damp any mechanical vibration, when placed underneath a radio set or a loud speaker.

AWARDED THE RADIO NEWS LABORATORIES CERTIFICATE OF MERIT NO. 1471.

RADIO LAMP AND LOUD SPEAKER

This combination electric lamp and horn loud speaker was submitted to the RADIO NEWS LABORATORIES for



test, by the Faries Mfg. Co., Decatur, Ill. It is very attractive in appearance and has fine tonal qualities.

AWARDED THE RADIO NEWS LABORATORIES CERTIFICATE OF MERIT NO. 1368.

GEM-JAC

The Gem-Jac shown was submitted to the RADIO NEWS LABORATORIES for test, by the Chicago Telephone Supply Co., Elkhart, Ind. This small jack is of original construction, and



takes up very little space behind the panel.

AWARDED THE RADIO NEWS LABORATORIES CERTIFICATE OF MERIT NO. 1478.

FIXED CONDENSER

The fixed condenser shown was submitted to the RADIO NEWS LABORATORIES for test, by the Tobe-



Deutschmann Company, Cornhill, Boston, Mass. It is designed for use in "B" battery eliminator cir-

cuits, and will stand excessively high voltages. The capacity is 4-*mf*.

AWARDED THE RADIO NEWS LABORATORIES CERTIFICATE OF MERIT NO. 1467.

POWER-AMPLIFIER TUBE

The tube shown was submitted to the RADIO NEWS LABORATORIES for



test, by the Van Horne Company, Franklin, Ohio. This tube passed all tests. It is provided with four binding posts, so that it can be placed in the last-stage amplifier of any set without the necessity of changing any of the wiring.

AWARDED THE RADIO NEWS LABORATORIES CERTIFICATE OF MERIT NO. 1337.

DRY-CELL "B" BATTERY

The battery shown was submitted to the RADIO NEWS LABORATORIES for



test, by Wireless Dry Cells, Ltd., Niagara Falls, N. Y. This 45-volt "B" battery was found to be made of excellent materials, and tests proved it to have a long life.

AWARDED THE RADIO NEWS LABORATORIES CERTIFICATE OF MERIT NO. 1452.

VARIABLE CONDENSER

The variable condenser shown was submitted to the RADIO NEWS LABORATORIES for test, by the Pacent Electric Company, 91 Seventh Ave., New York City. This variable condenser is of the straight-line-fre-

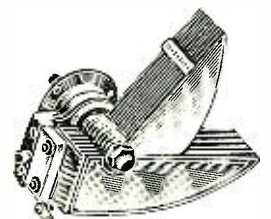

quency type; its mechanical and electrical design is very good.

AWARDED THE RADIO NEWS LABORATORIES CERTIFICATE OF MERIT NO. 1323.

DRY-CELL "B" BATTERY

The dry-cell "B" battery shown was submitted to the RADIO NEWS



LABORATORIES for test, by the Standard Electric Novelty Company, 19 Bond Street, New York City. It was found to be made of very good material and to have a long life. It is of the 45-volt type.

AWARDED THE RADIO NEWS LABORATORIES CERTIFICATE OF MERIT NO. 1474.

VACUUM TUBE

The vacuum tube shown was submitted to the RADIO NEWS LABORATORIES for test, by the Van Horne Company, Franklin, Ohio. This



tube was found to have exceptionally good characteristics, and stood up well under all tests.

AWARDED THE RADIO NEWS LABORATORIES CERTIFICATE OF MERIT NO. 1337.

VACUUM TUBE

The vacuum tube shown was submitted to the RADIO NEWS LABORATORIES for test, by the Van Horne Company, Franklin, Ohio. The tube has a split base, with a sponge-rubber ring interposed, which effectively absorbs mechanical vibrations. The tube can be used either as a detector or an amplifier.



AWARDED THE RADIO NEWS LABORATORIES CERTIFICATE OF MERIT NO. 1500.

DOUBLE-DUTY BATTERY CHARGER

The double-duty battery charger shown was submitted to the RADIO NEWS LABORATORIES for test by the Acme Electric and Manufacturing Company, 1444 Hamilton Avenue,



Cleveland, Ohio. This charger employs a large rectifier tube and can be used for charging storage "A" or "B" batteries.

AWARDED THE RADIO NEWS LABORATORIES CERTIFICATE OF MERIT NO. 1445.

JACK SWITCH

The Jack Switch shown, submitted to the RADIO NEWS LABORATORIES for test, by the Bono Mfg. Co., 426 S. Clinton St., Chicago, Ill., provides a convenient means for switching from one to another stage of audio-frequency amplification. The telephone plug is inserted in a hole through the center of the control knob. This device passed all tests satisfactorily.

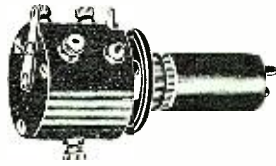

AWARDED THE RADIO NEWS LABORATORIES CERTIFICATE OF MERIT NO. 1517.

"B" ELIMINATOR AND POWER AMPLIFIER

The "B" Eliminator and power amplifier shown, submitted to the RADIO NEWS LABORATORIES for test, by the General Radio Co., 11 Windsor St., Cambridge, Mass., comes in kit form. Aside from the single stage of power amplification, the eliminator unit is capable of supplying "B" current for all of the tubes in the set with which it is used. This device passed all tests satisfactorily.

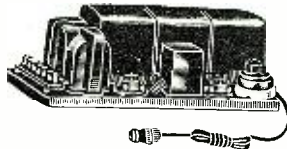

AWARDED THE RADIO NEWS LABORATORIES CERTIFICATE OF MERIT NO. 1505.

TRICKLE CHARGER

The "Konite Recti-Trickler" or Trickle Charger shown, submitted to the RADIO NEWS LABORATORIES for test, by the Konite Corp., 25-27 West Broadway, New York City, is a comparatively new form of rectifying device; no tube is employed. It proved to be satisfactory on test.



AWARDED THE RADIO NEWS LABORATORIES CERTIFICATE OF MERIT NO. 1522.

AUDIO-FREQUENCY TRANSFORMER

The Audio-Frequency Transformer shown, submitted to the RADIO NEWS LABORATORIES for test, by the Carter Radio Co., 300 S. Racine Ave., Chicago, Ill., is of unique construction and takes but little space behind the panel of a radio set. The mechanical and electrical construction is excellent. This jack is supplied in all standard types.



AWARDED THE RADIO NEWS LABORATORIES CERTIFICATE OF MERIT NO. 1545.

AWARDED THE RADIO NEWS LABORATORIES CERTIFICATE OF MERIT NO. 1518.

PLUG-IN "B" ELIMINATOR

The "B" Eliminator shown, submitted to the RADIO NEWS LABORATORIES for test, by Silver-Marshall, Inc., 110 South Wabash Ave., Chicago, Ill., comes in kit form. It

is designed for use with a Raytheon tube; the voltage range is from zero to 300. It gave excellent re-

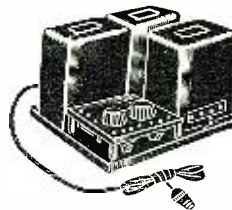

sults on test and was found to pass no hum.

AWARDED THE RADIO NEWS LABORATORIES CERTIFICATE OF MERIT NO. 1519.

TAPPED INDUCTANCE

This tapped inductance, submitted to the RADIO NEWS LABORATORIES for test, by the (Remier) Gray & Daulson Mfg. Co., 260 First St., San



Francisco, Cal., is designed for use in the Infradyne circuit. It was found to be of excellent construction.

AWARDED THE RADIO NEWS LABORATORIES CERTIFICATE OF MERIT No. 1573.

SOCKET

The Socket shown, submitted to the RADIO NEWS LABORATORIES for test, by the Insulating Company of



America, Inc., 59 Warren Street, New York City, is very simple in construction and consists primarily of the four prongs which can easily be riveted into holes in a sub-base. The mechanical construction was found to be excellent.

AWARDED THE RADIO NEWS LABORATORIES CERTIFICATE OF MERIT NO. 1520.

RADIO JACK

The Radio Short Jack shown, submitted to the RADIO NEWS LAB-



ORATORIES for test, by the Carter Radio Co., 300 S. Racine Ave., Chicago, Ill., is of unique construction and takes but little space behind the panel of a radio set. The mechanical and electrical construction is excellent. This jack is supplied in all standard types.

AWARDED THE RADIO NEWS LABORATORIES CERTIFICATE OF MERIT NO. 1545.

AUDIO-FREQUENCY AMPLIFIER

The "Tru-Phonic" Audio-Frequency Amplifier, submitted to the RADIO NEWS LABORATORIES for test, by the



Alden Mfg. Co., 52 Willow St., Springfield, Mass., is a unit as shown, comprising three stages of audio-frequency amplification em-

ploying a new form of coupling system. The unit can be attached to any form of radio set. It gave excellent results on test.

AWARDED THE RADIO NEWS LABORATORIES CERTIFICATE OF MERIT NO. 1548.

FACE PLATE

The Face Plate shown, submitted to the RADIO NEWS LABORATORIES for test, by the Alden Mfg. Co., 52 Willow St., Springfield, Mass., is to be used in conjunction with the "Na-Aid" triple-condenser unit. It is easily attached to the radio-receiver panel.



AWARDED THE RADIO NEWS LABORATORIES CERTIFICATE OF MERIT NO. 1549.

TIP JACK

The Tip Jack shown, submitted to the RADIO NEWS LABORATORIES for test, by the Carter Radio Co., 300



S. Racine Ave., Chicago, Ill., can be easily mounted on the panel of any radio set. It is designed to take the cord tips of any type of head-phone or loud-speaker.

AWARDED THE RADIO NEWS LABORATORIES CERTIFICATE OF MERIT NO. 1547.

FIXED RESISTANCE

The fixed resistance shown, submitted to the RADIO NEWS LABORATORIES for test, by the Tobe-Deutschmann Co., Cornhill, Boston, Mass., employs a metallic composi-



tion enclosed within an evacuated tube, so that it cannot be affected by climatic conditions; it comes in all standard resistance values.

AWARDED THE RADIO NEWS LABORATORIES CERTIFICATE OF MERIT NO. 1506.

CAGE ANTENNA AND GROUND

The Cage Antenna and Ground shown, submitted to the RADIO NEWS LABORATORIES for test, by the Radio-Kraft Mfg. Co., 503 F. W. Bann

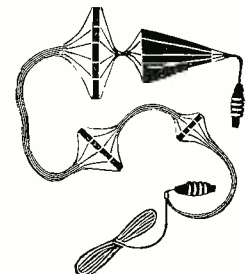

Bldg., Main St., at Pico, Los Angeles, Calif., comes as a complete assembly. A good grade of stranded copper wire is employed, together with copper hoops which space the wires.

AWARDED THE RADIO NEWS LABORATORIES CERTIFICATE OF MERIT NO. 1543.



The "Ham" Meets the "Egg"

By "BILL" SCHUDT, Jr.

WE had just moved into the new house, and it was a bright warm Saturday afternoon. I was busily engaged in erecting a mast in the back yard to support my thirty-foot antenna.

I had gone as far as placing a few guy wires when a rather enthusiastic voice joyously remarked:

"Oh, are you putting up an aerial?"

"Yeah," I replied, "who told you?" Having fastened the third guy securely I turned to view my new acquaintance.

He was a dear boy, for all the world like Harold Lloyd—shell-rimmed eyeglasses and all.

Evidently my short, if not curt, reply took him by surprise, for he hesitated momentarily before replying in a meeker tone:

"No one told me. I have a radio, too!

In fact I may be able to give you a few tips on just the correct methods to pursue in putting up that aerial. I've been experimenting with the new science for a long time now. Let's see; it must be pretty nearly two years since I built my first set."

I eyed him rather suspiciously and thought to myself that at least I was going to have a lot of fun with this "expert" giving me "hints for beginners."

"Oh," I replied, "That is, indeed, very

kind of you. Know anything about Hertz antennas?"

"Why-er, no I don't. The 100-foot kind is the best though," he stammered.

Four more guys having been properly placed, I proceeded to measure off the proper length for my aerial—when my newly acquired assistant politely told me that if I didn't make that aerial a good bit longer I wouldn't be able to get much distance.

"In fact," he continued, "anybody will tell you that and I can prove it to you."

I really don't know why the warm weather affects me, but it does, and it was acting unusually well on this day for I had stood this bird's lingo long enough.

"Say, listen, 'Big Boy.' Before you go any further with this aerial job I want to make a few things more than clear to you. First, this aerial is for a transmitter. The transmitter will operate on forty meters. I'm not going to, nor do I want, to receive distance or any music whatsoever on it. Furthermore I'm one of those terrible people you read about, an *AMATEUR!*" I was yelling at him now and he was listening to every word with marked interest, so I continued: "And, if you think you can help me, c'mon up to the shack and hitch the 'soup jars' together so we'll have a nice peep-peep note when we get on the air."

"An Amateur?" he howls at me, "and you've got a transmitting set too? You know, I've always wanted to see a sending set."

"Well, hike up a coupla flights of stairs with me and you can see all the transmitting stuff that yours truly has collected since the advent of the jumping-flivver spark coil."

By this time I had all of the guys tightened and the aerial in place and was on my way toward the house. My friend remained in the rear and suddenly bursts forth with an Indian sort of howl: "Hey, aren't you going to put up more wire than that? That thing doesn't look to me as if it would work."

"Well, maybe it won't," I said cynically: "Come on in and we'll see."

As I opened the door of the shack he immediately darted into the room ahead of me, as though after a million dollars. Getting to the center of the room he stopped short, and with a disappointed look in his eyes, demanded impatiently:

"Where's the sending set?"

"Right there to the left of that big switch," I remarked casually: "See the two inductances?"

"What, that mess of apparatus is a sending set?" says my "pal." "Why my super-heterodyne is much larger."

"Really!" I replied: "Well that's gonna be awfully tough on my grandchildren. Whether you believe it or not, that mess, or conglomeration of junk that you see held together with an occasional wire here and there is My Transmitter!"

"Oh, I believe you, all right, but I expected to see a real transmitter," he mutters.

(Continued on page 394)

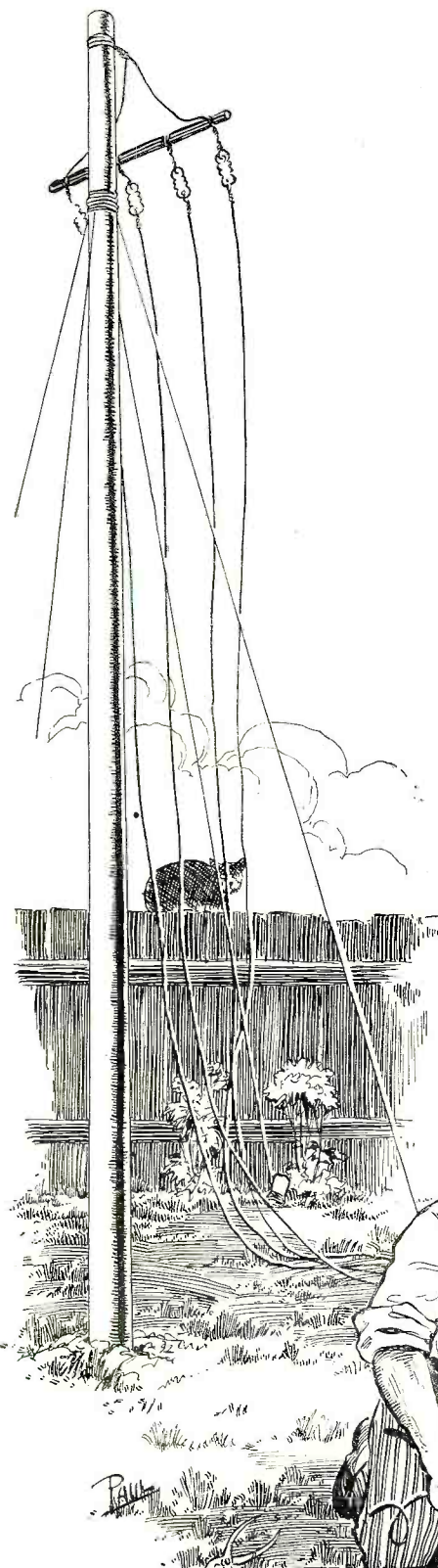

"Oh, are you putting up an aerial?"
"Yeah," I replied, "who told you?"



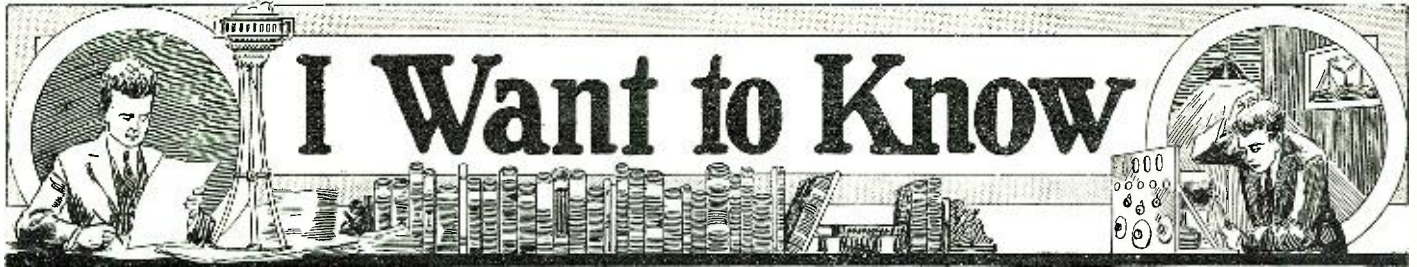

Conducted by Joseph Bernsley

THIS Department is conducted for the benefit of our Radio Experimenters. We shall be glad to answer here questions for the benefit of all, but we can publish only such matter as is of sufficient interest to all.

1. This Department cannot answer more than three questions for each correspondent. Please make these questions brief.
2. Only one side of the sheet should be written upon; all matter should be typewritten or else written in ink. No attention paid to penciled matter.
3. Sketches, diagrams, etc., must be on separate sheets. This Department does not answer questions by mail free of charge.
4. Our Editors will be glad to answer any letter, at the rate of 25c. for each question. If, however, questions entail considerable research work, intricate calculations, patent research, etc., a special charge will be made. Before we answer such questions, correspondents will be informed as to the price charge.

Mr. Bernsley answers radio questions from WRNY every Thursday at 8:15 P. M.

The I Want to Know Department can not undertake to supply picture diagrams of circuits; the schematic diagrams, which are standard in their use of symbols, are made as plain as possible and full information is given with them. When a picture diagram of a given circuit is available elsewhere, we will supply this information on request.

THE ARKAY RECEIVER

(Q. 2188). Mr. L. K. Riley, Geneva, N. Y., asks as follows:

Q. 1. A friend of mine is obtaining wonderful reception with a small four-tube receiver, which he says is termed the "Arkay" receiver, and which was described in some radio section of a newspaper. I wonder if you can furnish me with any data or information concerning the construction and wiring diagram of this receiver? I am very much interested, due to its high efficiency, and would like to construct one similar to that of my friend.

A. 1. The Arkay receiver, to which you refer, was described in the Newark Sunday Call, and the following is a reprint of the description of this receiver. All the necessary information is included.

"A stage of radio frequency, detector, and two stages of audio-frequency amplification are employed in this circuit. No 'trick' wound coils are employed. Single-layer inductances which can be constructed at home are ample. The two dials may be logged and after a short time the owner should be able to pick up many stations throughout the country. The set is quite selective and it has been possible during the tests to log DX through a great many locals.

R.-F. Input Circuit

"Unlike the majority of tuned-radio-frequency receivers of the neutrodyne type which make use of an 'untuned-primary' coil underneath or alongside of a secondary, the improved Arkay circuit employs a tuned primary coil directly coupled to the antenna circuit through a series condenser. In this manner a greater amount of radio-frequency current is obtained from the antenna than with the untuned primary coil. The latter system is not as efficient as the former, due to the losses which occur in coupling. The single-circuit idea appears to have considerable merit, and actual comparisons seem to favor this form of tuning for R.F. work.

"Radio fans who were owners of single-tube 'single-circuit' receivers will recall the remarkable distances covered with this type of set, compared with a receiver making use of a coupler having separate primary and secondary windings. The former outfit, while not much on selectivity, certainly took the prize for sensitiveness. This circuit employed as a R.F. amplifier carries with it the efficient qualities of the one-tube set.

"The following is a list of parts required to complete this set:

- 1 Panel 7 x 14 or longer;
- 1 Baseboard to suit panel;
- 5 Binding Posts;
- 2 Variable Condensers, .0005- μ f.;
- 4 201-A Sockets;
- 2 Audio Transformers; 1:6 and 1:2;
- 1 Self-adjusting Rheostat, 1/2 ampere, and mounting;
- 4 201-A Tubes;
- 1 Grid Condenser, .00025- μ f., and 5-megohm leak;
- 1 .002- μ f. Fixed Condenser;
- 2 3-inch Tube Forms, 4 1/2 and 3 1/2 inches long;
- 1 Binding-Post Strip;
- 2 30-ohm Rheostats;
- 1 Single-Jack Filament Control or cut-off switch;
- 6 Lengths of busbar wire;
- 2 4-inch Dials.

Making the R.F. Coil

"The radio-frequency coil is easy to make and consists of a single layer of wire wound on a

cardboard or bakelite tube; the lighter the tubing, the better. The coil employed in the set was 2 1/2 inches in diameter and 5 inches long. As it may be difficult to get tubing of this size, it is suggested that a 3-inch tube be used in its place. Start about half an inch from one end of the tube and wind 60 turns of No. 22 DCC wire, taking a tap or loop at this point. Continue winding, taking another tap at the 80th turn, completing the coil at the 100th turn. Make sure to leave about an inch of wire at the beginning and end of the coil for connections. The coil should be mounted above the baseboard of the set on blocks of wood or by means of small brass rods; its end should point toward the front panel and be placed at the right of the baseboard.

"This coil is tuned by means of a .0005- μ f. variable condenser, which is mounted on the panel a little to the left of the end of the coil. The taps are used for different aerials. No switch is employed for the taps, as this proper point will be determined by trial.

Secondary Coil

"The secondary coil has three separate windings. On one end is the R.F. 'reversed coil'; in the center is the secondary, which takes up most of the space; and on the remaining end is the detector-plate coil, T. The secondary coil, as well as the two smaller coils, are all wound with No. 24 DCC wire. A quarter of an inch separation is left between each winding on this form.

"Starting one-quarter of an inch from one end of a 3-inch tube, which should be 3 1/2 inches long, wind tightly 14 turns of wire, making provision at the beginning and end for holding the wires in place. Two small holes will be satisfactory for holding the start and finishing wires. Leave at least an inch of wire for connections.

"Then skip about one-quarter of an inch and in the opposite direction wind the secondary of 45 turns of wire. Leave another quarter of an inch and wind in the same direction the detector-plate coil of nine turns. This completes the entire inductance.

"The secondary coil is mounted at right angles to the radio-frequency coil and at least five inches away, so that the fields of the two coils will not interfere. Back of the secondary coil is the .0005- μ f. variable condenser.

"The coil may be mounted on the condenser end-plate, provided the condenser has an insulated form. (The condenser used is a .0005- μ f. straight-line wavelength type, with a hard-rubber end plate). Or the coil may be supported by means of

the busbar wires which connect to its six terminals. "Keep all wires out of the end fields of the secondary coils. Do not run wires through the coil or across the ends. Run them away from the windings rather than parallel or too close.

Four Binding Posts

"Battery binding posts are mounted on a small panel to the rear of the baseboard. There are four in number; the "A—" is also ground. The antenna post is mounted on a separate small panel away from the battery and ground binding posts. This connection is brought out on the side near the .0005- μ f. antenna tuning condenser, and run to the rotor plates.

"The by-pass condenser, .002- μ f., is connected between the detector plate coil winding and the "A—" battery wire. The .00025- μ f. grid condenser is mounted close to the detector tube socket, underneath the secondary tuning coil.

"A single-circuit jack with filament control can be employed for the output, or a 'cut-off switch' may be mounted on the panel, for extinguishing the filaments. The two audio transformers are mounted at right angles to each other. The shielding will allow them to be placed close together in case the set is made compact. The baseboard is 9 inches deep."

HERALD-TRIBUNE FIVE-TUBE SET

(Q. 2189) Mr. N. R. Porter, Miami Beach, Fla., asks:

Q. 1. The New York Herald-Tribune published some time last summer an unusually selective five-tube radio receiver which impressed me very much. I am desirous of constructing this set, but have lost the description of this receiver. Have you the information available, or do you keep files of other radio publications?

A. 1. The article to which we think you refer, is entitled "A Select Five-Tube Radio Receiver," and was published in the Herald-Tribune's Radio Section. The receiver is unusually selective and, we believe, will prove interesting to circuit seekers. We are, therefore, reprinting practically the entire description including all the necessary constructional details.

"There is nothing particularly new in this circuit, which is the old Weagant, with a few variations. The set originally was designed for local reception only, but one local did not come in very well, so a stage of radio-frequency amplification was added. A location in the center of Manhattan was selected for a test. In this particular spot the locals have a habit of overpowering each other at times. Several other sets had been

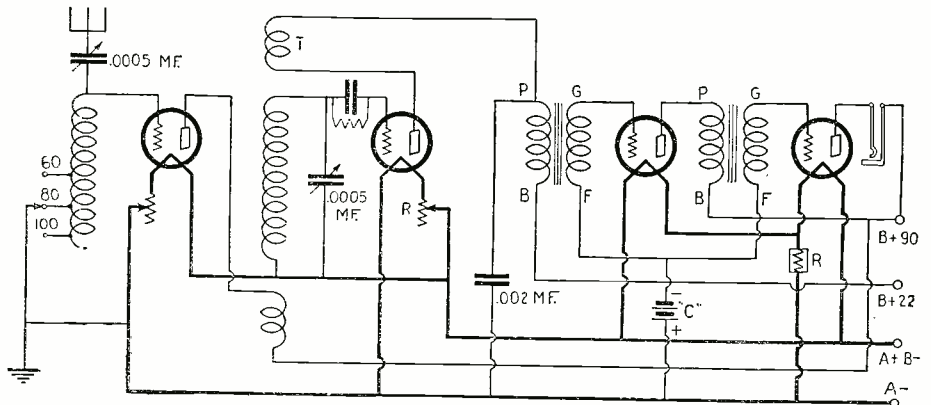

Q. 2188

The Arkay receiver, a very efficient and sensitive 4-tube set, incorporating a stage of tuned radio frequency amplification, the tuner of which is extremely novel, and a detector stage combining regeneration, besides the usual two stages of audio-frequency amplification.

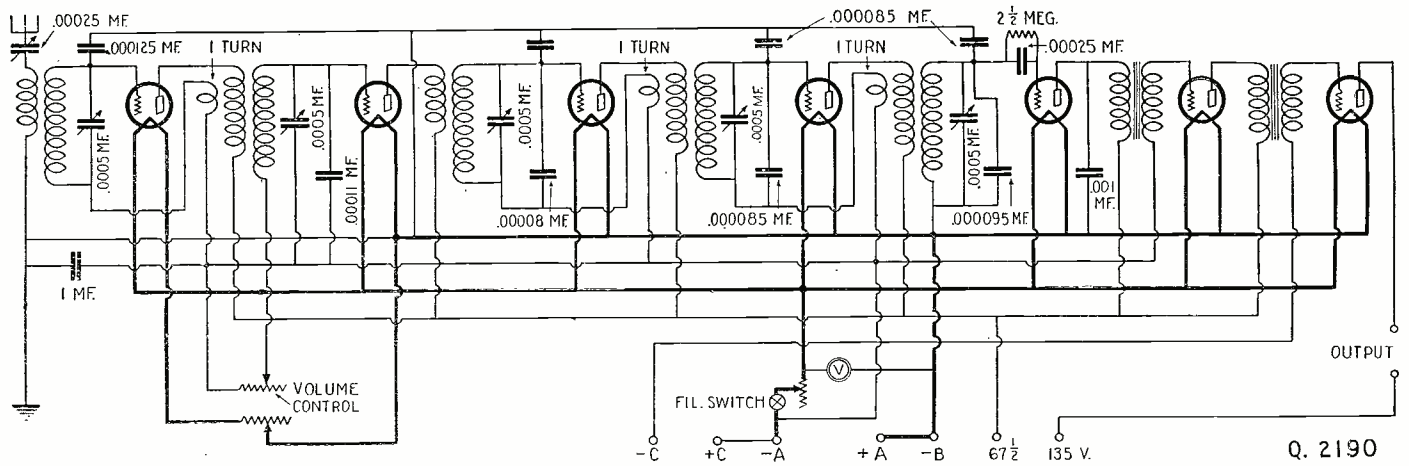

The schematic wiring diagram of the Kellogg R.F.L. receiver. This set combines many desirable features which are very popular with the broadcast listener; the most important of which are four stages of tuned-radio-frequency amplification before a detector, and two stages of audio frequency amplification. A power tube is used in the last audio stage, using the voltage shown.

tried out previously, sets which had been boosted as being ultra-selective, but which usually had brought in two stations at a time. The result of the test with the Weagant circuit was very satisfactory, all the locals being easily separated and the selectivity being close enough without any cutting of side bands. The volume was ample and the quality equal to any set the author has heard. The set is compact, the panel being 7 x 21 inches, and the baseboard 12 x 20 inches. The length of the panel is only 21 inches, making it shorter than the average for a set using this circuit, which is about 26 inches. The arrangement of parts also is quite different, the result being a shortening and more direct running of leads and a more efficient placing of parts.

"The coils are of the ribbed type of hard-rubber tubing, recommended for its high electrical efficiency. There are twelve ribs running lengthwise of the tube, spaced equally around the circumference. The turns of wire, touching only the tops of the ribs, leave a space under the coils and provide practically an air core. The antenna coil was wound on a 3-inch tube, 3 inches long, with No. 22 D.C.C. wire, fifteen turns for the primary coil (L1), and forty-six turns for the secondary (L-2). The number of turns for this coil may vary, depending upon the length and type of aerial used. The aerial used with this set was about seventy-five feet in length. If a shorter aerial is used, fifty to fifty-four turns may be required. The spacing between the primary and secondary is not critical; from one-eighth inch to one-quarter inch works equally well.

Construction of Coils

"The R.F. coil form is 3 inches in diameter, and 6 inches long, as it performs a three-fold duty—that of supporting the R.F. primary, the R.F. secondary and the regenerative coil. The R.F. primary coil (L3) is composed of twenty turns of No. 22 D.C.C., the R.F. secondary coil (L4) of forty-six turns of No. 22 D.C.C., and the regenerative coil (L5) of twelve turns of No. 30 D.C.C. The spacing between the R.F. primary and the R.F. secondary must be two inches; or slightly more may prove even better. This may seem to be a great distance to separate the two coils, but the coupling seems more than ample. The selectivity of this circuit is, no doubt, due to

the extremely loose coupling of the primary and secondary. The regenerative coil (L5) is spaced about one-eighth inch from the secondary.

"To obtain a variable capacity of .0002- μ f. maximum for the regenerator, a larger condenser can be used by removing a number of the rotor plates. In this case, a .00035- μ f. condenser was used, after removing four rotor plates, which brought the capacity down to what was estimated at approximately .0002- μ f.

"The inductance forms can be fastened directly to the baseboard with a wood screw, or elevated a half inch or so on S-shaped strips of brass.

"The set should ordinarily tune from 200 to 526 meters smoothly and with equal volume. However, several sets that were built were found a little tricky on wavelengths under 300 meters—that is, there was a tendency to spill over and difficulty in balancing. This tendency was corrected by making use of the Rice system of neutralization, which consists of an inductance and a neutralizing condenser. These parts are indicated in the diagram to show their location; but need only be used if difficulty is experienced on the low wavelengths. There is, however, only one chance in a hundred of their being required. The coil, L6, is composed of the same number of turns as the R.F. coil, and is wound directly over the R.F. coil, L3, in this manner.

"Solder one end of the wire to the side of the R.F. coil marked "B + 67" and bring the wire diagonally across the R.F. coil and wind in the same direction as the winding on the R.F. coil; then fasten the twentieth turn to the neutralization condenser. The other side of the condenser leads to the grid of the R.F. tube. To operate, tune in one of the lowest stations you can get (where the squeal seems the lowest), and turn the condenser plates in or out, as the case may be, until the squeal just stops. The set should then tune from 200 to 526 without a whistle. The neutralizing condenser may be any suitable type procurable; a midget can be used.

"The tube in the last stage may be a 201-A if the horn type of loud-speaker is used. However, if the builder intends to use a cone speaker, he will require a great output voltage to properly vibrate the cone. The use of a UX-171 power tube is suggested here as a suitable means of providing the necessary power without distorting the

signal. A self-adjusting rheostat of one-half ampere capacity must be provided for this type of tube.

"The choke and large condenser shown in the diagram can be used or not as the builder sees fit. The choke can be a standard commercial instrument designed for this purpose. The choke and condenser take up little space, and can be placed on a little shelf in the corner of the cabinet on the audio side of the set. When the 171 power tube is used, the choke-condenser output circuit must be employed.

Parts Required

- 1 Cabinet, 21 in. long and 12 in. deep;
- 1 Baseboard, 7 in. x 20 in. wood. Brass strip, 1/2 x 1/16;
- 1 Panel, 7 x 21 x 3/16 in.;
- 2 Variable Condensers, .0005;
- 1 Variable condenser, .0002;
- 5 201-A tubes;
- 2 Rheostats;
- 2 Sockets;
- 3 Sockets, gang, bakelite;
- 2 Tubular Forms, 3 x 6 in. and 3 x 3 in. for coils;
- 1 Grid Leak, variable;
- 1 Grid Condenser, .00025;
- 3 Self-adjusting Rheostats and mountings;
- 1 Audio Transformer;
- 2 Resistor Couplers;
- 4 Resistances, .05, .25, .1 and 2.0 megohms;
- 2 Coupling Condensers, .006;
- 12 Binding Posts;
- 1 Terminal Strip, 1 1/2 x 4 x 3/16 inches;
- 1 Terminal Strip, 1 1/2 x 8 x 3/16 inches;
- 3 Dials;
- 1 Filament Switch;
- 1/2 lb. No. 22 D.C.C. wire;
- 1/2 lb. No. 30 D.C. wire;
- Miscellaneous, such as screws, wire for connections, etc."

KELLOGG R.F.L. RECEIVER

(Q. 2190) Mr. W. D. Bridge, Scranton, Pa., asks:

Q. 1. I would like to construct the Kellogg R.F.L. receiver, but lack the necessary constructional data, especially the condenser and coil values. Can you furnish me with the desired information, (Continued on page 432)

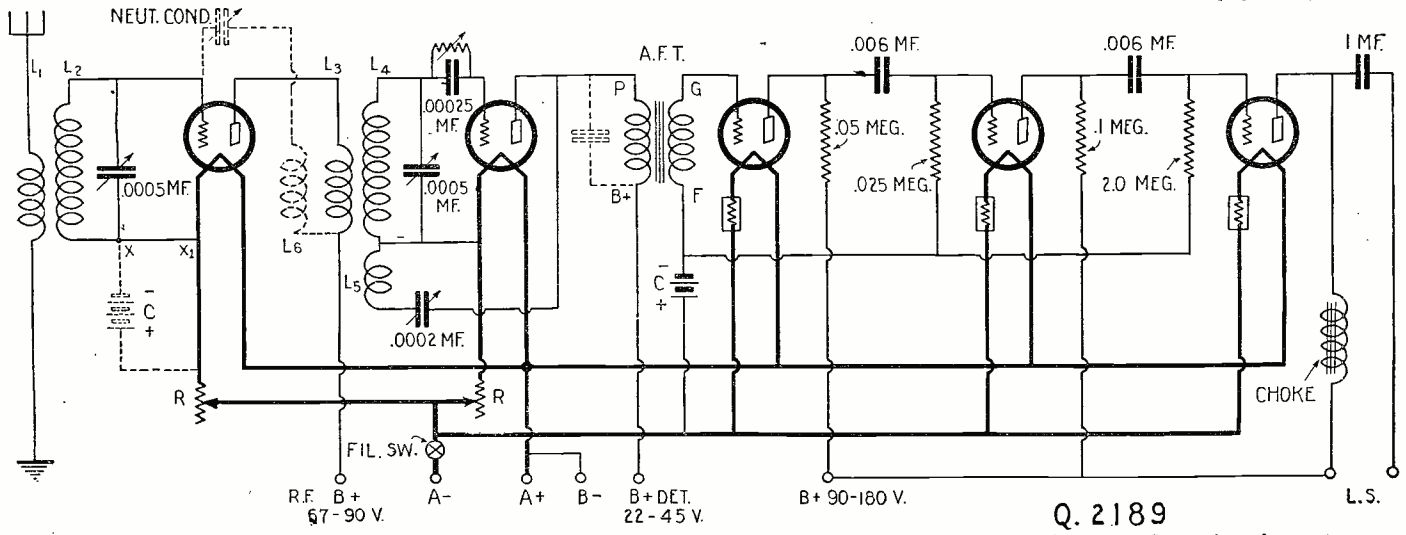

A composite 5-tube set, whose peculiar features are a combination to make up a set that will be noted for its performance. It consists of a neutralized tuned RF stage, a modified Hartley type of detector, one stage of transformer-coupled audio-frequency amplification, and two stages of resistance-coupled audio-frequency amplification.

**30
DAYS
FREE
TRIAL**

7 Tube Set Single Dial Radio



The Metrodyne

ONLY ONE DIAL TO TUNE

Retail Price
\$75
Completely Assembled
Big Discounts
to Agents and Dealers

Wonderful offer direct from the factory! The world's greatest radio. A perfect working, single dial control, 7 tube receiver. And just to prove our claims, we will ship it to your home for **30 days' free trial**. Test it under all conditions. Test it for distance, volume and tonal quality — and if you are not convinced that it is the best single dial set you ever heard, return it to the factory. We don't want your money unless you are completely satisfied.

**BIG PROFITS
TO AGENTS AND DEALERS**
Our Agents and Dealers make big money selling Metrodyne Sets. You can work all or part time. Demonstrate the superiority of Metrodynes right in your home. Metrodyne Radios have no competition. Lowest wholesale prices. Demonstrating set on 30 days' free trial. Greatest money-making opportunity. Send coupon below — or a letter — for our agent's proposition.

Metrodyne Super-Seven Radio

A single dial control, 7 tube, tuned radio frequency set. Approved by America's leading radio engineers. Designed and built by radio experts. Only the highest quality low loss parts are used. Magnificent, two-tone walnut cabinet. Artistically gilded genuine Bakelite panel, nickeled piano hinge and cover support. All exposed metal parts are beautifully finished in 24-k gold.

Easiest set to operate. Only one small knob tunes in all stations. The dial is electrically lighted so that you can log stations in the dark. The volume control regulates the reception from a faint whisper to thunderous volume, 1,000 to 3,000 miles on loud speaker! The Metrodyne Super-Seven is a beautiful and efficient receiver, and we are so sure that you will be delighted with it, that we make this liberal **30 days' free trial offer**. You to be the judge.

Mail COUPON Below!

Let us send you proof of Metrodyne quality

F. L. Warnock, Greentown, Ind., writes: "I received the Metrodyne in good shape and am more than pleased with it. Got stations 2,000 miles away."

C. J. Walker, Mariposa, Calif., writes: "Received my Metrodyne Single Dial set O. K. I believe that these one-dial sets are going to be excellent sellers. I had no trouble in tuning in stations enough to satisfy anyone, so you will please send me another set."

Roy Bloch, San Francisco, Calif., writes: "Very often we travel from New York to the Hawaiian Islands quickly — from station to station — by means of the little tuning-knob which operates the electrically-lighted dial. The Metrodyne Single Dial Set is much easier to operate than any radio set I've ever seen."

We will send you hundreds of similar letters from owners who acclaim the Metrodyne as the greatest radio set in the world. A postal, letter or the coupon brings complete information, testimonials, wholesale prices, and our liberal **30 days' free trial offer**.

METRO ELECTRIC COMPANY
2161-71 N. California Ave., Dept. 107
Chicago, Illinois

Gentlemen:

Send me full particulars about Metrodyne 6 tube and 7 tube sets and your **30 days' free trial offer**

Name _____

Address _____

If you are interested in AGENT'S proposition, place an "X" in the square



**30
Days' FREE Trial**

Metrodyne Super-Six

Another triumph in radio. Here's the new 1927 model Metrodyne 6 tube long distance tuned radio frequency receiving set. Approved by leading radio engineers of America. Highest grade low loss parts, completely assembled in a beautiful walnut cabinet. Easy to operate. Dials easily logged. Tune in your favorite station instantly on same dial readings every time. No guessing.

Mr. Howard, of Chicago, said: "While five Chicago broadcasting stations were on the air I tuned in seventeen out-of-town stations, including New York and San Francisco, on my loud speaker horn, very loud and clear, as though they were all in Chicago."

We are one of the pioneers of radio. The success of Metrodyne sets is due to our liberal **30 days' free trial offer**, which gives you the opportunity of trying before buying.

METRO ELECTRIC COMPANY
2161-71 N. California Ave. • Dept. 107 • Chicago, Illinois

**6
Tube Set**
\$48.50
RETAIL PRICE
Completely Assembled

MAIL THIS COUPON
or send a postal or letter. Get our proposition before buying a radio. Deal direct with manufacturer — **Save Money.**

the final condenser!

The Country's Foremost Radio Engineers Have Acclaimed

METRALIGN SLT STRAIGHT LINE TUNING

Here at last is the final condenser acclaimed by both amateurs and experts as the ONLY condenser embodying new and vitally important improvements over old type condensers—solving forever, the tuning evils of the past.

Makes Any Set a New Set—in 15 Minutes

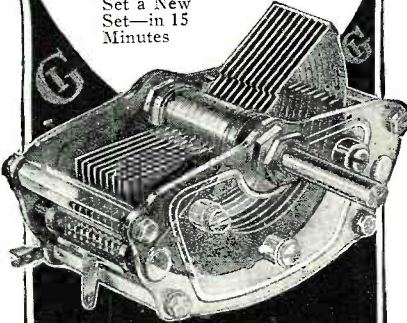

Separates All Stations on All Wave Lengths

METRALIGN SLT is the only condenser combining Straight Line Capacity, Straight Line Wave Length and Straight Line Frequency, eliminating the faults and retaining the advantages of each type—the result is a perfect tuning unit.

METRALIGN SLT spreads stations so evenly over the dial that all stations on all wave lengths can be quickly and easily tuned in or out and accurately logged.

FREE

We have prepared a most comprehensive booklet on tuning. It is written in simple language and tells all you want to know about condensers. Write for a copy today.

GENERAL INSTRUMENT CORPORATION
477 Br'dw'y New York City

A Sub-Paneled Four-Tube Receiver

(Continued from page 366)

complete set of instruments identical with those chosen by the writer. It is not necessary that he do so, but in case of doubt it is the safest thing to do.

If the same sockets used by the writer are chosen, they will mount flush with the top of the sub-panel, as shown in the illustrations. The midget condenser, used to stabilize the radio frequency stage, needs no adjustment after it has been set at the proper point. It is placed, therefore, on the sub-panel with the other fixed instruments.

LIST OF PARTS NEEDED

The parts required for this receiver follow:

- 1 Front Panel, 7x18 inches, of Formica, Bakelite, Condensite, or similar material,
 - 1 Sub-Panel, 4x16 $\frac{3}{4}$ inches, of hard rubber,
 - 1 pair Hard Rubber Brackets,
 - 1 Antenna Coupler,
 - 1 Interstage Transformer, R.F., with tickler,
 - 2 Variable Condensers, .0005- μ f.,
 - 1 Variable Condenser, .000045- μ f.,
 - 2 A.F. Transformers, both low ratio (or one low, one high),
 - 2 Vernier Dials,
 - 1 Pointer Knob,
 - 1 Rheostat, 6-ohm,
 - 1 Rheostat, 20-ohm,
 - 4 UX flush-mounting Sockets,
 - 1 Single closed-circuit Jack,
 - 1 Filament Switch,
 - 1 Fixed Condenser .001- μ f.,
 - 1 Fixed Condenser .00025- μ f., with grid-leak clips,
 - 1 Fixed Grid-leak, 2-megohm,
 - 10 Engraved Binding Posts.
- Approximate cost \$40.00.

It will simplify construction if the sub-panel and the instruments it bears are assembled separate from the rest of the set, and the front panel with its instruments in the same way. Do all possible wiring before fastening the two together. This will simplify greatly the final wiring job.

OPERATION

The set is balanced, as has been mentioned, by the small variable condenser which acts as an energy shunt in the plate circuit of the first tube. It short-circuits enough of the energy, which would normally be fed back to the grid through the grid-plate capacitance of the tube itself, to suppress the tendency which the tube has to oscillate.

To adjust this, tune to a station of low wave-length with the small condenser at zero position, and the tickler at zero coupling. It will probably come in attended by a shrill whistle. Now adjust the balancing condenser until the whistle disappears and the signals come in clearly. Do not set it at a higher value than is necessary to kill oscillations. If you do, it will decrease signal strength unnecessarily. When a point is reached at which the set is free from oscillation over the whole tuning range, the balancing condenser may be forgotten until tubes are changed.

The rest of the tuning operations are the same as with any similar set. The two

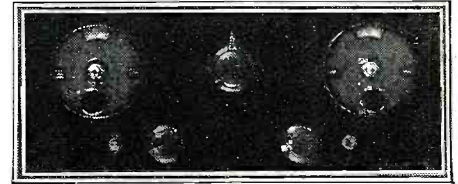

A panel view of the completed receiver. The center knob is the regeneration control; the large dials are the condenser controls.

dials should run approximately in synchronism, and must be tuned simultaneously. The six-ohm rheostat controls all of the amplifying tubes. Once the balancing condenser has been set this rheostat may be adjusted by turning it up as far as possible without making the set squeal. The detector rheostat may prove a bit more critical in adjustment. The tickler knob acts as a volume control. It should never be turned far enough to make the set squeal.

IT is against the policy of RADIO NEWS to publish the names of manufacturers or of makes of instruments in connection with the apparatus described in these pages, but this information will be gladly given privately. If you are interested in any special instruments described here, address a letter to the READERS' SERVICE DEPARTMENT, enclosing stamped return envelope. The names and addresses of the manufacturers will be given free of charge. —EDITOR.

HOW ABOUT THE "I-DON'T-KNOWS?"

Since the year 1922 4,263,486,246,000 radio questions have been asked of clerks in radio stores. Two of these were answered correctly, the answer in each case being "It is possible."—Zeh Bouck in *New York Sun*.

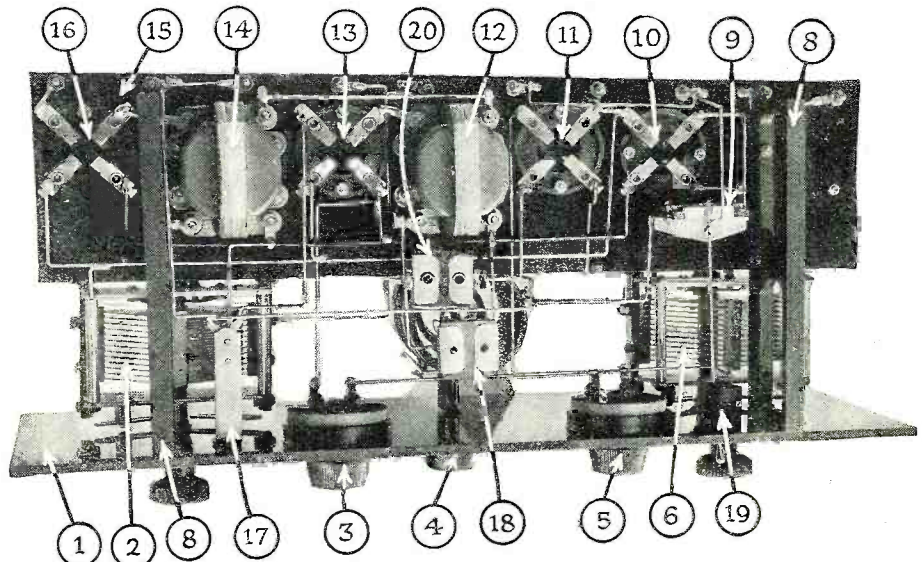

Showing the apparatus and wiring on the under side of the sub-panel. The numbers correspond to those in the illustration on page 366.



The New Balkite Charger
with both Trickle and
high charging rates

MODEL J. Has two charging rates. A low trickle charge rate and a high rate for rapid charging. Can thus be used either as a trickle or as a high rate charger. Noiseless. Large water capacity. Rates: with 6-volt battery, 2.5 and .5 amperes; with 4-volt battery, .8 and .2 amperes. Special model for 25-40 cycles. Price \$19.50. West of Rockies \$20. (In Canada \$27.50.)



Balkite Trickle Charger

MODEL K. With 6-volt "A" batteries can be left on continuous or trickle charge thus automatically keeping the battery at full power. With 4-volt batteries can be used as an intermittent charger. Or as a trickle charger if a resistance is added. Charging rate about .5 amperes. Over 200,000 in use. Price \$10. West of Rockies \$10.50. (In Canada \$15.)



A New Balkite "B" at \$27.50

Balkite "B" eliminates "B" batteries and supplies "B" current from the light socket. Noiseless. Permanent. Employs no tubes and requires no replacements. Three new models. Balkite "B"-W at \$27.50 for sets of 5 tubes or less requiring 67 to 90 volts. Balkite "B"-X for sets of 8 tubes or less; capacity 30 milliamperes at 135 volts—\$42. Balkite "B"-Y, for any radio set; capacity 40 milliamperes at 150 volts—\$69. (In Canada: "B"-W \$39; "B"-X \$59.50; "B"-Y \$96.)



Balkite Combination

supplies automatic radio power

When connected to your "A" battery supplies automatic power to both "A" and "B" circuits. Controlled by the filament switch on your set. Entirely automatic in operation. Can be put either near the set or in a remote location. Will serve any set now using either 4 or 6-volt "A" batteries and requiring not more than 30 milliamperes at 135 volts of "B" current—practically all sets of up to 8 tubes. Price \$59.50. (In Canada \$83.)

All Balkite Radio Power Units operate from 110-120 volt AC current with models for both 60 and 50 cycles.

Operate your radio set from the light socket

*Either with a Balkite Charger
and Balkite "B" or with the new Balkite
Combination Radio Power Unit.*

Now you can operate your radio set from the light socket. Merely by adding the new Balkite Radio Power Units—either by adding a Balkite Charger and Balkite "B," or by adding the new Balkite Combination Radio Power Unit.

In either case the result is the same—light socket operation, maximum convenience, and smooth, silent power.

Balkite Light Socket Power is noiseless. There is no hum. It is never low and never runs down, but is always exactly what is required by the set. It is permanent. Balkite Radio Power Units are permanent pieces of equipment. They employ no bulbs, and have nothing to replace or renew. They cannot deteriorate from either use or disuse. Other than a negligible amount of household current their first cost is the last. With sets of high current requirements their use is highly desirable for the saving alone. They require no changes in your set.

Over 600,000 radio receivers—one of every ten—are already Balkite equipped. Equip yours with Balkite and convert it into a light socket receiver. Know the pleasure of owning a set always ready to operate at full power.

Listen to the Balkite Radio Symphony Concerts with Walter Damrosch and his New York Symphony, Saturday nights 8 P. M. Eastern Standard Time beginning October 23. Stations: WEAf, WEEL, WGR, WFI, WCAE, WSAI, WTAM, WWJ, WGN or WLIB, WCCO, KSD, WDAF, WOC.

FAN STEEL
Balkite
Radio Power Units

Manufactured by FANSTEEL PRODUCTS COMPANY, INC., North Chicago, Illinois



SM

630

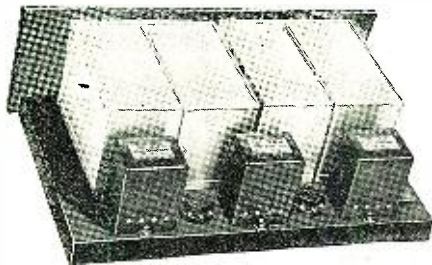

Shielded Six

The Shielded Six is one of the highest types of broadcast receivers. It embodies complete shielding of all radio frequency and detector circuits. The quality of reproduction is *real—true* to the ear.

Behind the Shielded Six is competent engineering. It is sensitive. Day in and day out it will get distance—on the speaker. It is selective. Local stations in the most crowded area separate completely—yet there are but two dials to tune.

These features—its all-metal chassis and panel, its ease of assembly, and many others—put it in the small class of ultra fine factory built sets, priced at several times the Six's cost.

The SM-630 Shielded Six Kit—including all specified matched and measured parts to build this remarkable receiver—price \$95.00.

The 633 Essential Kit—contains 4 condensers, 4 R.F. transformers, 4 coil sockets, 4 stage shields and the link motion—all laboratory matched—price \$45.00.

Clear and complete instructions, prepared by S-M engineers, go with each kit—or will be mailed separately for 50c.

220 & 221 Transformer

S-M 220—the big, husky audio transformer you hear in the finest sets—the only transformer with the *rising* low note characteristic that means real quality—not only on paper—but when you *hear* it—\$6.00.



S-M 221 is an output transformer that will bring out the low notes on your present set. It eliminates blasting for practically all good speakers—\$6.00.

SILVER-MARSHALL, Inc.

848 W. Jackson Blvd., Chicago, U. S. A.

The Infradyne

(Continued from page 357)

produce the intermediate frequency; it will *beat* with a received frequency equal to 8,460 kc. (or 5,260 kc. plus 3,200 kc.), to produce the intermediate frequency. However, a frequency of 8,460 kc. is equivalent to a wavelength between 35 and 36 meters, which is, of course, far below the broadcast band.

Let us next consider the shortest wavelength to be received. 200 meters is equivalent to 1,500 kc. In this case the oscillator frequency will be 1,700 kc., the second harmonic of which is 3,400 kc. This will likewise not add to any received frequency to produce the intermediate frequency. It will beat with 6,600 kc. to produce the intermediate, or sum-frequency; but 6,600 kc. is equivalent to about 45.5 meters which is also far below the broadcast band. Any given station is therefore received at *only one place on the oscillator dial*.

It will also be readily apparent that there

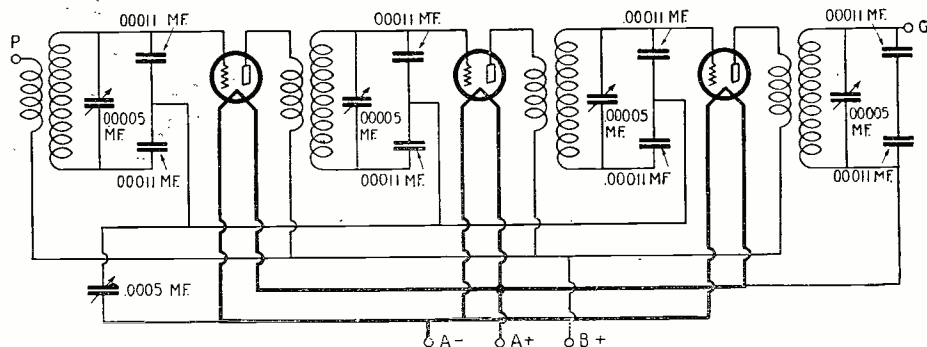

The circuit diagram of the Infradyne short-wave amplifier. There are four coupling transformers and their attendant fixed and variable condensers, the latter employed for peaking the transformers and stabilizing the circuits.

is no opportunity for confusion to result from the production of the intermediate frequency by heterodyning between powerful stations on adjacent wavelength bands, as there is in the case of the super-heterodyne.

SELECTIVITY AND SENSITIVITY PROBLEMS

Having discussed the fundamental differences between the Infradyne and the super-heterodyne, let us consider the matter of selectivity, or sharpness of tuning. The super-heterodyne is generally dependent for its selectivity upon one transformer stage, tuned to respond to a narrow band of frequencies, and upon the natural selective qualities of the loop antenna with which it is used. Here it might be mentioned that the amount of energy picked up by a loop is exceedingly small; if it were possible to obtain with this type of receiver, when using an antenna, selectivity equal to that obtained with a loop, it would be desirable to use the antenna, because of the greater energy pick-up. Occasionally two, or even four sharply tuned stages are used in a super-heterodyne. This practice often results in poor reproduction of speech and music, due to cutting off of the extreme voice and music frequencies, and in instability, so that the set is difficult to handle.

Tuned-radio-frequency sets usually depend for their selectivity upon not more than two stages of radio-frequency amplification, functioning at the frequency of the received signal. Were it possible to employ successfully more than two stages of such amplification the sensitivity and selectivity of these receivers would undoubtedly be considerably increased. In the usual type of set such an attempt may result in uncontrollable instability, because of stray coupling between stages.

This is not to convey the impression that more than two stages of such amplification are never used. There are on the market two or three commercially-made receivers employing up to as many as four stages of tuned-radio-frequency amplification. Such sets are very carefully laid out and contain elaborate shielding, which the average set builder is by no means equipped to make. Their cost, which is high, also places them well beyond the reach of most of us.

R.F. AMPLIFICATION

In the Infradyne, two stages of tuned-radio-frequency amplification, operating at the received signal frequency, are employed ahead of three stages of amplification at the very high sum-frequency heretofore described. All of these stages can be operated at maximum efficiency and there is no tendency toward undesirable reaction between the lower-frequency and highest-frequency amplifiers. The receiver can therefore be kept perfectly stable at all times without the use of any of the "losser" methods of control now used in radio-frequency sets. The high-frequency stages can be quite broadly tuned,

as any very slight loss in selectivity, which might result from this practice, is more than compensated by the additional sharpness of tuning obtained in the two low frequency stages.

Incidentally, it will be recalled that a circuit can, at high frequencies, respond to a fairly broad band of frequencies and still be tuned quite sharply with respect to *wavelength*. For instance, 90 meters equals 3,331 kc.; but 3,321 kc. and 3,341 kc. equal respectively 90.35 and 89.8 meters. A circuit tuned sharply between 89.8 and 90.35 meters will therefore still pass freely a band 20 kc. wide. This permissible slight broadness of tuning of these circuits results in complete response to the full range of music and voice frequencies. Music and speech are, therefore, not distorted in the radio-frequency amplifiers, but reproduced just as they are received.

For the benefit of those who are interested in this receiver and desire some details of

CORRECTION

The kit of parts manufactured by the Bremer-Tully Mfg. Co., of Chicago, and especially designed for their patented Counterphase circuit was illustrated in the article "Kits of Parts for the Set Constructor" on page 224 of the September issue of RADIO NEWS and described as "parts for a 6-tube Neutrodyne set." We wish to correct this erroneous statement. The Bremer-Tully Counterphase is original and is not to be confused with the Neutrodyne circuit.

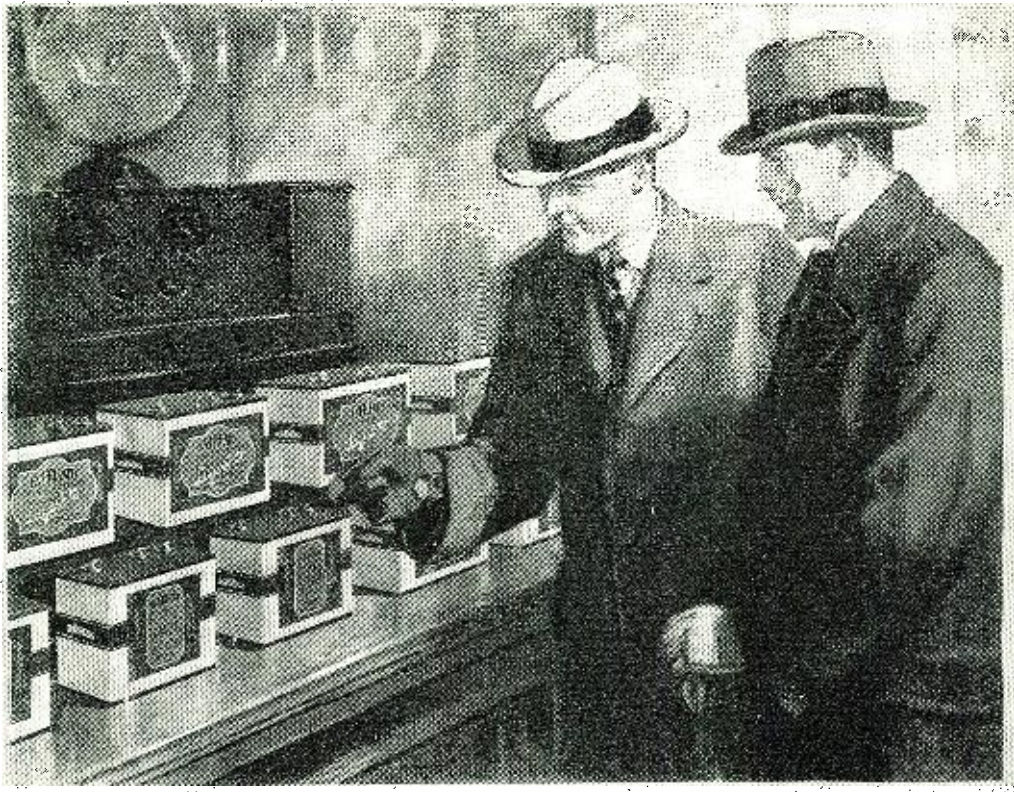

"They last twice as long as the smaller Batteries of equal voltage"

"THAT'S a pretty broad statement, Tom. Won't you have to make it conditional on the number of tubes in the set or the use of the new power tubes?"

"No, sir! Under the same operating conditions—whether you use four, five tubes or more, whether you use a power tube that uses up to 135 volts, the Eveready Heavy-Duty No. 770 or the even longer-lived Eveready Layerbilt No. 486 will last twice as long as the smaller sized 45-volt batteries."

"Well, they ought to, they cost more."

"Yes, about a third more—but lasting twice as long, they cost much less."

"Your arithmetic is good, Tom, but if that's so, when I bought my set why did the dealer equip it with the smaller Eveready 772's? Why didn't he put in the Eveready Heavy-Duty Batteries?"

"He probably thought he was doing

NOTE: A "C" battery gives a quality of reception unobtainable without it and greatly increases the life of your "B" batteries.

you a favor—making your first investment cost you a little less. That little difference looks like a lot to a good many folks who are buying their first set, equipped with tubes, loud speaker, 'A' and 'B' batteries and everything."

Heavy-Duty batteries last twice as long as the smaller batteries of equal voltage. Eveready Heavy-Duty Batteries are the great contribution that the world's foremost electro-chemical

laboratories has made in "B" battery economy, dependability and satisfaction.

Dry "B" batteries give a noiseless current, pure D. C. (direct current), the kind that is essential if you prize pure tone.

Send for booklet, "Choosing and Using the Right Radio Batteries," which we will be glad to send you upon request. This booklet also tells about the proper battery equipment for use with the new power tubes. There's an Eveready dealer nearby.

Manufactured and guaranteed by
NATIONAL CARBON CO., INC.
 New York San Francisco
 Canadian National Carbon Co., Limited
 Toronto, Ontario

LEFT - Eveready Layerbilt No. 486.
 RIGHT - Eveready Dry Cell Radio "A" Battery, 1 1/2 volts.

EVEREADY
Radio Batteries
—they last longer

Tuesday night means Eveready Hour — 9 P. M., Eastern Standard Time, through stations:

- | | |
|------------------|------------------|
| WEAF—New York | WSAI—Cincinnati |
| WJAR—Providence | WTAM—Cleveland |
| WEEL—Boston | WWJ—Detroit |
| WTAG—Worcester | WGN—Chicago |
| WFI—Philadelphia | WOC—Davenport |
| WGR—Buffalo | WCCO—Minneapolis |
| WCAE—Pittsburgh | WCCO—St. Paul |
| | KSD—St. Louis |

Radio Ops See Foreign Lands

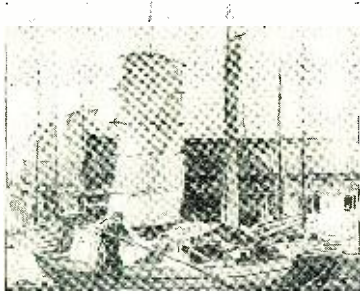

Radio operators on ships have marvelous opportunity for travel and adventure. They earn good pay—in addition to board and sleeping quarters.

Study at home now for a voyage next summer.



Radio Institute of America —world's oldest radio school —offers Home Study Courses that qualify you to pass the U. S. Government Commercial or Amateur License examinations.



Radio Institute of America instruction is the finest obtainable at any price.



RADIO INSTITUTE OF AMERICA

formerly Marconi Institute
Established in 1909
324 Broadway, New York City



Mail coupon for complete description of course.

CUT HERE

Radio Institute of America (1)
324 Broadway, New York City

Please send me full information about your Home Study Course of radio instruction.

I am interested in the complete course including code instruction.

I am interested in the technical course without code instruction.

Name.....

Address.....

construction, the following information is presented.

It will be noticed, in the illustrations showing the interior of the set, the radio-frequency transformers shown are of the toroidal type. As this type of coil is rather difficult for the home constructor to wind, and single-layer solenoid inductances will function as well if placed at right angles to each other, data is given for their construction. Wind a primary of 15 turns on a 3-inch insulator tube and a secondary of 50 turns, using No. 24 D.C.C. wire. This data will suffice for the two radio-frequency transformers. For the antenna coil 50 turns of the same wire is wound on a 3-inch form with a tap at the 15th turn, which is connected to the antenna as shown in the diagram. The secondary of each of these coils is shunted with a 23-plate variable condenser (.0005- μ f.)

The tapped inductance, which is the oscillator coupler, consists of three coils wound on a tube 1½ inches in diameter and about 2 inches long. These coils are of 14, 14 and 8 turns respectively, all wound in the same direction with No. 24 D.S.C. wire. There should be a space of 1/16 inch between the two 14-turn coils, and 3/16 inch between the 14- and the 8-turn coil. Commencing with the 8-turn coil, the terminals should be numbered from 1 to 6; 1 being the *outside* and 2 the *inside* of the 8-turn coil, 3 the terminal of the middle coil nearest the 8-turn coil, 4 the other end of the middle coil, 5 the inside terminal of the second 14-turn coil and 6 the outside terminal of this coil.

It has been mentioned that the amplifier is a high-frequency combination; and those who have done some work on the short waves will realize that the units of such an amplifier must be most carefully made, if it is to function at maximum efficiency. The transformer secondaries are wound on a 1½-inch ribbed form, and consist of 35 turns of No. 28 D.S.C. wire. In the output transformer the secondary consists of 28 turns of the same wire. The primaries are wound inside of the secondaries and consist in each case of 20 turns of No. 28 D.S.C. wire.

The various capacities used throughout this amplifier, it need hardly be said, should have the exact values indicated. It would be well to follow as carefully as possible the illustrations showing the arrangement of the apparatus in this amplifier; as a slight deviation from the design will tend to unbalance the whole system.

QUIET OPERATION

The writer has made the statement that quieter operation is obtained in the Infrazyne through the reduction of "background noise." Much of this noise is due to direct pick-up of signals by the intermediate amplifier circuits; and it has been shown that, because of the value of the intermediate frequency chosen, this difficulty is eliminated. In addition, noises originating in the circuit itself, many of which are due to mechanical vibration at audio frequencies of the radio-frequency tubes or their associated wiring, are suppressed by the high-frequency amplifier. Not only does the elimination of background noise result in quieter and more enjoyable reception, but the improved ratio of signal-to-background strength makes possible more satisfactory reception from very much greater distances.

CALIBRATION

Of most decided importance to the owner of any radio receiver are ease of calibration and control. In the Infrazyne, the antenna circuit and two initial radio-frequency stages are tuned by means of a single dial. A clever method of balancing these tuned circuits has eliminated any broadness of tuning, which might have resulted from this simplification. A second dial controls the fre-



From
Atlantic to Pacific
From
Canada to South America



Registered U. S. Pat. Off.

TRANSFORMERS

Have Made Finer Radio Reception Possible

THESE are no interference from powerful local broadcasting stations possible with these units. They can be used under the towers of a super power station and they still will assure selection of broadcast concerts at choice.

THEY combine tremendous power with a faithful tonal quality not obtainable with other transformers.

THEY amplify the weakest signals to the utmost loudspeaker volume.

THEY are independent of confusion in broadcast conditions.

THEY will operate with all types of standard tubes.

THEY are all that the most critical set-builder could desire, unsurpassed for quality, clarity and volume.

No. H.210 Transformers	\$8.00
No. H.215 Transformer	8.00
No. F.320 Transformer	8.00
No. L.425 R.F. Choke	5.50
No. L.430 R.F. Transformer	5.50

Remember
The Name H. F. L.

Insist
On H. F. L. Units

HIGH FREQUENCY LABORATORIES

131 N. Wells Street
Chicago, Illinois

WANTED: RADIO EXPERTS

\$60 to \$100 A WEEK TO START!

Everywhere men who know radio are wanted. Manufacturers, distributors, dealers, broadcasting stations, want competent men. Big salaries paid. Bright future in this fast-growing business.

OUR ENGINEERS WILL TRAIN YOU

Now is the time to make the big money in radio. We will train you for those big-pay jobs. A thorough, practical course in radio prepared by radio's great engineers. Get this training now at no cost to you.

WE GIVE TRAINED MEN POSITIONS

We give all Ambu-trained radio men a chance to make good at big pay. Our plan enables you to start right in making money, either working for us or in your own business.

Radio Set FREE! Every Ambu student is given an Ambu five-tube radio set FREE! Get stations from 40 to 550 meters. Write at once for special offer

AMBU ENGINEERING INSTITUTE
2631H Prairie Avenue Chicago, Illinois

EVERYTHING IN RADIO
AT ATTRACTIVE PRICES. SETS OR PARTS.
Prompt and Honest Service. Write for Prices.
Mail Order Only.
ALL RADIO COMPANY. 417 North Clark St., Chicago

ELECTRAD

Your Set Is As Good As Your Parts

No doubt about that. If you know radio you know how important your Grid Leaks are. Use Electrad Metallic Leaks. New—totally different. No carbon, paper, varnish, fiber. The metallic resistance element is fused to the inside of a glass tube. Capped with the exclusive Electrad ferrule. Paraffined under high vacuum.

Six points of superiority: Noiseless, Constant, Accurate, Non-hydrosopic, Non-inductive, Unvarying under any weather or working conditions. Greater current-carrying capacity without over-heating or change of resistance.

Make this test—try these leaks in your own set. Hear the improvement in reception. Sizes 5000 ohms to 10 megohms. Price U. S. 60c., Canada 85c.

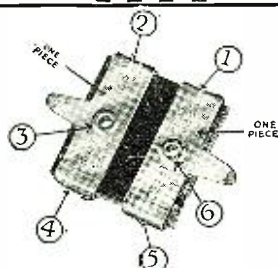
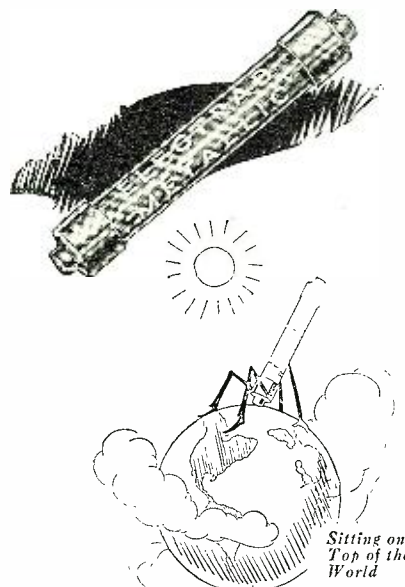

Use ELECTRAD Certified Condensers

Without hesitancy we claim the Electrad Certified Six-Point Fixed Condenser to be without equal. Here is why: Uniform pressure insured by rigid binding at six points. Sheet copper, not tinfoil. Soldering iron can't hurt it. Certified electrically and mechanically. Guaranteed to remain within 10% of calibration. Standard capacities. All types. Prices U. S. 30c to 75c, Canada 45c to \$1.50, in sealed packages at all good radio stores.

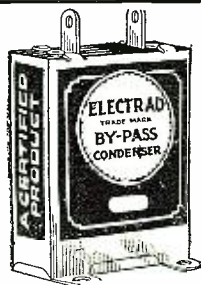

ELECTRAD Certified By-Pass Condensers

Prevents B-voltage fluctuation. Gives undistorted amplification. Each condenser certified electrically and mechanically, tested at 1000 volts. Maximum working voltage 250 A.C. Has low power factor, low radio frequency resistance and negligible D.C. leakage. Don't take substitutes. Get the Electrad Certified. If your dealer can't supply you, let us know. Prices U. S. 60c to \$3.75, in Canada 85c to \$5.25.

ELECTRAD Certified Lead-In

Copied and imitated, but the quality never approached. Triple-ply insulation full 10 inches long, covered with water-proof webbing. Fahnestock clips, all connections **riveted** and **soldered**. Fits under locked windows and doors. Bend to any shape. Saves walls, and window and door trim. Price U. S. 40c, Canada 60c, at all good radio stores.

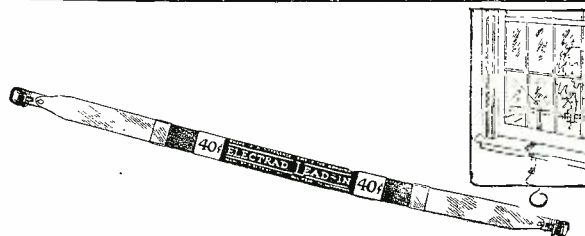

For perfect control of tone and volume use the Electrad 500,000 ohm compensator. For free hook-up write 428 B'way, New York City.



ELECTRAD

Inc.

**more
power
to you—
and perfect
tone too!**



Power detector tube to replace Type 200 and 201-A. Doubles volume and distance.

Ask your dealer for the largest line of radio tubes in the world. Sonatron offers 25 distinct types—a tube for every purpose. To obtain maximum efficiency from your set use Sonatron tubes.



Sonatron Amplifier, complete with three, Red, White and Blue tubes—\$20.00. Can be attached to any set in one minute. One year guarantee for greater distance, increased volume, fidelity of reproduction, and true tone.

SONATRON TUBE COMPANY
Chicago New York Newark Detroit
and Windsor, Ont., Canada

**SONATRON
TUBES and
AMPLIFIERS**

quency generated by the local oscillator. It has been shown that one setting only of this dial is obtained from each station. Calibration of the receiver is, therefore, but a few minutes' work; and control has been simplified to the greatest extent consistent with efficient operation.

Although the Infradyne calls for the use of ten tubes it is, nevertheless, economical in operation. The first cost occasioned by the additional tubes is more than justified by the many advantages which have been enumerated. The receiver has been designed to accommodate the new power tubes and the further improvement in quality which they offer has therefore been made available.

The receiver operates best with a very short antenna. In order to take advantage of the extreme selectivity of which the set is capable, one only 15 to 25 feet in length should be used. The writer has found the 15-foot wire to be more satisfactory, and has been able to cover a 1,500-mile radius with this arrangement.

Reception over long distances and with more than ample volume is easily possible with an antenna of the picture-moulding variety; so that the set is well adapted to use in crowded districts, where space is at a premium and room for an outside antenna is not available.

In recapitulation, we have a receiver which offers extreme selectivity with perfect reproduction; which is capable of really enjoyable reception of distant stations; which is scientifically designed to employ readily available, standard parts and which is, withal, easily controlled and attractive in appearance.

LIST OF PARTS

- 1 Infradyne Amplifier (SA);
 - 1 Triple Variable-Condenser Unit (C-1);
 - 1 Variable Condenser, .00035- μ f. (C-2);
 - 1 Tapped Inductance (L-3);
 - 2 30-ohm Rheostats (R, R1);
 - 1 Set of 3 R.F. Transformers (L, L1, L2);
 - 2 Vernier Dials;
 - 7 UX tube Sockets;
 - 1 Self-adjusting Rheostat, 112 type (R-4);
 - 2 Self-adjusting Rheostats, 201-A type (R-4);
 - 1 Self-adjusting Rheostat, 6-v. 199 type (R-4);
 - 1 10-ohm Rheostat (R-2);
 - 1 50,000-ohm Variable Resistance (R-3);
 - 3 Rheostat Dials;
 - 1 Filament Switch (F);
 - 1 Single closed-circuit Jack (J);
 - 1 Open-circuit Jack (J-1);
 - 1 0-5 D.C. Voltmeter (V);
 - 1 Megohm Grid Leak (G);
 - 1 2-Megohm Grid Leak (G-1);
 - 1 .0001- μ f. fixed Condenser (C-4);
 - 2 1- μ f. fixed Condensers (C);
 - 2 .0005- μ f. Condensers (C-3);
 - 1 .00025- μ f. Fixed Condenser (C-5);
 - 9 Binding Posts;
 - 1 Panel, 3/16 x 7 x 30 inches;
 - 1 Baseboard, 3/4 x 10 x 34 inches;
 - 2 Audio-Frequency Transformers (T & T-1).
- Approximate cost, \$75.00.

IT is against the policy of RADIO NEWS to publish the names of manufacturers or of makes of instruments in connection with the apparatus described in these pages, but this information will be gladly given privately. If you are interested in any special instruments described here, address a letter to the READERS' SERVICE DEPARTMENT, enclosing stamped return envelope. The names and addresses of the manufacturers will be given free of charge. —EDITOR

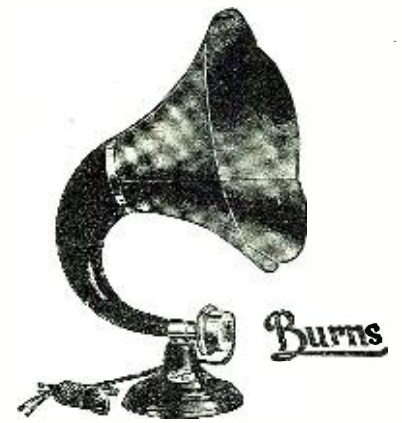

The Speaker That Satisfies

To secure the best reproduction from any set a speaker of proper design must be used. The BURNS is capable of reaching the full range of tones with amazingly pleasing results. A trial will convince you.

At Your Dealers Or Write Direct

Manufacturer

American Electric Company

State & 64th Sts., Chicago

Ask About The BURNS "B" Eliminator

**NOW—ANY SET CAN GET
LOW WAVE
Stations—Amateurs**

Experience a new radio thrill! Explore the short waves on which super-power stations are experimenting daily and amateurs are talking from all parts of the globe. Enjoy a new radio delight with the



SUBMARINER

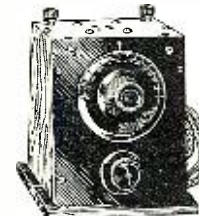

Converts Any Set Into a Low Wave Receiver Gets the Short Wave Experiment Stations broadcasting on 41 meters, 63 meters, etc., and a wide band of Amateurs' Stations.

Price, \$15. No extras needed. Anyone can attach in one minute, ready to operate.

**Everywhere—
a Sensation!**

No jumble of stations in the low waves—no disagreeable noises. Ideal for summer reception. Hear KDKA talking to Europe. Listen to an A. R. R. L. operator speaking to Australia! The low-waves abound with new wonders and strange voices from far-off places. The SUBMARINER brings them all to you. Send for this marvelous new instrument today. Sent post-paid upon receipt of \$15, or C.O.D., plus postage. State type of detector tube in your set. Money back if not delighted. Order at once.

**ORDER DIRECT
MONEY-BACK
GUARANTEE**

J. M. P. MFG. CO.

Dept. 115-X

Milwaukee, Wisc.

**FREE! —
Radio Catalogue**

*Radio Parts of
the Best Quality*

- 1. Right Prices
- 2. Quick Delivery
- 3. Dealer Cooperation
- 4. Complete Stock
- 5. National Advertising

**CHICAGO
RADIO APPARATUS**

415 South Dearborn Street, Chicago
Dept. RN

Insure your copy reaching you each month. Subscribe to RADIO NEWS — \$2.50 a year. Experimenter Publishing Co., 53 Park Pl., N. Y. C.

MAGNAVOX

CONE SPEAKER

(PATENTED)

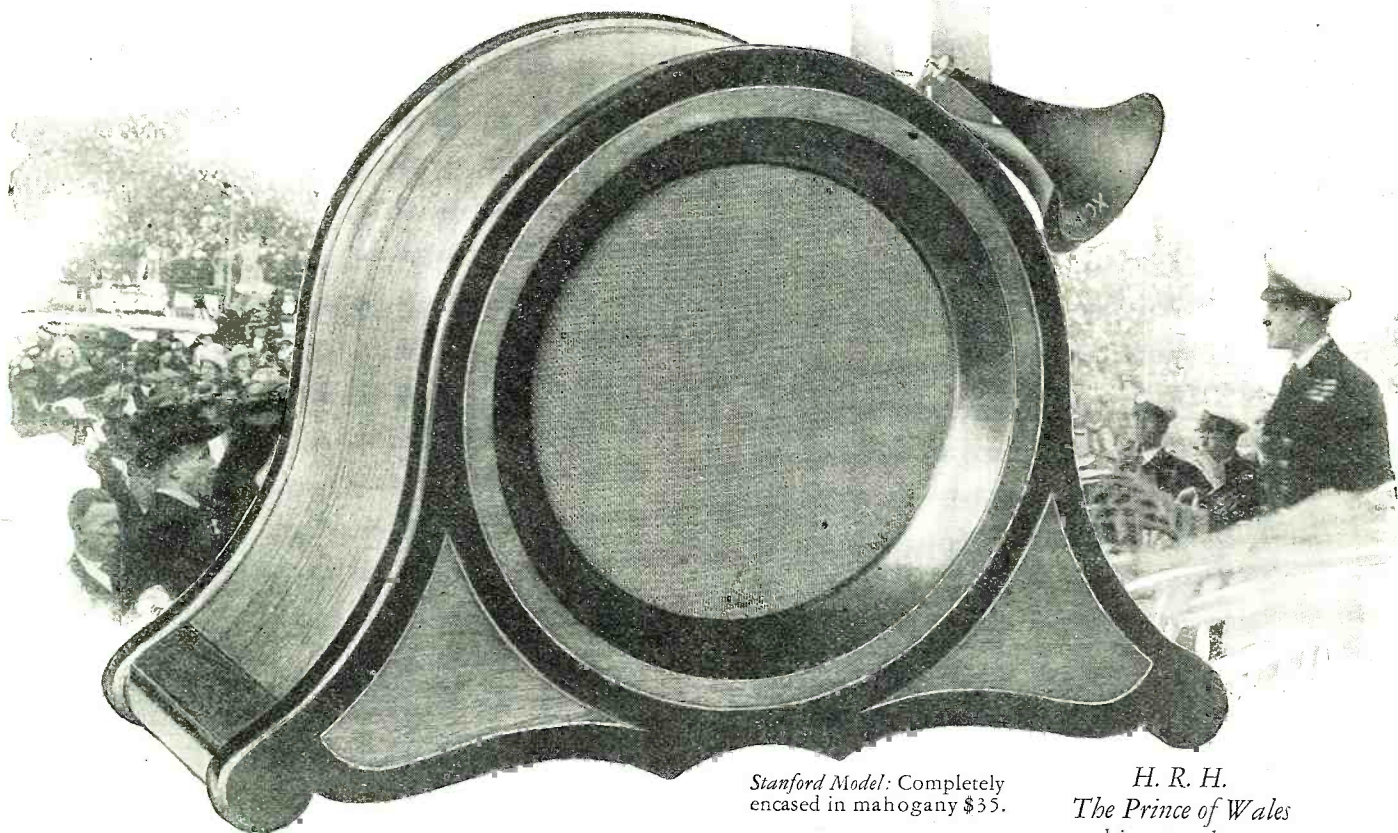

Stanford Model: Completely encased in mahogany \$35.

The speaker with 400,000 friends

THE first loud speaker ever made was a *Magnavox*—a wonder for its day. Since then *Magnavox* has made and sold 400,000 loud speakers, keeping constant pace with all advances in sound amplification.

The new *Magnavox* cone speaker has been pronounced the ultimate. It reproduces the entire tonal scale with original tone values unimpaired. This new cone is made under exclusive *Magnavox* patents—the same marvelous reproduction cannot be secured from any other speaker—cone or otherwise.

Enjoy the prestige of owning the most advanced loud speaker. *Magnavox* dealers are continually demonstrating it. Operates with and improves any set.

THE MAGNAVOX COMPANY, Oakland, California
R. S. Williams & Sons, Ltd., Toronto, Distrs. for Canada [not inc. Br. Columbia]

H. R. H.

The Prince of Wales speaking to a large audience at San Diego in 1919. Note the *Magnavox* amplifying equipment. Even before the days of popular broadcasting *Magnavox* speakers were recognized as pre-eminent for clear, powerful reproduction. They have steadily maintained this position.

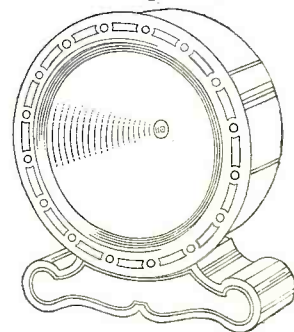

Magnavox Cone Speaker. Cornell model, covers entire tonal scale. Artistic non-resonant metal finish, two toned mahogany base, \$22.50.
56X © 1926

The Passing of "By-Pass" Condensers



Dubilier Condenser Type 907—Capacities 0.1 to 2.0 mfd.
Price \$.60 to \$1.75

"By-Pass" was the name originally given to small paper condensers by Dubilier. This name described their functions—such as shunting radio frequency currents around high resistances, and their use in amplifier circuits.

But now the clumsy old "By-Pass" condenser is out of date. The high voltages used in radio today along with sub-panel construction, demand a condenser of higher electrical efficiency and more compact size.

In the new Type 907, Dubilier has made a compact all-purpose condenser with a working voltage of 160 volts D.C. With improved soldering lug terminals and mounting feet, Type 907 will give more efficient service in smaller space for every purpose for which the old "By-Pass" type of condenser has been used.

For long life at high voltages insist on Dubilier Paper Condensers.

Dubilier

CONDENSER AND RADIO CORPORATION

*Working voltage means more than "test voltage". It is the voltage at which a condenser may be safely used in continuous operation.

"Echoing Silence"

(Continued from page 345)

the invention will be sold only on a royalty basis and will not be disposed of outright.

"I must hasten to complete the description of my change in the receiver. My first rebroadcasting results were made by means of a single piece of wire across the output terminal posts, intended for the loud speaker on usual sets. I then experimented and found that up to a certain point the longer the wire between these posts the greater was the appreciable volume. The final result was the construction of this piece of apparatus which, as you will note, resembles an unusually-shaped loop aerial, but is in reality the set's loud speaker. To say that I merely placed a wire across the output posts and the set spoke, is of course cutting a long story short, for actually I experimented every evening for several months before I was rewarded with even a tiny squeal. Then followed many hours of discouraging tests and changes and tests again, the squeal growing in volume until everyone in the neighborhood was protesting. The neighbors' objections first informed me that I was producing audible waves that had the penetrating property of radio waves, and gave me the necessary nerve and enthusiasm to continue in my experiments.

"There is little more than I can tell you without giving away the secret, so being the host, I suggest that we spend the remainder of the evening in seeing what entertainment we can pull in out of the air." As he turned to tune the set he indicated a chair behind me. "Better sit down and take a load off your feet."

For the first I realized that I had been standing all this time and that I really had tired myself in maintaining a strained attitude ever since entering the laboratory. With relief I sank into the indicated chair, at the same time turning my eyes to the old man in his comfortable rocker. His grizzled chin was sunk upon his breast, his pipe still tightly clamped between his jaws, and his audible breathing indicated that our wordy barrage had really been more than he could comprehend.

Needless to recite the several hours I sat there drinking in the melody from voice and instrument, singing and playing in distant cities here and there; enough to say that when my host finally opened the switch, stopping the sibilant but not unpleasant hiss which seemed to fill the air between the broadcasting periods, I could hardly realize that more than a few minutes had passed. The first selection had for a short while aroused the old man from his slumbers, but even in his sleep half-smiles flickered across his face in time with the heart-bursting melodies.

"Why do these vibrations seem to penetrate so deeply into our senses?" I asked as I rose to go.

"Probably for these reasons," he started to explain. "It is my belief that every undertone and overtone which our physical ear has been unable to handle, and which are especially abundant in every voice and musical sound, is faithfully handled by the radio broadcasting apparatus; and would be faithfully reproduced to our hearing sense, were it not for the relatively clumsy distortion of present-day loud speakers and the limitations of our physical ear. My discovery has made a short cut, eliminating the loud speaker and the ear, so that the full range of vibrations are hurled direct at our appreciative auditory nerves. No doubt there are many higher frequencies present in the radio wave, to which even our sensitive nerves are insensible."

Save Your Set From Lightning



You never know what lightning will do and any radio set which is without the protection of a lightning arrester is at the mercy of a storm.

The National Board of Fire Underwriters specify that an approved Radio Lightning Arrester must be used with all out-door aerial installations.

Protection is easy. Insure your insurance and save your set with a WIRT LIGHTNING ARRESTER (listed as standard by Underwriters' Laboratories). The cost is a trifle.

THE WIRT LIGHTNING ARRESTER is an approved air-gap type, made of bakelite giving ample insulation, with brass terminals moulded in bakelite, far enough apart so that there is no leakage. A "petticoat" of bakelite shields the Arrester from water and dust. Handsome and rigid. Lasts a lifetime. Easy to install. Full directions on box.

Don't wait for a warning from the elements—it may be too late then. Install the WIRT LIGHTNING ARRESTER—now.

When you install your WIRT LIGHTNING ARRESTER, get a WIRT INSULATOR and prevent leakage along your lead-in wire. It keeps the wire at the proper distance, provides perfect insulation, and prevents wear and tear on the wire by preventing sagging and swaying.

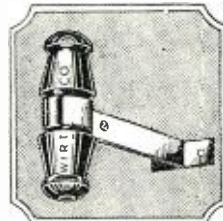

The Wirt Lightning Arrester is listed as standard by Underwriters' Laboratories.

WIRT LIGHTNING ARRESTER\$1.00
WIRT INSULATOR\$.35

Sold by Leading Radio Dealers

WIRT COMPANY

PHILADELPHIA PENNSYLVANIA
Makers of Dim-A-Lite

PATENTS

If you have an invention and desire to secure a patent, send for our Evidence of Invention Blank and free guide book "HOW TO GET YOUR PATENT." Tells our Terms, Methods, etc. Send model or sketch and description of your invention for INSPECTION and INSTRUCTIONS.

No Charge for the Above Information

RANDOLPH & CO., Dept. 459 Washington, D. C.

Effarsee

Makes Summer Radio Reception a Pleasure

It gives a maximum of volume, minimum of static and sharper tuning. Place it anywhere—even under the carpet. Sent prepaid for \$4. Write for complete information.

FISHWICK RADIO COMPANY
132 Central Parkway & Elm, Cincinnati, O.

Insure your copy reaching you each month. Subscribe to RADIO NEWS—\$2.50 a year. Exporter Publishing Co., 53 Park Pl., N.Y.C.

Why the Experts Choose the

LYNCH METALLIZED Fixed Resistor



"Right On the Button!"



Glenn H. Browning uses and endorses the Lynch Metallized Resistor.

In describing the construction of experimental receivers, amplifiers and power units, it is significant that such authorities as Laurence M. Cockaday (*Popular Radio*) Herman Bernard (*Radio World*), E. M. Sargent, G. M. Best (*Radio*), and many other eminent designers specify Lynch Metallized Resistors.

These men *know* radio. They realize the importance of resistors that will remain absolutely noiseless, permanently accurate, efficient, dependable—and they choose Lynch. There could be no greater testimony of the true worth of our product.

PRICES

.25 to .10 Megohms	\$.50
Above .01 to .24 "	.75
.001 to .01 "	1.00
Single Resistor Mounting	.35
Double Resistor Mounting	.50

ARTHUR H. LYNCH, INC.,
FISK BUILDING

Broadway & 57th St., New York, N. Y.

Tel. Circle 5471



As Great an Advance as the Tungsten Lamp

The old carbon lamp consumed more current to give less light. Tungsten, which is *metal*, proved more economical, more efficient. It meant more light, longer life. Lynch Metallized Resistors are warranted absolutely noiseless, permanently accurate, dependable!

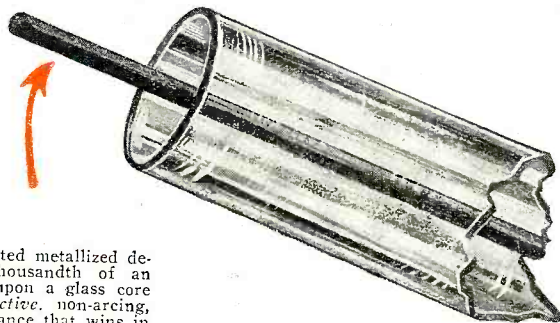

A concentrated metallized deposit one-thousandth of an inch thick upon a glass core gives *conductive, non-arcing, silent, resistance* that wins in the acid test of time.

Dealers—Write Us!

LYNCH Power Amplifier & "B" Supply UNIT



Brings Your Set Up To Date

The only real advance claimed by the makers of this year's best sets is improvement in tone performance. This improvement can be made in your present set by simply adding the Centralab Modu-Plug. This modernizing device makes your reception equal in tone performance to that of the latest high-priced receivers.

Modu-Plug is warranted by Central Radio Laboratories, makers of variable resistances for sixty-nine manufacturers of leading standard sets.

Centralab Modu-Plug replaces the loud speaker plug. Gives any degree of tone volume from a whisper to maximum by simply turning the small knob on the plug, without adjustments of other controls. Modu-Plug matches the speaker impedance to the output impedance of the set. Reduces interfering noises. Clarity and faithful reproduction equal the latest developments in perfected performance.

\$2.50 at your dealer's, or mailed direct on receipt of price.

Central Radio Laboratories
19 Keefe Ave., Milwaukee, Wis.



Centralab Radiohm permits clear, true-tone reception by holding the sensitive regenerative position which immediately precedes the oscillation point, without distortion or loss of selectivity. A standard unit on leading sets. Retail price, \$2.00, at your dealer's or from us.



"You young fellows sure do believe in climbin' the high mountains," came from the old man's rocker, as he twisted his head back and forth and rubbed his arms and knees, for the purpose, as he explained, of "gettin' out the kink."

"Before leaving," I said enthusiastically, giving voice to certain plans which had been rapidly formulating in my mind, "I'd like to make you a little proposition. I've got business in Springfield tomorrow evening and the next day, but will cut it as short as possible and speed on up to a very close friend's farm, located about fifty miles north of Springfield. He's really an old chum of mine, is decidedly well off financially, and is ready any time for any new venture I may sponsor, having come out pretty well in the past of several deals I brought to him. His dad is one of the directors in a large radio manufacturing corporation in Chicago; and if he and his dad knew what I know they'd walk a hundred miles to get in first and highest bid on your discovery or invention."

"You don't know me any better than I know you, but under any circumstances I'd be ready to vouch for their absolute integrity. They'll do the square thing by you, shoulder all the responsibility of floating the venture, and I can assure you you'll never have a kick-back out of it. My proposition, which I must admit is decidedly brassy from practically a total stranger to you, is for you to fend off all prospective buyers of your invention who may show up between now and the twentieth of this month, when I expect to return with my chum and his dad. In other words, I'm asking you to give me a ten-day option without a deposit—but wait, I'll give you my check for a hundred dollars to show you I'm positive they'll bring this matter to a conclusion to your entire satisfaction."

I jerked out my check-book and fountain pen, but paused in surprise as I noticed the bewildered look upon his face.

"My knowledge of business with its options, contracts, and the like is very limited," he began slowly, doubt and uncertainty seeming to measure his words. "I don't wish to offend you by not seeming to enter into the spirit of your proposition; but there are several matters which I did not and can not explain to you just now which forbid my entering into any negotiations for this discovery. I am just on the verge of definitely proving to myself whether or not I have here a peculiar combination of elements which can or cannot be duplicated. Although we may say that this is my own invention there are several factors involved which I have been unable to calculate or comprehend; and until such time as I can definitely put these constants on paper and duplicate my efforts and results in another receiver, I am unwilling to enter into any future plans for marketing the idea."

Considering his words for a moment, I said, "Nevertheless I will plan on returning on the twentieth with my friend and his father. If nothing else comes of their visit, they will at least have experienced a thrill from your receiver such as they have never had before, and by which I am sure they will feel amply repaid for their time and trouble."

With these words I reached for my hat, shook his hand heartily, and with the old neighbor trailing behind me, left the house. At the corner, shaking the old man's hand, I thanked him for the great good turn he had done me, and bidding him good-night hurried to my hotel and room. Although I composed myself for sleep a dozen times I found it impossible to control the darting thoughts in my mind. My nerves were still tingling from my evening's experience and it was not until dawn flushed my bed-

Greater Distance Finer Selectivity Greater Power

with

AERO COIL SUPER-SENSITIVE

INDUCTANCE UNITS



TUNED RADIO FREQUENCY KIT

\$12.00

Replace your present inductances with this Aero Coil Tuned Radio Frequency Kit. It will positively improve the performance of your receiver. Special patented Aero Coil construction eliminates radio frequency losses. You will notice instantly, a tremendous improvement in volume, tone and selectivity.

This kit consists of three matched units. The antenna coupler has a variable primary. Uses .00035 condenser. Coils are uniformly air spaced. No dope is used. Consequently they tune into resonance on a "knife's edge."

FREE with each kit

Eight page color circuit, layout and instruction sheet for building the super-sensitive 5 tube Aerodyne Receiver packed with each kit. Get yours TODAY from your nearest dealer.

Aero Products, Inc.
Dept. 105, 1772 Wilson Avenue
Chicago, Ill.

CARTER

"SHORT" JACK



Open circuit . . . 25c ea.
Closed circuit . . . 30c ea.
Fits any plug. Wide terminals. Easy soldering. Heavy insulation. Strong springs.

TIP JACK



10c ea.
Minimum size. Sturdy Nickel plated. Heavy contact spring. Carter quality.

In Canada: Carter Radio Co., Limited, Toronto

Carter Radio Co.
300 & 302 N. LAKE AVENUE
CHICAGO, ILL. U.S.A.

AMPLION

FOR BETTER RADIO REPRODUCTION

The Radio News "Auto-Former" receiver, equipped with MAR-CO illuminated controls. Contrast these glowing spots of light with clumsy dials.

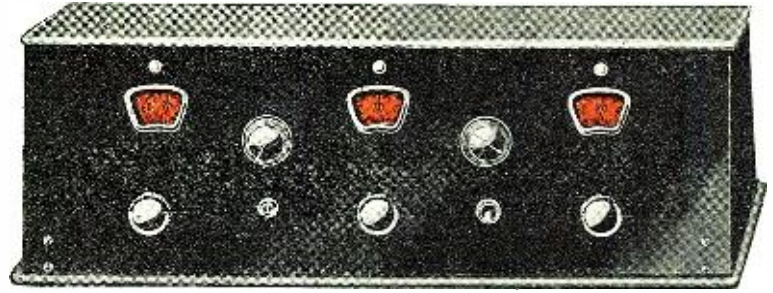

Hair-trigger tuning response flashes in the spotlight of beauty

MAR-CO Illuminated Controls, \$3.50 each

MAR-CO 4" vernier dials, [fit any set] nickel plated \$2.50
gold plated \$2.75

New MAR-CO rheostat dial 75c



Two-thirds actual size

The receiver you equip with MAR-CO controls differs from any dial operated set.

In micrometer fineness of control—in swift certain response—in utter absence of "play"—the new MAR-CO illuminated control is approached only by the celebrated MAR-CO dial. Perfection of gearless "friction-drive" is yours *only* with MAR-CO tuning.

Searching action, in keeping with 1927 broadcast conditions

— flashing beauty . . . in step with 1927 standards of set design

— these advanced features distinguish your MAR-CO equipped set.

Any set you build, or remodel, can have MAR-CO controls. Scales read 0 to 100, or 100 to 0, as desired. Packed with each control is a special MAZDA bulb which runs on your regular "A" battery or on a separate "C" battery. The template, also included, reduces the panel mounting to a simple 10-minutes' diversion. The instruction booklet illustrates 15 standard makes of condensers fitted to MAR-CO controls. Send now for your copy. Martin-Copeland Co., Providence, R. I.

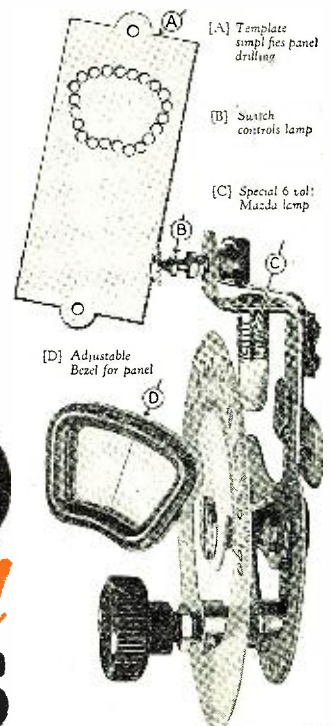

MAR-CO *Illuminated* CONTROLS



Poly Claro-Plug Improves Your Loud Speaker's Tone Almost Beyond Belief

Chases the scrapes, rasps and other extraneous noises from your loud speaker; modifies static; broadens the range, booming in the bass and high tones; improves the tone quality of even the most inexpensive loud speaker.

Merely plug into the loud speaker jack and push phone plug into sleeve provided. For sets without jacks, attach to binding posts—simple, easy, quick. Try one on your set today. Sold with money back guarantee.



Price \$1.50

Polyplugs Can't Be Tugged or Jarred Loose!

The loudspeaker cord criss-crosses through Polymet's exclusive tension slot. Now just try to loosen that positive contact by tugging or jarring—not a chance in the world! Automatic, quick, easy. Demonstrating the fact that it pays to buy the best!

Poly Plug, Genuine Bakelite 50c
E-Z Plug, Composition 35c



Move Your Loud Speaker to Any Room, Porch or Lawn!

Exclusive tension slot construction assures positive contact—the only connector with this important feature. Entirely automatic. No screws to fuss with. Instantaneous connection.

- Connector only 35c
- With 20 ft. Cord \$1.25
- With 25 ft. Cord 1.50
- With 35 ft. Cord 1.75
- With 50 ft. Cord 2.00

Over 110 receiver and power unit manufacturers specify Polymet Products as standard equipment. **THEY KNOW!** At good dealers everywhere.

Write today for illustrated descriptions of all Polymet products. Sent FREE on request.

Polymet Manufacturing Corporation
599A Broadway - New York City
"World's Largest Manufacturers of Radio Essentials"

POLYMET PRODUCTS

room wall that I finally fell into dream-filled, fitful slumber.

Two days later I relieved my mind to my chum by a full recital of all I had seen and heard at the home of the young radio inventor. He was visibly impressed by my words and manner and expressed himself as more than willing to take the matter up with his father at once. Little persuasion in turn was necessary to get the manufacturer interested in a new departure in the radio field. On the morning of the eighteenth he appeared at the farmhouse door, a special directors' meeting having made it necessary for him to remain in Chicago until evening, and then drive all night in his car to be with us on schedule.

While it was our intention to leave that morning for Springfield, reach there around noon and be at our destination before nightfall, circumstances arose in my chum's agricultural affairs which made it impossible for us to get away before early afternoon. As a result we did not reach Springfield before five o'clock; and to attempt to make our destination that night would put us three hours after dark and make necessary a very tiresome and tedious drive over country roads which were none too good. We therefore decided to stay at a hotel that night and continue on our way the first thing in the morning.

To make sure that young Stebbins would be at home on the following day, I wired him the time we expected to arrive and added that he need not bother with answering my telegram unless he would be unable to see us as originally planned. Having no doubt that all was in order, I suggested after dinner that we go up the street and take in a show I had seen advertised.

I must admit that I myself obtained little entertainment from the performance, as my mind was busy with the morrow and what the results of our journey would be. But as my friends appeared to be enjoying it, we remained until the end and it was close to midnight before we returned to our hotel.

As the desk clerk gave me my key he also handed me a telegram, stating that it had been received shortly after we went out. Frankly, I was afraid to open it, and my fingers trembled as I tore the thin yellow envelope. Instinct told me that the message it contained would be disappointing, and that my plans and our mutual hopes would be for naught. Slowly I unfolded the single sheet, and as I read I seemed to hear the roar of castle walls falling around my throbbing ears.

"DO NOT COME PREVIOUS RESULTS HAVE FAILED AND FURTHER DUPLICATION NOW SEEMS IMPOSSIBLE WRITING YOU FULLY ABOVE ADDRESS TONIGHT."

"Well, boys," my chum's father broke out as soon as he had read the message, "guess that lets me out. I didn't build up too many hopes on this matter, but I must say I allowed myself a few prophetic dreams on the strength of your enthusiastic descriptions, and I'm really disappointed in the way things have turned out. However," with brusque good nature, "can't be helped now. I've got a long drive on the back track ahead of me tomorrow, so I'll have to be turning in."

As he turned to me and took my hand, I said, "I'm sorry I dragged you away from your work on this fruitless trip, but if you had been through my experience you would not wonder that I was so anxious to have you foster what appeared to be a marvelous step forward in our pet science."

"Yes, from what you have told me, I envy you your experience. But still I can't help but believe that what the young genius has once accomplished will some day again be duplicated; if not by himself, then by some

Easy to Solder This New Way

Indispensable for all soldering work. Simple — Speedy — Economical

Pat. Applied For

\$3.75 COMPLETE

Press-to-Feed Electric Soldering Iron

One hand does the work of two. Speeds up radio set construction. Far better than a blow torch. Solder will not melt until it reaches soldering point. Porcelain insulations prevents heat from entering handle.

AGENTS—DEALERS—JOBBER

This newly invented electric soldering iron offers big money making opportunity. Order a sample today \$3.75. Discounts in quantities on request. Write to:

ILLINOIS STAMPING & MFG. CO.
220 N. Jefferson St., Dept. 11, Chicago

YOU AINT HEARD NOTHIN YET!
Until You've Listened Through

THE PERFECT RECTIFIER **LEBNITE** THE CRystal SUPREME

THE POWERFUL NEW **MULTIPOINT FIXT DETECTOR**

75c Post Paid

75c Post Paid

Latest Scientific Achievement in Crystalodom

This wonderful new mineral is soft and pliable as Tinfoil, yet rugged as steel; stands any voltage and is most stable for reflex circuits.

Added Range and Volume for Crystal Sets

THE KEY TO QUALITY AND VOLUME RECEPTION

Order today from your Dealer or direct from

PALMER & PALMER 401 WEST UTAICA ST. BUFFALO, N. Y.

Manufacturers of the famous MULTIPPOINT LINE

DEALERS WRITE FOR CATALOG AND DISCOUNTS

KENNEDY & KENNEDY, 1442 Yonge St., Toronto, Ont., Exclusive Canadian Distributor

World BATTERY

6-Volt Storage Radio "A" Battery

Most amazing battery value ever offered! A genuine World 6-Volt Radio "A" Battery with 25 ampere capacity for only \$5.00! Just the thing for Trickle Charger. Famous World Quality assured. Equipped with

\$5.00 C.O.D. Send No Money

Solid Rubber Case

an assurance against acid and leakage. Order Now. We ship same day — by express C. O. D. subject to your examination on arrival. Extra Offer: 5% discount for cash in full with order. ACT TODAY!

World WORLD BATTERY CO.
Dept. 110,
STORAGE BATTERIES 1219S. Wabash Ave., Chicago

WONA - WEA - WGN - WLS - KRL - KGO - KFAB - WLV - KOP

PATENTS WRITE for our Four Guide Books and "RECORD OF INVENTION BLANK" before disclosing inventions. Send model or sketch and description of your invention for our INSPECTION and INSTRUCTIONS FREE. TERMS REASONABLE. Electrical and Radio Cases a specialty.

VICTOR J. EVANS & CO.
919 NINTH ST., WASHINGTON, D. C.

CECO Tubes

“Best by Test” in the Laboratory
“Best by Performance” in the Home

The outside of CECO is like other tubes. It is the “know how”, the care, the scientific skill built into the INSIDE that makes CECO tubes different and superior as detectors, as amplifiers. Repeated testing at every stage of manufacture protects and insures the quality of every CECO Tube.

Two Wonderful New Tube Developments

For Voltage Amplifiers Type “G”

Fil. V 5.0 Fil. Amp. 0.25

Plate Volts 90-180
 Carries more power without over-loading than any other available High Mu. Average Voltage Amplification 20. Average output Impedance 25,000.

PRICE \$2.50

FOR QUALITY AND VOLUME TYPE “H”

Fil. V 5.0 Fil. Amp. 0.25
 Plate Volts 67-90

For DETECTORS use CECO Type “H” with the usual Grid Leak and Condenser, or for perfect reproduction with absolutely no hiss or rushing sound, omit the Grid Leak and Condenser and use 90 Volt “B” with 4.5 Volt “C” Battery.

When connected this way it cannot be overloaded. Average Mutual Conductance 940.

PRICE \$2.50

With these tubes increased quality and volume are especially noticeable in such systems as LYNCH Power Amplifier and “B” Supply and Browning-Drake Hook-ups.

Your dealer has CECO Tubes or can get them for you. Insist on the genuine. There is no substitute for CECO quality.

WRITE FOR DATA SHEET ON TUBE CHARACTERISTICS

C. E. MANUFACTURING CO., Inc.
 PROVIDENCE, R. I.



10 Types One Quality - the Best

- Type “A”
 Fil. Volts. 5.0
 Fil. Cur. 0.25
 P. Vol. 20-120
 List. \$2.00
- Type “B”
 Fil. Volts. 3
 Fil. Cur. .06
 P. Vol. 20-80
 List. \$2.00
- Type “C”
 Same as “B” with
 201A Base
 List. \$2.00
- Type “D”
 For Half-Wave
 Rectifier
 Give specifications
 Type “E”
 Fil. Volts. 2
 Fil. Cur. .125
 P. Vol. 135
 Power Amplifier Dry
 Cell
 List. \$2.50
- Type “F”
 Fil. Volts. 5
 Fil. Cur. .5
 P. Vol. 90-180
 Power Amplifier
 Storage
 List. \$5.00
- Type “G”
 Fil. Volts. 5.0
 Fil. Amp. 0.25
 P. Vol. 90-180
 High Mutual
 List. \$2.50
- Type “H”
 Fil. Volts. 5.0
 Fil. Amp. 0.25
 P. Vol. 67-90
 Special Detector
 List. \$2.50

AX BX



*The New CECO Plant Located at Providence, Rhode Island.
 The Largest in the World Devoted Entirely to Radio Tube Manufacture*

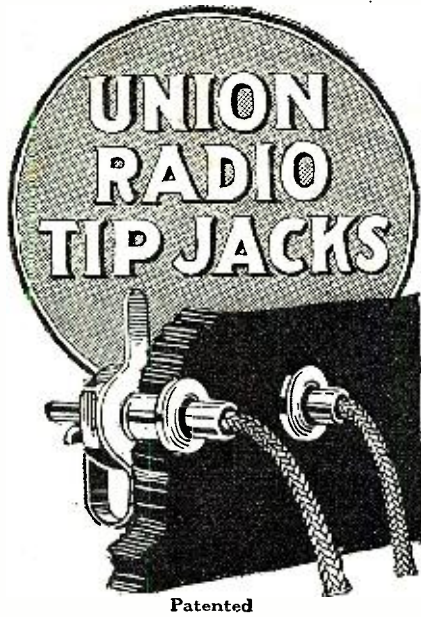

Quick, Easy, Positive Connections

Quicker, easier and surer than binding posts. Lock fast to panel and never loosen. Hold battery lead wires and phone tips securely—release instantly. No tops or parts to lose. Heavily nickel plated. They are used as standard equipment on many of the finest sets.

25c a pair

Firmly grip all wires from No. 11 to No. 24 B & S gauge. Three sizes, for all panels. TYPE A (Standard) for 3/16" to 1/4" panels. TYPE B (Special) for panels, cabinet walls and partitions from 5/16" to 1/2" thick. TYPE C (Special) for panels up to 1/8" thick.

Ask your dealer for Union Radio Tip Jacks or write for Circular C.



Identification Tags

Hard, red fiber ovals with stamped designations. Thread them on your wires—they save time in tracing leads. Complete set of 9 tags only 10c.

TO ALL BRANCHES OF THE TRADE

Send for illustrated circulars and sample of these fast-selling radio products, and details of our attractive proposition.

UNION RADIO CORPORATION
124 S. S. EX. AVENUE, NEWARK, N.J.
NEW YORK OFFICE 40 EAST 34th STREET

other experimenter in the same field. I shall be grateful if you will take the time to let me know the final outcome of the matter."

My chum took my hand in a friendly grasp and squeezed my arm in sympathy. "I'm driving back with my Dad in the morning as far as the farm," he said. "Here's luck to you and the young scientist you've discovered. Come out and tell me all about it just as soon as you're at liberty again. And come prepared to spend that month's vacation with me that we've been planning on so long."

I followed them to the elevator with my eyes, and smiled somewhat wanly as they turned and nodded to me and then rose from my view.

Thanks to an efficient postal system, the letter was delivered to me by the first morning's mail, and I was soon in possession of all the disappointing facts. Needless to take your time in quoting Stebbins' letter in full; the facts, as briefly as possible, are as follows:

The heart of the unique reproducing apparatus had been a crystal, similar to that used in ordinary crystal receiving sets. Certain peculiarities of this particular crystal specimen had baffled him, however; and the day after I visited him he had wrapped it carefully and sent it to a firm of metallurgists in Springfield for analysis. On the strength of their report he had hurried to that city and obtained from the same supply house who had furnished him with the original crystal, several other samples of the same substance which he carried personally to the same metallurgists for a similar test. The results of the latter tests were a source of disappointment; as was the test of every other specimen he was able to obtain from the wholesale house, completely exhausting their stock of this particular variety in his efforts to obtain a duplicate of the original crystal.

The report of the metallurgists, in brief, had been that the specimen he had submitted had responded very strongly to a test for radio-activity, indicating that the rarest of elements, radium, had entered into the composition of this certain metallic crystal. To the best of their knowledge, radium or any other radio-active elements, had never before been known to occur in combination with this metal. Tests of all remaining specimens for radio-activity met with no positive response; so that they were forced to regard as a freakish composite the first crystal he had submitted to them.

Sadly disappointed he returned to his home, convinced that for the time being he would have to be satisfied in operating a unique set, which could not be duplicated until such time as similar results could be obtained from some other method. But when the crystal was once more adjusted in its place he was surprised to find that the expected results did not materialize. For forty-eight hours he worked steadily, taking time only to eat and drink; but failed miserably in obtaining the faintest re-broadcasted sound.

Finally, removing the crystal once more from the set, he decided it was fairly possible that in testing it the chemist had held it in his fingers; under which circumstances the natural body oil would have coated its sensitive surface with a positive insulation. Tired in body and mind, he reached for a bottle of benzine; determined that, if thoroughly cleansing the crystal produced no better results, he would get some much-needed sleep and take up the problem later.

Placing the crystal in a small earthen crucible he poured over it a generous portion of the liquid—when with a hiss a small cloud of vapor arose which, as it cleared away, disclosed the dust-like particles of

Thousands Use These Ingenious TRANSMITTER UNITS



Here's a marvel of Engineering design—a practical miniature transmitter, used by thousands of radio fans and experimenters for amplification purposes. It is a most novel unit, having hundreds of uses. Every amateur should have two or three of these amplifiers in his laboratory.

A FEW USES FOR THESE UNITS

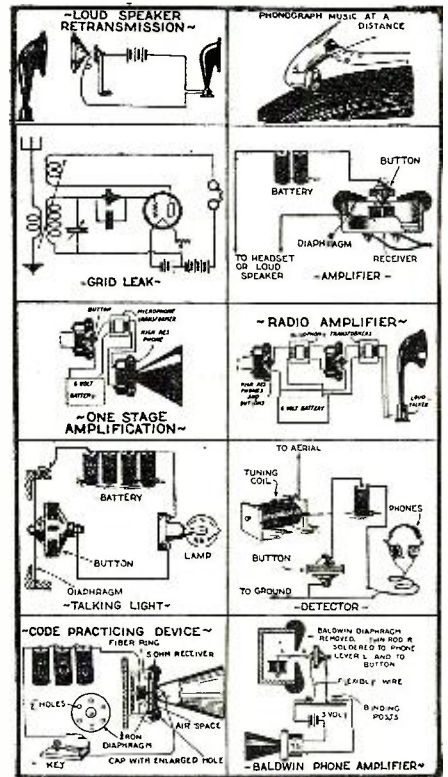

With each unit is mailed an eight-page instruction pamphlet containing suggestions for innumerable uses. Our supply is limited; avoid disappointment by ordering today. The coupon below is for your special convenience.

SPECIALLY PRICED
While they last— **95c**
(or Two for \$1.75) per unit

THE PRESS GUILD,
66-R West Broadway, New York, N. Y.
Enclosed find 95c/\$1.75 for which send me postpaid one/two amplifier units as advertised.

Name

Address

City, State

RAYTHEON ANNOUNCES

89%
MORE
POWER

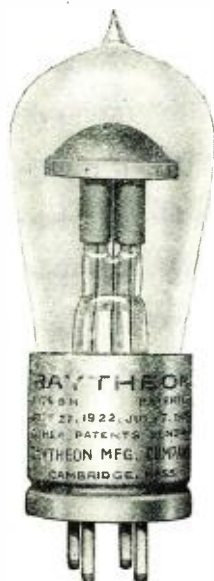

Greater
Reliability
in
Radio Power

Light Socket Power for Filament and Plate of Type 199 Tubes Now Practical

FOUR years ago the scientists in the Raytheon Laboratory tackled the problem of using alternating current as a supply for radio power. After three years of research the well-known Raytheon, Type B, was developed. In the one short year since this tube was introduced the B-power market has been revolutionized, and the Raytheon equipped B-power units today are unquestionably the leaders in quality.

Raytheon, Type B, the 60 milliamper tube, remains the standard for regular B-power service.

Now these same engineers have perfected the next logical step toward a.c. operation—a new and exceptional rectifier for a new and exceptional service. Raytheon, Type BH, has a rated capacity of 85 milliamperes, more than enough

to supply the 60 milliamper current for the filaments of Type 199 receiving tubes connected in series. Here is a wonderful opportunity for the home constructor to obtain complete a.c. operation. Think of it, both A and B power from a single rectifier! Leading radio magazines will carry detailed information on how this may be accomplished.

The new tube has been rated 200 volts output. This is just what has been needed for the new power amplifiers using the UX-171, the latest development in quality reproduction for the home. This unit will also be described in articles by radio authorities, and complete factory-built B-power units of this type are now available at radio dealers for those who require the extra power.

One last word on Reliability to those who are not already familiar with Raytheon and the Raytheon policy. Complete power units, equipped with Raytheon tubes, are manufactured by Companies selected for their excellent engineering and production facilities. No others are authorized to sell Raytheon rectifiers or to use the trademark word RAYTHEON. Hence, by making certain that you are purchasing a genuine Raytheon unit you are not only assured of the utmost in reliable rectification, but also that the unit has been carefully designed for the service for which it is intended. You will find a variety of prices and styles to meet every requirement.

Raytheon is the Heart of Reliable Radio Power.

RAYTHEON MANUFACTURING COMPANY, CAMBRIDGE, MASSACHUSETTS

**28th
YEAR
FOUNDED
1899**

FREE RAILROAD FARE

LEARN ELECTRICITY

In the Great Shops of
COYNE



In 12 WEEKS
Earn \$60 to \$200 a Week

Get in the field that offers you the BIG PAY—BE AN ELECTRICAL EXPERT. Coyne is not a Correspondence School. Everything is practical. No books or useless theory. You do actual work on our huge outfit of electrical apparatus—everything from door-bells to power plants—everything to make you a \$60 to \$200 a week EXPERT. A Coyne trained man can take his place anywhere in the electrical world. Learn in Chicago, the Electrical Center of the World.

You Don't Need Education or Experience Coyne gives you education and experience by actual work. My training is practical and easy to understand.

Free Railroad Fare and Radio and Auto Course FREE!

Right now I am including a free course in Radio. Also a complete course in Auto, Truck and Tractor Electricity and Storage Batteries and I'll pay your railroad fare to Chicago.

Earn While You Learn—We help students to secure part time jobs to earn a good part of their living expenses while training and assist them to a big pay job on graduation.

SEND COUPON NOW!

Don't delay a minute—send that coupon right now for my big free catalog and full particulars of special offer. No obligation on your part at all. ACT NOW!

COYNE Electrical School
H. C. LEWIS, President
Dept. 76-77
1300-10 W. Harrison St.
CHICAGO, ILLINOIS

Get my Big Free Book

SPECIAL OFFER NOW

Mail this Coupon

H. C. LEWIS, Pres.
Coyne Electrical School Dept 76-77
1300-10 W. Harrison St., Chicago
Dear H. C.: Please send me free your big new catalog and full particulars of your **Free Railroad Fare Offer** and two free courses.

Name _____
Address _____
City _____
State _____

what had once been a sensitive crystal now disintegrated and scattered over the bottom of the dish.

His grief mounting almost to speechless rage, he glared at the bottle that had done the mischief. In raised letters on its side appeared the unmistakable and startling legend—H₂SO₄. Close to the point of nervous exhaustion, his fingers had strayed at the critical moment; and, instead of the intended benzine bath, he had poured into the crucible a quantity of pure, undiluted, sulphuric acid.

But life was not all disappointment for the young inventor. It developed that my chum's father was a director of the same factory whose salesman had stolen young Stebbins' first invention. Within a short time the salesman was seeking a new connection, the corporation paid my friend a substantial bonus as amends for past neglect, and the royalty returns were transferred to his account.

An enthusiastic welcome is always extended to me at the Stebbins home; and he now feels free to confide in me any and all of his latest discoveries, without fear that the fruit of his efforts will be purloined. With the income he is deriving from his first invention he has added considerably to his laboratory equipment; and, when last I saw him he was still busy experimenting and seeking the illusive "vibration of silence."

The "Ham" Meets the "Egg"

(Continued from page 374)

"Say, for the love of Mike, that's real. What'you want it to do, get up on its front paws and walk around the room and roll over on its back?" was my retort, and in quite furious and indignant manner, too.

"It may be real but it isn't like the ones I saw in pictures. They all were on great big black panels and stood as high as this room.

At this point I devoted several minutes to explaining that the set he made reference to was for 600-meter work and a commercial product. Mine, I told him, was home-made, but worked.

"How far do you get with it?" he queried. "France, Great Britain, and all over the United States and Canada," I replied proudly.

This didn't seem to impress him at all, since he was interested in the result of my opening a package which contained the new five-watt bottle.

Carefully I removed the packing and brought forth the little giant, then inserting it in the socket I looked back at the boy friend and remarked:

"Tis she! That's the one that does the trick on forty meters!"

"You have to have a license to operate that thing, don't you?" was his next interrogation.

This appeared to be a good place to put on the old brave, indifferent act, and I says, "Yeah, you're supposed to have one, but mine is for the other town. Anyhow it doesn't permit me to operate on this wavelength."

"Aren't you afraid of getting caught doing that?" said he.

"Oh, no!" I declared emphatically: "I should worry about the radio inspector! He'll never know the 'diff'! You see what he doesn't know won't hurt him much—"

Not giving him a chance to ask any further foolish questions, and to change the trend of the conversation, I asked him casually what his line of business was.

"I'm the new radio supervisor for this

BIG SUMMER OFFER

\$2 VALUE \$..FOR..

This is the biggest opportunity of the year.

To the readers of RADIO NEWS we have arranged to offer a big reduction in the famous Conrad Pattern's and E. I. Co. Books; millions of these have been bought by Radio Fans. They are recognized and sold by the best Radio stores and Newsdealers.

We offer any \$2.00 worth of these books and patterns you may select for \$1.

Think of it \$2 for \$1. Just check \$2 worth from the list below and send \$1 with the coupon and we will mail you the materials at once.

LARGE ORDERS ACCEPTABLE IN THE SAME PROPORTION.

MAIL THIS COUPON NOW!

THE CONRAD CO., Inc. RN-10
64 Church St., New York, N. Y.

Gentlemen:—I enclose \$1, please send me the items checked below. (Items checked not to exceed \$2 worth.)

E. I. BOOKS, regular price 25c

- No. 1. Tips for the Radio Constructor.
- No. 2. How to Make Practical Radio Receivers.
- No. 3. Radio Questions Answered.
- No. 5. Loud Talkers and How to Build Them.
- No. 6. How to Tune Your Radio Set.
- No. 7. One Hundred Radio Hook-ups.
- No. 8. All About Radio Parts.
- No. 9. History and Operation of Vacuum Tubes.
- No. 10. The Neutrodyne and All About It.
- No. 11. How Radio is Received.
- No. 13. Reflex Radio Receivers.
- No. 14. The Super-Heterodyne, Theory and Construction.

CONRAD PATTERNS, regular price 50c

- No. 2. How to Make a Two-Stage Amplifier.
- No. 4. How to Make a Reinartz Receiver.
- No. 5. How to Make a Reflex Receiver.
- No. 6. How to Make a Cockaday Receiver.
- No. 9. How to make the S. T. 100 Receiver.
- No. 11. How to Make a Five-Tube Cockaday Receiver.
- No. 12. How to Make a Portable Receiver.
- No. 13. How to Make a Harkness Receiver.
- No. 15. How to Make a Low Loss Receiver.
- No. 16. How to Make the Tropadyne Super-radio.
- A. Radio Map of the U. S. on Cloth.
- B. 20 Radio Diagrams and Hook-ups.
- C. All About Aerials and Their Construction.
- D. Radio Amateurs' Practical Design Data.

NAME

ADDRESS

CITY, STATE

Insure your copy reaching you each month. Subscribe to RADIO NEWS—\$2.50 a year. Experimenter Publishing Co., 53 Park Place, N. Y. C.

BOSCH RADIO

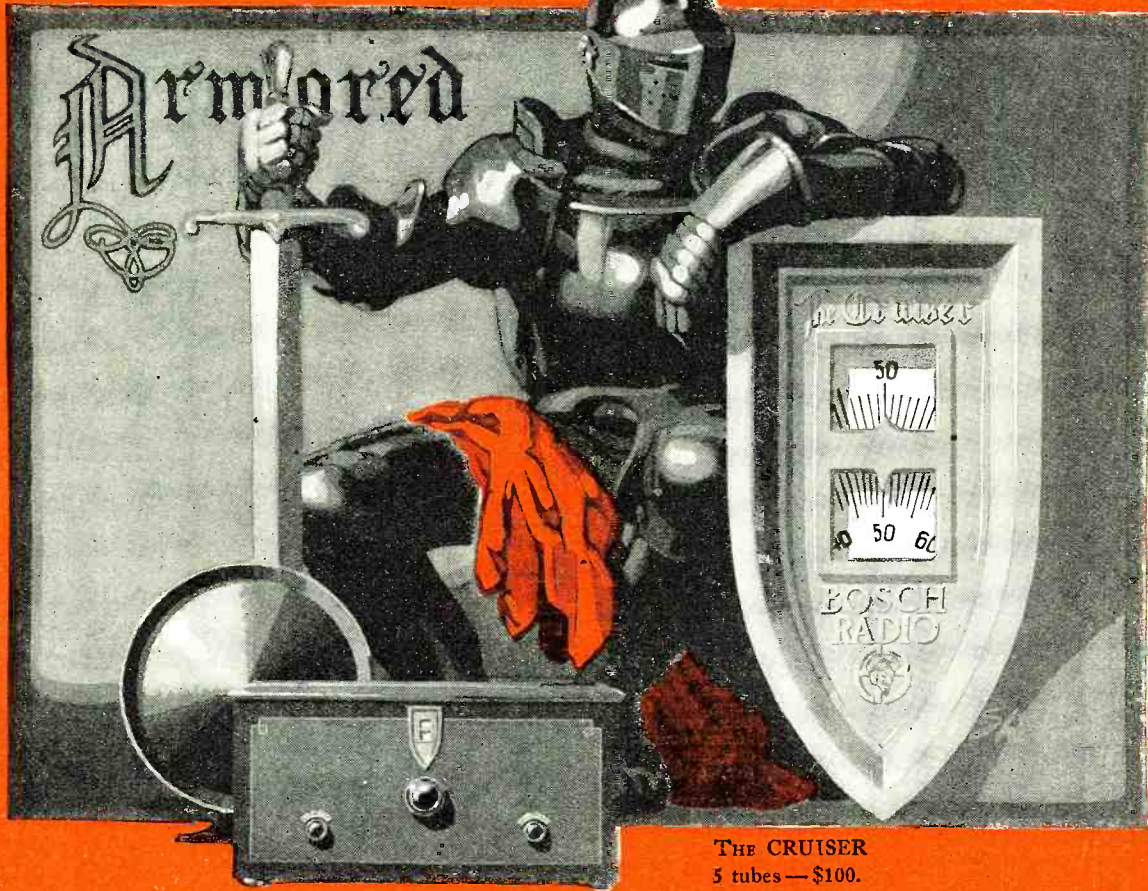

THE CRUISER
5 tubes — \$100.

If you want radio without petty interferences, radio of truer, finer selectivity, radio of easy operation—then the new Bosch models will fully satisfy your requirements. The Bosch Amborada is a seven tube receiver completely Armored and Shielded against interferences and has tonal range from a whisper to dance volume. It successfully and instantly separates “close in” stations without whistling or blurred reception. Two controls only: one for station selection and one for volume. Ample room is provided in the handsome Early American period Amborada cabinet for all batteries, chargers or power units—perfect radio and quality in furniture is embodied in this receiver. The Cruiser is a completely armored and shielded five tube receiver of Unified-Control, single station selector for powerful stations and two dial advantages for “Cruising the Air.” The Bosch Radio Line fulfills every radio requirement, five, six, seven tube receivers, two cone type reproducers, famous NoBattery “B” Power Unit and other radio equipment. Every receiver, every item in the line is Bosch precision built, ahead of the industry, and you can prove it for yourself, just visit a Bosch Radio Dealer. We will tell you his name upon request.

AMERICAN BOSCH MAGNETO CORP.
Main Office and Works: - - Springfield, Mass.
Branches: New York Chicago Detroit San Francisco

Manufactured under patent applications of the American Bosch Magneto Corporation and licensed also under applications of the Radio Frequency Laboratories, Inc.

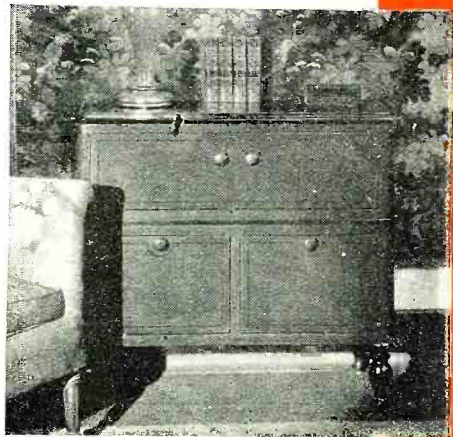

The AMBORADA—7 tubes—\$310.
All prices slightly higher, Colorado, west, Canada

EVERY NOTE LEAVING THE MICROPHONE REACHES YOUR SPEAKER AMPLIFIED EVENLY

by the
Jefferson Concertone

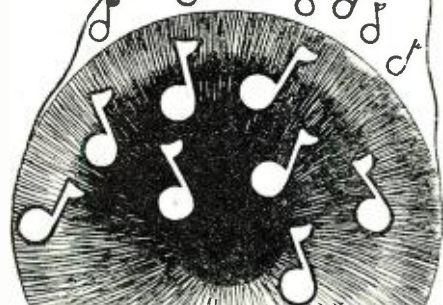

The latest circuits specify
JEFFERSON Concertone

(AL-2 SEALED) AUDIO FREQUENCY TRANSFORMERS

Because they do not lose, distort or "blast" any notes (from the lowest to the highest audible to human ears), the new large Jefferson "Concertone" Transformers are being used in latest circuits.

Not only do they make programs sound wonderfully natural and life-like by amplifying all tones equally; they also increase sensitivity and improve distance reception. Ideal for use with power tubes because of heavily insulated extra large cores and windings. Each "Concertone" is sealed against moisture in a 3 3/8" long x 2 3/4" high metal case—convenient for double-decking.

Make your set a 1927 model in quality of tone by installing a pair of "Concertones." \$6 each—at your dealer's.

Send For Latest Literature

Other Jefferson Guaranteed Radio Products include "Star" A.F. Transformers, \$2.75. \$3; Tube Rejuvenators, \$7.50; Tube Testers (for dealers, experimenters) \$8, \$9. Tube Chargers (described below). No. 280 Tube Charger with large socket only, \$3.50; No. 285 Tube Charger with small socket only, \$3.50.



Without removing your tubes from the set

KEEP TUBES LIKE NEW—CHARGE THEM MONTHLY and ALL AT ONCE

Tubes gradually weaken with use, as do batteries. Once a month attach Jefferson Tube Charger to light socket and connect with set for 10 minutes. Rejuvenates run-down tubes. Improved reception with longer life of tubes and batteries will be worth many times the price to you. Guaranteed.

Jefferson Tube Charger, \$3.50

Makes it easy to regularly charge tubes, all at once, in your set, at home. Enjoy top-notch reception every night. Get one front dealer today.

Jefferson Electric Mfg. Co.
Largest manufacturers of small transformers
541 SO. GREEN ST. CHICAGO, ILL. U.S.A.

district," he coolly stated, taking a piece of pink paper from his inside coat pocket!

NOTICE TO HAMS

Editor, RADIO NEWS:

I should be pleased if you would call attention to the fact, through the medium of your valuable journal, that I should be pleased to forward cards to Irish experimenters from amateurs in your country. Cards should be addressed to the Station, c/o "Irish Radio Journal," 34, Dame Street, Dublin.

W. R. BURNE,
Managing Editor, Irish Radio Journal.

CALLS HEARD

A. G. WEYNTON, "CESCA," CRANBROOK AVE., CREMORNE, SYDNEY, AUSTRALIA

1aa0, 1aci, 1ado, 1bqm, 1bgq, 1cmx, 1hra, 1pi, 2agq, 2bx, 2uo, 3bk, 3lw, 3ww, 4ag, 4iz, 4xj, 4xt, 5aq, 5aab, 5akt, 5akn, 5amn, 5avt, 5dl, 5dq, 5gc, 5uk, 5ww, 5yd, 6ajj, 6alr, 6anm, 6bao, 6beh, 6bhk, 6bjn, 6bls, 6boo, 6bqt, 6buc, 6bwi, 6cor, 6dat, 6eb, 6z, 6hv, 6ih, 6jn, 6ky, 6mb, 6oi, 6pr, 6sv, 6ts, 6tx, 6ukm, 6xam, 6zv, 7pu, 7rl, 7vr, 7wa, 7xf, 8adg, 8bhm, 8bon, 8bpl, 8gz, 8uz, 9bhx, 9bwo, 9bvh, 8bzj, 9che, 9clj, 9clr, 9cpq, 9cv, 9cxc, 9dau, 9dcz, 9dng, 9eas, 9ect, 9eck, 9eii, 9etf, 9kg, 9kv, 9mh, 9xi, KFUH.

hufxj, huwyi, hu6axw, hu6ddl.
c2rc, c4gt, f8kf, g2od.
jizj, m4v, m9a.
pi3aa, pilhr.
All cards qsl'd card for card; time, qrh, qso, qsb, qss, can be given on request. Calls above heard between May 16 and 28, 1926.

L. F. STROBEL, 680 YALE STREET, AKRON, OHIO, 8BSR

40 Meter Band
6abg, 6abx, 6afg, 6afs, 6afu, 6ahp, 6aji, 6ajm, 6akw, 6ann, 6ano, 6bab, 6bam, 6bdw, 6bhv, 6bih, 6bil, 6bpg, 6bq, 6bur, 6cae, 6cbj, 6ccl, 6cco, 6cey, 6cis, 6civ, 6ckv, 6clp, 6clt, 6csd, 6css, 6csu, 6csv, 6cto, 6cur, 6cuw, 6dad, 6dam, 6dau, 6dax, 6dh, 6dl, 6iz, 6hu, 6kg, 6la, 6nx, 6pl, 6qs, 6rp, 6sh, 6ul, 6vr, 6vz, 6xi, 7aek, 7ca, 7cs, 7df, 7co, 7jf, 7pe, 7uj.
ENGLAND: 2nm, 2od, 2qb, 2wj, 5lf, 5ma, 5nn, 5rz, 5sz, 6ox, 6rm, 6yu
FRANCE: 8bf, 8dk, 8eu, 8gi, 8nk, 8yor.
ITALY: 1as, 1er, 1gw, 1rm, 1no.
SPAIN: Ar24.
BELGIUM: 4yz.
PORTUGAL: 3gb.
CHILE: 9tc.
SO. AFRICA: A4z.
HAWAII: 6dcf, 6x1.
AUSTRALIA: 2hk, 2cg, 2cs, 2ds, 2jw, 2lo, 2sw, 2tm, 2yi, 3bd, 3hl, 3kb, 3wm, 3yx.
NEW ZEALAND: 1ax, 1ig, 2ac, 3af, 3ak, 4al.
BRAZIL: 1ab, 1ae, 1ib, 2ab.
MEXICO: 1aa, 1k.
CANADA: 1am, 1ar, 1dd, 1ei, 4ac, 4dc, 4dw, 4fv, 5go.
PORTO RICO: 4kt.
MISCELLANEOUS: Aqe, b9, ca, fw, ntt.

A. G. HECKER, CAMP STREET, TEMORA, N.S.W., AUSTRALIA

UNITED STATES: 1pl, 1li, 1pr, 1cm, 1wr, 1iq, 1rg, 1yh, 1te, 1aa, 1aep, 1cmp, 1bb, 1ht, 1ao, 1ix, 1cx, 1bs, 1ka, 1ha, 1px, 1ahg, 1aaj, 1cmx, 1hze, 1er, 1lp, 1hd, 1azd, 1axa, 1bux, 2agq, 2lu, 2agt, 2lz, 2lv, 2zq, 2ai, 2kr, 2buy, 2xaf, 2af, 2bbx, 2cwx, 2cgv, 2gy, 2aq, 2re, 2ds, 2af, 2hg, 2acs, 2ahm, 2xhf, 2kg, 2aim, 3jw, 3wo, 3lva, 3jwa, 3kw, 3sl, 3ac, 3bw, 3ju, 3ef, 3sc, 3ot, 3qt, 3ld, 3lw, 4gt, 4tm, 4rin, 4ate, 4fu, 4oa, 4eco, 4si, 4cm, 4fl, 5et, 5uk, 5aj, 5agl, 5zai, 5nq, 5kfu, 5atv, 5agn, 5azk, 5nj, 5rft, 5ew, 5agz, 5akz, 5ms, 5agu, 5ux, 5aav, 5aab, 5acl, 5za, 5asw, 6dah, 6ij, 6aji, 6km, 6awt, 6bhx, 6chs, 6cej, 6za, 6cgv, 6rv, 6bjx, 6ar, 6cso, 6et, 6cg, 6cto, 6bur, 6ri, 6hao, 6an, 6agk, 6ct, 6hmw, 6bsz, 6nx, 6nt, 6ank, 6hcf, 6jp, 6uar, 6ot, 6xad, 6ers, 6cub, 6hgo, 6com, 6agn, 6bih, 6fa, 6xhj, 6af, 6hg, 6akz, 6dao, 6li, 6esw, 6lj, 6hm, 6ba, 6bkv, 6aii, 6hq, 6co, 6hil, 6azk, 6vr, 6tz, 6apk, 6aqp, 6cuk, 6zhe, 6dn, 6aoi, 6hjj, 6ahq, 6tx, 6ew, 6cmg, 6uc, 6qad, 6dai, 6hmt, 6cey, 6uf, 6sk, 6chx, 6kh, 6oi, 6ij, 6bmg, 6ctd, 6hm, 6hwi, 6jn, 6dhe, 6hoo, 6dl, 6hjl, 6ac, 6cyp, 6cgk, 6dam, 6aiv, 6cgn, 6am, 6bqt, 6aps, 6sv, 6ahp, 6alt, 6bon, 6akm, 6aak, 6hav, 6js, 7ly, 7uz, 7cq, 7ya, 7ak, 7ay, 7it, 7aek, 7ou, 7df, 7xf, 7ek, 7aaj, 7lq, 8ak, 8jq, 8do, 8don, 8cyi, 8pl, 8ca, 8bc, 8ry, 8ct, 8gz, 8chk, 8akf, 8aj, 8stn, 8er, 8cna, 8bf, 8dns, 8df, 8hnh, 8hce, 8eq, 8sf, 8hpl, 8chi, 8xe, 8kv, 8dgo, 8eh, 8dem, 9li, 9led, 9eli, 9ax, 9cid, 9ack, 9akf, 9cgv, 9cgn, 9hht, 9hhy, 9hjj, 9cxc, 9nq, 9ado, 9xn, 9aci, 9dk, 9bn, 9nlc, 9ec, 9uc, 9cca, 9zt, 9bpy, 9ek, 9dvr, 9bbh, 9lvc, 9lmg, 9dkv, 9apm, 9eez, 9bdf, 9bta, 9ebj, 9kd, 9hh, 9gx, 9ih, 9ab, 9biz, 9dwp, 9hmx, 9cmp, 9hwo, 9hqu, 9wi, 9cpq, 9fj, 9dau.
KDKA, KGO, WMAQ, WOR, KFI, KEL, KET, NKF, WIZ, NPG, NPL.

PRICES CUT
World STORAGE BATTERIES at Cost!
World

LIMITED TIME OFFER!
For a limited time only, genuine World Storage Batteries can be gotten at actual cost. Every cent of profit has been cut out in order to keep our full factory organization busy during the slack season. Prices below are lowest in history.
World Batteries are nationally known for dependable, long wearing performance. Solid Rubber Case prevents acid and leakage.
Send No Money!
Just state battery wanted and we will ship same day order is received, by Express C.O.D. subject to examination on arrival. 5% discount for cash in full with order. Send your order now and get your World Batteries at actual manufacturing cost.
WORLD BATTERY COMPANY
1219 So. Wabash Avenue Chicago, Ill.
Dept. 10

Solid Rubber Case Radio Batteries	Set your Radio Dial for the new 1000 w. World Battery Station W S B C, Chicago. Interesting programs every night.	Solid Rubber Case Auto Batteries
6-Volt, 100-Ampere \$10.50		6 - Volt, 11 - Plate \$20.50
6-Volt, 120-Ampere \$12.50		6 - Volt, 13 - Plate \$12.50
6-Volt, 140-Ampere \$13.25		12 - Volt, 7 - Plate \$16.25

KDKA WIBC WEAF KYW

LIGHTS YOUR DIALS
for easy adjustment at night or in the shaded radio corner with this new, handy and beautiful radio lamp.

PRICE \$2.00

DIALITE
Portable Radio Lamp
Ornamental as well as useful. Supplies the right amount of light for easy dial reading and adjusting. Handsomely designed. Has heavily weighted base. Old gold finish. Comes equipped with 6V bulb, switch and 5 1/2 feet of insulated wire. Simply attach to "A" battery and DIALITE is ready for service. It serves as a trouble finder, too.
AT ALL RADIO DEALERS
If your dealer cannot supply you, send \$2.00 and we will ship direct, postage prepaid. Money back if not satisfactory.
ACCESSORIES MFG. CO.
2314-29 N. Crawford Ave., Chicago, Ill.

Special Library of Information
on
RADIO PATENTS and TRADE MARKS
JOHN B. BRADY
Patent Lawyer
Ouray Building Washington, D. C.
Cable address: RADIOPAT Telephone: Main 4806

No Tubes to Buy— No Acid to Spill Lamp-Socket Reception



Harmless solution

Solution level always visible

These knobs regulate voltages

Only four connections to make

Plug can be left permanently in light socket

The Willard Selling Plan for Radio Dealers

Your local Willard Service Station will act as your jobber on Willard Radio Products.

This means a quick source of supply for strictly fresh material which you can turn over to your customers in the pink of condition.

Your local Willard Service Station also assumes the responsibility for service, if needed.

Months of operation have proved that this plan is effective, and profitable for all concerned.

Willard Radio Products will be advertised extensively this fall. Doubles and full-pages in The Saturday Evening Post and other leading publications.

The Willard "B" Power Unit

Here's a "B" Power Unit that does a real job in any radio set.

Its specially designed low-resistance filter cuts out hum while you are receiving and keeps it out during pauses in broadcasting.

No tubes are used, for this very different Unit rectifies the current from your lighting socket by means of a harmless solution which will not damage furniture or carpets. Consequently a safe Unit to place in the finest radio cabinet.

Delivers ample current for all types of radio sets up to and including those of ten tubes, as well as sets using power tubes.

Operates *economically* on any 110-volt, 50-60 cycle, alternating-current circuit.

WILLARD STORAGE BATTERY CO.
CLEVELAND, OHIO, U. S. A.

Have your local Willard Service Station explain the details of this practical plan for advertising and selling radio products. The advertisements are signed:

Sales and Service through
The Willard Battery men
and their
Authorized Radio Dealers

Appropriate signs and window cards will identify you as an Authorized Dealer. Booklets and other valuable selling helps will be furnished.

Your Nearest Willard Service Station is Your Nearest Willard Jobber

Use the Handsome Bodine De Luxe Loop



To Tune Out Interference

The artistically balanced, hand rubbed, solid walnut frame and lustrous silk winding of this beautiful loop harmonize with the finest furniture. It is very compact, yet highly efficient for its size. Equipped with jack which may be mounted in top of cabinet, to eliminate all exposed connecting wires.

Improves tone quality by tuning out interfering stations. Designed for regular loop sets, but can be used with many aerial sets with slight changes. Write for directions for converting aerial sets into loop sets. Ask your dealer to show you the beautiful Bodine De Luxe Loop.

Bodine Basket-Weave Folding Loop

Very popular because of its remarkable ability to pick up long distance signals. Specially designed wires do not sag. Loop holds its shape in service. Folds very compactly—ideal for camping. Calibrated dial permits logging. Ask your dealer about the Bodine Basket-Weave Folding Loop, the loop that is different.



Bodine Twin-Eight R.F. Transformer



The dream of set builders. Readily improves tuned radio frequency circuits. Makes them sensitive and selective. Improves tone quality. Write for data on Bodine Twin-Eight Hook-up which utilizes Twin-Eight coils.

Mail the Coupon

Bodine Electric Company,
2264 W. Ohio Street, Chicago, Ill.
Kindly mail FREE circular describing:
Bodine Radio Loops.
How to use a loop with aerial receiver.
How to build the Bodine Twin-Eight Receiver.

Name.....
Address.....

CANADA: 2ki, 3aa, 4gt, 4hd, 9ck.
JAPAN: 1aa.
SAMOA: Npu, 6zac.
JAVA: Pkx, anc, andir, anf.
GUAM: Npn.
PORTO RICO: 4sa, 4rl, 4je.
MEXICO: 1k, 9a.
PHILIPPINES: 1hr, 1dl, 1au, 3aa, cil8, npo, neqe.
CHILE: 1eg, 9tc.
CHINA: gefi, NPJ.
RABAU: vjz.
RUSSIA: rrp., IRAQ, 1dh.
FRENCH INDO-CHINA: 8qq, 8lbt.
PALESTINE: 6yx, 6zk.
SOUTH AFRICA: a3x.
FRANCE: 8jn, 8ec, Fw, Fnk.
HOLLAND: pcnu, pell.
ITALY: 1ax, 1de.
SPAIN: ear2i.
ENGLAND: 2nm, 2lz, 2od, 2kf, 2sz, 2cc, 3nn, 5lf, 5sz, 6uz.
IRELAND: 5nj.
GREENLAND: wap.
ANTARCTIC: aqe.
SHIPS: NRRL, GBE, NEDI, NUMM, NDF, KFUH, NVE, NRY, NIS, NLI, NIFJ.
UNKNOWN: NOEN, NEQQ, de8ssc, BAM, y5bk, mjh, 2bg.

F. J. HINDS, 3337 OAK PARK AVE., BERYN, ILL., 9APY

1aac, 1ahb, 1ajp, (1ane), 1chl, 1ckm, (2adk), 2aiz, 2cjj, 2cyh, 2dx, 2wc, 3clo, 3ol, (4aa), 4cu, (4dt), 4fl, 4it, 4wg, 5ahi, 5agu, 5ajm, 5akl, (5apq), 5atv, 5aau, 5awf, 5hn, 5jd, 5qj, 5qk, 5yb, 6aao, 6abg, 6aj, 6bil, 6cho, 6erz, 6ct, 6ctn, (6cuw), 6dbl, 6ka, 6lr, 7dd, 7fj, 7il, 7jj, 8dhx, 8dkn, (8cl), 8eu, 8uf, 8ut, 1aa, 1aci, 1ak, 1aof, 1ask, 1ave, 1hbh, 1bsd, 1bz, 1cjr, 1ckp, 1cmg, 1coe, 1db, 1rm, (1ue), 1za, 2aev, 2afv, 2aj, (2bm), 2cty, 2ez, (2oj), 3aal, 3apm, 3bnu, 3bwt, (3hu), 3qi, 3tr, 3vi, 4cm, 4it, 4iz, 4je, 4ll, 4lt, 4og, 4rm, (4rz), 4wu, 5aaq, 5abi, (5abz), 5ada, 5ade, 5ahr, 5alz, 5api, (5apq), 5aqx, 5atx, 5avv, 5ft, 5hn, 5hp, 5pi, 5qh, 5qz, 5uj, 5vv, 5wk, 6akm, 6akt, 6ano, 6bjv, 6bls, 6byg, 6cmx, 6cof, 6ers, 6erz, 6dag, 6dbl, 6hm, 6kg, 6lr, (6nw), 7afo, 7aib, 7cy, 7dd, 7eo, 7gv, 7jf, 7lu, (7mz), 7nl, 7no, 7oy, (7uq), (8acz), 8aul, (8ayp), (8hfg), 8hhm, 8cmm, (8cyd), 8dbb, 8dno, (8doi), (8dqa), (8lj), (8rv), 8uf.

CANADIAN: (c-3dh), c-3ni, c-3qs, c-4cc, c-4ea.
MISCELLANEOUS: Fw, c-6za, wir, wiz, wqo.
NAVY: Nfv, nism, nkf, nle, noeg, nsg.
ARGENTINA: Lpz.
ENGLAND: G-6tm.
SWEDEN: Srd.
CANADIAN: 3oh.
MISCELLANEOUS: Wiz, (wyf).
Heard on both 40 and 80 meter bands during July, 1926.
1aap, 1air, 1ajp, 1ans, 1xf, 2amd, 2axq, 2cua, 2th, 3ain, 3cva, 4aah, 4cj, 4dd, 4dy, 4ll, 4mi, 4rm, 4ry, 5aad, 5api, 5aq, 5aqt, 5ask, 5avf, 5di, 5em, 5kc, 5lg, 5pi, 5wi, 6alr, 6api, 6cwk, 6daq, 6dp, 6xi, 8ahc, 8ayp, 8hrc, 8ebr, 8daq.
PORTO RICO: 4rn.
CANADIAN: 3el.
MISCELLANEOUS: kio, naw, npg, wnp.
Card for Card, Gang. How about it?

HELPING THE FARMER

A radio bill has passed the Senate in time to give the farmers some relief from static next winter.—*Indianapolis News*.

"REBROADCASTING"

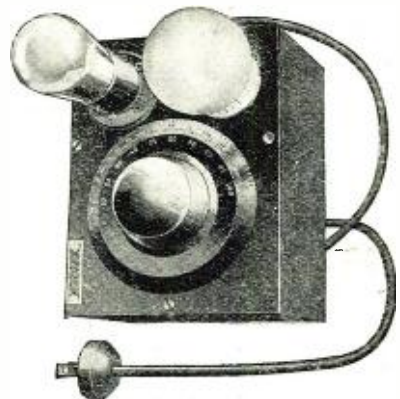

STOP GUESSING!

The wave length of stations are changing!

THE "SUPERUNIT" SET TESTER will tell you wave length of any signal which you receive. It also can be used to test a set. Indispensable to service men and DX fans.

This Tester operates from 110 volts A.C. without any batteries. Sold by up-to-date dealers everywhere.

\$10⁰⁰

Hanscom Radio Devices
Dept. B
WOONSOCKET, R. I., U. S. A.

Quality Radio Cabinets



BETTER HOMES CALL FOR BETTER RADIO CABINETS
You can save hundreds of dollars by installing your set in one of these Beautiful Cabinets.
MAKE \$100 LOOK LIKE \$1000
Write for new 1926-27 catalog
THE WIRTHMORE COMPANY
910 Wirthmore St., Rockford, Ill.

MAKES TUNING EASY

RADEX Tuning Charts show wave length your set is tuned to as dials are turned. Show where to set dials for every station in America and identify programs received without announcement.
Broadcasting Map and Air-Line Distances
Only 25c, coin or stamps.
RADEX, P. O. Box 143-W, Cleveland, Ohio

Insure your copy reaching you each month. Subscribe to RADIO NEWS — \$2.50 a year. Experimenter Publishing Co., 53 Park Pl., N. Y. C.



Why Risk Having an Orphan on Your Hands?

An orphan radio set, like an orphan automobile, is one whose maker has gone out of business—leaving no one to guarantee the set's performance—or the owner's satisfaction. When considering a radio, give as much thought to the maker and his ability as you do to the set. Will that company still be in business to guarantee your radio enjoyment in 1927, 1928—and the years that follow?

Kellogg Switchboard & Supply Company has taken its place as an important and, above all, *permanent* factor in the radio industry. Kellogg has been a master builder of superior telephone equipment for 29 years—it is now a six million dollar institution manufacturing both telephone and radio receivers—its past history and present stability are ample assurance that it will still be in business, and back of the Kellogg set you buy, whenever it may be necessary.

Heavily shielded around and between the coils, Model 507 receiver has *all* of the selectivity inherent to three stages of radio frequency amplification. For simplicity, four tuning elements are controlled by one knob. It is an exceptionally powerful set and the full, round quality of its flawless reproduction is all that you would expect from master builders of telephone equipment. Either model 507 or Model 508 is a solid dignified piece of furniture, both the cabinet and front panel being of the finest piano finished walnut.

Write for folder fully describing these receivers.

Kellogg Switchboard & Supply Co.
Dept. 1-J, 1066 West Adams Street, Chicago, Ill.

*Kellogg receivers are licensed under application for letters patent of Radio Frequency Laboratories, Inc. (R.F.L.)
Dealers and Jobbers inquiries invited.*

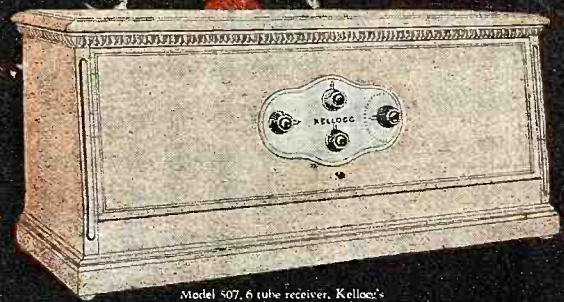

Model 507, 6 tube receiver. Kellogg's development of the sensational new RFL circuit. The acme of Selectivity and Musical Reproduction.

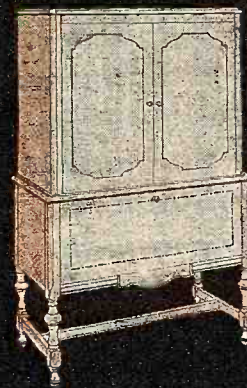

Model 508, the 6 tube Kellogg RFL, in a beautiful walnut console, equipped with the Kellogg new, long air column speaker.

KELLOGG Radio

FLAWLESS REPRODUCTION

Hammarlund's New Creation The "MIDLINE" Condenser

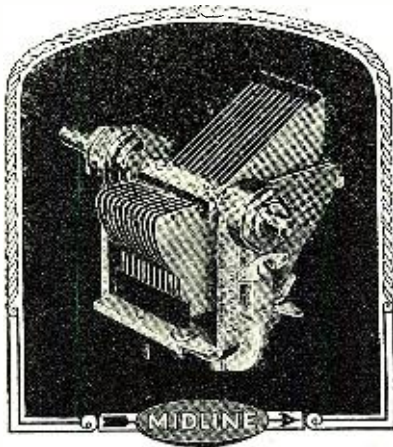

*Avoids Crowding
at Any Part
of the Scale*

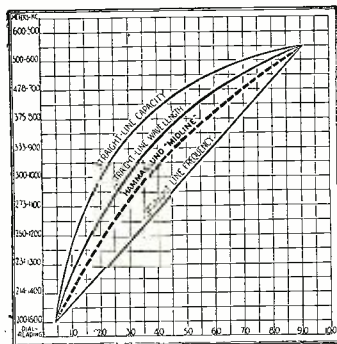

Watch for the handsome
new Hammarlund
"VERNITUNE" DIAL.
A revelation in accurate,
effortless tuning.

THE new Hammarlund "MID-LINE" condenser makes its bow with the claim of superiority over any other type ever produced.

Experience (yours and ours) is responsible for its many excellent features. "Straight-line-capacity" crowded the low waves; "Straight-line-frequency" crowded the high waves; "Straight-line-wave-length" merely compromised between the two. *But the Hammarlund "Midline" retains the important advantages of these earlier types without any of their disadvantages.*

All of the tried and true Hammarlund features are included: soldered, non-corrosive, brass plates with tie bars; rib-reinforced aluminum alloy frame; minimum dielectric; one-hole mounting with anchoring screw; bronze clockspring pigtail; friction brake. In addition, there have been added ball and cone bearings and a full-floating rotor shaft. This shaft supports no weight; it may be entirely removed, or it may be adjusted for coupling to other condensers in tandem, or for mounting a variable primary coil.

The "MIDLINE" is much more compact and even stronger and more beautiful than previous Hammarlund models.

The better dealers will have it soon.

For Better Radio
Hammarlund
PRECISION
PRODUCTS

HAMMARLUND MANUFACTURING CO.
424-438 W. 33d STREET, NEW YORK

"Ether Fleas"

(Continued from page 327)

them by idle and fatuous women listeners; and when they step before the microphone, another time, perhaps they will assume just a little more gravity and give the program itself just a little more of the consideration it deserves.

Radio-Frequency Amplification

(Continued from page 342)

To the manufacturer—your engineer should be able to answer all of these questions by actual numbers. To the amateur builder—the designer of the set you wish to build should give you a list of actual parts used, physical dimensions of spacing, solutions to the problems brought out in this article, and gain per stage and over-all gain in actual figures.

The answer to all of our questions and statements is to be found in the proper use of the tube voltmeter; a description of which may be found, for one place, in Van Der Bijl's "Thermionic Vacuum Tube." It has been said that the tube voltmeter is not an accurate means of measurement. Certainly it is not, if improperly used; but inasmuch as it is, if properly used, and is accepted as an indispensable necessity in the best laboratories of the world, it would seem that the decision must be in its favor.

Most certainly the writer feels that the days of guess work, and "tests" by listening to broadcasting, are about over so far as radio is concerned. Of equal importance with the above are the subjects of shielding and its imperfections, neutralizing, confining the fields of coils by the use of an iron core rather than by the use of shielding or closed field coils, and last but not least, the use of the double-grid tube to eliminate tube feedback with its complications. This last he hopes to write upon in an early article.

TUNING IN ON SCHOOL

Many boys and girls on farms within the radius of 100 miles from Rochester, N. Y., are going to school every day by listening through their radio receivers.



W.W.

"I can't even get Pittsburgh!"

HAVE YOU SEEN THE NEW MAGAZINE?

For Men and
Women who want
to become
Independent



The Magazine
of Opportunities
Earn a Second
Income

25¢ ON ALL NEWSSTANDS

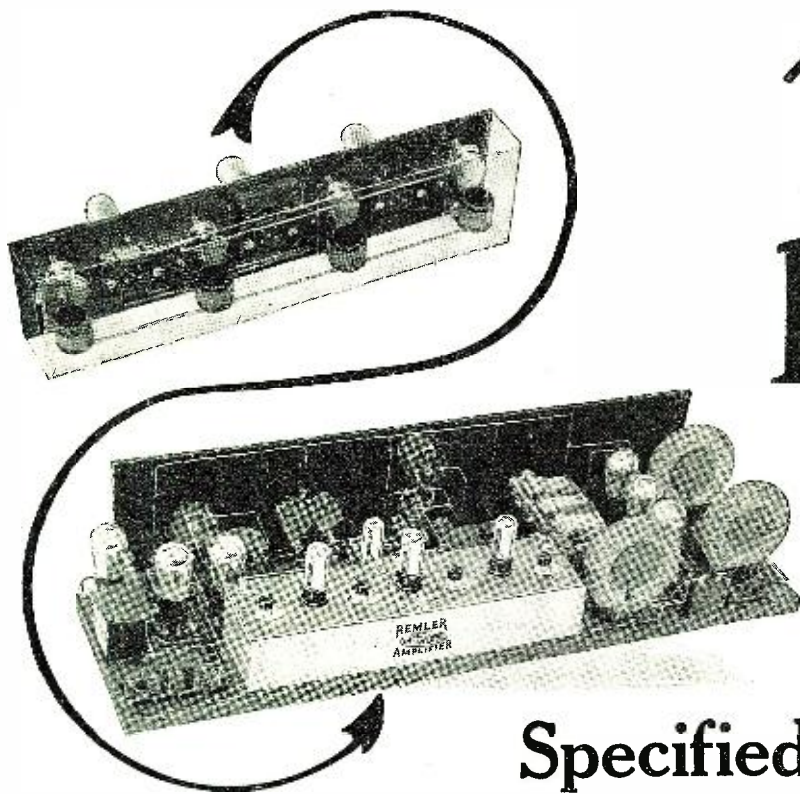

New Remler Infradyne Amplifier

Specified by Sargent *for the* Infradyne Receiver

THE REMLER No. 700 Infradyne Amplifier is a product of advanced radio research. It retains every advantage of multi-tube amplification at a fixed frequency and eliminates undesirable features present in other receivers of this general type.

All parts are made and assembled with the same care and precision which have marked REMLER items since their inception.

Inductance Coils and Condensers are designed and constructed to meet the exact requirements of this circuit. REMLER New and Improved Sockets insure absolutely clean and positive tube contacts. Maximum efficiency of operation is obtained by scientific arrangement of parts and wiring, which prevents energy leakage.

Controls are substantially mounted on a Bakelite panel. The Amplifier is enclosed in a polished and lacquered copper case, which acts as an effective shield, thus eliminating direct signal pick-up by the transformer windings.

E. M. Sargent's Infradyne article, reprinted from Radio Magazine, together with a special two-color descriptive folder, will be mailed free upon request.

Price
\$25⁰⁰

8 REMLER REASONS WHY

- 1 Reception is free from long-wave commercial station interference common in the past to ultra-sensitive receivers.
- 2 Objectionable features due to harmonic generation are eliminated.
- 3 Reception on one setting only of each dial.
- 4 Sensitivity is fully equal to that of any known receiver.
- 5 Extraordinary Selectivity.
- 6 Only 135 volts "B" required. Can be used for months on heavy duty dry "B's."
- 7 Exceptionally quiet operation on both local and distant stations.
- 8 Will bring in stations which would be lost in the "noise" level on any other receiver.



REMLER
TWIN-ROTOR
CONDENSER
\$5.00 complete

REMLER
GRAY and DANIELSON
Manufacturing Company



REMLER
IMPROVED
SOCKET
\$.50

260 First Street - - - San Francisco, Calif.

Chicago

New York

AMSCO

FOR EXCELLENCE

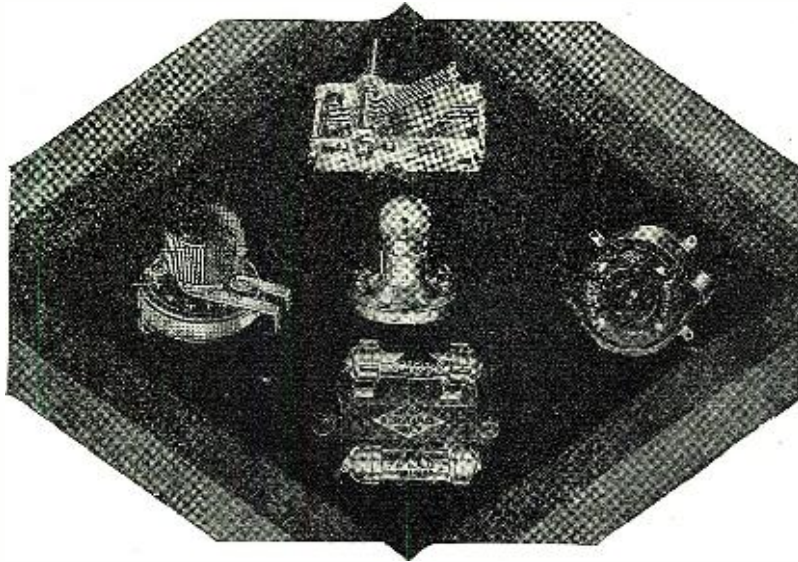

NEW!

AMSCO Announces new apparatus of new electrical and mechanical perfection for the new Radio year of 1926-27.

- ALLOCATING CONDENSERS Spread the stations with engineering precision
- METALOID GRID GATES Superseding grid leaks
- METALOID RESISTORS Stable, Silent and Sure
- RESISTIVE COUPLING AMPLIFIER UNITS Most Compact and Efficient
- AMSCO FILATROLS Perfected Automatic Rheostats
- AMSCO FLOATING SOCKETS Non-microphonic at last
- AMSCO TOM THUMB RHEOSTATS The midgets for giant performance

Ask your dealer or write for particulars
AMSCO PRODUCTS, Inc.
 Broome & Lafayette Streets, N. Y. C.
 Exhibitors: New York and Chicago Radio Shows



A RADIOPTIMIST

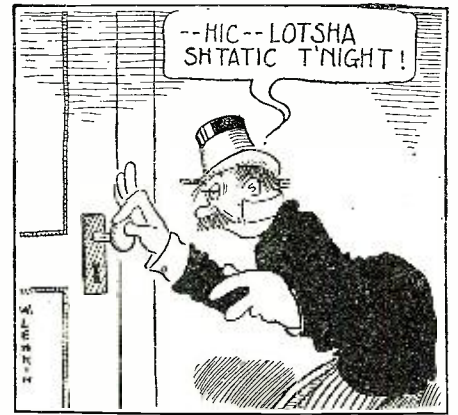

STANDARD-FREQUENCY TRANSMISSIONS

The Bureau of Standards will continue its standard-frequency transmissions from its station, WWV, Washington, until October; those from 6XBM, Stanford University, have been discontinued.

These transmissions are of definitely announced frequencies and are for use by the public in standardizing frequency meters (wavemeters) and transmitting and receiving apparatus. The transmissions are by continuous-wave radiotelegraphy. The signals have a slight modulation on high pitch which aids in their identification. A complete frequency transmission includes a "general call," a "standard frequency signal," and "announcements."

The "general call" is given at the beginning of the 8-minute period and continues for about 2 minutes. This includes a statement of the frequency. The "standard frequency signal" is a series of very long dashes with the call letters (WWV) intervening. This signal continues for about 4 minutes. The "announcements" are on the same frequency as the "standard frequency signal" just transmitted and contain a statement of the frequency. An announcement of the next frequency to be transmitted is then given. There is then a 4-minute interval while the transmitting set is adjusted for the next frequency.

The signals can be heard and utilized by stations equipped for continuous-wave reception at distances within about 500 to 1,000 miles from the transmitting station. Information on how to receive and utilize the signals is given in Bureau of Standards Letter Circular No. 171, which may be obtained on application from the Bureau of Standards, Washington, D. C. Even though only a few points are received, persons can obtain as complete a frequency meter calibration as desired by the method of generator harmonics.

SCHEDULE OF TRANSMISSIONS

Frequencies in kilocycles.
 (Approximate wavelengths in meters in parentheses)

Eastern standard time	Sept. 20	Oct. 20
10 to 10.08 p. m.	3.000 (100)	550 (545)
10.12 to 10.20 p. m.	3.300 (91)	630 (476)
10.24 to 10.32 p. m.	3.600 (83)	730 (411)
10.36 to 10.44 p. m.	4.000 (75)	850 (353)
10.48 to 10.56 p. m.	4.400 (68)	980 (306)
11 to 11.08 p. m.	4.900 (61)	1,130 (265)
11.12 to 11.20 p. m.	5.400 (56)	1,300 (231)
11.24 to 11.32 p. m.	6.000 (50)	1,500 (200)

SAVE \$25

Buy direct from our factory

\$16 "B" ELIMINATOR A.C. & D.C.

*USING 201A, 301A OR RAYTHEON TUBE

We invite comparison with all others

Delivers up to 150 volts. 10 to 30 mille amperes, variable controls on amplifier and detector outlets. Additional amplifier outlet and control \$2 extra.

NO HUM! NO TRANSFORMER HEATING! 10 days trial. Money returned if desired.

*Send postal for descriptive circular

U-FLEX TUBE REJUVINATOR \$4.00

25 cts. extra for parcel post.

U-FLEX Mfg. Co., No. 1 S. 39th St., Phila., Pa.

Bradleyleak

THE PERFECT GRID LEAK



Provides a noiseless range of grid leak resistance from 1/4 to 10 megohms. Assures most effective grid leak resistance value for all tubes. Small grid condenser (0.00025) is separate. Metal parts nickel plated. One hole mounting.

Allen-Bradley Co.

Electric Controlling Apparatus
 287 Greenfield Avenue Milwaukee, Wis.



Many a "radio evening" depends on this moment

THE moment you pay for a radio battery, you pay for something more than "just a battery." You are investing your money in many evenings of radio pleasure... or disappointment. You must get a battery that will give you trouble-free service and good, clear radio reception.

Prest-O-Lite Storage Batteries, made especially for radio use, have back of them more than twenty years of manufacturing experience. They are honestly made, only the finest materials go into their construction. They have been perfected in the world's largest electro-chemical research laboratories.

When you select a Prest-O-Lite "A" or "B" Storage Battery you are certain of getting real battery value. You are certain of getting batteries that can be depended upon to deliver their rated ampere-hour capacities. This lengthens the time between charging and assures good, clear reception.

Prest-O-Lite Batteries are attractively priced from \$4.75 up. So that it is no longer necessary to take a chance on batteries of unknown make. There's a man who sells them near you.

THE PREST-O-LITE CO., INC.
INDIANAPOLIS, IND.

New York

San Francisco

In Canada: Prest-O-Lite Company of Canada Ltd., Toronto Ontario

Send for free booklet

"What every owner of a radio should know about storage batteries" is a little booklet which every radio fan will find interesting and helpful. It is crammed full of hints that will bring surprising radio results—and save you money. It's yours for the asking, without obligation.



Designed especially for radio

Prest-O-Lite

STORAGE BATTERIES FOR
MOTOR-CARS AND RADIO

The SONOCHORDE CONE

A Wholly New and Different Conception

THIS is the Cone Speaker that took New England by storm. Surpassing all previous Sonochorde successes, the 1927 models sell on sight and hearing to those who demand highest quality in both tone reproduction and beauty of appearance. Sonochorde is not "just another Cone," but an entirely new and ingenious creation, scientifically correct, with over 16 exclusive features only found in this Cone masterpiece.

Send for the complete Sonochorde Story

Hastings Electric Sales Co.

42 Binford Street, South Boston, Mass.

BOUDETTE MANUFACTURING CO., SONOCHORDE MFGRS., CHELSEA, MASS.



Wall Model \$25.00



Back View Showing Rugged Construction



Floor Standard Model Piano Lamp Style \$35.00

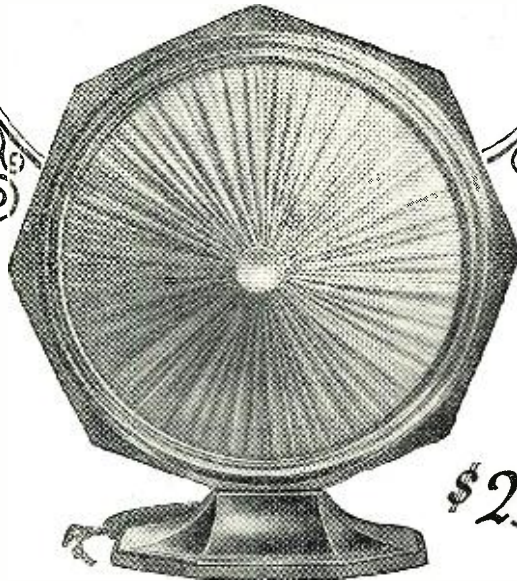

\$25.00

Read "AMAZING STORIES"

The Magazine of Scientifiction—Something New, Novel, Interesting—Don't miss the Big October Issue

25c—ON ALL NEWSSTANDS

Wired Radio and Its Applications

(Continued from page 325)

energy for actuating the loud-speaker which protruded from the top of the cabinet.

By a novel arrangement, the "A" and "B" current for the two vacuum tubes was supplied directly from the 110-volt line. Thus, the wires were not only acting as the carrier for the programs, but supplying the current for operating the receiver, making the use of batteries unnecessary.

The fundamental wiring arrangement of this set is shown in Fig. 1. It will be noted that the primary coil of the coupling transformer is connected directly across the 110-volt line, but with the variable condenser in series with one of the leads. This coil and

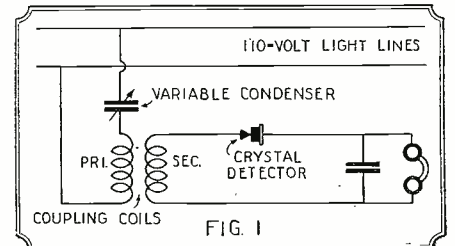

Circuit diagram of the receiving set, showing how it is connected to the light line.

condenser compose a tuned circuit; and when adjusted to any one of the carrier-current frequencies, will induce a current in the secondary coil of the coupling transformer, whence it passes through the detector-telephone circuit. There is no response in the telephones unless the tuned circuit is adjusted or brought into resonance with one of the frequencies being employed for the transmission of the programs.

The wired-radio transmitter employed was similar in most respects to the usual type of space-radio broadcast transmitter, and had the power of 500 watts. The output was fed into the 2,300-volt power line through a bank of low-capacity high-voltage condensers. The operating frequencies were in the vicinity of 40,000 cycles (7.500-meter wavelength), the most appropriate frequency to

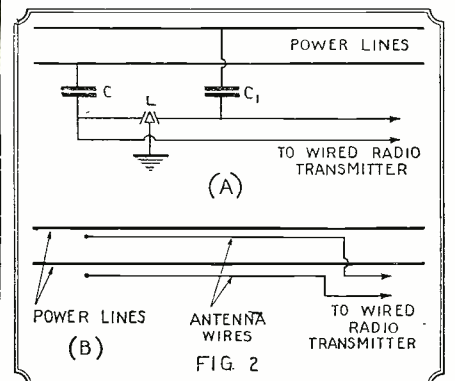

The two methods commonly employed for coupling carrier-current apparatus to power lines.

employ in connection with the transmission lines.

DIFFICULTIES ENCOUNTERED

The most difficult problem which has been encountered in the application of carrier-current telephony to power-transmission lines is that of efficiently connecting the carrier-current equipment to the power-line conductors. Two methods have been found satisfactory,

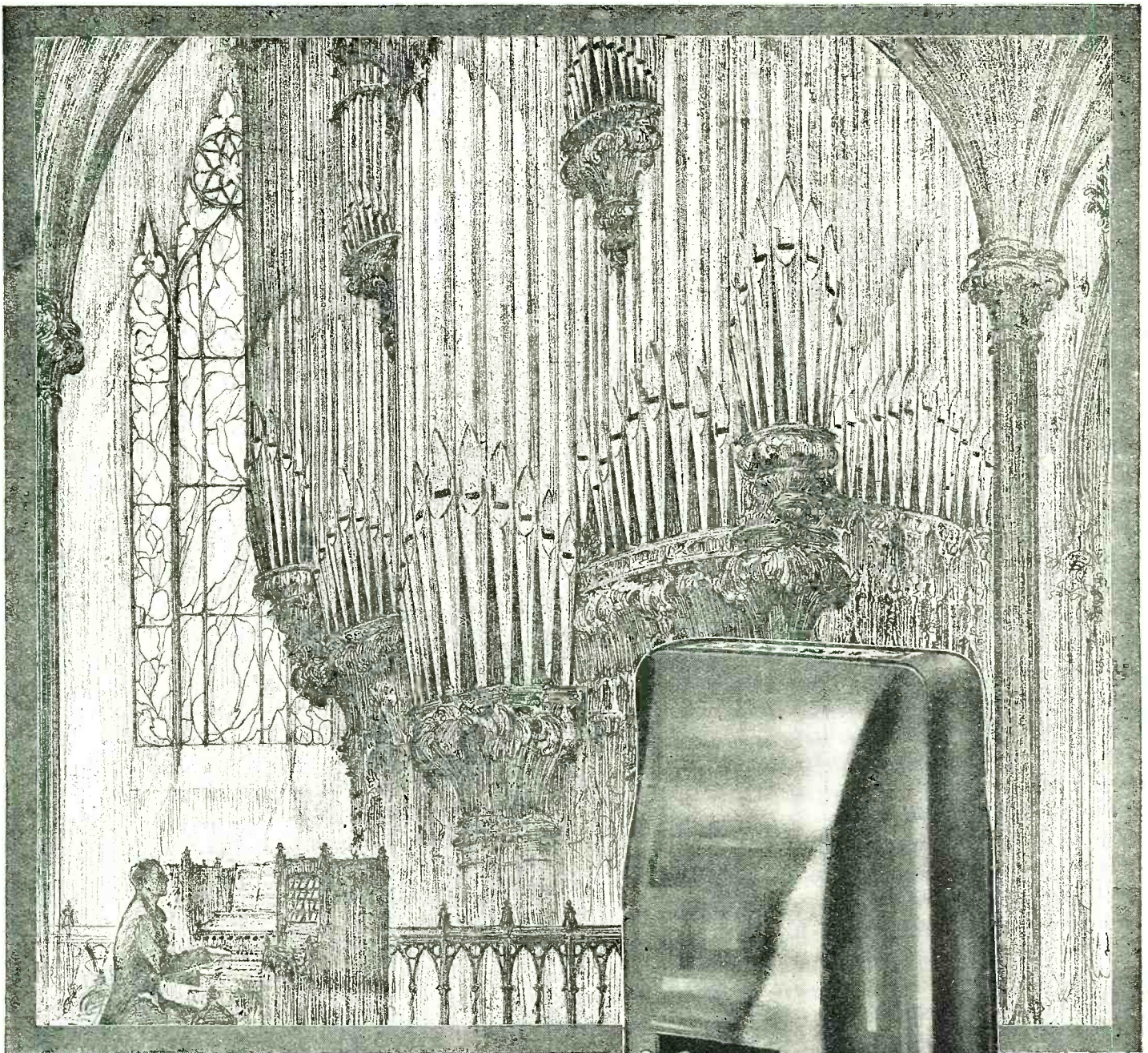

Samson Audio Units

are capable of uniform and faithful amplification well in excess of the most exacting broadcast requirements.

Their range extends from the lower fundamentals through the higher harmonics enabling them to reproduce, with equal clarity, the dull rumble of the tom-tom or the thin shrill of the flute.

This ability to reproduce the harmonics or higher multiple frequencies is what gives tone-color or background to sound—is what permits the listener to distinguish notes of the same pitch but from different instruments—results not possible with audio units which cut off at comparatively low frequencies.

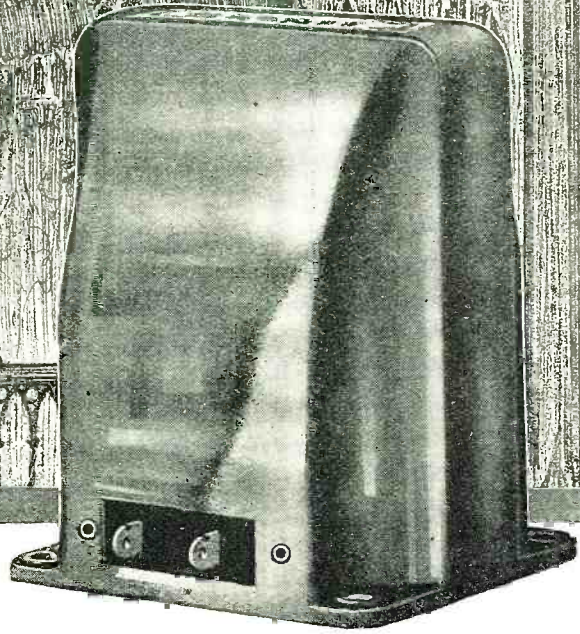

In a word—with a loud speaker of corresponding range—

Samson Audio Units

insure the sort of radio you've hoped to hear—the quality of radio that will make you think you've been translated from a broadcast listener to one of an audience which is listening, firsthand, to a speech or to music.

For 1926-27 the Samson Electric Company offers eleven different audio units:

Symphonic Transformers	Type X	\$9.00
Push-Pull Input Transformer	Type HW-A3	5.50
Standard Transformers	Type D Ratio 2-1, 3-1, 6-1	5.00
Dual Impedance	Type O (Donle Design)	5.00
Output Impedance	Type Z	5.00
Push-Pull Output Impedance	Type P	5.00
Plate Impedance	Type G	4.50
Grid Impedance	Type No. 3	4.50
Audio Frequency Choke		3.00

Our book—"Audio Amplification"—already accepted as a manual of audio design by many radio engineers—contains much original information of greatest practical value to those interested in bettering the quality of their reproduction. Sent upon receipt of 25c.

SAMSON ELECTRIC COMPANY

Main Office, Canton, Mass.

Factories at Canton and Watertown, Mass.

Manufacturers
Since 1882



PROVED!

Los Angeles, Calif.
Ferbend Electric Co.
Dear Sirs: No doubt you will be interested to know that we have installed your "B" Eliminator on eight different eight tube Super-Heterodynes, and that every one is giving complete satisfaction. (Signed)
National Electric Company

Hawkesbury, Ont., Canada.
Ferbend Electric Co.
Gentlemen: I am pleased to inform you that I received the FERBEND "B" Eliminator and after giving it a fair trial am glad to say it has exceeded all my expectations. I must say it was money well spent. (Signed) Will Dooley.

Naugatuck, Conn.
Ferbend Electric Co.
Dear Sirs: My FERBEND "B" Eliminator has been doing fine work since last December. After seven months use will say that I am very well pleased with it. (Signed)
Frank S. Lobdell.

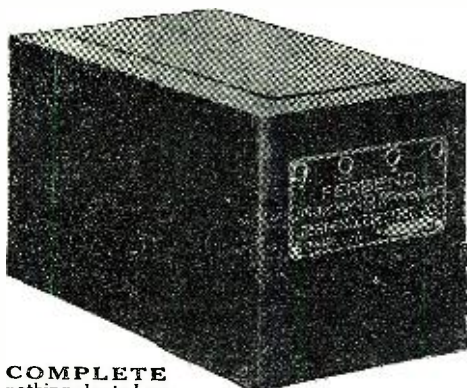

Lincoln, Nebr.
Ferbend Electric Co.
Dear Sirs: I have found your "B" Eliminator to be very satisfactory and the results obtained were even better than the more expensive one which I had been using, as it was free from all hum. I also found that it made the reproduction through the loud speaker fully 50% clearer. I am more than satisfied with the machine. (Signed) H. W. Bradley

\$12.50



COMPLETE
nothing else to buy
Replaces "B" Batteries. Operates Direct from Electric Light Socket.

FERBEND "B" ELIMINATOR

Many careful buyers choose to adopt a policy of "watchful waiting." This is often true in the purchase of an apparently better, but yet-to-be-proved, automobile. The same holds good for many other commodities. And Radio. With the original announcement of the good Ferbend "B" Eliminator and its amazing low price of \$12.50, many there were who chose to wait. They wanted to be convinced. True, thousands bought at the start and they are the ones who now tell you what to expect. Lack of space alone prevents us from publishing the hundreds of fine testimonials from satisfied users. They are all in our files open to public inspection at any time. A few reproduced here.

FERBEND Wave Trap

This Company also manufactures the famous Ferbend WAVE TRAP—the instrument which has been widely imitated but never equalled. It is the only original and genuine. Priced at **\$8.50**

The Ferbend "B" Eliminator successfully passed the rigid Laboratory tests of Radio News, Popular Radio and Radio Broadcast. It is a Proved Radio necessity, and a great one.

Ask Your Dealer—or Send Direct

If you prefer, we will make shipment direct to you upon receipt of price, or C. O. D., if desired. Use for 10 days to convince yourself—if unsatisfactory, write us within that time and purchase price will be refunded. Use the coupon now.

Ferbend Electric Co., 425 W. Superior St., Chicago, Ill.

MAIL THIS COUPON TO-DAY!

FERBEND ELECTRIC CO., 425 W. Superior St., Chicago

Send at once. Payment enclosed Send C. O. D. Send Literature

Name.....

Address.....

City..... State.....

in each of which the connecting medium is capacity. In one of these high-voltage coupling condensers are used as the connecting medium, with a protective ground, as shown at A in Fig. 2. In the other arrangement the capacity is obtained by stringing, parallel to the power-line conductors, two so-called antennae extending for perhaps 1,500 feet along the transmission line. The carrier equipment is connected to the two antennae and the carrier currents are transferred to the power-line conductors through the medium of the capacity between the antenna wires and the adjacent power-line conductors. This arrangement is shown at B of Fig. 2. A carrier-current telephone coupling panel, wherein high voltage condensers are employed, is shown in the illustration of Fig. 3. The upper part of the panel contains the chokes, the lower part of the panel the two intermediate high-voltage coupling condensers and the protective device.

Another early difficulty experienced was what has been termed "night effect." It was found that the signal intensity dropped considerably in the night-time; this being due to the short-circuiting effect on the various feed lines as the myriads of electric lights were turned on which naturally, altered the resistance of the wires.

OVERCOMING VARIATIONS IN THE LINES

Coupled with this were losses, due partly to the loss in the transmission conductors themselves and partly, as explained previously, to the shunting loss due to connected power apparatus. To obviate these difficulties, one company has adopted a full metallic circuit, using two of the power-line conductors as the two sides of the telephone circuit, similar to the one shown in Fig. 2. This arrangement is so decidedly superior from every standpoint to the more commonly employed arrangement of a ground return circuit, that it will undoubtedly become the standard arrangement of all carrier current systems.

Open sectionalizing switches introduce a substantial obstacle to carrier transmission over power lines. Another difficulty is offered when there is a change in the voltage of the transmission line. At such a point, the transformer or auto-transformer employed to effect the change acts as a barrier to the carrier-frequency currents. Fortunately, however, by means of a comparatively simple arrangement, known as a "by-pass antenna," the currents can be effectively transferred around such a barrier, although a considerable loss is incurred.

For the purpose of obtaining satisfactory operation under adverse conditions and to combat the effects heretofore mentioned, the equipment of one company has been designed to include an emergency power amplifier. Normally the power required for satisfactory transmission on most installations is in the order of one watt. The emergency amplifier increases the power to about fifty watts.

A typical carrier-current telephone transmitter and receiver control panel is shown in the illustration, Fig. 4. It includes the oscillator tube, which generates the carrier frequency, the modulator tubes and a power amplifier for emergency use. This particular unit is designed expressly for use in connection with power transmission lines.

USE IN TELEPHONE AND TELEGRAPH LINES

Telephone and telegraph lines are extensively employed for the transmission of carrier-current telegraph and telephone communications, aside from the regular traffic handled.

The ordinary telegraph employs a range of frequencies extending from 0 to 100 cycles per second. The ordinary telephone requires the range from 200 cycles to 2,000

Read

"AMAZING STORIES"

The Magazine of Scientifiction—Something
New, Novel, Interesting—Don't miss
the Big October Issue

25c -- ON ALL NEWSSTANDS

The New Amplification

A revolutionary principle sets a new standard for reproduction

THE achievement of reproduction so perfect that the music itself is reborn and lives again has been the goal of radio progress since radio began. To achieve—

The human voice with diction crisp and lifelike.

The flute, its high notes pure and flawless.

The organ with all its deep throated resonance.

The piano without the flatness of a gong, but each note in ringing clarity; each cord mellowed by the overtones blending in perfect harmony.

The full symphony orchestra, no longer the pale thinness of a single sound, but an ensemble of instruments with the individuality of each so distinct that the themes of everyone can be followed: The violins as they weave their delicate pattern against the background of the whole. The bass viols as they pursue their lone and solitary air.

Applause, no jumbled roar, but the clapping of hands.

THIS has been a goal as baffling and as elusive as the hidden notes themselves. And yet, these are some of the demonstrable results accomplished by the Na-Ald Truphonic Coupler.

The Na-Ald Truphonic Coupler is a new instrument; new in principle, new in design and new in construction. It is neither a resistance, transformer or impedance coupling, but a new differential system, invented by H. P. Donle, balancing transformer and impedance action in such a way as to produce amplification precise, undistorted and at a volume hitherto thought impossible.

The complete Na-Ald Truphonic Audio amplifier is installed on any set by simply slipping in the special adapter and tubes and connecting

the loud speaker. Maximum power tube volume may be safely employed as an output unit for the protection of the loud speaker is

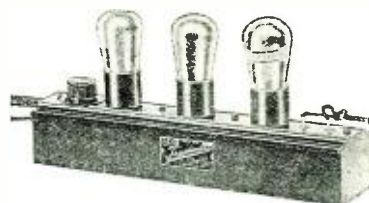

Na-Ald Truphonic Coupler

included. Individual couplers or complete amplifier assemblies are supplied for the set builder.

Words can't convince you of the performance of this remarkable little device. A demonstration will. Call at your dealers and he will gladly give one.

Price complete amplifier ready to attach\$20.00
(includes battery leads, sockets, output unit for protecting loud speaker with power tubes, connecting adapter.)

Individual Truphonic Coupler or Output Unit.....\$5.00 per stage

Complete amplifier parts for set builders.....\$20.00
(3 couplers, output unit, sockets, battery leads, catacomb)

For complete information write—

THE ALDEN MANUFACTURING CO.

Dept. K-20

Springfield, Mass.

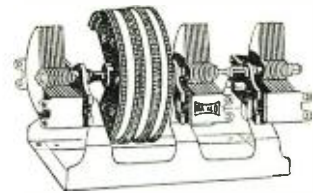

Na-Ald Localized Control Tuning Unit

FROM station to station with the touch of but three fingers of one hand. From one program to another as easily as turning the pages in a book. This amazingly simple tuning device reduces the complications of tuning to a single motion and leaves you free to wander thru the air at will. All three condensers operated at one opening in the panel. All can be moved together. Each can be moved separately. Simple and exact tuning results.

Price Quadruple...\$16.00
Triple 10.00
Double 8.00



Na-Ald 481-X S Cushion Mount Socket

IMPROVED amplification demands a cushion mount socket if microphonic disturbances within the tube are to be removed. The Na-Ald 481-X S Cushion Mount Socket by means of a perfected resilient mounting, floats the tube and gives complete protection against lateral as well as vertical shocks. The only socket on the market with this feature. Fits all tubes.

Price50c



Na-Ald Connectoralds

THE improved tone and quality of the new UX power tubes 171, 112 and 120 can now be had on any set without the need of rewiring for the additional B and C batteries required. Na-Ald Connectoralds function as adapters and, at the same time, provide cables for attaching the B and C batteries without affecting the rest of the set.

Price 120 Connectorald...\$1.25
Price 112 Connectorald... 1.50

BOSCH RADIO

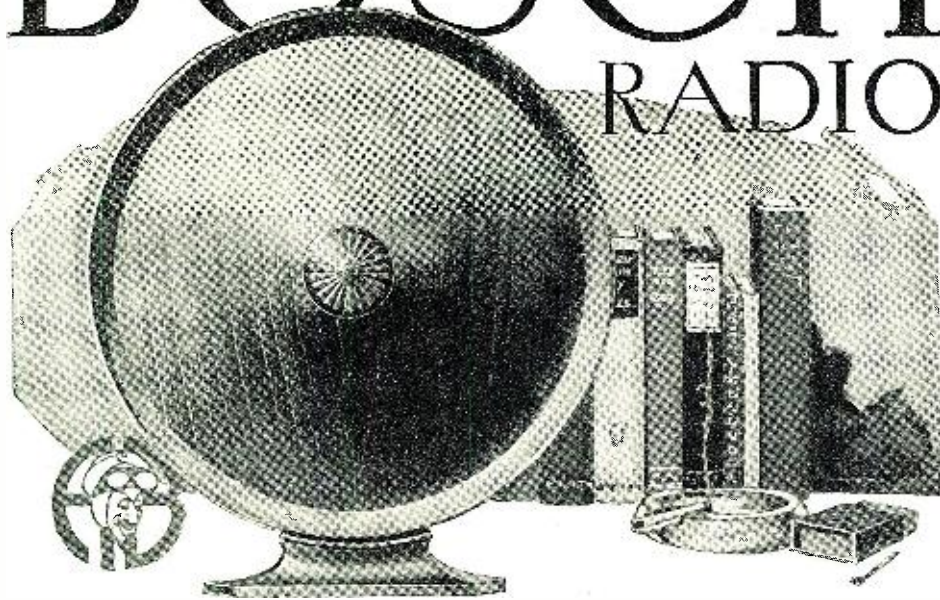

AMBOTONE REPRODUCER

Built by the makers of Bosch Radio Receivers and Bosch Electrical Equipment, the Bosch Ambotone Reproducer has a mellowness of tone that is only rivaled by an old violin and a clear natural reproduction which is outstanding in radio today. This distinctive cone reproducer has the mellowness of a wood instrument, and is absolutely accurate in reproduction over the full range of orchestral music and the human voice. Nothing is lost to the Bosch Ambotone; nothing blurred or distorted, not even the bass notes so commonly lost in radio reproduction. The Ambotone will give you the most from your receiver. Attractive in appearance it will improve your radio corner. Ask your Bosch Dealer to demonstrate the Ambotone.

Bosch Ambotone \$27.50. Bosch dealers also have an art pedestal which is sold separately at \$11.50. Ask to see it.
All prices slightly higher, Colorado, west and in Canada.

AMERICAN BOSCH MAGNETO CORPORATION

SPRINGFIELD, MASS. BRANCHES: NEW YORK CHICAGO DETROIT SAN FRANCISCO

Investigate
Our
Trial
Offer

MASS. RADIO SCHOOL

18 Boylston St., Boston, Mass.

FALL TERM SEPTEMBER 13

Send for Free Catalog

Positions
Secured
Licensed
Graduates

FREE RADIO GUIDE

NEWEST 1927 EDITION
Shows the latest circuits, the newest developments in radio at startling low prices. Get the parts you want here and save money. The best in parts, kits, complete factory-built sets and supplies. Orders filled same day received. Write for free copy NOW; also please send names of one or more radio fans.
BARAWIK CO., 542 Monroe St., Chicago, U.S.A.



PATENTS

DON'T LOSE YOUR RIGHTS
Before disclosing your invention to anyone send for free blank form "EVIDENCE OF CONCEPTION" to be signed and witnessed.
LANCASTER & ALLWINE
Reg. Pat. Attys. in U. S. and Canada
270 Ouray Bldg., Washington, D. C.
Originators of the form "Evidence of Conception"

or more. Commercial equipment in operation at the present time utilizes frequencies between the ordinary telephone range and about 30,000 cycles. Frequencies of ten thousand cycles per second or over are high enough to act as "carriers" of telephone currents. In the use of carriers a very narrow band is all that is required for each telegraph channel; but a broad band is necessary for each telephone channel as the band must, in the latter case, be of sufficient width to include the entire band of speech frequencies. Thus, it is apparent that more channels are provided for the telegraph than for the telephone.

In either case, of course, it is necessary to employ a different frequency for each channel. Thus, an ordinary open-wire line, such as is used for telephonic communication, is used with this equipment to transmit frequencies from about 5,000 to 30,000 cycles per second. This permits multiplex operation by utilizing different portions of this range for separate and independent messages. The same holds true of multiplex telegraphy except that the frequency range employed is considerably lower. In both cases, generators for each of the separate frequencies are connected to the line at the sending station. The currents from them are separated at the receiving station by selective circuits, each of which discriminates against all currents except those of frequencies within a particular narrow range.

A typical commercial carrier current telegraph installation is shown in the illustration, Fig. 5. There is one testing panel and four panels for both sending and receiving, upon each of which are mounted an oscillator, amplifiers, demodulator, selective circuits, and relays, for one duplex carrier-current telegraph channel.

A carrier-current telephone installation is shown in the illustration of Fig. 6. There are four sending and four receiving panels, upon which is mounted equipment such as modulators, demodulators, amplifiers, and selective circuits, for four carrier-current telephone channels. There is also one testing panel and one low- or voice-frequency panel containing the necessary apparatus for associating the four sending and receiving carrier current channels with the regular open-wire line.

COMMERCIAL VALUE OF CARRIER-CURRENT SYSTEMS

It is evident that both carrier-current telegraph and telephone systems have a great commercial value, when it is considered that not only does the system allow the use of telegraph, telephone and power lines for other than their normal functions, but also provides means for handling an enormous amount of traffic; for as many as forty separate telegraph messages can be transmitted over one set of wires. Naturally this spells rapidity, and rapidity is an important factor in the business world where "expedite" is a by-word.

Carrier-current systems have proved of considerable value in connection with power transmission as they provide a fool-proof means of inter-communication between the central power house and the numerous substations where instant contact is of prime importance for giving orders.

Carrier-current telephony will no doubt be employed by all railroads in the future, so that passengers will be in a position to communicate with their homes or places of business. It has already been tried out and proved quite successful. (See *RADIO NEWS* for June, 1926, page 1636.) Antenna wires were placed on the roofs of the cars, parallel to the railroad telegraph wires which run alongside the tracks. It is apparent that this method of pick-up is identical to that illustrated in the diagram B (Fig. 2), except that the antenna wires in this particular case are not stationary.

Insure your copy reaching you each month. Subscribe to *Radio News*—\$2.50 a year
Experimenter Publishing Co., 53 Park Place, N. Y. C.

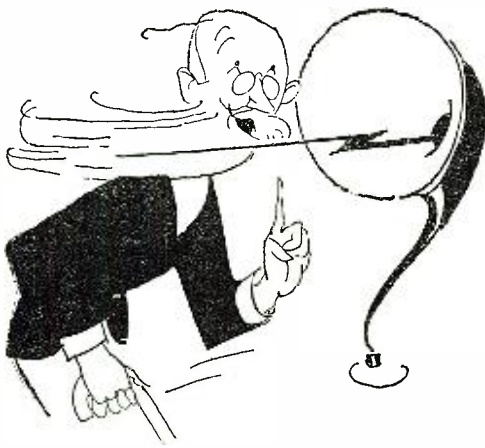

There's sound sense in quiet charging-

Clear, full, volume in your reception is the only way in which your Rectigon "makes itself heard." All because of the wealth of pep it packs into your batteries. But you'll never hear a peep from a Rectigon, itself, while it's doing its charging job. Not a murmur—not a bit of fuss. It's so quiet it wouldn't disturb the snooze of the lightest sleeper. Rectigons are popular for home charging because they do away with even the slightest annoyance and bother.

when you keep batteries lively with

No acids, no chemicals—no moving parts—nothing to spill or burn. No muss, no worry. You'll have no spoiled rugs, no ruined clothing.



Saves its cost in short order—Count the dollars spent in a few trips to the service station and you'll hotfoot it for a Rectigon, for the good it does your pocketbook as well as your batteries.



Snaps on in an instant—Just plug into the light socket, snap on the terminals. Saves service station bother. Spares interruptions caused by absent batteries.



Charges both "A" and "B" batteries—Keeps both packed with power. Bulb is used for "B" battery charging and it is enclosed, like all other parts, in metal, safe from accident. (Rectigon charges automobile batteries, too.)



Perfect safety for your set—If you tune in while you're charging there'll be no harm either to set or batteries. Nor will batteries be discharged if anything happens to the current while your Rectigon's attached.



*No Storage Battery Radio
is Complete
Without a Rectigon*

The Westinghouse Rectigon Battery Charger

©, 1926, W. E. & M. Co.

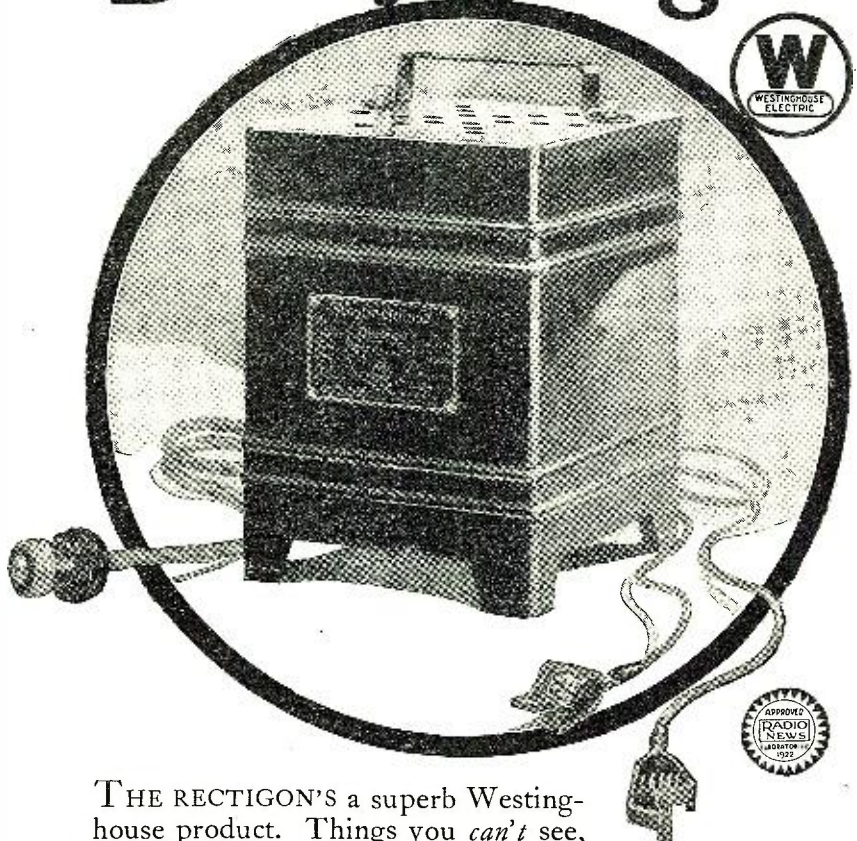

THE RECTIGON'S a superb Westinghouse product. Things you *can't* see, like extra heavy insulation, things you *can* see, like the durably enameled case—all are of highest quality. Westinghouse also manufactures a complete line of radio instruments, and Micarta panels and tubes.

WESTINGHOUSE ELECTRIC & MANUFACTURING CO.

Tune in on KDKA - KYW - WBZ - KFKX

Now!

PRICE
Complete with
Raytheon Tubes
\$37⁵⁰

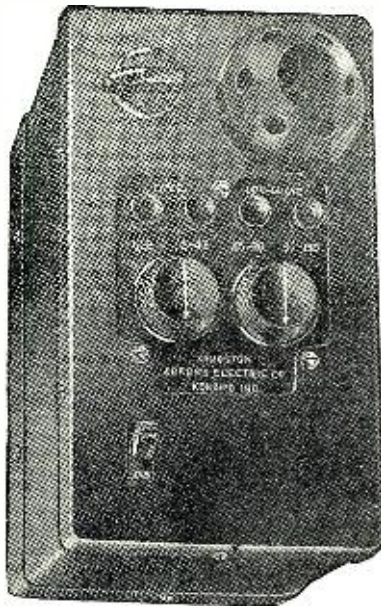

KINGSTON

B BATTERY ELIMINATOR

Do away with troublesome, expensive, bulky batteries, with acid, with stained carpets, with a dead radio just when you want it most. Install the KINGSTON B Battery Eliminator, and forget your battery troubles forever.

The Kingston Eliminator is compact, trim, handsomely finished in black and nickel, and guaranteed not only to remove the battery nuisance, but to deliver clearer tone and increased volume. A trial will convince you.

With the Kingston three different voltages are obtainable at the same time, each tap adjustable over a wide range, making any desired voltage from 5 to 150 possible and harmonizing perfectly with your own set. The Raytheon tube is used as a rectifier. The Eliminator operates without noise or vibration and will not heat, contains no acid or solution, is no trouble to operate and the operation cost is so low as to be negligible. It will not get out of order.

At Your Dealer's



KINGSTON

Bradleystat

PERFECT FILAMENT CONTROL

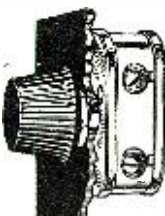

Provides complete noiseless filament control for all radio tubes without change of connections. Metal parts are nickel plated. One hole mounting. Self contained switch opens battery circuit when desired.

Allen-Bradley Co.
Electric Controlling Apparatus

287 Greenfield Avenue Milwaukee, Wis.

Radio Books AND Patterns

Books, Patterns and
Diagrams on every
important radio circuit

Write for circular

The Conrad Co., Inc.
64 Church Street, New York

Whether carrier-current telephony will be actively employed for "broadcasting" entertainment to "electric-light customers" remains to be seen. That is dependent upon the public, as well as upon the enterprise of the public utilities. Certainly, it would be a convenient arrangement, and might well compete with the phonograph which still holds the upper hand.

Methods of Oscillation Control

(Continued from page 367)

the tuned-radio-frequency classification of circuits, will show the reason why this type of receiver is hard to control and to prevent self-oscillation. The close coupling that exists between the plate coil of the first tube and the grid coil of the second tube is responsible for what is known as inter-stage coupling. This coupling may be varied in two ways: first, by having the ratio of both coils vary from unity, or thereabouts to a high ratio, such as 100:1; and second, by placing a variable condenser across the plate coil (of the first tube) which is commonly known as the primary. However, if the coils are such that the mutual coupling between them is nearly unity, and there is a variable tuning condenser across the grid coil, the plate coil will be similarly affected and the condition will resolve itself into the same as shown in Fig. 2. In other words, we will have a tuned-plate regenerative circuit which, however, may cause trouble by the creation of self-oscillation.

OTHER METHODS OF CONTROL

Engineers long since found that by reducing the number of turns in the primary coil, self-oscillation could be readily controlled; but they also found that there ensued a

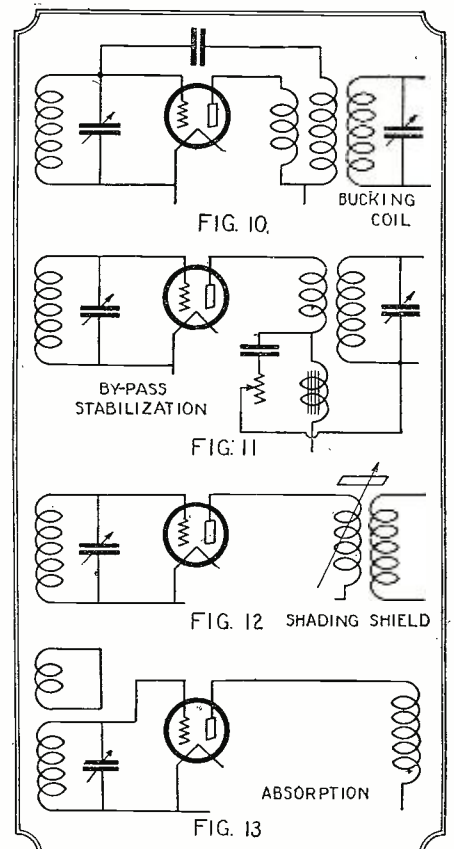

Four stabilizing arrangements making use of inductances or capacities. The "counter-E.M.-F." arrangement shown in Fig. 10 is quite efficient.

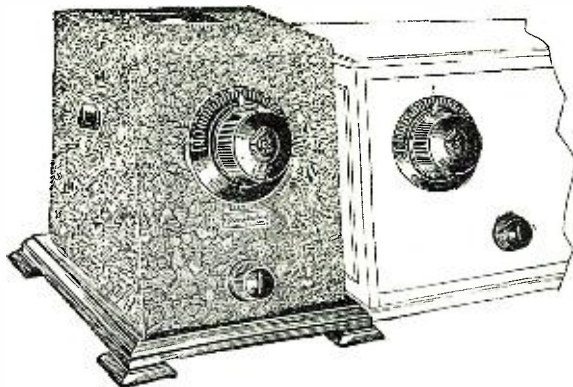

Double your stations— Penetrate interference— Cut through locals by adding Penetrola to your present radio set

Penetrola transforms your old radio set into a powerful up-to-date receiver. It gives greater range and volume and real selectivity. It stops radiation and "blooming." It is easily attached and operates with any set.

Hitherto, if you have wanted greater range and power than your radio receiver could deliver, there was nothing to do but discard your old set and buy a new one.

This is no longer necessary. Now you can add Penetrola—the unique radio "booster"—to the receiver you already own. Provided you have a fairly good set to begin with, the resulting combination is a powerful up-to-date receiver that in most cases will out-perform any set on the market. It will add more in performance than many times its cost in a new set.

Penetrola increases range and power. It penetrates distance and interference and gives real selectivity. In many cases it will double and triple the number of stations received.

Here's an instance: WCAL and WCBD could not be separated on a certain receiver. They came in together at 47 on the dial. On the audibility meter WCAL showed a signal strength of 35, WCBD a signal strength of 29. Penetrola was added. WCAL jumped to a signal strength of 2,000 while WCBD went to zero. WCBD was entirely eliminated, while WCAL came in with signal strength increased 57 times.

Endless similar instances could be quoted from letters received from the thousands of satisfied Penetrola users.

Penetrola increases clarity and quality of reception also. It makes operation near the oscillation point

unnecessary. It stops your set from radiating and "blooming." It stabilizes reception.

Penetrola is not a wave-trap. It is the first step of amplification of the most advanced radio set on the market—the Walbert Isofarad. Penetrola makes this new and revolutionary circuit available to those who already own a radio set. Connected between the aerial and the receiver, it selects and amplifies signals before they reach the set. In effect it brings the station you want close to your receiver and rejects all others.

Penetrola can be added to your set in a few minutes. It requires no changes, no other additions, and no extra batteries. It uses a standard radio tube. It is a permanent investment, for it will operate with any type of set—either the one you own now, or any you may buy in the future. And no matter how fine a radio receiver you now own, Penetrola will improve it.

Add Penetrola to your set now. Practically all dealers have it. If, however, you are unable to obtain it, write to us direct. Satisfaction is guaranteed or your money will be refunded.

Penetrola is manufactured by the makers of the Walbert Isofarad Receiver—the most advanced radio receiver on the market. If you do not already own a radio receiver, let us tell you about the Isofarad with Penetrola built-in.

PRICE
\$35

Prices slightly higher
West of Rockies
and in Canada

If you are mechanically minded build Penetrola yourself. Kit of essential parts, not including some common parts procurable from your dealer, and complete instructions—\$15.

If your dealer can't supply you Mail the Coupon

Walbert Manufacturing Company, 911 Wrightwood Avenue, Chicago
Walbert of Canada, Ltd., London, Ontario

Walbert Manufacturing Company
911 Wrightwood Ave., Chicago
Gentlemen:

Enclosed please find check or money order for \$35 for which please send me one Walbert Penetrola. If at the end of 7 days it does not perform to my entire satisfaction I will return it and you will refund my money.

Loop type Outdoor aerial type
(Check which type of set you own)
 Send me complete information about the Walbert Isofarad receiver without obligation.

Name _____

Address _____

RN

Walbert Penetrola

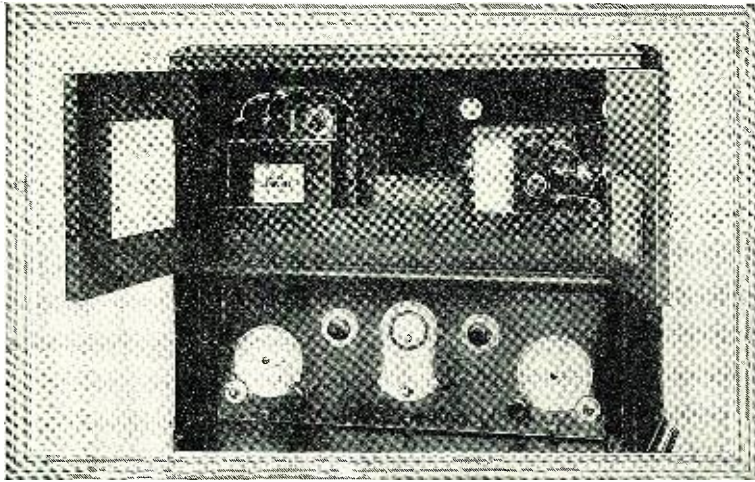

Unipower (shown at left) in Stromberg-Carlson No. 602

In less than 3 MINUTES!

Install this rich, permanent radio power

LESS than 3 minutes! Just hook two wires to your set, plug into a light socket—and Unipower is connected. Then forget it! Sit back and quit fretting about "A" battery inconvenience. Feel the keen pleasure of undisturbed, uninterrupted radio reception that only Unipower can give.

Three simple motions in three minutes! Yet the results are immediate and permanent. Gone at once are the worries caused by "A" battery failure. Unipower's rich power assures continuous reception—always of clearest tone and quality.

Gone, too, the fuss and

trouble always associated with "A" batteries. No longer the tracking in and out of dirt-bearing battery men—or lugging to and fro of acid-staining storage batteries. Never, as before, will you be without the use of your set for whole days at a time! Or even hours!

Unipower is a miniature power plant, carefully designed to furnish radio "A" power from the light socket. It keeps your set at full power always—even under unusual conditions caused by overwork or neglect.

Your dealer will show you the Unipower most ideal for your own set and conditions of use. Or we shall gladly mail you, free, complete descriptions of all Unipower models. Gould Storage Battery Company, Inc., 250 Park Avenue New York.

Unipower

Trade Mark

RADIO "A" POWER THAT CANNOT FAIL

Reserved for the
CAMFIELD RADIO MFG. CO.
829 Harrison Street
Oakland California



FREE RADIO GUIDE
NEWEST 1927 EDITION
Shows the latest circuits, the newest developments in radio at startling low prices. Get the parts you want here and save money. The best in parts, kits, complete factory-built sets and supplies. Orders filled same day received. Write for free copy NOW; also please send names of one or more radio fans.
BARAWIK CO., 542 Monroe St., Chicago, U.S.A.

H. F. L. NINE IN LINE
All parts in stock. Dealers write for Discounts.
FREE—Catalog upon request showing 79 other lines.
SHURE RADIO CO., 15-19 S. Wells, Chicago

Insure your copy reaching you each month. Subscribe to Radio News—\$2.50 a year.
Experimenter Publishing Co., 53 Park Place, N. Y. C.

marked drop in both the sensitivity and the volume output of the receiver. It was necessary, therefore, to find more satisfactory remedies for this bugbear.

One of the first attempts employed was the introduction of a "series variable grid-resistance," also known as a damping resistance. This offered a solution to the problem, but indeed a very unsatisfactory one; for, although it did control self-oscillation, it rendered the circuit very insensitive. Fig. 4 shows how the device was incorporated.

In Fig. 5, can be seen the same resistance in the grid return circuit; this position being preferable, for the reason that any adjustments made would not be affected by so-called "hand capacity." But this circuit too had all the earmarks of the previous one, and hence has been discarded as obsolete.

The same effects have been obtained through the scheme depicted in Fig. 6, where the series variable resistance is placed in the plate circuit of the tube.

One of the first steps that really gave proof of real merit was the circuit of Fig. 7, in which "potentiometer stabilization" has been used. By its use, the grids of the radio-frequency amplifier tubes can be biased with a potential varying from a maximum positive value to a maximum negative value, depending upon the terminal volts of the "A" battery supply; for a six-volt battery, of course, being plus six to minus six volts. In this way, a circuit can be very conveniently regulated from a condition of maximum sensitivity to one of maximum amplification and a happy medium arrived at, on all wavelengths between the extremes of the broadcast range, with the assurance of good reproduction.

But radio fans soon tired of the additional controls, which presented a complication of matters, and longed for a receiver that needed no split-hair adjustments, which could be depended upon to give maximum amplification without distortion over the entire broadcast band without further unnecessary compensations, either in tuning or amplification control.

NUMBER OF CONTROLS

An outcropping of further research produced the "reversed feed-back" circuit of Fig. 8. Though this circuit gave quality reproduction, it has the undesirable feature of adding two controls rather than simplifying the operation of the circuit.

As time went on, it was thought that fixed resistances might be of use in some position in the circuit where their use would not affect the circuit's sensitivity. Thus, in Fig. 9 is seen the "shunt-resistor" method of controlling oscillation, the value of the resistance being chosen for a fixed position of the tickler coil when the grid circuit is tuned to the lowest wavelength.

However, since the transformer ratio of the tuned-radio-frequency transformer varied more or less proportionately with the wavelength, creating a condition of maximum sensitivity and amplification at the lower wavelengths but affording no appreciable amplification at the higher wavelengths, radio-frequency transformers were made the subject of intense experimenting. Small diameter air-core and iron-core transformers, as well as large diameter transformers using various ratios from unity to one to a hundred, were tried out.

A happy medium was found by using a relatively large transformer, with which fairly good amplification could be obtained and the circuit safeguarded against self-oscillation. Improvements and modifications were made, one of the circuits being that of Fig. 10, which is known as the "bucking-coil" method of stabilization. This circuit, although giving good results, was superseded by that shown in Fig. 11, which employs "bypass stabilization," although it too incorporates an additional control.

You'll Note a Difference

*when Van Horne
tubes are used
throughout your set*

Improvement in your reception is entirely up to you—equip your set with Van Horne Tubes throughout—then tune in distant stations with the same ease as you do nearby ones—then listen to the radio programs just as they are being broadcasted.

There will be a new tone quality—a surprising richness and softness of tone that means many hours of radio happiness.

*Then too~theyll last
clear thru the season*



The Van Horne Guarantee

Because of the individual care in the making and testing of each Van Horne Tube a very liberal guarantee is possible.

Should the user find any Van Horne Tube unsatisfactory for any reason it will be immediately replaced. This broad guarantee fully protects the user—insuring the best possible reception.

These Two Unusual Tubes Will Make a World of Improvement in Your Reception

FOR ALL BUT THE LAST AUDIO STAGE

Van Horne Cushion Base Tubes

In every receiving set there is vibration. While barely perceptible it builds up through the various stages of the set resulting in howling, unnatural tone quality and otherwise spoiling reception.

The reason the Cushion Base Tube makes such a wonderful improvement in reception is because the tube is "Cushioned." This means that all vibration is absorbed, giving an unusual softness and fullness of tone of reception that follows the elimination of vibration.

To improve reception order your set from your dealer today.

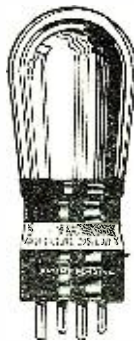

FOR THE LAST AUDIO SOCKET

Van Horne Adapted Mogul 5 VCX Power Tube

The Mogul 5 VCX is a double capacity power tube—specially to carry all of the signal to the speaker without distortion or loss of signal quality.

Because it can be used in your set without a change in wiring it is an addition that you should make for that increase in volume and improvement in reception that is absent when an ordinary tube of insufficient capacity is used.

Ask your dealer to demonstrate this remarkable tube to you.

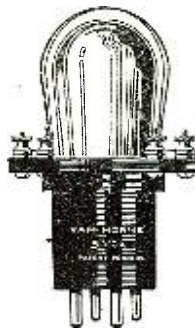

THE VAN HORNE CO., INC.,
1001 CENTER STREET, FRANKLIN, OHIO

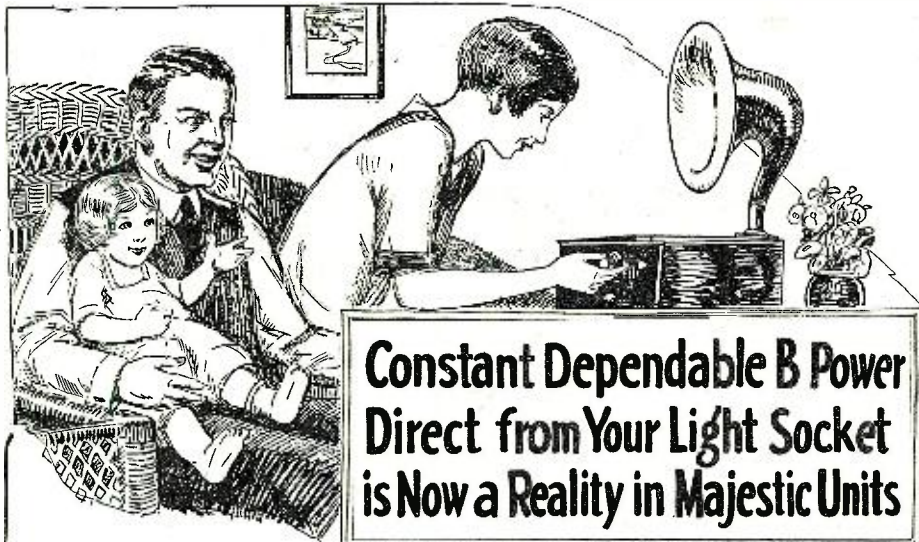

**Constant Dependable B Power
Direct from Your Light Socket
is Now a Reality in Majestic Units**

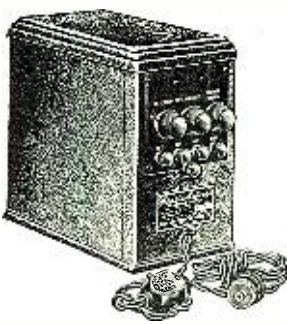

The day of better radio reception is here. Improved tone quality, greater volume, and more reliable all-around service are now made possible by Majestic B Power Units. They attach direct to your light socket saving you constant bother and attention. No acids to spill. No "hum." Reliable, unvarying power at an average cost of about one-tenth cent an hour! Economical, powerful—lasts as long as any receiver. Fully guaranteed.

Majestic "B" Current Supply
delivers pure direct current—from your light socket

Their low purchase cost and the savings they bring to you make them an investment that soon is repaid. Don't delay—see your dealer at once or write for free literature.

DEALERS: If you are not yet equipped to get your share of the Majestic business, see your jobber or write direct giving us his name.

New York Show Booth No. 10, Section "B"
Chicago Show Booth No. 6, Section "F"

GRIGSBY-GRUNOW-HINDS COMPANY
4572 ARMITAGE AVE., CHICAGO, ILL.

- Majestic Standard-B Current Supply**
Especially adapted for sets having not more than seven 201-A tubes, or six 201-A plus one 135-150 volt power tube. Popularly priced for the average set. Improves tone—better reception.
Price \$32.50
West of Rocky Mountains \$35.00
- Majestic Super-B Current Supply**
Capacity 1 to 12 tubes, including the use of 135-150 volt power tubes. Complete with switch to control current from light socket.
Price \$35.00
West of Rocky Mountains, \$37.50
- Majestic Master-B Current Supply**
Rating 60 mills at 150 volts. Particularly adapted for Radiola 25, 28 and 30 and super heterodynes. Will operate all power tubes, also the new super power tube UV-111 (180 volts). Unequalled for sets having a very heavy current draw.
Price \$42.50
West of Rocky Mountains, \$45.00

The Magazine of Scientifiction:
AMAZING STORIES
Master, intriguing stories by H. G. Wells, Jules Verne, etc.
25c—ON ALL NEWSSTANDS

FREE RADIO GUIDE
NEWEST 1927 EDITION
Shows the latest circuits, the newest developments in radio at startling low prices. Get the parts you want here and save money. The best in parts, kits, complete factory-built sets and supplies. Orders filled same day received. Write for free copy NOW; also please send names of one or more radio fans.
BARAWIK CO., 542 Monroe St., Chicago, U.S.A.

The ADVANCE fixed CRYSTAL DETECTOR
Super-tested for sensitivity and permanent setting of gold point. Positively fixed. Finest construction. \$5.000 now in use and giving perfect satisfaction. \$1.50—at dealers or by mail prepaid. Send name of nearest dealer with remittance.
ADVANCE ELECTRIC CO., 1260 W. 2nd St., Los Angeles, Cal.

The "shading-shield" method of Fig. 12 has been used with fair success and allows a lower transformer ratio to be used, thus giving slightly better amplification. In Fig. 13 can be seen the "closed-circuit damping coil," which absorbs energy from the tuned circuit, thus increasing its resistance at the lower wavelengths; and as the wavelength is increased, the inherent amplification falls off safely to a point below that of oscillation. In Figs. 14 and 15, which are variations of the preceding circuit, a series resistor has been placed in circuit with one of the damping coils and a variable condenser in the other. Circuit 15 represents the most desirable arrangement of this type of stabilization, although it too presents the undesirable additional control.

FOUCAULT METHOD

The problem has resolved itself into the creation of a circuit which will give a higher degree of amplification over the entire band of wavelengths, and at the same time be safeguarded against self-oscillation under no matter what conditions. In the search for a solution, engineers came upon the principle described by Foucault when the famous French scientist was investigating the effects of "eddy currents" and "hysteresis" (flow of magnetic force) in electromagnetic apparatus.

They realized the potency of such a principle if applied to radio engineering design, for, as they knew from previous experience, when eddy currents are produced in various metals, the result is a manifestation of heat, the amount of which depends entirely upon the amount of current dissipated as loss. It was correctly conjectured, therefore, that the external field of a coil could be so regulated that by placing in its proximity a fixed metal shield the result would be a uniformly-stabilized circuit.

Thus, in Fig. 16 can be seen a clever method of accomplishing this end. The metal end of the variable condenser has been placed close to the end of the inductance coil, so that the magnetic field created by self-oscillation is quickly dissipated in the metal end plate.

Fig. 17 shows this more clearly. There

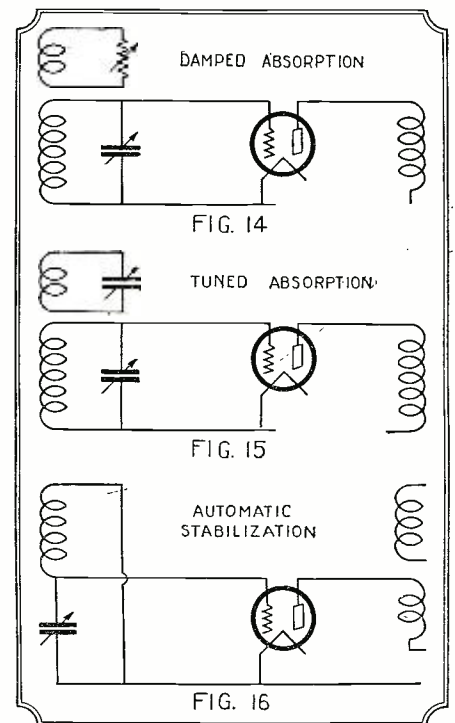

Figs. 14 and 15 both employ a separate oscillatory circuit which tends to absorb energy from the main tuning circuit. Fig. 16 is a very efficient arrangement, employing the "Foucault effect."

FREE

This 84 Page Wonder Book of RADIO Bargains



Send for this guide to Radio prices and Radio quality. All of our vast resources and radio experience have been utilized to assemble for you in one gigantic institution, the best and newest things in radio. The Randolph catalog is indeed the radio market place of the world—a masterpiece of merchandising that befits our house—the largest exclusive radio mail order house in the world.

What Our Catalog Contains

Over 2,000 items—from the most beautiful, fully equipped console model radio set, down to the smallest part or tool for the set builder—kits, parts, and supplies of every conceivable type and style. All beautifully illustrated and interestingly described. And to give this book added value, we have included radio data that makes it an invaluable text book for every lover of today's most fascinating and most wonderful achievement—RADIO.

Radio Sets

In this great radio market place you will find table model sets and console types with built-in loud speakers; the newest amphiphonic console sets; new Spanish period consoles; five, six, seven, and eight tube sets, with three dial, two dial, and the newest and most popular single simplified control. All sets are assembled in beautiful, genuine mahogany and walnut cabinets in a choice of latest types and designs.

5 Tube sets as low as \$24.90
Latest 1927 Models

All Randolph sets are sold at amazingly low prices. No matter what kind of set you want—no matter how little you want to pay—you can select YOUR SET AT YOUR PRICE from the Randolph catalog.

Radio Kits

A great array of kits for the set builder! These include all well-known circuits, approved and adopted by the world's foremost radio engineers—all classes of radio frequency, Super Heterodyne, and every other approved, popular circuit.

YOU MUST HAVE THIS BOOK

Space limitations here prevent our telling you more about the Randolph Catalog. Simply fill out and mail the coupon—or you may send a postal or letter—and this truly remarkable Radio book will come to you **ABSOLUTELY FREE**. MAIL THE COUPON NOW.

Randolph Radio Corporation
180 North Union Avenue • Dept. 11 • Chicago, Ill.

Radio Parts and Supplies

The Randolph catalog also contains a most complete line of "B" Battery Eliminators, including the famous Raytheon Eliminators; the latest type of Loud Speakers, Cone Speakers, a complete line of quality "A" power units—in fact, you will find listed in this wonder book every part that goes into the construction of a radio set, or any accessories you desire, at prices that mean a substantial saving to you.

Free Radio Service

Everyone has need for radio service. The average man has no time to keep up with the rapid developments of radio. We employ Radio Engineers who have made radio their life work. Their expert advice and helpful suggestions solve every radio problem of our customers.

Our Guarantee

Every article in our catalog is based on careful laboratory analyses and tests. We guarantee to back up every item in our catalog with our own as well as manufacturer's assurance of quality.

Why We Save You Money

Because we handle radio exclusively and sell a tremendous volume of everything in Radio, we can concentrate our buying power for the benefit of our customers.

Volume purchases regulate prices. We command rock bottom prices from manufacturers, and in many cases we contract for entire factory output of exclusive products. You will benefit by our great volume of purchases and sales, by securing anything you may want in radio at a substantial saving.

This Coupon Brings the Great RADIO Book FREE

RANDOLPH RADIO CORPORATION
180 N. Union Ave., Dept. 11
Chicago, Illinois

Send me—free—your 84-page, 1927 Radio Book.

Name.....

Street and No.....

R. F. D..... Box.....

City..... State.....

The CHELSEA Truphonic Six

Easily one of the real sensations of the year, the Chelsea Truphonic Six must be seen and heard to be appreciated. Built by one of the oldest radio manufacturers, noted the world over for its reliable products, this Chelsea receiver incorporates the new truphonic circuit, called the greatest radio contribution of the season. The circuit is fully shielded. Since a power tube may be used in the last stage, tremendous amplification and a tone stability wholly new is now obtained.

Ask Your Dealer To Demonstrate This Remarkable Value
Or Write Us Direct

CHELSEA RADIO CO., CHELSEA, MASS.

Other Chelsea Sets \$26.00 and \$50.00—each a leader in its class.
Send for details.

\$60

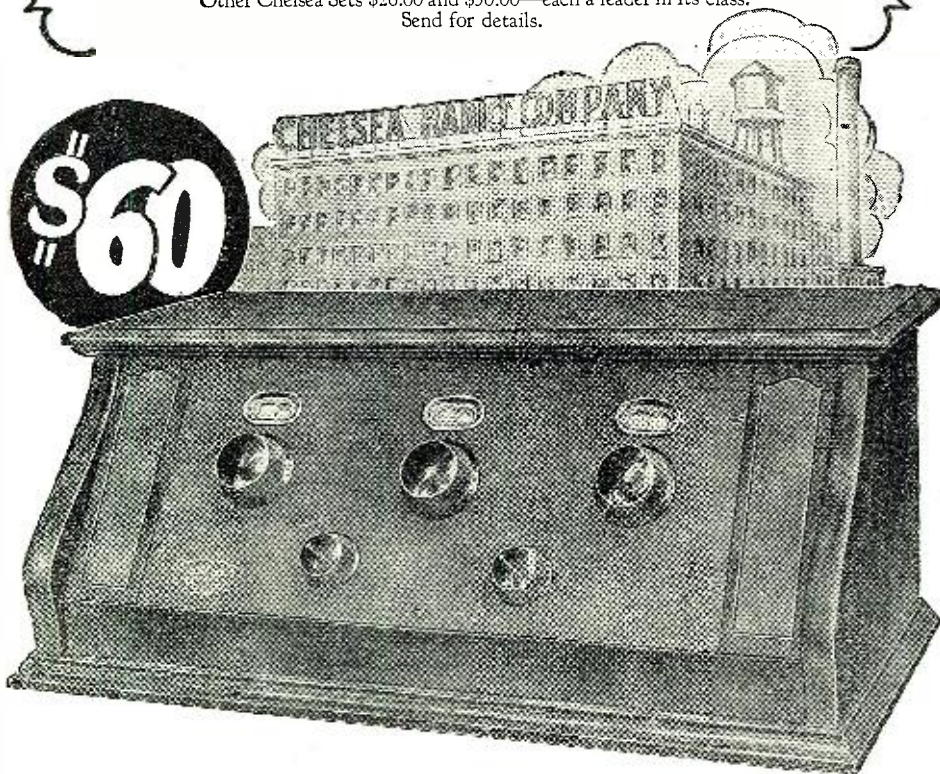

A RADIO EDUCATION—IN 5 VOLUMES

THEORY, DESIGN, CONSTRUCTION, OPERATION AND MAINTENANCE
LEARN AT HOME

These five component parts of a complete Radio Instruction Course are outlined in five volumes that contain not merely the essentials as so many books do, but more, they contain all that any modern up-to-the-minute textbook on any subject would cover. They are in themselves a COMPLETE radio education teaching every possible portion of Radio science. Size of each book 6 by 9 inches, handsomely bound and illustrated with charts, diagrams, descriptions of equipment, etc.

SEND NO MONEY for these books. Just forward your name and address and mention you wish "the Radio Reading Course". We send you the books at once. On receipt of same you pay the postman \$1.97 plus a few cents postage and then they are yours.

THE CONSRAD CO., Inc., 64 Church St., New York, N. Y.

FREE RADIO GUIDE

NEWEST 1927 EDITION
Shows the latest circuits, the newest developments in radio at startling low prices. Get the parts you want here and save money. The best in parts, kits, complete factory-built sets and supplies. Orders filled same day received. Write for free copy NOW; also please send names of one or more radio fans.

BARAWIK CO., 342 Monroe St., Chicago, U.S.A.

LATEST
NOOK-UPS

COIL WINDINGS

Audio-B Eliminator—Bell Ringing Trans.

TELEPHONE RINGER—CHOKE—
IGNITION—CONTROLLER & SPECIAL
SOLENOID WINDINGS

Easton Coil Co. P. O. Box 237
Easton, Pa.

are no small compensating controls either for sensitivity, amplification or tuning. Three tuning controls afford a maximum amount of amplification, selectivity and volume without the necessity for further adjustment. The peculiarities of the circuit are such that no self-oscillation can take place; yet the amplification at all wavelengths is very high and does not vary. This method by far eclipses those which employed additional and complicated controls.

Radio Outlets

(Continued from page 344)

bottom piece in the case assembly for passing the wire to be attached to the jack terminals. A quarter-inch hole is adequate.

WIRING THE OUTLETS

When you are ready to mount the "outlet" and wire it up, separate it into the two logical parts and mount the back of the case on the molding. Then, before attaching the front of the case, draw the two leads from the receiving set through the hole that you have drilled, in either the top or the bottom piece of the case assembly; and connect these two wires to the sleeve and tip terminals of the jack, which is attached to the front of the case.

When you have done this you are ready to attach the front of the case to the part that is already mounted on the wall. When this last operation is completed the completed unit should present a very pleasing appearance and also be quite serviceable and very convenient.

From the foregoing description you have probably noted that the general scheme is to have all the output jacks connected in parallel. This means that when loud speakers are plugged in at two different points they will be in parallel.

It may so happen that you prefer the double type of "outlet." If such is the case, the following list of required apparatus will be of interest to you.

- 2 Single- or double-circuit jacks;
- 2 Composition pieces, $4 \times 1\frac{1}{4} \times \frac{1}{4}$ inches;
- 2 Composition pieces, $4 \times 1\frac{1}{2} \times \frac{1}{4}$ inches;
- 2 Composition pieces, $1\frac{1}{2} \times 1\frac{1}{4} \times \frac{1}{4}$ inches;
- 1 Brass strip, $5 \times \frac{1}{2} \times \frac{1}{8}$ inches;
- 14 $\frac{1}{2}$ inch and 2 $\frac{7}{32}$ inch, No. 4/36 flat-head brass machine screws.

Radio Wrinkles

(Continued from page 371)

type obtainable from any radio or electrical dealer.

The pulleys are fixed upon a board 9 x 24 inches wide, each reel being 6 inches apart, while leaving plenty of room for the wire reel. It will be found in practice that a small wooden clamp at each end to hold the wire taut will be useful when finer wires are being used.

CLEANING AERIAL WIRE

An outdoor aerial will become heavily oxidized within the space of a year. This oxidation reduces the over-all efficiency of the aerial system; and should therefore be cleaned off every six months or so.

Here is a simple and effective way of doing it. Purchase twenty-five cents' worth of muriatic acid, and mix it with three parts of water in a large earthenware dish. Coil the aerial wire into a roll and place it in the

The New Karas Equamatic Five Tube Sensation

Now Being Featured By Radio Broadcast

FULFILS in an extremely simple manner a very desirable and **HIGHLY IMPORTANT FUNCTION** that our foremost radio engineers have been striving to accomplish ever since the advent of radio broadcasting.

THE **EQUAMATIC SYSTEM** AUTOMATICALLY provides a **CONTINUOUS MAXIMUM** and an abso-

lutely **EQUAL TRANSFER OF ENERGY** between primary and secondary inductances at all wave lengths by a coupling system unique to radio engineering practice—it also **ELIMINATES** the overlapping of electrostatic and electromagnetic fields with their harmful, broadening and distorting effects.

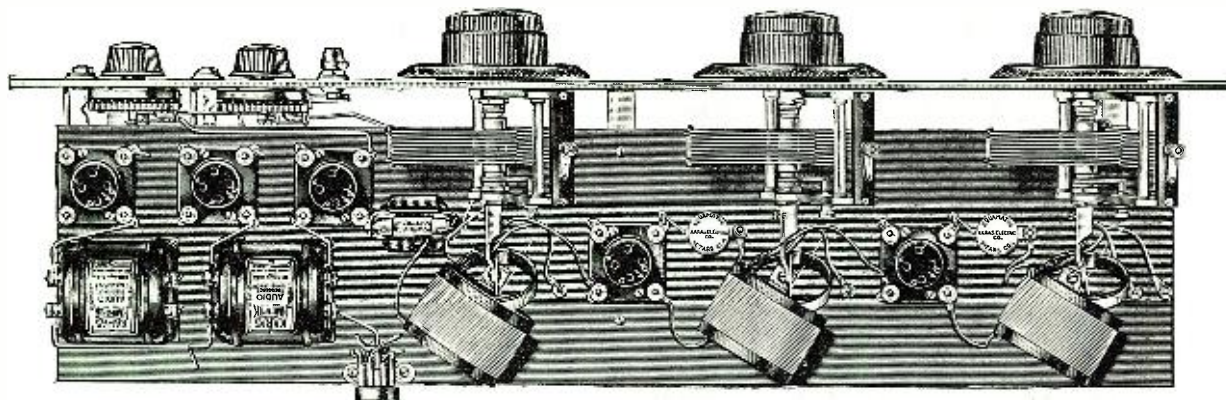

Pure Tone—Great Volume

The result of the **EQUAMATIC SYSTEM** from five tubes is a clean, clear, pure and powerful signal—equal in **VOLUME** to the usual six and seven tube sets—sharpness and **SELECTIVITY** equal to the superheterodyne—**SENSITIVITY** equal to a regenerative circuit—and a **PURITY** of tone equal to a crystal detector.

How It Works

In the **EQUAMATIC SYSTEM** the primary coils are attached to the shafts of the condensers—and are adjustable in their relation to both the condenser shafts and the secondary coils. The primaries are also **ENTIRELY SEPARATED** from the secondaries. The secondaries are adjustable to any angle in relation to the primaries and also as to their degree of coupling with the primaries. The primaries are **AUTOMATICALLY**, constantly and **CONTINUOUSLY** varied—at a definite, everchanging rate of variation—with the turning of the condenser dials.

This **POSITIVE, AUTOMATIC** action provides the **ABSOLUTELY EXACT** amount of coupling—at every wave length setting—necessary to deliver to the secondary coils **EXACTLY** the amount of energy required to cause the tubes to constantly operate at their **HIGHEST EFFICIENCY**.

The Reason for It

In order to keep radio tubes **CONSTANTLY** operating at their highest efficiency—just under the oscillation point—it is **ABSOLUTELY** necessary to continuously maintain an **EQUAL TRANSFER OF ENERGY** between primary and secondary coils. In order

Order Through Dealer or Direct on This Coupon

The Karas apparatus essential to the construction of the five tube **EQUAMATIC** receiver is carried by nearly every good radio parts dealer in most cities. Secure the parts from your dealer. If he is out of them order direct from us using this coupon. Send no money. Just hand the postman purchase price plus a few cents postage.

KARAS ELECTRIC CO.

Manufacturing Plant: N. Rockwell St.
Offices: 1027 Association Bldg., Chicago, Ill.

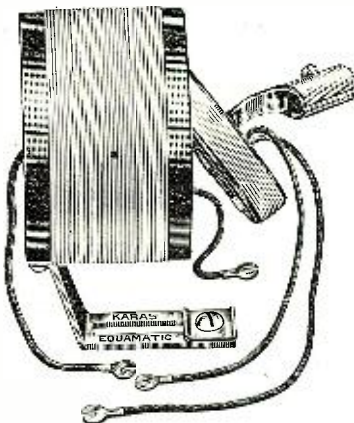

to maintain this equal transfer of energy every wave length setting must have a **DIFFERENT AND EXACT** coupling between primaries and secondaries. To secure **PERFECT** reception every successively longer wave length requires a greater transfer of energy—therefore a correspondingly greater degree of coupling—than the preceding shorter wave length. The problem has been to provide this exact and constantly varying coupling by some simple mechanical means.

The **EQUAMATIC SYSTEM** solves this problem—does it **POSITIVELY, SIMPLY** and **AUTOMATICALLY** and does not resort to **ANY** lesser methods whatsoever.

On account of the extremely high efficiency of this system the reception from a home built five tube **KARAS EQUAMATIC** receiving set is as nearly perfect as radio reception can be with present day knowledge.

Easy to Build

A manual of complete diagrams and instructions for building this five tube **KARAS EQUAMATIC** receiver in complete detail is included with each set of **KARAS EQUAMATIC** coils. (This manual will be sent separately upon receipt of 10c to anyone interested.) The placing of every part and every wire connection is clearly explained. Even

though you may never before have built a set you can proceed without hesitation, confident of successfully constructing as efficient a receiving set as can be made. To build this powerful, sweet toned, long range receiver, you will need the Karas parts listed on the accompanying coupon.

**Licensed Under King Patents Pending*

KARAS ELECTRIC COMPANY,
1027 Association Building, Chicago, Ill.

Please send me set of 3 Equamatic Inductance Coils, \$12; 3 special Orthometric Condensers with extended shafts, \$7 each; 3 Micrometric Vernier Dials, \$3.50 each; 2 Harmonik Audio Transformers, \$7 each; 2 Equamatic Retard Coils, \$1 each; and 3 sub-panel brackets, 70c. for which I will pay the postman \$60.20 plus postage, upon delivery. It is understood that I have the privilege of returning any of this apparatus for full refund any time within 30 days if it does not prove entirely satisfactory.

NAME

ADDRESS

If you send cash with order we will ship these parts postpaid.

NATIONAL

VELVET-VERNIER DIAL
TYPE C — ILLUMINATED

THE NEW NATIONAL VELVET-VERNIER DIAL TYPE C HAS AN ILLUMINATED SCALE BRILLIANTLY LIGHTED BY A SMALL CONCEALED LIGHT AND EITHER TURNED ON SEPARATELY WHEN NEEDED OR CONNECTED TO THE FILAMENT SWITCH, THUS ACTING AS A THERMOSTAT WHEN THE TUBES ARE LIGHTED. IT HAS EVERY FEATURE WHICH HAS MADE THE TYPE A AND TYPE B DIALS SO POPULAR. VARIABLE RATIO 6:1 TO 20:1 WITH NEW AND BETTER ADJUSTER, EASILY READ SCALE—EASILY MOUNTED ON PANEL WITH ORDINARY DRILL AND SCREW DRIVER. ONLY HEAVY BAKELITE CASE, WEARPROOF AND DISTINGUISHED IN APPEARANCE. AND FINALLY THE NATIONAL VELVET ACTION FOR HAIRLINE TUNING ACCURACY—RETAINING THESE QUALITIES UNCHANGED NO MATTER HOW LONG IT IS USED.

NATIONAL COMPANY, INC., ENGINEERS AND MANUFACTURERS
110 BROOKLINE STREET, CAMBRIDGE, MASS. — W. A. READY, PRESIDENT

BE SURE YOU GET GENUINE NATIONAL PRODUCTS

PRICE TYPE C—ILLUMINATED DIAL\$3.00

Send for Bulletin 109-RN

Visit our exhibits at New Madison Square Garden, New York, Sept. 13th-18th, and at the Coliseum, Chicago, Oct. 11th-17th.

Just the Book You Wanted

“RADIO NEWS” AMATEURS’ HANDBOOK
Volume No. 1 (Fourth Printing)

Check full of radio constructive and instructive articles from cover to cover. Written by foremost radio authorities, in plain everyday language which everyone can understand. Sections include articles on Receiving Sets and Sundry Apparatus, Transmitters and Accessories, Radio Theory, Vacuum Tube Data, and Practical Hints for the Amateur. A book which also serves as a ready reference and should find a place in the library of every amateur. It contains 224 pages and over 375 illustrations, diagrams, and photographs, bound in a multi-colored heavy board. On sale at all leading radio stores. If your dealer cannot supply you, send a dollar bill and the book will be forwarded to you postpaid.

Price 50c

EXPERIMENTER PUBLISHING CO., Inc., 53 Park Pl., New York

dish. Leave it there for about an hour and stir the solution three or four times every fifteen minutes or so. Next prepare a strong solution of soda and water in another large dish and place the roll of wire in this to neutralize the acid. Let the wire remain in this solution for about ten minutes; then take it out and scrub off any remaining scales of oxidation with an old tooth brush. You will find the wire to be in the same clean condition as when purchased.

Contributed by Fred. W. Davey.

Types of Audio Amplifiers

(Continued from page 364)

AUDIO COUPLING DEVICES

Now, let us consider what is required in an audio-frequency amplifier. We have two electron tubes to be joined together in such a way that the voltage developed in the output (or plate) circuit of one is transferred with as little loss as possible to the input (or grid) circuit of the other tube. The voltage developed in the output of a tube can be utilized only by causing part of it to appear in some resistance or impedance external to the tube. Thus in Fig. 2 we have shown a resistance R connected in the plate circuit of a tube in series with the “B” battery. A current I flows in this circuit so that, in accordance with our study above, the voltage drop across the terminals of this resistance is RI.

But this is not the total voltage developed in the plate circuit of the tube. It must not be forgotten that there is a high resistance existing within the tube between the plate and filament, which is determined by the design of the tube, and which we cannot change. Suppose this resistance is r_p . The voltage drop in it will then be $r_p I$, for the same current flows through it as flows through the external resistance R. The total voltage developed in the plate circuit is, therefore, the sum of the internal and external voltage drops, of which the only portion we use is the external drop. The voltage between the points a and b (Fig. 2) is a fraction of the total voltage, and this fraction is

$$\frac{R}{R + r_p}$$

In other words, this fraction expresses the part of the total voltage in the plate circuit which is available, and it is to our interest to make it as large as is practically possible. This is done by using large values of R, that is, by making the external resistance as large as possible. We can never hope to transfer the total voltage developed in the plate circuit of the tube to the points a and b (or to the input of the succeeding tube), for this would require that the resistance be infinite.

RESISTANCE-CAPACITY COUPLING

The next point we have to consider is the manner of connecting the points a and b to the succeeding amplifier tube. The connections cannot be made directly to the grid and filament of the latter tube; for in that case there would be impressed on the grid of the second tube a very large positive bias, due to the “B” battery. This bias must be removed; otherwise there would be a large grid current in the second tube which would cause distortion and other ill effects. It is removed by placing before the grid a blocking condenser C, which presents infinite impedance to the continuous (or direct) voltage, but which allows the alternating signal voltages to go through.

However, by adding this condenser to the circuit we have allowed the grid of the second tube to “hang up in the air.” In other words, the grid is “free” to collect a con-

Now you can afford the best in RADIO Sold on the Clark fifty-fifty plan half cash--half trust

BST-5

5-ply walnut
vernier piano
finish cabinet

Send \$20
only

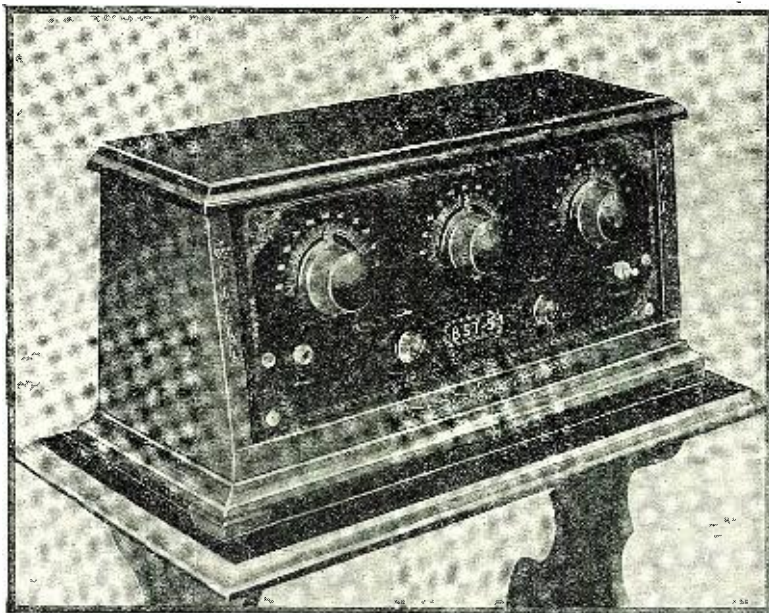

NEW
MODEL

Shielded
Receiver

\$40.00

New model cabinet base 21" long by 8" wide, height 9½", top 21" by 6".

THIS highly sensitive, powerful and selective BST-5 radio receiver has all up-to-the-minute improvements. Heavy aluminum automobile type chassis, shielded against stray currents and distortion. Flexible grip, Universal type sockets, eliminating microphonic noises. Has provision for battery eliminator and any power tube. Fahnestock clips on sub-panel for adjusting C battery, has voltages for power tube. Efficient on either long or short aerial, including indoor aerial. This BST-5 sets a new standard for true tone values and selectivity. This BST-5 gives greater volume than many six tube sets and consumes less current.

28 Stations in 3½ Hours

Mr. E. H. Thiery, Tax Collector, New Hartford, Conn., writes: "I am well pleased with my BST. In three hours and a half on Wednesday night I got the following stations: WTIC, WJZ, WGY, WBZ, WPG, WNAC, WMSG, WEEL, KDKA, WAAM, WEAN, WSAR, WJBI, WMAC, WLWL, WJAR, WAHG, WBNY, WEAJ, WNJ, WCSH, WSAN, WHK, WMCA, WRVA, WHN, WHAR, WWJ.

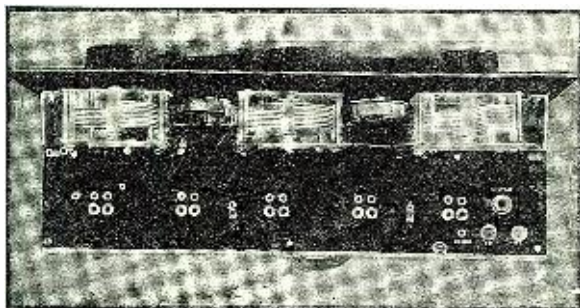

Top inside view showing compact aluminum shielded-indestructible chassis.

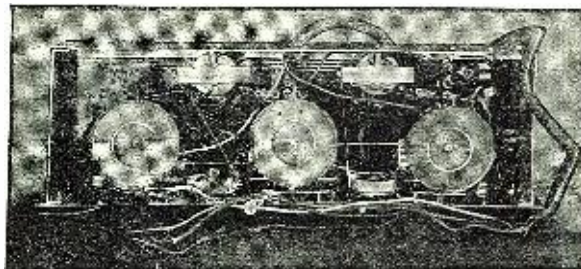

Bottom inside view showing improved foolproof curkoid coils and rigid construction, with complete harness for simple installation.

Our Offer:—Send us your check or post office money order for \$20.00, one-half its price, try out the BST-5 in your own home for ten days, then either send us the other \$20.00, making \$40.00 in all, or return the set and we will return your \$20.00—no questions, no argument.

GUARANTY RADIO GOODS CO.,
141 West 45th Street, New York City.

Gentlemen:—Ship me one BST-5, \$40.00 Radio Set, for which I enclose \$20.00 on account. I am to test it out for ten days in my own home and if satisfactory I will then send you the balance of \$20.00; but if not satisfactory to me I will return the set at the end of the ten days' trial and you are to return my \$20.00 immediately on receipt of the set without question.

NAME

ADDRESS

Ferguson

IN MANY receivers one may experience excellent "tone quality." With **FERGUSON** you are conscious of something more: a degree of fullness that gives you each note from every instrument in perfect timbre. Not mere music, but the soul of the artist seems to come into your living room.

One Tuning Control—Calibrated in Meters gives you, in a moment, the program to suit your mood.

Complete shielding of all tuning elements gives this 6-tube Receiver its marked selectivity.

See, hear, compare!

J. B. FERGUSON, INC.
225 West 57th Street
New York, N.Y.

The **FERGUSON**
Model Ten \$110.00
With table, as shown, 147.50
(Ten per cent increase west
of the Rockies)



No Seasonal Models—
Continually Developing Refinements

The Gold Standard of Radio Receivers

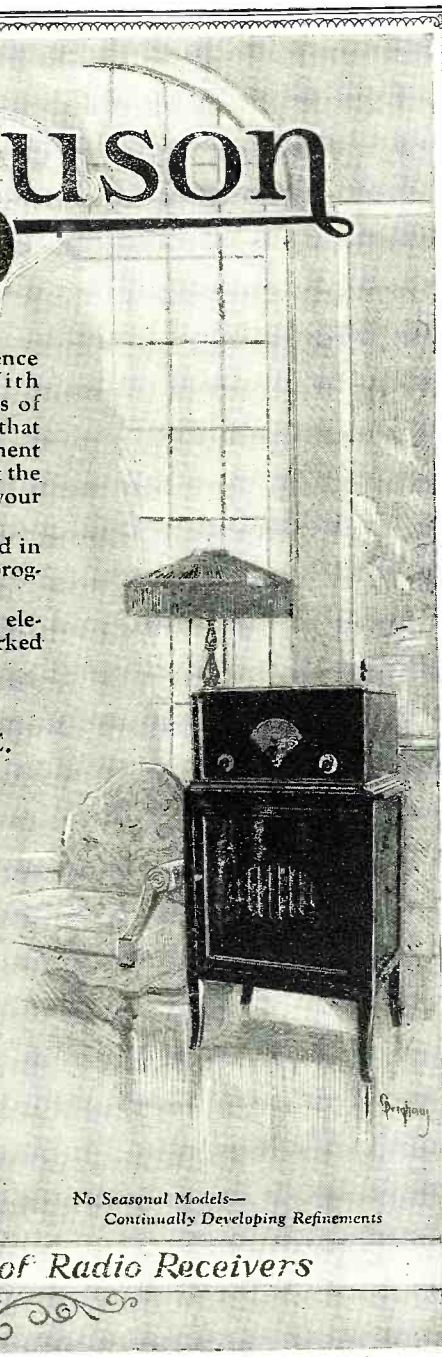

siderable number of electrons and acquire quite a large negative bias. This is not a good thing; it is almost an axiom in radio that a tube should never be operated with a "free" grid, as the circuits become unstable and almost anything is likely to happen.

To avoid the "open" or "free" grid we must provide a "grid leak"; in other words, we must place a leakage path in the circuit, over which these electrons trapped on the grid may flow away from the grid to the filament whence they came. The addition of this leak resistance to the circuit completes what is generally known as the resistance-capacity-coupled amplifier, and is shown in full in Fig. 2. This is the simplest type of amplifier, from all viewpoints; it is simple to construct, the cost is relatively low, and the electrical analysis is much simpler for this than for any other known type of amplifier. The detailed analysis of the circuit will be undertaken in a succeeding article of the series.

IMPEDANCE COUPLINGS

The most general type of amplifier coupling device (other than the transformer type) may be represented by the circuit of Fig. 2, in which the various paths of the amplifier network may include complex impedances rather than pure resistances. In other words, it is possible to vary the amplifier circuit of Fig. 2 by replacing the pure resistances with certain combinations of resistances, inductances and capacities.

For instance, if we replace the resistance in the plate circuit external to the tube (R in Fig. 2) by an impedance coil (Z in Fig. 3) we will have what is generally known as the impedance-coupled amplifier. The same general principles apply to this type of amplifier as to the resistance-capacity coupled amplifier, as far as the voltages are concerned, with the following exception: in the resistance-capacity coupled amplifier the voltage ratio (defined in previous articles of the series) is practically independent of the frequency, provided the blocking condenser C is sufficiently large.

In the impedance-coupled amplifier the effect of the blocking condenser remains as before, but added to this is the effect of the varying impedance at various frequencies. At low frequencies the blocking condenser, in both types of amplifiers, tends to reduce the voltage ratio; at the lower frequencies, from about 200 cycles per second down, producing the effects studied in our previous articles. In the impedance-coupled amplifier, the impedance in the plate circuit acts in the same manner, thereby accentuating the effect if the impedance is not large enough. The use of the impedance, however, permits smaller "B" battery voltages to be used; as the impedance generally has relatively low resistance to the direct voltage, but of course has an impedance to the alternating signal voltages which depends upon the frequency of these voltages.

We have said before, that it is necessary to make the resistance R of Fig. 2 as high as practically possible, in order to make the voltage ratio as high as possible. The same is true of the impedance Z in Fig. 3. There is a practical limit to which R may be increased, however, for very large plate-circuit resistances require "B" batteries of rather high voltage. The impedance Z, of Fig. 3, however, has relatively low direct-current resistance, so that it may not be necessary to use such high voltages; provided, of course, that the resistance of the impedance coil is kept low. The inductance of the coil must be kept as high as practically possible, for a high inductance will keep the voltage ratio high throughout the greater part of the range of acoustic frequencies.

AEROVOX
"Built Better"

LAVITE RESISTANCES

Guaranteed to dissipate 4 Watts

AEROVOX products are used by over 200 of America's Radio Manufacturers. AEROVOX Fixed Condensers are approved by M.I.T. and Yale Universities.

AEROVOX WIRELESS CORP.
489-491-493 Broome St., New York

Branch Offices:
St. Louis, Mo., 3rd & Olive St. Building
Cincinnati, O., 121 Pine Street Bldg.
Chicago, Ill., 51 W. Jackson Boulevard
New York, N.Y., 22 Bowling Green
San Francisco, Cal., 374 N. San Pedro St.

Free! ★ Free!

One Genuine, regulation Size
VALET Auto-Strop Razor

With every five months' subscription to **RADIO NEWS** we are offering free—
one genuine regulation sized Auto-Strop Razor.

SEND \$1 Today and get Radio News for five months and one Razor free.

Experimenter Publishing Co., Inc.,
Dept. R.N. 10
53 Park Place - New York, N. Y.

FREE RADIO GUIDE

NEWEST 1927 EDITION
Shows the latest circuits, the newest developments in radio at startling low prices. Get the parts you want here and save money. The best in parts, kits, complete factory-built sets and supplies. Orders filled same day received. Write for free copy NOW; also please send names of one or more radio fans.

BARAWIK CO., 342 Menree St., Chicago, U.S.A.

LATEST HOOK-UPS

Largest variety of Radio Parts!

1926
EDITION
No. 16

300
Illustrations

8-Page
log book of
all U. S.
Broadcast
Stations



THIS
68 PAGE
RADIO
CATALOGUE
FREE

75 HOOKUPS

BUY FROM RADIO'S OLDEST MAIL ORDER HOUSE

WE are the oldest established, exclusive radio mail order house in the country. Our motto is "Quick Shipment." All orders are shipped within 24 hours. Quick, prompt, courteous service. We carry a larger variety of radio parts and findings than any other radio house in the country.

"RASCO HAS IT"

If you are in need of certain small radio parts that other radio and mail order houses do not bother to carry, get the Rasco parts catalog, and you will find them there, anything from a screw to copper ribbon and telephone diaphragms, as well as thousands of other small radio findings. Just to mention a few:

Lugs, nuts, dials, vernier dial, jacks, plugs, every kind of knob, cords, panels, screws, sliders, washers, selenium, tinfoil, switches, crystals, cap nuts, Litz wire, cord tips, brass rods, resistances, name plates, spring binding posts, switch parts, metal ribbon, carbon balls, binding posts, all types, switch points, switch levers, lock washers, carbon grains, ground clamps, metal pointers, insulated tubing, low melting metal, antenna connectors, bus bar wire, as well as thousands of other articles.

We carry the Largest Variety of Small Radio Parts in the World.

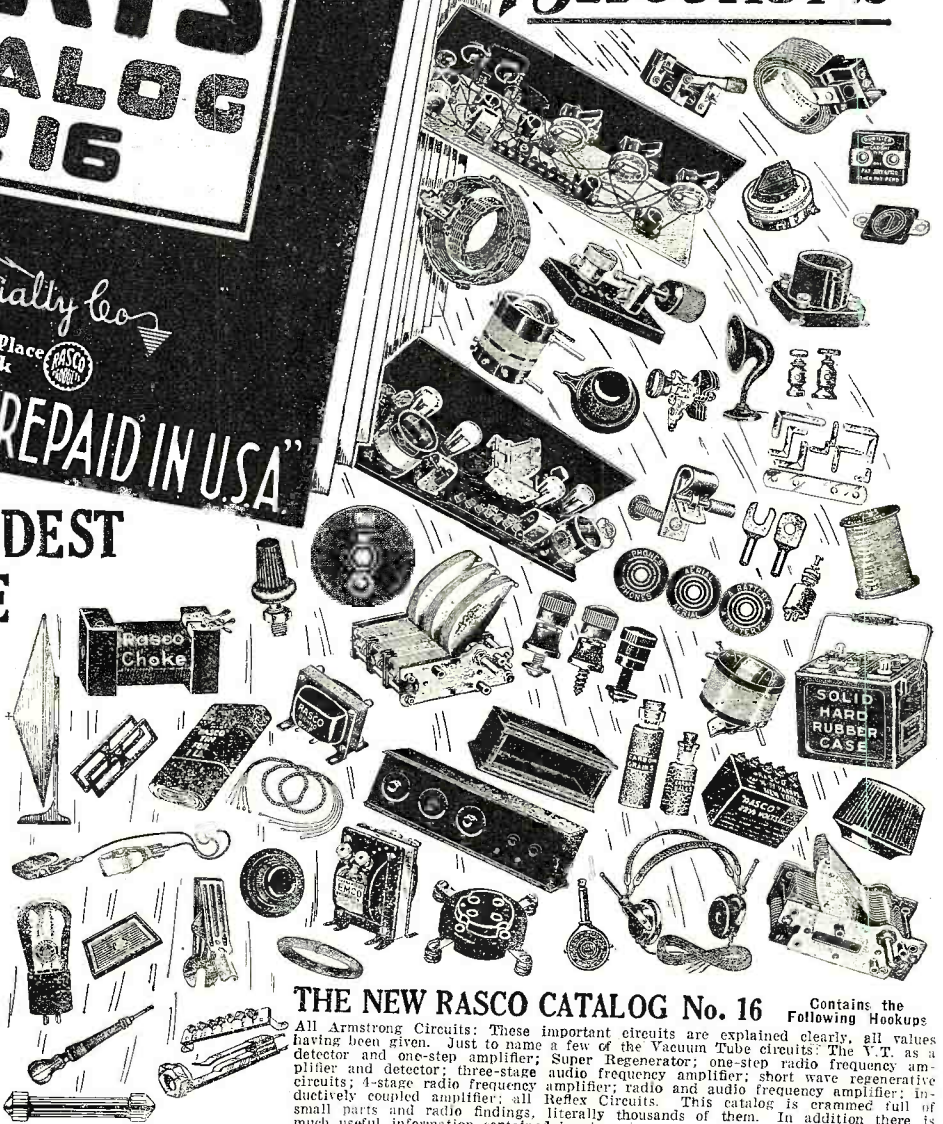

THE NEW RASCO CATALOG No. 16 Contains the Following Hookups
All Armstrong Circuits: These important circuits are explained clearly, all values having been given. Just to name a few of the Vacuum Tube circuits: The V.T. as a detector and one-step amplifier; Super Regenerator; one-step radio frequency amplifier and detector; three-stage audio frequency amplifier; short wave regenerative circuits; 4-stage radio frequency amplifier; radio and audio frequency amplifier; inductively coupled amplifier; all Reflex Circuits. This catalog is crammed full of small parts and radio findings, literally thousands of them. In addition there is much useful information contained herein.

If you will paste this coupon on a post card and mail today, we will be pleased to send you our new Catalog at once. 

RADIO SPECIALTY CO., 98 Park Place, New York R.N.-10-26
You may send me, without charge or obligation, your NEW CATALOG No. 16. (Write on margin if you desire.)
Name
Street
P. O. State.....

RADIO SPECIALTY CO.
98 Park Place New York, N. Y.

YAXLEY

APPROVED RADIO PRODUCTS

Radio Conveniences

Automatic Relay



Undoubtedly the greatest advance in radio convenience, satisfaction and economy ever offered to the set user.

The Relay is for the set using a trickle charger and B eliminator or either. The relay automatically cuts off the trickle charger, cutting in the A battery and B eliminator when the switch or filament control of the set is turned on. When the set is turned off, the relay automatically cuts out the B eliminator and A battery, cutting in the trickle charger again. Easily wired.

Absolutely fool proof. The result of experience in design and manufacture of relays for over 25 years. Voltage drop negligible. Self-cleaning, silver wiping contacts. Handsome enameled metal case, with Bakelite base. Brackets for convenient mounting. Approved and will be used by leading manufacturers of charging equipment.

No. 444 Relay Switch, complete with cord and separable attachment plug, as illustrated \$5.00

Radio in Every Room

Yaxley Radio Convenience Outlet receptacles and plates fit standard outlet boxes.

- No. 135—For Loud Speaker or Head 'Phones \$1.00
- No. 136—For Aerial and Ground \$1.00
- No. 137—For Battery Connections \$2.50

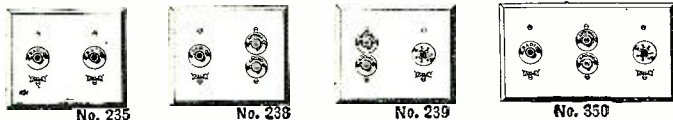

Also furnish in the following combinations:
 No. 235—Two No.'s 135 \$2.00
 No. 238—Combining No. 135 and No. 136 2.00
 No. 239—Combining No. 136 and No. 137 \$3.50
 No. 350—Combining No. 135, No. 136 and No. 137 4.50

Order from your dealer or remit, with his name, to us. Write us for complete illustrated descriptive folders, showing many hook-ups.

Yaxley Mfg. Co.

Jack
 Jack Switches
 Junior Jacks
 Pilot Light Brackets
 Pilot Light Switches

9 So. Clinton St.,

Dept. N.

Chicago, Ill.

Phone Plugs
 Rheostats
 Battery Switches
 Inductance Switches
 Panel Lights

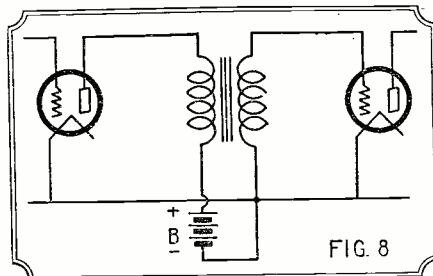

The typical transformer-coupled audio-amplifier circuit arrangement.

GRID-LEAK EFFECTS

By examining the diagrams on page 364 it will be easily understood that the grid-leak resistance represents a partial short-circuit across the input of the second tube; in other words, the lower this resistance is, the smaller will be the voltage drop across it, in comparison with the voltage drop available, which is that across the points a and b.

To be explicit, the circuit of Fig. 4 is exactly the same as that of Fig. 2, as can be proven by comparing the two circuits. The voltage drop across the points c and d is only a portion of the voltage drop across the points a and b. The fraction, of the voltage across a and b, which is available across c and d, is represented by the ratio of the resistance, cd, to the reactance of the blocking condenser C.

To keep this fraction as high as possible, the impedance between c and d must be kept as high as possible. If the impedance, cd, is a pure resistance, the grid of the tube will be blocked, or become "free". Therefore there is a practical limit to increasing its size, beyond which we may not go. In one type of amplifier, shown in Fig. 5, the grid-leak resistance is replaced by a grid-leak impedance. This impedance is high to the alternating signal voltage, but has a relatively low resistance, allowing the grid charges to leak away easily so that overloading does not generally occur on strong signals. This system was described in the June, 1926 issue of RADIO NEWS by Fred A. Jewell.

INCREASING THE VOLTAGE RATIO

As a further change in the circuit arrangement, H. P. Donle (see RADIO NEWS for June, 1926) has arranged the two impedances on a single iron core, as illustrated in Fig. 6. The two windings have a turns-ratio of 1 to 1, and a coupling or blocking condenser is used as in the other types of amplifiers. The reason for this will be studied in a later article, but we may indicate it here.

It has been said before that the highest voltage ratio possible with an amplifier, using a circuit arrangement like those in Figs. 2, 3 and 5, is unity. That is, the highest theoretical voltage, that can be impressed on the input of the second tube, is the voltage drop in the impedance or resistance in the external plate circuit of the first tube. Practically the voltage ratio is less than unity, so that there is not only no increase in voltage, as the signals pass through the coupling device, but there is an actual attenuation, or decrease of voltage. To prevent this attenuation Mr. Donle introduces into the leak impedance an electromotive force, through the mutual inductance between the plate coil and the impedance coil. This is accomplished by placing them on the same iron core. At the same time they are so arranged that the capacity between the coils is very small. As a result of this, the system has many of the advantages of the ordinary impedance-coupled amplifiers, with the additional advantage of giving higher voltage ratios.

GEM TUBE

A Guaranteed Radio Tube Within Reach of All

A tube for a dollar of \$3 value. A trial order will convince you as it has thousands of others. (Blue or Silver with Bakelite Base). Send your orders at once.

Orders sent C.O.D. with UV. or parcel post

Dealers, Write for Discounts

Types \$1

401A
 400
 499
 499A Each

With Stand- and Base
 All Tubes with UV. or UX Bases

GEM TUBE CO.
 (Dept. N.) 200 E'way, N. Y. City
 220 So. State St., Chicago, Ill.
 Lafayette Bldg., Detroit, Mich.

Andrews Radio Directory and LOG BOOK

Just what you've always needed—only log that helps you get all its possibilities out of your set. Every station listed 3 ways —by wavelengths, call letters, and cities, allowing its use with any program anywhere. Users tune in obscure stations never heard before. Gives you all the information you want about every station. Incorporates Broadcast Station map. Lists all stations in U. S., Can., Mex. and Cuba. Always up-to-date and authentic as it is checked by latest Government Reports. Simple and easy to understand and use. Each station can be individually logged. Sold by radio and news dealers everywhere or by mail, postpaid on receipt of 25c in stamps.

THE WAYNE-ANDREWS CO., INC.
 1003 Andrews Bldg. Ft. Wayne, Ind.

25c

FREE RADIO GUIDE

NEWEST 1927 EDITION

Shows the latest circuits, the newest developments in radio at startling low prices. Get the parts you want here and save money. The best in parts, kits, complete factory-built sets and supplies. Orders filled same day received. Write for free copy NOW; also please send names of one or more radio fans.

BARAWIK CO.
 542 Monroe St., Chicago, U.S.A.

RADIO PANELS OF GENUINE BAKELITE

Cut, drilled and engraved to order. Send rough sketch for estimate. Our New Catalog on Panels, Tubes and Rods—all of genuine Bakelite—mailed on request.

STARTEST MFG. CO.
 520 S. GREEN ST. CHICAGO

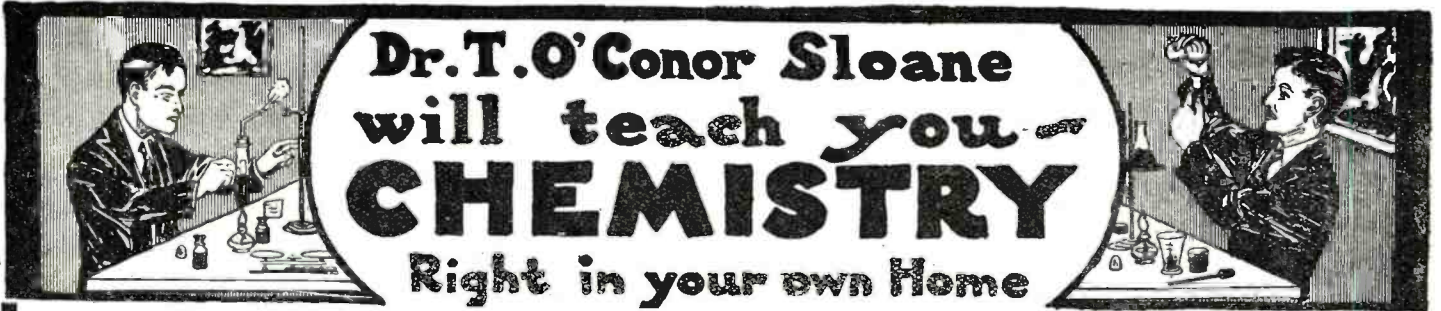

Dr. T.O'Connor Sloane
will teach you
CHEMISTRY
Right in your own Home

Good Chemists Command High Salaries



T. O'CONNOR SLOANE
A.B., A.M., LL.D., Ph.D.

Noted Instructor, Lecturer and Author. Formerly Treasurer American Chemical Society and a practical chemist with many well known achievements to his credit. Not only has Dr. Sloane taught chemistry in the class-room but he was for many years engaged in commercial chemical work.

Industrial firms of all kinds pay tempting salaries to get the right men. Salaries of \$10,000 to \$12,000 a year are not unusual for chemists of exceptional abilities. Chemistry offers those who are ambitious and willing to apply themselves conscientiously the greatest opportunities of any vocation. Why be satisfied with small pay and hard, thankless work—learn the profession of Chemistry and your salary will depend only upon your own efforts and your own abilities.

The work of the chemist is extremely interesting. If you are fond of experimenting, if you like exciting and fascinating work, take up Chemistry. To the man who is dissatisfied with his present job, to the young man just deciding on his life work, Chemistry holds alluring charms, and countless opportunities. If you want to earn more money, the way is open through our course in Chemistry.

NOW IS THE TIME TO STUDY CHEMISTRY

Never before has the world seen such splendid opportunities for chemists as exist today. The war has awakened the United States to the need of trained chemists and chemical engineers. Everywhere the demand has sprung up. In factories, mills, laboratories, electrical shops, industrial plants of all kinds, chemistry plays a vital part in the continuation and expansion of the business. In every branch of human endeavor the need for chemists has arisen. No profession offers such alluring opportunities and the next ten years are going to show the greatest development in this science that this country has ever seen. Those who have the foresight and ambition to learn chemistry now will have the added advantages and greater opportunities afforded while the chemical field is growing and expanding.

What Well-Known Authorities Say About Our Course

From Hudson Maxim.
"Dr. Sloane has done a much-needed work in a much better way than anything of the kind has, heretofore, been done."

"Dr. Sloane has a remarkable faculty of Presenting Science for self-instruction of the student in such a clear and understandable way as to be most readily grasped and assimilated. I therefore, unreservedly recommend and place my highest indorsement on his work."

From Dr. W. W. de Kevlor.
"I can not recommend your course too highly and I congratulate both you and Dr. Sloane on same."

From John A. Tennant.
"This is something which has long been needed. Your long experience in the teaching of chemistry... assurance that the course will be practical as well as plain to the untrained students."

What the Students Say:

"Your course has been worth \$50,000 to my concern"

"This is just like reading some fascinating fiction story."

"I have just been made Assistant Chemist of my concern."

"Your course is just what a person wants to start in the wonderful science of Chemistry."

"I find that your course is very interesting. I wait patiently for the next lesson."

"I find the study of chemistry more and more interesting at every lesson and you may be sure that I am getting into studying habit even more than I ever did even in my school days."

"I like the lessons so much that I honestly would not sell them for many times their price."

"I am taking this opportunity to express my satisfaction with your chemical lessons."

"I now have a fine position as chemist at the Du Pont Dye Works. It was thru your course alone that I have been so successful."

"I have written to different people about your course and they speak very highly of same."

"If I don't learn it isn't your fault for I find that your lessons contain a whole lot."

(Name and address on request)

You Can Learn At Home

NO PREVIOUS SCHOOLING NEEDED

Dr. Sloane will teach you Chemistry in a practical and intensely interesting way. Our home study course written by Dr. Sloane himself is practical, logical and remarkably simple. It is illustrated by so many experiments that are performed right from the start that anyone, no matter how little education he may have, can thoroughly understand every lesson. Dr. Sloane teaches you in your own home with the same individual and painstaking care with which he has already taught thousands in the class room. He will, in addition, give you any individual help you may need in your studies. This personal training will be of inestimable value to you in your future career.

Experimental Equipment Given to Every Student



We give to every student without additional charge, this chemical equipment including fifty pieces of laboratory apparatus and supplies and thirty-nine different chemicals and reagents. The fitted heavy wooden box serves not only as a case for the outfit but also as a laboratory accessory for performing countless experiments. Full particulars about this special feature of our course are contained in our free book "Opportunities for Chemists."

DIPLOMA AWARDED TO EACH GRADUATE

Upon graduation each student is awarded our Diploma in Chemistry, certifying that he has successfully completed his studies. Your name on this certificate will be a source of pride to you all your life, as well as an aid to obtaining a position in Chemistry.

Easy Monthly Payments

You do not have to have even the small price of the course to start. You can pay for it in small monthly amounts or earn it as many others are doing. The cost is very low, and includes even the Chemistry outfit—there are no extras to buy with our course. Write us and let us explain how you can qualify for a trained technical position without even giving up your present employment.

SPECIAL 30 DAY OFFER

Besides furnishing the student with his Experimental Equipment, we are making an additional special offer for a short while only. You owe it to yourself to find out about it. Write today for full information and free book, "Opportunities for Chemists." Send the coupon right now while it is fresh in your mind. Or just write your name and address on a postal and mail it to us.

CHEMICAL INSTITUTE OF NEW YORK
Home Extension Division 10
66-R-West B'way
New York City

Please send me at once, without any obligation on my part, your free book "Opportunities for Chemists," and full particulars about the Experimental Equipment given to every student. Also please tell me about your plan of payment and your special 30 day offer.

Don't Wait -- Mail the Coupon NOW!

CHEMICAL INSTITUTE of NEW YORK, Inc.

66—R, WEST BROADWAY Home Extension Division 10 NEW YORK CITY

NAME

ADDRESS

CITY STATE

THOUSANDS OF SET BUILDERS LAST SEASON STOPPED
PAYING FANCY PRICES AND BOUGHT OUR
CABINETS—WHY NOT YOU?

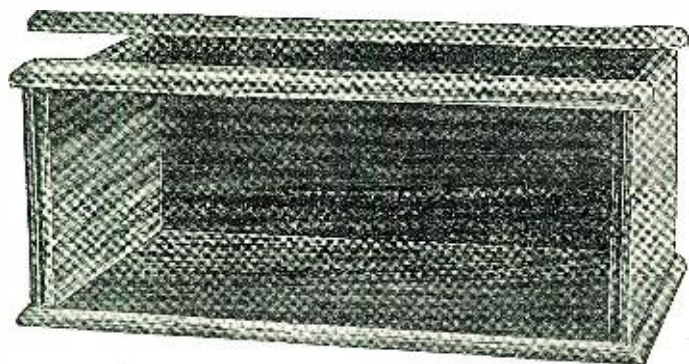

"PIEDMONT"

7" x 18" x 10"
7" x 21" x 10"
7" x 24" x 10"
7" x 26" x 10"

YOUR CHOICE
ONLY \$2.65 EACH
F.O.B. HICKORY.
Cash With Order—
No C. O. D.
We ship by express.

The price is very low and we shall make only a few cents on each cabinet,
BUT WE EXPECT TO SELL A LARGE QUANTITY OF THEM.
Hardwood with mahogany finish. Three coats of the new lacquer finish and
then rubbed down to a smooth glossy piano-like finish that is very hard and
durable. Fancy Nickle Plated Hinges.

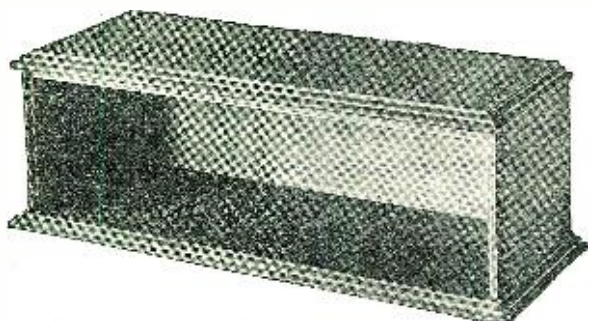

"IVEYLINE"

Made in hardwood, rubbed
mahogany finish and Solid
Black Walnut.

7" x 18" x 10" \$3.50	\$5.00
7" x 21" x 10" 3.75	5.25
7" x 24" x 10" 4.00	5.50
7" x 26" x 10" 4.75	6.25
7" x 28" x 10" 5.50	7.00
7" x 30" x 10" 6.00	8.00

FREE BASEBOARD.
Full Length Piano Hinge.
Lid Support. Rubber Feet.
7½ in. depth same prices.
CASH WITH ORDER,
F.O.B. HICKORY.

THE SOUTHERN TOY COMPANY, INC.

FREE CATALOG

HICKORY, N. C.



Instruments are Necessary—

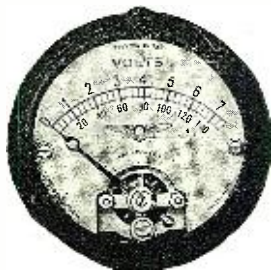

Pattern No. 135-B
One of the many
Jewell Radio instruments

Jewell instruments set the highest mark in
meter construction and are available in patterns
and combinations covering the needs of the en-
tire radio field.

Development and research engineers specify
Jewell instruments.

Manufacturers insist upon Jewel instruments
for adjustment of production standards.

Jobbers and retailers check their various lines
by Jewell instruments.

Experimenters and set builders who demand
dependable instruments turn to Jewell.

Send for New Radio Instrument Catalog No. 15-C

Jewell Electrical Instrument Co.

1650 Walnut St. - Chicago
"26 Years Making Good Instruments"

There is another variation of this type of
amplifier which must be considered. We
have passed from the simple voltage-divider
to the resistance-capacity coupled amplifier;
from this to the impedance-capacity coupled
type and then to various combinations of
these. It will be noted that the Donle am-
plifier bears considerable resemblance to the
transformer type, although differing consid-
erably from the latter in its action. We
shall now pass from the foregoing types to
the transformer-coupled amplifier. It is in-
teresting to note this transition from the one
type to the other, since by doing so it is
possible to understand many things about
amplifiers which have heretofore troubled
us.

THE AUTO-TRANSFORMER

The impedance coil is generally considered
merely as an *impedance* coil, or, as it is
termed in telephone parlance, a "retardation
coil." It may very easily and properly be
considered as an auto-transformer, or as a
transformer of two windings, in which the
two have merged together, forming a single
winding.

Let us then, take an impedance coupled
amplifier, such as that shown in Fig. 3, and
arrange it so that the plate current of the
first tube flows through only part of the coil
winding, as shown in Fig. 7. The general
characteristics of the circuit have not been
changed, but now, on account of the electro-
magnetic effects, the voltage ratio may be-
come higher than unity. We therefore have
the impedance coil acting as a transformer
rather than as a voltage-divider; and the
voltage ratio of this auto-transformer is,
very approximately, the same as the turns-
ratio. That is, if the tapping point, b, is one-
third the way up the coil, the voltage
between a and c will be, very approximately,
three times the voltage between b and c.

The circuit now possesses the features of
a circuit employing a two-winding trans-
former, except that the blocking condenser C,
is still required in the grid circuit of the
second tube. We will not now go further
into the discussion of this type of amplifier,
except to say that the writer does not believe
that the full merits of the auto-trans-
former have been generally recognized. It is
a well-known fact that auto-transformers
can be built, with much less wire and
smaller core, to handle the same power and
to have the same ratios as two-winding
transformers. There are other things to
consider, however, and we will study these
in a future article.

STANDARD TRANSFORMER COUPLING

It is but another step from the one-wind-
ing transformer, or auto-transformer, to the
two-winding transformer. This is shown in
the circuit of Fig. 8. The circuit appears
entirely different from that of Fig. 7, but
a glance will show the reasons why. In the
first place, since the grid (or input) circuit
of the second tube is not *conductively* con-
nected to the plate circuit of the first tube,
in which the "B" batteries are connected,
there is no longer any fear of an excessive
grid bias in the second tube due to the "B"
batteries. This means, therefore, that we
can remove the blocking condenser. Further-
more, since the secondary winding of the
transformer, which is connected to the input
of the second tube, has relatively low resis-
tance, there is likewise no longer any fear
of a "free" grid in the second tube. Conse-
quently we can eliminate the grid-leak resis-
tance. And there you are.

We have now pointed out the similarities
existing between all of the popular types of
audio frequency amplifiers; and have con-
sidered the reason for the particular ar-
rangements used. We have not, however,
gone very deeply into the subject, for there
remains to be studied the effects of varying
the many different elements of these circuits.

Insure your copy reaching you each month. Subscribe to Radio News—
\$2.50 a year. Experimenter Publishing Co., 53 Park Place, N. Y. C.

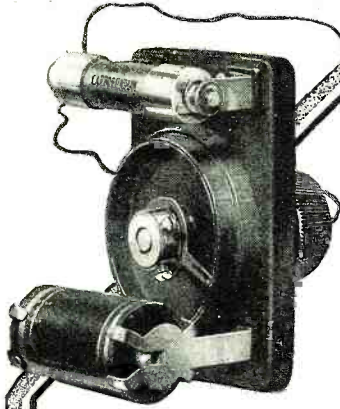

Tone Quality is the Thing

WITH the passing of the volume and distance fans there enters the demand for natural undistorted reproduction—the demand for a real quality of tone. The trend of radio is toward the crystal clear reception that you can get on any set with the Carborundum Stabilizing Detector Unit.

It's a Carborundum Detector permanent, rugged and fixed under a five pound pressure—no cat's whisker—no adjustment—no possibility of burning out.

By means of a potentiometer and tiny booster battery it is electrically controlled to match the receiving conditions of all sets of any type. Gives you greater selectivity and distance—but above all quality of tone.

Dealer or Direct
\$3.50
IN U. S. A.

THE CARBORUNDUM STABILIZING DETECTOR UNIT

Reg. U. S. Pat. Off.

Improves Any Set

Send for the 1927 Hookup Booklet on 6-tube Shielded Set, Improved 200-mile Crystal Set, Circuits, Etc.

Made exclusively by
THE CARBORUNDUM COMPANY
NIAGARA FALLS, N. Y.

SALES OFFICES AND WAREHOUSES IN
New York, Chicago, Boston,
Cincinnati, Cleveland, Philadelphia, Detroit,
Pittsburgh, Milwaukee, Grand Rapids
The Carborundum Co., Ltd., Manchester, Eng.



The Detector Alone
\$1.50
IN U. S. A.

The Carborundum Company
Niagara Falls, N. Y.

Please send free Hook-Up Book D-1.

Carborundum is the Registered Trade Name used by The Carborundum Company for Silicon Carbide. This Trade Mark is the exclusive property of The Carborundum Company.

Name _____

Street _____

City _____ State _____

A STROLOGY!

The high art of hoodwinking
Mr. Average Man!

Read The Daring Exposé in October

Science and Invention

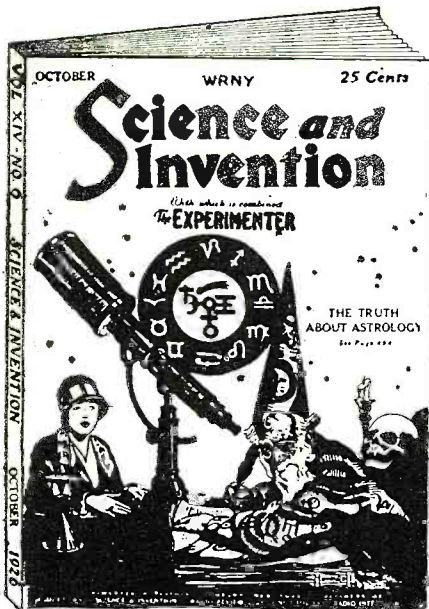

Your horoscope, when read by a (competent?) astrologist will positively reveal some marvelous things for your future life—the planets say so. Of course this entirely depends on when you were born—but Science and Invention says this is all pure bunk. You ought to know the facts about Astrology. Get a copy of October Science & Invention now—from your nearest newsdealer—and read the big article on this subject.

OTHER FEATURE ARTICLES IN OCTOBER

COULD NOAH'S ARK HOLD ALL THE ANIMALS?

The modern scientific viewpoint is illustrated and described in an interesting way. You will enjoy it.

HOW NORTH POLE AIRPLANE FLIGHT WAS NAVIGATED

How Commander Byrd navigated his airplane to the North Pole and back, explained with simple diagrams by an aeronautical engineer.

WINTER HOUSE GARDEN

An interesting and seasonal article by the well-known authority on flowers, Dr. Ernest Bade.

PIPE CONTEST

What can you do with iron or other pipe and fittings? New prize contest will appear in the next number.

HOW TO READ BLUEPRINTS

A subject which is engaging the attention of more people than ever before. This article will be profusely illustrated with photos and diagrams, making the subject as plain as A B C.

**OVER \$5,000
IN PRIZE OFFERS**

MANY MORE BIG ILLUSTRATED ARTICLES
EXPERIMENTER PUB. CO. INC.,—53 Park Place, New York

OCTOBER ISSUE 25c — ON ALL NEWSSTANDS

WAIT! *It's Coming-*

—a perfected “A” Battery Eliminator that actually ELIMINATES the “A” Battery!

- It is entirely new in principle!
- It operates DIRECTLY from the light socket!
- It has no battery to bother with!
- No acids or liquids to replace!
- It needs no attention of any kind!
- It has been thoroughly tested and proved!
- It will be ready October 1!

DEALERS — JOBBERS

This revolutionary new “A” Eliminator is the only one of its kind. There is nothing like it. It has no competition. It will sell at a price that will permit of legitimate profits to dealers and jobbers. Distribution will be limited to protect trade outlets. Full announcement will be made October 1. If you are interested in obtaining full particulars before that date, write immediately, or even better, wire.

THE COOPER CORPORATION
CINCINNATI, OHIO
Radio Division, Dept. N.

A Book for every Radio Set user!

The Radio Trouble Finder

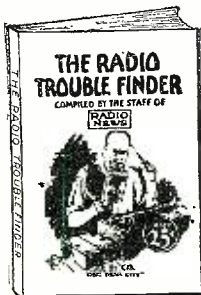

No matter how much or how little you know of your radio receiver, this new “Radio Trouble Finder” book is going to be a big help.

Gives special simple tests by which you can determine what is wrong with your receiver. Then for each particular fault there is explained the proper procedure for correcting it.

All troubles and their remedies are arranged in simple charts so that even the most inexperienced radio user will have no trouble in keeping his set at all times in first class condition.

200 ILLUSTRATIONS
SIZE 6 x 9 INS.

25c—ON ALL NEWSSTANDS
THE CONSRAD CO., Inc., 64 Church St., New York

In other words, although we have the fundamental circuit arrangements, we know nothing as yet about the *values* of the resistances, impedances, capacities, etc. We want to get as much amplification as possible. This means we want the voltage-ratio of the coupling device to be as high as possible. At the same time we wish to avoid all effects that lead to distortion.

In other words, all this requires that the separate systems be studied in detail; we shall proceed to do so in the succeeding articles, which will deal mainly with the resistance-capacity-, impedance-capacity-, and transformer-coupled types of amplifiers. We shall determine what value of capacity to use, how high to make the external plate resistance, what turns-ratio to use in the transformer, and many other important things.

A New Amplifier and “B” Supply Unit

(Continued from page 359)

As there are quite a few holes to be drilled in the brass base, it is well to keep in mind that much time and energy can be saved by using sharp drills. It only takes a minute or so to sharpen a small twist drill with a file.

Hold the drill in a vise and file away from the cutting edges until new and sharp edges are obtained. If a new drill and a dull drill are simultaneously examined and compared, no difficulty will be had in determining just how to sharpen the old drill. The following points should be watched during the process:

The cutting edges should be lower than the trailing edges.

The point of the drill should be kept in the center. That is, both sides should be filed equally, so that the drill will not make over-size holes.

The angle of the drill point should be the same as that of a new drill.

The larger holes required in a number of places in the base, for groups of leads to pass through, may readily be made with a small drill and reamer if a large size twist drill is not available. Most radio-set constructors have a reamer.

The three grid condensers, for the resistance-coupled amplifier, and the output condenser are all contained in one unit, with four pairs of leads. This is mounted with the leads coming out through the bottom and passing directly through four large holes in the base plate. The various leads are then run under the base in straight lines towards the units to which they are to be connected, and then brought up through another set of holes. Thus much of the wiring is concealed and at the same time kept shorter than would be possible if it were located above the base.

After all the holes have been drilled and the burrs removed with a rose bit, the various parts are fastened in place with short, 6-32 round head brass machine screws. Before mounting the filament resistances, however, the spring clips must be removed from the fiber base, and the holes at each end more deeply countersunk; so that, when again assembled, there will be no possibility of the heads of the machine screws protruding far enough to cause a short circuit on the brass base.

THE INSULATING PANELS

Fig. 6 gives the size and location of the holes for the two small panels. One, located at the rear of the amplifier, contains all the necessary binding posts; while the other, which is located at the front, serves as a control panel and is equipped with the two plate-voltage and grid-bias controls, in addition to the 110-volt A.C. switch and the filament jack. The two panels are held in

place, until the top and sides of the metal case are assembled, by means of machine screws passing through the vertical side of the upper brass-angle frame.

WIRING

After the two small panels and all of the component parts of the amplifier power supply unit are in place, the actual wiring is started. The first step is to bend down the soldering lug on one of the filament prongs of each of the first two amplifier sockets, and solder to the brass base. The remaining filament prongs on these same two sockets are then soldered directly to the lug on each of the self-adjusting rheostat mountings. The grid and plate terminals of the double-resistor mounts are connected to the sockets with short lengths of bus bar. The flexible leads supplied with the grid-condenser block are of sufficient length to run under the base to the three resistor mounts. The remainder of the connections are made with No. 18 stranded, rubber-covered wire. When running the wires under the base, make them of such a length that they can be grouped together and bound into a single cable, when the wiring has been completed, as shown in Fig. 4.

POWER-TUBE GRID VOLTAGE

The rheostat located in the center of the front control panel controls, in connection with the 50,000-ohm fixed resistor and the 1.0- μ f. fixed condenser (located under the base), the "C" voltage supply for the last tube. As the plate voltage supplied to the UX-171 is over 180, the "C" voltage is in the neighborhood of 40, negative; and is readily varied by changing the resistance of the rheostat. The purpose of the fixed re-

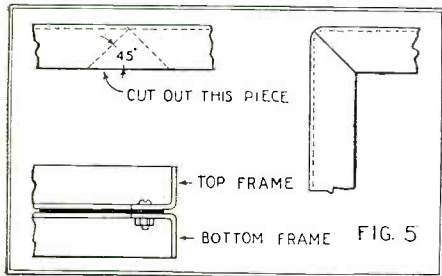

If these directions are followed for the amplifier-case construction, the finished job will be neat and the work required for its completion, a minimum.

sistor and condenser is to form an audio-frequency filter circuit, to keep the audio-frequency component of the plate current from passing through the variable resistor and thus producing a pulsating grid-biasing voltage.

COMPLETING THE UNIT

After the unit has been completely wired and perforated brass sides and top are made and fastened in place. The perforated brass comes in strips 12 inches wide and of any desired length. As the sides of the case are just six inches high, the material is cut with out waste by dividing a strip down the center. A frame of flat brass strip $1\frac{1}{2} \times \frac{1}{8}$ -inch is soldered to the top and bottom edges (on the inside) of the sides in order to stiffen them and prevent buckling. When the sides have been placed in position on the base, holes are drilled through the sides of the upper brass-angle frame, which is attached to the base, and into the brass stiffening strips that are soldered to the bottom edge of the perforated side sheets. Round-head brass machine screws through these holes will then hold the sides securely in place. A hole is cut in the lower rear corner of the back, near the power transformer, for the porcelain bushing through which the flexible lamp cord is brought out.

The manner in which the side sheets are fitted and fastened to the two insulating

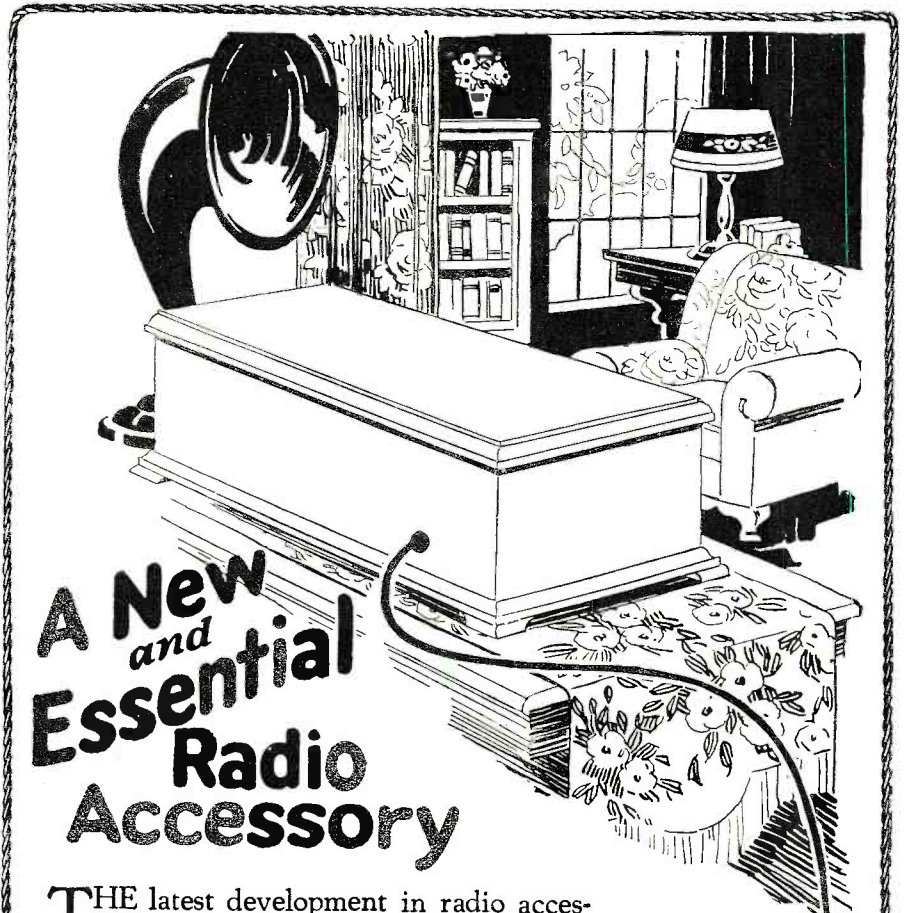

A New and Essential Radio Accessory

THE latest development in radio accessories is the Belden Fused Radio Battery Cord, with two enclosed fuses to protect the A and B-Battery circuits.

This remarkable and efficient fused battery cord acts as a safety valve for your radio set; it protects the batteries from accidental discharge, and likewise eliminates the fire hazard from crossed wires.

The Belden Fused Radio Battery Cord makes a neat installation by dispensing with the usual array of loose wires behind the set, and it protects tubes from burn outs.

Ask your nearest radio dealer today for a Belden Fused Radio Battery Cord, sold only in the Belden striped orange and black carton. Your set is not complete without the protection of this essential battery cord. It is inexpensive insurance against fire hazard and costly short circuits.

The A-Battery and B-Battery fuses are enclosed in a neat bakelite cover that is easily opened to permit inspection of the fuses. The fuses are not interchangeable with each other, nor with automobile fuses, so wrong fuses cannot be used accidentally. New fuses can be obtained from your dealer.

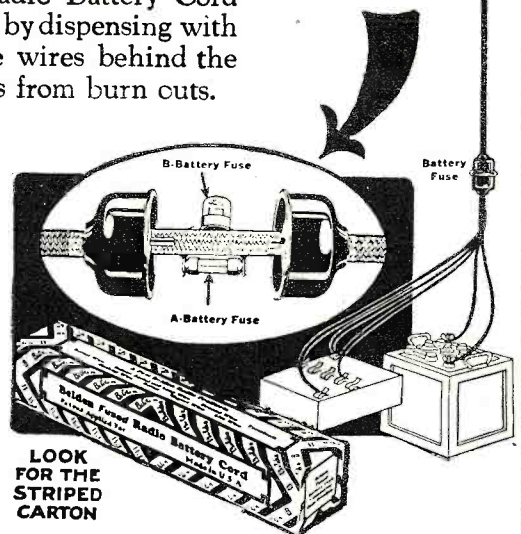

BELDEN MANUFACTURING CO.
2314A So. Western Ave., Chicago

Belden Fused Radio Battery Cord

For Better Results build your set with —



Dependable Products

Endorsed and used by
leading set builders

*May we send
you our complete
catalog?*

Write Dept. [R. N.]

LESLIE F. MUTER COMPANY
76th & Greenwood Avenue
CHICAGO, ILL.



Variable High Resistance

Single Pole Double Throw

Double Pole Double Throw

Triple Pole Double Throw

Five Pole Double Throw

Resistance Amplifier Unit

Fixed Grid Leaks

Resistance Amplifiers

Interference and Static Eliminator

Audio Frequency Transformers

Push-Pull Panel Switch

Automatic Shock-Proof Phone Plug

Fixed Condensers

Fixed Rheostats

Lightning Arrester

Antenna Lead-In Insulator

Adjustable Ground Clamp

Standard Complete Aerial Kit

Variable Condensers

panels is quite clearly shown in the various illustrations and presents no constructional difficulties.

The top consists of another angle-brass frame identical in size to the upper of the two used in the construction of the base. Inside this frame is soldered a panel of perforated brass. If the work has been carefully done the top will fit snugly over the sides and the complete unit will look just like the model shown in Fig. 2.

The brass angle strips, plates, and perforated sheet may be obtained from any large hardware store or metal supply house.

USING THE AMPLIFIER

If the set with which the amplifier is to be used has a detector jack, then it is a simple matter to plug in the amplifier. If not, then the method of connecting the input of the amplifier to the output of the detector tube will largely depend upon the circuit used in the set. If the detector circuit is of the non-regenerative type, a lead may be run from the plate terminal of the detector tube socket direct to the lower or P input binding post on the amplifier. The upper, or "B+", amplifier input terminal going to the "B+Det." supply binding post on the same panel.

In most cases, however, the most satisfactory way to connect the external amplifier to the set is to disconnect the primary transformer lead marked P from the first audio transformer in the set. The other, or "B+"

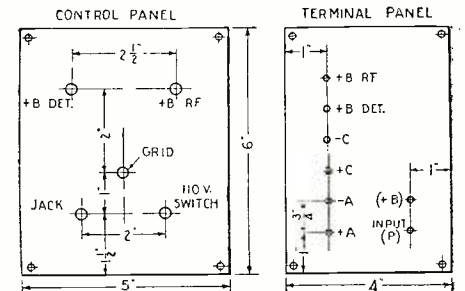

FIG. 6
Above are shown data for the drilling of the two small panels for the eliminator and amplifier.

input lead being obtained by connecting to the "B+Det." terminal of the "B" supply.

A double lead must also be run from the "A" battery binding posts on the set; or if more convenient, direct from the "A" battery to the "A" posts on the amplifier. If the radio set is equipped with a radio-frequency amplifier, then a lead must also be run from the "B+" R.F. binding post to the corresponding post on the amplifier terminal board.

A "C" battery of from 1½ to 3 volts is connected to the amplifier "C" posts. This grid voltage is for the first two resistance-coupled-amplifier tubes.

OPERATING THE AMPLIFIER

After the amplifier and radio set have been properly connected up, insert the tubes in their proper sockets, using 201A or 301A type tubes in the radio-frequency amplifier sockets and, if desired, in the detector socket. The first two audio amplifier tubes are high-μ; and the last, or power audio tube, is a UX-171 or CX-371. A type "BH" double-wave filamentless rectifier tube is used in the remaining socket.

Insert the A.C. plug in a lamp socket, or other convenient outlet, plug in the loud-speaker, to light the filaments of the high-μ tubes by means of the filament jack, and pull the A.C. switch on the control panel.

Set the two-plate voltage-control resistors at a high value of resistance (low voltage) and tune in some local station.

The three controls should then be adjusted to their optimum values. If the detector voltage is excessive, the detector tube will generally go into oscillation very readily and

New 1927 RADIO CATALOG Now Ready

SENT FREE!

More than a score of new hook-ups—all the latest and best—with specified parts to build them—at prices that mean big savings for you. And all the latest parts and accessories as advertised in current radio magazines. The largest, most complete and up-to-date radio stock in the world. Yours to choose from in this new catalog. Write for your copy.

Write Today!

CHICAGO SALVAGE STOCK STORES

DEPT. R. N.

509 S. State Street, CHICAGO, U. S. A.



FREE RADIO GUIDE

FREE RADIO CATALOG & GUIDE for 1927. Gives special hook-ups with illustrations. Shows savings on standard radio parts, complete sets, kits. Be sure to get this snappy book before you buy. Write letter or postal NOW. Also include name of another fan.

BARAWIK CO., 542 Monroe St., CHICAGO, U. S. A.

"Lighting Fixtures"

READY TO HANG
(Direct from Manufacturer)
Completely wired including glassware
Send for new Catalogue No. 27
(Just reduced prices)
Special Proposition to Dealers
ERIE FIXTURE SUPPLY CO.
STATION R ERIE, PA.

with a loud pop. If, on the other hand, the detector voltage is too low, the detector tube will not regenerate. Excessive plate voltage on the R.F. tubes will generally cause undesired oscillation. If the grid-biasing voltage is too great, negatively, the signal received, aside from being distorted, will lack volume. Insufficient grid bias in most cases results in the familiar "motor-boating" characteristic of the rectifier tube, when not operated under the proper conditions.

If a plate milliammeter, with a scale of 0-50 or thereabouts, is available it may be temporarily connected in the plate circuit of the power tube and used as a convenient indicator for determining just when the proper value of the grid bias is obtained. When properly adjusted the deflection of the milliammeter needle, when a strong signal is being received, is at minimum.

There will be no doubt as to the proper adjustment once it is obtained, as the broadcasting will come in with great volume and well-nigh perfect quality. The shrill notes of the upper musical scale as well as the low notes of the bass will be present in their proper proportions, as well as all the overtones and harmonics so essential for fullness, mellowness, roundness, and naturalness of tone quality.

Perhaps, before concluding, it might be well to mention one more point. No matter how good the amplifier, if one has a poor speaker, the best quality cannot possibly be obtained. So, be sure and use a good speaker.

LIST OF PARTS

- Resistor Assortment (three 0.1-meg., one 1.0-meg., one 2.0-meg., one 1/2-meg., and one 1/4-meg.);
- 1 Resistor, .05-meg., R2;
 - 4 Resistor Mounts, three double, one single;
 - 2 Self-Adjusting Rheostats, 1/4-amp. (R1);
 - 3 UX Tube Sockets;
 - 1 Raytheon type "BH" Tube and Socket (T3);
 - 1 UX-171 or CX-371 Tube (T2);
 - 2 High- μ Tubes (T1);
 1. Variable Resistor, 25,000-ohm (R3);
 - 1 Variable Resistor, 1,000-200,000-ohm (R4);
 - 1 Variable Resistor, 100-50,000-ohm (R5);
 - 1 S.C. Filament Control Jack;
 - 1 Switch, 110-volt;
 - 1 Filter Condenser Block, 1-, 1-, 6-, 2- and 4- μ f. units (as shown respectively from left to right on the schematic wiring diagram (C4);
 - 3 Filter Chokes, 50-henry (L1);
 - 1 Grid Condenser Block (three 1.0- μ f. and one 4.0- μ f. mfd. filter condensers), C3;
 - 1 Power Transformer, L2;
 - 1 Transformer Condenser Block, two 0.1- μ f. units (C1);
 - 1 Fixed Condenser, 1.0- μ f. 500-volt type (C2);
 - 2 Insulating Panels (Fig. 6);
 - 8 Binding Posts;
- Lamp cord and plug, brass as diagramed, wire, solder, screws, etc.
Approximate cost, \$80.85.

IT is against the policy of RADIO NEWS to publish the names of manufacturers or makes of instruments in connection with the apparatus described in these pages, but this information will be gladly given privately. If you are interested in any special instruments described here, address a letter to the READERS' SERVICE DEPARTMENT, enclosing stamped return envelope. The names and addresses of the manufacturers will be given free of charge.

—EDITOR.

Bradleyohm-E

PERFECT VARIABLE RESISTOR

for B-Eliminators



Bradleyohm-E is a new and enlarged Bradleyohm designed especially for B-Eliminator Voltage Control. The extra long columns of scientifically-treated graphite discs insure perfect voltage control over a wide range. It is made in several ranges for various B-Eliminator circuits.

Bradleyunit-A

PERFECT FIXED RESISTOR



Bradleyunit-A is a solid molded resistor for radio circuits. It is molded and heat-treated under high pressure, making it impervious to moisture. The silver-capped ends can be soldered without affecting the calibration of the Bradleyunit.



Are You Building a B-Eliminator?

IF so, follow the example of leading radio engineers and use the Bradleyohm-E and Bradleyunit-A for your voltage control.

Most of the well-known factory built B-Eliminators are equipped with Bradleyohms as standard equipment. Surely, no better recommendation of the reliability and stability of the Bradleyohm can be asked.

Build permanent performance and high efficiency into your B-Eliminator by asking your dealer for Bradleyohm-E and Bradleyunit-A for your circuit.

Allen-Bradley Co.

287 Greenfield Ave., MILWAUKEE, WIS.

Use
Allen-Bradley
Perfect Radio Devices

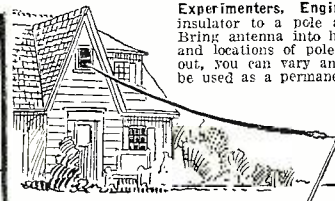

Experimenters, Engineers! Attach Reel Aerial insulator to a pole and push pole into ground. Bring antenna into house. By changing distance and locations of pole, and reeling antenna in or out, you can vary antenna as desired. May also be used as a permanent aerial.

In a Jiffy Anywhere Put Up, Change or Take Down Your Aerial

No more hours wasted putting up or taking down antennas. No leads to solder. No holes to drill. No tangling of wire. Carry a 21-ounce REEL AERIAL in pocket and put up a 100% efficient aerial in a few moments—any time, any place—outdoors, indoors. Its hard drawn FLAT copper wire (3/4 in. wide) can be led in under or over window or door which can be closed tight without harm to wire. Aerial can be reeled out or in to any desired length up to 100 ft. Unused portion in case does not cause dead-end losses. Place case on or near set and connect with cord which plugs into center of Reel Aerial. Order today. Satisfaction Guaranteed.

SEND NO MONEY, JUST MAIL COUPON

HAWKEYE RADIO CO., Division of Hawkeye Lightning Rod Co., Dept. 1410, Cedar Rapids, Iowa. Ship me—on YOUR MONEY BACK GUARANTEE—one Reel Aerial C.O.D. I will pay postman \$5 plus few cents postage (postage prepaid when money accompanies order).

NAME
ADDRESS

You are dealing with an old reliable firm. SEND THE COUPON NOW!



Illustration is 1/2 size. Reel Aerial weighs only 21 oz. Nickeled case, 3/4 in. dia. fits pocket. Contains 100 ft. 3/4-in. flat copper wire—best antenna known.



The best permanent aerial known. Reel Aerial has same inductance value as stranded copper wire. Being flat and smooth it is easily cleaned.



For indoor aeriels—can be put up around walls or reeled out on floor.



For use in halls, theatres, laboratories, schools, clubs, on trains, at fairs, etc.

The Manufacture of Variable High Resistances

(Continued from page 341)

A DIFFERENT SYSTEM OF MANUFACTURE

However, the type of resistance in which we are interested is not directly in either class, and its method of manufacture is rather unique. Briefly, the resistance unit is a strip of specially treated fiber held by pressure in contact with a wire winding. Upon first inspection it would appear that the wire winding would short-circuit the resistance; but the wire is cut in half lengthwise and therefore acts only as a positive contact between the unit and the slider. The winding has approximately 150 turns, giving as many definite steps of resistance from minimum to maximum.

The manufacture of these rheostats and potentiometers is interesting, chiefly because of the great care needed in their preparation. The first part to be considered is the resistance unit. As mentioned above this is a strip of fiber, equal in length to the circumference of the rheostat, and about half an inch wide. This strip is impregnated with a special preparation, of which the chief constituent is graphite. After impregnation these strips are tested to ascertain that the coating is constant over the entire strip, applying or removing some of this coating if needed to get this desired condition. In an accompanying illustration are shown the operators performing these tests.

It is absolutely necessary that the wire winding be smooth, so that there will be no unevenness in the contact made by the slider. After this wire has been mechanically inspected it is cut in half along the strip, so there will be no short-circuiting of the resistance. The wire-wound strip and resistance element are next placed around a moulded core where they are held in place by a bakelite ring. The resistance is again checked at this point to make sure that there has been no change while the strip and wire winding were being assembled on the bakelite core.

This core and ring, enclosing the resistance, is then assembled on the base, to which is attached the slider and its attendant parts. After this the rheostat or potentiometer as the case may be, is given a final test.

A NON-INDUCTIVE RESISTANCE

There are several advantages in this type of resistance. In the first place as the resistance unit is an impregnated strip and the wire is used only for mechanical purposes, the result is an absolutely non-inductive resistance. Those readers who have endeavored to wind resistances of this type, using ordinary resistance wire, will appreciate what a feat such as this really means. There are many places in a radio receiving circuit where the introduction of resistance is necessary, but where the least bit of inductance will throw the circuit out. The same is true in respect to capacity, of which there is a certain small amount in some types of resistances. However, in the resistances here described the capacity at maximum resistance is only two micromicrofarads.

This is of extreme importance when the variable high resistance is used in radio-frequency circuits; and great care has been taken in the design to keep this capacity at a minimum. Any appreciable capacity in the unit would hold the R.-F. resistance value far below the desired or calibrated D.C. resistance value.

USED IN AUDIO AMPLIFICATION

The uses to which a resistance of this character may be put are manifold. They are most convenient for adjustable voltmeter multipliers, high-frequency capacity and in-

Byrd Took Day, Peary 8 Months To Reach Pole
Three-Motored Airplane
Speed Modern Arguments
Over North Waste, While
Discoverer Used Sled
Radio Informed World
News of 1926 Trip Came
Home, 1908 Expedition
Was "Lost" Whole Year

Home of Hurricanes Is Quest of Expedition to Greenland
Natural History Museum's Explorers Will Study
Weather, Birds and Beasts of Arctic

MacMILLAN PARTY MOVES NORTHWARD
Sachem and Bowdoin Leave
for Rockland and Bar Harbor

Where great achievements and human lives depend upon constant and effective operation—where the obligation of confidence **MUST** be met—"ESCO" has been chosen.
ELECTRIC SPECIALTY COMPANY

Manufacturers of Motors, Generators, Motor-Generator Sets, Dynamotors and Rotary Converters for all Radio Purposes. Have you got your copy of Bulletin 237B and ESCO "Filter Facts"? If not, write for them.

TRADE "ESCO" MARK

211 South Street

Stamford, Conn. U.S.A.

S. O. S. HYDROMETER
Simple—durable—accurate—no float to break—balls easy to read.
Swim all three, charged fully
Sinks the white, charge still right
Sinks the green, charge is lean
Sinks the red, charge is dead

Over four million patented Chaslyn Balls used by leading battery manufacturers as standard equipment in glass cased batteries and power units. Ask your dealer—if he can't supply, send seventy-five cents to

THE CHASLYN COMPANY
4617 Ravenswood Ave., Chicago

SINK WHITE CHARGE RIGHT
SINK GREEN CHARGE LEAN
SINK RED CHARGE DEAD

Rubber Covered Insulators

Actual Size

Neat and efficient. For antenna ground and for lead in wires. Small screw starts readily and makes finished job. Great improvement over ordinary large, unsightly insulators. They keep the wires in place and out of the way. Packed 10 in a box, 25c at your dealers or direct from us.

CULVER-STEARN'S MFG. CO.
Worcester, Mass., U. S. A.

Insure your copy reaching you each month. Subscribe to Radio News—\$2.50 a year. Experimenter Publishing Co., 53 Park Place, N. Y. C.

ductance bridges, galvanometer and phone shunts and numerous other uses. However, it is in radio receivers that the main uses of these resistances occur, and it would take more space than is available to give to enumerate all the different functions. One of interest might be mentioned, however, and that is the use of a high resistance in the plate and grid circuits of a resistance-coupled amplifier. Ordinarily these resistances are fixed and of the familiar cartridge type, but as there is a wide field for the experimenter along these lines, the use of variable high resistances will present him with an opportunity hitherto unrealized. Comparatively little is known of the various actions and reactions within the instruments making up an amplifier of this type, but with variable resistances of high values much may be learned.

40 Non-Technical Radio Articles

every month for the beginner, the layman and those who like radio from the non-technical side.

SCIENCE & INVENTION, which can be bought at any newsstand, contains the largest and most interesting section of radio articles of any non-radio magazine in existence.

Plenty of "How To Make It" radio articles and plenty of simplified hook-ups for the layman and experimenter. The radio section of SCIENCE & INVENTION is so good that many RADIO NEWS readers buy it solely for this feature.

Radio Articles Appearing in the October Issue of "Science and Invention" Magazine.

- Radio Fan's Home Page.
- How to Build the 3-Tube Monogram Receiver, by Joseph Liebowitz.
- Below 100 Meters.
- How to Make a Simple Drum Dial—Adapted to any Variable Condenser, by Herbert Hayden.
- How to Build a Deaf-Phone with 2-Stage Vacuum Tube Amplifier, by A. P. Peck.
- Radio Oracle—Questions and Answers.
- Radio Wrinkles—Illustrated.

Radio Set Owners' Information

(Continued from page 330)

ally connected *in series* with those normally employed with the set, thereby providing the higher "B" and "C" voltages for the power tube. None of the original battery connections to the set are to be changed. A somewhat similar connecting arrangement is utilized with the power tubes having the separate terminals. Diagrams are provided with these tubes.

THE TANTALIZER



Wives should be careful what they tune-in at mealtimes.

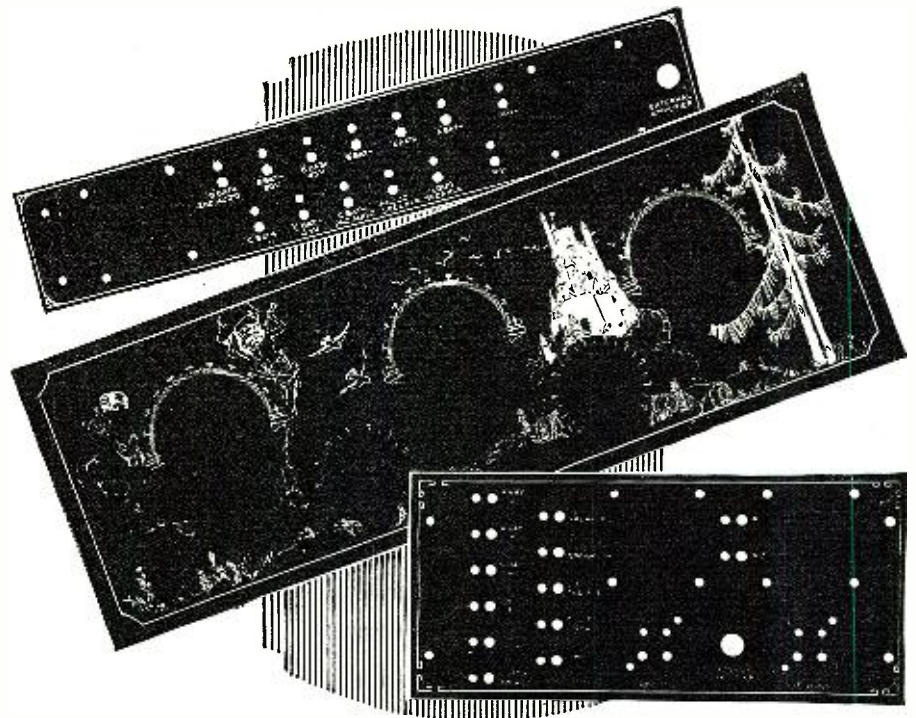

Punched and Veri Chromed Formica Base Panels

ON high-grade sets this year punched Formica base panels marked in gold by the Veri Chrome process will be very widely used. These panels have a very attractive appearance and give the interior of the set a finished appearance.

The panels may be had in either high gloss or mat finishes. The markings may be either gold or silver. For front panels Veri Chrome decoration in much greater variety of effects is now available. Some sets will have elaborate pictures. Others simple severe decoration. Dull satin finished wood effects are available.

FORMICA PANELS FOR KITS

Veri Chrome decoration has been applied to panels for numerous well-known kits. These include: Madison-Moore Superheterodyne; Victoreen Superheterodyne; Bremer-Tully Counterphase 5 and 6; Browning-Drake National; General Radio Universal Receiver; and L. C. 26 Cockaday.

Panels in standard sizes are sold in neat trade-marked envelopes. Special sizes may be had on order.

THE FORMICA INSULATION COMPANY

4618 Spring Grove Avenue Cincinnati, O.



FORMICA

Made from Anhydrous Bakelite Resins
SHEETS TUBES RODS

"BELIEVE ME, MISTER, YOU HAVE THE GOODS!"

A radio dealer whose name will be furnished upon request quotes:

"I can show two verifications from real foreign stations—and not on Test Week either—and have letters out now asking for three more!

"I have the Quadraformer set beside one of the best known makes of supers, of which I am the authorized dealer, and the Quadraformer outperforms it every time."

Wonderful reception. Unusual for even the Quadraformer; but it does show what the Quadraformer will do when our simple assembly instructions are faithfully followed.

**GEARHART-SCHLUETER RADIO CORP.,
Fresno, California**

The fact is undeniable; in every section of the country, radio enthusiasts are turning to the Quadraformer—hundreds of them every month.

A number of revolutionary advantages have been attained. The total absence of all stabilizers, resistances, and other neutralizing devices allows all the radio energy to be utilized in developing the true signal. Speech and music come in with rich, sweet tones. There is little or no back-ground of noise. There is no distortion. Distance seems to make little difference.

You can easily build this wonderful five tube receiver yourself. You need only the Quadraformer essential kit which sells for \$12.75 and a few other standard parts. Send 10c today for the QUADRAFORMER BOOK which tells the whole story. Please mention your dealer's name.



ALL DONLE

Tubes have been developed with the consistent idea that proper use of rare atmospheres results in a high efficiency obtainable by no other means.

The B-6 Detector - - \$5

**THE
DONLE-BRISTOL
CORPORATION**

Meriden - Connecticut

If You Want to Make More Money—
Read the Magazine That Tells You How!

"MONEY MAKING"

25c THE COPY—ON ALL NEWSSTANDS

I Want to Know

(Continued from page 376)

also whether the receiver is designed for power-tube operation, and the correct plate and grid voltages necessary for the power tube, if used?

A. 1. The following is all the constructional information we have available on the Kellogg R.F.L. receiver. Schematic wiring diagram is Fig. (2), 2190.

The five tuning condensers are mounted on a common shaft, which is split between each two condensers by means of an insulating bushing. The station indicator is a transparent sheet mounted on a cylindrical metal frame, and placed in the center of the condenser group. The shaft is turned by means of a worm drive between the right-hand pair of air condensers. Back of the condensers are mounted the tube sockets, adjusting condensers and miscellaneous apparatus, while underneath the shelf are the four R.F. transformers, and the antenna tuned circuit, which is the unshielded coil. The filament rheostat and meter panel are mounted to the right of the condenser group, since the filament adjustment is seldom made; and it is not necessary to have the voltmeter on the panel for an operating indicator, as the dial is illuminated. On the left, at the rear, is the antenna series condenser, which is adjusted upon installation of the set to the point of greatest efficiency for that particular antenna system, and is left alone.

Each of the four R.F. transformers is tuned with a .0005- μ f. variable condenser, each condenser being shielded by a metal can. The antenna coil secondary condenser is not shielded, being at the extreme left front of the assembly. From the diagram it can be seen that the grid return for three of the tuned circuits is through a one-turn coil, which is coupled loosely with the primary of the next R.F. transformer, and permits efficient neutralization of the amplifier.

Coil Specifications

Each R.F. transformer consists of an 8-turn primary, wound on a 2 $\frac{3}{8}$ -inch form, and a 62 $\frac{1}{4}$ -turn secondary wound on a 2 $\frac{3}{4}$ -inch form, each coil being of the cylindrical, space-wound type, with No. 20 enameled wire. The balancing coil, in the case of those transformers which are so equipped, is placed close to the primary, and both coils are at the low-potential, or filament end of the secondary. The antenna coil consists of a 45-turn primary, and 51 $\frac{1}{4}$ -turn secondary, both wound adjacent to each other on a 2 $\frac{3}{4}$ -inch form, with No. 20 enameled wire. Copper cans enclose each R.F. transformer, and the connecting leads from the transformers to the condensers and tube sockets are brought up through holes in the tops of the cans. This prevents coupling between tuned stages, and is the reason for the sensitivity and selectivity of the set.

Each variable condenser is adjusted for minimum setting by means of set screws with which the rotor plate groups are attached to the shaft; and after all rotor plate groups are adjusted, the individual tuned circuits are brought to resonance by means of small shunt variable mica condensers, which are shown in the diagram in parallel with the variable air condensers. Additional shunt mica condensers are connected directly to the positive filament circuit from the grids of certain of the R.F. amplifiers, in order to stabilize the circuit.

Volume control is obtained by varying the filament current of the first R.F. amplifier tube, and placing a variable high resistance in the grid return of the second R.F. amplifier. The two variables are mounted on the same shaft, and are so adjusted that the set does not oscillate at any time during the operation of the volume-control dial. The positive "A" and negative "B" battery circuits are grounded to the frame and shields, so that the shielding becomes the actual conductor for the A and B current. This reduces the number of wires in the set, and simplifies testing. A voltmeter enables voltage control through a master rheostat, which is in the negative filament lead.

MAPPING STORMS BY RADIO

While en route from Port au Prince, Haiti, to St. Thomas, Virgin Islands, the U. S. naval transport *Kittery* successfully plotted the path of a hurricane by using its radio compass. The navigator took the bearings of the point of *heaviest static*, and from this data computed the center of the storm as it swept along. Checking this with later weather reports it was found he had made his calculations accurately.

A new use for the radio compasses in foretelling the lanes of hurricanes and storms in time to save lives and property is predicted, according to a Navy Department announcement.

Likes and Dislikes of the Radio Audience

(Continued from page 350)

Perhaps he was right, that people would pay for the privilege of keeping something off the air. It is like the old song "Johnny Morgan plays the organ, his sister plays the drum, with a tum tum di dum. Oh the music is so sweet—people give them a penny to keep in another street." Whether a penny or the millions, who can tell? But the only way we, who are running programs, know what you want, is to learn from you.

LETTERS FROM WRNY FANS

At WRNY we do get a tremendous amount of mail from people, who grow extremely enthusiastic about one thing or another, but everybody doesn't take the trouble to sit down to comment on everything which is liked, or anything which isn't. That is human nature.

Of course, we do have ways of learning much from our listeners. For instance, when WRNY took the momentous step of changing its wavelength to 374.8 meters, we didn't need to ask. We received. Every one of our dozen telephone lines was clogged all day long by fans who congratulated us—and some very few who didn't; I think the complaints came about in the ratio of one to two hundred congratulations. Then in poured the mail, more than *three thousand* letters the very first week. Isn't that wonderful?

AN APPRECIATED FEATURE

Then, when the Edison German Hour program went on, the letters averaged *one hundred and fifty* a day for that feature alone. No doubt you have been following the summer concert course of the Edison Hour, taking you on a musical tour of all nations. By the time this reaches you, of course, that will be long past, and a new series of importance will be delighting you, as the Edison Ensemble brings it to you.

The month just passed has been particularly momentous. It marked the tieup of WRNY with Station WMAF of South Dartmouth, Mass. That powerful station, which operates on 440.9 meters, is owned by the millionaire philanthropist, Colonel E. H. R. Greene, and is reputed one of the greatest distance-achievers in the world. Every Tuesday and Thursday now you can hear WRNY programs on either wavelength.

HOW AN ORCHESTRA IS MADE UP

Before I give you a rapid-fire resumé of the month's high spots, I will give you a little story of popular education in music. So I will tell you something about an orchestra, and the individual members of the family you hear in a concert, whether over the air or in a hall.

The average concert orchestra has these sections:

- Strings;
- Wood wind;
- Brass;
- Percussion.

The conductor with his baton gives the beat of the time, the spirit, and the whole direction to the meaning of the phrases. He is the soul of the orchestra; and a great conductor can make any body of *good* musicians into *master* musicians. A musician who merely beats time is not a real conductor.

The string section consists of the violins, violas, 'cellos and bass violins. The violins divide into firsts and seconds. At the first desk of the first violins is the concertmaster, who is the chief man of the orchestra un-

None other than high quality radio products can give good steady results—



All Benjamin Radio Products are of the same high standard as the far-famed Cle-Ra-Tone Sockets—

The most beautiful or the largest radio set it is possible to produce is helpless with just a little technical flaw in its interior. Thus if you would have clear and consistent radio reception you can not afford to use "bargain" radio parts.

There are just three characteristics which have gained popularity for Benjamin Radio Parts; the best possible quality in material; the highest perfection in technical construction; and absolute permanence in cooperating with other radio parts to give perfect radio reception.

Improved Tuned Radio

Frequency Transformers

Proved through exhaustive and comparative tests to be the most efficient coil for modern radio sets. Better in all important features and characteristics. Space wound. Basket weave. Cylindrical.

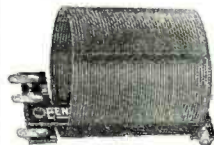

2 1/4" Diameter Transformer

Compact. Especially desirable for crowded assembly. Eliminates interfering "pickup." Set of three, \$5.75; Single transformers, \$2.10.

3" Diameter Transformer

Capacity coupling reduced to lowest degree. For use with .00035 Mfd. Condensers. Set of three, \$6.00; Single Transformers, \$2.25.

Push Type Cle-Ra-Tone Sockets

Spring Supported, Shock Absorbing. Stop Tube Noises. Greatest aid to non-noisy operation. Contacts always clean. 75 cents each.



Battery Switch

Quick, positive, clean-cut make and break. When it's "in" it's "off," eliminating danger of wasteful use of battery. 30 cents each.



Straight Line

Frequency Condensers

No crowding of stations. The broadcast range is spread evenly over the complete dial. Stations come in without interference, and tuning is much easier. Adjustable turning tension. Low loss characteristics give a definite and distinct radio reception. Beautiful in appearance—a credit to the looks and efficiency of any set. Finished in dull silver. Made in three sizes:

- .00025 Mfd., \$5.00
- .00035 Mfd., \$5.25
- .0005 Mfd., \$5.50

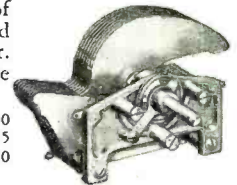

"Lekeless"

Transformers

Uniform high inductance, low distributed capacity and low resistance. The external field is so slight that it permits placing coils close together without appreciable interaction. Single transformers, \$2.50.



Brackets

An aid to simplification in set construction. Supports sub-panel, with room underneath for accessories and wiring. Plain and adjustable. Plain 70 cents per pair; adjustable, \$1.25 per pair.



PRIZES FOR RADIO HOOKUPS

A contest for new and original circuits. Write our nearest office for full details.

Benjamin Electric Mfg. Co.

New York 120-128 South Sangamon Street San Francisco
247 W. 17th Street Chicago 448 Bryant Street
Manufactured in Canada by the Benjamin Electric Mfg. Co. of Canada, Ltd., Toronto, Ontario

If your dealer cannot furnish you with Benjamin Radio Products send amount direct to our nearest sales office with his name and we will see that you are promptly supplied.

Build with PILOT Parts and SAVE MONEY!

Trade  Mark



VERNIER DIAL
(Pilot Kilograg)
Ratio 10:1. Makes fine tuning positive. Genuine Bakelite. Knob and flat surfaces knurled.
No. 1275 \$1.00
(Dia. 4 in.)

4 INCH DIAL

One piece massive, handsome, of solid genuine Bakelite. Knob and flat surfaces knurled.
No. 1274 50c

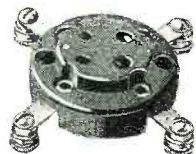
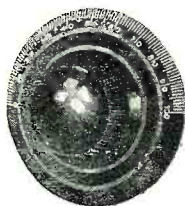

FITALL UNIVERSAL SOCKET
Accommodates all tubes, old style or new U2 tubes. Genuine Bakelite. Binding posts reversible.
No. 203 40c

SERIES RHEOSTATS & POTENTIOMETERS
(One hole mounting)
Genuine Bakelite. Adjustable to panel of any standard thickness. Slider built as unit assembly.
Rheostats: 6, 10, 20, 30 ohm 70c
Potentiometers: 200 ohm 90c
400 ohm \$1.20



PILOT KNOBS
Genuine Bakelite. No. 1251 has 8x32 threaded bushing or hole and set screw for 1/4 inch shaft. No. 1252 has only hole and set screw for 1/4 inch shaft.
No. 1251 15c
No. 1252 20c



PILOT SWITCH
Bakelite Insulated. Complete with "on" and "off" name plate. Single hole mounting.
No. 41 45c



PILOT PLUG
Genuine Bakelite, automatic plug of the spring grip type. Tips inserted and removed in a jiffy.
No. 275 40c



PILOT LUG-JACK
May be used with or without solder connections.
No. 1161—Single circuit open 35c
No. 1162—Single circuit closed .. 40c
No. 1163—Filament control, Single Jack 45c
No. 1164—Filament control, Double Jack 50c



PILOT LIGHT
Tells at a glance when tubes are lit from front panel. Single hole mount. Saves Batteries.
No. 40 45c

SNAP TERMINALS AND STRIPS

Takes all standard phone tips and Pilot snap terminals. Genuine Bakelite and nickel plate. Markings white enamel.
No. 1000 (strip) 50c
Snap terminals accommodates any standard size wire. No soldering, positive permanent connections.
No. 280 Snap Terminal 10c

THE set builder who for the first time uses Pilot Parts is astonished at their marvelous high quality and perfect performance. He wonders how it is possible to make and sell them at such low prices.

Tremendous quantity production makes Pilot low prices possible without in the least sacrificing their high standard of excellence.

Pilot is the largest radio parts plant in the world. It enjoys the cooperation of America's greatest chain store systems and through their various radio departments sells millions of parts every year—more than any other manufacturer.

Other manufacturers by reason of small production must maintain high prices. They therefore shout superior quality as their excuse for high prices. Pilot does not excuse its low prices. It explains them as being caused by quantity sales. And Pilot does not have to talk high quality: it proves it by perfect performance.

In a recent International contest announced through Radio Broadcast, the winner—J. H. Butler, of Brooklyn, N. Y.—used Pilot variable condensers and Uncle Sam in his Navy Department has just recently adopted Pilot fixed condensers.

Pilot parts are sold and used all over the civilized world.

If there is an S. S. Kresge Co. store in your town you will find Pilot Parts on sale in their Radio Department exclusively. If there is no Keesge Co. store, look for the Pilot dealer. Insist on Pilot parts and get perfect performance at low cost.

If no S. S. Kresge Co. store or other Pilot dealer is convenient you may send your order direct to us, accompanied by express or post office money order, adding ten cents additional to the prices quoted in this ad to cover cost of packing, shipping, etc. When ordering be sure to send us the name of your Radio Dealer.

PILOT ELECTRIC MFG. CO.
100 South 3d St., Brooklyn, N. Y.

Dealers in Cities where there are no Kresge Stores are invited to ask regarding Pilot parts Franchise.

PILOT PARTS for PERFECT PERFORMANCE

Pilot Condensers
"Velvet Feet"
CAPACIGRAD
Modified Straight Line. Centrally located bearings, cut out stator and rotor plates, extra reinforcements of rotor plates.
(8 Plate) 170 M.M.F. \$1.60
(13 Plate) 300 M.M.F. 1.90
(17 Plate) 380 M.M.F. 2.10
(23 Plate) 500 M.M.F. 2.25
Double Condenser (2-17 Plate) Each section 380 M.M.F. \$4.00

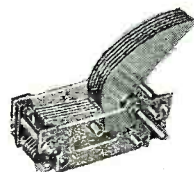

True Straight Line Frequency, solid brass plates, Special Bushings—free from chatter.
(8 Plate) 170 M.M.F. \$1.60
(13 Plate) 300 M.M.F. 1.90
(17 Plate) 380 M.M.F. 2.10
(23 Plate) 500 M.M.F. 2.25
Double Condenser (2-17 Plate) Each section 380 M.M.F. \$4.00



MIDGET CONDENSER
(NEUTRAGRAD M-7)
Compensates for variations in coils and condensers. Especially important where uni-control is employed. One hole mount.
(7 Plate) 25 M.M.F. \$.80
(13 Plate) 50 M.M.F. 1.00



ISOGRAD FIXED CONDENSERS

Accurate, permanent, noiseless mica condenser. Bakelite moulded, small in size. Terminal lugs flush with Bakelite. Completely sealed. Approved and purchased by U. S. Naval Research Labs. Prices on capacities not shown furnished on request.



Capacity:
.00025 and .0005 35c ea.
.001 and .002 40c ea.
.003 and .004 50c ea.
.005 60c
.01 70c
.015 \$1.20
Grid resistance clips 10c additional attached.



No. 34

SUB-PANEL BRACKET
Designed for mounting front and sub-panel. Genuine Bakelite. 6 3/4 in. long by 2 in. wide.
No. 34 50c

COIL MOUNTING BRACKET
Especially designed to accommodate basket weave coils. Attachable anywhere. Genuine Bakelite.
No. 33 10c



No. 11 No. 33

BINDING POSTS
Top genuine Bakelite, Non-removable head, all standard markings in white enamel.
No. 20A (state markings desired) 20c each
Nickel Plated Post No. 11 10c

ADJUSTOGRAD
700 ohm. For eliminating squeals and howls. Controls self oscillations of tubes in RF circuits.
No. 700 50c



PILOT SHORT WAVE PLUG-IN COILS

Primary adjustable coil and tickler are on the same interchangeable piece. Coil without mounting supplied in 11 inch lengths.
No. 1050 Primary, complete with mounting \$2.00
No. 1051 Plug-in, 19 to 58-meters \$2.00
No. 1052 Plug-in 38 to 105 meters 2.25
No. 1053 Plug-in, 86 to 220 meters \$2.50
No. 1054 Plug-in, 200 to 600 meters 2.50
No. 1055 Coil, 3" Dia. by 1 1/2" long, No. 18 S.C.C. wire, 13 turns per inch 2.75
No. 1056 Coil, 3" Dia. by 1 1/2" long, No. 24 D.S.S. wire, 32 turns per inch 3.60



Made By Worlds Greatest Radio Parts Manufacturer

der the conductor. He is assistant to the conductor and speaks for the men. He gives definition to the bowing and phrasing and fingering; and in an orchestra, where there are as many as forty violins, you can realize the importance of this.

The violas are to the violins as the baritone is to the tenor, or the contralto to the soprano. The viola is played in the same manner as the violin, but the tone is five notes lower and more mellow.

The 'cello is played between the knees of the artist. It is to the violin as the bass is to the tenor. The viola, 'cello and the bass violins are the foundation of the string section. The bass violins are those big violins played by the artist, when he tries to reach up to the top. In little orchestras about all they do is to say "oom pah, oom pah"; but in great concert orchestras, they do a big job.

THE WIND INSTRUMENTS

Now comes the wood wind section, called that in spite of the fact that often the instruments are not of wood. Here you have the clarinets and bassoons played from the mouth—straight instruments with their notes brought out by the fingers over the holes. The oboe ("oh boy") is another instrument held in the same way; but the oboe differs from the clarinet in that the reed is not kept in adjustment in the instrument, but is always in the mouth of the player, on his tongue. The oboe is weird in tone and pathetic. The clarinet compares to the viola, the bassoon to the 'cello.

The flute and piccolo are held parallel with the lips, and the air is sent at right angles to the instruments.

Now in the brass, we have the trumpet, the slide trombone which all people recognize. But the French horn and the English horn and tuba are difficult to describe. Sometime I'll let you see a picture of them.

Now for the percussion. That includes drums, tympani (another form of drum of hemispherical shape), the triangle, bells and all the traps. They make the noises, thunder, etc. Of course every good orchestra also adds the harp for special effect, and sometimes the xylophone and other instruments on occasions.

Now you have a panorama of the orchestra formation.

A MONTH'S FEATURES AT WRNY

During the past month at WRNY we put on the first exclusive radio prize fight, between Jimmy Rappaport and Bennie Martini, with that old veteran Jimmy Macdonald refereeing the bantams. The event was staged by Starlight Park. Also, we had a real swimming contest at WRNY. Do you wonder how it was done? Look at the picture of the girls. One of them was a Comtesse du Barry.

For the Fourth we reproduced the actual events at the Congress in 1776 when the Declaration was signed. The voices of John Hancock, John Adams, Thomas Jefferson and the rest spoke up in the way they did in the historic days.

During the past month Louise Closser Hale and Olive Wyndham were heard in an Edison Hour prize play. One of the most beautiful musical events ever radioed began this month at WRNY with the A. Y. Cornell Opera Company. Such voices! Fresh, beautiful and dramatic. And at the piano was the distinguished pianist composer Charles Gilbert Spross.

As dramatic as anything I have ever heard was the speech of Commander Edward Ellsberg, who raised the submarine S-51. He told just how it was done; and we were all weeping, when we weren't so tense we could scarcely breathe. Commander Ellsberg is a real literary man and quite an orator.

Did you hear us the night we brought Punch and Judy back to the kiddies?



Men relate this simple way to get a new thrill in shaving

Men the nation over are awakening to the fact that there is a general switch to the Valet AutoStrop Razor.

Its sales have pyramided in an astounding manner.

All because men are discovering that a sharp blade for every shave is a genuine luxury.

The Valet AutoStrop is the *only* razor that sharpens its own blades. A few strokes on its strop restore a blade to new-like keenness.

Sharpen it, then shave, then clean—all in a jiffy, and without removing the blade from the holder.

This is a different principle. The blade doesn't get duller and duller until it must be thrown away.

Every shave can be with a blade of super-keenness.

Have you fallen into a habit? Do you continue your old way of shaving?

Then join the thousands upon thousands who have turned to a new and better way and whose enthusiasm never wanes.

A speedy, comfortable shave every time—uniformly perfect. An end to "pulling." An end to wasting time.

"There's no shave like it," men say. Why miss this supreme improvement?

Valet AutoStrop Razor

REG. U. S. PAT. OFF.

\$5 to \$25
Other sets
at \$1

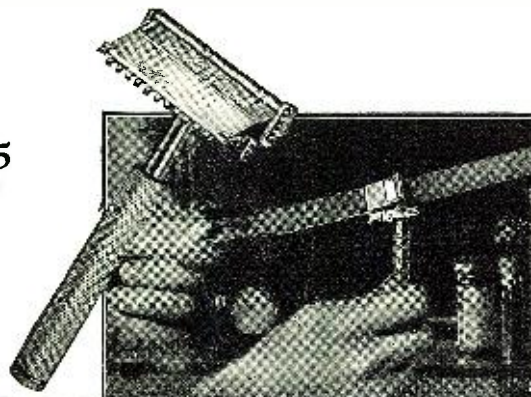

The RAZOR
That
Sharpens
Itself

AUTOSTROP SAFETY RAZOR CO., 656 First Avenue, New York City

PRECISION

"B" Power Unit

135 Volts with a 120 Milliampere Output

100 Microfarad Condensing Capacity

50 or 60 Cycle Current

Precision's reservoir of stored up power (much more than ever needed), coupled with ample filtering capacity, gives an even flow of "B" voltage that will not be affected in the slightest way by AC interference—Precision brings out all of the fine tonal qualities of your receiver. Cost of operation shows no recognizable difference in your electric light bill. Employs no tubes to burn out, and will prevent burning out of tubes in your receiver.



135 Volts \$42.50
Price complete
90 Volts \$37.50

Precision will last for years. On a recent test, it operated a 12-tube set for 2000 consecutive hours and is still going with no sign of diminished efficiency. Precision Electric Manufacturing Corporation is one of the real pioneers in the eliminator field—Precision B Eliminators are now giving satisfactory service after three years' use.

Buy your Precision today—write us, giving the name and address of your dealer.

PRECISION ELECTRIC MFG. CORP.
717 EAST 9th STREET LOS ANGELES

Have you been listening to my family concert parties on Wednesday nights?

I hope you are getting acquainted with my Bohemian child, Josefa Chiekova, and my Italian boy, Alberto Terrassi, and my American-Irish infant, J. Milton Bevan, and my Spanish youngster, Alfonso Romero, and all the rest of that merry family.

See you again next month.

Assuring Safety in Radio Installations

(Continued from page 329)

may eat through the connecting wires and cause them to break. Therefore, each time you charge your battery, clean off the terminals thoroughly. Remove every trace of corrosion; and then, after the wires leading from the battery to the set have been securely clamped in place, coat the entire battery terminal and a few inches of the connecting wires with vaseline or some other heavy grease. This will effectually prevent further corrosion; and if it is done properly, you will not have to clean the terminals again for several months.

THE "B" ELIMINATOR

The recent popularity of "B" battery eliminators has brought new problems to the radio fan. A "B" eliminator is a power device, to be connected to the same electrical circuit that supplies your light, heat and other electrical conveniences throughout the home. Since this circuit carries a high voltage, and is capable of much damage if not properly handled, certain precautions must be observed when using a "B" eliminator.

The first and foremost thing is to fuse the circuit at the point where it leaves the base plug or outlet box. This can best be accomplished by employing a small porcelain fuse block, of the type shown in Fig. 2, and wiring it up as indicated. You can then insert 5-ampere fuses in the two receptacles provided, and you will be sure that your "B" eliminator will be amply protected. This fuse block may be screwed to the base-board alongside of the outlet, where it can be readily observed at all times.

If one of the fuses in this circuit should blow out, it is probably due to a defect in the "B" eliminator, and the cause should be



FLOATING through a sea of ether waves—martial strains—broadcast from a forty-five piece band! Lost—every now and then—somewhere—seven men!

Just because most speakers cannot reproduce lower tones—six bass horn players and one bass drummer—seven men—lost!

You can rescue this seven—hear them! The new Spartan Disc Speaker brings out with equal amplification every note over the entire audible musical scale!



Encased in a handsome, well proportioned, matched walnut cabinet. Equipped with the Spartan Semi-Balanced Armature Disc Unit. Over all dimensions: Height 14 inches, Width 16 inches, Depth 6 inches. Price \$25.00

Note

The Spartan Disc Speaker used by Arthur H. Lynch in his new "B" Supply Unit which is described in Radio News. This very remarkable speaker is now available at your Dealer's.

SPARTAN ELECTRIC CORPORATION
NEW YORK, N. Y.

Hear it ALL—get a

Spartan Disc Speaker

DEALERS & SET BUILDERS

It will pay you to investigate and build sets with our amazing new transformers. Highest efficiency. Perfectly tuned and matched to exact peak. Designed for high power receivers. Also manufacturers of T.R.F. receivers and highest quality tubes and accessories.

IMPERIAL RADIO CORPORATION

2466 Lincoln Ave., Chicago, Ill.
Exclusive distributors of H.F.L. Transformers.

C. L. PARKER

Ex-Examiner U. S. Patent Office
Attorney-at-Law and Solicitor of Patents
McGill Building, Washington, D. C.
Patent, Trade Mark and Copyright Law



In this issue:
OCTOBER, 1926

"THE MAD PLANET," by Murray Leinster. A tremendous story by the author of "The Runaway Skyscraper," and a sure classic.

"BEYOND THE POLE," by A. Hyatt Verill. The final instalment, wherein our explorer describes his further adventures as guest of the lobster-like race.

"THE ISLAND OF DR. MOREAU," by H. G. Wells. The final instalment. As surprising an ending as you could wish for, with thrills that you follow breathlessly.

"THE DIAMOND LENS," by Fitz-James O'Brien. This is one of the world's classics.

"A DRAMA IN THE AIR," by Jules Verne. It was one of the first stories ever published by him, and is considered a perfect gem by followers of Verne literature.

"THE SECOND DELUGE," by Garret P. Serviss. A worthy successor to the story "A Columbus of Space." Don't miss it!

PRICE 25c PER COPY
AT ALL NEWSSTANDS

FREE RADIO GUIDE

FREE RADIO CATALOG & GUIDE for 1927. Gives special hook-ups with illustrations. Shows savings on standard radio parts, complete sets, kits. Be sure to get this thrifty book before you buy. Write letter or postal NOW. Also include name of another fan.
BARAWIK CO., 542 Monroe St., CHICAGO, U. S. A.

A Laboratory Product



CRESCENT LAMPE RESISTANCES

for Distortionless Amplification
Used by chief radio experimenters and amateurs in America. All capacities 12,000 ohms and up. Special sizes made to order. Write today for full information. Liberal discounts to dealers.
CRESCENT RADIO SUPPLY COMPANY, 1-5 Liberty Street, Jamaica, N. Y.

Insure your copy reaching you each month. Subscribe to Radio News—\$2.50 a year. Experimenter Publishing Co., 53 Park Place, N. Y. C.

located before a new fuse is inserted. Possibly such a blow-out may be due merely to a short-circuit between the wires connecting the fuse block and the "B" eliminator. Investigate all sources and locate the trouble, because if you insert a new fuse without investigating, it will probably immediately blow out.

In the case of home-made "B" battery eliminators, the fuse block just mentioned is an absolute necessity, and must not be neglected. Home-made eliminators are subject to many troubles which may cause damage to the lighting circuit or to the main house fuses if they are not protected by the devices described.

In home-made "B" eliminators, especially when the transformers and chokes are wound by the constructor, there is apt to be a lot of heat generated. Therefore, never enclose a home-made eliminator in an airtight cabinet. If you must use a cabinet, provide an ample number of holes in its sides to allow good ventilation. If a "B" eliminator transformer is allowed to heat up, it may burn out the windings and blow the fuses. Ventilation will keep the heat at a minimum and often prevent such an occurrence.

SWITCHES FOR THE RECEIVER

When a receiving set is equipped with a "B" eliminator, and two switches are necessary for turning off the entire set (one for the "A" battery circuit, and the other for the "B" eliminator circuit) there is always a likelihood of the latter's being left on through carelessness. This risk can be eliminated, by providing a single switch for turning on and off both of the circuits simultaneously, and with only one movement on the part of the operator. If you purchase from your local electrician a double-pole, single-throw snap switch and wire it up according to the diagram in Fig. 3, you need only turn this switch to disconnect both the "A" battery and the "B" eliminator. If you will further add to the equipment a signal light, either in the "A" circuit or in the 110-volt "B" eliminator circuit, you will not forget to turn off the set, because the light will call you back.

DON'T USE OLD WIRE

Never use old scraps of wire to connect up the "A" battery to the set, or either the input or output circuits of the "B" eliminator. If a short-circuit should occur, you may find some damaged apparatus, a badly run-down battery, or even a fire started by the heat generated at the short-circuit. Buy good, heavily-insulated wire and, if a break in the insulation should occur, *replace the entire wire*. Do not attempt to splice in another short piece, as you will probably only run into more trouble.

These are the principal risks that beset the radio fan. They are not very great dangers in most cases; but it is the little things that count and that are annoying. Avoid them and you will derive greater enjoyment from your radio receiving set.

SYLVAN HARRIS, who has been for the past year and a half managing editor of RADIO NEWS, has resigned to join the radio engineering staff of a prominent Chicago radio manufacturing company, where he will conduct research work, in which he has already distinguished himself as a scientific investigator.

Readers of RADIO NEWS will be favored by a continuation, however, of the interesting articles which Mr. Harris has contributed for some years to this magazine, popularizing the technical side of radio in brief and understandable form.

Earn a **SECOND** Income!

How many people in the United States would deliberately turn down a worth-while opportunity to earn, in a bonafide method or business, an actual steady income over and above their present salary or income?

Very, very few.

Here is a new magazine, "MONEY MAKING" established with the worthy purpose of telling the millions in the United States of many actual, practical and specific means of making money—either as increased salary or as an additional income.

Articles in this new magazine are written by men and women who are experts on their subjects or are compiled by the editor from facts obtained from the best sources:

Walter MacIntosh in an article entitled "Turning Idle Hours Into Golden Hours" says:

"One of our eminent practical psychologists has said that most people can do about three times more work than they think they can.

We haven't all an equal amount of money. But we all have twenty-four hours a day—no less, no more. Many times, the difference between financial success and financial failure can be explained by the fact that the man who succeeded turned his spare time into money; while the man who failed simply wasted his spare time, because he placed no money value on it."

No longer do you have to wish that an opportunity for increasing your income present itself.

MONEY MAKING tells you of hundreds of ways, and tells you how to start, how others have succeeded, what rules to follow, what initial investment is necessary, and all the vital factors to success.

Nowhere else is this information compiled and presented in such a practical, useable manner.

Buy a copy of this new magazine from your nearest newsdealer now—if there is none near you, fill out the coupon below, for \$1.00 we will be glad to send you MONEY MAKING postpaid for five months.

October
Issue
25c



Now on
All
News
stands

Partial List of Contents for October

Turning Idle Hours Into Golden Hours, Walter MacIntosh. The Open Air Profession, Utah Vincent Wilcox. Starting in the Mail Order Business, George R. Downs. Making Money Transplanting Forest Trees, Armstrong Perry. The Junk Man—A By-Product of Civilization, Walter Raleigh. The Easiest People in the World To Sell To, J. H. Thomas. How to Start a Circulating Library. Goldfish Breeding, W. M. Butterfield. Selling Farm Produce on the Spot to Motorists, Henry Calvert. An Endless Chain Agency, C. S. Lonsshore. Taking the Kinks Out of Produce Distribution, Clayton D. Reeves. If I Had \$100 to Start a Business, S. Sachs.

Several departments including prize contest record. Successful Egg Farming, Charles Weeks. Turning

Dough Into Dollars, S. N. Elliott. Some Odd Ways of Earning Money, Victor Carson. Direct Selling—What It Has to Offer, Wm. C. Bartlett. Finding Lost Articles, Romanzo Nelson. A Course in Window Trimming, Ernest A. Douch. Professional Shopping, Real Estate—Where the Big Money Is, W. M. Ostrander. Law as a Profession, Harold R. Lister. How to Make Patents Pay, Ralph Burch. Money Making in Subscriptions, M. B. Flaum. Mail Order Opportunity, Ioss D. Brenner. Making Ornamental Flowers from Sea Shells, Dr. E. Badg. Women's Department—You Can Make Money, Montano Perry. How Country Women Sell Food Products. How City Women Sell Food Products. Making Cushions for Profit, Hazel P. Shewalter. How to Make Lamp Shades, William Mallard. Professional Candy Making, Dorit K. Weigert.

If You Cannot Obtain
"MONEY MAKING" in
Your Locality Use This
Coupon →

The Consrad Co.,
Incorporated
53 Park Place,
New York City

CONSRAD CO., INC.,
53 Park Place, New York.

Gentlemen:—I am enclosing \$1.00 for which kindly send me, postpaid, MONEY MAKING for 5 months.

NAME

ADDRESS

CITY, STATE

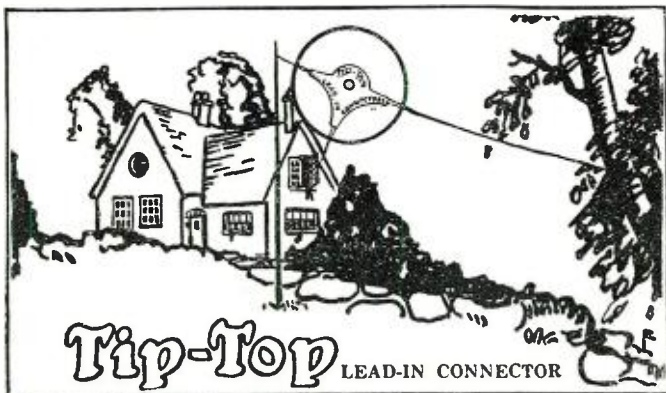

Tip-Top LEAD-IN CONNECTOR

**Don't Neglect
this point of contact**

Use a Tip-Top Lead-in connector on your outside aerial, for best distance results, and better reception.

Jobbers and Dealers write for discounts.

JAMES F. DOOLAN

MANUFACTURING CORPORATION

36 - 42 West 47th Street

New York, N. Y.

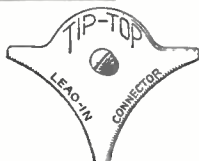

25c

Only a screwdriver needed.

No solder.

No loose connections.

"B" Battery Eliminators

(Continued from page 335)

ing-current light line is shown in Fig. 5. This comprises the four sections we have just described.

The circuit diagram for a 110-volt direct-current "B" eliminator is shown in Fig. 6. In this case no power transformer or rectifier tube is employed. The maximum voltage that can be obtained from this eliminator, or any 110-volt D.C. eliminator, is 95; as there is a drop of voltage in the filter system. Very high voltages cannot be had as it is not possible to step up a direct current.

ADVANTAGES OF "B" ELIMINATORS

Eliminators occupy little space, are neat in appearance, and cause no worry; for once an eliminator is installed and placed in operation it requires no attention. Though the first cost has to be taken into consideration, the operating cost is low.

The greatest advantage of the "B" eliminator rests in the fact, that it will supply a constant voltage at all times and will continue to do so—providing there is not a great voltage drop in the light line, which very seldom occurs. Slight voltage variations in the light line are not sufficient to make any appreciable difference in the output voltage of a good eliminator.

What may also be considered an advantage is that the latest eliminators are capable of supplying the high voltage which is necessary for power amplification, this potential ranging anywhere from 135 to 350 volts.

An Autotransformer Receiver

(Continued from page 354)

9th turn from what will be the filament end of the coil. In this case, it is recommended to place the coils at right angles to each other in the receiver, as indicated in Fig. 4. This practice does away with the greater part of the inductive coupling between stages, and assures the best possible results in reception.

The inductances are tuned by means of the variable condensers C 1, which also are all of the same size—17 plates (.00035- μ f.) The coils in combination with these condensers will tune from about 190 to 550

LIST OF PARTS FOR AUTO-TRANSFORMER RECEIVER

- 1 Set of 3 Plug-in Coils (L1);
 - 3 Variable Condensers, S.L.F., .00035- μ f. (C1);
 - 2 Variable Resistances, one 0-50,000-ohm (R2), one 0-500,000-ohm (R1);
 - 3 Illuminated Vernier Dials;
 - 5 Self-adjusting Rheostats (R3);
 - 3 Fixed Condensers, two .001- μ f. (C2), one .002- μ f. (C4);
 - 2 Audio-Frequency Transformers (T1 and T2);
 - 5 Spring Sockets (S);
 - 1 Grid Condenser, .00025- μ f. (C3) with Grid Leak, 3-megohm (R4);
 - 2 Radio-Frequency Chokes (L2);
 - 1 Filament Switch;
 - 1 Single-Circuit Jack;
 - 7 Binding Posts;
 - 1 Bakelite Panel, 7 x 21 inches, with Sub-Panel 9 x 21 inches; and two Brackets.
- Approximate cost, including miscellaneous, \$50.00.

Goodrich Silvertown



Radio Panels

For greatest range and selectivity

- 1 Easier to drill and machine.
- 2 Better color, lasting lustre.
- 3 Lower free sulphur—no discoloration.
- 4 Higher softening point—no warping.

Goodrich V. T. Sockets

Radiophone Ear Cushions

Hard Rubber Tubes for Coils

Spaghetti Tubing

Battery Mats

The B. F. Goodrich Rubber Company

Established 1870

Akron, Ohio

BAKELITE KNOBS

AID CLEAR RECEPTION

Write for Booklet 24.



BAKELITE CORPORATION

247 Park Avenue, New York, N. Y.

Chicago Office: 636 West 22nd St.

BAKELITE CORPORATION OF CANADA, Ltd.,

163 Dufferin St., Toronto, Ontario, Canada

AMRAD Neutrodyne

The Biggest Value
in Radio!

For "UV" or UX Type Tubes
NEW KLOSNER UNIVERSAL SOCKET

Hexagonal shaped holes for large prongs, spring grip terminal lugs, and ease in mounting make it the socket leader for 1926.

KLOSNER RADIO CORPORATION
1022 East 178th Street - New York

FREE RADIO GUIDE

FREE RADIO CATALOG & GUIDE for 1927. Gives special hook-ups with illustrations. Shows savings on standard radio parts, complete sets, kits. Be sure to get this thrifty book before you buy. Write letter or postal NOW. Also include name of another fan.

PARAWIK CO., 542 Monroe St., CHICAGO, U. S. A.

Insure your copy reaching you each month. Subscribe to Radio News—\$2.50 a year
Experimenter Publishing Co., 53 Park Place, N. Y. C.

meters, thus nicely covering the broadcast wavelength range.

The condensers C 2, which serve to pass the radio-frequency currents and to block the plate potentials from the grids, may be any size from .001- μ f. up; it is not necessary that they be larger than .006- μ f. for best results. The choke coils L 2 used in the receiver shown are commercial products—but the builder who prefers to construct as many parts as possible can easily make these chokes by winding about 400 turns of very thin insulated wire on a small wooden spool. The best wire to use for this purpose is No. 32 enameled-and-SSC copper wire.

OSCILLATION AND VOLUME CONTROLS

We come now to one of the most important parts in the receiver, the oscillation control or stabilizer. For this purpose a 50,000-ohm variable resistance is employed which serves to control the plate voltage of the radio-frequency amplifier. It is not at all necessary to have a by-pass condenser for the high-resistance of the "B" battery, as in general practice, because the radio-frequency currents do not flow through the resistance, or the battery either, but directly to the filament. This control is placed on the front panel, as shown.

After the receiver has been stopped from oscillation at any one wavelength, it will be found that it is quiet on all wavelengths, and has even the tendency to be somewhat less stable at high wavelengths, which is a certain indication of all-around efficiency.

In case a strong local signal has the tendency to overload the detector and thus

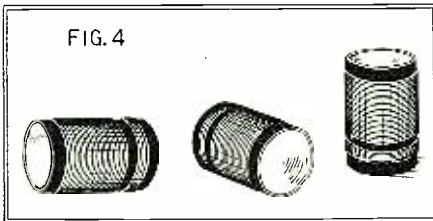

By placing radio-frequency transformers at right angles to each other, as shown, interference between coils is greatly reduced.

cause distortion, the stabilizing resistance can be used to decrease the signal strength, and in this way to prevent distortion and overloading. It should be understood that for volume control a different knob is provided, so that it may be said that the 50,000-ohm resistor is only a stabilizer and quality control.

As pure volume control we use a "modulator," which is a 500,000-ohm potentiometer connected across the secondary of the first audio-frequency transformer. The grid of the first A.F. tube is connected to the sliding arm of the potentiometer, which enables us to regulate the volume at will from a whisper to the maximum, by a single turn of the regulating knob. It is generally known that this way of controlling volume is one which gives not only a very wide range of control, but introduces no distorting factors whatsoever. Even better, if the transformers are not what they should be, the volume control, which is after all a resistance across the transformer, serves to flatten its amplification curve and thus give purer quality.

Of course it would not do to count upon the volume control to improve the quality of the amplifying transformer, and therefore the builder is recommended to use the best transformers obtainable. Transformers today have been brought to such a degree of perfection, that they give almost even amplification over the entire range of frequencies used in broadcasting work; and it is an investment which will pay in added

A·B & C Light Socket Radio Power

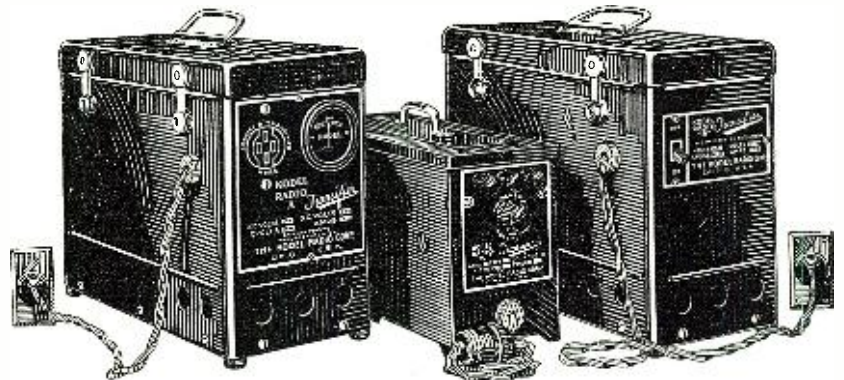

for any set - new or old

Now all radio power is in your light socket. Kodol A and B Transifiers replace all batteries—just plug in the wall socket and smooth uniform A, B, and C current flows to your receiver—gives new pep, new life to any set—longer range, greater volume—reception such as was never possible even with fresh new batteries.

Kodol A & B Transifiers

Are vastly different and superior to so-called power units. Transifiers consume current only while you operate the set—much lower maintenance cost—less than one-half cent per hour to operate both A and B Transifiers. You may purchase both A and B or either model separately from your radio dealer.

<p>MODEL 10 "A" TRANSIFIER Supplies constant 2, 4, or 6 volts "A" power to sets using up to 10 tubes. Absolutely no hum, noise or interference. Price without bulb \$42.50</p>	<p>MODEL 61 "B" TRANSIFIER Smooth, powerful, noiseless "B" current for sets up to 6 tubes. 22½ to 90 volts. Price without bulb \$28.50</p>	<p>MODEL 10 "B" TRANSIFIER 22½ to 150 volts "B" power, 4 to 10 volts "C" power. Constant uniform current to supply any size set. Will operate power tubes. Price without bulb \$42.50</p>
---	---	--

["Behind the Scenes in a Broadcasting Station", an interesting, 24-page booklet, together with literature describing Kodol A and B Transifiers, will be mailed free on request.]

DEALERS: Write for particulars on Kodol Radio power devices.

THE KODEL RADIO CORPORATION, 501-521 EAST PEARL ST. CINCINNATI, O., U. S. A.
Owners and Operators of Broadcasting Station WKRC

Battery Chargers **KODEL** *Radio Receivers*
Power Units **KODEL** *Loud Speakers*
POWER SPECIALISTS SINCE 1912

THE TUBE WITH THE SENSIBLE GUARANTEE

Visible Truth!



Vibrationless
Uniform
and Good

All tubes look alike more or less—they are easily disqualified in handling. You are told "this" is better or "that" is better—Perhaps it is true—Perhaps not.

Supertrons are different
You see a re-enforced interior construction.
You see the most expensive and best material—*Isolantite*.
You see DEFINITE QUALITY.
You are told SUPERTRON is the best—it's truth—It's Visible Truth.
Guaranteed by Serial Number

All types at public demand prices

SX 01 A\$2.00
SX 99 2.25
SV 99 small 2.25
SV 99 large 2.25
SX 12 (Power) 5.00
SX 20 (Power) 2.50
SX HiMu 3.00
Supertheon Half 4.00
Supertheon Full 5.00

In Canada slightly higher.

SUPERTRON MFG. CO., Inc.
HOBOKEN, NEW JERSEY

Branch Office
30 N. Dearborn Street, Chicago
Export Dep't, 220 Broadway, N. Y. C.

SUPERTRON
SERIAL NUMBER GUARANTEE
The Foremost Independent Tube in America

pleasure to purchase one of the better makes of transformers.

As we have provided an oscillation control, which, as shown, is at the same time a device for the prevention of overloading the detector, and a distortionless volume control, the receiver has no filament rheostats other than the self-adjusting type, and no controls are needed for this purpose. The use of these automatic devices allows all tubes to operate at the proper brilliancy and greatest efficiency; they are protected from damage and cannot be overheated by too high filament current. The use of such filament controls results generally in better quality of reception and longer life of the vacuum tube.

USE OF POWER TUBE

No provision is made to switch from one stage of amplification to the other one, because the volume is so completely under control. However, the receiver has been so built that one of the new power tubes can be utilized. If the receiver is operated by means of dry cell "B" batteries, the use of the 112-type tube in the last stage is recommended, with a plate voltage of from 135 to 180 volts, and appropriate "C" battery. If a good "B" eliminator is employed the 171-type tube can be used to advantage, if the speaker is provided with a choke coil and condenser.

The construction and general plan of the receiver will be clearly visible from the illustrations and the picture diagram of the apparatus, and its construction should not offer any difficulties to the amateur. For the sake of appearance and for ease in tuning a new style of vernier dial is employed, such that a small pilot light can be placed behind the panel. As the reading scale is semi-transparent celluloid, at night the readings are clearly visible and the closest tuning is possible.

IT is against the policy of RADIO NEWS to publish the names of manufacturers or of makes of instruments in connection with the apparatus described in these pages, but this information will be gladly given privately. If you are interested in any special instruments described here, address a letter to the READERS' SERVICE DEPARTMENT, enclosing stamped return envelope. The names and addresses of the manufacturers will be given free of charge. —EDITOR

New Developments In Radio Apparatus

(Continued from page 339)

electrical connection is made to the binding post, B2, at the top of the cover by a light, flexible brass strip. There is always a positive contact here, for there is no danger of turning off the connection, as in other types of condensers. The three mounting holes, II, are cast in the outer frame of the instrument, so that rigidity is assured. The binding posts, B1 and B2, are mounted on a bakelite strip and project through holes in the top of the cover, allowing ample clearance for electrical purposes.

A GUILTY CONSCIENCE

Ferdinand, I'm grieved to say,
Stole some jam one sunny day;
Lifted down a monster pot
And he ate a dreadful lot!

Then, "Hullo!" a loud voice said—
Ferdie dropped the pot and fled,
For he didn't guess at all
'Twas the radio in the hall!
Leslie M. Oylar in "Wireless Magazine."



CHALFONTE-HADDON HALL
ATLANTIC CITY

On the Beach and Boardwalk. In very center of things

Welcome you to Atlantic City with all the hospitality and friendly atmosphere of home.

American Plan only. Always open.

"Dual-Trio" Radio Concert every Tuesday evening. Tune in WPG at 9. Illustrated folder and rates on request.

LEEDS AND LIPPINCOTT COMPANY



Silent "B" Power with World Radio Storage "B" Battery

12 Cells 24 Volts

Lasts Indefinitely—Pays for Itself
Dependable. Quiet "B" power, clear without "hum." Economy you have never before thought possible. Outstanding performance. Recharged for almost nothing. Solid rubber case insures against leakage or acid. Extra heavy glass jars. Heavy rugged plates. Approved and listed as standard by Pop. Radio Laboratories, Pop. Sci. Inst. Standards, Radio News Lab., Lefax, Inc., and other Radio authorities.

Extra Offer: 4 Batteries in series (90 Volts) \$10.50.
Just state number of batteries
SEND NO MONEY! wanted and we will ship same day order is received. Pay expressman after examining batteries. 5 per cent discount for cash with order. Send your order today—NOW!

WORLD BATTERY COMPANY
1219 So. Wabash Ave. Dept. 75 Chicago, Ill.
Makers of the Famous World Radio "A" Storage Battery
Prices: 6-volt, 100 Amp. \$10.50; 150 Amp. \$12.50; 140 Amp. \$12.25.
All equipped with Solid Rubber Case.

World STORAGE BATTERIES
Set your Radio Dial for the new 1000-watt World Storage Battery Station, W.S.B.C. Chicago. Always something interesting.

INDIA • WEA • WGN • WIS • KHL • RKO • KFAB • WJW • K37

Bradley Amplifier
Resistance-Coupled
PERFECT AUDIO AMPLIFIER



Provides audio amplification with minimum distortion. Bradleyunit molded resistors used in the Bradley Amplifier do not vary with age and are not affected by atmospheric conditions. Can be used to replace transformer amplifiers in standard radio sets with decided increase in tone quality.

Allen-Bradley Co.
Electric Controlling Apparatus
287 Greenfield Avenue Milwaukee, Wis.

A NEW RADIO PLUG



Simple to use, gives perfect electrical contact with any style tip.
Simply push cord tip through plug, loop cord and push tip back into plug.
Sent postpaid on receipt of 50c
CULVER-STEARN'S MFG. CO.
Worcester, Mass.

Insure your copy reaching you each month. Subscribe to RADIO NEWS—\$2.50 a year. Experimenter Publishing Co., 53 Park Pl., N.Y.C.

The Radio Burglar Alarm

(Continued from page 340)

a good many burglars may share the experience of "Soupy Sam," now No. 7146, whose brief and touching account of his troubles is told above.

The radio burglar alarm "sees in the dark," so to speak; it is much less expensive than the complicated maze of wires now used for electric protection systems; and it transmits its warning to the guards, watchmen and police who will answer its summons, without apprising the intruder of his danger until it is too late.

The well-known phenomenon of "body capacity," which every builder of a radio set has encountered, may be employed for the purpose of detecting the introduction of a human being into the neighborhood of radio apparatus; but it is not necessary that any of the instruments should be in the immediate vicinity of a safe which it is desired to guard. It is only necessary to have a wire running to the safe, and another to the ground; or any large insulated sheet of metal may be used to create an electric "atmosphere," which cannot be entered without upsetting the balance of the system and giving an electrical signal—which will operate a relay and set off bells or an electric siren, turn on lights, or otherwise give warning of the intrusion, as desired by its constructor.

BUILDING A BURGLAR DETECTOR

In the pictorial diagram is shown a circuit, which is very easily built and which will prove to be an efficient burglar alarm. It will be seen that the safe, which is insulated from the floor, is one plate of a condenser and the floor (or ground) is the other. The inductance has 55 turns of No. 26 DSC wire wound on a 2½-inch tube, inside of which is the rotor coil, 1¾ inches in diameter and consisting of 28 turns of No. 32 DSC wire. The vacuum tube used is a 201A type, having 38 volts on the plate and 1½ volts negative "C" battery.

A reading of 2½ milliamperes was observed when the rotor was suitably adjusted and no person was nearer the safe than 10 feet. The adjusting was done by means of a rod of insulation about 15 inches long. As the operator had to be nearer the safe than 10 feet, when the adjustments were made, it was found that the reading on the meter was about 2½ milliamperes, when he was using the rod. But when this reading was obtained on the meter and he withdrew to a distance of 10 feet or more, the meter reading increased to about 3½ milliamperes. When any one approached the safe the meter reading gradually fell, and dropped almost to zero when he was within one foot of the safe. The same thing happened whether one touched the safe with his bare hand or while wearing rubber gloves, or by means of some other high insulator. This is because the conductivity does not enter into consideration at all, but only the capacity effect. The meter reading will fall to zero, of course, if either of the wires leading to the system should be cut.

It will be noticed that instead of a relay there is shown in this diagram a milliammeter. Of course in an alarm system, using a circuit of this type, it would only be necessary to employ instead of the meter a relay of the galvanometer or polarized type; that is one which operates on a very small current. Such a relay may be connected to any type of alarm that the constructor wishes to use.

All these facts show experimentally that, no matter in what way one might approach the safe, or otherwise interfere with the system, the burglar alarm would operate.

SILITE

TRICKLE CHARGER

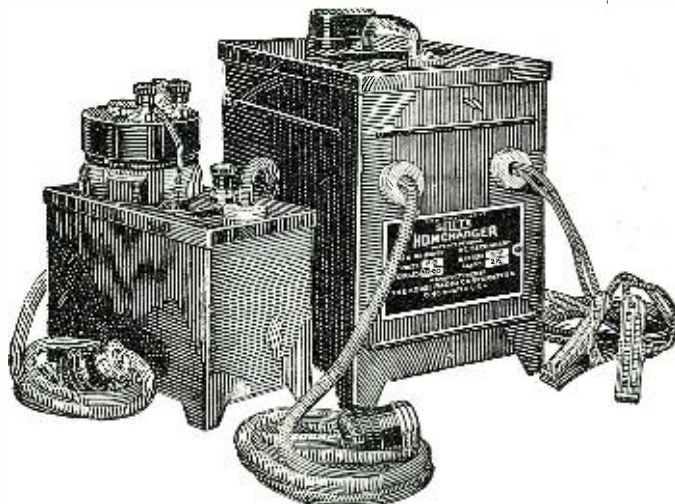

Absolutely Noiseless— Makes a power unit of your storage battery!

You can make a power unit of your present storage battery with the new Silite Trickle Charger.

Absolutely noiseless, without bulbs or moving parts, Silite Trickle Charger is left permanently on charge. It replaces at a slow rate the power you use while your set is operating. Silite Trickle Charger may even be used while your set is in operation without hindering enjoyable reception.

No Bulbs—No Adjustments—Can't Wear Out!

Silite is the marvelous new metallic glass rectifying element discovered and perfected in the Kodol Laboratories. Silite Chargers have no adjustments, no wearing parts—they cannot overheat or damage your battery. Silite Trickle charges at .6 ampere—much faster than other trickle chargers—enough to keep a battery always at top efficiency. Your nearest radio dealer can show you the Silite Trickle Charger.

SILITE HOMCHARGER

Absolutely silent—fast 2½-3 ampere charging rate. No bulbs. Can be used while set is in operation. Complete, nothing else to buy . . . \$19.50

SILITE TRICKLE CHARGER

Makes a power unit of your battery. Left permanently on charge keeps a battery always at full efficiency. Absolutely silent—no bulbs. Complete . . . \$10.00

["Behind the Scenes in a Broadcasting Station", an interesting, 24-page booklet, together with literature describing Silite Battery Chargers, will be mailed free on request.]

DEALERS: Write for full information on Silite Chargers and other Kodol Products.

THE KODEL RADIO CORPORATION, 501-521 EAST PEARL ST. CINCINNATI, O., U. S. A.
Owners and Operators of Broadcasting Station WKRC

Battery Chargers
Power Units

KODEL Radio Receivers
Loud Speakers

POWER SPECIALISTS SINCE 1912

RADIO PROTECTION

Check up on these Care-Takers and Inspectors

Are you fully protected?

Pocket Meters
Panel Meters
Charge Indicators
Tube Testers
Tube Reactivators
Battery Chargers
"B" Power Units

Choose a **STERLING** device from the above list!



A Test in Time Saves Many an Hour of Poor Reception!

Stave off impending troubles in your set by knowing exactly what's what within your batteries and tubes. It only takes a moment to find out with the use of Sterling Inspectors. It takes only a few minutes per week to keep your set in first class operating condition.

These Inspectors Are a Necessary Part of Your Equipment

and their cost is small compared to the troubles they avert. You don't need to be Radio wise to use them—anybody can get results, save time and money too.

At most all radio stores.

The Sterling Manufacturing Co.,
Cleveland, Ohio



Charge Indicator
shows instantly (1) whether your "A" Battery is fully charged (2) approximately how long it will operate before recharging is necessary, and (3) when it has been charged enough. **PRICE \$2.00**



Tube Tester
This little meter-equipped tester plugs into the tube socket, finds a bad tube, and indicates whether any tube is in "good", "fair" or "poor". **PRICE \$7.50**

Radio in Transatlantic Flight

(Continued from page 349)

stations equipped to give one-, two- and three-point bearings to ships at sea. These bearings are remarkably accurate, and ship-masters today accept them as a definite check upon their positions when approaching a landfall.

That portion of the route, to be followed by the Fonck airplane, that parallels the coast from New York to Maine, follows the coast of Nova Scotia, then that of Newfoundland, is liberally supplied with radio-compass stations; and so is the route from the west coast of Ireland to France similarly equipped to supply radio bearings.

It is estimated by manufacturers that 250 vessels are now equipped with radio compasses. Many of these steamers are fast express liners, traversing the North Atlantic steamship tracks. From Newfoundland to Ireland there is a span of approximately 1900 miles. For two-thirds of this distance the course of the airplane will follow the steamer tracks. It is therefore reasonable to expect, at this time of the year, that vessels with radio compasses will be at all times within radio range, and a bearing can be obtained that will check or stabilize the course of the airplane.

RADIO WEATHER REPORTS

The use of radio will, of course, not be confined to compass bearings. Prior to the date of the "hop-off" arrangements have been made with the masters of all transatlantic liners to forward reports, at 8 A.M. and 8 P.M. Eastern Standard Time, of the weather conditions upon the Atlantic. This information, consisting of the force and direction of the wind, barometer and thermometer readings, and general weather conditions, will be turned over to Mr. J. H. Kimball, associate United States weather forecaster for New York. For a period approximating ten days prior to our departure, Mr. Kimball will daily prepare a weather map of the North Atlantic. When meteorological conditions favorable to a dash across the ocean are indicated, then the "hop-off" will take place. It is only by use of radio that such a knowledge can be acquired.

During flight, the radio will be in constant use. Besides radio-compass work, weather conditions far in advance of the flight can be obtained by the airplane pilots, unexpected conditions in our path can be anticipated and our course changed to avoid them. Should a steamer be sighted in the course of flight its position can be obtained by radio and that of the airplane accurately determined, with the result that the course may be corrected or checked.

BROADCASTING THE FLIGHT

There is a tremendous public interest in hazardous aeronautical feats. News of such exploits generally comes upon the completion of the voyage. In the present expedition we propose, through the recently developed method of short-wave communication, to advise the interested public of our progress throughout the flight.

The last, but by far the most important, use of radio will be that of obtaining assistance in the event of an emergency-forced landing at sea. It is only a year ago that the whole world anxiously awaited news of Commander Rodgers and his crew, who had been forced down in the flight from San Francisco to Honolulu. Nine days of utter silence created an anxiety, that was intensified as the days passed and hundreds of searching vessels reported failure to learn the fate of the crew. Rodgers' airplane was equipped with radio, but in an emergency it failed.



RADIO'S BEST WIRE

"From the Ground Up"

Now is the time to look over your set and get it ready for the coming season's fine programs. Look particularly to your wiring. Very likely your old aerial is corroded and needs replacing or perhaps you need a new ground wire or some new bus bar. For whatever purpose you might need it, there is a "Corwico" wire that will serve you best and last the longest.

FREE Write for interesting booklet, telling all about the various kinds of radio wire and their uses.

Dealers and Jobbers—Write for the "Corwico" wire proposition.

See Our Exhibit New York Radio Show Booth CC-17

CORNISH WIRE COMPANY

30 Church Street New York City

don't move your set

BIRNBACH EXTENSION CORD

will move your speaker from room to room or to porch and lawn

20 FEET COMPLETE WITH CONNECTOR \$1.00

30 FEET COMPLETE \$1.20

50 FEET COMPLETE \$1.80 *Postpaid*

BIRNBACH RADIO CO. 370 SEVENTH AVE. NEW YORK CITY

You can be quickly cured if you

STAMMER

Send 10 cents for 288-page book on Stammering and Stuttering, "Its Cause and Cure." It tells how I cured myself after stammering 20 yrs. **E. M. Bogue, 6960 Bogue Bldg., 1147 N. Ill. St. Indianapolis.**

We do not propose to be placed in such a helpless position and an emergency "plain aerial" set will be carried, that will operate when the modern equipment is silenced. It will have a radius of perhaps 50 miles in daylight and emit a broad wave that will be heard on even a very "sharp tuning" receiver. Unless we are hopelessly off the steamer tracks it should be capable of summoning prompt assistance.

RADIO EQUIPMENT OF THE PLANE

The airplane to be used in this attempted 3,600-mile flight is well adapted for radio installation. The cabin is enclosed and roomy. For communication with shore and ships, it will carry a set of French design and manufacture which has been most successfully used on other long flights.

This French equipment, known as the "main set," will operate on 300, 600, 800, 900 and 1000 meters, using continuous wave, interrupted wave, and voice transmission. It consists of three tubes; two oscillators and one modulator, each rated at 50 watts.

The primary source of power will be obtained from a dynamo producing 8 volts and 1500 volts DC. for filament lighting and plate supply, respectively. This dynamo is driven from a 12-volt storage battery, which, in turn, will be charged from a fan-driven generator placed in the wind-stream of the airplane. Similar sets have a daylight range of approximately 300 miles.

The set, used as a telephone transmitter, has a range of about 100 miles and undoubtedly many broadcasting listeners near New York will hear this station during test flights. This equipment has already been licensed by the U.S. Radio Service and the call letters WOP assigned.

EMERGENCY SET

The emergency equipment is most elementary, consisting of an induction coil with vibrator "make and break" operated from the storage battery. This coil will be placed in series with the antenna and ground. The antenna for this purpose, being that also used for the short-wave set, is located along the top of the fuselage running its entire length. A loading coil or inductance will be added to increase the wavelength. In the event of the insulation being poor, caused by spray or moisture, a condenser will be provided and placed across the spark-gap.

The antenna system for the main set will be a standard trailing airplane antenna operated on a hand reel (much like a fishing line) and provided with a weight at the end, which will revolve on a swivel to prevent twisting. A spring inside this weight takes care of any jerking movement.

44- AND 22-METER SET

The short-wave transmitter consists of a crystal-controlled master oscillator, using a French 50-watt tube on greatly reduced voltage on about 44 meters, feeding into two French 50-watt tubes in parallel, which will act as combined amplifiers and frequency multipliers. Two antenna coupling coils will be provided to radiate simultaneously on 44 and 22 meters; the former wave will be radiated on a trailing antenna, while a small fixed antenna will be arranged to carry the 22-meter wave. This double transmission will provide a good wave for all distances, day or night. We anticipate excellent results, clear across the Atlantic, unless conditions are phenomenally bad.

The weight of this set will be approximately 20 pounds, occupying a space only 10x9x17 inches. The use of French tubes permits utilizing the same source of power provided for the larger main set.

FORCE OF HABIT

The modern nouveau riche jumps up to change the needle when a radio selection ends.—Life.

The New Triple Duty GOLD SEAL HOMCHARGER

The
World's
Most
Popular
Battery
Charger



\$19.50
Complete

**Charges three times faster!
Rejuvenates lifeless tubes •
supplies current for 8-volt power tubes!**

It's more than just a battery charger—the new Triple Duty Gold Seal Homcharger. Charges three times as fast as other chargers—fully charges the average battery overnight. No bulbs—no liquids—Homcharger can be used for charging automobile batteries, too!

An exclusive Homcharger feature this season is the new tube rejuvenation process. Terminals are provided for bringing

old radio tubes back to life without removing them from the set.

Homcharger may also be used as a power unit for 8-volt A. C. power tubes. Provides uniform light socket current for operating these tubes.

Only Homcharger offers these exclusive features—still Homcharger costs no more than ordinary battery chargers. Any radio dealer can show you the new Triple Duty Gold Seal Homcharger.

["Behind the Scenes in a Broadcasting Station" an interesting 24-page booklet, will be mailed free on request, together with literature describing the Triple Duty Gold Seal Homcharger.]

The Kodel Radio Corporation, 501 E. Pearl St., Cincinnati, O.
Owners and Operators of Broadcasting Station WKRC

Battery Chargers Power Units **KODEL** **Radio Receivers Loud Speakers**
POWER SPECIALISTS SINCE 1912

Best Yet in a Crystal Set



"TALKING BOOK"

A Complete Radio Set

Pair of standard Ear Phones, Aerial and Ground Leads, Indoor Antenna. Self contained in attractive book.

With Celerundum Rectifier—No Batteries Required.

Price \$5.00 complete at your dealer or direct.

THE LISTEN-IN CO.,
115 Federal St., Boston, Mass.

Learn Watchwork, Jewelrywork and Engraving A fine trade commanding a good salary, and your services always in demand. Address Horological, Dept. 5, Bradley Institute, PEORIA, ILLINOIS, for our latest catalog.

BE SURE YOU'RE RIGHT



Tapped Inductance Coil; 90 to 200 Meters. It is vital that you use this item in constructing the Infrazyne Circuit.

Postpaid anywhere **\$1.25** in U. S. for.....
Cash with Order

Heintz & Kohlmoos, Inc.,
221 Natoma St., San Francisco, Cal.

IVORY RADIO PANEL beats them all. If your set isn't as attractive as your neighbor's, change your panel for a pure White Ivory panel, and have the best looking set in town. Cut any size or shape you desire only 3c square inch. Write today for FREE sample. **IVORYLITE RADIO PANEL CO.,** 3222 Ave. F, Fort Worth, Texas.



Speakers Loops Units
For the finest Radio Reception
QUALI-TONE SPEAKERS
Four Models



Quali-Tone Speakers represent at the one time the utmost in quality and performance at low cost and extraordinary beauty of appearance and design. THE JUNIOR QUALI-TONE is ideal for portable receivers and for use wherever space is limited. It is finished in black crystal, equipped with the popular Quali-Tone adjustable Unit — height 13 in. Bell 8½ in. Price \$7.50—QUALI-TONE Model No. 2 is most artistically designed, finished in a semi-dull black leather pattern that is exceedingly attractive. It is slightly larger than the Junior being 15 in. high with a 10 in. Bell. Price \$10.00.—QUALI-TONE No. 3 has an 11½ in. Bell of Bakelite polished to a deep black lustre that delights the eye. Sound chamber and base have a dull black Morocco leather finish that harmonizes with any surroundings. It is 19½ in. high and is equipped with the justly famous QUALI-TONE De Luxe Unit. Price \$15.00.—QUALI-TONE Model No. 4—the Speaker Supreme—has a polished Bakelite Bell, while the sound chamber and base have a dull black Morocco finish. Like No. 3 this marvelous Speaker is also equipped with the QUALI-TONE De Luxe Unit that assures a quality of tonal reproduction altogether beyond expectations. Height 22½ in. Bell 11 in. Price \$25.00.

Quali-Tone De Luxe Unit

Extremely powerful concert type. Finished in black crystal enamel with metal trimming. Constructed to handle extra heavy volume. Adaptable to any standard make of phonograph or console set. Price \$7.50.



Quali-Tone Phonograph Radio Unit

With adapter will transform any standard phonograph into a loud speaker. Adaptable to consoles with built-in speakers. Price \$6.00.

QUALI-TONE LOOP

With exclusive thumbscrew adjustment The Quali-Tone's new thumbscrew adjustment keeps the loop wires taut always—an improvement that contributes largely to the startling performance of this remarkable loop. Then too, the long vertical strands of the Quali-Tone greatly increase efficiency and add appreciably to the distance range obtainable. The Quali-Tone will out-perform any loop on the market and will invariably produce a decided improvement in the operation of any receiver.

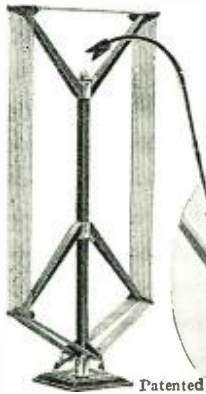

RECOMMENDED

The Quali-Tone Loop holds two world's records. It has brought in stations 8000 miles distant. Radio Engineers and Fans alike proclaim the Quali-Tone superior to all others. Mr. E. H. Scott, Designer of the World's Record Super 9 used the Quali-Tone exclusively.

DEALERS Write for discounts. JOBBERS Send for circulars today!

Duro Metal Products Co.
2651 N. KILDARE AVE., CHICAGO

The American Trickle Charger \$6.00

RELIABLE NO EXPERIMENT
WRITE TO US DIRECT

AMERICAN BATTERY CO.,
2057 N. Racine Ave., Est'd 1889 CHICAGO

FREE RADIO GUIDE

FREE RADIO CATALOG & GUIDE for 1927. Gives special hook-ups with illustrations. Shows savings on standard radio parts, complete sets, kits. Be sure to get this thrifty book before you buy. Write letter or postal NOW. Also include name of another fan.
BARAWIK CO., 542 Monroe St., CHICAGO, U. S. A.

A Unique Nine-Tube Superheterodyne

(Continued from page 365)

secondary eliminates, to a certain degree, the hissing noises so frequently experienced in superheterodyne receivers.

RESULTS OBTAINED

Regarding its efficiency: with four stages of intermediate, and two stages of audio amplification, two detectors and the oscillator, an average of only 13 milliamperes of "B" current was measured. The "A" battery current, with four WX12 tubes for the intermediate frequencies, four UX201A tubes for detectors, oscillator and first audio, and one UX112 tube for the second audio, is 1.75 amperes.

As for selectivity; a 500-mile station on 308 meters, with local station on 302 meters, a 1700-mile station on 405.5 meters, with local station on 400 meters and a 60-mile station on 217 meters have been brought in under the towers of a 2,000-watt station. All stations were received without the local signals in the background.

The record for the greatest number of stations within one month was obtained in Chicago with this receiver, where 105 stations in the United States, 7 Canadian, 1 Mexican and 1 Cuban, were logged while 13 local broadcast stations were on the air.

BUILDING THE SET

For such results the constructor is emphatically advised to incorporate only the very best apparatus in this receiver.

The design requires a base panel of high-insulating material in place of the usual base-board, and all wiring is kept under this base.

The transformers are mounted with 4/36 x 5/8-inch screws and nuts through the eyelets of the terminals. They range from the left, as follows: two iron-core, one air-core, one iron-core, and one air-core long-wave transformers; first audio transformer; R.F. choke unit, second A.F. transformer.

The radio-frequency choke unit is mounted with but three screws. The radio-frequency transformer, used as oscillator coupler, mounts on the lower part of the base panel, as do the two 1-µf. by-pass condensers, the mica condensers, the midget condenser, the audio amplifier rheostat, and the bracket for the battery cable. All wire connections are shown in the diagram.

It will be noted, that the connections to the two tuning condensers are accomplished through holes provided in the base panel. The plate and grid connections of the transformers, except the grids of the seventh and eighth tubes, are simply bridged with lugs to the respective terminals of the sockets. All battery connections run into the prongs of the cable bracket. It is advisable to have the latter leads running close together, and

A RADIOPTIMIST



Tone Clarity Beyond Expectation

Note the clarity and richness of tone any Amperite-equipped set gives you. Amperite is the automatic rheostat which does away with guessing and uncertainty as to correct tube current.

AMPERITES 1-A are used in the Lynch Power Amplifier and "B" Supply Unit. Described in Radio News.

Write for free hook-ups

Radiall Company

Dept. R.N.-10 50 Franklin St., N. Y. City

AMPERITE
REG. U.S. PAT. OFF.
The "SELF-ADJUSTING" Rheostat

22½ VOLT
unacid
everlasting
rechargeable
"B"

STORAGE
BATTERY
\$2.95

Includes
chemical



45 volts, \$5.25; 90 volts, \$10.00; 112½ volts, \$12.50; 135 volts, \$14.75; 157½ volts, \$16.80. Truly the biggest buy today. Easily charged on any current including 32 volt systems. Any special detector plate voltage had. Tested and approved by leading authorities such as Popular Radio laboratories. Over 3 years sold on a non-red tape 30-day trial offer with complete refund if not thoroughly satisfied. Further guaranteed 2 years. Knock-down kits at greater savings. Complete "Hawley" "B" Battery Charger \$2.75. Sample cell 5c. Order direct—send no money—simply pay the expressman cost on delivery. Or write for my free literature, testimonials and guarantees. Same day shipments.

B. HAWLEY SMITH

314 Washington Ave.

Danbury, Conn.

RADIO BOOK FREE



64 pages full of opportunity. Your Guide to what's right and standard in Radio; full explanation of liberal offer paying agents \$60 to \$100 a week and how to get latest radio goods at wholesale.

Big Money In Radio

We want live dealer and agents in every locality. Lifetime opportunity. This Book more than a catalog—shows big profit way to get into world's newest and richest field—make big money—turn full or spare time into cash. Accept This Offer! Write for FREE book. Lowest prices—make 40 to 60% every sale. 5-tube Coast Receiver \$39.50 Retail. Sells on sight. Hundreds of such money makers. Write for special agent's wholesale prices. Newest sets, parts and accessories—tremendous saving and profit. Write for FREE book and amazing offers.



Standard Radio Company, 1410 Walnut St., Kansas City, Mo.

spaghetti insulation should be used, where ever short-circuiting might happen. The "C—" battery lead connects to the grid returns of all transformers (except the choke unit), and a soft rubber-covered wire should be soldered to this for the "C—" battery terminal connection; another wire of this kind is soldered to the center tap of the loop for the "C+" battery connection. The rest of the circuit is self explanatory.

The functions of the tubes, from left to right, are:

- First detector, 201 A
- Four intermediate-frequency stages, WX 12
- Second detector, 201 A
- Oscillator, 201 A
- First audio, 201 A
- Second audio, UX 112

It is very important to select uniform tubes for the intermediate-frequency stages. These, being hooked up in series, can be operated from the 6-volt storage battery and can not be overloaded. Therefore, no voltmeter is included on the front panel.

OPERATION

If a "B" eliminator is preferred the 90-volt terminal can be used also for the detector plate, instead of 67½ volt. It is important to keep the storage "A" battery well charged, as a weak battery will cause undesirable noises. The "C" battery connects to the rubber-covered leads, and a bias of 4½ to 6 volts should be tried.

An ordinary loop aerial with a center tap will be sufficient for good reception of broadcast signals up to 2,500 miles on the loud-speaker. For longer distance an external aerial will be helpful, connecting it to one of the end terminals of the loop.

Only a speaker, which will stand great volume, will take the tremendously powerful output of this receiver. It is advisable to use one of the cone type. For tuning local stations the variable resistance will bring down the volume to any desired softness.

LIST OF PARTS

- 3 Iron-core I.F. Transformers (T);
 - 2 Air-core I.F. Transformers (T1);
 - 2 Audio Transformers (T2);
 - 1 Radio-Frequency Choke (L1);
 - 1 Oscillator Coupler (L2);
 - 1 7x26-inch Panel;
 - 1 7x24-inch Sub-Panel;
 - 2 Variable Condensers, .0005-µf. (C);
 - 2 Mica Condensers, .0005-µf. (C2);
 - 2 Vernier Dials;
 - 1 Midget Condenser, .000045-µf., (C1);
 - 1 Mica Condenser, .002-µf., (C3);
 - 1 By-Pass Condenser, .001-µf., (C4);
 - 1 Battery Cable, 7-wire;
 - 1 Variable Resistance, 200,000-ohm (R);
 - 2 Rheostats, 6-ohm (R1);
 - 1 Self-adjusting Rheostat (R2);
 - 1 Filament Switch (S);
 - 2 Brackets;
 - 9 Sockets;
 - 5 Jacks;
 - Bus Bar, Wire, Spaghetti, Terminal Lugs, 6/32 and 4/36 Screws and Nuts.
- Approximate Cost, \$80.00.

IT is against the policy of RADIO NEWS to publish the names of manufacturers or of makes of instruments in connection with the apparatus described in these pages, but this information will be gladly given privately. If you are interested in any special instruments described here, address a letter to the READERS' SERVICE DEPARTMENT, enclosing stamped return envelope. The names and addresses of the manufacturers will be given free of charge. —EDITOR.

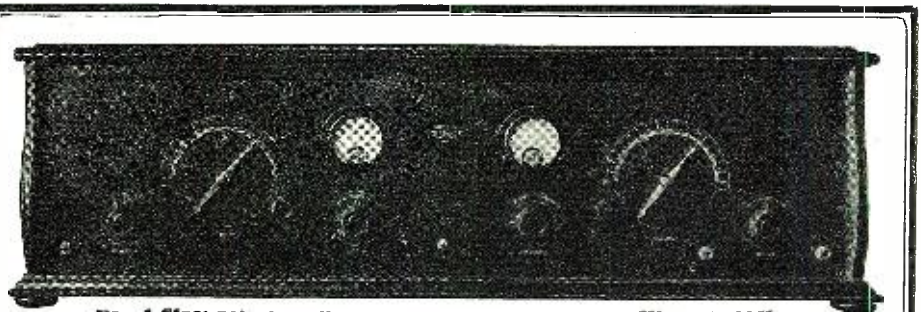

Panel Size: 36"x9x1-4"

Weight: 55 lbs.

A New and Advanced Model— Norden-Hauck Super-10

Highest Class Receiver in the World

THE NORDEN-HAUCK SUPER-10 is an entirely new and advanced design of Receiver, representing what we believe to be the finest expression of Modern Radio Research Engineering. It is the product of years of experience devoted exclusively to the attainment of an ideal Broadcast Receiver—regardless of cost. Results obtained in every respect will upset all your previous ideas of good radio reception. Here are only a few of the host of features that place the NORDEN-HAUCK SUPER-10 far in advance of competition:

- 10 tubes employed to give perfect reproduction with unlimited range and volume power.
- Super selectivity on all wave lengths.
- Built to Navy Standards.
- Wide wave length range without change of coils, etc. (Adaptable 35 meters to 3600 meters if desired.)
- Use Loop or Antenna.
- Simple to operate, having only two major tuning controls.
- No Harmonics. Signals are received only at one point.
- Special Power Audio Amplifier, operating any loudspeaker and eliminates necessity of external amplifier.
- Can be operated directly from house current if used with NORDEN-HAUCK POWER UNIT AB-2. Special.

The NORDEN-HAUCK SUPER-10 is available completely constructed and laboratory tested, or we shall be glad to supply the complete engineering data, construction blue prints, etc., for those desiring to build their own receiver.

UPON REQUEST a complete catalog, attractively illustrated, will be gladly mailed without charge, or full size constructional blue prints, showing all electrical and mechanical data, will be promptly mailed post-paid upon receipt of \$2.00.

Write, Telegraph or Cable Direct to

Norden-Hauck, Inc.

Engineers

Marine Building, Philadelphia, U. S. A.

TEAR OFF AND MAIL TODAY

NORDEN-HAUCK, Inc.
Philadelphia, U. S. A.

Gentlemen:—

Please send me without cost or obligation on my part, attractive illustrated literature describing the new Norden-Hauck Super-10.

I enclose \$2.00 for which please send me, postpaid, complete full size constructional drawings and all data for building the Super-10.

Name

Address

100 Volt Storage "B" Battery \$10

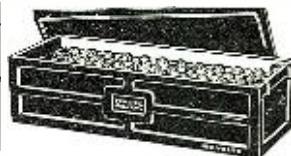

Everybody can now enjoy the benefits of Storage "B" Batteries—more power, quieter reception, greater economy. Rubber case prevents leakage or shorting. Easy to recharge. Will last for years with ordinary care.

SERVICE Rechargeable "B" Batteries
in all-rubber cases 50 VOLT \$5.50
100 VOLTS \$10.00 125 VOLT \$12.50

Prices in Canada:
50 Volt . . \$7.75
100 Volt . . \$14.50
125 Volt . . \$17.00

SERVICE "A" Batteries
Indestructible rubber case. 2 year guarantee.
6Volt.100amp.hr. \$14.00
6Volt.120amp.hr. \$16.00

SERVICE Double-Duty CHARGER

Charges 6-volt "A" or Auto Batteries or up to 125 volts of "B" Battery IN SERIES. Noiseless in operation. Extremely economical. The height of convenience.



SERVICE BATTERY CO. of Canada, 137 Roncesvalles Ave. Toronto, Ontario

SERVICE BATTERY CO.
704 East 102nd Street Cleveland, Ohio

Complete with Bulb \$14.50

NEW!

The Super-Heterodyne Book

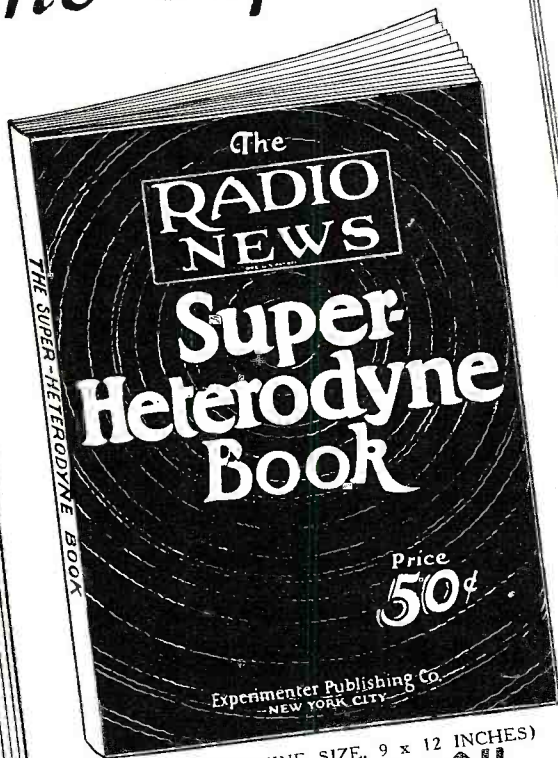

(FULL MAGAZINE SIZE, 9 x 12 INCHES)

50c On All Newsstands

The greatest book of superheterodyne circuits, information and data ever compiled on these great receivers

Now!—a veritable encyclopedia on ALL existing forms of superheterodynes, giving the step-by-step advancement from the first, early hookups to the very latest and finest Super-Receivers of today.

All kinds of wiring diagrams on all the well known Supers. Notes on advanced hookups and constructional improvements with drawings. Valuable information including all patents covering Super-Heterodynes.

Information and data without end. Just the book for every man who owns a super or who wants to install or construct one of these powerful sets.

Get your copy today--from any radio or newsdealer, or use the special coupon below.

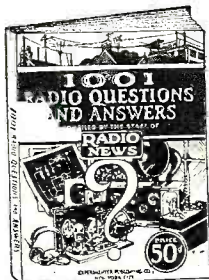

Meet your radio problems and beat them

Radio engineers spent 7 months to give you this valuable book

A brand new book filled to the brim with a priceless array of selected Questions and Answers that are necessary to everyone in the construction, care and maintenance of modern sets, including information on hundreds of simple and complex circuits in common use today.

Contains 116 pages, 300 illustrations and is published in the large Magazine Size 9 x 12 inches

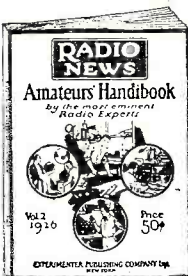

Read the best in radio

Selected radio articles by the most eminent radio engineers

116 pages, 300 illustrations, large size 9 x 12 inches

The "RADIO NEWS" Amateurs' Handbook is a large 116 page magazine size book containing a wide, varied and carefully selected array of the finest and most helpful radio articles that have appeared in the pages of Radio's Greatest Magazine, RADIO NEWS.

NEW 2nd EDITION

Get more from your receiver

Use this big bookful of shortcuts, hints and practical ideas

A big book full of shortcuts, hints and practical ideas. The 500 RADIO WRINKLES BOOK is a very comprehensive compilation of the best time and money saving hints that can be effected. Under fifteen separate and distinct headings, the entire field of radio apparatus and instruments has been covered in simple, understandable language.



Contains 116 pages, 300 illustrations and is published in the large Magazine Size 9 x 12 inches

IF YOUR RADIO OR NEWSDEALER CANNOT SUPPLY YOU USE THIS COUPON

EXPERIMENTER PUBLISHING CO., Inc.,
53 Park Place, New York, N. Y.

Gentlemen:—Enclosed find \$..... for one copy of
 SUPERHETERODYNE BOOK 1001 RADIO QUESTIONS and ANSWERS AMATEURS' HANDBOOK 500 RADIO WRINKLES.

NAME

ADDRESS

CITY, STATE

These and other big books of the Experimenter Publishing Co., on various interesting and helpful subjects are sold at all newsstands throughout the country—ask your newsdealer to let you see them.

EXPERIMENTER PUBLISHING CO., Inc.
53 Park Place - - - New York, N. Y.

A New Rectifier Tube

(Continued from page 343)

BETTER REGULATION

Another feature of the new rectifier, which is of great importance in connection with the "A-B-C" power supply unit, is the improved regulation of the tube itself. Actual measurements have shown that the new tube has a constant voltage drop from a very low current up to 85 milliamperes. If the output from the rectifier is never less than 10 milliamperes, as will be the case if a suitable system is adopted, the only regulation of the power supply needed will be that of the transformer and filter circuit. There will be no loss of voltage due to changing characteristics of the tube. This feature is really remarkable and one which has never before been available in power-supply rectifiers.

In order to take advantage of this characteristic, the constructor of the unit may well pay attention to the proper design of its power transformer and filter circuit, with regard to loss of voltage which might be caused by poor regulation.

An opportunity to improve the regulation of the filter circuit may be found in condenser C_3 of Fig. 1. By increasing this capacity from 2- to 4- μ f., at 85 milliamperes, an increase in D.C. output of approximately 15 volts may be secured.

MARGIN OF RESERVE POWER

Still another feature of the new tube which is of considerable importance in obtaining high-quality reproduction is the reserve power available for momentary overloads without damage to the rectifier. Extreme bursts of volume from the speaker demand proportionate amounts of energy from the power-supply unit. If this energy is not available at a constant voltage, there is certain to be distortion and a considerable loss of quality. If the power-supply unit is properly designed with regard to regulation, and if the rectifier is capable of delivering these peaks of energy without loss of voltage, good reproduction is insured at all times.

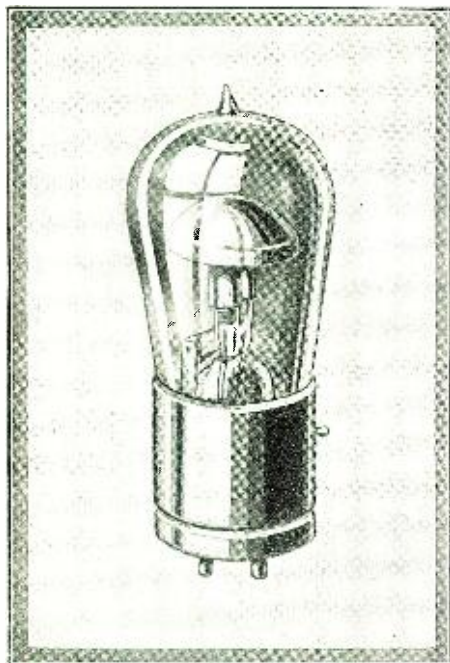

The size of this rectifier tube is approximately the same as that of the ordinary vacuum tube. The position of the elements may be easily seen.

Photos courtesy Raytheon Mfg. Co.

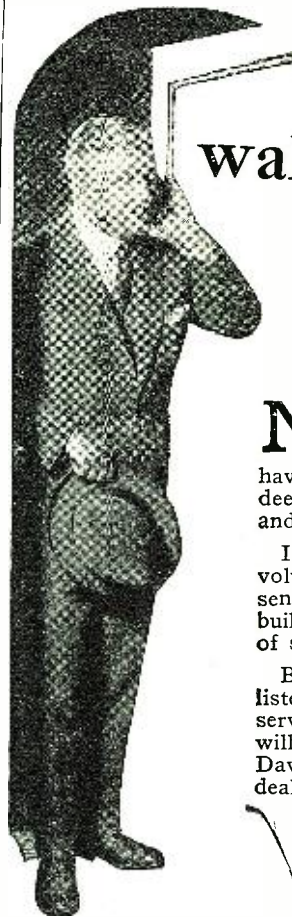

If a stranger walked into YOUR home?

"JUST now I am listening to the 'How', and if a stranger should walk into my house, not knowing I had a radio, he would believe the musicians were actually hidden in another room. I recommend Daven Resistance Coupled Amplification to anyone!"

J. H., Philadelphia, Pa.

NEVER has any radio hookup caused the sensation that the Daven Bass Note Circuit is causing. It does the thing that radio hook-ups of the past have never been able to accomplish—brings out all the deep bass tones as clearly and perfectly as the middle and higher registers.

In addition to this new quality of tone, it gives ample volume, perfectly controllable from whisper to roar; sensitivity, selectivity and ease of tuning. Simple to build, because constructed in straight line, economical of space.

Build yourself a Daven Bass Note set. The parts listed below may be secured from any authorized Daven service dealer with full instructions for assembling. We will gladly send you catalog, full information about the Daven Bass Note Circuit and address of nearby Daven dealer.

DAVEN BASS NOTE CIRCUIT

Made up of these Daven Standard Parts:

- | | |
|---|-----------------------------|
| 1 Set D.R.F. Coils | 1 Daven Leakandenser No. 22 |
| 1 Daven Super-Amplifier with the new Glastors | 1 Daven 1/4 Ampere Ballast |
| 3 Daven MU-20 Tubes | 1 Daven 1/2 Ampere Ballast |
| 1 Daven MU-6 Power Tube | 1 Daven Type "A" Condenser |

The Dealer on whose window you see the sign below, will get real pleasure out of demonstrating Daven Amplification for you.

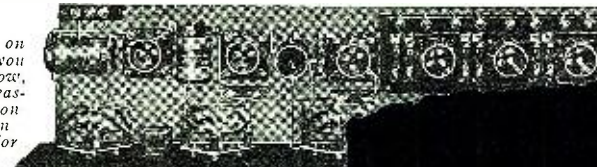

This valuable book (25c at the dealer's, 30c by mail)

Birdseye view of an economical Bass Note



The Sign of
DAVEN RADIO CO.
Trade Mark Resistor Special
140 SUMMIT ST.

Build Better Sets OF KELBRAKETS

75c
KELBRAKETS No. 15
PER PAIR
MGT. 2.02

REAL EFFICIENCY
BRIGHT ALUMINUM
FREE ASSEMBLY BOOKLET

KELLERADIO, INC.
821 Market St. San Francisco, Calif.

GEN-RAI

Reg.

Offers without charge Hook-ups Blueprint Reprints and instructions for the Gen-Ral coils which made their mark in Chicago.

Write to—
GENERAL MANUFACTURING COMPANY
6637 So. Cottage Grove - Chicago

FREE New **Princo Radio**

FREE CATALOG — New Kind 5-Tube Radio. Coast-to-Coast on Horn — Direct from Factory — Dealers. Agents—Write for special offer today.

\$42.00 list
5 days trial

DEPT. R.N.
PORTS MFG. CO. FRESNO CALIF.

FREE RADIO GUIDE

FREE RADIO CATALOG & GUIDE for 1927. Gives special hook-ups with illustrations. Shows savings on standard radio parts, complete sets, kits. Be sure to get this thrifty book before you buy. Write letter or postal NOW. Also include name of another fan.

BARAWIK CO., 542 Monroe St., CHICAGO, U. S. A.

Get a Handy Binder for your RADIO NEWS. Holds and preserves six issues, each of which can be inserted or removed at will. Price 65c. Experimenter Pub. Co., Inc., Book Dept., 53 Park Place, N. Y.

How to Get the Most Out of Your Set



Learn the principles of radio from this remarkable book
514 PAGES

Compiled by HARRY F. DART, E.E. Formerly with the Western Electric Co., and U. S. Army Instructor of Radio Technically edited by F. H. DOANE

STOP turning the dials blindly. Learn what happens when you turn them and why. Then you will get greater distance, greater volume, most enjoyable quality. The I. C. S. Radio Handbook will help you to get more enjoyment out of radio. It clears up the mysterious — tells you just what you want to know. Written by nationally known radio authorities in language that you can understand. An absolute necessity for every radio fan. A wonderful bargain at \$1. Note this partial list of contents—

Electrical terms and circuits, antennas, batteries, generators and motors, electron (vacuum tubes), many receiving hook-ups, radio and audio frequency amplification, broadcast and commercial transmitters and receivers, super-regeneration, licenses, etc.

Get only \$1 with the coupon today and the handbook.



The various constants shown in Fig. 1 will enable the builder to construct a power supply unit of good regulation, and by using the new tube he will have achieved all that is to be desired.

(In the August, 1926, issue of RADIO NEWS appeared constructional data for a Batteryless Receiver, utilizing the principle of series filament connections with an "A and B" eliminator. In forthcoming issues we will present complete data for building a set with a power-amplifier stage, utilizing similarly an eliminator with the added features of "C" current supply and high "B" voltage for the power tube.—Editor.)

Correspondence from Readers

LIGHTNING PLAYS ANOTHER PRANK

Editor RADIO NEWS:

I have been reading the first article, "Summer Radio Reception," in the June issue of RADIO NEWS; and am sorry that your \$300 prize contest for a story of destruction by lightning is not in effect at the present time.

A few days ago the city's electrical inspector asked me to visit a house with him, a house located on Wayne Street, in this city, where the radio aerial had been struck by lightning during a storm a few days previously.

The house was nearly square, and the roof sloped to a peak at the center, where the chimney projected through; eavestroughs ran completely around the four sides of the roof. The farther end of the aerial was fastened to a pole on the garage, at the rear of the lot, and ran to the chimney; thence at right angles down the slope of the roof, clearing the troughs two or three inches, and down the siding on insulators to the top of the foundation. Here a sharp bend was made, and the wire entered the basement, which was installed within.

Paralleling the aerial, between garage and house, but about ten or twelve feet below it, were lighting wires, running from a switch in the house to the garage; these wires were led out from the house about a foot below the eavestroughs, and pitched downwards to the garage.

As no two of the people who viewed the damage agreed on the course taken by the bolt after it struck, I will try to describe what I saw and let you figure it out. Not a shred of the aerial could be found, from the insulator on the pole, at the garage, to the point where the right turn was made to enter the basement. The few inches of horizontal lead-in wire which projected from the tube through the wall seemed to have been burned off at the end; and the white wall at this point was scorched and blackened, but had not caught fire.

At the rear of the house, the lighting wires that led out to the garage were burned and their insulation, as well as the lighting fixtures in the garage, was destroyed. Where these wires entered the house, close under the eaves, and led down between the sheathing and the plaster to a wall switch in the kitchen, the greatest damage had been caused. The second story was covered with shingles, which had been blown off for several feet on either side of the wire; so was the plaster and lath on the inside, and the rear wall of the house was almost completely wrecked. In the rear of the house, the ceiling and walls were scorched around all the light fixtures, and every lighting switch in the house was destroyed. In the bathroom on the second floor, whence the wires led out to the garage, the fixtures were badly dam-

Sales Representative Wanted

Who is now calling on the radio and electrical trade, to sell our new, wonderful cone loud speakers. Exclusive territory and big commission. Give references and full particulars.

Metro Electric Company
2165 N. California Ave., Dept. 11
Chicago, Ill.



CHICAGO RADIO BATTERIES

Solid One Piece Rubber Containers
GUARANTEED FOR 2 YEARS

FAMOUS for unexcelled quality, guaranteed long-lived service and unvarying dependability Chicago Batteries offer the Radio fan an "A" Power that is backed by years of experience and master workmanship with the finest materials available. Endorsed and approved by leading Radio and Automotive authorities. Chicago Batteries in their new non-leak, solid rubber cases represent an amazing value at lowest cost.

PRICES

RADIO BATTERIES
SOLID RUBBER CASES

6 volts, 100 amps.	\$ 8.29
6 volts, 120 amps.	10.29
6 volts, 140 amps.	12.45

SAVE MONEY—ORDER DIRECT

Buy Chicago Batteries direct from the manufacturer. Batteries shipped same day order is received. Express C O D or 3% discount cash with order.

CHICAGO BATTERY WORKS
1210 So. Peoria St. Chicago, Ill.

WORLD'S RECORD SUPER 9 BLUE PRINTS

FREE Write for a complete description of the Peer of all receivers—the wonder receiver that holds 4 fully verified World's Records for distance. The World's Record Super 9 is one of the few receivers to bring London into Chicago during the last two International Contests. Thousands of testimonials hail the World's Record Super 9 as the marvel of Radio. Write for free list of records and testimonials today!

You can build an exact duplicate of the original World's Record Super 9 by following our Blue Prints. Building instructions complete in every detail with each set of Blue Prints make it easy for anyone to build this remarkable receiver with perfect success. Complete Building instructions and Blue Prints \$5.00. Remit with order or we will send C. O. D.

M-S SYNDICATE
1486 E. 118th Street - Cleveland, Ohio

The Outstanding Winner—1927
HENRY - LYFORD
CIRCUIT

This is not a freak circuit but one based on somewhat different yet absolutely sound engineering principles. The Radio press from coast to coast has pronounced it one of the most selective and remarkable distance getters yet developed. This receiver is described in the new development section of Radio News.

COMPLETE PARTS
FOR THIS
FAMOUS **\$69.50**
CIRCUIT

Write for special pamphlet and Hookup IT'S EASY TO BUILD for wholesale Catalog describing all standard parts and kits.

HEINS & BOLET
52 PARK PLACE - NEW YORK

Insure your copy reaching you each month. Subscribe to RADIO NEWS — \$2.50 a year. Experimenter Publishing Co., 53 Park Pl., N.Y.C.

Insure your copy reaching you each month. Subscribe to RADIO NEWS — \$2.50 a year. Experimenter Publishing Co., 53 Park Pl., N.Y.C.

aged, a large piece being burned out of the rim of the bathtub. Here it seemed as if the bolt had found a ground, in the water-pipes, and ceased the destruction. All the plaster was torn off the walls in this room, and from a wall of the adjoining room.

No damage was done to any wiring in the basement and the radio set was not injured; the tubes all lit and were ready to function as soon as a new aerial was installed.

It is my idea that the lightning would not make the square turn in the lead-in going through the wall to the arrester in the basement; and not finding a ground, jumped to the eavestrough, and from that to the wires leading to the garage; doing all the damage in its course along the latter until it grounded on the water pipe. In opposition to this theory is the fact that the spouting made a square turn between the lead-in and the lighting wires where it entered the house. About the only other alternative seems to be that the bolt of lightning was forked and struck, both the aerial and the wires several feet below it, at the same time.

The fact remains, however, that the lightning arrester installed in the basement did no good whatever; as there is no evidence that the bolt got that far.*

On every aerial installation that I have supervised I have insisted that the arrester be placed on the outside of the house, and the lead-in run straight down to it, with no sharp turns; also that a good ground be provided directly beneath it and the connection made with heavy copper wire.

I would appreciate a discussion regarding this point, as the matter is considered of some importance by the electrical inspectors and the fire department of this city.

PAUL L. RAPP,

620 Brighton Ave., Toledo, Ohio.

(*NOTE: While the precautions suggested by Mr. Rapp are excellent and should be taken, it would hardly seem from his account that the work done by the lightning arrester should be condemned; as the radio set was completely protected from injury. All the damage in this case, except for the destruction of the aerial, was done by the current which followed the lighting wires, and which would probably have done so even if there had been no radio set in the home. This case simply confirms what we have said before, many times, as to the safety of radio apparatus properly protected.—EDITOR.)

INSECTS AND RADIO

Editor, RADIO NEWS:

I have just read the article in May RADIO NEWS headed "Nature's Radio," which particularly attracted my attention, as I have

STAGE FRIGHT

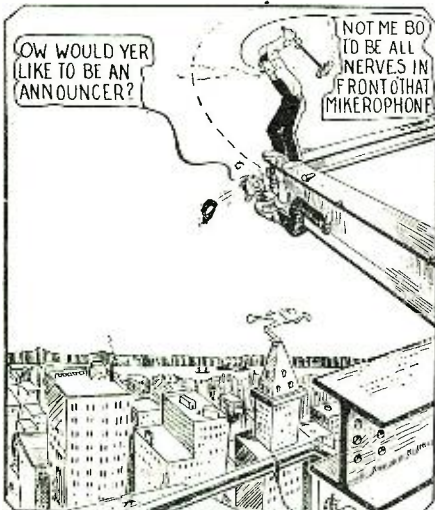

"MOST POWERFUL IN THE WORLD"
Navy Model
UNIVERSAL TRANSOCEANIC

Design by
CHAS. R. LEUTZ



LICENSED UNDER HOGAN PATENT 1,014,002

Wavelength Range 35 Meters to 3600 Meters

Full details are given in our 88 Page Catalog Free.
Wire or write for your copy today.

MANUFACTURED BY

GOLDEN-LEUTZ, Inc., Sixth & Washington Aves., Long Island City, N. Y.

CABLE "EXPERINFO"
The Universal Transoceanic is supplied completely constructed and laboratory tested and is also supplied in Kit form, all parts ready for assembly. The complete set of Constructional Blue Prints covering all mechanical, electric assembly details, wiring diagrams and instructions will be mailed upon receipt of \$5.00 net.



MURRAY UNIT REALLY ENDS TROUBLE

For constant Radio "A" power; can be operated while set is in use. Simply connect to light socket. No adjustment; no wires to change; no low batteries. Equipped with hydrometer in cap for gravity test and 2-amp. G. E. Tungar bulb. Delivered ready to use. \$29.50 LIST

Agents Wanted! Murray Distributor 4837 N. Robey St., C, CHICAGO

NEW INFRADYNE KIT

ALL GENUINE PARTS IN STOCK NOW!
WHOLESALE CATALOG
FREE Listing thousands of new radio parts, kits, furniture, accessories and complete radio sets, at prices that save you money. Write for your copy now, its free.
THE HARCO CO., 1253 S. Wabash Ave., Chicago, Ill.

TELEGRAPHY
(Morse and Wireless) and RAILWAY ACCOUNTING taught thoroughly. Big salaries; great opportunities. Oldest, largest school. Endorsed by Telegraph, Railway, Radio, and Government officials. Expenses low—opportunities to earn large portion. Catalog free.
DODGE'S INSTITUTE Swan Street, Valparaiso, Ind.

INVENTORS who derive largest profits know and heed certain simple but vital facts before applying for Patents. Our book Patent-Sense gives those facts; sent free. Write LACEY & LACEY, 631 F St., Washington, D. C. Established 1869.

Insure your copy reaching you each month. Subscribe to Radio News—
\$2.50 a year. Experimenter Publishing Co., 53 Park Place, N. Y. C.

New Way to Learn ELECTRICITY

1—with Lessons
The Laws of Electricity made easy to understand. Then by easy stages we give you Electrical Engineering subjects, Drafting, Radio, Ignition, etc., the advanced subjects you must have to fill one of the BETTER positions in Electricity.

2—with Job-tickets
Wonderful NEW system of one-step-at-a-time instructions for doing practical work which materials and tools to use, the short cuts and new methods. Shows you how to APPLY what you learn in lessons.

3—with OUTFITS
SEVEN (7) Outfits of standard tools and materials given to every student without extra charge. To learn by doing:
1. Electrical Soldering
2. Bell-Wiring Equipment
3. Electric light wiring
4. Voltmeter and compass
5. Transformer outfit set
6. Radio Receiving
7. Standard Power motor

5 Job Tickets
3 Lessons FREE

Success for you in ELECTRICITY or money refunded. Men accepted for training under positive agreement to help them find well-paid positions after they finish, or money refunded.

Start with the Coupon!
Chief Engineer Dunlap
AMERICAN SCHOOL
Dept. E785 Drexel Av. & 58th St., Chicago

Chief Engineer Dunlap, American School
Dept. E785 Drexel Av. & 58th St., Chicago
I accept your offer to send me 5 Job Tickets & Electrical lessons absolutely FREE to prove that by your NEW WAY I can learn at home in spare-time under money-back guarantee.

Name _____
Address _____

\$75 A WEEK BUILDING RADIO SETS In Your Spare Time

Join the Radio Association of America. Learn how to build and repair sets. The Association will train you—start you out in business, if you wish. Be the radio "doctor" of your community. \$3 an hour upwards easily made.

EARN \$500 IN SPARE HOURS
"I have at last found myself," writes Lyle Follick, Lansing, Mich. "I have already made over \$500." Werner Eichler, Rochester, N. Y., writes, "... have made over \$50 a week in my spare time." Our members are starting radio stores, increasing their salaries, securing better positions, passing radio operator examinations, earning big money in spare time.

JOIN ASSOCIATION NOW!
Are you interested in Radio for pleasure or profit? Join now because we have a Special Plan whereby your membership need not cost you a cent. Only limited number of these memberships acceptable. Write now for details—before it is too late.

MAIL THIS COUPON

Radio Association of America,
Dept. 1510, 4513 Ravenswood Ave., Chicago
Send me details of your Special Radio Association Membership Plan.

Name _____
Address _____
City _____ State _____

5 Tube Set—\$20—Latest Design

This wonderful set made possible because practically everything is manufactured in our own factory. We supply Chassis completely wired with cushion sockets S.L.F. condensers, vernier dials. No cabinet. Dimensions to fit 7x18 cabinet, expressage extra, weight 13 pounds. Money refunded if unsatisfactory. Remit cash, money order, etc. Best radio set for the money.

DUKE RADIO COMPANY, 326 W. Madison St., CHICAGO, ILLINOIS

FREE RADIO GUIDE

FREE RADIO CATALOG & GUIDE for 1927. Gives special hook-ups with illustrations. Shows savings on standard radio parts, complete sets, kits. Be sure to get this thrifty book before you buy. Write letter or postal NOW. Also include name of another fan.

BARAWIK CO., 542 Monroe St., CHICAGO, U. S. A.

accidentally noted a peculiarity in connection with wasps or "mud hornets," as they are sometimes called in this vicinity. One of the nests noticed was in an old rotten log. We watched this for a few minutes and only an occasional wasp was seen to enter or leave. We then threw a stick at the hole, and some twelve or so immediately flew out and buzzed around excitedly for a short time and re-entered. Almost immediately numbers began to fly from all directions and enter the nest. This influx was kept up for over half an hour, during which time not a single one left the hole.

Again, have you noticed how these insects behave when wounded away from home? I have deliberately crushed the abdomen of some, many times outside of a building when there was not another to be seen. Almost at once, one or more would be seen flying or crawling around the injured one.

The question is, so far as I am concerned, how is the intelligence in these instances carried?
J. R. Howse,
Lumby, British Columbia.

A TRAGEDY IN D MINOR

Editor, RADIO NEWS:
I wrote you once before about my aged grandmother and her radio set; how she was hard of hearing and had to use three stages of audio so she could hear the local stations. She just didn't have no ear-drums at all, but her head acted like a sounding board. With the full three stages of audio she'd radiate like a cone speaker and all the folks round our district admitted that she was the most faithful reproducer of broadcast music in the county. Early in the evenings all the neighbors would come over to our house to listen to grandma work. The low notes came through just as good as the high ones. Honest when some guy hit a drum, you'd swear that it originated in grandma's head. A flute or a fiddle was just as good. Well, you can bet we all enjoyed it immensely, particularly us at home as it was a great pleasure to us to have people droppin' in in the evenin'. Our home was a regular social center. But of course the music was best of all. Then, last week poor old grandma died. The doctor said it was due to two stations heterodyning each other. Anyways, her skull was fractured. So I'm writing you in behalf of my folks and our neighbors in the hopes that you can recommend some make of loud speaker which will not rattle on three stages of audio, that will reproduce drums good and leastwise not crack like grandma's dome did.

Yours for better reproduction,
OSKAR WILD,
P. S. We sure miss Grandma in the evenings.

Station WRNY NEW YORK

374.8 Meters - 800 kilocycles
is owned and operated by the publishers of this magazine
Our Editors will talk to you several times every week
See your Newspaper for details
TUNE IN ON WRNY

See that screw
A SCREW DRIVER ADJUSTS AN XL IN CROWDED PLACES

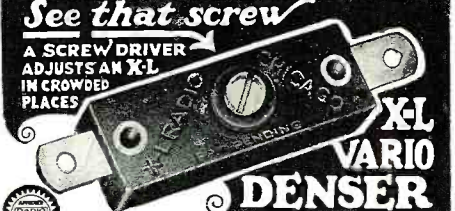

XL VARIO DENSER

RESULTS in easier tuning, more distance, volume and clarity—greater stability. Indorsed by leading authorities.

MODEL "N"—A slight turn obtains correct tube oscillation on all tuned radio frequency circuits. Neutrodyne, Roberts two tube, Browning-Drake, McMurdo Silver's Knockout, etc. Capacity range 1.8 to 20 micro-micro farads. **PRICE \$1.00**

MODEL "G"—with grid clips obtains the proper grid capacity on Cockaday circuits, filter and intermediate frequency tuning in heterodyne and positive grid bias in all sets.

CAPACITY RANGE

Model G-1—00002 to .001 MFD
Model G-5—0001 to .003 MFD
Model G-10—0003 to .001 MFD

PRICE \$1.50

X-L PUSH POST—Push it down with your thumb, insert wire, remove pressure and wire is firmly held. Releases instantly. **PRICE 15c**

PUSH POST PANEL—permanently marked in white on black insulating panel. In box including soldering lugs, raising bushings and screws for mounting, etc. **PRICE \$1.50**



X-L Radio Laboratories, 2426 LINCOLN AVE., CHICAGO, ILL.

WRITTEN 2-YEAR GUARANTEE

ARROW BATTERY

Battery Prices SMASHED!

To Consumers Only
Here is a real battery quality, guaranteed to you at prices that will astound the entire battery-buying public. Order Direct From Factory. You pocket the Dealer's Profit in your own pocket. You actually save much more than half, and so that you can be convinced of true quality and performance, we give a **Written 2-Year Guarantee**. Here is your protection! No need to take a chance. Our battery is right—and the price is lowest ever made. Convince yourself. Read the prices!

Auto Batteries Radio Batteries
6 Volt, 11 Plate, \$8.50 6 Volt, 10 Amp, \$8.50
6 Volt, 13 Plate, \$10.25 6 Volt, 120 Amp, \$11.25
12 Volt, 7 Plate, \$11.75 6 Volt, 140 Amp, \$11.75

Buy Direct—Send No Money
We ask no deposit. Simply send name and address and style wanted. Battery will be shipped same day we receive your order Express C. O. D. subject to your examination on arrival. Our guarantee accompanies each battery. We allow 5% discount for cash in full with order. You cannot lose! Send your order today—NOW!

ARROW BATTERY CO.
Dept. 8 1215 So. Wabash Ave., Chicago



Our Radio Dealers Make Big Money

Dealers looking for big turnover and quick profits will send for this 96-page catalog of radios and accessories, including Brenner, Tully, Balkite, All American, G. E. Tungar, Thorola, Majestic, Utah, R. C. A. Tubes, nationally advertised parts, batteries, chargers, etc. Write for catalog No. 91H. Full facts, territories open, etc. Tell us about your business, as we sell wholesale only. Real money waiting. Don't delay.

NEW ENGLAND MILLS CO.
Distributors Nationally Advertised Radio Lines
Dept. 91H Chicago, Ill.



FREE

Send \$1 for 5 months subscription to SCIENCE & INVENTION and get one genuine

VALET Auto-Strop Razor FREE!
EXPERIMENTER PUB. CO., Inc.
53-R Park Place New York, N. Y.

Broadcasting in Australia

By HAROLD A. REEVE

UNDER the supervision of the Federal Government of Australia, broadcasting has made rapid strides in that continent. The great boom, which followed that in the United States, has passed and the people of Australia now regard radio, not as a novelty, but as a necessity, especially in the inland districts, where the country is sparsely populated, and other means of communication are slow. At present there are 106,592 licensed listeners-in in Australia, of whom 52,437 are in Victoria and 33,300 in New South Wales.

The principal stations in Australia have quality of transmission and range equal to, if not better than many of the broadcasting stations in other countries of the world. They are termed "A" class stations. Every person desirous of listening in must pay a license fee, which is collected by the Federal Government at the post offices. The fee in the metropolitan areas is 27½ shillings (\$6.68) per annum; while in country districts a smaller fee is charged. From each license fee 2½ shillings (60 cents) is deducted by the government for administrative expenses, twice that sum for royalty fees. The remainder of the revenue collected in each state is paid to the "A" class station or stations operating in the capital of the state.

LEADING AUSTRALIAN STATIONS

The "A" class stations of Australia are as follows:

	Meters	Watts
2BL, Sydney	353	5,000
3LO, Melbourne	371	5,000
4QG, Brisbane	385	5,000
5CL, Adelaide	395	5,000
3AR, Melbourne	484	1,600
7ZL, Hobart	535	3,000
2FC, Sydney	1100	5,000
6WF, Perth	1250	5,000

Excellent musical programs are provided by these stations, there being morning, afternoon and nightly entertainment each day of the week. Special attention is given to commercial and market reports, and to news services for the man on the land. These reports are of incalculable value, for they enable country folk to know the state of the markets as soon as the city dwellers, and they hear the latest news in many cases several days before a newspaper is received. Listeners-in in all parts of the United States and Canada and in European countries have successfully logged the stations, and numerous letters and cards are received by the stations by each overseas mail.

Owing to the high wavelength of two of the leading stations, the types of sets in universal use in America have not been very popular in Australia up to the present; the regenerative circuits appear to be the most extensively used. However, the super-het and the neutrodyne circuits are now gaining favor, particularly among people in the cities, who have not the facilities for erecting aeri-als. It is very difficult for the Government officials to trace the owners of such sets. Postmen are instructed to report all new outdoor aeri-als and persons who fail to take out a license are fined in the courts.

THE COPYRIGHT SITUATION

There is considerable discontent at present regarding the copyright charges, and efforts are being made to induce the federal government to appoint a commission to inquire into the matter. The payment of two shillings (49 cents) per license by the broadcasting companies gives the right to broadcast 12,000 copyright items within the twelve months for stations paying over £1000 (\$4880) in copyright fees, and 8,400 items for stations pay-

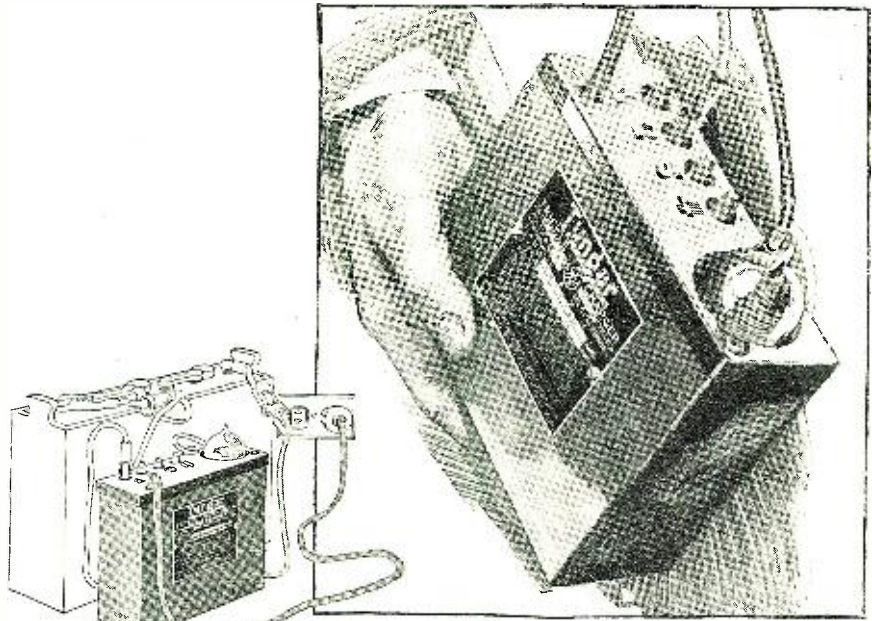

General Electric *presents the new* Tungar Trickle Charger

Been waiting for this? So many fans have! A small, compact charger that does a full-size job.

Connect a G-E Tungar Trickle Charger to your radio "A" battery—and leave it. Put it in your radio cabinet—and forget it. Your set will have constant power—always.

This new General Electric Charger allows just enough current to trickle continuously into the battery to replace the power used by the set.



The Tungar Trickle Charger is convenient, clean, complete—ready for installation. It is moderate in its price—and in its running cost.

East of the Rockies
\$12 complete with bulb
(60 cycles, 115 volts)

Merchandise Department
General Electric Company
Bridgeport, Connecticut

Tungar

REG. U.S. PAT. OFF.

TRICKLE CHARGER

Tungar—a registered trademark—is found only on the genuine. Look for it on the name plate.

GENERAL ELECTRIC

LEARN THE CODE AT HOME

WITH THE OMNIGRAPH

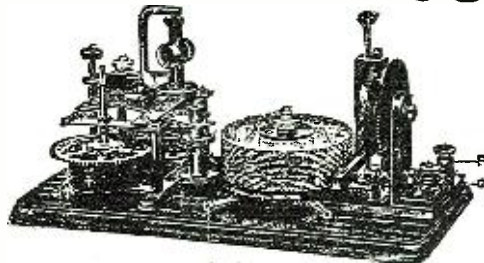

THE OMNIGRAPH Automatic Transmitter will teach you both the Wireless and Morse Codes—right in your own home—quickly, easily and inexpensively. Connected with Buzzer, Buzzer and Phone or to Sounder, it will send you unlimited messages at any speed, from 5 to 50 words a minute.

THE OMNIGRAPH is not an experiment. For more than 15 years, it has been sold all over the world with a money back guarantee. The OMNIGRAPH is used by several Depts. of the U.S. Govt.—in fact, the Dept. of Commerce uses the OMNIGRAPH to test all applicants applying for a Radio license. The OMNIGRAPH has been successfully adopted by the leading Universities, Colleges and Radio Schools.

Send for FREE Catalog.
THE OMNIGRAPH MFG. CO.,

DO IT TODAY.
15 HUDSON STREET, NEW YORK CITY

If you own a Radio Phone set and don't know the code—you are missing most of the fun

Get a Handy Binder for your RADIO NEWS. Holds and preserves six issues, each of which can be inserted or removed at will.

Price 65c.

Experimenter Pub. Co., Inc., Book Dept., 53 Park Place, New York

Big, Revised FALL EDITION is Here!

**6
BIG
FEATURES**
*Photos of American
Radio Artists*

ALL U. S. BROADCAST STATIONS *(Listed three ways)*

In this New Fall Edition of Radio Review appears the most complete, up-to-date list of all U. S. Radio Broadcast stations in existence, listed 3 separate ways, Alphabetically by call letters, by wave-lengths, and by states and cities. It gives the wave length in Meters and Kilocycles, the power, the location, the ownership and the hours of operation of each station.

LATEST LIST REVISED WAVE LENGTHS

ALL CANADIAN BROADCAST STATIONS *(Listed two ways)*

All Broadcast stations in Canada are listed in Radio Review and in two different ways for the convenience of the reader. First, by call letters and second, by Provinces and cities. Like the listing of the U. S. Broadcast stations all details are given including ownership, power, Meter and Kilocycle wave-length, etc. This is a handy section for Fall D.X. work.

ALL FOREIGN BROADCAST STATIONS

Besides the U. S. and Canadian stations Radio Review contains the finest list obtainable of Foreign Broadcast stations including even such countries a Jugoslavia, Poland, India, Peru, etc., giving Ownership, Call letters, Wave Length and Power.



SET OWNERS BOOK OF INFORMATION

Radio Review not only contains the Broadcast stations of the World, but a big section of many pages gives the latest, finest information on how to operate, how to repair or improve a set, or how to build various accessories. It is of great value to every owner of a Receiver.

CONSTRUCTION OF MODERN CIRCUITS

This section of Radio Review contains circuits of every description gathered from all over the world. All articles are of constructional nature and are fully illustrated with pictures, diagrams, etc. Each circuit is described completely and in detail. All the latest hook-ups are covered.

S. GERNSBACK'S RADIO ENCYCLOPEDIA

In each issue is a special supplement of S. Gernsback's Radio Encyclopedia—this is not a dictionary but a regular Encyclopedia explaining fully every radio word. The supplement is profusely illustrated and is the most up-to-date and complete radio reference ever published. It is Radio's finest Encyclopedia.

50¢ - SOLD ON ALL NEWSSTANDS
Published by THE CONSRAD CO. Inc. 53 Park Place New York, N.Y.

Distantone

"Built By Craftsmen"



NO BATTERIES! Operates From Your House Current

All batteries eliminated. Simply plug into your AC light socket. Beautiful duo-tone solid walnut cabinet, highly finished. Panel control board is of metal, artistically decorated in duo-tone effect. Equipped with built-in speaker of great volume and tone clarity. Five tubes. Two dial control.

List Price Without Tubes
Model E Console with Power Unit... \$275
Model E Console without Power Unit \$165

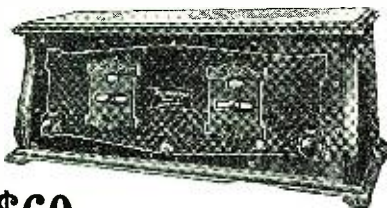

\$60 Model E VALUE UNSURPASSED!

Without a doubt, here is 1927's most beautiful and efficient table model. It is a five tube, two dial control receiver, with richly finished duo-tone cabinet and harmonizing panel. It is a receiver of great volume, superb tone and long distance. Over-all dimensions 20x10x9 inches. Wave length range 180 to 550 meters.

THE DISTANTONE LINE

In addition to the two models shown here, the Distantone line includes five tube receivers of two and three dial control and five and six tube sets with single dial control, all tuned radio frequency.

DISTRIBUTORS

Write or wire us today for the Distantone proposition.

DISTANTONE RADIOS INC.,
Lynbrook, Long Island, N. Y.

ing fees less than that sum. The copyright items include all songs, solos and instrumental music, whether it is played in the studios or in the theatres, churches, dance halls or picture theatres which are broadcast. In effect this gives the broadcasting stations the right to put on the air about thirty items per performance. It is contended by the companies that the fees are excessive.

There are twelve "B" class broadcasting stations in Australia.

A Symposium on the Broadcast Situation

(Continued from page 326)

lic will wake up and speak to their representatives, and to offending stations, adequate legislation will soon come, and in the meantime interference from pirates will stop. There is no chaos at present in broadcasting, nor is there any likelihood that there will be. The listening public may rest assured that the majority of broadcasters have sufficient common sense to remain on their present frequencies. A minority may temporarily change, but wherever such changes are found to cause interference listeners-in have full control of the situation—if they will only exercise it—by way of letters of protest to the offending stations."

—Greenleaf W. Pickard.

JOHN L. REINARTZ
Inventor of Reinartz Circuit



"The broadcasting interests can ill afford to court disaster by indiscriminate use of the air. Each licensee is morally bound to observe the contents of his license. Those few who may disregard propriety will soon discover that the public will view them with contempt."

—John L. Reinartz.

DR. J. HARRIS ROGERS
Inventor of Underground Radio

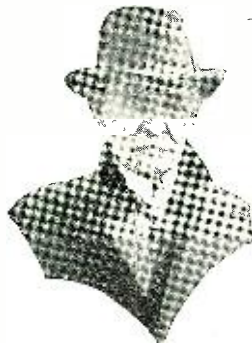

"Loyalty to science and the radio art, not to speak of self-interest, will in my humble opinion adjust the conditions arising from the federal court's decision affecting broadcasting; and will thus prevent the chaotic conditions feared by a panicky public."

—J. Harris Rogers.

FROM THE SUPERVISORS OF RADIO
Second District

"Regarding the radio situation in the Second District, I have to advise that as a result of the recent changes in wavelength

How Does the Battery Behave?



Send your battery to the charging station regularly for thorough examination. But between calls make your own tests. It takes but a minute or two, and no effort at all, with a

SCRANTON KANTSTICK BATTERY TESTER

Four colored divisions—an exclusive Scranton feature—show at a glance whether battery charge is Good, Fair, Poor or Dead.

Six laboratory tests insure absolute accuracy in every detail. Floats move freely without sticking.

Highly endorsed. Widely used. Fully guaranteed. In individual container at \$1.00.

SCRANTON BATTERY-CAP-TESTER An Entirely New Idea

Instantaneous. Simply remove vent plugs and replace with new Scranton Battery-Cap-Testers. Always ready for instant use. No breakage. No spilling of acid. Absolutely accurate. Also tells instantly when to add water. Set of three \$2.

If your dealer cannot supply you with Scranton Instruments order direct from us.

DEALERS

Every radio set owner needs a hydrometer. In the Scranton line there are types to meet every price requirement. All dependable instruments in steady demand. Write for catalog.

The Scranton Glass Instrument Company Scranton, Pa.

Send Coupon for Booklet

SCRANTON GLASS INSTRUMENT CO., Scranton, Pa.		RN-10
Dear Sirs: Please send me free copy of "Handbook of the Battery."		
Name		
Street and No.		
City	State	
Dealer's Name		

OPPORTUNITY AD-LETS

Follow these advertisements every month. Reliable advertisers from all over the country offer their most attractive specials in these columns.

Classified advertising rate twenty-two cents a word for each insertion. Ten per cent discount for 6 issues, 20 per cent discount for 12 issues. Name and address must be included at the above rate. Cash should accompany all classified advertisements unless placed by an accredited advertising agency. No advertisement for less than 10 words accepted.

Objectionable or misleading advertisements not accepted. Advertisements for the December issue must reach us not later than October 1st.

CIRCULATION LARGER THAN THAT OF ANY OTHER RADIO PUBLICATION

EXPERIMENTER PUBLISHING CO., INC., 53 Park Place, New York, N. Y.

Agents Wanted

Big Money and fast sales. Every owner buys gold initials for his auto. You charge \$1.50; make \$1.35. Ten orders daily easy. Write for particulars and free samples. American Monogram Co., Dept. 133, East Orange, N. J.

Guaranteed Genuine Gold Leaf Letters anyone can put on store windows. Large profits, enormous demand. Free samples. Metallic Letter Co., 422 N. Clark, Chicago.

Agents—our super embossed display signs for all stores are tremendous sellers. \$75 to \$100 per week easily made. Write now for details. Artistic Signs, 799-O Broadway, New York.

Lightning Electrolyte. Charges storage batteries instantly. Gallon costs 50c, sells \$10.00. Make it yourself. Guaranteed formula \$5.00. Write for free circulars. Murphy, Chemist, Tujunga, Calif. Box-D.

Boston Maid Frocks for Women and Children—nationally known—famously popular. From Mill to Wearers \$3.50 to \$20. Great income producers for men and women agents. Write for selling outfit. Bosworth Mills, B-16, Melrose, Mass.

We Start You In Business, furnishing everything. Men and Women, opportunity to earn \$10.00 to \$100.00 weekly operating Regsdale's original "New System Specialty Candy Factories" anywhere; wholesale or retail. Valuable commercial candy book free. W. Hillory Regsdale, Drawer 210, East Orange, N. J.

Earn \$10 daily silvering mirrors, plating, refinishing metalware, headlamps, chandeliers, bedsteads. Outfits furnished. Bolanger Deco Laboratories, 1133 Broadway, New York.

Agents: \$100 a Week Paid to Men who will help in spare time to demonstrate amazing new kind of radio set. Get's 40 to 350 meters. We put you in your own radio business. No investment required. Write quick for details. Ambu Engineering Institute, 2632-1C Prairie Ave., Chicago.

Business Opportunities

Free Book. Start little Mail Order Business. Pier, 990 Cortland Street, N. Y.

Stocks—Bonds, Domestic—Foreign, bought—sold. Dealers in all marketable securities. Frank Y. Everett & Co., 20 Broad St., New York.

Manufacture Crystals—Big profits, particulars free. Box 313, Wichita, Kansas.

Chemistry

Learn Chemistry at Home. Dr. T. O'Connor Sloane, noted educator and scientific authority, will teach you. Our home study correspondence course fits you to take a position as chemist. See our full page ad on page 423 of this issue. Chemical Institute of New York, 66 W. Broadway, New York City.

Correspondence Courses

Used correspondence school courses. All kinds. Sold on repurchase basis. Big saving. Money back guarantee. Lists free. (Courses bought). Lee Mountain, Pisgah, Alabama.

Help Wanted

Detectives Needed Everywhere. Travel. Experience unnecessary. Write, George Wagner, former Government Detective, 1968 Broadway, N. Y.

Earn \$25 weekly, spare time, writing for newspapers, magazines. Experience unnecessary. Details FREE. Press Syndicate, 973, St. Louis, Mo.

All men—women, 18-60, wanting to qualify for Permanent Government Positions. \$140-\$300 month, home or elsewhere. Write, Mr. Ozment, 251, St. Louis, Mo.

Men Wanting U. S. mail positions. \$142-\$225 monthly; steady; experience or correspondence course unnecessary; details free. Write R. Bradford, 112 Bergen Ave., Jersey City, N. J.

Incorporations

Delaware Incorporator, Charters; Fees Small; forms. Chas. G. Guyer, 901 Orange St., Wilmington, Del.

Instruction

Learn Chemistry at Home. Dr. T. O'Connor Sloane noted educator and scientific authority, will teach you. Our home study correspondence course fits you to take a position as chemist. See our full page ad on page 423 of this issue. Chemical Institute of New York, 66 W. Broadway, New York City.

Miscellaneous

I Catch from 45 to 60 Foxes in from 4 to 5 weeks' time. Can teach any reader of this magazine how to set them. Just drop me a card for particulars. W. A. Hadley, Stanstead, Quebec, Canada.

Inventors: Use our special service for presenting your invention or patent to manufacturers. Adam Fisher Mfg. Co., 278-A Enright, St. Louis, Mo.

Correspondence desired with fans of other countries; also trade stamps. John C. Barnhart, 243 Spruce St., Sunbury, Penna.

Grieps Rep. Shop, repair phonographs, guns, locks, umbrellas and picture framing, send us the work. Carthage, Mo.

Machine work of any kind wanted by well equipped shop. The Greaves-Klusman Tool Co., Cincinnati, O.

Learn to Play the Harmonica Correctly. Complete method with piano accompaniment. \$0.35. Prunyi, Belden Ave., Norwalk, Conn.

Motorcycles, Bicycles

Don't Buy a Bicycle Motor Attachment until you get our catalog and prices. Shaw Mfg. Co., Dept. 6, Galesburg, Kansas, City.

Musical Instruments

Cornetists—Trombonists—Saxophonists—Clarinetists. Get "Free Pointers". Name instrument. Virtuoso School, Dept. T, Buffalo, N. Y.

Old Coins

German Gov't Bond 5,000,000 Mk. 1924, \$1.50. 2,000,000 Mk Bond 1923, \$5.00. 500,000 Mk. Bill and Catalogue, 10c. Norman Shultz, Box 746, Salt Lake City, Utah.

Wanted—Old coins (Indian head) pennies; big prices paid; stamp for circular. Laine, Dept. B, 4104 Michigan, Chicago.

Old Money Wanted

\$2 to \$500 each paid for hundreds of Old or Odd Coins. Keep all old money, it may be very valuable. Send 10c for New Illustrated Coin Value Book, 4x6. Guaranteed prices. Get posted. We pay Cash. Clarke Coin Company, 14 Street, LeRoy, N. Y.

Patent Attorneys

Inventors—Should write for our Free Guide Books and "Record of Invention Blank" before disclosing inventions. Send model or sketch of your invention for our Free Inspection and Instructions. Radio, Electrical, Chemical, Mechanical and Trademark experts. Terms reasonable. Victor J. Frans & Co., 922 Ninth, Washington, D. C.

Patents—Send for form "Evidence of Conception" to be signed and witnessed. Form, fee schedule, information free. Lancaster and Allwine. Registered Patent Attorneys in United States and Canada, 269 Ouray Bldg., Washington, D. C.

Patents

Inventions Commercialized. Patented or unpatented. Write Adam Fisher Mfg. Co., 278 Enright, St. Louis, Mo.

Patent Sense valuable book free. See Lacey's ad page 448. Lacey & Lacey, 431 F St., N.W., Washington, D. C.

Postage Stamps

Stamp Collectors—Phillips Monthly Bulletin (illustrated) offers over 2900 special bargains, sets, packets, single stamps etc., each issue. Free. Phillips, Box 1012, Hartford, Conn.

Radio

Build a Lifetime "B" battery from my better Edison Elements. With welded connections 7c pair. Sample cell 10c. Paul Mills, Woodburn, Oregon.

Radio (Continued)

Boys! Don't Overlook This. The "Rasco" Baby Detector. Greatest detector ever brought out with molded base. Fully adjustable. See former advertisements in this publication, or our catalog. Detector with Galeia Crystal, complete 50c, the same detector with Radiocite Crystal, 75c pre-paid. Send for yours today. Radio Specialty Company, 96-98 Park Place, New York City.

Attention!—50 Vacuum tube hook-ups. The greatest collection of vacuum tube circuits ever brought under two covers at such insignificant cost. These diagrams will be found in the great "Rasco" catalog, which contains ray materials and parts in a greater profusion than any other catalog. Tie in stamps, or coin, will bring the catalog to you. Radio Specialty Co., 96-98 Park Place, New York City.

Play your Phonograph thru your Radio. Results equal to New Electric Phonographs. Inexpensive hook-up. Complete plan \$1.00. Mogie & McClelland, Dept. B, Winfield, Kansas.

Thorola Doughnut Coils, \$4.75 per set of three. Remler 631 Condensers, \$3.75. Lacault's Ultradyne Superheterodyne Kits, \$12.65. Postpaid. New and Second Hand Sets at bargain prices. Send for list. Acme Trading Company, Box 284, Saint Louis, Mo.

Radio Catalog sent free on request. Utah Standard Speaker—\$13.75, with 3R Receiver \$75.00. Radio Specialty Shop, 523 Park Ave., Kent, Ohio.

Salesmen Wanted

A Salesman wanted in every town or city within 25 miles of a broadcasting station to sell Radiogem, the complete radio receiving set that retails for \$2.50. With Radiogem there is nothing else to buy—the outfit includes the Radiogem receiving apparatus, 1,000 ohm-phone, and aerial outfit. The cheapest radio outfit on the market—yet as practical as the most expensive. Big money to the right men. Send \$2.00 for sample outfit. The Radiogem Corp., 66-R West Broadway, New York City.

A Paying Position Open to representative of character. Take orders shoes—hosiery direct to wearer. Good income. Permanent. Write now. Tanners Shoe Mfg. Co., 8-463 C St., Boston, Mass.

Scenery for Rent

World's Most Beautiful Settings for operas, plays, minstrels. Amelia Grain, Philadelphia.

School of Electricity

Electricity—Short day or evening courses in Electricity, Drafting, Engineering, and Architecture. In Chicago earn while you learn. Part Time positions pay expenses. Faculty of experts. Special short courses. Diplomas in 2 years. B.S. Degree in 3 years. Small classes, individual instruction. 23-year old institution with thousands of successful graduates. Enter any time. Employment bureau. Moderate tuition—monthly payments. New College building—all athletics. All details in 72 page "Blue Book." A copy will be sent to you free. Write today. Chicago Technical College, Dept. 27, 118 E. 26th St., Chicago, Ill.

Song Writing

Songwriters! Substantial Advance Royalty Payment essential to publication contract. Expert advice furnished beginners upon receiving poems requiring musical settings and copyright protection for free examination. Send today. Walter Newcomer, 1674 Broadway, New York.

Stammering

Stop Stammering, increase salary. Descriptive booklet free. Samuel Robbins, 390 Bevilston St., Boston.

Stutter-t-t-tering and stammering cured at home. Instructive booklet free. Walter McDonnell, 121 Arcade, 1126 Granville Avenue, Chicago, Ill.

Telegraphy

Telegraphy—Both Morse and Wireless taught thoroughly. Big salaries. Wonderful opportunities. Expenses low, chance to earn part. School established fifty years. Catalog free. Dodge's Institute, Cour St., Valparaiso, Ind.

Wanted to Buy

Full Value Paid for Old Gold, Jewelry, Watches. Diamonds, crowns, bridges, dental gold, silver, platinum, gold or silver ore, magnets points, old false teeth. Packages returned if our offer is not satisfactory. United States Smelting Works (The Old Reliable) 39 So. State St., Dept. 16, Chicago, Ill.

made by a number of stations in the Second District, conditions are unsatisfactory."

—Arthur Batcheller, Supervisor.

Third District

"I have just returned from a trip; there are no changes in my district. I do not anticipate any. Conditions are very good."

—R. Y. Cadmus, Supervisor.

Sixth District

"To date KQW, San Jose, KTAB, and KFWM, Oakland, KFQU, Alma, have changed to longer wavelengths. Several more are contemplating changes and a few new stations are projected; but none are in operation. The attention of prospective owners is being directed to the fact that no assurance can be given of frequency being available when station is completed. The general tendency manifested is to await action by Congress. I believe the radio industry as a whole has suffered materially from the condition. However, we feel the outlook is encouraging for the orderly conduct of broadcasting until Congress can act."

—J. F. Dillon, Supervisor.

Seventh District

"Four stations have changed their wavelengths, giving as reasons a desire to reduce the previous interference; one new 500-watt station in Alaska, two 10-watt stations in the state of Washington and one 10-watt station in Montana have been licensed. Several small stations have increased their power. Practically all stations have signified their intention to remain as formerly licensed. We expect but little change from previous radio conditions in the Seventh District."

—O. R. Redfern, Supervisor.

The following were received after Page 326 had gone to press, and could, therefore, not be included in the alphabetical list of America's radio leaders:

FROM ADMIRAL BULLARD

"My personal observation leads me to believe that "chaos" is too harsh a word to apply to radio receiving since the opinion of the Attorney General regarding the jurisdiction of the Department of Commerce over permanent assignment of wavelengths for radio broadcasting. I find considerable confusion and interference, which in some localities is being adjusted by application of the gentlemen's agreement, similar to that adopted by the radio conferences at Washington and lived up to, but some pirates of the air still exist and refuse to abide, causing receiving public considerable annoyance. Undoubtedly the only solution is the passage of one of the two radio bills now before Congress, or possibly a compromise, adopting the best portions of each. I have a decided opinion regarding these bills, but my opinion has not been asked on these and is not expressed."

—Admiral W. H. G. Bullard, U. S. N.

FROM H. P. DAVIS

"Concerning the so-called chaotic condition of the air at the present time, I am glad to note that only a few station owners have taken it upon themselves to leave their assigned wavelengths and so create some disturbance. I am certain, however, that the industry will continue to regulate itself just as it has in the past, under the jurisdiction of the Department of Commerce. In a final analysis, the public must be the judge of broadcasting; and any station which offends, either in program offering or any phase of transmission, whether it be time on the air, or in wavelength, must pay the penalty of the public's disapproval."

—H. P. Davis, Vice President Westinghouse Electric and Mfg. Co.

Bigger Radio Bargains Than Ever Before

TO the thousands of readers who are looking forward to the pages of Barawik bargains carried in these columns in former years, we announce a new policy. The growth of radio has been so rapid that we have found it impossible to list the thousands of items in ordinary ads—we have been compelled to issue a large 164-page BUYER'S GUIDE for the purpose. In it you will find everything that pertains to radio—complete factory-built sets, parts, supplies and accessories, fully described, illustrated and priced at tremendous savings—without doubt the largest collection of standard high-grade radio merchandise ever assembled in the industry.

Our latest edition is just off the press, brimful of the best approved new radio merchandise, such as power packs, amplifiers and other recent radio improvements. Be sure to get your copy of this thrift-book before you spend another cent for sets, parts and radio supplies.

EVERYONE INTERESTED IN RADIO SHOULD HAVE THIS GUIDE

It gives information about the newest and most advanced ideas in radio development, describes and illustrates the latest improvements. It will keep you posted on what's up-to-date. It will help you to build a better set or buy a complete modern one. Also shows hundreds of new items of merchandise at big savings, such as electrical and wiring material, household appliances, auto supplies, etc.

All Newest Circuits and Information Free

Shows latest hookups and information, completely illustrated. Every radio set owner, amateur, beginner and fan should have a copy.

Send the Coupon for Free Copy Today—Now!

You need this book before you spend another cent on radio. Just mail the coupon and free copy will be sent you. Also please include name of a friend interested in radio to whom we can send free copy also.

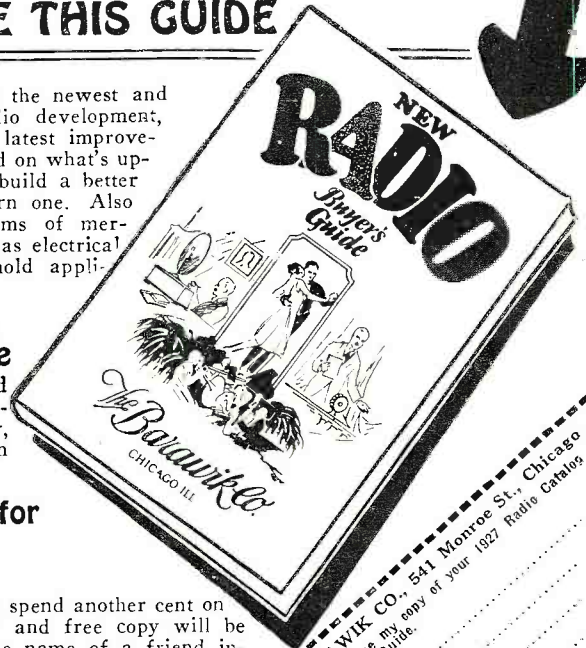

The Barawik Co.

541 Monroe Street, Chicago, Ill.

BARAWIK CO., 541 Monroe St., Chicago
 and
 Send me my copy of your 1927 Radio Catalog
 and
 Buyer's Guide.
 Name _____
 Address _____
 Friend Address _____

RADIO CATALOG

Dealers! Send for our new 1927 Catalog. Contains nationally advertised high quality sets, kits and parts.
 Use your letterhead.

Western Radio Co. MFG
 134-136 W. Lake St. Chicago, Ill.

Send for a copy of our new catalogue. Mailed Free.
RICHTER BROS.
 The Home of Service and Satisfaction.
RADIO and ACCESSORIES
 1720 Garsuch Ave., Dept. K. Baltimore, Md.
 We handle nothing but standard merchandise.

Bradleyometer

THE PERFECT POTENTIOMETER

Uses graphite disc resistors which are noiseless and not affected by atmospheric conditions. Metal parts are nickel plated. One hole mounting. Finish and knob match Bradleystat. Made in 200 and 400 ohm ratings.

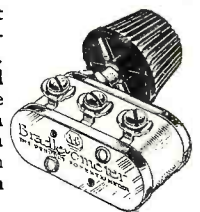

Allen-Bradley Co.

Electric Controlling Apparatus
 287 Greenfield Avenue Milwaukee, Wis.



ENTIRELY NEW IMPROVEMENTS found only in the New COUNTERPHASE

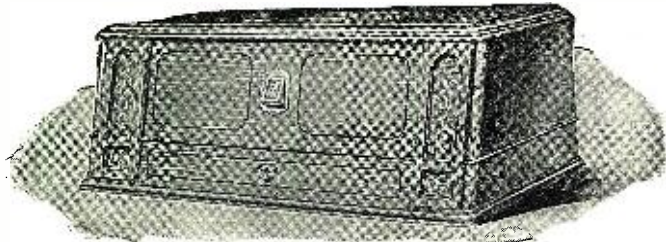

COUNTERPHASE-EIGHT

In the Counterphase-Eight there are five tuned stages, two audio and one power stage. All parts are firmly mounted on a cast aluminum chassis which provides against breakage or shifting of parts and each stage is individually shielded, the tuned stages being separated from each other by four surfaces. The Counterphase-Eight is \$225.00.

The new Counterphase-Six with four tuned stages, one audio and one power stage is \$155.00.

Those familiar with the unsurpassed selectivity of the Nameless and the original Counterphase will be interested in knowing that B-T believe that the Counterphase-Eight is the most selective receiver ever built. It employs a new and exclusively B-T "Rejector stage", without a tube therein, and tuning is accomplished with "Straight-Line-Selectivity" condensers designed expressly for these receivers.

The Station Indicator employs B-T patented ideas not found elsewhere that permit absolutely accurate calibration of each individual set. The simplicity with which this has been accomplished will surprise you.

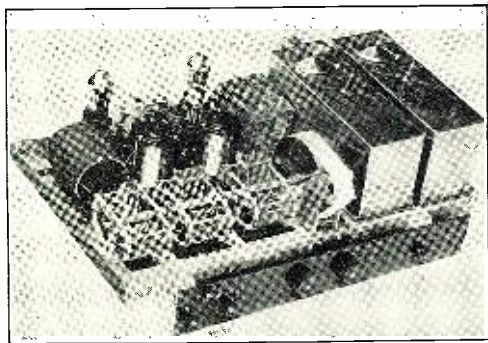

Counterphase-Eight chassis showing part of the shields removed.

We can touch only upon a few points here. If you are considering an investment in radio you cannot afford not to investigate the Counterphase. These models are not available in kit form.

Circulars are free on all B-T apparatus. "Better Tuning" 10th Edition, gives more complete and extensive information on many subjects. It is well worth reading. Please use coupon.

- Send "Better Tuning" 10th Edition; 10c enclosed.
 Send information on factory-built Counterphase Receivers. B-T-Power Unit. B-T parts and kits.

.....
(NAME)

.....
(ADDRESS)

R.N.-10

Bremer-Tully are best known for the individuality of their creations and the more than ordinary success that has followed every B-T product.

Readers of RADIO NEWS will be quick to appreciate that when Bremer-Tully put out what they feel safe in calling a "permanent model receiver" that the matter is worthy of consideration.

The Counterphase-Eight and the new Counterphase-Six are the greatest efforts of the B-T Company and reflect in every detail the rare engineering, designing and manufacturing ability on which the success of so many previous products is based.



Don't Gamble with uncertain "B" voltage

There is no radio product in which the user must put more trust in the ability and sincerity of the manufacturer than B-Eliminators.

The product is designed for reliable results. There are no knobs to turn. The voltage and current is sufficient for multi-tube sets, including power tube, and the user always knows the voltage delivered. It's different,—and we believe better. Price

\$49.50

Not sold in
Kit form



Manufacturing Co.
520 So. Canal Street
Chicago, Ill.

7th Successful Year!

Every inch of this big 4-story factory is devoted to building Miraco Sets



America's foremost direct-selling radio set factory invites you to enjoy the Ultra-selectivity, Tremendous distance range, clear tone and great volume of a Big Powerful latest model Miraco!

30 DAYS FREE IN YOUR HOME

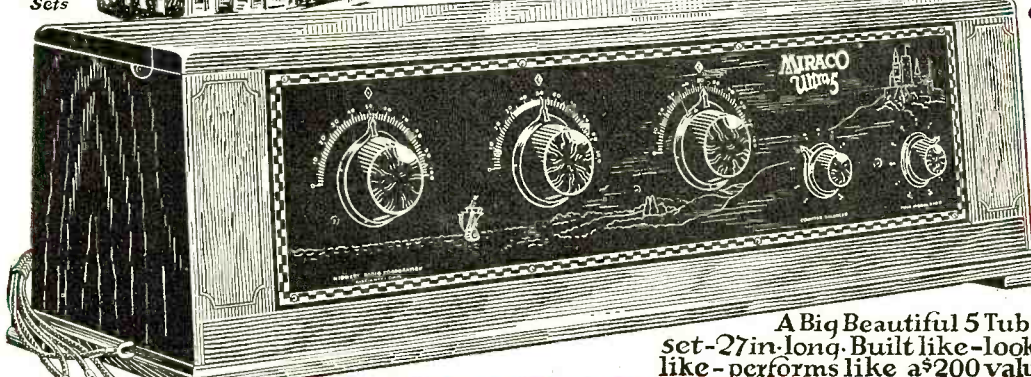

Coupon Brings Amazing Special Offer

Retail LIST Price now only **49.75** GET SPECIAL OFFER One Year GUARANTEE



A Big Beautiful 5 Tube set-27in-long. Built like-looks like-performs like a \$200 value.

Coast to Coast and Foreign Reception Certified by Miraco users!

MIRACO RADIO GETS 'EM COAST TO COAST

Send for Proof!

Reports from users everywhere leave little for us to add. These are only a few of the many in our file and which we receive daily. Send coupon for plenty of additional proof and testimony of nearby users.

3 WISC. USERS HEARD FRANCE
Kenosha, Wis. I was one of Kenosha's International Test Listeners during the test week Jan. 24 to 30. A sending and receiving of the Kenosha Ewo. News verified by Kenosha Ewo. News topover I had PTT Toulon, France. On Thursday, Jan. 24, I picked up L.O.X. at Argentina. Both verified by Kenosha Ewo. News as having some of the program. We have sold a number of Ultra-5 and two of the sets reported having PTT also. Horace R. Boylan.

OREGON HEARS FLORIDA-MEXICO. Astoria, Ore. Comparison with higher priced radio sets has proved the Miraco everything you claimed for it. I have had about 100 stations from Florida to New York and from Mexico City to Canada, all on the loudspeaker. Vernon Hill.

THRU LOCAL COAST TO COAST
Cleveland, O. Located about 1 1/2 miles from WTAM, I can tune them out on 3 degrees of the dial. I have gotten: 9 New York stations; 14 Chicago stations; Mexico City; Los Angeles; Denver; Cuba and Miami, Fla. all with good loudspeaker volume. Geo K. Montgomery.

ILL. HEARS LONDON-LOS ANGELES. Danville, Ill. List enclosed of stations logged this week on Miraco Ultra-5. Received several foreign stations on loudspeaker. London was heard plainly. I had Cuba and Mexico City several times. Also logged KFI, Los Angeles, Earl Everett.

THRU CHICAGO LOCALS-COAST TO COAST. Chicago, Ill. Some of the stations I get on Ultra-5 with all Chic. stations broadcasting: KFAB Pullman, Wash.; WJAZ New York; KFLA Denver, Colo.; KFI Los Angeles, Cal.; KFKX Hastings, Neb.; KGA Denver, Colo.; 6WK Tullahoma, Tenn.; WJAZ Ft. Worth, Tex.; WJL Charlotte, N.C.; WCAP Wash. D.C.; WGY Schenectady, N.Y.; WJZN, Y.W.A.X Jacksonville, Fla. A. Huff.

EQUALS HIGH PRICED SETS. Pittsburgh, Pa. I am getting the very best results in Radio Reception that can be found in any high priced super set or any costing 5 times the price of my Miraco Ultra-5. Sunday evening 11:15 P. M., Madrid, Spain, entertainment was clear. I tune them in on the loudspeaker coast to coast and then some more. If there is anything on the air the Miraco will bring it home. J. H. Adamson.

N.Y. HEARS LOS ANGELES. Glenfield, N.Y. Have logged 93 stations in 3 weeks on my Miraco. Sets all on the loudspeaker including stations in Canada, Florida, Cuba and Los Angeles. Mirco Leskey Burdick.

COLORADO TOURS CONTINUED. Jaraco, Colo. It is really wonderful what your Miraco Ultra-5 can do. I have gotten Seattle, San Francisco, Los Angeles, Phoenix, Ariz., San Antonio, New Orleans, Miami, Florida, and Atlantic City and New York City and C.K.Y. Canada.

Now I say that is touring the continent. Stewart L. Medill.

Big Powerful New **MIRACO** TRADE MARK REGISTERED **Ultra-5** Sloping Front Cabinet-Panel-Dials Finished in Walnut

Guaranteed by a Big Old Company 7th Successful Year

ULTRA-SELECTIVE LONG DISTANCE SET EASY ON BATTERIES!

Unless convinced—after a good long trial in your home—that the beautiful new high-powered Miraco is the most astonishing bargain offered in big, fine, high-grade radios, don't buy it. Could any offer be fairer? And, remember, this offer is made by a large responsible manufacturing corporation—one of the oldest and most successful set-builders in the industry—a concern which has grown to immense size through the recommendations of satisfied customers who bought after trial.

Testimony of delighted users from coast to coast offers positive proof that the big Miraco actually is unmatched (even at much higher prices) for "razor-edge" selectivity combined with extreme long distance reception, clear natural tone, powerful loud speaker volume and economy in use of battery current.

It comes completely built, thoroughly tested and factory guaranteed for one year. A big, beautiful expensive looking radio—one you'll be proud to have friends see and hear. Has stylish sloping front cabinet, handsomely gold illustrated genuine Bakelite front panel and large Bakelite knobs with "arrow point" indicators for fine tuning—in beautiful walnut finish throughout.

Clip coupon now for literature and Special Offer that will surprise and interest you.

Compare its construction with highest priced sets—study this picture

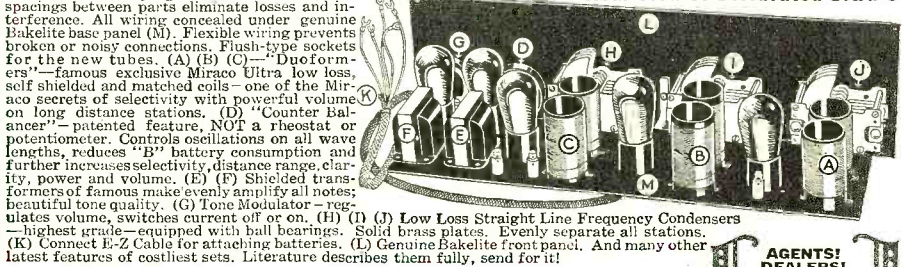

Note the neat sturdy high-class construction; wide spacings between parts eliminate losses and interference. All wiring concealed under genuine Bakelite base panel (M). Flexible wiring prevents broken or noisy connections. Flush-type sockets for the new tubes. (A) (B) (C)—"Duoformers"—famous exclusive Miraco Ultra low loss, self shielded and matched coils—one of the Miraco secrets of selectivity with powerful volume on long distance stations. (D) "Counter Balancer"—patented feature, NOT a rheostat or potentiometer. Controls oscillations on all wave lengths, reduces "B" battery consumption and further increases selectivity, distance range, clarity, power and volume. (E) (F) Shielded transformers of famous make evenly amplify all notes; beautiful tone quality. (G) Tone Modulator—regulates volume, switches current off or on. (H) (I) (J) Low Loss Straight Line Frequency Condensers—highest grade—equipped with ball bearings. Solid brass plates. Evenly separate all stations. (K) Connect U-Z Cable for attaching batteries. (L) Genuine Bakelite front panel. And many other latest features of costliest sets. Literature describes them fully, send for it!

Single Dial Control!

The celebrated Miraco Ultra-5—U.S. Navy type circuit, above described, has also been adapted to Single Dial Tuning—without sacrifice of selectivity, volume, clearness, power, tone or distance getting qualities! In the magnificent big Miraco Unitune-5, here shown, you turn one vernier knob for stations everywhere. Literature describes this great achievement. Also offered on 30 days free trial!

All the Proof you want is waiting for You!

Coupon or postal brings reports from hosts of users in your vicinity and elsewhere proving that Miraco sets at rock-bottom money-saving factory prices, outperform sets costing up to four times as much. You can also buy speakers, tubes, batteries, etc. at big savings from us! Get our proposition before spending money elsewhere.

MIDWEST RADIO CORPORATION
Pioneer Builders of Sets

404-D Miraco Building
Without obligation, send free literature, testimony of users. AMAZING SPECIAL OFFER and full particulars of your big money-saving factory-price proposition on Guaranteed Miraco sets and all radio supplies. () Agent () Dealer

Cincinnati, O.

NAME _____
ADDRESS _____

Send coupon for Amazing Special Offer!

SELECTIVITY! How with my other set costing twice or three times as much only I got the Ultra-5 as good or better in most cases. Earl Branscombe.

LOCALS! Detroit, Mich. I can tune in 100 stations with Miraco. Can cut thru WWJ, WGX and WJZ. Very very strong local stations. Charles Paul.

know these Radiotrons and keep your set up to date

You can get fine, clear performance with one type of RCA Radiotron right through your set. Or you can change one tube in a set, and get more power. Change another—if you have a storage battery set—and get bigger distance reach. Know the Radiotron family, and keep pace with the Radiotron laboratories, and you can keep your old set up to date. Here are the most important Radiotrons to know!



for dry battery sets

Radiotron UX-199 (or WD-11 or WX-12), for any or all sockets.

For big performance on small current.

Power Radiotron UX-120, for the last audio stage.
For added power—bigger volume—clearer tone

for storage battery sets

Radiotron UX-201-A, for any or all sockets.

Efficient, long-lived under heavy usage.

Detector Radiotron UX-200, for the detector socket of specially built sets—for long range.

Super-detector Radiotron UX-200-A, for the detector socket, where a 201-A is now used. A special tube that gives added sensitivity—longer distance reach.

Power Radiotron UX-112 or UX-171, for the last audio stage.
For added power and finer tone.

for A. C. operated sets

Super-power Radiotron UX-210, for utmost loudspeaker volume—the most powerful receiving tube in existence.

Many a set can be kept long at its best efficiency—or carried onward with the development of radio—by knowing all the Radiotrons, keeping step with the Radiotron laboratories—and watching always, when you buy, for the mark on the glass and the base, to prove a tube is a genuine RCA Radiotron.

New York RADIO CORPORATION OF AMERICA Chicago San Francisco

RCA Radiotron

MADE BY THE MAKERS OF THE RADIOLA